

**RADON REMEDIATION: AN ANALYSIS OF DOSE-REDUCTION,
DURABILITY AND EFFECTIVENESS**

by Maria Magdalena Johnstone B.Sc. (Hon.)

Submitted for the Degree of Master of Philosophy

University of Leicester

2002

M0008389NN

UNIVERSITY COLLEGE NORTHAMPTON		
D	PARK LIBRARY	✓
Acc. No.	10267982	✓
Class No.	D363.738	JOH

ABSTRACT

Radon is a colourless, odourless, inert, radioactive gas found in Group 8 of the Periodic Table; it is formed by the decay of uranium in soils and rocks. The half-life of radon is 3.8 days. Radon, in the built environment, is the second largest cause of lung cancer after cigarette smoking and is responsible for 3-5% of the UK cancer deaths. Radon can accumulate in workplaces to levels (400 Bq.m^{-3}), above which action is required under UK legislation by employers to remediate so as to reduce levels and lower the risk to human health.

The remediation and post-remediation research programme in the NHS properties in Northamptonshire is perhaps the most mature in the UK, commencing in 1993. This thesis includes a review of the main remediation projects in National Health Service (NHS) properties in Northamptonshire. Data has been obtained from a range of sources, post-remediation, to enable a cost-effectiveness assessment. Using direct radon measurements and questionnaires, to determine occupancy, dose reduction has been calculated for all members of staff in the remediated venues. The reduction in dose is lower than the reduction in radon. The trends in radon levels post-remediation have been investigated; night-time levels are reduced more than daytime levels and this has a clear implication for dose to staff.

The effective lifetime of the remediation systems has been investigated. Remediation systems, operated through a clear management system, have been found to remain effective up to eight years after installation. A Decision Support System to support radon management in the workplace is proposed as well as suggestions for future research.

Table of Contents

Abstract	i
Table of Contents	ii
List of Figures	v
List of Tables	xi

1. INTRODUCTION

1.1. Chemistry of Radon	1
1.2. History of Radon Research	4
1.3. The UK National Radon Programme	6
1.4. Radon Geology and Other Sources of Radon	8
1.4.1. Radon and Northamptonshire Geology	12
1.5. Radon Migration into the Built Environment	14
1.6. Radon in the Workplace	17
1.7. The Building Research Establishment	20
1.8. The Radon Council	20
1.9. Aims and Objectives of Present Work	21
1.10. Research Approach and Method Used	22

2. RADON UNITS AND MEASUREMENT

2.1. Radon Units	23
2.2. Radon Detection	29

3. HEALTH RISKS AND COST EFFECTIVENESS

3.1. Radon and Risks for Health- Dose to the Lungs	35
3.2. Radiation Dose due to Radon Exposure	37
3.3. Dose to Other Organs	38
3.4. Radon Health Risk Debate	39
3.5. Cost Effectiveness and Health Improvement	41
3.6. Cost Effectiveness Studies in Northamptonshire	42

4. RADON RESEARCH PROJECTS IN THE UK AND IN NORTHAMPTONSHIRE

4.1. Radon Concentration Measurements- Previous UK Projects	45
4.2. Previous Northamptonshire Projects Concerning Radon in the Workplace	46
4.2.1. General Studies	46
4.2.2. National Health Service Studies	48
4.2.3. Studies in Northamptonshire Schools	50
4.3. Decision Support Systems for Radon Monitoring and Remediation	52

5. MONITORING AND RADON REMEDIATION

5.1. Principles of Radon Remediation in the Built Environment	56
5.2. Study from Hospital in North Wales	59
5.3. Case Study from Buxton (Derbyshire)	71

6. POST REMEDIAL STUDIES IN NHS PROPERTIES

6.1. Survey of Staff Working Patterns and Personal Radon Exposure	76
6.2. Radon Measurement in Remediated Clinics in Northamptonshire	78

6.3. Location A1 Data	82
6.4. Location A2 Data	99
6.5. Location B Data	110
6.6. Location C Data	121
6.7. Location D Data	133
6.8. Location E Data	147
6.9. Kettering Hospital Data	157
<u>7. DISCUSSION AND CONCLUSIONS</u>	181
<u>8. REFERENCES</u>	196

List of Figures

1. INTRODUCTION

Figure 1.1.1. Main Decay Series of ^{238}U	2
Figure 1.1.2. Radiation Dose to UK Population	3
Figure 1.4.1.1. Geological Succession in Northamptonshire	13
Figure 1.5.1. Radon Ingress Into Houses	15

2. RADON UNITS AND MEASUREMENT

Figure 2.1.1. Attached and Unattached Radon Progeny	27
Figure 2.2.1. Radon Track Etch Detector CR-39	29
Figure 2.2.2. Rad 7 Monitor	32
Figure 2.2.3. Rad Home Monitor	34

3. HEALTH RISKS AND COST EFFECTIVENESS

Figure 3.1.1. Lifetime Risk of Lung Cancer Potentially Induced by Radon to non-Smokers	36
Figure 3.6.1. Map of Affected Areas Studied in the Cost Effectiveness Study	43

4. RADON RESEARCH PROJECTS IN THE UK AND IN NORTHAMPTONSHIRE

Figure 4.2.1.1. Northamptonshire Districts	46
Figure 4.3.1. Workplace Decision Support System	53
Figure 4.3.2. Domestic Decision Support System	54

5. MONITORING AND RADON REMEDIATION

Figure 5.1.1. Radon Sump	57
Figure 5.1.2. Underfloor Fan	57
Figure 5.1.3. Ventfan	58
Figure 5.2.1. Map of North Wales	59a
Figure 5.2.2. Radon Level Variation, R1, N Wales Hospital, 12.04.99-25.05.99	61
Figure 5.2.3. Radon Level Variation, R1, N Wales Hospital, 12.04.99-23.04.99	62
Figure 5.2.4. Radon Level Variation, R1, N Wales Hospital, 23.04.99-04.05.99	62
Figure 5.2.5. Radon Level Variation, R1, N Wales Hospital, 04.05.99-15.05.99	63
Figure 5.2.6. Radon Level Variation, R1, N Wales Hospital, 15.05.99-27.05.99	63
Figure 5.2.7. Radon Level Variation, Room 1, North Wales Hospital, Weekend Days, 17.04.99-23.05.99	64
Figure 5.2.8. Radon Level Variation, Room 2, North Wales Hospital	65
Figure 5.2.9. Typical Diurnal Cycle	66
Figure 5.2.10. Radon Level Variation, R3, N Wales Hospital, 29.03.99-01.04.99	67
Figure 5.2.11. Radon Level Variation, R3, N Wales Hospital, 27.05.99-17.06.99	68
Figure 5.3.1. Radon Map of Derbyshire	71

6. POST REMEDIAL STUDIES IN NHS PROPERTIES

Figure 6.1.1. Room Occupancy Questionnaire	77
Figure 6.2.1. Distribution of Radon Levels in NHS Properties in Northamptonshire	79
Figure 6.3.1. Plan of Location A1	83
Figure 6.3.2. Radon Level Variation in Room 1, Clinic A1	87a
Figure 6.3.3. Radon Level Variation in Room 2, Clinic A1	87b

Figure 6.3.4. Radon Level Variation in Room 3, Clinic A1	87c
Figure 6.3.5. Radon Level Variation in Room 4, Clinic A1	87d
Figure 6.3.6. Radon Level Variation in Room 5, Clinic A1	87e
Figure 6.3.7. Reduction Factor of Individual Doses Compared to Reduction Factor in Average Radon Levels, Clinic A1	93
Figure 6.3.8. Comparison of Ratio Night Time per Daytime Radon Levels Pre and Post Remediation	94
Figure 6.3.9. Average Radon Daily Values in Room 1, Clinic A1	95
Figure 6.3.10. Average Radon Daily Values in Room 2, Clinic A1	96
Figure 6.3.11. Average Radon Daily Values in Room 3, Clinic A1	97
Figure 6.3.12. Average Radon Daily Values in Room 4, Clinic A1	97
Figure 6.3.13. Average Radon Daily Values in Room 5, Clinic A1	98
Figure 6.4.1. Location A2 Plan	99
Figure 6.4.2. Radon Level Variation in Room 1, Clinic A2	102a
Figure 6.4.3. Radon Level Variation in Room 2, Clinic A2	102b
Figure 6.4.4. Radon Level Variation in Room 3, Clinic A2	102c
Figure 6.4.5. Radon Level Variation in Room 4, Clinic A2	102d
Figure 6.4.6. Radon Level Variation in Room 5, Clinic A2	102e
Figure 6.4.7. Reduction Factor of Individual Doses Compared to Reduction Factor in Average Radon Levels, Clinic A2	105
Figure 6.4.8. Average Radon Daily Values in Room 1, Clinic A2	106
Figure 6.4.9. Average Radon Daily Values in Room 2, Clinic A2	107
Figure 6.4.10. Average Radon Daily Values in Room 3, Clinic A2	108
Figure 6.4.11. Average Radon Daily Values in Room 4, Clinic A2	109
Figure 6.4.12. Average Radon Daily Values in Room 5, Clinic A2	109

Figure 6.5.1. Plan of Location B	110
Figure 6.5.2. Radon Level Variation in Room 1, Clinic B	112a
Figure 6.5.3. Radon Level Variation in Room 2, Clinic B	112b
Figure 6.5.4. Radon Level Variation in Room 3, Clinic B	112c
Figure 6.5.5. Radon Level Variation in Room 4, Clinic B	112d
Figure 6.5.6. Reduction Factor of Individual Doses Compared to Reduction Factor in Average Radon Levels, Clinic B	117
Figure 6.5.7. Comparison of Ratio Night Time per Daytime Radon Levels Pre and Post Remediation in Clinic B	118
Figure 6.5.8. Average Radon Daily Values in Room 1, Clinic B	118
Figure 6.5.9. Average Radon Daily Values in Room 2, Clinic B	119
Figure 6.5.10. Average Radon Daily Values in Room 3, Clinic B	120
Figure 6.5.11. Average Radon Daily Values in Room 4, Clinic B	120
Figure 6.6.1. Plan of Location C	121
Figure 6.6.2. Radon Level Variation in Room 1, Clinic C	125a
Figure 6.6.3. Radon Level Variation in Room 2, Clinic C	125b
Figure 6.6.4. Radon Level Variation in Room 3, Clinic C	125c
Figure 6.6.5. Radon Level Variation in Room 4, Clinic C	125d
Figure 6.6.6. Reduction Factor of Individual Doses Compared to Reduction Factor in Average Radon Levels, Clinic C	129
Figure 6.6.7. Comparison of Ratio Night Time per Daytime Radon Levels Pre and Post Remediation in Clinic C	130
Figure 6.6.8. Average Radon Daily Values in Room 1, Clinic C	130
Figure 6.6.9. Average Radon Daily Values in Room 2, Clinic C	131
Figure 6.6.10. Average Radon Daily Values in Room 3, Clinic C	132

Figure 6.6.11. Average Radon Daily Values in Room 4, Clinic C	132
Figure 6.7.1. Plan of Location D	134
Figure 6.7.2. Radon Level Variation in Room 1, Clinic D	138
Figure 6.7.3. Radon Level Variation in Room 4, Clinic D	139
Figure 6.7.4. Reduction Factor of Individual Doses Compared to Reduction Factor in Average Radon Levels, Clinic D	145
Figure 6.7.5. Average Radon Daily Values in Room 4, Clinic D	146
Figure 6.8.1. Plan of Location E	147
Figure 6.8.2. Radon Level Variation in Room 1, Clinic E	150a
Figure 6.8.3. Radon Level Variation in Room 2, Clinic E	150b
Figure 6.8.4. Radon Level Variation in Room 3, Clinic E	150c
Figure 6.8.5. Radon Level Variation in Room 4, Clinic E	150d
Figure 6.8.6. Reduction Factor of Individual Doses Compared to Reduction Factor in Average Radon Levels, Clinic E	153
Figure 6.8.7. Average Radon Daily Values in Room 1, Clinic E	154
Figure 6.8.8. Average Radon Daily Values in Room 2, Clinic E	155
Figure 6.8.9. Average Radon Daily Values in Room 3, Clinic E	155
Figure 6.8.10. Average Radon Daily Values in Room 4, Clinic E	156
Figure 6.9.1. Kettering Hospital- Initial Building Plan Pre Remediation	158
Figure 6.9.2. Comparison of the Radon Level Variation in Rooms A and D in 24 Hours Time Surveys	159
Figure 6.9.3. Kettering Hospital- Present Building Plan After Change of Use and Building Refurbishments	161
Figure 6.9.4. Radon Levels in Room 4, Kettering Hospital, 1996	162
Figure 6.9.5. Radon Level Variation in Room 1, Kettering Hospital, Year 2000	167

Figure 6.9.6. Radon Level Variation in Room 2, Kettering Hospital, Year 2000	167
Figure 6.9.7. Radon Level Variation in Room 3, Kettering Hospital, Year 2000	168
Figure 6.9.8. Radon Level Variation in Room 4, Kettering Hospital, Year 2000	169
Figure 6.9.9. Radon Level Variation in Room 5, Kettering Hospital, Year 2000	170
Figure 6.9.10. Radon Level Variation in Room 6, Kettering Hospital, Year 2000	171
Figure 6.9.11. Radon Level Variation in Room 7, Kettering Hospital, Year 2000	172
Figure 6.9.12. Radon Level Variation in Room 8, Kettering Hospital, Year 2000	173
Figure 6.9.13. Average Radon Daily Values in R1, Kettering Hospital, Year 2000	176
Figure 6.9.14. Average Radon Daily Values in R2, Kettering Hospital, Year 2000	176
Figure 6.9.15. Average Radon Daily Values in R3, Kettering Hospital, Year 2000	177
Figure 6.9.16. Average Radon Daily Values in R4, Kettering Hospital, Year 2000	177
Figure 6.9.17. Average Radon Daily Values in R5, Kettering Hospital, Year 2000	178
Figure 6.9.18. Average Radon Daily Values in R6, Kettering Hospital, Year 2000	179
Figure 6.9.19. Average Radon Daily Values in R7, Kettering Hospital, Year 2000	179
Figure 6.9.20. Average Radon Daily Values in R8, Kettering Hospital, Year 2000	180

7. DISCUSSION AND CONCLUSIONS

Figure 7.1. Reduction in Dose Compared to Reduction in Radon Level for 46 Members of Staff Working Part-time Hours	186
Figure 7.2. Reduction in Dose Compared to Reduction in Radon Level for 12 Members of Staff from 5 NHS Clinics (Denman <i>et al.</i> , 1999)	186
Figure 7.3. Reduction in Dose Compared to Reduction in Radon Level for the Present Series, Compared to the Pilot Study Series	187
Figure 7.4. Ratio Night time/Daytime Radon Level Pre and Post Remediation	191
Figure 7.5. Ratio of Day Time Radon Level to Average Radon Level	192

List of Tables

1. INTRODUCTION

Table 1.1.1. Main Radon Isotopes	1
Table 1.1.2. Half Lives and Alpha Energies of Radon and Progeny	3
Table 1.2.1. Mortality from Lung Cancers Among Miners Exposed to Radon	5
Table 1.4.1. Global Average Uranium Content of Rocks	9
Table 1.4.2. Sources of Radon in Atmosphere	11
Table 1.4.3. Average Radon Levels in European Countries and the USA	12
Table 1.4.1.1. Radon Levels Above Action Level Related to Geology	14

2. RADON UNITS AND MEASUREMENT

Table 2.1.1. Risk Factors and Tissue Weighting Factors for Organs and Tissues	25
Table 2.2.1. Ranges of Alpha Particles Emitted by Radon Isotopes	30
Table 2.2.2. Etching Conditions Used for CR-39	30
Table 2.2.3. Rad 7 Normal Mode Counting Errors for 1 Hour Counting Time	33
Table 2.2.4. Seasonal Correction Factors, Indoor Radon Measurements in the UK	34

3. HEALTH RISKS AND COST EFFECTIVENESS

Table 3.1.1. Average Frequencies for the Major Types of Lung Cancers	37
Table 3.3.1. Estimated Radon Doses to Organs due to Radon	39
Table 3.6.1. Cost of the NHS Remediation Programme, Inflation Corrected for Current Prices	44

4. RADON RESEARCH PROJECTS IN THE UK AND IN NORTHAMPTONSHIRE

Table 4.2.1.1. Workplaces Tested for Radon in Northampton	47
Table 4.2.1.2. Radon Level Variation in Comercial Premises in Northampton, by Postcode	47
Table 4.2.2.1. NHS Premises in Northamptonshire	48
Table 4.2.2.2. Distribution of Radon Levels, NHS Properties in Northamptonshire	49
Table 4.2.3.1. Rooms in Schools with Radon Levels Above the Action Level	50
Table 4.2.3.2. Costs of Northampton Schools Remediation	51
Table 4.2.3.3. Radon and Dose Reduction After Remediation in Schools in Northampton	51

5. MONITORING AND RADON REMEDIATION

Table 5.1.1. Effectiveness of Methods of Preventing Radon Entry into Buildings	56
Table 5.2.1. Average Track-Etch Detectors` Radon Levels (Bq.m ⁻³) in North Wales Hospital	60
Table 5.2.2. Radon Corrected Values in North Wales Hospital	69
Table 5.3.1. Radon Levels Pre and Post Remediation in Buxton	74

6. POST REMEDIAL STUDIES IN NHS PROPERTIES

Table 6.3.1. Track-Etch Detectors in Clinic A1 Post Remediation	84
Table 6.3.2. Location A1 Grab Sample Results Pre-Remediation	85
Table 6.3.3. Time Averages of Rad 7 Radon Concentration Measurements in Location A1 Pre-Remediation	85
Table 6.3.4. Range of Daytime Radon Concentration Estimated for January '94 in Clinic A1, Pre-Remediation	86

Table 6.3.5. Corrected Daytime Radon Concentration Values, Clinic A1, Post Remediation	86
Table 6.3.6. Corrected Average Radon Values from Continuous Monitoring in Clinic A1, Post Remediation	87
Table 6.3.7. Time Averages of Rad 7 Radon Concentration Measurements in Clinic A1 Post Remediation	89
Table 6.3.8. Staff Room Occupancy in Clinic A1	89
Table 6.3.9. Estimated Radon Exposure ($\text{kBq.m}^{-3}.\text{h}$), Clinic A1, Pre-Remediation	90
Table 6.3.10. Estimated Radon Exposure($\text{kBq.m}^{-3}.\text{h}$),Clinic A1, Post Remediation	90
Table 6.3.11. Annual Dose per Person (mSv) in Clinic A1	91
Table 6.3.12. Potential Annual Dose per Person (mSv) in Clinic A1, for Full Time Working Hours (37 hours per week)	91
Table 6.3.13. Annual Effective Doses of Staff, Clinic A1	92
Table 6.4.1. Location A2 Grab Sample Results Pre-Remediation	100
Table 6.4.2. Corrected Daytime Radon Concentration Values, Clinic A2, Post Remediation	101
Table 6.4.3. Corrected Average Radon Values from Continuous Monitoring in Clinic A2, Post Remediation	101
Table 6.4.4. Time Averages of Rad 7 Radon Concentration Measurements in Clinic A2 Post Remediation	102
Table 6.4.5. Staff Room Occupancy in Clinic A2	102
Table 6.4.6. Estimated Radon Exposure ($\text{kBq.m}^{-3}.\text{h}$), Clinic A2, Pre-Remediation	103
Table 6.4.7. Estimated Radon Exposure ($\text{kBq.m}^{-3}.\text{h}$), Clinic A2, Post Remediation	104
Table 6.4.8. Annual Dose per Person (mSv) in Clinic A2	104

Table 6.4.9. Potential Annual Dose per Person (mSv) in Clinic A2, for Full Time Working Hours (37 hours per week)	104
Table 6.5.1. Time Averages of Rad 7 Radon Concentration Measurements in Clinic B Pre-Remediation	111
Table 6.5.2. 1 Month Track-Etch Detector Results in Clinic B Pre-Remediation	111
Table 6.5.3. Range of Daytime Radon Concentration Estimated for January '94 in Clinic B, Pre-Remediation	112
Table 6.5.4. Corrected Daytime Radon Values, Clinic B, Post- Remedial Studies	112
Table 6.5.5. Corrected Average Radon Values from Continuous Monitoring in Clinic B, Post Remediation	113
Table 6.5.6. Time Averages of Rad 7 Radon Concentration Measurements in Clinic B Post Remediation	113
Table 6.5.7. Staff Room Occupancy in Clinic B	114
Table 6.5.8. Estimated Radon Exposure (kBq.m ⁻³ .h) in Clinic B, Pre-Remediation	114
Table 6.5.9. Estimated Radon Exposure (kBq.m ⁻³ .h), Clinic B, Post Remediation	115
Table 6.5.10. Annual Dose per Person (mSv) in Clinic B	115
Table 6.5.11. Potential Annual Dose per Person (mSv) in Clinic B, for Full Time Working Hours (37 hours per week)	116
Table 6.5.12. Real Annual Effective Doses of Staff, Clinic B	116
Table 6.6.1. Time Averages of Rad 7 Radon Concentration Measurements in Clinic C Pre-Remediation	123
Table 6.6.2. 1 Month Track-Etch Detector Results in Clinic C Pre-Remediation	123
Table 6.6.3. Range of Daytime Radon Concentration Estimated for January '94 in Clinic C, Pre-Remediation	124
Table 6.6.4. Corrected Daytime Radon Values, Clinic C, Post- Remedial Studies	124

Table 6.6.5. Corrected Average Radon Values from Continuous Monitoring in Clinic C, Post Remediation	124
Table 6.6.6. Time Averages of Rad 7 Radon Concentration Measurements in Clinic C Post Remediation	126
Table 6.6.7. Staff Room Occupancy in Clinic C	126
Table 6.6.8. Estimated Radon Exposure ($\text{kBq}\cdot\text{m}^{-3}\cdot\text{h}$), Clinic C, Pre-Remediation	126
Table 6.6.9. Estimated Radon Exposure ($\text{kBq}\cdot\text{m}^{-3}\cdot\text{h}$), Clinic C, Post Remediation	127
Table 6.6.10. Annual Dose per Person (mSv) in Clinic C	127
Table 6.6.11. Potential Annual Dose per Person (mSv) in Clinic C, for Full Time Working Hours (37 hours per week)	128
Table 6.6.12. Annual Effective Doses of Staff, Clinic C	128
Table 6.7.1. Location D Grab Sample Results Pre-Remediation	135
Table 6.7.2. 1 Month Track-Etch Detector Results in Clinic D Pre-Remediation	136
Table 6.7.3. Range of Daytime Radon Concentration Estimated for January '94 in Clinic D, Pre-Remediation	136
Table 6.7.4. Corrected Daytime Radon Values, Clinic D, Post- Remedial Studies	137
Table 6.7.5. Corrected Average Radon Values from Continuous Monitoring in Clinic D, Post Remediation	137
Table 6.7.6. Time Averages of Rad 7 Radon Concentration Measurements in Clinic D Post Remediation	140
Table 6.7.7. Staff Room Occupancy in Clinic D	141
Table 6.7.8. Estimated Radon Exposure ($\text{kBq}\cdot\text{m}^{-3}\cdot\text{h}$), Clinic D, Pre-Remediation	141
Table 6.7.9. Estimated Radon Exposure ($\text{kBq}\cdot\text{m}^{-3}\cdot\text{h}$), Clinic D, Post Remediation	142
Table 6.7.10. Annual Dose per Person (mSv) in Clinic D	143

Table 6.7.11. Potential Annual Dose per Person (mSv) in Clinic D, for Full Time Working Hours (37 hours per week)	144
Table 6.7.12. Annual Effective Doses of Staff, Clinic D	144
Table 6.8.1. Location E Track-Etch Detector Results Pre-Remediation	149
Table 6.8.2. Corrected Daytime Radon Values, Clinic E, Post-Remedial Studies	150
Table 6.8.3. Corrected Average Radon Values from Continuous Monitoring in Clinic E, Post Remediation	150
Table 6.8.4. Time Averages of Rad 7 Radon Concentration Measurements in Clinic E Post Remediation	151
Table 6.8.5. Staff Room Occupancy in Clinic E	151
Table 6.8.6. Estimated Radon Exposure ($\text{kBq.m}^{-3}.\text{h}$), Clinic E, Pre-Remediation	152
Table 6.8.7. Estimated Radon Exposure ($\text{kBq.m}^{-3}.\text{h}$), Clinic E, Post Remediation	152
Table 6.8.8. Annual Dose per Person (mSv) in Clinic E	152
Table 6.8.9. Potential Annual Dose per Person (mSv) in Clinic E, for Full Time Working Hours (37 hours per week)	153
Table 6.9.1. Radon Levels in Kettering Hospital (Bq.m^{-3})	164
Table 6.9.2. Room Occupancy in Kettering Hospital	165
Table 6.9.3. Staff Exposures ($\text{kBq.m}^{-3}.\text{h}$) due to Radon in Kettering Hospital	165
Table 6.9.4. Annual Dose (mSv) to Staff in Kettering Hospital	166
Table 6.9.5. Radon Concentrations in Kettering Hospital (Bq.m^{-3}), corrected with the calibration factor for the RadHome, Year 2000	174
Table 6.9.6. Average Radon Levels(Bq.m^{-3}), Kettering Hospital, 1999 and 2000	175

7. DISCUSSION AND CONCLUSIONS

Table 7.1. Change of Radon Source Post Remediation	184
Table 7.2. Reduction in Doses compared to Reduction in Radon Levels for 46 Members of Staff	188
Table 7.3. Data to Test 'Dose Reduction Hypothesis'	189
Table 7.4. Ratio Night Time per Daytime Radon Level Pre and Post Remediation and Change in Ratio	191
Table 7.5. Ratio Dose/Average Corrected Radon Level	193
Table 7.6. Staff Doses	193

1. INTRODUCTION

1.1. The Chemistry of Radon

Radon is a colourless, tasteless and odourless gas found in Group 8 of the Periodic Table. It is chemically inert and this is the reason why it can diffuse out of the ground without entering into a chemical reaction with the chemical components of the soil. Radon exists only in trace quantities in the atmosphere (less than 0.00001 %); is fairly soluble in cold water and most ground water in the UK contains low concentrations of radon. Its density is 9.25 g dm^{-3} , boiling point is $-62 \text{ }^\circ\text{C}$, melting point is $-71 \text{ }^\circ\text{C}$ and it has 3 main isotopes (out of a total of 28) (Table 1.1.1.).

Table 1.1.1. Main Radon Isotopes

Radon Isotopes	Name	Decay Series	Half Life
Rn-219	Actinon	U-235	3.9 seconds
Rn-220	Thoron	Th-232	54.5 seconds
Rn-222	Radon	U-238	3.8 days

The most abundant isotope is ^{222}Rn , formed by the decay of ^{226}Ra , which is part of the ^{238}U series (Figure 1.1.1.). This isotope has a half-life of 3.8 days; this is sufficient time to enable a large proportion of the radon to diffuse out of the soil as gas and enter the atmosphere or the built environment.

Figure 1.1.1. Main Decay Series of Uranium-238

Nuclide	Approximate Half Life
Uranium-238	4.5 billion years
↓ α	
Thorium-234	24 days
↓ β, γ	
Protactinium-234	1.2 minutes
↓ β, γ	
Uranium-234	245 thousand years
↓ α	
Thorium-230	80 thousand years
↓ α	
Radium-226	1.6 thousand years
↓ α	
Radon-222	3.8 days
↓ α	
Polonium-218	3 minutes
↓ α	
Lead-214	27 minutes
↓ β, γ	
Bismuth-214	20 minutes
↓ β, γ	
Polonium-214	16×10^{-5} seconds
↓ α	
Lead-210	22 years
↓ β, γ	
Bismuth-210	5 days
↓ β, γ	
Polonium-210	138 days
↓ α	
Lead-206	Stable

The half-lives and alpha energies of the short lived daughters of radon are given in

Table 1.1.2.

Table 1.1.2. Half-lives and Alpha Energies of Radon and its Progeny (Webb, 1992)

Nuclide	Half-life	Decay type	α -energy
^{222}Rn	3.8 days	α	5.5 MeV
^{218}Po	3 minutes	α	6 MeV
^{214}Pb	26.8 minutes	β, Γ	-
^{214}Bi	19.7 minutes	β, Γ	-
^{214}Po	164 μs	α	7.7 MeV

^{222}Rn contributes around 50% of the dose to the average person in the UK. Around 85% of the total radiation dose to UK individuals comes from natural radiation sources and radon gas accounts for half of the total average population dose. Artificial radiation accounts for 15% of the total average population dose (around 0.4 millisieverts), most of which comes from medical sources. Figure 1.1.2. shows the exposure of the UK population from all the radiation sources.

Figure 1.1.2. Radiation Dose of the UK Population (DETR, 2000a)

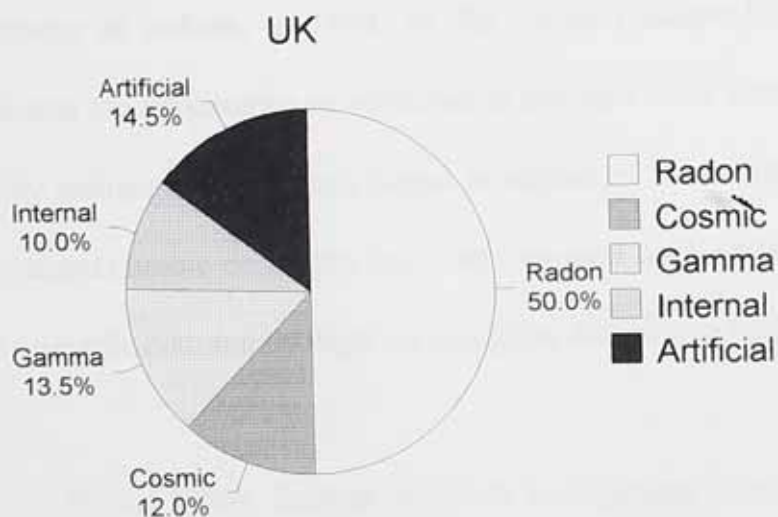

^{220}Rn contributes to less than 4% of the radiation dose received by the average UK person.

1.2. History of Radon Research

The impact of radon upon human health has been established by the study of miners, many of whom work in elevated levels of the gas. In the sixteenth century Paracelsus wrote: "There is also a gas in the earth which rules the lungs of those who live in the mines. And as those on the earth become lung-sick through their gas, so do those...who are subject in the mines to the earthly gas" (Temkin *et al.*, 1941).

The hazards of ionising radiation could only begin to be investigated after the discovery of X-rays by Wilhelm Konrad Roentgen in 1895, followed by the discovery of natural radioactivity, the research work of Pierre and Marie Curie and the isolation of radon from pitchblende. The first X-ray treatment ever given to a patient was done by Victor Despeignes of Lyon, only five months after their discovery (Doll, 1995). The first cancer-treatment with radon (radium emanation) was performed a few years after the discovery of radium, in 1898, by the Curies (Laugier, 1996). By 1896, workers were reporting the appearance of erythema of the skin. Four years after Roentgens' discovery, highly malignant carcinomas began to appear on the hands of workers that had already contracted chronic dermatitis but it was not until work on rats was published in 1900, that the scientific community began to recognise the risks to health.

By the 1920's, German scientists were putting forward the idea that radon was the cause of the great excess of lung cancers (Ludewig and Lorensen, 1924). However, after the start of the second world war, radon began to be associated with good health. Despite the growing evidence, it was not until the early 1950's that it was finally accepted by the

majority of the researchers that radon was the major cause of radiation damage to lung tissue in miners. Data on the mortality from lung cancer among miners exposed to radon is to be found in Table 1.2.1. The work of the American scientist WF Bale (Bale, 1980), had an important role to play in the recognition of the harmful nature of radon exposure.

Table 1.2.1. Mortality from Lung Cancers Among Miners Exposed to Radon (Source: NRPB)

Area	Date	Observed	Expected
Colorado, USA	1951-1982	246	59
Ontario, Canada	1955-1981	152	68
Beaverlodge, Canada	1950-1980	65	34
West Bohemia, Czech	1953-1990	702	138
Malmberget, Sweden	1951-1976	51	15
Yunnan, China	1976-1987	981	267
Cornwall, UK	1941-1986	105	67
France	1946-1985	45	21

During the 1950's, in the Western regions of the USA, houses were being built from materials salvaged from old uranium mines. These, soon after building, were found to have very high levels of radon. However, at that time, it was considered unlikely that radon could enter buildings from soil gas rather than from building material.

The most significant event to draw the radon problem to the attention of the modern media and the public, happened in 1984, 'The Watras Incident' (Joyce *et al.*, 1986; Pearce, 1987). Stanley Watras had levels of radon in his home almost 100,000 Bq.m⁻³, many times higher than previously known (Ennemoser *et al.*, 1994). In the case of radon, the source of radioactivity was qualitatively differed from previous events (De La Bruheze, 1992).

The Watras incident accelerated the measurement of radon levels in domestic dwellings in the USA. It appeared that one in eight American homes may have a radon problem. The data lead to the conclusion that radioactivity from the decay of indoor radon caused between 2,000 and 20,000 Americans to die yearly from lung cancer (The Radon Council Limited, 1995).

Within the UK, monitoring was gathering pace (Nero and Lowder, 1983) and the more general scientific press were also dealing with the growing concern (Cliff *et al.*, 1983; New Scientist, 1984). In the UK, the public interest on the radon problem has been kept alive by constant media coverage of the issue (Daily Mail, 1998, The Guardian, 1998, The Times, 1998). A recent report by the Imperial Cancer Research Funds Epidemiology Unit at Oxford, demonstrated for the first time, in the UK, that there was significant evidence to confirm that radon was a human carcinogen at the levels found in domestic dwellings (Darby *et al.*, 1998). Up until this report, the impact of radon on health had largely been evaluated from studies on miners.

1.3. The UK National Radon Programme

The radon problem is one not just of national but of international concern; the geology of different countries determines high radon levels outdoors and subsequently indoors. National radon monitoring programmes have been carried out in a number of countries, mostly in the developed world.

In the UK, the formation of the National Radiological Protection Board (NRPB) in 1970, by the Radiological Protection Act (RPA), created an organisation to give advice, conduct research and provide technical services in the field of radiation protection. In 1977, the NRPB received further directions under the RPA to give advice on the application, in the UK, of international standards and to specify Emergency Reference Levels (ERLs) for limiting radiation dose in accident situations (NRPB, 1990). Surveys of radon in UK dwellings commenced and initial findings were published in 1974.

The NRPB first issued formal advice on radon in 1987. The recommendations were based upon advice from the International Commission on Radiological Protection and the Royal Commission on Environmental Protection. The UK Government accepted the NRPB's advice and initiated a programme to determine the means of reducing high exposure in existing homes and reducing it in future ones (NRPB, 1987). The Action Level (AL) in homes, at that time, was initially set at 400 Bq.m^{-3} , but this was reduced to 200 Bq.m^{-3} after advice from the NRPB in 1990. The Working Action Level (WAL) for radon is fixed at 400 Bq.m^{-3} . In 1988, a survey of 2,100 homes was completed and published; surveys after that were larger and covered bigger areas (Cliff, 1978).

The true geographical extent of the problem was becoming apparent by the late 1980's and it was much larger than had previously been considered possible. In 1990, the NRPB introduced the concept of the Affected Area (AA), where 1% or more of homes were above the AL. At the same time this AL was reduced to 200 Bq.m^{-3} , so increasing the number of homes that were classified as a health risk. This serious implication was also reinforced with a clear statement that 1 in 20 (some 2,000) lung cancer deaths per year, in the UK, could be due to radon.

By 1991, the number of homes tested for radon had risen to around 30,000 and by 1992 the number was up to 100,000. The number had increased to 250,000 by 1996, then the NRPB released a new radon map covering all parts of England and Wales. By autumn 1997, the number was up to 360,000 and the percentage of homes tested that were above the AL was 9.7% (NRPB, 1996).

The surveys of buildings enabled AA status to be determined. Cornwall and Devon were declared AA in 1990. Derbyshire, Northamptonshire and Somerset were classified as such in 1992. Regions of Scotland and Northern Ireland were included in this category in 1993. Additional parts of England were shown to have >1% of the homes above the AL in 1996. In 1996, regions of Wales were also declared as AA's.

In 1997, the NRPB sent questionnaires to around 10,000 homes in the in Cornwall and Devon (Bradley and Thomas, 1997). Some 50% of the households returned their completed questionnaires and it was found that only around 10% of them had carried out some form of remediation.

1.4. Radon Geology and Other Sources of Radon

Radon in the outdoor air has a mean level of 3.4 Bq.m^{-3} (Wrixon *et al.*, 1988). Average indoor levels in the UK are around 20 Bq.m^{-3} (NRPB, 1990a). The soils' chemical composition is the main factor that determines the radon levels inside buildings above. Soils with high levels of uranium would be expected to produce high levels of radon gas. In order for it to escape to the surface, the soil must be porous and allow gas to migrate. Uranium is found in shales, granites, phosphate ores and pitchblende minerals.

The global average uranium content of rocks is given in Table 1.4.1. (Gillmore *et al.*, 2000).

Table 1.4.1. Global Average Uranium Content of Rocks (Gillmore *et al.*, 2000)

Rock Type	Average Uranium Content (mg kg ⁻¹)
Igneous Rocks	
Granites	4.8
Basalts	0.6
Sedimentary Rocks	
Organic-rich black shales	8.2
Common shales	3.5
Limestones	2
Sandstones	1

The highest indoor radon concentrations in Cornwall and Devon are associated with granites and uranium mineralization. The occurrence of radon in many other parts of UK is associated not only with granites, but also with sedimentary rocks. In Derbyshire high radon levels are due to underlying black shales and carboniferous limestone. Northamptonshire occupies an area of limestone, sandstone and phosphatic ironstone (Sutherland and Sharman, 1996).

There are two factors that influence the efficiency of soils as sources of radon: 'radon availability' and 'radon migration' (Nazaroff and Nero, 1988). The former factor depends on the radium content of the soil and on the size and structure of the soil grains, as well as the moisture content of the soil. The latter factor depends on the magnitude of the mechanisms driving the flow and on the ease of migration. Only radon produced in the top two metres of soil will pose an environmental threat; radon diffuses easily out of the dried and cracked soil.

The transporting mechanisms for radon gas out of the soil include convection and where appropriate, transport through streams. Diffusion of radon is slower in water than in air; the air/ water partition coefficient for radon gas is high.

In 1996, the NRPB published a Radon Atlas of England (NRPB, 1996a), together with an explanatory report; high-level radon areas were assessed taking into account different data: geochemical and mineralogical, the permeability of rocks and soil, radon concentration in soil-gas measured over different rock units and radon levels recorded in dwellings. Geological radon potential mapping is an interpretation of all the available information.

Changes in radon emanation from rocks are used in predicting earthquakes, based on the idea that radiation levels increase due to important movements in the structure of rocks and appearance of suitable channels (Henricke and Koch, 1993). There is evidence that the radon emanation depends on the lithologic and rheologic parameters of the rock, which change in the preparatory stage of the seismic cycle (Garavaglia *et al.*, 1999). Geological data indicating that high radon levels could be found in a wide variety of environments is available from a range of research areas, like studying monsoon circulations (Rangarajan, 1984).

Apart from soil and rocks, other sources of radon include groundwater, oceans, building materials and natural gas (Table 1.4.2.).

Table 1.4.2. Sources of Radon in Atmosphere (WHO, 1983).

Source	Radon Production Yearly (Bq)
Soil	9×10^{19}
Groundwater	2×10^{19}
Oceans	9×10^{17}
Building materials	3×10^{16}
Natural gas	3×10^{14}
Coal	2×10^{13}

Spring water can be a significant radon source where it is used directly from the ground, but in the UK, water is mainly processed and radon levels entering buildings are negligible, only 1 Bq.l^{-1} (Henshaw *et al.*, 1993). Radon in water pipes can contribute to indoor radon level (Yu *et al.*, 1998) and can be absorbed in the scale within the water pipes (Field *et al.*, 1995); there is even a difference in radon levels in a room based on the fact whether the toilet tank has a lid or not (Pengji and Yunlong, 1993).

Building materials rich in uranium influence the radon levels in indoor rooms situated in high-rise office buildings in Hong Kong (Phillips *et al.*, 1997) and other countries, although not a significant source of radon in the UK (NRPB, 1990a). Radon exhalation rate from building materials decreases with the building age (Yu *et al.*, 1995).

The UK has very low average indoor radon levels compared with the rest of the world (Table 1.4.3., The Radon Council Limited, 1995).

Table 1.4.3. Average Indoor Radon levels in European Countries and the USA (The Radon Council Limited, 1995)

Country	Radon (Bq.m ⁻³)
Sweden	100
USA	61
UK	20
Denmark	68
Finland	90
France	76
Ireland	68
Italy	55
Netherlands	31
Norway	90

1.4.1. Radon and Northamptonshire Geology

Radon in Northamptonshire has been found in particular geological formations: the Northampton Sand Formation (Sutherland, 1991) and in the Marlstone Rock Bed (Sharman, 1991). The geological succession in Northamptonshire is shown in Figure

1.4.1.1.

Figure 1.4.1.1. Geological Succession in Northamptonshire (Sutherland, Sharman, 1996)

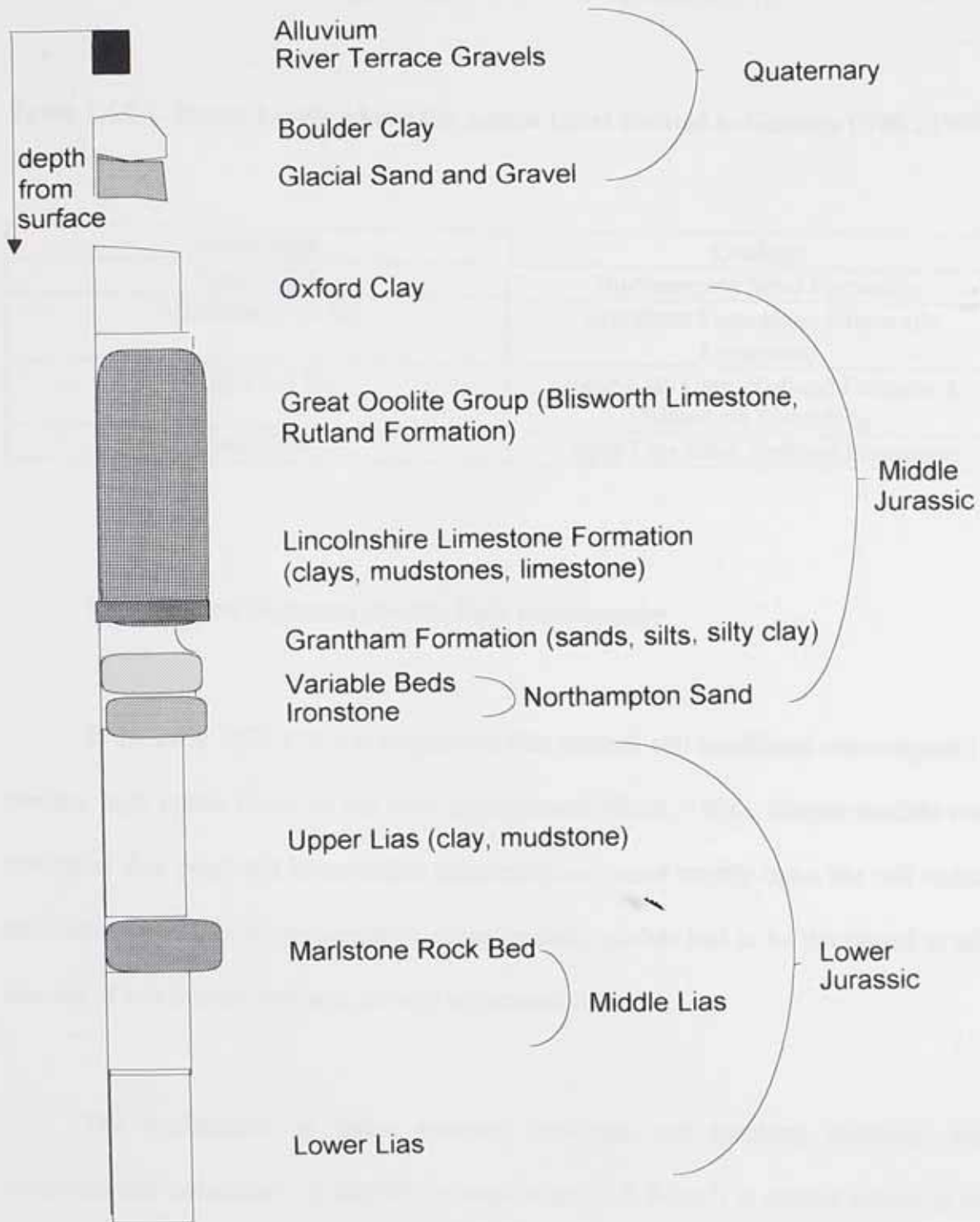

The status of radon AA was given to Northamptonshire in 1992, after the NRPB surveyed more than 6,500 houses in the county and found that more than 1% had levels above the AL of 200 Bq.m⁻³ (Miles *et al.*, 1992). The percentage of houses above the AL can be related to the underlying geology (Table 1.4.1.1., NBC, 1994).

Table 1.4.1.1. Radon Levels Above the Action Level Related to Geology (NBC, 1994)

Radon Risk	Geology
High >10%	Northampton Sand Formation
Moderate 3-10 %	Grantham Formation, Blisworth Limestone
Slight 1-3 %	Upper Lias Clay, Rutland Formation, Blisworth Limestone
Low <1 %	Upper Lias Clay, Rutland Formation

1.5. Radon Migration into the Built Environment

In the early 1970's, it was considered that unusual soil conditions were required to produce high radon levels in the built environment (Scott, 1994). Simple models were developed that predicted house radon concentration, based mostly upon the soil radium concentration and on its permeability. More realistic models had to be developed to take account of soil fracture patterns, as well as permeability.

The explanation of radon entering buildings and reaching relatively high concentrations compared (20 Bq.m⁻³) to outside air (3.4 Bq.m⁻³) is mainly based on the convective flow and on pressure differences. The stack effect is due to the displacement of warm air to higher levels inside the house and results in lower pressure at ground level,

causing radon from the soil to be drawn into the house by the movement of air from the higher outside pressure to the lower indoors pressure. There are three major sources of radon in homes:

- building materials,
- soil below the building,
- well water.

In most buildings in the UK the vast majority of radon comes from the subjacent soil rather than the building materials. The small pressure difference between the outdoor and indoor pressures (few Pascals) is enough to draw radon from the surrounding soil into a building via cracks in floors and walls (Figure 1.5.1.).

Figure 1.5.1. Radon Ingress into Houses

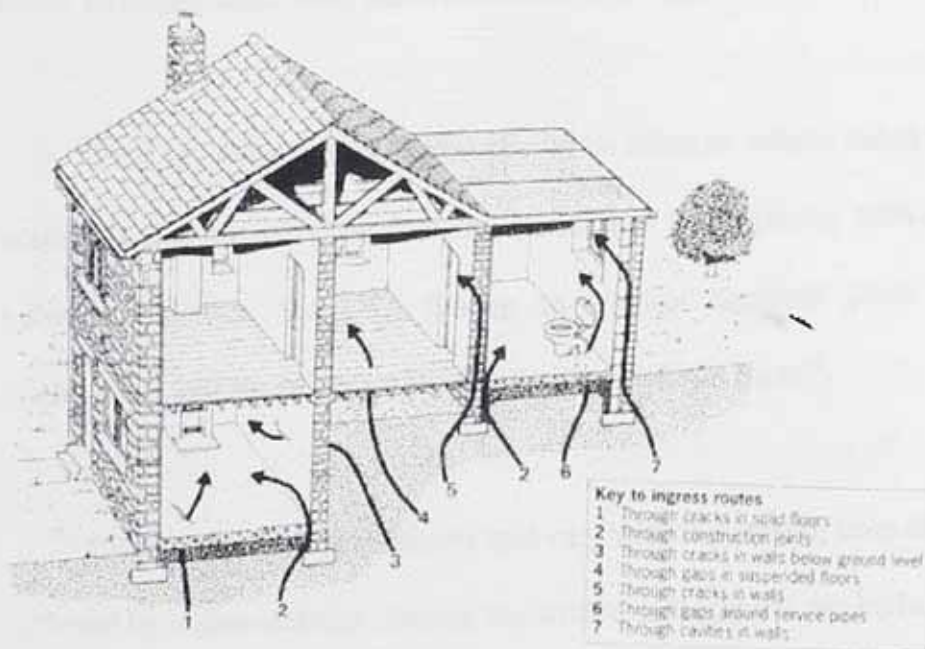

Modern buildings that minimise draughts and reduce ventilation are prone to higher levels, on the same geology, than those that are poorly insulated and leave windows and doors open for long periods. In houses with fans in the kitchen and bathroom, the air is sucked out of the house and pressure is lowered, allowing the previously described process to increase. Radon gets into the built environment only if there are cracks in walls, joints with gaps, loose fittings and sumps.

Wellwater is used by very few people in the UK and that is why this source is not important for the majority of British households. Radon is soluble in water and other liquid solvents. High radon concentrations in tap water from wells drilled in granite rocks increase the average indoor radon level; the highest radon values are released from water when using a shower or a washing machine. Indoor radon concentrations due to the water supply can reach $1,000 \text{ Bq.m}^{-3}$, as reported in Norway, Denmark and Finland (Gabriel, 1997). Drinking water with dissolved radon is an ingestion hazard.

The AL, above which action should be taken to reduce radon concentration in UK homes, is 200 Bq.m^{-3} (The Ionising Radiations Regulations, 1999). These values vary between countries, the USA having an average domestic level of 148 Bq.m^{-3} , the Netherlands 200 Bq.m^{-3} and Canada has a level of 800 Bq.m^{-3} .

Radon levels change hourly and vary with the season, time of day and are strongly affected by human activity. During the winter, radon levels are higher than in the summer, due to reduced ventilation in the cold season and high temperature differences between indoors/ outdoors. This can be balanced as less radon is released from a cold, wet soil. Regarding the time of day, the highest radon levels seem to occur late at night and in the

early morning; the lowest levels occur around midday, due to more ventilation while the building is being used by people. Human activity can increase or lower indoor radon levels by opening and closing windows and doors, switching on and off ventilation and heating. Radon levels also vary between different rooms of the same building, in accordance with the position of a certain room; the highest levels of radon in a house would be found in the cellar whereas the lowest would be at the top floor (Mose *et al.*, 1992). Monitoring of NHS properties in Northamptonshire has shown first floor radon levels 50 - 75% less than ground floor levels (Denman, 1995).

1.6. Radon in the Workplace

Surveys of radon in mines, in the UK, have taken place since the mid 1960's and it was found that around 40% of the miners in non-coal mines were exposed to levels considered damaging to health. When these occurred there were no statutory regulations controlling radiation exposure for radon. The Ionising Radiation Regulations (IRR) introduced statutory control of radon in workplaces for the first time in 1985 (Health and Safety Executive, 1985).

When elevated levels of radon were first found in domestic dwellings in Cornwall it was realised that above ground workplaces were likely to be affected in a similar proportion. A planned survey was carried out for local authorities in the South-West of England, especially in schools and offices; this confirmed the original suspicions. Those above the WAL have either had to reduce levels below this value, or restrict staff doses by applying the IRR, with the designation of a supervised area; the WAL's in the 1985 regulations were drafted in terms of radon progeny, equivalent to 400 Bq.m^{-3} . The present

1999 regulations specify this level of 400 Bq.m^{-3} directly. Above $1,000 \text{ Bq.m}^{-3}$ there is the requirement for the designation of a controlled area. In 1996, it was reported that results were available for around 6,000 workplaces in the UK in areas with high radon (Dixon *et al.*, 1996). Cornwall was the worst affected with 21% of the workplaces above the WAL, Northamptonshire having some 14% and Somerset, the lowest, with 5%.

These results are extremely worrying as significant numbers of workers must be exposed to elevated radon levels. What is perhaps even more alarming is that the number of workplaces for which there are data is a very small proportion of the total. Very few businesses are taking their legal obligations, in Northamptonshire, seriously (Denman and Phillips, 1998c). The application of the regulations is the responsibility of the Health and Safety Executive (HSE) for certain types and size bands of business (mostly large and the total is 450,000 for the whole UK) while for others it is the responsibility of local authority Environmental Health Officers (EHO's).

The preferred method to check if legislation is followed has been the targeted mail shot according to postcode, to hit those with the highest probable level of radon. Reduction of radon in the workplace must be considered a priority area for the future as there is legislation that can be used to control levels. One of the big stumbling blocks may be the cost of such radon programmes to employers.

In 1992, a programme of testing in National Health Service (NHS) premises in Northamptonshire was started and elevated levels of radon were found (Denman, 1994). Further investigation found that there were certain workers who were receiving very high doses of radiation (Denman and Parkinson, 1996). To deal with the problem, a large radon

remediation programme was carried out and some 1,038 locations were tested with the highest level being $3,750 \text{ Bq.m}^{-3}$ (Phillips and Denman, 1997). The total cost of the programme was in the region of £100,000 and it did enable the NHS to achieve a large dose reduction to staff at a value of £184,000 per Man-Sievert. This is around half the amount the NRPB calculate is required to achieve similar dose reductions to patients from dental X-rays and which they considered justified when compared to the costs of the effects of radiation.

Radon monitoring in the UK, in a wide range of buildings, will continue to happen and this will enable present geological data to be expanded (Appleton and Ball, 1995). Radon in the workplace will grow in importance, with the HSE as well as EHO's driving campaigns for testing and remediation where necessary. There are a number of unresolved issues that are coming to the attention of the research community, e.g. radon progeny concentration and power lines are still active research programmes for some as is progeny deposition due to static electricity (Batkin *et al.*, 1998) or smoking habits related to radon radiation (Lee *et al.*, 1999).

The UK has one of the lowest average indoor radon levels in the developed world and countries with higher levels should be even more active. The average UK indoor domestic level of 20 Bq.m^{-3} is much lower than Sweden (100), France (76) and the USA (61), only Japan is significantly lower (10). The consensus of opinion, within the UK, is that the radon programme has been successful within the financial constraints that have been applied.

1.7. The Building Research Establishment

Another key player in the UK programme has been the Building Research Establishment (BRE). The BRE has undertaken a comprehensive study of radon remedial measures in existing buildings (BRE, 1992a) and new buildings (BRE, 1992b).

Two approaches to dealing with radon have been developed:

(i) Passive; this system consists of an airtight barrier across the whole of a building;

(ii) Active; this system consists of a powered radon extraction system, a sump.

New regulations establish that all new houses should be built with a passive barrier and in areas with higher radon levels with both passive and active systems, the latter one not including necessary a pump (DETR, 1999). The costs of such systems are in the region of £1,000, but they have effectively been falling in real terms as their price has stayed at about that level for some 10 years. Originally, the NRPB suggested time-scales within which action should be taken (Gardner *et al.*, 1992). This was 3 years if the level was 500 Bq.m⁻³ and as little as 6 months if it was as high as 3,000 Bq.m⁻³. These guidelines were dropped by the end of 1992 and new guidance is given on radon protective measures (BRE, 1999).

1.8. The Radon Council

The Radon Council evolved from an exploratory meeting of interested organisations in 1990 due to the need to develop an industry led organisation that could ensure 'Best Practice' in radon remediation via private companies (Phillips, 1995). It is a

non-profit making body composed of a wide range of government departments, quasi-government bodies, research organisations, professional bodies and private companies. EHO's are now able to direct members of the public to reputable contractors with a proven track record. Public confidence in the effectiveness of such systems has seemed to increase from earlier days (late 1980's - early 1990's).

1.9. Aims and Objectives of Present Work

The main aims of the present research project are:

1. Participate in significant remediation projects in UK institutions;
2. Evaluate the results of remediations in the workplace;
3. Determine if the dose reduction to staff is in line with original predictions;
4. Propose management regimes for remediated buildings.

The main objectives of the present project are:

1. Review of current regulation concerning radon in the workplace;
2. Review of the durability and cost-effectiveness of radon remediation techniques in the workplace;
3. Collection and interpretation of data from remediated locations;
4. Determine the dose received by staff, post remediation in UK workplaces.

1.10. Research Approach and Method Used

The present project commenced in 1997 and is a continuation of the work undertaken by Parkinson (1994) and Barker (1998). Intensive long term research was carried out on the four remediated sites studied by Parkinson before remediation. Two more NHS remediated sites in Kettering were included in the study, one of which had extensive internal building work that resulted in a restructuring of the use of the building. To determine if changes in use on a site influence radon levels after remediation, measurements in the seventh site were performed, inside a Kettering Hospital.

Two other case studies in the workplace have been carried out, one in North Wales where the research was in the incipient stages of dealing with the radon problem and another one in Buxton, where the local Town Hall was successfully remediated and the research was in its final stages of dealing with the radon problem (Figure 4.4.1.).

Radon measurements in the workplace remediated venues were made using a continuous radon monitor, Rad-7, working in parallel with track-etch detectors. The time dependence of radon variations was recorded and average radon levels calculated for the daytime working hours. Staff questionnaires were designed and used to determine the working patterns of the occupants of the remediated buildings; radiation doses post remediation were calculated for each member of the staff. The staff exposures before and after remediation were compared.

2. RADON: UNITS AND MEASUREMENT

2.1 Radon Units

The radon decay series undergoes alpha, beta and gamma emission to different decay products ($\text{Rn}^{222} \rightarrow \text{Po}^{218} \rightarrow \text{Pb}^{214} \rightarrow \text{Bi}^{214} \rightarrow \text{Po}^{214} \rightarrow \text{Pb}^{210} \rightarrow \text{Bi}^{210} \rightarrow \text{Po}^{210} \rightarrow \text{Pb}^{206}$) (Figure 1.1.1.). The solid radioactive products are isotopes of Po, Bi and Pb and are named radon daughters. Radioactivity is the number of radioactive transformations over a unit of time and is measured in Becquerel (Bq). One Bq equals one disintegration per second. The activity concentration is measured in $\text{Bq}\cdot\text{m}^{-3}$ or in Curie (Ci- older unit of radioactive decay, still used in the USA).

$$1\text{pCi L}^{-1} = 37 \text{ Bq}\cdot\text{m}^{-3}$$

The concentration of radon decay products in air is given as the potential alpha energy concentration (PAEC) or potential alpha energy released (PAER), the sum of all the alpha energies of the short lived decay products in a unit of air. The unit for PAEC is the working level (WL), a combination of short lived decay products that results in the emission of 1.3×10^5 mega electron volts in a litre of air (WHO, 1988).

$$1\text{WL} = 2.08 \times 10^{-5} \text{ J m}^{-3}$$

The PAEC exposure is expressed as working level months (WLM), in $\text{J}\cdot\text{m}^{-3}\cdot\text{h}$,
where

Table 2.1.1. Risk Factors and Tissue Weighting Factors for Various Organs and Tissues

$1\text{WLM} = 2.08 \times 10^{-5} \text{ J m}^{-3} \times 170 \text{ h}$, for a typical 170h working month (WHO, 1988).

The absorbed dose is a measure of the radiation energy absorbed by the living tissues and is measured in Gray (Gy) or Rad (Radiation absorbed dose). One Gray is one Joule of absorbed radiation energy per kilogram of single organ. One Rad is the absorption of 10^{-2} joules of radiation energy per kilogram of material.

$$1\text{Gy} = 1\text{J/kg} = 100 \text{ Rad}$$

The dose equivalent is the absorbed dose weighted for the biological damage caused and is measured in Sievert or Rem.

$$1\text{Sv} = 1 \text{ J/kg} = 100 \text{ Rem}$$

The effective dose to an organ (Sieverts) is calculated by multiplying the dose absorbed by the organ with the Tissue Weighting Factor that is related to the tissues' sensitivity and risk factor of alpha particles in inducing biological damage. Tissue Weighting Factors are calculated by models derived by the International Commission on Radiological Protection (ICRP, 1991). Table 2.1.1. shows the risk factors and tissue weighting factors for various tissues and organs.

Table 2.1.1. Risk Factors and Tissue Weighting Factors for Organs and Tissues (ICRP, 1991)

Tissue/ Organ	Risk Factor (Sv ⁻¹)	Tissue Weighting Factor
Lung	8.5x10 ⁻³	0.12
Testes/Ovaries	1.0x10 ⁻³	0.2
Bone Surface	5.0x10 ⁻³	0.01
Thyroid	8.0x10 ⁻⁴	0.05
Breasts	2.0x10 ⁻³	0.05
Other tissues	5.0x10 ⁻³	0.05

The whole body effective dose is calculated by adding all the individual organs' effective doses. The annual whole body dose to an average member of the UK population is 2.6 mSv (Hughes and O'Riordan, 1993).

The equilibrium factor (F) is the activity of the progeny divided by the activity of ²²²Rn. For a given decay product, the equilibrium factor F is:

$$F = \frac{\text{Activity of progeny}}{\text{Activity of } ^{222}\text{Rn}}$$

In complete equilibrium, $F_1 = F_2 = F_3 = F_4 = 1$ for the four short lived progeny (Durrani, 1993). In a closed system, ²²²Rn is in equilibrium with the parent ²²⁶Ra after around 4 half lives, 15 days; the short lived daughters take the same time to achieve equilibrium and the activity concentration of the decay products is equal to the radon activity concentration (Nazaroff and Nero, 1988). For a non-closed system (in domestic properties and workplace over ground), a value of 0.4 - 0.5 is used (NRC, 1991, ICRP, 1993).

The main physical processes that happen to radon gas are: decay, attachment, deposition, recoil. The radon daughters can be found in the following states: unattached-airborne, attached- airborne, deposited onto room surfaces or implanted onto room surfaces. The radon daughters produced in unattached state are single atoms or ions and measure only a few nanometers (nm); water vapour molecules may coalesce around the ion (Frey *et al.*, 1981). The attached radon daughters cling on ambient aerosols with sizes of nm order up to 1 micrometer (μm). The fraction of attached progeny depends on the number of aerosol particles and the degree of ventilation; the relative number of radon daughters in air is expressed by F.

^{222}Rn decays to free ions of ^{218}Po that joins water molecules (Frey *et al.*, 1981) and is highly mobile when unattached; it can plate out to surfaces, leave the air volume, decay to Po^{214} or attach itself to an aerosol particle (Porstendörfer, 1984). The attached fraction depends on the number of aerosol particles. The attachment theory of radon progeny onto ambient aerosols was experimentally verified and confirmed by Tokonami, 2000.

Electric fields concentrate a localised source of radon daughters when switched on or off (Ziegler *et al.*, 1993) and electromagnetic fields may attract radon daughter nuclei (Henshaw *et al.*, 1996), but these effects are insignificant compared to the variations related to the air-conditioning systems. Figure 2.1.1. shows the process influencing the activity balance of radon decay products.

Figure 2.1.1. Attached and Unattached Radon Progeny

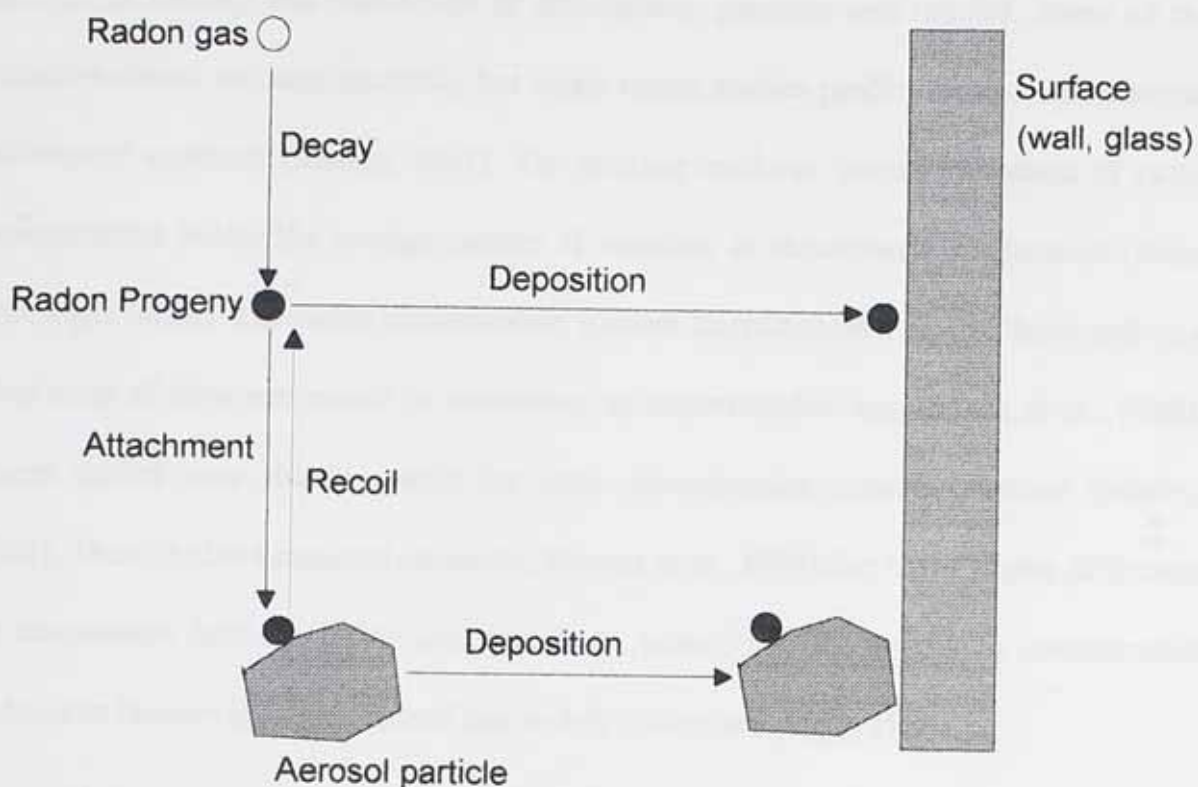

When $F = 1$ in equilibrium, PAEC is at its maximum value (WHO, 1988). The greater the value of F , the greater the PAEC available to enter the respiratory system (Nazaroff and Nero, 1988). The actual doses received are also influenced by the size of aerosols (NRC, 1991). F varies from one site to another and with time (values in the range 0.03-0.87), according to the characteristics of the site and climate and is log-normally or normally distributed (Vargas *et al.*, 2000). The equilibrium factor and the unattached fraction are influenced by the working conditions. The radon concentration is strongly influenced by the ventilation system and the factor F is influenced by dust-producing work processes (Streil *et al.*, 1999).

Concentrations of radon in air vary significantly, both indoors and outdoors, due to changes in heating and ventilation or atmospheric pressure and rainfall. Some of the variation causes are unpredictable, but some recent studies predict diurnal and seasonal patterns of variation (Marley, 2001). The average outdoors diurnal variations of radon concentration follow the average pattern of variation in atmospheric temperature (Miles and Algar, 1988). The radon concentration indoors fluctuates on a diurnal basis and on a time scale of days and weeks in sometimes an unpredictable way (Dixon *et al.*, 1988); recent studies were able to predict the radon concentration variations indoors (Marley, 2001). There is also a seasonal variation (Wrixon *et al.*, 1988) due to the higher difference in temperature between inside and outside in winter; the average radon concentration indoors in January is about twice of that in July (Miles and Algar, 1988).

The conversion of mSv to kBq h m⁻³ recommended by the NRPB for occupational exposures is:

1mSv = 126 kBq h m⁻³ (Parkinson, 1994), following the assumptions that:

- at equilibrium, $F = 1.0$ and $1WL = 3,700 \text{ Bq m}^{-3}$
- in typical indoor air, $F = 0.5$ and $1WL = 7,400 \text{ Bq m}^{-3}$

therefore $1WLM = 7,400 \text{ Bq.m}^{-3} \times 170\text{h} = 1,258 \text{ kBq h m}^{-3}$

also $1 \text{ WLM} = 10 \text{ mSv}$ (IRR 1985)

thus $1\text{mSv} = 1,258/10 \text{ kBq h m}^{-3} \sim 126 \text{ kBq h m}^{-3}$

2.2 Radon Detection

Radon can be detected by its emission of alpha particles (Nazaroff and Nero, 1988), as 'real time' value or averaged over longer periods of time. Techniques can be classified:

- (I)- by whether they measure gas activity (A) or potential alpha energy concentration (PAEC) (decay products);
- (II)- by their time resolution, being either grab-sample, continuous or integrating;
- (III)- by obtaining the sample, passive by diffusion or active, being pumped.

The main methods for detecting radon are: zinc sulphide scintillation chambers, ionisation chambers, alpha track registration, liquid scintillation counting, semiconductors and linked absorbers (Ball *et al.*, 1991).

- zinc sulphide scintillation chambers
- ionisation chambers
- track-etch detectors (TED) recording uses a polyallyl diglycol carbonate sheet (CR-39, CR= Columbia Resin) inside a plastic case of a few centimetres in size (Figure 2.2.1.).

Figure 2.2.1. Track- Etch Detector

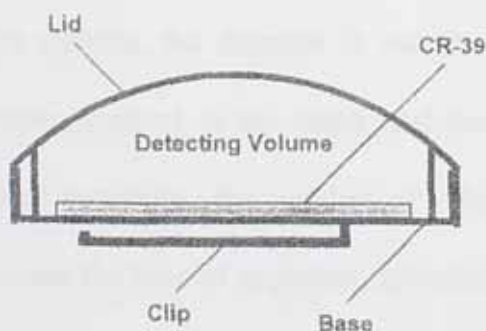

Radon enters the case by diffusion via a small gap (0.1 mm, small enough for preventing the entrance of the radon daughters); the radon decays and the alpha particles cause etching on the CR-39 sheet. The range of alpha particles emitted by radon isotopes' products in air and in the CR-39 detector material is given in Table 2.2.1. (Gabriel, 1997).

Table 2.2.1. Ranges of Alpha Particles Emitted by Radon Isotopes (Gabriel, 1997)

Isotope	Alpha Energy (MeV)	Range in air (cm)	Range in CR-39 (μm)
^{222}Rn	5.49	3.95	35.5
^{218}Rn	6	4.5	40.7
^{214}Rn	7.68	6.65	59.8

The plastic sheet is sent for processing in an alkaline solution ($_{\text{aq}}\text{NaOH}$, 1-12 M), at a temperature of 40-80 $^{\circ}\text{C}$ due to enhance the etching. Table 2.2.2. shows the parameters for the best results.

Table 2.2.2. Etching Conditions Used for CR-39

Etching parameter	Value
temperature	75 $^{\circ}\text{C}$
molarity of NaOH	6.25 M
period of etching	7.5 h

After etching, the detector is put in warm water at 60 $^{\circ}\text{C}$ to stop the reaction for 30 minutes, washed in tap water and finally in deionised water and dried in air. With an optical apparatus, the number of 'chippings' is found, the density of the damage and knowing the time of exposure, calculations are made to determine the radon gas level that produced the number of impacts found (Cliff *et al.*, 1991). The results are measured in tracks per unit area and are proportional to the time integral of the radon concentration

outside the detector (Bartlett *et al.*, 1987). A threshold of 15 kBq.h.m⁻³ has been set for the NRPB detector. The TED can be left in rooms for a period of 6 days up to 1 year, according to calibration. NRPB surveys include two detectors to be placed in houses for 3 months' period time of exposure for the most accurate results. A standard protocol for placing the TED's indicates that one detector to be placed in the living area, another in the bedroom area, on a shelf near an internal wall, away from sunlight, draughts, sources of heat or electrical items (NRPB, 1990a). At the end of the exposure the sealed detectors have to be returned for analysis to the NRPB. Two TED's cost around £40. The advantages of using these detectors are: light, not very expensive, quiet, small, data easy to interpret, accurate measurements over longer periods of time by passive way. They require careful storage and sometimes can be refrigerated.

- liquid scintillation counting
- semiconductors are based on the fact that emitted alpha particles can interact with the surface layer of a semiconductor to produce detectable current pulses. Two meters of this type were used in the present measurements: a Rad-7 meter and a Rad Home meter.

The Niton Rad 7 is a portable instrument (Figure 2.2.2.) measuring radon concentration in a matter of minutes and able to operate in continuous mode for several days without supervision. It draws air from the tested room with a pump, through a tube, two filters and a drying column and the air is sent into a 0.7 litres' sample cell. The filters exclude the radon progeny in the initial sample from being pumped into the cell. Inside the cell, the radon progeny, a positively charged ion of ²¹⁸Po, moves under the influence of the electric field and is deposited electrostatically on the solid state silicon diode detector.

Further decays produce alpha particles that have a 50% chance of entering the detector and are counted into two channels, one for ^{218}Po and the other for ^{214}Po .

Figure 2.2.2. Rad-7 Meter

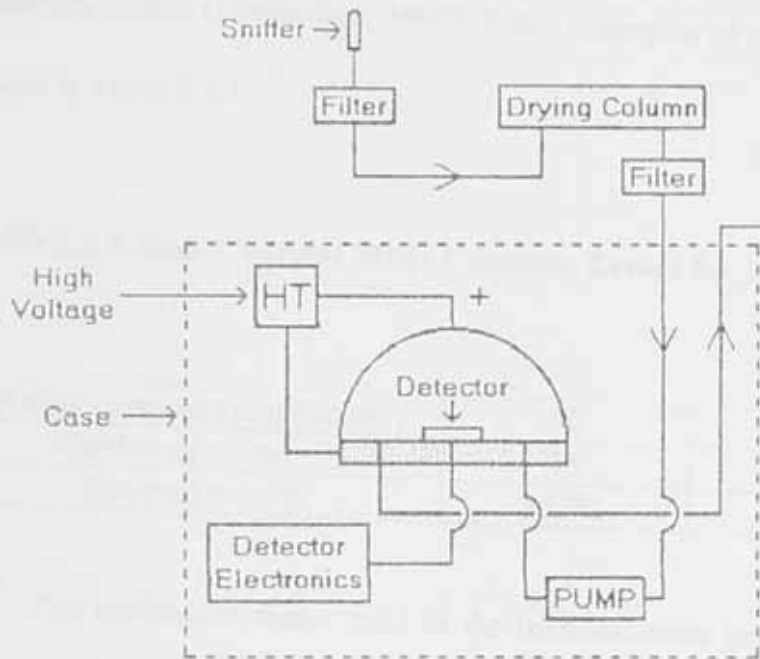

The meter has two functioning modes: sniff (radon concentration deduced from channel for ^{218}Po) and normal (radon concentration deduced by using the sum of the two channel counts). The sniff mode computes radon concentration from ^{218}Po counts and has a fast time response due to the short half life (3.04 min) of ^{218}Po . The normal mode uses the sum of the ^{218}Po and ^{214}Po counts and gives smaller statistical errors, allowing long-time measurements and thus accurate averages, whereas the sniff mode has a fast time response but is less accurate. Some of the pre remedial measurements were done in sniff mode in order to eliminate the influence of the previous sampling point, but the data was mostly calculated in normal mode, with short cycle times, between 15 minutes to 2 hours, referred as grab sample measurements; the present measurements were all done in normal mode.

The Rad-7 is calibrated to a Niton master instrument, calibrated itself in accordance with the USA Environmental Protection Agency standards. Usually, the precision of individual Rad-7 radon concentration measurements is limited by counting statistics (Niton Corporation, 1992). Some examples of normal mode counting errors are given in Table 2.2.3.

Table 2.2.3. Rad-7 Normal Mode Counting Errors for 1 hour Counting Time

Radon Concentration (Bq.m ⁻³)	20	400	1,000
Number of counts= N	15	300	750
Error: $\pm 2 \sigma = \pm \sqrt{N}$	$\pm 52\%$	$\pm 12\%$	$\pm 7\%$

The calibration factor used in the measurements before remediation was 2.16 for normal mode and 4.31 for sniff mode (Parkinson, 1994). The continuous radon monitor used in this study after remediation was reading a factor of 1.71 low for the normal mode (Calibration Factor = CF = 1.71); this was determined after the calibration of the meter in June 1999 at the NRPB in Chilton and recalibrated in September 1999. All the results were consequently amended, plus that an appropriate seasonal correction factor (SCF) was applied, taking into account in what month of the year the measurement was recorded. The seasonal correction factors calculated for Northamptonshire in 1992 (Miles *et al.*, 1992) were confirmed for the whole of the UK in 1995 (Pinel *et al.*, 1995). Table 2.2.4. contains the values of the seasonal correction factors for 1 month and 3 months; data are also available for 6 months' measurements (Pinel *et al.*, 1995).

Table 2.2.4. Seasonal Correction Factors for Indoor Radon Measurements in the UK
(Miles *et al.*, 1992), (Pinel *et al.*, 1995).

Month in which measurement starts	Measurement for 1 month (Miles)	Measurement for 3 months (Miles)	Measurement for 3 months (Pinel)
January	0.66	0.74	0.74
February	0.73	0.83	0.79
March	0.81	0.96	0.91
April	0.97	1.15	1.10
May	1.18	1.45	1.34
June	1.40	1.64	1.55
July	2.00	1.59	1.56
August	1.63	1.28	1.36
September	1.31	1.04	1.12
October	1.03	0.88	0.92
November	0.87	0.76	0.80
December	0.77	0.73	0.74

The RadHome meter contains a detection unit, electronics and a battery unit fitted inside a metallic case. The detection unit is based on an optimised chamber with silicon detector (Figure 2.2.3.). The measurements are done in pulse.h⁻¹, where 1pulse.h⁻¹ = 65 Bq.m⁻³ and the background radiation is considered to measure 1.5 pulse.h⁻¹. The meter is calibrated in a radon chamber by comparison with the measurements done in parallel in a ionisation chamber.

Figure 2.2.3. Rad Home Meter

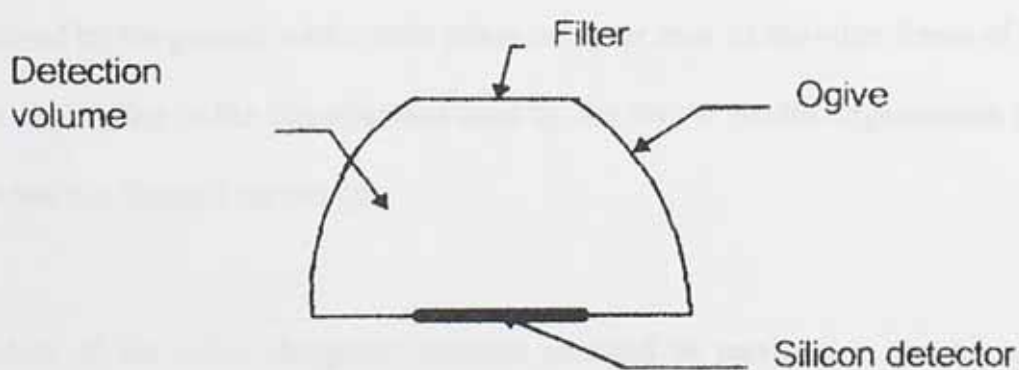

- linked absorbers

3. HEALTH RISKS AND COST EFFECTIVENESS

3.1. Radon and Risks for Health- Dose to the Lungs

^{222}Rn decays with a half-life of 3.82 days into ^{218}Po , which in turn changes by α decay into ^{214}Pb and by β and γ decay into ^{214}Bi and ^{214}Po (Figure 1.1.1.). The vast majority (>90%) of the radiation damage caused to living tissue is from the progeny, not from the radon itself. ^{222}Rn , ^{218}Po and ^{214}Po are all alpha particle emitters (WHO, 1988). Their decay (Table 1.1.2.) results in very localised energy deposition in the respiratory system. Alpha particles are high linear energy transfer (high LET) radiation which deposit most of their energy over a very short distance, causing massive chemical and biological damage to adjacent cells. The decay energies of ^{214}Po and ^{218}Po are 7.69 MeV and 6MeV and their half lives are respectively 164 μs and 3.05 minutes (Eatough and Henshaw, 1992).

It is presently acknowledged that the most important component of the radiation exposure to the UK public is due to the inhalation of radon and its daughters indoors. The dose received by the general public from radon is higher than all the other forms of natural radiation. According to the classification used by the World Health Organisation (WHO, 1988), radon is a Group 1 carcinogen.

Most of the radon daughters become attached to particles in the air and get breathed into the respiratory system; only a small fraction remains in the unattached form (Figure 2.1.1.). The size of the particles determines how far the radioactive material is

inhaled; for particles of 0.01-7 μm , the smaller the particle, the further it travels, so the very small particles travel until they reach the alveoli. For particles $< 0.01 \mu\text{m}$, a large proportion are deposited in the upper respiratory tract leading to damage of the trachea.

The layer of cells lining the bronchi is covered by mucus and these cells are easily damaged by alpha particles that come from radon daughters being breathed in the lungs, attached to minute particles from the atmosphere. Although there are natural clearance mechanisms, they are too slow to remove all the radioactive material before it has decayed, delivering a radiation dose to the sensitive lung cells. The thin layers of cells in the bronchi are covered by mucus that allow alpha radiation to penetrate the layer of living cells underneath. The nuclear DNA of the cells is damaged by the alpha particles by breaking its double strand and abnormal cells appear, resulting in cancers of the bronchi (Melloni *et al.*, 2000). The risk of lung cancer increases as the indoor radon concentration increases and the population exposure to radon increases (Figure: 3.1.1.) (DETR, 2000b).

Figure 3.1.1. Lifetime risk of lung cancer potentially induced by radon to non smokers (DETR, 2000b)

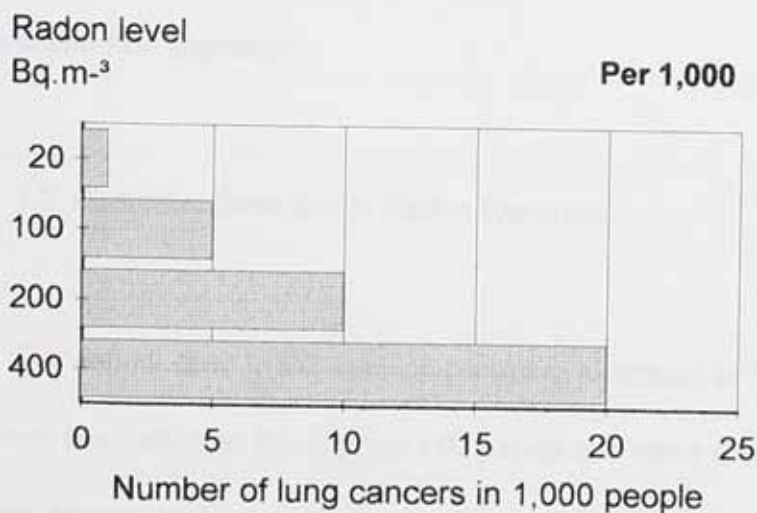

The probability for basal cells to be damaged as a result of radiation is higher than for secretory cells and ^{214}Po alpha particles are primarily responsible for transformations in bronchial target cells (Hofmann *et al.*, 2000). Most respiratory cancers are thoracic, with the largest proportion of lung tumours in the bronchi. There are four major classes of lung cancers in humans and their appearance frequencies differ for smokers and non smokers (Table 3.1.1.) (Gabriel, 1997).

Table 3.1.1. Average Frequencies for the Major Types of Lung Cancers

Cancer Type	Average Frequency
Squamous Cell Carcinoma	33-50 %
Small Cell Carcinoma	16-33 %
Adenocarcinoma	10-16 %
Large Cell Carcinoma	< 5-10 %

The effects of radon are stochastic and can occur at any time after the biological damage; the time taken for the cancer to appear is the latency period and can be from 5 to 50 years. To estimate the lung cancer risk arising from exposure to radon daughters, three different approaches are used:

- the miner epidemiology approach
- the residential epidemiology approach
- the dosimetric approach.

3.2. Radiation Dose due to Radon Exposure

The annual dose to the average person in Cornwall is 7.8 mSv, with radon making up 81% of that, while to the average UK person the value is less, at 2.6 mSv. The annual radiation dose to body tissues due to radon exposure at 20 Bq.m^{-3} is 10 mSv. In most

circumstances the lung cancer risk from radon is small, but, for example, living in a house with radon at the AL of 200 Bq.m^{-3} carries a (3-5)% risk of fatal lung cancer (NRPB, 2000). Radiation doses to lungs from inhalation of radon daughters cannot be measured and are estimated using models that take into account the various processes involved: inhalation, deposition, clearance and decay of radon progeny in the airways of the lung. Such models calculate doses on the basis of the total mass of the blood-filled lung (ICRP, 1994). Radiation doses to tissues and cells of the respiratory tract are influenced by breathing characteristics and are determined by respiratory parameters (body size, level of physical activity, state of health, smoking habits). The ICRP model distinguishes the following anatomical regions of the human respiratory tract:

- extrathoracic- anterior and posterior nasal passages
- thoracic regions- bronchial, bronchiolar, alveolar interstitial

Most respiratory cancers are thoracic, with the largest number of tumours in the bronchi.

3.3. Dose to Other Organs

It has been suggested that radon could lead to the development of other cancers, such as skin cancer, leukaemia and cancer of the prostate. Radon decay products can deposit on thin skin in sufficient quantity to give significant doses; if the basal cells are irradiated, a risk of cancer follows (Eatough and Henshaw, 1995). Radon dissolved in drinking water can cause the stomach to receive a significant dose in the hour that the water remains there before being transferred to the small intestine (Cross *et al.*, 1985). When radon reaches the bloodstream, it is transported to the red bone marrow that absorbs it due to its fat content. The radon is dissolved in the lipid content and thus concentrated in the cells. This process could explain the induction of acute myeloid leukaemia

(Henshaw *et al.*, 1990). More recent research into the effects of natural indoor radon exposure could find no association between household exposure to radon and leukaemia in adults in the UK (Law *et al.*, 2000).

Breathing radon affects other tissues: the skin (25 mSv), red bone marrow (0.7 mSv), liver (0.5 mSv) and other tissues (0.2 mSv) (Kendall, 2000). Estimated equivalent doses to various organs resulting from exposure to radon are detailed in Table 3.3.1.

Table 3.3.1. Estimated Radiation Doses to Organs due to Radon (NRPB, 2000).

Organ	Equivalent Dose (mSv)	
	BEIR**	Knursheed***
Lung	100	-
Red bone marrow	0.1-1.2	0.65
Bone surface	0.08-0.8	0.03
Breast	0.3	0.42
Liver	0.5	0.09
Muscle*	0.2	0.05
Skin of face or neck	25 (1-200)	-
*Typical dose to other body organs	**Biological Effects of Ionising Radiation	***Author "Doses to systemic tissues from radon gas"

3.4. Radon Health Risk Debate

Radon, a human carcinogen, has been a topic of some vigorous debate even though the consensus of opinion is clearly in favour of it being so (Darby *et al.*, 1998). The evidence for radon being a carcinogen was originally based upon classical epidemiology. Two central criteria in understanding the biological mechanisms are the dose-response relationship and experimental support. Animal studies provide a great amount of

experimental support and enable a range of working models to be produced that give rise to a clear understanding of how cancers can arise. Work with miners shows that radon is a carcinogen at the elevated levels that they are exposed to.

A number of studies aimed to prove radon as a health risk, look for a direct link between domestic radon exposure and cancer. A project in South-West England on 982 individuals with cancer demonstrated higher lung cancer rates related to length of exposure and radon levels. The conclusion was that, in the UK, about 5% of lung cancers are due to radon (Darby *et al.*, 1998).

The common assumption in radon studies is that health risk is proportional to radiation dose and so a linear, no-threshold model is commonly in use. This model assumes that there is a direct and linearly proportional relationship between radon exposure level and cancer induction, with no lower threshold (NRC, 1991). A number of geographical correlation studies have tried to relate the average radon concentrations and average lung cancer rates in geographical areas of different sizes. In the USA, Cohen correlated mean lung cancer rates with mean radon concentrations and the result was a negative trend (Cohen, 1997). The study has been criticised by epidemiologists (Lubin, 1998).

Radon levels probably have multiplicative effects on cancer risks for smokers, but better methods are needed to inform the smoking public about their additional risk from exposure to even low levels of radon (Lee *et al.*, 1999, Melloni *et al.*, 2000). The theory is that if radon doubles the risk of lung cancer to an individual and the smoking increases the risk ten folds, the combined risk would be twenty times greater (NRC, 1988). Lifetime

risk of fatal lung cancers for smokers lies in the range (10- 15)% and for non-smokers in the range (1- 3)%; for a mixed population of smokers and non-smokers, the risk range is (3- 5)% (NRPB, 2000).

3.5. Cost Effectiveness and Health Improvement

Cost Effectiveness Analysis (CEA) is a method used to evaluate the health outcomes and resource costs of interventions. Its aim is to compare the relative value of alternative interventions for improving health. Until quite recently, there was no detailed consensus over a CEA methodology (Kassirer and Angell, 1994). The need to standardise CEA has been recognised for at least a decade (Task Force, 1995).

The necessity of comparing different cost effectiveness results is a common requirement in radon research and a number of studies have been published (Denman and Phillips, 1998a: Denman and Phillips, 1998b: Denman *et al.*, 1999a, Denman *et al.*, 1999b, Denman *et al.*, 2000a, Denman *et al.*, 2000b). These studies compare cost effectiveness in remediation programmes in workplaces and in particular in hospitals, in schools in the UK and abroad and in domestic properties in the UK, in new and existing houses. These comparative studies reveal that it is essential to establish a commonly accepted basis for calculating remediation costs, such as 'the annual cost per lung cancer saved'.

CEA is conducted from a societal perspective that represents the public interest. Studies (Denman *et al.*, 1998a: Denman *et al.*, 1998b: Denman *et al.*, 1999b) have

indicated the wider cost benefits of the radon remediation programmes to society, quoting results in terms of costs of remediation programme per annual lung cancer averted. CEA in health care is based on the assumption that health benefits are the objectives that decision makers want to maximise, subject to a constraint on health care resources (Russell *et al.*, 1996).

Costs and health outcomes occurring during different time periods should be discounted to their present value and at the same rate. The discount rate recommended to be used is 3%; before discounting, all the costs should be adjusted for inflation in this two stage correction. The discount rate (overall 6%) should be reviewed periodically to reflect important economic changes (Weinstein *et al.*, 1996).

3.6. Cost Effectiveness Studies in Northamptonshire

Since 1993, a comprehensive radon remediation programme in NHS properties in Northamptonshire has been undertaken, and Denman *et al.* (1997) have studied the costs and dose saving and reported on the cost effectiveness. The method has been extended and applied to domestic properties in Northamptonshire (Denman and Phillips, 1998a). The analysis has now been extended to domestic remediation programmes in North Oxfordshire and Somerset, as well as subsets of expanded Northamptonshire data. The areas studied are shown in Figure 3.6.1.

Figure 3.6.1. Map of Affected Areas Studied in Cost Effectiveness Study

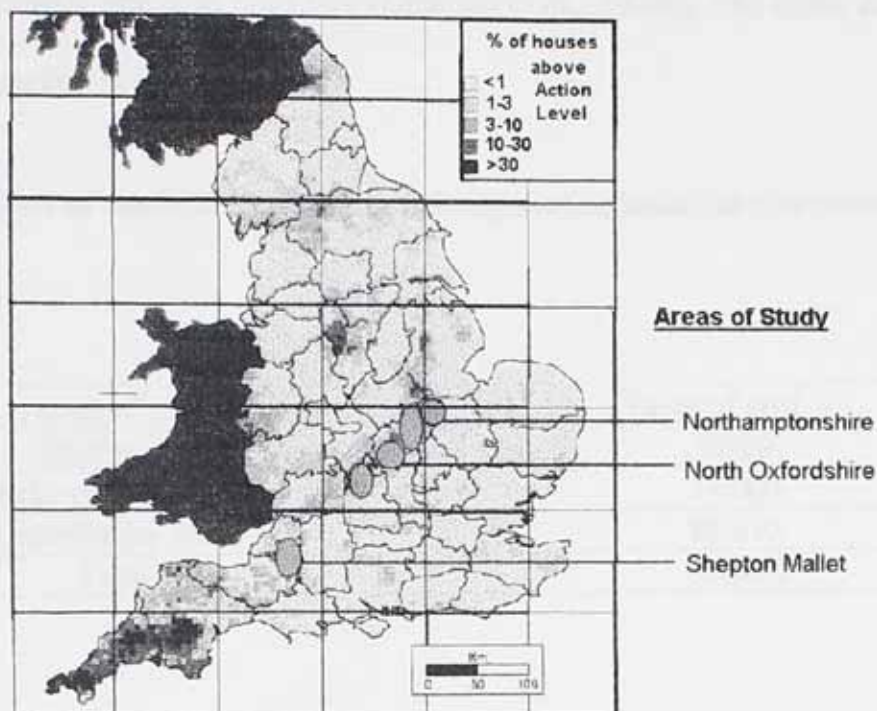

The comprehensive radon remediation programme in NHS properties in Northamptonshire included 2 major hospitals, 26 health centres and 14 clinics. The series showed the typical log-normal distribution of initial radon levels as noted in previous studies. Using over 1,000 TED's, some 21 locations with radon levels above the WAL were found. Denman *et al.* (1997) reported that a total of 135 staff worked in the affected rooms, out of a total of 11,100 staff and that the collective dose saved annually was estimated to be 0.533 man-Sievert.

The total cost of the NHS remediation programme, including the initial TED survey, remedial work and subsequent testing, was £107,650, giving a total cost per man-Sievert annually saved of £201,970 (Denman *et al.*, 2000c). The costs, corrected for inflation, are detailed in Table 3.6.1.

Table 3.6.1. Costs of the NHS Remediation Programme, Inflation Corrected (Denman *et al.*, 2000c).

Name of cost	Value of cost (£)
Staff costs	9,980
Track-etch detectors	14,000
Remediation work	83,670
Total	107,650

Denman *et al.* (1997) compared the remediation programme in NHS properties with the NRPB initiative to reduce patient dose from dental X-Rays. Converted to 1997 prices, the NRPB programme had total costs of £327,000 per man-Sievert saved annually. The NRPB (1994) considered that the programme was justified but approaching the financial estimate of the general health detriment of X-Ray dose which would be saved. If other workplaces in Northamptonshire would be similar to NHS properties, the total lung cancers averted by remediation would be 0.75 per year (Denman *et al.*, 2000c).

4. RADON RESEARCH PROJECTS IN THE UK AND NORTHAMPTONSHIRE

4.1. Radon Measurements- Previous UK Projects

The first major project that measured radon levels in dwellings was carried out by the NRPB in 2,000 buildings, between 1981 and 1987 (Wrixton *et al.*, 1988). One year measurements were performed using TED's and the radon concentration variation followed a log- normal distribution curve. The highest radon concentrations were in the South- West of England and at that time Northamptonshire was not highlighted as a potential problem.

As a result of this first major project, the Department of the Environment commissioned the NRPB to carry out further surveys. By the end of 1991, 92,000 dwellings in England were monitored for radon and it became clear that the affected counties were Cornwall, Devon, Northamptonshire and Somerset (Green *et al.*, 1992).

A map with radon AA's was established by the NRPB (Figure 3.6.1.). During the 1980's, it was estimated that at least 100,000 homes in the UK were likely to require remedial work (NRPB, 1990a). Since 1987, around 400,000 government- funded tests have been carried out by the NRPB (DETR, 2000).

4.2. Previous Northamptonshire Projects Concerning Radon in the Workplace

4.2.1. General Studies

The highest percentage of dwellings above the AL (10-30%) in Northamptonshire was recorded in the Northampton and Kettering areas (Figure 4.2.1.1.).

Figure 4.2.1.1. Northamptonshire Districts



The number of workplaces that were tested since 1992, when Northamptonshire was declared an AA, and the percentage above the AL is given in the Table 4.2.1.1.

Table 4.2.1.1. Workplaces Tested for Radon in Northamptonshire (Denman and Phillips, 1998c)

District	Number tested	Percentage above Action Level	Average radon level (Bq.m ⁻³)	Population	Area (ha)
Corby	37	11	38	53,000	8,000
Daventry	228	9	74	63,000	66,600
E Northants	80	10	63	68,000	51,000
Kettering	178	16	107	77,000	23,400
Northampton	184	21	55	181,000	8,100
S Northants	52	10	61	71,000	63,500
Wellingborough	95	14	66	68,000	16,300

Radon levels vary greatly even in small areas, as shown in Table 4.2.1.2.

Table 4.2.1.2. Radon Level Variation in Commercial Premises in Northampton, by Postcode (Denman and Phillips, 1998c)

Radon (Bq.m ⁻³)	Percentage of properties				
	NN1	NN2	NN3	NN4	NN5
0-99	33.6	53.3	56.3	75	50
100-199	23.5	20	18.8	4.1	25
200-399	14.3	0	15.6	8.3	6.2
>400	28.6	26.7	9.3	12.8	17.8

4.2.2. National Health Service Studies

A far more extensive review has been conducted in NHS properties. The NHS properties in Northamptonshire comprise 82 sites with different sizes, out of which 21 are small Health Centres and 2 are large General Hospitals (Denman *et al.*, 2000a). Table 4.2.2.1. gives in detail the distribution of the NHS properties in Northamptonshire:

Table 4.2.2.1. NHS Premises in Northamptonshire (Denman *et al.*, 2000a)

Type of Property	Number
General Hospital	2
Other Hospital	10
Nursing Home	21
Staff Accommodation	4
Management Offices	3
Health Centre	26
Health Advice Shop	2
Clinics	14

Legislation requires employers, including the Health Authority, to identify and remediate any workplaces with high radon levels and assess the risks caused by the exposure (Ionising Radiations Regulations, 1999). In the NHS premises, the responsibility of co-ordinating the survey work was taken by the Radiation Protection Adviser (RPA) to the Health Authority. A number of 1,038 detectors was used in the 1,023 rooms of the NHS premises and the results showed a log normal distribution, with 8% over the WAL of 400 Bq.m⁻³ and 1% over 1,000 Bq.m⁻³, as shown in Table 4.2.2.2. (Denman *et al.*, 1997).

Table 4.2.2.2. Distribution of Radon Levels in NHS Properties in Northamptonshire (Denman *et al.*, 1997)

Average radon level (Bq.m ⁻³)	General Hospital A	General Hospital B	Total
< 100	207	130	655
101-200	37	44	184
201-300	13	19	64
301-400	8	7	39
401-500	8	1	33
501-600	1	1	16
601-800	4	0	14
801-1000	0	1	8
1001- > 1201	3	2	10

Estimates of personal radon exposure were recorded for 33 workers working in 4 NHS sites above the WAL (Parkinson, 1994). The project used personal radon meters, combined with continuous environmental monitoring of radon levels in the workplace.

Another project that followed in the previous ones' footsteps concentrated on the health issues due to radon exposure of NHS workers in Northamptonshire (Barker, 1998). The conclusions indicated that remedial programmes can be cost effective when compared to other forms of risk reduction.

4.2.3. Studies in Northamptonshire Schools

In 348 Northamptonshire schools, 2,372 TED's were placed and 20 schools were found to have one or more rooms with radon levels above the WAL (Denman *et al.*, 2000a). Schools are workplaces. Only half of the number of rooms that would have been predicted as having raised radon levels from the NHS data, had levels above WAL, maybe due to the number and size of large classrooms and greater air mixing due to high occupancy (Denman *et al.*, 1999b). The number and type of affected rooms in 20 schools is shown in Table 4.2.3.1.

Table 4.2.3.1. Rooms in Schools with Radon Levels above the Action Level (Denman *et al.*, 2000a).

Type of room	Number of Affected rooms
Classroom	48
Library	2
Hall	3
Head's office	7
Deputy Head's office	2
Secretary's office	1
Other office	9
Staff room	7
Boiler room	2

The costs of the Northamptonshire schools remediation programme are given in Table 4.2.3.2. (Phillips *et al.*, 2000)

Table 4.2.3.2. Costs of Northamptonshire Schools Remediation (Phillips *et al.*, 2000)

	Pupil areas	Staff areas	Total
Detectors costs (£)	26,430	10,140	36,570
Remediation costs (£)	38,020	2,750	40,770
Total costs (£)	64,450	12,890	77,340

The radon reduction and reduction in dose in the schools studied in Northamptonshire is given in Table 4.2.3.3. (Phillips *et al.*, 2000)

Table 4.2.3.3. Radon and Dose Reduction After Remediation in Some Schools in Northamptonshire (Phillips *et al.*, 2000)

	Initial Radon (Bq.m ⁻³)	Final Radon (Bq.m ⁻³)	Annual individual dose saving (mSv)	Annual collective dose saving (mSv)
Pupils average	570	57	2.4	66
Pupils total	-	-	132.5	3,630
Staff average	655	58	2.24	4.5
Staff total	-	-	177	357

4.3. Decision Support Systems for Radon Monitoring and Remediation

Decision support systems (DSS) are applications designed to aid professionals in making key decisions in a certain area; the improved system is computerised. They can simplify access to data needed to make decisions, provide reminders and prompts, assist in establishing a diagnosis and in entering appropriate orders, and alert professionals when new patterns are recognised. DSS's that present specific recommendations in a form that can save time have been shown to be highly effective, sustainable tools for changing professionals' behaviour. Designing and implementing such systems is challenging. Automated DSS's will be used more broadly once computer-based records and order-entry systems will become more common (Payne, 2000).

There is no DSS already designed for tackling radon, neither for the domestic market, nor for the workplace. The Department of the Environment (DOE, 1995, DOE, 1996a, DOE 1996b, DOE 1996c) and the NRPB (NRPB 1996b, NRPB, 1996c) have published literature that suggests ways of helping people in making a decision about their radon problem.

To provide scientific support to the planning of the present research and as a management proposal for radon, two different DSS's have been designed in a completely original project. One DSS is designed for the workplace, where the decisions are based on legal requirements (Figure 4.3.1.) and another one for the domestic market, where the decisions are voluntary (Figure 4.3.2.).

Figure 4.3.1.

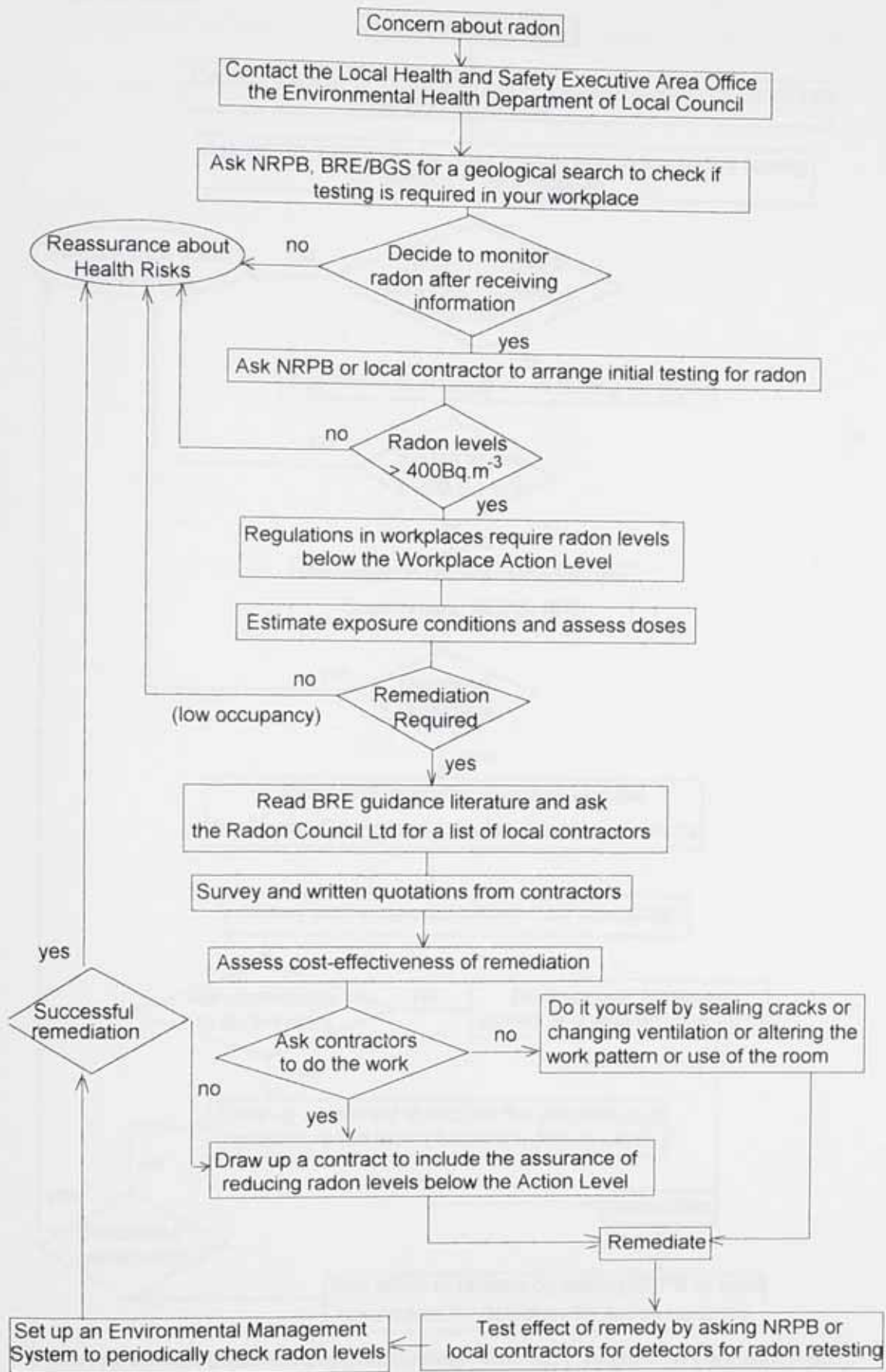

Workplace Decision Support System- Legal Requirements to Deal with Radon

Figure 4.3.2.

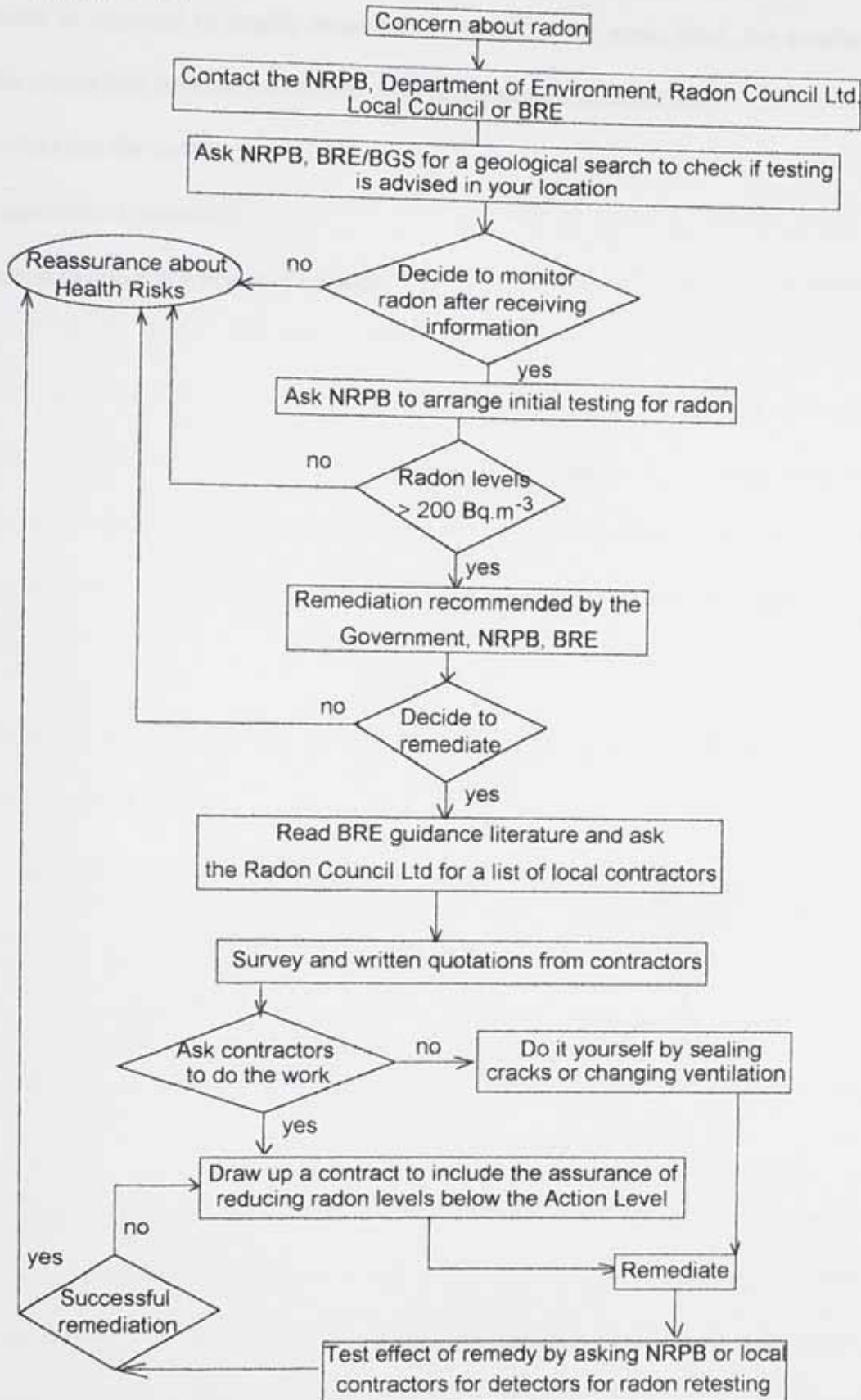

Domestic Market Decision Support System- Voluntary Actions to Deal with Radon

A comparison of the two DSS's will highlight the main differences- voluntary actions as opposed to legally bounded ones and, in the same time, the similarities; the main stages that anybody concerned with radon should consider are:

1. initial test for radon;
2. remediate if necessary;
3. retest to check the effect of remedy.

Method	Approximate Cost
Initial Test	20
Radon Mitigation	1000
Retest	20
Total	1040

5. MONITORING AND RADON REMEDIATION

5.1. Principles of Radon Remediation in the Built Environment

It has been suggested that a change of use of rooms or change in the internal construction of a building, can alter significantly the radon levels. In the management of high radon levels it is essential to reduce levels as quickly and effectively as possible; increasing ventilation alone can be advantageous. In extreme cases, for very small store rooms or unused areas, it may be cost effective to seal the room permanently as the cost of long term remediation may be greater than the value of the space. The five main methods of preventing radon getting into the built environment are given in Table 5.1.1. (Cliff, 1994).

Table 5.1.1. The Effectiveness of the Main Methods of Preventing Radon Entry into Buildings (Cliff, 1994)

Method	Radon reduction factor
Sealing cracks	2.9
Sealing membrane	2.2
Pressurisation	3.7
Subfloor ventilation	2.2
Subfloor depressurisation	19

The BRE advises on a range of reliable, practical and cost effective radon remedial measures, applicable for all types of buildings found in the UK. Different techniques of risk assessment and remedial work can be used and practical and effective solutions of remediation can be usually found for any type of building once a decision to remediate has been made. In existing buildings, sealing of the floor or of individual cracks and service

entries has proved neither very successful nor cost effective, but in the case of new buildings, the costs are significantly lower (Woolliscroft, 1992). For suspended floors, subfloor ventilation can be effective, but costly in the meantime. Subfloor depressurisation with the radon sump (Figure 5.1.1.) is the most cost effective means of remediation.

Figure 5.1.1. Radon Sump

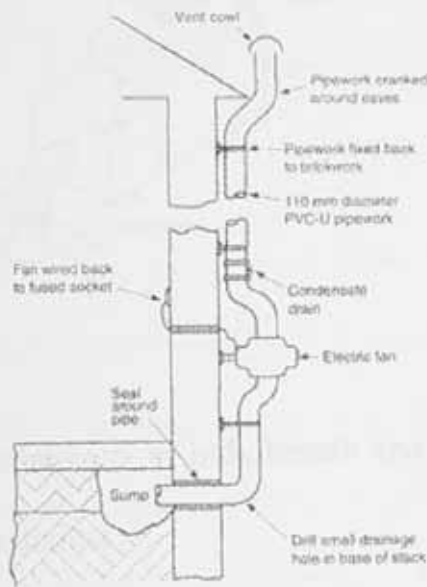

Underfloor fans can be used instead of sumps (Figure 5.1.2.).

Figure 5.1.2. Underfloor Fan

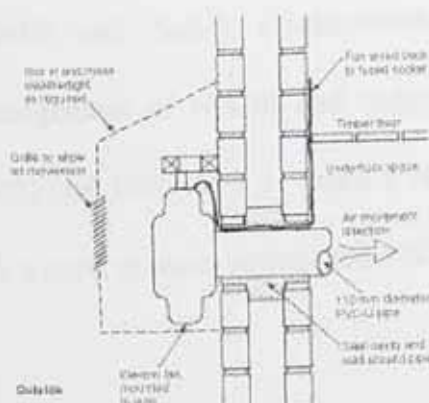

Positive pressurisation is more cost effective, with costs of fitting a fan around £300.

Ventfans are used in this purpose (Figure 5.1.3.).

Figure 5.1.3. Ventfan

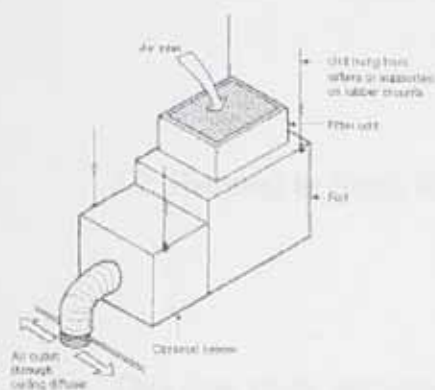

Ventilation is of little benefit and not really effective as a permanent method of radon remediation.

The employer has a legal responsibility to reduce radon risk by remediation or restriction of access in an AA. Exposure of workers to radon is governed by the IRR 1985 (Health and Safety Executive, 1985) and the Approved Code of Practice covering radon (Health and Safety Commission, 1988). Employers in AA's are required by the Management of Health and Safety at Work Regulations (Health and Safety Executive, 1992) and IRR 1999 to make a risk assessment about radon. The risk assessment in the AA's must contain written rules if the WAL is over 400 Bq.m^{-3} (Dixon, 2000).

As an example of the decision not to remediate, the data from a hospital in North Wales is displayed below (chapter 5.2.). To illustrate cases of complicated remedial projects, a case study in a Victorian building in Buxton (chapter 5.3.) and a hospital in Kettering (chapter 6.9) are chosen.

5.2. Hospital in North Wales

This case study includes extensive measurements carried out in a hospital in North Wales. In 1996, regions of Wales were declared radon AA's. In June 1998, the NRPB published formal advice to Government on radon AA's in Wales. Concern about radon was raised due to these developments and the Radiation Protection Adviser (RPA) of the Medical Physics Department in the Northampton General Hospital (NGH) was consulted. Measurements were made in ground floor rooms of the hospital. It was agreed to monitor radon levels with a Rad-7 detector to confirm TED's results, establish any trends that might assist remediation and persuade the local management of the need to remediate.

One of the reasons for the data collection was to constitute a case study for the present thesis. A total of 68 locations were assessed by TED's in May to August 1998; of these, 4 locations (Rooms 1-4) were over the WAL of 400 Bq.m^{-3} . Table 5.2.1. includes

Figure 5.2.1. Map of North Wales

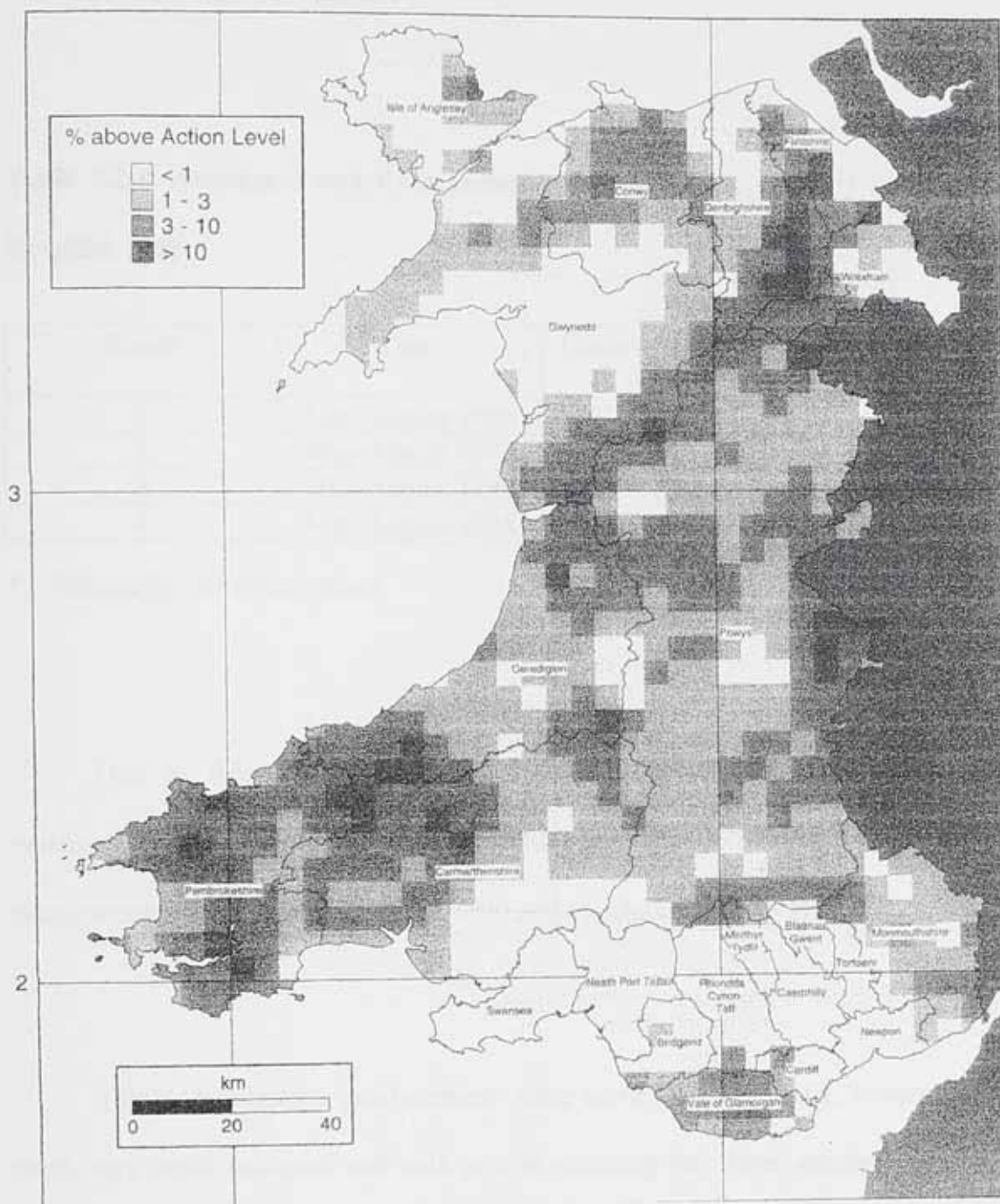

the TED's values in the four monitored rooms above the WAL and radon levels are seasonally corrected with the SCF's.

Table 5.2.1. Average Track-Etch Detector Radon Levels (Bq.m⁻³) in North Wales Hospital, 1998.

Room	Date	Uncorrected Radon (Bq.m ⁻³)	Corrected * Radon (Bq.m ⁻³)
1	May-August 1998	350	770
2	May-August 1998	270	594
3	May-August 1998	220	484
4	May-August 1998	200	440

* = Seasonally corrected values

Due to these initial high radon levels, the RPA decided to continue the measurements and record the radon variation continuously with a Rad-7 meter. These measurements were started in March 1999 and concluded in June 1999.

The most extensive measurements were carried out in room 1, a mortuary waiting room, very rarely occupied and with people spending very small amounts of time there. The measurements started on 12.04.1999 and concluded on 27.05.1999. The radon level variation in room 1 over all the monitored period is given in Figure 5.2.2. and detailed for shorter intervals in Figures 5.2.3.- 5.2.6.

Figure 5.2.2. Radon Level Variation in Room 1, Wales Hospital, 1999.

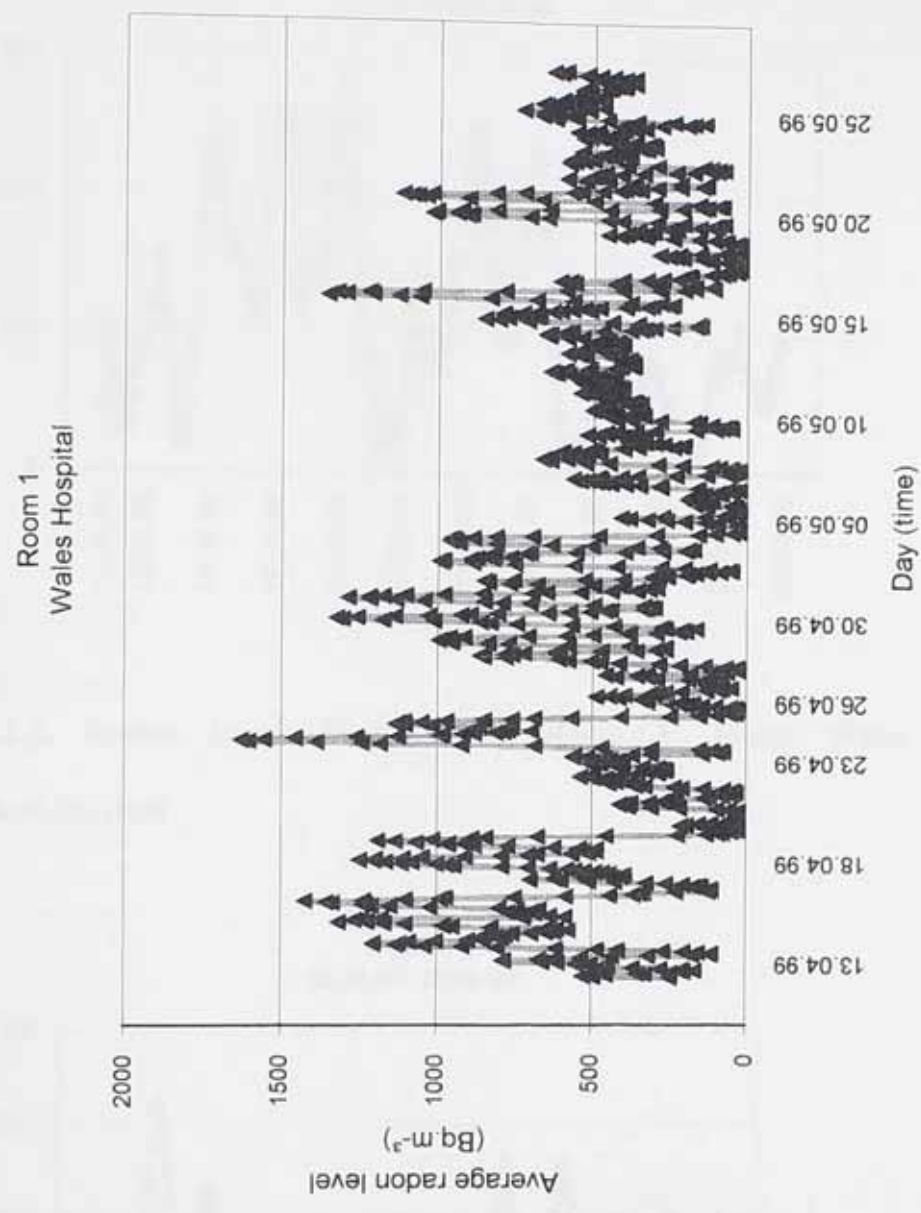

Figure 5.2.3. Radon Level Variation in Room 1, North Wales Hospital, 12.04.1999-23.04.1999

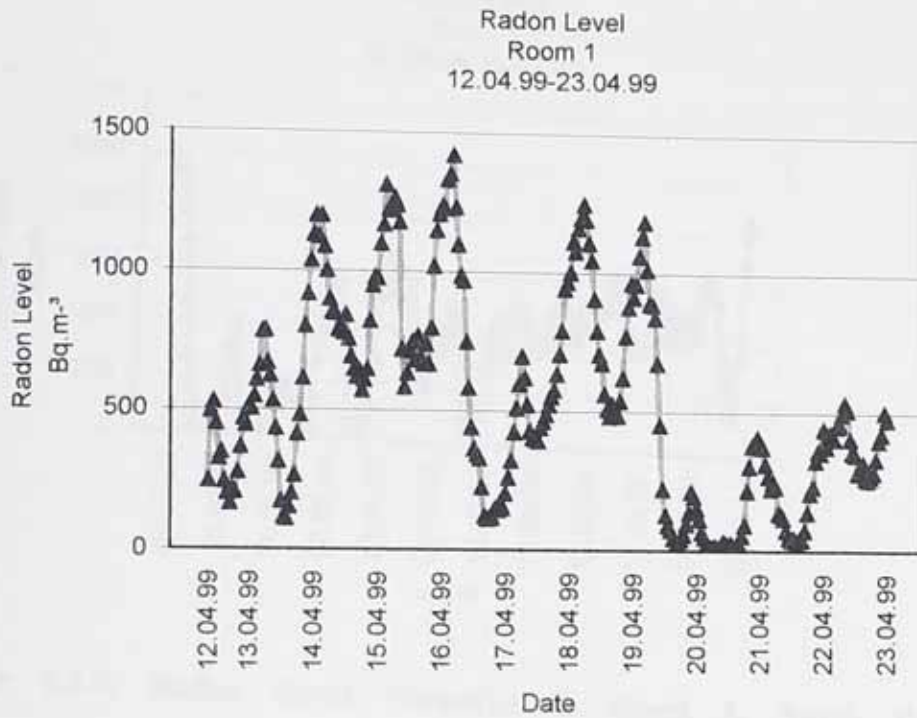

Figure 5.2.4. Radon Level Variation in Room 1, North Wales Hospital, 23.04.1999-04.04.1999

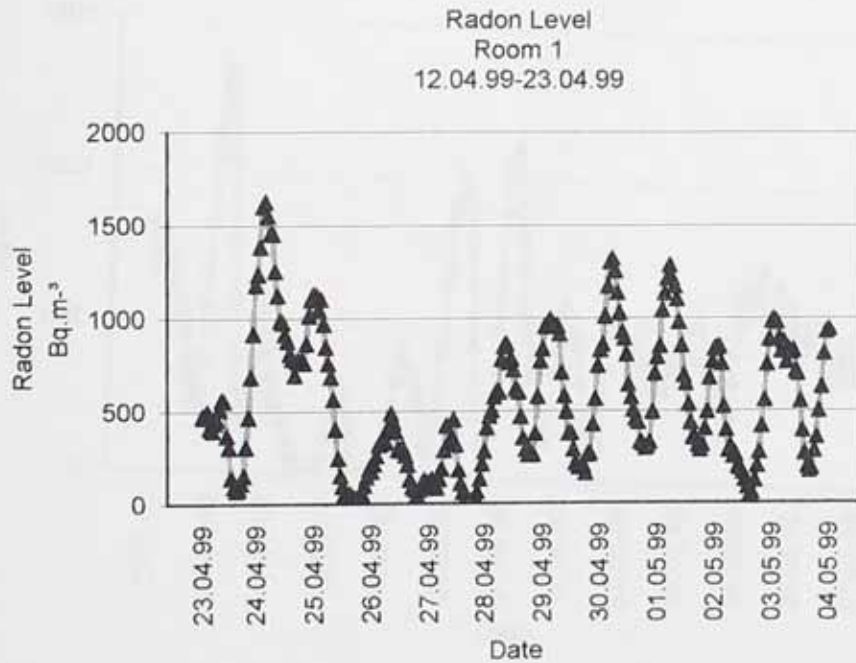

Figure 5.2.5. Radon Level Variation in Room 1, North Wales Hospital, 04.05.1999-15.05.1999

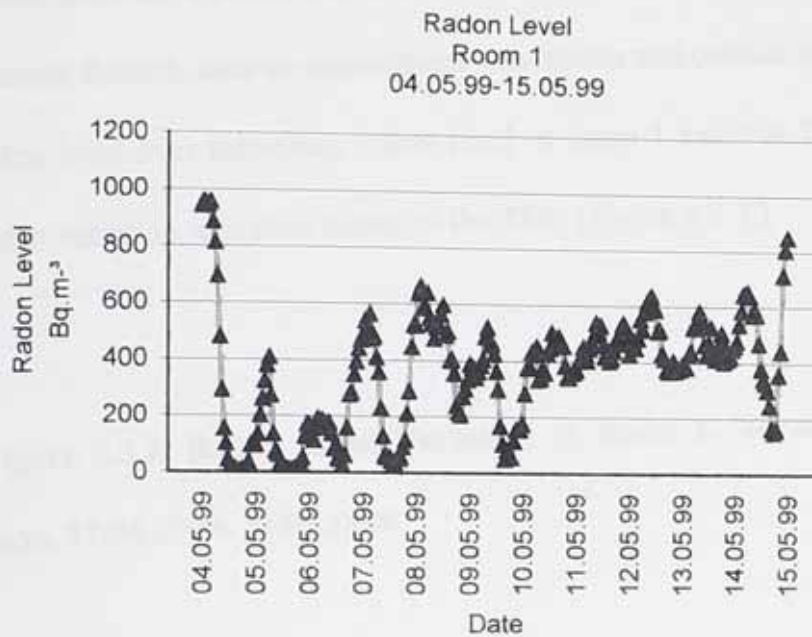
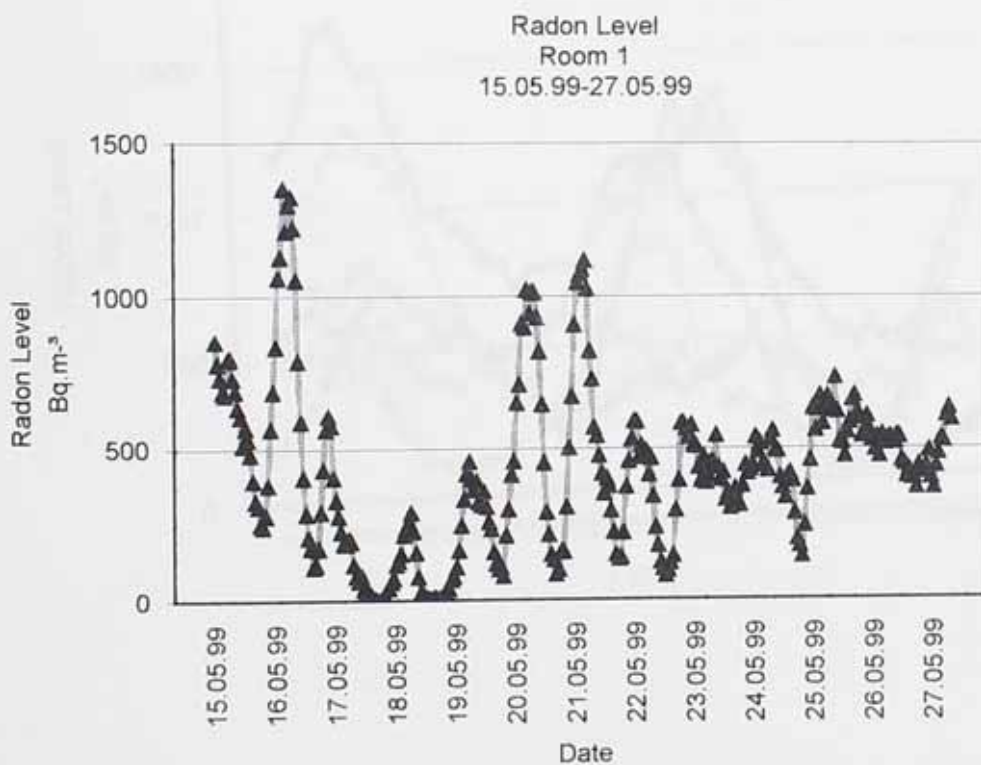
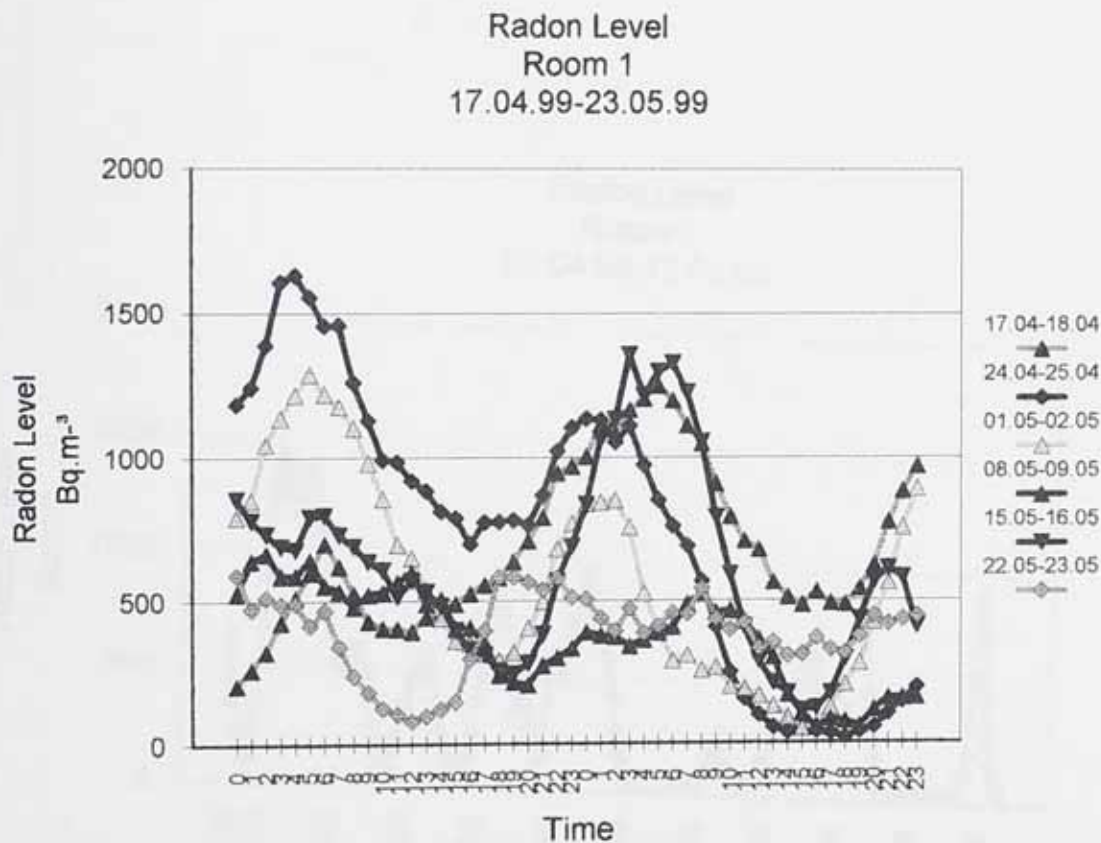

Figure 5.2.6. Radon Level Variation in Room 1, North Wales Hospital, 15.05.1999-27.05.1999



The radon levels in room 1 resembled a typical diurnal cycle (TDC) with maximum radon values recorded between 12 midnight and 10 a.m. and minimum radon values between 10 a.m. and 8 p.m. There are a few exceptions determined probably by external factors, such as atmospheric conditions and outside pressure. The ratio maximum radon level over minimum radon level in room 1 exceeds 200. The weekend pattern of radon variation was even closer to the TDC (Figure 5.2.7.).

Figure 5.2.7. Radon Level Variation in Room 1, North Wales Hospital, Weekend days, 17.04.1999- 23.05.1999



In Figure 5.2.7. the radon variation pattern for all the Saturdays and Sundays is not influenced by staff movement in and out of rooms and that is why it is closer to the theoretical predicted TDC.

Measurements in room 2, an office, started on 01.04.1999 and concluded on 12.04.1999. There is one person working in the office for short periods of time in a day. The radon level variation in room 2 is represented in Figure 5.2.8.

Figure 5.2.8. Radon Level Variation in Room 2, North Wales Hospital, 01.04.1999-12.04.1999

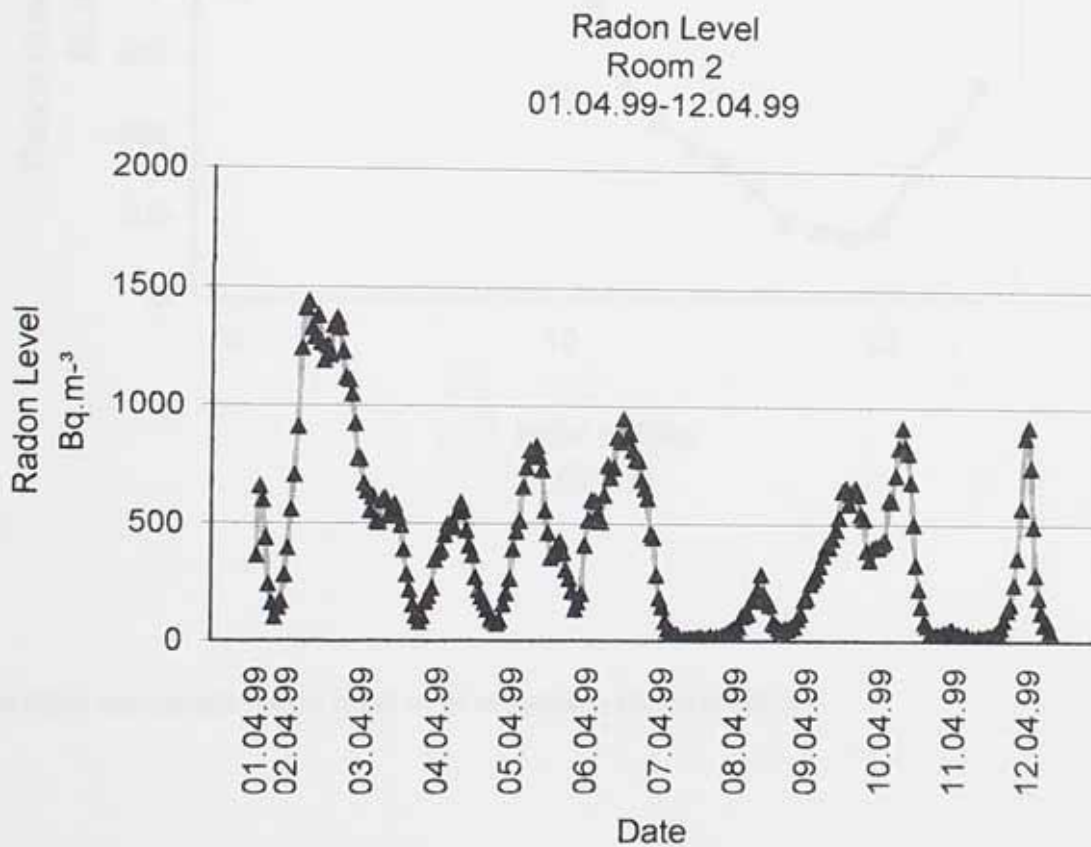

Radon levels in room 2 fitted a TDC, with one main exception on the 6.04.1999, when a maximum radon value was recorded after mid day. The weekend patterns of radon variation resembled a TDC due to lack of disturbance. A TDC is given in Figure 5.2.9. and is built on part of the measurements done in room 2 of the North Wales hospital.

Figure 5.2.9. Typical Radon Diurnal Cycle

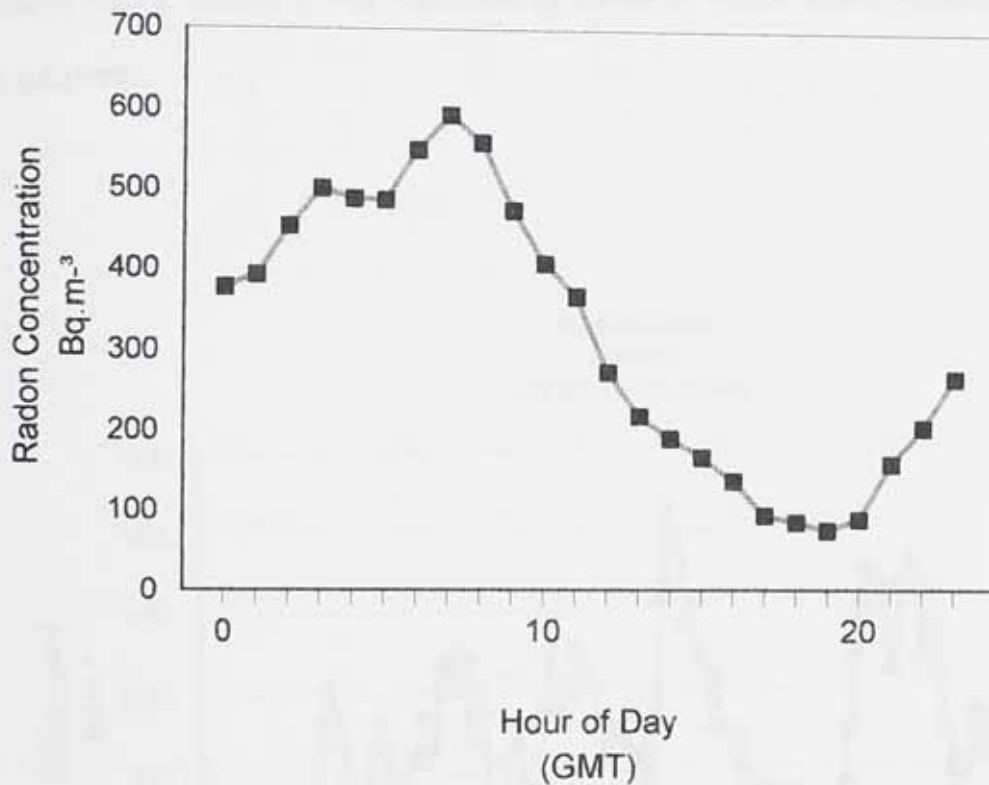

The ratio maximum radon level over minimum radon level is 8.

Room 3, another office, occupied by two people, was monitored twice, once between 22.03.1999-01.04.1999 and the second time between 27.05.1999-17.06.1999. The radon level variation in room 3 for these two periods of time is given in Figures 5.2.10. and 5.2.11. Figure 5.2.10. shows two distinctive maximum peaks, one of 529 Bq.m⁻³ on the 28.03.99, a Sunday, and the other (455 Bq.m⁻³ and 466 Bq.m⁻³) on 30.03.99, a Tuesday. The first spike could be due to a marked change in use of the room, as in weekends the windows and doors stay shut, whereas the other two peaks could be due to increased radon emission from source to the built environment.

Figure 5.2.10. Radon Level Variation in Room 3, North Wales Hospital, 29.03.1999-01.04.1999

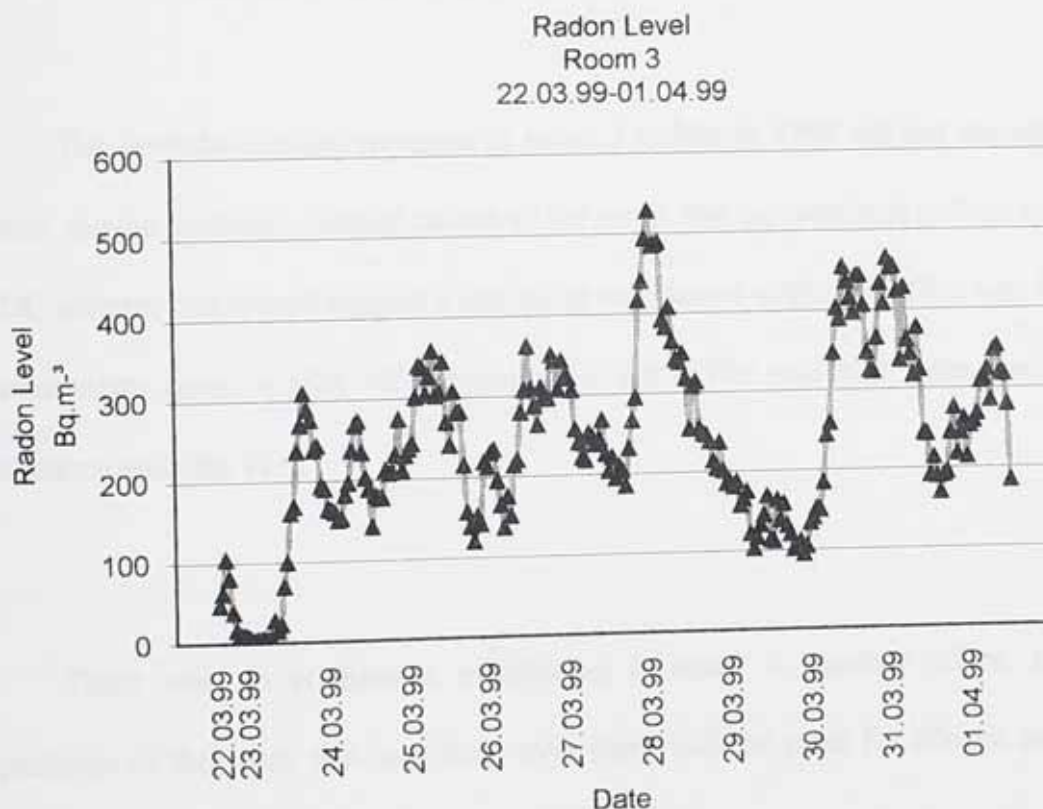
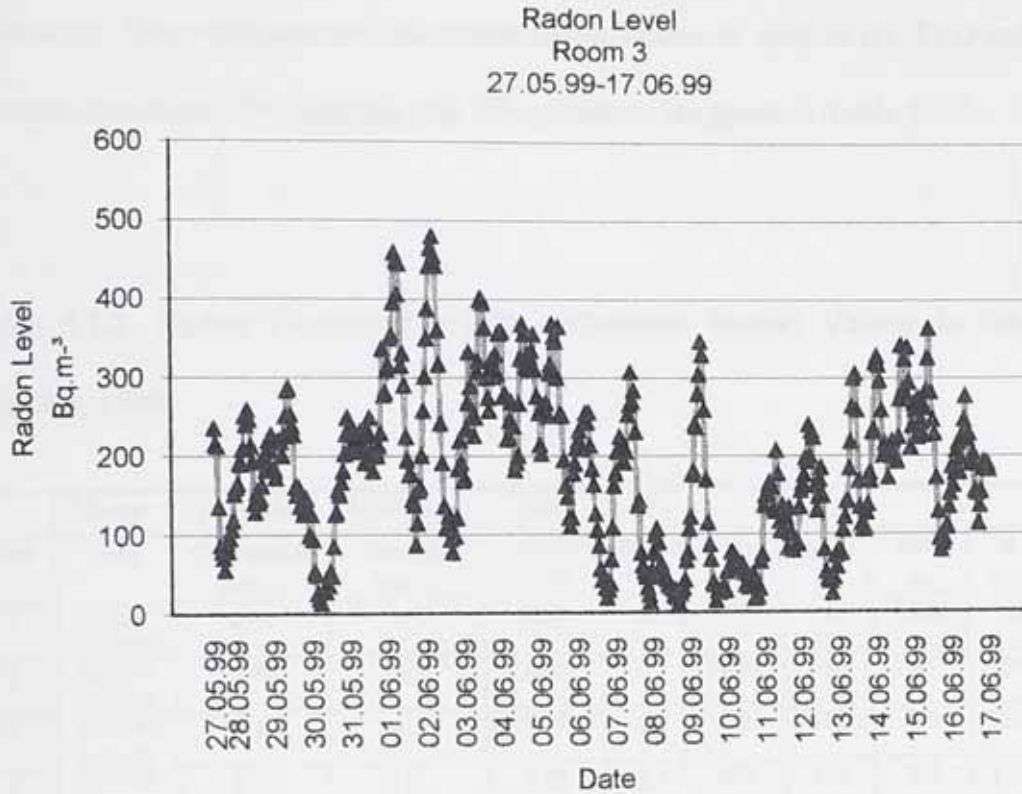

Figure 5.2.11. Radon Level Variation in Room 3, North Wales Hospital, 27.05.1999-17.06.1999



The weekdays radon variation in room 3 in March 1999 did not resemble a TDC pattern, maybe because a change of use of the room, but the weekend pattern was close to a TDC pattern; this would suggest a change in ventilation while the office was in use. The measurements done in May 1999 resemble a TDC. The weekend radon variation is in accordance with the TDC.

There was no continuous monitoring in room 4, another office, due to the importance of the work that was done over there and the need for silence and privacy; permission to measure in this office was not given.

The average radon levels recorded in each room were corrected with the NRPB SCF's. Additionally the CF of 1.71 for the meter was used due to the NRPB recommendations to apply corrections to all the measurements done with the Rad-7 before calibration. The minimum and maximum radon values, as well as the TED radon values, standard deviation, 50% quantile and 75% quantile, are given in Table 5.2.2.

Table 5.2.2. Radon Corrected (*1.71 calibration factor) Values in North Wales Hospital, 1999

Room	Radon Date	Continuous Correction factor	Monitoring Average Radon	year '99 Corrected average *	Min	Max	50% qu	75% qu	st dev	TED year '98
1	12.04.99 27.05.99	1.08	795	869	0	2,788	731	1,064	550	770
2	01.04.99 12.04.99	0.97	685	665	0	2,488	610	1,037	601	594
3	22.03.99 01.04.99	0.82	411	337	0	905	408	536	192	484
3	27.05.99 17.06.99	1.36	313	422	12.5	822	316	423	172	484
4	/	/	/	/	/	/	/	/	/	440

Table 5.2.2. shows that the average corrected radon values (Bq.m^{-3}) are similar to the TED values recorded one year earlier. The most indicative values are the ones averaged over a period of three months with the TED's. Due to the high values, remediation work was considered and planned. As a result of the fact that the reorganisation of Health Service provision in Wales resulted in change of use to all rooms, a decision has been made not to remediate. The average cost required to remediate a room in the workplace is £5,200 including VAT, with a range of £850 to £18,300.

The occupancy of room 1 is listed as low and there is a very low degree of occupancy of the other rooms. Accordingly, no remediation has been carried out. It would not be cost effective to remediate rooms that are scarcely used. The radiation dose depends on the average radon level in the built environment, as much as on the occupancy of the venue. A general warning was given to the management and staff that if people do use the rooms again, then remediation must be done. The Ionising Radiation Regulations in workplaces state that the employer does not need to remediate, but can declare a controlled area and ensure restricted access by establishing written local rules of using the rooms only for a short time (IRR, 1999).

Another decision not to remediate has been taken in the Northamptonshire NHS remediation programme where two locations are used as store areas, marginally above the WAL, have not been remediated (Denman *et al.*, 1997). The locations that are rarely entered by staff do not justify remediation. There are other alternatives to remediation and to remediate is not always the best solution. The decision not to remediate needs to be followed by reassurance about the health risks (Figure 4.3.1.). This method of avoiding the use of the AA's is highly cost effective. It requires instead an environmental management system- DSS.

5.3. Case Study from Buxton (Derbyshire)

In 1992, the same year as Northamptonshire, Derbyshire was declared a radon Affected Area (Figure 5.3.1).

Figure 5.3.1. Radon Map of Derbyshire With Radon Precautions Requirement for New Dwellings (BRE, 1992)



A radon company providing practical advice and assistance on radon remediation in that area, has an ongoing exchange of expertise with the radon research team at UCN. A survey conducted in 1991 for the Local Authority in Buxton was of particular interest for the present theses, as an example of a long term remediation project that needs to be assessed for its efficiency after 10 years. The venue of the project is a Victorian building, situated on the top of a hill, built using local materials, with very high ceilings and extensive cellars into the bed rock. Initial radon monitoring was carried out in five rooms by the NRPB and confirmed elevated radon levels in the building. High radon levels were recorded in most of the rooms (18), either below ground level, or on the ground level at one end of the building.

Once the survey was completed, a detailed financial quotation for the buildings' treatment was given to the Council. The internal air quality was poor, due mainly to numerous modifications that had been carried out to the internal structure of the building. Due to the size and structure of the building, it was decided that any treatment needed to be taken in stages and each stage would need to be finished before moving to the next one. One of the basement rooms (Room 8) suffered a change of use between the initial NRPB monitoring and this survey's initial measurement of radon levels. Members of staff were restricted from using the radon high level rooms, as soon as the results were known and allowed unrestricted entry only when the remediation was completed.

The building was remediated in the following manner, with each stage being tested prior to commencing the next:

1. The boiler room in the basement area was sealed off and provided with its own ventilation.
2. A section of the cellar was sealed off in order to create an internal sump and an in-line fan was used.
3. The other rooms in the basement area were either treated individually, or grouped together and treated by a heat recovery ventilator system that changed the air in the office at an adjusted rate for lowering the radon levels.
4. The basement areas with a wooden sub floor were treated by creating a negative pressure within the subfloor space by means of an axial fan, vented to the outside air.
5. Offices on the ground floor were treated similarly, using heat recovery ventilators and the important heat loss was adjusted by in line duct heaters. Each stage was monitored to ensure that modifications carried out did not affect the balance of the air flow through the dwelling and interfere with already treated areas.

The radon levels were reduced throughout the building and the air quality had improved after remediation (Table 5.3.1.). The complete cycle in the workplace DSS in dealing with radon was applied in this case (Figure 4.3.1.). Only the combination of remediation methods resulted in substantial reductions of radon. The average reduction factor of the building was 12.4. The total cost of the programme was only £20,000 (for 2001 values prices are multiplied by a factor of 1.32, = £26,600).

Table 5.3.1. Radon Levels Pre and Post Remediation in Buxton Building

Room	Radon Level (Bq.m ⁻³)			Reduction Factor
	NRPB	Before Remediation	Post Remediation	
1	-	330	150	2.2
2	-	410	189	2.2
3	-	647	44	14.7
4	-	6,541	70	93.4
5	-	1,788	117	15.3
6	400	433	288	1.5
7	300	451	226	2
8*	1,040	570	370	1.5
9	-	596	310	1.9
10	-	1,724	81	21.3
11	730	470	189	2.5
12	-	677	144	4.7
13	-	725	148	5
14	-	2,000	48	41.7
15	240	255	133	2
16	-	536	136	4
17	-	237	136	1.7
18	-	1,210	211	5.7

* = room 8 suffered a change of use between the first and second tests which could explain the variation in readings

The main conclusions of this case study are:

1. The positive decision to remediate and the consequent expenditure to pay for the work enabled the rooms to become suitable. The advantages of the work were clear and the whole project highly cost effective.

2. A clear protocol was followed, as well as the DSS (Figure 4.3.1.).

3. A range of remediation methods was considered and applied.

4. The dose reduction to a member of staff who would spend 8 hours per day in the rooms with the highest reduction factors in the building (e.g. room 4, 10, 14) is on average 13 mSv per annum.

5. The remediation is still working, ten years after the completion of work. The radon levels were remeasured recently and proved that the remediation system continues to function and will do so as long as no changes to the building structure will occur.

Assessing the problem thoroughly, mixing techniques of risk assessment and remedial work, drawing on the expertise of previous projects, practical and effective solutions of remediation can be usually found for any type of building, once remediation work is worthwhile. The management of the rooms after remediation is vital, as a change of use in the remediated rooms could affect the overall cost-effectiveness of the project.

6. POST REMEDIAL STUDIES IN NHS PROPERTIES IN NORTHAMPTONSHIRE

6.1. Survey of Staff Working Patterns and Personal Radon Exposure

In order to obtain information about the time spent by individuals in each room, staff members were asked to fill in a questionnaire and indicate the occupancy of the rooms and their working patterns (Figure 6.1.1.). The questionnaire asked for the time spent in each of the rooms and the total time spent in the building. The information was used, together with the hourly radon readings, to determine the radiation dose received by Northamptonshire NHS staff, working in the 5 studied clinics and the Kettering Hospital.

Some 46 members of staff completed the questionnaires. The majority of staff were working part-time, either due to part-time working schedule, or time share of a full time programme and time spent in other clinics. The majority of the staff worked between normal office hours (9 a.m. to 5 p.m.), however, clinic A1 ran evening sessions once per week. The total number of hours per year was calculated assuming a 48 working week's pattern for all the staff. The post-remediation results were compared to the pre-remediation values obtained in the same clinics. It was assumed that the same members of staff kept their occupancy patterns before and after remedial work in the building.

Figure 6.1.1. Room Occupancy Questionnaire

Northampton Medical Physics Department

Radon Questionnaire -Northamptonshire Clinic

It would be much appreciated if you could take the time to answer the following questions about the time spent in your place of work. The information requested will form an essential part of a study to estimate the importance of radon in the workplace.

The information will only be used for the purpose of the present study, in which individuals will not be identified. However, it would be helpful if you could give your name and telephone number in case of any queries. In question 3 you are asked to state how your time spent at the clinic is divided between the rooms. You can choose to give answers in hours per week or per month. If you can not give exact answers, please make your best estimate. The rooms where you spend the most time are the most important for this survey. Thank you for your co-operation.

Name:

Job Function:

Telephone Number:

1. How frequently does your work take you to the clinic? (choose one option from those below)

Times per week	Times per month	Less than once per month

2. How much time do you spend at the clinic in total?

Hours per week	Hours per month

3. How much of your time at the clinic do you spend in each room? (please answer either in hours per week or hours per month and state in which rooms)

Room number	Room description	Hours spent in room per week or month	
		9 a.m. - 5 p.m. Mon- Fri	Other times
1	Reception		
2	Consultation		
3	Staff		

The radiation dose per person was calculated using the occupancy data obtained and the relationship between mSv and kBq.h.m⁻³ given in Chapter 2.1. Estimates of personal radon exposure were calculated by multiplying the number of hours spent in each room per year with the estimated average radon level of that room and multiplied by the exposure factor shown in Chapter 2.1.

The effective dose was calculated with the formula:

$$\text{Effective Dose (mSv)} = \frac{\text{Radon Concentration (Bq.m}^{-3}\text{)} \times \text{Duration (hours)}}{126 \times 1,000}$$

The radiation dose per person before remediation was calculated for each individual, assuming an unchanged occupancy pattern before and after remediation and taking as real the post remedial occupancy patterns. The reduction in dose was calculated.

6.2. Radon Measurements in Remediated Clinics in Northamptonshire

The radon remediation programme in Northamptonshire NHS properties started in 1992 and two projects (Parkinson, 1994, Barker, 1998) measured a number of rooms for limited periods of time. TED's and a continuous radon meter (Rad-7) working either in grab-sample mode or in normal mode were used. The present work is much more extensive, both time-wise and regarding the amount of data obtained by direct reading continuous measurements. The project is conducted in NHS properties with a large number of rooms. The average radon values estimated over longer periods of time approximate with more accuracy the real average radon value, so that a more accurate

dose per member of staff can be calculated. Another very important reason for the present project was to test the 'Dose reduction hypothesis' of Denman *et al.* (1997) that stipulates that the reduction in average radon level in a room after remediation would be more significant than the actual reduction in dose for each member of a staff spending full time in that venue.

Out of the 82 NHS locations studied since the start of the project, 8% were found above the WAL of 400 Bq.m⁻³ and 1% were above 1,000 Bq.m⁻³ (Denman *et al.*, 2000a). The results from the TED's are shown in Figure 6.2.1. and the distribution of the radon levels is a predicted log-normal distribution, similar to that found in the NRPB report (Green *et al.*, 1992).

Figure 6.2.1. Distribution of Radon Levels in NHS Properties in Northamptonshire

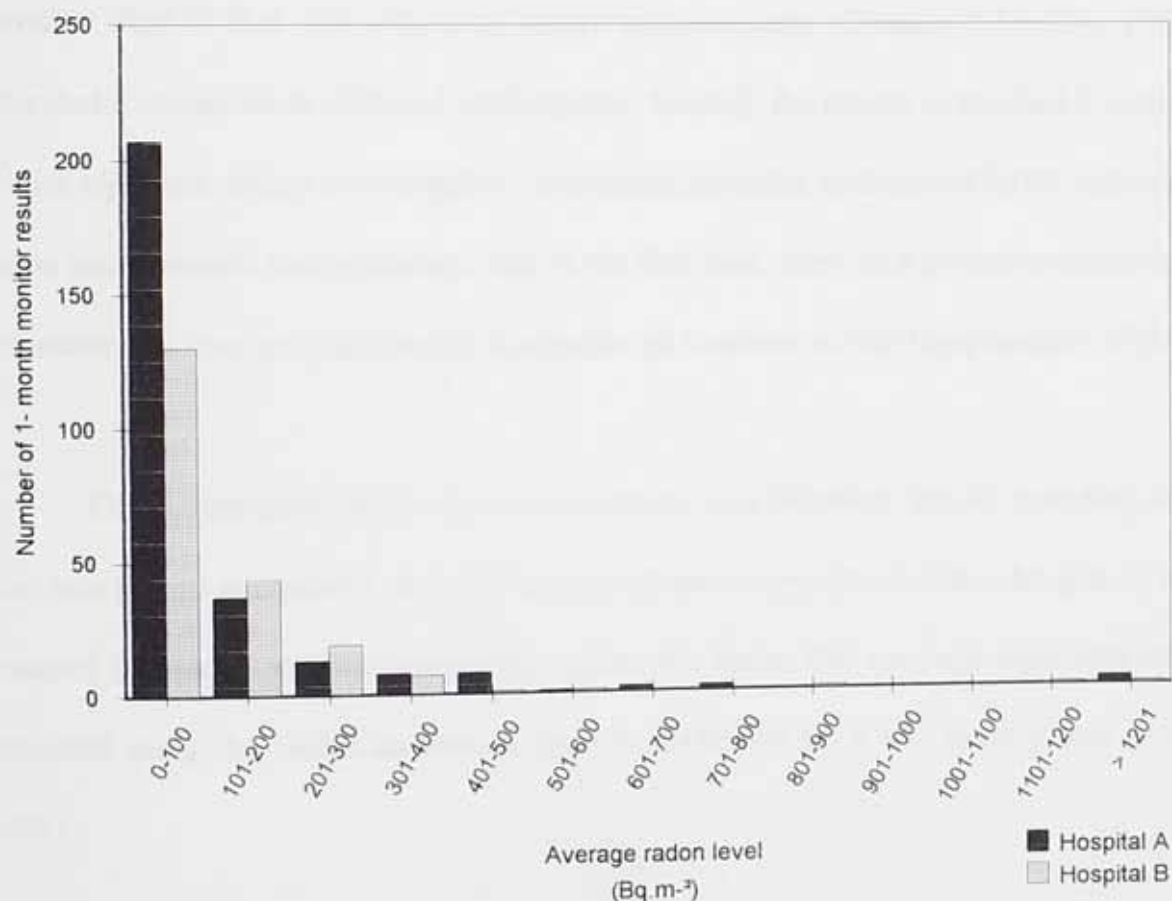

Measurements were carried out using direct reading radon meters and TED's in some of the locations of the NHS properties (Denman, 1994; Parkinson, 1994). Five of the studied locations are of particular interest to the present study; these locations were monitored before the remediation work had been carried out and average radon levels in the buildings were above the WAL of 400 Bq.m^{-3} . The remediation projects in the five locations studied were carried out between 1995 - 1996. The present study has monitored radon levels in the same locations, after remediation work had been carried out.

This part of the current research project took place between 1997 and 1999. TED's were placed in the buildings for a period of at least 1 month and sometimes were placed for the same period of time and used in parallel with a continuous Niton Radon monitor (Rad-7) that was recording hourly measurements (Chapter 2.2.). The TED's provided a useful check of Rad-7 performance. Overall, the results of the Rad-7 in these clinics represent almost 10 months of continuous sampling and around 7,000 individual radon concentration measurements. This is the first time when such extensive continuous measurements have been performed in remediated locations in Northamptonshire's NHS.

The normal protocol for the measurements was followed: the air sampling inlet tube was placed at around 1 metre of height and out of regions of direct draught. It was assumed that radon was well mixed throughout the room. The readings were seasonally corrected using the NRPB correction factors, confirmed by a UK study (Pinel *et al.*, 1995).

The measurements were carried out at five locations, A, B, C, D and E, two in Northampton, comprising three clinics (A1, A2 and B) and three in Kettering (C, D and E) (Figures 6.3.1., 6.4.1., 6.5.1., 6.6.1., 6.7.1. and 6.8.1.). These locations were selected for the present study on the basis that they used to have higher than the WAL radon levels in their rooms.

The records of the pre-remedial measurements were kept by the Medical Physics Department and remediation measures were in place. Each location had some of 4-5 rooms monitored, all the rooms forming part of the same unit. The average number of staff working in each of the premises was 5-9. A total of 46 members of staff working in these five clinics participated at the present research.

Another location of particular interest for the present thesis was a Kettering hospital (Figure 6.9.1.) with initial increased radon levels, where remediation work has been carried out and change of use of the building appeared (Figure 6.9.3.). Post remediation measurements at the location started in April 2000.

6.3. Location A1 Data

The clinics A1 and A2 were at opposite ends of the same building, separated by a large open hall. The building had been previously shown to have multiple points of radon entry that were treated as two independent remediation projects. Measurements after remediation for the present study were carried out in five rooms of each of the clinics A1 (Figure 6.3.1.) and A2 (Figure 6.4.1.). At the location A1, measurements started in January 1998 and concluded in April 1998.

Rooms 1 and 4 were consultation rooms, with approximate dimensions of 2.5x4x2.5m and 3x4x2.5m. Room 1, a consultation room, was at an extremity of the clinic and used less, with the door opened most of the times and the windows less often. Room 4, another consultation room, was near the main clinic entrance and intensively used, meaning that the door would be intermittently closed and opened and the windows opened more often.

Room 2 was a passage storage room for medical apparatus, size 2x2.5x2.5m, doors opened for the most part of the time, but windows blocked. Room 3 was a small hall used also as an office, with four doors communicating into the enclosure and no window; at least two of the doors would be opened in average at once and one of the doors was an entrance door communicating to a large outside hall. The approximate measures of Room 3 were 2x2.5x2.5m. Room 5 was a very small staff room, size 1.5x2x2.5m, with a small unused window and a permanently opened door communicating into Room 3.

Figure 6.3.1. Plan of Location A1 (not at scale)

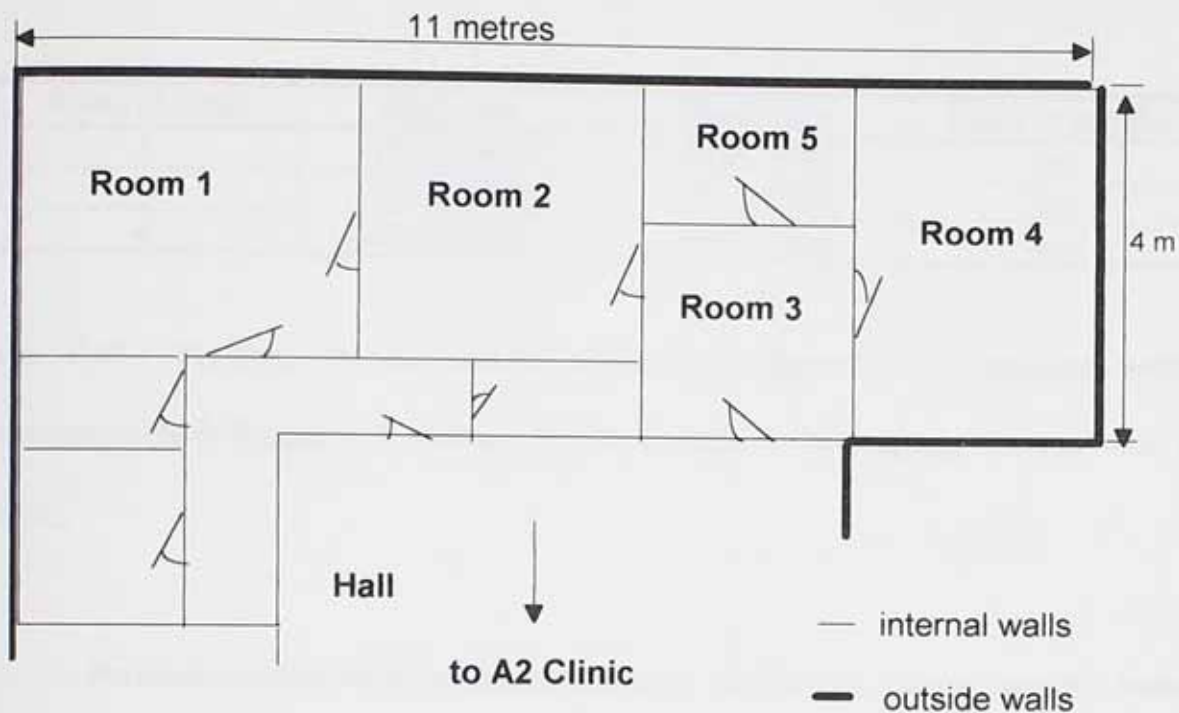

Location A1 results represent around 2 months of continuous sampling with the Rad-7 monitor, with the average counting time rate of 1 hour. The measuring protocol was followed as described in Chapter 2.2. The filter to the pump was replaced with a new one at the beginning of the measurements. The drying columns were replaced at regular intervals with dry- regenerated ones. It was assumed that radon was well mixed throughout the rooms tested.

Three TED's were set up in three rooms (Rooms 1, 2 and 4), along with the Rad-7 Radon monitor. The TED's were set up as in Table 6.3.1.

Table 6.3.1. Track- Etch Detectors in Clinic A1 Post Remediation

Room Number	Start Date	Finish Date	Rad-7 in parallel
1	09.02.1998	23.02.1998	yes
2	23.01.1998	09.02.1998	yes
4	23.02.1998	09.03.1998	yes

The Rad-7 detector, set on normal mode (see Chapter 2.2.), recorded hourly measurements in Rooms 1- 5 of clinic A1, for periods of time varying between 14 to 18 days.

Previous measurements, before remediation, in clinic A1, commenced in October 1993 using a series of room-by room grab sample measurements revealing radon concentrations in the range (200 - 900) Bq.m⁻³, in correlation with the initial 1-month TED's data (Table 6.3.2) (Parkinson, 1994).

The measurements were carried out on weekdays under normal working conditions, the windows were kept closed due to the low external temperature and the building had not been remediated. TED's were placed according to the measuring protocol (Chapter 2.2.) for a 1 month period. The results are shown in Table 6.3.2, and include the SCF's used (Parkinson, 1994).

Table 6.3.2. Location A1 Grab Sample Results Pre-Remediation (Parkinson, 1994)

Room Number	Date	Radon Concentration (Bq.m ⁻³)	Track-Etch Detectors 07.09.93-07.10.93 (Bq.m ⁻³)	Track-Etch Detectors 05.01.94-11.02.94 (Bq.m ⁻³)
Room 1	01.10.93 and 15.10.93	773	754	396
Room 2	01.10.93 and 15.10.93	499	618	710
Room 3	15.10.93	387	-	868
Room 4	01.10.93 and 15.10.93	467	323	298
Room 5	01.10.93 and 15.10.93	223	157	192
Room 6	01.10.93	251	-	-

The averages of time-dependant radon concentrations, recorded with the continuous radon monitor Rad-7 between January- February 1994, were calculated for each room, for working hours and non-working hours. The daytime values included the normal working hours and the general average values were based on the integrated exposure during all the hours of the test. The results of the measurements and calculations are given in Table 6.3.3. (Parkinson, 1994).

Table 6.3.3. Time Averages of Rad-7 Radon Concentration Measurements in Location A1 Pre-Remediation (Parkinson, 1994).

Room	Date	Average Radon Concentration (Bq.m ⁻³)	Daytime Radon Concentration (Bq.m ⁻³)
Room 1	24.01.94-29.01.94	733	269
Room 1	30.01.94-04.02.94	1,280	1,082
Room 1	24.01.94-04.02.94	1,005	681
Room 2	14.01.94-24.01.94	1,187	644
Room 3	07.02.94-11.02.94	625	545
Room 4	06.01.94-14.01.94	645	630

In order to calculate the radon exposure of each individual working in the clinic, a value of the likely range of daytime radon concentrations was calculated and these are given in Table 6.3.4. (Parkinson, 1994).

Table 6.3.4. Range of Daytime Radon Concentrations Estimated for January 1994 in Clinic A1, Pre-Remediation (Parkinson, 1994).

Room	Estimated Mean	Daytime Radon	Concentration (Bq.m ⁻³)
	Lowest	Mean	Highest
Room 1- Room 4	300	540	680
Room 5	155	220	290

In this study, the daytime radon values in the five rooms of clinic A1, post remediation were assessed and the results, including average values for the daytime working hours, minimum radon values and maximum radon values, are given in Table 6.3.5. The minimum and maximum radon concentrations were different in each room. The highest corrected radon concentration was 512 Bq.m⁻³ and the peak values were recorded either between 12 pm - 7 am, or between 2 pm - 6 pm.

Table 6.3.5. Corrected (*1.71=*CF) Daytime Radon Values, Clinic A1, Post-Remedial Studies

Room	Daytime Radon	Concentration	(Bq.m ⁻³)
	Lowest	Mean	Highest
Room 1	16.9	157.3	511.8
Room 2	5.3	154	297.9
Room 3	13.3	206	439.8
Room 4	13.3	90	190.8
Room 5	10.7	206	495.9

The corrected radon average concentrations were calculated taking into account the SCF's (Table 2.2.4.) and the calibration factor of 1.71 (CF) for the Rad-7 (Chapter 2.2.) and are shown in Table 6.3.6.

Table 6.3.6. Corrected Average Radon Values from Continuous Monitoring in Clinic A1, Post- Remediation.

Room	Date	Actual mean (Bq.m ⁻³)	Seasonal Correction Factor	Corrected mean*CF (Bq.m ⁻³)	Track-etch detectors (Bq.m ⁻³)
Room 1	09.02.98-23.02.98	74	0.73	92.4	114.6
Room 2	23.01.98-09.02.98	71.6	0.7	85.7	152.2
Room 3	09.03.98-23.03.98	185.6	0.81	257	/
Room 4	23.02.98-09.03.98	45.2	0.77	59.5	123.2
Room 5	23.03.98-08.04.98	188.5	0.89	287	/

The pattern of variation of radon concentration was different for each room (Figures 6.3.2.- 6.3.6. plotted with the uncorrected values). The figures show a complex time dependence, with different mean levels and time patterns being observed in different days even in the same room and different patterns between different rooms. This complex behaviour demonstrates the need to average over as long time as possible in order to obtain representative data for exposure calculations. Despite the complex time dependence, some important features can be distinguished:

- Room 1 has the maximum values (*CF) in the range 500-720 Bq.m⁻³,
- Room 2 in the range 430-550 Bq.m⁻³,
- Room 3 in the range 600-770 Bq.m⁻³,
- Room 4 in the range 170-257 Bq.m⁻³ and
- Room 5 in the range 685-855 Bq.m⁻³.

Figure 6.3.2. Radon Level Variation, Room 1, Clinic A1

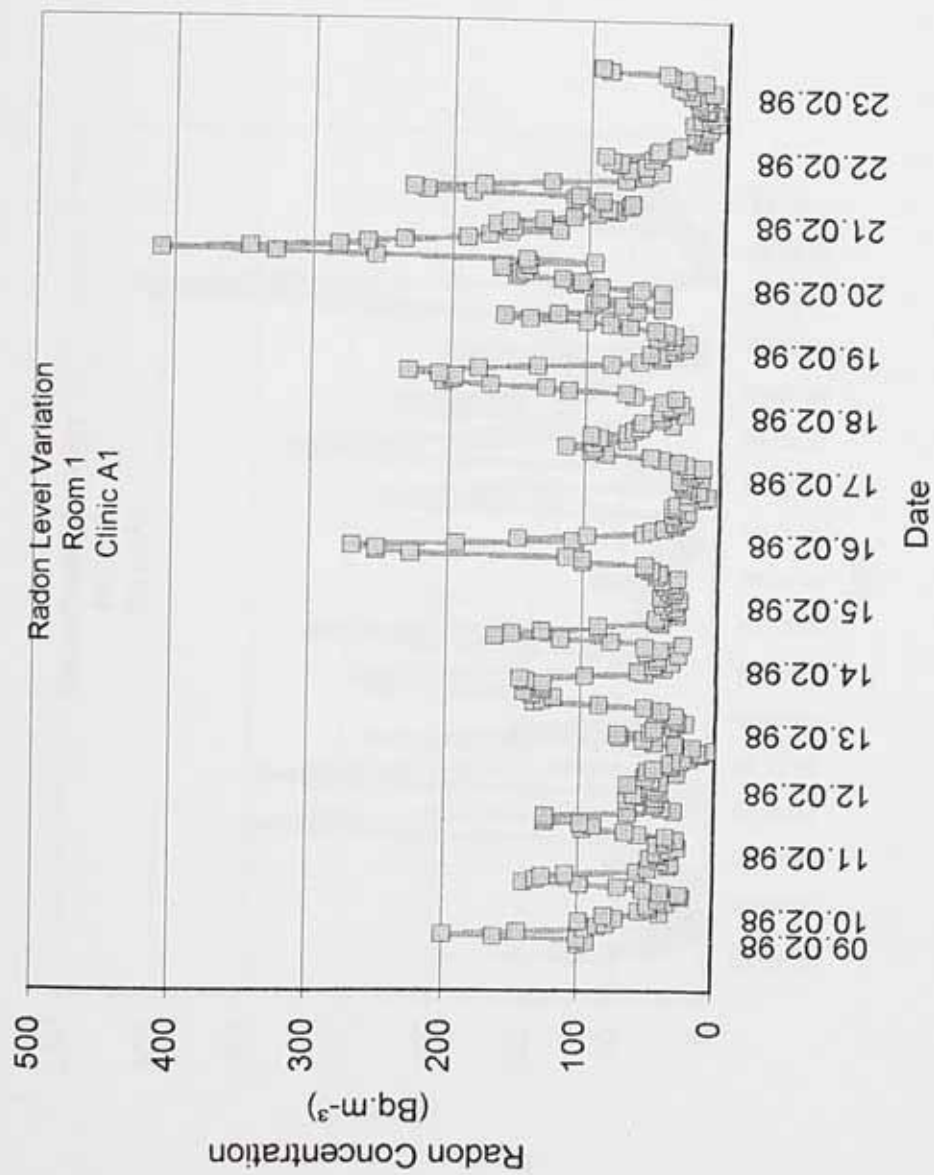

Figure 6.3.3. Radon Level Variation, Room 2, Clinic A1

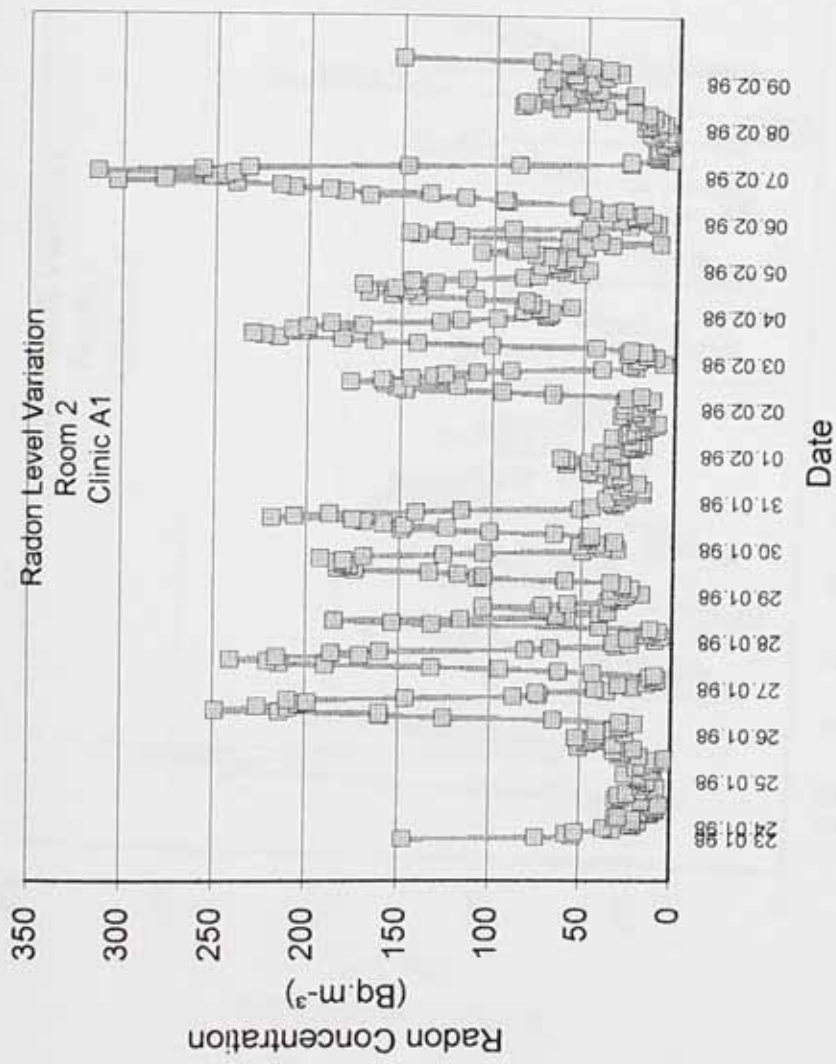

Figure 6.3.4. Radon Level Variation, Room 3, Clinic A1

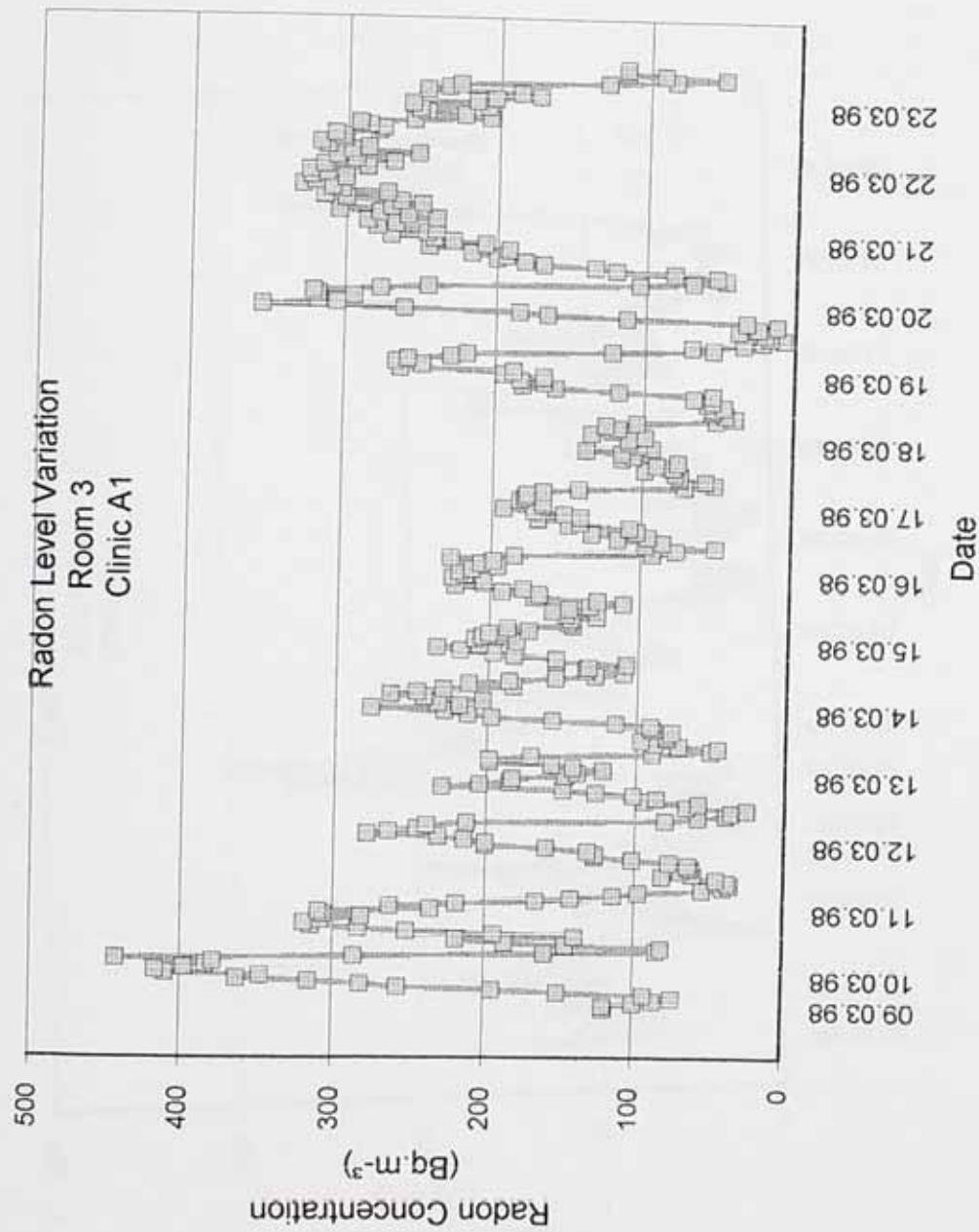

Figure 6.3.5. Radon Level Variation, Room 4, Clinic A1

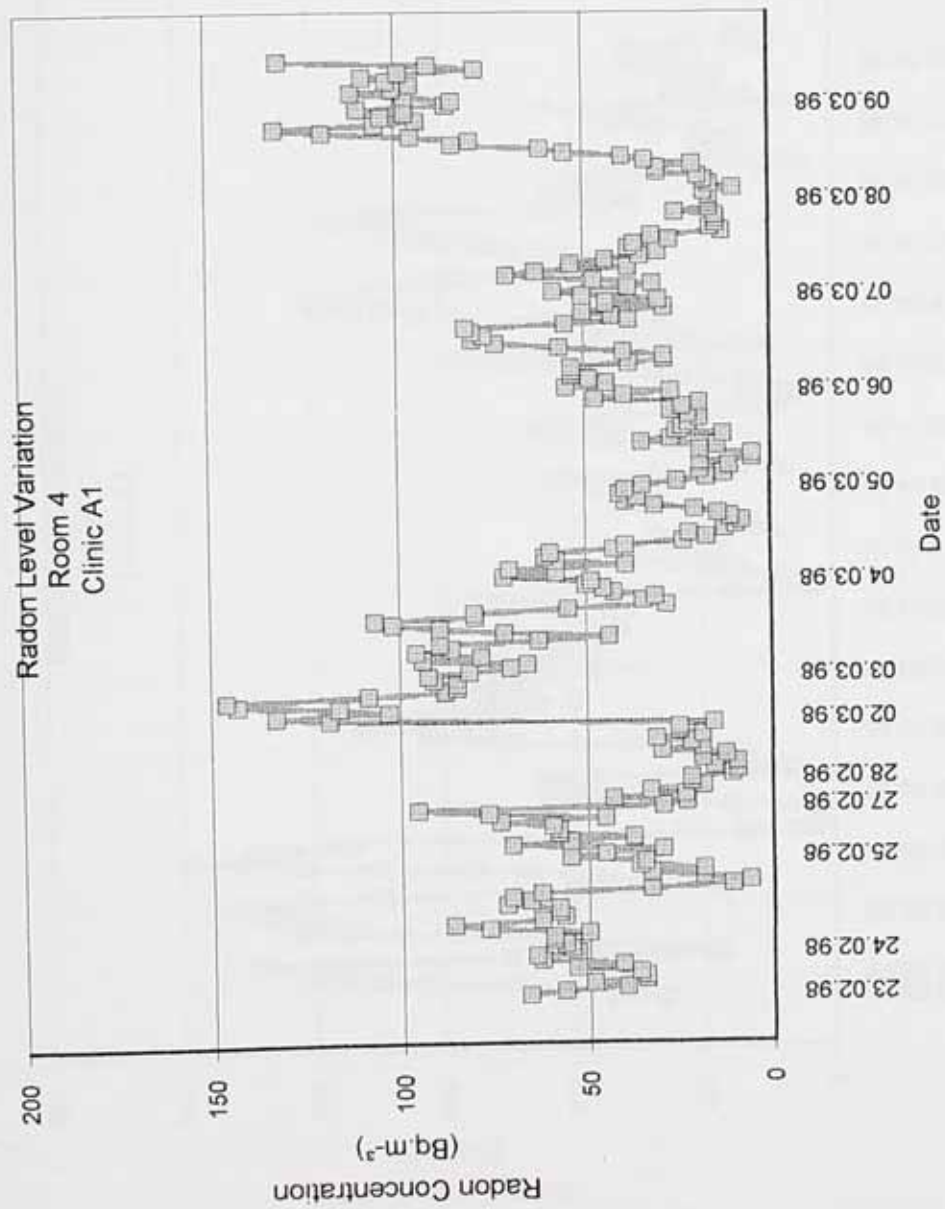
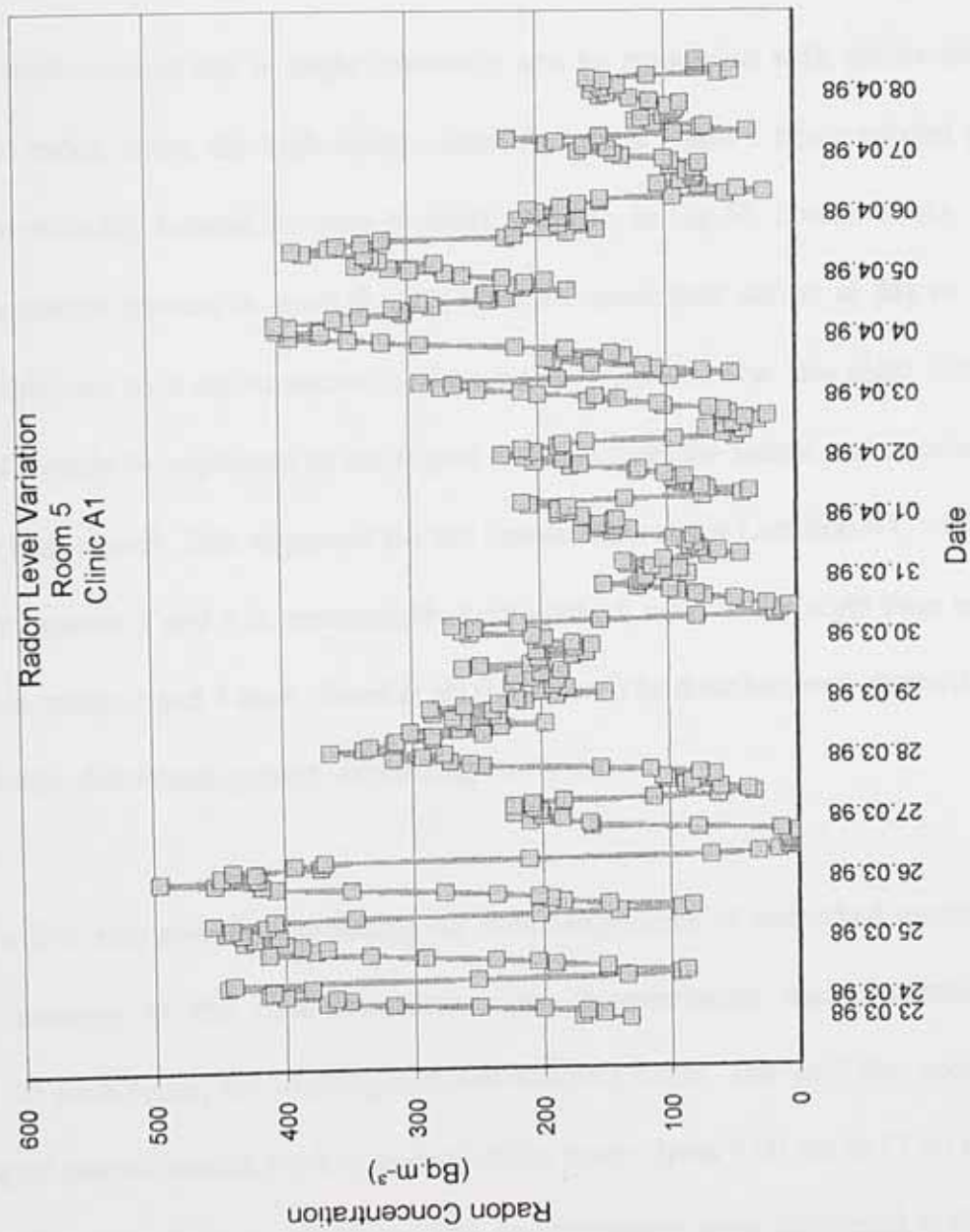

Figure 6.3.6. Radon Level Variation, Room 5, Clinic A1



Characteristic day to night differences were observed in some of the rooms, as well as a pattern of variation close to the TDC (Figure 5.2.9). The radon concentration was consistently higher at night in room 3 and room 5, it was about the same in the night-time and daytime in room 4 and it was consistently lower at night in room 1 and room 2. The rooms with higher night radon values had the highest average radon concentrations (*CF): room 3- 257 Bq.m⁻³ and room 5- 287 Bq.m⁻³. The other rooms had lower average radon values (*CF): room 1- 92 Bq.m⁻³, room 2- 86 Bq.m⁻³ and room 4- 60 Bq.m⁻³.

The characteristic day to night variations can be associated with the location of the source of radon entry, the high radon values in rooms 3 and 5 being related to the radon source probably located in room 5, more specific, in the SE corner of the room. The radon variation pattern in room 4, with alternate maximum values at day or night, would be explained by a radon source in the adjacent room 5. The low night values in rooms 1 and 2 could be explained by the higher distance from the source and intermediate doors being kept closed. This argument fits the known facts about Location A1, where the door between rooms 3 and 5 is permanently kept opened, even in the night time and the door between rooms 2 and 3 kept closed at all the times. The door between rooms 3 and 4 is intermittently closed and opened, depending on its use.

As a first step towards estimating the radon exposures of individual members of staff, the averages of the time-dependent radon concentration measurements were calculated for each room, for working and non-working hours. The staff that completed the occupancy questionnaires work in normal office hours (from 9.00 am to 17.00 pm), so these hours were selected as work hours. The questionnaires were completed at the time

of the post remediation measurements. The average radon concentrations in each room were calculated during the normal working hours and during night time and the ratio between average radon levels in night time hours and working daytime hours are given in Table 6.3.7.

Table 6.3.7. Time Averages of Rad 7 Radon Concentration Measurements in Clinic A1 Post Remediation

Room	Daytime mean (Bq.m ⁻³)	Night time mean (Bq.m ⁻³)	Daytime corrected*CF (Bq.m ⁻³)	Night time corrected*CF (Bq.m ⁻³)	Ratio night time/day time radon concentration
Room 1	92	56	115	70	0.6
Room 2	90	53.2	108	64	0.6
Room 3	120.5	250.8	167	347	2.1
Room 4	52.6	37.8	70	50	0.7
Room 5	120.4	256.7	183	391	2.1

A total of nine members of staff that were working at the clinic answered the room occupancy questionnaire and the results of their occupancy of the rooms are given in Table 6.3.8. Many of the members of staff were working part time hours or had duties elsewhere.

Table 6.3.8. Staff Room Occupancy in Clinic A1

Member of staff	Hours Spent Per Year (48 working weeks per year)					
	Room 1	Room 2	Room 3	Room 4	Room 5	Total
1	/	/	/	288	/	288
2	3.2	168	5.6	3.2	12	192
3	48	/	864	48	96	1,056
4	12	/	/	336	12	360
5	12	144	24	672	36	888
6	24	384	72	/	48	528
7	24	276	24	/	12	336
8	/	/	/	696	24	720
9	12	/	/	348	24	384

Assuming the same occupancy pattern pre-remediation as well as post remediation and the same members of staff working in the clinic, the past time exposures can be calculated and are displayed in Table 6.3.9.

Table 6.3.9. Estimated Radon Exposure (kBq.m³.h) in Clinic A1 Pre-Remediation

Member of staff	Radon Exposure (kBq.m ³ .h)					
	Room 1	Room 2	Room 3	Room 4	Room 5	Total
1	/	/	/	155.52	/	155.52
2	1.73	90.72	3.02	1.73	2.64	99.84
3	25.92	/	466.56	25.92	21.12	539.52
4	6.48	/	/	181.44	2.64	190.56
5	6.48	77.76	12.96	362.9	7.92	468.02
6	12.96	207.36	38.88	/	10.56	269.76
7	12.96	149.04	12.96	/	2.64	177.6
8	/	/	/	375.84	5.28	381.12
9	6.48	/	/	187.92	5.28	199.68

The estimated radon exposure per person, after remediation work was carried out in clinic A1, is given in Table 6.3.10.

Table 6.3.10. Estimated Radon Exposure (kBq.m³.h) in Clinic A1 Post- Remediation

Member of staff	Radon Exposure (kBq.m ³ .h)					
	Room 1	Room 2	Room 3	Room 4	Room 5	Total
1	/	/	/	20.16	/	20.16
2	0.37	18.14	0.94	0.22	2.2	22.24
3	5.52	/	144.3	3.36	17.57	170.75
4	1.38	/	/	23.52	2.2	27.1
5	1.38	15.55	4.01	47.04	6.9	74.88
6	2.76	41.47	12.02	/	8.8	65.05
7	2.76	29.81	4.01	/	2.2	38.78
8	/	/	/	48.72	4.4	53.12
9	1.38	/	/	24.36	4.4	30.14

The annual radiation dose per person, measured in mSv's, was calculated for each person, pre and post remediation, using the effective dose formula from Chapter 6.1.; the reduction factor was calculated too and the data obtained is listed in Table 6.3.11.

Table 6.3.11. Annual Dose per Person (mSv) in Clinic A1

Member of staff	Pre-remediation Dose (mSv)	Post-remediation Dose (mSv)	Reduction Factor
1	1.23	0.16	7.7
2	0.79	0.18	4.4
3	4.28	1.36	3.1
4	1.51	0.22	6.9
5	3.71	0.59	6.3
6	2.14	0.52	4.1
7	1.41	0.31	4.5
8	3.02	0.42	7.2
9	1.58	0.24	6.6

Due to the nature of part time work of most of the staff, the calculated doses are lower than those for full time workers. To assess the maximum potential dose, the radiation doses were calculated for each person, assuming a 37 hours working week and the same pattern of room occupancy (Table 6.3.12.).

Table 6.3.12. Potential Annual Dose per Person (mSv) in Clinic A1 for Full Time Working Hours (37 hours per week), Clinic A1

Member of staff	Pre-remediation Full Time Dose (mSv)	Post-remediation Full Time Dose (mSv)	Reduction Factor
1	7.61	0.97	7.8
2	7.32	1.6	4.6
3	7.2	2.7	2.7
4	7.46	1.05	7.1
5	7.43	1.17	6.4
6	7.2	1.73	4.2
7	7.45	1.61	4.6
8	7.46	1.03	7.2
9	7.1	1.04	6.8

Only two members of staff were working in clinic A1 at the time of the pre-remedial and post-remedial studies; the doses before remediation and after remediation, taking into account the real occupancy pattern, are given in Table 6.3.13., as well as the real reduction factor. It can be seen that the estimates that assume the same occupancy before and after remediation, are slightly lower than the real doses in the pre-remediation case. This suggests a change of use of the building, as well as a different working pattern.

Table 6.3.13. Annual Effective Doses of Staff, Clinic A1

Member of staff	Pre-remediation dose (mSv)	Estimated pre remediation dose (mSv)	Post remediation dose (mSv)	Reduction Factor	Estimated Reduction Factor
3	4.8	4.28	1.36	3.5	3.1
5	6.4	3.71	0.59	10.8	6.3

If the individual dose reductions for each member of staff are compared to the reduction in average radon level in the room that the individual occupied the most, we obtain a random dependence, as in Figure 6.3.7. From this figure it can be noticed that the least reduction in dose compared to the reduction in the most used room, is obtained for members of staff 2, 6 and 7, that spend most of their time in room 2. Once again, this pattern of behaviour is consistent with a room where the radon source was located before the remediation work. The high reduction in average radon level is explained by the source being eliminated from room 2 after remediation. The low reduction in individual doses is explained by the fact that in room 2, daytime values are higher on average than night time values.

Figure 6.3.7. Reduction Factors of Individual Doses Compared to Reduction Factors in Average Radon Levels, Clinic A1

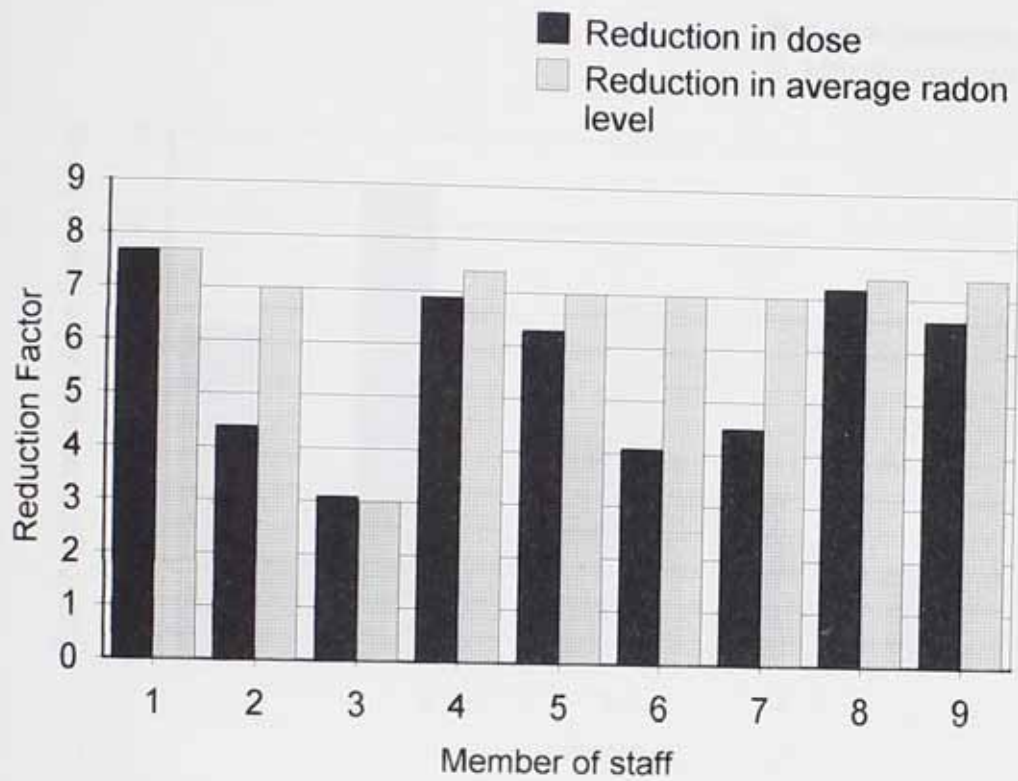

Comparing the individual changes in ratio between day time and night time radon levels before and after remediation in each room, a pattern as in Figure 6.3.8. would suggest the location of the radon source in room 2 before remediation and in room 5 after remediation. The average radon levels decreased significantly after remediation, but it seems that the radon source was shifted to the neighbouring room.

Figure 6.3.8. Comparison of Ratio Night Time per Daytime Radon Levels Pre and Post Remediation, Clinic A1

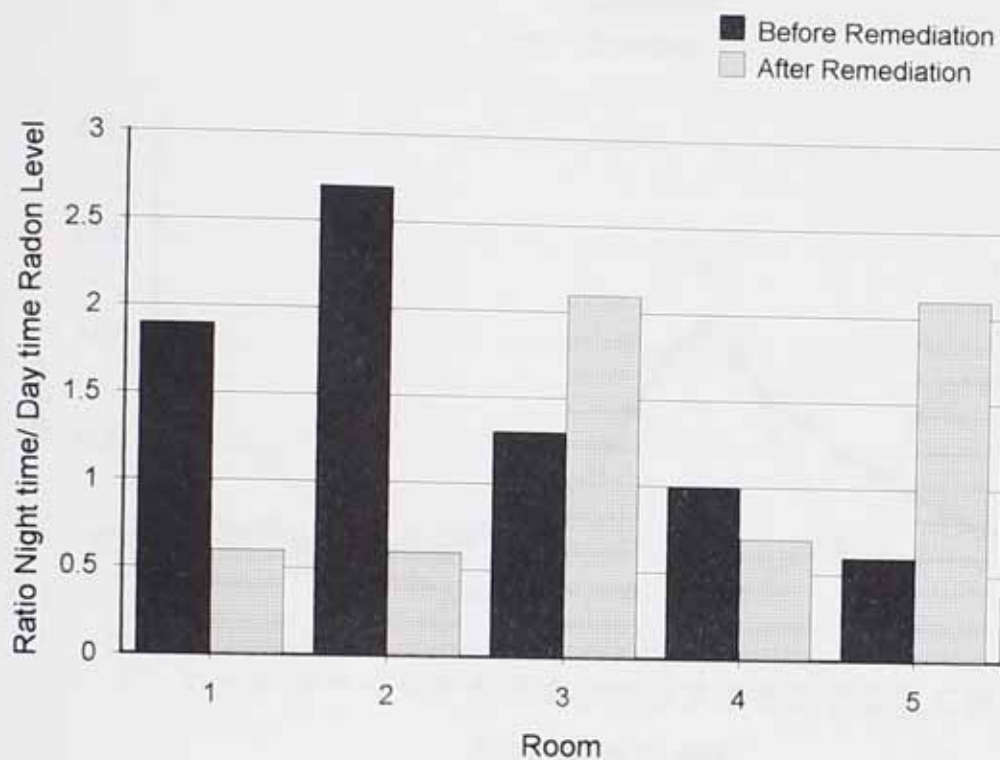

The radon level variation was plotted in room 1 for eight weekdays, two Saturdays and two Sundays, for radon uncorrected values. The average daily value of radon in room 1, giving the pattern of radon variation in weekdays as opposed to weekends, identifies a similar variation for weekdays and Saturdays, but a different pattern for Sundays, with peak values after 8 p.m. (Figure 6.3.9.).

Figure 6.3.9. Average Radon Daily Values in Room 1, Clinic A1

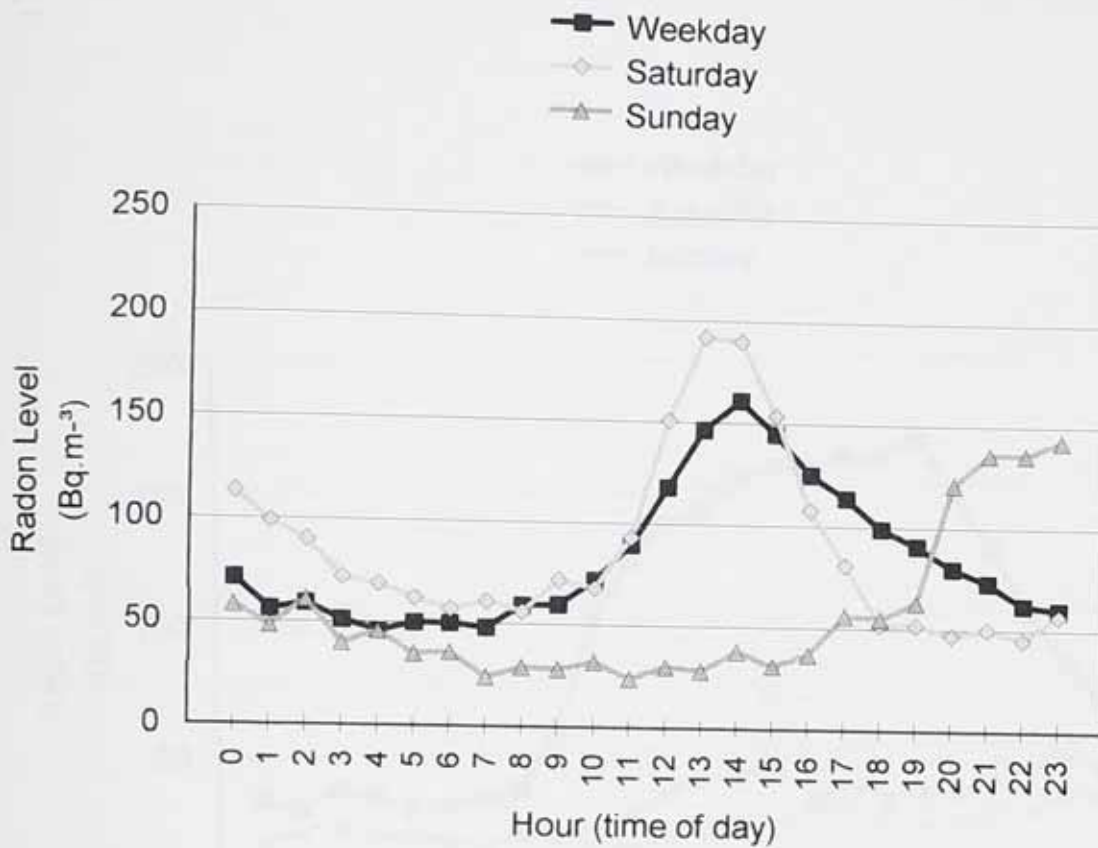

The average daily uncorrected radon values in room 2 are plotted for 10 weekdays, 3 Saturdays and 3 Sundays. The variation of radon concentration in room 2 approximates well with the real values. Radon levels in weekdays increase after 7 a.m. and reach a maximum value at 6 p.m., whereas radon levels on Saturdays vary slightly, having an almost constant pattern and on Sundays the radon levels decrease after 7 a.m., having maximum values at 2 a.m. This behaviour is consistent with the radon source being in room 5. Radon levels are generally low in room 2 and they increase with the use of the building, during working hours in the working days, while doors that communicate

to room 3 and indirectly 5 are opened (between 9 a.m. to 6 p.m. on weekdays, the radon concentration increases from 100 Bq.m⁻³ to a maximum of 169 Bq.m⁻³).

Figure 6.3.10. Average Radon Daily Values in Room 2, Clinic A1

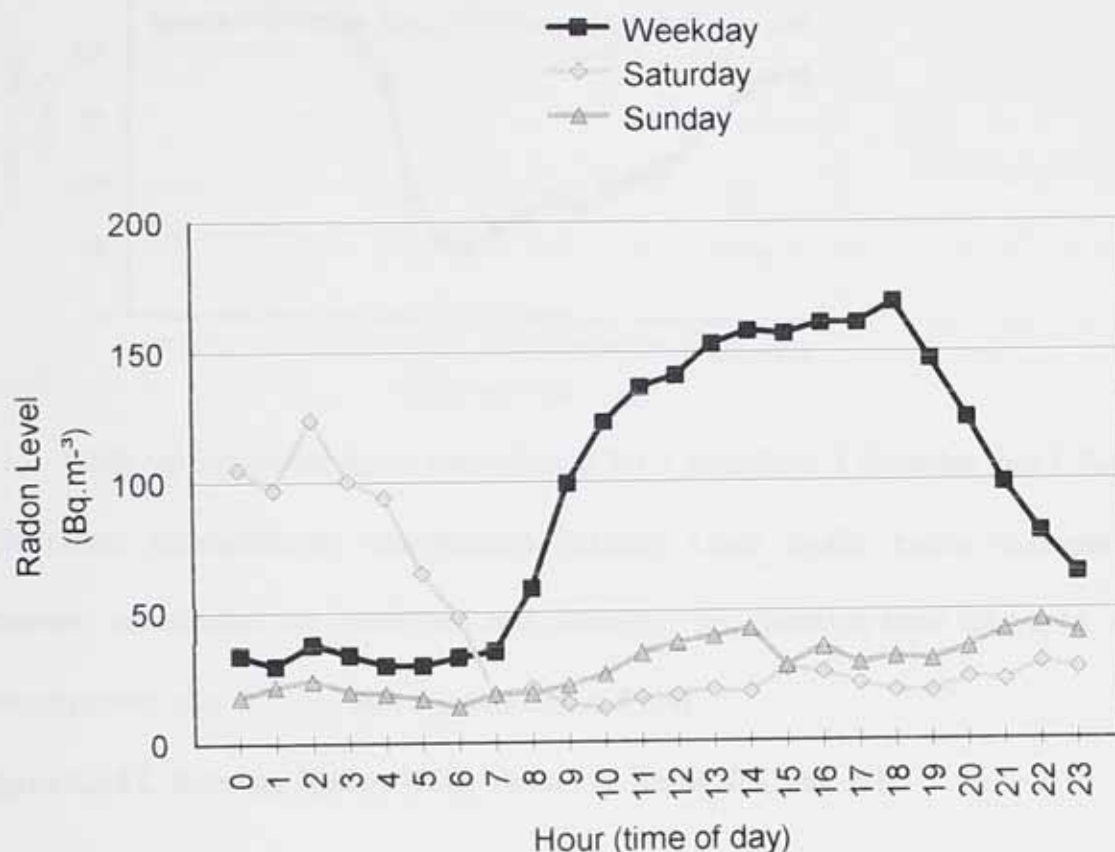

Average radon uncorrected values in room 3 are plotted for 9 weekdays, 2 Saturdays and 2 Sundays. Radon levels have similar values and only slight variations in the interval (175-275) Bq.m⁻³ for Saturdays and Sundays, but for weekdays, there is a sharp decrease in radon concentrations after 7 a.m., with increasing radon concentrations after 6 p.m. (more than 100 Bq.m⁻³).

Figure 6.3.11. Average Radon Daily Values in Room 3, Clinic A1

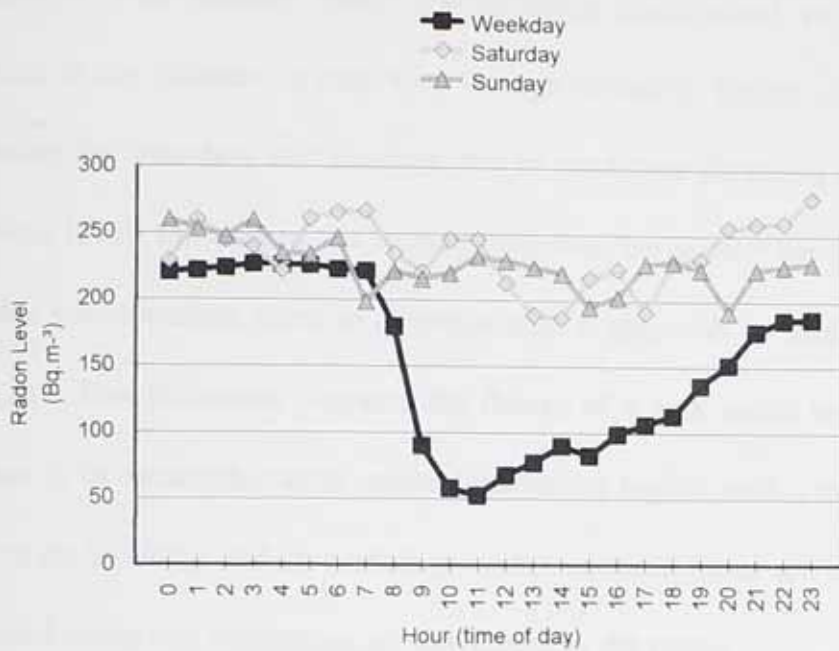

Daily variations for room 4 are plotted for 5 weekdays, 1 Saturday and 1 Sunday, with radon concentration (uncorrected values). Once again, radon concentration variations are similar for weekdays and Saturday, but Sundays have increased radon concentrations after 2 p.m., with a maximum at 6 p.m.

Figure 6.3.12. Average Radon Daily Values in Room 4, Clinic A1

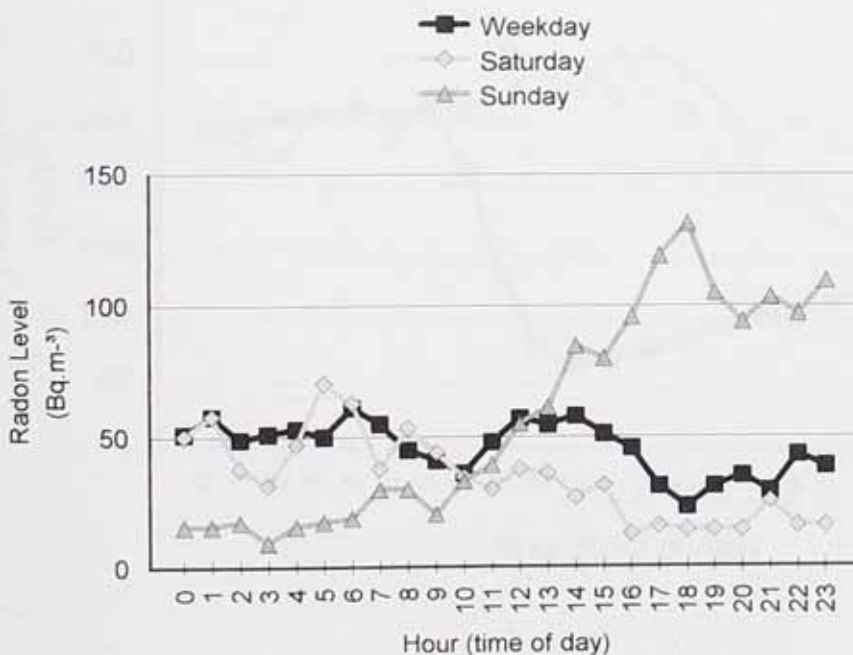

Daily variations for room 5 are plotted for 11 weekdays, 2 Saturdays and 2 Sundays, with average radon concentration uncorrected values approximating radon levels at any moment in time with enough accuracy. Radon concentration variations are similar for Saturdays and Sundays, but in weekdays the radon concentrations are at their lowest levels throughout the working interval, between 9 am to 6 pm. In weekdays, the radon concentration starts to decrease after 6 am, with its minimum value at 10 am, 64 Bq.m⁻³. This behaviour supports the theory of a new radon ingress post remediation in room 5; in weekends, radon concentrations are higher, with a maximum of 382 Bq.m⁻³ at 3 am on Saturday and in weekdays, radon concentrations are consistently lower, due to opened doors and continuous air movement in the room.

Figure 6.3.13. Average Radon Daily Values in Room 5, Clinic A1

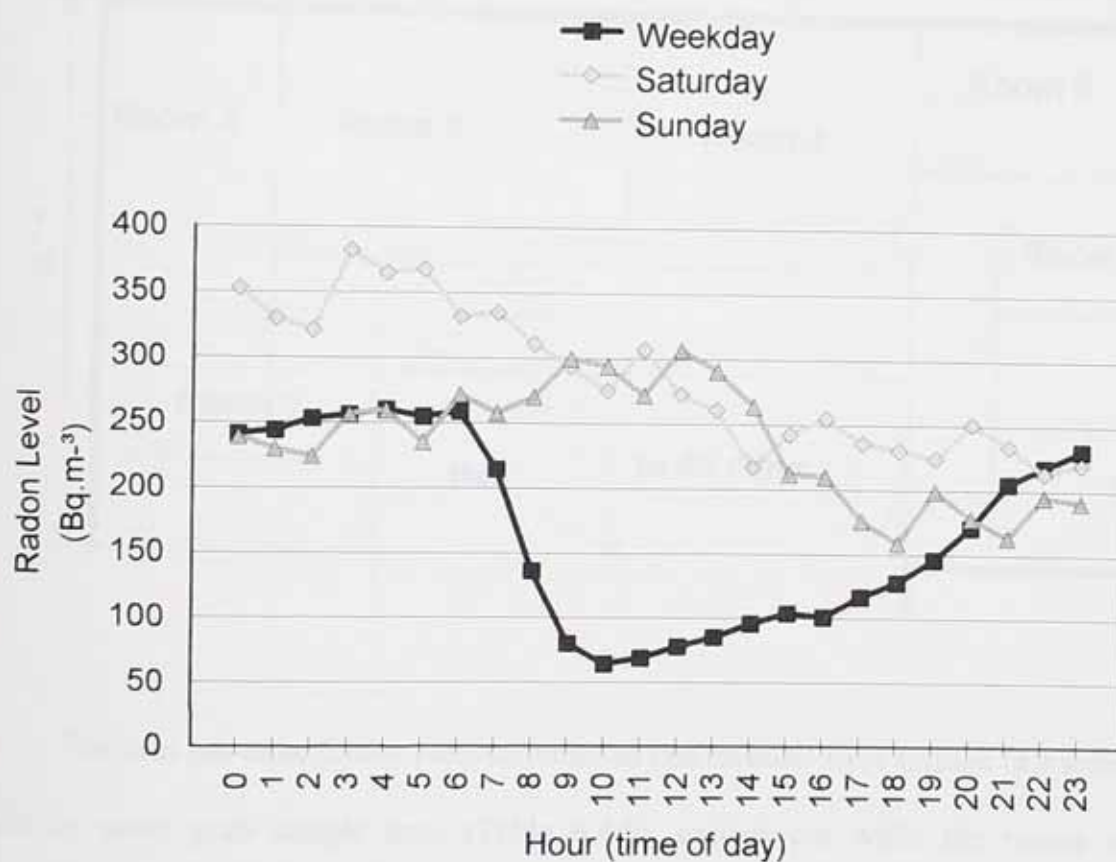

6.4. Location A2 Data

Clinic A2 had five rooms monitored between December 1998 and January 1999; Room 1 was a storage room with many book shelves and files stacked up to the ceiling; there was very little usable space left, size 2x3x2.5m, an unused small window and a permanently opened door leading into the receptionist's room. Rooms 2, 3, 4 and 5 were all consultation rooms, with doors and windows kept closed for at least 4 hours of the working day. The approximate sizes of the rooms were as follows: Room 2 - 2x1.5x2.5m, Room 3- 2.5x3.5x2.5m, Room 4- 2.5x2.5x2.5m and Room 5- 2x3.5x2.5m.

Figure 6.4.1. Plan of Location A2 (not at scale)

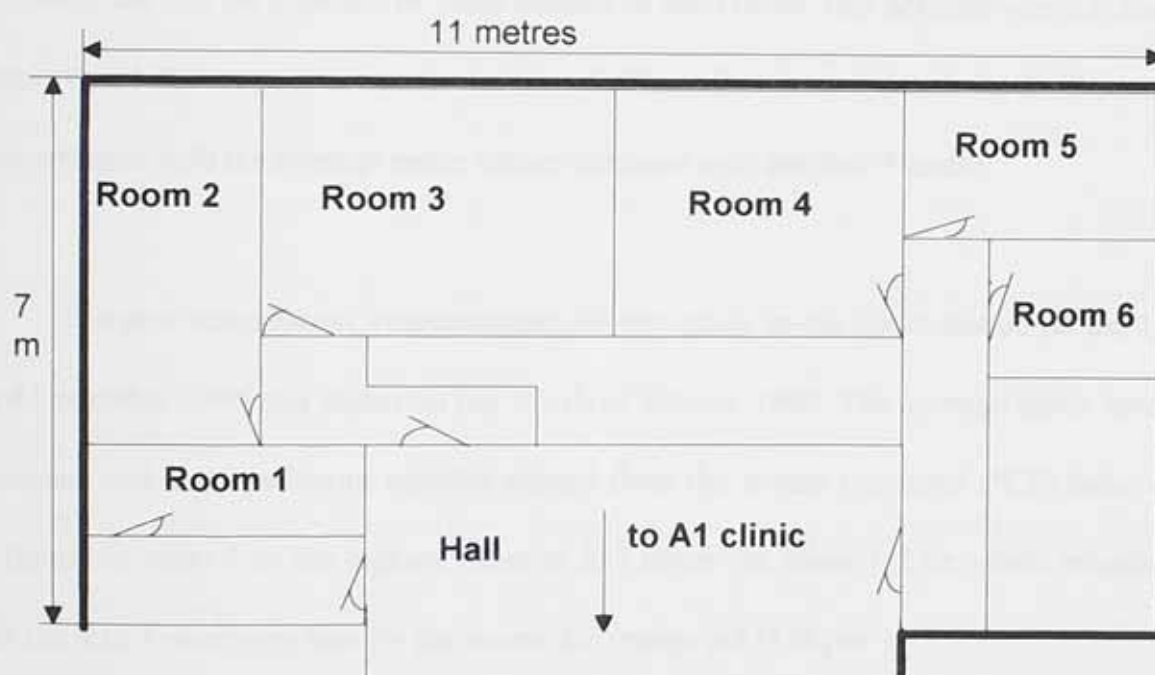

Previous pre-remediation measurements at this location were limited to a series of room by room grab sample tests (Table 6.4.1), carried out while the rooms were unoccupied, in October 1993. The results are similar to the 1-month TED's data and suggest two radon sources, one in room 1 and the other one in room 4.

Table 6.4.1. Location A2 Grab Sample Results Pre-Remediation

Room	Date	Radon Concentration Bq.m ⁻³	Track-Etch Detectors Bq.m ⁻³
1	04.10.93	1,400	821
2	04.10.93	360	181
3	04.10.93	180	123
4	04.10.93	790	445
5	04.10.93	180	97

Due to the nature of the work in clinic A2, continuous Rad 7 measurements were possible only for shorter periods of time between 7 days to 14 days. TED's were placed in the rooms and left for a period of three months in each room; one detector was left for a longer period of time of four months in room 1. The values recorded with the TED's were in accordance with the average radon values obtained with the Rad 7 meter.

The post remediation measurements for this study in the clinic started on the 11-th of December 1998 and ended on the 27-th of January 1999. The average radon levels measured with the continuous monitor ranged from the lowest corrected (*CF) value of 14 Bq.m⁻³ in room 3 to the highest value of 321 Bq.m⁻³ in room 1. The values recorded with the Rad 7 were very low for the rooms 2-5 (range 3-131 Bq.m⁻³).

The average daytime radon values were calculated for each room, in order to determine the radon exposure and radiation dose per each member of staff. The calculated and recorded daytime values, corrected with CF but not with the SCF, are given in Table 6.4.2.

Table 6.4.2. Corrected Daytime Radon Values, Clinic A2, Post Remedial Studies

Room	Daytime Radon Concentration (Bq.m ⁻³)		
	Lowest	Mean	Highest
1	56	203	321
2	3	11	37
3	3	12	27
4	3	35	131
5	3	10	32

The corrected average radon values from Rad-7 are compared to the TED values in Table 6.4.3. These take into account the SCF and the Rad-7 CF of 1.71. The corrected average radon concentration values obtained with the TED's are given in the same table with the previous values and are in correlation (Table 6.4.3.). There is a difference between the radon concentrations recorded with the TED and Rad 7 in rooms 1 and 5. The TED radon level of 55 Bq.m⁻³ instead of 134.8 Bq.m⁻³ in room 1, could be due to the fact that the TED detector was pushed away on the shelf by some files that were partially blocking it. The TED in room 5 was recording higher values (57 Bq.m⁻³ instead of 9.5 Bq.m⁻³) due to its position being changed by a member of staff, in an incorrect position, too close to the floor.

Table 6.4.3. Corrected Average Radon Values from Continuous Monitoring, Clinic A2, Post Remediation

Room	Date	Mean Radon Bq.m ⁻³	Seasonal Correction Factor	Corrected Mean * CF Bq.m ⁻³	Track Etch Detectors Bq.m ⁻³
1	20.01.99-27.01.99	119.4	0.66	134.8	55
2	11.12.98-22.12.98	6.4	0.77	8.4	19
3	04.01.99-12.01.99	7.1	0.66	8	17
4	12.01.99-20.01.99	20.7	0.66	23.3	15
5	22.12.98-04.01.99	5.6	0.74	9.5	57

The average daytime and night time radon values were calculated and the ratio night time per daytime values calculated (Table 6.4.4.)

Table 6.4.4. Time Averages of Rad 7 Radon Concentration Measurements in Clinic A2, Post Remediation

Room	Mean Daytime Radon (Bq.m ⁻³)	Mean Night time Radon (Bq.m ⁻³)	Mean Daytime Radon Corrected*CF (Bq.m ⁻³)	Mean Night time Radon Corrected*CF (Bq.m ⁻³)	Ratio Night time / Daytime Mean Radon
1	118.5	120.4	133.7	135	1.01
2	6.5	6.2	8.6	8.3	0.96
3	7.2	7.1	8.1	8	0.98
4	20.7	20.6	23.4	23.3	0.99
5	5.8	5.4	9.9	9.1	0.92

The uncorrected radon concentration pattern was different for each room and the data for each room are given in Figures 6.4.2.- 6.4.6. Rooms 1 and 4 display radon variation patterns closer to the TDC (Figure 5.2.9.), with a maximum radon level in room 1 of 321 Bq.m⁻³ and in room 4 of 131 Bq.m⁻³ (*CF).

The pattern of staff occupancy of the rooms is given in Table 6.4.5.

Table 6.4.5. Staff Room Occupancy, Clinic A2

Member of staff	Hours spent per year (48 working weeks per year)					
	Room 1	Room 2	Room 3	Room 4	Room 5	Room 6
1	48	48	144	96	96	48
2	/	/	72	101	72	/
3	/	/	/	/	/	144
4	14.5	14.5	14.5	14.5	14.5	/
5	/	/	/	/	72	72

Figure 6.4.2. Radon Level Variation, Room 1, Clinic A2

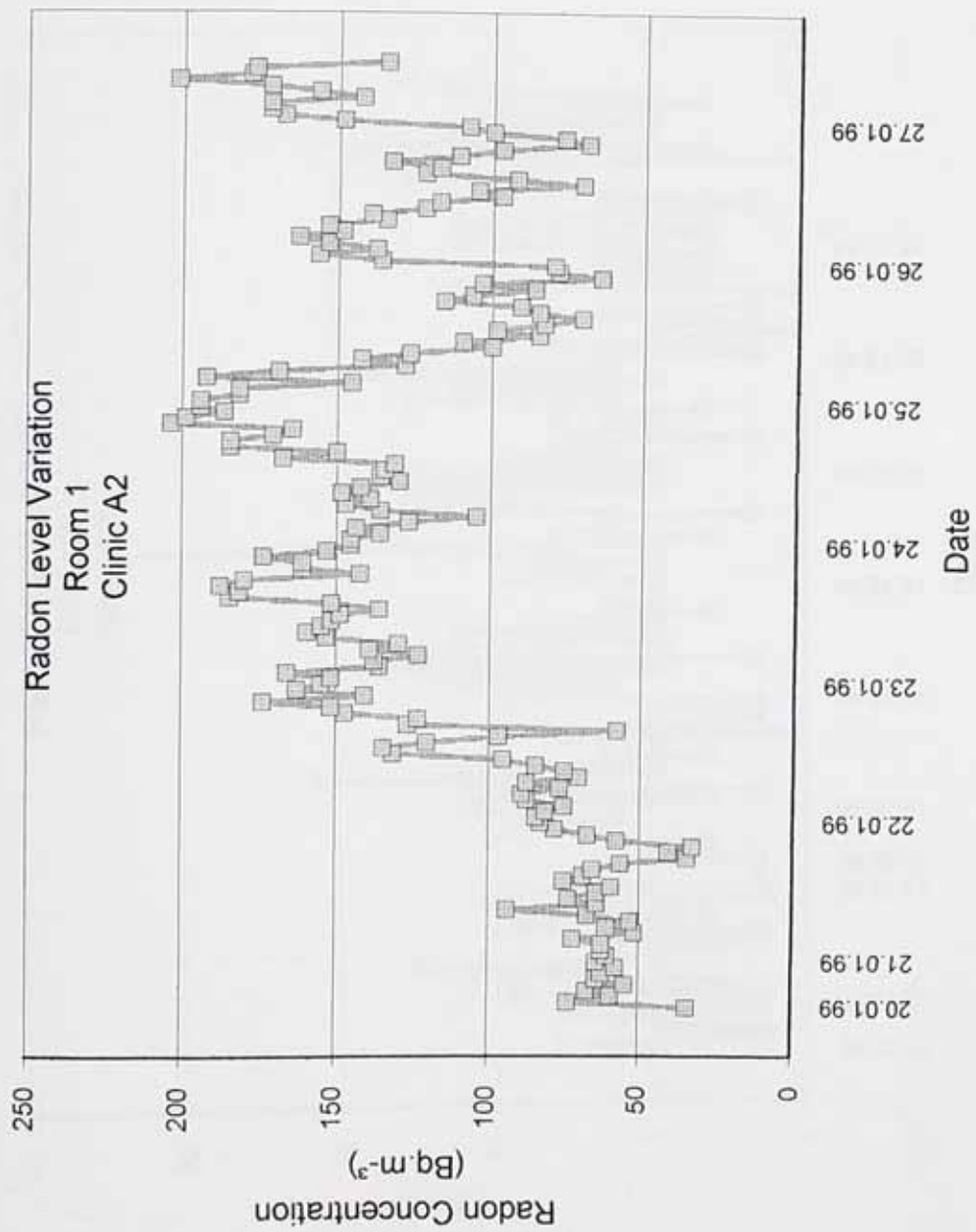

Figure 6.4.3. Radon Level Variation, Room 2, Clinic A2

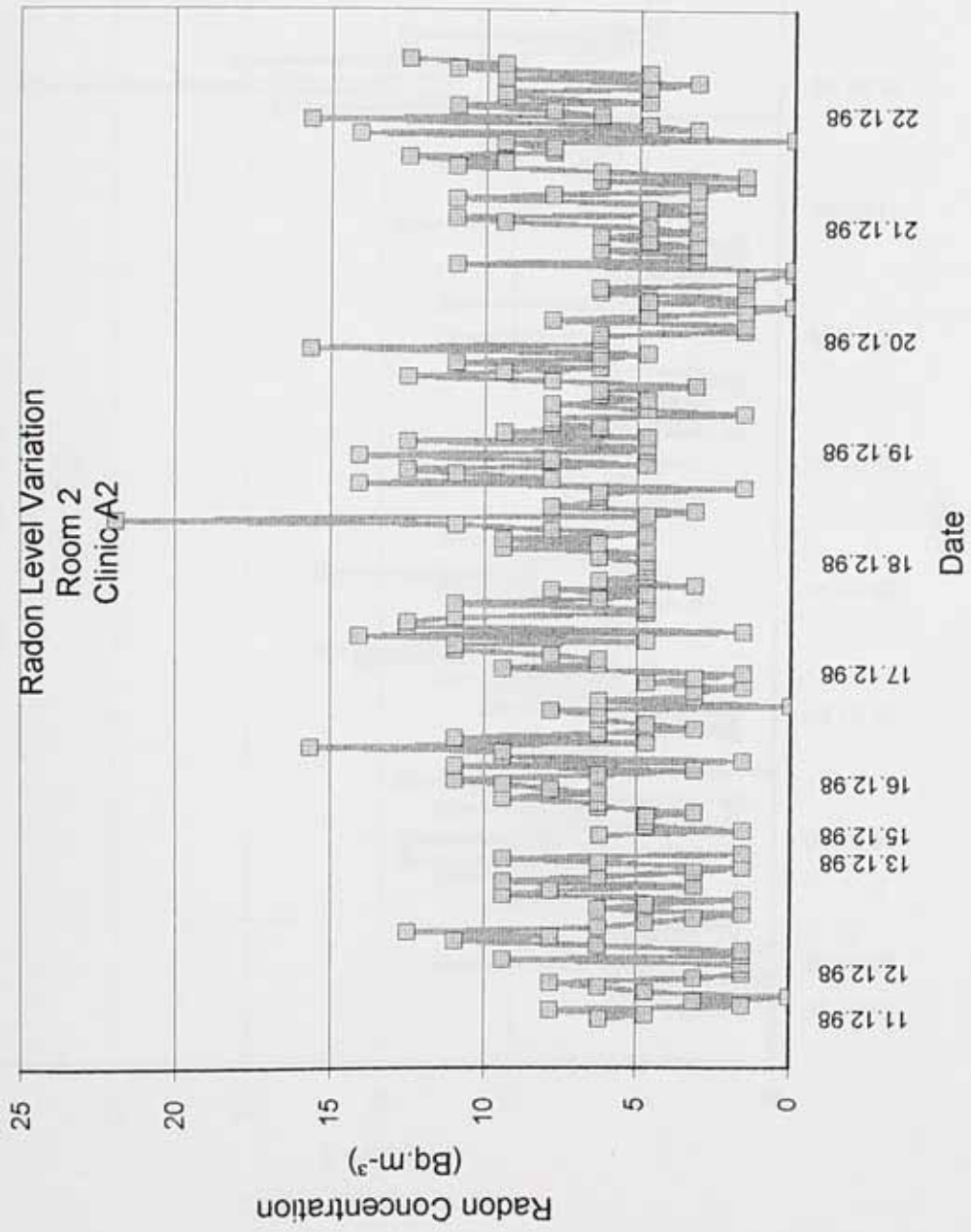

Figure 6.4.4. Radon Level Variation, Room 3, Clinic A2

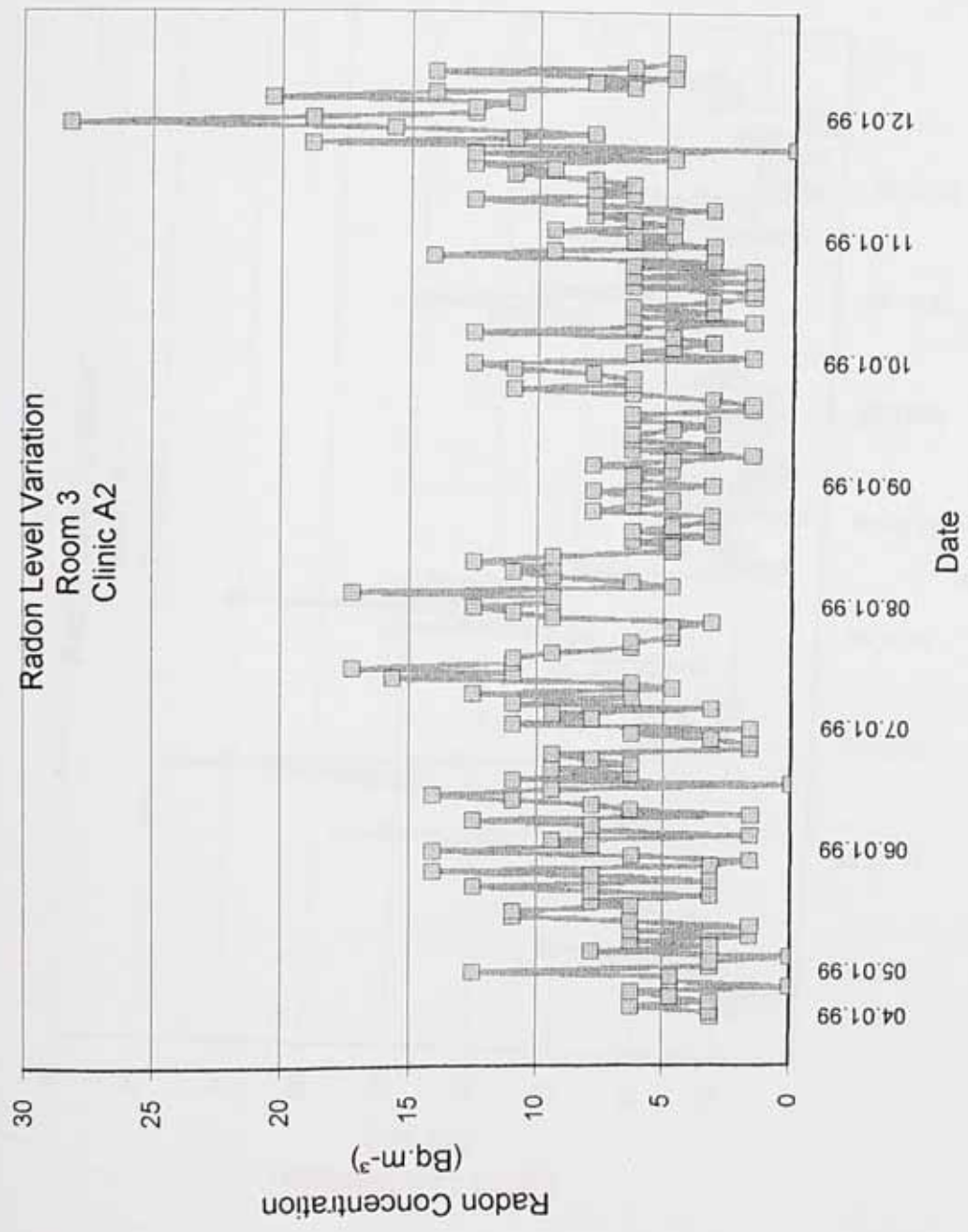

Figure 6.4.5. Radon Level Variation, Room 4, Clinic A2

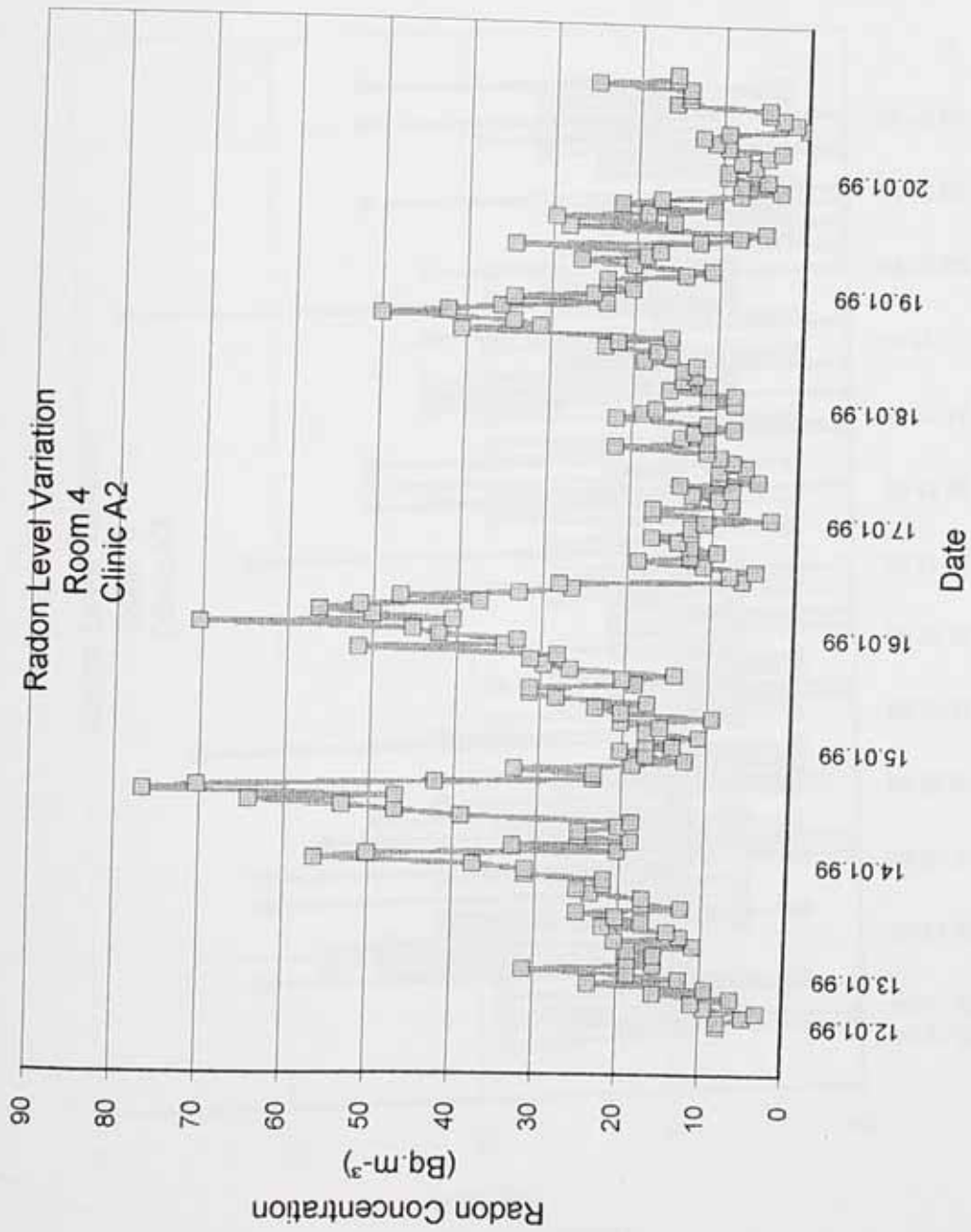
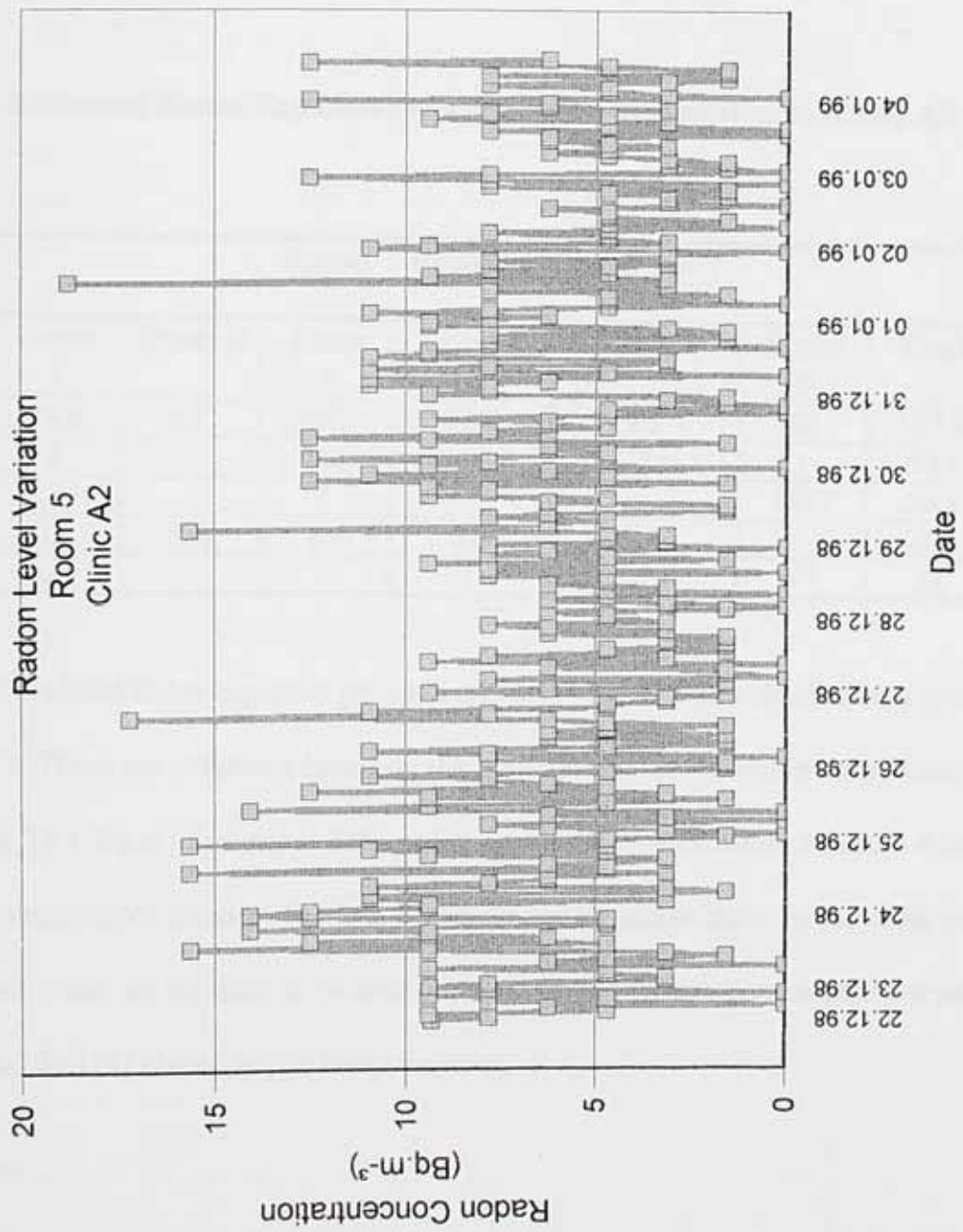

Figure 6.4.6. Radon Level Variation, Room 5, Clinic A2



It was assumed that the same members of staff were working at the clinic pre-remediation and that they had had the same pattern of room occupancy after remediation. The calculated exposures for each member of staff pre-remediation are given in Table 6.4.6. Due to the unavailability of data for room 6 for the studies pre-remediation (measurement was not conducted in this room before remediation), the exposures are calculated on the assumption that the average radon concentrations in room 6 is 210 Bq.m^{-3} (averaged 33% radon concentration of room 4 and 66% radon corrected concentration of room 5).

Table 6.4.6. Estimated Radon Exposure (kBq.h.m^{-3}) Pre-Remediation in Clinic A2

Member of staff	Radon Exposure (kBq h.m^{-3})						
	Room 1	Room 2	Room 3	Room 4	Room 5	Room 6	Total
1	39.4	8.7	17.7	42.7	9.3	10	127.8
2	/	/	8.8	45	7	/	60.8
3	/	/	/	/	/	30.2	30.2
4	12	2.6	1.8	6.5	1.4	/	24.3
5	/	/	/	/	7	15	22

The calculated radon exposure per each member of staff after remediation is given in Table 6.4.7. These are estimates based on the assumption that the radon concentration in Room 6 is 18.5 Bq.m^{-3} (averaged 33% radon corrected concentration of room 4 and 66% radon concentration of room 5). Data for this room are unavailable, as the room was very small and it was not possible to receive approval for a continuous measurement with the Rad- 7 and the TED placed in this room was lost.

Table 6.4.7. Estimated Radon Exposure (kBq.h.m⁻³) Post Remediation in Clinic A2

Member of staff	Radon Exposure (kBq.h.m ⁻³)						Total
	Room 1	Room 2	Room 3	Room 4	Room 5	Room 6	
1	6.4	0.4	1.2	2.2	0.9	0.9	12
2	/	/	0.6	1.6	0.7	/	2.9
3	/	/	/	/	/	2.7	2.7
4	1.9	0.1	0.1	0.3	0.1	/	2.5
5	/	/	/	/	0.7	1.3	2

The annual radiation dose per person was calculated, as well as the reduction factor (Table 6.4.8.).

Table 6.4.8. Annual Dose per Person (mSv) in Clinic A2

Member of staff	Pre-remediation Dose (mSv)	Post-remediation Dose (mSv)	Reduction Factor
1	1.01	0.09	10.8
2	0.48	0.02	22.5
3	0.24	0.02	11.2
4	0.19	0.02	9.7
5	0.17	0.01	11.3

Assuming a full time working schedule of 37 hours per week for each member of staff, the calculated radiation doses per person are given in Table 6.4.9.

Table 6.4.9. Potential Annual Dose per Person (mSv) in Clinic A2 for Full Time Working Hours (37 hours per week)

Member of staff	Pre-remediation Dose (mSv)	Post-remediation Dose (mSv)	Reduction Factor
1	3.75	0.35	10.7
2	4.06	0.18	22.5
3	2.96	0.26	11.4
4	4.76	0.49	9.7
5	2.15	0.2	10.8

Doses to staff pre-remediation were not calculated and are not available, so the comparison must be made by assuming the same patterns of occupancy before remediation as in the present post-remediation study.

If we compare the reduction factor in individual doses with the reduction factor in average radon levels, we obtain the data in Figure 6.4.7. The most significant reduction in radon levels is in rooms 2 and 4 (levels reduced by a factor of 21 and 19). The radon level in room 1 has the least reduction, but is still significantly decreased (by a factor of 6). It appears that the secondary radon source in room 4 was completely eliminated and the one in room 1 was significantly reduced. There is still a radon ingress in room 1, but well under the WAL.

Figure 6.4.7. Reduction Factors of Individual Doses Compared to Reduction Factors in Average Radon Levels in Clinic A2

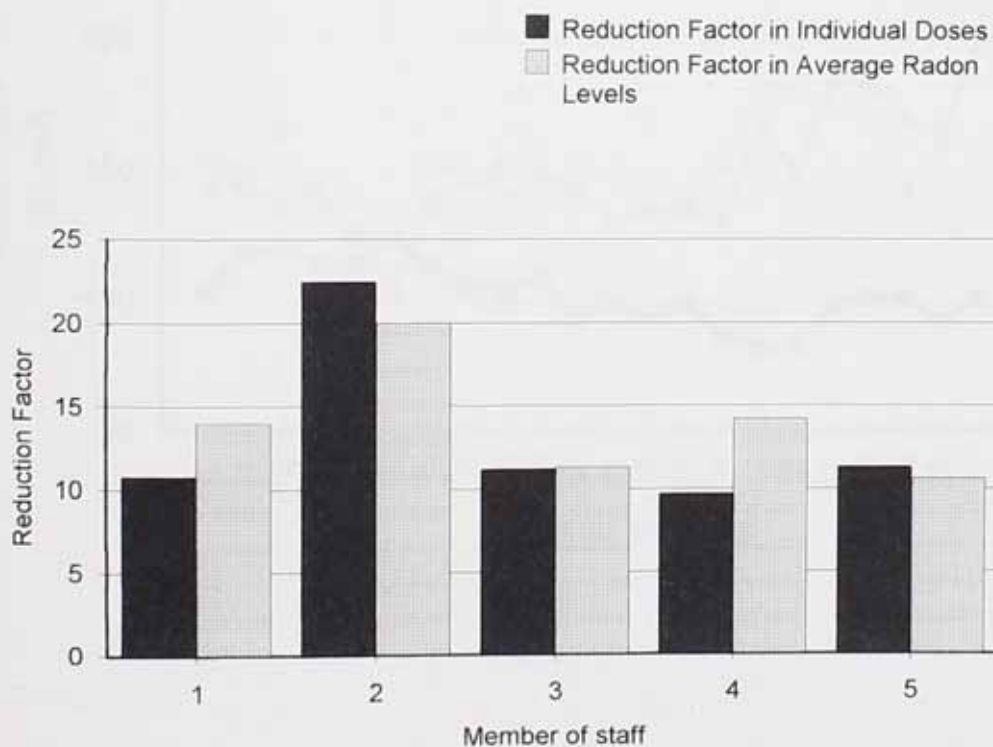

Plotting the radon level variation in room 1 for the weekdays, compared to Saturdays and Sundays, average uncorrected radon levels for each hour are considered, for four weekdays, one Saturday and one Sunday. The average daily value of radon in room 1, giving the pattern of radon variation in weekdays as opposed to weekends, identifies a similar variation for weekdays, Saturdays and Sundays, with lower values in weekdays and weekend peak values after 2 p.m. (Figure 6.4.8.). This pattern of variation supports the idea of a weak radon ingress in this room as the weekend levels are higher than the weekdays ones, overall.

Figure 6.4.8. Average Radon Daily Values in Room 1, Clinic A2

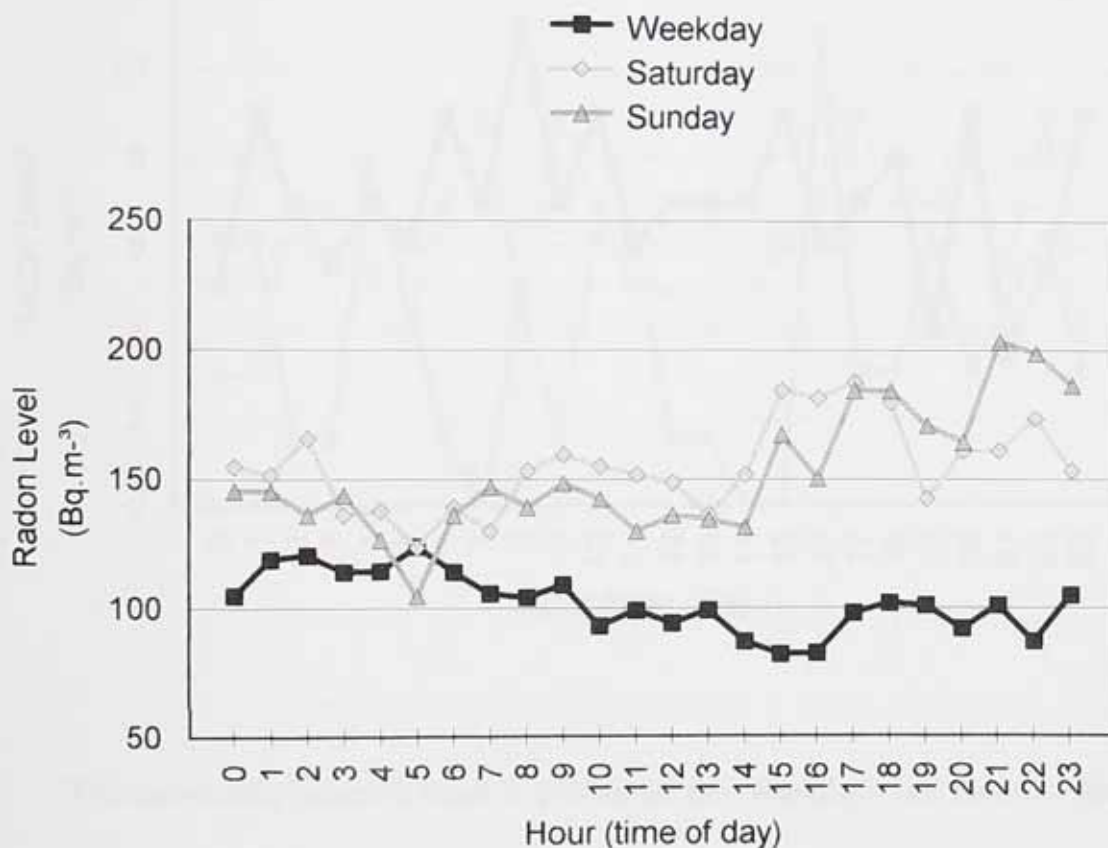

The average radon daily values in room 2, weekdays compared to weekends, are given in Figure 6.4.9., for four weekdays, two Saturdays and one Sunday. The variation is similar for weekdays and Saturdays but different for Sundays; due to low radon concentrations, the different pattern of variation is not too significant.

Figure 6.4.9. Average Radon Daily Values in Room 2, Clinic A2

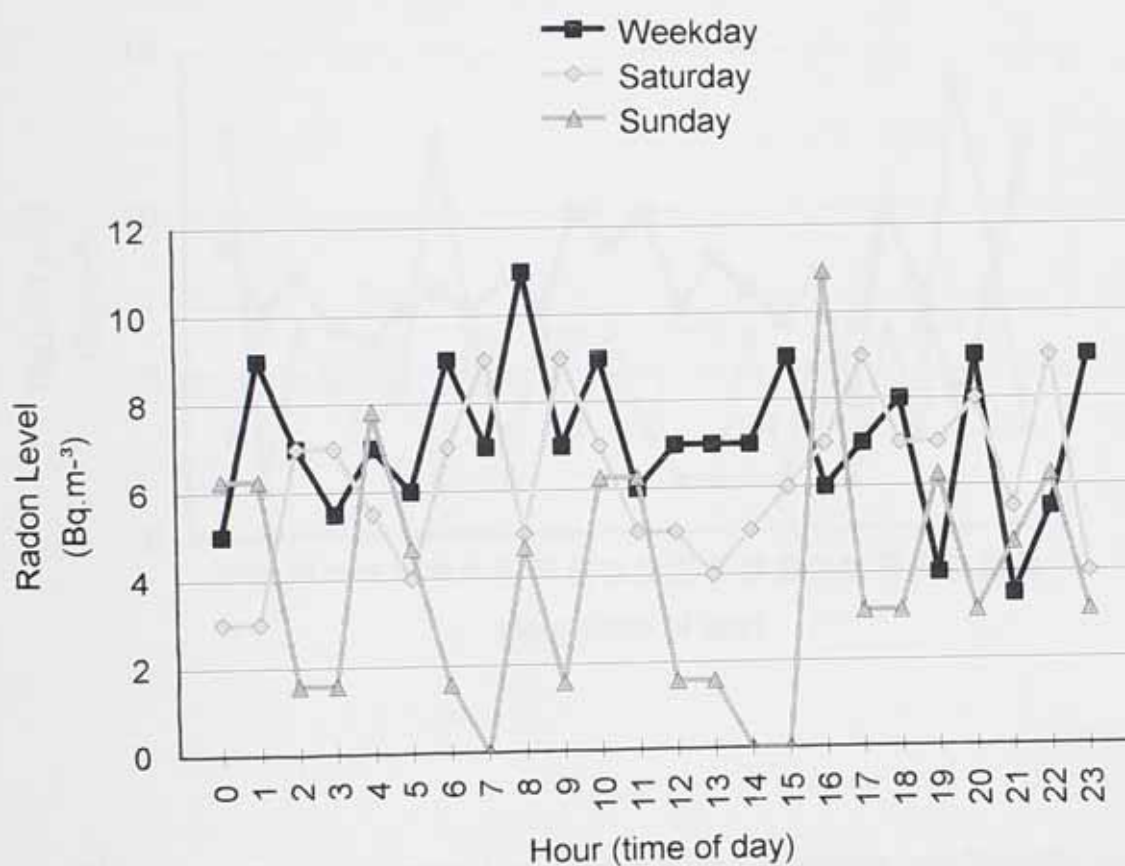

The daily radon values in room 3, plotted for five weekdays, one Saturday and one Sunday, have a similar variation, with radon levels at very low concentrations, given in Figure 6.4.10.

Figure 6.4.10. Average Radon Daily Values in Room 3, Clinic A2

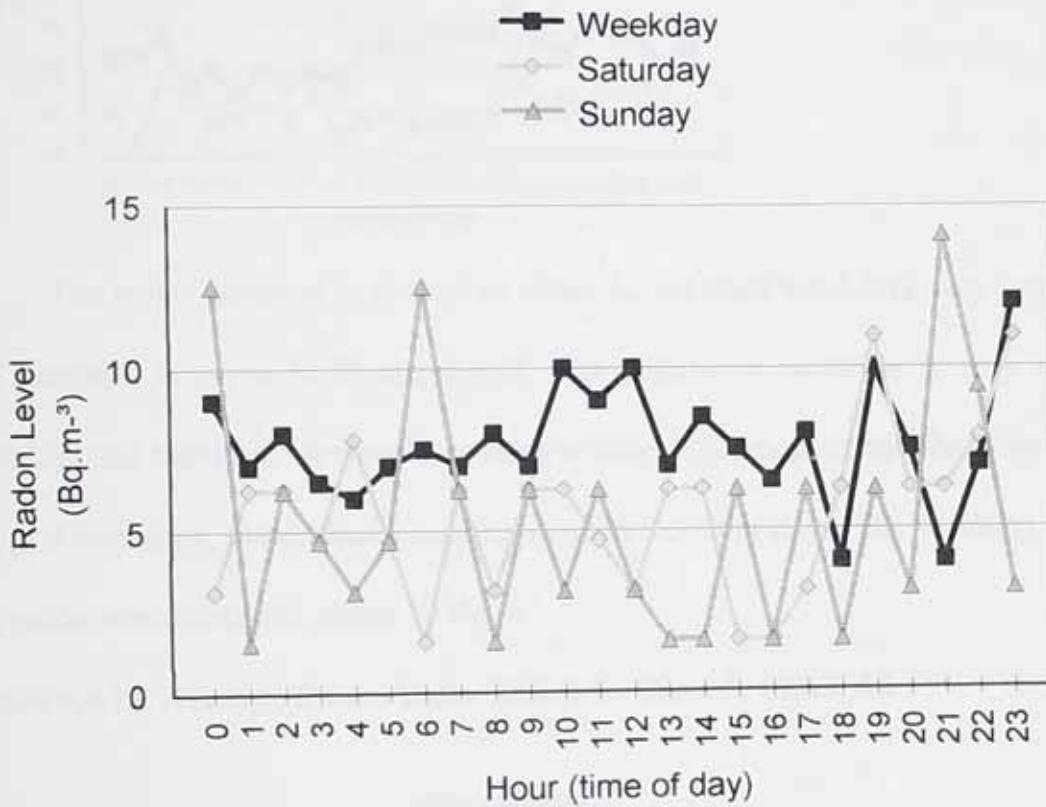

The radon variation in room 4 of clinic A2, for 5 weekdays, one Saturday and one Sunday, is given in Figure 6.4.11. The pattern of variation is very similar for weekdays and Sundays. The first half (a.m.) of the Saturday has a different pattern and higher radon concentrations.

Figure 6.4.11. Average Radon Daily Values in Room 4, Clinic A2

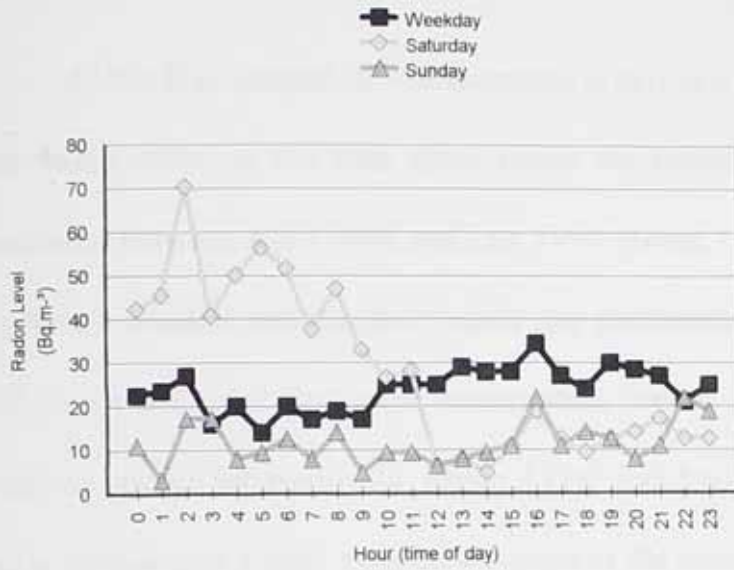

The radon variation in room 5 of clinic A2 for eight weekdays, two Saturdays and two Sundays, is given in Figure 6.4.12. The pattern of variation is very similar for weekdays and Sundays. On Saturdays there is little difference, except the radon level at 3 pm, at a minimum, rather than a maximum as in the other days. The variation is for very low radon concentrations, under 10 Bq.m^{-3} .

Figure 6.4.12. Average Radon Daily Values in Room 5, Clinic A2

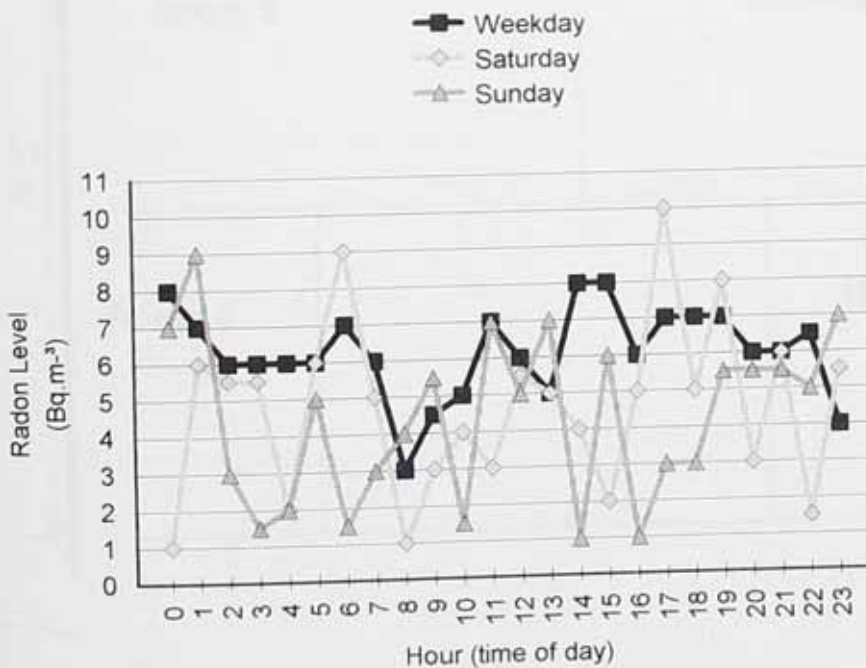

6.5. Location B Data

Clinic B is situated in Northampton, is part of a large building and occupying less than half (~40%) of the total space inside the building. Four rooms in clinic B were monitored between April 1998 and July 1998: Room 1, the staff room (2.5x2x2.5m), did not have a window and the door would stay permanently opened. Room 2 (3x3.5x2.5m) and Room 3 (3x4x2.5m) were consultation rooms, frequently used, with doors and windows opened intermittently. Room 4 (2x2.5x2.5m) was used as a recovery room and had a window and a door, both closed most of the times. All the rooms had a single door communicating into a small common hall separated by a door from the waiting area that was in common with a large hall (Figure 6.5.1.).

Figure 6.5.1. Plan of Location B (not at scale)

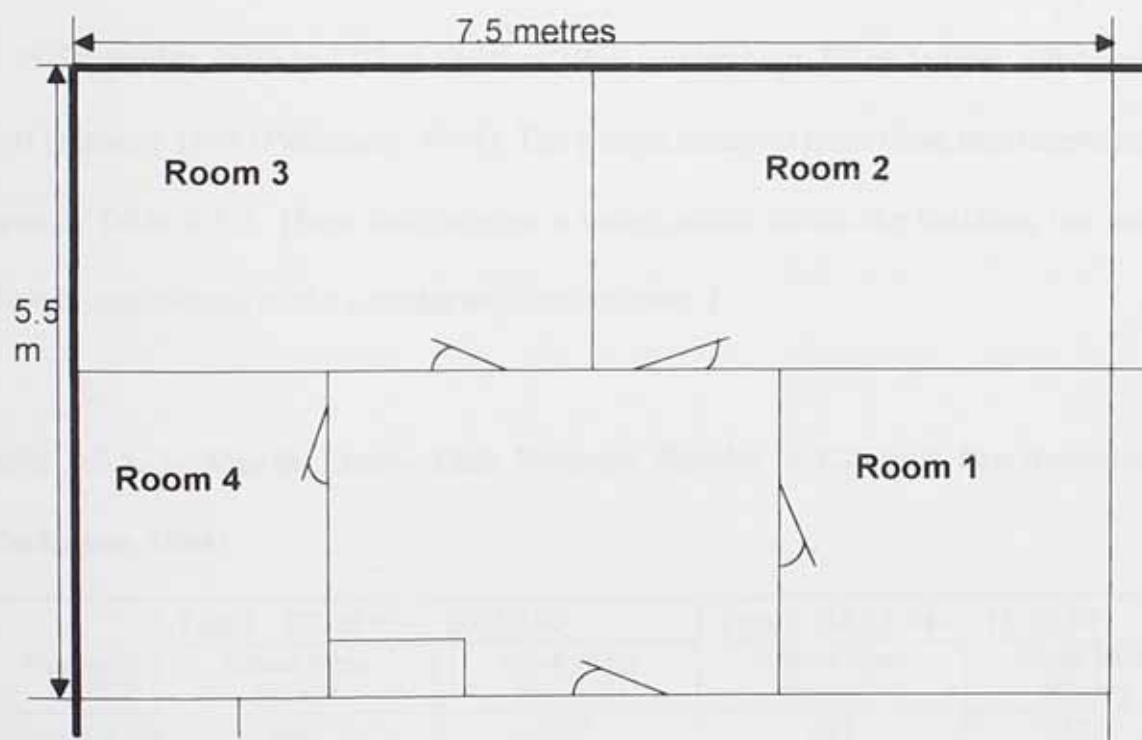

Measurements started at the present clinic in September 1993, using continuous 24 hours monitoring at each point. The temporal variation of radon concentration was determined in four rooms (Parkinson, 1994). The average radon concentrations calculated pre-remediation are given in Table 6.5.1.

Table 6.5.1. Time Averages of Rad7 Radon Concentration Measurements in Location B Pre-Remediation (Parkinson, 1994).

Room	Date	Average Radon Concentration (Bq.m ⁻³)	Daytime Radon Concentration (Bq.m ⁻³)
1	16.12.93-17.12.93	318	211
2	17.12.93-18.12.93	230	302
3	21.12.93-22.12.93	179	156
4	22.12.93-23.12.93	90	104

TED's were placed in all the four rooms for more than a month at a time, between 07 of September 1993 and 07 of October 1993 and between 05 of January 1994 and 11-th of February 1994 (Parkinson, 1994). The results obtained from these measurements are given in Table 6.5.2. These data suggest a radon source inside the building, but outside clinic B, somewhere in the corridor adjacent to room 1.

Table 6.5.2. 1- Month Track- Etch Detector Results in Clinic B Pre-Remediation (Parkinson, 1994).

Room	Test 1 07.09.93- 07.10.93	Test 2 05.01.94- 11.02.94	
	Annual Mean (Bq.m ⁻³)	Actual Mean (Bq.m ⁻³)	Actual Mean (Bq.m ⁻³)
Room 1	642	617	421
Room 2	77	74	113
Room 3	/	/	195
Room 4	/	/	55

The daytime radon concentrations in the four rooms in Clinic B were estimated for January 1994 (Parkinson, 1994). The estimates are given in Table 6.5.3.

Table 6.5.3. Range of Daytime Radon Concentrations Estimated for January 1994 in Clinic B, Pre-Remediation (Parkinson, 1994).

Room	Estimated Mean	Daytime Radon	Concentration (Bq.m ⁻³)
	Lowest	Mean	Highest
Room 1	180	315	485
Room 2	40	115	190
Room 3	70	195	320
Room 4	20	55	90

The post remedial measurements in this study started in April 1998 and finished in July 1998. A continuous radon measurement method was used and the Rad-7 was placed in each room for periods of time between 10 to 29 days. The radon level variation in all four rooms is given in Figures 6.5.2.- 6.5.5. The variation in room 2 shows two maximum radon concentrations on Saturday 09.05.98 at 9a.m., 226 Bq.m⁻³ and on Sunday 10.05.98 at 7 a.m., 229 Bq.m⁻³. In room 3, there is a maximum radon level on Sunday 07.06.98, at 10 p.m., of 94 Bq.m⁻³. It appears that a much reduced ingress of radon is happening somewhere in room 2, at the border between rooms 2 and 3. The corrected (*CF) daytime radon values were calculated and are shown in Table 6.5.4.

Table 6.5.4. Corrected Daytime Radon Values, Clinic B, Post- Remedial Studies

Room	Daytime Radon	Concentration	(Bq.m ⁻³)
	Lowest	Mean	Highest
Room 1	3	19	68
Room 2	3	73	388
Room 3	6	43	91
Room 4	5	32	63

Figure 6.5.2. Radon Level Variation, Room 1, Clinic B, Post Remediation

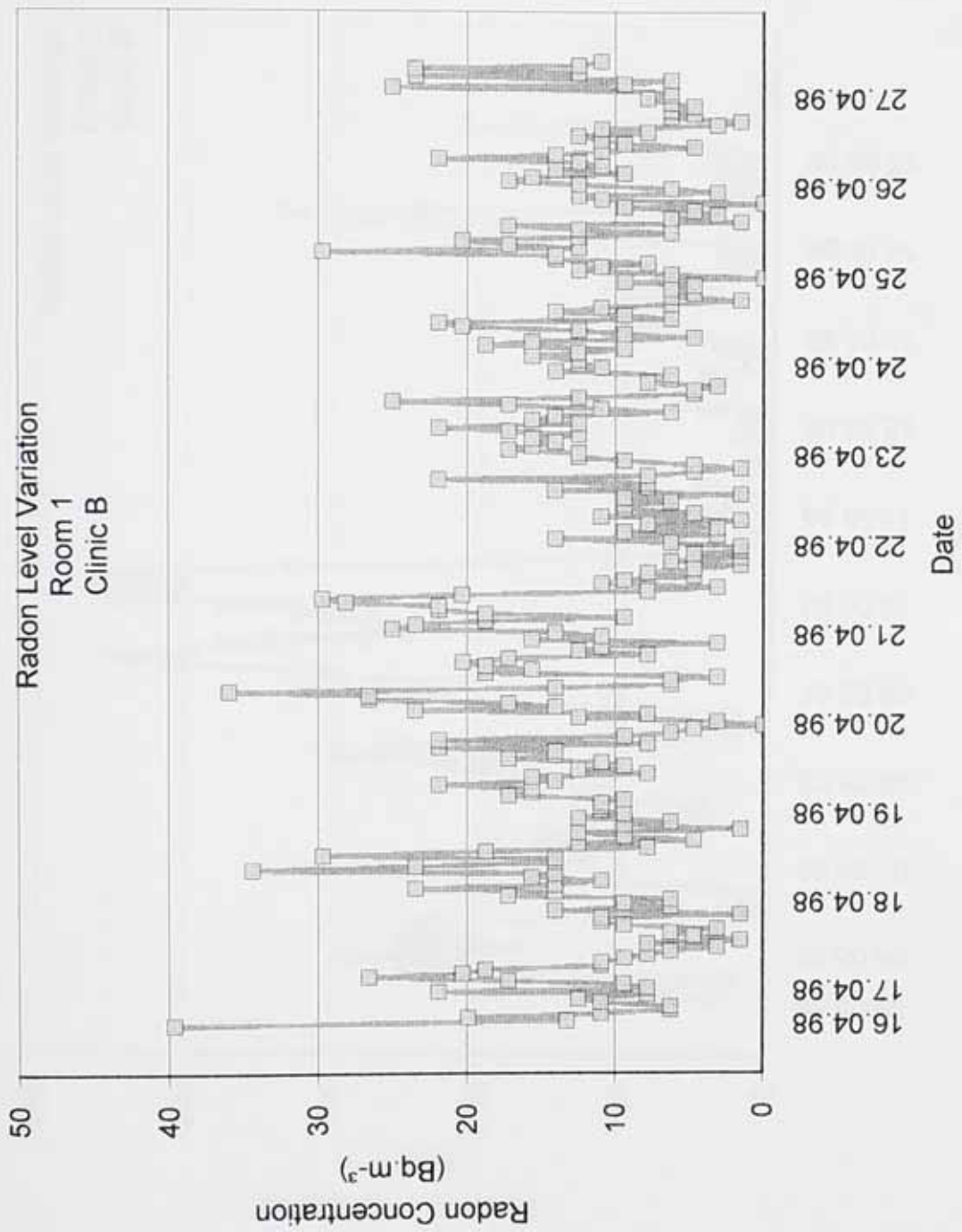

Figure 6.5.3. Radon Level Variation, Room 2, Clinic B

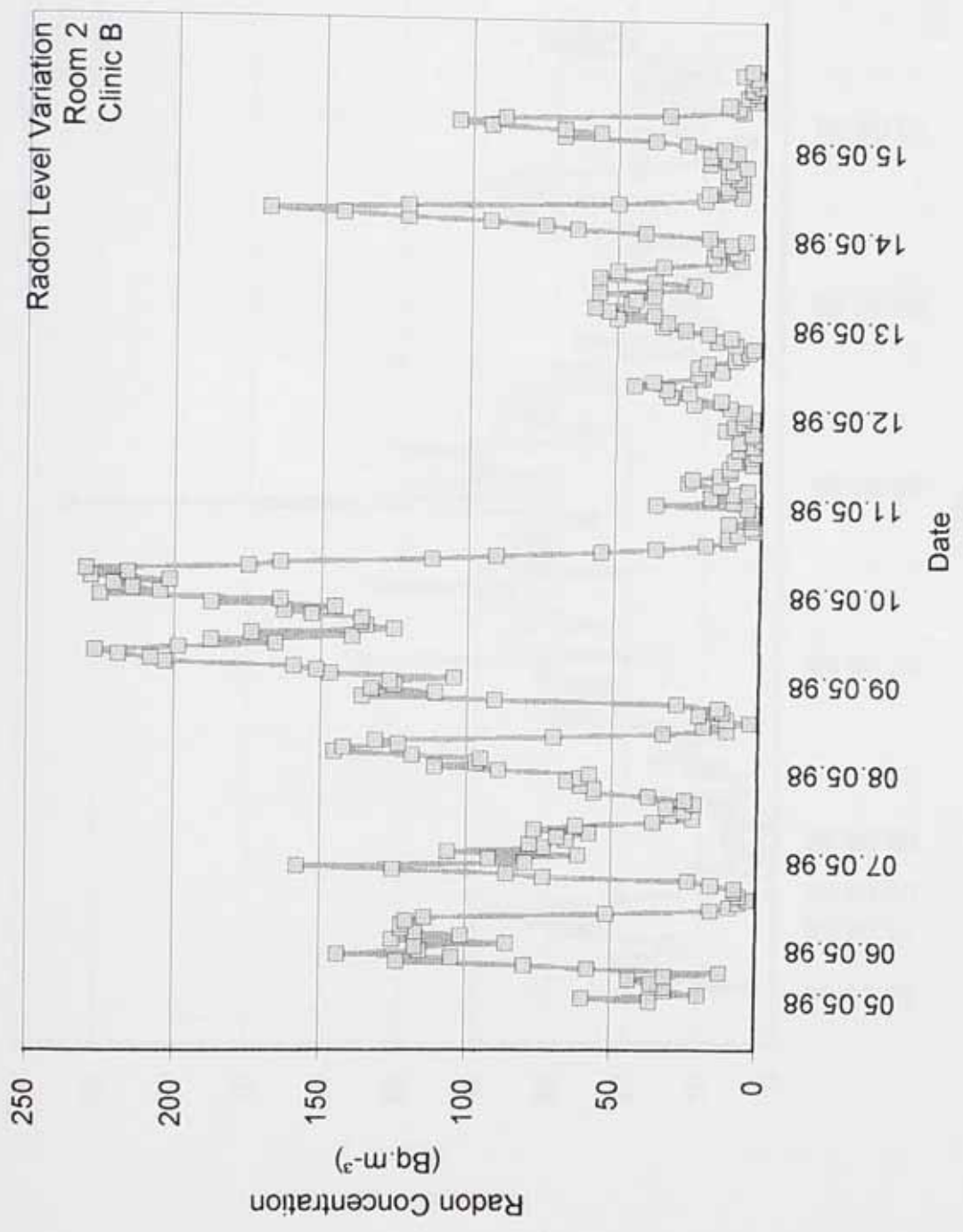

Figure 6.5.4. Radon Level Variation, Room 3, Clinic B

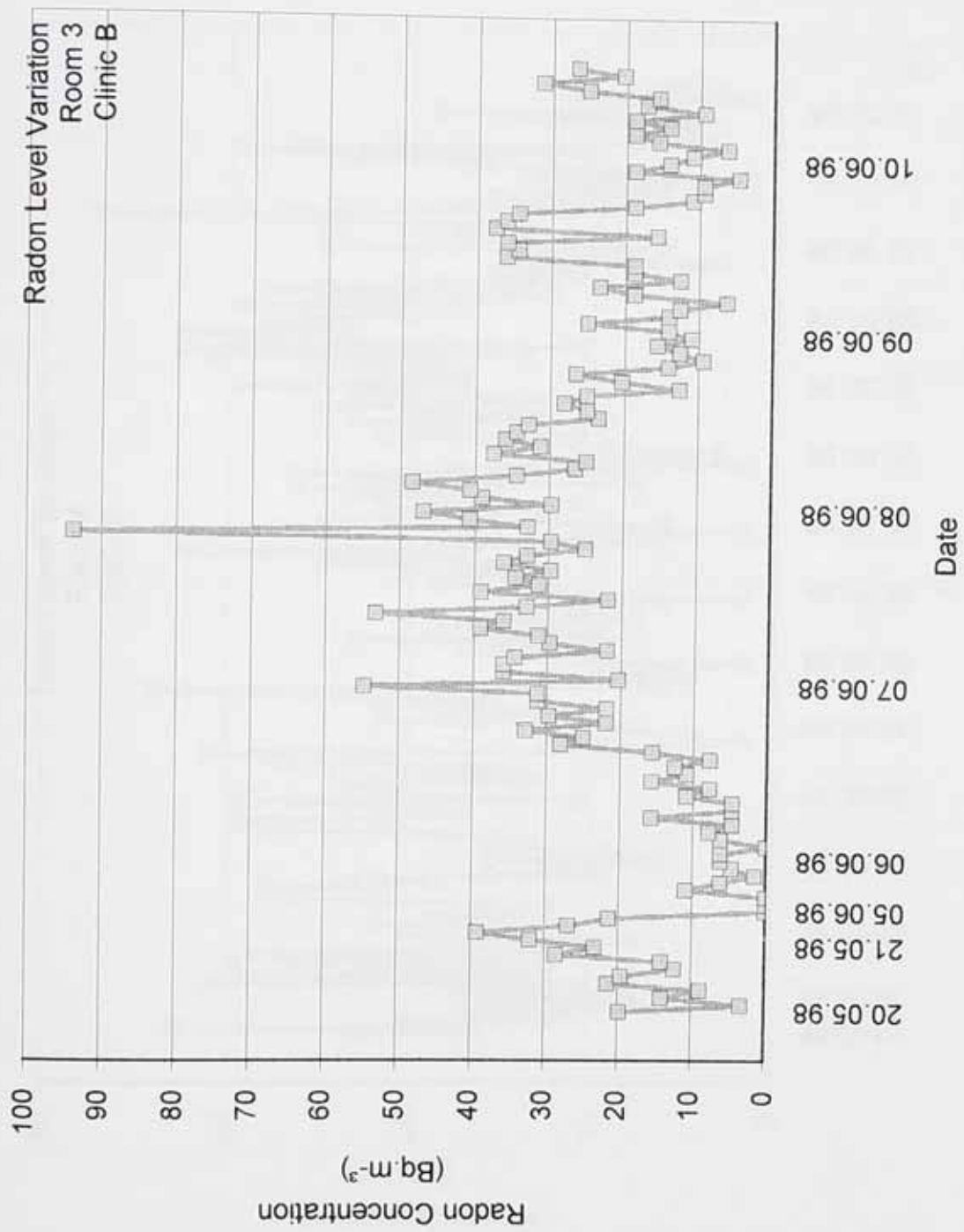
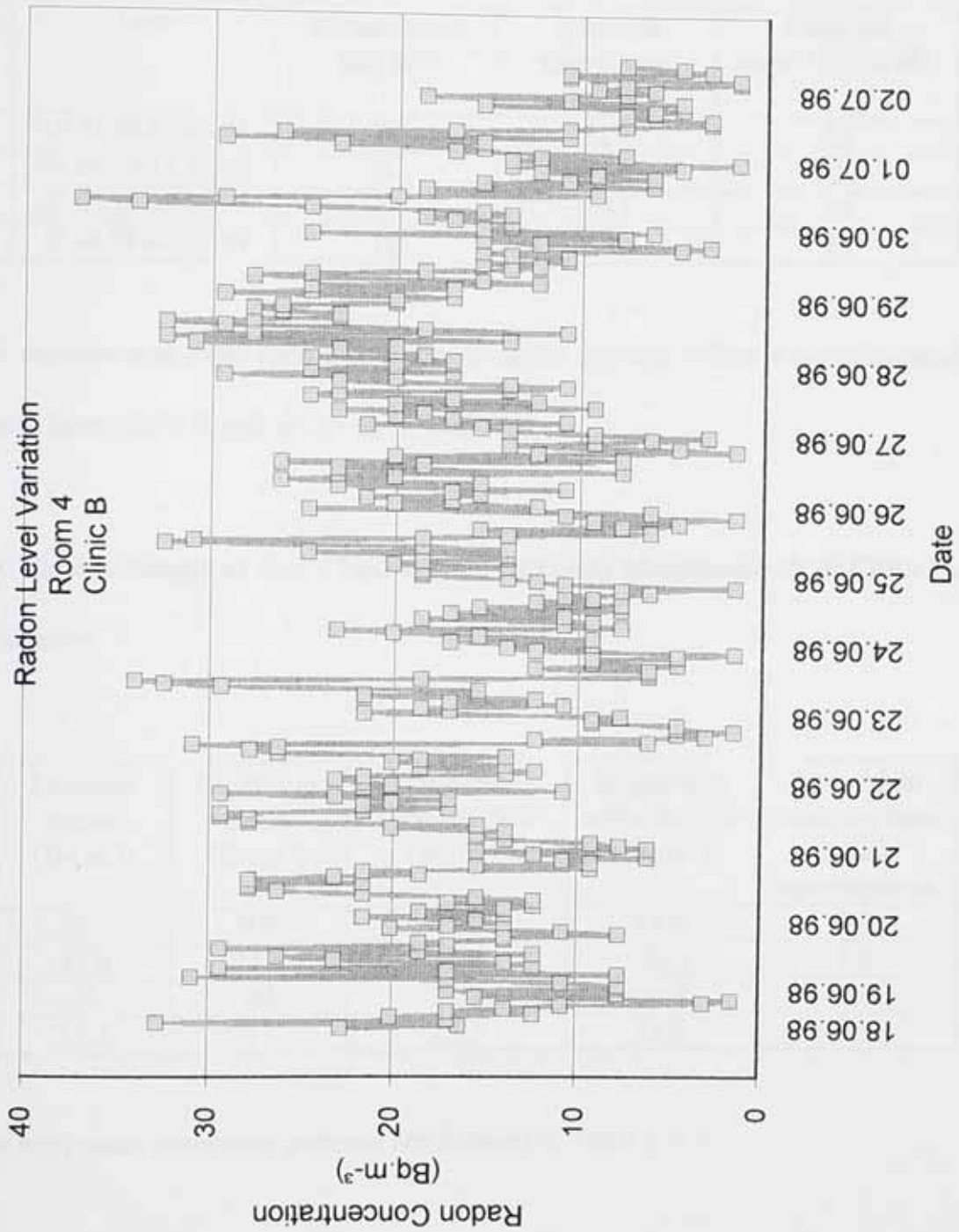

Figure 6.5.5. Radon Level Variation, Room 4, Clinic B



The corrected average radon values from the continuous measurement are given in Table 6.5.5.

Table 6.5.5. Corrected Average Radon Values from Continuous Monitoring in Clinic B, Post- Remediation.

Room	Date	Actual mean (Bq.m ⁻³)	Seasonal Correction Factor	Corrected mean*CF (Bq.m ⁻³)
Room 1	16.04.98-05.05.98	10	1.02	18
Room 2	05.05.98-15.05.98	60	1.18	122
Room 3	20.05.98-18.06.98	23	1.31	50
Room 4	18.06.98-02.07.98	16	1.48	40

The daytime and night time radon concentration average values were calculated for each room from clinic B and are given in Table 6.5.6.

Table 6.5.6 Time Averages of Rad 7 Radon Concentration Measurements in Clinic B, Post Remediation

Room	Daytime mean (Bq.m ⁻³)	Night time mean (Bq.m ⁻³)	Daytime corrected*CF (Bq.m ⁻³)	Night time corrected*CF (Bq.m ⁻³)	Ratio night time/ day time radon concentration
Room 1	10.9	9.7	17.9	16.9	0.9
Room 2	42.9	77.4	50.6	156.2	1.8
Room 3	25	20	32.7	44.8	0.8
Room 4	18.5	13	27.3	32.9	0.8

The staff room occupancy patterns are detailed in Table 6.5.7.

Table 6.5.7. Staff Room Occupancy in Clinic B

Member of staff	Hours Spent Per Year (48 working weeks per year)				Total
	Room 1	Room 2	Room 3	Room 4	
1	156	/	36	/	192
2	/	168	48	/	216
3	144	/	/	/	144
4	/	/	192	/	192
5	24	768	144	/	936
6	24	768	144	/	936
7	156	/	36	/	192
8	312	/	48	/	360
9	/	/	72	/	72

The estimated radon exposure before remediation, assuming the same occupancy pattern as after remediation at the time pre-remediation, is given in Table 6.5.8.

Table 6.5.8. Estimated Radon Exposure (kBq.h.m⁻³) Pre-Remediation in Clinic B

Member of staff	Radon Exposure (kBq.h.m ⁻³)				Total
	Room 1	Room 2	Room 3	Room 4	
1	49.1	/	7	/	56.1
2	/	19.3	9.4	/	28.7
3	45.4	/	/	/	45.4
4	/	/	37.4	/	37.4
5	7.6	88.3	28.1	/	124
6	7.6	88.3	28.1	/	124
7	49.1	/	7	/	56.1
8	98.3	/	9.4	/	107.7
9	/	/	14	/	14

The radon exposure calculated for each member of staff after remediation is given in Table 6.5.9.

Table 6.5.9. Estimated Radon Exposure (kBq.h.m⁻³) in Clinic B Post Remediation

Member of staff	Radon Exposure (kBq.h.m ⁻³)				Total
	Room 1	Room 2	Room 3	Room 4	
1	2.9	/	2	/	4.9
2	/	14.6	2.7	/	17.3
3	2.7	/	/	/	2.7
4	/	/	10.8	/	10.8
5	0.5	66.5	8.1	/	75.1
6	0.5	66.5	8.1	/	75.1
7	3	/	2	/	5
8	5.9	/	2.7	/	8.6
9	/	/	4	/	4

The annual radiation dose per person calculated for the radon levels pre and post remediation is given in Table 6.5.10.

Table 6.5.10. Annual Dose per Person (mSv) in Clinic B

Person	Pre-remediation Dose (mSv)	Post-remediation Dose (mSv)	Reduction Factor
1	0.44	0.04	11.4
2	0.23	0.14	1.6
3	0.36	0.02	18
4	0.3	0.09	3.3
5	0.98	0.6	1.6
6	0.98	0.6	1.6
7	0.45	0.04	11.3
8	0.85	0.07	12.5
9	0.11	0.03	3.7

The estimated dose for full time working members of staff is given in Table 6.5.11.

Table 6.5.11. Potential Annual Dose per Person (mSv) in Clinic B for Full Time Working Hours (37 hours per week)

Person	Pre-remediation Full Time Dose (mSv)	Post-remediation Full Time Dose (mSv)	Reduction Factor
1	4.12	0.37	11.1
2	1.87	1.13	1.7
3	4.44	0.27	16.4
4	2.75	0.79	3.5
5	1.87	1.13	1.7
6	1.87	1.13	1.7
7	4.12	0.37	11.1
8	4.21	0.23	18.3
9	2.75	0.79	3.5

In terms of dose, four members of staff were identified as having worked in the clinic pre-remediation, as well as post-remediation. The doses pre-remediation and post-remediation, taking into account the real occupancy pattern, are given in Table 6.5.12., as well as the real reduction factor. It can be seen that the estimates that assume the same occupancy pre and post remediation, are lower than the dose in the pre-remediation case, apart from member of staff number 6. This suggests a change of use of the building, as well as a different working pattern.

Table 6.5.12. Annual Effective Doses of Staff, Clinic B

Member of staff	Real pre remediation dose (mSv)	Estimated pre remediation dose (mSv)	Real post remediation dose (mSv)	Real Reduction Factor	Estimated Reduction Factor
2	1.4	0.23	0.14	10	1.6
6	0.8	0.98	0.6	1.3	1.6
7	2	0.45	0.04	50	11.3
9	0.8	0.11	0.03	26.7	3.7

Figure 6.5.6. compares the reduction factors in individual doses to the reduction factors in average radon levels. The reduction in doses is similar with the reduction in

radon levels in the rooms used the most, with the exception of members of staff 1, 7 and 8, that spend most of their time in room 1, where the radon level was highly reduced (16.7 times) but also spend time in room 3, where radon levels were only slightly reduced (3.5 times).

Figure 6.5.6. Reduction Factors of Individual Doses Compared to Reduction Factors in Average Radon Levels in Clinic B

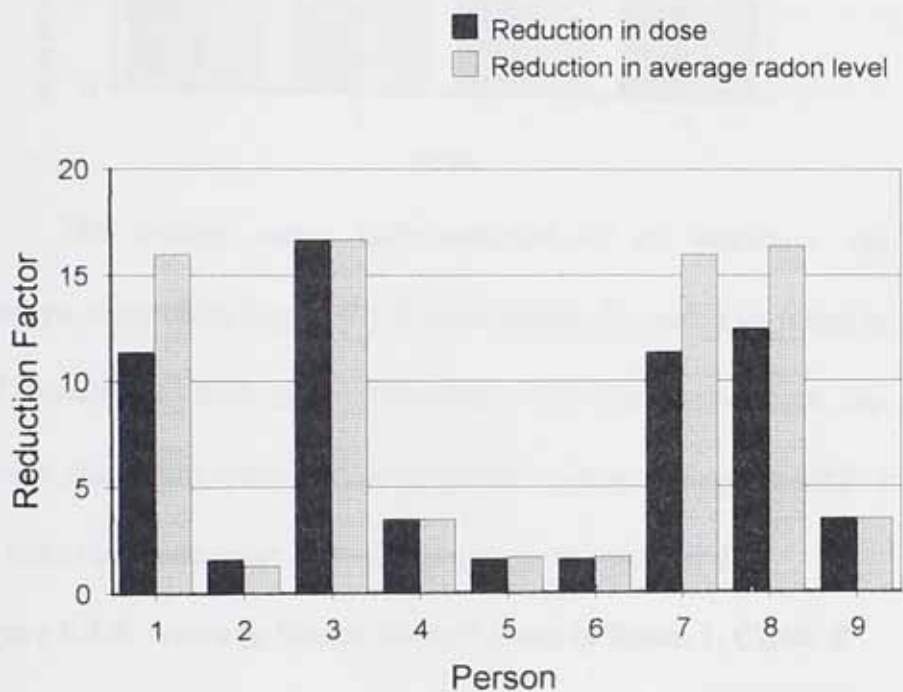

The ratio of night-time radon levels to daytime radon levels both pre and post remediation, is given in Figure 6.5.7. The night time radon level pre-remediation was higher in room 1, that used to be the site for radon ingress at that time, and that the night time level after remediation is higher in room 2, that is the present radon entry in the clinic. In the other two rooms, 3 and 4, the ratio has slightly reduced after remediation.

Figure 6.5.7. Comparison of Ratio Night Time per Daytime Radon Levels Pre and Post Remediation in Clinic B

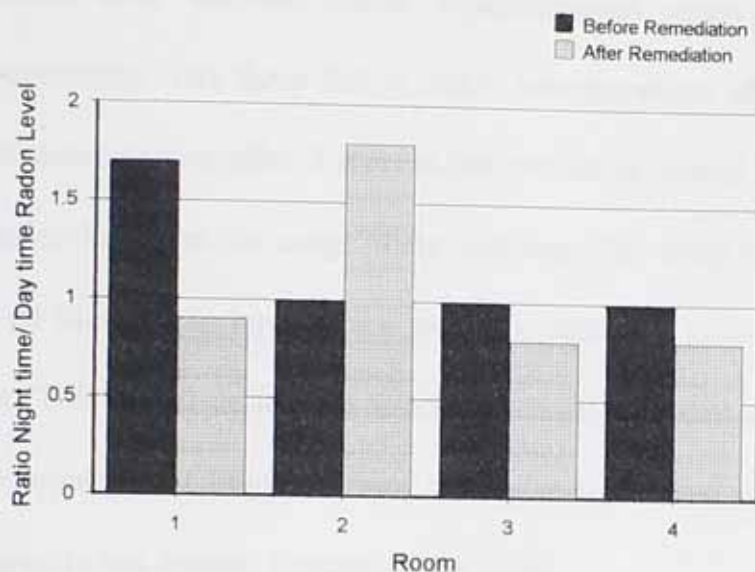

The average radon daily variation for six weekdays, two Saturdays and two Sundays, is given in Figure 6.5.8. Once again, the radon variation is similar for weekdays and Sundays, as well as for Saturdays, with some exceptions, the most significant one being a maximum radon concentration at 1 pm on Saturdays, while in the rest of the week the radon concentration is at a minimum at this time of day.

Figure 6.5.8. Average Radon Daily Values in Room 1, Clinic B

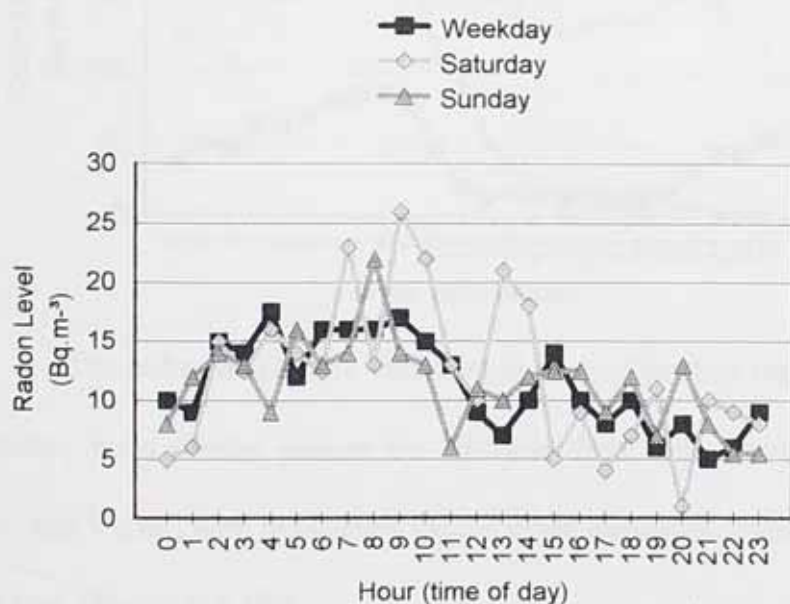

The radon level daily variation in room 2, recorded for eight weekdays, one Saturday and one Sunday, is given in Figure 6.5.9. and demonstrates a similar pattern of variation, with weekday radon concentrations much lower than weekend radon concentrations. The sharp fall in radon concentrations after 9 a.m. and the increase in radon concentration after 7 p.m. in the weekdays, would suggest a clear dependency of the radon levels on the usage of the building. The sharp radon concentration fall after 7 a.m. on Sunday can be due to a problem, such as a cleaner moving the position of the meter. This would tie in with similar repeated problems encountered at the time of the measurements in Clinic B, where the meter kept being switched off or moved, despite warnings to not disturb, attached to the meter.

Figure 6.5.9. Average Radon Daily Values in Room 2, Clinic B

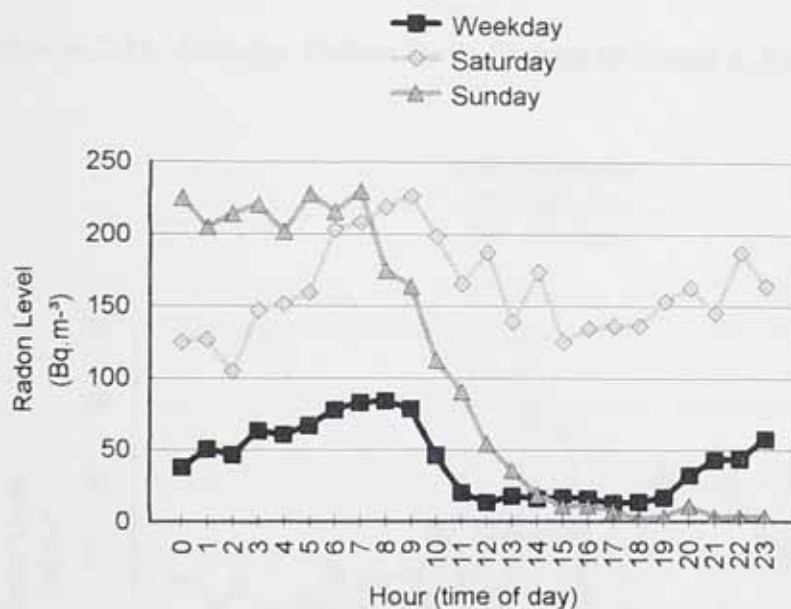

The radon level daily variation in room 3 for two weekdays, one Saturday and one Sunday, has a similar pattern for all these days, with some exceptions on Sunday at 10 a.m. and 9 p.m., with maximum values when the radon levels for weekdays and Saturdays are low. (Figure 6.5.10.)

Figure 6.5.10. Average Radon Daily Values in Room 3, Clinic B

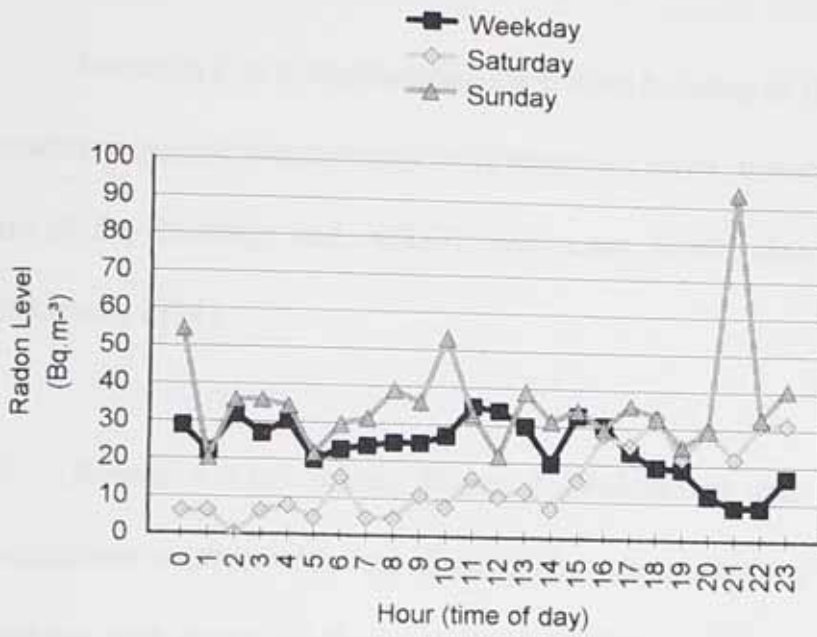

The radon daily variation for nine weekdays, two Saturdays and two Sundays in room 4 in clinic B, has a similar pattern for all the days, with radon concentrations lower than 30 Bq.m⁻³ at any time (Figure 6.5.11).

Figure 6.5.11. Average Radon Daily Values in Room 4, Clinic B

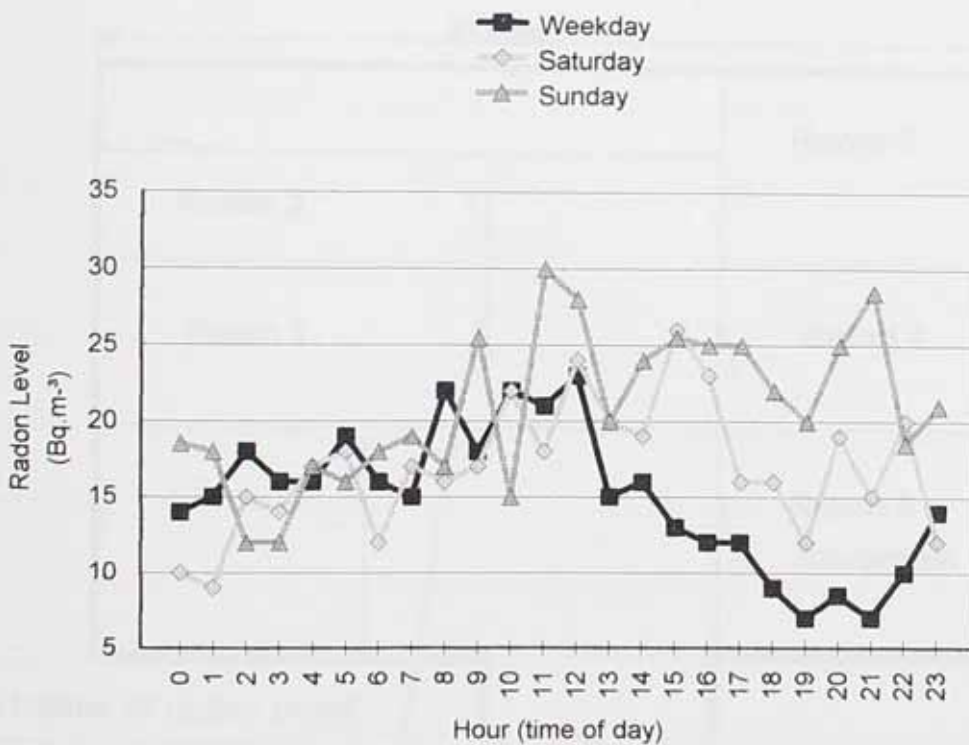

6.6. Location C Data

Location C is a Northamptonshire NHS building in Kettering. It has a radon proof membrane beneath the recently built reception room; however, rooms 1-4 are in the old part of the building and initially had radon levels above the WAL of 400 Bq.m^{-3} (Parkinson, 1994).

Rooms 1 ($2 \times 3.5 \times 3 \text{m}$), Room 3 ($3 \times 3.5 \times 3 \text{m}$) and Room 4 ($2 \times 3.5 \times 3 \text{m}$) were consultation rooms, with one door each, communicating in the common hall. The windows and doors of these rooms stayed closed at most of the times. Room 2 ($1.5 \times 3.5 \times 3.5 \text{m}$) was a storage area and a passing room, with two doors opened and closed continuously as members of staff passed through (Figure 6.6.1).

Figure 6.6.1. Plan of Location C (not at scale)

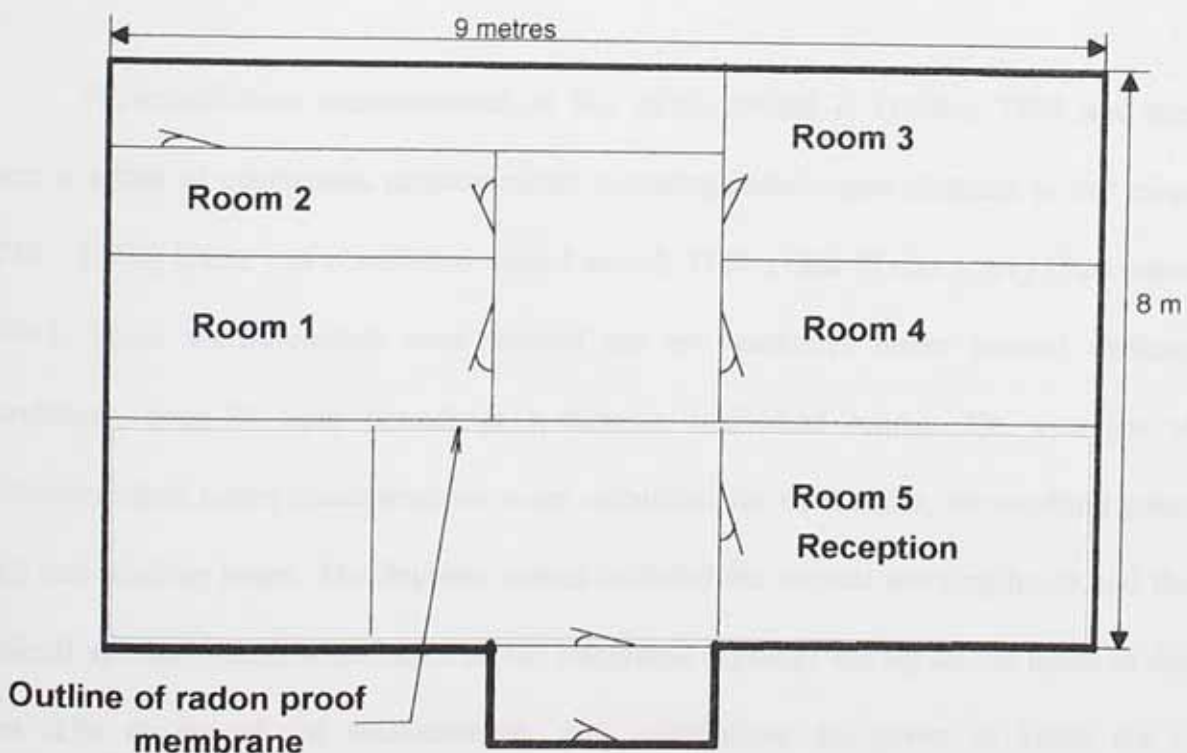

Post-remediation measurements in clinic C started in February and ended in March 1999. The Rad-7 Radon monitor was used to obtain the individual radon concentration measurements and track-etch detectors were placed for three months in all the monitored rooms. The results represent a month and a half of continuous sampling, with the average counting time rate of 1 hour.

Three TED's were set up in three rooms (Rooms 2, 4 and 5), on the 1 of February 1999; the track-etch detectors from rooms 4 and 5 were left there for a period of three months and were collected in April 1999, whereas the detector from room 2 was left over there for a period of two and a half weeks, in parallel with the continuous radon monitor. The purpose of the latter measurement was to have two sources of data for the same measurements. The recorded values varied between (45-206) Bq.m⁻³. The Rad-7 detector, set on normal mode, recorded hourly measurements in Rooms 1- 4 of clinic C, for periods of time varying between 7 to 16 days.

Pre-remediation measurements in this clinic started in October 1993 and they were a series of continuous measurements revealing radon concentrations in the range (274 - 1,220) Bq.m⁻³, in correlation with 1-month TED's data (Table 6.6.1) (Parkinson, 1994). These measurements were carried out on weekdays under normal working conditions, over 24 hour periods at a time in individual rooms. The averages of time-dependant radon concentrations were calculated for each room, for working hours and non-working hours. The daytime values included the normal working hours and the general average values were based on the integrated exposure during all the hours of the test. The results of the measurements and calculations are given in Table 6.6.1. (Parkinson, 1994).

Table 6.6.1. Time Averages of Rad-7 Radon Concentration Measurements in Location C Pre- Remediation (Parkinson, 1994).

Room	Date	Average Radon Concentration (Bq.m ⁻³)	Daytime Radon Concentration (Bq.m ⁻³)
Room 1	14.10.93-15.10.93	1,220	1,012
Room 2	19.10.93-20.10.93	1,120	990
Room 3	07.10.93-08.10.93	274	487
Room 3	25.10.93-26.10.93	823	990
Room 4	20.10.93-21.10.93	864	748
Room 4	26.10.93-27.10.93	875	553
Room 5	21.10.93-22.10.93	283	383
Room 5	27.10.93-28.10.93	328	573

TED's were placed in the rooms for a 1- month period of time, between January 1994 and February 1994. The results are shown in Table 6.6.2. and include the SCF's used (Parkinson, 1994).

Table 6.6.2. 1- Month Track- Etch Detector Results in Clinic C Pre-Remediation (Parkinson, 1994).

Room	Test 1	05.01.94-11.02.94
	Annual Mean (Bq.m ⁻³)	Actual Mean (Bq.m ⁻³)
Room 1	926	926
Room 2	485	485
Room 3	336	336
Room 4	136	136
Room 5	106	106

In order to calculate the radon exposure of each individual working in the clinic, an estimation of the likely range of daytime radon concentrations was calculated and the values for each room are given in Table 6.6.3. (Parkinson, 1994). The data suggest a radon source in room 1.

Table 6.6.3. Range of Daytime Radon Concentrations Estimated for January 1994 in Clinic C, Pre-Remediation (Parkinson, 1994).

Room	Estimated Mean	Daytime Radon	Concentration (Bq.m ⁻³)
	Lowest	Mean	Highest
Room 1	395	695	1,065
Room 2	205	365	560
Room 3	145	330	480
Room 4	50	100	220
Room 5	75	165	280

The corrected (*CF) daytime radon values in the five rooms of clinic C, post remediation, including average values for the daytime working hours, minimum radon values and maximum radon values, are given in Table 6.6.4.

Table 6.6.4. Corrected Daytime Radon Values, Clinic C, Post- Remedial Studies

Room	Daytime Radon	Concentration	(Bq.m ⁻³)
	Lowest	Mean	Highest
Room 1	5	398	1,033
Room 2	48	356	1,049
Room 3	3	50	154
Room 4	8	147	527
Room 5	/	/	/

The corrected radon average concentrations were calculated taking into account the SCF and CF (Table 6.6.5.)

Table 6.6.5. Seasonally Corrected Average Radon Values from Continuous Monitoring in Clinic C, Post- Remediation.

Room	Date	Actual mean (Bq.m ⁻³)	Seasonal Correction Factor	Corrected mean*CF (Bq.m ⁻³)	Track-etch detectors (Bq.m ⁻³)
Room 1	01.03.99-08.03.99	234	0.81	324	/
Room 2	01.02.99-17.02.99	240	0.73	299	206
Room 3	17.02.99-01.03.99	32	0.74	40	/
Room 4	08.03.99-16.03.99	81	0.81	113	56
Room 5	/	/	/	/	45

The pattern of variation of radon concentration was different for each room. Figures 6.6.2.- 6.6.5. show a complex time dependence, with different mean levels and time patterns being observed in different days even in the same room and different patterns between different rooms.

The maximum corrected values in room 1 are in the range 400-490 Bq.m⁻³ (maximum uncorrected value of 606 Bq.m⁻³ on Sunday, 07.03.99, at 7 p.m.). In room 2, the maximum radon values are in the range 400-450 Bq.m⁻³ (maximum uncorrected radon level 735 Bq.m⁻³ on Wednesday, 10.02.99, at 6 a.m.). In room 3, the maximum radon values are in the range 60-85 Bq.m⁻³ (maximum uncorrected value 116 Bq.m⁻³ on Wednesday, 24.02.99, at 11 p.m.) and in room 4 in the range 100-250 Bq.m⁻³ (maximum uncorrected radon level of 308 Bq.m⁻³ on Thursday, 11.03.99, at 5 p.m.). In rooms 2 and 3 the radon activity concentration was higher at night (room 2 with the ratio average night time radon level per daytime radon level of 1.3 and room 3 with a ratio of 1.2) and in the other two rooms (room 1 and room 4) it was about the same (ratio of 1 and 0.9).

The average radon concentrations in each room were calculated during normal working hours and during night time and the ratio between average radon levels in night time hours and working daytime hours are given in Table 6.6.6. These data show a significant reduction of radon level in rooms 1,2,3,5 but an unchanged situation in room 4. It seems that the radon source is still in room 1, but the ingress of radon is reduced.

Figure 6.6.2. Radon Level Variation, Room 1, Clinic C

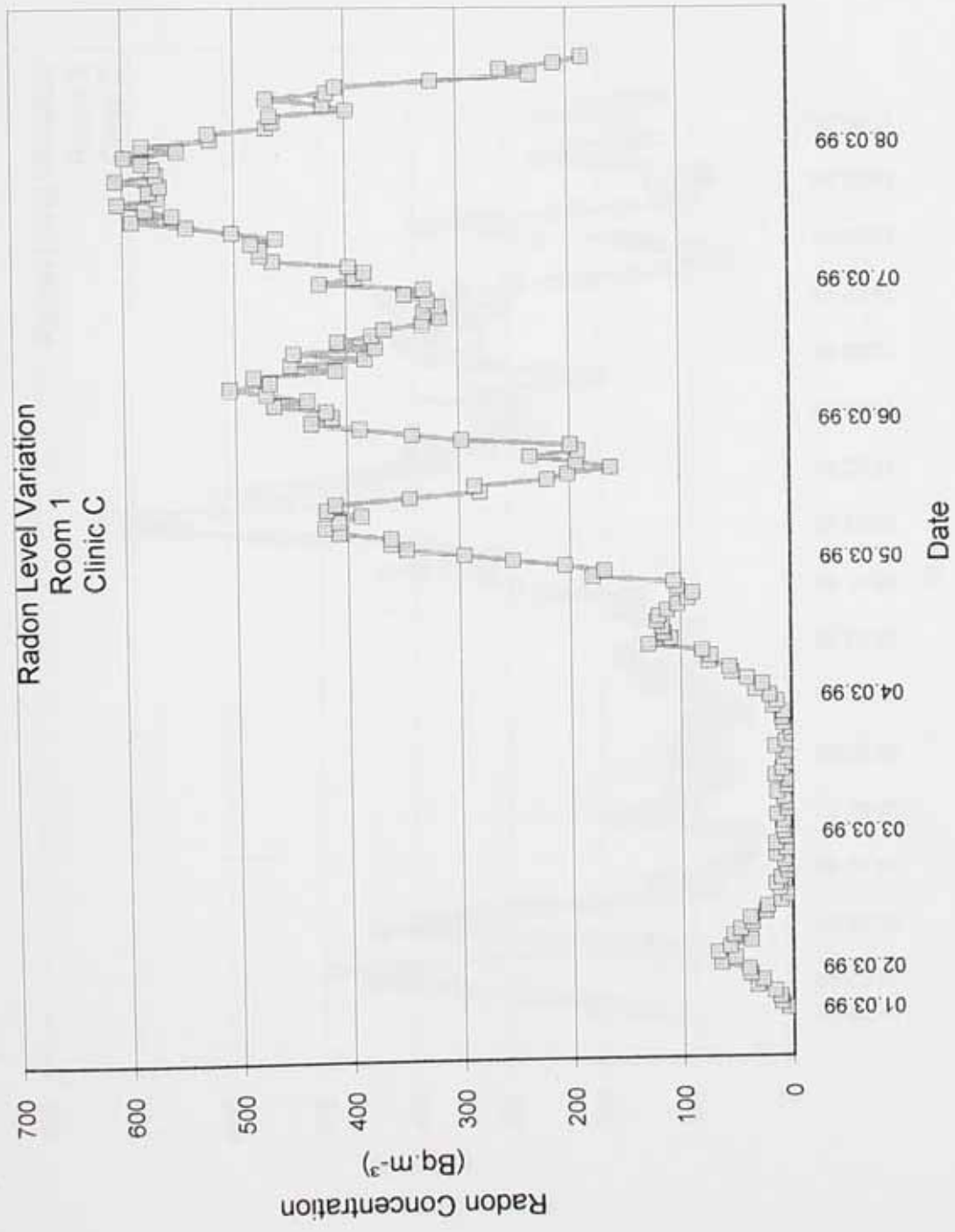

Figure 6.6.3. Radon Level Variation, Room 2, Clinic C

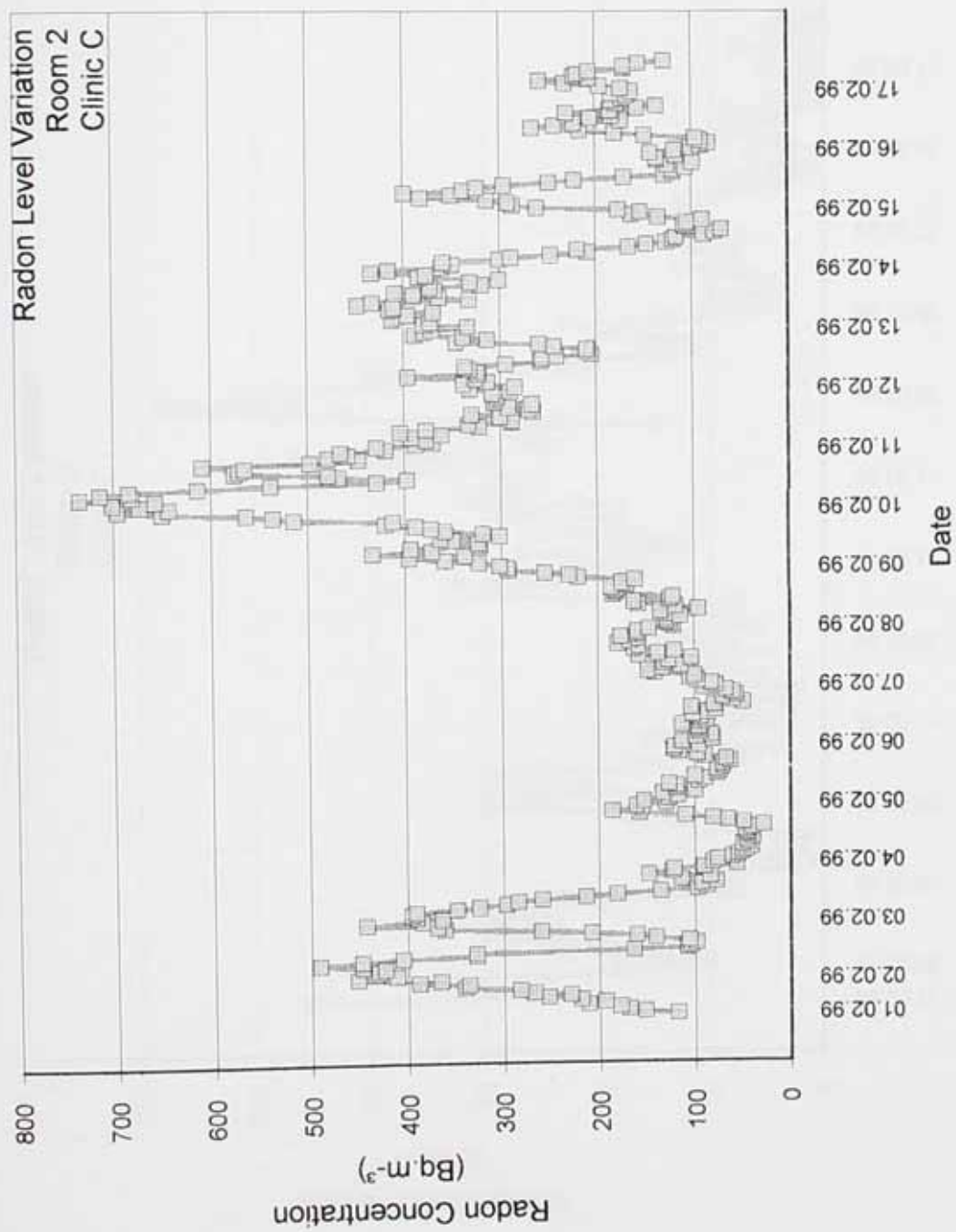

Figure 6.6.4. Radon Level Variation, Room 3, Clinic C

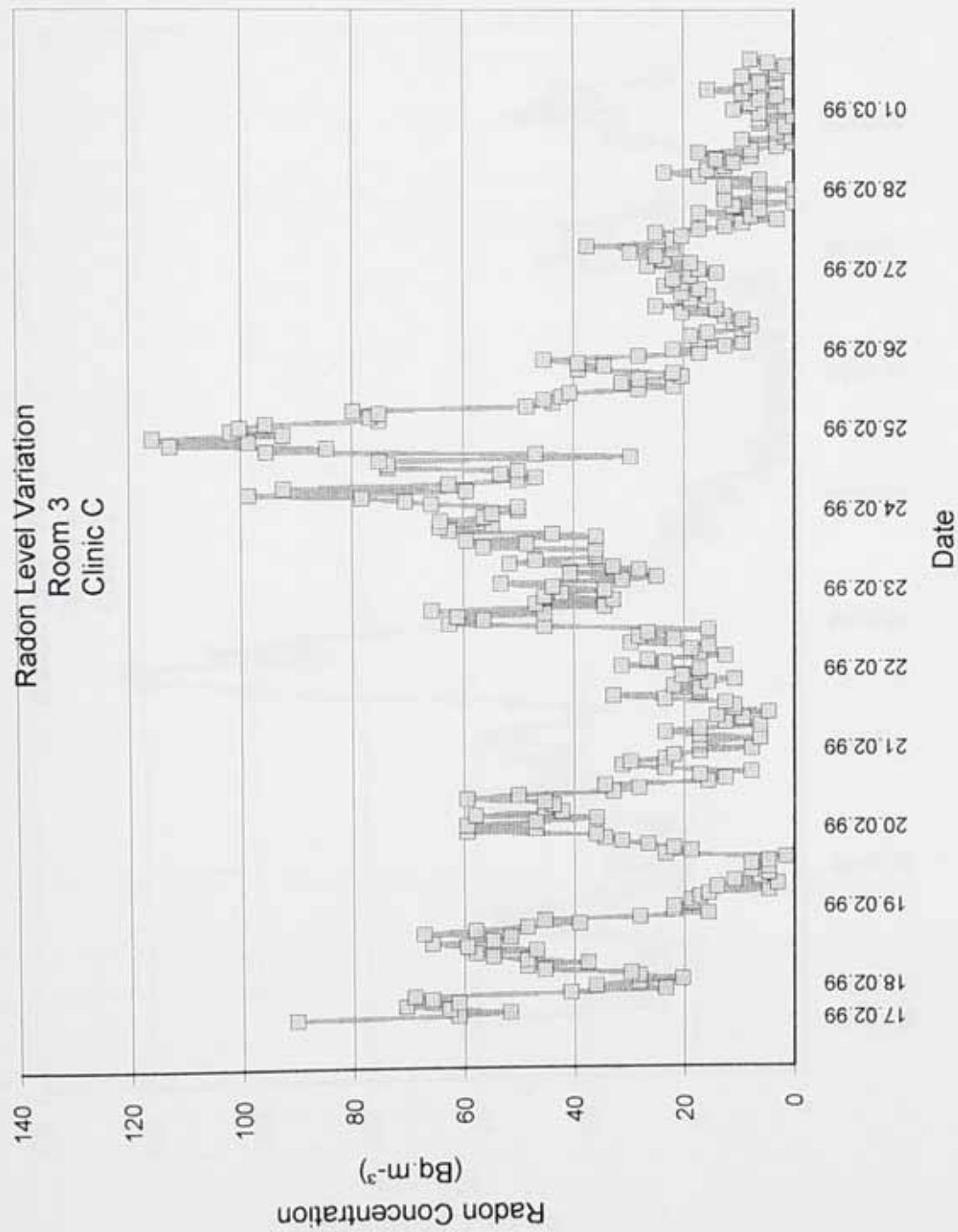

Figure 6.6.5. Radon Level Variation, Room 4, Clinic C

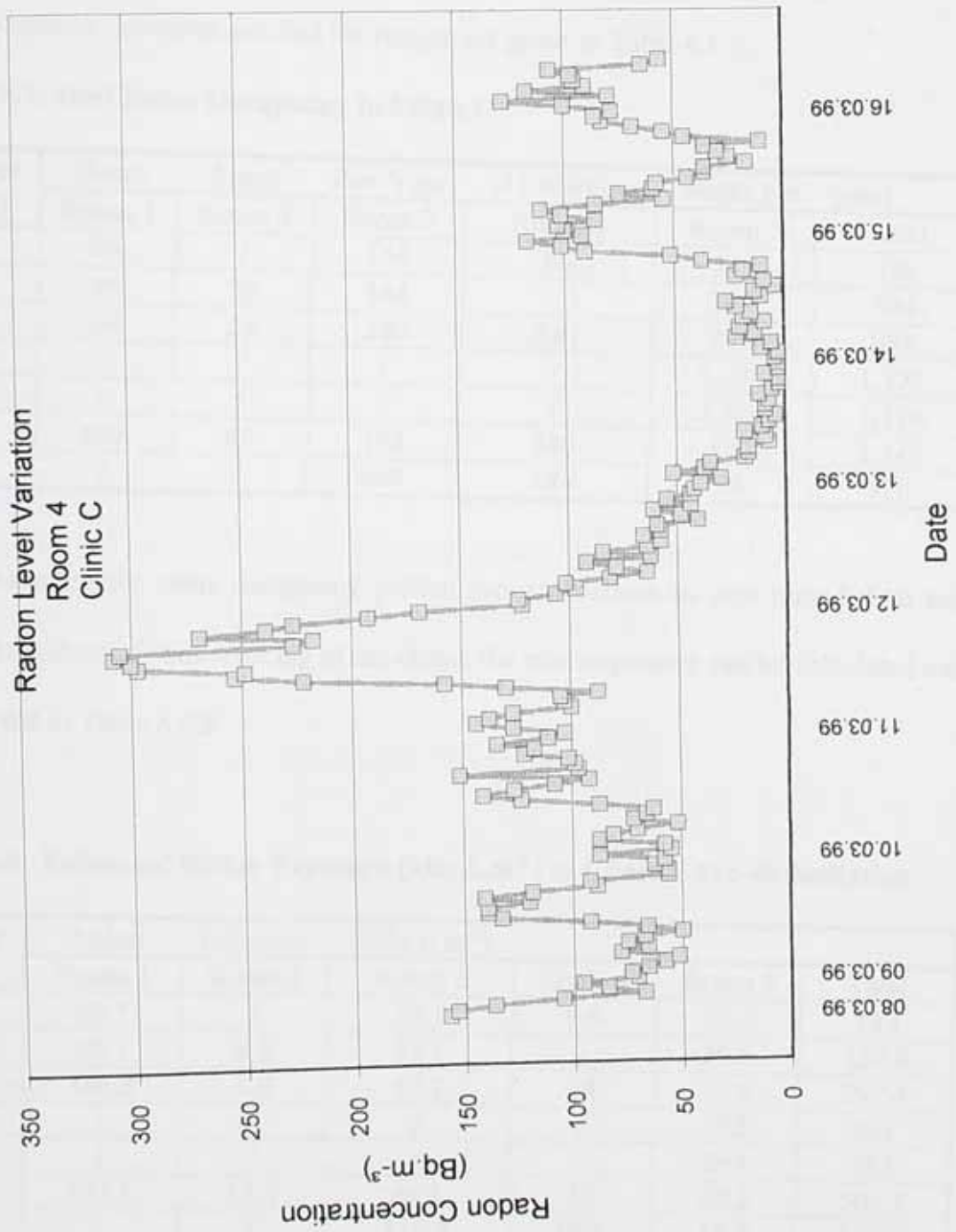

Table 6.6.6. Time Averages of Rad 7 Radon Concentration Measurements in Clinic C

Room	Daytime mean (Bq.m ⁻³)	Night time mean (Bq.m ⁻³)	Daytime corrected*CF (Bq.m ⁻³)	Night time corrected*CF (Bq.m ⁻³)	Ratio night time/day time radon concentration
Room 1	232.8	234.8	322.5	325.2	1
Room 2	208.3	272	260	339.5	1.3
Room 3	29	34	36.7	43	1.2
Room 4	85.7	77	118.7	106.7	0.9

A total of seven members of staff that were working at the clinic answered the room occupancy questionnaire and the results are given in Table 6.6.7.

Table 6.6.7. Staff Room Occupancy in Clinic C

Member of staff	Hours Spent Per Year (48 working weeks per year)					
	Room 1	Room 2	Room 3	Room 4	Room 5	Total
1	96	/	144	96	240	576
2	96	24	144	/	240	504
3	240	24	240	240	240	984
4	/	/	/	/	1,776	1,776
5	/	/	/	/	1,776	1,776
6	480	48	192	240	480	1,440
7	/	/	480	144	96	720

Assuming the same occupancy pattern pre-remediation as post remediation and the same members of staff working in the clinic, the past exposures can be calculated and are displayed in Table 6.6.8.

Table 6.6.8. Estimated Radon Exposure (kBq.h.m⁻³) in Clinic C Pre-Remediation

Member of staff	Radon Exposure (kBq.h.m ⁻³)					
	Room 1	Room 2	Room 3	Room 4	Room 5	Total
1	66.7	/	33.1	9.6	39.6	149
2	66.7	8.8	33.1	/	39.6	139.4
3	166.8	8.8	55.2	24	39.6	297.4
4	/	/	/	/	293	293
5	/	/	/	/	293	293
6	333.6	17.5	44.2	24	79.2	504.5
7	/	/	110.4	14.4	15.8	140.6

The estimated radon exposure per person after remediation work was carried out in clinic C is given in Table 6.6.9.

Table 6.6.9. Estimated Radon Exposure (kBq.h.m⁻³) in Clinic C Post- Remediation

Member of staff	Radon Exposure (kBq.h.m ⁻³)					Total
	Room 1	Room 2	Room 3	Room 4	Room 5*	
1	31	/	5.3	11.4	10.8	58.5
2	31	6.2	5.3	/	10.8	53.3
3	77.4	6.2	8.8	28.5	10.8	131.7
4	/	/	/	/	79.9	79.9
5	/	/	/	/	79.9	79.9
6	154.8	12.5	7.1	28.5	21.6	224.5
7	/	/	17.6	17.1	4.3	39

* due to the lack of continuous measurements (permission to measure not given), daytime radon concentration value assumed 45 Bq.m⁻³ in Room 5, the same as the average radon value from the TED's

The annual radiation dose per person (mSv), before and after the remediation work was carried out and the reduction factors are listed in Table 6.6.10.

Table 6.6.10. Annual Dose per Person (mSv) in Clinic C

Member of staff	Pre-remediation Dose (mSv)	Post-remediation Dose (mSv)	Reduction Factor
1	1.18	0.46	2.6
2	1.11	0.42	2.6
3	2.36	1.04	2.3
4	2.33	0.63	3.7
5	2.33	0.63	3.7
6	4	1.78	2.2
7	1.12	0.31	3.6

Due to the nature of the part time work of the staff, the calculated results are lower than the radiation doses for full time staff. To assess the difference, the radiation dose was calculated for each person, assuming a 37 hours working week and the same pattern of room occupancy. The potential radiation doses for each person working full time in clinic C, are given in Table 6.6.11.

Table 6.6.11. Potential Annual Dose per Person (mSv) in Clinic C for Full Time Working Hours (37 hours per week)

Member of staff	Pre-remediation Full Time Dose (mSv)	Post-remediation Full Time Dose (mSv)	Reduction Factor
1	4	1.43	2.8
2	3.7	1.49	2.5
3	4.56	1.89	2.4
4	2.33	0.63	3.7
5	2.33	0.63	3.7
6	4.52	2.2	2
7	3.7	0.76	4.9

Only two members of staff participated at the pre-remediation questionnaire, as well as the post remediation one. The doses pre-remediation and post-remediation, taking into account the occupancy pattern, are given in Table 6.6.12., as well as the reduction factor. It can be seen that the estimates that assume the same occupancy pre and post remediation, are very slightly lower than the doses in the pre-remediation case.

Table 6.6.12. Annual Effective Doses of Staff, Clinic C

Member of staff	Pre-remediation dose (mSv)	Estimated pre remediation dose (mSv)	Post remediation dose (mSv)	Reduction Factor	Estimated Reduction Factor
2	1.3	1.11	0.42	3	2.6
4	2.5	2.33	0.63	4	3.7

A comparison of the individual dose reductions for each member of staff to the reduction in average radon level in the room that the individual occupied the most, gives a random dependence, as the one in Figure 6.6.6. Apart from the members of staff 4 and 5, the other five members of staff have lower reduction factors of individual doses than reduction factors in radon level, due to differing occupancy of rooms.

Figure 6.6.6. Reduction Factors of Individual Doses Compared to Reduction Factors in Average Radon Levels in Clinic C

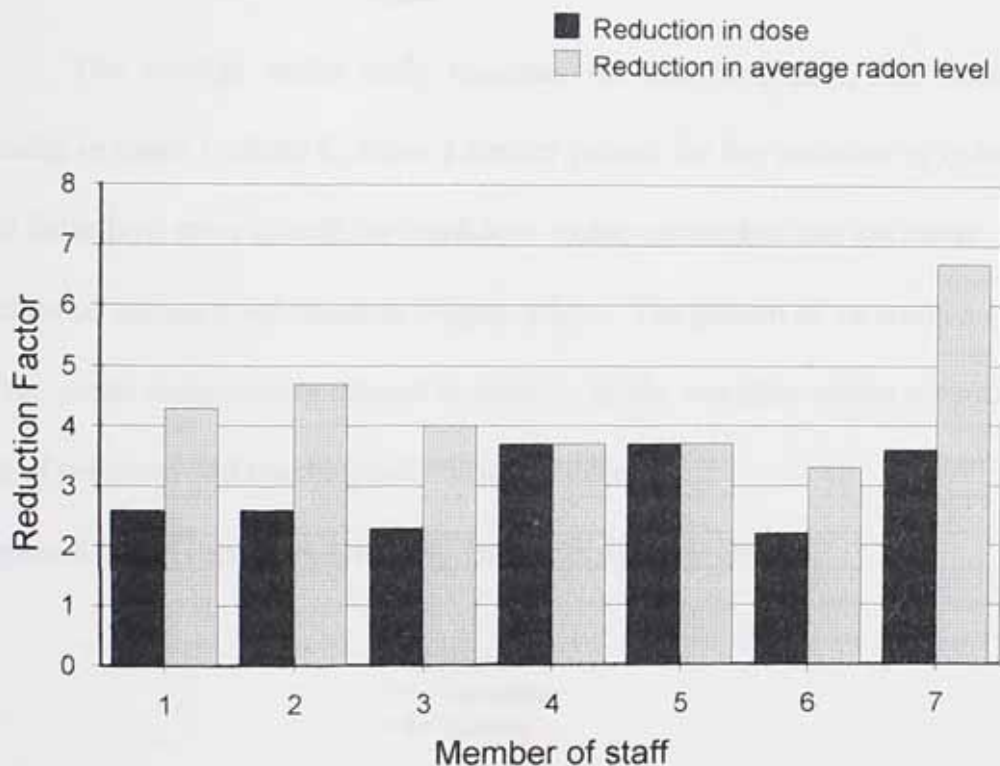

Comparing the individual changes in ratio between day time and night time radon levels pre and post remediation in each room, a variation as the one in Figure 6.6.7. is obtained. This suggests that the differences between night time radon concentrations and daytime levels were significantly reduced in rooms 1-3. Room 4 is almost the same situation pre and post remediation.

Figure 6.6.7. Comparison of Ratio Night Time per Daytime Radon Levels Pre and Post Remediation in Clinic C

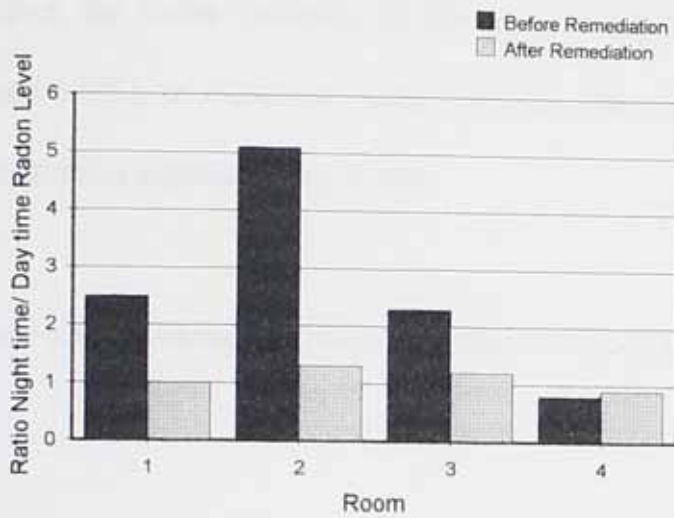

The average radon daily variation for four weekdays, one Saturday and one Sunday in room 1, clinic C, show a similar pattern for the variation of radon in weekdays and Saturdays, even though the weekdays' radon concentrations are lower, and a different pattern of variation for Sundays (Figure 6.6.8). The pattern of variation supports the idea of the radon source being present in room 1, as the weekday values are influenced by the use of the room and opening and closing of doors.

Figure 6.6.8. Average radon daily values in room 1, clinic C

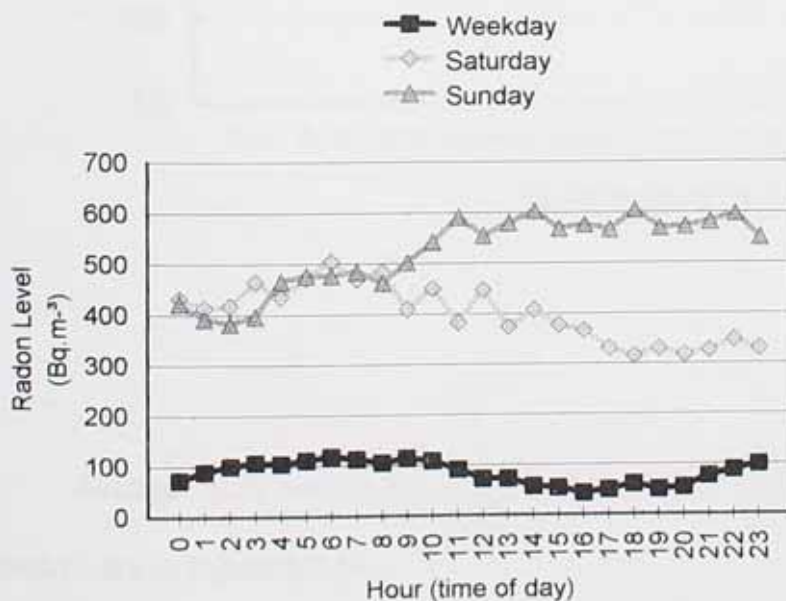

Average daily radon variation for eleven weekdays, two Saturdays and two Sundays in room 2 in clinic C, show a similar radon variation pattern for weekdays and Sundays, the radon variation on Saturdays being different between 10 a.m. - 8 p.m. (Figure 6.6.9.). In weekdays, there is a clear decrease in radon level after 9a.m. and the concentration stays low until 5 p.m.

Figure 6.6.9. Average radon daily values in room 2, clinic C

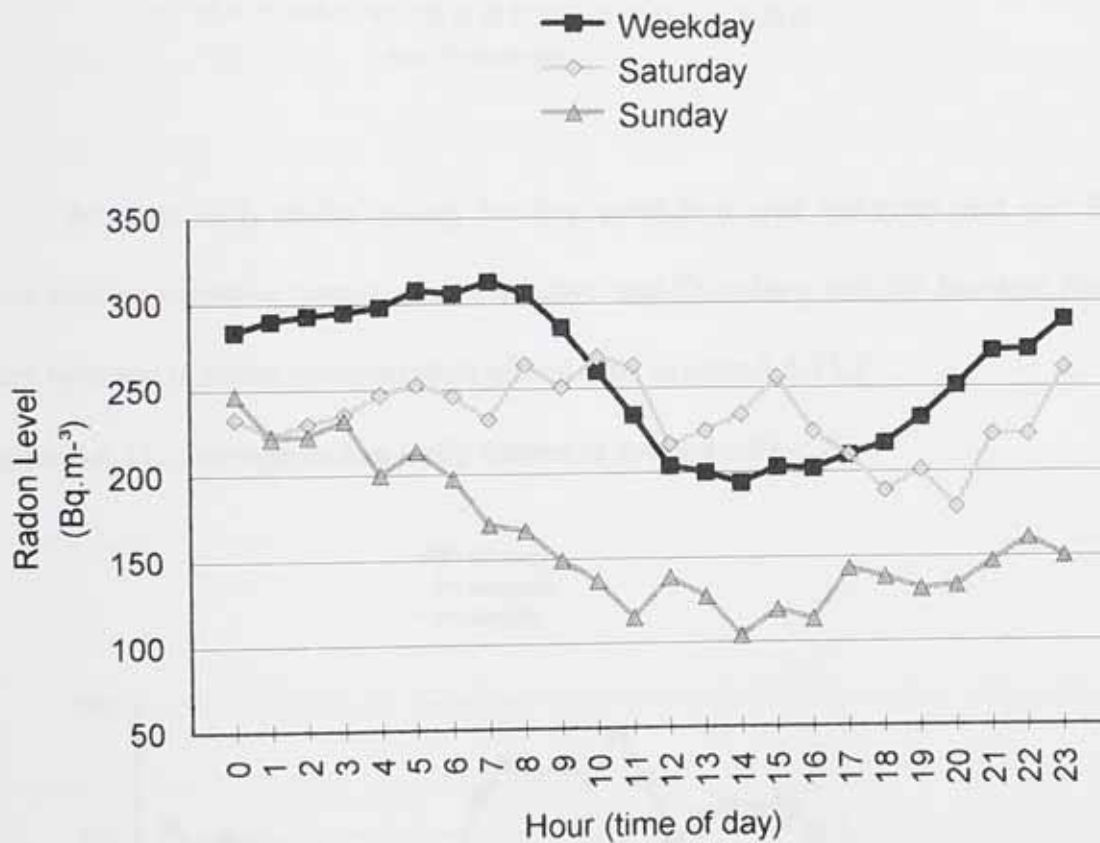

Average daily values for room 3, for seven weekdays, two Saturdays and two Sundays, are in Figure 6.6.10.

Figure 6.6.10. Average radon daily values in room 3, clinic C

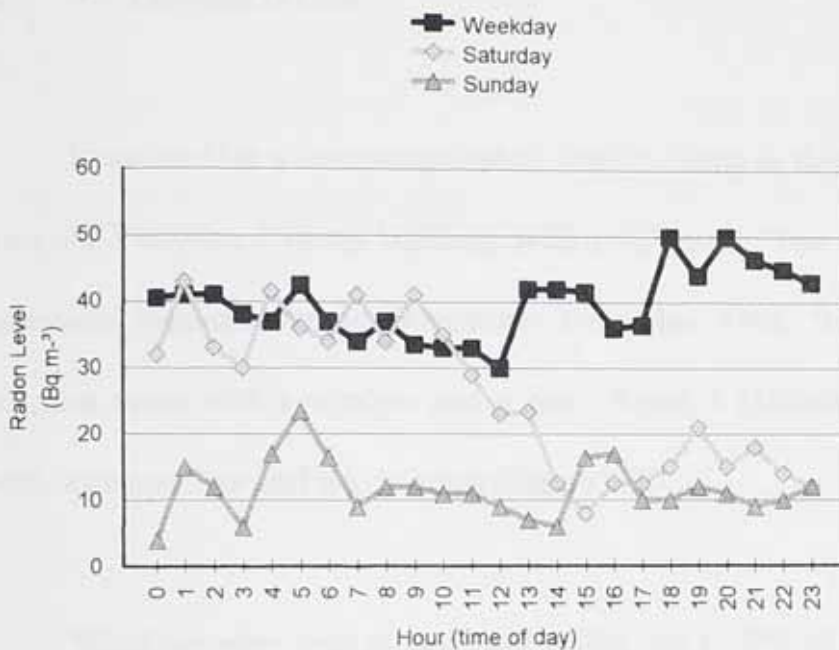

Average daily radon values for five weekdays, one Saturday and one Sunday, show similar variation patterns for weekdays and Saturdays, but for Sundays there is a sharp increase in radon concentration after 6 p.m. (Figure 6.6.11.).

Figure 6.6.11. Average radon daily values in room 4, clinic C

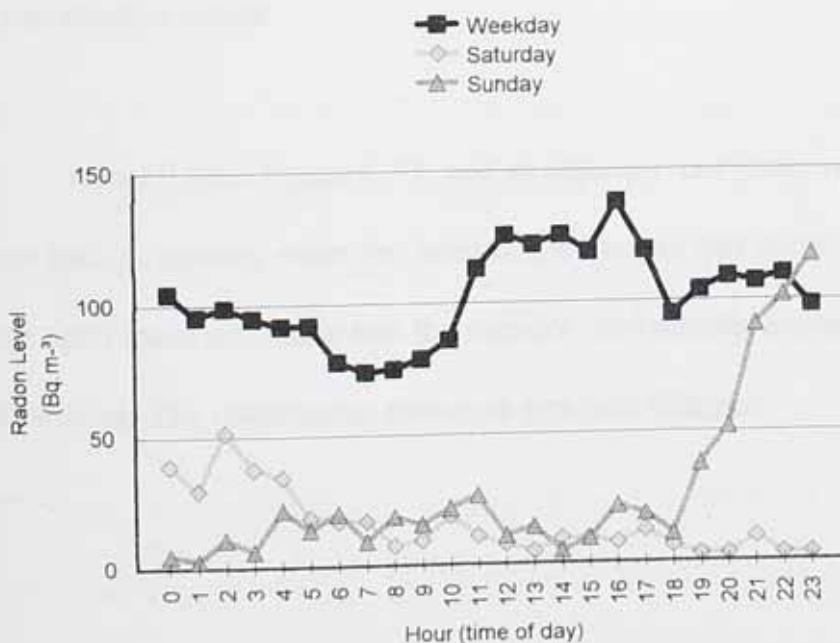

6.7. Location D Data

Location D is a Northamptonshire NHS building in Kettering. Clinic D is situated in an old Victorian 3 storey building, with a basement. Two rooms were monitored by continuous measurement in November- December 1998. Room 1 (2 x3x3m) was a treatment room with a window and a door. Room 4 (3x3x3m) was a larger treatment room, with one door and one window (Figure 6.7.1.).

Windows were kept closed most of the day (~75% of the day), doors in room 1 would be slightly more often opened than in room 4, as room 1 was partially used for staff that would need to move in and out of the room. Both rooms were connected through the doors with a long open hall. The clinic had a false double ceiling installed and minor building work intended to change the use of the space started at the end of 1998 and ended towards the middle of 1999. The works did not affect any of the offices or examination rooms.

Room 9 from Figure 6.7.1. and an adjacent room have now been knocked into one room and the waiting room has been opened up, so that there is no longer a room, but a large open space extending into the corridor, and directly accessible as soon as one enters the building. The remediation measures were not changed.

Figure 6.7.1. Plan of Location D (not at scale)

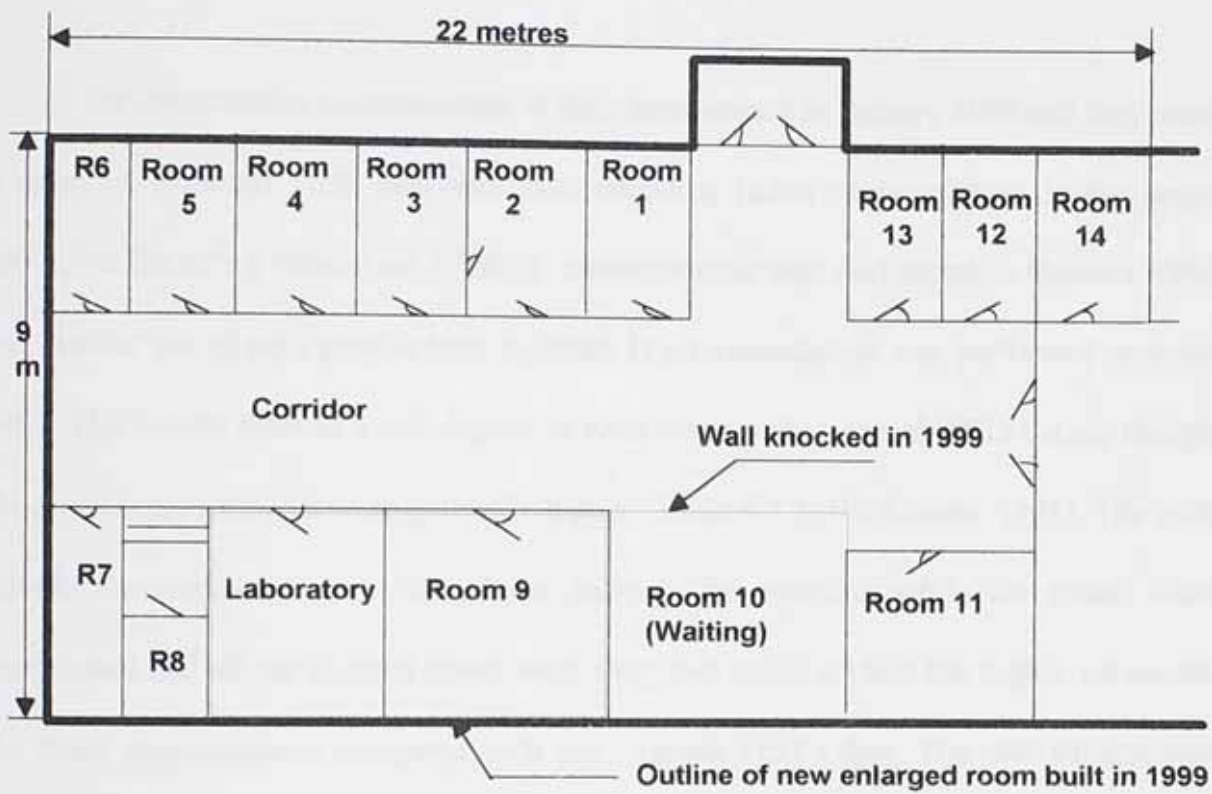

Because of the constant daily use of the clinic and absolute requirement for silence during the consultations, it was not possible to obtain approval to place the Rad-7 monitor in more than two rooms; the instrument has a continuous buzzing noise that was found to be interfering with staff's work and peace of patients. In the given circumstances, for the measurements in November- December 1998, TED's were placed for three months, between 24.11.1998 to 02.02.1999, in eight rooms.

It was possible to continuously measure the radon level with the Rad-7 monitor only in two rooms; once again, the staff and patients could not put up with the noise made by the continuous monitor. Eight TED's were set up in Rooms 1, 2, 4, 9, 10, 11, 13, 14; the recorded radon concentration values varied between 5-51 Bq.m⁻³. The Rad-7 detector,

set on normal mode, recorded hourly measurements in Rooms 1 and 4 of clinic D, for periods of time varying between 3 to 6 days.

Pre-remediation measurements in this clinic started in January 1993 and they were a series of 1 month TED' measurements revealing radon concentrations in the range 390-1,790 Bq.m⁻³; a second set of TED' measurements was performed in October 1993 and another set of grab sample tests in clinic D pre-remediation was performed in April 1993. The results showed a fair degree of correlation with 1-month TED's data, though the direct measurements were generally higher (Table 6.7.1) (Parkinson, 1994). The grab sample measurements were carried out early in the morning while the rooms were unoccupied and all the internal doors were shut; this could explain the higher values for the direct measurements compared with the 1-month TED's data. The data suggest two possible radon sources, one in room 3 and another one in room 10.

Table 6.7.1. Location D Grab Sample Results Pre-Remediation (Parkinson, 1994)

Room Number	Date	Radon Concentration (Bq.m ⁻³)	Track-Etch Detectors (Bq.m ⁻³)
Room 1	02.04.93	1,500	390
Room 2	02.04.93	1,800	-
Room 3	02.04.93	3,200	-
Room 4	02.04.93	1,900	1,029
Room 5	02.04.93	150	-
Room 6	02.04.93	200	-
Room 7	02.04.93	100	-
Room 8	02.04.93	50	-
Room 9	02.04.93	800	337
Room 10	02.04.93	2,400	-
Room 11	02.04.93	1,800	1,790
Room 12	02.04.93	1,300	530
Room 13	02.04.93	1,800	1,195
Room 14	02.04.93	1,900	-

TED's were placed in the rooms for a 1- month period of time, between January 1993 and February 1993 and October 1993 to November 1993. The results are shown in Table 6.7.2. and include the SCF's used (Parkinson, 1994).

Table 6.7.2. 1- Month Track- Etch Detector Results in Clinic D Pre-Remediation (Parkinson, 1994).

Room	Test 1 08.01.93-	09.02.93	Test 2 04.10.93-	01.11.93
	Annual Mean (Bq.m ⁻³)	Actual Mean (Bq.m ⁻³)	Annual Mean (Bq.m ⁻³)	Actual Mean (Bq.m ⁻³)
Room 1	-	-	390	390
Room 4	868	1,173	1,190	1,190
Room 9	337	455	-	-
Room 11	-	-	1,790	1,790
Room 12	-	-	530	530
Room 13	1,195	1,615	-	-

In order to calculate the radon exposure for each individual working in the clinic, an estimation of the likely range of daytime radon concentrations was calculated and the values for each room are given in Table 6.7.3. (Parkinson, 1994).

Table 6.7.3. Range of Daytime Radon Concentrations Estimated for January 1994 in Clinic D, Pre-Remediation (Parkinson, 1994).

Room	Estimated Mean Daytime Radon Concentration (Bq.m ⁻³)		
	Lowest	Mean	Highest
Room 1-4	300	600	1,200
Room 9	200	455	650
Room 11-14	300	600	1,200

The uncorrected daytime radon values in the five rooms of clinic D, post remediation, including average values for the daytime working hours, minimum radon values and maximum radon values, are given in Table 6.7.4. The minimum and maximum radon concentrations were different in each room.

Table 6.7.4. Corrected Daytime Radon Values, Clinic D, Post- Remedial Studies

Room	Daytime Radon Concentration (Bq.m ⁻³)		
	Lowest	Mean	Highest
Room 1	1.4	4.7	19.8
Room 4	2	3.8	7.8

The corrected radon average concentrations were calculated taking into account the SCF and CF (Table 6.7.5.)

Table 6.7.5. Corrected Average Radon Values from Continuous Monitoring in Clinic D, Post- Remediation.

Room	Date	Actual mean (Bq.m ⁻³)	Correction Factor	Corrected mean*CF (Bq.m ⁻³)	Track-etch detectors (Bq.m ⁻³)
Room 1	01.12.98-07.12.98	5	0.77	6.6	43
Room 2	24.11.98-02.02.99	/	0.74	/	8
Room 3	/	/	0.74	/	37
Room 4	24.11.98-27.11.98	4.5	0.87	6.7	5
Room 5	/	/	0.74	/	/
Room 6	/	/	0.74	/	/
Room 7	/	/	0.74	/	5
Room 8	/	/	0.74	/	5
Room 9	24.11.98-02.02.99	/	0.74	/	51
Room 10	24.11.98-02.02.99	/	0.74	/	6
Room 11	24.11.98-02.02.99	/	0.74	/	9
Room 12	/	/	0.74	/	8
Room 13	24.11.98-02.02.99	/	0.74	/	9
Room 14	24.11.98-02.02.99	/	0.74	/	13

/ value assumed by average

The pattern of variation of radon concentration was different for each room (Figures 6.7.2. and 6.7.3.). The figures show a complex time dependence, with different mean levels and time patterns being observed in different days even in the same room. The maximum corrected values in room 1 are in the range 6-6.8 Bq.m⁻³ and in room 4 in the range 14-15.3 Bq.m⁻³. All the data recorded after remediation suggest that the radon source was eliminated.

Figure 6.7.2. Radon Level Variation, Room 1, Clinic D

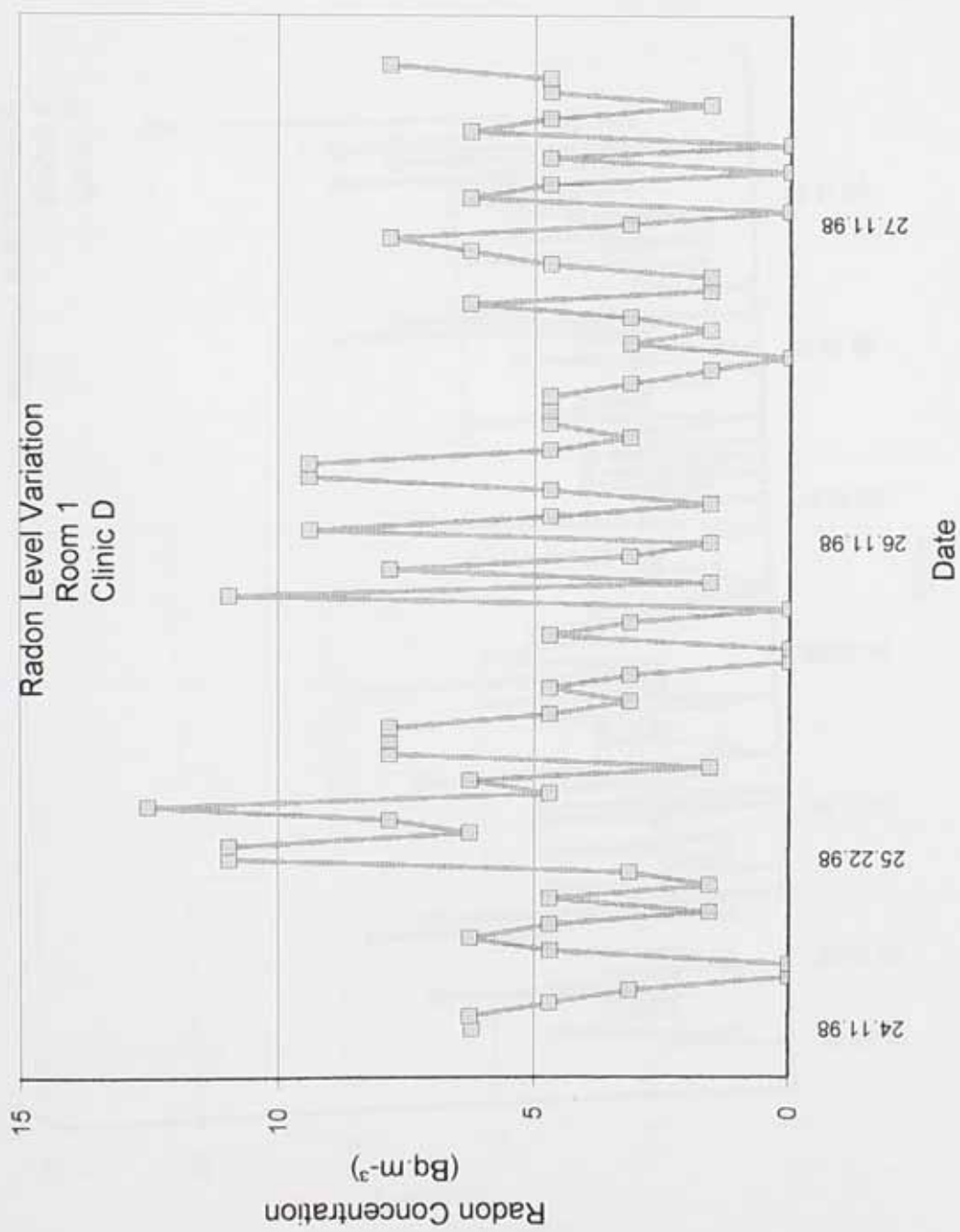
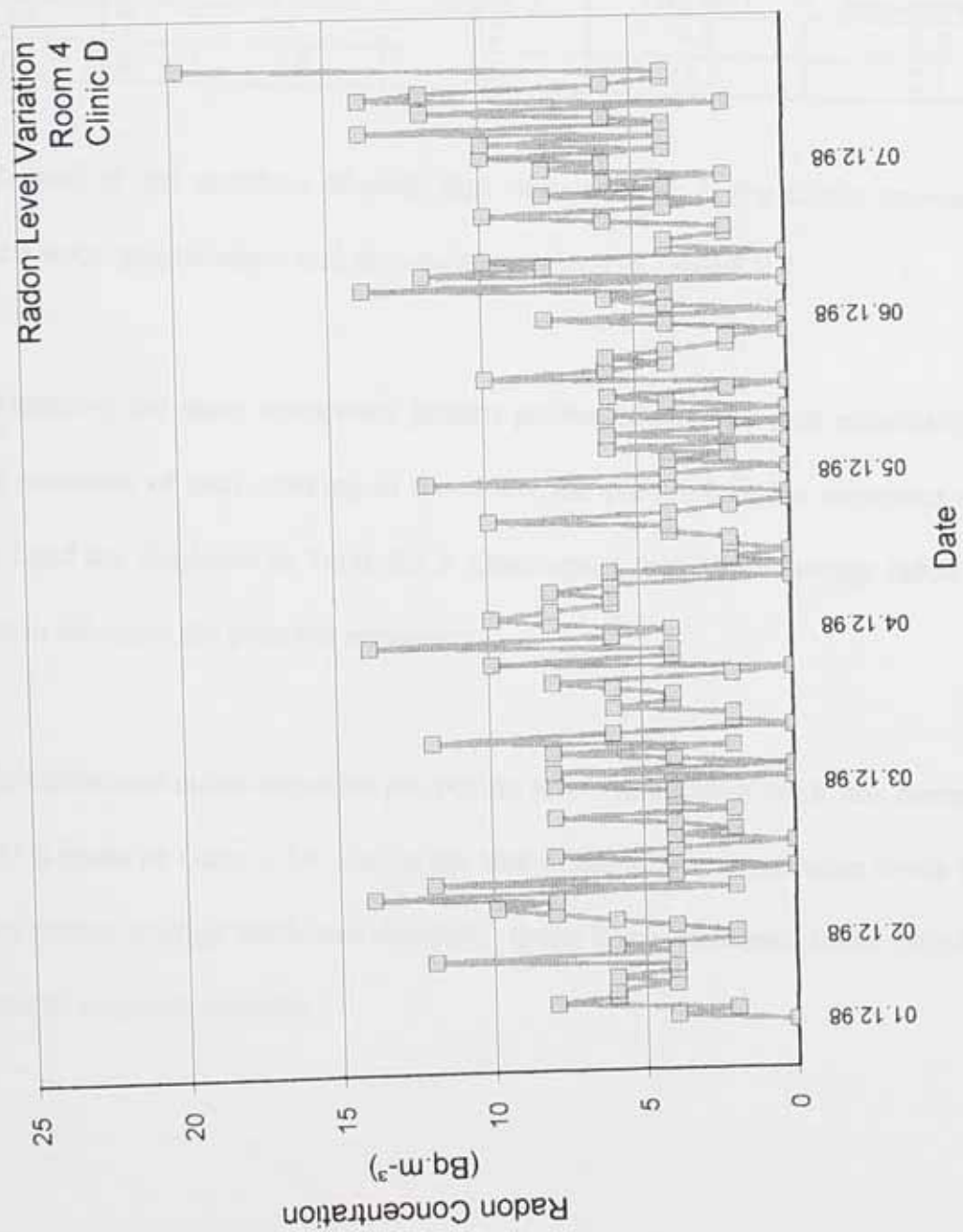

Figure 6.7.3. Radon Level Variation, Room 4, Clinic D



The average radon concentrations in the two rooms were calculated during the normal working hours and during night time and the ratio between average radon levels in night time hours and working daytime hours are given in Table 6.7.6.

Table 6.7.6. Time Averages of Rad 7 Radon Concentration Measurements in Clinic D

Room	Daytime mean (Bq.m ⁻³)	Night time mean (Bq.m ⁻³)	Daytime corrected*CF (Bq.m ⁻³)	Night time corrected*CF (Bq.m ⁻³)	Ratio night time/ daytime radon concentration
Room 1	4.7	7	6.2	9.2	1.5
Room 4	3.8	7.8	5.6	11.6	2.1

A total of ten members of staff, that were working at the clinic, answered the room occupancy questionnaire and the results are given in Table 6.7.7.

Assuming the same occupancy pattern pre-remediation as post remediation and the same members of staff working in the clinic, the pre-remediation exposures can be calculated and are displayed in Table 6.7.8. Once again, the TED's average radon levels were used to calculate the personal exposure.

The estimated radon exposure per person after remediation work was carried out in clinic D is given in Table 6.7.9. Due to the lack of daytime average radon levels for all the studied rooms, average track-etch detectors' radon levels were used in the calculation of the personal exposure to radon.

Table 6.7.7. Staff Room Occupancy in Clinic D

Person	Hours Spent per Year			(48 working weeks per year)												Total
	R1	R2	R3	R4	R5	R6	R7	R8	R9	R10	R11	R12	R13	R14		
1	/	/	/	/	/	/	/	24	1,200	/	/	24	48	24	1,320	
2	/	/	/	/	/	/	/	/	1,200	/	/	/	/	/	1,200	
3	/	/	/	/	/	/	/	/	912	/	/	/	/	/	912	
4	240	240	/	240	/	/	240	/	/	/	/	/	/	/	960	
5	192	384	/	192	/	/	384	/	/	/	/	/	/	/	1,152	
6	384	384	/	192	/	/	384	/	/	/	/	/	/	/	1,344	
7	192	192	/	864	/	/	192	/	/	/	/	/	/	/	1,440	
8	192	192	192	/	/	/	/	/	/	/	/	/	/	/	576	
9	144	96	360	/	/	/	77	12	24	/	/	/	16	16	745	
10	/	/	/	/	/	/	/	12	824	/	12	888	20	20	1,776	

Table 6.7.8. Estimated Radon Exposure (kBq.h.m⁻³) in Clinic D Before Remediation

Person	Radon Exposure (kBq. h.m ⁻³)														Total
	R1	R2	R3	R4	R5	R6	R7	R8	R9	R10	R11	R12	R13	R14	
1	/	/	/	/	/	/	/	1.2	546	/	/	14.4	28.8	14.4	604.8
2	/	/	/	/	/	/	/	/	546	/	/	/	/	/	546
3	/	/	/	/	/	/	/	/	415	/	/	/	/	/	415
4	144	144	/	144	/	/	24	/	/	/	/	/	/	/	456
5	115.2	230.4	/	115.2	/	/	38.4	/	/	/	/	/	/	/	499.2
6	230.4	230.4	/	115.2	/	/	38.4	/	/	/	/	/	/	/	614.4
7	115.2	115.2	/	518.4	/	/	19.2	/	/	/	/	/	/	/	768
8	115.2	115.2	115.2	/	/	/	/	/	/	/	/	/	/	/	345.6
9	144	57.6	216	/	/	/	7.7	0.6	10.9	/	/	/	9.6	9.6	456
10	/	/	/	/	/	/	/	0.6	374.9	/	7.2	532.8	12	12	939.5

Table 6.7.9. Estimated Radon Exposure (kBq.h.m⁻³) in Clinic D Post- Remediation

Person	Radon Exposure (kBq. h.m ⁻³)														Total
	R1	R2	R3	R4	R5	R6	R7	R8	R9	R10	R11	R12	R13	R14	
1	/	/	/	/	/	/	/	0.12	61.2	/	/	0.26	0.43	0.31	62.3
2	/	/	/	/	/	/	/	/	61.2	/	/	/	/	/	61.2
3	/	/	/	/	/	/	/	/	46.5	/	/	/	/	/	46.5
4	5.7	1.9	/	1.1	/	/	1.2	/	/	/	/	/	/	/	9.9
5	4.6	3.1	/	0.8	/	/	1.9	/	/	/	/	/	/	/	10.4
6	9.2	3.1	/	0.8	/	/	1.9	/	/	/	/	/	/	/	15
7	4.6	1.5	/	3.8	/	/	1	/	/	/	/	/	/	/	10.9
8	4.6	1.5	7.1	/	/	/	/	/	/	/	/	/	/	/	13.2
9	3.4	0.8	13.3	/	/	/	0.4	0.1	1.2	/	/	/	0.1	0.2	19.5
10	/	/	/	/	/	/	/	0.1	42	/	0.1	9.8	0.2	0.3	52.5

The annual dose per person, measured in mSv, was calculated for each person, before and after the remediation work was carried out and the reduction factor was calculated; the data obtained is listed in Table 6.7.10.

Table 6.7.10. Annual Dose per Person (mSv) in Clinic D

Member of staff	Pre-remediation Dose (mSv)	Post-remediation Dose (mSv)	Reduction Factor
1	4.8	0.49	9.8
2	4.34	0.48	9
3	3.3	0.37	8.9
4	3.6	0.08	45
5	3.96	0.08	49.5
6	4.88	0.12	40.7
7	6.1	0.08	76.3
8	2.74	0.1	27.4
9	3.62	0.15	24.1
10	7.46	0.42	17.8

Due to the nature of the part time work of the staff, the calculated results are lower than the radiation doses for potential full time staff. To assess the difference, the radiation dose was calculated for each person, assuming a 37 hours working week and the same pattern of room occupancy. The potential dose for each person working full time in clinic D, is given in Table 6.7.11.

Table 6.7.11. Potential Annual Dose per Person (mSv) in Clinic D for Full Time Working Hours (37 hours per week)

Member of staff	Pre-remediation Full Time Dose (mSv)	Post-remediation Full Time Dose (mSv)	Reduction Factor
1	6.41	0.71	9
2	6.41	0.71	9
3	6.41	0.71	9
4	6.7	0.14	47.8
5	6.1	0.13	46.9
6	6.4	0.16	40
7	7.51	0.11	68.3
8	8.46	0.32	26.4
9	6.93	0.35	19.8
10	7.2	0.41	17.6

Six members of staff were working at the clinic before remediation, as well as after remediation. The dose pre-remediation and post remediation, taking into account the occupancy pattern, are given in Table 6.7.12., as well as the reduction factor. It can be seen that the estimates that assume the same occupancy pre and post remediation, are very similar to the real doses in the pre-remediation case.

Table 6.7.12. Annual Effective Doses of Staff, Clinic D

Member of staff	Pre-remediation dose (mSv)	Estimated pre remediation dose (mSv)	Post remediation dose (mSv)	Reduction Factor	Estimated Reduction Factor
5	3.6	3.96	0.08	45	49.5
6	6.8	4.88	0.12	56.7	40.7
7	7.2	6.1	0.08	90	76.3
8	2.3	2.74	0.1	23	27.4
9	2.3	3.62	0.15	15.3	24.1
10	6.3	7.46	0.42	15	17.8

Figure 6.7.4. compares the individual dose reductions for each member of staff to the reduction in average radon level in the room that the individual occupied the most.

Figure 6.7.4. Reduction Factors of Individual Doses Compared to Reduction Factors in Average Radon Levels in Clinic D

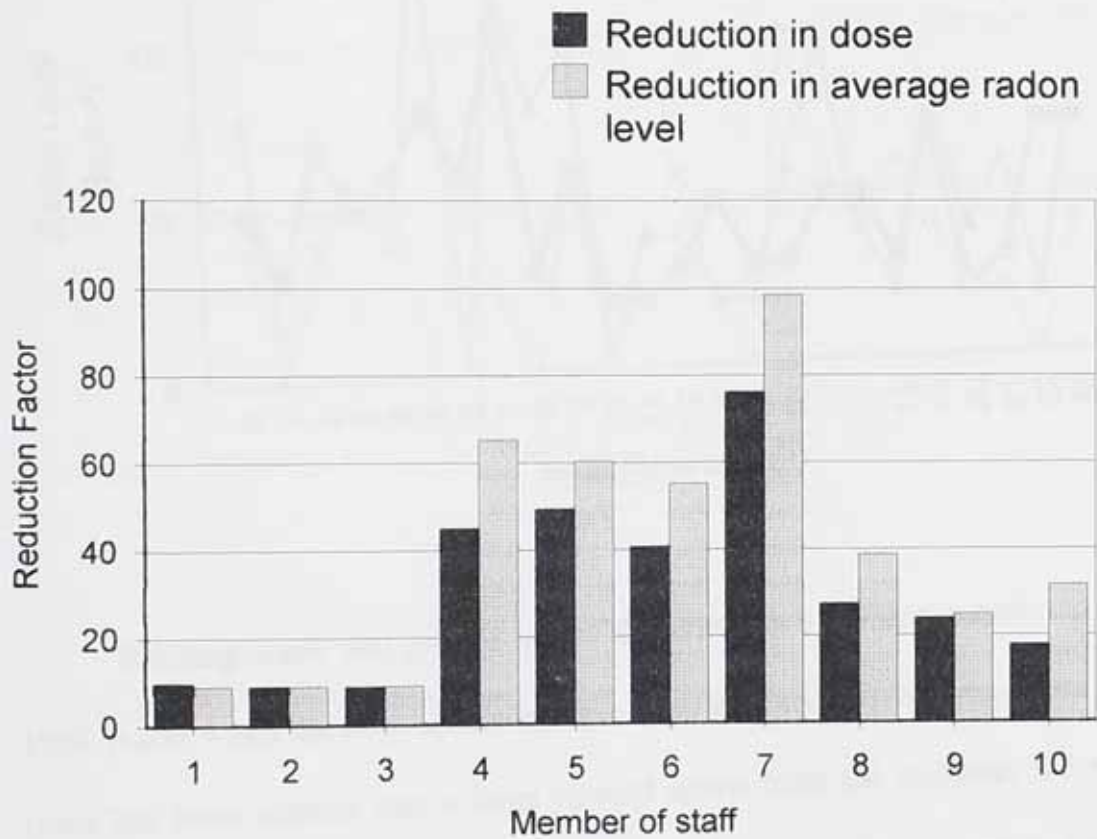

The average daily variations for three weekdays, one Saturday and one Sunday in room 4, are given in Figure 6.7.5.

Figure 6.7.5. Average radon daily values in room 4, clinic D

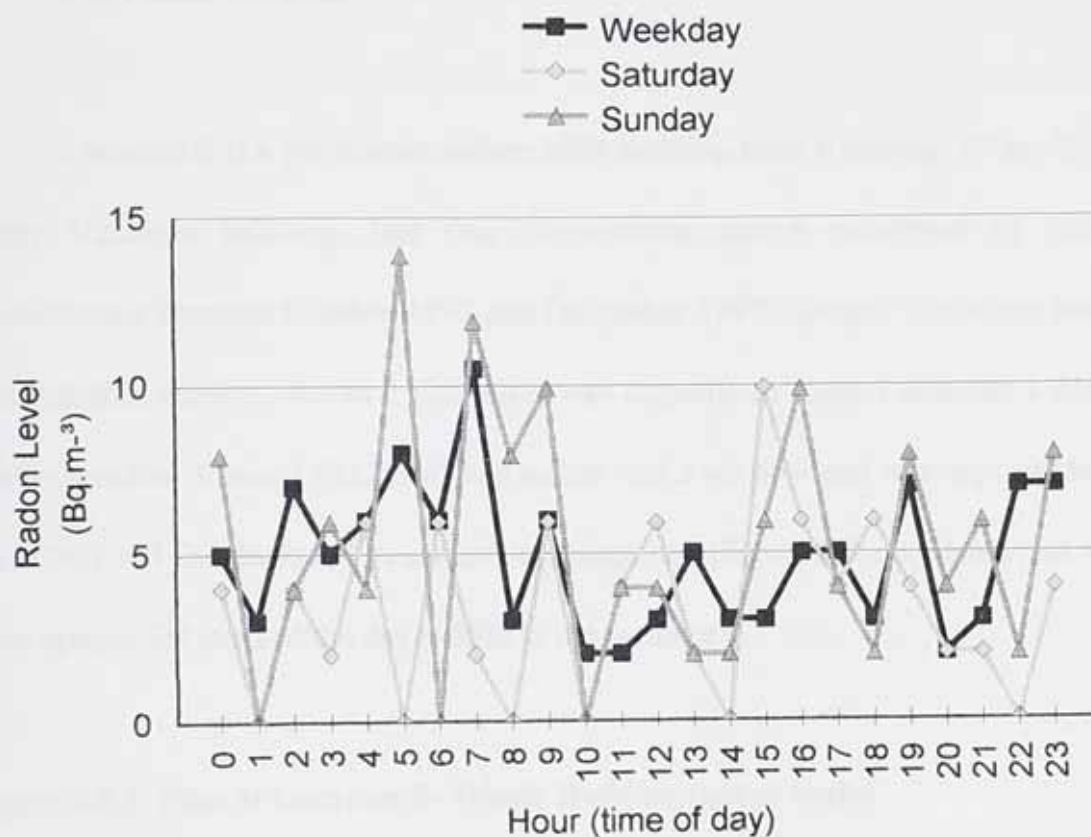

Building work was carried out in the clinic in 1999 and completed by August 1999. Room 9 and the next laboratory have been knocked into one room and the waiting room has been opened into a large opened space from the corridor; the remediation measures were not affected. TED's were placed in the building, starting October 1999 and were collected in January 2000. The results showed little change from the previous post remediation measurements from 1999. The new results are room1: 26 Bq.m⁻³, room4: 18 Bq.m⁻³, room10: 30 Bq.m⁻³, room 11: 19 Bq.m⁻³, room 13: 20 Bq.m⁻³ and the corridor 18 Bq.m⁻³. Remediation measures are still functioning after building work and change of use of the space inside the clinic.

6.8. Location E Data

Location E is a Northamptonshire NHS building from Kettering. Clinic E, a single storey Victorian building, had four consultation rooms monitored by continuous measurement between October 1997 and December 1997. Room 1 (2x3x3m) had a door and a double window. Room 2 (2x3x3m) was opposite to room 1 and had a door and a double window. Room 3 (2x3x3m) had a door and a window and was opposite to room 4 (3x3x3m). All the doors led to a small common hall (Figure 6.8.1.). Doors and windows were opened for most of the day (~85% in the summer).

Figure 6.8.1. Plan of Location E- Whole Building (not at scale)

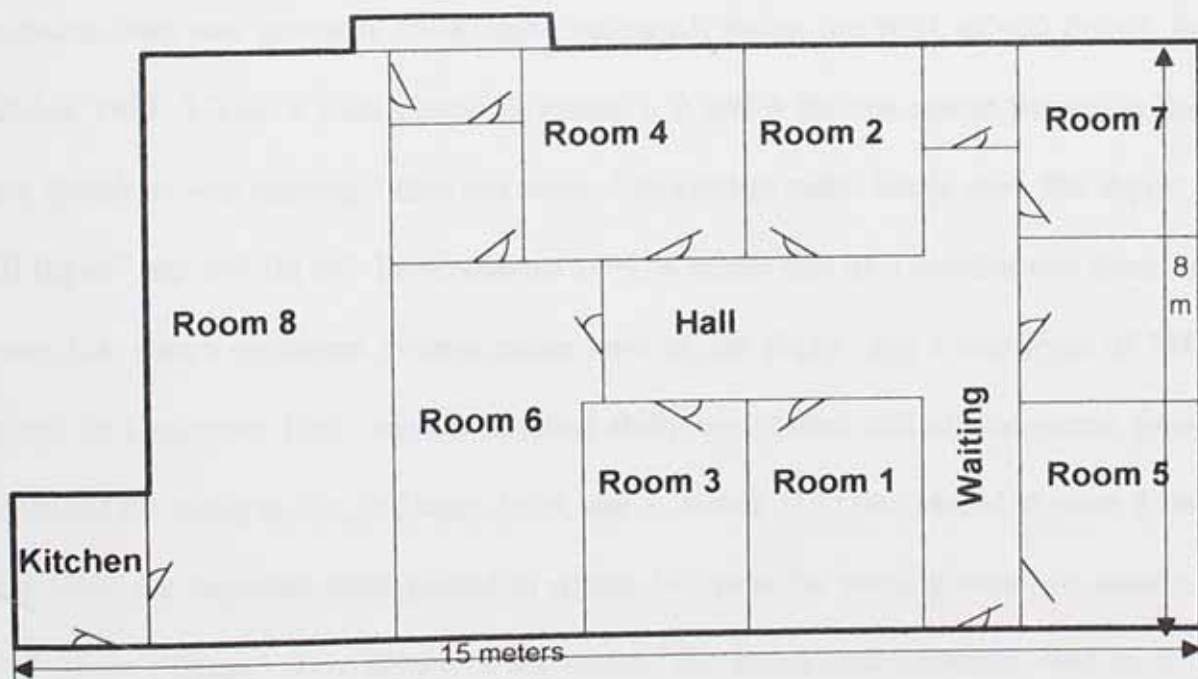

TED's were placed for three months, between 12.12.1997 to 16.03.1998, in six rooms, post remediation. It was possible to continuously measure the radon level with the Rad-7 monitor in four rooms, all consultation rooms. Six TED's were set up in rooms 1-6 and the recorded values varied between (32-51) Bq.m⁻³. The Rad-7 detector, set on normal mode, recorded hourly measurements in rooms 1-4 of clinic E, for periods of time varying between 10 to 18 days.

Extensive previous measurements in this clinic started in December 1992; a 1 month TED test was performed in room 5 and a radon level close to 290 Bq.m⁻³ was obtained; the conclusion was that a more extensive survey of the building was required. The monitoring continued in February 1993 and 1-month TED tests were applied in room 2 and room 8, with average levels of 380 Bq.m⁻³ and 230 Bq.m⁻³; the conclusion was that the radon level was generally raised, but consistently below the WAL of 400 Bq.m⁻³. In October 1993, 3 TED's were placed in rooms 1, 2 and 4 for one month period; at the time, the clinic was running 5 days per week. The average radon levels were 580 Bq.m⁻³, 500 Bq.m⁻³ and 330 Bq.m⁻³. In November 1994, a repeat test of 3 months was done in rooms 1-4, with a minimum average radon level of 226 Bq.m⁻³ and a maximum of 348 Bq.m⁻³. In December 1995, another detailed study was started and all the rooms were monitored for radon levels. In March 1996, one 1- month TED was placed in room 1; in May 1996, six detectors were placed in rooms 1-5, plus the waiting room; in January 1997, seven detectors were placed in six rooms. The radon concentrations were in the range 39 - 640 Bq.m⁻³.

In the most extensive survey, in December 1995, all the fourteen rooms were monitored for a period of two months and high radon levels were found at the room 1-room 5 end of the building, with a possible ingress in rooms 1 and 4. Remedial work was recommended in May 1996. The data recorded with the TED's pre and post remediation work is given in Table 6.8.1.

Table 6.8.1. Location E Track- Etch Detector Results Pre and Post Remediation

Room	Date								
	21.12.92 21.01.93	26.02.93 01.04.93	04.10.93 11.11.93	21.11.94 20.02.95	22.12.95 26.02.96	14.03.96 23.04.96	07.05.96 27.06.96	January 1997- 3 months	January 1997-2 months
1	-	-	580	226	435	516	140	56	-
2	-	380	500	348	248	-	120	39	53
3	-	-	-	244	293	-	180	58	-
4	-	-	330	281	315	-	290	63	-
5	289	-	-	-	390	-	160	39	-
6	-	-	-	-	180	-	-	-	-
7	-	-	-	-	173	-	-	-	-
8	-	230	-	-	135	-	-	-	-
9	-	-	-	-	304	-	90	-	-
10	-	-	-	-	181	-	-	-	-
11	-	-	-	-	218	-	-	-	-
12	-	-	-	-	158	-	-	-	-
13	-	-	-	-	120	-	-	-	-
14	-	-	-	-	46	-	-	-	-

The present post-remediation study concentrated on the main four rooms in the clinic with continuous monitoring using the Rad-7 detector and 1 and 3 months TED's monitoring. Data from continuous monitoring allowed for daytime radon values for four rooms of clinic E to be determined, including average values for the daytime working hours, minimum radon values and maximum radon values (Table 6.8.2.).

Table 6.8.2. Corrected (*CF) Daytime Radon Values, Clinic E, Post- Remedial Studies

Room	Daytime Radon Concentration (Bq.m ⁻³)		
	Lowest	Mean	Highest
Room 1	10.7	52	117.8
Room 2	5.3	36	91
Room 3	5.3	38	101.7
Room 4	15.7	79	235.5

The corrected radon average concentrations were calculated taking into account the SCF and CF and were in agreement with the TED's values (Table 6.8.3.).

Table 6.8.3. Corrected Average Radon Values from Continuous Monitoring in Clinic E, Post- Remediation.

Room	Date	Actual mean (Bq.m ⁻³)	Correction Factor	Corrected mean*CF (Bq.m ⁻³)	Track-etch detectors (Bq.m ⁻³)
Room 1	10.11.97-24.11.97	32.1	0.87	47.9	45.6
Room 2	12.12.97-22.12.97	20.1	0.77	26.4	31.8
Room 3	24.11.97-12.12.97	24.5	0.81	33.9	47.3
Room 4	31.10.97-10.11.97	51.7	0.88	77.8	51.3
Room 5	12.12.97-16.03.98	-	-	-	31.8
Room 6	17.12.97-14.02.98	-	-	-	43.2

The pattern of variation of radon concentration was different for each room (Figures 6.8.2. to 6.8.5.). The figures show a complex time dependence, with different mean levels and time patterns being observed in different days even in the same room and different patterns between different rooms. The maximum corrected values in room 1 are in the range 57-61 Bq.m⁻³, in room 2 in the range 38.5-40 Bq.m⁻³, in room 3 in the range 48.5-50 Bq.m⁻³ and in room 4 in the range 114.5-123 Bq.m⁻³.

Figure 6.8.2. Radon Level Variation, Room 1, Clinic E

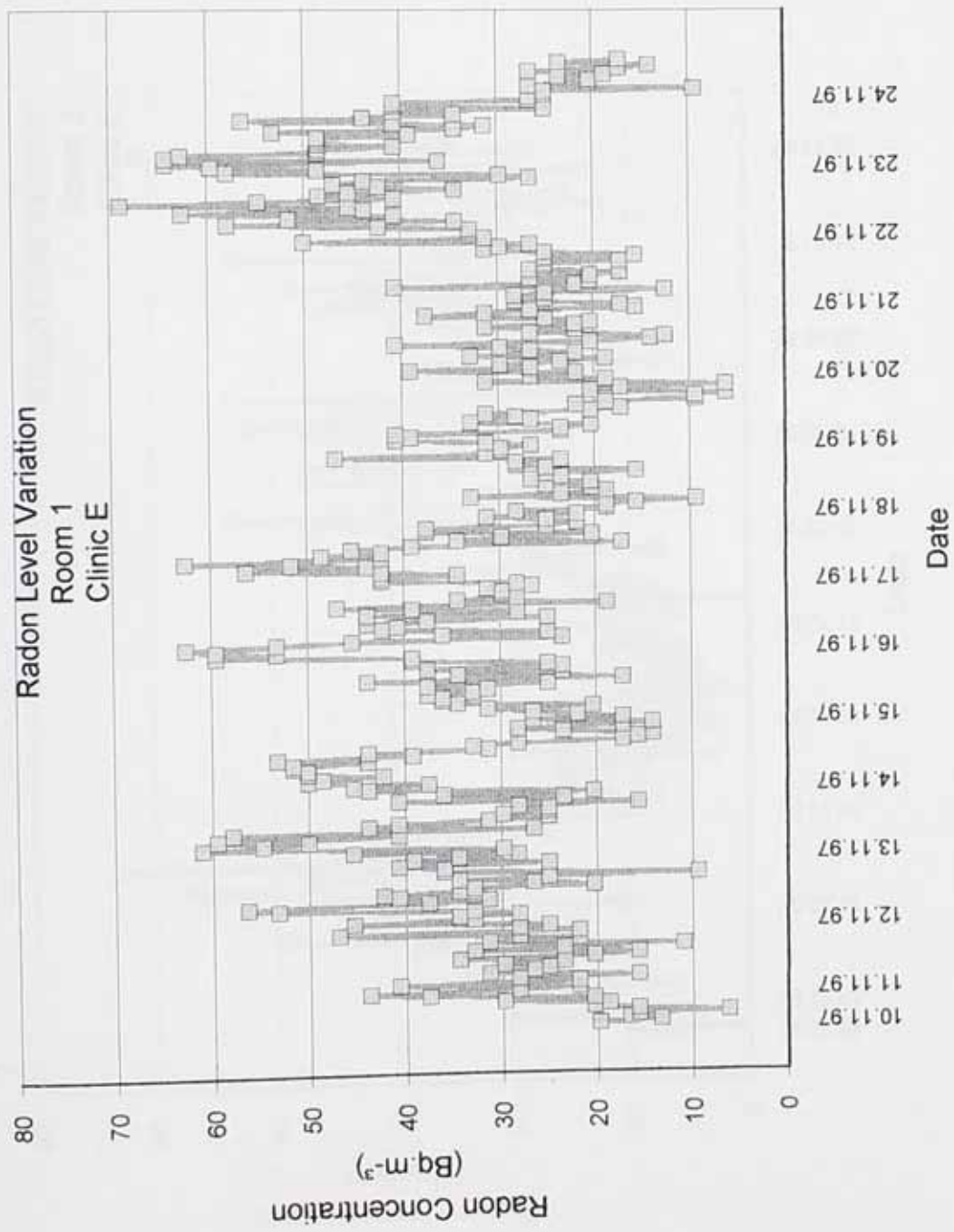

Figure 6.8.3. Radon Level Variation, Room 2, Clinic E

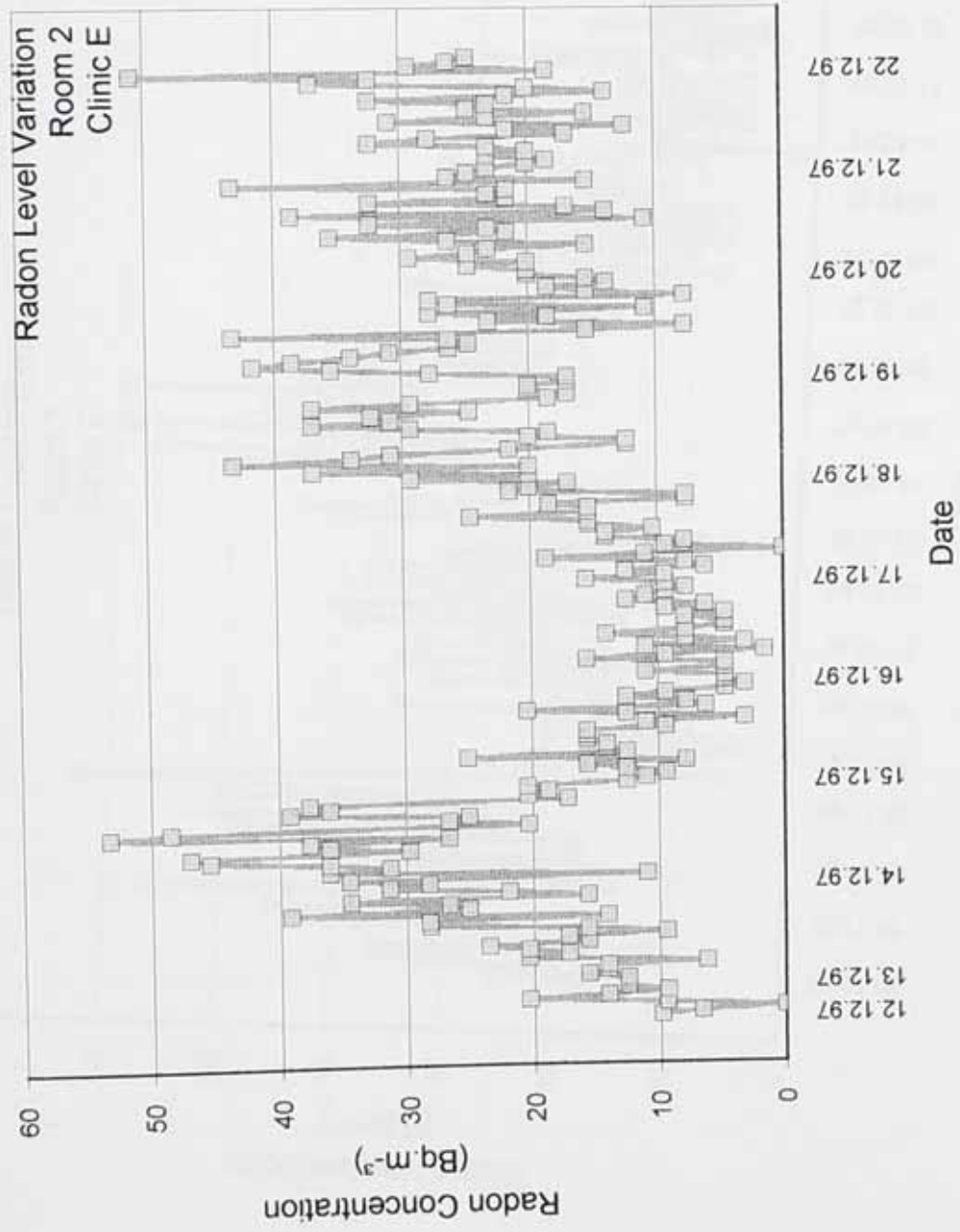

Figure 6.8.4. Radon Level Variation, Room 3, Clinic E

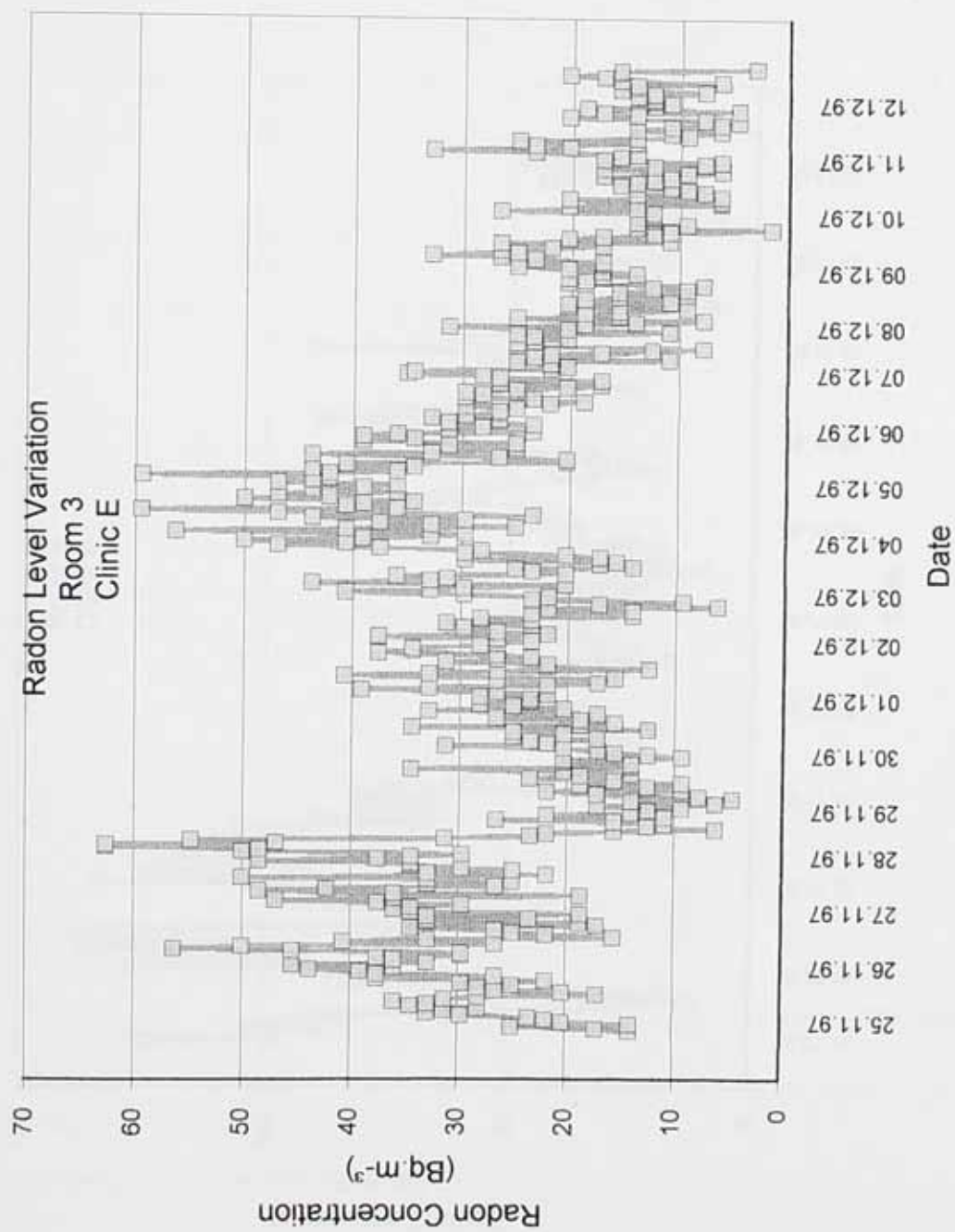
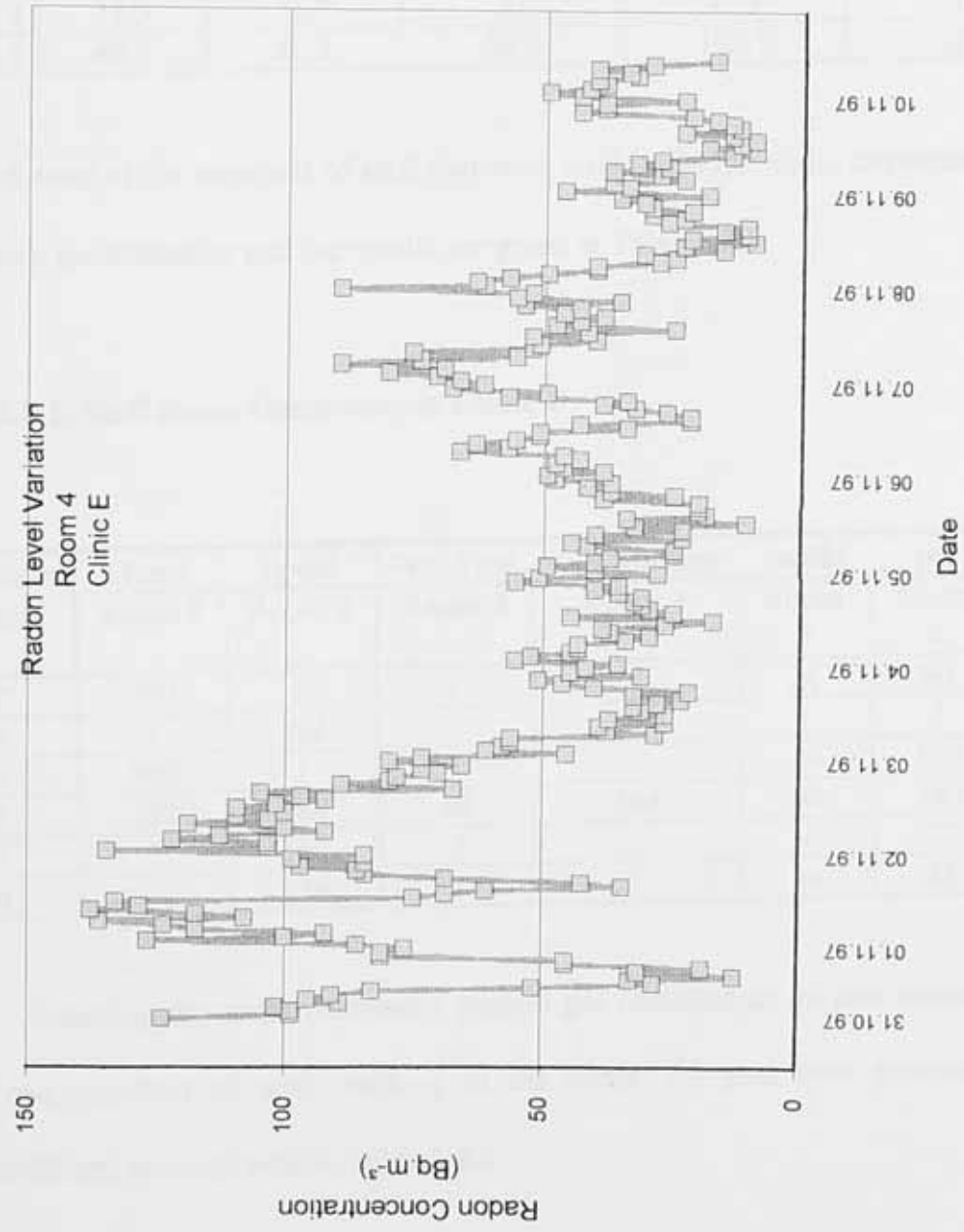

Figure 6.8.5. Radon Level Variation, Room 4, Clinic E



The average radon concentrations in the rooms were calculated during the normal working hours and during night time and the ratio between average radon levels in night time hours and working daytime hours are given in Table 6.8.4.

Table 6.8.4. Time Averages of Rad 7 Radon Concentration Measurements in Clinic E

Room	Daytime mean (Bq.m ⁻³)	Night time mean (Bq.m ⁻³)	Daytime corrected*CF (Bq.m ⁻³)	Night time corrected*CF (Bq.m ⁻³)	Ratio night time/day time radon concentration
Room 1	30.4	50.6	45.2	75.3	1.7
Room 2	21.1	25.1	27.7	36.5	1.3
Room 3	22.3	36.9	31	51.1	1.6
Room 4	46.2	86.2	69.6	129.7	1.9

A total of six members of staff that were working at the clinic answered the room occupancy questionnaire and the results are given in Table 6.8.5.

Table 6.8.5. Staff Room Occupancy in Clinic E

Members of staff	Hours Spent Per Year (48 working weeks per year)						
	Room 1	Room 2	Room 3	Room 4	Room 5	Room 6	Total
1	360	/	/	/	24	60	444
2	/	192	/	/	/	/	192
3	960	/	/	/	48	192	1,200
4	288	288	96	144	96	240	1,152
5	/	360	/	/	/	72	432
6	/	216	/	/	24	48	288

Assuming the same occupancy pattern pre remediation as post remediation and the same members of staff working in the clinic, the past time exposures can be calculated and are displayed in Table 6.8.6.

Table 6.8.6. Estimated Radon Exposure (kBq.h.m⁻³) in Clinic E Before Remediation

Member of Staff	Radon Exposure (kBq.h.m ⁻³)						Total
	Room 1	Room 2	Room 3	Room 4	Room 5	Room 6	
1	156.6	/	/	/	9.4	10.8	176.8
2	/	47.6	/	/	/	/	47.6
3	417.6	/	/	/	18.7	34.6	470.9
4	125.3	71.4	28.1	45.4	37.4	43.2	350.8
5	/	89.3	/	/	/	13	102.3
6	/	53.6	/	/	9.4	8.6	71.6

The estimated radon exposure per person after remediation work was carried out in clinic E is given in Table 6.8.7.

Table 6.8.7. Estimated Radon Exposure (kBq.h.m⁻³) in Clinic E Post- Remediation

Member of staff	Radon Exposure (kBq.h.m ⁻³)						Total
	Room 1	Room 2	Room 3	Room 4	Room 5	Room 6	
1	16.3	/	/	/	0.8	2.6	19.7
2	/	5.3	/	/	/	/	5.3
3	43.4	/	/	/	1.5	8.3	53.2
4	13	8	3	10	3	10.4	47.4
5	/	10	/	/	/	3.1	13.1
6	/	6	/	/	0.8	2.1	8.9

The annual dose per person, measured in mSv's, was calculated for each person, pre and post remediation work and the reduction factor was calculated (Table 6.8.8.).

Table 6.8.8. Annual Dose per Person (mSv) in Clinic E

Member of Staff	Pre-remediation Dose (mSv)	Post-remediation Dose (mSv)	Reduction Factor
1	1.4	0.16	8.8
2	0.38	0.04	9.5
3	3.74	0.42	8.9
4	2.78	0.38	7.3
5	0.81	0.1	8.1
6	0.57	0.07	8.1

The doses for each person working full time for 37 hours a week in clinic E, are given in Table 6.8.9.

Table 6.8.9. Potential Annual Dose per Person (mSv) in Clinic E for Full Time Working Hours (37 hours per week)

Member of staff	Pre-remediation Full Time Dose (mSv)	Post-remediation Full Time Dose (mSv)	Reduction Factor
1	5.61	0.62	9
2	3.5	0.39	9
3	5.53	0.63	8.8
4	4.29	0.58	7.4
5	3.34	0.43	7.8
6	3.5	0.43	8.1

A comparison of the individual dose reductions for each member of staff to the reduction in average radon level in the room that the individual occupied the most, shows a random dependence, as the one in Figure 6.8.6.

Figure 6.8.6. Reduction Factors of Individual Doses Compared to Reduction Factors in Average Radon Levels in Clinic E

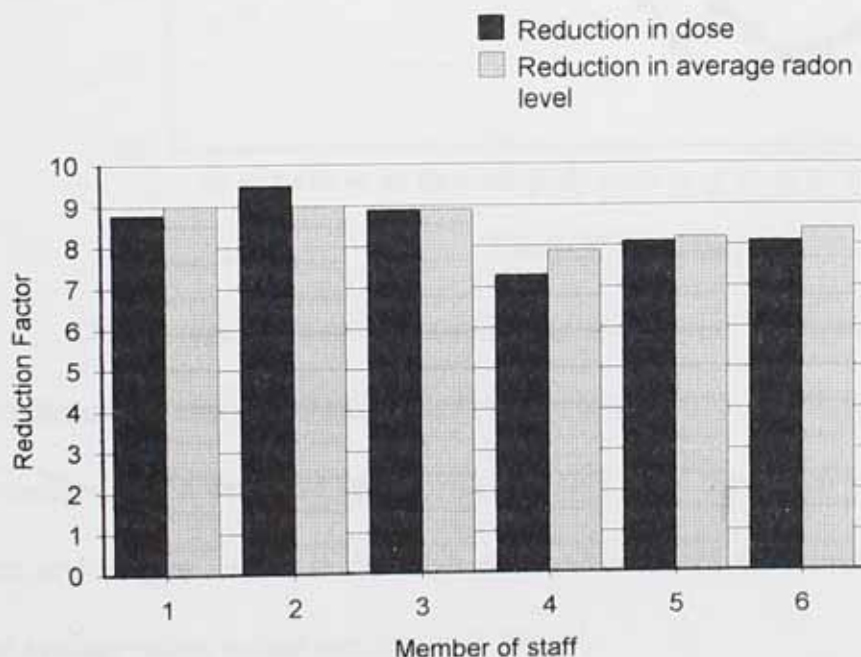

The average daily radon variation for nine weekdays, two Saturdays and two Sundays in room 1, clinic E, does not show significant differences between these days (Figure 6.8.7.). All the average radon values are below 65 Bq.m^{-3} , and the working hours weekday radon values are below 35 Bq.m^{-3} . The average radon values decreasing after 10 a.m. and until 6 p.m. in weekdays, suggest dependency of radon levels on usage of rooms.

Figure 6.8.7. Average Radon Daily Values in Room 1, Clinic E

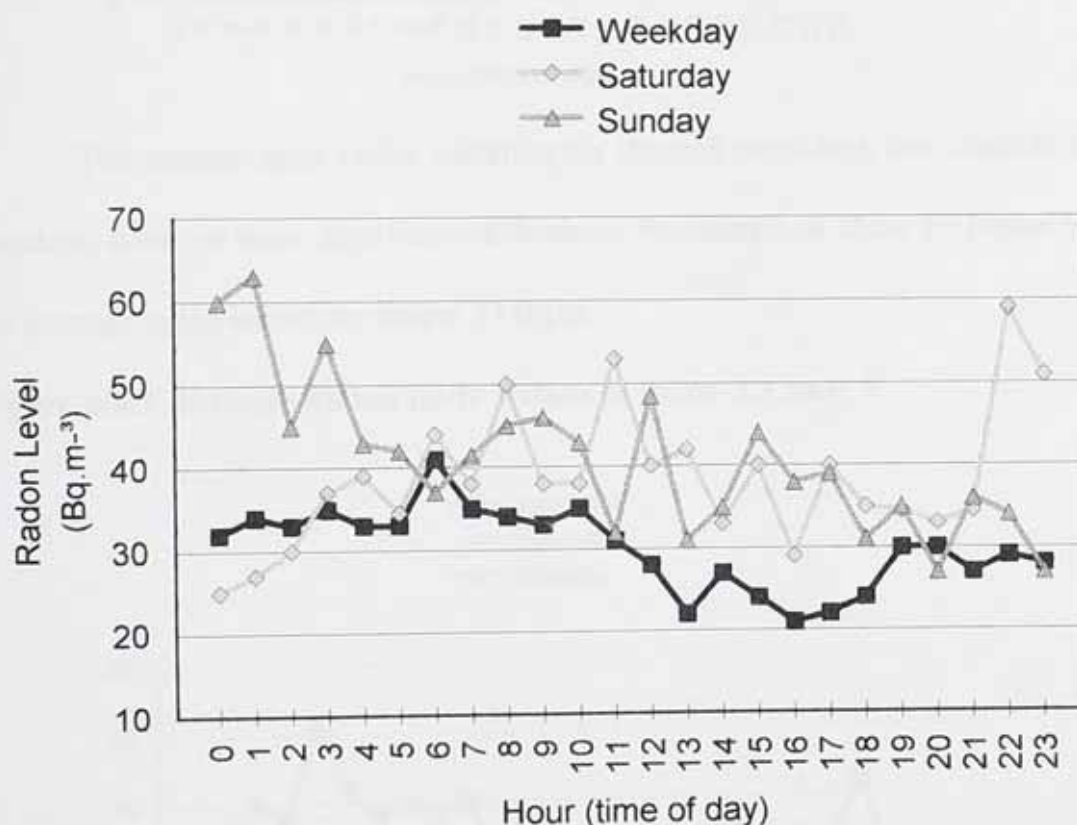

The average daily radon variation in room 2 in clinic E is given for five weekdays, two Saturdays and two Sundays and shows a similar variation pattern for weekdays and Saturdays, but a different pattern for Sundays (e.g. maximum radon concentration at 7 a.m. and 12 p.m., while in the other days radon values are minimum - Figure 6.8.8.). All the average radon values are below 43 Bq.m^{-3} .

Figure 6.8.8. Average Radon Daily Values in Room 2, Clinic E

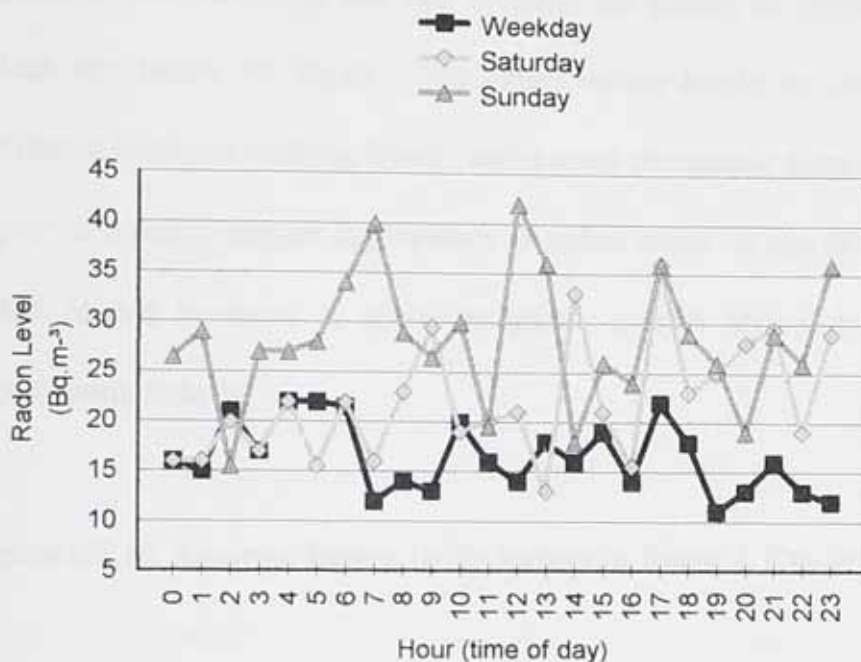

The average daily radon variation for thirteen weekdays, two Saturdays and two Sundays, does not show significant differences for room 3 of clinic E (Figure 6.8.9.). All the average radon values are below 37 Bq.m⁻³.

Figure 6.8.9. Average Radon Daily Values in Room 3, Clinic E

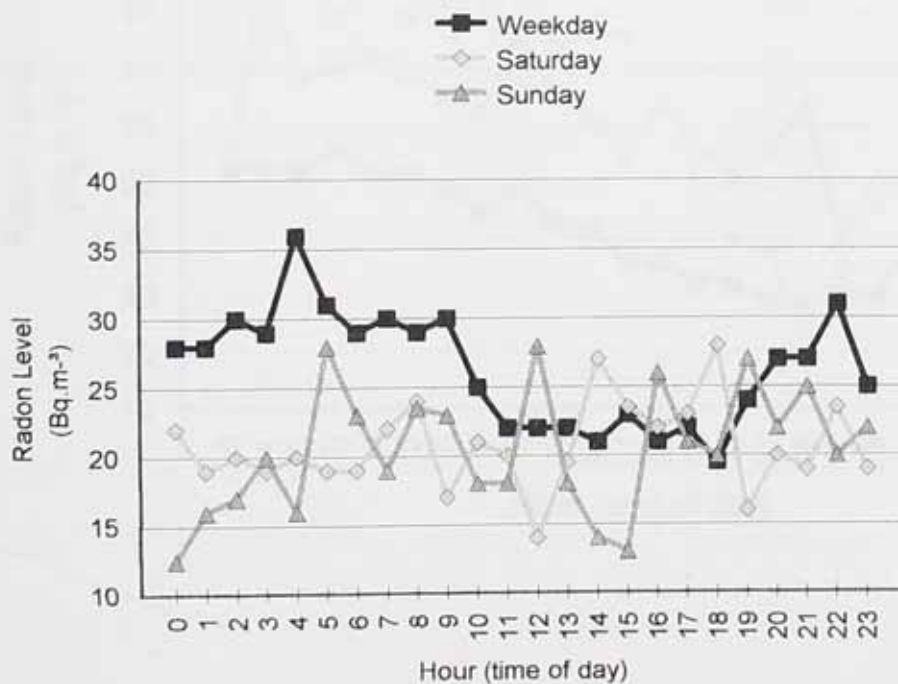

No significant differences in daily radon variation in room 4 of clinic E, for five weekdays, two Saturdays and two Sundays are shown in Figure 6.8.10. Average radon values are below 98 Bq.m⁻³. The lower radon levels in weekdays and even more decreased levels in working hours (radon level decreasing from 43 Bq.m⁻³ at 9a.m. to 30 Bq.m⁻³ at 6 p.m.), suggest dependency of radon levels on use of room. It appears that the radon source in room 4, pre-remediation, is still active, but the radon ingress is significantly reduced.

Figure 6.8.10. Average Radon Daily Values in Room 4, Clinic E

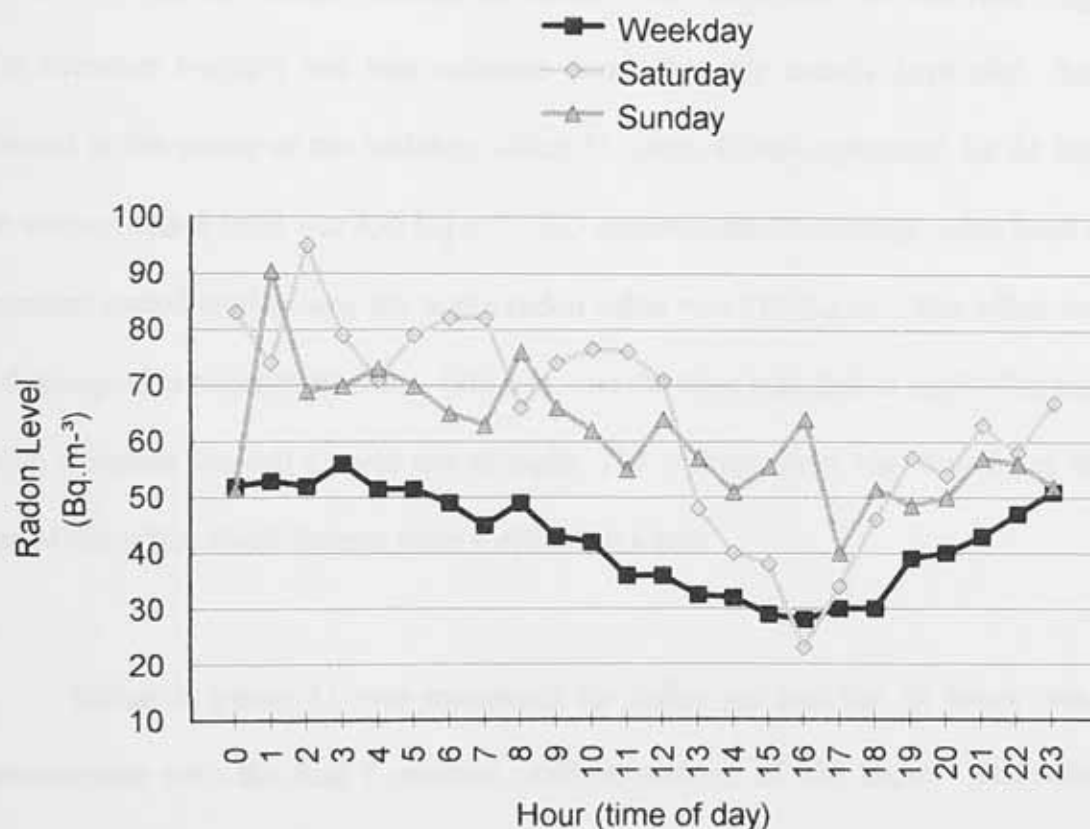

6.9. Kettering Hospital Data

This case study deals with a listed Victorian hospital building, built in local sandstone (Chapter 1.4.1.) in 1830's, situated in Kettering, a radon AA (Figure 6.2.2.). Remediation work was carried out after high radon levels were found out in the centre of the building in room D (room 4) (Figure 6.9.1).

Initial measurements were performed with TED's in 1992-1993 with a follow-up in October 1993, obtaining data with a continuous radon monitor, Rad- 7. The initial layout of the building included four offices with a common corridor and a separate entrance to a small therapy section; the office floors were built on bare rock (Fig 6.9.1). The common corridor has two entrance doors that are usually kept shut. An office situated in the centre of the building, office D (room 4) was monitored for 24 hours and the average radon level was 836 Bq.m^{-3} . TED's monitored the average radon level over an extended period of time and the mean radon value was 770 Bq.m^{-3} . The office was used and occupied between 8.30 a.m. - 4.00 p.m. and the door was shut at night. The pattern of radon variation showed a rapid rise at night. The waiting room was situated at the right side of the office block formed from 4 offices in a row.

Office A (room 1), was monitored for radon gas and the 24 hours continuous measurement with the Rad 7 monitor, with an average of 225 Bq.m^{-3} . The office was unoccupied all day and the door was kept shut at all times. No night-time rise in the radon levels was observed; a comparison of the radon level variation in the two extensively studied offices shows the increasing pattern of radon level in office D (room 4) and a constant pattern in office A (room 1) (Fig 6.9.2.).

Fig 6.9.1. Kettering Hospital- Initial Building Plan Before Remediation

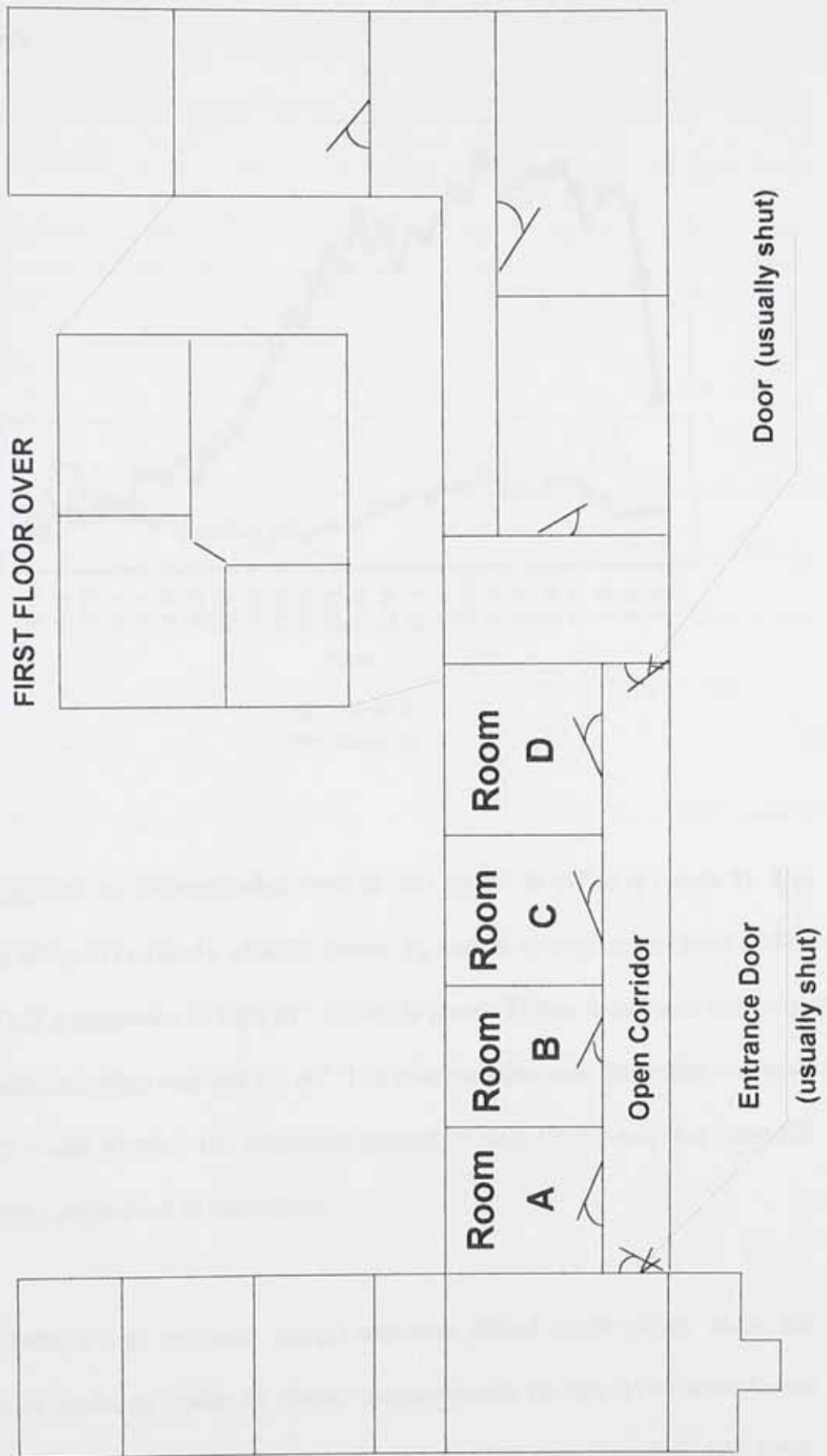
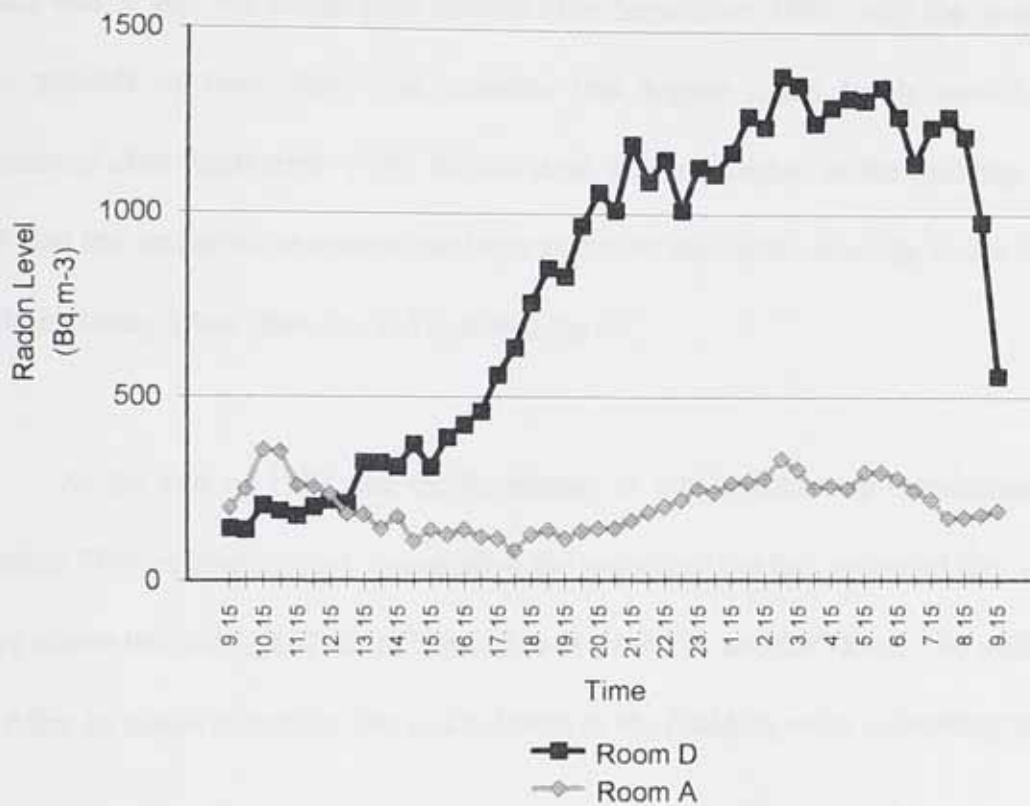

Fig 6.9.2. Comparison of the Radon Level Variation in Rooms A and D in 24 Hour Real Time Surveys



TED's suggested an average radon level of 300 Bq.m⁻³ in office A (room 1). The office adjacent to office D (room 4), office C (room 3), had an average radon level of 525 Bq.m⁻³ and the TED's measured 279 Bq.m⁻³. Office B (room 2) was monitored only with TED's and the recorded value was 163 Bq.m⁻³. The interpretation was that radon was only entering office D (room 4) from the subjacent ground (Figure 1.5.1.) and that remedial work should be only carried out in this office.

In early 1994, a wall mounted extract unit was placed in the office where the highest levels were recorded (room 4). Initial measurements in June 1994 were below limit; TED's were placed by the building contractors for 107 days, between 4.06.1994-

19.09.1994, in office D (room 4), the average radon level was 301 Bq.m^{-3} . Office A (room 1) had an average radon level of 207 Bq.m^{-3} . At the time of the measurements, the central office was in use, but it was kept unused after September 1994, with the door closed for long periods of time; thus it is possible that higher radon levels would have been monitored after September 1994. At that time, the conclusion of the building contractors was that the remediation system has been effective due to the average radon levels in the building being lower than the WAL of 400 Bq.m^{-3} .

At the end of 1994 and the beginning of 1995, follow-up measurements by the Medical Physics Department, to establish the impact of the fan, recorded that radon levels were above the WAL, 662 Bq.m^{-3} in office D (room 4) and 207 Bq.m^{-3} in office A (room 1). After an initial reduction, the radon levels in the building were increasing again.

In 1996, two years after remediation, the internal structure and use of the building changed. The opportunity was taken to fit a radon proof membrane. Radon levels were still raised, but below the WAL. The building was changed to form an enlarged therapy department (Figure 6.9.3.) and building regulations were followed. Office D had walls removed to provide a waiting area and the right side door of the corridor was removed to leave instead an opened doorway. Office A became a treatment room, functioning daily (room 1) and rooms B and C were kept as offices (rooms 2 and 3) An under floor space was created with ventilation holes and a radon proof membrane was added. Radon measurements were performed in room 4 (former office D) and the average value was recorded as 784 Bq.m^{-3} . The measurements were performed between 20.02.1996 and 07.03.1996 (Figure 6.9.4).

Fig 6.9.2. Kettering Hospital- Present Building Plan After Change of Use and Building Refurbishments

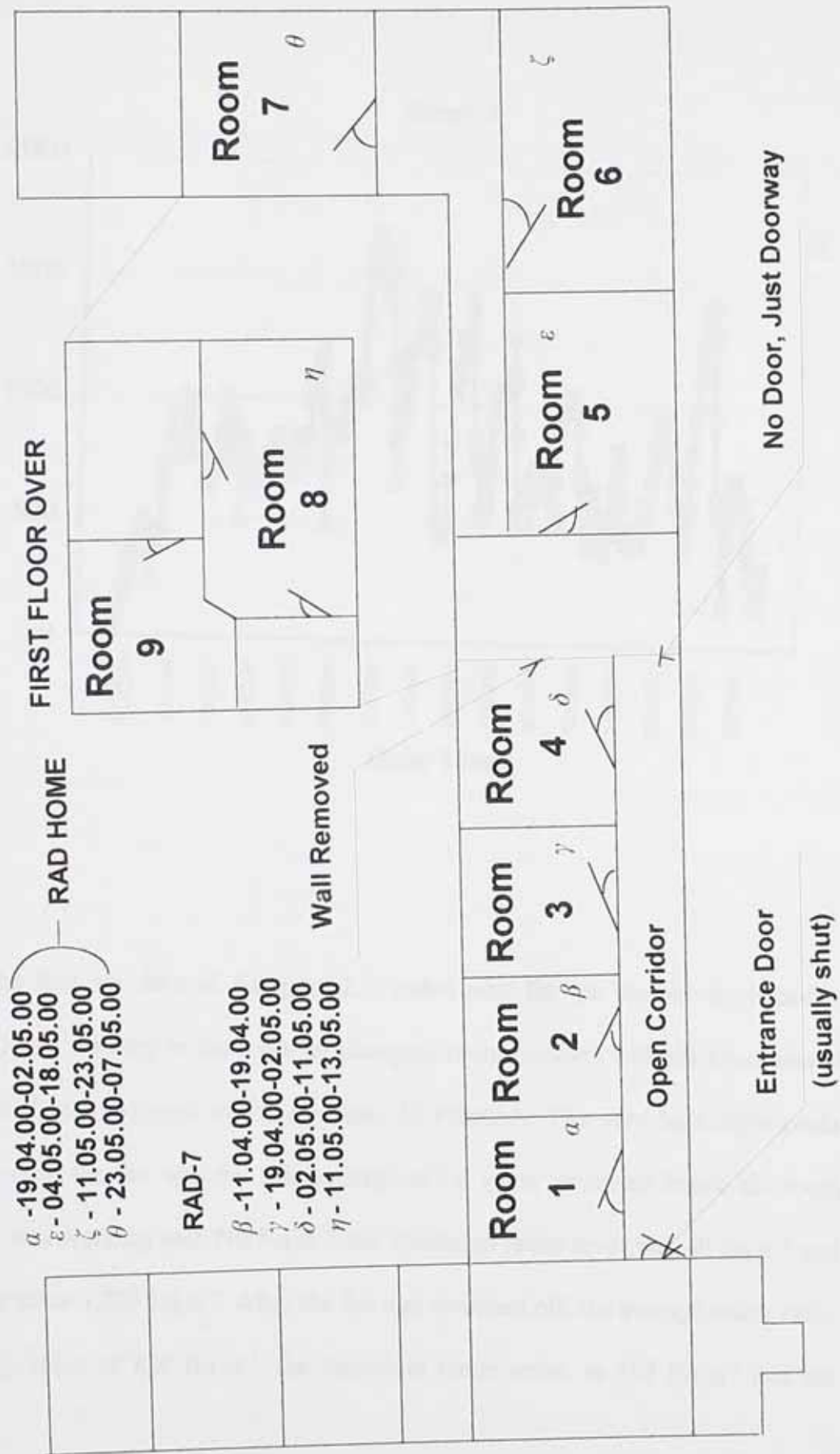
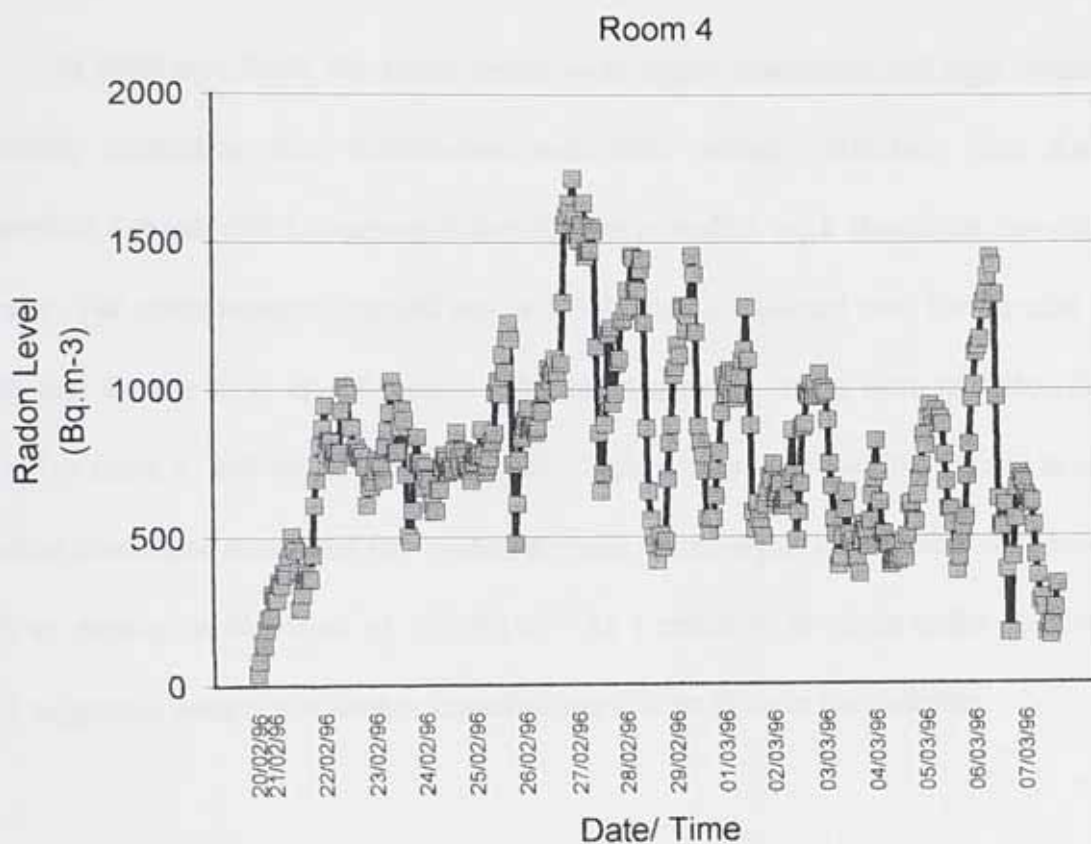

Figure 6.9.4. Radon Levels in Room 4, Kettering Hospital, 1996



For the first six days of this period, a radon vent fan (as the one described in Figure 5.1.3.) was working in the room by changing room pressure with the expulsion of air radon, but it was switched off on Monday, 26 February. The very high night peaks were absent when the fan was on. The average radon value measured inside the room while the fan was working was 710 Bq.m⁻³; the minimum radon level was 40 Bq.m⁻³ and the maximum value 1,226 Bq.m⁻³. After the fan was switched off, the average radon value increased to a value of 826 Bq.m⁻³, the minimum radon value to 162 Bq.m⁻³ and the

maximum radon level to $1,716 \text{ Bq.m}^{-3}$. The conclusion was that further remedial work was required and an extract fan fitted to provide forced ventilation.

In 1999 and 2000, the radon levels were again monitored and high values were recorded, suggesting that remediation was only partially effective. The Radiation Protection Adviser (RPA) suggested that further remedial work should be carried out at the site. The measurements carried out in 1999, were conducted both for the aim of this study and for the RPA investigations. The average radon levels were as following: 332 Bq.m^{-3} in room 1, 248 Bq.m^{-3} in room 2, 255 Bq.m^{-3} in room 3 and 305 Bq.m^{-3} in room 4. Another monitored room was the treatment room on the right, functioning daily (room 6), with an average radon level of 127 Bq.m^{-3} . As a result of the high radon readings, the RPA suggested once again further remedial work to be done in the building.

In 2000, measurements were performed for a one month period, between 11.04.2000 and 11.05.2000, using two continuous radon monitors, Rad-7 (Figure 2.2.2.) and RadHome (Figure 2.2.3.). Rooms 1-9 were monitored and all had average radon levels below the WAL. The highest radon average level was recorded in the left hand side treatment room (room 1), the same one that had a level of 225 Bq.m^{-3} in 1993, 207 Bq.m^{-3} after the initial remediation, in 1994 and 332 Bq.m^{-3} in 1999. The average corrected radon level in room 1 in April- May 2000, was 234.5 Bq.m^{-3} . The next high average radon level of 158.6 Bq.m^{-3} was recorded in room 5, situated in the right hand side of the building, a treatment room functioning only two afternoons a week. Room 2 had an average radon level of 45.9 Bq.m^{-3} , room 3 had an average radon level of 112 Bq.m^{-3} , room 4 an average radon level of 157 Bq.m^{-3} , room 6 an average radon level of 64.5 Bq.m^{-3} and room 7 an average radon level of 68.3 Bq.m^{-3} ; room 7 is a treatment room functioning only two days

a week. Rooms 8 and 9 had an average radon level of 41 Bq.m⁻³. The results of all the measurements performed in the hospital since 1991, are given in Table 6.9.1. Room 3 appears as having a source of radon before remediation, as well as the secondary source in room 1. It seems that after remediation, the primary source in room 3 was significantly reduced, whereas the secondary source in room 1 is still active.

Table 6.9.1. Radon Levels in Kettering Hospital (Bq.m⁻³)

Room	Radon Level (Bq.m ⁻³)							
	Year 1991	Year 1993	Year 1994	Year 1996	Year 1999	Start 2000*	April-June 2000 average	April-June 2000 daytime
1	300	225 and 300*	207*	/	332	311	309	280
2	/	/	/	/	248	219	46	47
3	/	525 and 279*	305*	/	255	203	99	119
4	770	836 and 700*	301* and 662*	784	226 and 305	226 and 212	157	152
5	/	/	/	/	/	/	209	177
6	140	65	/	/	127	150	85	102
7	/	/	/	/	/	/	90	98
8	/	/	/	/	/	/	41	16
9	125	/	/	/	/	/	41	16

* = TED measurements

Both the Rad7 and the RadHome meter were regularly calibrated; the Rad-7 meter was reset and repaired midway through this study. All the measurements were seasonally corrected with the corresponding NRPB SCF's. TED measurements recorded the following average radon levels: room 1- 311 Bq.m⁻³, room 2- 219 Bq.m⁻³ and room 3- 203 Bq.m⁻³ and room 4- 226 Bq.m⁻³ and 212 Bq.m⁻³. Most results were consistent with previous surveys conducted with TED's, the only discrepancy was recorded in room 2; the continuous measurement was done over 10 days, including a week when the manager was on leave, while the door was shut. The low reading suggests that any radon reaching the room has entered the building elsewhere in the department.

Since 1996, the rooms have been used as a mix of management and secretarial support offices and consulting rooms. The offices have a higher more regular occupancy than the consulting rooms, as the clinical therapist also spent time at other clinics. Members of the present staff were asked to complete a room occupancy questionnaire in April 2000 and the occupancy data is given in Table 6.9.2. It was assumed that the occupancy did not change throughout the study and it was the same in the previous studies for each member of the staff.

Table 6.9.2. Room Occupancy in Kettering Hospital

Person	Times per week	Hours per year (48 working weeks per year)									Total
		R1	R2	R3	R4	R5	R6	R7	R8	R9	
1	2	/	/	/	/	192	/	/	/	/	192
2	4	648	/	72	/	/	/	/	/	/	720
3	2	/	/	/	48	192	/	/	/	/	240
4	3	/	/	/	/	/	/	1,008	/	/	1,008
5	5	/	/	/	/	/	/	/	864	/	864
6	5	/	/	1,776	/	/	/	/	/	/	1,776
7	3	/	/	/	/	48	48	/	144	/	240
8	12	/	/	24	48	/	480	/	24	/	576
9	3	/	/	/	48	/	576	/	48	/	672
10	1	/	/	4.8	/	/	220.8	4.8	4.8	4.8	240

The radiation doses per person were calculated based on their patterns of use of the rooms and daytime radon level in each room (Table 6.9.3.).

Table 6.9.3. Staff Exposure (kBq.h.m⁻³) Due to Radon in Kettering Hospital

Person	Radon Exposure per year (kBq.h.m ⁻³)									Total
	R1	R2	R3	R4	R5	R6	R7	R8	R9	
1	/	/	/	/	25.8	/	/	/	/	25.8
2	138	/	10.9	/	/	/	/	/	/	148.9
3	/	/	/	5.7	25.8	/	/	/	/	31.5
4	/	/	/	/	/	/	74.8	/	/	74.8
5	/	/	/	/	/	/	/	14.1	/	14.1
6	/	/	269.6	/	/	/	/	/	/	269.6
7	/	/	/	/	6.4	3.7	/	2.3	/	12.4
8	/	/	3.6	5.7	/	37	/	0.4	/	46.7
9	/	/	/	5.7	/	44.5	/	0.8	/	51
10	/	/	0.7	/	/	17	0.4	0.8	0.8	19.7

The annual dose is included in Table 6.9.4.

Table 6.9.4 Annual Dose (mSv) to Staff in Kettering Hospital

Person	Annual Dose (mSv)									Total
	R1	R2	R3	R4	R5	R6	R7	R8	R9	
1	/	/	/	/	0.2	/	/	/	/	0.2
2	1.1	/	0.09	/	/	/	/	/	/	1.19
3	/	/	/	0.05	0.2	/	/	/	/	0.25
4	/	/	/	/	/	/	0.59	/	/	0.59
5	/	/	/	/	/	/	/	0.11	/	0.11
6	/	/	2.14	/	/	/	/	/	/	2.14
7	/	/	/	/	0.05	0.03	/	0.02	/	0.1
8	/	/	0.03	0.05	/	0.29	/	0	/	0.37
9	/	/	/	0.05	/	0.35	/	0.01	/	0.41
10	/	/	0.01	/	/	0.14	0	0.01	0.01	0.17

Most doses were low, partly due to the limited time spent by most of the staff in the unit. Two people received elevated doses: staff member 2 is spending 13.5 hours each week in room 1, receiving an annual dose of 1.18 mSv and staff member 6, spending 37 hours per week in room 3 and receiving an annual dose of 2.14 mSv. Comparing these doses with the Annual Dose Limits for Radiation Workers in the Ionising Radiation Regulations (6 mSv), these doses are well below the limits.

The pattern of radon variation was different for each room. Room 1 was monitored with the RadHome detector, between 19.04.2000 to 02.05.2000. The radon level variation pattern in room 1 is given in Figure 6.9.5. The maximum radon value was recorded on a Wednesday, 26.04.00, at 9 am, a radon concentration of 1104 Bq.m⁻³. Out of a total of 310 hours of measurement, 28 times the radon concentration is above the WAL (9% of time). It appears that the secondary radon source in room 1 is still active as the radon levels continue to be high.

Figure 6.9.5. Radon Variation in Room 1, Kettering Hospital, Year 2000

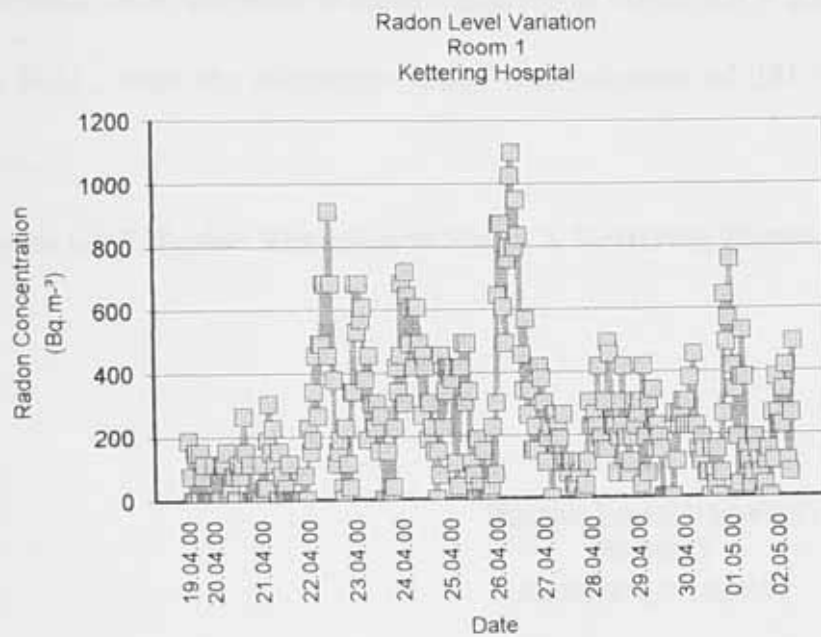

Room 2 was monitored with the Rad-7 detector between 19.04.00 and 02.05.00.

The radon level variation pattern is given in Figure 6.9.6. Radon levels are well below the WAL.

Figure 6.9.6. Radon Variation in Room 2, Kettering Hospital, Year 2000

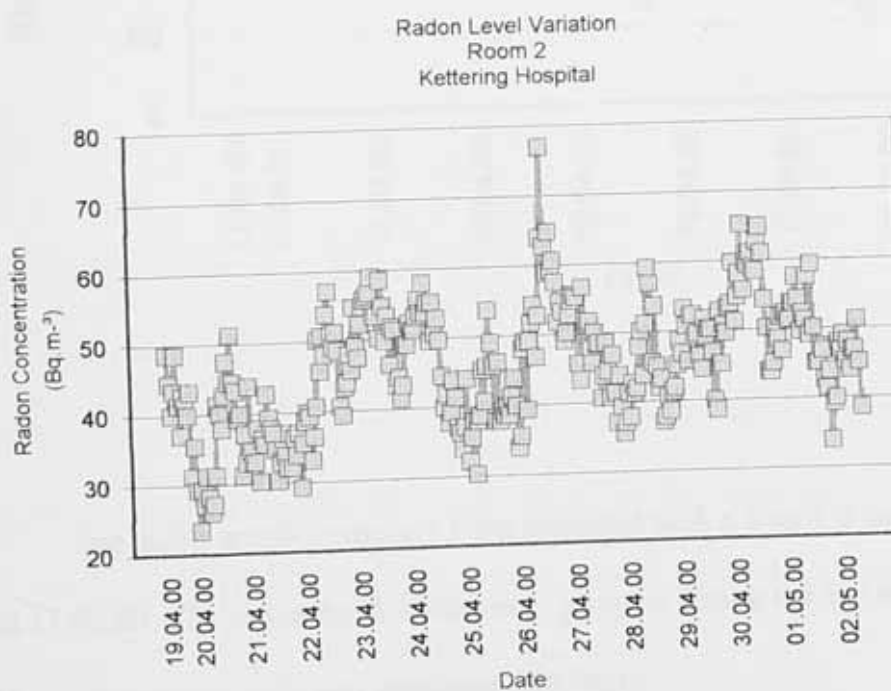

Room 3 was monitored with the Rad-7 detector between 11.04.00 and 19.04.00. The radon level variation in room 3 is given in Figure 6.9.7. Radon levels are well below the WAL, even the maximum radon concentration of 281.5 Bq.m⁻³ is lower than the WAL.

Figure 6.9.7. Radon Variation in Room 3, Kettering Hospital, Year 2000

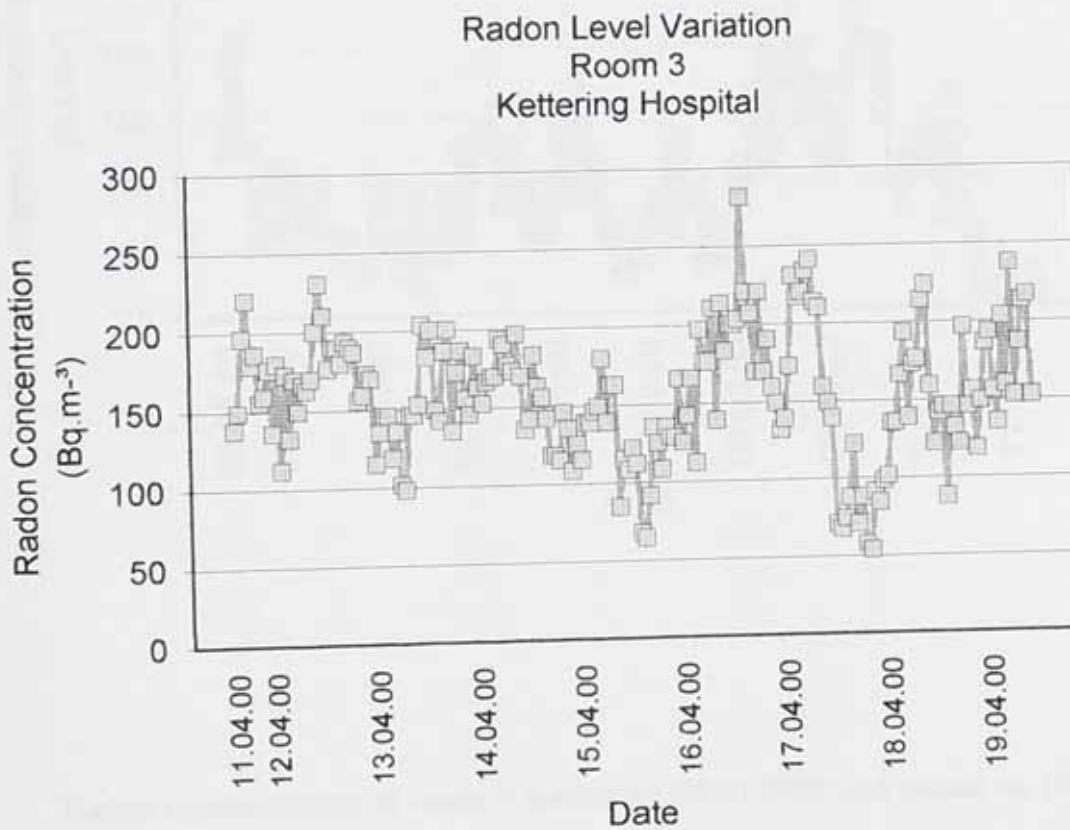

The radon levels in room 4 were recorded with a Rad-7 detector between 02.05.00 and 11.05.00. The radon level variation is given in Figure 6.9.8. Out of a total number of 216 measurements, only two are above 250 Bq.m⁻³.

Figure 6.9.8. Radon Variation in Room 4, Kettering Hospital, Year 2000

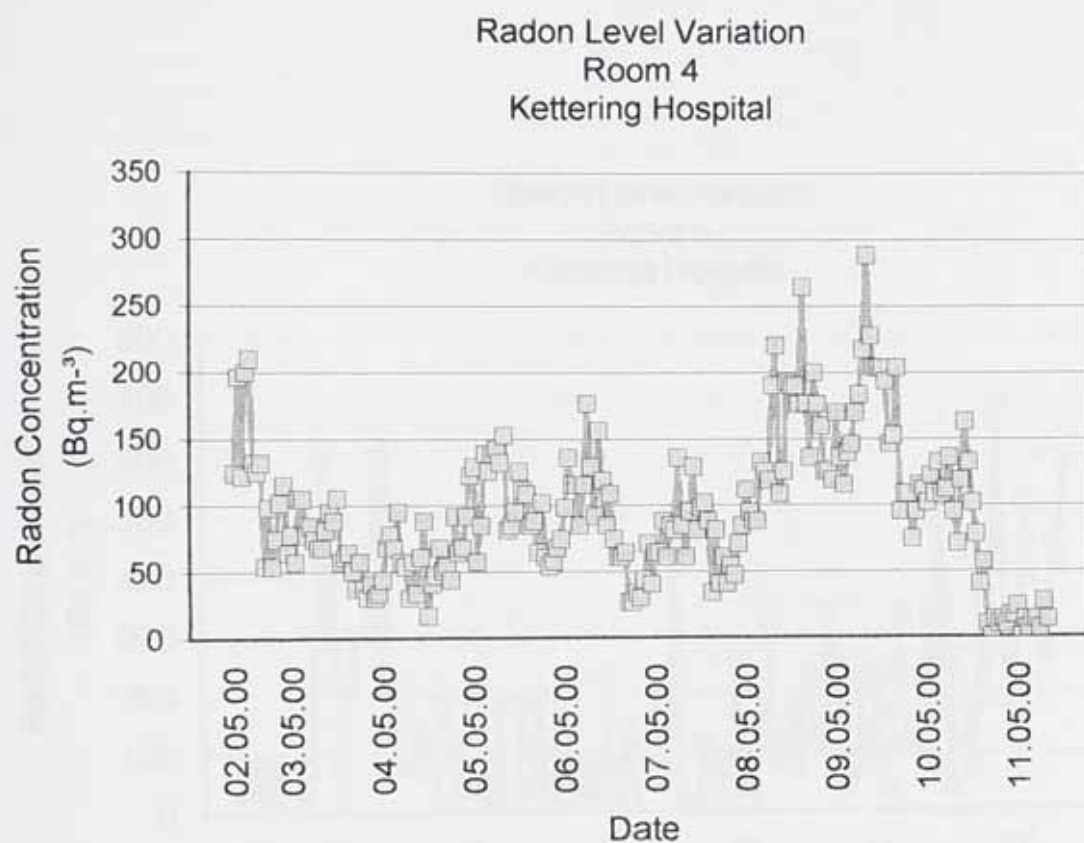

Radon measurements in room 5 started on 04.05.2000 and ended on 10.05.2000 and were performed using the RadHome. The radon level variation in room 5 is given in Figure 6.9.9. Out of 145 measurements, 14 are above the WAL (9.6%), with a maximum radon concentration around 700 Bq.m⁻³. It seems that radon was directed from room 3 to the right, towards room 5 and the knocking down of the wall helped the formation of a secondary radon source after remediation in room 5.

Figure 6.9.9. Radon Variation in Room 5, Kettering Hospital, Year 2000

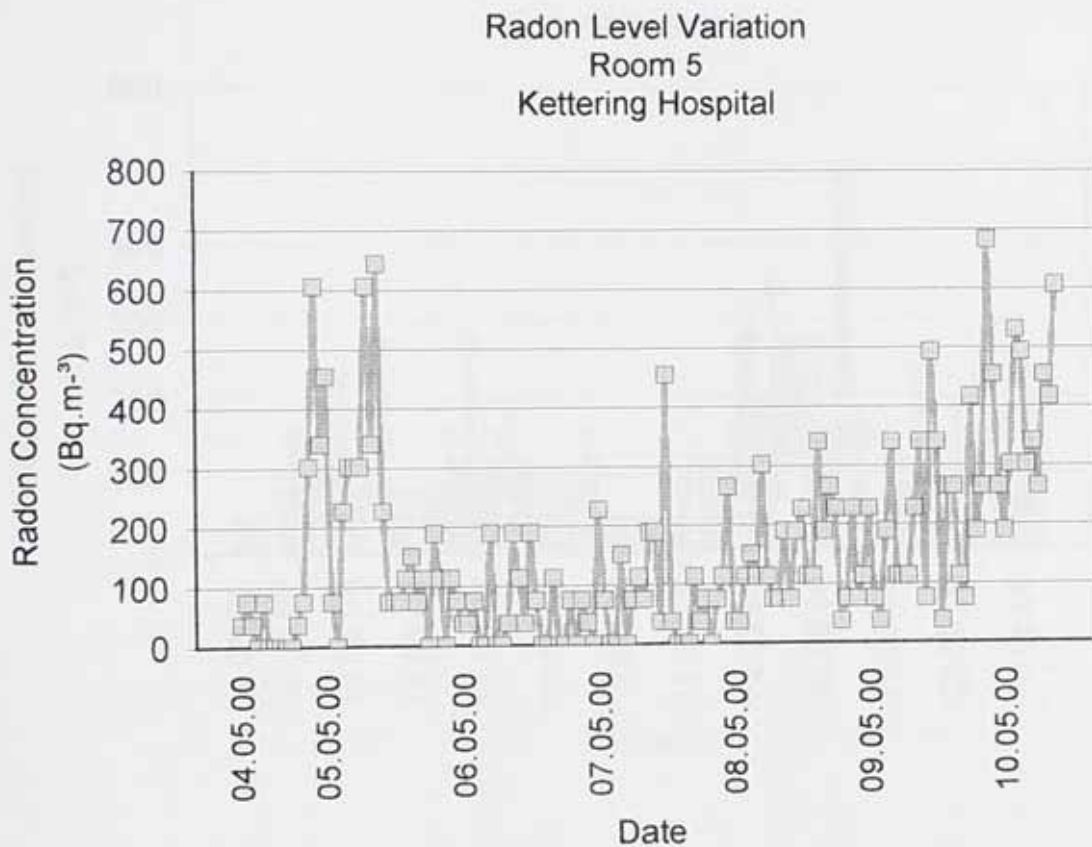

The measurements in room 6 were carried out with a RadHome, between 11.05.2000 and 23.05.2000; Figure 6.9.10. shows the radon level variation in room 6. Out of 289 recorded measurements, only two are above the WAL.

Figure 6.9.10. Radon Variation in Room 6, Kettering Hospital, Year 2000

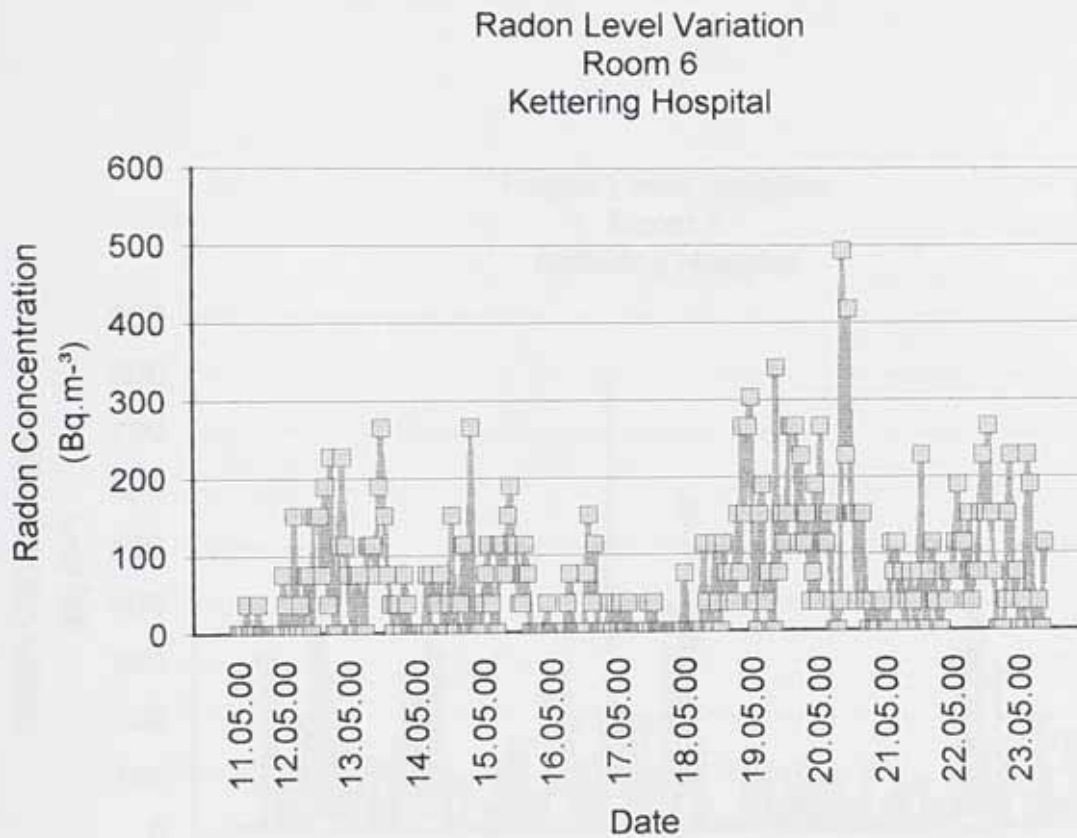

Similar measurements performed with the RadHome were carried out in room 7, between 23.05.00 and 07.06.00. The radon level variation in room 7 is given in Figure 6.9.11. Even though the maximum radon levels are high at 800 Bq.m⁻³, out of a total of 351 measurements, in only 7 occasions is the radon concentration above the WAL (less than 2% of the times). This excludes the possibility of a tertiary radon source in the hospital.

Figure 6.9.11. Radon Variation in Room 7, Kettering Hospital, Year 2000

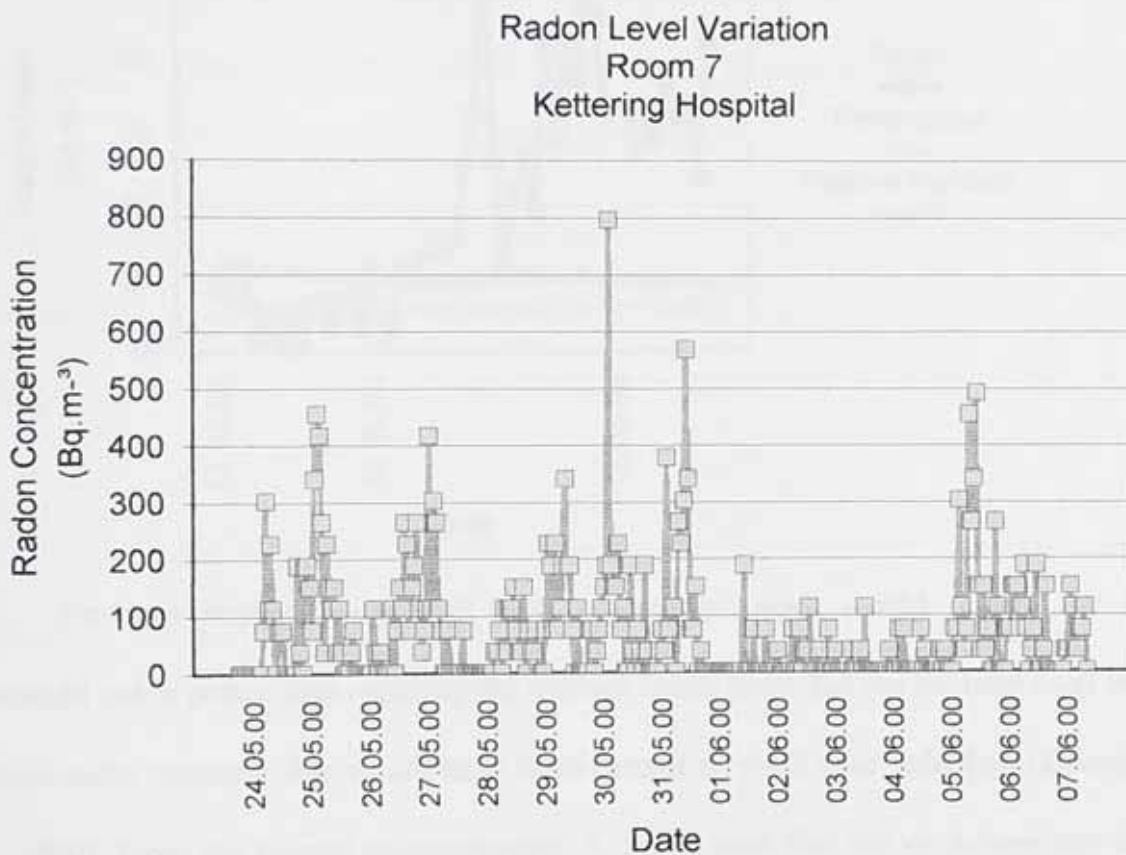

The last sets of continuous radon measurements for 2000, carried out in room 8 with the Rad-7, were started in 11.05.00 and ended in 13.05.00. The radon variation is given in Figure 6.9.12, along with the temperature ($^{\circ}$ Celsius) and relative humidity. It can be noticed an almost constant temperature and humidity.

room 2 is minor, compared to the one in room 1. The reduced radon values in room 4 suggest that the source of radon in this area has been ended and the levels in this room could be explained by diffusion from elsewhere.

The corrected average values, taking into account the RadHome calibration factor of 0.759, are given in Table 6.9.5. The average radon levels have been calculated for all the monitored days, the daytime average values, that include daytime hours from 9am to 5pm and include weekends and Bank Holidays, the night time average levels, from 6pm to 8am, the average working hours, including Mondays to Fridays, from 9am to 5pm and the ratio average night time radon levels per daytime radon levels. The dates of the measurements and the minimum and maximum values in each room are also shown in Table 6.9.5.

Table 6.9.5. Radon Concentrations in Kettering Hospital (Bq.m^{-3}), corrected with the calibration factor for the RadHome, Year 2000

	Room 1	Room 2	Room 3	Room 4	Room 5	Room 6	Room 7	Room 8	Room 9
Date	19.04.00 02.05.00	19.04.00 02.05.00	11.04.00 19.04.00	02.05.00 11.05.00	04.05.00 10.05.00	11.05.00 23.05.00	23.05.00 07.06.00	11.05.00 13.05.00	/
Monitor	RadHome	Rad7	Rad7	Rad7	RadHome	RadHome	RadHome	Rad7	/
Average Radon	234.4	45.9	156.9	98.52	158.8	65	68.2	40.8	40.8
Average day	214.2	47.2	153.2	104	98.8	88.7	57.5	16.3	/
Average night	254.6	44.6	160.6	93	218.8	41.3	78.9	65.3	/
Average working hours	213.1	47.5	151.8	119.6	134.2	77.2	74.2	16.3	16.3
Minimum	0	23.3	54.3	0	0	0	0	0	/
Maximum	1,100.5	77	281.8	288.7	684	494	570	108.7	/
Ratio average night/day	1.2	0.9	1	0.9	2.2	0.5	1.4	4	/

A comparison of the seasonally corrected average radon levels measured in year 2000 with those measured in 1999, allows to calculate the reduction factor for each room (Table 6.9.6.).

Table 6.9.6. Average Radon Levels (Bq.m⁻³) in Kettering Hospital in 1999 and 2000

Room	Average radon 1999	Average radon 2000	Reduction Factor
1	332	234.4	1.4
2	248	46	5.4
3	255	157	1.6
4	226	99	2.3
5	/	187.4	/
6	127	76.7	1.7
7	/	87.5	/
8	/	40.8	/
9	/	40.8	/

In conclusion, radon still present in the therapy department gives rise to a limited dose to staff. However, both the average radon level and the calculated doses are below the legal limits and further action to reduce radon is not necessary. The recommendation is to apply simple methods of reducing radon, like opening doors and windows. An extract fan was fitted to provide forced ventilation in January 2001.

The radon daily variation for six weekdays, two Saturdays and two Sundays in room 1 of the Kettering hospital does not show any significant differences (Figure 6.9.13.). The sudden drop in radon levels after 9a.m. in weekdays supports the theory of a radon source in room 1, post-remediation.

Figure 6.9.13. Average Radon Daily Values in Room 1, Kettering Hospital

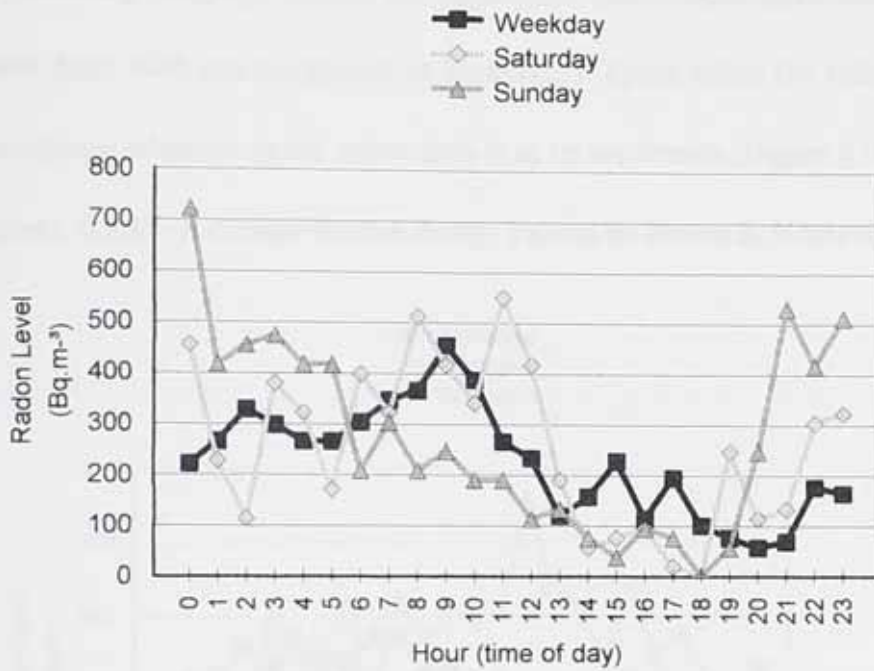

The radon daily variation for six weekdays, two Sundays and two Saturdays in room 2 of the Kettering Hospital, shows a slightly different pattern for radon variation on Sundays before 9 am, but after that, the pattern is similar for all the days (Figure 6.9.14).

Figure 6.9.14. Average Radon Daily Values in Room 2, Kettering Hospital

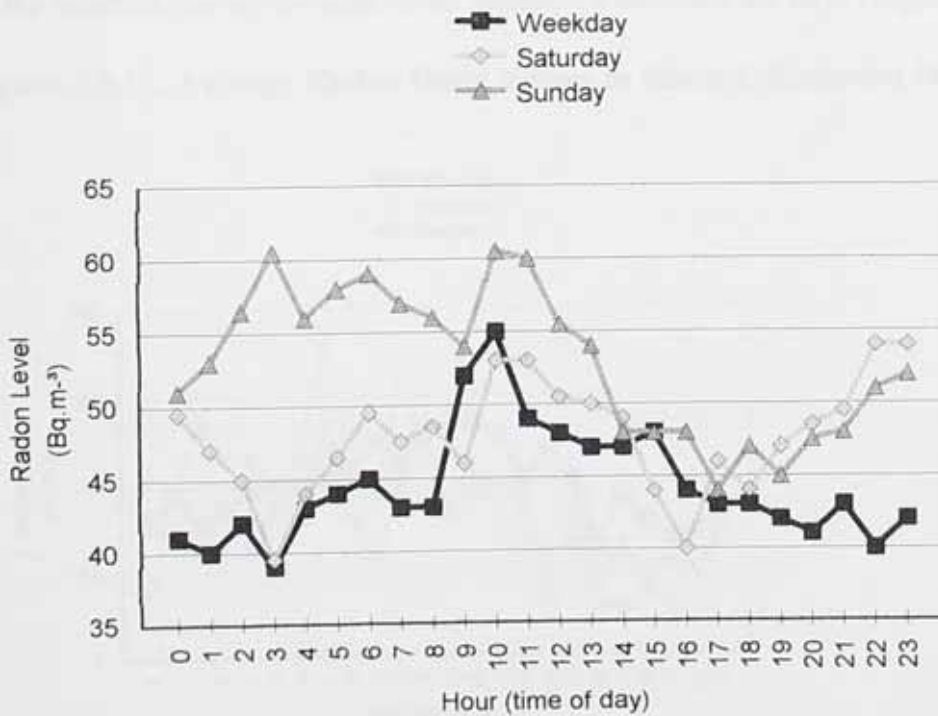

The radon daily variation for six weekdays, one Saturday and one Sunday in room 3, Kettering hospital, shows no significant differences between the radon variation in these days, with one exception on Sundays at 2 p.m. when the radon concentration is at its maximum, whereas in the other days is at its minimum (Figure 6.9.15.).

Figure 6.9.15. Average Radon Daily Values in Room 3, Kettering Hospital

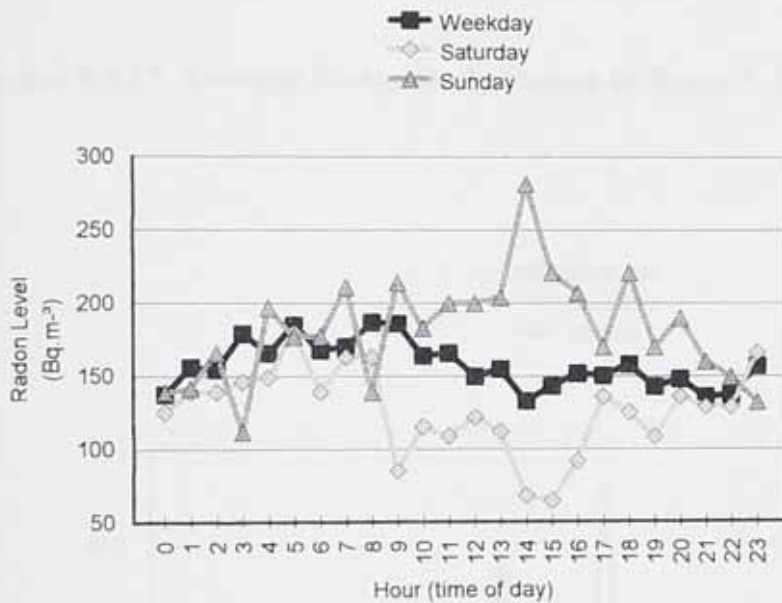

The radon variation for seven weekdays, one Saturday and one Sunday in room 4 of the hospital, shows no significant difference between the days (Figure 6.9.16.).

Figure 6.9.16. Average Radon Daily Values in Room 4, Kettering Hospital

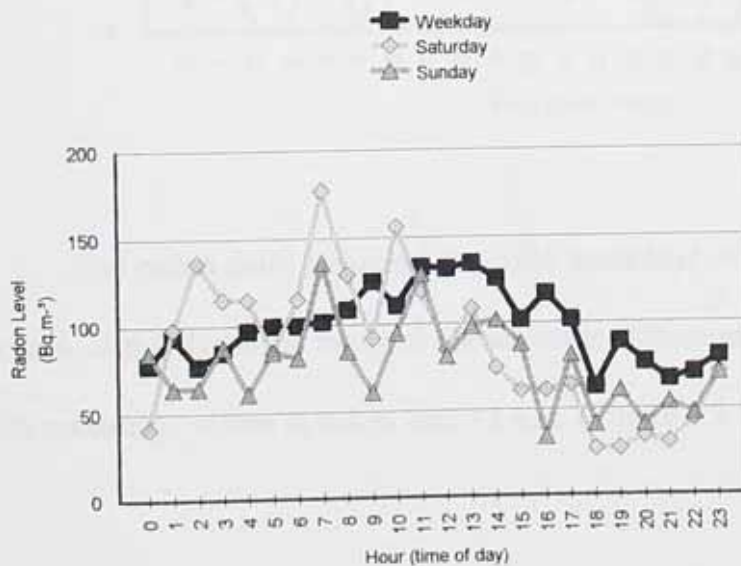
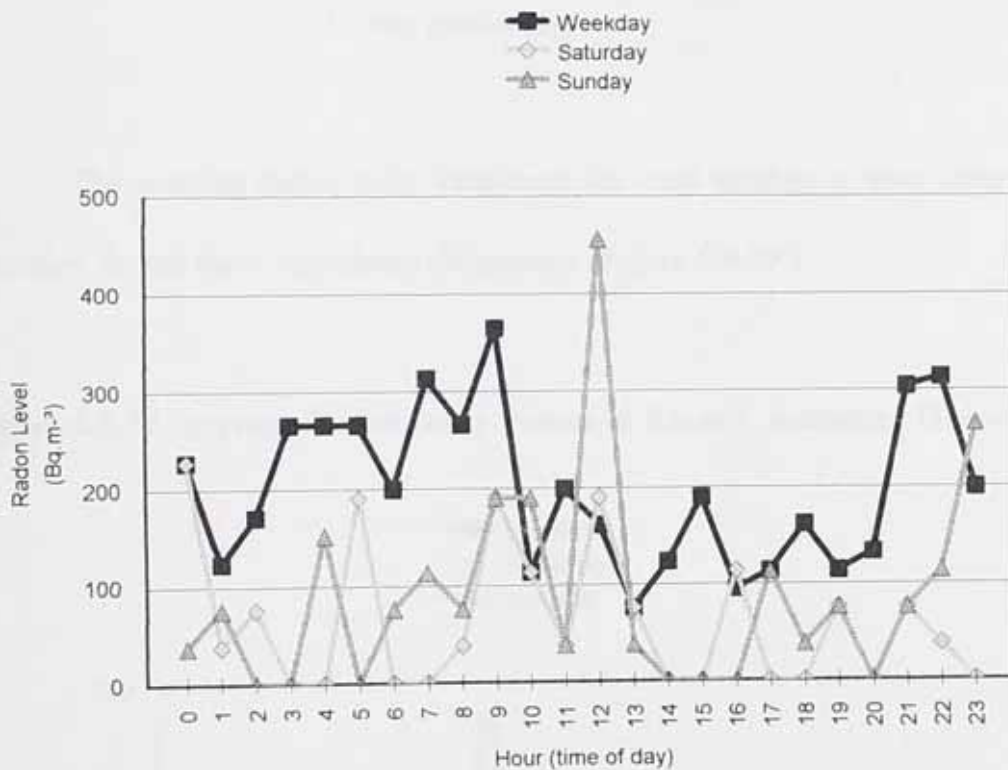

Figure 6.9.17. Average Radon Daily Values in Room 5, Kettering Hospital

The daily radon variation for four weekdays, one Saturday and one Sunday in room 5 does not show significant differences (Figure 6.9.17.). Once again, the sudden drop in radon levels after 9a.m. and a constant low (less than 200 Bq.m⁻³) radon average concentration until 6p.m., supports the suggested secondary radon source in room 5.

Figure 6.9.17. Average Radon Daily Values in Room 5, Kettering Hospital



The radon daily variation for eight weekdays, two Saturdays and two Sundays in room 6 of the Kettering hospital shows some differences for radon levels on Saturdays, with maximum values at 8 a.m. and 11 a.m. (Figure 6.9.18.)

Figure 6.9.18. Average Radon Daily Values in Room 6, Kettering Hospital

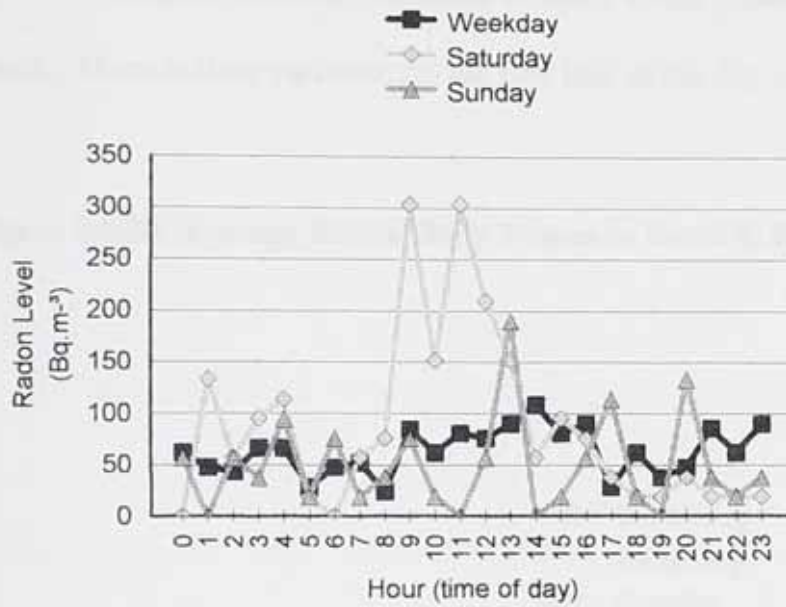

The average radon daily variations for nine weekdays, two Saturdays and two Sundays, do not show significant differences (Figure 6.9.19.).

Figure 6.9.19. Average Radon Daily Values in Room 7, Kettering Hospital

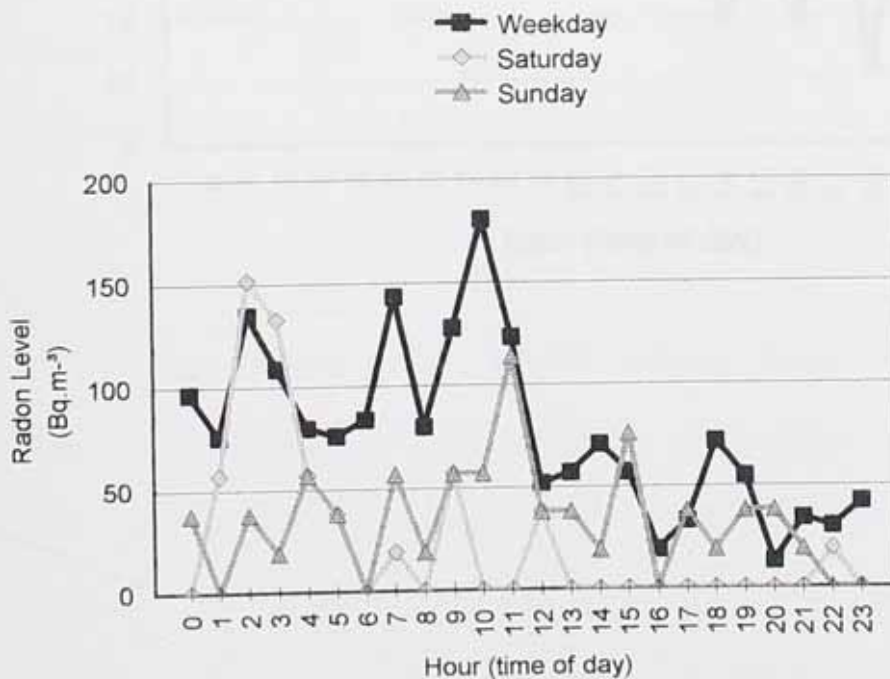

Average radon daily variation in room 8 was measured with not very conclusive results. There is little variation for the first half of the day, until 10 a.m. (Figure 6.9.20.).

Figure 6.9.20. Average Radon Daily Values in Room 8, Kettering Hospital

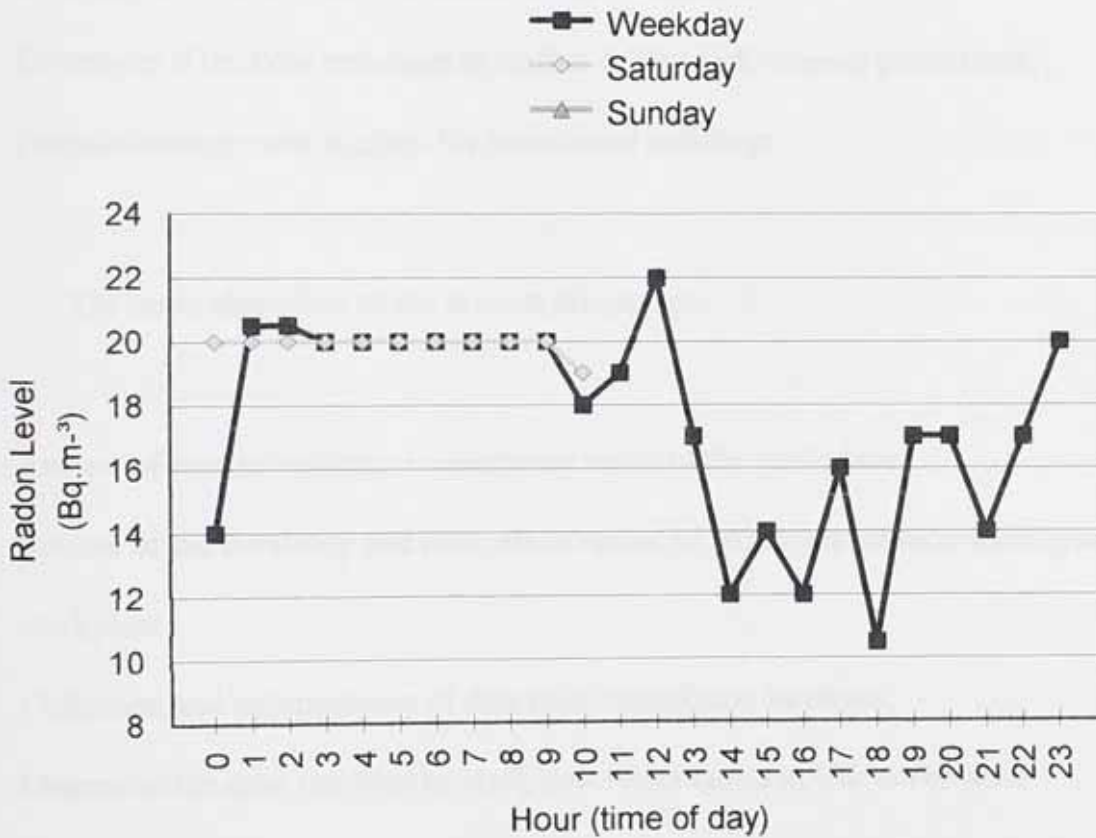

7. DISCUSSIONS AND CONCLUSIONS

The main aims of the thesis are:

- Participate in significant remediation projects in UK institutions;
- Evaluate the results of remediations in the workplace;
- Determine if the dose reduction to staff is in line with original predictions;
- Propose management regimes for remediated buildings.

The main objectives of the present project are:

- Review of current regulation concerning radon in the workplace;
- Review of the durability and cost-effectiveness of radon remediation techniques in the workplace;
- Collection and interpretation of data from remediated locations;
- Determine the dose received by staff, post remediation in UK workplaces.

The present project includes remediation case studies from NHS clinics and hospitals and continues the work started by the Medical Physics Department in Northampton General Hospital (Denman, 1994, Parkinson, 1994, Denman and Parkinson, 1996, Denman *et al.*, 1997, Denman and Phillips, 1998c, Barker, 1998).

The present work is the most extensive post-remediation radon research project carried out to date in Northamptonshire's workplaces and includes five clinics and one hospital. Data collection started in October 1997 and concluded in Spring 2001, including more than 18 months of continuous measurement in Northamptonshire's NHS remediated properties. The project, completed with a study in a North Wales' unremediated hospital and a case study in Derbyshire, deals with remediation issues in the workplace. This project extends with previous workplace studies in Northamptonshire (Denman *et al.*, 1999b, Denman *et al.*, 2000 a, Phillips *et al.*, 2000).

The results from post-remediation studies were evaluated for all the NHS and related properties. Post remedial data from six clinics and one hospital, suggested that remediation had been effective in the majority of situations, with radon reduction factors within a range 1.4-98.5 (Figures 6.3.7., 6.4.7., 6.5.6., 6.6.6., 6.7.4., 6.8.6.). The highest reduction factor was in clinics D (almost 100), A2 (20) and B (17) (Figures 6.7.4., 6.4.7. and 6.5.6.); pre-remedial radon levels were markedly reduced, fulfilling UK legislation.

The dose reduction to staff is around 15% and is in line with previous findings that suggested a reduction of some 14% of the total dose (Barker, 1998). To calculate dose from radon, 46 members of NHS staff participated in the present survey. The collective dose saving for these members of staff is almost 81 mSv per year. This represents an average reduction of 1.75 mSv per year for part-time staff. The dose reduction is similar for full time staff.

Management regimes for remediated buildings were designed, based on Department Of Environment (DOE, 1995, 1996a, 1996b, 1996c) and NRPB (NRPB

1996b, 1996c) literature. An original Decision Support System for management of radon in the workplace and in domestic buildings has been designed (Figures 4.3.1. and 4.3.2.). It aims to give clear directions about dealing with the radon problem, from the initial stages until post-remediation. The three main projects of the present thesis deal with different stages in the DSS. The North Wales study is an example of pre-remedial stage. The clinics and hospital in Northampton are at post-remedial stage, with ongoing monitoring and change of use of buildings (Denman *et al.*, 2000a).

The current legislation regarding radon in the workplace is reviewed, starting with the initial introduction of statutory control in workplaces (Health and Safety Executive, 1985), to include Ionising Radiation Regulations 1999 (IRR, 1999).

Different remediation techniques used are described as is a case study in Derbyshire that used combined remediation techniques and that indicates that remediation can operate for up to at least 10 years. Using techniques of risk assessment by selecting the appropriate method of remediation, practical and effective solutions to remediation can be usually found for any type of building. Review of radon levels and room use post-remediation is vital, as a change of use in the remediated rooms could reduce its overall effectiveness.

The review of the durability and cost-effectiveness of radon remediation techniques in the workplace includes Northamptonshire studies (Denman and Phillips, 1998a, 1998b, Denman *et al.*, 1999a, 1999b, 2000a, 2000b). It is found that the National Radiological Protection Board remediation programme is justified when compared to

other NHS programmes, as the one to reduce X-rays dose to dental patients (Denman *et al.*, 1997).

One of the main issues in post-remediated studies the location of any new, post-remediation, radon source in the built environment. A technique to identify new radon sources is given by the variation of the night-time to daytime radon levels' ratio pre and post remediation (Figures 6.3.8., 6.5.7. and 6.6.7.). This can be supported by using the average daily radon values in each room of different clinics (Figures 6.3.9.-6.3.13., 6.4.8.-6.4.12., 6.5.8.-6.5.11., 6.6.8.-6.6.11., 6.7.5., 6.8.7.-6.8.10. and 6.9.13.-6.9.20.). Sometimes, a secondary new source of radon became evident. Table 7.1. contains information on the possible change of radon source in all the post-remediated sites.

Table 7.1. Change of Radon Source Post-Remediation

Site	Radon Source	
	Before Remediation	After Remediation
Clinic A1	room 2	room 5, SE corner, reduced
Clinic A2	rooms 1, 4	room 1, reduced
Clinic B	corridor near room 1	room 2, higher
Clinic C	room 1	room 1, high but under WAL
Clinic D	room 3, 10	no source
Clinic E	room 1, 4	room 1, 4, reduced
Kettering Hospital	room 1, 4	room 1, 5

In one case studied, limited change in use of a remediated building where radon levels were already low, did not influence greatly the radon levels post remediation (clinic D). The issue is complicated by repeated small building alterations carried out in a remediated building, as in the case of the Kettering hospital. The recommendations from

the present study are, that is vital to monitor radon levels post remediation after each building alteration and any substantial change of use of the building.

The present study goes some way to confirming the 'Dose Reduction Hypothesis' of Denman *et al.* (1997). The first part of the hypothesis states:

The reduction in dose is half of the reduction in radon level in the most occupied room.

The second half of the hypothesis states:

The reduction in daytime levels is lower than the reduction in night-time levels, when the building is unoccupied by staff (Denman *et al.*, 1999).

In the present study, for 23 members of staff (50%), out of 46 staff representatives, working part-time, the reduction in dose is lower than the reduction in average radon. For 14 (30.4%) members of part-time staff, the reduction in dose is equal to the reduction in radon, and for 9 (19.6%), the reduction in dose is higher than that in average levels (Figures 6.3.7., 6.4.7., 6.5.6., 6.6.6., 6.7.4. and 6.8.6.).

The reduction in dose differs from the reduction in radon level in the studied properties. Sometimes, the reduction factor in dose is higher, other times equal or lower than the reduction factor in average radon level, depending of the occupancy pattern of the worker. A scatter graph of the reduction in dose function of the reduction in radon level in the room where the individual spent the most time in, is given in Figure 7.1. This graph corresponds well to the situation recorded by Denman *et al.* (1999) in 5 NHS remediated clinics in Northamptonshire in a pilot study that prompted the present extensive work (Figure 7.2.).

Figure 7.1. Reduction in Dose Compared to Reduction in Radon Level for 46 Members of Staff working Part-time Hours

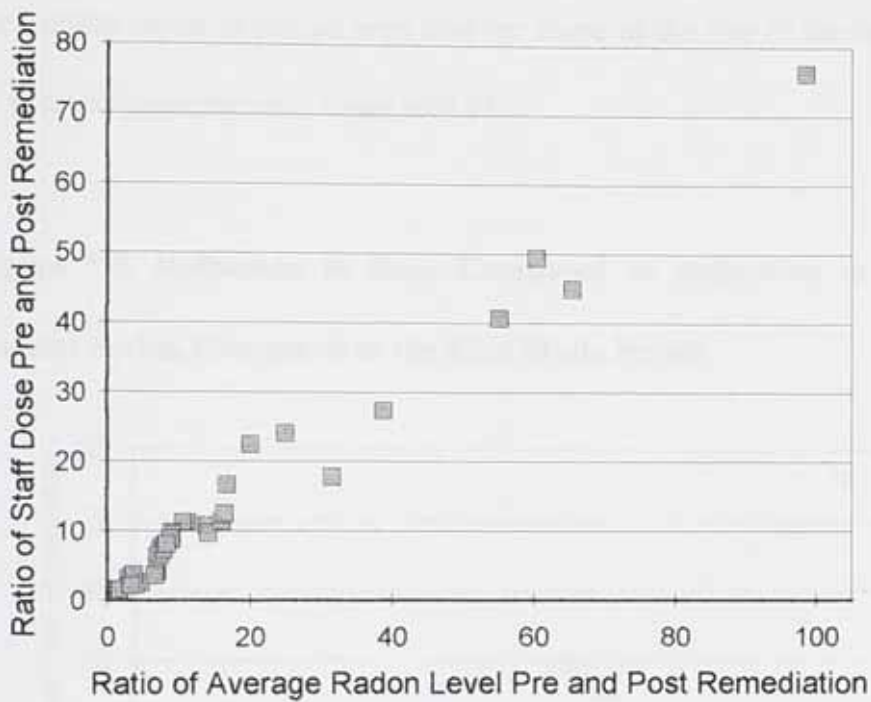
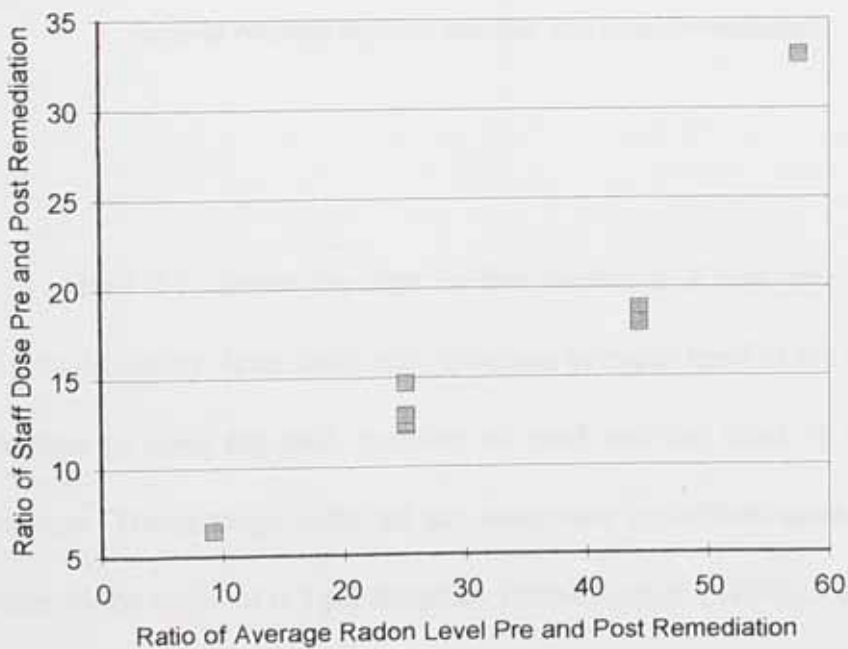

Figure 7.2. Reduction in Dose Compared to Reduction in Radon Level for 12 Members of Staff from 5 NHS Clinics Working 37 Hours a Week (Denman *et al.*, 1999)



A direct comparison of the pilot study data and the present data is given in Figure 7.3. The line of equality is traced on the same graph, as well as the line of the best fit for the current series. it can be seen that the slope of the line of the best fit is under the value of 1, more precisely, it is equal to 0.85.

Figure 7.3. Reduction in Dose Compared to Reduction in Radon Level for the Present Series, Compared to the Pilot Study Series

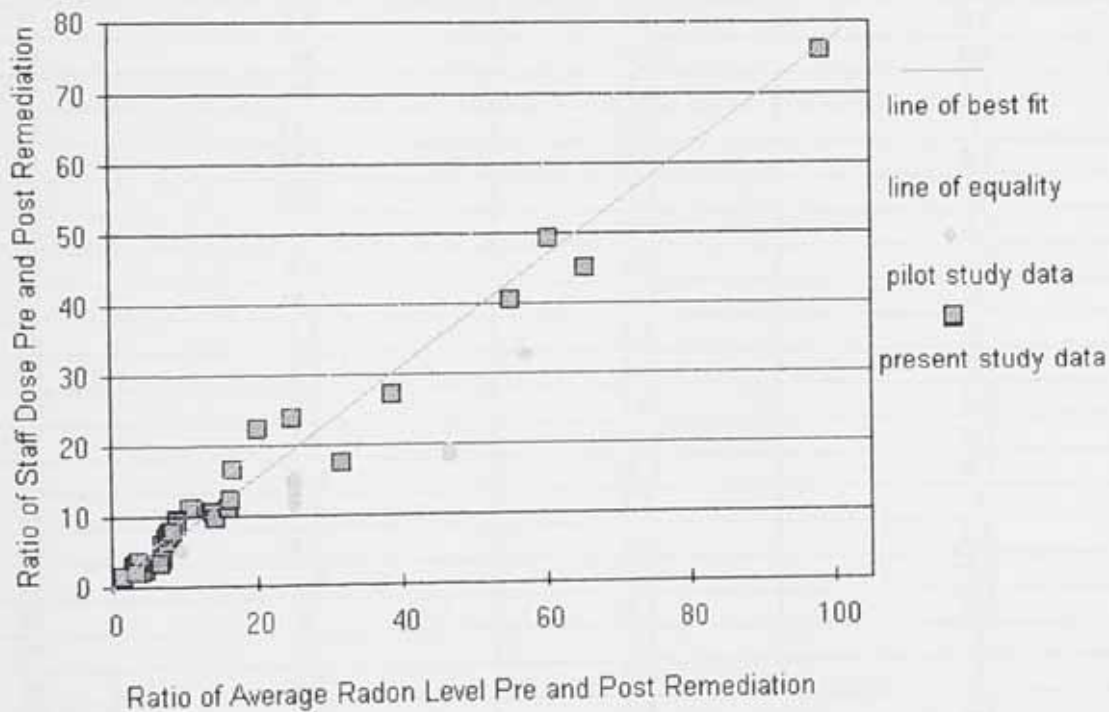

Table 7.2. shows the data for the members of part-time staff that participated in the present survey. It includes the reduction in radon level in the most occupied room, the reduction in dose for each member of staff and the ratio of dose reduction to radon reduction. The average value of the ratio dose reduction/radon reduction is 0.85, quite similar to the value of 0.5 predicted by Denman *et al.* (1999) in the pilot study. The range of the ratio is 0.5-1.2 and the standard deviation of the series 0.18.

Table 7.2. Reduction in Doses compared to Reduction in Radon Levels for 46 Members of Staff

Member of Staff	Reduction in Radon Level	Reduction in Dose	Ratio Dose Reduction/Radon Reduction
1	7.7	7.7	1
2	7	4.4	0.6
3	3	3.1	1
4	7.4	6.9	0.9
5	7	6.3	0.9
6	7	4.1	0.6
7	7	4.5	0.6
8	7.4	7.2	1
9	7.4	6.6	0.9
10	14	10.8	0.8
11	20	22.5	1.1
12	11.3	11.2	1
13	14.2	9.7	0.7
14	10.6	11.3	1
15	16	11.4	0.7
16	1.3	1.6	1.2
17	16.7	16.7	1
18	3.5	3.5	1
19	1.7	1.6	0.9
20	1.7	1.6	0.9
21	16	11.4	0.7
22	16.4	12.5	0.7
23	3.5	3.5	1
24	4.3	2.6	0.6
25	4.7	2.6	0.5
26	4	2.3	0.5
27	3.7	3.7	1
28	3.7	3.7	1
29	3.3	2.2	0.7
30	6.7	3.6	0.5
31	9	9.8	1.1
32	9	9	1
33	9	8.9	1
34	65.4	45	0.7
35	60.3	49.5	0.8
36	55.1	40.7	0.7
37	98.5	76.3	0.8
38	38.7	27.4	0.7
39	24.9	24.1	1
40	31.5	17.8	0.6
41	9	8.8	1
42	9	9.5	1
43	8.9	8.9	1
44	7.9	7.3	0.9
45	8.2	8.1	1
46	8.4	8.1	0.9
dose reduction hypothesis average		0.5	calculated average 0.85

Dose to staff in the clinics studied post remediation were in the range 0.01-1.78 mSv for part-time working hours and in the range 0.11-2.7 mSv for full time working hours. The average radon levels post-remediation were in the range 5-324 Bq.m⁻³.

Table 7.3. contains information on the members of staff which had a higher reduction in dose than the reduction in radon level.

Table 7.3. Data to Test ‘Dose Reduction Hypothesis’

Clinic	Member of Staff	Reduction Factor in Dose/ Reduction Factor in Radon Level
A1	2, 6, 7	< 1
	4, 5, 8, 9	> 1
	1, 3	= 1
A2	1, 4	< 1
	2	> 1
	3, 5	= 1
B	1, 7, 8	< 1
	2	> 1
	3, 4, 5, 6, 9	= 1
C	1, 2, 3, 6, 7	< 1
	4, 5	= 1
D	4, 5, 6, 7, 8, 9, 10	< 1
	1, 2, 3	= 1
E	1, 4, 6	< 1
	2	> 1
	3, 5	= 1

In clinics C and D, more members of staff experienced a lower reduction in dose than the reduction in radon level. All these members of staff have in common the fact that their occupancy meant that they were spending little time inside the clinics.

The dose reduction for the members of staff that were monitored both pre and post remediation, is not always in accordance with the predicted dose reduction. The predicted dose reductions for members of staff in clinics A1, C and D approximates well

the dose reductions (Table 6.3.13., 6.6.12. and 6.7.12.), even though the reduction factors differ in clinic B (Table 6.5.12.).

The slight differences in reduction in dose in clinics A1, C and D, are due to different occupancy patterns of rooms pre and post remediation. The situation in clinic B can be explained by a new radon source post-remediation in room 2, causing an increased radon level in this room. Alterations to building probably caused more radon to ingress through previously insignificant access points.

The second part of the 'Dose Reduction Hypothesis' stipulates that the achieved dose reduction is around half of the reduction in average radon level due to a preferential reduction in the night-time high radon levels, when staff are absent (Denman *et al.*, 1999). A graph of the ratio night time/daytime radon level pre and post remediation, shows that the situation before remediation was that in 2 out of 12 locations, the night time radon level was lower than the daytime radon level, in 3 locations it was the same and in 7 locations the daytime level was higher than the night time radon level before remediation.

The situation changed post-remediation, with a clear shift to a lower night time radon level; in 6 out of 12 locations, the night time radon level was lower than the daytime radon level, in 1 location the night time and daytime radon level after remediation was the same and in 5 locations the daytime level was higher post-remediation than the night time level. A comparison of the two sets of data shows that in 75% of the rooms the reduction in night time radon levels was higher post remediation (Table 7.4.).

Figure 7.4. Ratio Night time/Daytime Radon Level Pre and Post Remediation

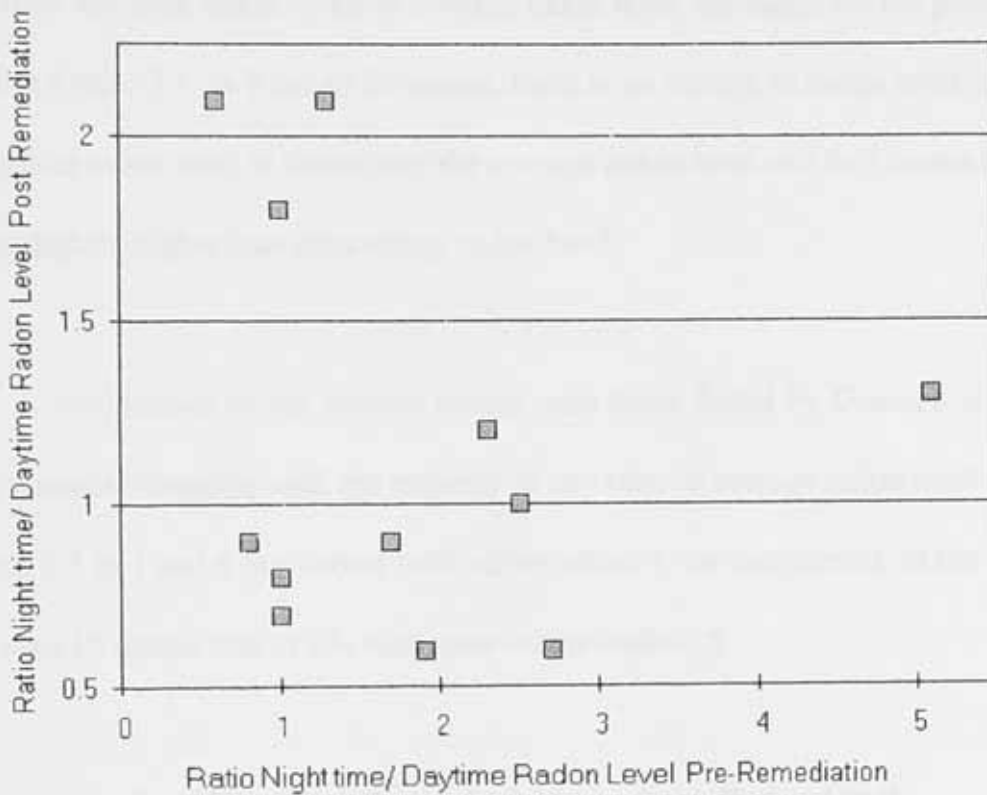

Table 7.4. Ratio Night Time per Daytime Radon Level Pre and Post Remediation and Change in Ratio

Ratio Night time/Daytime Radon Level Before Remediation	Ratio Night time/Daytime Radon Level After Remediation	Change in Ratio Before Compared to After Remediation
1.9	0.6	3.17
2.7	0.6	4.5
1.3	2.1	0.6
1	0.7	1.43
0.6	2.1	0.29
1.7	0.9	1.9
1	1.8	0.55
1	0.8	1.25
2.5	1	2.5
5.1	1.3	3.9
2.3	1.2	1.9
0.8	0.9	0.9

Most dose received by staff are below the dose predicted using the Working Action Level. This fact could be related to the part-time nature of work for NHS staff or to the ratio day time radon levels to average radon level, the range for the present study is shown in Figure 7.5. In 8 out of 24 rooms, there is no change in radon level, in 13 rooms the daytime radon level is lower than the average radon level and in 3 rooms the daytime level is slightly higher than the average radon level.

A comparison of the present results with those found by Denman *et al.* (1999), shows a similar situation with the majority of day time to average radon level ratio values between 0.5 to 1 and a few rooms with values above 1. In comparison, in the 1999 study, there were 15 rooms (out of 73) with ratio values under 0.5.

Figure 7.5. Ratio of Day Time Radon Level to Average Radon Level

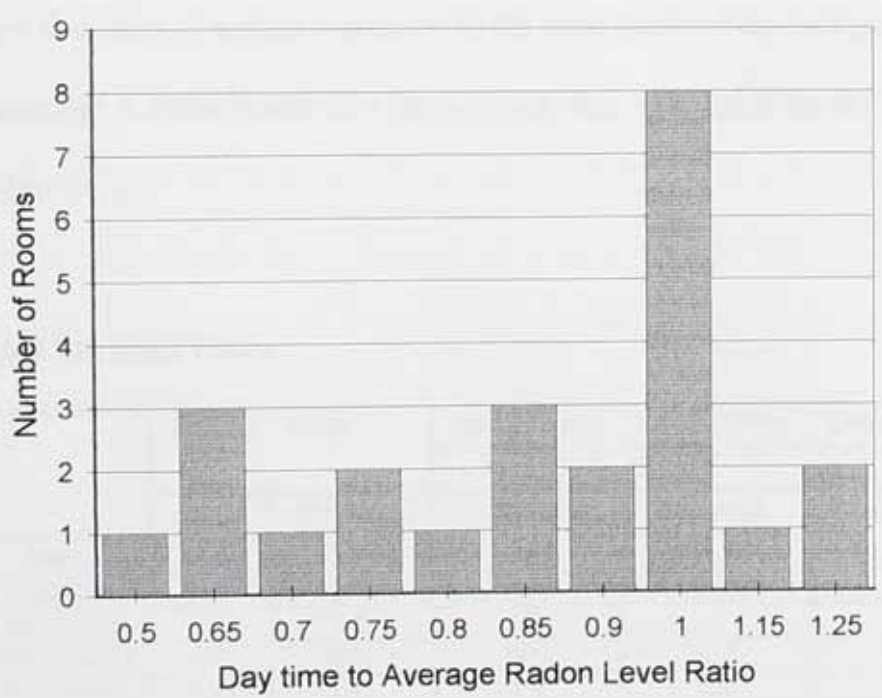

The ratio between the estimated dose and the average seasonally corrected radon level in the room in which each member of staff spends the most time is calculated for the present study for part-time and full time hours and compared to the results in the 1999 study. (Table 7.5.)

Table 7.5. Ratio Dose/Average Corrected Radon Level

	Ratio dose/average radon level ($\times 10^{-3}$)			
	Present Study		Denman <i>et al.</i> Study (1999)	
	Actual	37 h week	Actual	37 h week
Mean	6	15	5	11
Minimum	0.1	1	0.2	1
Maximum	16	34	24	51
50% quantile	4	14	4	8
75% quantile	9	18	7	13

The dose received by staff in the present study are calculated for part time and for a full time week and compared to the values given by Denman *et al.* (1999). The figures show that there is a clear reduction in the dose received by staff post remediation, that is, in average, 6 times lower than the average dose calculated for the Working Action Level (Table 7.6).

Table 7.6. Staff Doses

	Present Study		Denman <i>et al.</i> Study (1999)		Denman <i>et al.</i> Study (1999)	
			Under 400 Bq.m ³		400 Bq.m ³	
	Actual	37h week	Actual	37h week	Actual	37h week
Mean	0.32	0.79	0.9	1.8	2	4.4
Minimum	0.01	0.11	0.08	0.45	0.1	0.5
Maximum	1.78	2.7	5	5	9.6	20.4
50% quantile	0.17	0.63	0.5	1.7	1.6	3.2
75% quantile	0.45	1.11	1.4	2.2	2.8	5.2

The present data support the 'Dose Reduction Hypothesis' (Denman *et al.*, 1997) showing that the reduction in dose is lower than the reduction in radon level for 2.6 more

members of staff than members of staff with higher reduction in dose than in radon level. The ratio dose reduction/radon reduction is 0.85, quite similar to 0.5, as predicted by Denman *et al.* (1999).

The second part of the Denman hypothesis is also investigated, the present data showing greater reduction in the night time levels than daytime levels (75% of rooms).

The implications of the present research project impact on the management of post-remediated workplaces. Any change in the use of a building, or any extra building work post-remediation, needs to be carefully considered and radon levels must be re-measured once the alteration has happened. The present work demonstrates that sumps with pumps are effective and they should be used in all the workplaces with radon levels above the WAL.

The numbers of lung cancers that would be avoided due to the present remediation programme, can be calculated using the NRPB estimate that 3.5×10^{-4} lung cancers are induced per Working Level Month (NRPB, 1993) and the fact that 1 mSv is received from 13.6 Working Level Hour (Nazaroff and Nero, 1988). For the total NHS workforce of 11,000 in Northamptonshire, a saving of 1.75 mSv per person would mean some 0.54 lung cancers avoided by the remediation work undertaken. The NHS remediation programme is effective, but a regular monitoring of radon levels in remediated buildings is required. This should be done at least once every five years when no change has appeared in the structure of the building and always after an alteration.

The present study is part of an ongoing project started in Northamptonshire in 1992 (Denman, 1994) and has answered suggestions for further work posed by previous researchers (Parkinson, 1994), (Barker, 1998). There are some suggestions for further research work.

Proposals for further research work are:

- continuation of present research into other post remediation sites, to include specific remediation methods and relate the type of remediation and exact costs to the dose saving;
- a comparative study of the different remediation methods and their durability;
- research into remediation projects, more than 10 years after completion of project to check if remediation continues after longer periods of time;
- further investigation into new radon sources and ingress after remediation to determine influence of remediation on radon distribution;
- a post-remedial study in domestic properties, to lead to a cost effectiveness study in homes.
- research into the management protocols in NHS properties; do they adopt a post-remediation management system?

8. REFERENCES

- Alsop S. and Watts M. (1997) Sources from a Somerset village: A model for informal learning about radiation and radioactivity, *Science Education*, 81, 6, 633-650.
- Appleton J.D. and Ball T.K. (1995) Radon and background radioactivity from natural sources; Characteristics, extent and relevance to planning and development in Great Britain. British Geological Survey Technical Report WP/95/2.
- Atman C.J., Bostrom A., Fischhoff B. and Morgan M.G. (1994) Designing risk communications - completing and correcting mental models of hazardous processes, *Risk Analysis*, 14, 5, 779-788.
- Baldwin G., Frank E. and Fielding B. (1998) US women physicians' residential radon testing practices, *American Journal of Preventive Medicine*, 15,1,49-53.
- Bale W.F. (1980) Hazard associated with radon and thoron. Memo to the file, Division of Biology and medicine, USAEC, Washington, DC, March 1951, *Health Physics*, 38, 1061-1066.
- Ball T.K., Cameron D.G., Coleman T.B. & Roberts P.D. (1991) Behaviour of radon in the geological environment- a review, *Quarterly Journal of Engineering Geology*, 24, 169-182.

Barker, S. P. (1998) The health implications of radon in the NHS workplace, in Northamptonshire, Mphil Thesis, University of Leicester.

Batkin I., delRe R.B., Boutin J.G. and Armitage J. (1998) Gamma spectroscopy investigation of radon daughter deposition on electrostatically charged surfaces, *Physics in Medicine and Biology*, 43, 3, 487-499.

Blythe A. (1996) House fitness standard - unfit without radon!, *Environmental Radon Newsletter*, 8, 3.

Bradley, E.J. (1996) Responses to Radon Remediation Advice. Proceedings of the Ninth International Congress of the International Radiation Protection Association, 4/798 - 4/800.

Bradley, E.J., Lomas, P.R., Green, B.M.R., Smithard, J. (1997) Radon in Dwellings in England:1997 Review. NRPB Report, R293.

Bradley E.J. and Thomas J.M. (1997) An analysis of responses to radon remediation advice, NRPB-M707.

Brannigan E. (1999) Radon remediation in Northern Ireland, National Radiological Protection Board, *Environmental Radon Newsletter*, No. 21.

Brookins D.G. (1990) The indoor radon problem, Columbia University Press, New York.

Building Research Establishment (1992), Radon sumps: a BRE guide to radon remedial measures in existing dwellings. Garston, BRE Bookshop, BR227.

Building Research Establishment (1992), Radon: Guidance on protective measures for new dwellings. Garston, BRE Bookshop, BR2111.

Building Research Establishment (1999), Radon: Guidance on Protective Measures for New Dwellings. Garston, BRE Bookshop.

Cliff K.D. (1978) Assessment of airborne radon daughter concentrations in dwellings in Great Britain, *Phys. Med. Biol.* 23, 696-711.

Cliff K.D., Wrixon A.D., Green B.M.R and Miles J.C.H. (1983) Radon daughter exposure in the UK, *Health Physics*, 45, 2, 323-330.

Cliff K.D., Miles J.C.H. and O'Riordan M.C. (1991) Validation Scheme for Laboratories Making Measurements of Radon in Dwellings - Memorandum NRPB - M276, NRPB, Chilton.

Cohen B.L. (1997) Problems in the radon vs lung cancer test of the linear no-threshold theory and a procedure for resolving them, *Health Physics*, 72, 623-628.

Colgan, P.A., Gutiérrez, J. (1995) Justification and Optimisation in the Choice of Reference Levels for Radon in Existing Spanish Dwellings, *Journal of Radiological Protection*, 15, 289-301.

Colgan, P.A., Gutiérrez, J. (1996) Cost Effectiveness of Reducing Radon Exposure in Spanish Dwellings, *Journal of Radiological Protection*, 16, 181-190.

Cross F.T., Harley N.H. and Hofmann W., (1985) Health effects and risks from ^{222}Rn in drinking water, *Health Physics*, 48, 5, 649-670.

Daily Mail, 19 May 1998, p.4.

Darby S., Whitley E., Silcocks T., Thakrara B., Green B.M.R., Lomas P.R., Miles J.C.H., Reeves G., Searn T. and Doll R., (1998) Risk of lung cancer associated with residential radon exposure in South - West England: A case-controlled study. *British Journal of Cancer*, 78, 3.

De la Bruheze A. (1992) Radiological weapons and radioactive waste in the United States: insiders and outsiders views, 1941-55, *British Journal for the History of Science*, 25 (2), 85, 207-227.

Denman A.R. (1994) The significance of raised radon levels in NHS properties in Northamptonshire, *Radiation Protection Dosimetry*, 54, 1, 65-68

Denman A.R. and Parkinson S. (1996) Estimates of radiation dose to NHS workers in Northamptonshire from raised radon levels. *The British Journal of Radiology*, 69, 1, 72-75.

Denman A.R., Barker S.P., Parkinson S. and Phillips P.S. (1997) The health benefits and cost effectiveness of the radon mitigation programme in NHS properties in Northamptonshire, *Journal of Radiological Protection*, 17, 4, 253-259.

Denman A.R. and Phillips P.S. (1998a) A review of the cost effectiveness of radon mitigation in domestic properties in Northamptonshire, *Journal of Radiological Protection*, 18, 5, 119-124.

Denman, A.R. and Phillips, P.S. (1998b) The Cost Effectiveness of Radon Mitigation in Schools in Northamptonshire, *Journal of Radiological Protection*, 18, 203-208.

Denman, A.R. and Phillips, P.S. (1998c) Workplace radon in Northamptonshire, *Environmental Management and Health*, 9, 5, 194-199.

Denman, A.R., Harris, E.P., Hermann, M.R., Phillips, P.S. (1999a) Auditing the cost-effectiveness of radon mitigation in the workplace, *Managerial Auditing Journal*, 14, 9, 461-467.

Denman, A.R., Phillips, P.S. and Tornberg, R. (1999b) The cost effectiveness of radon remediation programmes in hospitals, schools and homes in radon Affected Areas in the UK, *Book of Abstracts, EC Radon in the Living Environment International Workshop*, Athens, Greece, April 1999, 22-23.

Denman, A.R., Phillips, P.S. and Tornberg, R. (2000a) A comparative review of the effectiveness of radon remediation programmes in hospitals, schools and homes in Northamptonshire, UK, *International Radiation Protection Association (IRPA), 10-th International Congress*, Hiroshima, May 2000.

Denman, A.R., Phillips, P.S. and Tornberg R. (2000b) Comparing the value of remediation programmes in radon affected areas: a case study in hospitals, schools and homes in Northamptonshire, UK, *Fresenius Environmental Bulletin*, 9, 435-442.

DETR (1999) *Radon: guidance on protective measures for new dwellings*, BRE, 1-37.

DETR (2000a) The Environment in Your Pocket 2000, DETR, 2000.

DETR (2000b) Radon. Don't live with the risk. A householder's guide, DETR, 2000.

Dixon D.W., O'Riordan M.C. and Burnett R.L. (1988) Monitoring exposure to radon daughters in places of work, *Radiation Protection Dosimetry*, 24, 467-470.

Dixon D.W., Gooding T.D. and McCready-Shea S. (1996) Evaluation and significance of radon exposure in British workplace buildings, *Environment International*, 22, 1, S1079-S1082.

Dixon D.W. (2000) Assessing workplace risks, *Environmental Radon Newsletter*, 25, 3.

Doll R. (1995) Hazards of ionising radiation - 100 years of observation on man, *British Journal of Cancer*, 72, 6, 1339-1349.

Donohoe K. and Royal H. (1996) Importance of radon as a threat to public health, *Otolaryngology - Head and Neck Surgery*, 114, 2, 271-276.

Duggan M.J. and Bradford G.F. (1974) The exposure of the general population to airborne radon and its daughters. Presented at the International Symposium on Radiation Protection - Philosophy and Implementation, Society for Radiological Protection, Aviemore, Scotland, June 1974.

Durrani S.A. (1993) Radon as a health hazard at home: what are the facts?, Nuclear Tracks and Radiation Measurements, 22 (1-4), 303-317.

Eatough J.P. and Henshaw D.L. (1992) Radon and thoron associated dose to the basal layer of the skin, Physical Medical Biology, 37, 955-967.

Eatough J.P. and Henshaw D.L. (1995) The theoretical risk of non-melanoma skin cancer from environmental radon exposure, Journal of radiological Protection, 15, 1, 45-51.

Ennemoser O., Ambach W., Auer T., Brunner P., Schneider P., Oberaigner W., Purtscheller F. and Stingel V. (1994) High indoor radon concentrations in an alpine region of Western Tyrol, Health Physics, 67, 2, 151-154.

Environmental Law Institute (May 1992) Preliminary Research Report, Radon and Real Estate: A Survey of Selected State Laws, Proposed Laws and Litigation.

Evans, R.G. (1995) Manufacturing Consensus, Marketing Truth: Guidelines for Economic Evaluation, Ann Intern Med., 123, 59-60.

The Express on Sunday, 5 October 1997, p.59.

Field R.W., Fisher E.L., Valentine R.L. and Kross B.C. (1995) Radium-bearing pipe scale deposits- implications for national waterborne radon sampling methods, *American Journal of Public Health*, 85, 4, 567-570.

Frey G., Hopke P.K. and Stunkel J.J. (1991) Ecologic bias revisited, a rejoinder to Cohen's response to 'Residential ^{222}Rn exposure and lung cancer: testing the linear no-threshold theory with ecologic data', *Health Physics*, 75, 1, 31-33.

Gabriel S. (1997) Retrospective radon exposure assessment: development of alpha track techniques and field applications, PhD Thesis, University College Dublin, 48-3502.

Garavaglia M, Braitenberg C, Zadro M, Quattrocchi F (1999) Radon measurements in soil and water in the seismic Friuli area, *Nuovo Cimento Della Societa Italiana Di Fisica C- Geophysics and Space Physics*, 22, 3-4, 415-422.

Gardner A.F., Gillett R.S. and Phillips P.S. (1992) The menace under the floorboards, *Chemistry in Britain*, 24, 4, 344-348.

Gillmore G.K., Sperrin M., Phillips P.S. and Denman A.R. (2000) Radon-Prone Geological Formations and Implications for Cave Users, *Technology*, 7, 645-655.

Gold, M.R., Siegel, J.E., Russell, L.B, Weinstein, M.C., eds. (1996) *Cost-Effectiveness in Health and Medicine*, New York, NY: Oxford University Press.

Green B.M.R., Lomas P.R. and O'Riordan M.C. (1992) Radon in dwellings in England. NRPB-R254.

The Guardian, 19 May 1998, p.7.

Hamilton E. (1997) Too much of a bad thing, Chemistry in Britain, 33,4, 49.

Harley N.H. (1984) Radon and lung cancer in mines and homes, New England Journal of Medicine, 310, 23, 1525-1527.

Health and Safety Executive (1985) The Ionising Radiations Regulations (1985) SI 1333, HMSO, London.

Health and Safety Executive (1992) The management of health and safety at work regulations (1992) SI 2051, HMSO, London.

Henshaw D.L., Eatough J.P. and Richardson R.B. (1990) Radon exposure as a causative factor in induction of myeloid leukemia and other cancers, The Lancet, 335, 1008-1012.

Henshaw D.L., Perryman J., Keitch P.A., Allen J.E. and Camplin G.C. (1993) Radon in Domestic Water Supplies in the UK, Radiation Protection Dosimetry, 46, 4, 285-289.

Henshaw D.L., Ross A.N., Fewes A.P. and Preece A.W. (1996) Enhanced deposition of radon daughter nuclei in the vicinity of power frequency electromagnetic fields, *International Journal of Radiation Biology*, 69, 1, 25-38.

Hess C.T., Weiffenbach C.V. and Northon S.A. (1983) Environmental radon and cancer correlations in Maine, *Health Physics*, 45, 2, 339-348.

Hofmann W., Menache M.G., Crawford- Brown D.J, Caswell R.S. and Karam L.R. (2000) Modeling energy deposition and cellular radiation effects in human bronchial epithelium by radon progeny alpha particles, *Health Physics*, 78, 4, 377-393.

Hoover H.L. and Hoover L.H. (1950) *Agricola, De Re Metallica*, Dover Publications, New York.

Huber J., Ennemoser O. and Schneider P. (2001) Quality control of mitigation methods for unusually high indoor radon concentrations, *Health Physics*, 81, 2, 156-161.

Hughes J.S. and O'Riordan M.C. (1993) *Radiation exposure of the UK population- 1993 review*, NRPB, Chilton.

ICRP (1991) *Annals of the ICRP. Publication 60, 1990 Recommendations of the ICRP*, Pergamon, Oxford.

ICRP (1993) *Annals of the ICRP. Publication 65, Protection against Radon - 222 at Home and at work*, Pergamon, Oxford.

ICRP (1994) Annals of the ICRP. Publication 66, Human respiratory tract model for radiological protection, Pergamon, Oxford.

The Ionising Radiations Regulations (1985) SI 1985, No. 1333, London HMSO.

The Ionising Radiations Regulations (1999) The Stationery Office Limited, Statutory Instrument 1999 No. 3232, ISBN 0 11 085614 7.

Jones M. (1994) Solving the radon problem in the UK-the role of Environmental Health Officers, *Radiation Protection Dosimetry*, 56, 4, 367-370.

Jones M. (1997) Department of Environment radon policy, *Environmental Radon Newsletter*, 10, 2.

Joyce C., Kenward M. and Pearce F. (1986) Perils in the all-American home, *New Scientist*, 110, 1511, 22-23.

Jukes G. (1996) Action needed to prevent deaths from radon, *Environmental Radon Newsletter*, 8, 2.

Kassirer, J.P., Angell, M. (1994) The Journal's Policy on Cost- Effectiveness Analyses, *N Engl J Med.*, 331, 669-670.

Kendall G.M. and Muirhead C.R. (1997) Radon-cancer link, *Chemistry in Britain*, 33,7, 21.

Kendall G.M. and Muirhead C.R. (1997) Five fallacies about radon, *Journal of Radiological Protection*, 17, 3, 195-196.

Kendall G.M. (2000) Doses from radon to organs other than lung, *Environmental Radon Newsletter*, 23, 4.

Krafthefer B. (1984) Measurements of radon decay products in residential environments, *Ashrae Journal - American Society of Heating, Refrigeration and Air-Conditioning Engineers*, 26, 5, 55.

Laugier A. (1996) The first century of radiation oncology in France, *Bulletin de la Academie Nationale de Medecine*, 180, 1, 143-160.

Law G.R., Kane E.V., Roman E., Smith A. and Cartwright R. (2000) Residential radon exposure and adult acute leukaemia [letter], *Lancet*. 355, 9218, 1888.

Lee T.R. and MacDonald S. (1994) Public responses to indoor pollution from radon, *Radiation Protection Dosimetry*, 56, 1-4, 331-337.

Lee M.E., Lichtenstein E., Andrews J.A., Glasgow R.E. and Hampson S.E. (1999) Radon smoking synergy: a population based behavioural risk reduction approach, *Preventive Medicine*, 29, 3, 222-227.

Lubin J.H. (1998) On the discrepancy between epidemiologic studies in individuals of lung cancer and residential radon and Cohen's ecologic regression, *Health Physics*, 75, 4-10.

Lubin J.H. and Boice J.D. Jr. (1997) Lung cancer risk from residential radon: meta-analysis of eight epidemiologic studies, *Journal of National Cancer Institute*, 89, 49-57.

Ludewig P. and Lorenser E. (1924) Untersuchungen der Grubenluft in den Schneeberger Gruben auf den Gehalt an Radiumemanation, *Z. f. Phys.*, 22, 178-185.

Lugg A. and Probert D. (1997) Indoor radon gas: a potential health hazard resulting from implementing energy-efficiency measures, *Applied Energy*, 56, 2, 193-196.

Marley F., Denman A.R. and Phillips P.S. (1998) Studies of radon and radon progeny in air conditioned rooms in hospitals, *Radiation Protection Dosimetry*, 76, 4, 273-276.

Marley F. (1999) Investigation of atmospheric, mechanical and other pressure effects influencing the levels of radon and radon progeny in buildings, *Health Physics*, 77, 5, 556-70.

Marley F., Denman A.R. and Phillips P.S. (2000) Examination of the influence of water-heated central heating systems on the levels of radon and radon progeny in the workplace, *Radiation Measurements*, 32, 15-25.

Miles J.C.H. and Algar R.A. (1988) Variations in radon-222 concentrations, *Journal of Radiological Protection*, 8, 2, 103-105.

Miles J.C.H., Green B.M.R. and Lomas P.R. (1992) Radon affected areas: Derbyshire, Northamptonshire and Somerset, *Doc. NRPB*, 4, 6.

Miles J. and Appleton D. (2000), Identifying high radon areas, *Environmental Radon Newsletter*, 23, 3.

Nazaroff W.W. and Nero A.V. (1988), *Radon and its decay products in indoor air*, John Wiley & Sons, New York.

Nero A.V. and Lowder W.M. (1983) Indoor radon, *Health Physics*, 45, 2, 273-275.

NRC (1991) Comparative dosimetry of radon in mines and homes, National Academy Press, Washington DC.

NRPB (1987) Exposure to radon daughters in dwellings. ASP10. HMSO, London.

NRPB (1990a) Board statement on radon in homes. Doc. NRPB, 1, 1.

NRPB (1990b) Statement on limitation of human exposure to radon in homes, Doc. NRPB, 1,1, 15-16.

NRPB (1990c) Radon affected areas: Cornwall and Devon, Doc. NRPB, 1, 4, 37-43.

NRPB (1990d) Human Exposure to Radon in Homes. Documents of the NRPB, 1, 1.

NRPB (1992) Radon Affected Areas: Derbyshire, Northamptonshire and Somerset. Doc. NRPB, 3, 4.

NRPB (1993) Estimates of Late Radiation Risks to the UK Population. Doc. NRPB, 4, 4.

NRPB (1994) Guidelines on radiology Standards for Primary Health Care. Doc. NRPB, 5, 3.

NRPB (1995) Radon in the workplace, NRPB.

NRPB (1996a) Radon Atlas of England, NRPB, ISBN 0 85951 400 5.

NRPB (1996b) Radon Affected Areas: England and Wales. Doc. NRPB, 7,2.

NRPB (1996c) Radon Questions and Answers, NRPB.

NRPB (1996d) Radon measurement and advisory services, NRPB.

NRPB (2000) Health risks from radon, NRPB, ISBN 0-85951-449-8.

Oge M. (1994) The US environmental agency's strategy to reduce risks of radon, *Radiation Protection Dosimetry*, 56, 4, 343-354.

O'Riordan T. (1986) The politics and economics of nuclear electricity, *Catalyst*, 5, 12, 41-53.

O'Riordan M. (1996) Riddle of radon, *Journal of Radiological Protection*, 16, 4, 269-273.

Parkinson, S. (1994) An estimation of the radon exposure to some NHS workers in Northamptonshire, MSc thesis for University College, London.

Patrick, D.L., Erickson, P. (1993) *Health Status and Health Policy: Allocating Resources to Health Care*, New York, NY: Oxford University Press.

Payne, T.H. (2000) Computer decision support systems, *Chest*, 118, 2, 47S-52S.

Pearce F. (1987) A deadly gas under the floorboards, *New Scientist*, 113, 1546, 33-35.

Pengji Z and Yunlong Z (1993) The effect of water used in toilets on indoor radon level, *Nuclear tracks and Radiation Measurement*, 22, 1-4, 509-510.

Phillips P.S. (ed) (1995) *The radon manual - 2nd edn.* The Radon Council Limited, Shepperton, Middlesex.

Phillips P.S. and Denman A.R. (1997) Radon: a human carcinogen, *Science Progress*, 80, 4, 317-336.

Phillips P.S., Denman A.R. and Barker S. (1997) Silent, but deadly, *Chemistry in Britain*, 33, 1, 35-38.

Phillips P.S., Denman A.R. and Bates M.P. (1999) The UK radon programme: a review of the response to the discovery of elevated levels in the built environment, *Environmental and Waste Management*, 2, 3, 167-183.

Phillips P.S., Denman A.R. and Gillmore G. (2000) Radon, Schools and health: implications for policy and practice of a comparative study of programmes in Poland and the UK, *Fresenius Environmental Bulletin*, 9, 711-718.

Pinel J., Fearn T., Darby S.C. and Miles J.C.H. (1995) Seasonal correction factors for indoor radon measurements in the U.K., *Radiation Protection Dosimetry*, 58, 2, 127-132.

Porstendörfer J. (1984) Behaviour of radon daughters products in indoor air, *Radiation Protection Dosimetry*, 7, 1-4, 107-113.

Rangarajan C., Subramanian S.K. and Eapen C.D. (1984) Results of the studies of monsoon circulation with radon as a tracer, *Pure and Applied Geophysics*, 122, 1, 124-132.

Russell, L.B., Gold, M.R., Siegel, J.E., Daniels, N., Weinstein, M.C. (1996) The Role of Cost-Effectiveness Analysis in Health and Medicine, *JAMA*, 276, 1172- 1177.

Scheberle D. (1994) Radon and asbestos - a study of agenda setting and casual stories, *Policy Studies Journal*, 22, 1, 74-86.

Scivyer C. and Woolliscroft M. (1998) Radon Remediation and Protective Measures in UK Buildings: the Work of the Building Research Establishment Ltd, *Radiation Protection Dosimetry*, 78, 1, 39-44.

Scivyer C. (2001) BRE's radon test house, *Environmental Radon Newsletter*, National Radiological Protection Board, 26, 4.

Scivyer C. and Noonan K. (2001) Long term reduction of very high radon levels, *Environmental Radon Newsletter*, National Radiological Protection Board, 26, 3.

Scott A.G. (1994) Radon sources, radon ingress and models, *Radiation Protection Dosimetry*, 56, 4, 145-149.

Siegel, J.E., Weinstein, M.C., Russell, L.B., Gold, M.R. (1996) Recommendations for Reporting Cost-Effectiveness Analyses, *JAMA*, 276, 1339- 1341.

Steinhausler F. (1994) A risk-based approach to health criteria for radon indoors-report on a WHO initiative, *Radiation Protection Dosimetry*, 56, 4, 355-358.

Streil T., Reichelt A. and Reineking A. (1999) The influence of the working conditions on the equilibrium factor F and the unattached fraction f_p , *Nuovo Cimento Della Societa Italiana Di Fisica C-Geophysics and Space Physics*, 22, 3-4, 551-556.

Sutherland D. and Sharman G. (1996) Radon- in Northamptonshire?, *Geology Today*, 3, 63-67.

Swedjemark G.A. (1996) Swedish radon programme, *Environmental Radon Newsletter*, 6, p.4.

Task Force on Principles for Economic Analysis of Health Care Technology (1995) *Economic Analysis of Health Care Technology: a Report on Principles*, *Ann Intern Med.*, 123, 61-70.

Temkin C.L. Rosen G., Zilboorg G. and Sigerest H.E. (1941) *Paracelsus, Four Treatises of Theophrastus von Hohenheim called Paracelsus*, The John Hopkins Press, Baltimore.

The Radon Council Limited (1995) *The radon manual*, Second Edition, ISBN 0951943111.

The Times, 19 May 1998, p.7.

Tokonami S. (2000) Experimental verification of the attachment theory of radon progeny onto ambient aerosols, *Health Physics*, 78, 1, 74-79.

Vargas A., Ortega X. and Porta M. (2000) Dose conversion factor for radon concentration in indoor environments using a new equation for the F-f(p) correlation, *Health Physics*, 78, 1, 80-85.

- Wang Y., Ju C., Stark A.D. and Teresi N. (2000) Radon awareness, testing and remediation survey among New York state residents, *Health Physics*, 78, 6, 641-647.
- Warlick S.R. (1996) Military use of nasopharyngeal irradiation with radium during World War 2, *Otolaryngology-Head and Neck Surgery*, 115, 5, 391-394.
- Weinstein, M.C., Siegel, J.E., Gold, M.R., Kamlet, M.S., Russell, L.B. (1996) Recommendations of The Panel on Cost-Effectiveness in Health and Medicine, *JAMA*, 276, 1253-1258.
- Welsh I. (1993) The NIMBY syndrome: its significance in the history of the nuclear debate in Britain, *British Journal for the History of Science*, 26 (1), 88, 15-32.
- WHO (1983) Environmental Health Criteria 25: Selected Radionuclides, World Health Organisation, Geneva.
- WHO (1988) International Agency for Research on Cancer Monographs on the Evaluation of Carcinogenic Risks to Humans, 43, World Health Organisation, Lyon.
- Woolliscroft M. (1992) The Principles of Radon Remediation and Protection in UK Dwellings, *Radiation Protection Dosimetry*, 42, 3, 211-216.

Wrixon A.D., Green B.M.R., Lomas P.R., Miles J.C.H., Cliff K.D., Francis E.A., Driscoll C.M.H., James A.C. and O'Riordan M.C. (1988) Natural radiation exposure in UK dwellings, NRPB-R190, HMSO, London

Yu K.N., Chan T.F. and Young E.C. (1995) The variation of radon exhalation rates from building surfaces of different ages, *Health Physics*, 68, 5, 716-8.

Yu K.N., Young E.C., Stokes M.J. and Tang K.K. (1998) Radon properties in offices, *Health Physics*, 75, 2, 159-164.

Yu K.N., Cheung T, Guan Z.J., Mui B.W.N. and Ng Y.T. (2000) Rn-222, Rn-220 and their progeny concentrations in offices in Hong Kong, *Journal of Environmental Radioactivity*, 48, 2, 211-221.

Ziegler J.F., Zabel T.H. and Curtis H.W. (1993) Video display terminals and radon, *Health Physics*, 65, 3, 252-264.