

PHYSICAL MEASUREMENTS

WITH THE

VALVE ULTRA - MICROMETER

by

Jas. S. Rankin, B.Sc., A.R.T.C.

ProQuest Number: 13905367

All rights reserved

INFORMATION TO ALL USERS

The quality of this reproduction is dependent upon the quality of the copy submitted.

In the unlikely event that the author did not send a complete manuscript and there are missing pages, these will be noted. Also, if material had to be removed, a note will indicate the deletion.



ProQuest 13905367

Published by ProQuest LLC (2019). Copyright of the Dissertation is held by the Author.

All rights reserved.

This work is protected against unauthorized copying under Title 17, United States Code
Microform Edition © ProQuest LLC.

ProQuest LLC.
789 East Eisenhower Parkway
P.O. Box 1346
Ann Arbor, MI 48106 – 1346

PHYSICAL MEASUREMENTS WITH
THE VALVE ULTRA-MICROMETER.

Within recent years the advent of the thermionic valve has made possible the design of apparatus for the determination of very small displacements. Among the pioneers in this field mention might be made of Whiddington¹, Dowling², and Thomas³ each of whom by differently arranged circuits made use of the extraordinary sensitivity of a valve when in a state of oscillation. In the author's researches which are embodied in this thesis under the headings,

- (1) The Elastic Range of Friction,
- (2) The Magnetostriction of Various Steels,
- (3) The Effect of Tensile Overstrain on the
Magnetostriction of Steel,

Whiddington's general method was adopted and a brief outline of the method used will now be given.

The arrangement is shown in diagrammatic form in Fig. 1. A parallel plate condenser C is included in the grid circuit of the oscillatory valve circuit A. Variations in the capacity of this condenser alter the frequency of the electrical oscillations, which are arranged to be of the order of a million per second - a frequency which, in itself, is far too high to produce an audible note in the telephones placed in circuit B. Interaction between the circuit A and a similar oscillatory circuit B, the frequency of which can be adjusted by varying the condenser C¹ so as to be nearly, but not quite, equal to that of A, causes a series of beats to be produced in the telephone circuit, the frequency of which is such as to produce an audible note. Since the frequency of the note is equal to the difference between the/

the frequencies of the two circuits, it will be readily understood that a relatively small change in the frequency of A will produce a marked alteration in the pitch of the note emitted by the telephone. For example, if the frequencies of the two circuits A and B are 1,000,256 and 1,000,000 per second, the note would be of the same pitch as that given by the middle C of a piano, and any small change in the frequency of A could be easily detected by the ear.

To lessen the errors in detecting a change in frequency further use may be made of the principle of "beats"[‡], and it will be found possible to detect a change of even less than unity in the frequency of A. This is made possible by setting up a third oscillatory valve circuit containing capacities and inductances so large as to produce by induction an audible note in the telephones. This note can be adjusted so as to produce beats with the heterodyne note derived from the interaction of circuits A and B. It is a simple matter to observe a variation of one per second in the frequency of such beats, and thus it follows that a difference of the same magnitude in the frequency of the circuit A can be detected. Professor Whiddington demonstrated that it was possible to detect a change of 4×10^{-9} inch in the distance between the plates of the condenser C by means of his apparatus.

The theory of the method as given by Whiddington may be stated as follows;

The natural frequency, N, of a circuit comprising a capacity C connected to an inductance L is given by

$$N = \frac{1}{2\pi\sqrt{LC}}$$

If the condenser is composed of two parallel plates of area A and separated by distance x, we have

‡ This was done in research (3) above.

$$C = A/4\pi x$$

$$\text{Whence } N = \sqrt{x/\pi LA}$$

Differentiating with regard to x , we get

$$dN/dx = 1/2\sqrt{\pi LAx} = N/2x$$

The value of N is arranged to be of the order of 10^6 , so that assuming the plates are separated by 0.001 inch, we have

$$dN/dx = 10^9/2$$

Taking the least observable change in N as 1, the corresponding value for dx is 2×10^{-9} inch.

(1) THE ELASTIC RANGE OF FRICTION

In a paper on "Molecular Contact" by James S. Stevens, published in the "Physical Review" for 1899, it is shown (by an interferometer method) that when one metal plate is pulled over the surface of another, as in an ordinary experiment for finding coefficients of friction, then, before slipping occurs, elastic strains are produced of magnitudes one or two tenths of a wavelength of yellow light ($\lambda = .00006$ cm.) It was thought that a further investigation of this elastic range of friction, using an oscillating-valve ultramicrometer method capable of detecting say 10^{-7} cm., might lead to a better understanding of the nature and distribution of ordinary friction and of the action of the surface films concerned.

The apparatus first employed is illustrated by Figs. 1 and 2. A parallel plate condenser C , formed of two rectangular metal plates (7 cm. \times $2\frac{1}{2}$ cm.) with surfaces say 1/20 mm. apart, was placed in an oscillating electric circuit (frequency of the order one million per second) connected to the grid of a thermionic valve. A second valve was provided with a similar grid circuit having a variable condenser C^1 , so that its frequency could be adjusted to say 1 million 200 per second. The high-frequency currents/

currents in the plate circuits of these two oscillating valves, acting on ear telephones gave rise, due to interference, to an audible note in the telephones of beat frequency about 200 per second. An alteration of the capacity of the condenser C, produced by a change in the distance between the plates of say 10^{-7} cm. caused the frequency of the note heard in the telephones, to alter in a manner which could readily be recognized by the ear.

One of the plates of the condenser C - the right-hand plate which had a hole drilled in its centre - was fixed to the top of the thin plate F, the friction at the under surface of F being the subject of investigation. The other plate of the condenser C was attached to a carefully measured standard steel rod R fixed to a rigid support; the dimensions of the rod were such that a pull of 100 grams extended it by 10^{-6} cm. The apparatus was enclosed in a lead-lined box to avoid electric induction effects and placed on a firm foundation to avoid vibration.

A tangential pull (of say 10 grams weight) applied to the plate F increased slightly the distance between the plates of the condenser C; a pull (of say 200 grams) applied to the rod R decreased this distance by about the same amount. The elastic yield at the friction surfaces could thus be measured by the elastic extension of the standard rod R - the equality of the two strains being detected by the change in the frequency of the note heard in the telephones, as loads were lifted off and on. The rigidity of the supports was tested by applying pulls to various points other than the end of the rod R or the friction plate F.

Fig. 3 shows the results obtained using as friction surfaces steel against cast iron. The elastic range of friction is clearly shown, and the "yield-point" on the graph when limiting friction was reached at the pull of 20 grams was fairly accurately determined by the manner in which the note heard in the telephones slowly altered after the pull was applied.

FIG. 3.

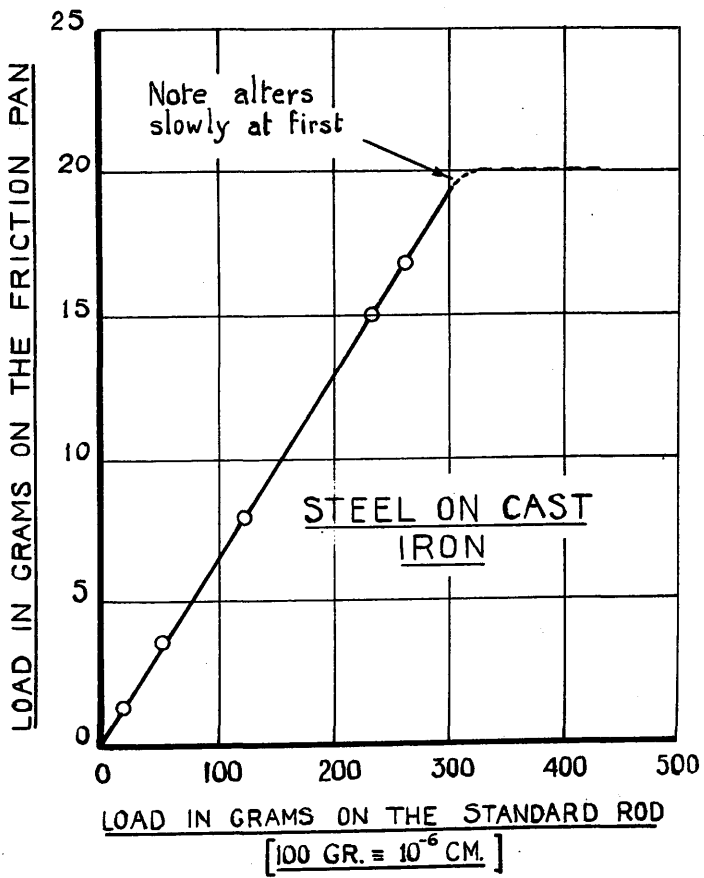

The effect produced by adding additional normal load to the friction plate F, such that the normal reaction between the surfaces was doubled (160 grams instead of 80), was also tested with the same two surfaces; and the experiments indicated that the elastic modulus for friction was thereby ^{about} doubled. For example, 10 grams pull on the friction plate now produced only about one-half the elastic yield previously observed: limiting friction, now reached with about 40 grams pull instead of 20, occurred at about the same total elastic yield. But it has to be confessed that it was found impossible to obtain conclusive results both as regards the elastic modulus and (to a less extent) as regards the position of the yield-point or of limiting friction. The surfaces, as used, may be described as reasonably clean; they gave an ordinary coefficient of friction 0.25. They were not in the condition used, for example by Hardy⁴ (which might perhaps be described as unreasonably clean) when a coefficient of limiting friction for steel on steel as high as 0.74 was obtained.

As the inconsistencies in the observations might in large measure be due to a varying distribution of the friction grip and to varying cleanness of surface, it was decided to try further experiments using glass surfaces. By examining the layer between the surfaces under monochromatic (sodium) light and under white light, it was thought that the interference bands and colours seen should at least indicate the nature of the distribution of the friction grip.

Glass plates of good optical polish were obtained, smaller plates ($2\frac{1}{2}$ cm. square by 0.7 cm. thick) to rest on larger ones; and the friction apparatus illustrated by Fig. 2 was modified so that a larger glass plate could be firmly bound to the base of the cast-iron support.

When the upper plate was laid on the lower one and the surfaces examined/

examined under monochromatic light, straight parallel equally spaced interference bands were observed, indicating that a wedge of air had been trapped between the plates (see Fig. 4). A considerable load ($W - W^1$) could be placed on the top plate without altering the number of bands seen, and the top plate could be slipped all over the lower one without appreciably altering the appearance of the interference bands. If white light were used no bands might be seen (the plates being then everywhere further apart than .0002 cm.), or more usually coloured fringes⁵ would be visible only at the narrow edge A. By manipulation of the top plate the parallel fringes could be replaced by a uniform colour, and by pressing the plates together this colour could be got to change and ultimately to pass through orange, straw, whitish, grey (when film was of thickness about 10^{-5} cm.) to black; showing that the plates were of good optical polish and that whatever "dirt" had been trapped with the air between the plates could be pressed to very small thickness. The experiments were performed in an ordinary Glasgow atmosphere - not a very clean one - and it should be remembered that glass surfaces are exceptionally hygroscopic.

What the nature and distribution of the forces (both normal and tangential) between the two friction plates may be, is a difficult question to answer. The layer between the plates may be of a thickness equal to many wave-lengths of light, or, say, ten or more times the mean free path (10^{-5} cm.) of a gas molecule in the air. The particles in the solid surfaces are thus well beyond the range of direct action on each other - the range of molecular forces being of the order 10^{-6} cm. It is impossible to think of air layers of great thickness bound to the surfaces and (acting like rigid solids) giving support to the upper plate. It might be thought that casual "dirt" in the atmosphere could give a prop-like support which would account for the wedge shape of the trapped/

FIG. 4.

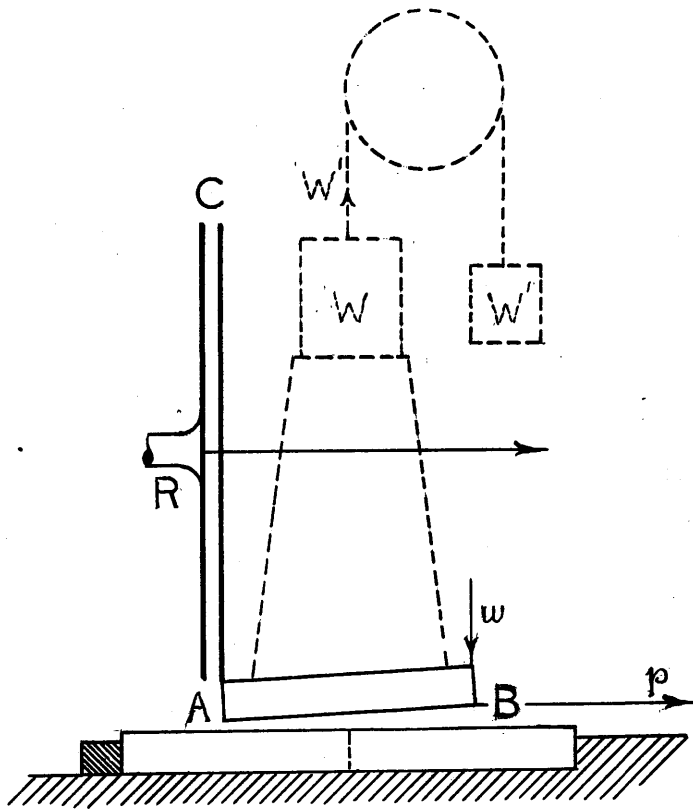

PLAN

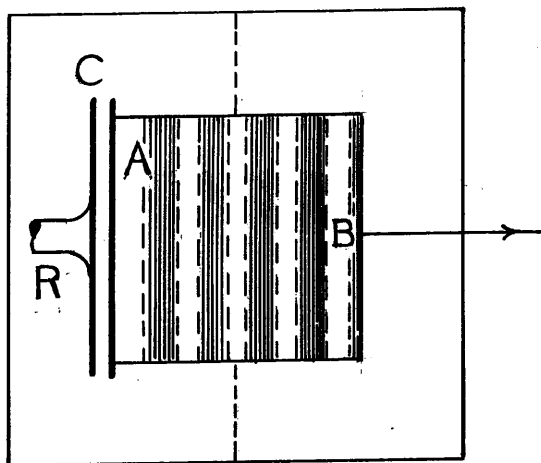

trapped layer, and on examining the layer with a microscope (using magnification of only 100) dirt specks could readily be detected; but the fact that the top plate could be moved over the lower one without appreciably altering the appearance of the interference bands is against this supposition. On the other hand, there is no doubt that the surface layers of water and of "grease", referred to by the late Lord Rayleigh in a paper "On the theory of Surface Forces"⁶, are of fundamental importance in friction problems. Such layers may be quite thick. For example, in an investigation of the heat transmitted through a boiler tube to clean and to oily water⁷, decreases in transmission as great as 20 per cent. were observed, and attributed to oily layers which formed on the surface of the tube. The layers could be readily seen with the naked eye and could be rubbed off the surface of the tube at the conclusion of the experiments; they were estimated as being of thickness of the order one-hundredth of a millimetre.

The approximate permanence, when one plate is moved over the other, of the wedge shape of the trapped layer (illustrated in Fig. 4) may be accounted for by regarding the upper plate to be at least partially supported cantilever fashion from the narrow edge A, where the forces in the film will be greatest. That such a cantilever support is possible may be demonstrated by allowing the upper plate to project far beyond the edge of the under one. If the plates at A are close enough to show straw and whitish colour, under white light, the upper plate can be permanently supported with its centre of gravity projecting well beyond the edge of the under plate.

Experiments were also performed using the ultramicroscope to illustrate the distribution of the supporting and tangential forces between two plates. For example, to test for the existence of forces/

forces at the wide edge B, of a trapped film, an under plate was cut in two (along the dotted line shown in Fig. 4) and an attempt was made to slip out the portion under the wide edge B without permanently altering the capacity of the condenser C. The attempt failed. The half plate could be removed, but there was always a very small permanent change in the capacity of C, even when the half plate was moved very slowly so as to avoid a drag due to viscosity in the layer. The small friction force thus shown to exist at B might be due to casual "dirt" or to unavoidable surface layers, but the main forces existed at the narrower edge A.

The effect on the capacity of the condenser C produced by adding a small weight w to the top surface of the upper plate was also investigated. By placing w above the wide edge B (Fig. 4) a much greater elastic change occurred in the capacity of C than by placing w above the narrow edge A. An attempt was made to get more consistent results for the magnitude of the tangential strain produced by a pull p (see Fig. 4) by applying a correction for this tilting action, a correction found by using the principle of moments and the magnitude of the tilt effect produced by w ; but the attempt failed. For one reason, another complication had to be considered. The main grip at the edge A might be unsymmetrically distributed, so that, when the pull p was applied, elastic rotation might occur about a vertical axis somewhere about the letter A shown in the plan, Fig. 4. Such a rotation might give rise to either an increase or a decrease in the capacity of the condenser C, depending on the position of the axis of rotation. It was several times observed that, when the friction plates were in very close contact, pull on the upper plate slightly increased the capacity of C instead of decreasing it; the increase in capacity due to the closer approach of the condenser plates at one edge (as the result of rotation) having been greater than the decrease in capacity due to separation at the other edge.

When experiments on the elastic range of friction were started, it was thought that by comparing the elastic friction moduli got for different materials, some information might be obtained which would throw light on the question why it is we can speak of the coefficient of friction for glass on glass, brass on brass, steel on brass and so on. The experiments just described show, however, that this idea had to be abandoned. One could never be sure that the distribution of the friction grip was the same in different experiments and the large corrections necessary for tilting and rotation effects would be unknown. Nevertheless the following results obtained with glass, brass and steel surfaces, all of good optical polish, and with two different normal loads, are thought to be worth recording.

Fig. 5 shows results obtained with glass surfaces. The surfaces having been well cleaned, the top plate was gently placed on the lower one and adjusted to give a narrow gap between the plates of the condenser C. A weight W. placed on a small stool (see Fig. 4), was laid on the top plate - the normal reaction between the surfaces being then 166 grams, or on the average about 26 grams per sq. cm. The layer between the plates was then examined under white light and no coloured bands were seen, so that the plates were everywhere further apart than .0002 cm. There were 15 bands seen with sodium light (the plates lying as illustrated in Fig. 4), so, at the wide edge B, the plates were further apart than .001 cm. Curves A_1 and A_2 were obtained together, a point on A_1 , then a point on A_2 . The reduction of the normal reaction (to half value) required for A_1 was obtained with as little disturbance of the friction plates as possible, by applying an upward pull W' to the load W already placed on the top plate (see Fig. 4). The curves indicate that the yield between the plates was not quite elastic right up to limiting friction; and they indicate that there was a yield of more than .001 cm. before slipping occurred, but of course, due to tilting, the condenser plates would/

FIG. 5.

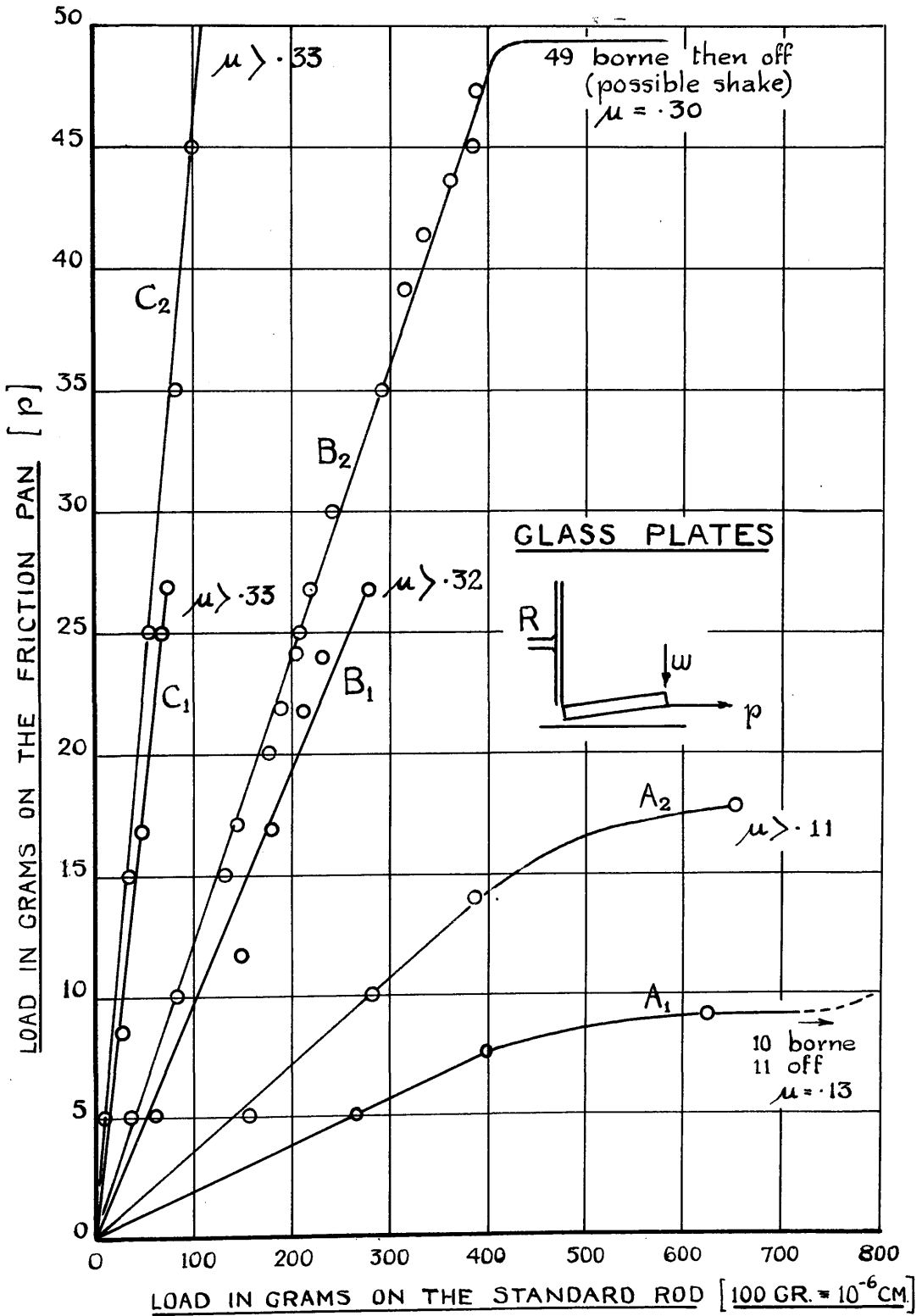

- A₁, A₂—No colour with white light: 15 yellow bands with Na light.
 $w = 1$ gr. at edge produced same effect as 180 grs. on Rod R.
 A₁—Normal reaction 83 grs.; A₂—Normal reaction 166 grs.
- B₁, B₂—5 coloured fringes from edge A to rather more than half-way across the plate, then no colour to B, with white light.
 B₁—Normal reaction 83 grs.; B₂—Normal reaction 166 grs.
- C₁, C₂—Plate pressed on till whitish colour with white light—straw colour all gone.
 C₁—Normal reaction 83 grs.; C₂—Normal reaction 166 grs.

would not remain parallel. The effect produced (in the telephones) by placing a little additional load, $w = 1$ gram, on the outer edge of the upper plate was the same as that due to applying 180 grams pull to the rod R. The coefficient of limiting friction was 0.13.

Curves B_1 , B_2 , were obtained with the glass plates in much closer "contact." Five coloured fringes were seen stretching more than half-way across the plates, so the layer between the plates varied in thickness from about .00006 cm. to about .00025cm. The coefficient of friction was about 0.32.

For curves C_1 , C_2 the top plate was pressed well on to the under one till the straw colour disappeared, leaving a whitish colour all over, so that the plates were separated by a distance of about .000015 cm. Due to the breaking of a hook the pull p was not carried up to limiting friction, so the coefficient should probably be much greater than the value .33 marked on the curves. With very clean surfaces values as high as 0.8, 0.9, greater than unity, had been obtained but the handling of the plates necessary in these experiments rendered extreme cleanness impossible.

Fig. 6 shows similar results obtained using brass and wrought-iron plates of good optical polish. The only method of investigating the character of the layer trapped between the plates was now by means of the little load w . In the case of both brass and of steel it was found that practically the same tilting effect was produced by applying w anywhere round the edge of the top plate, and no tilting effect was observed when w was placed near the centre. This indicates that the surfaces in "contact" were slightly convex, so probably the under plates had been slightly buckled by the application of the strap which bound them to the massive cast-iron support.

FIG. 6.

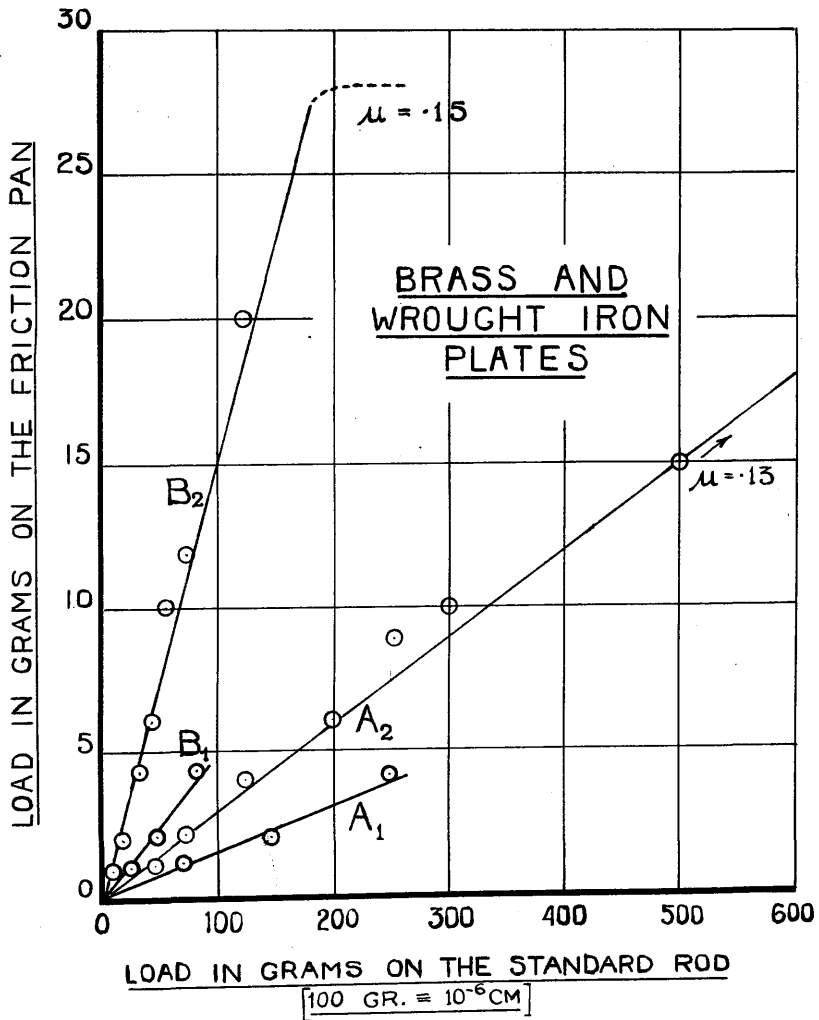

A₁, A₂ — Wrought iron plates
 A₁ — Normal reaction 95 grs.
 A₂ — Normal reaction 176 grs.
 B₁, B₂ — Brass plates
 B₁ — Normal reaction 99 grs.
 B₂ — Normal reaction 181 grs.

(2) THE MAGNETOSTRICTION OF VARIOUS STEELS.

The term magnetostriction has been given to the changes produced by magnetization in the length of the magnetic substances. Joule⁸, one of the earliest experimenters on the subject, found that the length of a soft iron rod was increased by the application of magnetizing force. Later, experiments on the extension of steel rods were made by Mayer⁹, and by Barrett¹⁰, who extended the inquiry to nickel and cobalt, finding that nickel contracted when magnetized. The whole subject was exhaustively examined by Shelford Bidwell¹¹. He tested iron, steel, nickel, and cobalt throughout a very wide range of magnetizing forces, using rods and also rings (to secure uniform magnetization and determinate magnetizing forces). His experiments with iron and steel specimens show that if the magnetizing force is pushed to high values a contraction takes place instead of an expansion. The measurements were made by a series of levers and mirrors.

The maximum amount of elongation produced is naturally very small (about 1/200,000 to 1/400,000 of the length of the specimen used, according to Bidwell), and it was felt by the writer that an apparatus similar to that used in finding "The Elastic Range of Friction" would be sufficiently sensitive to determine the small changes involved.

Fig. 7 shows the theoretical arrangement of the valve circuits ultimately used and it may be mentioned that it is similar to that used by Vincent¹² for observing small changes of frequency. A and B are two oscillating valve circuits placed a few feet apart, the frequency of the oscillations generated being again about one million per second. If the two circuits are nearly in unison, an audible beat note will be heard in the telephones in the crystal circuit C. Any small change in the frequency of, say, the B circuit will change the note in the crystal circuit. Hence any small change in the capacity in the B circuit can be readily detected.

FIG. 7.

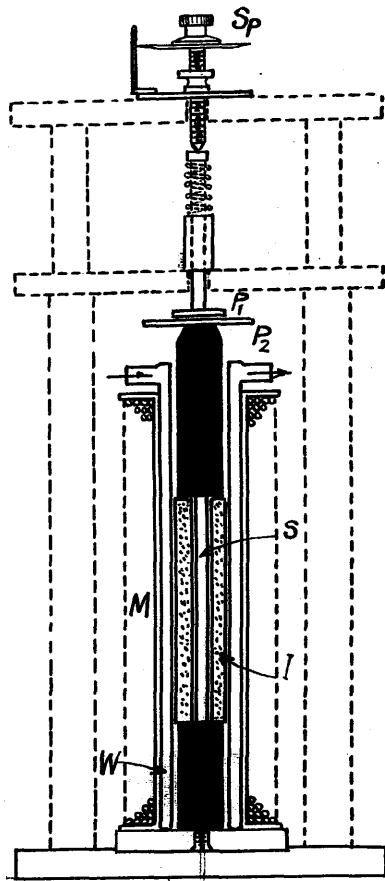
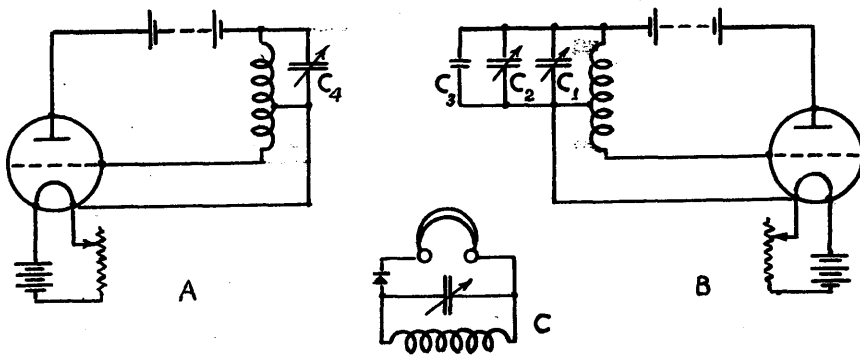

FIG. 8.

An attempt was made to detect small changes in capacity by noting the deflection of a galvanometer placed in the C circuit, as described in Vincent's article; but great difficulty was experienced in keeping the galvanometer "spot" steady and the method was ultimately abandoned.

The Condensers C_1 and C_4 are variable up to a maximum of 0.0005 microfarad. C_2 is a small vernier condenser of the cylinder type, one revolution of the spindle giving a change in capacity of about 6 micro-microfarads (1 micro-microfarad = 0.9 e.s. unit); C_3 represents the capacity between the plates P_1 and P_2 (Fig. 8), and it is the change in capacity between these plates which gives a measure of the movements observed in the magnetostriction experiments.

Fig. 8 shows the details of the magnetizing coil M and the specimen S to be tested. The specimen S is screwed into two ebonite rods, the lengths of which ensure that it is always exactly at the centre of the magnetizing coil. As trouble due to rise in temperature was expected, a brass tube I, covered with 85 per cent. magnesia (a heat insulating substance), surrounded the specimen and a cylindrical vessel W, through which water could circulate, formed a water-jacket between the coils of the magnetizing coil and the specimen. By means of a spherometer Sp. the top plate P_1 could be adjusted to any desired distance from P_2 .

A preliminary experiment was carried out to test the efficiency of the water circulator. The specimen S and the ebonite rod with its attached plate P_2 were removed and a thermometer placed inside the coil. Before turning on the water, time-temperature readings were taken for a few minutes with a current of 20 amperes passing through the magnetizing coil M, and it was found that a considerable rise in temperature took place (about 3° in 14 minutes). On turning on the water the temperature fell rapidly to about 1°C . below/

below room temperature and ultimately remained very steady. (As the magnetostriction observations for any one specimen occupied a period of only about 3 minutes, the magnetizing currents being increased from zero to about 19 amperes, any alteration in length due to temperature change must be negligibly small. As a further confirmation of this a brass specimen of the same dimensions as the steel specimens was placed in the apparatus and a current of 19 amperes passed through the magnetizing coil for about 5 minutes. No expansion was recorded.)

Before cutting the long bars from which the steel specimens were taken, a BH curve for each bar was obtained using a ballistic galvanometer. These curves are shown in Fig. 9. The specimens for the magnetostriction tests were then cut, one from each bar, 5 inches long and $\frac{1}{4}$ inch diameter. The procedure followed in obtaining the magnetostriction results was as follows. The specimen was first demagnetized by placing it inside a long vertical solenoid and rapidly reversing a current through the solenoid, the current being decreased from about 1 ampere to zero - the amount of demagnetization being observed, in the usual way, by means of a small magnetometer needle. The specimen was then cooled in tap-water for about a minute, to bring it to about the same temperature as the inside of the magnetostriction magnetizing coil. After placing the specimen inside the coil as in Fig. 8 and setting the indicator of Condenser C_2 to zero, the condenser plate P_1 was lowered by turning the spherometer Sp. until it was very close to P_2 . The condenser C_1 was then adjusted until a note was heard in the telephones. In all subsequent experiments the setting of condenser C_1 was not altered and all tuning was done by means of the spherometer and its associated plate P_1 . This ensured that the capacity between P_1 and P_2 remained practically the same in all the tests and so the sensitivity of the apparatus could be taken as constant throughout.

FIG. 9.

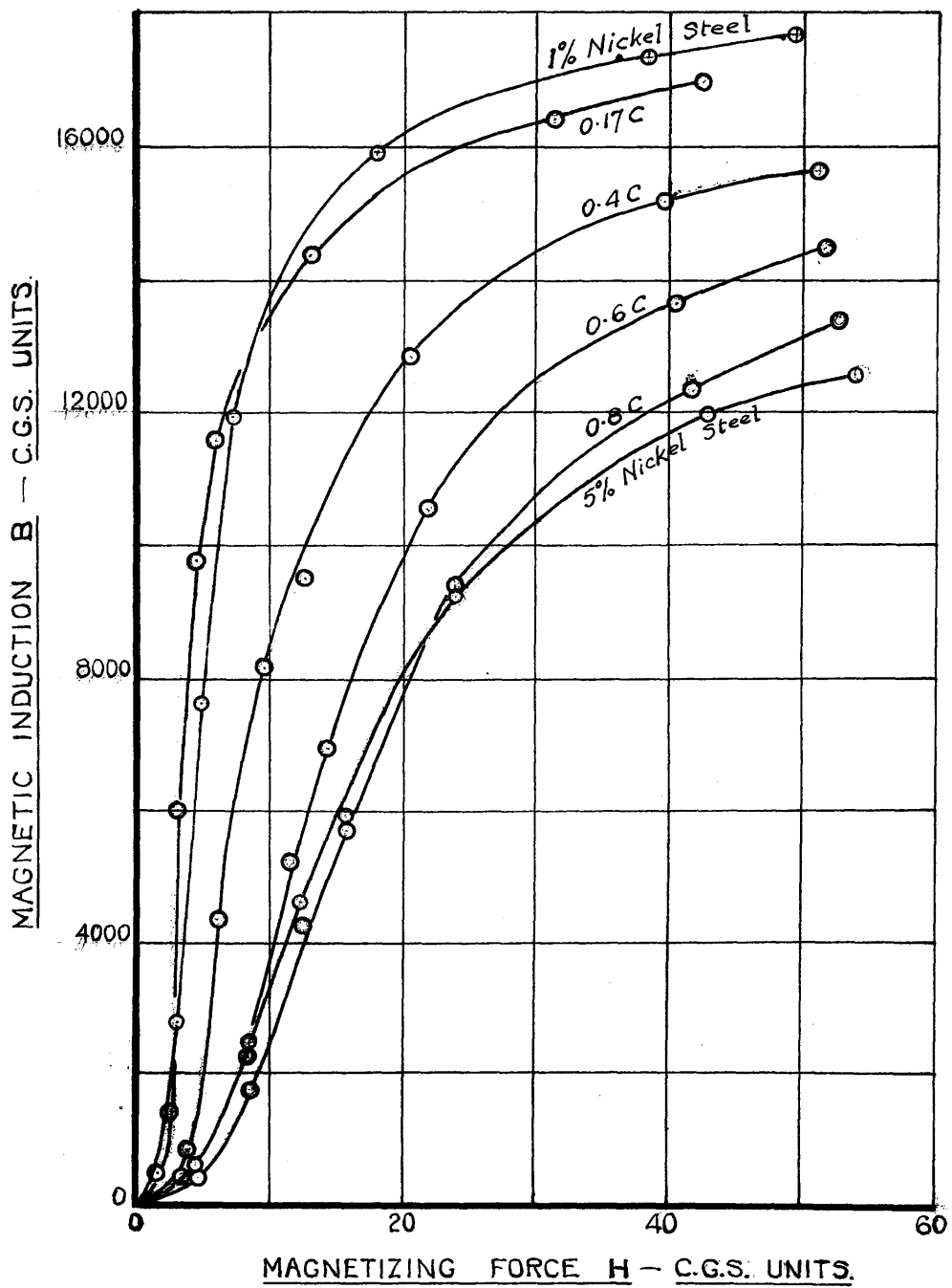

When the note was found to be steady a current of about 2 amperes was passed through the coil. This altered the note, but by adjusting the condenser C_2 the note could be brought back to its original frequency. The reading of condenser C_2 was taken as a measure of the displacement of plate P_2 . The current was then increased, by six steps, to approximately 19 amperes, and the corresponding settings for condenser C_2 were always noted.

The specimen was then removed and demagnetized as before, cooled down, and placed in the apparatus; then the experiment was repeated. In this way six tests were carried out on each specimen and the results of these tests were plotted and a mean curve obtained for each specimen. It may be mentioned that for any one specimen the results varied from 10 to 15 per cent. above or below the mean curve.

Lastly an attempt was made to get an approximate estimate of the value of the condenser C_2 readings in terms of the displacement between the plates P_1 and P_2 . This was done by tuning in a suitable note in the telephones as before, and then turning the spherometer through a very small amount and adjusting the condenser C_2 to bring the note back to its original value. This was repeated several times and it was found that 1.0° on the condenser C_2 scale was approximately equal to an alteration of 10^{-6} cm. in the distance between the plates P_1 and P_2 . The writer claims no great accuracy for the standardization. Great accuracy was not considered essential as only comparative curves for the different specimens were required.

As will be noticed from Figs. 9, 10, and 11, four carbon steels (0.17 per cent. carbon to 0.8 per cent. carbon) and two nickel steels ((i) 1 per cent. nickel, 0.10 - 0.15 per cent. carbon, and (ii) 5 per cent nickel) were tested. In Fig. 10 the actual magnetizing force (H.), acting at the centre of the specimens of/

FIG. 10.

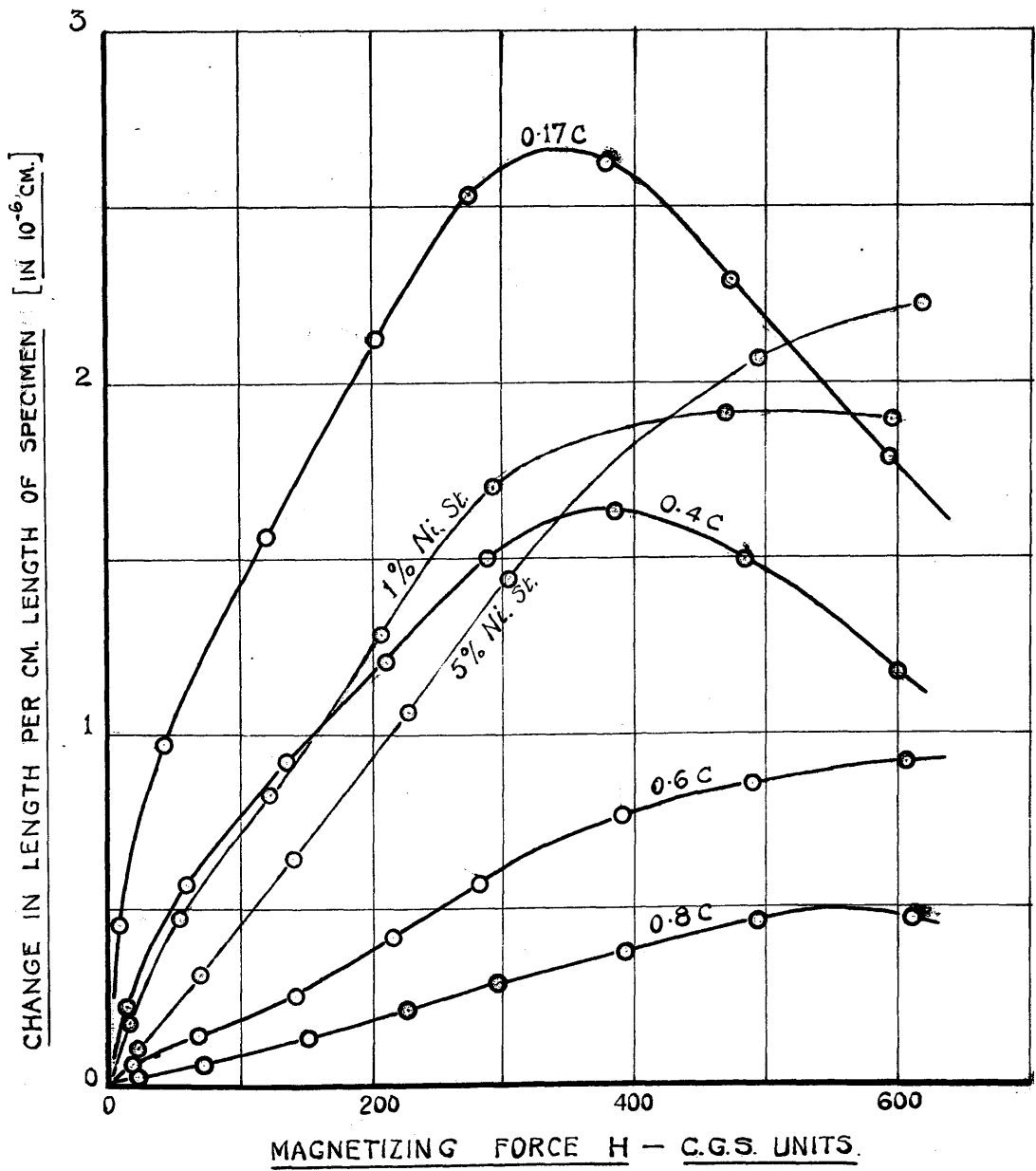
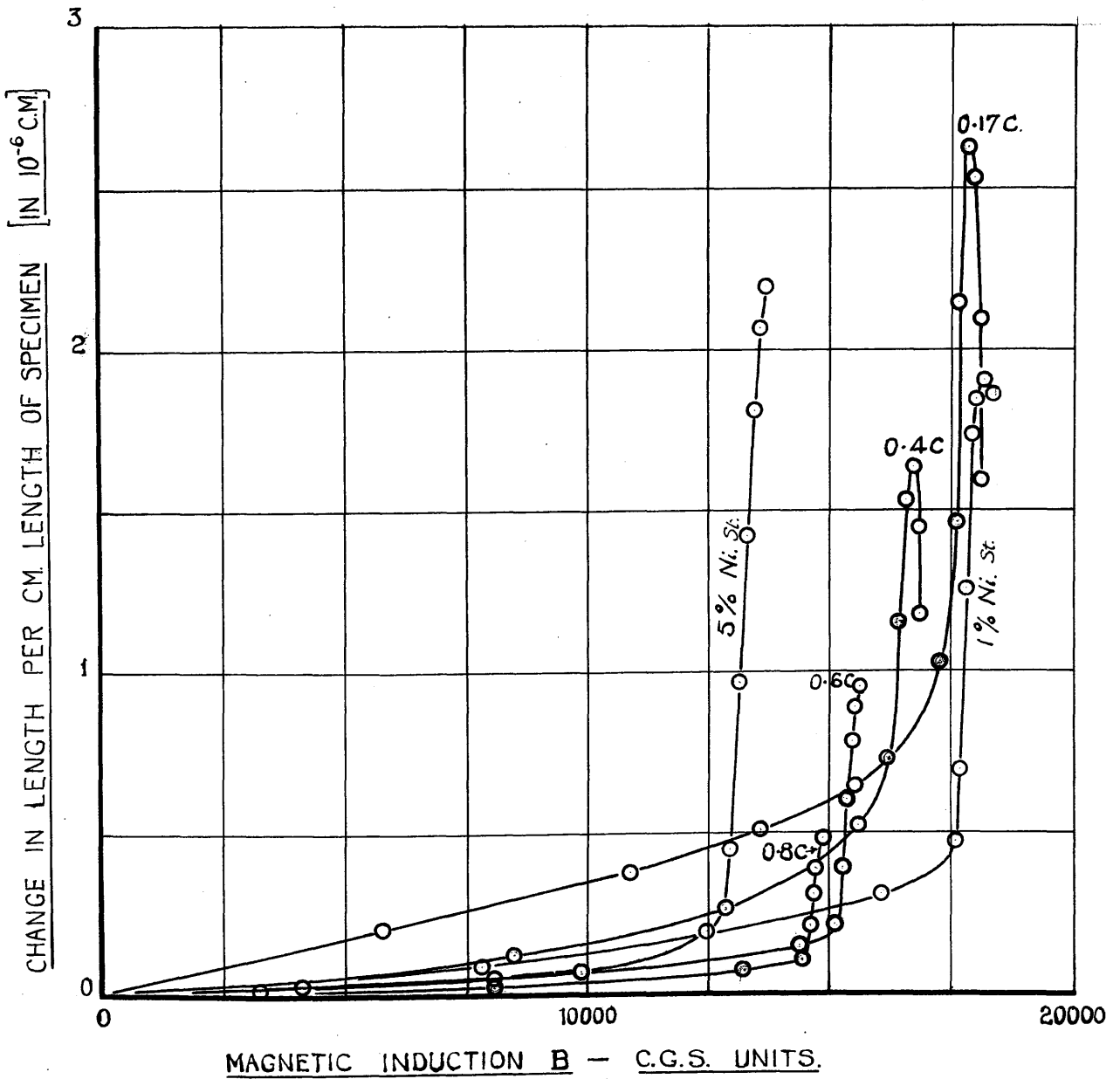

FIG. 11.



of steel with various carbon content, is plotted against the change of length per cm. length of specimen, and the difference between the four carbon steels is clearly indicated. Fig. 11 shows interesting curves obtained by using as abscissa the magnetic induction B ., instead of the magnetizing force H . The corresponding curves for the nickel steel specimens are shown in red in Figs. 10 and 11. The value of Young's modulus for all the specimens may be assumed to be practically the same; no solution, therefore, for the explanation of the widely different curves can be sought in this direction.

(3) THE EFFECT OF TENSILE OVERSTRAIN ON THE MAGNETOSTRICTION OF STEEL.

Using the apparatus shown in Fig. 8 an attempt was also made to investigate the magnetostrictive effect on overstrained steel. The 0.17 per cent. carbon steel bar was subjected to a gradually increasing pull in a testing machine until ultimately it broke. A specimen of the same dimensions as the others used was then cut from one portion of this overstrained bar. The magnetostrictive effect was found to be similar, up to the magnetizing force 300 (see Fig. 10), to that obtained for the unstrained 0.17 carbon steel specimen, but no turning point could be detected with the overstrained material. It was felt, however, that the apparatus was not sufficiently sensitive or dependable to allow of definite conclusions to be established with regard to the effect on magnetostriction of hardening by overstrain.

A new apparatus was therefore designed to avoid as far as possible some of the troubles previously experienced. The same oscillating valve circuits were used and are shown in Fig. 7. The condenser C_4 was kept fixed at the same value (about 0.0004 microfarads) throughout all the tests. This ensures that the oscillating frequency of the circuit A keeps the same value throughout /

throughout - a necessary condition if the sensitivity is to remain constant. C_1 is a vernier condenser variable up to about 0.00009 microfarad. C_2 is a condenser of special design giving very small changes in capacity, and is shown in Fig. 12. A glass rod G can be moved up or down in a vessel containing mercury, by means of the vertical ratchet of a microscope (not shown). A narrow-bore tube T filled with mercury also dips into this vessel. Contact wires w are connected as shown. When the glass plunger moves up or down the level of the mercury in the larger vessel alters, and so an alteration of the capacity of the tubular condenser takes place. It will also be noticed that even for a fairly large up or down movement of the glass rod G the level of the mercury surface is only altered by a small amount. By taking careful measurements it was found that when the glass rod was displaced vertically 1 cm., the change in capacity was only about 0.284 e.s. unit. Hence an efficient variable condenser capable of giving extremely small variations in capacity was obtained. Further, since the rise or fall of the mercury in contact with the outside of tube T was only about 2 mm., and since care was taken in all the tests to start with the larger mercury surface at the same zero level, it could reasonably be inferred that the change in capacity would be practically proportional to the linear displacement of rod G.

In Fig. 12, also, is shown a specimen S in the magnetizing coil M within which is a cylindrical vessel W, through which water could circulate, thus forming a water jacket between the magnetizing coil and the specimen. An aluminium rod A, which supports one of the condenser plates P_1 , is screwed into the specimen S, the other end of S being fixed as shown to the base of a brass tube B. At the top end of B is a vulcanite plate P_3 which supports the adjustable condenser plate P_2 . Plates P_1 and P_2 are insulated as indicated and form the condenser C_3 (Fig. 7) a triangular plate D is also attached to the upper end of tube B, and has three rods R/

FIG. 12.

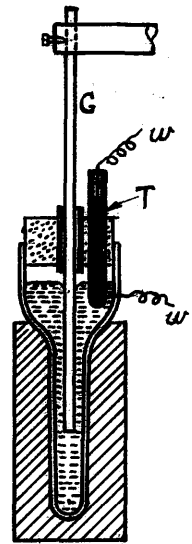
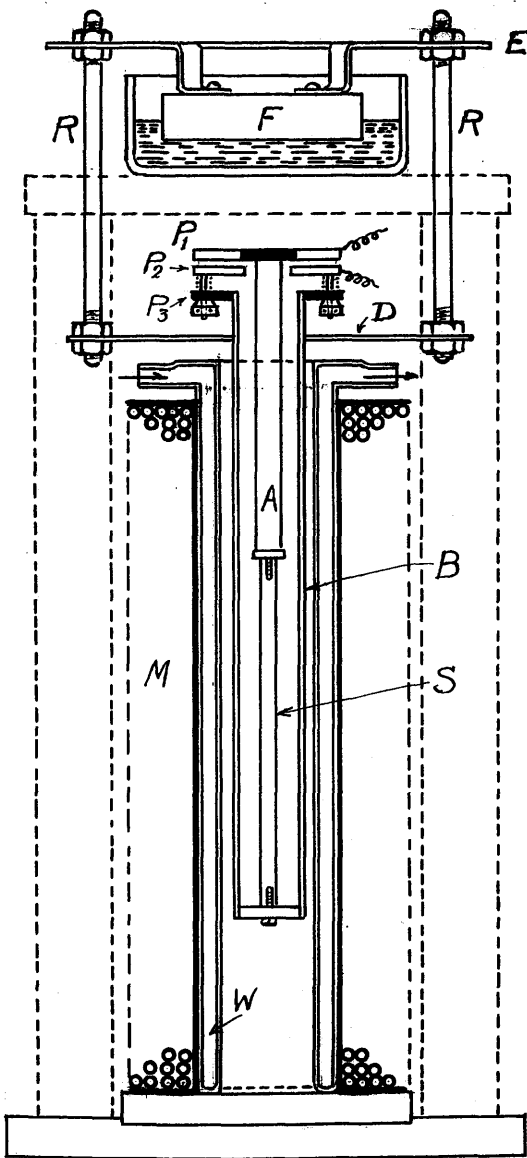

R (one not shown) screwed into it at its angular points. To the rods R is also attached a plate E which is fixed to a wood float F floating in a bath of mercury as shown. Thus when a current passes through the magnetizing coil, the specimen S can move freely into the strongest part of the field, and no change in capacity can take place between P_1 and P_2 due to this lateral motion; but if the specimen extends or contracts along its axis the capacity will alter. Of course the various dimensions of the apparatus are so devised that the centre of the specimen S coincides very closely with the centre of the magnetizing coil.

In carrying out a test the plates P_1 and P_2 were adjusted until a note was heard in the telephones. The screw of the ratchet for operating the glass rod G of the condenser C_2 was turned until the index on the vernier scale was at a suitable zero on the vertical scale of the microscope. This, of course, alters the note. The vernier condenser C_1 was then adjusted until exact unison was got with a standard tuning note produced by another single valve circuit with coils and condensers arranged to give any desired audible note. This standard tuning note used in all the tests had a frequency round about 400. It should be noted that the sensitivity of the apparatus varies with the distance apart of the plates P_1 and P_2 , so that strictly speaking these plates should always be at the same distance apart for all specimens, otherwise a serious error is introduced. Thus, if the distance apart of the plates is say 0.006 in. instead of 0.005 in., it can be shown that the sensitivity is now reduced to about two-thirds of its original value. Hence, whenever a new specimen was being tested the plates P_1 and P_2 were carefully adjusted until the setting of the vernier condenser C_1 , giving exact unison with the standard note, was about the same value as for all the other specimens. In the actual tests the setting of C_1 lay between about 165° and 175° , and it was subsequently found that within this range of 10° the sensitivity of the apparatus was practically constant.

In order to get an idea of the order of the displacements between the plates P_1 and P_2 in terms of say 1 cm. vertical shift of the glass rod G in the mercury condenser, several measurements were made. As already stated careful measurements showed that when the rod G moved vertically 1 cm. the capacity was altered by 0.284 e.s. unit. To get the distance between P_1 and P_2 , the capacity between these two plates was obtained by putting a calibrated variable condenser in place of this plate condenser, and thence noting the actual capacity required to bring the note into unison with the standard. Equating this capacity with $A/4\pi d$, the formula for the capacity of a parallel plate condenser, and substituting for A the previously measured area 21.0 sq. cm. of the plate condenser, the mean distance d between the plates P_1 and P_2 was found to be 0.00778 cm.

If d = distance between the plates, then for a displacement δ , the change in capacity

$$\begin{aligned} &= A/4\pi d - A/4\pi(d + \delta) \\ &\approx A\delta/4\pi d^2 = 21.0 \delta/4\pi(0.00778)^2 = 27600 \delta. \end{aligned}$$

Now, if the glass rod G of the mercury condenser has to be moved vertically 1 cm. to give this same change in capacity, then

$$27600 \delta = 0.284 \text{ and } \therefore \delta = 0.284/27600 = 10.3 \times 10^{-6} \text{ cm.}$$

A movement of .01 cm. of the plunger G altered the frequency by an amount readily detectable by the ear, so that the apparatus was apparently capable of detecting a shift between the plates of 10.3×10^{-8} cm.

Overstraining Experiments. - Mild steel rods about 30 in. long and 7/16 in. in diameter, cut from the same bar and specially annealed, were kindly supplied by The Clyde Alloy Steel Co., Ltd., Motherwell. They were marked A, B, C, D, and E, and each treated in the following way. (See Fig. 13)

Rod A. - The BH curve was obtained for A by means of a ballistic galvanometer and a magnetostriction specimen (No.1), 5 in. long and $\frac{1}{4}$ in. in diameter, was prepared from it. The remainder was/

was subjected to a gradually increasing pull on the 50 - ton testing machine in the laboratory of the Mechanics and Mechanical Engineering Department of the Royal Technical College. A yield-point was detected at 18.9 tons per sq. in. The pull was increased until the rod fractured, the breaking stress being 26.3 tons per sq. in. of original area, or about 33.4 tons per sq. in. actual stress, the total extension (before the neck formed) being 27 per cent.

A second magnetostriction specimen (No. 2) was prepared from this rod, and heated for a few minutes in boiling water to effect recovery from the overstrain.

Rod B. - This rod was subjected to a gradually increasing pull until a yield-point was detected at 18.8 tons per sq. in. It was then removed from the testing machine and heated for a few minutes in boiling water. On again straining it a yield-point was obtained at a higher stress of about 22.4 tons per sq. in. The rod was again placed in boiling water and on pulling it again a third yield-point was observed at 25.0 tons per sq. in. On boiling again and applying a pull a fourth yield-point was detected at 28.5 tons per sq. in., and on increasing the pull the rod ultimately broke at a breaking stress of 33.0 tons per sq. in. (29.4 tons per sq. in. of original area). A magnetostriction specimen (No.3) was now prepared from this rod.

Rod C. - A gradually increasing pull was applied to the rod until a yield-point was detected at 18.4 tons per sq. in. It was then heated in boiling water, and after finding its BH curve a magnetostriction specimen (No. 4) was obtained from it.

Rod D. - A yield-point was detected at 18.0 tons per sq. in. and after boiling, a second yield-point was observed at 21.6 tons per sq. in. The rod was again placed in boiling water and thereafter a BH curve was obtained, and a magnetostriction specimen (No. 5) was then prepared.

Rod E. - A yield-point was detected at 18.7 tons per sq. in. and after boiling there was a second yield-point at 23.6 tons per sq. in. On boiling again a third yield-point was observed at 29.4 tons per sq. in. After boiling and the BH curve obtained a magnetostriction specimen (No. 6) was made.

Fig. 13 shows the stress-strain curves for tensile tests performed on the rods A to E, the percentage extensions at the yield-points and at fracture being shown approximately to scale. No extensometer readings were obtained of the elastic strains, as it was considered necessary to note the yield-point and fracture extensions only. The extensions were obtained by simply measuring the distance between marks previously scribed on the bar at 8 in. apart. Examination of the curves will show certain discrepancies which are probably due to faulty material. Thus compare the first yield-point extension (0.75 per cent.) of rod D with the corresponding extension (2.62 per cent.) of rod E, or the third yield-point stress (25.0) and extension (0.56 per cent.) of rod B, with the third yield-point stress (29.4) and extension (4.19 per cent.) of rod E.

As rod E differed appreciably in elastic properties from the other four rods, a further comparison between rods A and E was made. A sufficient length of the broken rod A was available to enable another tensile test to be made after re-annealing, so the two rods A and E were annealed together for 2 hours at from 780° to 800° C. The rods were then turned down in the centre and careful tensile tests were made, using a Ewing extensometer, and a 5 - ton testing machine. Curves marked A' and E' on Fig. 13 give the results of these experiments. Rod A' gave a badly defined yield-point at say less than 15 tons per sq. in. Rod E' gave a fairly well defined yield-point at 16.5 tons per sq. in. These low yield-points indicate more drastic annealing than had originally been applied, and it is unlikely that the difference between the curves A' and E' could be accounted for by the/

FIG. 13.

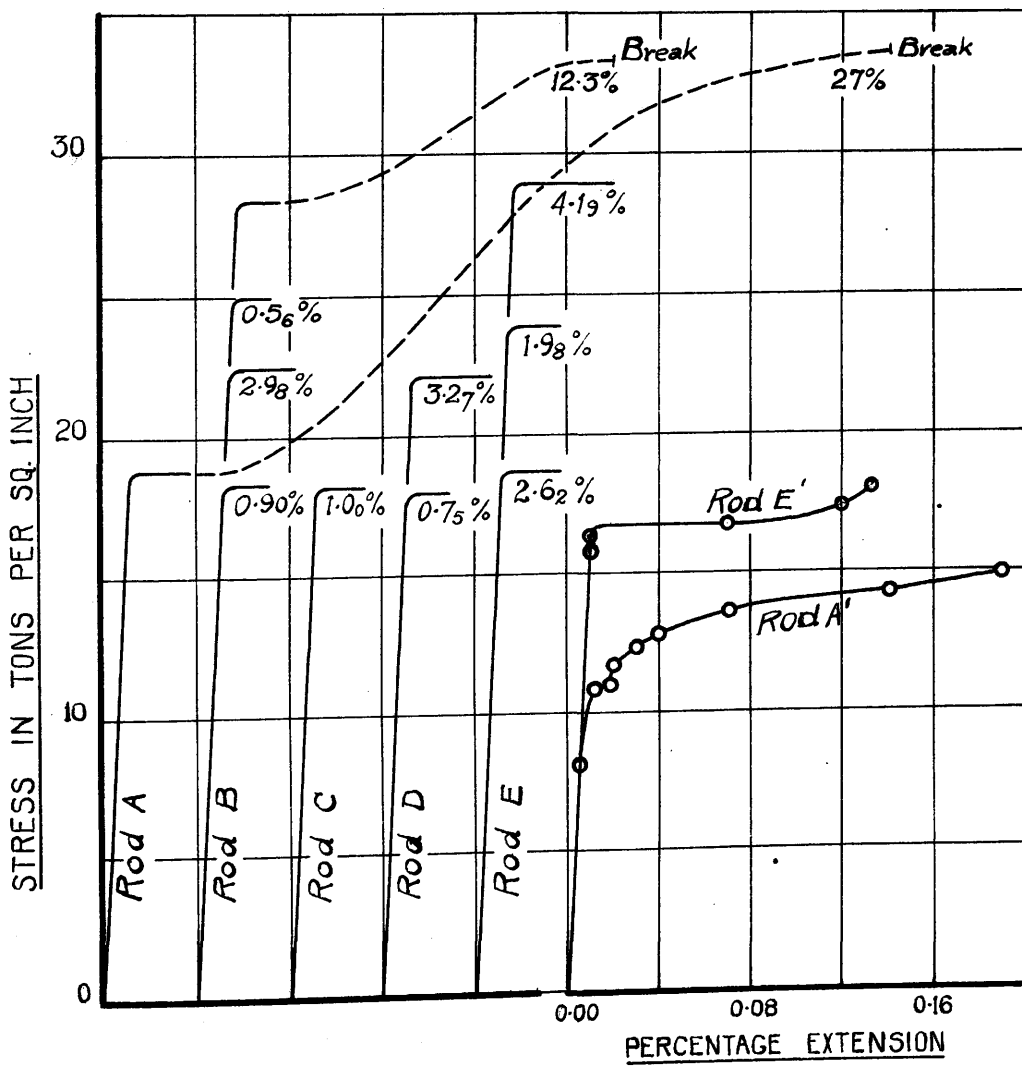

the difference, great as it is, in the original tests represented by curves A and E.

Magnetic Tests. - The magnetic quality of the material in different conditions of hardness was determined by using a long magnetizing coil and a ballistic galvanometer. Fig. 14 shows the BH curves for the virgin material (rod A before overstraining), and for the material overstrained as illustrated at C,D, E, Fig. 13. The fractured rods A and B were too short to allow of BH curves being accurately found.

Magnetostriction Tests. - The magnetostriction curve of specimen No.1 (virgin material) was first obtained. This specimen was placed in the apparatus (Fig. 12) and the plates P_1 and P_2 adjusted as previously explained. It was always found necessary to wait about 30 minutes or so before the note was quite steady. Apparently it took this time for the specimen and its associated connections to assume the temperature of the inside of the water-cooled magnetizing coil. When all was steady and the note in the telephones was in exact unison with the standard note, a current of about 2 amperes was switched on. Due to magnetostriction the specimen lengthened and the capacity of $P_1 P_2$ decreased so that the note altered, but by lowering the glass rod G (Fig. 12), this loss in capacity could be compensated, and the note was again in exact unison with the standard. The reading on the microscope scale to which G was attached was of course observed. The difference between this reading and the zero reading on the scale before putting on the current was taken as a measure of the displacement of plate P_1 . The current was then increased, by six or seven steps, to approximately 19 amperes, and the corresponding readings on the microscope scale were always noted. As the alteration of the current and the adjusting of the glass rod G could be done in a few seconds any alteration in length due to a possible temperature change would be negligibly small. The specimen was then demagnetized by sending through the magnetizing coil/

FIG. 14.

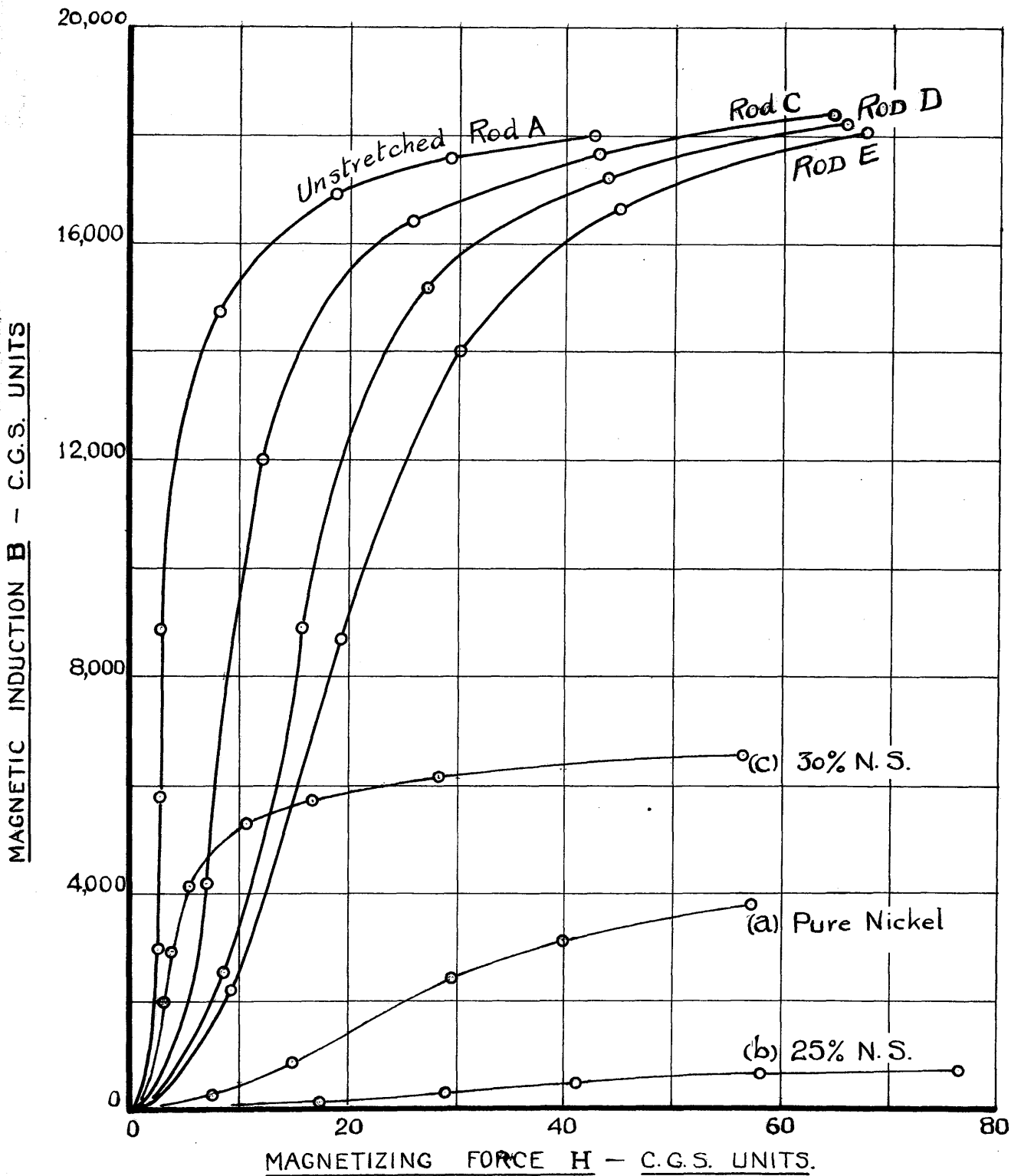

Rod C:- 1 yield point : 1% extension : 18.4 tons per sq. in.
Rod D:- 2 yield points : 4.02% extension : 21.6 tons per sq. in.
Rod E:- 3 yield points : 8.79% extension : 29.4 tons per sq. in.

coil an alternating current from an a.c. motor generator (50 cycles and 160 volts) stepped down to 30 volts by means of a suitable transformer. This alternating current was gradually *reduced to zero by means of a variable liquid resistance. The amount of demagnetization was observed in the usual way* reduced by means of a small magnetometer needle placed a few centimetres away from the coil. After some time, when temperature conditions had again become steady, magnetostriction results *re- This was repeated about six times, and the results of these tests were plotted and a mean curve obtained.* were again obtained. It may be mentioned that for any one specimen the results only varied by about 2 or 3 per cent. above or below the mean curve. All the other specimens No. 2 to No. 6 were dealt with in a similar manner.

Fig. 15 shows the curves obtained for the various specimens, and the marked difference between the unstrained specimen No.1 and the other strained specimens should be carefully noted. The increase in magnetostriction shown to be the result of hardening by tensile overstrain was entirely unexpected as in the previous experiments already described it was shown that hard high-carbon steel showed less magnetostriction than soft low-carbon steel. Specimens No.2 and No.3, which were obtained from the fractured rods (A and B, Fig. 13) gave readings similar to those obtained from No.6 (rod E), in spite of the great difference in total extension given to the rods - 27 per cent. rod A, 12.3 per cent. rod B, and 8.8 per cent. rod E. The change in magnetostrictive extension, therefore, does not depend simply on the amount of tensile extension. The large plastic extension given to A, and to B in carrying the load beyond the fourth yield-point, appears to have a different effect on magnetostriction from yield-point extension. It may be recalled that rod E differed appreciably in elastic behaviour from rods B, C, and D, and it may be recorded that a sixth rod F of the original material being available, it was overstrained exactly in the same way as E, and a magnetostriction specimen No.7 cut from it. The yield point stresses obtained with specimen F, and the magnetostriction curve obtained from specimen No.7 agreed to within about 5 per cent./

FIG. 15.

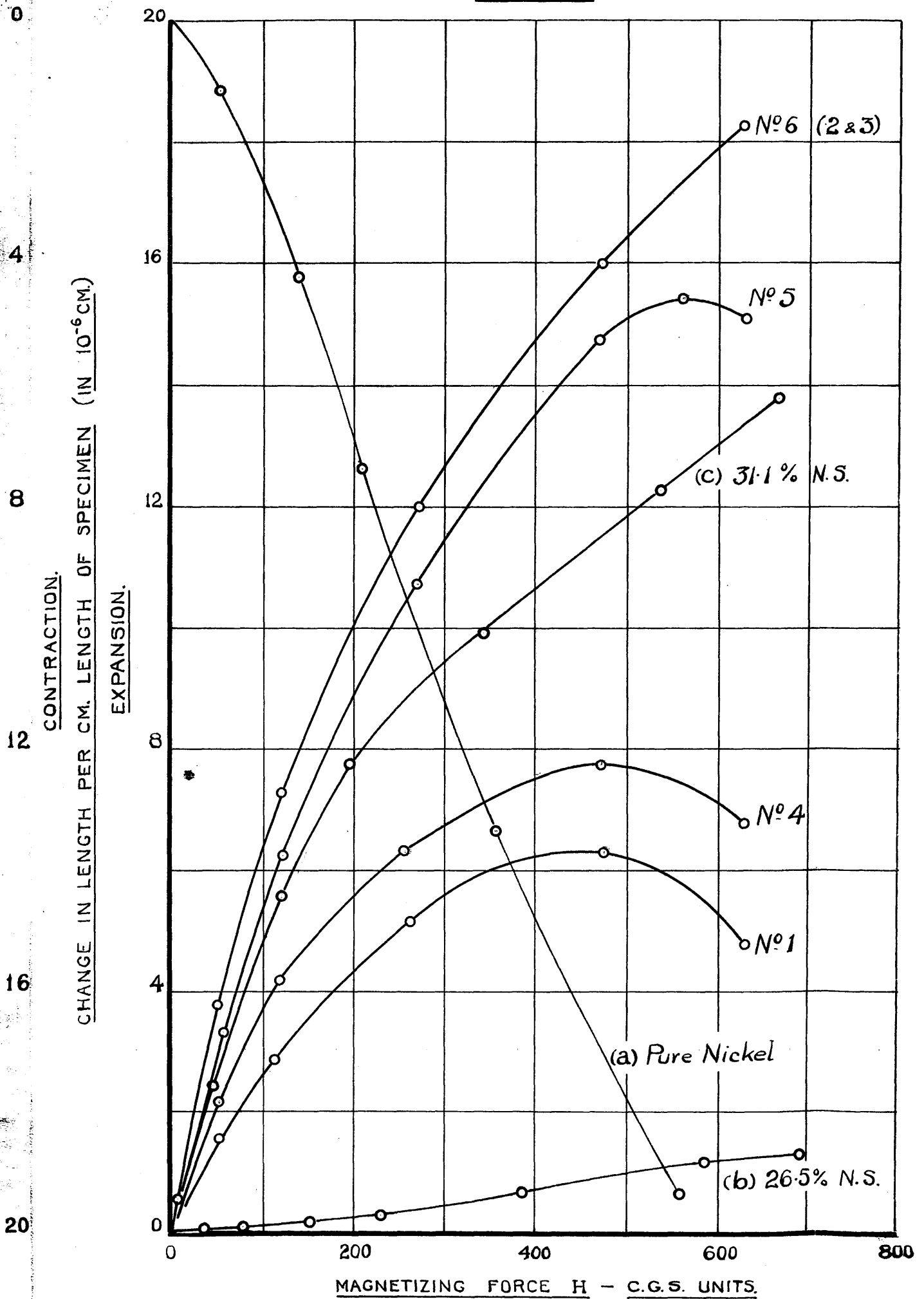

- Nº 1 - From Rod A : Unstrained.
- Nº 2 - From Rod A : 1 yield-point and fractured : 27% extension : 33.4 tons per sq. in.
- Nº 3 - From Rod B : 4 yield-points and fractured : 12.3% extension : 33.0 tons per sq. in.
- Nº 4 - From Rod C : 1 yield-point. : 1.00% extension : 18.4 tons per sq. in.
- Nº 5 - From Rod D : 2 yield-points. : 4.02% extension : 21.6 tons per sq. in.
- Nº 6 - From Rod E : 3 yield-points. : 8.79% extension : 29.4 tons per sq. in.

cent. with those obtained from specimen E. It will be noticed also that the curves for specimens No.5 and No.6 (rods D and E) are much nearer each other than might be expected, and whereas specimen No.5 showed a distinct turning point at a field of 560 c.g.s. units, specimen No.6 showed no turning point at a field of 620 c.g.s. units. Interesting curves showing the magnetostriction plotted against the magnetic induction B, instead of against the magnetizing force H, are shown on Fig. 16. The large increase in the magnetostriction, for small changes in the induction at the saturation values of the induction B, is clearly indicated.

Magnetostriction of Nickel and Nickel Steel. - Results have already been given for steels containing 1 per cent. and 5 per cent. nickel respectively. (See Figs. 10 and 11). When these results were obtained the intention was to determine the magnetostriction for nickel steels of composition passing through that of the alloy of critical composition 25 per cent. nickel; but it was found impossible to obtain the material. However, when the strained specimens were being done, other two nickel steels were obtained from Messrs. T. Firth and Sons, Ltd., Sheffield, and the experiments described below were performed - the magnetostriction results being obtained with the apparatus of Fig. 12.

The BH curves for pure nickel (curve a), 30 per cent. nickel steel (curve c), and 25 per cent. nickel steel (after freezing) (curve b) are shown in Fig. 14. The last-mentioned alloy is a peculiar substance. It is non-magnetic as it comes from the manufacturer; but after freezing to a very low temperature it becomes magnetic and remains so until it is heated up to 580°C .¹³ A magnetostriction specimen was prepared from the rod before it had been frozen, but no signs of magnetostriction could be detected. Neither was any magnetostriction observed after it was frozen in ice and salt. However, after it was frozen in liquid air (produced in the Technical Chemistry Department of the Royal Technical College) and allowed to return to room temperature, the magneto-

FIG. 16.

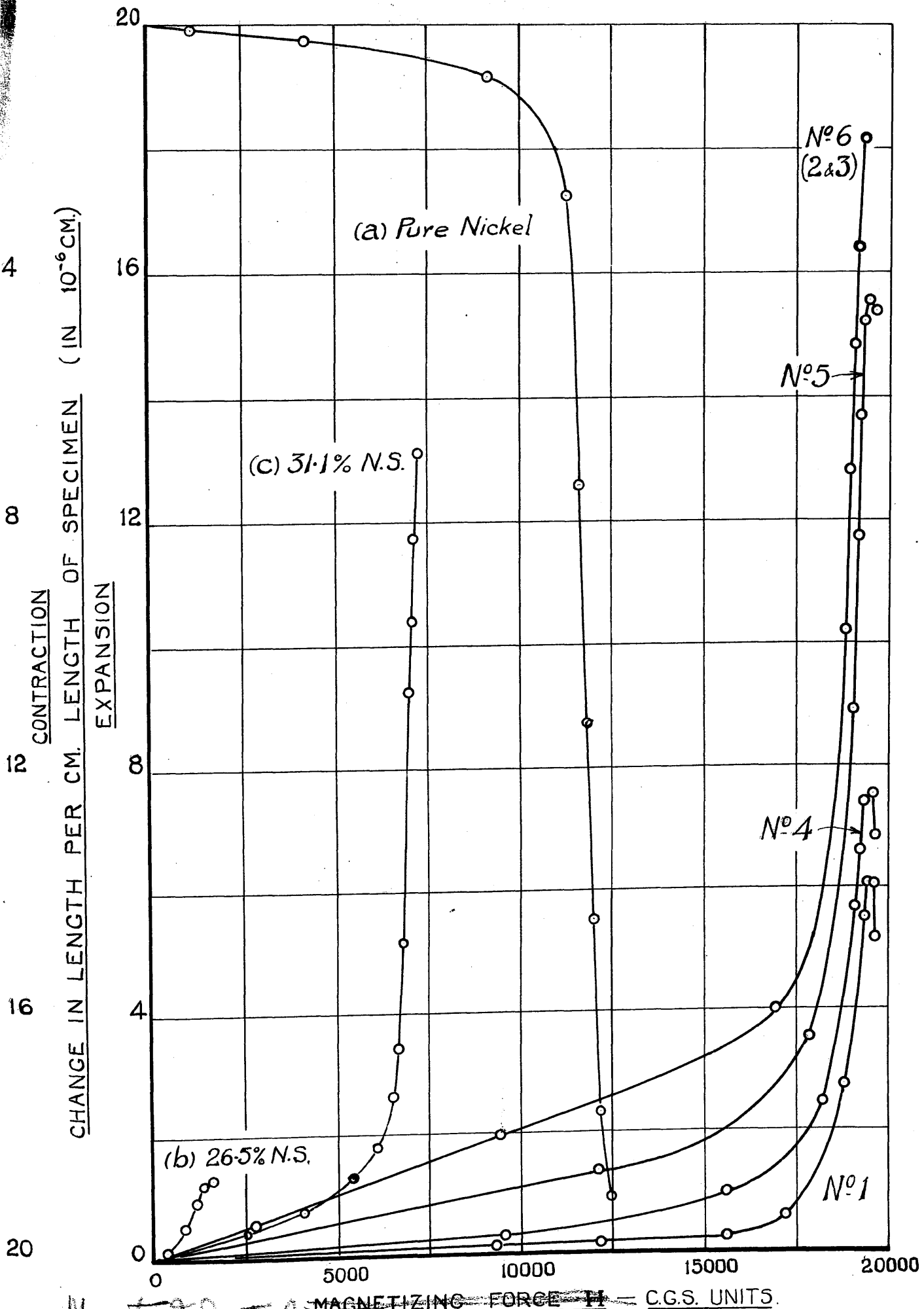

Magnetic Induction B

MAGNETIZING FORCE H - C.G.S. UNITS.

[For Nos. 1, 2, 3, 4, 5 and 6 see Fig. 15.]

striction curves (b) shown in Figs. 15 and 16 were obtained. The large quantity of liquid air required for freezing the rod used for finding the BH curve, was kindly supplied by the British Oxygen Co., Glasgow. The magnetostriction curves (a) for pure nickel are shown in red on Figs. 15 and 16, and the comparatively large alteration in length (a contraction) compared to the expansion for ordinary steel, will be observed. In Figs. 15 and 16 are also shown the magnetostriction curves (c) for the 30 per cent. nickel steel. The marked increase in magnetostriction in passing from 25 per cent. nickel steel to 30 per cent. nickel steel should be noted.

The percentages of nickel in the "25 per cent." nickel steel and the "30 per cent." nickel steel were actually 26.5 and 31.1 respectively, these figures being supplied by the makers. The extra 1.5 per cent. nickel in the first-mentioned alloy may possibly account for the low saturation value of B compared to that shown in Ewing's book.¹³

FURTHER EXPERIMENTS ON THE MAGNETOSTRICTION OF OVERSTRAINED MATERIALS.

The results already described on the effect of tensile overstrain on the magnetostriction of steel were felt to be of sufficient importance to encourage further experiments of a similar nature.

It was decided first to ascertain the effect of simple tensile overstrain on the magnetostriction of nickel. Nickel does not exhibit the phenomenon of the yield-point and it shows only contraction on magnetization, so that a comparison of the effect produced by overstrain on nickel with that recorded for steel should be of interest.

Experiments on Nickel Rods - The elastic properties of nickel, as revealed by tensile tests are shown in Fig. 17.
Curve/

FIG. 17.

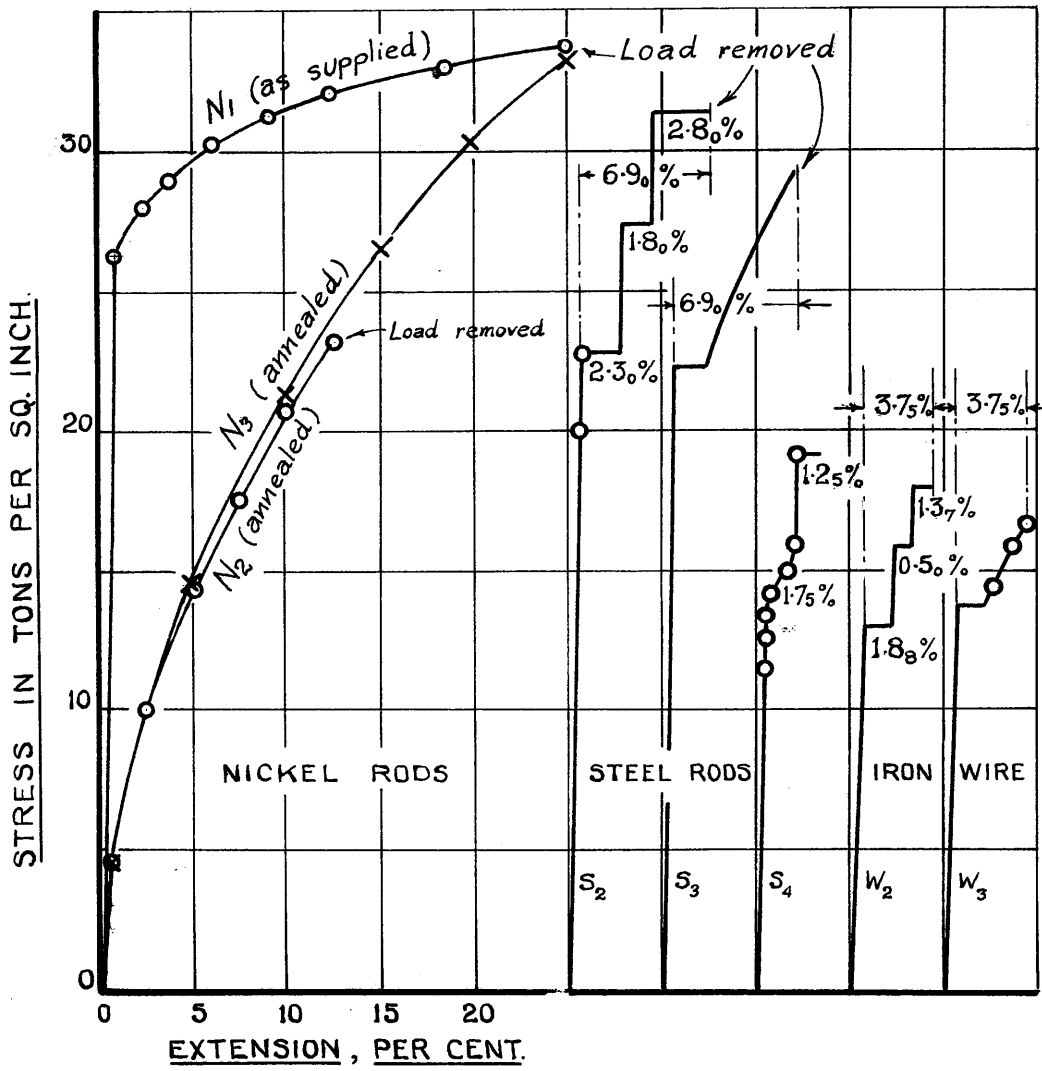

Curve N_1 is a stress-strain curve obtained for the nickel in the condition as supplied. Curves N_2 and N_3 were obtained from specimens which had been annealed for about half an hour at 900° C. The rod N_2 was given a permanent stretch of $12\frac{1}{2}$ per cent., rod N_3 a stretch of 25 per cent.

Fig. 18 gives the BH curves for nickel in four different conditions. Curve N_1 is for nickel in the condition as supplied, curve N_2 for annealed nickel stretched by $12\frac{1}{2}$ per cent., N_3 for annealed nickel stretched by 25 per cent., curve N_4 is for annealed nickel unstrained. The magnetostriction (or contraction due to magnetization) for nickel in these four conditions is also shown on Fig. 18: the curves should be compared with those obtained for steel and shown on Fig. 15. In the case of steel, tensile overstrain (by yield-points) increased the extensions produced by magnetization. In the case of nickel, plastic tensile overstrain produced a decrease in the contractions produced by magnetization. On the other hand magnetization produced greater contraction (at higher magnetic fields) on the nickel in the condition as supplied than on annealed nickel. This is not perhaps what would be expected, since nickel in the condition as supplied, and annealed nickel after stretching are both harder than annealed nickel.

It was next decided to detect by magnetostriction experiments the difference between steel in the condition as supplied and when annealed. Moreover the difference between the effects produced by yield-point extension and by plastic extension of steel had not been clearly investigated, so further experiments on steel rods and on steel and nickel wires were carried out.

Experiments on Steel Rods.- Four mild steel rods (0.15 per cent. Carbon, 0.76 per cent. Manganese) about 30 in. long and $\frac{3}{8}$ in. in diameter, cut from the same bar, were supplied by the Clyde Alloy/

FIG. 18.

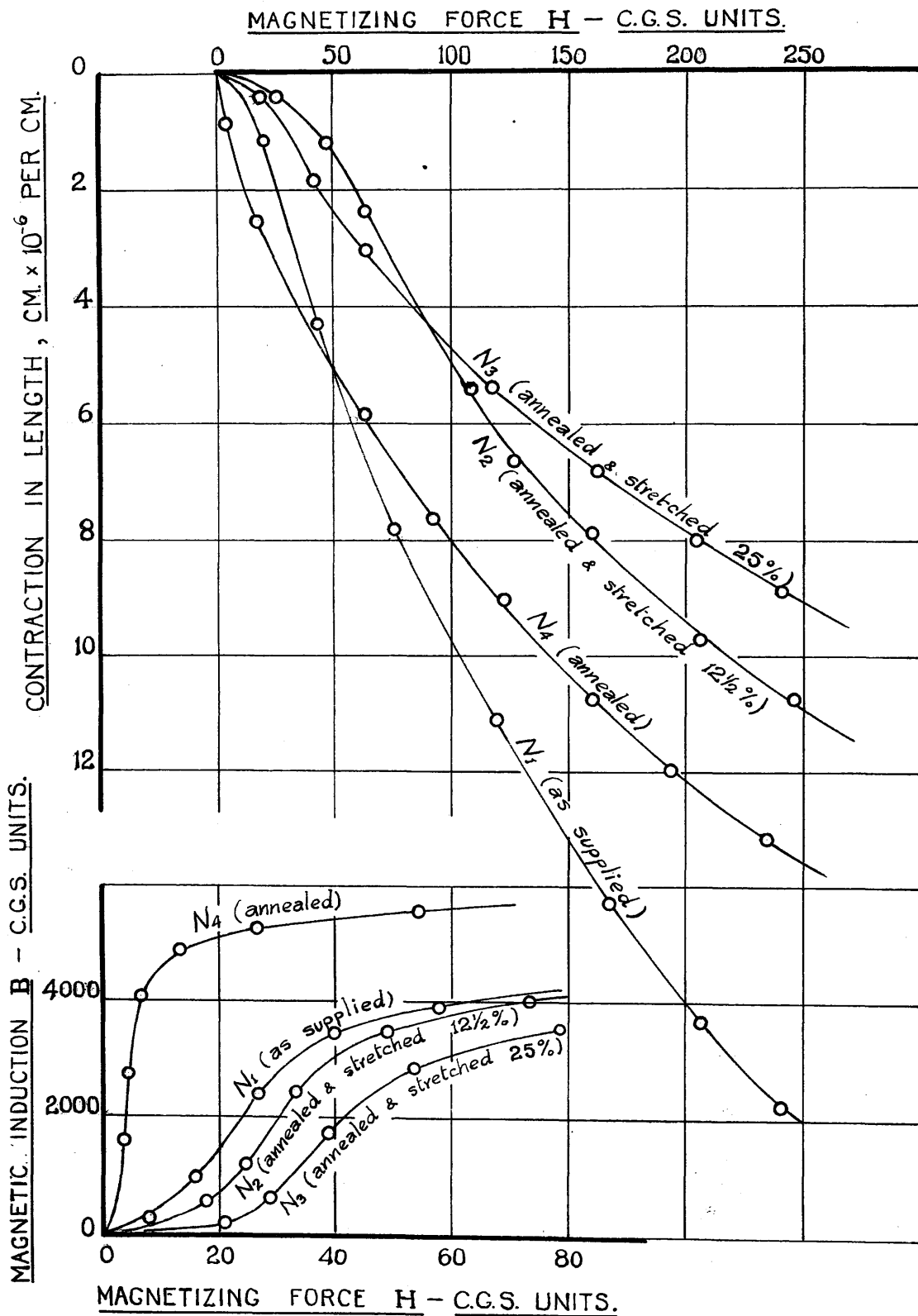

Alloy Steel Co., Ltd., Motherwell. The elastic properties of this steel are illustrated by tension tests shown in Fig. 17. The first rod S_1 was used in the condition as supplied; the second rod S_2 was overstrained in tension by the passage of three yield-points (recovery from each overstrain being effected by warming to 100° C.), the total extension given being 6.9 per cent., the maximum stress applied 31.7 tons per sq. in. (see graph S_2 Fig. 17). The third rod S_3 was overstrained by the passage of one yield-point and the immediate increase of load till the same total extension 6.9 per cent. was given. The stress required for this was 28.8 tons per sq. in. The fourth specimen S_4 was annealed at 900° C for at least half an hour. Graph S_4 , Fig. 17, illustrates the elastic properties of the steel in the annealed state, but magnetic tests were made only on the annealed rod, not on overstrained annealed material.

Fig. 19 shows the BH curves (top parts) and magnetostriction curves obtained for this steel in four different conditions. Annealed steel, S_4 , is shown to have given less expansion due to magnetization than steel S_1 in the condition as supplied. (Annealed nickel gave less contraction than nickel as supplied.) Stretching by three yield-points, S_2 , is shown to have had a much greater effect, in increasing magnetostrictive expansion, than stretching the same amount by a single loading, S_3 . The stress required in the first case (31.7 tons per sq. in.) was greater than that required in the second (28.8 tons per sq. in.). Perhaps it should be remarked that the magnetostrictive expansions are all less than those observed previously. (See Fig. 15). This may have been due to difference in the quality of the steels. The steel used before contained more carbon (0.22 and 0.25 per cent.) than the steel considered here, so it should have exhibited less rather than greater expansions (see Fig. 10); but manganese content may have something to do with the question and is unknown for the previous steel. It has to be admitted, however, that there may be a difference/

FIG. 19.

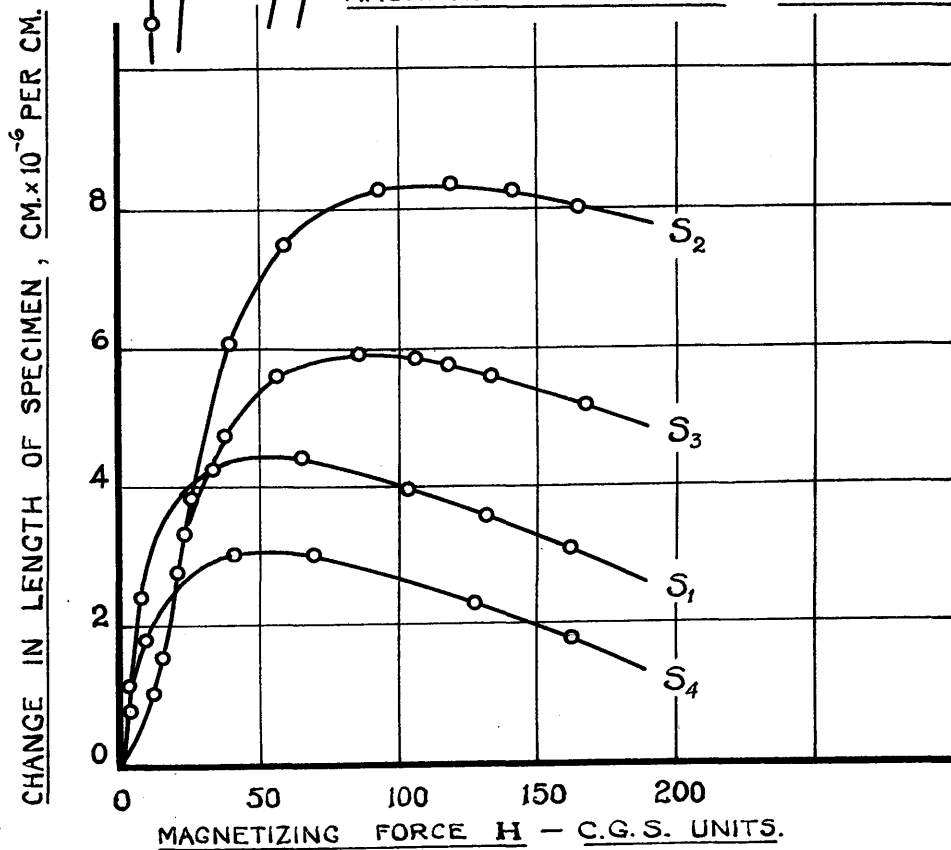
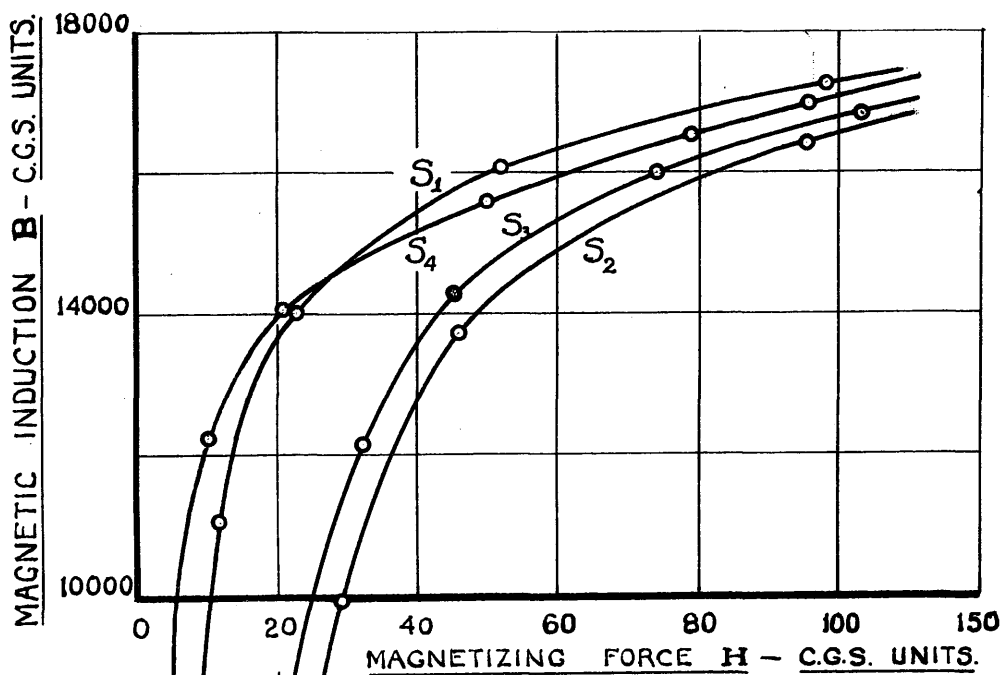

S_1 —As supplied.

S_2 —As supplied, but with 6.9% extension by three yield-points:
31.7 tons per sq. in. stress.

S_3 —As supplied, but with 6.9% extension by single loading:
28.8 tons per sq. in. stress.

S_4 —Annealed.

difference in the sensitivity of the apparatus set up at the two different times, and it has to be remembered that distances are being measured in millionths of a centimetre.

It may also be noted here that an attempt was made to find the difference (if any) between the magnetostriction of steel immediately after overstraining and after recovery from overstrain had taken place. After a specimen had been permanently stretched, it was fitted as quickly as possible into the magnetostriction apparatus. It took, however, about two hours (due to "creep" and temperature changes) before the beat note was sufficiently steady to allow of readings being taken. No change in the magnetostrictive extensions observed was detected even after two days; but the main recovery from the effects of overstrain may have occurred in the first two hours.

Experiments on Iron Wires. - The first experiments performed with wires were a repetition of those with steel rods illustrated in Fig. 19. "Best iron" wire (0.05 per cent. Carbon) was supplied by Messrs. J. Royston, Son and Co., Ltd. The wire in the condition as supplied of course did not exhibit the phenomenon of the yield-point, so three pieces of wire 1/16 in. diameter were annealed by heating for over half an hour to about 920°C. Two of these were overstrained by tension in the manner illustrated on Fig. 17. Wire W_2 was given only yield-point extension: three yield-points are indicated but it is doubtful if at the second one (0.5 per cent.) the extension had continued throughout the whole length of the specimen. Wire W_3 was given the same total extension as W_2 (3.75 per cent.) by a single loading.

In order to get magnetostriction specimens of wire fitted into the apparatus, little brass ends had to be fixed to the wires and the top given lateral support to minimize the swaying which was apt to be set up.

Curves W_1 , W_2 , W_3 and W_4 , Fig. 20, show the change in length produced by magnetization in 1/16 in. iron wire (1) in the condition as supplied, (2) annealed and overstrained by yield-points, (3) annealed and overstrained by the same amount in a single loading, and (4) in the annealed state.

Curve W_1 shows that cold drawn iron wire in the condition as supplied exhibits almost nothing but contraction on magnetization; an observation similar to this but for nickel-steel was made by Nagaoka and Honda in 1902¹⁴.

Curves W_2 , W_3 and W_4 show that a greater effect was produced by overstraining the thin wire by a single loading than by yield-points; the opposite effect was obtained in the case of steel rods.

In order to investigate further the effect of wire drawing, specimens of $\frac{1}{8}$ in. diameter wire and of the $\frac{7}{32}$ in. diameter rod, from which both the $\frac{1}{8}$ in. and the 1/16 in. wire had been cold drawn, were tested with the results shown by the dotted curves W and R on Fig. 20. Cold drawing from $\frac{7}{32}$ in. to $\frac{1}{8}$ in. diameter is shown to have considerably increased magnetostrictive expansion, but on further drawing to 1/16 in. diameter extension practically disappeared and large magnetostrictive contraction was obtained at moderately large fields. This is rather an astonishing result.

Experiments on Nickel Wires. - A sample of nickel wire about 1/16 in. diameter being available, it was tested in the conditions (i) as supplied (ii) after annealing for about 15 minutes at 350°C . (the critical temperature for nickel, that is the temperature at which it loses its magnetic properties, is about 320°C .), (iii) after annealing for 15 minutes at 900°C . The curves n_1 , n_2 , n_3 (in red) on Fig. 20 show the contractions observed on magnetizing the nickel wire in these three conditions. Again the result is rather surprising. Annealing at 350°C . produced a reduction/

FIG. 20.

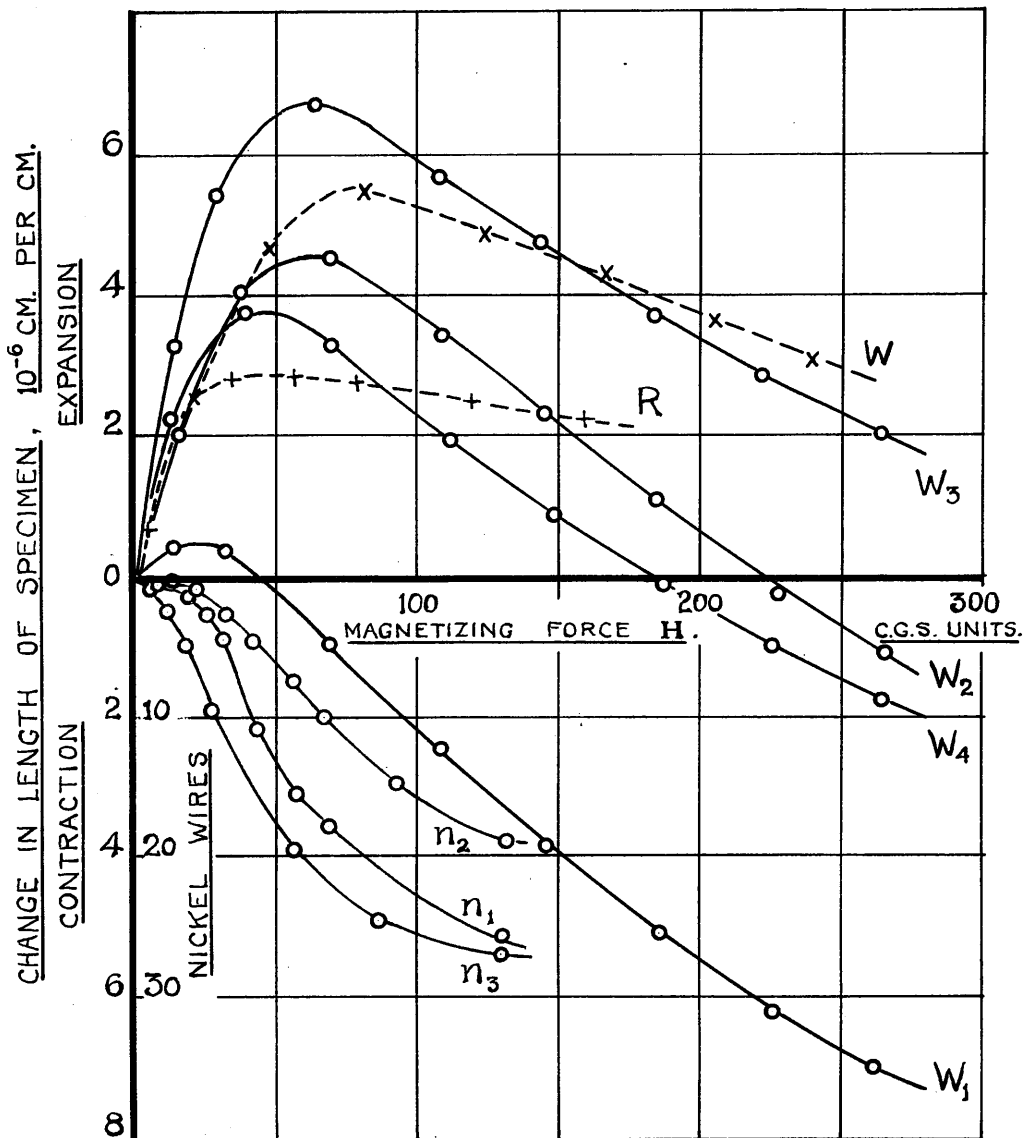

R - Rod as supplied, (7/32 in. dia.)

W - Iron wire as supplied, (1/8 in. dia.).

W_1 - Iron wire as supplied, (1/16 in. dia.).

W_2 - Iron wire annealed, with 3.75% extension by yield-points:
18.5 tons per sq. in. stress, (1/16 in. dia.).

W_3 - Iron wire annealed, with 3.75% extension by single loading:
16.9 tons per sq. in. stress, (1/16 in. dia.).

W_4 - Iron wire annealed, (1/16 in. dia.).

n_1 - Nickel wire, (drawn).

n_2 - Nickel wire, (annealed at 350° C.).

n_3 - Nickel wire, (annealed at 900° C.).

reduction in the contraction, while annealing at 900°C . produced an increase over that observed with the wire in the condition as supplied.

The BH curves which had to be obtained before the magnetostriction curves of Fig. 20 could be plotted, are shown on Fig. 21. They were obtained by the single-pole magnetometric method suitable for long thin wires.

Explanation - At first it was thought that Webster's¹⁵ results on the magnetostriction of iron crystals and the work of Kaya, Honda and Masiyama¹⁶ on iron and nickel crystals afforded a likely explanation of the effect of overstrain on the magnetostriction of steel. Webster obtained results for the magnetostriction of short rods taken from single iron crystals - iron crystallizes in the body-centred cubic form. His specimens were (1) with their lengths perpendicular to the faces of the cubic crystal - called the (100) specimens; cut from the crystals as follows, (2) with their lengths perpendicular to the face diagonal planes - the (110) specimens; and (3) with lengths along the cube diagonals - the (111) specimens. The (100) specimens gave a very big magnetostrictive expansion compared with the (110) specimens; whereas the (111) specimens showed a contraction for all magnetic fields up to the maximum field used. Hence on the doubtful assumption that overstrain produces certain rotations in the crystal elements of the crystalline grains a possible theory could be formulated.

It is, however, a well known fact that tensile strain within the limits of elasticity suffices not only to reduce greatly the magnetostrictive expansion of steel but actually to change it into a contraction, and it is unlikely that such small elastic strains can be accompanied by appreciable rotation of the crystal elements. Hence it seems desirable to look in the first place for an explanation of the effects of overstrain on magnetostriction, in the internal elastic strains set up in the material by the overstrain, leaving aside the question as to why elastic-strain alters magnetostriction.

FIG. 21.

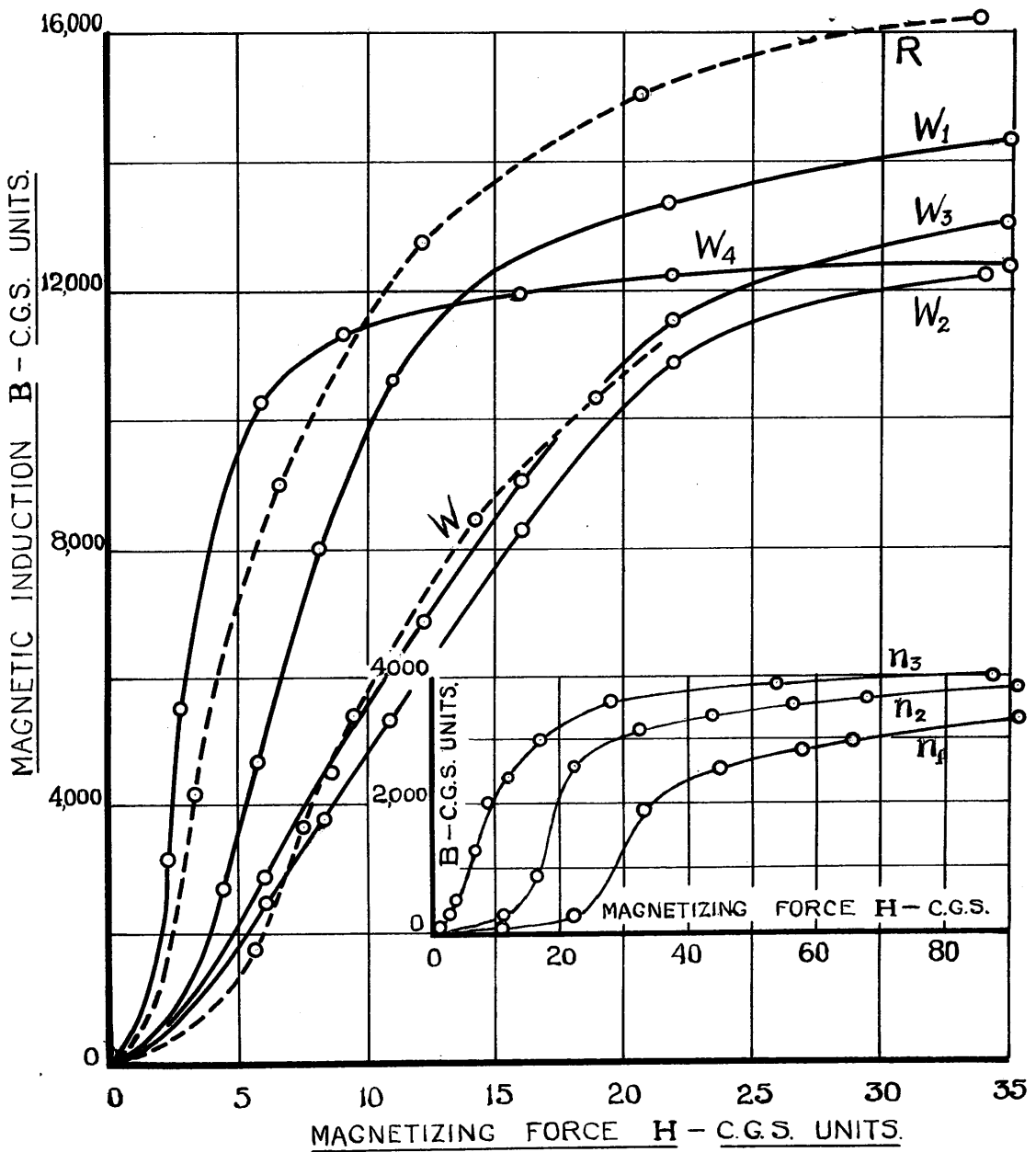

[For $R, W, W_1, W_2, W_3, W_4, n_1, n_2,$ and n_3 see Fig. 20.]

As it was desirable to obtain an estimate of the magnitude of the magnetostrictive effect of elastic stress or strain on the material being used, experiments were performed with a specimen of the annealed iron wire 1/16 in. in diameter. The apparatus was slightly modified (the mercury bath in which the apparatus floated being removed, etc.) to enable loads to be suspended from the foot of the wire specimen under test, and then the curves a, b, c, d of Fig. 22 were obtained, showing how all expansion on magnetization had disappeared, and only contraction obtained, when the wire was under as low a tensile stress as say 4 tons per sq. in. Curves similar to these obtained, but with greater stresses, by Bidwell are shown in Ewing's "Magnetic Induction in Iron and other Metals." The difference between the curves obtained with the unstressed wire and that shown for a similar wire in Fig. 20 (e.g. maximum extension now only 2.3×10^{-6} instead of 3.8×10^{-6} cm. per cm. length) has probably to be accounted for by the different methods of fixing the specimen which had to be adopted.

A comparison of curves a and c, Fig. 22, shows that tensile stress of about $3\frac{1}{2}$ tons per sq. in. sufficed to reduce magnetostrictive expansion (and increase magnetostrictive contraction) by about $3\frac{1}{2}$ to 4×10^{-6} cm. per cm. length, at higher magnetizing fields. And it may be inferred that a compressive elastic stress $3\frac{1}{2}$ tons per sq. in. would increase magnetostrictive expansion by the same amount. Now referring to Fig. 20, it will be noticed that the increase in the magnetostriction of annealed 1/16 in. wire (curve W_4), when the wire has been overstrained by a single loading (curve W_3) is on the average about 3.5×10^{-6} cm. per cm. length of specimen. Thus if it can be assumed that the tensile overstrain has left the material under an internal compressional stress of about $3\frac{1}{2}$ tons per sq. in., an explanation of the increase in magnetostriction is given. Now referring to curve W_2 , Fig. 17, it will be noticed that the "step" between the yield-points obtained with this wire was about $3\frac{1}{2}$ tons per sq. in., and this rise in/

FIG. 22.

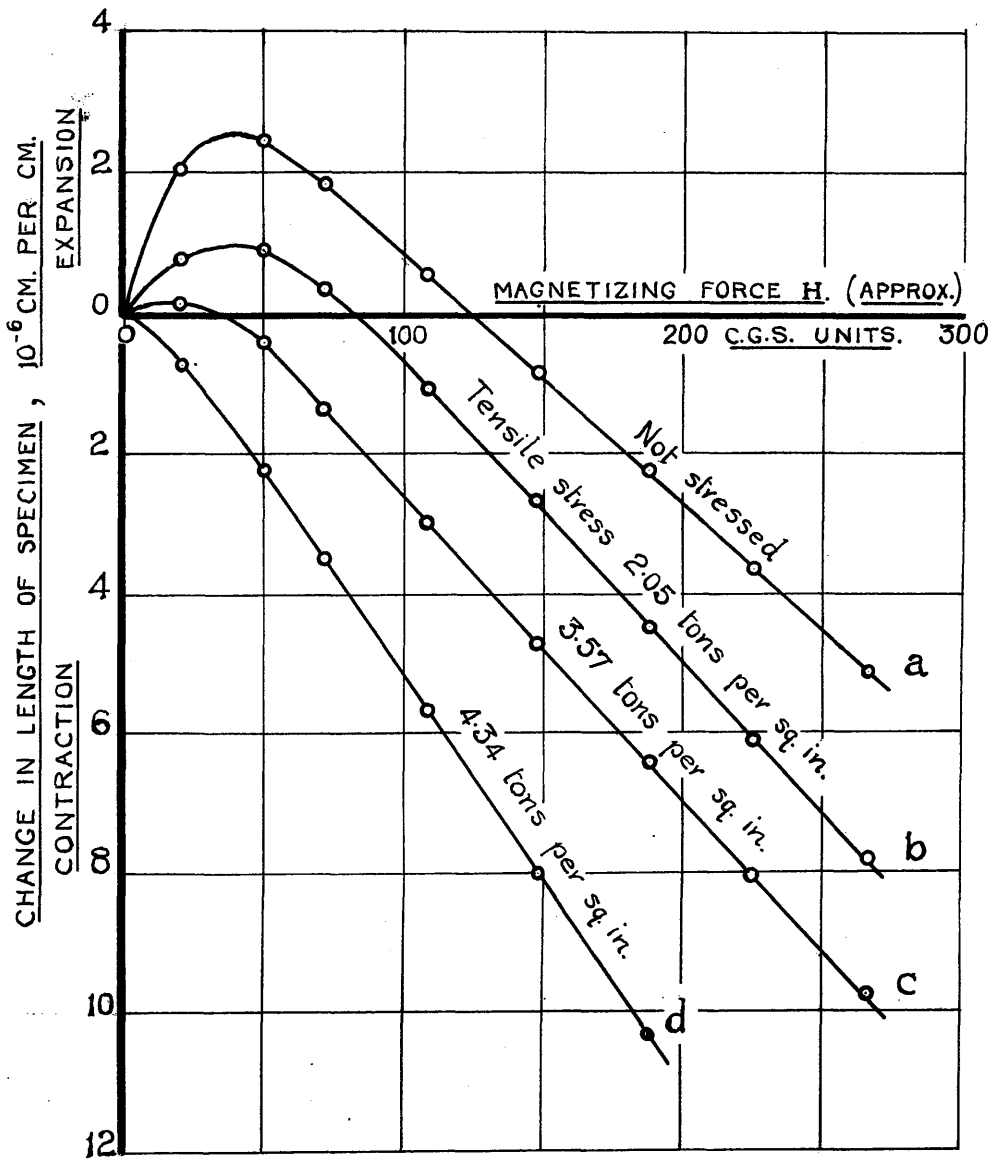

in the yield-point, due to recovery from overstrain has long been attributed to internal compressive stress set up by the process of recovery from overstrain¹⁷. Of course, to maintain equilibrium tensional stresses must also be present so that the total compressional force in the material is balanced by the total tensional force, and in the case under consideration since the compressional stress is predominant the area under compression is less than that under tension. In an article entitled "Elasticity Problems in Metals," Sachs¹⁸ considers internal stress distributions in metals and gives diagrams of the tensional and compressional stresses in brass rods drawn from 33 mm. to 30 mm. diameter. The tensional stress at the outer layer of the rod is as high as $\frac{5}{4}$ the strength of the material, and the compressive stress near the centre of the specimen is even greater. If the same distribution of the stress occurs in iron which is cold drawn, then Sachs's values indicate that at the first stage of the drawing process the compressive stress is predominant, and this may account for the increase in the magnetostriction of the $\frac{1}{8}$ in. diameter wire W (Fig. 20) when drawn from the $\frac{7}{32}$ in. rod R. Unfortunately Sachs does not give figures for more drastic hard-drawing, so that the nature of the stress distribution in this case can only be conjectured, but from the curve W_1 , Fig. 20, if the theory being indicated is to hold good, the predominant internal stress in $\frac{1}{16}$ in. drawn wire must be tensional. Sachs speaks of "dangerous tensile stresses in the outer skin."

The apparent inconsistency in the behaviour of steel rods and iron wires shown by a comparison of magnetostrictive curves S_2 , S_3 , of Fig. 19 with W_2 , W_3 of Fig. 20 (material strained by yield-points and by a single loading) may perhaps be explained by the fact that magnetostriction specimens were obtained from the rods by turning them down from $\frac{3}{8}$ in. to $\frac{1}{4}$ in. diameter, and this may have altered the distribution of internal stress produced by the/

the tensile overstrain. But the internal stress distributions may be a function of the radius of the cylindrical specimens and even of the size of the crystalline grains of the material.

The results obtained with nickel can also be regarded as in harmony with the theory which attributes the magnetostrictive effects of overstrain to elastic internal stresses. Bidwell showed that elastic tensile stress decreased the contraction observed on magnetizing nickel. Thus to account for curves N_2 and N_3 of Fig. 18, tensile overstrain of nickel must be supposed to leave the material under predominating elastic tensile stress - the phenomenon of recovery from overstrain which sets up compressive stresses is not observed with nickel. The effect produced by annealing drawn nickel wire, illustrated by curves n_1 , n_2 , n_3 of Fig. 20 may be accounted for by supposing the slight relief of internal stress, produced by heating to 350°C ., to have been a greater relief of compressional stress than of tensional, whereas heating to 900°C . has completely relieved the drawn wire which was under excess tensional stress initially. The theory is of course tentative and not completely convincing.

A comprehensive survey of the experimental work done in connection with magnetostriction has been prepared by Williams¹⁹: the subject is also dealt with in the book "Magnetism and Atomic Structure" by Stoner. In J. J. Thomson's "Applications of Dynamics to Physics and Chemistry" the effect of strain on magnetization is treated mathematically. The mathematical theory of magnetostriction is dealt with in a paper by R. H. Fowler, F.R.S. and P. Kapitza²⁰, where calculations based on a quantum theory agree with Webster's¹⁵ experimental results.

In conclusion the writer takes this opportunity of expressing his indebtedness to Professor James Muir, D.Sc., M.A., for his valuable/

valuable advice and assistance during the progress of the research which was carried out in the Natural Philosophy Department of the Royal Technical College.

BIBLIOGRAPHY

1. Whiddington, Phil. Mag., Nov. 1920
2. Dowling, Phil. Mag., vol. 46, p. 81 (1923).
3. Thomas, "The Engineer", vol. 139, p. 102 (1925).
4. Hardy, "Dictionary of Physics", vol. 1, p. 576
5. For a description of Newton's colours of thin plates and the thickness of film concerned see S.P. Thompson's "Light Visible and Invisible", p. 140.
6. Lord Rayleigh, "Collected Papers", vol. iii, p. 523.
7. McKerracher and Porter, "The Channel", Vol. VI, No. 6, 1923.
8. Joule, Phil. Mag., 1847, Vol. XXX.
9. Mayer, Phil. Mag., Vol. XLVI.
10. Barrett, Nature, 1882, Vol. XXVI.
11. Shelford Bidwell, Proc. Roy. Soc., 1886, Vol. XL; Phil. Trans., 1888; Proc. Roy. Soc., 1890, Vol. XLVII.
12. Vincent, Proc. Phys. Soc., 1919 - 20, Vol 32.
13. For more details see Ewing, "Magnetic Induction in Iron", page. 187.
14. Nagaoka and Honda, Phil. Mag., 4, July, 1902.
15. Webster, Proc. Roy. Soc., A, Vol, 109, 1925.
16. Honda and Kaya (Tokyo); Tohoku Univ. Sei. Rep., 15, pp. 721-753; 1926. Honda and Masiyama (Tokyo); Tohoku Univ. Sci. Rep., 15, pp. 755-776; 1926.
Kaya and Masiyama, Nature, 120, pp. 951-952, Dec., 31, 1927.
17. e.g. Muir, Proc. Roy. Soc., Vol. 77, 1906.
18. Sachs, Trans. Faraday Soc., Vol. 24, 1928, p. 91.
19. Williams, "Journal of the Optical Society of America and Review of Scientific Instruments," Vol. 14, Numbers 1 to 6, 1927.
20. Fowler and Kapitza, Proc. Roy. Soc., May 2nd, 1929.