

STUDIES ON
THE THERMODYNAMICS OF ASSOCIATION OF IONS
IN AQUEOUS SOLUTIONS

A Thesis

Submitted to the University of Glasgow

for the degree of

DOCTOR OF PHILOSOPHY

by

V.S. KRISHNAN NAIR, M.Sc.

February, 1958.

ProQuest Number: 13850333

All rights reserved

INFORMATION TO ALL USERS

The quality of this reproduction is dependent upon the quality of the copy submitted.

In the unlikely event that the author did not send a complete manuscript and there are missing pages, these will be noted. Also, if material had to be removed, a note will indicate the deletion.



ProQuest 13850333

Published by ProQuest LLC (2019). Copyright of the Dissertation is held by the Author.

All rights reserved.

This work is protected against unauthorized copying under Title 17, United States Code
Microform Edition © ProQuest LLC.

ProQuest LLC.
789 East Eisenhower Parkway
P.O. Box 1346
Ann Arbor, MI 48106 – 1346

PREFACE

The work described in this thesis was carried out at the University of Glasgow, in the Chemistry Department which is under the direction of Professor J. Monteath Robertson, F.R.S.

The material of part I has been published in the Journal of Chemical Society in the series "Thermodynamics of Ion Association". A paper dealing with the spectrophotometric work described in the appendix, together with a potentiometric study of the dissociation of the hydrogen chromate ion, is to appear in the Transactions of Faraday Society.

The author wishes to express his most sincere appreciation for the inspiration given by Dr. Nancollas under whose sympathetic guidance and encouragement this work was performed. Thanks are due to Dr. S.P. Datta, Biochemistry department, University College, London for advice on cell design, loan of a platinum resistance thermometer and provision of pressure correction tables. The author acknowledges the help of Dr. I.C. McNeill for photographs of the apparatus and that of Mr. J. Findlay for photographic reproductions of the graphs and figures.

Mr. A. Laurie is thanked for his generous technical assistance throughout the work and Mr. J. Leslie for construction of the glass apparatus.

The author also wishes to thank the University of Travancore, Trivandrum, India for his deputation to the University of Glasgow which made this work possible.

V.S. KRISHNAN NAIR.

CONTENTS

Preface

Summary

	Page
GENERAL INTRODUCTION	1
PART I - SOME THALLOUS SALTS WITH UNIVALENT ANIONS ..	8
<u>Introduction</u>	8
<u>Experimental and Apparatus</u>	12
Preparation of Reagents	12
Apparatus	15
a) Solubility determinations	15
b) Conductivity measurements	16
Experimental Technique	24
a) Solubility measurements	24
b) Conductivity measurements	28
<u>Results and Discussion</u>	33
a) Solubility experiments	33
b) Conductivity experiments	44
PART II - BIVALENT METAL SULPHATES	53
<u>Introduction</u>	53
<u>Apparatus and Experimental Technique</u>	57
Preparation of Reagents	57
Potentiometer and accessories	59
Temperature measurement	63

CONTENTS (contd.)

	Page
Platinum resistance thermometer	63
Triple point cell	67
Standardisation of thermometer	75
E.M.F. Cell and Electrodes	79
Procedure for e.m.f. measurements	88
<u>Results and Discussion</u>	94
a) Dissociation of the bisulphate ion	94
b) Association of bivalent metal cations with the sulphate ion	116
PART III - GENERAL DISCUSSION	141
APPENDIX	160
BIBLIOGRAPHY	178

SUMMARY

The thermodynamics of ion association in aqueous solutions of 1:1 and 2:2 valency type electrolytes have been studied.

The thesis is divided into three parts together with an appendix. In part I, the uncharged ion pairs formed by the thalious ion with the azide, nitrate and bromide ions have been studied by solubility measurements on thalious iodate in sodium azide and potassium nitrate solutions at 0°, 10°, 25° and 40°C., and on thalious bromide in sodium perchlorate and potassium nitrate solutions at 25° and 40°C. Conductivity measurements of thalious chloride solutions at 40°C and on saturated solutions of thalious bromide at 25° and 40°C have also been made. The heat and entropy of association are compared with data for other uncharged ion pairs.

Part II deals with a study of association of bivalent cations with the sulphate ion using the cell

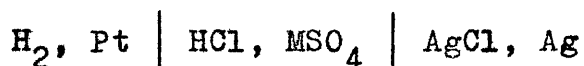

in which e.m.f.s were measured to an accuracy of ± 0.01 m.v. A detailed investigation of the second dissociation of sulphuric acid, has been made over the temperature range

0°C to 45°C using the cell,

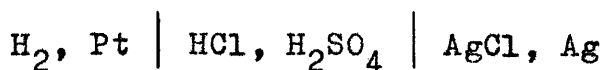

and the results obtained are discussed and compared with the available data in ^{the} literature. The heat of dissociation of bisulphate is in good agreement with values obtained by calorimetric and spectrophotometric methods. The ionic association in solutions of the sulphates of magnesium, zinc, cobalt, nickel and manganese has been studied at various temperatures in the range 0°C to 45°C., in a range of ionic strength and the thermodynamic functions have been derived.

Part III consists of a general discussion of the results. The entropies of the various ion pairs have been estimated, taking into account both translational and rotational terms. The heat and entropy data have been discussed in relation to the factors involved in the association process. ΔS hydration of the ion-pairs are compared in relation to their size, and a good linear relationship between ΔS hyd (ion pair) and reciprocal of interionic distance has been observed for the 1:1 ion pairs (including some silver salts). A similar relationship is indicated for the sulphates of

the transition metals cobalt, nickel and manganese.

An appendix is included dealing with a spectrophotometric study of the equilibrium $\text{HCrO}_4^- \rightleftharpoons \text{H}^+ + \text{CrO}_4^{--}$ at 25°C., at wave lengths 355, 365, 370, 375 and 385 m.u. A value of 2.97×10^{-7} obtained for the dissociation constant is in agreement with the potentiometric value.

GENERAL INTRODUCTION

GENERAL INTRODUCTION

In 1926, Bjerrum^{1a} advanced his theory of association of ions. He pictured a state intermediate between a free ion and a neutral molecule, which he termed an 'associated ion pair', this being a pair of oppositely charged ions caught in each other's electric field and therefore temporarily functioning as a separate kinetic entity. Bjerrum emphasised that the Debye Hückel Onsager theory should be applied only to those ions which were not associated in this way.

The average effects of ion-pair formation may be calculated by considering that all oppositely charged ions within a certain critical distance "q" of one another are 'associated into ion pairs. If we consider a solution of a symmetrical electrolyte, the average distribution of negative ions will be greater in the vicinity of a given positive ion than in the bulk of the solution. The number of negative ions in a shell of thickness 'dr' at a distance 'r' from the positive ion obtained from the Boltzmann expression is $n_- \exp\left(-\frac{Z_1 e \psi}{kT}\right) 4 \pi r^2 dr$

where $Z_1 e \psi$ is the electrical potential energy of the negative ion of valence Z_1 , and n_- is the bulk concentration of the negative ions. When 'r' is small,

since the potential of the central ion will be dominant,

$$\psi = \frac{Ze}{\epsilon r} \quad \text{where } \epsilon \text{ is the dielectric constant}$$

of the medium, so that the number of negative ions in the shell considered is

$$4 \pi n_- \exp\left(-\frac{Z^2 e^2}{\epsilon k T r}\right) r^2 dr$$

If we consider a series of such shells of the same thickness, the number of negative ions which can be found in each succeeding shell on a time average basis can be estimated. With increasing distance from the central ion, the probability of finding a negative ion in any unit volume decreases, but since the total volume considered is progressively increasing, the two opposing effects combine to give a critical value for 'r'. At this distance there is a minimum probability of finding a negative ion anywhere on the sphere surrounding the positive ion and it corresponds to, q, the distance at which the mutual potential energy of the two ions becomes equal to 2 kT.

$$q = \frac{Z^2 e^2}{2 k T} = Z^2 |3.57| \text{ \AA in water at } 25^\circ\text{C.}$$

The Debye-Hückel expression for activity coefficient of ions is given by

$$-\log f^{\pm} = \frac{A Z_1 Z_2 I^{\frac{1}{2}}}{1+B \delta I^{\frac{1}{2}}}$$

where A and B are constants depending on temperature and solvent properties and δ is an 'ionic size' parameter. It is derived from a consideration of only long range Coulomb forces and how they are modified by the short range electrostatic interaction between the ions, considered as rigid spheres. Empirical extensions of the type

$$-\log f^{\pm} = \frac{A Z_1 Z_2 I^{\frac{1}{2}}}{1+B \delta I^{\frac{1}{2}}} + bI$$

have been made both by Guggenheim^{2a} and by Davies^{3a} accounting for interactions between ions and solvent molecules and possible deviations from the nondeformable sphere model for ion. Davies equation has the form

$$-\log f^{\pm} = A Z^2 \left[\frac{I^{\frac{1}{2}}}{1+I^{\frac{1}{2}}} - 0.2I \right]$$

and corresponds to a "q" value of 4 Å in water. This expression has been used widely and found to give activity coefficients in good agreement with experimental

values up to an ionic strength of 0.1 m for 1:1 electrolytes^{4a}.

A number of methods are available for the study of ion association in solution. Among them are (1) conductivity (2) solubility (3) e.m.f. (4) spectrophotometry and (5) vibration spectroscopy. Measurement of conductivity has been widely used, the deviation from Onsager equation being ascribed to ion association. Thus Davies^{5a} and coworkers have determined the dissociation constants for a large number of 1:1, 2:2, 1:2 and 3:3 electrolytes. This method is particularly suitable for symmetrical valency type electrolytes, for in these, ion pairs have no residual charge and hence do not contribute to the observed conductivity. Measurement of solubility of sparingly soluble salts in^{the} presence of added electrolytes has been used by Davies^{6a} to study calcium salts of organic acids and by Bell and George^{7a} for calcium and thallos ion pairs. Monk et al^{8a} have used e.m.f. measurements extensively. The spectrophotometric method depends upon the ion and ion pair having different extinction coefficients. Raman spectra and other vibration spectra have also been used to a

limited extent. Mention can be made of other methods such as reaction kinetics, molecular refractivity and nuclear magnetic resonance.

Much of the available data on ion association refer to only a single temperature or a small range of temperature. It is of interest to study thermodynamic properties of the association process. Let us consider the state of two water molecules in pure water and the change brought about by replacing one of them by an ion such as K^+ , (of about the same size as a water molecule). We find that whereas the mutual potential energy between the two water dipoles with their axes lying along the line joining their centres is about -0.15 electron volt, the potential energy between the K^+ ion and the water molecule is about -0.7 electron volt. This indicates a considerable interaction between the K^+ ion and surrounding water molecules, leading to orientation of the water dipoles around the ion, the so called "ice-berg" effect^{9a}. When an ion M^{m+} is brought into solution the system loses entropy and when this associates with an ion X^{n-} , the partial neutralisation of charge causes an

increase in disorder of the water molecules and a consequent breakdown of the "iceberg" structure.

In general, an association reaction may be written as

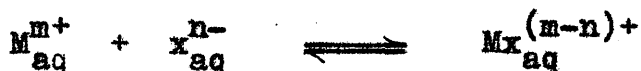

If we consider a symmetrical electrolyte, the above equation reduces to



$$\text{or } K = \frac{Mx \cdot fMx}{M^{m+} \cdot x^{m-} \cdot fM^{m+} \cdot fx^{m-}} = \frac{Mx}{M^{m+} \cdot x^{m-} \cdot f_m^{+2}}$$

It is desirable to collect data over as large a temperature range as possible to obtain reliable thermodynamic properties. In the present work, part I deals with association of the thallos ion with the azide, nitrate, bromide and chloride ions. These have been studied by solubility measurements on thallos iodate and thallos bromide in presence of added salt solutions at 0°C, 10°C, 25° and 40°C. and by conductivity measurements on thallos chloride at 40°C. Part II is devoted to 2:2 electrolytes. The sulphates of magnesium, zinc,

cobalt, nickel and manganese have been studied by an e.m.f. method at temperatures from 0°C. to 45°C. The second dissociation of sulphuric acid has also been measured. Each part is introduced separately and part III consists of a general discussion of the results. An appendix is included in which the equilibrium $\text{HCrO}_4^- \rightleftharpoons \text{H}^+ + \text{CrO}_4^{2-}$ has been studied at 25°C by a spectrophotometric method.

PART I

SOME THALLOUS SALTS WITH UNIVALENT ANIONS

Introduction

It has been fairly well established that the Debye-Hückel theory of interionic attraction and the Onsager treatment of conductivity explain more or less correctly the behaviour of electrolyte solutions at very great dilutions. Taking into account effects due to short-range interactions between ions and solvent molecules and those among the ions themselves not represented by the rigid-sphere model for ions assumed by Debye and Hückel, a number of modifications have been made to Debye-Hückel's expression for ^{the} activity coefficient. The expression derived by Davies^{1b} and used extensively has been found to yield very reliable and consistent data for normal 1:1 electrolytes to concentrations up to 0.1 M. The Onsager limiting law for conductivities has been put to test for a number of 1:1 electrolytes by Shedlovsky and many other workers^{2b} who have shown that it is obeyed very well to concentrations up to 0.001 M. The validity of these equations is rather more limited in range in the case of electrolytes of higher valency type. Since

theory is borne out by experiment to a great extent with uni-univalent electrolytes, any deviation from theory in this class can be attributed to factors like ion association. It is therefore, apparent that uni-univalent salts are amongst the most suited for a quantitative study of the phenomenon of ion association.

As has been explained previously, according to Bjerrum's electrostatic treatment^{3b}, the minimum distance of closest approach for univalent ions of opposite charge is given by $q = \frac{e^2}{2\epsilon K T}$. The high dielectric constant of water ($\epsilon = 78.54$) when substituted gives $q = 3.57 \text{ \AA}$ for aqueous solutions at 25°C. The possibility of finding many ions within this range of one another is rather remote, when we consider that in such solutions many ions, especially the cations, are hydrated to some extent and hence possess effective radii of higher magnitude than the crystal radii. Among the univalent cations, Ag^+ and Tl^+ probably form the most stable ion pairs.

La Mer and Goldmann^{4b} determined the solubility of thallos iodate in salt solutions to study the effect of added salt, with and without a common ion, on the activity coefficient of thallos iodate. Conductivity

measurements have been made on thallos chloride as early as 1911 by Bray and Winninghoff^{5b} and later by Garrett and Vellenga^{5b}. However, these workers did not attempt measurements at different temperatures which would have enabled calculation of heat and entropy values for the association. The solubility of calcium iodate in solutions of the sodium salts of organic acids has been used by Davies^{6b} to obtain the degree of dissociation of the corresponding calcium salts. Employing a similar technique Bell and George^{7b} determined the solubility of thallos iodate in different salt solutions at three temperatures and reported values for the entropy of dissociation of the ion pairs of Tl^+ ion with Cl^- , OH^- , SO_4^{--} and CNS^- ions.

In the present work, thermodynamic data for thallos azide and nitrate have been obtained by a similar series of solubility measurements at 0° , 10° , 25° and $40^\circ C$. Determination of solubilities of thallos bromide has been done at $25^\circ C$ and $40^\circ C$ in solutions of potassium nitrate and sodium perchlorate. These in conjunction with the conductivity measurements on saturated solutions

of thalious bromide at the two temperatures have provided the free energy, heat, and entropy data for thalious bromide. Conductivity measurements on solutions of thalious chloride at 40° have been used to obtain the mobility of Tl^+ ion which was required for calculations on thalious bromide and the association constant for thalious chloride. The latter measurements together with the conductivity data on thalious chloride at 25° by other workers^{5b} have also enabled a comparison of the entropy values for thalious chloride obtained by the two methods.

Experimental and Apparatus

Preparation of reagents

(1) Conductivity water. This was prepared by a mixed bed deionization process, described by Davies and Nancollas^{8b}.

Distilled water was slowly passed down a column consisting of an intimate mixture of one part (approximately 10 m.l.) of the strong acid resin Amberlite I R - 120, and two parts (approximately 20 m.l.) of the strong base resin Amberlite I R A - 400.

Any cation impurities in the water exchanged with hydrogen ions from the acid resin, and as the latter ions were immediately neutralised by the basic resin, the former process went to completion. The anion impurities were likewise removed by the strong base resin.

The specific conductivity of the water was usually about 0.08 to 0.10×10^{-6} reciprocal ohms.

(2) Preparation and purification of salts

(a) For solubility experiments:- Thallous iodate was prepared by dropping solutions of equivalent quantities of A.R. potassium iodate and A.R. thallous sulphate into a large volume of distilled water kept vigorously stirred

at 65°C, over a period of two hours. The precipitate was allowed to settle and washed six times with warm water by decantation. It was then digested with three times its weight of conductivity water for four hours at 80°C and most of the smaller particles were removed by repeated sedimentation.

In order to prepare thallos bromide, solutions of A.R. potassium bromide and A.R. thallos sulphate were added dropwise to a large volume of distilled water kept stirred at room temperature. The precipitate was similarly washed six times and digested with conductivity water at 50°C for two hours. Sedimentation was employed as before.

Sodium azide was recrystallised three times from conductivity water and dried in an oven at 110°C. A.R. potassium nitrate was used without further purification.

b) For conductivity experiments:- Thallos chloride was prepared by mixing equivalent solutions of A.R. hydrochloric acid and A.R. thallos sulphate. The precipitate was washed free from traces of sulphate and chloride. It was then recrystallised four times from conductivity water and dried at 110°C. The thallos

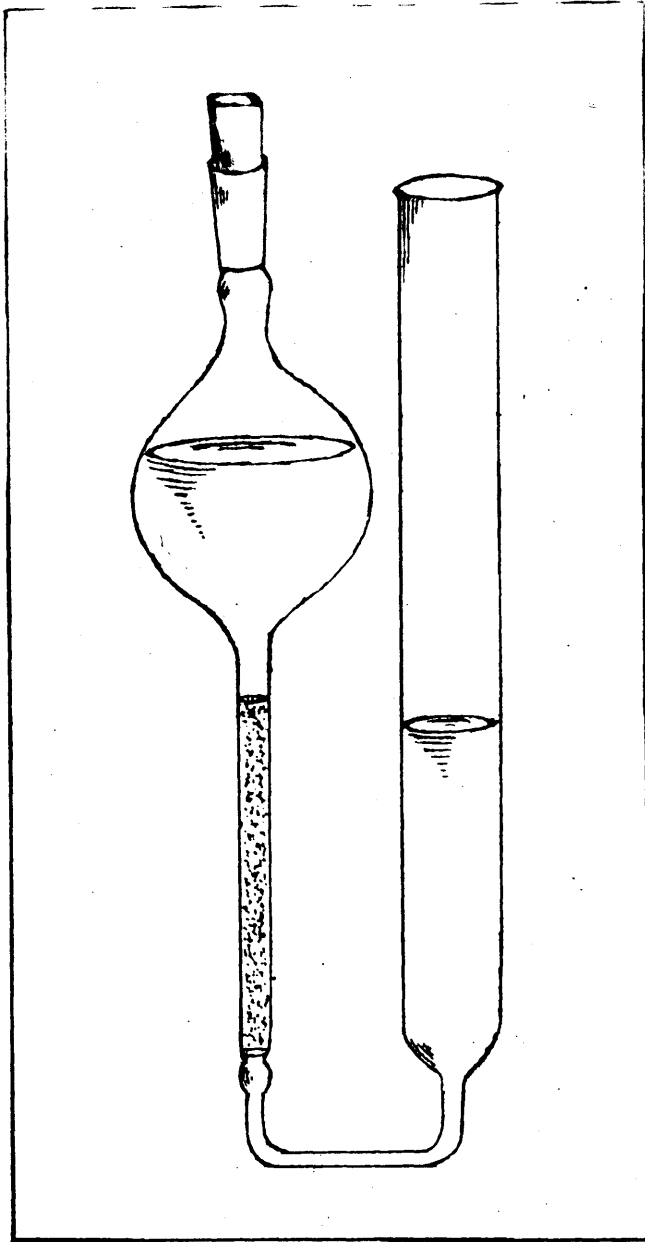

FIG. I. THE SATURATOR

bromide, prepared as before, was purified in the same way by recrystallisation.

3) Preparation of stock solutions

Steamed out, seasoned pyrex stock flasks with glass stoppers were used for the preparation of stock solutions.

Samples of the reagents purified and dried as described before were weighed out from small pyrex weighing bottles using a Stanton semi-micro balance and weights which had been calibrated by the method of Kohlrausch^{9b}. Solutions were made up by weight with conductivity water using a large Sartorius balance sensitive to 0.001 gm. Stock solutions thus prepared were diluted to the required concentration by the weight method using a weight burette. Vacuum correction was applied to all weighings.

Stock solutions of sodium perchlorate were prepared by exact neutralisation of carbonate-free sodium hydroxide solution with perchloric acid solution.

Apparatus

a) Solubility Determinations

Saturators similar to the type described by Davies^{6b}, made of pyrex glass were used (Fig. 1). One of the two limbs consisted of a bulb of about 100 m.l. capacity

connected to a short, horizontal capillary tube through a vertical tube of about 12 cms long and 0.8 cm^2 cross section and a number 3 sintered partition. This limb was to contain the column of sparingly soluble salt and the other limb was a wider vertical tube to collect the solution.

A waterfilled glass thermostat, stirred by an electrically driven paddle system was employed. The temperature was kept constant to $\pm 0.1^\circ\text{C}$ by means of a toluene-mercury regulator operating a 200 watt bulb through a 'Sunvic' relay. The solubility measurements at 0°C and at 10°C were carried out using a thermostat in a low temperature room kept at about 2°C and employing a "Circotherm" thermostating unit. To obtain 0°C , powdered ice was used. The constancy of temperature was about $\pm 0.1^\circ\text{C}$.

b) Conductivity measurements

The conductivity measurements were made on a screened A.C. bridge of the type described by Jones and Joseph^{10b} and by Shedlovsky^{10b}, the precautions recommended for minimising effects due to the inductance and capacity of the various parts of the bridge being followed.

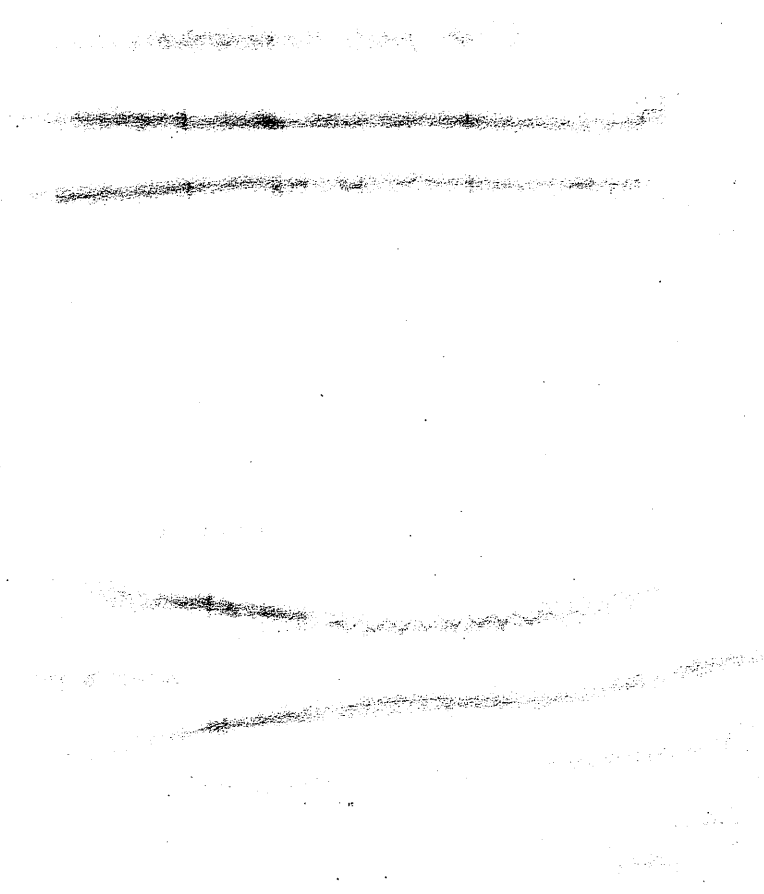

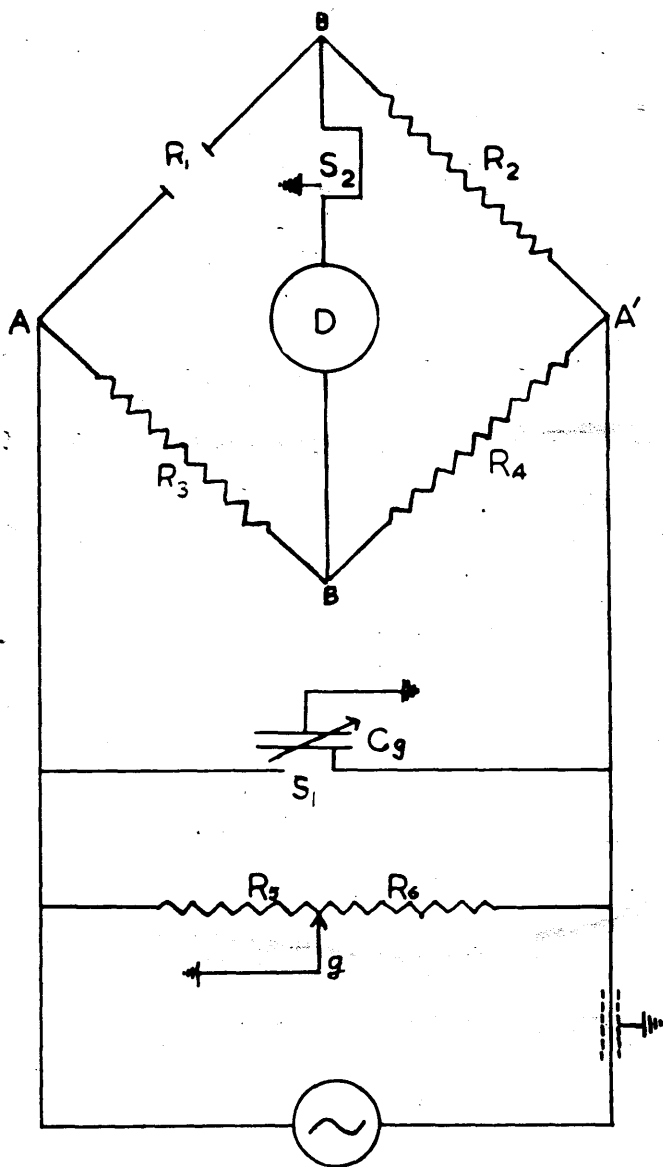

FIG. 2.

THE CIRCUIT

The circuit was essentially as shown in the diagram (Fig. 2). R_1 was the cell, and R_2 a Sullivan non-reactive resistance box, reading from 10,000 to 0.1 ohm. The ratio arms R_3 and R_4 were obtained from a 100 ohm Sullivan nonreactive slide resistance, the total resistance being subdivided into 10^5 equal parts by means of two concentric dial systems. The amplifier was a two stage, high gain, mains-operated model and measurements were usually made at 1000, 2000 and 3000 cycles per sec. The oscillator, a mains-operated Hartley type with continuously variable frequencies, from 15 c.p.s to 4 Kc.p.s. was placed about twelve feet away from the bridge to prevent interaction. The leads, which were screened and grounded, connected the oscillator to the bridge via a Sullivan balanced and screened transformer, designed to screen effectively the supply source from the bridge without upsetting the balance of the latter to the earth. The sharpness of the sound minimum in the detector was improved considerably by earthing the bridge. A modified Wagner earth described by Jones and Joseph^{10b} which also ensured the

telephone earpiece being maintained at ground potential thus eliminating any leakage of current, was used. In the diagram it is represented by the resistances R_5 , R_6 , the contact g , and the variable condenser C_g .

The condenser was connected by switch S , to either A or A' . The bridge was balanced in the usual way and the detector D , was connected to ground by switch S_2 . B was then brought to ground potential by adjustment of the contact ' g ' and the condenser C_g . The bridge was again balanced. The process was repeated if there was any change.

Connections to the cell were made by taking leads from the electrodes to two mercury cups supported in the thermostat. This prevented heat interchange to the cell from the room.

Any resistance effect due to the leads from the mercury cups to the bridge was compensated by having an equal length of identical wire connecting the resistance box R_2 to the circuit.

A Sulliven decade stable mica condenser, reading from 0 to 0.01 μ .F., could be connected across R_2 or the cell in order to compensate for capacity effects in the

PLATE I

FIG.3 HARTLEY BARRETT CELL



arms of the bridge. The connections to the cell and the resistance box could be interchanged by means of a commutator of the rocking type.

When the resistance of water was being measured, a shunt was necessary across the cell. This was supplied by a 9991.8 ohm standard resistance.

The cells were supported in a large, earthed copper thermostat containing transformer oil to eliminate capacity errors^{10b}. The bath was stirred by an efficient electrically driven multiple paddle system and the temperature was kept constant to $\pm 0.005^{\circ}\text{C}$ of the required temperature by means of a toluene-mercury Spiral regulator operating a 60 watt carbon filament lamp through a vacuum relay. The thermometer used had been standardized against two platinum resistance thermometers constructed as described later.

Two types of conductivity cells were used:-

A Pyrex Hartley-Barrett cell^{11b} was employed for measurements on thalious bromide. The dipping electrodes of greyed platinum were situated near the cell wall so as to allow an efficient four bladed stirrer to be supported from a pulley shaft through a central aperture in the

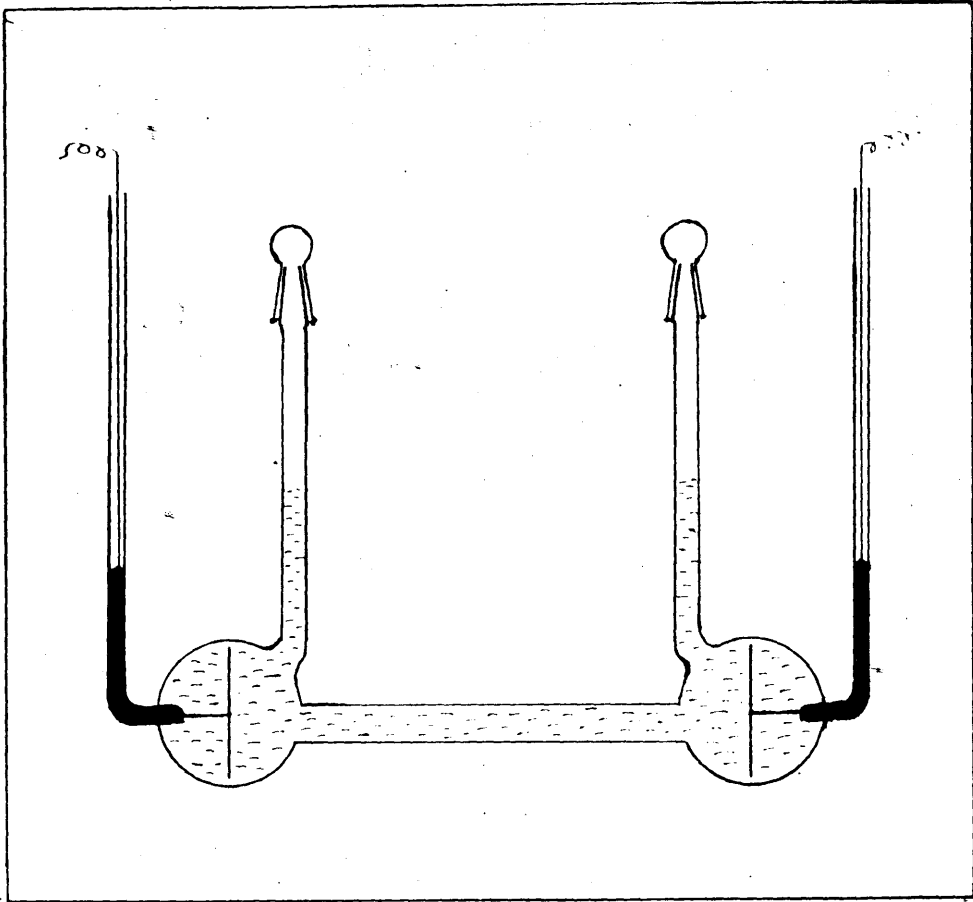

FIG. 4. JONES - BOLLINGER CELL

cell cap (Fig. 3). The position of the electrodes was accurately fixed in the cell by fine lines etched on the male and female components of the ground glass joint. A small hood attached to the stem of the stirrer prevented contamination of the cell contents by foreign matter falling through the aperture in the cap. A side tube on the cap with a three-way tap enabled purified air or nitrogen raised to the bath temperature to be passed over the surface of the cell solution. The cap also had an inlet tube closed by a small ground glass cap to allow additions of solutions to be made.

A Jones and Bollinger cell^{12b} was used for measurements on more concentrated solutions of thallos chloride. It consisted of a tube about 12 cms. long, having a bulb at each end which accommodated a large circular platinum electrode each sealed in through a lead-in tube. Each bulb also carried a filling tube, spaced well away from the lead-in tube (to eliminate any "capacitance by path"), and provided with ground glass joint (fig. 4). The cell was cleaned and the electrodes were platinised in a solution consisting of 0.025 N hydrochloric acid containing 0.3% by weight of platinum chloride and 0.025% of lead

acetate, as recommended by Jones and Bollinger^{12b}. The current density was 10 M.A./cm², its direction being reversed every ten seconds for a total time of about ten minutes.

Experimental Technique

a) Solubility measurements

The thalious iodate or the thalious bromide was washed into the narrow limb of the saturator so as to form a column of about 8-10 cms. height above the sinter. The saturator was placed in the thermostat with the bulb well immersed in the water. About 50-75 cc. of conductivity water were taken in the bulb and after allowing time for the water to reach the thermostat temperature, it was passed down the column. 50 cc. of water required about 2 hours at 25°C, 1½ hours at 40° and more than 3 hours at 0° and 10°C. to pass through. The solution was transferred back into the bulb and again allowed to circulate. The observed solubilities were a little high at the beginning, but after a number of washings constant values were obtained from three different saturators. With the different salt solutions which were used as solvent, a similar procedure was

adopted, the column having been washed at least four times with the solution being used beforehand. Complete saturation was obtained after twice passing through the column.

The thalious iodate in the saturated solutions was estimated by titration of the iodine liberated on addition of potassium iodide and dilute sulphuric acid, with standard sodium thiosulphate solution of about 0.01 N. A freshly prepared starch solution was used as indicator towards the end of the titration.

A.R. sodium thiosulphate was used to prepare the standard solution, 3 gms. of A.R. borax per litre was added, and the stock solution allowed to stand for at least one week before being used. It was standardised periodically with A.R. potassium iodate which had been dried at 110°C for two hours. The strength of the thiosulphate remained constant to better than 0.1% over a period of two months.

The thalious bromide was estimated by Mohr's titration with a standard solution of A.R. silver nitrate using potassium chromate as indicator.

The addition of potassium iodide to thalious iodate

solutions produces a transient yellow precipitate of thallos iodide, which dissolves in the liberated iodine on addition of acid to form the TlI_4^- ion. In the course of the titration, however, as iodine is removed, the thallos iodide precipitates, thus obscuring the end point of the titration and restricting the accuracy. La Mer and Goldmann^{4b} believed the precipitate to be thallos sulphide and used arsenite in place of thiosulphate. Bell and George^{7b}, however, experienced similar difficulty even using arsenite. The latter workers, therefore, modified the procedure by filtering the mixture free of thallos iodide after addition of potassium iodide. They used a weight method of titration, adding 0.2 gm. of potassium iodide to a weighed 10 m.l. of the solution, and titrating a weighed amount of the filtrate. There will, however, be considerable uncertainty concerning the respective amounts of potassium iodide remaining unreacted and thallos iodide removed, in each titration, thus causing differences in densities. Moreover, the filtration takes an appreciably long time and perceptible liberation and consequent loss of iodine takes place. It was, therefore, decided to adopt the following procedure which was found

to be very convenient and reliable.

10 m.l. portions of the saturated solution were pipetted out into wide centrifuge tubes, excess of potassium iodide was added and the mixture centrifuged in a "Minor" centrifuge. (Measuring and Scientific Equipment Ltd., Spenser Street, Westminster, S.W.1.). The thallos iodide settled down easily. The clear supernatant liquid was transferred into a clean titration flask and the mouth of the centrifugal tube was washed into the flask. 5 m.l. of distilled water were added to the precipitate in the tube, stirred and again centrifuged. The wash liquid was added to the main solution. Washings were repeated five times and the total volume of the solution was titrated with standard thiosulphate after adding 3 m.l. of 2 N sulphuric acid. Preliminary experiments showed that three or four washings removed all traces of iodate from the precipitate.

With thallos bromide solutions in the Mohr's titration, a similar difficulty was encountered, the addition of potassium chromate causing the precipitation of thallos chromate. Here also the same procedure of removing the precipitate by centrifugation was employed.

A known slight excess of potassium chromate was added to ensure presence of enough CrO_4^{--} ion after complete removal of Tl^+ as thallos chromate.

Grade A glassware with calibrations by the National Physical laboratory was used in all experiments. The addition of thiosulphate and silver nitrate was made from a 25.00 m.l. burette, the final additions being made from a microburette. The pipettes were brought to the thermostat temperature before use and the necessary corrections for volume and density of solutions were applied.

Duplicate determinations of solubility agreed to better than 0.1%.

b) Conductivity measurements

Determination of cell constant:-

A.R. potassium chloride was recrystallised four times from conductivity water. The crystals were then placed in a platinum dish and dried in an electric oven at 110°C . Samples were heated to dull red heat in a platinum dish and allowed to cool in a desiccator before use.

The cell constant of the Hartley-Barrett type cell was determined by the method of Davies^{13b}. The cell was first dried, weighed, rinsed with conductivity water

several times and swept free of carbon dioxide by passing a stream of purified air through it for about half an hour.

The stream of air was obtained by purifying laboratory-compressed air. This was effected by passing the compressed air through a cotton wool filter, bubblers containing 2 N sulphuric acid, to remove ammonia, and 10% caustic potash, to remove carbon dioxide. Finally, the air passed through a spray trap, a cotton wool filter and filter paper held between spirally grooved metal discs.

About 350 gms. of conductivity water were collected in the cell directly from the resin column, the air stream being maintained all the time. The cell was placed in the thermostat kept at 25°C and connected into the circuit. The water was stirred at a constant rate of about 300 r.p.m., and the airstream was continued. The conductivity of the water was measured periodically until a constant bridge reading was obtained. This usually took approximately 3-4 hours and under test it was found that this constant value could be maintained for more than eight hours. About 2 gms. of approximately 0.01 N potassium chloride stock solution were added to the water in the cell by

means of a weight burette and stirring was continued. When the resistance became constant, the resistance box setting was adjusted so that the bridge readings for the two positions of the commutator were close together. The bridge readings were determined for two different settings of the resistance box, the stirring of the cell being stopped temporarily during the actual measurement. Four or five further additions of the stock potassium chloride solution were made, the same series of operations being repeated to measure the resistance after each addition until a concentration of about 0.001 N was obtained in the cell. The cell was then taken out, its outer surface was cleaned and dried and the whole weighed. The weight of water in the cell was evaluated from the known weights of potassium chloride solutions added. The cell constant was calculated by comparing each measured value with the conductivity values derived by Shedlovsky^{14b} and Davies^{13b} at the same concentration of potassium chloride using the interpolation formula

$$\Delta = 149.92 - 93.85 C^{\frac{1}{2}} + 500.$$

Two cells which were used to determine the solubility of thallos bromide, gave as the mean of eleven and thirteen determinations (three series) of cell constant a value of $0.03696 \pm 0.03\%$ for one and $0.06897 \pm 0.03\%$ for the other.

To determine the cell constant of the Jones-Bollinger type of cell, the conductivity values for demal potassium chloride solutions given by Jones and Bradshaw^{15b} were employed. The cell was cleaned, filled with conductivity water and placed in the thermostat. Resistance readings were taken when temperature equilibrium was obtained. This took only less than half an hour. The cell was emptied and rinsed several times with an exactly 0.01 demal solution of potassium chloride. It was then filled with the same solution and again allowed to equilibrate in the thermostat. The resistance was measured as before. This procedure was repeated using different fillings of solution. The conductivity of 0.01 D potassium chloride solution at 25°C. is $0.0014087 \text{ ohm}^{-1} \text{ cm}^{-1}$. Nine determinations gave a mean value of $7.7705 \pm 0.04\%$ for the cell constant.

In order to determine the conductivities of saturated

solutions of thallos bromide at 25°C and 40°C, about 350 m.l. of conductivity water were taken in the Hartley-Barrett type cell which was being swept by the purified airstream. The cell was placed in the thermostat and the air stream was continued. Stirring was at the rate of about 300-400 r.p.m. When the water resistance reading became constant, a 10 m.l. volume of the recrystallised thallos bromide in aqueous suspension was added. The stirring was continued for more than 24 hours; the constant resistance reading was measured. A second 5 m.l. volume of the same suspension was added and the resultant value of resistance measured in order to allow for traces of impurities in the thallos bromide suspension. These corrections never exceeded 0.08% of the observed conductivity.

Two different cells with two different samples of thallos bromide were employed at both the temperatures.

After preliminary measurements with very dilute solutions of thallos chloride using the Hartley-Barrett type cell at 40°C, it was decided to extend measurements to more concentrated solutions employing the Jones-Bollinger type cell. In this the concentrations studied were in the range 4.0 to 16.0 m. moles per litre. The experimental procedure was ~~as~~ described previously for

the cell constant, stock solutions of the recrystallised thalious chloride of the required concentrations being used in place of 0.01 D potassium chloride solution. The temperature of the bath was constant at $40^{\circ} \pm 0.01^{\circ}\text{C}$.

Results and Discussion

a) Solubility experiments

Some of the results obtained for the water solubilities of thalious iodate and thalious bromide are compared with values obtained by other workers in Table I. The good

Table I

Solubilities in water - m. moles/litre

Salt	Temp.	La Mer and Goldmann ^{4b}	Bell and George ^{7b}	Keefer and Reiber ^{16b}	Present work
	0°		0.650		0.656
TlIO ₃	25°	1.844	1.838		1.842
	40°		3.043		3.048
TlBr	25°			2.007	2.009

agreement between them is evident. The experimental results of the solubility determinations of thalious iodate and thalious bromide in different salt solutions are recorded in the first two columns of Tables II and III.

Table II

Solubility of thalious iodate in salt solutions.Concns. in m.moles/l.

$m(\text{NaN}_3)$	S	I	f_{\pm}	$[\text{NaIO}_3]$	$[\text{Tl}^+]$	$[\text{N}_3^-]$	$[\text{TlN}_3]$	K
Sodium azide at 10°C.								
-	1.016	1.014	0.9660	-	1.014	-	-	-
17.93	1.144	19.02	0.8759	0.005	1.100	17.89	0.043	2.83
20.24	1.155	21.34	0.8702	0.005	1.105	20.19	0.048	2.84
27.24	1.182	28.35	0.8552	0.007	1.118	27.17	0.062	2.81
30.35	1.193	31.46	0.8497	0.008	1.123	30.28	0.068	2.77
36.4	1.214	37.52	0.8398	0.009	1.131	36.32	0.081	2.81
								Mean K = 2.81
Sodium azide at 25°C.								
-	1.842	1.836	0.9542	-	1.836	-	-	-
6.49 ₃	1.935	8.42	0.9095	0.004	1.927	6.49 ₁	0.002	(1.89)
9.12	1.973	11.05	0.8986	0.005	1.936	9.09	0.031	(2.18)
12.11	2.004	14.05	0.8879	0.006	1.954	12.06	0.045	2.41
14.81	2.029	16.77	0.8798	0.008	1.967	14.76	0.056	2.48
20.23	2.072	22.21	0.8657	0.010	1.992	20.15	0.073	2.41
23.71	2.097	25.71	0.8580	0.012	2.005	23.63	0.087	2.48
27.05	2.119	29.05	0.8513	0.014	2.016	26.95	0.097	2.46
								Mean K = 2.44

Table II (contd.)

$m(\text{NaN}_3)$	S	I	f^{\pm}	$[\text{NaIO}_3]$	$[\text{Tl}^+]$	$[\text{N}_3^-]$	$[\text{TlN}_3]$	K
Sodium azide at 40°C.								
-	3.048	3.031	0.9401	-	3.031	-	-	-
15.98	3.350	19.21	0.8703	0.015		15.90	0.087	2.24
21.80	3.423	25.07	0.8541	0.021	3.288	21.68	0.118	2.26
26.89	3.477	30.19	0.8436	0.025	3.317	26.75	0.140	2.22
32.07	3.536	35.40	0.8343	0.030	3.343	31.89	0.176	2.37
34.28	3.554	37.60	0.8307	0.032	3.357	34.10	0.180	2.28
41.72	3.621	45.08	0.8196	0.038	3.390	41.51	0.214	2.26
47.11	3.664	50.48	0.8125	0.043	3.413	46.88	0.233	2.21

Mean K = 2.26

$m(\text{KNO}_3)$	S	I	f^{\pm}	$[\text{KIO}_3]$	$[\text{Tl}^+]$	$[\text{NO}_3^-]$	$[\text{TlNO}_3]$	K
Potassium nitrate at 0°C.								
-	0.656	0.655	0.9724	-	0.655	-	-	-
32.76	0.778	33.49	0.8467	0.007	0.737	32.72	0.040	2.33
47.84	0.808	48.58	0.8247	0.010	0.750	47.78	0.058	2.37
50.92	0.813	51.66	0.8214	0.011	0.752	50.86	0.060	2.32
57.24	0.826	57.99	0.8139	0.012	0.755	57.17	0.070	2.45
59.80	0.830	60.55	0.8113	0.013	0.757	59.73	0.072	2.42

Mean K = 2.38

Table II (contd.)

$m(\text{KNO}_3)$	S	I	f^+	$[\text{KIO}_3]$	$[\text{Tl}^+]$	$[\text{NO}_3^-]$	$[\text{TlNO}_3]$	K
Potassium nitrate at 25°C.								
20.68	2.073	22.66	0.8647	0.016	2.001	20.61	0.066	2.16
28.64	2.127	30.64	0.8484	0.022	2.031	28.55	0.089	2.15
38.46	2.178	40.50	0.8323	0.028	2.061	38.35	0.117	2.14
39.58	2.195	41.61	0.8307	0.029	2.061	39.45	0.127	2.15
42.79	2.207	44.83	0.8263	0.032	2.071	42.66	0.130	2.15
								Mean K = 2.15
Potassium nitrate at 40°C.								
20.56	3.408	23.82	0.8569	0.030	3.290	20.46	0.101	2.09
24.46	3.454	27.74	0.8485	0.035	3.315	24.33	0.122	2.04
30.44	3.517	33.75	0.8373	0.043	3.352	30.30	0.148	2.07
38.24	3.590	41.58	0.8246	0.054	3.394	38.06	0.179	2.04
39.39	3.600	42.73	0.8229	0.055	3.399	39.20	0.184	2.04
42.54	3.631	45.89	0.8185	0.059	3.410	42.34	0.204	2.10
								Mean K = 2.06

Table III

Solubility of thalious bromide in salt solutions.

$m(\text{KNO}_3)$	S	I	f^{\pm}	$[\text{TlNO}_3]$	$[\text{Tl}^+]$	$[\text{Br}^-]$	K
Potassium nitrate at 25°C.							
-	2.009	1.981	0.9526	-	1.981	1.981	7.81
(5.01)	(2.096)	7.06	0.9159	0.019	2.050	2.068	7.81
(10.01)	(2.159)	12.11	0.8946	0.036	2.095	2.131	7.81
(15.02)	(2.203)	17.14	0.8787	0.053	2.122	2.175	7.81
21.40	2.267	23.56	0.8626	0.075	2.165	2.240	7.69
26.49	2.320	28.69	0.8520	0.092	2.201	2.292	7.58
32.65	2.344	34.86	0.8401	0.109	2.207	2.316	7.69
37.77	2.385	40.00	0.8331	0.125	2.232	2.357	7.63

Sodium perchlorate at 25°C.

$m(\text{NaClO}_4)$	S	I	f^{\pm}	$[\text{Tl}^+]$	$[\text{Br}^-]$	K
5.21	2.095	7.28	0.9150	2.067	2.067	7.81
11.69	2.224	13.89	0.8885	2.197	2.197	7.31
16.50	2.228	18.70	0.8743	2.201	2.201	7.52
17.78	2.232	19.98	0.8710	2.204	2.204	7.58

Mean K =7.67

Table III (contd.)
Potassium nitrate at 40°C.

$m(\text{KNO}_3)$	S	I	f^-	$[\text{TlNO}_3]$	$[\text{Tl}^+]$	$[\text{Br}^-]$	K
-	3.492	3.428	0.9367	-	3.428	3.428	6.21
21.27	3.760	24.85	0.8546	0.115	3.581	3.696	6.62
26.34	4.000	30.13	0.8437	0.146	3.790	3.936	6.02
32.46	4.035	36.26	0.8310	0.175	3.796	3.971	6.17
37.56	4.123	41.41	0.8249	0.200	3.859	4.059	6.02

Sodium perchlorate at 40°C.

$m(\text{NaClO}_4)$	S	I	f^-	$[\text{Tl}^+]$	$[\text{Br}^-]$	K
11.62	3.597	15.16	0.8802	3.533	3.533	6.62
16.41	3.691	20.03	0.8662	3.626	3.626	6.49
20.25	3.732	23.92	0.8569	3.661	3.661	6.49

Mean K = 6.32

If S_0 and S represent the solubilities of a saturating salt in pure water and in a salt solution respectively, and f_{\pm}° and f_{\pm}^+ , the corresponding mean activity coefficients, then $f_{\pm}^+ = f_{\pm}^{\circ} S_0/S$. Since the solubilities in water of the two salts considered are low, a first approximation to f_{\pm}° can be obtained from the equation suggested by Davies^{1b},

$$-\log_{10} f_{\pm} = AZ^2 \left[\frac{I^{1/2}}{(1 + I^{1/2})} - 0.2I \right] \quad (1)$$

The coefficient "A" for aqueous solutions has the value 0.5 at 25°, 0.49 at 0° and 10° and 0.52 at 40°C. Z is the valency of the ion considered and I is the ionic strength, given by $I = \frac{1}{2} \sum CZ^2$.

A more accurate value for f_{\pm}° is obtained by allowing for a small extent of ion association to form ThIO_3 species, the constant for which was derived from the conductivity data of Davies^{17b} at 25°C. The corresponding association constants for 0°C and 40°C have been calculated by Bell and George^{7b} by assuming that their temperature dependence is correctly predicted by the electrostatic theory of Bjerrum^{3b}, using ionic radii derived from the degree of association at 25°C. The same assumption has been made

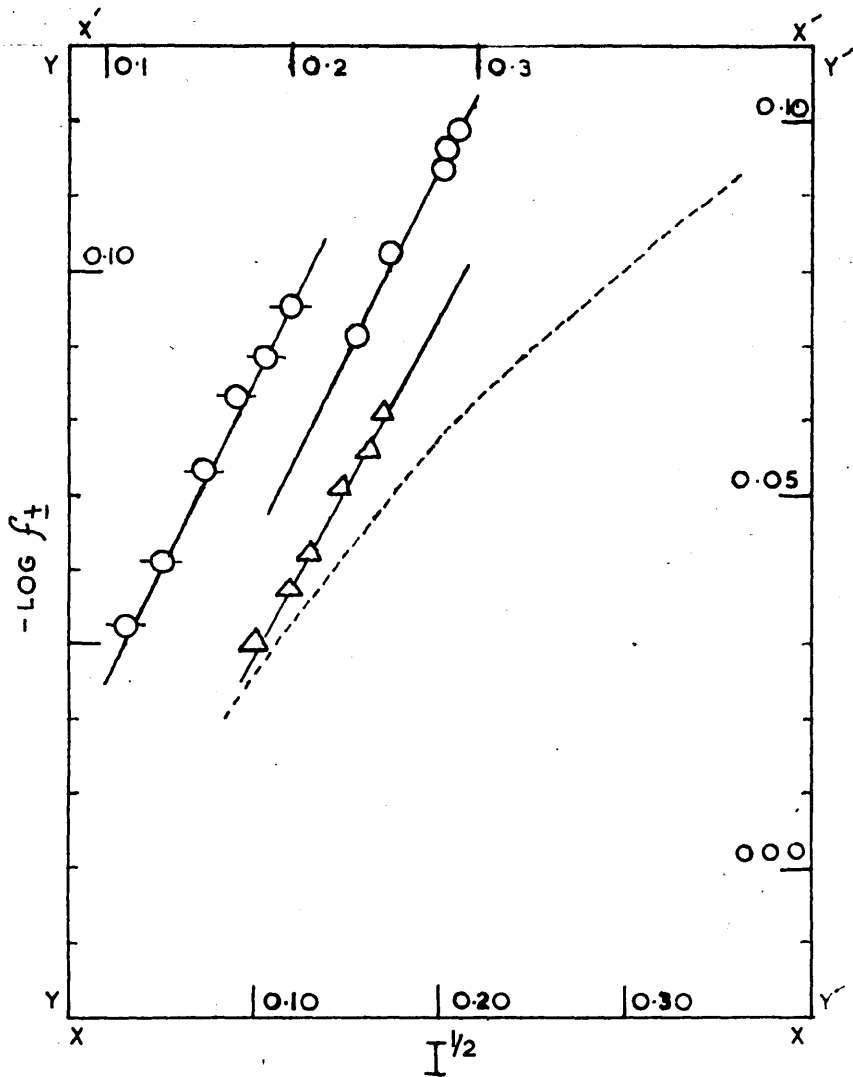

GRAPH I - PLOT OF $-\text{LOG } f_{\pm}$ AGAINST $I^{1/2}$

- | | | | | | |
|----------|----------------------------------|-------------------------|---------|---------------------------------|-------------------------|
| Δ | TiO_3 IN NaN_3 | $\text{XX}-\text{YY}$ | \circ | TiBr IN KNO_3 | $\text{XX}'-\text{YY}'$ |
| \circ | TiO_3 IN KNO_3 | $\text{XX}'-\text{YY}'$ | | | |

for calculating the value of this constant at 10°C.

Table IV gives these values of the dissociation constant.

Table IV

Dissociation constants of some ionic species.

Species	K_0°	K_{10°	K_{25°	K_{40°
TlIO ₃	0.53 ^{7b}	0.52	0.50 ^{17b}	0.47 ^{7b}
NaIO ₃		3.4	3.0 ^{18b}	2.6
KIO ₃	2.5 ^{7b}		2.0 ^{18b}	1.7 ^{7b}

The values of f^\pm for both saturating salts in salt solutions are considerably lower than predicted by equation (1) if all the ions are considered to be free. This is illustrated by graph I, in which $\log_{10} f^\pm$ is plotted against $I^{\frac{1}{2}}$ for thallos iodate and bromide in the salt solutions at 25°; the broken line represents equation (1), all ions being considered free. The negative deviations indicate a specific interaction between the Tl⁺ ion and the anion and this can be most directly interpreted in terms of partial association

of these ions to form species Tlx where $x = N_3^-$, NO_3^- etc. If all the deviations from equation (1) are attributed to this association, then the association constants of the various ion pairs can be calculated from the experimental data. For this, however, one must know the dissociation constants of other possible ion pairs such as KIO_3 , $NaIO_3$ etc. which may also be present in the solution. These have been determined from conductivity data by Davies^{18b} at 25°C. The values for other temperatures were calculated in the same way as $TlIO_3$, by using the electrostatic treatment of Bjerrum^{3b}. These constants are also included in Table IV.

The method of calculation can be best illustrated by taking a specific example. The equilibria existing in a solution of thalious iodate in sodium azide could be represented as follows:-

The activity product of $TlIO_3$,

$$K_s = [Tl^+][IO_3^-] f^{\pm 2} \quad \dots \quad (2)$$

the dissociation constant of $NaIO_3$,

$$K(NaIO_3) = [Na^+][IO_3^-] f^{\pm 2} / [NaIO_3] \quad \dots \quad (3)$$

the dissociation constant of TlN_3 ,

$$K(TlN_3) = k = [Tl^+][N_3^-] f^{\pm 2} / [TlN_3] \quad \dots \quad (4)$$

The activity product K_s , was calculated from the solubility data in pure water and using the dissociation constant of $TlIO_3$ at the appropriate temperature. This, as well as the value for the small constant concentration of species $TlIO_3$ for each temperature is given in Table V.

Table V

Some data on $TlIO_3$

Temp.	0°C	10°C	25°C	40°C
Activity product	4.064×10^{-7}	9.599×10^{-7}	3.068×10^{-6}	8.119×10^{-6}
Concn. of $TlIO_3$ in saturated Soln (m. Mole/l)	0.001	0.002	0.006	0.017

We can also write the following stoichio-metric relationships:-

$$\begin{aligned} \text{Solubility } S &= [IO_3^-] + [NaIO_3] + [TlIO_3] \\ &= [Tl^+] + [TlN_3] + [TlIO_3] \dots\dots (5) \end{aligned}$$

total concentration of added salt,

$$m(NaN_3) = [Na^+] + [NaIO_3] = [N_3^-] + [TlN_3] \dots (6)$$

and for electroneutrality,

$$[Tl^+] + [Na^+] = [IO_3^-] + [N_3^-] \dots\dots (7)$$

Successive approximations for ionic strength are made in equation (1) and using the relationships (2) ... (7), calculations are carried out until the values for f^{\pm} and the respective concentrations of the different ionic species become constant. The association constant of the ion pair TlN_3 is then given by $1/k$

$$\text{or } K_{\text{assoc.}} = \frac{[TlN_3]}{[Tl^+][N_3^-] f^{\pm 2}} \dots (8)$$

The constants obtained in this way for thallos azide and nitrate are given in the last two columns of Table III.

b) Conductivity experiments

The data obtained from conductivity measurements of thallos chloride solutions at 40°C are given in Table VI. Extrapolation of the observed conductivities to $C^{\frac{1}{2}} = 0$, (Graph II) gave the limiting conductivity of thallos chloride at 40°C as 198.6. Using the accurate mobility data at 40°C $\Delta^{\circ}\text{Cl} = 100.6$, reported by Benson and Gordon^{19b}, the mobility $\Delta^{\circ}\text{Tl}^+$ at 40°C is 98.0.

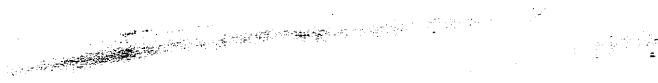

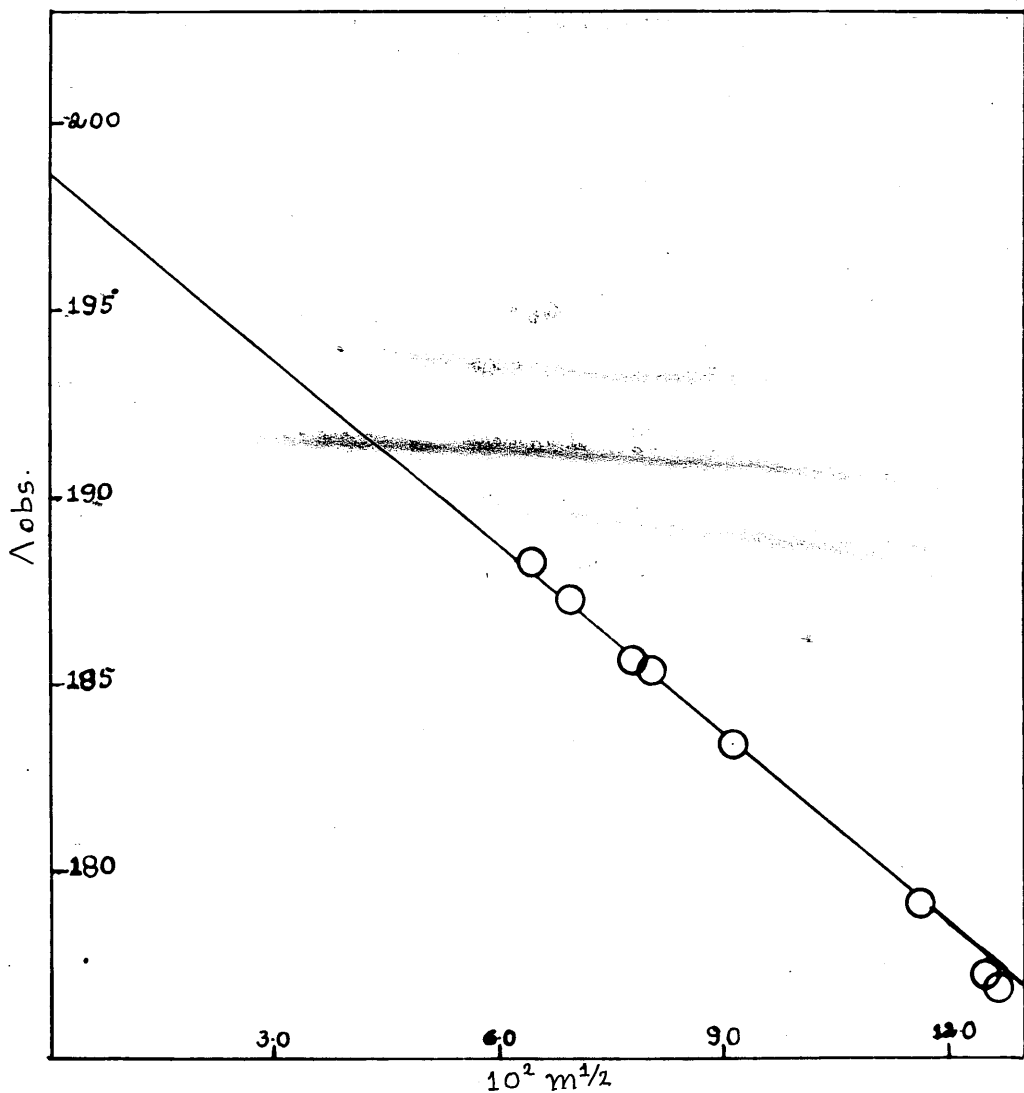

GRAPH II CONDUCTIVITY OF THALLOUS
CHLORIDE AT 40°C.

Table VI

Conductivity data of thallos chloride at 40°C.

$10^3 m$	$10^2 m^{\frac{1}{2}}$	obs.	$10^3 I$	α	K
4.2136	6.4912	188.38	4.172	0.9902	2.74
4.8361	6.9542	187.25	4.775	0.9873	3.13
6.1021	7.8116	185.73	6.010	0.9849	3.01
6.4491	8.0306	185.39	6.350	0.9846	2.93
8.3249	9.1241	183.40	8.169	0.9813	2.84
13.505	11.620	179.09	13.160	0.9746	2.52
15.637	12.505	177.34	15.180	0.9709	2.55
16.222	12.736	176.91	15.760	0.9701	2.54

Mean K = 2.78

The conductivity of free ions at each concentration was obtained from the Onsager equation

$$\Lambda = \Lambda^\circ - \left[\frac{2.801 \times 10^6 \cdot z_1 z_2 \cdot \eta \Lambda^\circ}{(\epsilon T)^{3/2} (1 + \sqrt{q})} + \frac{41.25(z_1 + z_2)}{\eta (\epsilon T)^{1/2}} \right] \sqrt{c}$$

For thallos chloride at 40°C, this equation reduces to $\Lambda = \Lambda^\circ - 129.42 (am)^{\frac{1}{2}}$, where "a" is the degree of dissociation. The values of "a" were calculated by

successive approximations using the relationship,

$$\alpha = \Lambda_{\text{obs}} / \Lambda = \Lambda_{\text{obs}} / [198.6 - 129.42(\text{am})^{\frac{1}{2}}]$$

The association constant was then derived from the equation

$$\log K_{\text{TlCl}} = \log \left[\frac{(1-\alpha)}{\alpha^2 m} \right] + 1.04 \left[I^{\frac{1}{2}} \left(1 + I^{\frac{1}{2}} \right) - 0.2 I \right];$$

the values obtained for α and K are given in the last two columns of Table VI.

Thallos bromide, is too sparingly soluble to permit of conductometric experiments similar to those used for the chloride. Preliminary experiments on the solubility of thallos iodate in solutions of potassium bromide showed a tendency for thallos bromide to be precipitated in the saturating column, probably owing to the similar solubility of the two salts. Duplicate data on conductivities of saturated solutions of thallos bromide at 25°C and 40°C obtained, agreed to better than 0.2%.

$\Lambda^{\circ}\text{TlBr}$ at 25°C was obtained from the $\Lambda^{\circ}\text{Tl}^{+} = 74.7$ of Robinson and Davies^{20b} and $\Lambda^{\circ}\text{Br}^{-} = 78.41$ of Benson and Gordon^{19b}; $\Lambda^{\circ}\text{Tl}^{+} = 98.0$ at 40°C together with $\Lambda^{\circ}\text{Br}^{-} = 104.4$ ^{19b} gave $\Lambda^{\circ}\text{TlBr}$ at 40°C. Table VII gives the

observed conductivities of saturated solutions of thallos bromide. The Onsager equation for thallos bromide works out as $\Lambda = \Lambda^\circ - 94.58(\alpha m)^{\frac{1}{2}}$ at 25°C and $\Lambda = \Lambda^\circ - 129.8(\alpha m)^{\frac{1}{2}}$ at 40°C. As was explained in the case of thallos chloride, the degrees of dissociation at the two temperatures were calculated by successive approximations. Table VII also gives the α values, and the constant concentrations of the species TlBr in the saturated solutions at 25° and 40°C, derived by combining the water solubility of the salt with the degree of dissociation.

Table VII

Data on saturated solution of thallos bromide

Temp	Λ_{obs}	$\Lambda^\circ \text{TlBr}$	α	[TlBr] m. mole.
25°	146.84	153.11	0.9861	0.0278
40°	189.26	200.4	0.9816	0.0641

From the solubility values of thallos bromide in potassium nitrate and sodium perchlorate solutions (Table III), the association constants for the ion pair

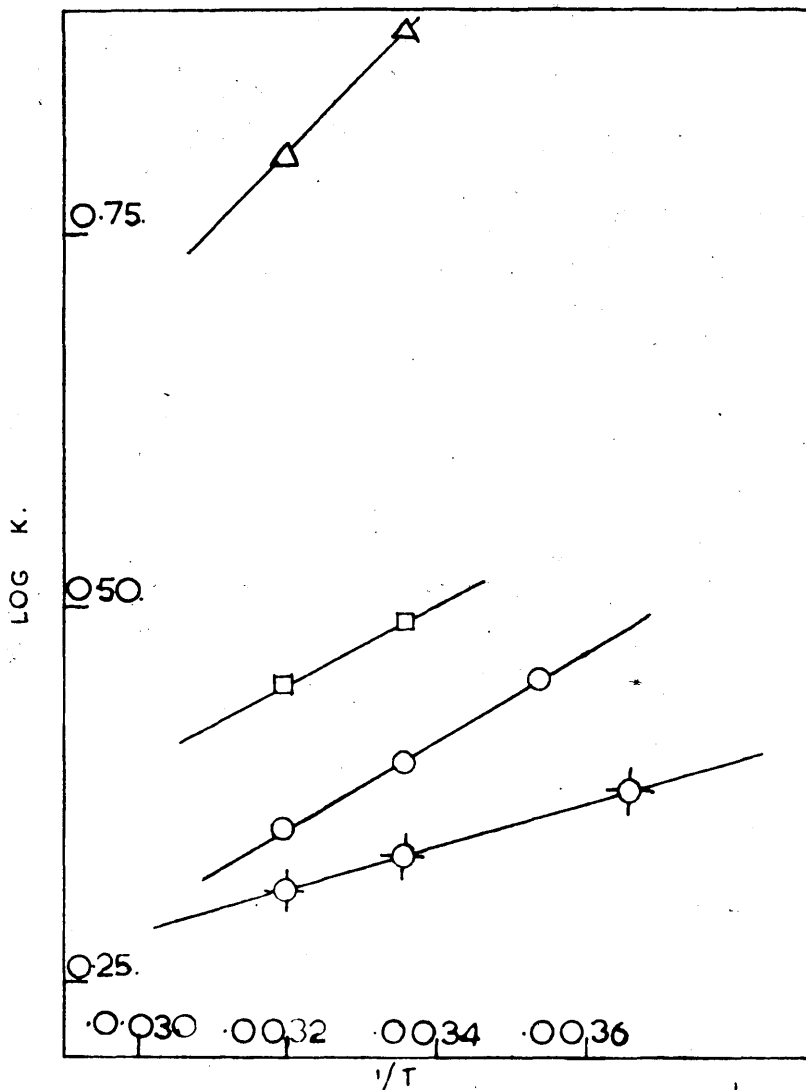

GRAPH III PLOT OF LOG K AGAINST $1/T$

- TIN₃
- TICI
- ⊙ TINO₃
- △ TIBr

TlBr were calculated at 25°C and 40°C. Allowance was made for TlNO₃ ion pair formation. Concordant values for the association constant were obtained in the two electrolytes as is shown by Table III. Keefer and Reiber^{16b}, determined ^{the} solubility of thallos bromide in potassium nitrate at 25°C and some of their results were also calculated (in parenthesis).

Using the Van't Hoff isochore,

$$\log K_2 - \log K_1 = \frac{\Delta H}{2.3026R} \left[\frac{1}{T_1} - \frac{1}{T_2} \right], \text{ where}$$

K₁ and K₂ are the thermodynamic association constants at T₁° and T₂° Kelvin, ΔH values, the heats of association of the ions were obtained from the linear plots of log K against $\frac{1}{T}$ (Graph II). ΔG₂₉₈, the free energy change due to association at 25°C was obtained from the relationship

$$\Delta G = - 2.3026 RT \log K, \text{ where } K$$

is the association constant at 25°C and T equals 298° Kelvin. The entropy of association Δs_{ass.} was derived from the equation

$$\Delta S = \frac{\Delta H - \Delta G}{T}$$

Calculation of the conductivity data^{5b} for thallose chloride at 25°C, using the Davies equation for activity coefficients gave a mean value of $K = 3.09$. This, in conjunction with the K value for thallose chloride at 40°C obtained in the present work gave $s_{\text{ass.}} = -1.8$ cal/deg/mole in excellent agreement with the value of -1.7 cal/deg/mole. obtained by Bell and George^{7b} by the solubility method. In view of this, it is justifiable to compare the entropy values obtained for all the ion pairs, including TlBr , with one another.

ΔH , ΔG and $\Delta s_{\text{ass.}}$ values are given in Table VIII, together with the data for thallose chloride, thallose hydroxide and thallose thiocyanate. Table VIII also includes the entropy of hydration of the respective anions. It is seen that the entropy of association of the ion pair approximately follows the entropy of hydration of the anion. This will be discussed later in the 'General Discussion'.

Table VIII

Thermodynamic properties

Reaction	ΔG at 25° (K cal.mole ⁻¹)	ΔH (K cal.mole ⁻¹)	ΔS ass.:1 cal.deg ⁻¹ mole ⁻¹	ΔS hyd. anion. cal.deg ⁻¹ mole ⁻¹
Tl ⁺ ,OH ⁻	- 1.12	+ 0.37	+ 5.1	- 43.8
Tl ⁺ ,NO ₃ ⁻	- 0.45	- 0.65	- 1.0	- 22.7
Tl ⁺ ,Cl ⁻	- 0.93	- 1.43	- 1.7	- 23.5
Tl ⁺ ,N ₃ ⁻	- 0.53	- 1.33	- 2.7	- 17.7
Tl ⁺ ,Br ⁻	- 1.20	- 2.45	- 4.2	- 20.0
Tl ⁺ ,CNS ⁻	- 1.09	- 2.96	- 6.4	- 17.6

Part II

BIVALENT METAL SULPHATES

INTRODUCTION

It is of interest to investigate the thermodynamic properties for the association between similarly charged ions of higher valency type. In this connection, the sulphates of the bivalent metals magnesium, zinc, cadmium, cobalt, nickel and manganese have been studied. With the cations of the transition metals, it is only to be expected that a simple picture based on electrostatic forces alone will not be sufficient to explain their interaction with an anion; short range quantum mechanical forces and stabilization due to the different bonding orbitals will have to be taken into consideration. Irving and Williams^{1c} found that the stability constants of the complexes formed by these cations with neutral ligands and with anions of weak acids followed a definite order $Mn < (Fe) < Co < Ni < Cu > Zn$. Williams^{1c} also pointed out the nonexistence of a similar sequence in the case of the sulphates of these metals from a consideration of available data. A more detailed study of these metal sulphates may throw more light on the factors involved in the association process.

A reference to literature shows that various methods

have been used to study the dissociation of bivalent metal sulphates. Thus, using conductivity measurements Davies^{2c} collected data for copper, zinc, magnesium and cadmium sulphates at 18°C and 25°C. A similar procedure was adopted by Money and Davies^{2c} for cobalt and nickel sulphate at 25°C., Owen and Gurry^{3c}, and Wyatt^{4c} for copper and zinc sulphate at 25°C., and Dunsmore and James^{5c} for magnesium sulphate at 25°C. Brown and Prue^{6c} used freezing point measurements on solutions of the sulphates of copper, zinc, magnesium, cobalt and nickel to obtain data at 0°C.; they also calculated values for zinc, copper and cadmium sulphates from the e.m.f. data of La Mer and Coworkers^{6c}. Jones and Monk^{7c} employed e.m.f. measurements to derive data for magnesium sulphate from 20°C. to 35°C. Much of the reported work refers to only one temperature so that it is not possible to obtain heat and entropy values. Moreover, differences have been noticed in the values obtained by different experimental methods. A completely unassociated 2-2 electrolyte which strictly obeys the Onsager law of conductivity is not known. so that difficulties are encountered in interpreting conductivity data. Also, according to Bjerrum's theory^{8c}, the minimum distance of closest approach of bivalent ions

will be $q = Z^2/3.57/\text{\AA} = 14.28\text{\AA}$, so that all ions of opposite charge falling within this range of one another will have to be considered as being associated. It is seen that the value of the association constant will depend to a large extent on the choice of 'q' in the activity coefficient expression:-

$$-\log fZ = \frac{AZ I^{\frac{1}{2}}}{1 + 9B I^{\frac{1}{2}}}$$

It is desirable to collect data for these sulphates over a large range of temperature employing the same experimental method. In the present work the equilibrium



has been studied at various temperatures from 0°C. to 45°C. by a precise e.m.f. method. The cell used was the concentration cell without transport, (A)

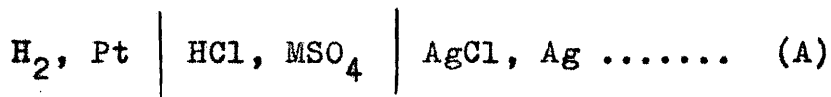

similar to the one employed by Jones and Monk^{7c} for study of magnesium and lathanum sulphates.

In order to evaluate the association constants in the metal sulphates, it was necessary to have a precise knowledge of the second dissociation constant 'k₂', of

sulphuric acid and its dependence on temperature, since at the pH's used, the bisulphate ion is an important constituent of these systems. 'k₂' has been determined by a number of workers employing different methods. Thus Sherrill and Noyes^{9c} combined data on conductivity and transport number for sulphuric acid solutions and for sodium bisulphate solutions, and Bray and Liebhafsky^{10c} made use of the kinetic salt effect on bromate - bromide reaction. Young, Klotz and Singleterry^{11c} employed a spectrophotometric study of solutions of a reference indicator in presence of sodium sulphate solution. Hamer^{12c} used an e.m.f. method and Kentama^{13c} solubility measurements on silver sulphate. The most direct study however, has been by Davies, Jones and Monk^{14c} who employed the cell

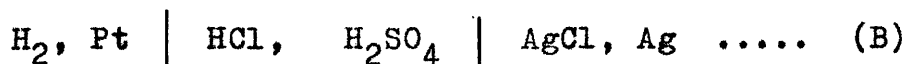

over the temperature range 5°C. to 50°C. and obtained e.m.f.s to within ± 0.1 m.v. It was thought desirable to redetermine 'k₂' at temperatures from 0°C. to 45°C. over a wide range of ionic strengths using the cell (B), since in the present work, measurements were possible to ± 0.01 m.v.

APPARATUS and EXPERIMENTAL TECHNIQUEPreparation of reagents

Constant boiling hydrochloric acid was prepared by the method suggested by Foulk and Hollingworth^{15c}, and by J.A. Shaw^{15c}, introducing the modifications recommended by Titus and Smith^{15c}. According to Titus and Smith, equilibrium could be reached fairly rapidly by starting the distillation with acid of density 1.14, which was not the case if the starting density was 1.06 as recommended by previous workers.

A.R. concentrated hydrochloric acid was diluted to a specific gravity of 1.14 with conductivity water in a pyrex "Quickfit" distilling flask (2 litres) surmounted with a splash bulb and connected to a pyrex Leibig's condenser having a 75 c.m. long water jacket and 1 c.m. inner bore. About 0.7 gm. of scrap platinum was put in, to prevent bumping, and the body and neck of the flask were covered with asbestos fibre. Uniform heating was ensured by using a heating mantle. The distillation was continuous and at a steady rate of less than 5 m.l. per minute. The distillate was collected in a pyrex stock flask, which had been

previously steamed for more than 30 minutes. The receiver was cooled in an ice bath. The first 25% of the distillate was discarded and the next 50% was used for a second distillation in which the first 75% was set aside, and the next 10 to 15% was collected as constant boiling acid. The barometric pressure was recorded at the beginning, after 75% had distilled over and at the end of the distillation.

Duplicate determinations of chloride^{16c} as silver chloride done a number of times over a period of one year agreed to better than $\pm 0.01\%$.

Different samples of A.R. sulphuric acid, supplied by the British Drug House, and Hopkin and Williams, were used. Duplicate sulphate determinations as barium sulphate^{16c} agreed to better than $\pm 0.02\%$.

The sulphates of the divalent metals magnesium, zinc, cobalt, nickel, manganese and cadmium were all of A.R. quality. The salts were recrystallised three times from conductivity water. In the case of cadmium sulphate, the solution was evaporated to about half the original volume and allowed to crystallise this salt having negative temperature coefficient of solubility. Manganese sulphate has a maximum solubility at 54°-55°C and solutions prepared at this temperature were evaporated

to about two-thirds the original volume before crystallisation.

The recrystallised salts were dried at about 110-120°C. Small samples of the powdered crystals were placed in pyrex weighing bottles with ground glass caps and converted into the anhydrous form by heating to constant weight at 350°C to 420°C in a muffle furnace. The stock solutions were analysed for sulphate and agreement was better than 0.03% of the calculated concentration. Anhydrous nickel sulphate dissolves in water only with great difficulty. Stock solutions prepared from the hydrated salt were analysed for nickel by precipitation as nickel dimethyl glyoxime^{16c}. Duplicate estimations agreed to 0.02%.

Cylinder hydrogen was freed from oxygen by passage through a 'deoxo' purifier (Baker Platinum Division, Engelhard Industries Ltd., London, W.C.1.) and saturated with water vapour by passing through a series of bubbles.

Potentiometer: A precision Vernier potentiometer (Croydon Precision Instrument Co., Croydon, Surrey, England) having a five dial decade system was used. The overall range of the potentiometer was from 1.9 volts

to 1 microvolt in two ranges, the first range being from 0.0 to 1.9 volts in steps of 10 micro volts. An auxiliary divider calibrated from 1.01800 volts to 1.01900 volts in steps of 50 microvolts was used for standardization with a Weston Standard Cell. The potentiometer had an accuracy of one part in 100,000 of the 1 volt setting.

All terminals, studs etc. were of copper and the studs were tipped with a precious metal alloy which ensured a good, clean contact and minimised the thermoelectric e.m.f.s generated by the action of the switches. A galvanometer key and a series sensitivity control were also included. The potentiometer coil was of well aged bare Manganin Telcuman of the same gauge throughout on the potential divider thus reducing the temperature coefficient of the potentiometer to a minimum.

The potentiometer had selector terminals for four test positions. As four cells each with four electrodes were being studied simultaneously, and provision had to be made for a platinum resistance thermometer and a standard resistance, a multiple switch box was incorporated in the circuit, between the cells and the potentiometer terminals. The potentiometer rested on a large metal

sheet which was earthed.

Two Weston Standard Cells (Cambridge Instrument Co., Ltd., London and Cambridge), mounted in metal cases were kept in a small oil thermostat maintained at $25^{\circ} \pm 0.1^{\circ}\text{C}$ by means of a 'Sunvic' bimetallic relay operating a 25 watt bulb. The oil was kept efficiently stirred with an electrically driven four-bladed metal stirrer. The standard cells were compared from time to time with one another and the difference between them was never greater than 20 microvolts.

A sensitive, spot reflecting, moving coil galvanometer of 25 ohm resistance (Cambridge Instrument Co., Ltd., Cambridge and London), mounted on a separate table away from other electrical circuits, in conjunction with a lamp and scale (Cambridge Instrument Co.) placed at one metre from the galvanometer mirror enabled measurements to better than 5 microvolts.

The thermostat was constructed for the potentiometric work. A large, rectangular metal tank of about 20 gallons capacity, mounted on a "Dexion" stand was fitted with a paddle system driven by an induction motor. The bath liquid consisted of water containing an antifreeze, ethylene glycol. The tank was insulated

with cork slabs of about 2" thickness. The temperature control was obtained by means of a spiral toluene-mercury regulator of large capacity, fixed very near the heating unit and operating a system of any combination among three bulbs of 250, 200 and 100 watts, through a vacuum relay. During the first series of experiments, the water in the thermostat was coloured with eosin, but subsequently red painted heater bulbs were used. This procedure was desirable for the light-sensitive silver - silver chloride electrodes. The relay coil was of a high resistance (5000 ohms working on 12 volts D.C.) so that there was no sparking in the toluene-mercury regulator during make and break. The temperature could be kept constant to better than $\pm 0.005^{\circ}\text{C}$. For working at temperatures down to 0°C , a refrigeration unit constructed by Frigidaire Division of General Motors Ltd., London, N.W.9. was incorporated. The refrigeration unit was provided with two adjustable valves at the two ends of the cooling coil. By adjusting the vapourisation valve on the liquid side and the constant pressure valve on the vapour side of the coil, and observing the gauge readings it was possible to alter the rate of cooling over a wide range.

The cooling coil itself was of tinned copper tubing about twenty feet long coiled around the stirrer near the bottom of the thermostat. Finer adjustments of temperatures below that of the room were obtained by operating both the toluene-mercury regulator controlled heating and cooling systems. A booster heater of the immersion type of 2000 watts enabled the temperature of the thermostat to be raised through 5°C in five minutes.

Temperature measurement

As precision measurements of e.m.f. to better than ± 0.01 m.v. were possible and temperature control of $\pm 0.005^{\circ}\text{C}$ was obtainable, it was decided to employ platinum resistance thermometers for determination of thermostat temperature. Accordingly, two platinum resistance thermometers were constructed, and standardized by comparison with a similar thermometer standardized by the National Physical Laboratory and obtained on loan.

Platinum resistance thermometer: The platinum resistance thermometer has the advantage that the reproducibility of the resistance R , over the temperature range from 180° to 600°C is $\pm 0.001^{\circ}\text{C}$.

The method suggested by Barber^{17c} was followed. Two thermometers of $R_0 = 20.6757$ abs. ohms and 13,8878 abs. ohms were made using about 50 and 35 cms. respectively of "Thermopure" platinum wire of 0.05 m.m. diameter. The wire was wound in the harddrawn condition on a silver-steel rod, 1.0 m.m. in diameter to form a helix with the turns touching each other. On releasing, the coil expanded slightly and the rod was withdrawn. The coil was about 2 cm. in length and 0.15 cm. in diameter. It was then stretched to a length of about 11 cms. which on releasing contracted to about 6 cms. It was thoroughly cleaned by washing in benzene and then boiling in a 50% solution of nitric acid, followed by washing several times in distilled water. A fine pyrex tube of 0.15 cm. bore and wall thickness of about 0.2 m.m., drawn down from larger tubing, was cut to a length 0.6 cm. greater than the overall length of the coil. Two small holes about 2 cms. apart and equidistant from the middle of the tube were made in the wall by piercing with a whitehot tungsten wire. The lip of glass projecting inside was removed by means of a fretsaw blade. The tube was cleaned and the coil introduced into it. Two

platinum leads 0.02 c.m. thick were fused on to either end of the coil. The ends of the glass tube were fused, sealing the leads, care being taken that they did not touch one another. The four platinum leads were fused on to four gold leads of 0.05 c.m. diameter. The gold leads were insulated by passing through a pair of twin-bore silica sheaths and were spot-welded at the free end to four short platinum wires of the same diameter. The whole set up was introduced into a pyrex glass sheath of about 0.9 c.m. diameter closed at one end and having a graded joint at the top. This enabled the short platinum leads to be sealed hermetically through the outer sheath.

The thermometer was evacuated with an oil pump while being baked at a temperature of 450°C in a muffle furnace over a period of twelve hours. Well dried air was admitted carefully into it and pumped out again. This process was repeated several times and finally the thermometer was sealed containing dry air while still in the furnace at 450°C . Thus the thermometer was freed from any moisture, an important prerequisite for good electrical insulation.

The surface of the glass around the external platinum glass seals, where the leads emerged from the



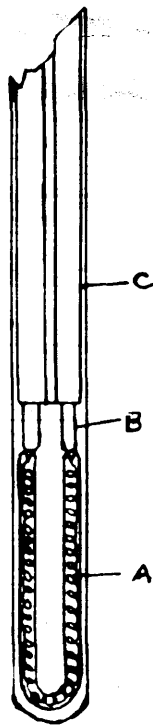
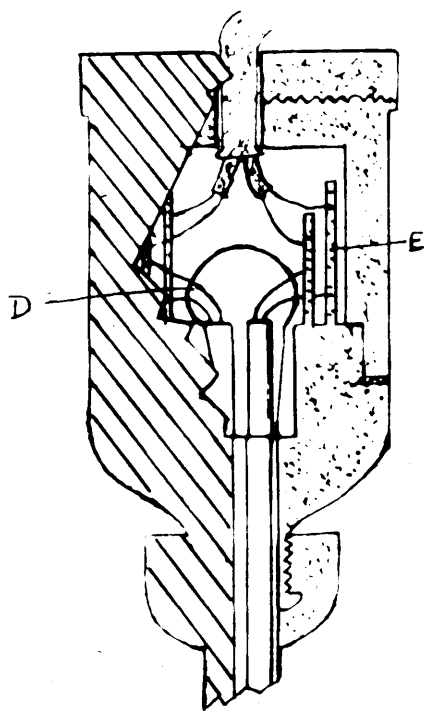

- A-Resistance Coil
- B-Gold Leads
- C-Silica tubes
- D-Platinum leads
- E Pillars

FIG.1. PLATINUM RESISTANCE THERMOMETER

sheath, was covered with pycene, in order to reduce surface leakage. The top was covered with insulating material and fixed into a wooden head, thus protecting the thermometer from radiation and draughts to avoid fluctuating e.m.f.s. The four cables attached on to the platinum leads were fixed to four pillars fixed inside the wooden top and gripped by a split collar (Fig. 1).

The completed thermometer was annealed by passing a current of 0.3 amp. for 30 minutes. The wire reached a temperature of about 700°C under these conditions.

The thermometers were calibrated against another platinum resistance thermometer (kindly lent by Dr. S.P. Datta) at the triple point of water and at several other temperatures below 100°C . Dr. Datta's thermometer had been standardized by the National Physical Laboratory.

Triple point cell: The procedure of Barber and Herington^{18c} was followed in constructing the triple point cell and in water purification.

Two stills were set up consisting of 2 litre round bottomed pyrex "Quickfit" flasks. The still heads were pyrex tubes of 100 cms. length and 2.5 cms. bore, filled

with helices of pyrex glass. The ground glass joints were ungreased. A pyrex glass tube sealed at the upper end and also at about 0.5 cm. from the bottom placed in each still prevented any bumping. Distilled water mixed with 0.2 gm. potassium permanganate and 0.4 gm. sodium hydroxide was refluxed for eight hours, after which, about $1\frac{1}{2}$ litres of water were distilled and used in the second still. No condenser was employed in this still. The rate of boiling was adjusted so that about a quarter of the steam reaching the top condensed in a pyrex bottle, the rest escaping. This prevented back diffusion of impurities. About 10 litres of water were distilled through each newly erected column before being used for steaming and filling the triple point cell.

The triple point cell consisted of two concentric pyrex tubes both of which were sealed and rounded off at the bottom so as to leave a well of about 10 inches depth in the inner tube. A tube with a constriction and carrying a B14 standard cone was fixed to the bottom of the outer tube. The top ends of the concentric tubes were joined together leaving an annular space

The first part of the document discusses the importance of maintaining accurate records of all transactions. It emphasizes that every entry should be supported by a valid receipt or invoice. This ensures transparency and allows for easy verification of the data.

In the second section, the author outlines the various methods used to collect and analyze the data. This includes both primary and secondary data collection techniques. The primary data was gathered through direct observation and interviews with key personnel. Secondary data was obtained from existing reports and databases.

The third section details the statistical analysis performed on the collected data. Various tests were used to determine the significance of the findings. The results indicate a strong correlation between the variables being studied. This suggests that the factors identified are indeed influential in the process being examined.

Finally, the document concludes with a series of recommendations based on the research findings. These suggestions are aimed at improving the efficiency and accuracy of the processes. It is recommended that the organization implement the proposed changes and continue to monitor the results to ensure long-term success.

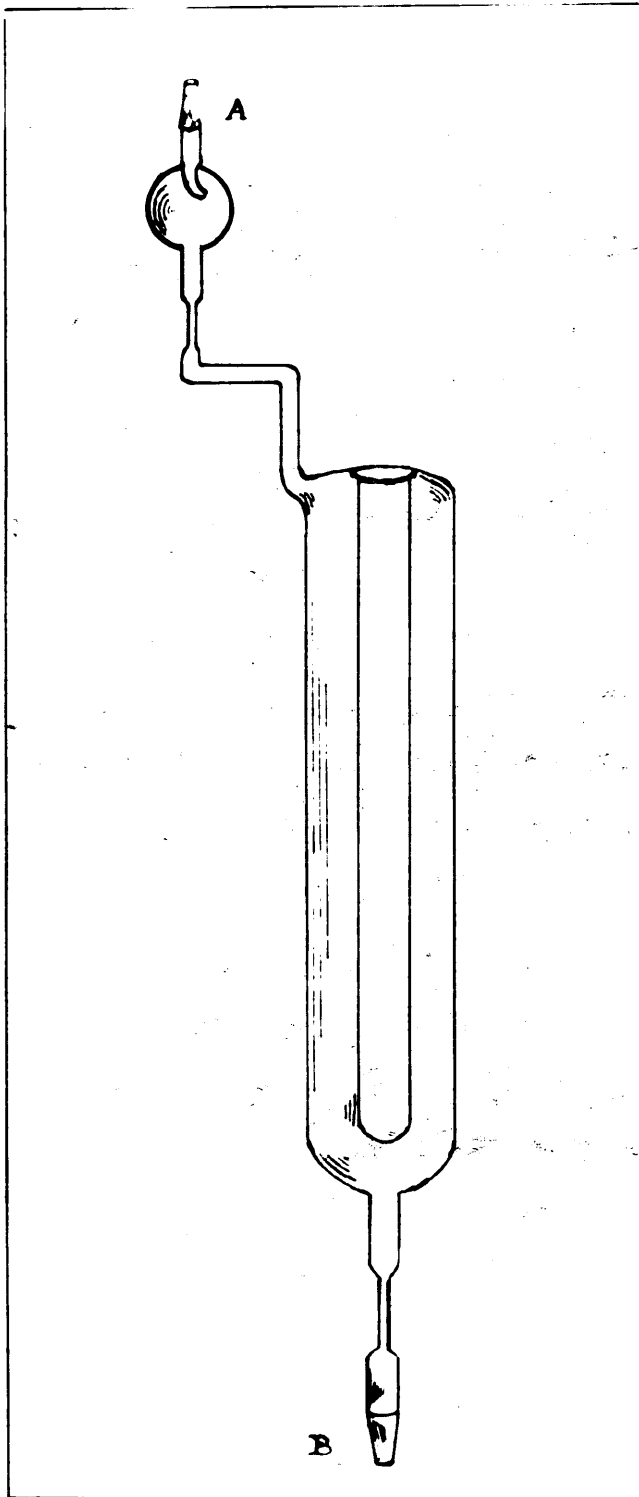

FIG. 2. TRIPLE POINT CELL (FIRST STAGE)

between the two tubes. On one side at the top end was connected a trap tube provided with a Bl4 standard cone (Fig. 2).

For cleaning the cell, part A was closed, the cell was filled with chromic acid and kept for several minutes before draining. It was washed well, filled with distilled water and closed at the open ends and kept as such until required for steaming. The second still was filled with doubly distilled water. The top of the still head was connected to the triple point cell at A by a Bl4 socket adapter at an angle of about 45° to the horizontal. Steaming was carried out for eight hours, when the cell was reversed and steaming continued through B for the same length of time. Finally the port A was reconnected and the cell steamed for one hour before sealing off at B by collapsing the constriction. The seal was blown into the form of a small bulge, the inside of the cell having been protected from contamination by placing a thin rubber membrane between the cell and the glass blower's mouth. This form of seal was preferable to the usual 'spiked' seal which was liable to fracture when immersed in ice bath constantly.

In order to fill the cell, the end A was connected to the top of the still head as before at an angle of

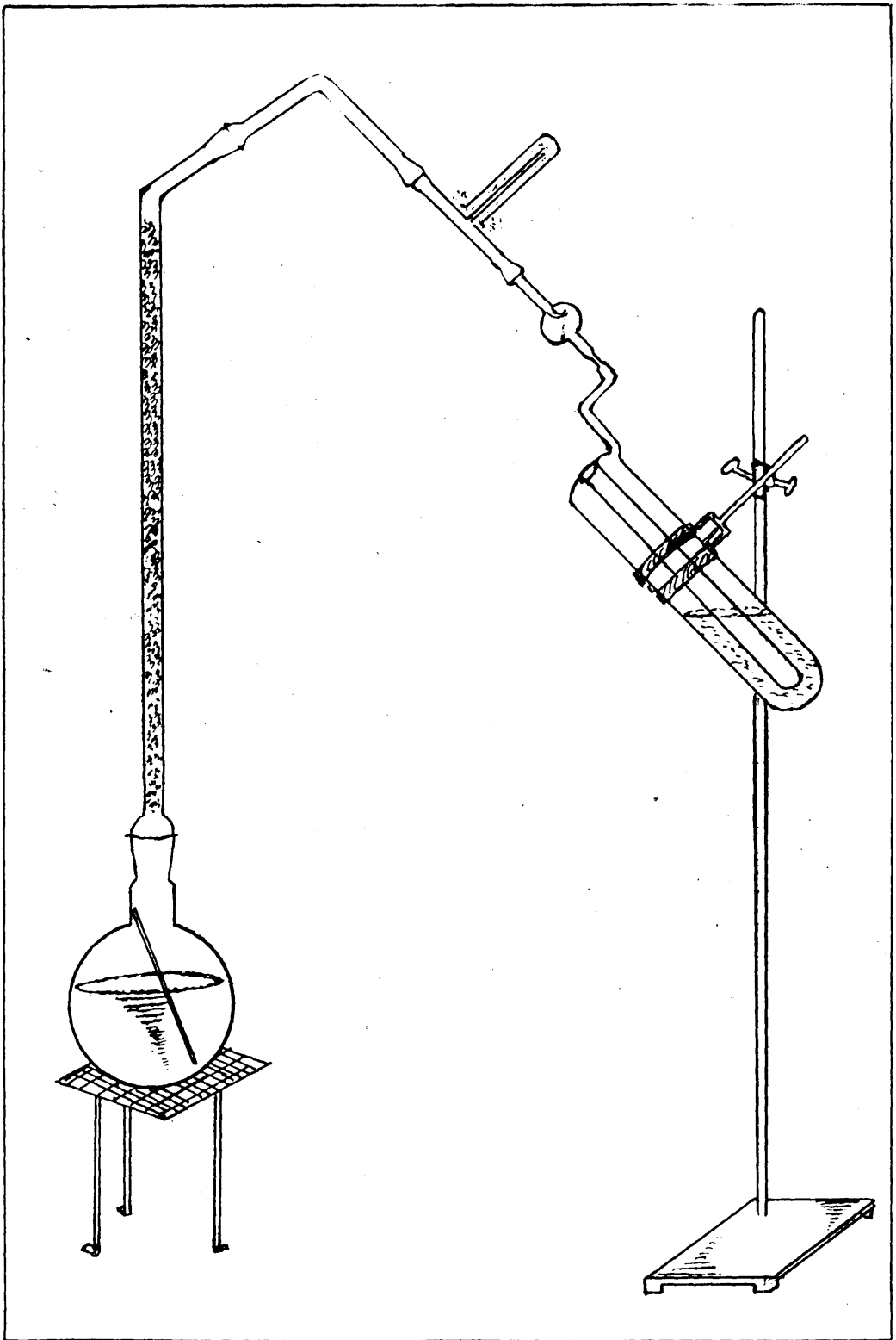

FIG.2. FILLING THE TRIPLE POINT CELL

about 45° , through an adapter with an open side tube. Partial steaming and condensing was carried out over a period of approximately four hours, until the body of the cell was completely filled (Fig. 3). The filled cell was removed and connected at joint A via a glass tap to a rotary oil pump. A very small ring of vacuum grease was placed at the base of joint A. Suction was applied and the cell, kept in a vertical position, was warmed uniformly and carefully by steadily waving a luminous Bunsen flame over the entire surface. Boiling occurred and was maintained steadily. This was continued until evaporation of water had lowered the level in the cell by about half an inch. The tap between the pump and the cell was closed and the cell was immersed in a bath of crushed ice and water. The seal was made by collapsing the constriction between the main body of the cell and the trap, and drawing off. The finished cell is shown in Fig. 4. Three such cells were constructed.

In use, the cell was immersed for at least one hour in a bath of finely divided ice. By rapidly cooling from within, a sheath of ice, one or two cms. thick was then produced inside the cell over the entire length of

The first part of the document discusses the importance of maintaining accurate records of all transactions. It emphasizes that every entry should be supported by a valid receipt or invoice. This not only helps in tracking expenses but also ensures compliance with tax regulations.

In the second section, the author outlines the various methods used for data collection and analysis. These include surveys, interviews, and focus groups. Each method has its own strengths and limitations, and the choice depends on the specific research objectives.

The third section provides a detailed overview of the results obtained from the study. It highlights the key findings and discusses their implications for the industry. The data shows a clear trend towards digitalization, which is reshaping the way businesses operate.

Finally, the document concludes with a series of recommendations for future research and practice. It suggests that further exploration is needed in the area of digital marketing strategies and their impact on customer behavior.

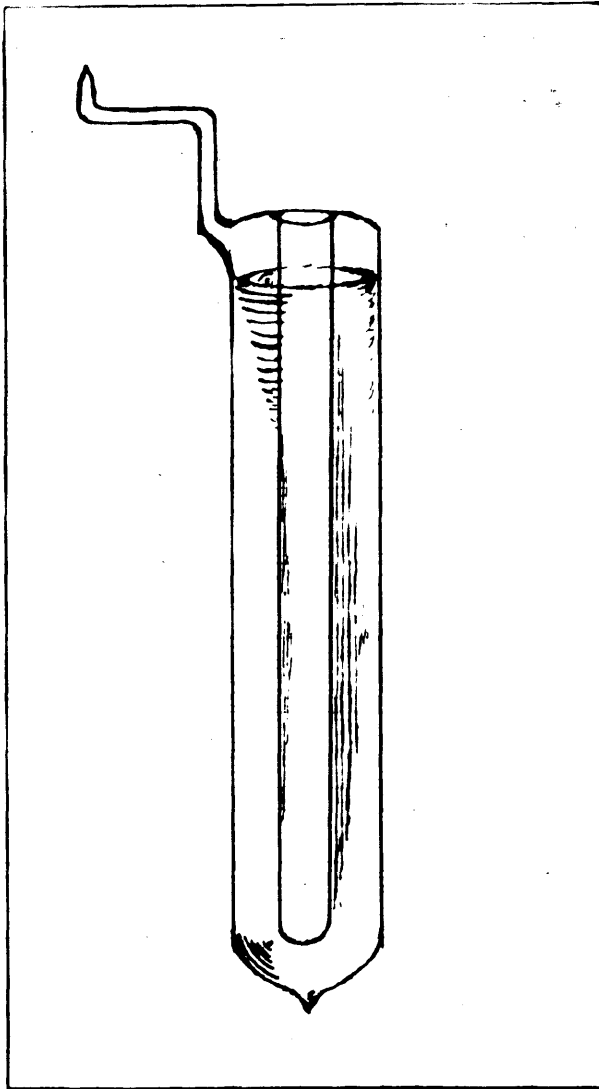

FIG.4. TRIPLE POINT CELL

(FINISHED STAGE)

the thermometer-well; this was achieved by filling with acetone well-cooled in a Dewar flask by addition of "Drikold." Warm water was placed in the thermometer well and a thin layer of ice adjacent to the wall of the cell was melted. The sheath of ice was released from the glass and a very pure water-ice interface was obtained. The thermometer-well was then filled with ice-cold water and the cell was ready for use.

A few important points in the preparation of the cell are the following:-

- 1) Continuous sheath of ice around the well was essential.
- 2) Single preparation of the ice sheath gave greater reproducibility.
- 3) Cell became steady only about 20 hours after preparation of the ice-water interface.
- 4) By keeping the cell completely and continuously immersed in crushed ice-water mixture, the equilibrium could be maintained for at least five days.

It should however be noted that ice prepared from distilled water must be used. By using commercial ice, a cell, left overnight, froze and broke. The usual reproducibility was of the order of $\pm 0.0001^{\circ}\text{C}$.

If R_0 , R_{100} and R_t represent the resistance values

of a thermometer at 0°C (triple point), 100°C (steam point), and $t^{\circ}\text{C}$ respectively,

$$R_t = R_0 \left[1 + \frac{A + F \cdot I}{100} \right] \quad \text{where}$$

$$A = t - \delta \left[\left(\frac{t}{100} \right)^2 - \frac{t}{100} \right] \quad \text{is a function of temperature}$$

is a constant, usually taken as equal to 1.495 for platinum. $F \cdot I$, the fundamental interval is $R_{100} - R_0$. Platinum resistance thermometers are usually calibrated by determination of their resistances at three fixed points, viz., triple point of water (0°C), steam point (100°C) and sulphur point (444.6°C). The first two resistance values give the function $\alpha = R_{100}/R_0$ and making use of the resistance at the sulphur point the value of δ can be calculated from the relationship.

$$100 R_t = R_0 \left[100 + t(\alpha-1) + \delta \left(\frac{t}{100} \right)^2 (1-\alpha) + \delta \left(\frac{t}{100} \right) (\alpha-1) \right] \quad \text{where}$$

$t = 444.6^{\circ}\text{C}$. At any temperature t , the resistance R_t would be given by

$$R_t = R_0 + t \left[\frac{R_0(\alpha-1)}{100} + \frac{\delta R_0(\alpha-1)}{100^2} \right] + t^2 \left[\frac{\delta R_0(1-\alpha)}{100^3} \right]$$

It is seen from the above equation that α is the most important constant, δ occurring only in the small terms. Any small difference of δ from 1.495, if present, introduces only a negligible error in the estimate of temperature especially when measurements are being made in the range 0°C to 50°C .

An alternate and simpler method of calibrating a thermometer is to determine its R_0 value and R_{t_1} , R_{t_2} etc. where R_{t_1} , R_{t_2} etc. represent the resistance of the thermometer at the known temperatures t_1° , $t_2^{\circ}\text{C}$. etc. The value for α can then be obtained by substitution in the equation given above. In the present case, the values for R_0 , and R_{t_1} , R_{t_2} , R_{t_3} etc. where t_1 , t_2 , t_3 etc. were a series of temperatures between 0°C and 60°C , were determined for the two thermometers and the standard thermometer. All three thermometers were put in series with a standard resistance, kept in a 25°C thermostat and a current of 1 m.a. was passed through the circuit. The e.m.f.s across each thermometer and the standard resistance were measured with the vernier potentiometer, and the values of the thermometer resistances calculated. The measurements were repeated in two triple point cells, prepared and kept at equilibrium for 20 hours as

described earlier. The thermometers were then immersed in the thermostat kept at a constant temperature and the experiment repeated.

The exact thermostat temperature was calculated from the known α and δ values for the standard thermometer and from the data at a series of temperatures, α values for the two thermometers were calculated. The R_0 values obtained by employing the two triple point cells in turn agreed to better than 1 in 100,000. Three different standard resistances, viz., an 1 ohm resistance, a 20.0132 ohm constantin coil and a 20.0 ohm nichrome resistor were used in turn and close agreement was observed among the values. Table I gives the resistance values of the three thermometers at 0°C, and some other temperatures, and the α values. The second column gives the resistance calculated at round temperatures for the standard thermometer and the exact temperatures, derived using the observed resistances of that thermometer (fourth column) and the resistance coefficients at 1°C intervals, are given in the third column. The last two columns give the corresponding resistance values for the two thermometers. A series of 11-15 resistance determinations at each temperature agreed to 1 in 50,000.

In the actual experiments with concentration cells, however, it was preferable to obtain e.m.f. data at round temperatures. It was, therefore,

Table I

Constants for the thermometers

	Calcd. Temp. resist. °C of stand. therm.	Calcd. temp. °C	obs. resist. of stand. therm.	obs. resist. of therm. I	obs. resist. of therm. II
0	27.5666		27.5666	20.6757	13.8878
3	27.9853				
4	28.0048	3.794	27.9822	20.9873	14.0943
9	28.5517				
		9.965	28.6572	21.4939	14.4346
10	28.6610				
15	29.2070				
		15.95	29.3106	21.9810	14.7622
16	29.3161				
20	29.7523				
		20.091	29.7621	22.3181	14.9887
21	29.8612	20.475	29.8040	22.3492	
24	30.1878				
		24.981	30.2945	22.7156	15.2559
25	30.2966	24.998	30.2964	22.7161	15.2577
26	30.4054	25.034	30.3003	22.7183	
30	30.8402	30.880	30.9358	23.1947	
31	30.9688	30.893	30.9371	23.1957	
35	31.3830	35.586	31.4466	23.5716	
36	31.4815				
		36.408	31.5357	23.6412	15.8817
37	31.5999				

Table I (contd.)

	Calcd. Temp. resist. °C of stand. therm.	Calcd. temp. °C.	obs. resist. of stand. therm.	obs. resist. of therm. I	obs. resist. of therm. II
41	32.0333	41.309	32.0667	24.0398	
42	32.1416				
		42.385	32.1832	24.1234	
43	32.2498				
51	33.1146	51.49	33.1673	24.8658	16.7077
52	33.2224	51.495	33.1679	24.7675	16.7086
56	33.6539				
		56.481	33.7057	25.2706	16.9792
57	33.7617				
α	1.39174 ₆			1.39054	1.39062
	1.495			1.495	1.495

decided to set a series of Beckmann thermometers at different round temperatures in the range of 0°C to 50°C required, by calibration against the platinum resistance thermometers. These Beckmann thermometers were used in the experiments.

E.M.F. Cell and Electrodes: The cell employed was of the usual H shaped one, similar to that used by Noyes and Ellis^{19c}, made of pyrex glass. Two hydrogen pre-



Faint, illegible text or markings, possibly bleed-through from the reverse side of the page, located in the lower-middle section.

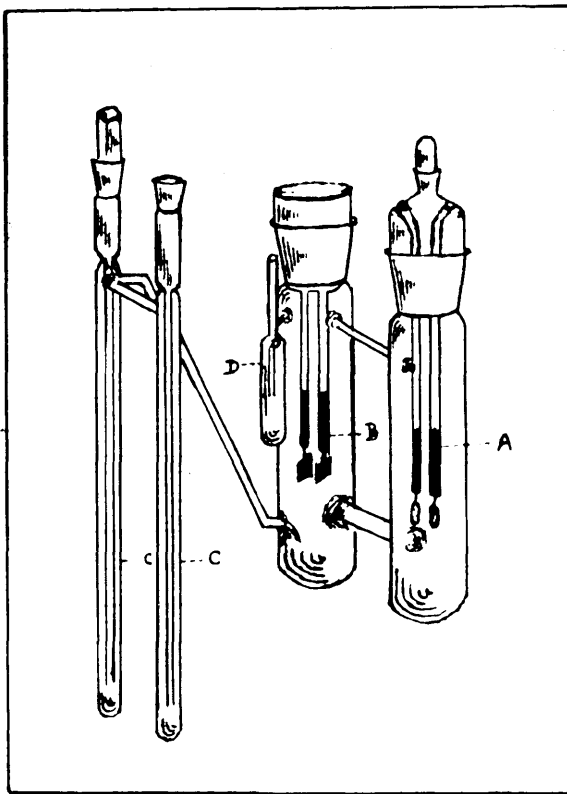

FIG.5. THE E.M.F. CELL

- A - Silver-Silver Chloride Electrode
- B - Hydrogen Electrode
- c - Presaturators
- D - Guard Tube

saturators were made integral with the hydrogen electrode compartment as was done by Harned and Morrison^{20c}. The modifications made by Ashby, Crook and Datta^{21c} were also incorporated. The cell was fitted with standard (B29) ground glass sockets, the electrodes being supported in standard cones. Each cell contained a pair of silver-silver chloride electrodes and hydrogen electrodes so that four estimates of the e.m.f. were possible. A guard tube was fixed to the hydrogen electrode compartment and any liquid collecting in it was immediately removed by suction. (Fig 5)

Hydrogen electrodes: Stout platinum foils 0.4 cm. by 2.5 cm., welded on to platinum wire 0.05 cm. in diameter^{20c}, were sealed into pyrex glass tubes. The electrodes were cleaned with chromic acid and washed. A little araldite resin was placed at the bottom end of the tubes and cast by heating in an oven at 120°C. This procedure ensured an excellent platinum-pyrex seal. A thin coat of platinum black was deposited on the electrodes by electrolysis in a solution containing 2.5% chloroplatinic acid in 1 N hydrochloric acid^{21c} for approximately 2 minutes at a current density of about 0.2 amp. per cm.², the current being reversed every 15 seconds. The coating thus

obtained was not sufficiently thick to obscure completely the brightness of the underlying metal. The platinum black was removed with aqua regia after every alternate run and fresh deposit made. Electrodes were preserved out of contact with air in water which had been previously bubbled with hydrogen.

Silver-silver chloride electrodes: The silver-silver chloride electrodes were the thermal-electrolytic type designated by Harned^{22c} as type (2), and used by Harned and Morrison^{20c}. A platinum wire 4-5 c.m.s. long and 0.02 c.m. in diameter was made into a helix of about 0.3 c.m. diameter. The helix was sealed into pyrex glass tube which was fixed into a standard ground glass cone. Each cone carried two such electrodes. The platinum spirals were cleaned, washed and filled with a thick paste of spectroscopically pure silver oxide (Johnson-Mathey and Co., 73-83 Hatton Garden, London, E.C.1.) in conductivity water. The electrodes were first dried in an oven and subsequently heated in a muffle furnace, the temperature being gradually raised to 450°C. When the decomposition was complete, they were allowed to cool in the furnace. The electrodes were given a second coating of the silver oxide paste and again heated. This

was necessary to ensure that a nonporous deposit of silver was formed. As in the case of the hydrogen electrodes, a little araldite resin was cast at the bottom of the electrode tubes. The electrodes were then chloridised in the absence of light by electrolysis in normal hydrochloric acid solution (prepared from constant boiling acid) at a current density of 2 m. amp. per cm.² for approximately two hours. A platinum helix of similar dimensions was made the cathode. Ashby, Crook and Datta^{21c} found that better agreement between pairs of electrodes and more rapid equilibration were obtained if the electrodes were warmed in water at 50°C. for 2 hours after chloridising, and this procedure was adopted, again without any exposure to light. Two batches of electrodes, each of four sets were prepared, and preserved in the dark in water containing a pinch of potassium chloride, the dissolved oxygen in the water having been expelled by bubbling hydrogen through it. Taniguchi and Janz^{23c} found that freshly prepared electrodes showed a higher potential than aged ones owing to a bias potential caused by concentration polarization. Depending on the porosity of the deposit of silver and silver chloride, the electrodes took periods ranging from 6 to 10 hours to one week to come to constant potential. These workers

also obtained rapidly equilibrating electrodes by making the latter sufficiently massive, that is greater than 30 m.g. Bates^{24c} suggests that the silver-silver chloride electrodes should be 150-200 m.g. for best results. The electrodes used in the present work were all about 100-200 m.g. in weight and were allowed to age for more than three weeks.

Calibration of the silver-silver chloride electrodes:

Harned and Ehlers^{25c} have determined the standard potential of the silver-silver chloride electrode over a temperature range of 0°C to 60°C at 5° intervals, using an extrapolation method. They employed the relationship

$$E + 2 k \log m - 2 k \mathcal{S} \sqrt{I} = E^\circ - 2 k B'm$$

where E and E° were the observed and standard potentials, I was the ionic strength and m was the molality.

$$k = 2.3026 RT/F.$$

The procedure most subsequent workers have adopted, is to use those standard potential values for their electrodes at the appropriate temperatures.

Recently, however, Bates, Guggenheim, Harned, Ives, Janz, Monk, Robinson, Stokes and Wynne-Jones^{26c} have observed that the most careful measurements confirm the

difficulty of fixing the standard potential of the electrode to better than 0.2 m.v., the uncertainty being most probably due to small differences in the structure of the solid phases. On the other hand, the activity coefficient of 0.01 m. hydrochloric acid is uncertain to only about 0.0005 which corresponds to only 0.03 m.v. These workers have therefore recommended that "in measurements of the highest precision each worker could advantageously determine the E° value of his own set of electrodes by standardisation at 0.01 m." They have also suggested that the value γ^\pm hydrochloric acid at 0.01 m be conventionally standardized as 0.904 exactly at 25°C, and 0.908 exactly at 0°C. and these values be used until there was convincing evidence that either value was wrong by as much as 0.001.

The electrodes used in the present work were standardized at these two temperatures using 0.01 m. hydrochloric acid and γ values recommended. For standardization at other temperatures, however, the changes in activity coefficient with temperature given by Harned and Owen^{27c} were used. The value at 25°C was checked at frequent intervals. The standard potentials obtained are given in Table II. As is seen from the table, the E° was

never more than 0.2 m.v. below Harned's value at 25°C. and 0.23 m.v. above the corresponding value at 0°C. The internal consistency among all the eight pairs of electrodes was better than \pm 0.02 m.v. Purlee and Grunwald^{28c} used electrodes in which the silver was formed as a mirror deposit before chloridising for working with organic solvents. They found that different thermal electrolytic electrodes and different mirror electrodes agreed only to within 0.2 m.v.

Table II

Standard potential of silver-silver chloride electrodes

Temp °C	\pm 0.01M HCl	E° value	E° obtained by Harned and Ehlers ^{25c}
0	0.9080	0.23657	0.23634
5	0.9056	0.23412	0.23392
10	0.9055	0.23128	0.23126
15	0.9055	0.22847	0.22847
20	0.9052	0.22535	0.22551
25	0.9040	0.22219	0.22239
30	0.9034	0.21892	0.21912
35	0.9025	0.21545	0.21563
40	0.9016	0.21181	0.21200
45	0.9008	0.20801	0.20821

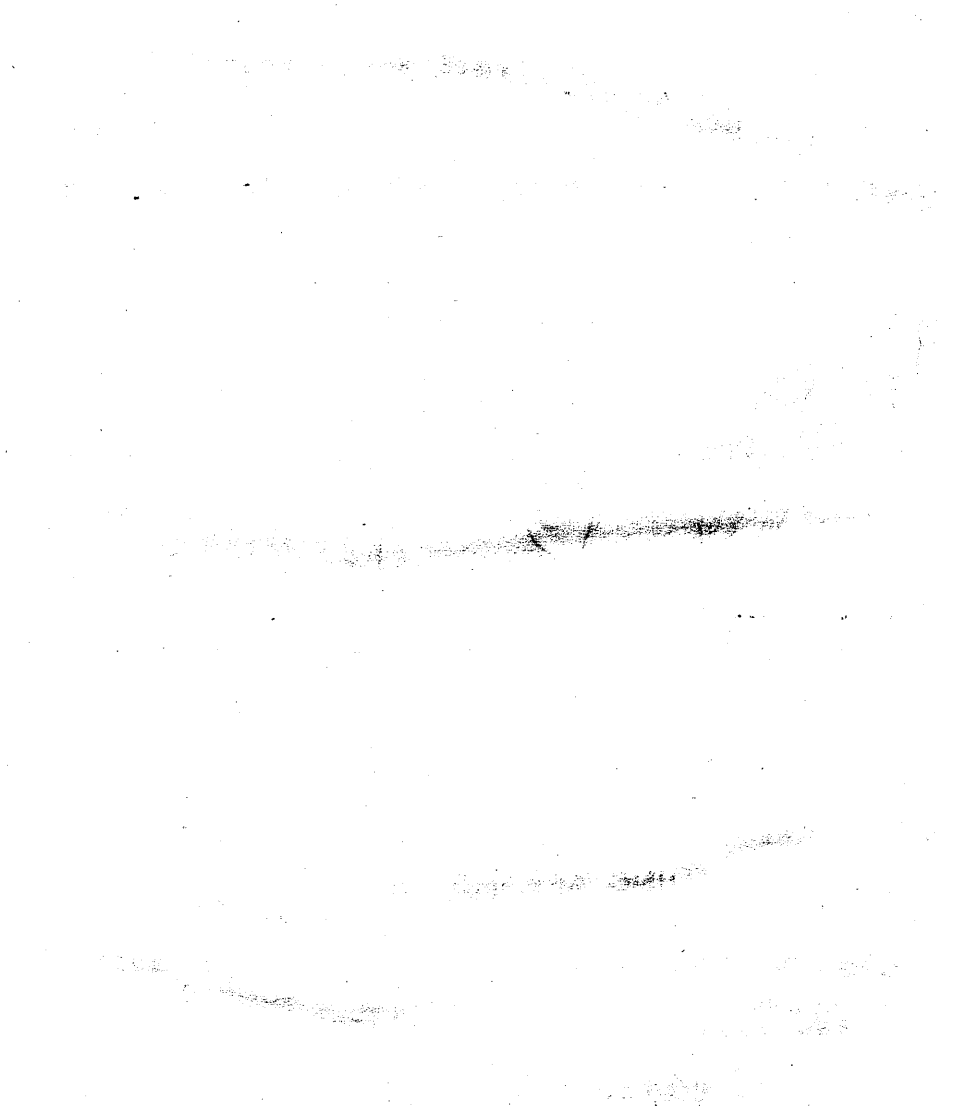

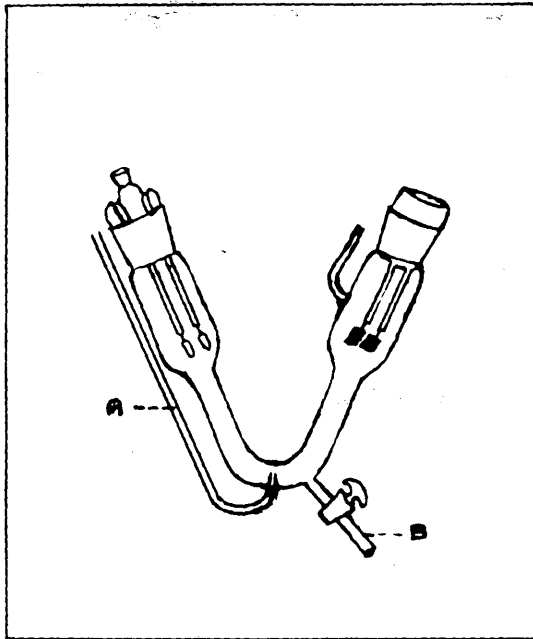

FIG. 6. WASHING APPARATUS

A - capillary Inlet for Hydrogen.

B - outlet

Procedure for e.m.f. measurements

Stock solutions of hydrochloric acid, sulphuric acid and the metal sulphates were prepared at approximately 0.2 m., in pyrex stock flasks having ground glass necks and stoppers and which had been cleaned and steamed before use. In the case of the metal sulphates, samples of the purified salts obtained in the anhydrous state by heating to constant weight in pyrex weighing bottles at the appropriate temperatures, were dissolved in dilute hydrochloric acid solution in stock flasks having B 34 sockets) by dropping in the weighing bottles. The experimental solutions were prepared from these by weight dilution in 500 m.l. pyrex stock flasks having B24 necks by employing a weight burette. Vacuum corrections were applied to all weights.

Each flask was mounted with a bubbling device provided with three-way and two-way vacuum taps. Hydrogen freed from oxygen, and saturated with water vapour by passing through a series of wash bottles, was bubbled through the solution for approximately one hour at the rate of about one bubble per second.

The electrodes were washed three times with the solution in a V shaped vessel provided with standard ground glass sockets, a capillary tube for bubbling

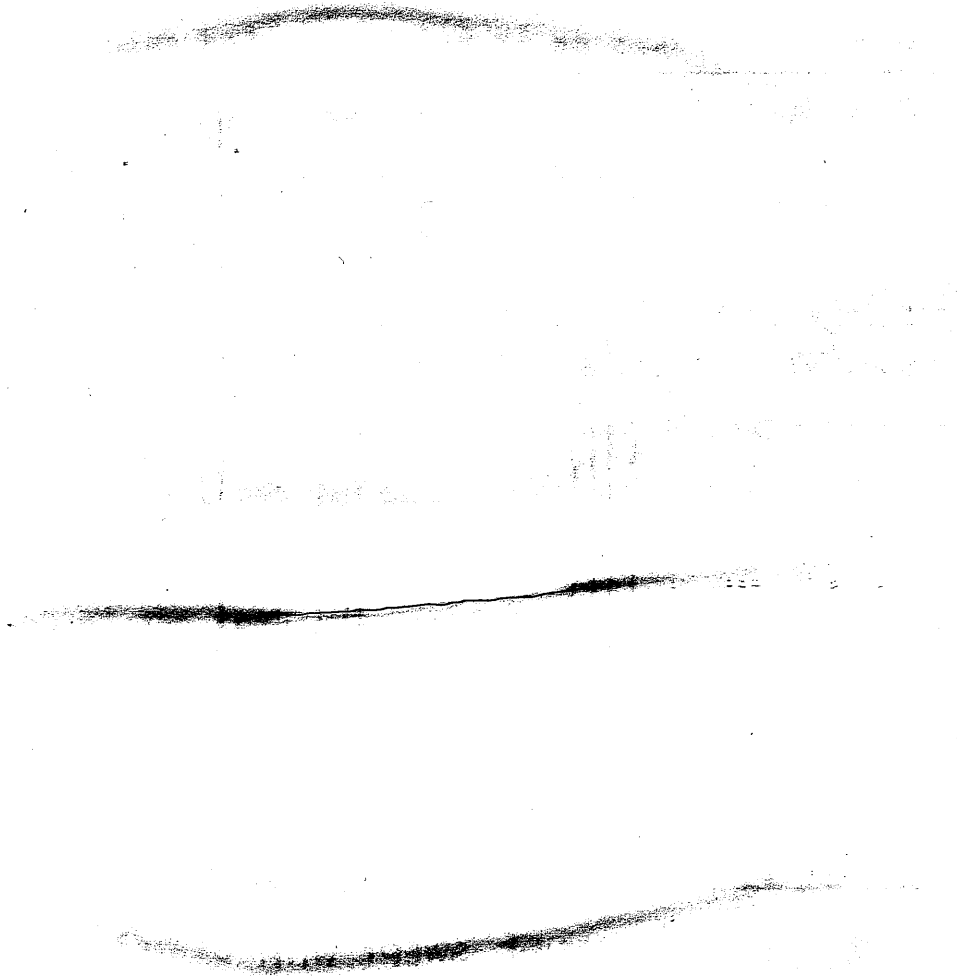

1877
1878
1879

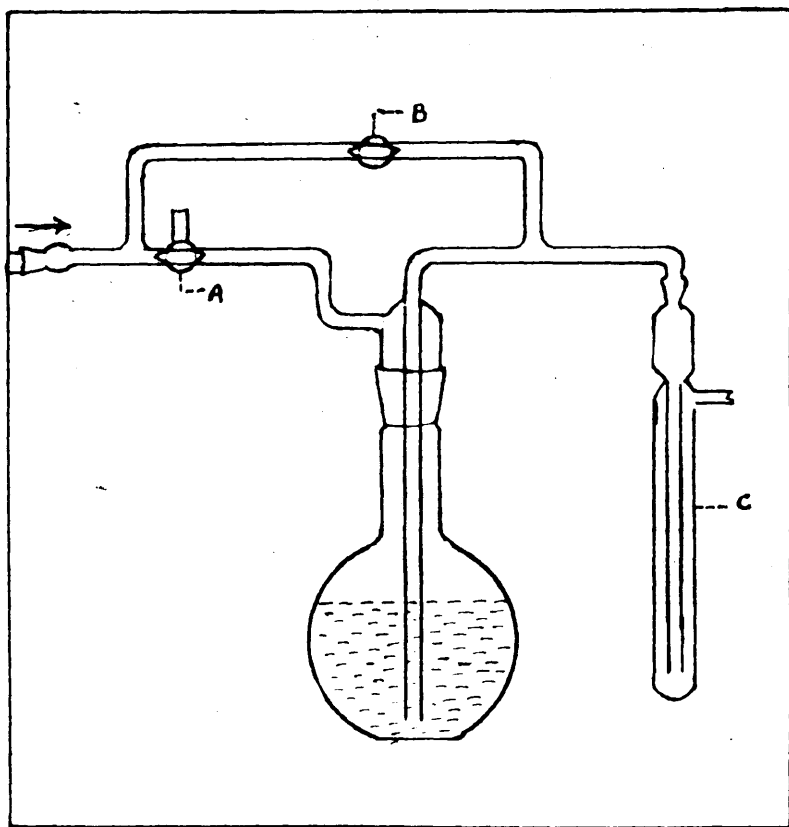

FIG. 7. THE CELL BEING SWEEPED WITH
HYDROGEN

- A - Three way Tap
- B - Two way Tap.
- c - Presaturator Integral with Cell

hydrogen during washing, and an outlet for the wash solution (Fig. 6).

The electrodes after rinsing were mounted in the cell which had been dried in an oven, and the cell was connected to the solution flask through a B10 standard joint. By adjusting the taps, it was possible to bypass the solution and sweep out the air in the cell with hydrogen (Fig. 7). At the end of about 5-10 minutes, the taps were adjusted so that the solution was transferred from the flask to the cell by hydrogen pressure without bringing into contact with atmospheric air. The filled cell was placed in the thermostat kept at the required temperature and hydrogen at a constant rate of about two bubbles per second was passed into the hydrogen electrode compartment. This hydrogen was saturated with water vapour by passage through another series of washbottles; it was then passed through a small bubble counter, and a short length of capillary tubing (to ensure uniform rate of bubbling). The hydrogen then bubbled through the presaturators, (Fig. 5) made integral with the hydrogen electrode compartment and kept immersed in the thermostat. This prevented any alteration of the concentration of the cell solution. Four such cells

PLATE II

A CELL BEING FILLED

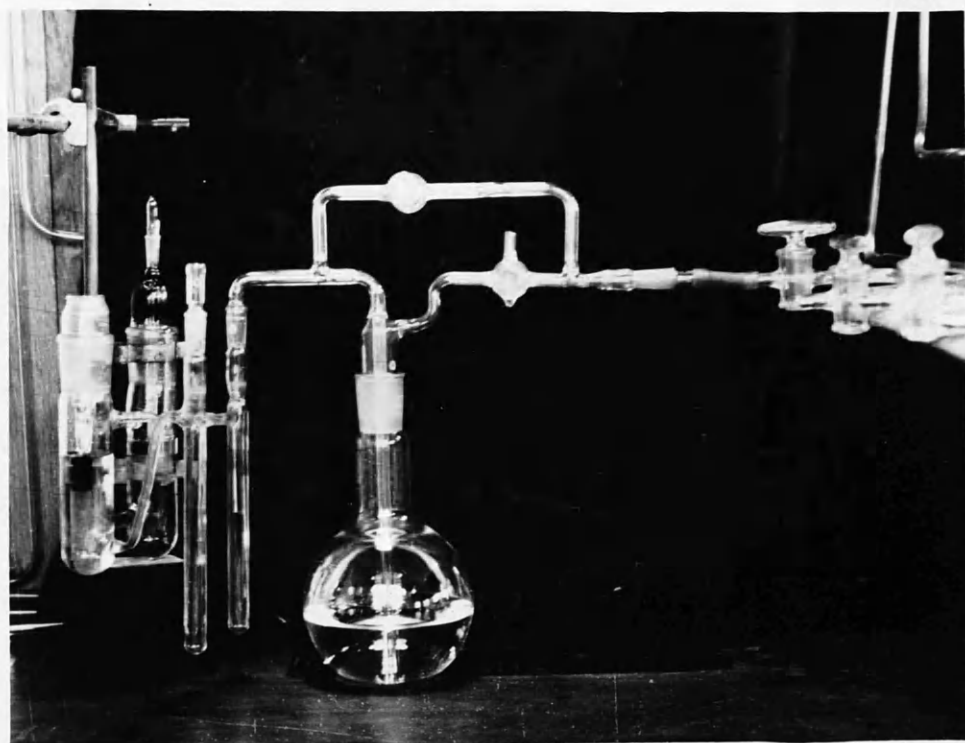

PLATE III

A RUN IN PROGRESS (E.M.F.)



were used simultaneously during each run. The cells were allowed to equilibrate for 3-4 hours, and the e.m.f.s were measured in the potentiometer using the duplicate sets of electrodes to obtain four readings. The cells were considered to have reached equilibrium, when the e.m.f. values remained constant for more than half an hour and the different combinations of electrodes agreed to within 0.02 m.v. The barometric pressure and the room temperature were recorded and the thermostat was raised through 5°C or 10°C as required and the cells were again allowed to equilibrate. It was found that they required only one hour to reach equilibrium at each new temperature, if a steady rate of hydrogen bubbling was maintained.

It was more convenient to start the run at the lowest temperature and raise it by steps of 5°C or 10°C. Measurements from 0°C to 25°C were made with one filling. A new filling was used for measurements in the range 25°C to 45°C, a check being made at 25°C. A few runs were also made with a single filling covering the whole temperature range in the course of 24 hours. The e.m.f. values obtained at the same temperature with different fillings never varied

by more than ± 0.03 m.v. The observed e.m.f.s were corrected for the pressure. In doing so, corrections of the barometer reading for temperature and latitude were made. In making the pressure correction, the effect of bubbler depth observed by Hills and Ives^{29c} was ignored since this would only amount to about $5 \mu\text{v. at } 25^\circ\text{C.}$

RESULTS AND DISCUSSION

a) Dissociation of the bisulphate ion: In the measurements with cell (B)

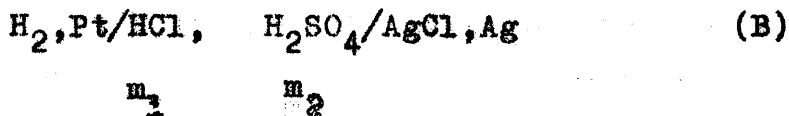

if m_1 and m_2 represent the molalities of hydrochloric acid and sulphuric acid, and E and E° , the corrected e.m.f. of the cell (B) and the standard potential of the silver-silver chloride electrode, respectively,

$$E = E^\circ - \frac{RT}{F} \ln a_{\text{H}^+} \cdot a_{\text{Cl}^-}$$

$$= E^\circ - \frac{2.3026 RT}{F} \log (f_{\text{H}^+} \cdot f_{\text{Cl}^-} \cdot m_{\text{H}^+} m_{\text{Cl}^-})$$

$$-\log m_{\text{H}^+} = \frac{(E - E^\circ)F}{2.3026RT} + \log f_{\text{H}^+} \cdot f_{\text{Cl}^-} + \log m_{\text{Cl}^-}$$

$$= \frac{(E - E^\circ)F}{2.3026RT} + \log f_1^{+2} + \log m_1 \dots (1)$$

$$\text{The ionic strength } I = 2 m_{\text{H}^+} - (m_1 + m_2) \dots (2)$$

$$m_{\text{HSO}_4^-} = m_{\text{H}^+} - (m_1 + m_2) \dots (3)$$

$$m_{\text{SO}_4^{--}} = m_2 - m_{\text{HSO}_4^-} \dots \dots \dots (4) .$$

Davies equation^{30c} for activity coefficient,

$$-\log f_z = AZ^2 \left[\frac{I^{\frac{1}{2}}}{1 + I^{\frac{1}{2}}} - 0.2I \right] \dots (5)$$

An apparent value for m_{H^+} was first obtained from equation (1), by substituting for f_1^{\pm} , the value obtained from equation (5) assuming complete dissociation. A series of successive approximations were then made for the ionic strength and new values for m_{H^+} were calculated until both m_{H^+} and I became constant. The concentrations of other ionic species were calculated from equations (3) and (4). The dissociation constant of the bisulphate ion, K_2 , was given by

$$K_2 = \frac{m_{\text{H}^+} \cdot m_{\text{SO}_4^{--}} \cdot f_{\text{H}^+} \cdot f_{\text{SO}_4^{--}}}{m_{\text{HSO}_4^-} \cdot f_{\text{HSO}_4^-}} \dots (6)$$

The Debye and Hückel values for the coefficient A , in the activity coefficient expression (5), and the values of $\frac{2.3026RT}{F}$ at the different temperatures, given by Robinson and Stokes^{31c} and used in the calculations, are given in Table III.

TABLE III

Values of constants used in the calculations

Temp °C	A	$\frac{2.3026RT}{F}$	Temp °C	A	$\frac{2.3026RT}{F}$
0	0.4883	0.054197	30	0.5142	0.060149
5	0.4921	0.055189	35	0.5190	0.061141
10	0.4961	0.056182	40	0.5242	0.062133
15	0.5002	0.057173	45	0.5296	0.063126
20	0.5046	0.058165			
25	0.5092	0.059158			

Table IVa gives the molal concentrations of hydrochloric acid and sulphuric acid in each run and the results are given in Table IVb. No drift in the value of K_2 the dissociation constant, with ionic strength was noticed. Plot of pk_2 against T^{-1} is shown in Graph 1.

Table IVa

Concentrations of solutions in experiments with sulphuric acid.

Run No.	m_1 m.moles	m_2 m.moles	Run No.	m_1 m.moles	m_2 m. moles
1	1.2711	1.3498	11	6.7748	5.4093
2	1.8441	1.8564	12	5.3530	7.1315
3	2.1606	2.2481	13	8.1637	8.4059
4	2.3804	2.0919	14	5.7665	10.1000
5	3.5560	2.9684	15	2.1500	1.7383
6	5.0645	3.6773	16	2.8003	3.1488
7	5.1554	5.5379	17	2.3264	2.2471
8	6.7047	3.8888	18	3.2284	2.6627
9	2.0278	2.0131	19	2.7147	2.7006
10	4.6073	5.4429	20	3.8725	4.1791

Table IVb

Results on bisulphate

Run No.	E-E°	10^3I	$10^3 \text{m}_{\text{H}^+}$	$10^3 \text{m}_{\text{HSO}_4^-}$	10^2k
Temp. 0°C					
1	0.29131	5.058	3.8394	0.1312	2.66
2	0.27541	6.941	5.3206	0.2362	2.60
3	0.26791	8.255	6.3320	0.3248	2.60
4	0.26583	8.060	6.2660	0.2981	2.60
5	0.24864	11.429	8.9764	0.5164	2.79 2.62
Temp. 5°C					
6	0.23929	14.331	11.537	0.8825	2.28
7	0.23366	18.813	14.753	1.4781	2.38
8	0.22920	16.311	13.452	1.0300	2.27 2.31
Temp. 15°C					
6	0.24842	13.842	11.292	1.1273	1.59
7	0.24280	17.909	14.301	1.9301	1.58
8	0.23795	15.788	13.191	1.2914	1.61 1.59
Temp. 25°C					
1	0.31904	4.769	3.6961	0.2754	1.07
2	0.30179	6.503	5.1005	0.4553	1.11
3	0.29371	7.677	6.0431	0.6137	1.11
4	0.29146	8.724	5.9632	0.6009	1.03
5	0.27280	10.510	8.5163	0.9765	1.13
7	0.25193	17.144	13.9187	2.3125	1.14

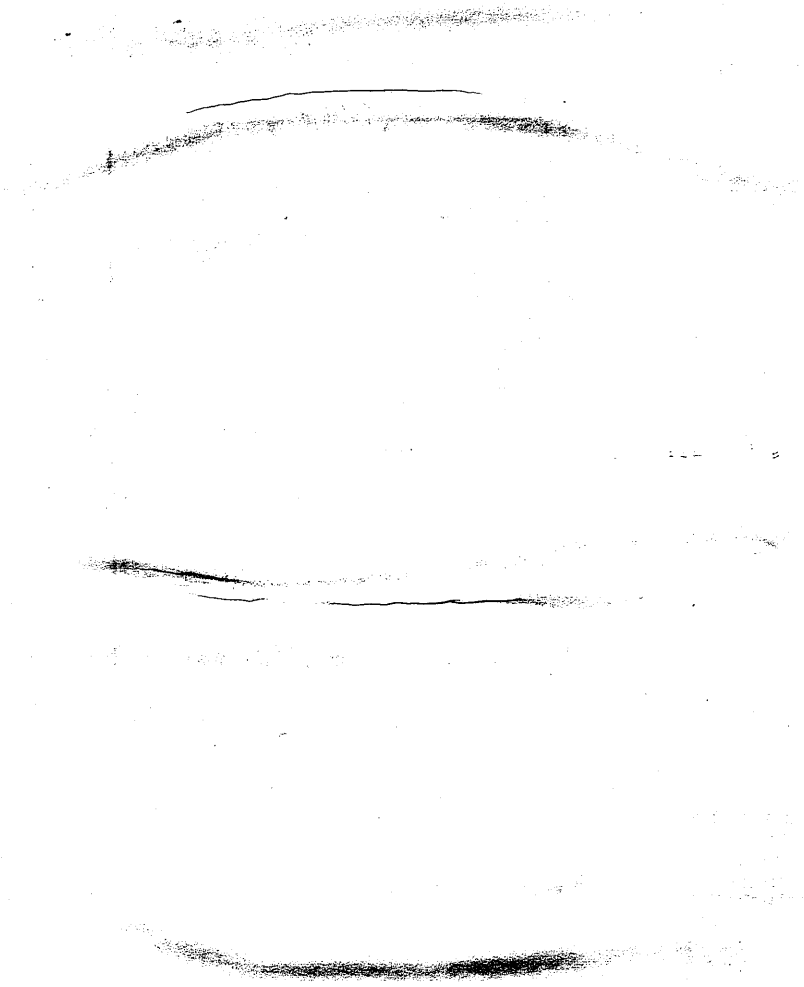

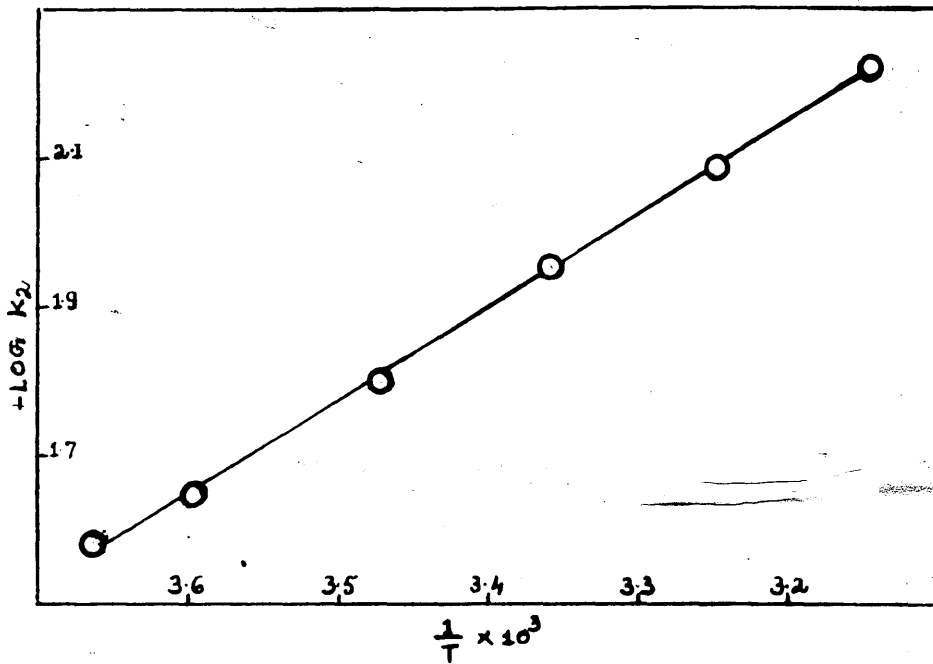

GRAPH 1. THE BISULPHATE ION

Table IVb (contd.)

Run No	E - E°	10 ³ I	10 ³ m _H ⁺	10 ³ mHSC ₄ ⁻	10 ² k
Temp. 25°C					
9	0.29737	7.049	5.5441	0.5099	1.14
10	0.25593	16.498	13.273	2.2204	1.14
11	0.24276 ₄	18.300	15.244	2.3493	1.15
12	0.24726 ₆	20.285	16.386	3.2300	1.12
13	0.23092 ₄	25.040	20.826	4.1498	1.15
14	0.23979	26.02	20.954	5.0454	1.12
15	0.29734	6.485	5.1866	0.4400	1.09
16	0.28032	10.131	8.0410	1.0570	1.05
17	0.29126	7.788	6.1804	0.6415	1.07
18	0.22760	9.543	7.7160	0.8378	1.12 1.10
Temp. 35°C					
2	0.31245	6.298	4.9995	0.5573	0.824
3	0.30418	7.396	5.9026	0.7543	0.806
9	0.30787	6.833	5.4371	0.6170	0.859
17	0.30164	7.504	6.0393	0.7833	0.777
18	0.28749	9.208	7.5994	1.0044	0.827
20	0.27490	12.830	10.441	1.7897	0.868 0.82

Table IVb (contd.)

Run No.	$E - E^\circ$	$10^3 I$	$10^3 m_{H^+}$	$10^3 m_{HSO_4}$	$10^2 k$
Temp. 45°C					
1	0.34145	4.517	3.5690	0.4017	0.622
2	0.32323	6.076	4.8881	0.0683	0.614
3	0.31468	7.140	5.7742	0.8826	0.615
9	0.31864	6.530	5.2854	0.7678	0.598
17	0.31210	7.221	5.8975	0.9251	0.580
18	0.29752	8.834	7.3625	1.1914	0.603
19	0.30382	8.444	6.9296	1.1863	0.592
20	0.28465	12.203	10.127	2.1033	0.622 0.60

For comparison with the present work, the available dissociation constant (k_2) data at 25°C. are given in Table V.

Table VDissociation constant of the bisulphate ion at 25°C.

Workers	Method	$10^2 k_2$	Reference
Sherrill and Noyes	Conductance and transport number	1.15 (1.18 molal scale)	9c
Bray and Liebhafsky	kinetics	1.15	10c
Young, Klotz and Singleterry	Spectrophotometry	1.04 ± 0.03	11c
Hamer	e.m.f.	1.20	12c
Kentama	Solubility	1.14	13c
Davies, Jones and Monk	e.m.f.	1.03	14c
Present work	e.m.f.	1.10	

Hamer^{12c} studied the cell

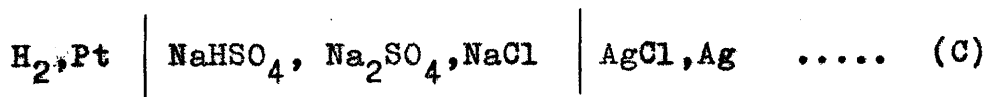

and calculated his results assuming the sodium sulphate to be completely dissociated and using the limiting Debye Hückel expression, $-\log f_z = AZ^2 I^{\frac{1}{2}}$ for the activity coefficient. Davies, Jones and Monk^{14c} have recalculated his results, accounting for the presence of NaSO_4^- ($k = 0.19$ at $25^\circ\text{C}.$)^{32c} and using the activity coefficient expression (5) of Davies^{30c}

$$-\log f_z = AZ^2 \left[\frac{I^{\frac{1}{2}}}{1+I^{\frac{1}{2}}} - 0.2I \right] \quad \dots \quad (5)$$

They have obtained by this method a k_2 of 0.0102 at 25°C.

In the work of Young, Klotz and Singleterry, (described by Robinson and Stokes)^{11c}, optical density measurements were made with two absorption cells one of which contained a reference indicator [4×10^{-6} methyl orange (In^-)] in 3×10^{-4} to 6×10^{-4} N hydrochloric acid so that both the 'acidic' and 'basic' forms of the indicator were present in substantial amounts. The other cell contained the same solution to which sodium sulphate in amounts up to 0.04 N was added. With a knowledge of the extinction coefficients of In^- and HIn , the two forms of the indicator, the indicator ratio $m_{\text{In}^-} / m_{\text{HIn}}$ in the two solutions could be determined, R° and R respectively. This ratio occurs in the equilibrium

$$k_{\text{Ind}} = \frac{m_{\text{H}^+} \cdot m_{\text{In}^-}}{m_{\text{HIn}}} \cdot \frac{f_{\text{H}^+} \cdot f_{\text{In}^-}}{f_{\text{HIn}}}$$

For the indicator solution with no added salt

$$\log m_{\text{H}^+}^\circ = \log k_{\text{Ind}} - \log R^\circ - 2 \log f_{\text{H}^+}^\circ$$

and for the indicator solution with added sodium sulphate

$$\log m_{\text{H}^+} = \log k_{\text{Ind}} - \log R - 2 \log f_{\text{H}^+}$$

The addition of sodium sulphate altered the indicator ratio in two ways, a neutral salt effect resulting from the increased ionic strength and a change in hydrogen ion concentration as a consequence of the formation of bisulphate ions. Sodium chloride or barium chloride was then added to the indicator solution containing no added salt in such amounts as to make the total ionic strength similar to that in the solution with the added sodium sulphate. Optical density measurements were made in the new solution and, assuming that the addition of the chloride of sodium or barium did not have any effect on the hydrogen ion concentration

$$\log m^{\circ} \text{H}^{+} = \log k_{\text{Ind}} - \log R' - 2 \log f_{-}^{+},$$

where R' is the indicator ratio in the new solution

$$\text{Hence } \log \frac{m_{\text{H}^{+}}}{m^{\circ} \text{H}^{+}} = \log \frac{R^{\circ}}{R} + 2 \log \frac{f_{-}^{\circ}}{f_{-}^{+}} \quad \text{and}$$

$$\log \frac{R^{\circ}}{R} = - 2 \log \frac{f_{-}^{\circ}}{f_{-}^{+}}$$

Thus $m_{\text{H}^{+}}$, the hydrogen ion concentration in the solution with added sodium sulphate was obtained relative to $m^{\circ} \text{H}^{+}$, the concentration in the indicator solution with

no added salt i.e. $m_{H^+} = x m^{\circ}_{H^+}$. The value of m_{H^+} was controlled by the relationship

$$k_2 = \frac{m_{H^+} \cdot m_{SO_4^{--}} \cdot f_{H^+} \cdot f_{SO_4^{--}}}{m_{HSO_4^-} \cdot f_{HSO_4^-}} \dots\dots (6)$$

$$\text{or } k_2 = \frac{x[c - (1 - x) m^{\circ}_{H^+}]}{(1 - x)} \cdot \frac{f_{H^+} \cdot f_{SO_4^{--}}}{f_{HSO_4^-}}$$

where 'c' = concentration of sodium sulphate. The value of $m^{\circ}_{H^+}$ was determined with a glass electrode and the activity coefficients were estimated from the Debye-Hückel equation $\log f^{\pm} =$

$$\frac{-A \cdot Z_1 Z_2 \cdot I^{\frac{1}{2}}}{1 + B d I^{\frac{1}{2}}}$$

The results were extrapolated to zero concentration to obtain k_2 , and the value given in Table V, was the mean of two series of measurements with sodium chloride and barium chloride respectively as the added neutral salt.

It may, however, be expected that the presence of ionic species such as $NaSO_4^-$ and HSO_4^- in the solution containing added sodium sulphate will have some effect on the total ionic strength which will not be adequately

compensated for by the addition of sodium chloride or barium chloride. Hamer^{33c} has pointed out that the k_2 values of these workers apparently refer to a value of - 5.8 Å for the 'ionic size'.

The k_2 values obtained in the present work and those of Davies, Jones and Monk^{14c} at different temperatures are given in Table VI.

Table VI

Dissociation constant of the bisulphate ion at various temperatures

Temp. °C.	0	5	15	25	35	45
$k_2 \times 10^2$						
Present work	2.62	2.31	1.59	1.10	0.82	0.60
Davies et al ^{14c}	-	1.73	1.43	1.03	0.78	-

As mentioned previously, in the present work, calculations have been made using the activity coefficient expression of Davies

$$-\log f_z = AZ^2 \left[\frac{I^{\frac{1}{2}}}{1 + I^{\frac{1}{2}}} - 0.2 I \right] \dots\dots\dots (5)$$

The debye-Hückel constant A, and the constant

$k = 2.3026 \frac{RT}{F}$ at the appropriate temperatures are those of Manov, Bates, Hamer and Acree, quoted by

Robinson and Stokes^{31c}, (Table III). The choice of a coefficient "0.2" for the term linear in ionic strength at all temperatures may be justified by the absence of any drift in the k_2 values. The small difference between the k_2 values at 25°C. given in Table VI can be completely accounted for by the use of the same 'A' value in both calculations. This is illustrated in Table VII which gives the recalculated data of Davies, Jones and Monk at 25°C. with $A = 0.5092$. At other temperatures also the differences between the two sets of values may be partly accounted for by the use of the same A values (Table III). Some recalculations at other temperatures are also included in Table VII.

Davies, Jones and Monk^{14c} made use of the freezing point data of Randall and Scott^{34c} on sulphuric acid solutions, to derive k_2 at 0°C.

Table VII

Recalculated values of Davies, Jones and Monk's data

Expt No.	a	b	c	e	f	g
$10^3 m_1$	3.842	5.736	7.085	2.831	2.913	3.575
$10^3 m_2$	4.143	7.784	7.641	3.340	3.403	4.209

Table VII (contd.)

A = 0.5092 Temp. 25°C. E° = 0.22239						
Expt No.	E	$10^3 I$	$10^3 m_{H^+}$	$10^3 m_{HSO_4^-}$	k_2	original k_2
a	0.4882	13.17 ₅	10.580	1.548	1.10	1.03
c	0.4584	22.68 ₅	18.705	3.662	1.12	1.06
e	0.5014 ₅	10.61	8.391	1.120	1.08	1.02
f	0.5003	10.76	8.540	1.179	1.06	1.00
T g	0.4904	13.07	10.426	1.567	1.10	1.03
A = 0.4921 Temp. 5°C. E° = 0.23392						
a	0.4810	13.91	10.95	1.178	1.73	1.64
b	0.4600	23.85	18.69	2.614	2.06	1.91
A = 0.5002 Temp. 15°C. E° = 0.22847						
a	0.4847	13.71	10.859	1.269	1.54	1.44
b	0.4632 ₅	23.03	18.281	3.023	1.60	1.52
A = 0.5190 Temp. 35°C. E° = 0.21563						
e	0.5047	10.21	8.189	1.322	0.814	0.79
f	0.5035	10.36	8.339	1.380	0.794	0.77

Using the activity coefficient expression (eqn. 5), with $A = 0.48$, they obtained the values 0.0225, 0.025, 0.028 and 0.032 for k_2 at molal concentrations 0.0005, 0.001, 0.002 and 0.005 respectively. The reason for the drift of the k_2 value with ionic strength is not very well understood; in the present work however, in the range of ionic strength 0.005 to 0.012 at 0°C there was no noticeable drift of k_2 with ionic strength.

In a paper read at the "Symposium on the structure of electrolytic solutions" (Electrochemical Society), Washington, Hamer^{33c} compared his own results^{12c} at 25°C with those of Davies, Jones and Monk^{14c}. In the original calculation he used the limiting Debye-Hückel equation, $-\log f_z = AZ^2 I^{\frac{1}{2}}$, but in the recalculation, equation (7) was employed to derive the activity coefficient in the successive approximations for pH

$$-\log f_z = \frac{AZ^2 I^{\frac{1}{2}}}{1 + B a_i I^{\frac{1}{2}}} \quad \dots\dots (7)$$

Both his own e.m.f. data on sodium sulphate and those of Davies, Jones and Monk were recalculated using $A = 0.5085$ and putting " a_i ", the distance of closest approach of ions equal to 0, 3.05 Å, 4 Å, 8 Å, 20 Å and ∞ . The values for p_k thus obtained were plotted against

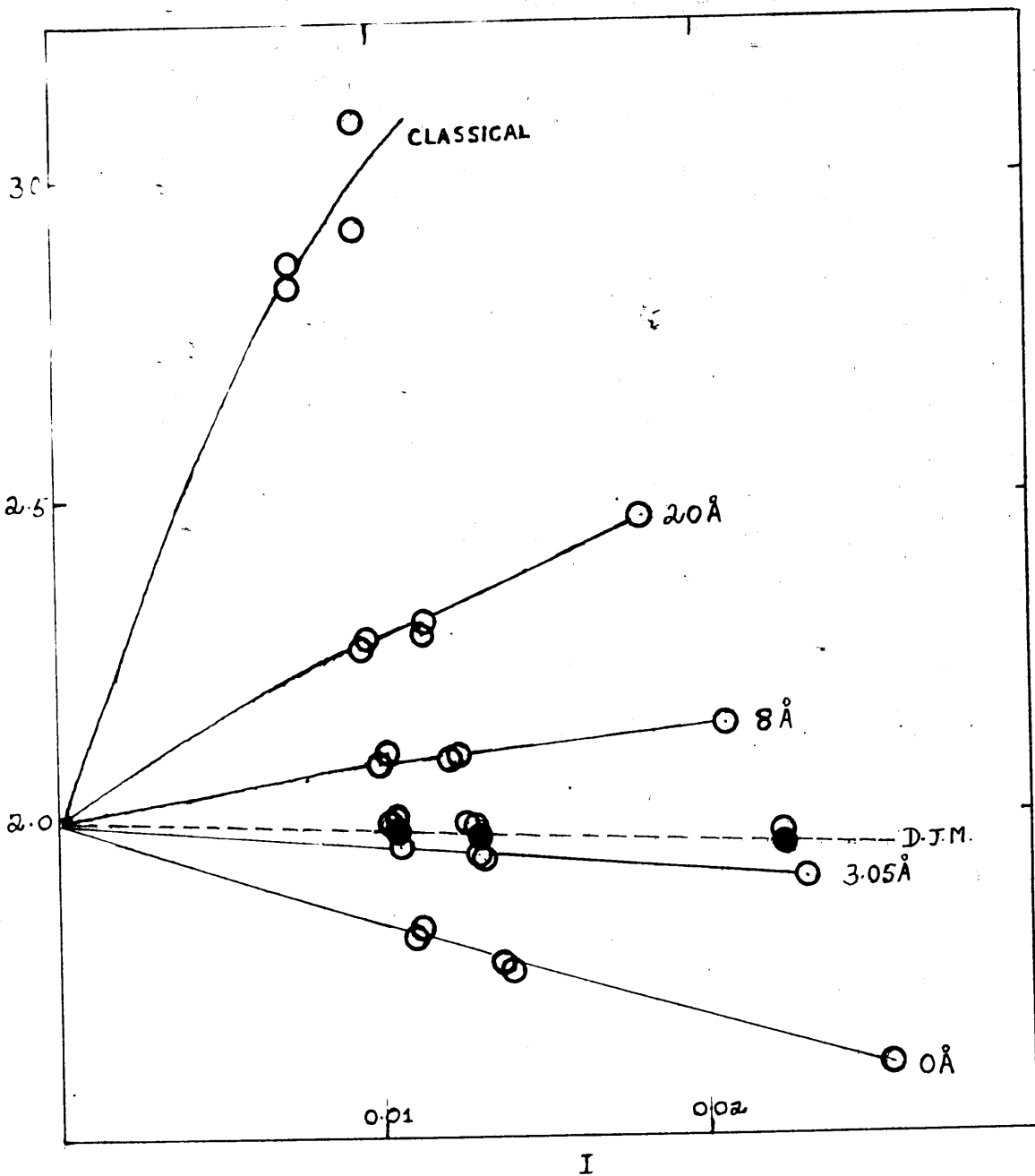

GRAPH 2 - HAMER'S PLOT OF D.J.M. DATA

ionic strength and extrapolated to zero ionic strength. Whereas the data on sodium sulphate did not show any convergence, those on sulphuric acid converged to a pk_2 of 1.991 at zero ionic strength (graph 2). Hamer concluded that the term β linear in ionic strength in the activity coefficient expression

$$-\log f_z = AZ^2 \frac{I^{\frac{1}{2}}}{1+B\alpha I^{\frac{1}{2}}} + \beta I \dots\dots\dots (8)$$

should also have been considered. He suggested that the value of β , dependent on the buffer ratio might not vary as much in the acid-acid mixtures of Davies et al as in his own acid salt-salt mixtures.

However, since Hamer did not take into account the ' βI ' term in his successive approximations, the slopes of his plots of pk' against ' I ' should yield the ' β ' values to be used at each ' α ' value. These ' β ' values could then be used in equation (8) for the successive approximations to obtain the concentrations of hydrogen ion. If this is done, however, impossible values are obtained for the concentrations of ionic species when $\alpha_1 = 8 \text{ \AA}$, 20 \AA etc. A more consistent method of extrapolation would probably be to ignore the ' βI ' terms

Table VIII

Data of Davies, Jones and Monk. Calculation of k_c
 using expression (7) for f^+ . Concns. in m. moles.

$$\underline{A = 0.5085}$$

$$\underline{a_1 = 3.05 \text{ \AA}} \text{ (corresponds to Davies equation)}$$

Expt No.	I	m_{H^+}	$m_{SO_4^{--}}$	$m_{HSO_4^-}$	$10^2 K_c$	AZ^2 z=2	$\frac{I^{\frac{1}{2}}}{1+Bd_1 I^{\frac{1}{2}}}$
$\underline{a_1 = 3.05 \text{ \AA}}$							
a	13.32	10.653	2.668	1.475	1.927	0.1052	
c	23.17	18.952	4.226	3.415	2.345	0.1344	
e	10.70	8.436	2.265	1.075	1.778	0.0954	
f	10.86	8.588	2.272	1.131	1.725	0.0960	
g	13.22	10.500	2.716	1.493	1.910	0.1049	
$\underline{a_1 = 8.0 \text{ \AA}}$							
a	12.49	10.236	2.251	1.892	1.217	0.0879	
c	20.81	17.774	3.048	4.593	1.180	0.1065	
e	10.16	8.165	1.994	1.346	1.209	0.0811	
f	10.30	8.307	1.991	1.412	1.171	0.0815	
g	12.40	10.093	2.309	1.900	1.227	0.0877	
$\underline{a_1 = 20.0 \text{ \AA}}$							
a	11.35	9.678	1.693	2.450	0.669	0.0636	
c	18.16	16.444	1.718	5.923	0.475	0.0727	
e	9.39	7.782	1.611	1.730	0.725	0.0603	
f	9.51	7.914	1.598	1.805	0.701	0.0605	
g	11.32	9.550	1.766	2.443	0.690	0.0637	

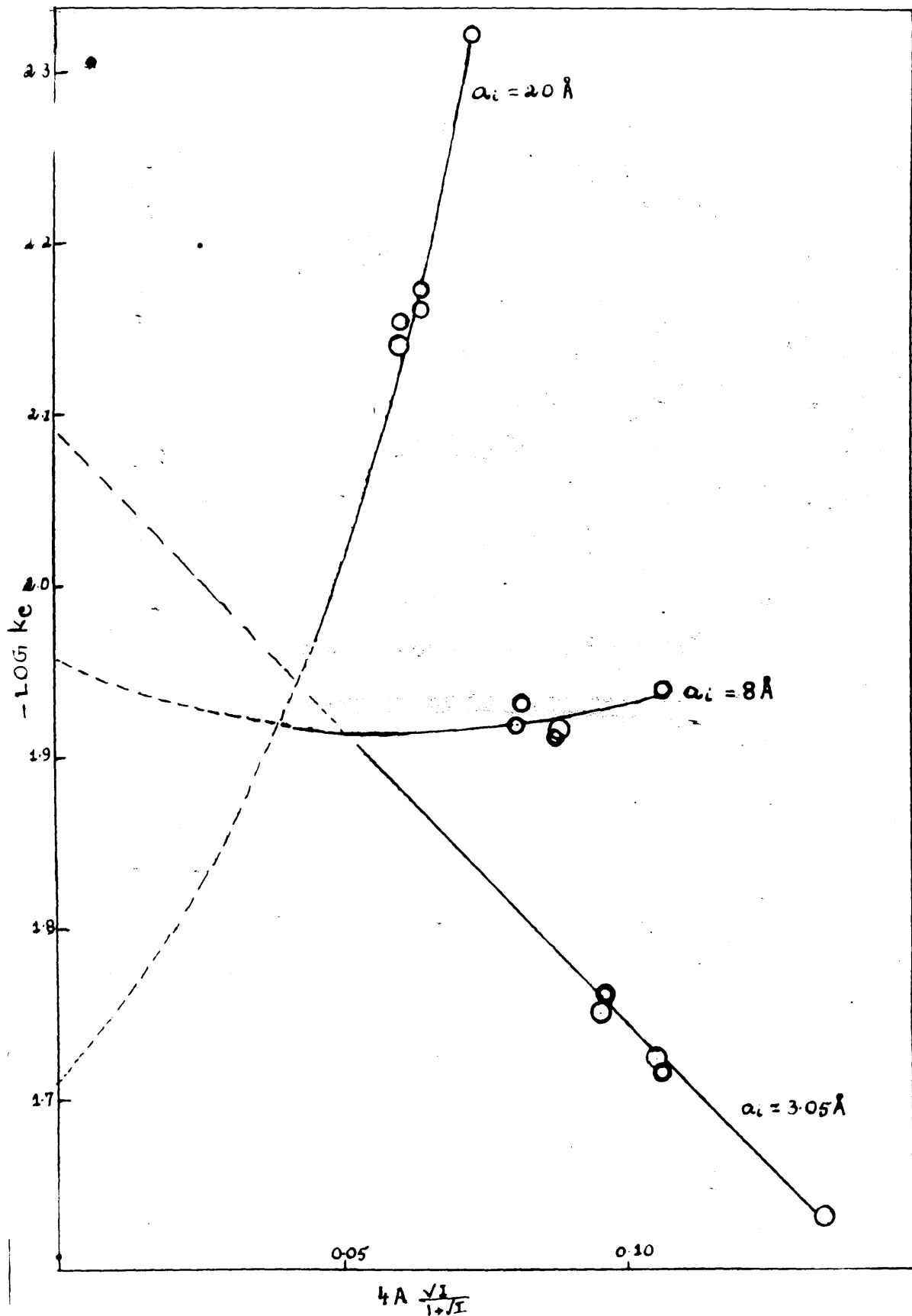

GRAPH 3- ALTERNATE PLOT OF D. J. M. DATA

and plot 'pk_c' where k_c is the stoichiometric dissociation constant) against $AZ^2 \frac{I^{\frac{1}{2}}}{1+B\alpha_1 I^{\frac{1}{2}}}$ in the equation

$$pk_c = pk_2 + AZ^2 \frac{I^{\frac{1}{2}}}{1+B\alpha_1 I^{\frac{1}{2}}} \dots$$

This has been done for values of $\alpha = 3.05 \text{ \AA}$, 8 \AA and 20 \AA with the experimental results of Davies et al.^{14c}. The values are given in Table VIII and the plot is shown in graph (3); convergence to a single pk₂ value on extrapolation to zero ionic strength seems improbable.

The heat of dissociation of the bisulphate ion has been obtained from the linear plot of pk₂ against T⁻¹ (graph 1). The heat and entropy values obtained in the present work together with those of other workers are given in Table IX.

Table IX

Heat and entropy data for dissociation of the
bisulphate ion

	Present work	Pitzer ^{35c}	Davies et al ^{14c}	Young et al ^{11c}
ΔH k.cal	- 5.4	-5.20 [±] 0.5	-5.20 [±] 0.1	-5.24 [±] 0.1
ΔG k.cal	2.67	2.62	2.70	2.72
ΔS cal/°C	-27.3	-26.3	-26.5	-26.6

b) Association of bivalent metal cations with sulphate ion

In the measurements using the cell

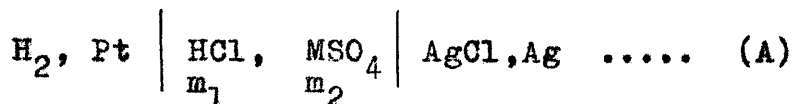

if m_1 and m_2 represent the molal concentrations of hydrochloric acid and the metal sulphate, the corrected e.m.f. of the cell (A) is related to the standard potential E° of the silver-silver chloride electrode by the relationship

$$E = E^\circ - \frac{2.3026RT}{F} \log(f_{\text{H}^+} \cdot f_{\text{Cl}^-} \cdot m_{\text{H}^+} m_{\text{Cl}^-})$$

$$- \log m_{\text{H}^+} = \frac{(E - E^\circ)F}{2.3026RT} + \log f_{\text{Cl}^-}^2 + \log m_1 \dots\dots\dots (1)$$

$$m_{\text{HSO}_4^-} = m_1 - m_{\text{H}^+} \dots\dots\dots (9)$$

Substitution of these values in the expression for the dissociation constant of the bisulphate ion

$$k_2 = \frac{m_{\text{H}^+} \cdot m_{\text{SO}_4^{--}}}{m_{\text{HSO}_4^-}} \cdot \frac{f_{\text{H}^+} \cdot f_{\text{SO}_4^{--}}}{f_{\text{HSO}_4^-}} \dots\dots\dots (6)$$

gives

$$\begin{aligned} \log m_{\text{SO}_4^{--}} &= \log k_2 + \log m_{\text{HSO}_4^-} - \log \frac{f_{\text{H}^+} \cdot f_{\text{SO}_4^{--}}}{f_{\text{HSO}_4^-}} \\ &- \log m_{\text{H}^+} \dots\dots\dots (10) \end{aligned}$$

The concentration of free metal ion,

$$m_{M^{++}} = m_{\text{HSO}_4^-} + m_{\text{SO}_4^{--}} \dots\dots (11)$$

and the concentration of the ion pair

$$m_{\text{MSO}_4} = m_2 - m_{M^{++}} \dots\dots\dots (12)$$

The ionic strength

$$I = m_1 + 4m_2 - 2m_{\text{HSO}_4^-} - 4m_{\text{MSO}_4} \dots\dots (13)$$

A series of successive approximations using equations (1), (9), (10), (11), and (12) together with equation (5) for the activity coefficients are made until the ionic strength and concentrations of the ionic species become constant. The association constant is then obtained from the expression (14).

$$K = \frac{m_{M^{++}} \cdot m_{\text{SO}_4^{--}} \cdot f_{M^{++}} \cdot f_{\text{SO}_4^{--}}}{m_{\text{MSO}_4} \cdot f_{\text{MSO}_4}} \dots\dots (14)$$

Equation (5) corresponds to a value of about 4.2 to 4.3 Å for the distance of closest approach of the ions, the factor "q" in the Debye-Hückel expression:-

$$-\log f_z = \frac{AZ^2 I^{\frac{1}{2}}}{1 + \frac{q}{a_0} I^{\frac{1}{2}}}$$

For bivalent ions, Bjerrum's^{8c} value of $q=14.28 \text{ \AA}$ at 25° . It is evident that the value of the association constant will depend very much upon the value of 'q' chosen. Guggenheim^{36c} has pointed out that if the value is not specified there is an indeterminacy of about 20% in the value of K for 2-2 electrolytes. He has also suggested that for these, it is probably better to use the activity coefficient expression

$$-\log f_z = 4a \left[\frac{I^{\frac{1}{2}}}{1+I^{\frac{1}{2}}} - 2 I \right]$$

which will correspond to $q = 10 \text{ \AA}$. However, Davies' equation has been very widely used in analysing conductance and e.m.f. measurements on higher valency type electrolytes. Brown and Prue^{7c} have shown that calculation from a theoretical model for a 2.2 electrolyte gives K values which are almost independent of q between $q = 5 \text{ \AA}$ and $q = 6.954 \text{ \AA}$. Beevers and Lipson^{37c} studied the structure of $\text{CuSO}_4 \cdot 5 \text{ H}_2\text{O}$ by X-ray diffraction and found that "the copper and sulphur positions give a typically

Table Xb (contd.)

Expt. No.	(E - E°)	10 ³ I	10 ³ m _{H₂SO₄}	-10 ³ m _{M⁺⁺}	10 ³ m _{M₂SO₄}	K
<u>Temp. 25°C</u>						
1	0.27704	16.455	0.6557	3.1433	0.4753	171.2
2	0.26566	22.660	1.0317	4.3987	0.8235	181.8
3	0.26249	22.965	1.0776	4.3872	0.7607	187.6
4	0.27313	21.995	0.9281	4.223	0.9107	189.8
5	0.30709	101.70	1.889	25.337	13.160	177.2
6	0.30838	50.78	1.131	12.279	4.448	165.9
<u>Temp. 30°C</u>						
5	0.31265	94.95	1.981	23.618	14.879	227.1
6	0.31406	47.25	1.197	11.451	5.276	223.6
7	0.31763	88.46	1.728	21.916	12.87	216.2
<u>Temp. 35°C</u>						
1	0.28706	15.68	0.789	3.027	0.592	246.7
2	0.27547	21.71	1.234	4.265	0.957	243.0
3	0.27218	22.05	1.284	4.252	0.896	234.9
4	0.28338	21.27	1.130	4.358	0.975	(224.7)
5	0.31951	92.80	2.128	23.142	15.355	246.9
6	0.32030	45.54	1.298	11.084	5.643	256.8
7	0.32410	83.75	1.838	20.809	13.977	257.8
<u>246.9</u>						

Table Xb (contd.)

Expt. No.	(E - E°)	10 ³ I	10 ³ m _H SO ₄	-10 ³ m _M ⁺⁺	10 ³ m _M SO ₄	K
<u>Temp. 40°C</u>						
5	0.32622	90.9	2.251	22.862	15.635	(260.4)
6	0.32657	43.75	1.394	10.944	5.783	271.7
7	0.330548	80.22	1.933	20.13	14.656	289.8
						<u>279.3</u>
<u>Temp. 45°C</u>						
1	0.29734	15.22	0.942	2.986	0.633	294.3
2	0.28548	20.90	1.452	4.190	1.032	295.4
3	0.28208	21.51	1.509	4.194	0.954	275.9
4	0.29379	20.61	1.336	4.284	1.049	(264.7)
5	0.33316	87.805	2.384	21.944	16.55	302.6
6	0.33288	42.12	1.385	10.393	6.334	332.4
7	0.33683	73.96	2.020	18.505	16.281	374.4
						<u>311.0</u>

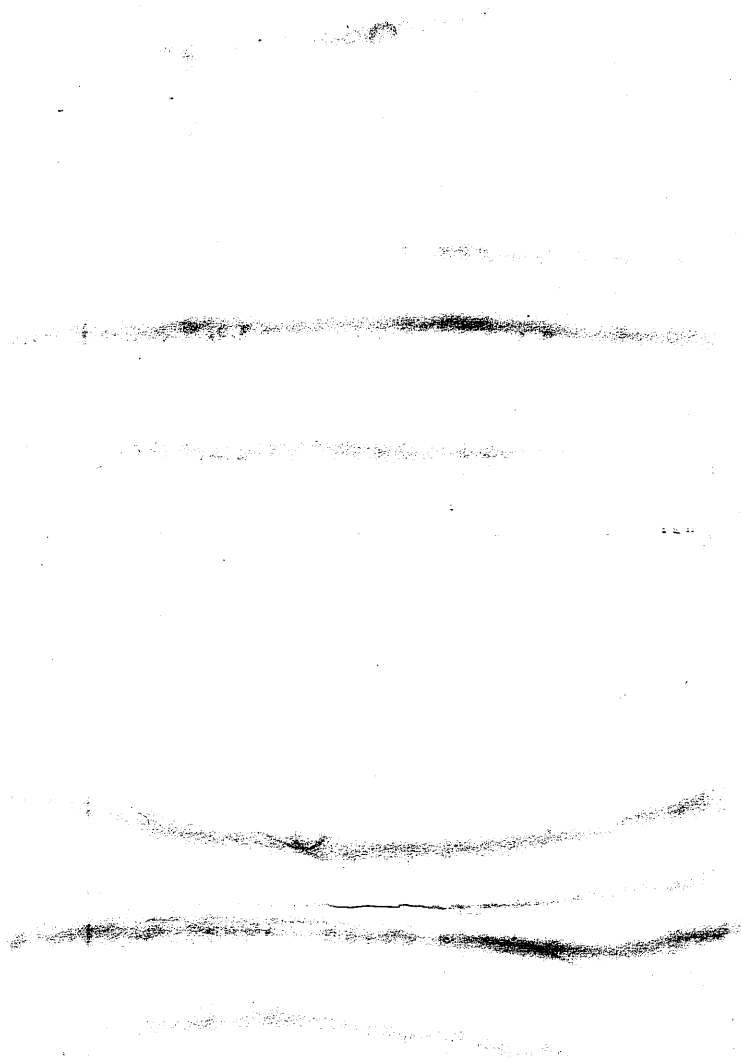

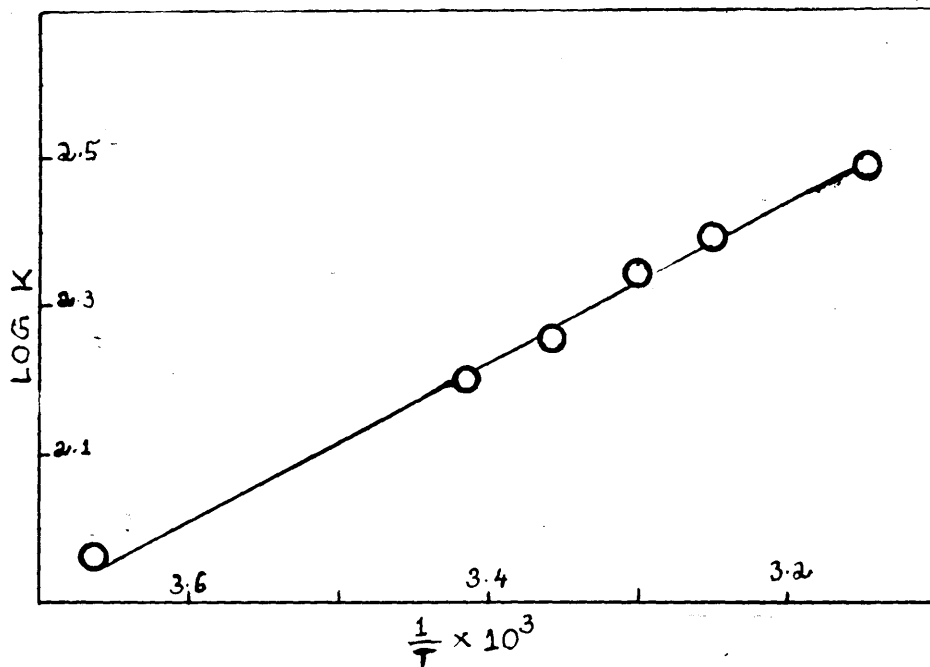

GRAPH 4. MAGNESIUM SULPHATE

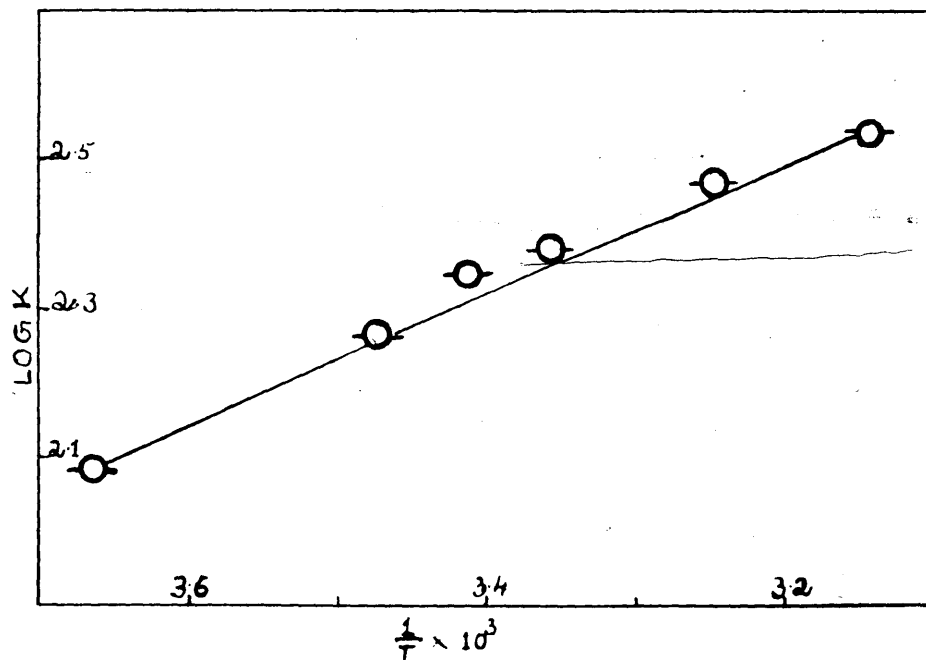

GRAPH 5- ZINC SULPHATE

Table XIaMolal concentrations in experiments with zinc sulphate

Expt No.	$10^3 m_1$	$10^3 m_2$
1	7.527	3.571
2	6.406	4.554
3	7.664	4.200
4	5.328	3.934
5	6.373	4.554
6	5.294	4.825

Table XIbResults on Zinc Sulphate.

Expt No.	(E - E°)	$10^3 I$	$10^3 m_{\text{HSO}_4}$	$-10^3 m_{\text{M}^{++}}$	$10^3 m_{\text{MSO}_4}$	K
<u>Temp. 0.°C</u>						
1	0.23783	19.47	0.438	3.205	0.366	119.8
2	0.246003	21.38	0.458	3.971	0.583	126.8
3	0.23745	21.58	0.506	3.736	0.464	117.2
4	0.25419	18.63	0.354	3.50 ^u	0.434	112.5
5	0.26425	21.39	0.457	3.981	0.573	124.0
6	0.25509	21.20	0.405	4.177	0.648	124.2
<u>Temp. 15° C</u>						
1	0.25130	20.532	0.724	3.587	0.613	189.4
2	0.26896	17.608	0.512	3.328	0.606	184.3
3	0.26068	20.351	0.661	3.828	0.726	182.3
4	0.27008	20.135	0.588	4.002	0.823	182.6
						<u>184.5</u>

Table XIb (contd.)

Expt No.	(E - E°)	$10^3 I$	$10^3 m_{\text{HSO}_4}$	$-10^3 m_{\text{M}^{++}}$	$10^3 m_{\text{MSO}_4}$	K
<u>Temp. 20°C</u>						
1	0.25605	20.04	0.833	3.513	0.687	222.9
2	0.27409	17.28	0.598	3.283	0.651	210.6
3	0.26114	19.89	0.765	3.760	0.794	214.7
4	0.27531	19.78	0.688	3.962	0.863	233.6
<u>Temp. 25°C</u>						
1	0.26086	17.96	0.792	3.006	0.565	248.8
2	0.270319	19.744	0.842	3.7541	0.7997	224.5
3	0.260739	19.830	0.9073	3.4945	0.7058	240.1
4	0.279059	16.950	0.6499	3.2318	0.7021	240.6
5	0.270529	19.565	0.831	3.711	0.4843	240.4
6	0.280269	19.14	0.740	3.843	0.982	248.1
<u>Temp. 35°C</u>						
1	0.27049	17.525	0.964	2.984	0.587	288.2
2	0.28028	19.080	1.019	3.674	0.880	278.1
3	0.27020	19.09	1.084	3.396	0.804	314.5
4	0.289301	16.46	0.796	3.178	0.756	287.7
5	0.28043	18.77	1.003	3.611	0.943	306.5
6	0.29068	18.54	0.904	3.773	1.052	298.0
<u>295.4</u>						

Table XIb (Contd.)

Expt No.	(E - E°)	10 ³ I	10 ³ m _{H₂SO₄}	-10 ³ m _{M⁺⁺}	10 ³ m _{M₂SO₄}	K
<u>Temp. 45°C</u>						
1	0.27995	16.89	1.118	2.892	0.679	394.3
2	0.29047	18.63	1.214	3.648	0.906	319.3
3	0.27991	18.65	1.283	3.378	0.822	362.3
4	0.29967	15.92	0.948	3.120	0.814	349.4
5	0.29062	18.32	1.197	3.593	0.961	345.3
6	0.30141	18.17	1.092	3.780	1.045	316.9
						<u>344.8</u>

Table XIIb (contd.)

Expt. No	(E - E°)	$10^3 I$	$10^3 m_{\text{HSO}_4}$	$-10^3 m_{\text{M}^{++}}$	$10^3 m_{\text{MSO}_4}$	K
<u>Temp. 5°C</u>						
1	0.24657	19.95	0.491	3.516	0.661	184.4
2	0.25314	16.77	0.369	2.890	0.470	(177.0)
3	0.23949	26.46	0.741	4.926	1.153	190.0
4	0.24818	28.82	0.733	5.820	1.549	185.2
5	0.26710	17.27	0.329	3.370	0.691	187.9
6	0.25559	23.61	0.532	4.700	1.150	188.3
<u>Temp. 15°C</u>						
1	0.27472	19.65	0.658	3.509	0.668	200.0
2	0.22686	16.42	0.496	2.865	0.495	201.8
3	0.24899	25.98	0.988	4.934	1.145	201.3
4	0.25816	28.29	0.981	5.822	1.547	196.1
5	0.27750	17.05	0.448	3.365	0.696	199.6
6	0.26513	23.13	0.721	4.678	1.172	205.1
<u>Temp. 25°C</u>						
1	0.265873	19.179	0.8421	3.484	0.4798	228.2
2	0.27283	16.06	0.640	2.85	0.5100	225.7
3	0.258618	25.263	1.2446	4.8716	1.2073	236.8
4	0.26831	27.52	1.236	5.726	1.643	231.3
5	0.288147	16.91	0.5904	3.4031	0.6575	(196.4)
6	0.276327	22.595	0.9245	4.6438	1.2058	228.7
<u>231.9</u>						

Table XIIb (contd.)

Expt. No.	(E - E°)	10 ³ I	10 ³ m _{HSO₄}	-10 ³ m _{M⁺⁺}	10 ³ m _{M₂SO₄}	K
<u>Temp. 35°C</u>						
1	0.27569	18.74	1.033	3.478	0.699	249.8
2	0.28267	15.70	0.786	2.829	0.531	259.7
3	0.268366	24.71	1.52	4.877	1.202	254.8
4	0.27869	26.895	1.512	5.735	1.634	247.4
5	0.29875	16.31	0.720	3.309	0.752	252.5
6	0.28655	22.10	1.135	4.626	1.224	250.6
						<u>252.1</u>
<u>Temp. 45°C</u>						
4	0.28937	26.43	1.805	5.768	1.601	261.1
5	0.30961	15.88	0.87	3.282	0.779	284.1
6	0.29722	21.56	1.352	4.586	1.264	285.7
4	0.28571	18.395	1.237	3.490	0.687	270.5
2	0.29280	15.365	0.950	2.836	0.524	278.8
3	0.27839	24.19	1.793	4.876	1.203	284.1
						<u>277.0</u>

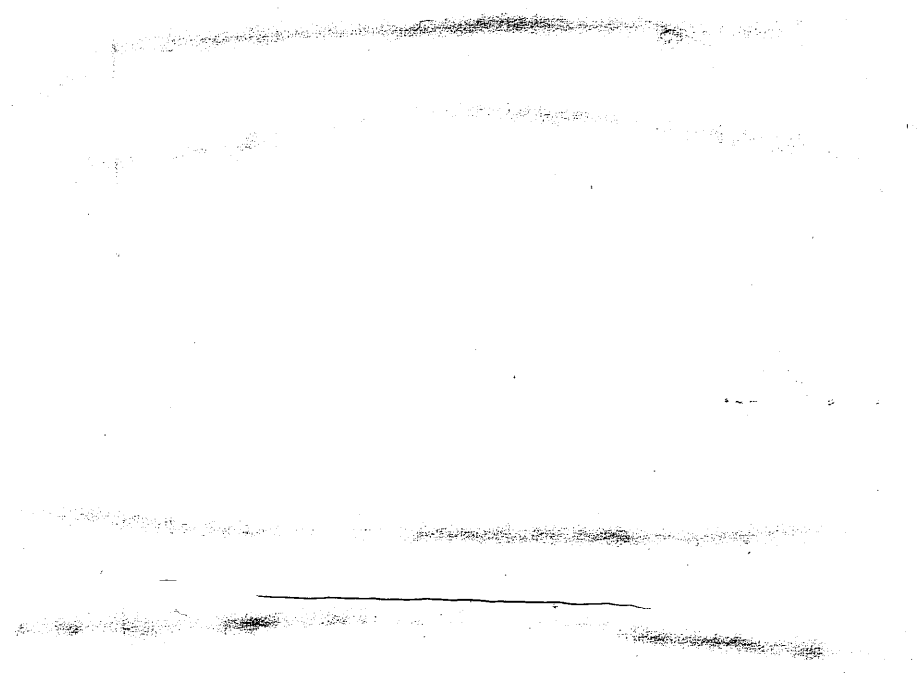

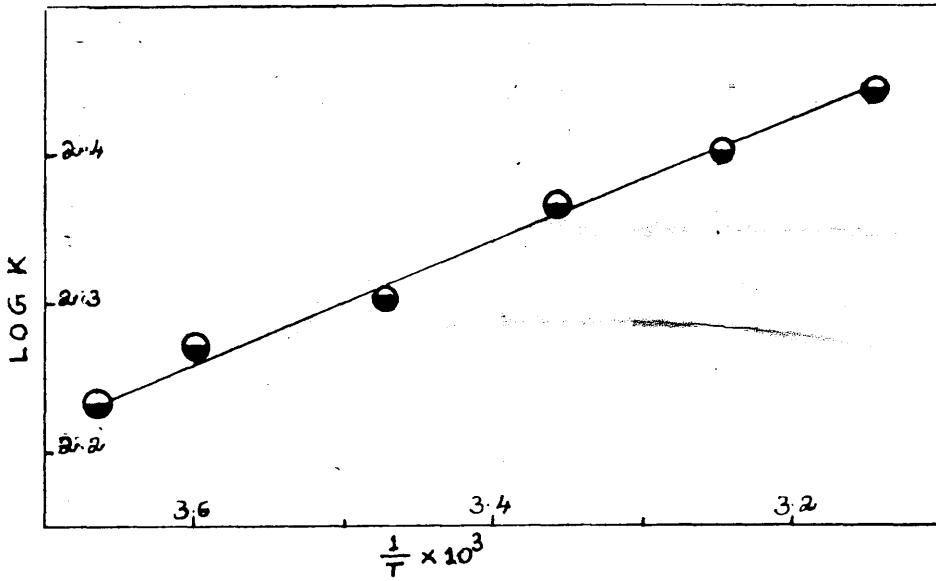

GRAPH 6 - COBALT SULPHATE

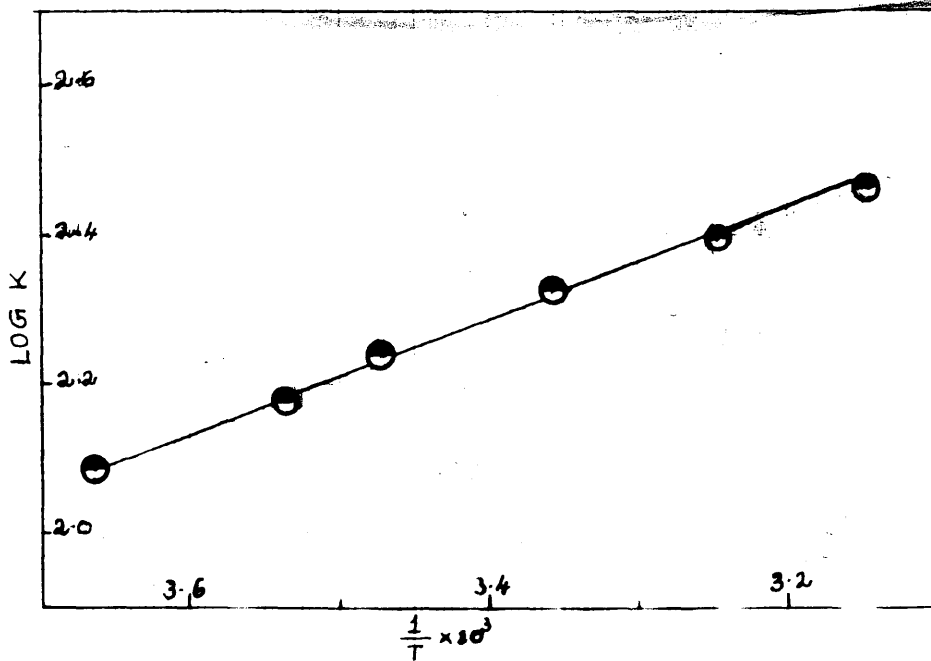

GRAPH 7 - NICKEL SULPHATE

Table XIIIb (contd.)

Expt. No.	(E - E°)	10 ³ I	10 ³ m _{HSO₄}	-10 ³ m _M ⁺⁺	10 ³ m _{MSO₄}	E
<u>Temp. 10°C</u>						
1	0.25369	15.85	0.421	2.552	0.316	157.0
2	0.26257	14.18	0.344	2.386	0.284	150.3
3	0.26959	10.904	0.226	1.705	0.158	145.9
<u>Temp. 15°C</u>						
1	0.25840	15.64	0.477	2.533	0.335	174.3
2	0.26746	14.00	0.388	2.358	0.312	173.8
3	0.27454	10.78	0.256	1.687	0.176	170.2
4	0.30275	19.925	0.593	4.470	1.089	178.6
5	0.29776	31.73	0.593	7.418	2.282	171.8
6	0.26737	38.23	1.148	8.617	2.683	175.6
7	0.27408	19.20	0.532	3.848	0.733	170.6
<u>Temp. 25°C</u>						
1	0.267969	15.20	0.6057	2.4802	0.3878	227.6
2	0.277409	13.75	0.502	2.341	0.329	199.6
3	0.284604	10.57	0.335	1.677	0.186	194.9
4	0.314423	19.22	0.467	4.344	1.215	218.6
5	0.309678	30.52	0.7503	7.183	2.517	207.5
6	0.278278	37.04	1.4365	8.437	2.863	206.6
7	0.284523	18.59	0.6815	3.772	0.809	207.4
8	0.243209	17.94	1.133	3.373	0.584	227.1
<u>210.1</u>						

Table XIIIb (contd.)

Expt. No.	(E - E°)	10 ³ I	10 ³ m _{H₂SO₄}	-10 ³ m _{M⁺⁺}	10 ³ m _{M₂SO₄}	K
<u>Temp. 35°C</u>						
1	0.27765	14.87	0.745	2.471	0.397	255.9
2	0.28737	13.37	0.620	2.313	0.357	238.9
3	0.29469	10.32	0.415	1.651	0.212	245.5
4	0.32636	18.725	0.580	4.278	1.281	247.0
5	0.32190	29.535	0.912	7.026	2.674	239.2
6	0.28929	35.55	1.721	8.221	3.079	246.8
7	0.29488	17.94	0.832	3.686	0.895	255.6
<u>Temp. 45°C</u>						
1	0.28739	14.45	0.883	2.435	0.433	309.6
2	0.29754	13.06	0.746	2.301	0.369	274.4
3	0.30494	10.11	0.505	1.645	0.218	279.3
4	0.33857	18.19	0.701	4.206	1.353	283.9
5	0.33430	28.24	1.072	6.769	2.931	293.7
6	0.30070	34.43	2.022	8.099	3.201	280.1
7	0.30581	17.35	0.994	3.622	0.959	304.9
<u>288.5</u>						
(289)						

Table XIVAMolal concentrations in experiments with manganese sulphate

Expt. No.	$10^3 m_1$	$10^3 m_2$
1	3.777	2.648
2	6.122	5.334
3	8.679	4.425
4	3.903	7.254
5	2.824	12.948

Table XIVbResults on manganese sulphate

Expt. No.	(E - E°)	$10^3 I$	$10^3 m_{\text{HSO}_4}$	$-10^3 m_{\text{M}^{++}}$	$10^3 m_{\text{MSO}_4}$	K
<u>Temp. 0°C</u>						
2	0.24873	23.95	0.504	4.707	0.627	101.3
1	0.26916	13.15	0.194	2.423	0.225	102.8
3	0.23188	23.48	0.590	3.992	0.433	100.9
4	0.27099	27.98	0.415	6.205	1.049	100.8
5	0.28891	43.53	0.435	10.409	2.539	106.8

102.7

Table XIVb (contd.)

Expt. No.	(E - E°)	$10^3 I$	$10^3 m_{\text{HSO}_4}$	$-10^3 m_{\text{M}^{++}}$	$10^3 m_{\text{MSO}_4}$	K
<u>Temp. 10°C</u>						
1	0.27947	12.75	0.256	6.205	1.049	135.0
2	0.25853	23.21	0.651	10.409	2.539	129.2
3	0.24097	22.97	0.761	2.373	0.275	122.1
4	0.28185	27.13	0.539	4.602	0.732	122.5
5	0.30077	41.75	0.555	3.945	0.480	134.0
<u>Temp. 20°C</u>						
1	0.29004	12.53	0.346	2.350	0.298	157.5
2	0.26863	22.43	0.852	4.505	0.839	164.6
3	0.25024	22.22	0.988	3.884	0.541	154.3
4	0.29306	25.97	0.704	5.858	1.396	160.5
5	0.31331	40.21	0.720	9.734	3.214	160.5
<u>Temp. 25°C</u>						
1	0.295261	12.32	0.381	2.329	0.319	175.5
2	0.273591	22.1	0.927	4.455	0.879	181.0
3	0.254573	21.9	1.069	3.839	0.586	177.8
4	0.298585	25.465	0.767	5.776	1.478	177.5
5	0.319188	38.79	0.770	9.372	3.576	192.7
<u>180.7</u>						

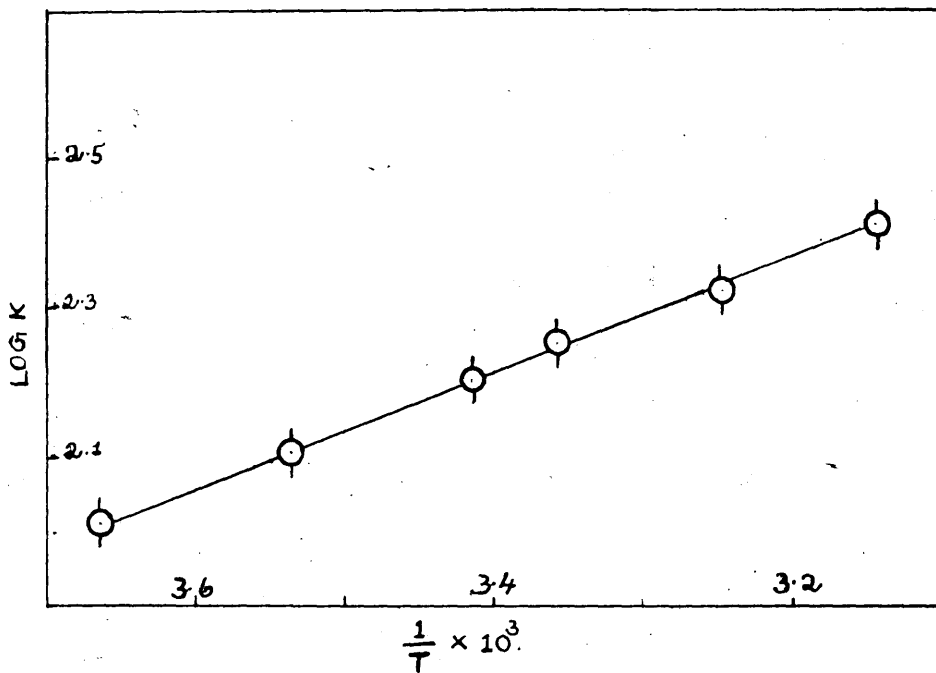

GRAPH-8 - MANGANESE SULPHATE

ionic structure." The distances of 3.55 Å and 3.6 Å found between the copper and sulphur atoms correspond to sulphate ions the oxygen atoms of which are in the octahedral coordination group around a copper ion composed of four water molecules and two oxygen atoms. Provided 'q' is large enough ~ 4 Å to place such ion pairs in the associated class, it is thus possible to obtain consistent results. Accordingly in the present work Davies activity coefficient expression (5) has been used introducing appropriate A value at each temperature (Table III). The results on magnesium sulphate, zinc sulphate, cobalt sulphate, nickel sulphate and manganese sulphate are given in Tables X(a), (b), XI(a), (b), XIII(a), (b), and XIV(a), (b) respectively. In the case of cadmium sulphate, however, the experimental e.m.f.s did not reach a constant value. A similar difficulty was experienced by Evans and Monk^{38c} with cadmium triglyconate. There was no noticeable drift with ionic strength in the values of the association constants derived. The plots of $\log K$ against T^{-1} for these metal sulphates are given in graphs (4), (5), (6), (7) and (8).

Although there are some differences in the

Table XV

Dissociation constant data on bivalent metal sulphatesat 25° $k \times 10^3$

Workers	method	MgSO ₄	ZnSO ₄	CoSO ₄	NiSO ₄	MnSO ₄
Present work	e.m.f.	5.60	4.17	4.33	4.76	5.55
Davies ^{2c}						
Money and Davies ^{2c}	conduct- ance	6.1	5.3	3.4	4.0	
Dunsmore and James ^{5c}	Do.	6.2				
(recal. by Jones and Monk ^{7c})		5.4				
Jones and Monk ^{7c}	e.m.f.	4.4				
Owen and Gurry ^{3c}	conduct- ance	-	5.3			
(recal. by Robinson and Stokes)			4.4			
Wyatt ^{4c}	Do.		4.9			
James ^{39c}	Do.					5.2

Table XVI

Thermodynamic data on bivalent metal sulphates

	ΔH kcal.	ΔG_{298} kcal.	$\Delta S_{\text{ass.}}$ cal/deg/mole.
$\text{Mg}^{++}\text{SO}_4^{--}$	5.03 (5.7)	-3.07 (-3.2)	27.19 (31.0)
$\text{Zn}^{++}\text{SO}_4^{--}$	3.94	-3.25	24.10
$\text{Co}^{++}\text{SO}_4^{--}$	1.88	-3.23	17.12
$\text{Ni}^{++}\text{SO}_4^{--}$	3.34	-3.17	21.83
$\text{Mn}^{++}\text{SO}_4$	3.43	-3.08	21.83

(The values in parenthesis for magnesium sulphate are those of Jones and Monk^{7c} who point out the desirability of extending the measurements with more refined apparatus to a larger range of ionic strengths.)

Least Squares.

	ΔH	ΔG	ΔS .
MgSO_4	4.84	-3.07	26.2.
2ZnSO_4	4.01	-3.25	24.2

expressions used to evaluate activity coefficients in the available data on metal sulphate it is interesting to compare them with those of the present work. This is done in Table XV. The heats of association were obtained from the slopes of the plots of $\log K$ against T^{-1} (graphs 4,5,6,7 and 8) and these together with the free energy and entropy values are given in Table XVI.

PART III

GENERAL DISCUSSION

In an association reaction between two ions of equal and opposite charge

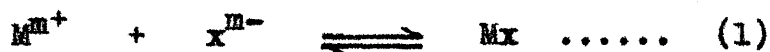

a positive entropy change will be expected as a result of ion pair formation. This is mainly a consequence of the much greater freedom which the surrounding water dipoles enjoy in the field around the 'neutral' ion-pair Mx , compared with the freedom they originally had in the fields of the separate ions. Table I illustrates that this is true for thallos hydroxide^{1d}, silver chloride^{2d}, silver iodate^{2d} and all the bivalent metal sulphates. This, however, need not always be the case as is demonstrated by the small negative values of entropy for thallos azide, nitrate, thiocyanate^{1d}, chloride and bromide. On the basis of ionic charge alone, a high positive entropy would be expected for the association of La^{+++} ion with $Fe(CN)_6^{---}$ and $Co(CN)_6^{---}$ ions whereas the values are only 23.9^{3d} and 21.7^{4d} respectively. With polyatomic ions one has to consider the loss of rotational entropy suffered by the ion during association.

Table I

Reaction	K298 (1.mole ⁻¹)	ΔG K.cal. mole ⁻¹)	ΔH (k.cal. mole ⁻¹)	ΔS (cal.deg ⁻¹ mole ⁻¹)	Ref.
Tl ⁺ , OH ⁻	6.67	-1.12	0.37	5.1	1d
Tl ⁺ , Cl ⁻	4.76	-0.93	-1.43	-1.7	1d
Tl ⁺ , Br ⁻	7.67	-1.2	-2.45	-4.2	
Tl ⁺ , N ₃ ⁻	2.44	-0.53	-1.33	-2.7	
Tl ⁺ , NO ₃ ⁻	2.15	-0.45	-0.65	-1.0	
Tl ⁺ , CNS ⁻	6.25	-1.09	-2.96	-6.4	1d
Ag ⁺ , Cl ⁻	2.0x10 ³	-4.5	-2.7	6.0	2d
Ag ⁺ , IO ₃ ⁻	6.8	-1.13	5.14	20.3	2d
Mg ⁺⁺ , SO ₄ ⁻⁻	1.79x10 ²	-3.07	5.03	27.19	
Zn ⁺⁺ , SO ₄ ⁻⁻	2.40x10 ²	-3.25	3.94	24.10	
Co ⁺⁺ , SO ₄ ⁻⁻	2.32x10 ²	-3.23	1.88	17.12	
Ni ⁺⁺ , SO ₄ ⁻⁻	2.10x10 ²	-3.17	3.34	21.83	
Mn ⁺⁺ , SO ₄ ⁻⁻	1.81x10 ²	-3.08	3.43	21.83	
Cu ⁺⁺ , SO ₄ ⁻⁻	2.32x10 ²	-3.23	3.71	23.3	5d
La ³⁺ , Fe(CN) ₆ ³⁻	5.5x10 ³	-5.09	2.0	23.9	3d
La ³⁺ , Co(CN) ₆ ³⁻	5.8x10 ³	-5.13	1.33	21.7	4d

Although a negative entropy change does not favour association, this can be offset by a favourable enthalpy change. It is important to consider both the enthalpy and entropy terms as is seen in the case of the thalious ion pairs which have negative ΔS_{ass} .

Gurney^{6d} has suggested that between two ions in solution there are two types of forces in operation (1) the long range Coulomb or electrostatic forces and (2) the short range or quantum mechanical forces. With ions of opposite charge, the electrostatic force is always one of attraction. In the case of ions having the electronic configuration of rare gases the only quantum mechanical force will be one of repulsion whereas for other ions it will be one of attraction. In the association reaction (1) in aqueous solution, W , the work done in the formation of an ion pair from the separate ions is given by

$$W = \Delta G/N - kT \ln 55.5 \dots\dots (2)$$

where N is the Avogadro's number and k the Boltzmann's constant. The function $kT \ln 55.5$ is characteristic of a reaction in aqueous solution in which the number

of solute particles is decreased by unity, 55.5 being the number of moles of water in 1000 gms. W may be regarded as consisting of two parts W_{env} and W_{non} . W_{env} represents the long range electrostatic forces dependent on environment and temperature and W_{non} , the quantum mechanical forces arising from the very rapid motion of electrons, independent of environment and temperature.

$$W = W_{env} + W_{non} = -kT[\ln K + \ln 55.5]$$

The thallos and silver ions do not have a rare gas structure and hence in their association with anions, electrostatic forces of attraction are possibly supplemented by quantum mechanical forces of attraction leading to ion-pair formation, not generally observed with many univalent cations. As would be expected there is no linear relationship between $\log K$ and z^2/r anion, in these cases, since the association is not governed solely by W_{env} . When W_{non} is important, with increasing temperature the tendency will be for thermal agitation to cause the dissociation of the ion-pair. For most of the thallos

ion-pairs this is found to be the case. Among the bivalent cations studied, Mg^{++} is the only one with a rare gas (neon) structure and it is seen that its heat of association with the sulphate ion is higher than that of the other bivalent cations studied.

In the case of the bivalent ions of the first transition series, Irving and Williams^{7d} found a definite stability order for their complexes with a large number of neutral ligands and with some anions of weak acids:-



This is the same as the order of the reciprocal of the cationic radius and the second ionisation potentials. These two parameters would be expected to determine the magnitudes of the electrostatic and covalent interactions respectively. This order will, however, hold only when the ligands interact with protons more strongly than does water, i.e. conjugate bases of weak acids. In these cases, Irving and Williams^{6d} have assumed that the free energy change on complex formation is dominated by the heat term in the relationship

$$\Delta G = \Delta H - T \Delta S \dots\dots (4)$$

and that with uncharged ligands the entropy term will be too small to derange the stability order. However with ligands such as SO_4^{--} , PO_4^{---} , IO_3^- etc. whose proton complexes are less stable than the H_3O^+ ion, the interactions with cations are also feeble. The heat of formation of their complexes with the transition metals may be small; but by virtue of their negative charge, there will be a partial neutralisation of the charge on the cation as a result of ion-pair formation, and the resulting gain in entropy will to a large extent offset the loss of interaction energy which occurs when a water molecule is replaced by such a ligand. The net free energy change being very small, there may be a derangement in the stability order. In the present work it has been observed that with cobalt and nickel the order is reversed when sulphate ion is the ligand. The pK at 25° for the metal sulphates and the radii and second ionization potentials of the metals concerned are given in Table II.

Table II

Bivalent ions of transitional metals

	Mg	Mn	Co	Ni	Zn	Cu
$-\log K_{\text{ass. MSO}_4}$	2.252	2.257	2.365	2.322	2.380	2.367
Radius Å*	0.66	0.78	0.74	0.73	0.72	0.72
E_2 k cal s*	525.7	534.7	586	579	633.5	648.6

* Brewer, Bromley, Gilles and Leggren

(National Nuclear Energy Series,

Division IV - 19b, McGrawhill, 1950, p. 154).

E_2 refers to total ionisation potential at 25°

for the process $M(\text{gas}) \longrightarrow M^{++}(\text{gas}) + 2e$.

The entropy cycle may be represented as:-

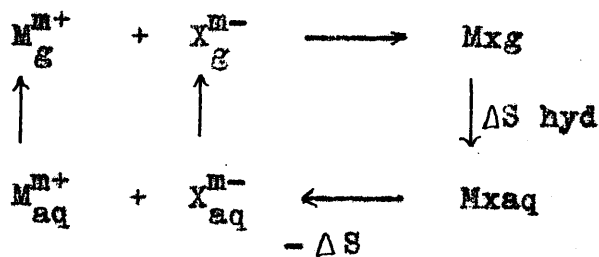

The entropy of association may be written:-

$$\Delta S_{\text{ass}} = S_{\text{g}}(Mx) + \Delta S_{\text{hyd}}(Mx) - S^{\circ}(M^{m+}) - S^{\circ}(X^{m-}) \dots (5)$$

where $S_g(Mx) = S_{\text{trans}}(Mx) + S_{\text{rot}}(Mx)$

$$S^\circ(M^{m+}) = S_{\text{trans}}(M^{m+}) + \Delta S_{\text{hyd}}(M^{m+})$$

$$S^\circ(X^{m-}) = S_{\text{trans}}(X^{m-}) + S_{\text{rot}}(X^{m-}) + \Delta S_{\text{hyd}}(X^{m-})$$

In calculating 'Sg' of an ion or ion pair, both translational and rotational terms were considered. S_{trans} for monatomic anions and diatomic ion pairs was obtained from the Sackur-Tetrode equation which at 25°C may be written $S_{\text{trans}} = 1.5 R \ln M + 26.03$ where M = atomic (or molecular) weight of the ion concerned.

$S_{\text{rot}}(x^-)$ for non linear, rigid anions (NO_3^- , IO_3^- and SO_4^{--}) was obtained from the equation^{8d}

$$S_{\text{rot}}(X^{m-}) = 2.2868(3 \log T + 3 \log I_A - 2 \log \sigma) + 267.52,$$

where I_A is the moment of inertia about a N-O, I-O or S-O bond, and " σ " is the symmetry number. For the linear ions OH^- , N_3^- and CNS^- as also for the ion pairs TlCl and TlBr , which were treated as "dumbbell" molecules, the rotational entropies were obtained from $S_{\text{rot}} = 4.574 \log IT + 177.7$ where I is the moment of inertia. In the case of those ion pairs with polyatomic anions, viz., NO_3^- , N_3^- , CNS^- , OH^- and SO_4^{--} , the sum of the translational and rotational terms was obtained^{8d} from

$$S \text{ trans}(Mx) + S \text{ rot}(Mx) = 2.2868 (8 \log T + 3 \log M + \log I_A I_B I_C - 2 \log \sigma) - 7.6973.$$

where M = molecular weight and

σ = symmetry number.

The product $I_A I_B I_C$ of the moments of inertia was evaluated by solving the determinant^{9d}

$$I_A I_B I_C = \begin{vmatrix} + I_{xx} & - I_{xy} & - I_{xz} \\ - I_{xy} & + I_{yy} & - I_{yz} \\ - I_{xz} & - I_{yz} & + I_{zz} \end{vmatrix}$$

where I_{xx}, I_{yy}, \dots are the moments and products of inertia with respect to a coordinate system having the centre of mass as origin and the M --- Y axis as x axis (Y = N, C, S etc.).

$$\text{i.e. } I_{xx} = \sum m_i (y_i^2 + z_i^2), \dots, \dots,$$

$$I_{xy} = \sum m_i x_i y_i, \dots, \dots,$$

where m_i is the mass of atom i whose coordinates are $x_i, y_i,$ and z_i .

Additional terms to account for free internal rotation were introduced for $TlNO_3$ and $AgIO_3$. This

Table III
Bond lengths

Compound	Bond	Dist Å
TlN ₃	Tl....N ⁽¹⁾	2.04
	N ⁽¹⁾ —N ⁽²⁾	1.24 ^{9d}
	N ⁽²⁾ —N ⁽³⁾	1.10 ^{9d}
TlNO ₃	Tl....O	2.85
	N — O	1.23
TlCNS	Tl....N	2.14
	N — C	1.22 ^{7d}
	C — S	1.56 ^{7d}
TlCl	Tl....Cl	3.25
TlBr	Tl....Br	3.39
TlOH	Tl....O	2.84
	OH	0.97
AgIO ₃	Ag....O	1.90
	IO	1.80
MSO ₄	MO	1.71
	S = O	1.51

(Where no other reference is given, data have been obtained from Pauling, "Nature of the Chemical Bond" Cornell University Press, Ithaca 1939.)

contribution^{8d}

$$S_{f.i.r.} = 2.2868 (\log T + \log I_r - 0.602) + 89.932,$$

where I_r , the "reduced" moment of inertia is given by

$$I_r = I_B^0 [1 - I_r^2 (\lambda_r A^2/I_A + \lambda_r B^2/I_B)].$$

In this formula I_r^0 is the moment of inertia of the "No₂ or IO₂ top" and $\lambda_r A$ and $\lambda_r B$ the direction cosines.

$$S_{f.i.r.} \text{ TlNO}_3 = 5.9 \text{ cal/deg. mole}$$

$$S_{f.i.r.} \text{ AgIO}_3 = 9.7 \text{ cal/deg. mole.}$$

In all cases the centre of mass was assumed to lie on the M Y axis. The angle Tl ... O ... N was assumed to be 105° and Ag ... O ... I to be 110°. By analogy with the structures of isothiocyanic acid^{10d}, and hydrogen and methyl cyanates^{11d} by electron microscopy and infra red spectra the angle between Tl Y axis and the linear CNS ion in Tl CNS was taken as 130°. Similarly from the known structure of methyl azide^{12d}, the angle between Tl ... Y axis and N₃⁻ ion in TlN₃ was

Table IVa

Entropies: cal. deg⁻¹ mole⁻¹

Ion	S _{trans}	S _{rot}	S _g	ΔS hyd	S _{aq} ^o 13d
Fl ⁺	41.88	-	41.88	-11.48	31.4
N ₃ ⁻	37.17	12.82	49.7	-17.7	32.0
NO ₃ ⁻	38.33	19.4	57.7	-22.7	35.0
CNS ⁻	38.13	15.5	53.63	-17.63	36.0
OH ⁻	34.47	6.8	41.27	-43.79	- 2.52
Cl ⁻	36.67	-	36.67	-23.47	13.2
Br ⁻	39.40	-	39.40	20.11	19.29
Mg ⁺⁺	35.33	-	35.33	-63.53	-28.2
Zn ⁺⁺	38.49	-	35.33	-63.94	-25.45
Co ⁺⁺	38.18	-	38.18	-65.18	-27.0
Ni ⁺⁺	38.17	-	38.17	-76.17	(-38.0)
Mn ⁺⁺	37.97	-	37.97	-57.97	-20.0
Cu ⁺⁺	38.40	-	38.40	-62.0	-23.6
SO ₄ ⁻⁻⁻	39.63	20.21	59.84	-55.74	4.1
Ag ⁺	39.98	-	39.98	-22.31	17.67
IO ₃ ⁻	41.42	21.69	63.11	-35.11	28.0

Table IVb
Thermodynamic Properties

Ion pair	$S_g(Mx)$ (cal.deg ⁻¹ mole ⁻¹)	ΔS_{ass} (cal.deg ⁻¹ mole ⁻¹)	$S^\circ(Mx)$ (cal.deg ⁻¹ mole ⁻¹)	$-\Delta S_{hyd}(Mx)$ (cal.deg ⁻¹ mole ⁻¹)	$(r_c + r_a)^{-1}$
TlOH	58.8	5.1	33.0	25.3	0.352
TlCl	60.9	-1.7	41.9	19.0	0.308
TlBr	62.8	-4.2	45.5	17.3	0.295
TlN ₃	66.7	-2.7	59.7	7.0	ca0.32
TlNO ₃	80.4	-1.0	64.4	16.0	0.289
TlONS	69.8	-6.4	60.0	9.8	ca0.30
AgCl	58.9	6.0	36.5	22.4	0.326
AgIO ₃	82.2	20.3	66.0	16.2	ca0.29
CuSO ₄	70.56	23.3	3.79	66.77	0.2506
MgSO ₄	68.22	27.19	3.09	65.13	0.2545
ZnSO ₄	70.33	24.10	2.75	67.58	0.2506
CoSO ₄	70.2	17.20	-5.7	75.9	0.2494
NiSO ₄	70.2	21.83	-12.07	82.27	0.2500
MnSO ₄	70.1	21.83	5.73	64.37	0.2469

(Data for ionic radii from Pauling, "Nature of the Chemical Bond" - Cornell University Press, Ithaca, 1939; for bivalent cations from Table II).

taken as 120° . In the case of MSO_4 , M, O, and S were assumed to be on the same axis, the remaining three oxygen atoms being tetrahedrally arranged round the S atom. The bond lengths used are given in Table III.

Substitution of the entropy values in equation (5) gives $\Delta S_{\text{hyd}}(\text{Mx})$, the entropy of hydration of the ion pair Mx. The entropy data are given in Tables IVa and IVb.

Powell and Latimer^{14d} have shown that the standard partial molal entropy " S° " of a very large number of monatomic ions can be expressed as a function of their mass, charge, and radii.

$$S^\circ = R \ln M + 37 - 270 \frac{z}{r_e^2} \dots (6)$$

where M = atomic weight z = charge on the ion and r_e = "effective" radius of ion. The linear dependence of the entropy on the first power of Z is in apparent disagreement with the Born^{15d} electrostatic treatment which requires linear variation with Z^2/r^2 . Recently Laidler^{16d} has illustrated that by assuming Gurney's^{6d} value for $S^\circ \text{H}^+ = -5.5 \text{ cal. deg}^{-1} \text{ mole}^{-1}$ and accounting for dielectric saturation in the vicinity of the

ion, Born relationship could be applied within a limited range of ionic radii.

Powell and Connick^{17d} and Cobble^{18d} have put forward, with varying success a number of empirical equations similar to (6), for oxy-anions and complex ions. In the case of complex ions, it is important, however, to treat ~~only~~ the hydration entropies in this way since these ions will have different translational and rotational entropy terms. For a number of oxy anions Cobble considered

$$S^{\circ} - R \ln M,$$

implying thereby that the gas entropy contained only a translational term. For inorganic complex ions Cobble^{18d} used a "corrected" entropy which took into account the entropy change consequent on the removal of water molecules from the normal coordinated solvated ion by the complexing agent. An approximate linear relationship between this corrected entropy and ratio of charge over interionic distance was obtained. An empirical equation which he suggested to predict the hydration entropies of uncharged ion-pairs, viz.

$$S' = 132 - 354/r_{1,2}$$

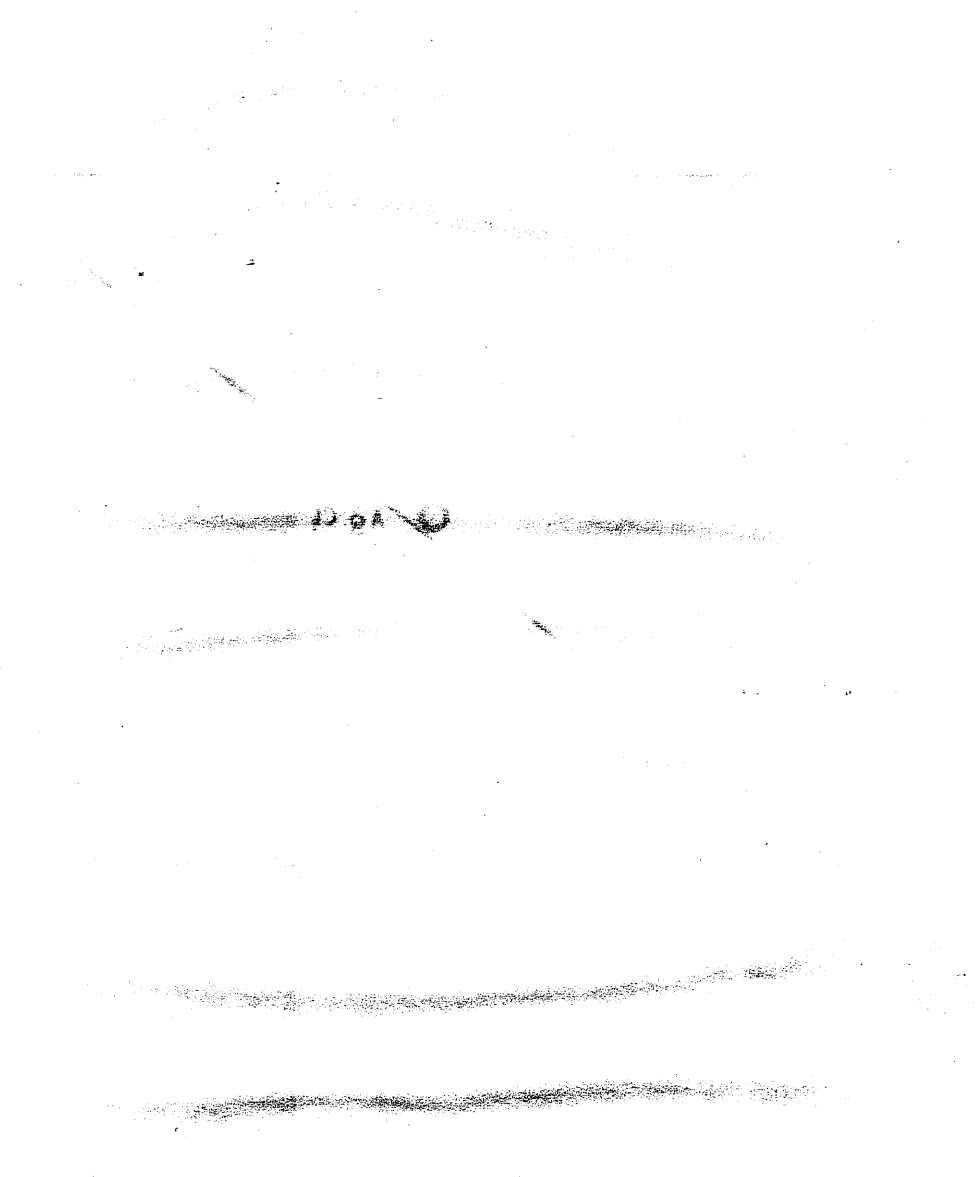

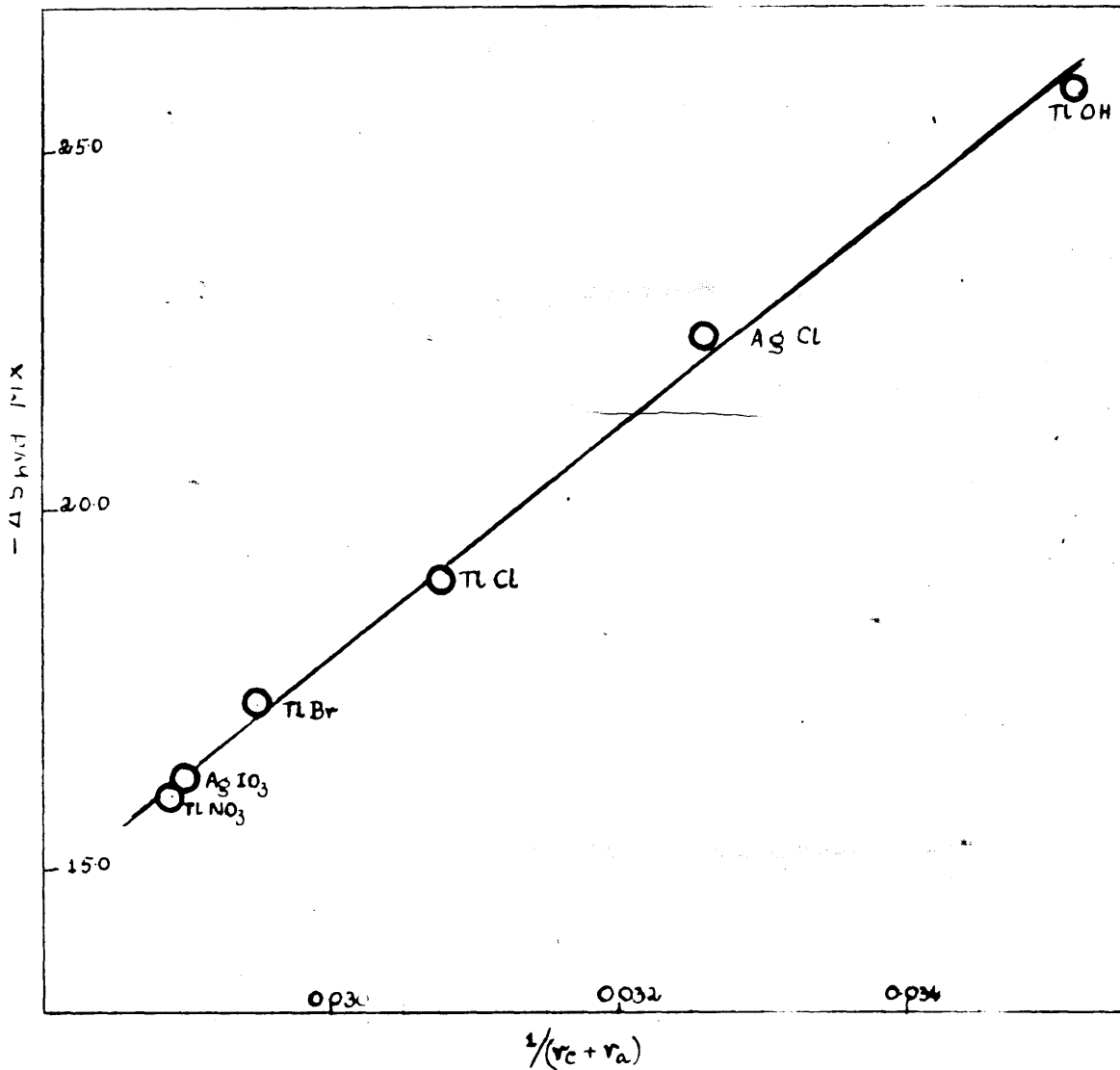

GRAPH 1 - UNI-UNIVALENT ION PAIRS

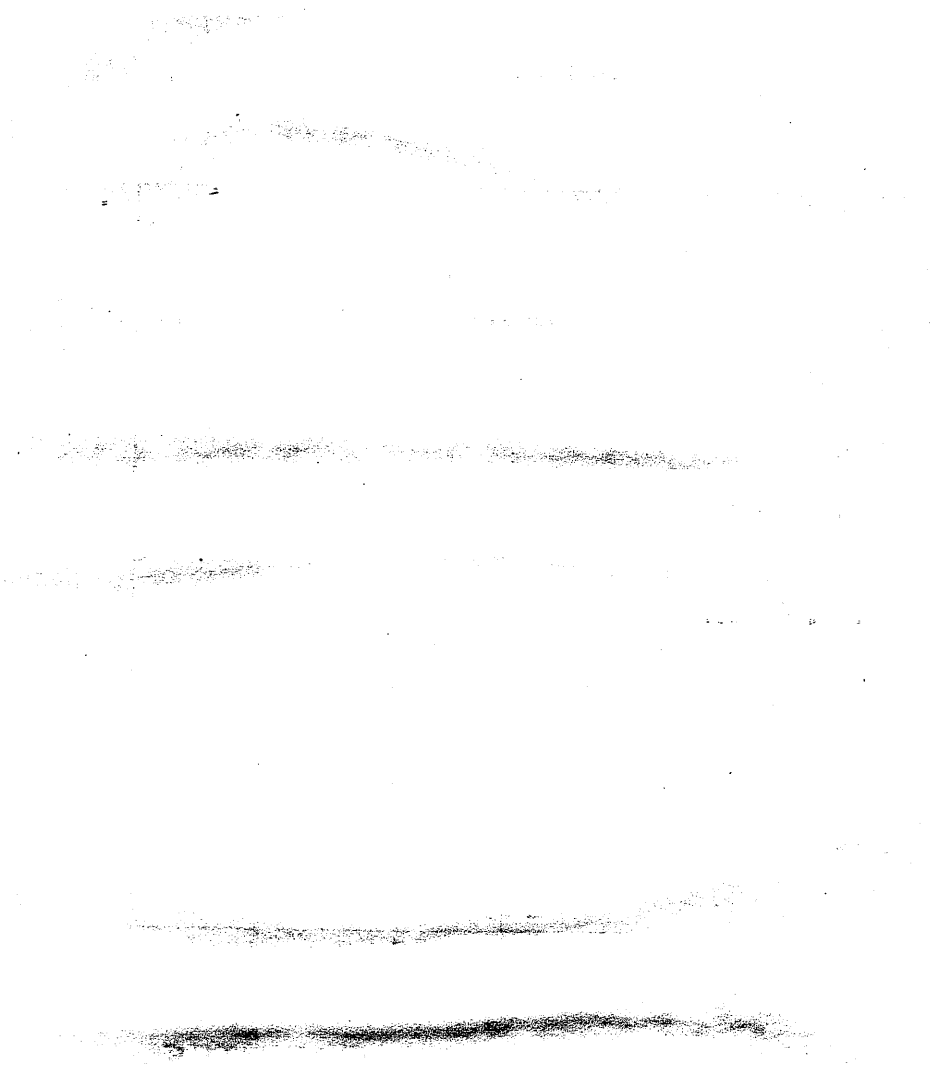

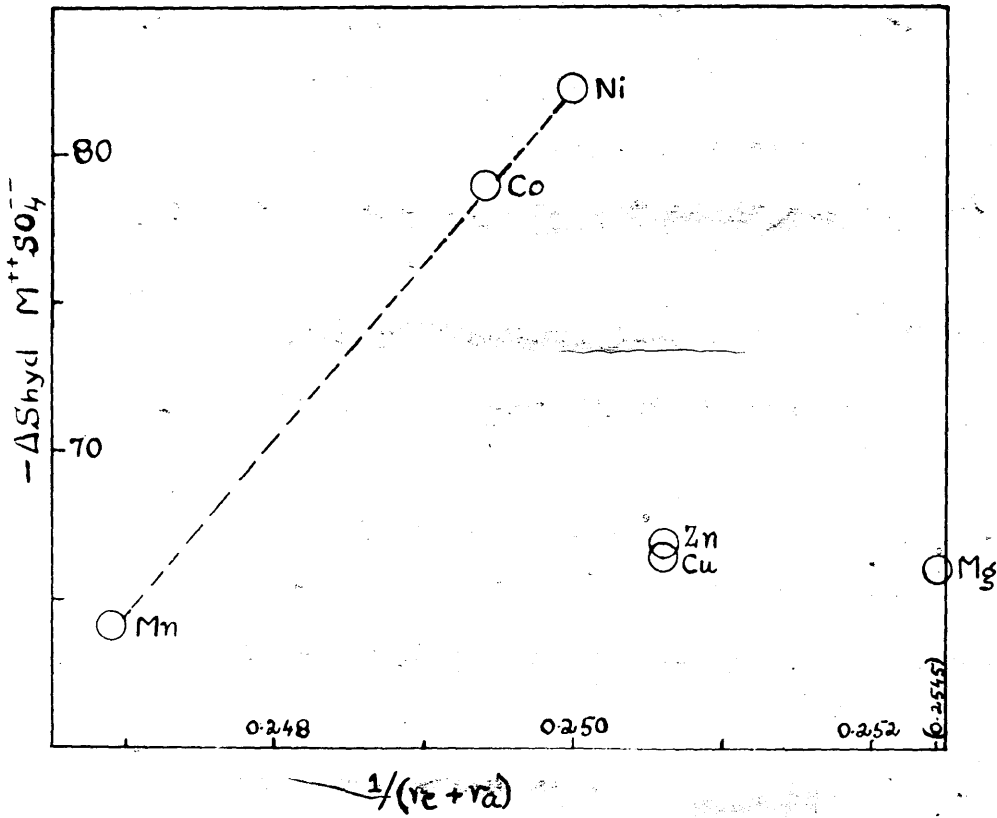

GRAPH 2 - BIVALENT METAL SULPHATES.

has been found not to be obeyed by the ion-pairs studied in the present work.

The good linear relationship between $\Delta S_{\text{hyd}} (Mx)$ and $(r_o + r_a)^{-1}$ for uni-univalent ion-pairs is shown in graph 1. It is seen that AgCl and AgIO_3 also fit in with the thalious data. $-\Delta S_{\text{hyd}} (\text{TlN}_3)$ and $-\Delta S_{\text{hyd}} (\text{TlCNS})$ are considerably lower than would be expected. There is some doubt about the aqueous entropies of the azide and thiocyanate ions but it is unlikely that these will be in error by more than a few entropy units. Contributions to entropy from bending vibrations would be expected to account for some of the discrepancy. Also, for linear ions there is some uncertainty about the ionic radius to be used. Graph 2 is a similar plot for the bivalent metal sulphates. In the case of Mn^{++} , Co^{++} and Ni^{++} a linearity is indicated between $-\Delta S_{\text{hyd}} (Mx)$ and $(r_o + r_a)^{-1}$, but it should be emphasised that there is considerable uncertainty about the value for $S^\circ \text{Ni}^{++}$ (Latimer^{13d}). As has been found by Irving and Williams^{7d} for the stability order, zinc does not fit in with this plot. For zinc, the radius is lower

and second ionisation potential higher than the other metals considered; also it is not a true transition metal comparable with the others.

A consideration of the hydration entropies of 1:1, and 2:2 valency type ion pairs (Table V) shows that the values for the latter are considerably higher and possibly reflect a smaller degree of charge neutralisation.

Table V

1:1 ion pair		2:2 ion pair	
	- ΔS_{hyd} (cal.deg ⁻¹ mole ⁻¹)		- ΔS_{hyd} . (cal.deg. ⁻¹ mole ⁻¹)
TlOH	25.8	MgSO ₄	65.13
TlCl	19.0	ZnSO ₄	67.58
TlBr	17.3	CoSO ₄	75.9
TlN ₃	7.0	NiSO ₄	82.27
TlNO ₃	16.0	MnSO ₄	64.37
TlCNS	9.8		
AgCl	22.4		
AgIO ₃	16.2		

APPENDIX

SPECTROPHOTOMETRIC STUDY OF THE DISSOCIATION OF
THE HYDROGEN CHROMATE ION

Introduction

The equilibria prevailing in aqueous solutions of chromates and dichromates have been studied by several workers as early as 1907^{1e}. Sherril has shown that the hydrogen chromate ion is an important constituent of such solutions and that the two important equilibria may be represented by the equations

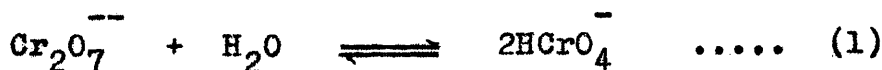

Although equilibrium constants were reported for the two reactions, the discrepancy among the values of these early workers was too large. The most reliable quantitative determination of these constants is, perhaps, that of Neuss and Rieman^{2e} by pH determination in 1934. More recently, Tong and King^{3e} and Davies and Prue^{4e} studied the first equilibrium by spectrophotometry. However, for the dissociation of the hydrogen chromate ion which becomes important at higher pH range, the data

available are few. Neuss and Rieman^{2e} used a glass electrode to determine the acidity of solutions containing potassium chromate and dichromate in fixed proportions and evaluated their data in terms of the two equilibrium constants but they did not attempt experiments at ionic strengths below about 0.01.

In the present work, the equilibrium (2) viz.

$\text{HCrO}_4 \rightleftharpoons \text{H}^+ + \text{CrO}_4^{--}$ has been studied at 25°C at ionic strengths 0.002 to 0.005, by measuring the optical densities of mixtures of chromic acid and sodium hydroxide solutions. Measurements have been done over the range of wavelength 355 to 385 mμ. The extinction coefficients ϵ_1 and ϵ_3 of the hydrogen chromate and dichromate ions respectively were determined from data obtained with chromic acid solutions, and ϵ_2 that of the chromate ion from the optical densities of potassium chromate solutions in 0.05 M potassium hydroxide solution^{5e}. The dissociation constant for the hydrogen chromate ion derived by this method agrees well with the value obtained by pH titration in this laboratory^{6e}.

Apparatus and Experimental

Preparation of solutions

A.R. Chromium trioxide was dried in an electric oven at 120°C for two hours, cooled in a desiccator and weighed out of contact with air and dissolved in conductivity water. The concentration was checked by potentiometric titration with standard alkali. The sodium hydroxide solution was prepared by diluting a carbonate-free saturated solution with conductivity water which had been previously bubbled with nitrogen for two hours. The solution was stored in a pyrex stock bottle provided with standard ground-glass joints carrying a burette with automatic filling device. The burette and the bottle had guard tubes containing soda lime. The alkali was standardised by titration with a standard solution of potassium hydrogen phthalate (A.R.).

Grade A glassware was used throughout.

Measurement of optical density and pH

Optical densities were measured with a Hilger Uvispec Spectrophotometer provided with a cell compartment through which water thermostated at 25°C was circulated; Quartz

cells were used throughout. In the experiments with chromic acid alone, and these with potassium chromate solution in 0.05 M potassium hydroxide, measurements were made with 1m.m., 1c.m. and 2c.m. cells. For the optical density measurements with mixtures of chromic acid and sodium hydroxide, however, it was found that the solutions would have to be as dilute as 10^{-4} M. At these concentrations the mixtures did not show good buffer action. In these cases, therefore 1m.m. cells were used and the total concentration of chromate was not less than 10^{-3} M.

To determine the pH values of the solutions, Cambridge glass and calomel electrodes were used together with a 'Doran' pH meter. The electrode system was standardised using B.D.H. tableid phosphate buffer, pH = 6.99 at 25° , which in turn had been checked with 0.05 M potassium hydrogen phthalate, pH = 4.005^{7e}.

Experimental procedure

To aliquot volumes of the stock chromic acid solution in volumetric flasks, the required volumes of the standard sodium hydroxide solution were added and

the mixtures made up with conductivity water.

The cells were cleaned in warm soap solution, washed several times with alcohol, and distilled water and finally with conductivity water. They were rinsed a number of times with the solution under study before filling. Conductivity water was used as 'blank' in experiments with mixtures of chromic acid and sodium hydroxide, and with chromic acid alone. In measurements with potassium chromate in 0.05 M potassium hydroxide, the 0.05 M potassium hydroxide solution was used as the 'blank'. Both the 'blank' and the solution cells were placed in the cell compartment and allowed to come to temperature equilibrium, which took about 15 minutes; at the end of this time, the absorption remained constant for at least one hour at any selected wavelength. The pH of the solution was also measured simultaneously and it showed no drift over a period of five hours.

Results and Discussion

In a mixture of chromic acid and sodium hydroxide, if the only absorbing species are the hydrogen chromate, chromate and the dichromate ions with ϵ_1 , ϵ_2 and ϵ_3 as

their respective extinction coefficients, and m_1 , m_2 and m_3 as their concentrations, the optical density of 10.m. thickness of solution will be given by,

$$D = \epsilon_1 m_1 + \epsilon_2 m_2 + \epsilon_3 m_3 \dots (3)$$

The total chromic acid concentration

$$m = m_1 + m_2 + 2m_3 \dots (4)$$

The values for ϵ_2 were obtained from optical density measurements on potassium chromate solution in 0.05 M potassium hydroxide at the wavelengths required. In order to estimate ϵ_1 and ϵ_3 , the optical density D' of solutions of chromic acid alone was measured.

$$D' = \epsilon_1 m_1' + \epsilon_3 m_3' \dots (5)$$

$$\text{or } \frac{m_1'}{D'} = \frac{1}{\epsilon_1} - \frac{m_3'}{D'} \cdot \frac{\epsilon_3}{\epsilon_1} \dots (6)$$

where m_1' and m_3' are the molar concentrations of hydrogen chromate and dichromate ions in the chromic acid solutions.

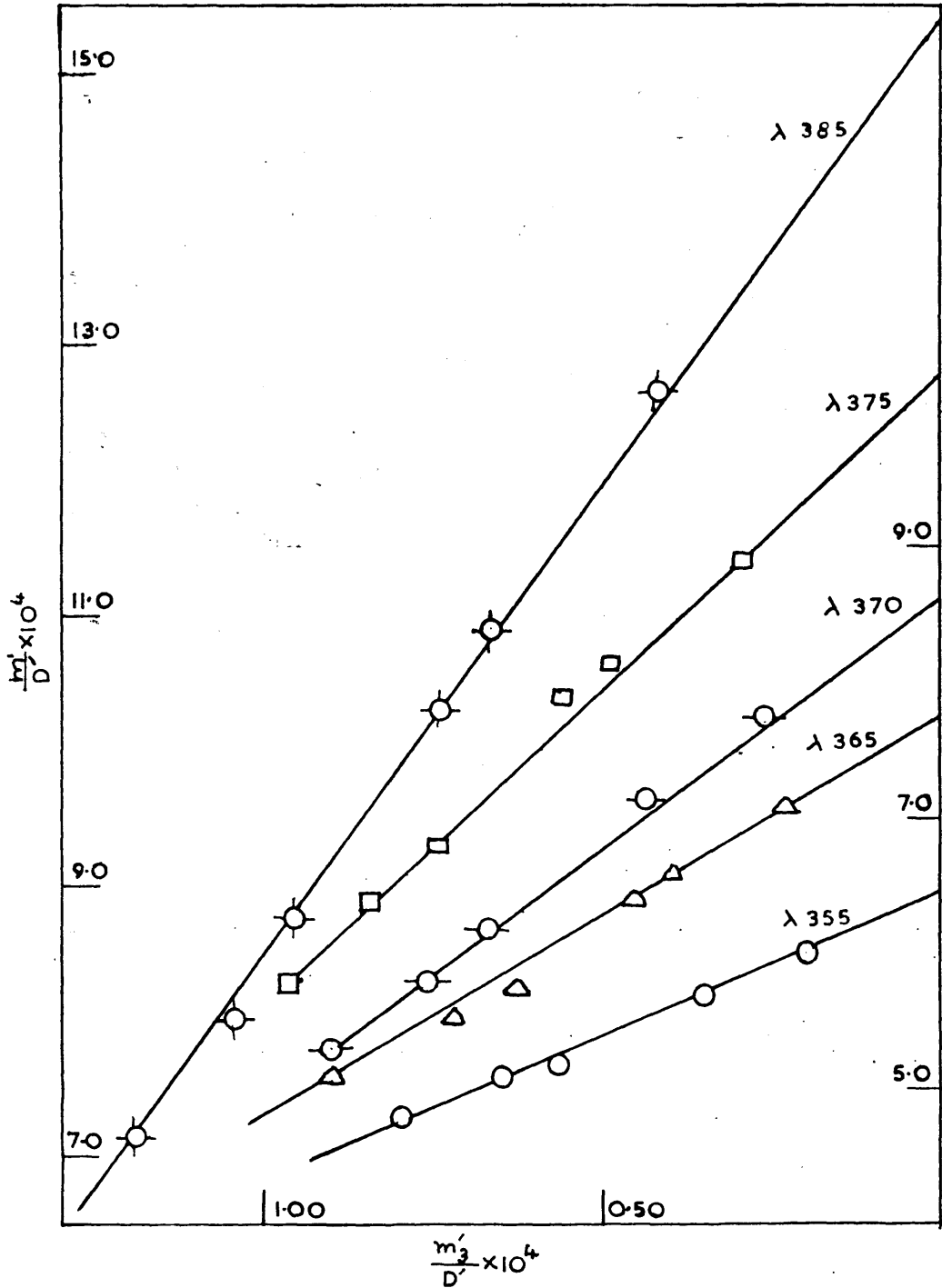

GRAPH I — PLOT FOR DERIVING ϵ_1 AND ϵ_3

Y-AXIS FOR $\lambda 385$ — LEFT HAND SIDE.

TABLE 1

	$10^3 m$	$10^3 I$	$10^3 m_1$	$10^3 m_3$	Optical density/c.m. D'				
					355mu	365mu	370mu	375mu	385mu
1	8.089	7.09	6.061	1.014	12.67	11.93	11.36	10.48	8.50
2	5.780	5.01	4.587	0.596	9.06	8.30	7.82	7.14	5.72
3	4.624	3.95	3.795	0.420	7.27	6.58	6.13	5.58	4.33
4	2.771	2.32	2.423	0.174	4.17	3.77	3.40	3.09	2.35
5	2.312	2.28	2.060	0.126	3.61	3.14	2.89	2.53	1.89
6	1.156	1.16	1.084	0.036	1.80	1.54	1.40	1.22	0.86

The constant^{4e} for the equilibrium (1)

$$\frac{[\text{HCrO}_4^-]^2 f_1^2}{[\text{Cr}_2\text{O}_7^{2-}] f_2} = 0.0303 \dots (7)$$

The activity coefficients f_1 and f_2 were obtained from the Davies equation^{8e} at 25°,

$$-\log f_2 = 0.5 z^2 \left[I^{\frac{1}{2}} / (1 + I^{\frac{1}{2}}) - 0.2 I \right] \dots (8)$$

The concentrations m_1' and m_3' for the different solutions of chromic acid were calculated by successive approximations of the ionic strength using equations (7) and (8). These are given in Table (1) which also includes the optical densities at the wavelengths studied. The values of $\frac{m_1'}{D}$ have been plotted against $\frac{m_3'}{D'}$ and these are shown in

graph (1). $\frac{1}{\epsilon_1}$ were obtained from the intercepts and $\frac{\epsilon_3}{\epsilon_1}$

from the slopes of the good straight line graphs (see graph (1)). The values for ϵ_1 and ϵ_3 obtained in this way for the different wavelengths are given in Table (2) which also gives the corresponding values for ϵ_2 .

TABLE 2**Extinction Coefficients**

λ m μ	ϵ_1	ϵ_2	ϵ_3
355	1560	3325	3340
365	1290	4415	4100
370	1160	4700	4220
375	985	4740	4420
385	650	4000	4540

Having obtained ϵ_1 , ϵ_2 and ϵ_3 , equations (3), (4) and (7) combine to give the quadratic in m_1

$$\left[f_1^2 (\epsilon_3 - 2\epsilon_2) / 0.0303 f_2 \right] m_1^2 + (\epsilon_1 - \epsilon_2) m_1 + \epsilon_2 m - D = 0 \quad \dots (9)$$

from which m_1 , the concentration of hydrogen chromate ion in the chromic acid - sodium hydroxide mixtures may be calculated by successive approximations for the ionic strength until both m_1 and I become constant. Values for m_3 can then be obtained from equation (7) and these for m_2 from equation (4). Table (3) gives the concentrations of the ionic species thus obtained. Table (4) contains the measured optical densities of the solutions. In equation (4), let $m_1 + m_2 = m'$. The equilibrium constant K for reaction (2)

$$K = \frac{\{H^+\} m_2 f_2}{m_1 f_1} \quad \text{i.e. } m' = \frac{f_2 \{H^+\} m_2}{f_1 K} + m_2$$

$$m_2 = \frac{m'}{1 + \frac{f_2 \{H^+\}}{f_1 K}} \quad (10)$$

TABLE 3

Concentrations of the absorbing ions

Expt No.	$10^3 m$	$10^3 [\text{NaOH}]$	$10^3 m_1$	$10^3 m_2$	$10^3 m_3$	$10^3 I$
1	1.485	1.919	0.979	0.434	0.036	2.39
2	1.485	2.111	0.810	0.626	0.024	2.76
3	1.485	2.303	0.636	0.818	0.015	3.14
4	1.485	2.495	0.459	1.010	0.008	3.51
5	1.858	3.455	0.256	1.597	0.003	5.05
6	1.858	2.879	0.790	1.021	0.024	3.92
7	1.858	2.495	1.126	0.637	0.048	3.18

TABLE 4

Optical densities and functions A and B

λ $\mu\mu$	Expt No.	D	A	B
355	1	3.14	1399	573
	2	3.45	1167	781
	3	3.76	933	986
	4	4.08	686	1196
	5	5.72	304	1520
	6	4.71	939	997
	7	4.04	1353	639
365	1	3.45	2448	1043
	2	3.99	2030	1417
	3	4.56	1594	1798
	4	5.10	1166	2160
	5	7.40	535	2698
	6	5.68	1638	1790
	7	4.55	2341	1180
370	1	3.42	2807	1153
	2	4.06	2318	1591
	3	4.69	1827	2010
	4	5.31	1343	2428
	5	7.84	594	3065
	6	5.84	1877	2010
	7	4.56	2682	1313

TABLE 4 (contd.)

λ μ	Expt No.	D	A	B
375	1	3.31	2956	1241
	2	3.96	2448	1696
	3	4.62	1935	2144
	4	5.26	1430	2572
	5	7.83	654	3142
	6	5.76	1984	2138
	7	4.43	2828	1406
385	1	3.25	2626	1117
	2	3.81	2158	1535
	3	4.36	1717	1921
	4	5.83	1277	2293
	5	6.54	596	2873
	6	4.75	1762	1914
	7	3.59	2511	1264

$$\text{and } m_1 = m' \left[1 - \frac{1}{1 + \frac{f_2}{f_1} \frac{\{H^+\}}{K}} \right] = \frac{m' \frac{f_2}{f_1} \frac{\{H^+\}}{K}}{1 + \frac{f_2}{f_1} \frac{\{H^+\}}{K}} \quad (11)$$

Substituting the values for m_1 and m_2 from (10) and (11) in equation (3)

$$(D - \epsilon_3 m_3) = \epsilon_1 \frac{m' \frac{f_2}{f_1} \frac{\{H^+\}}{K}}{1 + \frac{f_2}{f_1} \frac{\{H^+\}}{K}} + \frac{\epsilon_2 m'}{1 + \frac{f_2}{f_1} \frac{\{H^+\}}{K}}$$

$$\text{or, } (\epsilon_2 m' - D + \epsilon_3 m_3) = \frac{f_2}{f_1} \frac{H^+}{K} (D - \epsilon_3 m_3 - \epsilon_1 m')$$

Dividing by m_1'

$$\frac{f_1}{f_2} \frac{(\epsilon_2 m' - D + \epsilon_3 m_3)}{m'} = \frac{\{H^+\}}{K} \left[\frac{D - \epsilon_3 m_3}{m'} - \epsilon_1 \right]$$

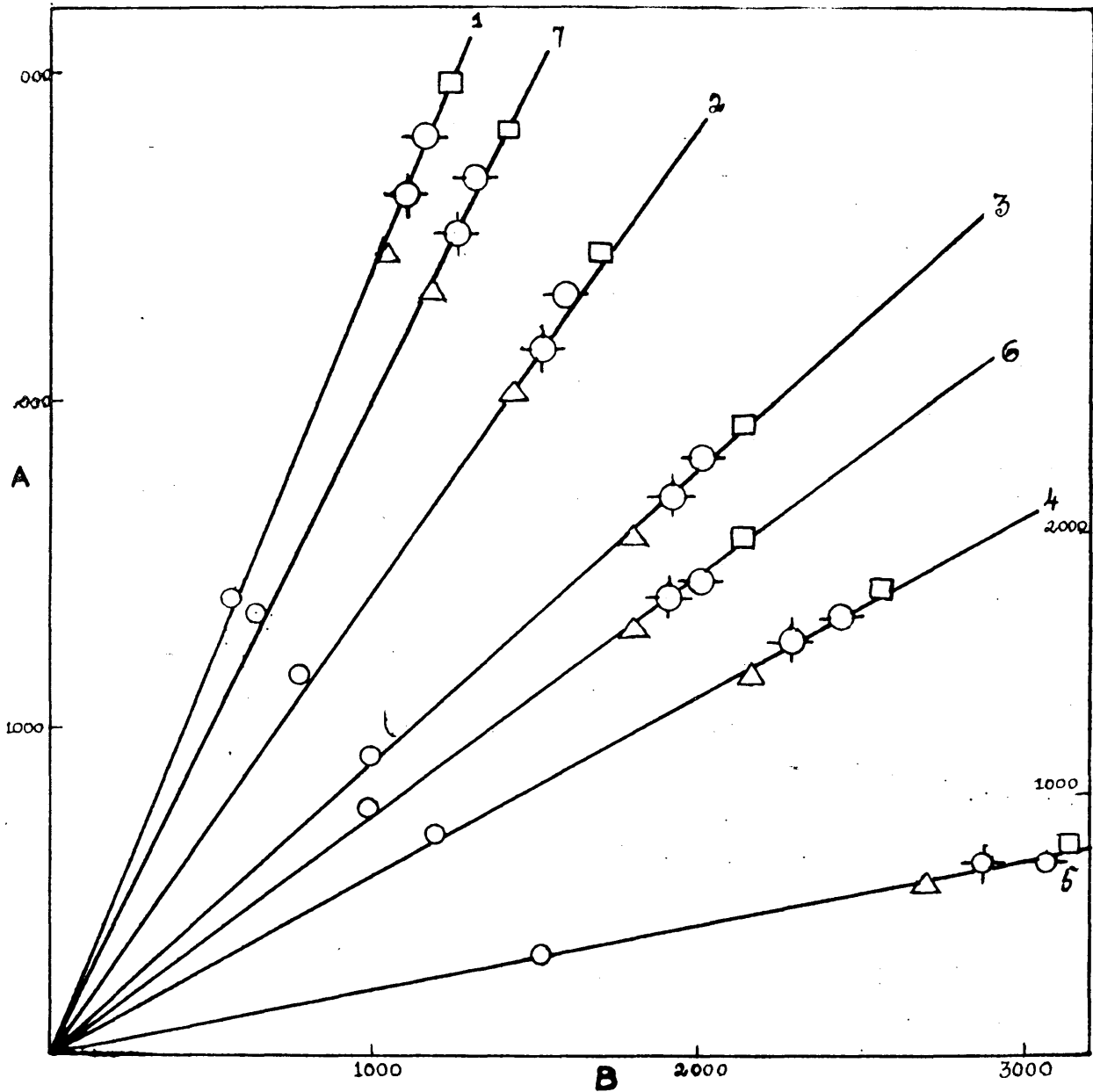

GRAPH 2 - PLOT OF FUNCTIONS A AND B

RIGHT HAND ORDINATES FOR EXPT. 6

TABLE 5

Expt. No.	1	2	3	4	5	6	7
pH	6.15	6.37	6.56	6.78	7.23	6.57	6.23
$\{H^+\}/K$	2.39	1.43	0.91	0.55	0.20	0.92	2.01
$10^7 K$	2.9 ₆	3.0	3.0 ₂	3.0 ₂	2.9 ₅	2.9 ₁	2.9 ₃

$$\text{or, } \frac{f_1}{f_2} \frac{[\epsilon_2^m + (\epsilon_3 - 2\epsilon_2)m_3 - D]}{m - 2m_3} = \frac{\{H^+\}}{K} \left[\frac{D - \epsilon_3 m_3}{m - 2m_3} - \epsilon_1 \right]$$

This may be written as

$$A = \frac{\{H^+\}}{K} \quad B \quad (12)$$

$$\text{in which } A = \frac{f_1}{f_2} \frac{2^m + (\epsilon_3 - 2\epsilon_2)m_3 - D}{m - 2m_3}$$

$$\text{and } B = \frac{D - \epsilon_3 m_3}{m - 2m_3} - \epsilon_1$$

The values for the functions A and B for the solutions at each wavelength are included in Table (4). Graph (2) shows the linear plot of A against B. The slopes of these lines give the value $\frac{\{H^+\}}{K}$ for each solution. Using the measured pH values, the dissociation constant K of the hydrogen chromate ion was derived and Table (5) gives the results. The mean value of K, 2.97×10^{-7} moles/l., agrees well with the potentiometric value^{6e} of $3.0_1 \times 10^{-7}$.

BIBLIOGRAPHY

BIBLIOGRAPHYGeneral Introduction

- 1a. Bjerrum, 1926, K. danske vidensk. Selsk, 7, No. 9.
- 2a. Guggenheim, Phil. Mag. 1935, 19, 588; 1936, 22, 32.
- 3a. Davies, J. Chem. Soc., 1938, 2093.
- 4a. Same as 3a and 8a.
- 5a. Davies, Trans. Farad. Soc., 1927, 23, 351; Money
and Davies, *ibid.*, 1932, 28, 609; Same as 3a;
Dunsmore and James, J. Chem. Soc., 1951, 2925.
- 6a. Davies, J. Chem. Soc., 1938, 277.
- 7a. Bell and George, Trans. Farad. Soc., 1953, 49, 619.
- 8a. Jones and Monk, Trans. Farad. Soc., 1952, 48, 929;
Evans and Monk, *ibid.*, 1955, 51, 1244.
- 9a. Bernal and Fowler, J. Chem. Phys., 1933, 1, 515;
Frank and Evans, *ibid.*, 1945, 13, 507.

Part I

- 1b. Same as 3a.
- 2b. Shedlovsky, J. Amer. Chem. Soc. 1934, 56, 1066; 1932, 54, 1411.
^{et al}
- 3b. Same as 1a.
- 4b. La Mer and Goldmann, J. Amer. Chem. Soc., 1929, 51,
2632.
- 5b. Bray and Winninghoff, *ibid.*, 1911, 33, 1663; Garrett
and Vellenga, *ibid.*, 1945, 67, 225.

- 6b. Same as 6a.
- 7b. Same as 7a.
- 8b. Davies and Nancollas, Chem. and Ind., 1950, 7, 129.
- 9b. Kohlrausch, Treadwell and Hall-Textbook of
"Analytical Chemistry"
- 10b. Jones and Joseph, J. Amer. Chem. Soc., 1928, 50,
1049; Shedlovsky, *ibid.*, 1930, 52, 1793.
- 11b. Hartley (and Barret) J. Chem. Soc., 1913, 786.
- 12b. Jones and Bollinger, J. Amer. Chem. Soc., 1931,
53, 411.
- 13b. Davies, Trans. Farad. Soc., 1929, 25, 129.
- 14b. Shedlovsky, J. Amer. Chem. Soc., 1932, 54, 1411.
- 15b. Jones and Bradshaw, *ibid.*, 1933, 55, 1780.
- 16b. Keefer and Reiber, *ibid.*, 1941, 63, 3504.
- 17b. Davies, J. Chem. Soc., 1930, 2410.
- 18b. Davies, Trans. Farad. Soc., 1927, 23, 351.
- 19b. Benson and Gordon, J. Chem. Phys., 1945, 13, 473.
- 20b. Robinson and Davies, J. Chem. Soc., 1937, 574.

Part II

- 1c. Irving and Williams, J. Chem. Soc., 1953, 3192;
Williams, *ibid.*, 1952, 3770.
- 2c. Davies, Trans. Farad. Soc., 1927, 23, 351; J. Chem.
Soc., 1938, 2093.
- 3c. Owen and Gurry, J. Amer. Chem. Soc., 1938, 60, 3074.

- 4c. Wyatt, Trans. Farad. Soc., 1951, 47, 656.
- 5c. Dunsmore and James, J. Chem. Soc., 1951, 2925.
- 6c. Brown and Prue, Proc. Roy. Soc., 1955, 232, 320;
La Mer and Parks, J. Amer. Chem. Soc., 1931, 53,
2040; Cowperthwaite and La Mer, *ibid.*, 1931,
53, 4333.
- 7c. Jones and Monk, Trans. Farad. Soc., 1952, 48, 929.
- 8c. Same as 1a.
- 9c. Sherrill and Noyes, J. Amer. Chem. Soc., 1926, 48,
1861.
- 10c. Bray and Liebhafsky, *ibid.*, 1935, 57, 51.
- 11c. Young, Klotz and Singleterry, Thesis (university of
Chicago, 1940), quoted by Robinson and Stokes.
"Electrolyte Solutions," Butterworths Scientific
Publications, London 1955, p.p. 374-376.
- 12c. Hamer, J. Amer. Chem. Soc., 1934, 56, 860.
- 13c. Kentama, Suomen Kem., 1957, 1, 30.
- 14c. Davies, Jones and Monk, Trans. Farad. Soc., 1952,
48, 921.
- 15c. Foulk and Hollingworth, J. Amer. Chem. Soc., 1923,
45, 1223; Titus and Smith, *ibid.*, 1941, 63, 3266.
J.A. Shaw, Indus. Engg. Chem., 1926, 18, 1065.
- 16c. Arthur Vogel, "A Text Book of Quantitative Analysis,"
Longmans Green and Co., London, 1947, p.p. 475-82,
497-99.

- 17c. Barber, J. Scien. Inst., 1950, J, 62, 27, 47.
- 18c. Barber and Herington, J. Appl. Phys. 1954, 5, 41.
- 19c. Noyes and Ellis, J. Amer. Chem. Soc., 1917, 39, 2532.
- 20c. Harned and Morrison, Amer. J. Science, 1937, 33, 161.
- 21c. Ashby, Crook and Datta, The Biochem. J., 1954, 56,
No. 2, 190.
- 22c. Harned, J. Amer. Chem. Soc., 1929, 51, 416.
- 23c. Tanaguchi and Janz, J. Electrochem. Soc., 1957,
104, 123.
- 24c. Bates, "Electrometric pH determinations," John Wiley
and Sons, Inc., New York, (1954), p. 200.
- 25c. Harned and Ehlers, J. Amer. Chem. Soc., 1932, 54,
1350.
- 26c. Bates, Guggenheim, Harned, Ives, Janz, Monk,
Robinson, Stokes, and Wynne-Jones, J. Chem. Phys.,
1956, 25, 361.
- 27c. Harned and Owen, "Physical Chemistry of Electrolytic
solutions," Reinhold Publishing Corporation,
New York, 1943, p. 547.
- 28c. Purlee and Grunwald, J. Phys. Chem., 1955, 59, 1112.
- 29c. Hills and Ives, J. Chem. Soc., 1951, 305.
- 30c. Davies, *ibid.*, 1938, 2093.
- 31c. Manor, Bates, Hamer, Acree, J. Amer. Chem. Soc.,
1943, 65, 1765, quoted by Robinson and Stokes,
"Electrolyte solutions," - Ref. 11c.

- 32c. Jenkins and Monk, J. Amer. Chem. Soc., 1950, 72, 2695.
- 33c. Hamer, Symposium on the structure of electrolyte solutions, (Electro-chemical Society), Washington, May 1957. Private communication to Dr. G.H. Nancollas.
- 34c. Randall and Scott, J. Amer. Chem. Soc., 1927, 49, 636.
- 35c. Pitzer, *ibid.*, 1937, 59, 2365.
- 36c. Guggenheim, "Discussions on Interactions in Ionic solutions," (Faraday Society), September 1957.
- 37c. Beevers and Lipson, Proc. Roy. Soc., 1934, A, 146, 570.
- 38c. Evans and Monk, Trans. Farad. Soc., 1955, 51, 1244.
- 39c. James, Ph.D. thesis, 1947. London.

Part III

- 1d. Same as 7a.
- 2d. Jonte and Martin, J. Amer. Chem. Soc., 1952, 74, 2053;
Renier and Martin, *ibid.*, 1956, 78, 1833.
- 3d. Davies and James, Proc. Roy. Soc., 1948, A195, 116.
- 4d. James and Monk, Trans. Farad. Soc., 1950, 46, 1041.
- 5d. Owen and Gurry, J. Amer. Chem. Soc., 1938, 60, 3074;
Davies, J. Chem. Soc., 1938, 2092.
- 6d. Gurney, J. Chem. Phys., 1938, 6, 499; "Ionic Processes in Solution," McGraw Hill, 1953.
- 7d. Irving and Williams, J. Chem. Soc., 1953, 3192.

- 8d. Herzberg, "Infra-red and Raman Spectra," van Nostrand, New York, 1945.
- 9d. Wilson, Chem. Rev., 1940, 27, 17; Hirschfelder, J. Chem. Phys., 1940, 8, 431.
- 10d. Dousmanis, Sanders, Jr.,
-J. Chem. Phys., 1953, 21, 1416.
Founes and Zieger,
- 11d. Eyster, Gillette and Brockway, J. Amer. Chem. Soc., 1940, 62, 3236.
- 12d. Pauling and Brockway, *ibid.*, 1937, 59, 13; Eyster and Gillette, J. Chem. Phys., 1940, 8, 369.
- 13d. Latimer, "Oxidation Potentials," Prentice-Hall, New York, 1952.
- 14d. Powell and Latimer, J. Chem. Phys., 1951, 19, 1139.
- 15d. Born, Z. Physik, 1920, 1, 45.
- 16d. Laidler, Canad. J. Chem., 1956, 34, 1107; Laidler and Pegis, Proc. Roy. Soc., A241, 1957.
- 17d. Powell and Connick, (Private Communication to Cobble - referred to in 18d).
- 18d. Cobble, J. Chem. Phys., 1953, 21, 1443-1450.

Appendix

- 1e. Sherril, J. Amer. Chem. Soc., 1907, 29, 1641;
Spitalsky, Z. anorg. chem., 1907, 54, 265;
Lundberg, *ibid.*, 1907, 55, 426.

- 2e. Neuss and Rieman, J. Amer. Chem. Soc., 1934, 56, 2238.
 - 3e. Tong and King, *ibid.*, 1953, 75, 6180.
 - 4e. Davies and Prue, Trans. Farad. Soc., 1955, 51, 1045.
 - 5e. Vandenberg, Jean Forsyth and Anne Garrett, Ind. Engg. Chem., (Anal), 1945, 17, 235.
 - 6e. (Miss) J.R. Howard (private communication).
 - 7e. British Stand., 1950, 1647.
 - 8e. Davies, J. Chem. Soc., 1938, 2093.
-