

# A LIFE CYCLE MODEL FOR PRODUCT-SERVICE SYSTEMS DESIGN

**David Baxter**  
Cranfield University  
d.baxter@cranfield.ac.uk

**Athanasia Doultsinou**  
Cranfield University  
a.doultsinou@cranfield.ac.uk

**Rajkumar Roy**  
Cranfield University  
r.roy@cranfield.ac.uk

**James Gao**  
Greenwich University  
j.gao@gre.ac.uk

## ABSTRACT

Western manufacturing companies are developing innovative ways of delivering value that competes with the low cost paradigm. One such strategy is to deliver not only products, but systems that are closely aligned with the customer value proposition. These systems are comprised of integrated products and services, and are referred to as Product-Service Systems (PSS). A key challenge in PSS is supporting the design activity. In one sense, PSS design is a further extension of concurrent engineering that requires front-end input from the additional downstream sources of product service and maintenance. However, simply developing products and service packages is not sufficient: the new design challenge is the integrated system. This paper describes the development of a PSS data structure that can support this integrated design activity. The data structure is implemented in a knowledge base using the Protégé knowledge base editor.

## KEYWORDS

Product-Service Systems, PSS, Product Lifecycle Management, PLM, Design

## 1. INTRODUCTION

The developing product-service-systems (PSS) paradigm focuses on the combination of products and services to deliver customer value. There are relatively few studies or proposals on the impact of a PSS sales strategy on the product and service design strategy. It is the assertion of this paper that it is not sufficient to simply design products and add service: system level design is necessary. A system level design concept has been proposed previously in the literature (Aurich et al., 2006, Aurich et al., 2004), and will be described in the following section. A particular strength of Product lifecycle management (PLM) systems is the capability to search for and retrieve previously applied product development knowledge. In order to support a system level design methodology with knowledge of previous projects using PLM, a knowledge structure is required. PLM tools are positioned by vendors as being capable of supporting life cycle design. However, existing PLM models do not contribute well to the system design paradigm since

they remain largely product focused. A system view of design is required for adoption within PLM systems to support PSS design.

This paper will describe the current status of PSS research. PLM research will also be introduced. A proposal for a system level concept for supporting PSS design and design knowledge reuse will then be introduced. Two previous research projects contributing to these proposals will be described. These projects represent proposals for a manufacturing knowledge base structure a service knowledge framework. The future research agenda will then be outlined, including the need for further verification of the system level concept through case studies and a methodology to translate a multi-perspective system focused knowledge base into a PLM system structure.

## 2. PSS DESIGN RESEARCH

Baines et al discuss the state of the art in PSS, stating that a PSS is “an integrated product and service offering that delivers value in use”. They

describe three PSS models: product-oriented (product plus additional services), use-oriented (leasing model), and result-oriented (selling the result or capability, not the product itself). The result oriented model is most closely aligned with the features of a PSS. Various PSS case studies are described, including fixed price printing from Xerox and a pay per wash laundrette system from Electrolux. They suggest that a successful PSS needs to be designed at the systemic level, from a client perspective. Organisational structures of PSS providers are also likely to change to support PSS delivery. They conclude that there is little guidance for manufacturers in PSS design and delivery (Baines et al., 2008).

Tukker and Tischner discuss the progression of PSS as a research field. They suggest that the PSS concept rests on two pillars: functionality is a starting point of business development; and the mode of fulfilment of that functionality is newly considered. New business models are therefore a key element of the PSS concept. Whilst PSS began firmly in the sustainability arena, it is recognised that PSS is not inherently more sustainable. The PSS model can provide an advantage to providers, by moving them up the value chain and forming unique relationships. With either objective, careful design of the PSS is required (Tukker & Tischner 2006).

Aurich et al developed an approach to life cycle oriented technical service design (Aurich et al., 2004), which was later modified to incorporate PSS concepts (Aurich et al., 2006). The basic premise is to apply a systematic approach to product and service design, from an integrated perspective. They suggest an integrated process model that applies processes from a library, which is driven by state changes in the developing system. They conclude that the systematic exchange of design information between design activities can improve the design of integrated solutions. Their proposals do not indicate how knowledge and information from product service offerings can be structured for design management and reuse.

The creation of generic PSS design methodologies is not generally accepted to offer benefit to PSS design, however there are a variety available in the literature to date. Tukker and Mont suggest that this emerging variety is in conflict with the potential for a generic methodology. They suggest that “certain generic principles will always be valid...” going on to suggest that “each company has to work out its own practical approach”. They emphasise the need to focus on the system perspective in PSS design (Mont & Tukker 2006).

Morelli emphasises the shift in production strategies from product delivery to the provision of

knowledge intensive systemic solutions (Morelli 2002). The lack of design research in PSS is noted, particularly with regard to translating emerging cultural and social patterns to viable PSS business models. Traditionally, design has been focused on the technical definition of artefacts. In this traditional model, the technical knowledge of the designer combines with knowledge of the production and consumption system they are projecting into. In PSS design, the designer must consider a much broader scope, including understanding user needs and patterns in a PSS model; conceptualising and representing PSS; and managing the design activity. PSS design must also make reference to the attitudes of user groups in their acceptance of these developing technological systems. Improved PSS service representations are required, and may be adapted from existing information system representation tools such as UML use cases or IDEF diagrams.

Sakao and Shimomura describe service engineering in the context of eco-design for combined product and service offerings. They propose a method to model and design services through a tool called service explorer. They also provide a design methodology, suggesting that artefacts (either contents or channels), having their own functions, behaviours and states, can be designed using existing CAD (computer aided design) systems and methodologies. Service engineering is an additional discipline introduced with the aim of increasing the value of artefacts though emphasising the service elements over the product elements. In addition to function, the ‘meaning of contents’ is proposed as a driver of user satisfaction. The service model comprises of four elements: flow, scope, view and scenario. They describe a design process to apply the various elements to service design. One aspect of the system is an attempt to define various aspects of value perceived by the service user, such as ‘self respect’ and ‘fun’ (Sakao & Shimomura 2007). The persona driven approach is often applied to traditional marketing methods in which user groups are segmented. The efficacy the persona driven model in traditional marketing is questionable (use cases, job- or outcome- driven specifications may be more appropriate (Ulwick 2005)); so whether this is appropriate to the development of a service network is also questionable. Regardless, the method provides an alternative view on service design with a strong emphasis on user value.

The key message of PSS design research to date is that a PSS design methodology is required to support two key elements: conceptualisation of the PSS itself and of the supporting business model. Whilst existing design methodologies and tools are

recognised to have a potential contribution to PSS design, the overriding message is that they are not currently adequate. A new approach to design is required, that is able to effectively support an integrated system level design of products, services and enterprise structures.

### 3. PLM RESEARCH

PLM is broadly applied in industry, to a range of processes including: requirements definition, detailed design, manufacturing planning, in-service management and end of life (Rangan et al., 2005).

It is suggested that domain ontologies could support the rapid deployment of PLM applications, as well as improving interoperability (Rangan et al., 2005). Gao et al suggest that the application of ontology to PDM and PLM structure can support the design project, enabling efficient management of conceptual design knowledge (Gao et al., 2003). Their proposed method demonstrates how a PDM / PLM system can play a central role in product design, manufacture and realisation through links to manufacturing and ERP software. Whilst the concept clearly has potential beyond product development, there is no explicit provision for system level specification or coordination: the concept remains product centric.

Weber et al propose a representation to improve the capability of PDM/PLM systems that distinguishes between properties (behaviour) and characteristics (physical attributes) of products, formalising relationships and their conditions. They claim that this could significantly improve the capability of PDM/PLM systems to control and speed up design activities (Weber et al., 2003). Whilst it is claimed that 'properties' includes a variety of life cycle elements (e.g. maintenance and repair properties), it is essentially related to the physical structure of the product and its substructures, and not the more holistic 'delivery system'. They suggest that the biggest deficit of current PLM systems is that there is no link to the characteristics and properties of the product, which limits the capability to support the whole development process and leaves CAD as the next best alternative 'master system'.

Sudarsan et al describe a product information modelling framework to support "the full range of PLM information needs" (Sudarsan et al., 2005). The framework is based on various standards, including the NIST core product model, open assembly model, design analysis integration model and the product family evolution model. The intention of the framework is to provide access to data components via a PLM system, which offers a detailed level view of the product description and design rationale. Regarding the adoption of PLM,

they suggest that "For the PLM concept to be successful, issues such as establishing data standards and designing corporation-wide integration architectures need to be addressed so that formerly fragmented information can be served up to individuals in a format they can use" (Sudarsan et al., 2005). Whilst 'product in use' is recognised as part of the life cycle view, the approach to managing in-use data is not presented. It is also not clear how such a framework could be applied to a system design problem, since there are no clear references to system level design and there is no link to organisation design.

Kiritsis et al describe the PROMISE project, which aims to contribute to two key PLM areas: to support through-life information flow and feedback (close the product lifecycle information loop); and to support the transformation of product lifecycle information to knowledge. Currently, for consumer products, information flow ends when the product arrives with the consumer. Service, maintenance and recycling feedback is not well supported. DFX scenarios are dependent on these information flows. The authors recognise that alongside the technology and data models required to support this feedback, business models need to be considered within which their proposals can be applied (Kiritsis et al., 2003).

In extended supply chains and collaborative design networks, data access and updating between partners is a major issue. Morris et al developed a framework to access data from multiple PDM systems, and to create a central repository. Such systems could, in the future, be standards compliant to support integration (Morris et al., 2005).

The application of PLM to life cycle issues results in a change of requirements for PLM education: emphasis is on the product development process rather than the product itself (Rangan et al., 2005). With the advent of PSS, the systemic implications of product development processes are now central aspects of design.

Existing PLM research is addressing the varied and complex needs of rapid system deployment, interoperability, integration, synchronisation, product modelling, through-life information management and feedback, and others. With reference to the developing PSS design challenge, the two key elements being developed during PSS design are the conceptualisation of the PSS itself and the supporting business model. Existing PLM frameworks will cope with varying degrees of success with system level design challenges. Many existing products that rely on PLM systems for their development are already complex systems, so the challenge is not to design a complex product. The challenge is to recognise that PSS design has a much broader scope than product design, and that

the ‘system’ must now incorporate the service delivery method. To use existing terminology, PSS design must include both product design and supply chain design. The authors’ assertion is that existing PLM models must be extended to take account of the PSS design challenge, since they are currently exclusively product focused.

#### 4. PLM STRUCTURE

The intention is to develop a generic data structure that can be applied to a variety of life cycle design problems. Since a key challenge in PSS design is the co-development of products, services and business models, a product centric structure is not appropriate: a broader focus is required. A combination of data structures and methods may be appropriate. The classes Product, Process and Resource (PPR) are frequently applied together as an upper level structure for both product- and software- development modelling purposes. A selection of applications will be described here, and the applicability to PSS design considered.

Maropoulos et al apply the PPR classes to a manufacturing planning problem: integrating design and manufacturing (Maropoulos et al., 2002). Chandra and Kamrani apply the PPR classes to a knowledge management framework to support product design in an extended enterprise scenario (Chandra & Kamrani 2003). In both cases, an extension required is the detailed descriptions of various additional processes (design,

manufacturing, maintenance). Huang and Mak describe the need to integrate PPR in the design (concurrent engineering) activity (Huang & Mak 1999). Product support, process support and integration of the two (activities consuming resources to realise products) are supported by their web-based DFX tool. In all cases, the application of PPR classes enables a range of activities and items to be described for the purpose of product design. The methods do not appear to support service or organisation design.

The original application of the three PPR classes appears to come from computer science. Norman Fenton made reference to them in his 1991 book “Software Metrics: A Rigorous Approach”. This is referenced by a later paper on software measurement (Fenton 1994). This view has been adopted in product development modelling, particularly since the introduction of product data management (PDM) systems and concurrent engineering. Concurrent engineering brought about the need to describe downstream activities (processes and resources) in order to optimise the product design. The computer systems used to store the range of varied data require a structured description of those various elements in terms that are easily transferred to a software system.

An upper level model that enables the description of a combined product and business system is proposed, as shown in figure 1.

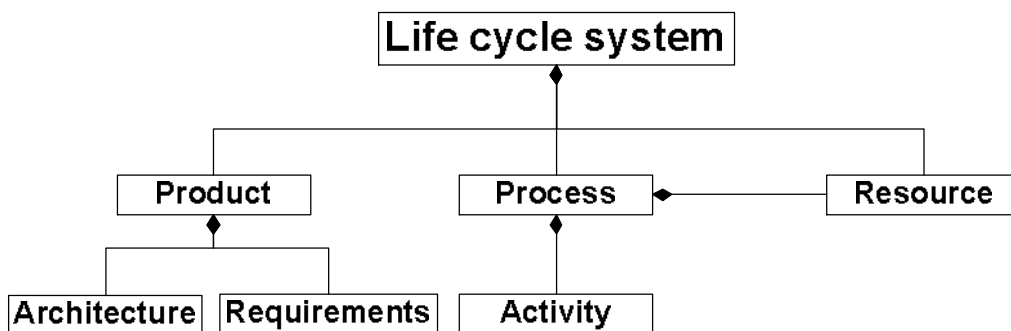

Figure 1: life cycle system structure

The class ‘life cycle system’ indicates that the system in question represents a combination of elements to describe any given life cycle activity. It is comprised of one or more classes, as necessary: product, process and resource. This enables the (static) description of product systems, i.e. an aircraft engine in flight. This example system is comprised of one or more products (the engines) plus a variety of supporting processes and resources: a refuelling supply chain, monitoring

systems, maintenance crews, technical support, and a variety of others.

The life cycle system structure also enables the description of organisational systems, i.e. an HR department. Resource systems can also be described, i.e. a fully equipped service facility. With the life cycle system view, any given step in a product life cycle can be described using common terms: conception, design, use, maintenance, disposal, and so on.

## 5. CASE STUDY

A case study was carried out with a leading manufacturer of vacuum pumps. This work is taking place as part of the project ‘Unification of design, manufacturing capability and service knowledge in new product development’ at Cranfield University. The aim of the project is to develop a methodology to capture, represent and reuse manufacturing engineering knowledge to support product development in a collaborative enterprise context. The developing research area of PSS has led to an interest in how this work might be extended to support PSS design.

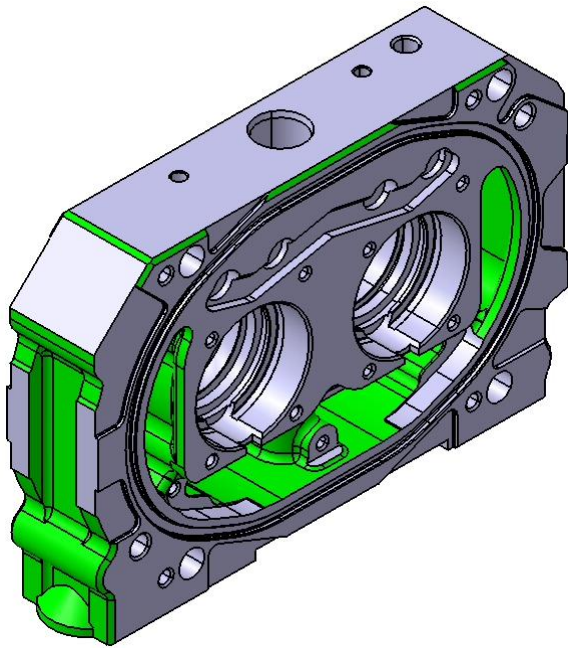

Figure 2: pump component used in detailed case study

The focus of the project is vacuum pump product development. An example component from the vacuum pump investigated in the detailed case study is shown in figure 2. This headplate component forms a key element of the product architecture, performing several system critical functions. The development of a design knowledge reuse model supporting the design of this component is described in previous work (Baxter et al., 2007a).

Three elements that contribute to collaborative product development were selected as focal areas: design, manufacturing and service. The research work to date has been investigating the knowledge applied within each of these areas in a product development context. The particular emphasis of this work is the application of the developed knowledge framework to PSS design.

A manufacturing knowledge framework was developed in earlier work (Baxter et al., 2007b). This framework made reference to a detailed knowledge capture exercise, in which manufacturing engineers described critical tasks. An analysis of the interview data led to the proposal of a manufacturing knowledge structure for product development support. The knowledge framework was combined with the manufacturing capability model (Young et al., 2007). An extended version of that framework is presented in figure 3. The knowledge structure is product centric, which is appropriate to a manufacturing view. It takes account of various product design aspects, since the purpose of the knowledge framework is product development support.

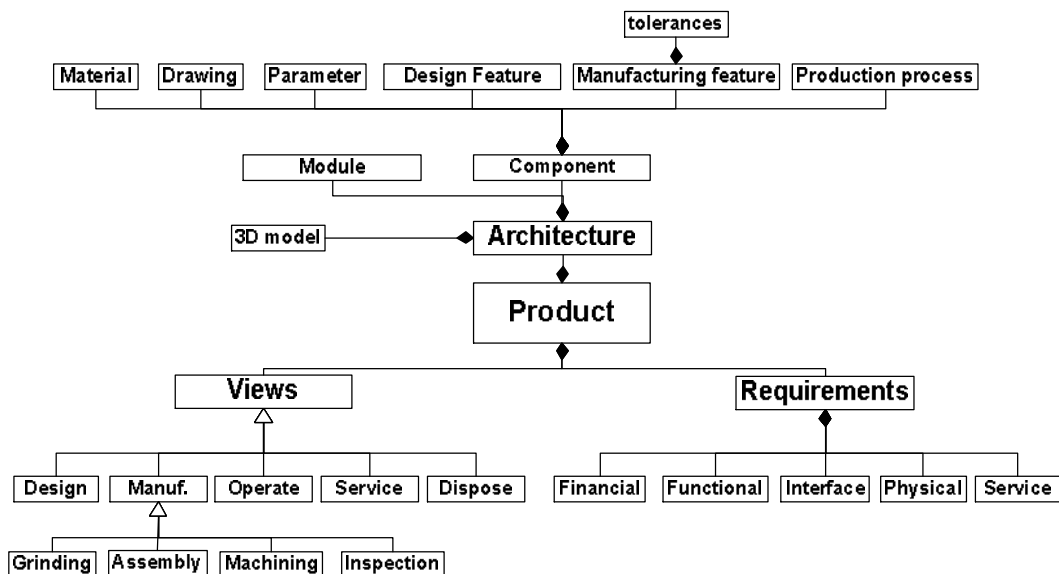

Figure 3: Manufacturing knowledge framework

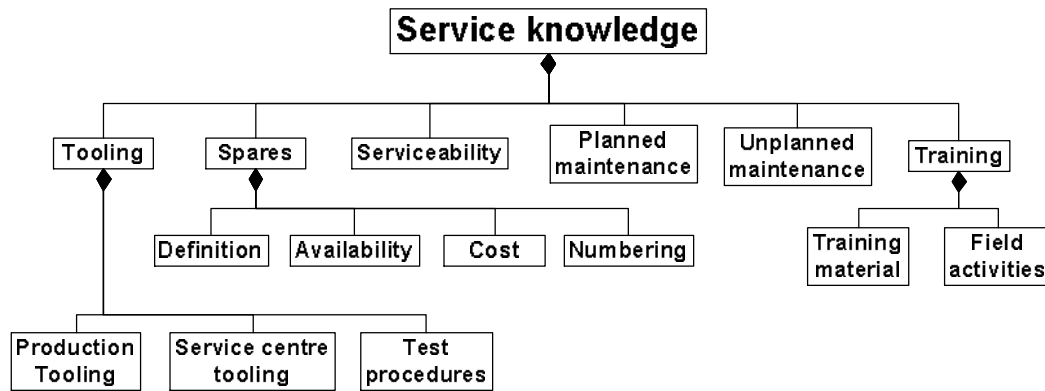

Figure 4: Service knowledge framework

A core component of PSS development is service. Service knowledge types applied in both product design and service operations were identified in earlier work (Doultsinou et al., 2007). Personnel were interviewed from a range of roles, including designers, project managers, service centre managers and service technicians. The interviews were analysed and a service knowledge framework was developed, as shown in figure 4.

The manufacturing and service knowledge frameworks were validated with the company through a series of interviews and workshops. The service knowledge structure was presented to the relevant personnel, and its validity for supporting the design and service operations discussed and verified. The manufacturing knowledge framework was implemented in a knowledge base using Protégé. The knowledge base was used to build examples of manufacturing knowledge that could be applied in product development projects. This enabled various scenarios to be demonstrated within a feature based design and manufacturing scenario, including: implementing a new component into manufacturing; manufacturing improvement projects; applying best practice machining methods; and tolerance definition. The validation of the

knowledge base showed that the different roles require different presentation of the manufacturing knowledge. For example, in a manufacturing engineering scenario a detailed machining process description in a tabular format could be usefully applied. The tolerance data required by design would not be accepted in that same format: designers would require a visual representation. As a result, an alternative representation was developed in the form of a component template drawing. One of the drawbacks of the Protégé knowledge base is the inability to deal with hypermedia. A PLM system, in contrast, is able to record a variety of media and data types, and maintain relationships with product structures. Since the relationships are based on the data objects and not 'products' per se, they can be formed between any logical entities. In the case of PSS design, relationships between products and services are required. As identified in the PSS research, changing business models as a result of PSS implementation must also be considered during design.

The proposal for a combined life cycle system model to support PSS design is shown in figure 5.

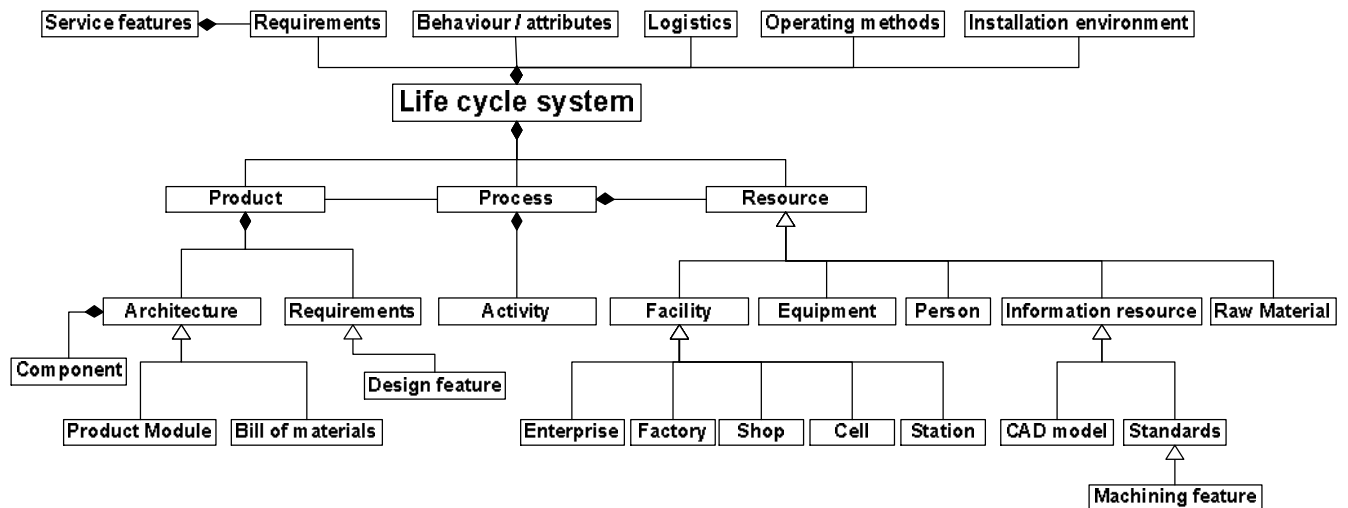

Figure 5: PSS design support framework for PLM

The proposed PSS knowledge framework for PLM support is different from the manufacturing and service knowledge frameworks in a variety of ways.

The manufacturing framework is product centric: the master view is the product. Product requirements, a variety of life cycle views, and a product architecture breakdown were all attributes of a product. This product focus is not suitable for a combined product and service development, since the service element remains peripheral; attached to a specific product. Result-oriented PSS business models are focused on the outcome of the product service combination. In such a scenario, it may be more appropriate to include that result as the central element. As a result, design features, tolerances and drawings are no longer directly associated with components. Design features are now associated with product requirements; distinct from the architecture. Machining features are now associated with standards; a subclass of the information resource class. In practice, tolerances are associated with the product architecture via the CAD model. The CAD model is now represented as an information resource. Product views are now reflected by the central element: the life cycle system. Where product focused views may confuse the description of combined service, disposal or manufacturing objects the focus on the system enables all of the associated views to share information within the life cycle context of a PSS.

The original service knowledge framework is not product focused, so there are no problems with sharing data relating to a single service but multiple products. However, the previous framework is also not 'service' or 'system' focused: it is lacking a use case, such as the design of a product, service, or

PSS. As such, it does not support the definition of relationships between service knowledge and products, since 'product' is not part of the structure. Aside from the integration with the product focused manufacturing framework, various semantic changes have taken place. 'Tooling' has become merged into the more general 'equipment' class. 'Test procedures' will now be described using the more general 'process' class, with relationships to any resources used. Spares (spare parts) are something of an anomaly. In one sense, spares are simply components: in the PLM structure, part of the bill of materials. In another sense, 'spare' is a designation given to a component or group of components: not all components are available as spares, and some components are sold as part of a spares kit. In the combined PSS framework, the bill of materials should be used to describe spare parts and spares kits.

The proposed framework enables a description of any given system within a PSS life cycle, in order to support PSS design.

## 6. APPLICATION

The PSS design support framework has been implemented using the Protégé knowledge base editor tool. The knowledge base enables the description of product architecture, components, requirements, manufacturing processes, service processes, facilities, and equipment. A detailed case study has been implemented, describing a vacuum pump from design, manufacturing and service perspectives.

An example process, the service process for a particular vacuum pump, is shown in figure 6.



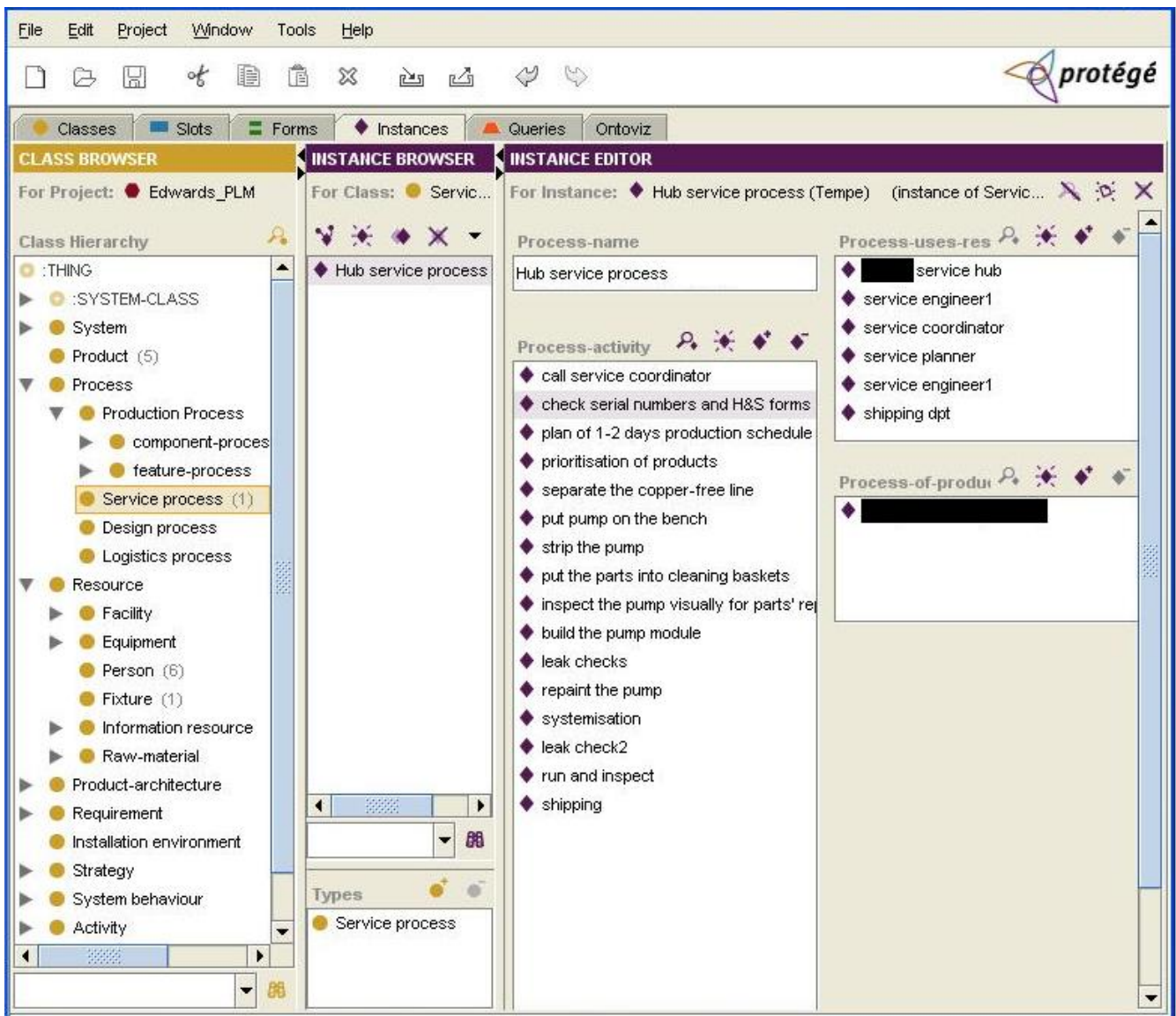

Figure 6: example service process implemented in the Protégé system

The detailed class structure will not be presented, since several classes have been added that are company specific. A top level structure showing relationships between some of the classes is shown in figure 7. All subclasses and several top level classes (including the 'system' class), are omitted in order to reduce the size and complexity of the diagram. The diagram demonstrates the relationships that have been created between the

various classes: instance relations between classes. This is a key mechanism that enables the Protégé knowledge base to show relationships between classes. In the process example shown in figure 6, product, resource and activity are all examples of instances of other classes. Those instance relations can be seen in figure 7, for example 'product-process' / 'process-of-product'.



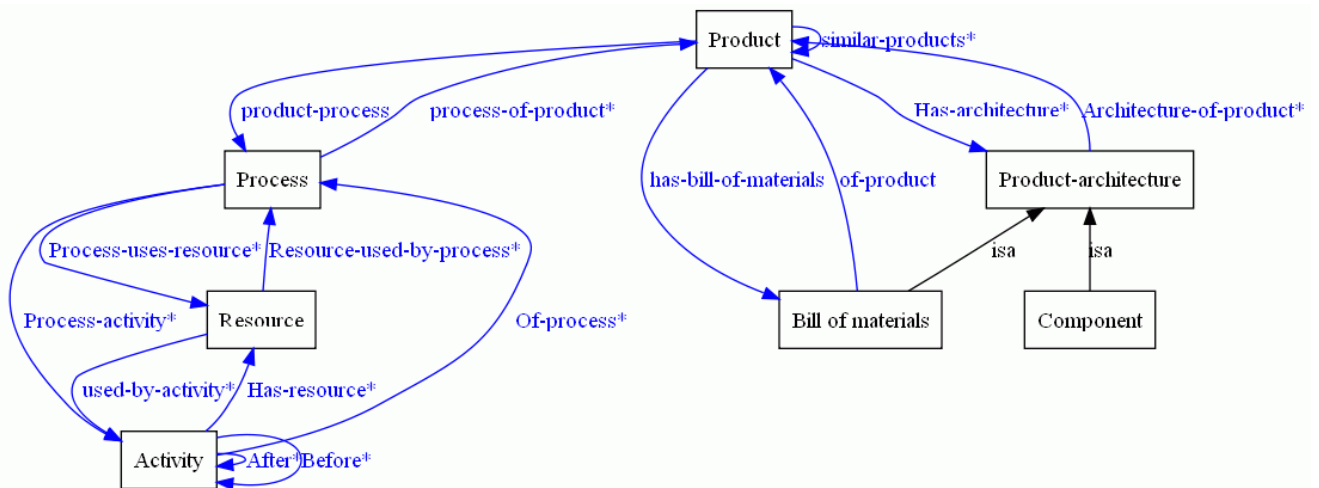

Figure 7: top level class structure of Protégé implementation

## 7. FURTHER WORK

The next step in the project is to apply the knowledge base structure and content to a PLM implementation. Various future research challenges exist in applying the PSS structure to a PLM system, including:

- Translation from a simple knowledge base object model to a full hypermedia-support PLM system
- Application of the framework within a PSS design methodology
- Application of standardisation: reference model ontology vs. flexible application
- Coordination and management of the model elements during a design project

A PLM system has a variety of object types, including a range of hypermedia objects, plus forms and other data sets, whereas the Protégé system has a limited range of data types (string, Boolean, etc.). As such, the translation from one to another requires various decisions to be taken. It is the intention to define a set of rules to support this conversion process.

Applying the system structure to a true PSS design, rather than the current 'product plus service' case study, will bring new challenges. This remains an area for future research: how well does the system focused view apply to a practical implementation of a PSS design project?

PLM practitioners have suggested that a reference model would support both implementation and interoperability. In the special case of PSS, an area for further research is to determine whether such a reference model is appropriate, and if so at what level.

Coordination of the model elements during a design project remains an issue for PLM research: it is not limited to PSS data structures.

## 8. CONCLUSIONS

This paper investigated the requirements of PSS design. These requirements were considered in light of existing PLM research. The research suggests that PSS design must include both product design and supply chain design. Existing PLM models must be extended to take account of the PSS design challenge, since they are currently product focused. A proposal was made in which the central element of the PLM data architecture is the 'Life Cycle System'. This system, it is argued, can be applied to the co-development of products, services and business models.

Various challenges remain, however the rapidly developing PSS research field and its developing scope in the hands of management science, manufacturing, and engineering scholars means the future is bright for PSS.

## 9. ACKNOWLEDGMENTS

The authors would like to acknowledge the support of the EPSRC through Cranfield IMRC, and Edwards Vacuum Ltd. The contribution from the other members of the Decision Engineering Centre at Cranfield University is also acknowledged.

## REFERENCES

- Aurich, J., Fuchs, C. & DeVries, M. "An Approach to Life Cycle Oriented Technical Service Design", CIRP Annals - Manufacturing Technology, 53 (1), 2004, pp 151-154.
- Aurich, J., Fuchs, C. & Wagenknecht, C. "Life cycle oriented design of technical Product-Service Systems", Journal of Cleaner Production, 14 (17), 2006, pp 1480-1494.
- Baines, T., Lightfoot, H., Evans, S., Neely, A., Greenough, R., Peppard, J., Roy, R., Shehab, E.,

- Braganza, A., Tiwari, A., Alcock, J., Angus, J., Bastl, M., Cousens, A., Irving, P., Johnson, M., Kingston, J., Lockett, H. & Martinez, V. "State-of-the-art in product-service systems", Proceedings of the Institution of Mechanical Engineers, Part B: Journal of Engineering Manufacture, 221 (10), 2008, pp 1543-1552.
- Baxter, D., Gao, J., Case, K., Harding, J., Young, R., Cochrane, S. & Dani, S. "An Engineering Design Knowledge Reuse Methodology Using Process Modelling", Research in Engineering Design, 18 (1), 2007a, pp37-48.
- Baxter, D., Roy, R. & Gao, J. "Specifying a manufacturing knowledge reuse framework", In: 4th International Conference on Digital Engineering Technology (DET 2007), Bath University, UK, September 17-20th 2007b, pp 372-379
- Chandra, C. & Kamrani, A. "Knowledge management for consumer-focused product design", Journal of Intelligent Manufacturing, 14 (6), 2003, pp 557-580.
- Doultinou, N., Roy, R., Baxter, D. & Gao, J. "Identification of Service Knowledge Types for Technical Product-Service Systems", In: 4th International Conference on Digital Engineering Technology (DET 2007), Bath University, UK, September 17-20th 2007, pp 549-555
- Fenton, N. "Software Measurement: A Necessary Scientific Basis", IEEE Transactions on Software Engineering, 20 (3), 1994, pp 199-206.
- Gao, J., Aziz, H., Maropoulos, P. & Cheung, W. "Application of product data management technologies for enterprise integration", International Journal of Computer Integrated Manufacturing, 16 (7), 2003, pp 491-500.
- Huang, G. & Mak, K. "Design for manufacture and assembly on the Internet", Computers in Industry, 38 (1), 1999, pp 17-30.
- Kiritsis, D., Bufardi, A. & Xirouchakis, P. "Research issues on product lifecycle management and information tracking using smart embedded systems", Advanced Engineering Informatics, 17 (3-4), 2003, pp 189-202.
- Maropoulos, P., McKay, K. & Bramall, D. "Resource-Aware Aggregate Planning for the Distributed Manufacturing Enterprise", CIRP Annals - Manufacturing Technology, 51 (1), 2002, pp 363-366.
- Mont, A. & Tukker, A. "Product-Service Systems: reviewing achievements and refining the research agenda", Journal of Cleaner Production, 14 (17), 2006, pp 1451-1454.
- Morelli, N. "Designing Product/Service Systems: A Methodological Exploration", Design Issues, 18 (3), 2002, pp 3-17.
- Morris, H., Lee, S., Shan, E. & Zeng, S. "Information Integration Framework For Product Life-Cycle Management of Diverse Data", Journal of Computing and Information Science in Engineering, 4, 2005, pp 352-358.
- Rangan, R.M., Rohde, S.M., Peak, R., Chadha, B. & Bliznakov, P. "Streamlining Product Lifecycle Processes: A Survey of Product Lifecycle Management Implementations, Directions, and Challenges", Journal of Computing and Information Science in Engineering, 5, 2005, pp 227-237.
- Sakao, T. & Shimomura, Y. "Service Engineering: a novel engineering discipline for producers to increase value combining service and product", Journal of Cleaner Production, 15 (6), 2007, pp 590-604.
- Sudarsan, R., Fenves, S.J., Sriram, R.D. & Wang, F. "A product information modeling framework for product lifecycle management", Computer-Aided Design, 37 (13), 2005, pp 1399-1411.
- Tukker, A. & Tischner, U. "Product-services as a research field: past, present and future. Reflections from a decade of research", Journal of Cleaner Production, 14 (17), 2006, pp 1552-1556.
- Ulwick, A. "What Customers Want: Using Outcome-Driven Innovation to Create Breakthrough Products and Services" McGraw-Hill, 2005
- Weber, C., Werner, H. & Deubel, T. "A different view on Product Data Management/Product Life-Cycle Management and its future potentials", Journal of Engineering Design, 14 (4), 2003, pp 447-464.
- Young, R.I.M., Gunendran, A.G., Cutting-Decelle, A.F. & Gruninger, M. "Manufacturing knowledge sharing in PLM: a progression towards the use of heavy weight ontologies", International Journal of Production Research, 45 (7), 2007, pp 1505-1519.ref\_end