

Taylor University

Pillars at Taylor University

Student Scholarship: Chemistry

Chemistry and Biochemistry

Fall 2019

It's Elementary: A Review of Forensic Analysis Techniques of Inorganic Components of Explosives

Sadie Schultz

Follow this and additional works at: <https://pillars.taylor.edu/chemistry-student>

 Part of the [Analytical Chemistry Commons](#), [Inorganic Chemistry Commons](#), [Organic Chemistry Commons](#), [Other Chemistry Commons](#), and the [Physical Chemistry Commons](#)

It's Elementary: A Review of Forensic Analysis Techniques of Inorganic Components of Explosives

Compiled by Sadie Schultz

Introduction

It's elementary, solving cases, catching the bad guy. There are always the right tools available to solve the crime brilliantly, in the last quarter of the episode just in time to nab the bad guy. While Sherlock Holmes and other mystery shows are incredibly entertaining to watch and do have some basis in reality, they do not explain exactly what forensics looks like. What we are able to detect and identify plays a large role in the crimes being solved. This is particularly true of bomb investigations.

Holmes seemed to have all the right tools at any given moment to solve the case. We do have some excellent tools, but there are quite a few factors to consider. There are many species to test for, for example, in bombing crime scenes. Explosives can be

made from organic or inorganic species.

These two species can require very different testing methods depending on their physical properties. It makes sense that there are many tools developed to test for these different species, but unlike Sherlock, we might not always have the perfect test. At a crime scene, we do not always know what we are looking for and the bomb residue is very sparse. This requires a very sensitive instrument that can detect a wide variety of samples. Ideally, this analysis can either take place at the crime scene and as soon as possible after the explosion. Police can only do so much to contain and preserve a crime.

Terrorism and crimes involving explosives are very time sensitive and important to investigate. Explosives can cause extensive damage and result in significant loss of life and/or serious

injuries. Hence, there is considerable effort put into learning more about these crimes.

First, what type of bomb was used? Where was it from? For example, if the investigator found that the bomb was made out of ammonium nitrate from a certain manufacturer, they could track this information back to the perpetrator.

However, there is great difficulty in studying explosives, especially once they have...exploded. Oftentimes, there are only trace amounts of residue left from the bomb.

Bombs consist of rapidly expanding gas which consists of a great deal of force.¹ Therefore, specialized equipment needs to be developed to analyze these samples quickly and specifically. Ammonium nitrate is a very common component used in explosives since it can be obtained from fertilizer.² Explosives that are made from common, easy to procure components are called improvised explosive devices.³ IEDs

are generally comprised of inorganic oxidizers and fuels.

This analysis of post blast residue can be performed in addition to recovered fragments of the bomb if they were able to be recovered.⁴ Parts of the bomb casing can be very helpful in determining its origin however, that might not always be possible. Therefore, trace analysis is very important.

Overall, there are many techniques that have been developed to study inorganic explosive residues. I have not addressed organic residues though they do comprise a significant portion of explosives. Some of the inorganic analysis techniques can also be used to analyze organic residues as well. One of the main reasons that techniques for investigating inorganic explosives are being investigated is the ease with which the components can be obtained and used.

At a crime scene post-blast analysis is the main path open to investigators.⁵ The development of techniques to study residues

left over from a blast requires bombs to be placed and detonated. Then samples can be taken in the same manner as they would in an active crime scene.

Explosives can be analyzed at different times depending on the investigation, before they explode (pre-blast) or more commonly, after they explode (post-blast).⁴ “Chemical explosive[s] [are] classified as low or high explosives according to their rates of decomposition.” Low explosives are not quite as powerful as high explosives and commonly called a propellant like gunpowder¹. High explosives require a detonator which sets off a smaller explosion to trigger the larger blast.

I should note that I am not discussing gunshot residue, even though there are inorganic components of the cartridge’s discharge. Guns use similar propellants and fuel such as nitrates⁶ but I am referencing inorganic explosives.

Post-blast residue can be found in very small quantities on cloth, soil, rocks and water⁴. Time could be a very big factor in detecting these samples,. If a particular instrument is portable, it will be used at the crime scene to preserve the samples.

Otherwise, samples will be collected and analyzed back at a lab. Swabbing is a very common method to collect residue from hard surfaces. Generally, sand and soil are some of the most difficult samples to extract. Interestingly, studies found that the amount of residue was not correlated to distance from the blast. In other words, the amount of residue found near the blast was the same as farther away within the blast radius.

I will be using specific reports of different methods of detection, and while this is by no means exhaustive, there are still quite a few techniques to review. I will examine their specific applications and overall usefulness in the forensic lab and

crime scenes. Some seem to be better than others, but most were designed for a specific purpose within forensic science. Many of them are actually combined techniques, like the traditional gas chromatography matched with mass spectrometry. The integration of these techniques will be discussed.

Injection Capillary Electrophoresis and Contactless Conductivity Detection

For this study, the authors focused on the anions of common explosive components separated by capillary electrophoresis (CE).³ They cite past studies where it was found to be an effective way of distinguishing ions. Electrophoresis uses voltage to separate species. Contactless Conductivity Detection is a specific detector for ions without directly touching them. The authors used real residue from an explosive for their samples. They point this out at the time (2011) and provide their background ion data since not much of this has been

studied yet. The authors here created a portable bench top method to analyze a great variety of explosive ions. It is also fast (60-90 seconds) which qualifies it as a viable option for onsite analysis.

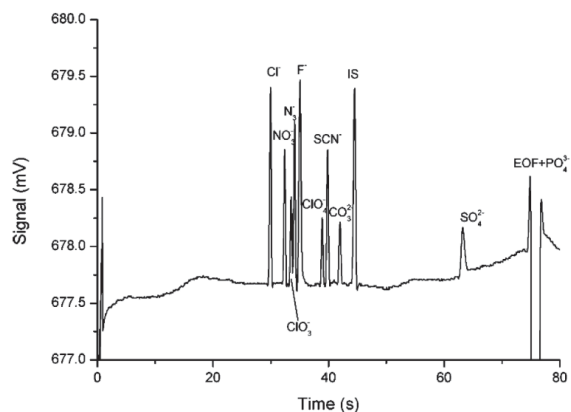

Spectrum from the capacitively coupled contactless conductivity detector (C⁴D).³

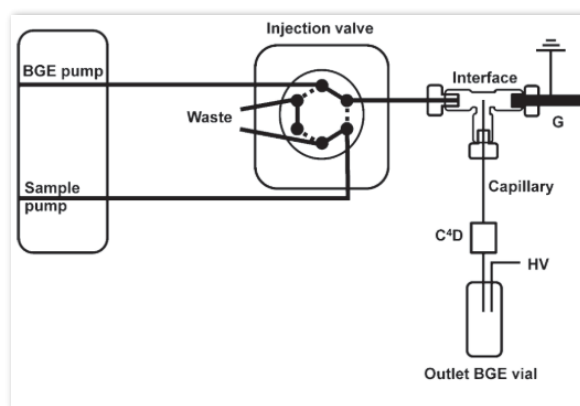

Schematic of the CE instrument.

The injection valve allows the seamless transition of sample into the pump system. The sample then flows through the interface and enters the high voltage (HV) field. The detector is situated further down. The sample then flows into a vial of background electrolyte solution.

This instrument has acceptable resolution for detecting ions and requires some sample prep including ultrasonication. At the time of the article, this instrument is benchtop portable.

Raman and Laser Induced Breakdown Spectroscopy

Raman spectroscopy uses monochromatic light to excite and then measure the energy scattered back.⁷ In this paper “All studies described were performed indoor using a partially open corridor providing a firing range up to 50 m long.”⁸ The researchers simply point their beam at the surface they are analyzing, up to 50

meters away. It is basically a laser gun to point at the post blast surfaces. It appears to be decently portable compared to traditional instruments according to the picture. Note that this apparatus is on wheels. They were able to optimize the procedure to only detect Raman energy and not the source fluorescence. These authors determined that for reasonable signal to noise ratio that one would need to take spectra ten times on each sample. Interestingly, Goma2-ECO, a Spanish denominated dynamite class high explosive mainly composed of ammonium nitrate, nitroglycol, and dinitrotoluene, can be distinguished from a sample of just ammonium nitrate using this method. As we know very well, science is not all about coming up with the perfect solution, it is coming up with a solution and refining it over time, especially as the technology improves. These authors definitely had the right idea. They tried combining two and then optimizing two methods for a specific

application and it might be useful in a certain situation.

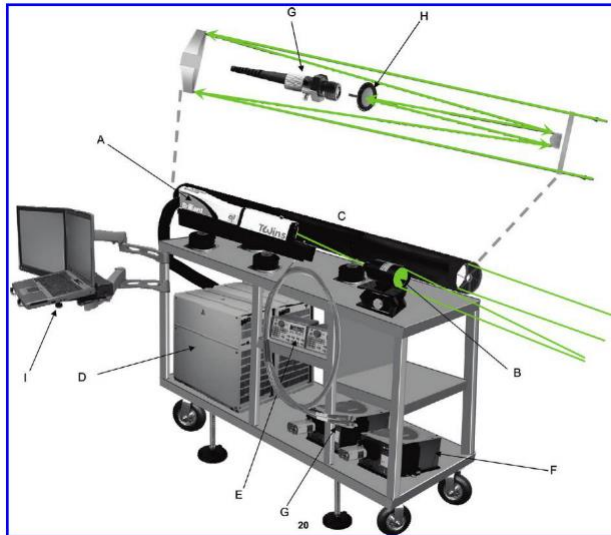

This figure shows the instrument setup.⁸ The laser and detector are mounted on the cart with the computer. The green arrows show the light path from the laser, through the instrument and to the detector.

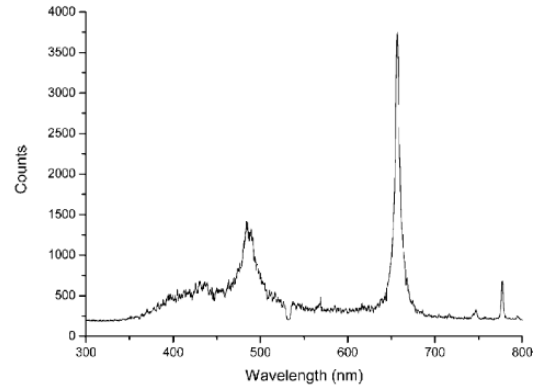
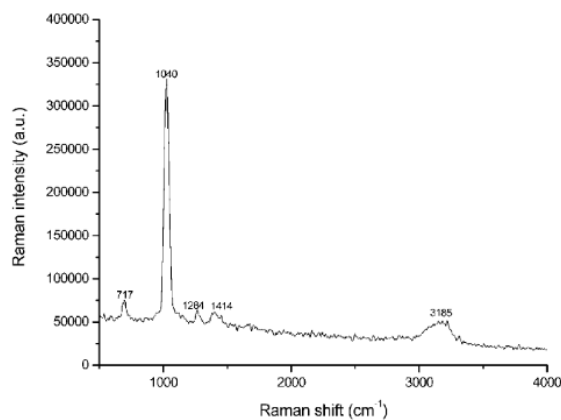

These spectra show the Raman/LIBS readout for an ammonium nitrate sample.⁸ This instrument is capable of collecting Raman and LIBS spectra in a few minutes or less.

Mass spectrometry

A large number of the techniques I found used some form of mass spectrometry. I will briefly outline that process here, although not all instruments use the same mass spectrometers.

Mass spectrometry attaches charges to molecules in the gas state, separates ions based on mass, and determines the molecular mass of the sample. There are a variety of ways to vaporize and attach the charges depending on the sample. Electron

ionization (EI) shoots electrons at the gaseous molecule, which knocks off an electron and causes bonds to fracture into ions. This technique is usually used for small molecules and only attaches one charge to each fragment. Electrospray ionization (ESI) uses high voltage to add charge to an intact molecule. This technique can add multiple charges to the molecule.

Laser electrospray

The purpose of Laser Electrospray Mass Spectroscopy (LEMS) is to provide a quick analysis with no sample preparation for inorganic compounds. The laser is used to vaporize the explosive's components while the electrospray can ionize them for the mass spectrometer to detect. In this particular study, the authors found and detected anions, cations and neutral species.⁹ Neutral species were detected by adding spectator ions (like Na⁺). It is important to note that LEMS is not as sensitive as ion

chromatography (IC) and capillary electrophoresis (CE) but its preparation is easy and only one instrument is required. The authors acknowledge the difficulty with contaminant ions because samples are taken from many different kinds of surfaces. They even looked at the difference between pre blast and post blast peaks. The main difference was an increase in concentration of nitrate and potassium in pre blast samples.

inorganic ion IED	training set size	samples	
		correctly characterized	percentage
chlorate, perchlorate, sugar	6	23/24	96%
ammonium nitrate	6	24/24	100%
preblast black powder (actual)	6	24/24	100%
postblast black powder (simulated)	6	24/24	100%
total	24	95/96	99%

Summary table of correctly identified species.⁹

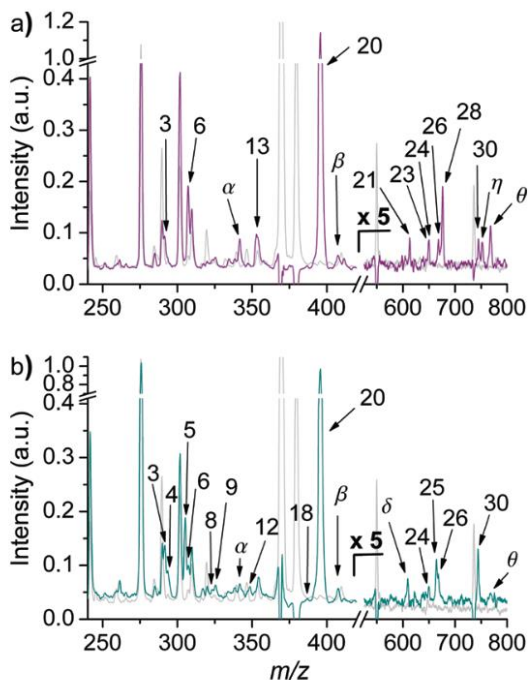

The top spectrum is from pre blast samples while the bottom is from post blast.⁹ The gray lines are background radiation. The numbers correspond to a table the authors compiled to more quickly determine the identity of the peaks.

Infrared Thermal Desorption-Direct Analysis in Real Time Mass Spectrometry

Forbes, et al show their new combination of Direct Analysis in Real Time Mass Spectrometer (DART-MS) and

Infrared Thermal Desorption (IRTD) is a viable test method for inorganic and organic explosive components. Stock solutions of organic and inorganic explosives were purchased and deposited on wipes which can be directly inserted into the instrument. The instrument that Forbes, et al used to analyze these explosives is made up of three main parts: an infrared thermal desorption unit, a direct analysis in real time unit, and mass spectrometer which has already been discussed. We will examine these instruments one at a time and discuss the benefit of integration.

The infrared thermal desorption unit (a) converts samples (specifically water and organic components) into volatiles by using vapor pressure and infrared heat, basically, a very efficient form of thermal desorption.¹¹ Thermal desorption seems to be mainly used to treat soil by volatilizing the molecules in the soil.¹² It can heat the samples in a few seconds to avoid decomposition.¹³

Direct Analysis in Real Time Mass Spectrometry (DART) is basically a really fast mass spectrometer (b).¹⁴ It uses time of flight measurement, which sends the ionized molecules in a tube under vacuum to the detector. It ionizes the samples with a plasma torch and separates them out into long lasting ions. The plasma could be made up of excited helium, neon or nitrogen. This helps release the sample from the surface (desorption). This method is nearly instantaneous. The authors point out that DART can also avoid decomposition since it heats up quickly and allows for desorption at a lower temp.¹³ The MS is an electrospray ionization mass spectrometer. The mass spectrometer of this particular instrument consists of a quadrupole and a time of flight analyzer. The quadrupole has four cylindrical electrodes that create a field to direct the ions toward the detector.¹⁵ The flight analyzer measures the time it takes an ion to travel a certain distance to the

detector.¹⁶ From this, the software can determine the mass to charge ratio.

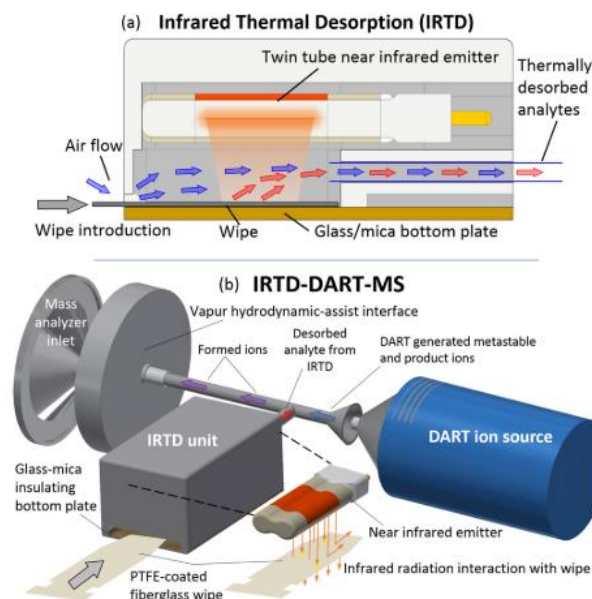

Schematic of IRTD-DART-MS.¹⁷

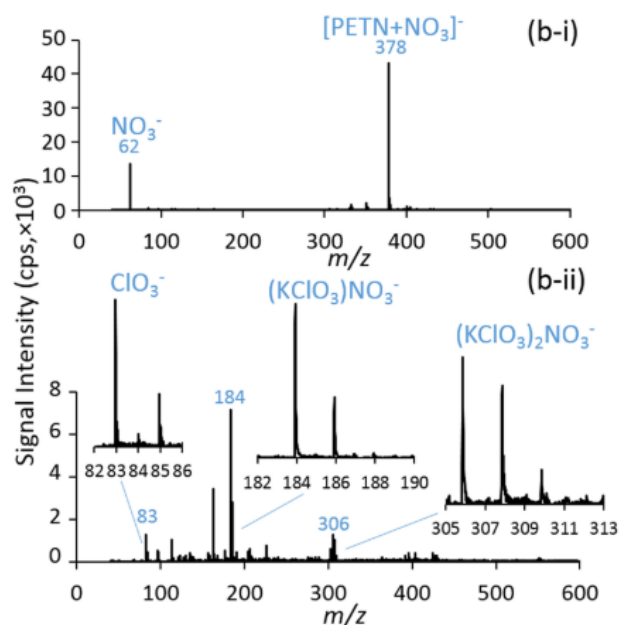

Example mass spectra of potassium chlorate and pentaerythritol tetranitrate.¹⁷

compd	ion obsd	m/z	mass (ng)	S/N ^{tb}
Inorganic Oxidizers				
PC	(KClO ₃)NO ₃ ⁻	184	10	7 ± 3
PPC	(KClO ₄)NO ₃ ⁻	200	5	5 ± 2
AN	(HNO ₃)NO ₃ ⁻	125	10	8 ± 3
CAN	(HNO ₃)NO ₃ ⁻	125	10	4 ± 2
Organic Explosives				
RDX	[M + NO ₃] ⁻	284	0.05	6 ± 2
Tetryl	[M - NO ₂] ⁻	241	0.2	5 ± 1
PETN	[M + NO ₃] ⁻	378	0.1	9 ± 3
HMTD	[M + H] ⁺	209	20	9 ± 3

This table shows the compounds tested in this study.¹⁷ Their molecular mass peak is shown as well as the mass tested and signal to noise ratio.

This technique allows for the analysis of the full compound in some cases instead of its ions which is more useful when identifying the specific compound unlike other methods. A unique aspect of DART was the ability to watch the sample droplet vaporize within the instrument to confirm atomization of the samples. The internal temperature was also monitored

which assisted in optimization of the instrument.

DART-MS using High Temperature

Thermal Desorption

The Joule Heating Thermal

Desorption, Direct Analysis in Real Time

Mass Spectrometer (JHTD-DART-MS)

requires its samples to be volatilized for detection. Thermal desorption's heat source is a looped nichrome wire which can generate about 750 degrees C.¹⁰ This assists the DART source in maintaining the samples at high temperature. This also includes a time of-flight detector. The authors performed a designing of experiments to optimize five factors. They mention the problem with vaporizing chlorate and perchlorate due to their high boiling points. Their solution was to quickly heat the sample by the JHTD unit. Overall, DART's heating was used first then JHTD starts rapid heating. The system is relatively

quick. “The transient heating ramp generated in the JHTD allowed for the efficient sequential desorption of volatile and non-volatile[s] compound at their respective optimal temperatures without excess degradation, decomposition, and fragmentation, an aspect vital to sensitive detection of complex mixtures, homemade explosives, and improvised explosives devices.”

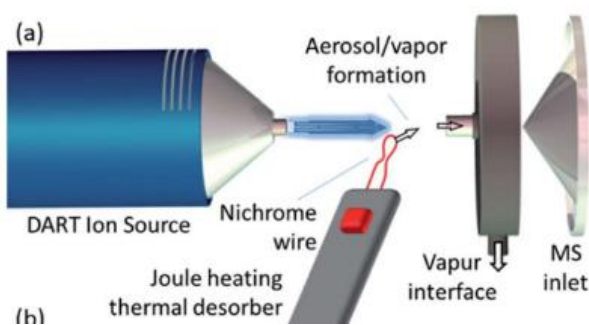

Schematic of DART-MS.¹⁰ The sample is heated by the JHTD and ionized by the DART unit. Then the sample is sent to the MS.

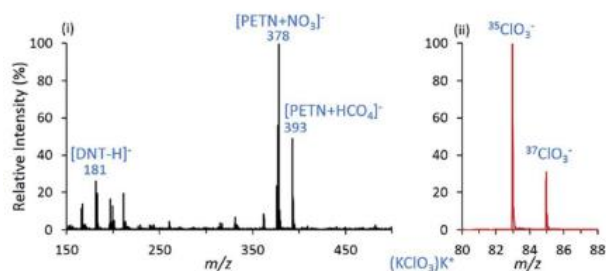

Spectrum of dinitrotoluene (DNT), potassium chlorate (PC), and pentaerythritol tetranitrate (PETN) in negative mode.¹⁰

Transmission Mode Desorption

Electrospray Ionization

Desorption Electrospray Ionization (DESI) is similar to DART. Ions are sprayed on the sample and then detected from above the sample.¹⁸ The heights and angles of the detectors are all customizable. Transmission mode (TM) is where the beam/sample is transferred through a specific mesh which mounts the sample. The MS source is ESI.

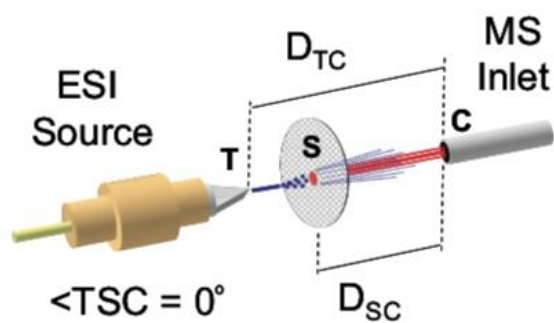

The ESI provides charge to the samples on the mesh.¹⁸ Then the samples are sent to the mass spectrometer.

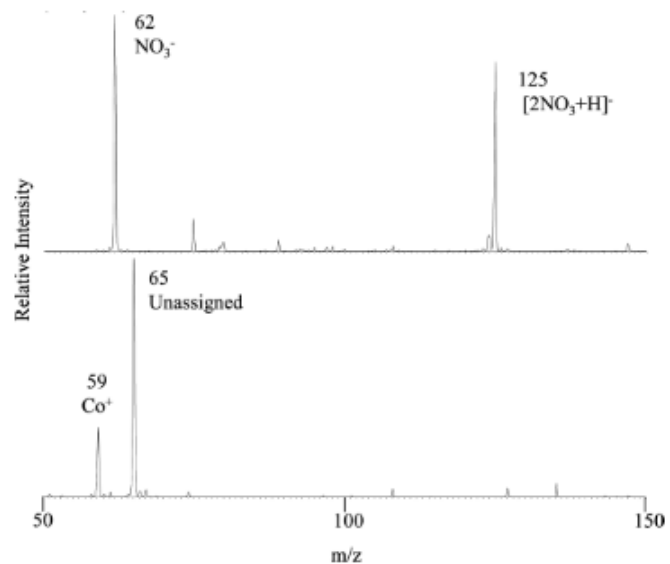

Spectrum of ammonium nitrate sample spiked with cobalt to test if contaminated ammonium nitrate ions could still be distinguished in the spectrum.¹⁹

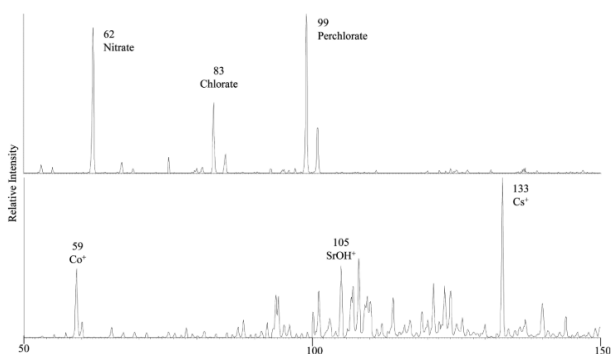

Spectrum of mixture of SrCl_2 , CoCl_2 , CsCl_2 , NaClO_4 , NaClO_3 , and NH_4NO_3 .¹⁹ Negative mode on top, positive on bottom.

Again, the principal use of the TM-DESI is to provide accurate, specific results in one machine for quick analysis. In this study, the authors were looking at radiological dispersion devices (RDDs or dirty bombs).¹⁹ These devices have organic and inorganic components as well as isotopic uniqueness that could be critical in determining the type of explosive used.

DESI is more of a surface analyzer. The TM allows the samples to be placed on a mesh and then directly analyzed. Not much sample prep is required except for a simple extraction. This study did not use the radioactive isotopes for safety but studied the stable forms instead. They used swabs and in cesium's case, explosions to simulate realistic sampling conditions and low concentrations. Their data was not as precise or as accurate as isotope ratio mass spectrometry which will be discussed later. but TM-DESI is considerably more portable than isotope ratio mass spectrometry instrument. The authors recommend using internal standards to assist in determining radionuclide ratios. Oxidizer ratios can be determined using this method. Black powder could not be identified directly but the amount of ascorbic acid present could be used to identify the manufacturer. According to the authors, in an effort to make this method even more efficient, they tested the

mesh as a swab on a variety of surfaces. They said this was successful, specifically when testing post detonation residue of cesium in conjunction with a common perchlorate and aluminum explosive. The authors used actual residue from an explosion. They discovered that the samples needed to be simply extracted to yield acceptable results.

Isotope Ratio Mass Spectrometry

Isotope Ratio Mass Spectrometry (IRMS) seems to have a more specific application to analyze ammonium nitrate. In this study, the authors looked at ammonium nitrate, specifically nitrate to study the isotopic differences between different batches. This also included also high density and low density samples.^{2,20} Depending on how the nitrate is processed, different isotopic ratios are formed. First, they separated nitrate from ammonium by precipitating it out with KOH in the form of

KNO_3 . They confirmed separation by comparing it to another KNO_3 , made it had a different isotopic ratio. After this, they used an elemental combustion system (ECS)²¹ elemental analyzer coupled with isotope ratio mass spectrometer via a Conflux IV interface. An elemental analyzer uses a furnace to decompose the samples into N_2 .²¹ Standards were analyzed as well to determine ratios. The high temperature conversion elemental analyzer (HTC) is made to analyze oxygen. N_2 had to be removed from these samples by a helium solution. Oxygen was analyzed in the form of CO. Prepping of these samples takes about a day with drying overnight. Both of these were coupled with the IRMS. Out of 26 samples, the authors were able to determine, through different the ratios of N_2 and O_2 between the two batches, one made in June, one made in November. This sample prep takes much more time and does not seem to be portable. However, in this

case the specificity is impressive. They did only test samples from one company. The authors suggest this method could be used to characterize brand types. Considering they were able to detect variation within product lines, it seems possible, depending on the variations between brands. A characterization table could be collected to speed the identification process. Speed is key since this could help identify the perpetrator. The authors suggest isotopic analysis of nitrate with NH_4^+ to further increase the specificity since they only analyzed the nitrate component of ammonium nitrate.

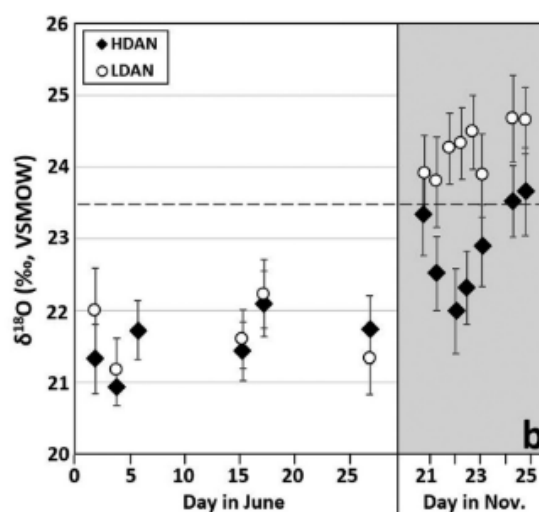

This graph shows the isotope ratio for oxygen.² High density ammonium nitrate (HDAN) and low density ammonium nitrate (LDAN).

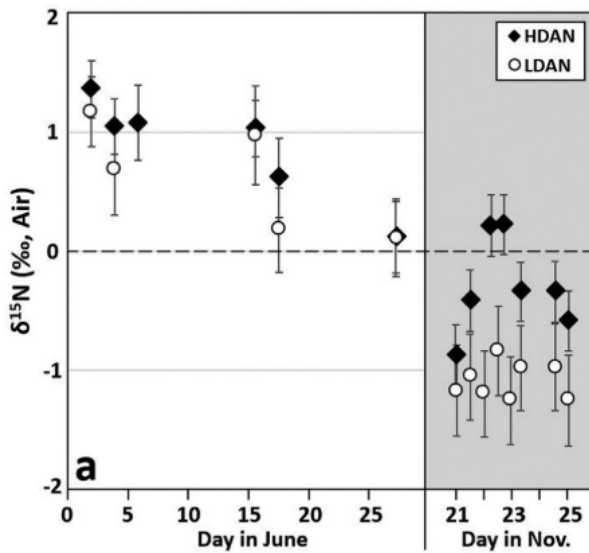

This graph shows the nitrogen isotope mass ratio of the June and November batch of ammonium nitrate.² The authors were able to differentiate them.

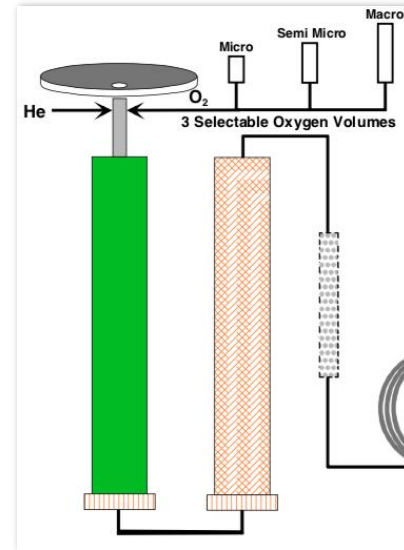

This is an example of the ECS section of the instrument.²¹ The helium carries the sample through the instrument. The colored tubes are where the heating occurs.

The sample is decomposed into gases in the tubes. The gases are separated and compared to reference isotope ratios.

Atmospheric Flow Tube–Mass Spectrometry

According to the authors, ion mobility spectrometry has been used routinely for detecting organic explosives.²²

In this study they look at analyzing inorganics. As we have seen before, this requires high temperatures which is difficult to obtain without decomposition. Their custom instrument is pictured below.²³ First the sample is vaporized by thermal desorption. The tube is called an atmospheric flow tube. It ionizes the samples after they are converted into vapor. It is paired with a mass spectrometer at the end to detect the different ions created. The MS contains a triple quadrupole. This is similar to DART except for the orientation of the sample and ionization source. The full method is called an atmospheric flow tube-mass spectrometry (AFT-MS). To increase volatility, they converted some species into a more acidic form, such as KClO_3 . They were able to detect it on nanogram and picogram levels. Using the acid, they were able to conduct these experiments at room temperature.

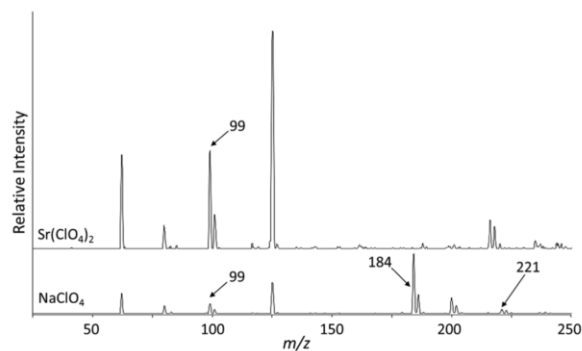
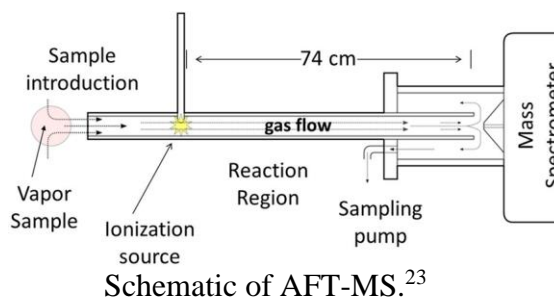

This mass spectrum is of NaClO_4 and $\text{Sr}(\text{ClO}_4)_2$.²² The parent peak of the perchlorate ion is present as well as the nitrate.

Conclusion

Many instruments and techniques are available for detecting inorganic explosives. Capillary electrophoresis is useful for separating ions. Raman and Laser induced breakdown spectroscopy is by far the most portable instrument. IRTD-DART-MS is fast and able to detect explosives at

approximately 10 nanograms. JHTD-DART-MS functions similarly to IRTD-DART-MS and had similar sensitivity. Isotope ratio mass spectrometry is not used to identify types of explosives, but it can differentiate between batches of ammonium nitrate.

Atmospheric Flow Tube–Mass Spectrometry is similar to DART and TM but the samples need to be converted to a more acidic form for volatility.

Forensics is a field dedicated to assist law enforcement and the government in determining the truth at crime scenes. This could mean the difference between freedom and imprisonment for one person or could determine the national security for a country. However, while this field has great importance, there does not seem to be an overwhelming amount of current research in this field. It was not difficult, but it took some digging to find studies completed in the past few years. I am encouraged by these few, and I am excited by what the authors

suggest might be in store for the detection of explosive material, to become faster, more sensitive and more portable, because at the end of the day, it is about protecting people, specifically when it comes to accessible homemade explosive components.

It is also beneficial to track what explosives are being used, and although this review is focused on the aftermath of these explosives and not about why we need to make it more difficult to obtain the components of these IEDs, it does prompt a separate discussion of how substances like ammonium nitrate in fertilizer should be regulated. This argument is fueled by reports of the destructive power of ammonium nitrate-like substances. Whether these substances should be regulated or not is beyond the scope of this review. However, information received by the techniques outlined in this review can be used to obtain information to inform that argument.

HMEs and IEDs are easy to make so they are an obvious choice for terrorists. Bombing makes up 57% of terrorist attacks.⁴

Forensics is not medical science but pursuing it can still save lives. It is so important, especially tracking the perpetrator down to stop them from blowing something up again. Forensics also works to learn about what terrorists or others use to attack their targets. This can assist other cases as well.

Hopefully, you have better idea of some of the tools forensic scientists have at their disposal. None of them are perfect, but they can help a great deal, especially when used expertly. We do not live in Sherlock Holmes's time, and that is a good thing. There are more techniques and technologies being developed constantly. Some will work, some will not and some will be improved. While July 4th is delightful, explosives have taken a great many lives. There is a great deal of brokenness in the

world. I am grateful there are hardworking, smart people out there working against it. Sherlock Holmes said, "Crime is common. Logic is rare. Therefore, it is upon the logic rather than upon the crime that you should dwell."²⁴

References

- (1) Wright, J. D. *Fire and Explosives*; Routledge: New York, NY, **2015**.
- (2) Grimm, B. L.; Stern, L. A.; Lowe, A. J. Forensic Utility of a Nitrogen and Oxygen Isotope Ratio Time Series of Ammonium Nitrate and Its Isolated Ions. *Talanta* **2018**, *178* (August), 94–101.
<https://doi.org/10.1016/j.talanta.2017.08.105>.
- (3) Blanco, G. A.; Nai, Y. H.; Hilder, E. F.; Shellie, R. A.; Dicoski, G. W.; Haddad, P. R.; Breadmore, M. C. Identification of Inorganic Improvised Explosive Devices Using Sequential Injection Capillary Electrophoresis and Contactless Conductivity Detection. *Anal. Chem.* **2011**, *83* (23), 9068–9075.
<https://doi.org/10.1021/ac2020195>.
- (4) Ulasan, S.; Residu, P.; Pandangan, S.; Forensik, K.; Afiq, M.; Huri, M.; Ahmad, U. K.; Ibrahim, R.; Omar, M. A Review of Explosive Residue Detection From Forensic Chemistry Perspective. *Malaysian J. Anal. Sci.* **2017**, *21* (2), 267–282.
<https://doi.org/10.17576/mjas-2017-2102-01>.
- (5) Johns, C.; Shellie, R. A.; Potter, O. G.; O'Reilly, J. W.; Hutchinson, J. P.; Guijt, R. M.; Breadmore, M. C.; Hilder, E. F.; Dicoski, G. W.; Haddad, P. R. Identification of Homemade Inorganic Explosives by Ion Chromatographic Analysis of Post-Blast Residues. *J. Chromatogr. A* **2008**, *1182* (2), 205–214.
<https://doi.org/10.1016/j.chroma.2008.01.014>.
- (6) Dalby, O.; Butler, D.; Birkett, J. W. Analysis of Gunshot Residue and Associated Materials - A Review. *J. Forensic Sci.* **2010**, *55* (4), 924–943.
<https://doi.org/10.1111/j.1556-4029.2010.01370.x>.
- (7) Itoh, T.; Sujith, A.; Ozaki, Y. Surface-Enhanced Raman Scattering Spectroscopy: Electromagnetic Mechanism and Biomedical Applications. *Front. Mol. Spectrosc.* **2009**, 289–319.
<https://doi.org/10.1016/B978-0-444-53175-9.00010-6>.
- (8) Moros, J.; Lorenzo, J. A.; Lucena, P.; Tobarria, L. M.; Laserna, J. J. Simultaneous Raman Spectroscopy-Laser-Induced Breakdown Spectroscopy for Instant Standoff Analysis of Explosives Using a Mobile Integrated Sensor Platform.

- Anal. Chem.* **2010**, 82 (4), 1389–1400.
<https://doi.org/10.1021/ac902470v>.
- (9) Flanigan, P. M.; Brady, J. J.; Judge, E. J.; Levis, R. J. Determination of Inorganic Improvised Explosive Device Signatures Using Laser Electrospray Mass Spectrometry Detection with Offline Classification. *Anal. Chem.* **2011**, 83 (18), 7115–7122.
<https://doi.org/10.1021/ac2014299>.
- (10) Forbes, T. P.; Sisco, E.; Staymates, M.; Gillen, G. DART-MS Analysis of Inorganic Explosives Using High Temperature Thermal Desorption. *Anal. Methods* **2017**, 9 (34), 4988–4996.
<https://doi.org/10.1039/c7ay00867h>.
- (11) Infrared Thermal Desorption
<http://www.tti-me.com/infrared.html>
(accessed Nov 20, 2019).
- (12) Mikhail, K. A Guide to Thermal Desorption (Adapted from EPA Technology Fact Sheet: EPA 542-F-96-005).
- (13) Forbes, T. P.; Sisco, E.; Staymates, M. Detection of Nonvolatile Inorganic Oxidizer-Based Explosives from Wipe Collections by Infrared Thermal Desorption - Direct Analysis in Real Time Mass Spectrometry. *Anal. Chem.* **2018**, 90 (11), 6419–6425.
<https://doi.org/10.1021/acs.analchem.8b01037>.
- (14) DART Technology
https://www.ionsense.com/DART_Technology/DART_Technology
(accessed Nov 20, 2019).
- (15) Jolliffe, C.; Savtchenko, S.; Gamble, H. Ion Transmission Through a Quadrupolar Ion Guide under the Combined Influence of Viscous Flow and RF Electrical Field Characteristics. **2005**, 1006.
- (16) University of Kentucky Discussion. Summary of the Characteristics of Different Mass Analyzers General : The Effect of Electromagnetic Fields on Ions.
- (17) Forbes, T. P.; Sisco, E.; Staymates, M. Detection of Nonvolatile Inorganic Oxidizer-Based Explosives from Wipe Collections by Infrared Thermal Desorption - Direct Analysis in Real Time Mass Spectrometry. *Anal. Chem.* **2018**, 90 (11), 6419–6425.
<https://doi.org/10.1021/acs.analchem.8b01037>.
- (18) Chipuk, J. E.; Brodbelt, J. S.

- Transmission Mode Desorption
Electrospray Ionization. *J. Am. Soc.
Mass Spectrom.* **2008**, *19* (11), 1612–
1620.
<https://doi.org/10.1016/j.jasms.2008.07.002>.
- (19) Evans-Nguyen, K. M.; Quinto, A.;
Hargraves, T.; Brown, H.; Speer, J.;
Glatter, D. Transmission Mode
Desorption Electrospray Ionization
(TM-DESI) for Simultaneous
Analysis of Potential Inorganic and
Organic Components of Radiological
Dispersion Devices (RDDs). *Anal.
Chem.* **2013**, *85* (24), 11826–11834.
<https://doi.org/10.1021/ac402386m>.
- (20) Benson, S. J.; Lennard, C. J.;
Maynard, P.; Hill, D. M.; Andrew, A.
S.; Roux, C. Forensic Analysis of
Explosives Using Isotope Ratio Mass
Spectrometry (IRMS) -
Discrimination of Ammonium Nitrate
Sources. *Sci. Justice* **2009**, *49* (2), 73–
80.
<https://doi.org/10.1016/j.scijus.2009.04.005>.
- (21) Ecs 4010. No. Mi, 1–59.
- (22) Ewing, R. G.; Valenzuela, B. R.;
Atkinson, D. A.; Wilcox Freeburg, E.
D. Detection of Inorganic Salt-Based
Homemade Explosives (HME) by
Atmospheric Flow Tube-Mass
Spectrometry. *Analytical Chemistry*.
2018, pp 8086–8092.
<https://doi.org/10.1021/acs.analchem.8b01261>.
- (23) Ewing, R. G.; Clowers, B. H.;
Atkinson, D. A. Direct Real-Time
Detection of Vapors from Explosive
Compounds. *Anal. Chem.* **2013**, *85*
(22), 10977–10983.
<https://doi.org/10.1021/ac402513r>.
- (24) Doyle, C. THE ADVENTURES The
Adventure of the Copper Beeches.
2011. <https://doi.org/10.1007/978-3-642-01459-8>.