



# Evaluation of the Overheight Detection System Effectiveness at Eklutna Bridge

## Final Report



**Prepared By:**  
**Ming Lee, Ph.D., P.E.**  
*University of Alaska Fairbanks*  
**Dan Moose**  
*Alaska ITS*

March 2013

**Prepared By:**

Alaska University Transportation Center  
Duckering Building Room 245  
P.O. Box 755900  
Fairbanks, AK 99775-5900

Alaska Department of Transportation  
Research, Development, and Technology  
Transfer  
2301 Peger Road  
Fairbanks, AK 99709-5399

INE/AUTC 13.12

FHWA-AK-RD-13-01

**REPORT DOCUMENTATION PAGE**

Form approved OMB No.

Public reporting for this collection of information is estimated to average 1 hour per response, including the time for reviewing instructions, searching existing data sources, gathering and maintaining the data needed, and completing and reviewing the collection of information. Send comments regarding this burden estimate or any other aspect of this collection of information, including suggestion for reducing this burden to Washington Headquarters Services, Directorate for Information Operations and Reports, 1215 Jefferson Davis Highway, Suite 1204, Arlington, VA 22202-4302, and to the Office of Management and Budget, Paperwork Reduction Project (0704-1833), Washington, DC 20503

1. AGENCY USE ONLY (LEAVE BLANK) FHWA-AK-RD-13-01	2. REPORT DATE March 2013	3. REPORT TYPE AND DATES COVERED Final Report (07/2008-08/2010)
--	------------------------------	--

4. TITLE AND SUBTITLE Evaluation of the Overheight Detection System Effectiveness at Eklutna Bridge Final Report	5. FUNDING NUMBERS DTRT06-G-0011 AUTC # RR08.09 T2-08-06
---	---

6. AUTHOR(S) Ming Lee, PH.D, P.E. University of Alaska Fairbanks Dan Moose Alaska ITS
---

7. PERFORMING ORGANIZATION NAME(S) AND ADDRESS(ES) Alaska University Transportation Center P.O. Box 755900 Fairbanks, AK 99775-5900	8. PERFORMING ORGANIZATION REPORT NUMBER  INE/AUTC 13.12
--	--

9. SPONSORING/MONITORING AGENCY NAME(S) AND ADDRESS(ES) Research and Innovative Technology Administration (RITA) (USDOT) 1200 New Jersey Ave, SE, Washington DC 20590 Fairbanks North Star Borough PO Box 71267, Fairbanks, AK 99707-1267	10. SPONSORING/MONITORING AGENCY REPORT NUMBER  FHWA-AK-RD-13-01
---	--

11. SUPPLEMENTARY NOTES
-------------------------

12a. DISTRIBUTION / AVAILABILITY STATEMENT  No restrictions	12b. DISTRIBUTION CODE
---	------------------------

13. ABSTRACT (Maximum 200 words)  The Eklutna River/Glenn Highway bridge has sustained repeated impacts from overheight trucks. In 2006, ADOT&PF installed an overheight vehicle warning system. The system includes laser detectors, alarms, and message boards. Since installation, personnel have seen no new damage, and no sign that the alarm system has been triggered. Although this is good news, the particulars are a mystery: Is the system working? Is the presence of the equipment enough to deter drivers from gambling with a vehicle that might be over the height limit? Is it worth installing similar systems at other overpasses? This project is examining the bridge for any evidence of damage, and is fitting the system with a datalogger to record and video any events that trigger the warning system. Finally, just to be sure, researchers will test the system with (officially) overheight vehicles. Project results will help ADOT&PF determine if this system is functioning, and if a similar system installed at other bridges would be cost-effective.
---

14. KEYWORDS: warning signals, warning devices	15. NUMBER OF PAGES 65
	16. PRICE CODE  N/A

17. SECURITY CLASSIFICATION OF REPORT  Unclassified	18. SECURITY CLASSIFICATION OF THIS PAGE  Unclassified	19. SECURITY CLASSIFICATION OF ABSTRACT  Unclassified	20. LIMITATION OF ABSTRACT  N/A
---	--	---	---------------------------------------

### **Notice**

This document is disseminated under the sponsorship of the U.S. Department of Transportation in the interest of information exchange. The U.S. Government assumes no liability for the use of the information contained in this document.

The U.S. Government does not endorse products or manufacturers. Trademarks or manufacturers' names appear in this report only because they are considered essential to the objective of the document.

### **Quality Assurance Statement**

The Federal Highway Administration (FHWA) provides high-quality information to serve Government, industry, and the public in a manner that promotes public understanding. Standards and policies are used to ensure and maximize the quality, objectivity, utility, and integrity of its information. FHWA periodically reviews quality issues and adjusts its programs and processes to ensure continuous quality improvement.

### **Author's Disclaimer**

Opinions and conclusions expressed or implied in the report are those of the author. They are not necessarily those of the Alaska DOT&PF or funding agencies.

# SI\* (MODERN METRIC) CONVERSION FACTORS

## APPROXIMATE CONVERSIONS TO SI UNITS

Symbol	When You Know	Multiply By	To Find	Symbol
<b>LENGTH</b>				
in	inches	25.4	millimeters	mm
ft	feet	0.305	meters	m
yd	yards	0.914	meters	m
mi	miles	1.61	kilometers	km
<b>AREA</b>				
in <sup>2</sup>	square inches	645.2	square millimeters	mm <sup>2</sup>
ft <sup>2</sup>	square feet	0.093	square meters	m <sup>2</sup>
yd <sup>2</sup>	square yard	0.836	square meters	m <sup>2</sup>
ac	acres	0.405	hectares	ha
mi <sup>2</sup>	square miles	2.59	square kilometers	km <sup>2</sup>
<b>VOLUME</b>				
fl oz	fluid ounces	29.57	milliliters	mL
gal	gallons	3.785	liters	L
ft <sup>3</sup>	cubic feet	0.028	cubic meters	m <sup>3</sup>
yd <sup>3</sup>	cubic yards	0.765	cubic meters	m <sup>3</sup>
NOTE: volumes greater than 1000 L shall be shown in m <sup>3</sup>				
<b>MASS</b>				
oz	ounces	28.35	grams	g
lb	pounds	0.454	kilograms	kg
T	short tons (2000 lb)	0.907	megagrams (or "metric ton")	Mg (or "t")
<b>TEMPERATURE (exact degrees)</b>				
°F	Fahrenheit	5 (F-32)/9 or (F-32)/1.8	Celsius	°C
<b>ILLUMINATION</b>				
fc	foot-candles	10.76	lux	lx
fl	foot-Lamberts	3.426	candela/m <sup>2</sup>	cd/m <sup>2</sup>
<b>FORCE and PRESSURE or STRESS</b>				
lbf	poundforce	4.45	newtons	N
lbf/in <sup>2</sup>	poundforce per square inch	6.89	kilopascals	kPa
<b>APPROXIMATE CONVERSIONS FROM SI UNITS</b>				
Symbol	When You Know	Multiply By	To Find	Symbol
<b>LENGTH</b>				
mm	millimeters	0.039	inches	in
m	meters	3.28	feet	ft
m	meters	1.09	yards	yd
km	kilometers	0.621	miles	mi
<b>AREA</b>				
mm <sup>2</sup>	square millimeters	0.0016	square inches	in <sup>2</sup>
m <sup>2</sup>	square meters	10.764	square feet	ft <sup>2</sup>
m <sup>2</sup>	square meters	1.195	square yards	yd <sup>2</sup>
ha	hectares	2.47	acres	ac
km <sup>2</sup>	square kilometers	0.386	square miles	mi <sup>2</sup>
<b>VOLUME</b>				
mL	milliliters	0.034	fluid ounces	fl oz
L	liters	0.264	gallons	gal
m <sup>3</sup>	cubic meters	35.314	cubic feet	ft <sup>3</sup>
m <sup>3</sup>	cubic meters	1.307	cubic yards	yd <sup>3</sup>
<b>MASS</b>				
g	grams	0.035	ounces	oz
kg	kilograms	2.202	pounds	lb
Mg (or "t")	megagrams (or "metric ton")	1.103	short tons (2000 lb)	T
<b>TEMPERATURE (exact degrees)</b>				
°C	Celsius	1.8C+32	Fahrenheit	°F
<b>ILLUMINATION</b>				
lx	lux	0.0929	foot-candles	fc
cd/m <sup>2</sup>	candela/m <sup>2</sup>	0.2919	foot-Lamberts	fl
<b>FORCE and PRESSURE or STRESS</b>				
N	newtons	0.225	poundforce	lbf
kPa	kilopascals	0.145	poundforce per square inch	lbf/in <sup>2</sup>

\*SI is the symbol for the International System of Units. Appropriate rounding should be made to comply with Section 4 of ASTM E380.  
(Revised March 2003)

## Executive Summary

The Eklutna Village Road bridge is located adjacent to the Native Village of Eklutna, northerly of the community of Chugiak. The bridge overcrosses the Glenn Highway at milepost 26.5 (.e., measured from the end in downtown Anchorage) with a clearance of 16 feet and 1 inch from the Highway. In the past, the bridge had sustained occasional collisions with overheight vehicles. A vehicle overheight detection and warning system was installed at a distance before the bridge on both the northbound and southbound directions of the Glenn Highway in 2006. However, since the completion of the system, collisions to the bridge by overheight vehicles still occurred and the system has had many technical issues (e.g., false alarms). To validate the effectiveness of the overheight detection and warning system at the bridge, the system at the southbound direction was upgraded with a new signal controller (iSINC), detector loops, two video cameras and a video recorder. The purpose of the new controller and the loops is to reduce the occurrences of false alarm while the added cameras and recorder provide data for the AKDOT&PF to determine if the system is effective.

After reviewing video images collected by the added monitoring system from August 2011 to June 2012, we conclude that the system is indeed functioning according to the design as the videos show that the system was triggered and issued warnings to the overheight vehicles. A few issues and limitations with the system are identified.

1. The system sometimes fails to activate Camera#1. The distance between the detector and the blankout sign may be too short to allow processing of higher speed vehicles of significant length. This design shortcoming can lead to failure of camera#1 activation when the triggering vehicles travel too fast to give the system sufficient time to process information.
2. Camera#2 can become out of focus to the level that manual on-site adjustment is needed to restore the focus. Without a means of remote communication to the controller, the camera can be out of focus for a long period of time without being noticed.
3. The recording time of Camera#2 needs to be long enough to make sure the videos follow the trucks all the way past the bridge. In addition, if the purpose of system is to gather evidence for bridge impacts, the resolution of camera#2 needs to be increased.

To address the issues identified, we make the following recommendations for the system at the Eklutna site:

- I. Relocate the blank-out sign for an additional 100 feet downstream from its current location away from the sensor array. Relocation of the sign will provide adequate processing time, which in turn will allow the fail safe and fault detection functions of the iSINC controller to work for vehicles at all speeds. It will also allow the existing camera array to capture the slower target vehicles all the way to the bridge structure. The resolution of the video image will also be improved as the relocated camera #2 will be closer to the bridge.
- II. Add a cellular radio modem for the system to be reached via a hardwire phone line or wireless connection supplied by an ISP. Addition of a cellular radio modem to the system will bridge the

existing communication gap between the cabinet and the closest connection points of the hardware or wireless connection. Real-time connection to the iSINC controller and the DVR can thus be established for data download, real-time status checks and manipulation of controller configurations.

- III. Restore controller cabinet grounding. Signal triggering irregularities such as signal not turning off correctly are more likely to occur if the system is not grounded.

The recorded data also help us identify situations when the system can be prone to false alarms. 65% of the false alarms in our data occurred in extreme winter weather events. We found that the system is often triggered for false alarms by freezing fog from the trucks' exhaust pipes when air temperature is below  $-10^{\circ}$  F. In addition, false alarms also tend to occur during heavy snow events. Thus, the false alarm rate of the system strongly depends on particular winter weather events. In addition, if a similar system is installed at another location in Alaska with a lower average winter temperature or more snow precipitation, the false alarm of the system is going to be higher than what observed in our study.

To conclude this study, we generalize and extend our findings and experience with the Eklutna system to make the a set of recommendations of design specifications and site consideration for future overheight detection systems to be installed in the State of Alaska. To make sure that the shortcomings of the Eklutna system are not repeated in the future, it is important to make sure that adequate distance be established between the overheight sensor and the blankout sign. The distance is critical for correct functioning of the system. It also gives the drivers sufficient amount of time to see and process the warning message.

The appendices of this report include documents created to help AKDOT&PF maintenance staff operate, troubleshoot, and maintain the system components added for this project (e.g., iSINC controller and cameras). Technical details of the recommendations can also be found in the appendices.

## Table of Contents

Executive Summary.....	2
Introduction .....	5
The Original System .....	5
The System Upgrades .....	9
The iSINC Controller.....	11
Cameras and DVR.....	12
Wireless Modem.....	14
Evaluation of System Effectiveness .....	14
Analysis of System Operation .....	15
Camera#1 .....	15
The Blankout Sign .....	16
Camera#2 .....	17
The VMS Sign .....	19
Analysis of Detector Activation and False Alarms .....	20
Conclusions .....	33
Recommendations .....	34
Appendix A Schematics and Operational Description of the iSINC Controller .....	38
Appendix B Eklutna Inbound OVHD Troubleshooting Guide.....	49
Appendix C Eklutna OVHD Annual Maintenance Guide .....	53
Appendix D Technical Details of the Recommendations .....	56

## Introduction

The Eklutna Village Road bridge is located adjacent to the Native Village of Eklutna, northerly of the community of Chugiak. The bridge overcrosses the Glenn Highway at milepost 26.5 (.e., measured from the end in downtown Anchorage) with a clearance of 16 feet and 1 inch from the Highway. In the past, the bridge had sustained occasional collisions with overheight vehicles. To reduce collisions to the bridge, the Alaska Department of Transportation and Public Facility (AKDOT&PF) installed an overheight vehicle detection and warning system at a distance before the bridge on both the northbound and southbound directions of the Glenn Highway (see Figure 1 for the location of the system) in 2006. The system consists of a laser detector, audible alarm speakers, and a variable message sign for each direction. After the completion of the system, the bridge still sustained occasional impacts from overheight violating vehicles, despite witness testimony that the system was triggered and did issue warning to the vehicles. Because the original system did not have cameras or data loggers, it was not certain that the system was indeed triggered and functioned as intended. If it was indeed triggered, it was not known why the drivers did not follow the system warning to take the ramp exits.

To address the problems with the original system, the objective of this research project was to upgrade the original overheight detection and warning system with additional equipment intended to improve its performance and to add surveillance functionality. Due to budget constraint, only the system for the southbound direction was upgraded. The Alaska University Transportation Center contracted Alaska ITS to design and install the system addition. The system upgrade includes a new signal controller and loops, two video cameras and a video recorder that saves the video footage every time the detector is triggered. The new controller helps reduce the occurrences of false alarms by filtering out passenger vehicles that have smaller span between wheel axles than trucks. The added cameras and recorder can provide data for the AKDOT&PF to determine if the system is effective.

## The Original System

Figure 1 shows the locations of the overheight detection system components. For each direction, the original system consisted of a detector (see Figure 2), an alarm speaker (see Figure 3), a blankout sign and flashers, (see Figure 4), and a Variable Message Sign (VMS) by the exit ramp (see Figure 5). Note that the pictures in Figure 2 to Figure 5 are taken from the Street View of Google Maps<sup>1</sup>, which must have been collected a few years ago. The alarm speaker mounted on top of the blankout sign (see Figure 4) is now removed.

Upon triggered by an overheight vehicle at the detector, the alarm speaker will go off and the blankout sign will display messages telling the driver of the overheight vehicle to take the ramp exit. The VMS by the ramp will then tell the driver to re-enter the freeway from the entrance ramp, thus by-passing the

---

<sup>1</sup> [Google Maps - ©2013 Google](#)



bridge without hitting it. The original system did not have a data logger thus there was no way to verify if the system was triggered.



Figure 1 The Location of the Original Eklutna Overhead Detection System



Figure 2 Southbound Overheight Detector (Source: Street View Google Maps ©2011 Google)



Figure 3 Southbound Alarm Speaker (Source: Google Maps ©2011 Google)



Figure 3. Southbound Freeway Mainline Blank Out Sign and Alarm Speaker (Source: Google Maps ©2011 Google)



**Figure 4 Southbound Exit Ramp Variable Message Sign (Source: Google Maps ©2011 Google)**

### **The System Upgrades**

The system upgrade designed and installed on the southbound lanes by Alaska ITS consists of an iSINC® signal controller, four new detector loops (i.e., two pairs), two video cameras, a Digital Video Recorder (DVR), a monitor and a wireless modem. The controller, monitor, and wireless modem are housed in the original cabinet that connects to the original system (Figure 6). The upstream inductive loop pair is located 11 foot ahead of the detection beam and the downstream pair is 5 foot past the detection beam. The first camera is mounted on the pole with the overheight detector (Figure 7), and the second camera on the pole with the blackout sign (Figure 8).



**Figure 5 Overheight Detection System Controller Cabinet**

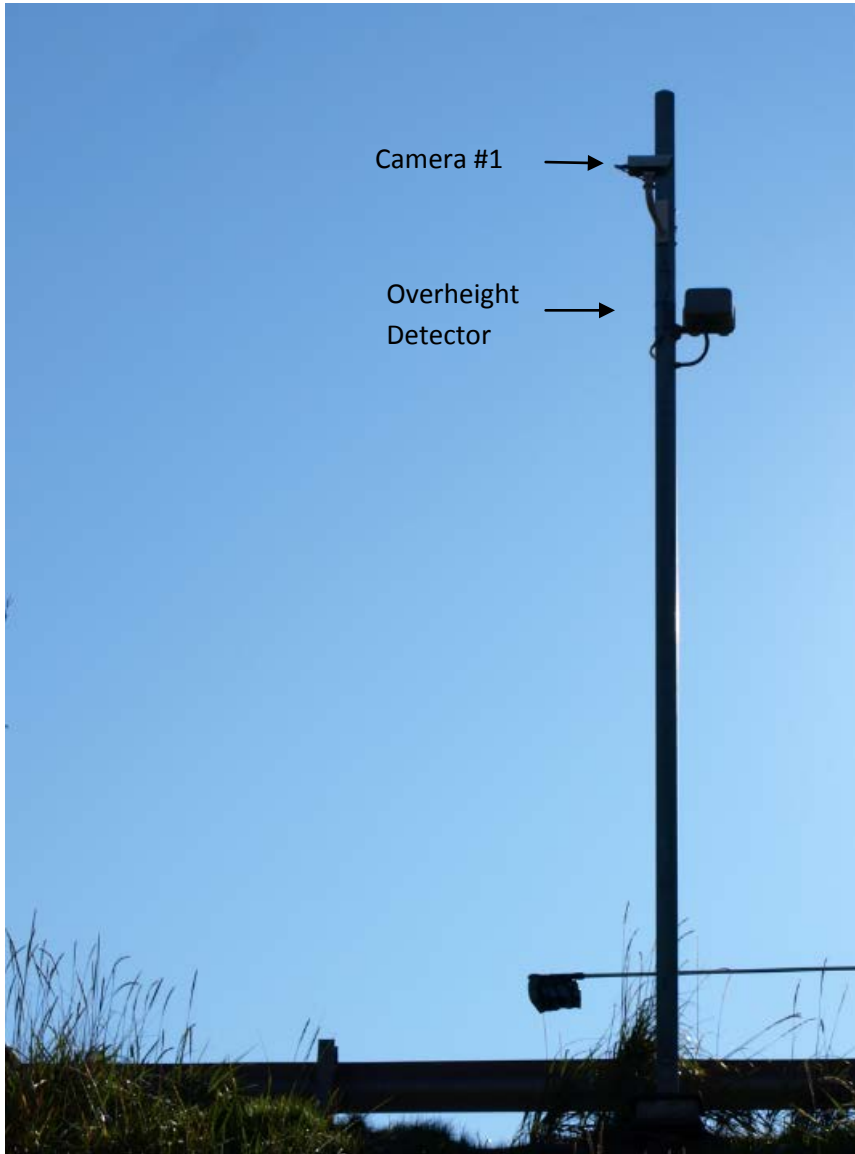

**Figure 6 Camera #1**

|



**Figure 7 Camera #2**

### **The iSINC Controller**

The iSINC Controller is designed to perform a wide range of ITS functions by integrating the signals of various traffic control devices such as loop detectors, Automated Vehicle Identification readers, cameras, VMS, communication systems, and other custom equipments. For the upgraded overheight detection system, four new permanent loop detectors were installed (i.e., 2 per lane) and connected to the iSINC controller. The loops are properly located upstream from the overheight detector to provide accurate information to the controller for the purpose of generating distinct vehicle count and classification records. The iSINC controller also receives signals from the overheight detector. As output

devices, the blankout sign, VMS and the accompanying flashers were also connected and are now controlled by the iSINC controller.

Using the signals from the loop detectors, the controller's built-in logic distinguishes vehicles with lengths that are less than 18 feet (i.e., trucks are typically measured at 18 feet or longer) . Thus, small vehicles such as passenger cars and pickup trucks that are unlikely to be overheight can be identified and ignored by the system. This can significantly reduce the chances of false alarms. For example, if a flying object hit the detector beam at a time when no vehicle over 18 feet was detected at the upstream loop, the system will ignore the trigger and no alarm will be issued.

Another fault detection logic of the iSINC controller is the ability to discern overheight detector triggers that occur outside of the correct sequence of loop triggers. That is, if the detector is triggered when no vehicle is detected at the upstream loop detectors, the detector is most likely hit and triggered by some foreign objects, not a vehicle. The same logic applies to situations when an overheight trigger occurs before the closest truck can reach the detector from the upstream detector. For example, if a trigger occurs one second after a truck passed the upstream loop, the trigger is most likely false, because no vehicle can possibly travel the distance between the upstream loop and the detector in such a short time. In such cases, the controller will not send in the signal and no alarm will be generated when triggers occur outside of the pre-set time parameters. This logic can reduce a major portion of false triggers caused by foreign objects, heavy rain or snowfall.

The iSINC is also able to determine the triggering vehicle's specific speed, allowing the timing and duration of signing to be set according to the vehicle's speed. The timings and durations to turn on the alarm speakers and VMS are now dynamically set for the triggering vehicle instead of the "one-duration fits all" approach. Now the alarm does not need to stay on excessively longer than the time needed for the specific overheight vehicle to drive past the message signs, which reduces the potential for non overheight vehicles to think the warning applies to them.

### **Cameras and DVR**

Camera #1, mounted on the pole with the detector (see Figure 7), is to provide streaming video of the Blank Out Sign (blankout sign) that directs overheight vehicles to exit the highway in advance of the overpass. This camera also captures the violating vehicles in both lanes as they approach the blankout sign/flashers. Figure 9 shows the video image captured by camera and displayed on the monitor housed in the system cabinet.

Figure 9 also shows the DVR unit (i.e., underneath the monitor) that is connected to the cameras and the iSINC controller. The DVR is currently set up to record for 15 seconds whenever the blankout sign/flashers are turned on by the controller. The DVR has the capacity to advance and retain frames prior to the trigger. This feature allows the saved video clips to demonstrate that the blankout

sign/flashers were actually turned on for a specific vehicle and were not false alarms. The video clip will show the actual activation as the truck approaches the sign.



**Figure 8 Video images captured by camera #1 (CH1) with a separate view of camera #2 (CH2)**

Camera #2's mission is to follow a violating vehicle's travel to verify whether or not the overheight vehicle complied with the blankout sign directive (i.e., OVERHEIGHT EXIT RIGHT). Camera 2 is mounted on the blankout sign pole in the approximate position formally occupied by the second alarm speaker, which had been removed due to increased weight that the speaker put on the top of the pole. The image captured by camera #2 is displayed in the smaller window on the monitor in Figure 9. This camera is for the sole purpose of monitoring the travel and not specifically for enforcement. Recording of the images captured by camera #2 to the DVR is also triggered by the iSINC controller.



### **Wireless Modem**

Although Alaska ITS had added a Wireless LAN modem to the system such that video file transfers may be made remotely, currently the data recorded by the system need to be downloaded manually from the data logger at the site, because communication lines are not available at the site of the controller cabinet. The MTA (Matanuska Telephone Association) currently has both hardwire phone line and wireless connection available in the vicinity, but neither is available at the controller cabinet which is located approximately 15-20 feet from the highway in a local depression. The distance between the controller cabinet and the closest connection points of existing communication lines is too great for the wireless modem to reach. Addition of a cellular radio modem to the system will bridge the communication gap between the cabinet and the closest connection points of the hardwire or wireless connection. Real-time communication to the controller could thus be established between the cabinet and a remote agent. It will allow the configuration changes to the iSINC and to the DVR to be made remotely thus saving time for retrieving data and allow quicker detection and corrections of system problems.

Alaska ITS also insulated the cabinet and added climate controls as well, which should add to lower operating costs and better protect the equipment contained.

Three additional technical documents are provided by Alaska ITS to help the maintenance staff of AKDOT& PF operate, troubleshoot and maintain the upgraded system in the future. For technical specification and operational instruction of the iSINC controller, the first document (see Appendix A) includes a drawing of the schematics and an operational description of the iSINC controller. The second document titled Eklutna Inbound OVHD Troubleshooting Guide is included in Appendix B. The third document Eklutna OVHD Annual Maintenance Guide is in Appendix C.

### **Evaluation of System Effectiveness**

The upgraded system was installed in the summer of 2010 and went through testing and fine-tuning for a few months during the winter of 2010-2011. We then collected data recorded by the added monitor system to examine if the overheight system functions correctly according to the design. Video footages recorded by the two cameras from August 15, 2011 to June 26, 2012 were retrieved for this analysis. It is noted that it was originally planned that data be collected in the early months of 2011. But, during the time the system was shut down for AKDOT&PF maintenance activities unrelated to this project. If not for the shutdown of the system, data could have been collected earlier in 2011. The end date was the date when this data set was retrieved for analysis. This data set provides the longest continuous period of system operation at the time of data retrieval.

A total of 184 incidences were recorded during the period of ten and a half months. It is important to note that the data do not provide complete monthly coverage for the months of June, July and August. The data cover 26 days in June, none of July and 16 days in August. With this data, we examined three

major components of the system: the detector, the blankout sign, and the VMS by the southbound exit ramp.

**Analysis of System Operation**

For every overheight incidence, the detector will first activate Camera#1, which captures images in front of the detector pole including the VMS sign. Camera#2 is then activated to capture images in front of the blank-out sign. The images captured by Camera#2 include the overpass bridge and the VMS sign by the ramp.

Before presenting results of system performance analysis, descriptive data related to the performance of each of the system component is first presented.

**Camera#1**

Of the 184 incidences detected during the period of analysis, the system failed to activate Camera#1 a total of 60 times. However, Camera#2 were indeed activated and produced recordings of these 60 incidences. A potential cause of such a non-functional event of Camera #1 was a specific shortcoming in the design of the system. The distance between the detector and the blankout sign was too short to allow processing of higher speed vehicles of significant length. This design shortcoming can lead to failure of camera#1 activation when the triggering vehicles travel too fast to give the system sufficient time to process information. Without images captured by Camera#1, we cannot verify if the blankout sign and the entire warning process were indeed activated.

Table 1 shows the breakdown of non-functional events of camera#1 by month. Note that the data do not cover the entire months of June, July and August. Shaded cells correspond to winter months when snow and temperature conditions result in slower average driving speed than summer months.

**Table 1 Camera#1 Non-Functional Events by Month**

Month	Not Activated	Activated	Total	Ratio of Not-Activated
January	11	18	29	0.38
February	4	7	11	0.36
March	1	5	6	0.17
April	2	9	11	0.18
May	8	19	27	0.30
June*	10	18	28	0.36
July*				
August*	2	11	13	0.15
September	7	13	20	0.35
October	9	14	23	0.39

November	4	5	9	0.44
December	2	5	7	0.29
<b>Total</b>	<b>60</b>	<b>124</b>	<b>184</b>	<b>0.33</b>

\* Incomplete monthly coverage

Table 1 shows a 0.33 overall ratio of non-functional events for Camera#1. That is, on average the system failed to activate camera#1 in one of every three overheight incidences. Prior to the analysis, it was hypothesized that vehicles travel slower in winter months (i.e., the shaded cells in Table 1) than summer, thus the non-functional ratio in winter may be lower than summer. However, the non-functional ratios in Table 1 do not support such hypothesis. There is no consistent patterns of variation in the non-functional ratio in winter when compared to the summer months.

To further examine the potential causes behind the non-functional events of Camera#1, we look at the breakdown of non-functional events of camera#1 by weather and resulting pavement conditions. Vehicles typically travel faster in dry pavement than wet. Table 2 shows that the ratio of not-activated among incidences of dry pavement is slightly higher than that in the wet condition. The unknown cases were incidences for which the camera images were out-of-focus to the level that pavement condition cannot be determined. This finding appears to support the hypothesis that the system is more likely to fail to activate camera#1 if the vehicles travel faster. However, it is important to note that the difference between the non-functional ratios of dry and wet condition is small. We also have just a limited number of cases in the wet pavement category. More data are needed to produce statistically convincing evidence that non-functional rate is higher in dry pavement.

**Table 2 Camera#1 Non-Functional Events by Daylight Conditions**

<b>Pavement Condition</b>	<b>Not Activated</b>	<b>Activated</b>	<b>Total</b>	<b>Ratio of Not-Activated</b>
Dry	37	98	135	0.27
Wet	8	25	33	0.24
Unknown	15	1	16	
<b>Total</b>	<b>60</b>	<b>124</b>	<b>184</b>	<b>0.33</b>

### **The Blankout Sign**

By design of the original system, after the detector is triggered, the alarm speaker will go off and the blankout sign will display a warning message telling the driver to take the ramp exit. Camera#1 of the added monitor system is installed to capture the blankout sign to see if it is actually turned on after an overheight violation is detected. Figure 10 shows the video image of the blankout sign captured by Camera#1. With the exception of cases identified as system error false alarms (see Table 4), the blankout sign was successfully activated and flashed in all the cases when camera#1 was activated.



**Figure 9 The blankout sign captured by Camera#1 in Incidence#2**

### **Camera#2**

The most significant technical issue with camera#2 is focus adjustment. During the duration of data collection, camera#2 went through three periods of time in which the camera was out of focus to the degree that only flashes can be picked out from the images (see Figure 11). When the camera is out of focus like this, technicians need to go to the controller at the site and manually adjust the camera back to focus. Note that a real-time communication between the controller and a remote agent via available communication lines can help detect the out-of-focus problems early. Currently, such communication is not available (see details in the previous section on wireless modem).



**Figure 10 An Out-of-Focus Video Produced by Camera#2**

The three out-of-focus periods of camera #2 are: 8/24 to 9/7 of 2011, 11/16 to 12/3 of 2011, and 5/2 to 6/14 of 2012. The possible cause for the out-of-focus event beginning on 8/24 of 2011 was strong wind as violently shaking tree leaves and branches were identified in the blurry images. The cause for the second out-of-focus event could be heavy snow storm. The blurry images produced by camera#2 on 11/16 show up-and-down motions with white background. No potential causes can be identified for the event in May of 2012, as this event occurred at night and nothing can be seen in the video images except for blurry flashes of vehicle headlight.

For all 184 incidences recorded by the system, there were only two cases when the system failed to produce recordings by camera#2. These two non-functional events were both part of the out-of-focus series. Judging from such a small number of occurrences, the non-functional events of camera#2 were more likely random errors that occurred during the electronic signal processing of the system.

It is noted that currently the electric grounding of the controller cabinet is not in place. Although we don't have direct evidence that the identified signal errors and irregularities are caused by the cabinet being not grounded, it is well known that signal triggering irregularities such as signal not turning off correctly are more likely to occur if the system is not grounded. Restoring the grounding of the cabinet is thus an urgent task to ensure the correct functionality of the system.

### The VMS Sign

The VMS sign is located at a spot near the visible limit of the images recorded by Camera#2. The activation of the VMS sign can be verified through the video images captured by Camera#2 in winter nights. Figure 12 and Figure 13 show the VMS sign before and after. When compared with Figure 12, it can be seen that VMS was illuminated in the center of the circle in Figure 13.



**Figure 11 The VMS before flashing (located in center of the circle area)**



**Figure 12 The VMS during flashing (located in center of the circle area)**

During the summer months, the view to the VMS sign is blocked by leaves on trees between the camera and the VMS sign. Without the leaves in winter, the flashing of the sign is clearly visible at night as shown in the above figures, but it cannot be recognized under daylight. The flashing of the VMS sign, when exposed under sunlight, is not strong enough to produce the necessary contrast to be seen in the video images shot by camera#2 from far away.

With favorable lighting conditions in winter months, the flashing of the VMS sign was unmistakably verified in a total of 25 incidences dating between 10/24/2011 and 4/21/2012.

#### **Analysis of Detector Activation and False Alarms**

Table 3 summarizes all activated cases by month. Because we have three months of partial coverage (i.e., June and August) or no coverage (i.e., July), we cannot look at the total activated cases per month to see which month has the most overweight activations. We thus calculated the Activation per Day variable to help us figure out the monthly distribution of activated cases. In addition, the number of Total Activated Cases is further divided into the numbers of Overheight Cases, False Alarms, and Unknown Cases. The Overheight Cases are those verified to be true over height violations and the False Alarms are cases verified to be non-overheight vehicles. All of the False Alarms in our data are by definition the False Positive cases.

Because we are examining data recorded by the detector system (i.e., the alarm), we are not able to identify the False Negative cases, which are by definition true overheight but no alarm. The Unknown Cases are those cases for which Camera#1 was not activated and Camera#2 was out-of-focus. We were not able to determine if these cases were false alarms or not. Note that the overall False Alarm Rate of 0.16 does not include the unknown cases.

**Table 3 System Activation by Month**

Month	Number of Days Covered	Total Activated Cases	Activation per Day	Overheight Cases	False Alarms	Unknown Cases
January, 2012	31	29	0.94	13	15	1
February, 2012	29	11	0.38	9	2	0
March, 2012	31	6	0.19	5	1	0
April, 2012	30	11	0.37	9	2	0
May, 2012	31	27	0.87	22	1	4
June*, 2012	26	28	1.08	24	2	2
July*						
August*, 2011	16	13	0.81	10	2	1
September, 2011	30	20	0.67	18	0	2
October, 2011	31	23	0.74	22	1	0
November, 2011	30	9	0.30	5	2	2
December, 2011	31	7	0.23	7	0	0
<b>Total</b>	<b>316</b>	<b>184</b>	<b>0.58</b>	<b>144</b>	<b>28</b>	<b>12</b>
				<b>False Alarm Rate</b>	<b>0.16</b>	

\* Incomplete data coverage

Figure 14 is a bar chart created from the Activation per Day variable in Table 3. We can see that system activation per day increases from April to June then decrease from August to September. With the exception of January (i.e., half of the cases are false alarms), activation per day stayed relatively low from November to March of the next year. This peaking pattern from April to September coincides with the summer construction season in Alaska as most of the overheight vehicles carry construction equipments and materials.



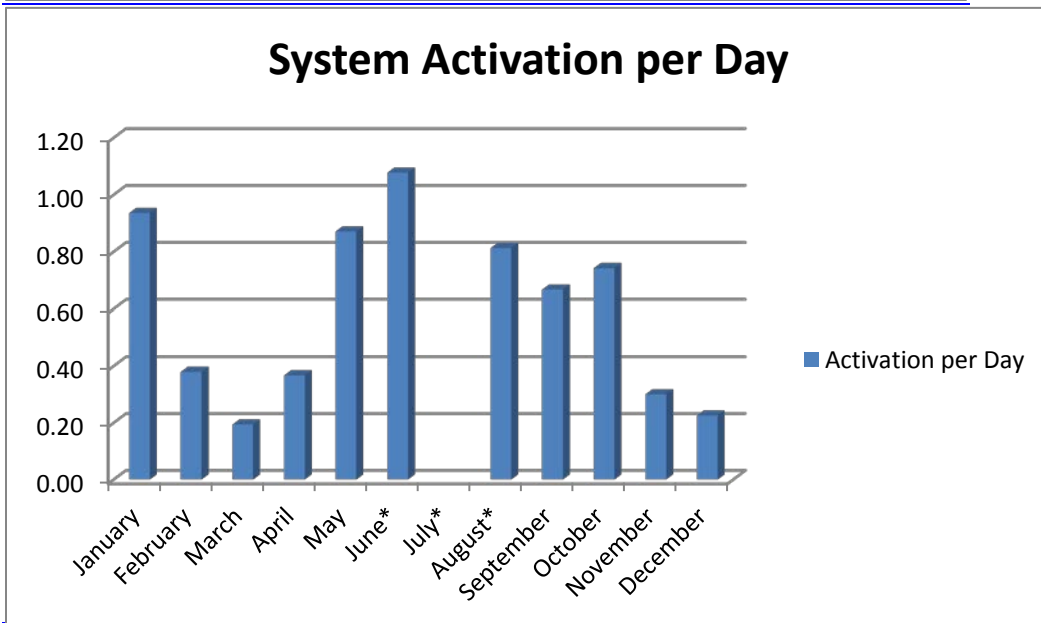
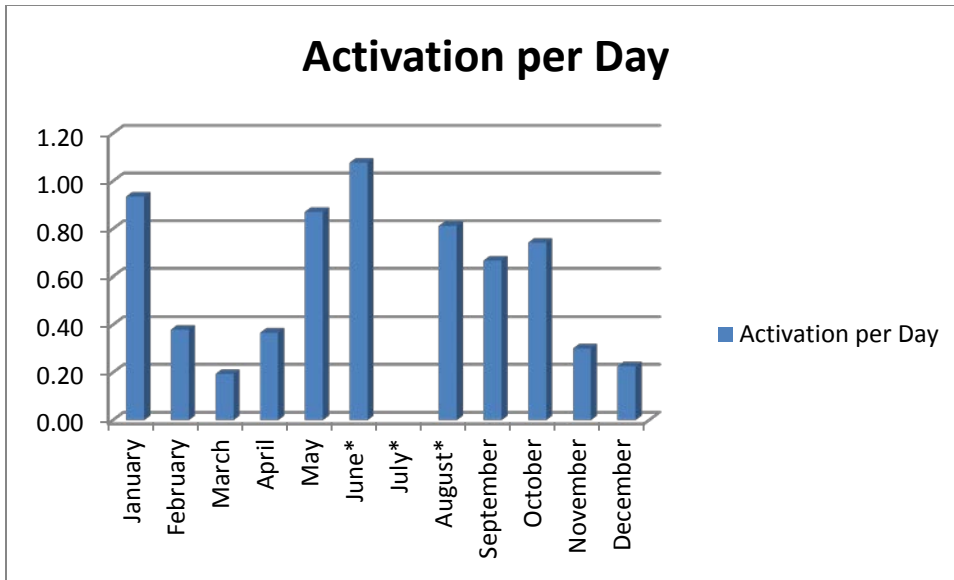

**Figure 13 System Activation Per Day by Month (August 2011 to June 2012)**

The numbers of False Alarms by month (see Figure 15) show that, except for January, there were at most two cases of false alarms per month. In September and December of 2011, there was no false alarm at all. In January, there was an exceptionally higher number of false alarms than occurred in every other month.

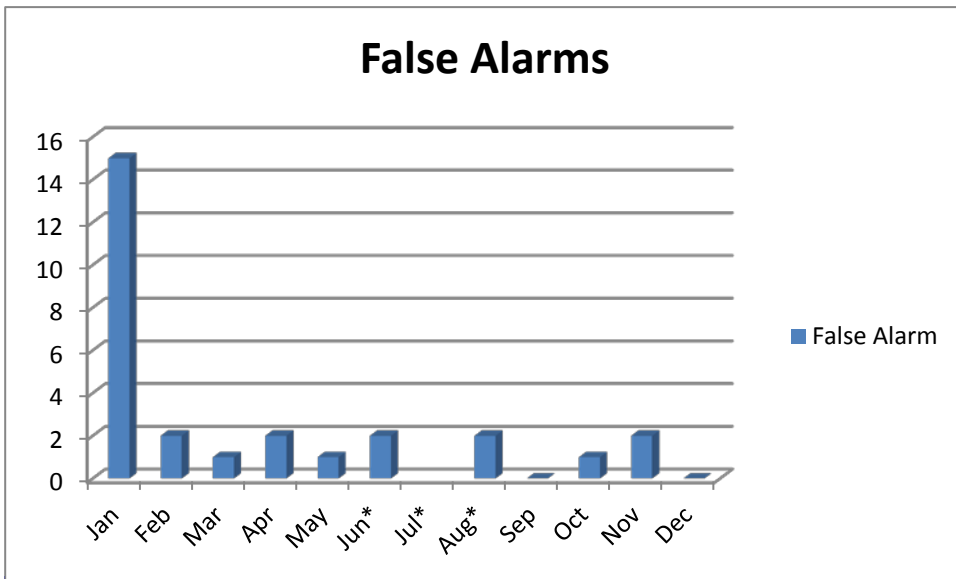
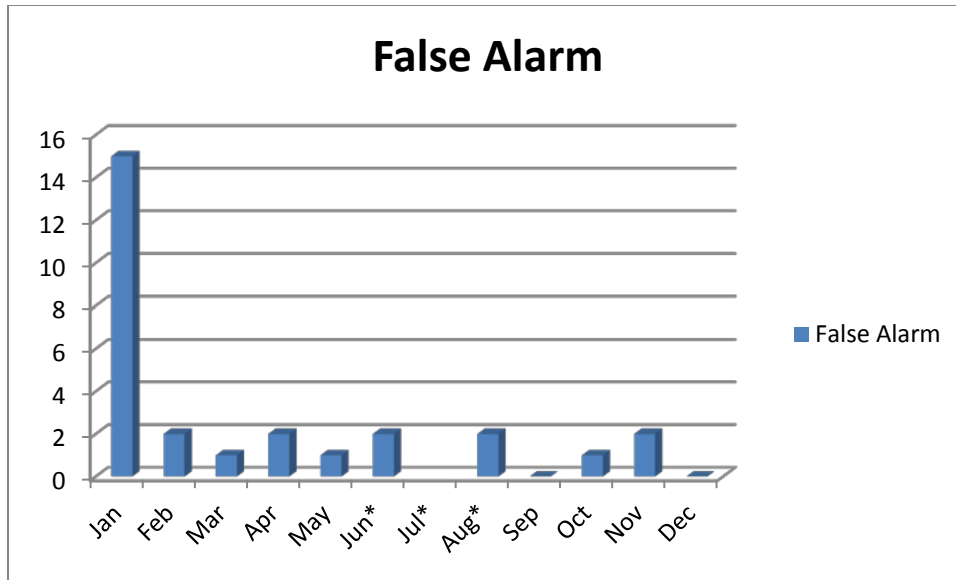

**Figure 14 Number of False Alarms by Month (August 2011 to June 2012)**

After examining the video footages from January of 2012, we found out that in all of the 15 false alarm cases this month the overweight detector beam was not blocked by the cargos of the trucks, but by the freezing fog coming from the exhaust pipes of the trucks. Figure 16 shows the video image of one of these incidents.



**Figure 15 The image of the truck recorded by Camera#2 in Incidence #4**

The truck in Figure 16 appears to be a typical tractor trailer with a standard height of approximately 13 feet. However, the dense fog coming from the exhaust pipes of the vehicle appears to add about 2 to 3 feet from the top of the truck. The overall height of the truck with the exhaust fog could easily reach the overheight detector.

Freezing fog formed from truck exhaust usually occurs when temperature is extremely low. To find out the air temperatures at which these false alarms occurred, we downloaded the daily minimum temperatures at the Eklutna weather station (i.e., located on Eklutna Lake Road at Latitude of 61.4495° and Longitude of -149.323°, which is approximately 1.4 miles from the overcrossing bridge site) from the web site of the National Climatic Data Center of the National Oceanic and Atmospheric Administration (NOAA). Figure 17 shows the minimum temperature curve from August 2011 to June 2012. Note that there is no data available for September 2011 at the Eklutna station. We used data of the same month from the nearby Eagle River station to complete the curve.

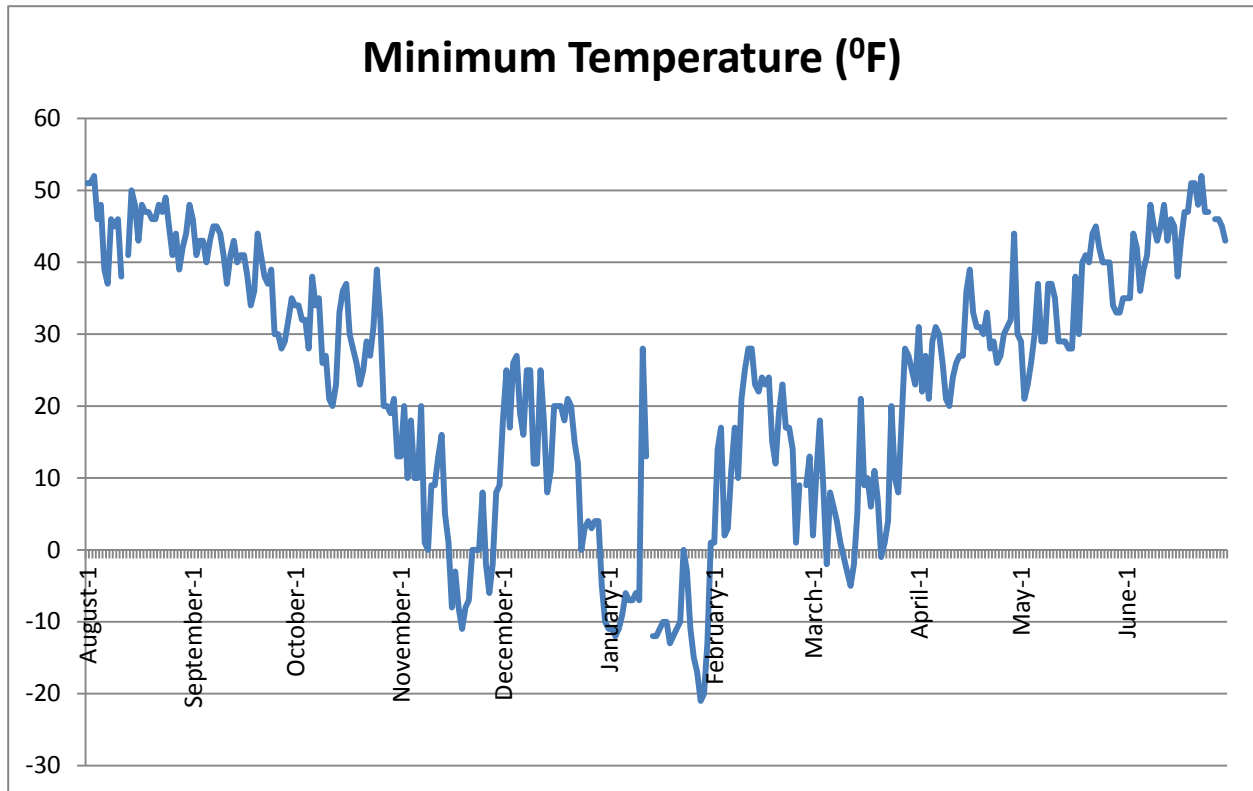

**Figure 16 Daily Minimum Temperatures at the Eklutna Weather Station, August 2011 to June 2012 (Source: NOAA)**

The lowest peak in Figure 17 occurred on January 28 of 2012 at the temperature of  $-21^{\circ}$  F. The data of Figure 17 show that the second half of January 2012 (January 14 to January 30) is the coldest period of that winter. We then compared the daily temperature data with our video records. We found that all 15 false alarms in January of 2012 occurred between January 14 and January 28 when the minimum temperatures range between  $-10^{\circ}$  F and  $-21^{\circ}$  F.

Table 4 shows the attributes of all false alarm cases. The causes for the false alarms are identified from the video recordings. The minimum temperature and precipitation/snow data from the same NOAA Eklutna weather station are referenced to show evidences that the low temperature and snow events identified in the videos did exist at the site during the time.

The video images for the two cases identified as caused by sunlight reflection show glare of sunlight (see **Figure 18**). The incidence on March 28 occurred during sunset at 6 pm and the one on April 14 occurred during sunrise at 6 am. Note that the Glenn Highway at the bridge site runs in the general direction of east-west. The rays of sunlight during sunrise and sunset run parallel to the highway and perpendicular to the detector beam, thus increasing the chance for sunlight reflection/glare to intersect the detector beam. Since no other potential cause can be identified for the false alarms in these two cases, sunlight reflection is determined to be the most likely cause of the false alarms.



**Figure 17 The Video Image of Lighting Condition during Sunset on March 28, 2012**

The cases labeled as system errors are those in which no causes can be identified in the recordings. Some of these could actually be caused by wind-blown objects or birds. We chose to label all of the non-identifiable cases as system errors such that the particular cases can be further examined. However, three of such recordings (i.e., two on 8/18/2011 and one on 5/11/2012) are true system errors as multiple activations of the system were recorded and most of them involved no trucks.

**Table 4 Causes False Alarm Cases**

Date	Time	Minimum temp of the day (F)*	Precipitation/ Snow (in)*	Cause of false alarms
8/18/2011	11:46:51	47	0.00	System error
8/18/2011	12:00:34	47	0.00	System error
10/28/2011	0:17:57	20	0.00	Flashes on top of truck
11/7/2011	7:39:16	20	5.50	Heavy snow
11/7/2011	8:19:12	20	5.50	Heavy snow
1/14/2012	14:12:18	-12	1.40	Low temperature/freezing fog
1/14/2012	17:04:20	-12	1.40	Low temperature/freezing fog
1/15/2012	23:00:00	-12	0.00	Low temperature/freezing fog
1/16/2012	0:01:03	-11	0.00	Low temperature/freezing fog
1/16/2012	8:08:11	-11	0.00	Low temperature/freezing fog
1/16/2012	12:52:37	-11	0.00	Low temperature/freezing fog
1/16/2012	13:42:19	-11	0.00	Low temperature/freezing fog
1/16/2012	18:00:41	-11	0.00	Low temperature/freezing fog
1/16/2012	19:35:40	-11	0.00	Low temperature/freezing fog
1/19/2012	13:58:26	-13	0.00	Low temperature/freezing fog
1/20/2012	3:51:45	-12	0.00	Low temperature/freezing fog
1/27/2012	6:33:58	-17	0.00	Low temperature/freezing fog
1/27/2012	23:15:54	-17	0.00	Low temperature/freezing fog
1/28/2012	7:53:14	-21	0.00	Low temperature/freezing fog
1/28/2012	20:23:07	-21	0.00	Low temperature/freezing fog
2/8/2012	13:17:42	10	0.00	System error
2/18/2012	16:30:53	15	0.00	System error
3/28/2012	18:16:48	28	0.00	Sunlight reflection
4/6/2012	9:19:09	31	0.30	Heavy snow
4/14/2012	6:59:06	27	0.00	Sunlight reflection
5/11/2012	22:37:34	35	0.00	System error
6/25/2012	17:37:58	47	0.00	Flashes on top of truck
6/26/2012	14:30:19		0.00	Wind

\* Source: NOAA Eklutna Weather Station

Figure 19 shows the percentage distribution of different false alarm causes. Of the 28 false alarm cases, 54% of them occurred when the minimum temperature of the day was below -10<sup>0</sup> F. When combined with false alarms triggered by heavy snow (11%), winter weather events account for 65% of all false alarms. In all of the cases identified as caused by heavy snow, heavy snow falls with visible snowflakes were identified from the video images. A large aggregation of snowflakes is capable of blocking the

detector beam and triggering the system. Thus, during heavy snow events, the system has a higher chance of being triggered for false alarms. A good example of this is the heavy snow event on the morning of 11/7/2011 (see Figure 20). In less an hour, the system was triggered twice for false alarms by the heavy snow fall.

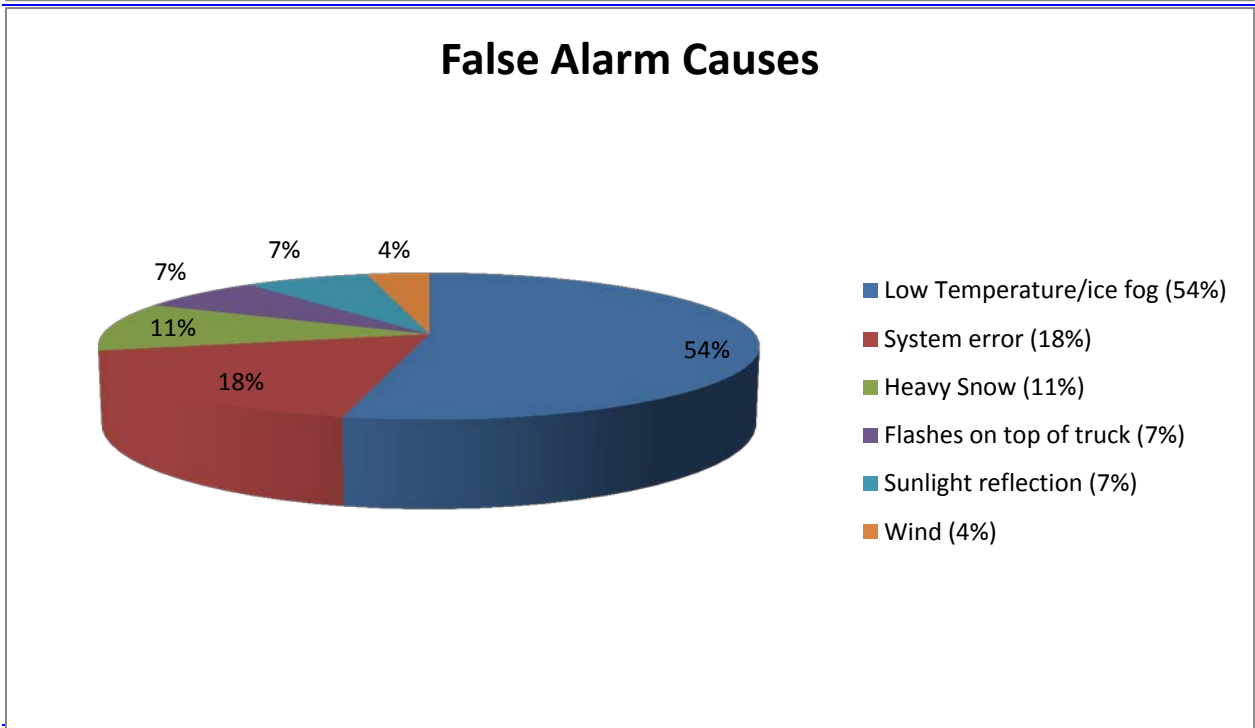
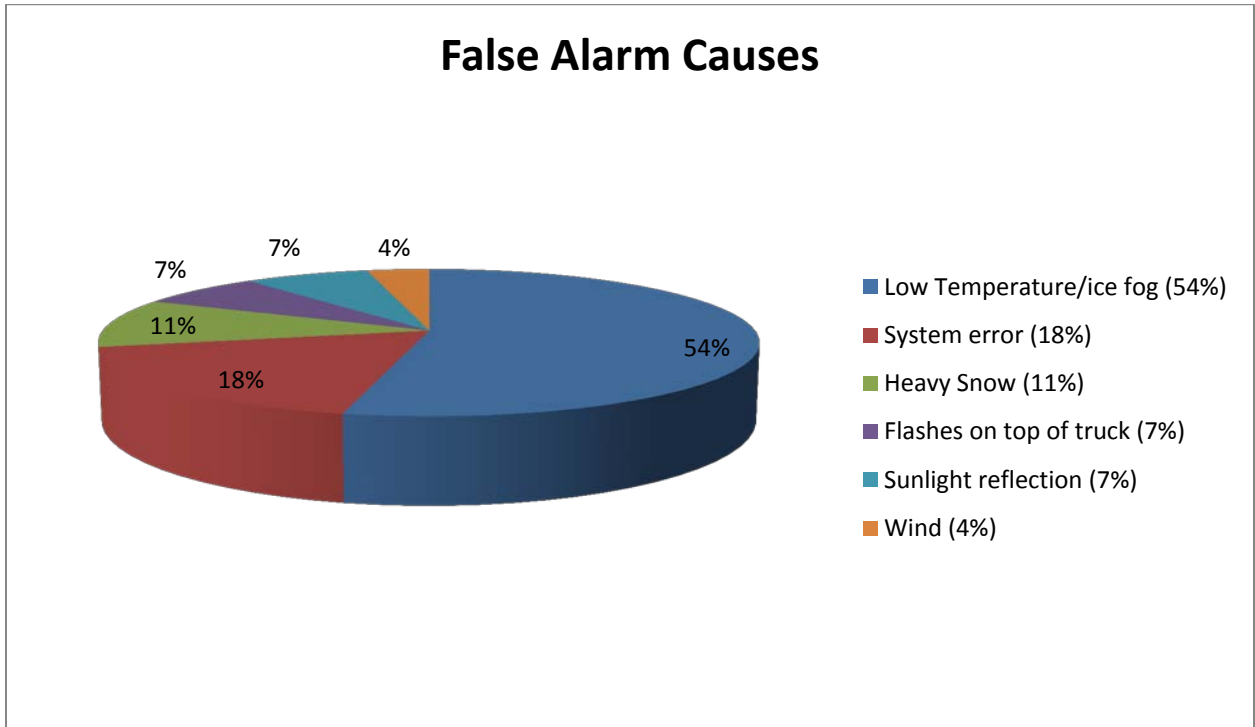

Figure 18 Percent Distribution of All False Alarm Causes



Figure 19 The Video Image of the Heavy Snow Even on November 7, 2011

It is important to recognize that the false alarm rate of the system strongly depends on particular winter weather events. The same system when examined with data from a different year is likely to have very different false alarm rate. In addition, if a similar system is installed at another location with a lower average winter temperature or more snow precipitation, the false alarm of the system is going to be higher than what we observed in this study.

All of the trucks appearing in the videos of the false alarm events stayed on the highway without taking the ramp. The recorded videos show that most of the trucks involving in the false alarms are semi trucks with trailers of standard dimensions. In addition to the possibilities that the drivers did not see the warning signs, it is also likely that either the drivers were familiar with the bridge overpass or they were confident that the trucks and cargoes were not overheight.

We also identified 15 cases of verified overheight violation that did not take the ramp exit. Most of these trucks carried cargoes of irregular shapes such as junk metals, double decks of cars, large containers, or large vehicles or equipment. These trucks appear in the videos to be taller than typical semi-tractor trailers. Figure 21 shows one of such an example. According to the recorded video, the truck in Figure 21 appears to have cleared the bridge underpass (Figure 22). However, it is noted that



the image of the truck at the bridge underpass is too small to serve as convincing evidence for the occurrence of bridge impacts.

Of the 15 cases, we can verify that 5 of them do not cause impacts to the bridge by comparing the speed of the vehicle immediately before the bridge with its speed past the bridge. In these 5 cases, the overheight vehicles show a continuous motion through the bridge without any sign of speed reduction. However, for rest of the 10 cases, either the video recordings stopped before the trucks reached the bridge or the camera was out-of-focus. For cases that occurred in winter, the trucks involved typically traveled too slow to reach the bridge before the pre-set recording time of Camera#2 expired. Note that currently the recording time of Camera#2 is maximized. However, even if the recording time could be lengthened, the image recorded would still be too small to render any useful information if impact did occur to the bridge.



**Figure 20** The image of an overheight truck recorded by Camera#2



**Figure 21 The end of recording showing the vehicle in Figure 21 clearing the underpass**

We also examined if we can unmistakably identify the triggering overheight vehicle from the images recorded by Camera#2. Specifically, we would like to know if it is possible to read the license plate numbers of the overheight trucks. After reviewing all videos, we concluded that, with the camera resolution and the lighting as they are, the only situation in which a vehicle may be identified is when the sides of the trailers are painted with recognizable signs of the trucking company. Figure 23 demonstrates one of such events. However, Figure 24 shows a more typical event in which identification of the truck in the image is not possible even during daylight hours. If one of the purposes of an overheight detection system is to gather evidence for investigating specific bridge impacts, the resolution of camera#2 would need to be increased, or an additional camera close to the bridge need to be installed. Note that there may not be existing electrical conduits to be used to connect the additional camera. Thus, if an additional camera is to be used, additional cost to put in the conduits may be required.



Figure 22 Truck with visible marking on the trailer



Figure 23 Truck with no visible marking on the trailers

## Conclusions

To validate the effectiveness of the overheight detection and warning system at the Eklutna Bridge, the system at the southbound direction was upgraded with a new signal controller, detector loops, two video cameras and a video recorder. The purpose of the new controller is to reduce the occurrences of false alarm while the added cameras and recorder provide data for the AKDOT&PF to determine if the system is effective.

After reviewing video images collected by the monitoring system for the analysis period of August 15, 2011 to June 26, 2012, we conclude that the system is indeed functioning properly as the videos show that the system was triggered and issued overheight warnings. However, we did identify occasional system errors and the following limitations that requires attention:

1. The system sometimes fails to activate Camera#1. The distance between the detector and the blankout sign may be too short to allow processing of higher speed vehicles of significant length. This design shortcoming can lead to failure of camera#1 activation when the triggering vehicles travel too fast to give the system sufficient time to process information.
2. Camera#2 can lose focus to the level that manual on-site adjustment is needed to restore the focus. Without a means of remote communication to the controller, the camera can be out of focus for a long period of time without being noticed.
3. The recording time of Camera#2 needs to be long enough to make sure the videos follow the trucks all the way past the bridge. In addition, if the purpose of system is to gather more specific evidence for bridge impact investigation the resolution of camera#2 needs to be increased.

The recorded data also help us identify situations when the system can be prone to false alarms. 65% of the false alarms in our data occurred in extreme winter weather events. We found that the system is often triggered for false alarms by the freezing fog from the trucks' exhaust pipes when air temperature is below  $-10^{\circ}$  F. In addition, false alarms also occur during heavy snow events.

The most important implication from our findings is that the false alarm rate of the system strongly depends on particular winter weather events. If a similar system is to be installed at another location in Alaska with a lower average winter temperature or more snow precipitation, the false alarm of the system is going to be higher than what observed in our study.

Three technical documents in the appendices A to C are provided to help the maintenance staff of AKDOT& PF operate, troubleshoot and maintain the upgraded system in the future.

## **Recommendations**

Based on the experience and lessons learned from this study, we make the a list of recommendations for both the system at the Eklutna and similar systems to be installed in the state of Alaska in the future. The followings are summaries of the recommendations. Technical details of the recommendations can be found in Appendix D.

The following improvement recommendations for the system at Eklutna:

- I. Relocate the blank-out sign for an additional 100 feet downstream from its current location away from the sensor array. Relocation of the sign will provide adequate processing time, which in turn will allow the fail safe and fault detection functions of the iSinc controller to work for vehicles at all speeds. It will also allow the existing camera array to capture the slower target vehicles all the way to the bridge structure. The resolution of the video image will also be improved as the relocated camera #2 will be closer to the bridge.
- II. Add a cellular radio modem for the system to be reached via a hardwire phone line or wireless connection supplied by an ISP. The distance between the controller cabinet and the closest connection points of existing communication lines is too great for the wireless modem to reach. Addition of a cellular radio modem to the system will bridge the communication gap between the cabinet and the closest connection points of the hardwire or wireless connection. Real-time connection to the iSinc Controller and the DVR can thus be established for data download, real-time status checks and manipulation of controller configurations.
- III. Restore controller cabinet grounding. Signal triggering irregularities such as signal not turning off correctly are more likely to occur if the system is not grounded.

We also generalize and extend our findings and experience with the Eklutna system to make the following recommendations of design specifications for any of such overheight detection systems to be installed in the State of Alaska.

### **I. Blankout Signs**

- a) Blankout signs must have a trigger time of less than 100 ms.
- b) Blankout signs must have a cone of vision equal to 30 degrees on the horizontal axis and 20 degrees on the vertical and conform to TS4 luminance and environmental requirements by NEMA (see Table 5).

**Table 5 NEMA TS4 requirements for 12 Inch Signs**

<b>Characteristics</b>	<b>NEMA TS4 Performances Requirements</b>
<b>Color</b>	590 nm (+/-5)
<b>Luminance</b>	7440
<b>Contrast ratio</b>	6
<b>Angularity</b>	Class E +/- 15° horizontal -10° vertical
<b>Temperature</b>	-34° / +74°C
<b>Protection</b>	NEMA 3R

- c) Blankout signs should utilize LED Displays with 12 inch characters for speeds above 55 mph.
- d) Blankout signs should be positioned such that target vehicles are exposed to a 3.5 second message duration. For a vehicle traveling 60 mph (88 feet per second), the display distance is 308 feet.
- e) Blankout sign position should allow for significant reaction time that consists of a minimum 4 second decision time and an 8 second turning movement. This equates to a 1056 feet distance between Blank Sign and off-ramp at 60 mph travel speed.
- f) As in the case of Eklutna, where an additional lane exists in which target vehicles may be present, another 8 seconds of response time should be added for this additional turning movement. Reaction and vehicle response time to the off-ramp equates to a distance of 1760 feet. Significant uphill grade would reduce this response distance requirement and a downhill grade would increase it.

**II. Site Monitoring:**

- a) Video or Infrared cameras (i.e., if night time visibility of the images is to be increased) should be utilized as they are at the Eklutna test site. That is, they should be positioned such that the image of the target vehicle is displayed prior to and during the sign illumination as it occurs. This pre-capture capability is necessary to ensure that the triggering vehicle and the activation of the warning signals can be unmistakably verified.
- b) The camera, if properly positioned should also be able to capture the target vehicle's progression down the technology corridor until it commits to the off-ramp when so directed. The camera should also have the capability to allow the system operators to view the vehicles should it not comply with its signaled directive and continues to proceed to the protected structure. Note that at Eklutna test site, we employed the second camera for this task (i.e., the first camera is to check if the blankout sign was indeed activated). When the

purpose of such a system is simply to monitor and record the eventual paths and consequent events of the overheight vehicles, one camera alone can meet the purpose.

Also note that at the Eklutna test site, the video capture device cannot capture slower target vehicles within the typically adequate video recording duration (15 second maximum set by the system manufacturer). This is partly due to the insufficient distance between the sensor and the blankout sign. Also, during winter snow events, vehicles tend move slower than expected. Future design of such systems should take into accounts of these two factors at the locations of installation.

- c) Remote communication to the site utilizing DSL or T1 technology for real-time operational video viewing and system controller configuration is recommended for purposes of maintenance and system reliability. Such communication would also allow for download of system logs and video captures without a site visit.

### **III. Controller**

- a) The controller should have the capability to perform the fail-safe and fault detection logic as used at the Eklutna test site to minimize false triggering. Note that fault detection at the Eklutna site is bypassed frequently because the distance between the sensor array and the existing blankout sign does not result in adequate processing time for the system.
- b) The controller should trigger the blankout sign and camera simultaneously as it does at the test site.
- c) The controller should be able to log trigger events, complete with timestamps. No such logging is implemented in the Eklutna test design.

### **IV. Site Layout Considerations:**

- a) The overheight sensor array should be positioned such that the distance between transmitter and receiver heads are minimized to reduce power loss that, in heavy snow/rain events and/or when the lenses are dirty, may cause false triggers.
- b) Loop detectors should be placed before and after the overheight detector beam such that false triggers can be minimized as implemented at the test site, which uses the controller logic that any trigger not generated in conjunction with the correct loop trigger sequence and count, is identified as false. Loops also allow for speed and length calculation. Length determination is useful in that it allows for the identification of passenger cars, reducing false triggers. Speed determination provides for elegant sign triggering by calculating individual trigger display time and duration based on each individual target vehicles speed.
- c) Sensor array should be far enough in advance of the blankout sign to allow for adequate sort decision processing time. In the case of the Eklutna test site, results showed that for longer vehicles travelling in excess of 55 mph the processing time was not adequate for the

fault detection of the iSINC controller. For shorter vehicles travelling substantially faster, the same situation occurred, resulting in the blankout sign not displaying the advisory message.

To determine the proper distance, the following set of rules is used. When applying the rules, we assume the average speed of a target (overheight) vehicle to be 60 mph (i.e., 88 feet per second). The designer of the system needs to apply an appropriate value for the maximum length of target vehicle that is specific to the intended installation location.

- i. The blankout sign should be located at a minimum of 1760 feet upstream of the off-ramp approach plus an additional 800 feet for each additional travel lane.
- ii. The sensor array should be located away from the blankout sign at a minimum of 308 feet for the display duration (i.e., 3.5 second for the driver to see the sign display and process the information), plus 88 feet (i.e., 1 second) for signal processing and relay trigger time, plus the maximum length of the target vehicle traveling at 88 feet per second after it pulls off from the trailing edge of the downstream loop. That is a total of 398 feet plus the maximum length of the target vehicle, measured from the edge of the downstream loop to the blankout sign.

#### V. **Site Considerations:**

The false alarm rate of an overheight detection system strongly depends on the weather conditions at the site. For locations with significant number of days when the average air temperature is below  $-10^{\circ}$  F, the false alarm rates at such locations can be expected to be higher than what we observed at Eklutna. Systems at locations with frequent rain and/or snow events also expect high false alarm rates.



[Appendix A Schematics and Operational Description of the iSINC Controller](#)

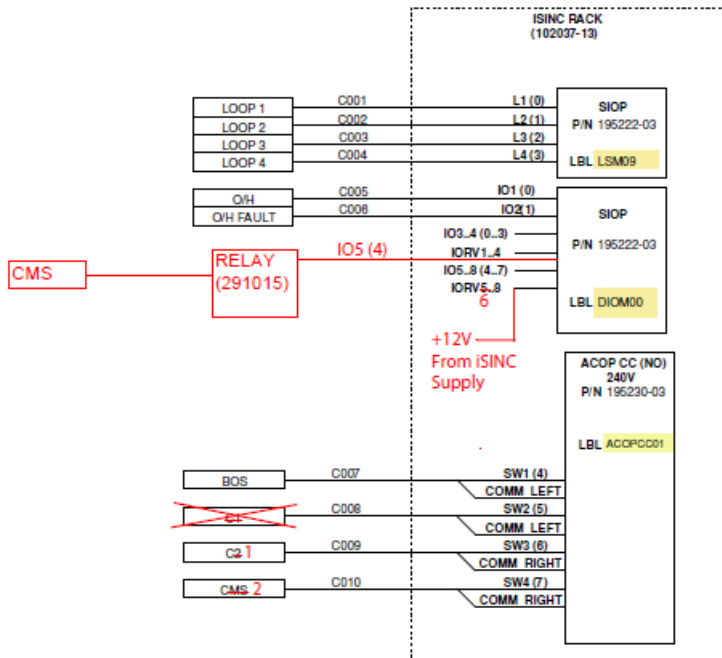

LEGEND:  
 OH- OVERHEIGHT DETECTOR  
 BOS - BLANK OUT SIGN  
 C - CAMERA  
 CMS - CHANGEABLE MESSAGE SIGN

NOTES: (THIS SHEET ONLY)

- 1 DEVICES LABELED WITH TEXT IN LBL FIELD. THE LAST TWO DIGITS IN THE SIOP LBL FIELD INDICATE UID OF THE CONNECTED MODULE.
- 2 ISINC MODULE UNIT IDENTIFIERS (UID) ARE CONSTRUCTED BY CONCATENATING THE SLOT AND BACKPLANE IDENTIFIERS TO FORM A TWO DIGIT HEXADECIMAL NUMBER (0x<BID>-<SID>) eg. IF BID = 1 AND SID = 2, THEN UID = 0x12.
- 3 TERMINATION CHANNEL NUMBERS ARE SHOWN FOR REFERENCE IN PARENTHESIS NEXT TO TERMINATION NAMES.
- 4 SEE DWG #81300739 FOR SIGNAL I/O, AC OUTPUT, AND FIBER OPTIC FIELD TERMINATIONS.
- 5 CONNECT DC DISTRIBUTION PANEL BUSSBAR TO CABINET GROUND ROD USING 6AWG BARE COPPER INCLUDED WITH RACK.

REV.	DESCRIPTION	DWN/DSN	APPR.	APPR.	DATE	CONFIDENTIAL THIS DOCUMENT CONTAINS INFORMATION PROPRIETARY TO IRD AND IS THEREFORE NOT TO BE DISCLOSED TO OTHERS OR USED FOR PRODUCTION WITHOUT WRITTEN PERMISSION FROM INTERNATIONAL ROAD DYNAMICS INC.	 NOT TO SCALE SIZE: B DIMENSIONS IN-VA	INTERNATIONAL ROAD DYNAMICS INC. SASKATOON SASKATCHEWAN CANADA	
A	INITIAL RELEASE	Spj	Spj	Neil Klassen	Nov 12 / 09			DWG.	SITE TERMINATION OVERHEIGHT ALASKA
						DWG. No.	C11185001	REV.:	A
						FILENAME:	C11185001.vthought	SHEET:	1 OF 1

## Operational Description for Eklutna OHVD iSinc Controller

This document serves as an appendix to the iSINC Rev T Firmware Document #81103701. Purpose of the document is to add detail to the menu items specific to the configuration of the Overheight Vehicle Detection System at Eklutna in addition to the general information contained in the manual. This document also serves as a quick-guide for operation of the controller.

### Starting/ Stopping the controller:

As soon as the 120VAC “iSinc” labeled power cord is plugged into a 120VQAC HZ circuit receptacle, the controller instantly powers up and loads the operating system. Allow about 30 seconds for full boot to occur and network connections to be established. Loop status LEDS on the LSM module will become active when the system is ready. Removal of power at any time stops the controller operation. Any power interruption has no negative effect on the operating system.

### Connecting and logging onto the iSinc controller:

Local, direct connection can be obtained by placing the connecting device through a Cat5e or similar cabling to the Ethernet port on the WCU card. Make sure the connecting device is within range of the IP address of the gateway. Be ready to supply the Login and Password. You will now have accessed the maintenance menu. See Section 3.3 for more detail.

To connect through the WIFI, set the connecting device to DHCP and be ready to supply the WEP key. Be ready to supply the Login and Password. You have now accessed the maintenance menu. See Section 3.3.

### For the system to operate, 2 key areas of the maintenance menu requires configuration.

1. Site Parameters that govern the generation of vehicle record needs to be established. Without vehicle records, system sorting cannot take place. At Eklutna 2 lanes needs to be created: SBright & SLeft. Loop inputs needs to be defined and overheight triggers established...Refer to Section 6.7 for Site parameters Overview, Section 6.7.1.5 for Overheight Processing and 6.7.1.5.1 for Overheight Fault Processing.  
Loop Tuning and Calibration Settings is described in detail within 6.4.2.
2. Sign Control parameters needs to be established within the Sorter segment of the menu. The operational description is found within 6.8.3.

To effectively monitor the Controller operation, the “View Vehicles” sub-menu, within the “Vehicle Passage” menu should be utilized. Details can be found under Section 6.1.1.

**1).Site Parameters**, as described in 6.7, allows vehicles records to be established by defining upstream and downstream loops. These loop combinations determine the vehicle’s length and speed and

determine whether or not there is an overheight detection associated with it.

```
Select Lane 1
Lane Name SBRight
Lane State ENABLED
AVI Only Lane N
Upstream Loop >
Downstream Loop >
Axle Sensors >
Off Scale >
Overheight >
Processing >
```

Lane has been selected now the Upstream Loop is selected and distance settings established.

```
Loop State ENABLED
Loop Type LSM
Module UID (hex) 9
Channel Num 0
Maxima Reporting DISABLED
Minima Reporting DISABLED
Width(cm) 183
```

After selecting the “Upstream Loop” in the prior menu. The Upstream Loop in Lane 1 is then enabled and the input card and channel are defined. Also the electro magnetic width is defined in centimeters. This setting contributes to the overall length calculation. Next the loop signal level is set within the loop calibration sub-menu as seen in this typical setting capture below.

```
Select Lane 1
Select Loop UPSTREAM
Loop Type LSM
On Debounce (ticks) [default 240] 240
Off Debounce (ticks) [default 240] 240
Threshold [default 8] 2
Detune Factor 0.5000
Baseline Average 14124
Baseline Stand Dev 0
Osc Freq kHz 0.0000
Show Freq per Lane
Show Freq per UID
```

The Downstream Loop is then established by selecting the corresponding field in the first screen capture above. Note the Input card and channel is defined as is the electro-magnetic width. In addition the "Distance" field is added. This field is used to define the distance between the loops. This field is critical to calculate the length and speed of the vehicle. If the displayed length is lower than measured, increase the distance proportionally within this field setting. Speed will simultaneously corrected.

```
Loop State ENABLED
Loop Type LSM
Module UID (hex) 9
Channel Num 1
Maxima Reporting DISABLED
Minima Reporting DISABLED
Width(cm) 183
Distance(cm) 497
```

Below are Southbound Left Lane (Lane 2 ) loop configurations: Upstream followed by the downstream setup below.

```
Loop State ENABLED
Loop Type LSM
Module UID (hex) 9
Channel Num 2
Maxima Reporting DISABLED
Minima Reporting DISABLED
Width(cm) 183
```

```
Loop State ENABLED
Loop Type LSM
Module UID (hex) 9
Channel Num 3
Maxima Reporting DISABLED
Minima Reporting DISABLED
Width(cm) 183
Distance(cm) 497
```

Loops are now configured. Overheight setting will now have to be established within the Site Parameters Lane configurations.

Under the processing header in the Site Parameters menu (first screen capture displayed above) the overheight enabling and fault settings sub-menus can be accessed for configuration. See below:

```
OH Fault Input ENABLED
Module UID (hex) 0
Channel Num 5
Polarity ACTIVE LOW
False Trig Detection ENABLED
False Trigger Threshold 4
Fault Clear Timeout (sec) 10
Fail Mode SAFE
```

```
OH Fault Input ENABLED
Module UID (hex) 0
Channel Num 5
Polarity ACTIVE LOW
False Trig Detection ENABLED
False Trigger Threshold 4
Fault Clear Timeout (sec) 10
Fail Mode SAFE
```

2). **Sign Control Settings** needs to be established under Sorter Parameters menu. See 6.8.3.

Because, vehicle speed has been calculated and is specific to each target vehicle, discrete on and off timer durations are calculated for each target vehicle. For simplicity they are expressed in distances,

since distances are the only variables, related to time that can be controlled. Below are the Lane 1 BOSSettings :

```
Sorter >
Err & Status >
Sign Config >
Class/Cmpl >
Traffic Control >
Match >
Video Capture >
CVD Server >
MBUS Bridge >
XML WIM IF >
AVI Link >
Backup Detect >
```

```
Sign Number 1
State ENABLED
Mode REAL
Module UID (hex) 1
Polarity ACTIVE LOW
Report Chan 4
Man Con UID (hex) 0
Tell Back >
```



Below are the Timer Settings:

```
Loop Number 1  
Distance(m) 35  
Active Immediate N  
Mode VIRTUAL  
Loop Type DIOM
```

```
Loop Number 2  
Distance(m) 200  
Mode VIRTUAL  
Loop Type DIOM
```

Loop Number 3

Distance(m) 150  
Mode REAL  
Speed Chg Type %  
Speed Up(%) 10  
Slow Down(%) 10  
Loop Type DIOM  
Module UID (hex) 0  
Polarity ACTIVE LOW  
Channel Num 0

Loop Number 4

Distance(m) 200  
Mode REAL  
Speed Chg Type %  
Speed Up(%) 10  
Slow Down(%) 10  
Loop Type DIOM  
Module UID (hex) 0  
Polarity ACTIVE LOW  
Channel Num 0

Vehicle Passage Menu:

```
Disconnect  
Vehicle Passage >  
Data Collection >  
Veh Rec Transmit >  
Calibration >  
Utilities >  
WCU Configuration >  
Site Parameters >  
Processing >  
System Passwords >  
Diagnostics View >  
Diagnostics >
```

```
Vehicle Display  
Hit <-- key to exit  
Hit space to pause
```

```
(16) LANE SBRight CLASS 1 GVW 0.0 kips LENGTH 17 ft  
SPEED 64 mph MAX GVW 0.0 kips Thu Feb 21 2013 13:46:58  
█
```

Note that the vehicle display assigns a unique vehicle reference number with time stamp. Lane that the vehicle travelled in, including vehicle speed and length are also displayed. Had an error or Overheight Detection trigger occurred there would have been a status displayed in the 3<sup>rd</sup> lane that is blank in the example above

## **Appendix B Eklutna Inbound OVHD Troubleshooting Guide**

## EKLUTINA INBOUND (SOUTHBOUND) OVHD TROUBLESHOOTING GUIDE

Prepared for AKDOT&PF M&O Daniel Moose 1-18-2013

### Device List and Description

#### Equipment Item1. Trigg Industries Z-Eye Overheight Detector Heads:

The system uses a Dual Eye detection system that operates in this way: A detector head is positioned on each side of the travel lane. Each detector is powered by 120 VAC. Each detector produces a constant infrared emitting beam and one photo detection eye. The infrared beam of one is targeted to the photo eye of the other. Any interruption of beams creates a dry contact closure. The Head nearest the cabinet (known as the Receiver Head) differs from the other in that it directly receives the contact closure forwarded by the other Head (known as the Transmitter Head) compares it with it's own contact closure and if the sequence of triggers follows the direction of the traffic in the travel lane, the contact closure is forwarded to the controller.

#### Equipment Item2. Inductance Loops:

The system uses a pair of inductance loops in each lane to allow vehicle presence detection to be supplied to the controller. This allows the iSinc controller to determine the speed and length of vehicles. Length calculation is used to filter out vehicles below 18 feet from being signaled. Speed calculation is used to determine sign trigger start times and sign display durations. Both timers are customized for each specific target vehicle. Inductance loops also perform another critical function to the system by the specific location of each loop in the lanes. The 6x6' embedded loops are placed 10 feet in advance and 10 feet downstream of the detection beam. This allows the iSinc controller to employ the logic that if OVHD trigger is received and no vehicle has been detected by loops, the OVHD trigger is false. This contributes to the reduction of false triggers associated with a system that has so much distance (and in times of snow or heavy rain) power loss between the Detector Heads.

#### Equipment Item3. Blank-Out Sign (BOS):

The Blank-Out Sign is located downstream of the Overheight Detector Array. The fixed message, LED Display utilizes 120VAC power sourced from the Controller Cabinet Breaker Panel. Control to the sign is via passive switching through the ACOP unit on the iSinc. Both switch legs are held high until the controller determines an activation is necessary and a switch leg is brought to neutral. The BOS fixed message directs the target truck to take the bypass ramp ahead.

#### Equipment Item4. Changeable Message Sign (CMS):

The CMS is located at the end of the bypass ramp and directs the target vehicle to bypass further structures. Thus the message can be changed via a null serial port connection via a laptop equipped with the appropriate controller software. Sign power and triggering follows that of the BOS. The relay within the controller is actually located behind the ACOP face plate.

#### Equipment Item5.      [Cohu Video Camera 1:](#)

Camera 1 is mounted on the OVHD Receiver Pole and is routed directly into the DVR. It is targeted at the BOS and has focus and zoom functions only. The DVR captures clips triggered by the controller whenever the BOS is triggered. Camera 1 shows the target truck as it approaches the BOS and documents the display performance of the BOS.

#### Equipment Item6.      [Cohu Video Camera 2:](#)

Camera 2 is mounted on the BOS and is targeted on the bypass ramp gore. The DVR captures clips initiated by the timing out of the BOS display. It is used to determine if the target vehicle adheres to its advisory message.

#### Equipment Item7.      [Global DVR:](#)

This DVR receives contact triggers from the iSinc to record video clips generated by Cameras 1 and 2. One of the unique features of this Controller is that it allows presets to add video frames to clips...this feature is key to Camera 1's performance as it allows the clip to show the BOS actually turning on. This is useful in ascertaining that the sign did trigger and was not stuck-on. A negative of the DVR is the limited duration of the clips produced. 15 second maximum.

#### Equipment Item8.      [International Road Dynamics iSinc Controller:](#)

iSinc controller receives the Loop and OVHD inputs, makes logical decisions based on system inputs and menu configurations and produces corresponding outputs that triggers the signs and recording devices. The system uses 12vdc as operating power. It utilizes the LINUX operating system for gney interface and uses CANBUS for internal processing. The combination of CANBUS and LINUX allows for robust performance. The system can be cold booted at any time. Input cards are hot swappable. A single configuration file can be remotely loaded to restore the flash drive if ever needed so that system backup is simplified. The system has built in Ethernet and also allows for serial connections.

#### Equipment Item9.      [Linksys Wireless Router and Connection Information:](#)

This router allows network communication to the DVR and iSinc via wireless Ethernet. Site Key is the same as the password.

Device	IP Address	Login	Password
Wireless Router	192.168.42.4 port 80 for browser	lrd306	irdfield
iSinc Controller for Telnet	192.168.42.11 port 23(2300) for setup menu	wcuroot	ekovhd
iSinc Controller for SSH	192.168.42.11 port 22 for file transfer	root	1pw3
Global DVR	192.168.42.13 port 9010 for video (TCPIP)	na	na
Global DVR	192.168.42.13 port 80 for browser setup menu	admin	1234

**Troubleshooting Tips:** (Refer to the iSinc WCU controller guide)

**SYSTEM TEST:**

With power restored to all devices, and a reasonable amount of time allowed for the iSinc to boot and for the loop input card to tune (about 45 seconds) turn on the DVR Monitor.

Take the test jumper out of the cabinet drawer and insert it into the overheight signal trigger connector slot, after removing this connector. The test jumper will now serve as a substitute input for this signal, allowing the next truck to receive the Warning Message.

Viewing the video monitor and listening to the sound of the relay’s contact closure will allow you to witness and confirm the operational success of the system. Should any fault occur, consult the accompanying troubleshooting guide.

*Note that the BOS connector can be removed and a volt meter substituted if you wish to conduct a test of the controller and not the sign itself.*

Monitor the DVR and confirm the sign triggering while logged into the iSINC vehicle display. Any failure to signal the target vehicle will be apparent. If the vehicle record displayed is correct and “Overheight Detected” is posted any failure would have to fall within the signal cabling or communication equipment between the sign and controller. If the vehicle record is not correct, the error will be posted. Consult the iSinc Firmware and Operators Manual for any further diagnostics.

**Appendix C Eklutna OVHD Annual Maintenance Guide**



## EKLUTINA OVHD ANNUAL MAINTENANCE GUIDE

CREATED BY Daniel Moose for AKDOT&PF M&O

Rev. B Feb.19 2013

### I. Blank-Out Sign: TURN OFF POWER TO THE SIGN AT THE CONTROLLER CABINET

- a) Using contact cleaner, apply to Electrical connections after opening connectors. Be careful and avoid overspray in order to protect plastics. Secure the re-connection.
- b) Using plastic safe Electronics Cleaner (super wash #406B-425G). Apply to controller card/line and column driver as well as the power distribution board. Apply to LED Boards and wipe clean. Move on to step 2 while residues evaporate. By following this order, this spray will dilute any contact cleaner overspray.
- c) Access Blank-Out Sign and perform internal and external Lens cleaning using a quality glass cleaner. After cleaning treat with Rain-X to prevent fogging and deter dust and film buildup.

### II. Changeable Message Sign: SAME METHOD AS ABOVE. Note that the controller equipment is located within it's own enclosure. Cameras:

- a) Using a soft cloth and industrial glass cleaner, polish lens.
- b) Provide Rain-x treatment.

### III. Overheight Detectors:

- a) At the Receiver, remove back cover and remove front and aft alignment screws so that the peep site is available.
- b) Mark reference marks on both axis adjustments so that the original position will not be lost. Slightly loosen the horizontal axis bolts.
- c) Watch the power meter as the sensor is moved slightly to the right, mark the optimum position then move left and mark again the ultimate position. If a physical difference exists between marks, position the mount where it is now centered between the 2 marks. Secure but do not over torque the mounting bolts.
- d) Repeat this procedure for optimizing the vertical axis. Confirm using the peep sites that the transmitter head is centered in the site. Seal the peep sites.
- e) Disconnect Power to the Overheight Receiver Head and clean and secure the signal and power connections using contact cleaner. Replace the Receiver's back cover, make sure a small amount of silicone is applied to the seal and then secure the cover.
- f) Clean both the receiver and transmitter heads' lens using the same methods prescribed for the cameras.

#### IV. Controller Cabinet: REMOVE POWER!

- a) Tighten all connections on the loop and Overheight trigger termination strips located at the back of the cabinet.
- b) Tighten all connections on the iSINC controller. This includes the BOS connections and camera contacts on the ACOP, located on the front of the iSinc and the Changeable Message Signs connected to the back of the iSinc.
- c) Remove the individual input cards one at a time and clean using contact cleaner for the backplane connections followed by general application of electronic cleaner on the remainder of the circuit board. Reseat and secure then repeat for the remainder of the cards.
- d) Perform general cabinet cleaning removing dust that will eventually migrate to the electronics.  
RESTORE POWER
- e) Using the refrigerant producing characteristic of off the shelf electronic dust remover, spray onto the heater sensing element in order to verify the performance of the cabinet heater. Using a lighter, do the same for the fan temperature sensor to ensure that it works also.

#### V. SYSTEM TEST:

- a) With power restored to all devices, and a reasonable amount of time allowed for the iSinc to boot and for the loop input card to tune (about 45 seconds) turn on the DVR Monitor.
- b) Login to the iSinc and disable the fault and fail-safe features.
- c) Take the test jumper out of the cabinet drawer and insert it into the overheight signal trigger connector slot, after removing this connector. The test jumper will now serve as a substitute input for this signal, allowing the next truck to receive the Warning Message.
- d) Viewing the video monitor and listening to the sound of the relay's contact closure will allow you to witness and confirm the operational success of the system. Should any fault occur, consult the accompanying troubleshooting guide.
- e) Re-enable the fault and fail-safe features.

## **Appendix D Technical Details of the Recommendations**

**Recommendations Specific to the Test Site at Eklutna: (Note that specific recommendations are applicable to both Outbound and Inbound Systems unless specifically stated).**

1. **Blank Out Sign Relocation.** Reposition the Blank Out Sign an additional 100' downstream from its existing location away from the Sensor Array.

**Benefits:**

A) Relocation will result in adequate controller processing time, which in turn will allow the failsafe and fault detection functions to work for all vehicles at all speeds.

B) Allow the existing Camera array to capture the slower target vehicles all the way to the bridge structure.

2. **Establish Remote Communication.** Add a Cellular Radio Modem to reach a hardwire phone line or wireless connection supplied by an ISP. Currently MTA has both in the vicinity but not at the depression in which the Southbound controller cabinet is located, Northbound connection is more easily obtained. Adequate WIFI signal is available. Southbound would require a radio similar to that provided by Raven Electronics to serve as a repeater.

**Benefits:**

Minimally, remote communication with the cabinet network would provide for real-time connection to the iSinc Controller and the DVR.

Such a connection would allow for real-time visual system status checks via the DVR split screen displays and through the controller vehicle display. Network connection to the system controller would also allow for real-time configuration performance diagnostics and if needed configuration modification and remote system restarts. Remote uploading and downloading of configuration files and archived log files would also be possible within existing system capability.

With proper bandwidth, downloading of video files would, likewise, be possible within existing system capability.

3. **Restore Controller Cabinet Grounding.**

**Benefits:** Dissipate sign triggering irregularities such as periodic sign signaling performance problems including the sign not turning off occasionally. This is an absolute must at the Inbound site.

4. **Secure the Blank Out Sign.** Tighten the Blank Out Sign structure's base mounting bolts at the Inbound BOS. The sign has a very notable lean...which will ultimately result in the break-away base allowing the sign head to collapse.

## **General System Design Considerations for Future Systems:**

Prepared for AKDOT by Daniel Moose rev. B 2/20/2013

### **VI. Blank Out Signs: General Performance and Positioning Guidelines**

1. Blankout Signs must have a trigger time of less than 100ms.
2. Blankout Signs must have a cone of vision equal to 30 degrees on the horizontal axis and 20 degrees on the vertical and conform to TS4 luminance and environmental requirements (see Design Attachment A, TS4 requirements for 12" Signs).
3. Blankout Signs should utilize LED Displays with 12" characters for speeds above 55 mph.
4. Blankout Signs should be positioned so that target vehicles are exposed to a 3.5 second message duration. For a vehicle traveling 60 mph (88' per second), the display distance = 308'.
5. Blankout Sign position should allow for significant reaction time that consists of a minimum 4 second decision time and an 8 second turning movement. This equates to a 1056' reaction time between Blank Sign and off-ramp at 60mph travel speed.
6. As in the case of Eklutna, where an additional lane exists in which target vehicles may be present, another 8 seconds of response time should be added for this additional turning movement. Reaction and vehicle response time to the off-ramp equates to a distance of 1760' (Significant uphill grade would reduce this response distance requirement as would a downhill grade increase it).

### **VII. Site Monitoring: Camera and DVR Positioning and Capability**

1. Video and or Infrared Cameras should be utilized as they were here at the test site. Cameras should be positioned so that the image of the target vehicle and the sign are displayed prior to and during the sign illumination, as it occurs. This pre-capture capability is necessary to ensure that discrete signaling is taking place, and that the Alert Message is not staying on continually.
  2. The Camera should also be positioned so that it captures the target vehicle's progression from the signal device, as it proceeds down the technology corridor, until it commits to either continuing on the mainline, toward the protected structure or it begins and then completes the turning movement to the off-ramp when so directed.

\* Note that at the Eklutna test site, we employed a second Camera to conduct this additional task. It should also be noted that at the test site, the video capture device would not allow for what turned out to be an adequate video recording duration (15 second maximum allowed) for covering slower target vehicles. DVR selection should require longer Clip Duration capability to ensure that turning movements have been completed and that the vehicles that do not

comply with their signaled directive have any consequence subjected to the structure captured.

3. Camera capability should contain full PTZ capability for easier maintenance and better performance.

### **III. Communication:**

Remote Communication to the site utilizing DSL or T1 technology allows for multiple high value benefits such as:

1. Real-time operational monitoring by viewing live video streaming.
2. Real-time controller monitoring via the controllers vehicle display.
3. Recent performance history by viewing recent video clips and review of site logs.
4. System maintenance and performance tuning by being able to adjust camera and controller settings.
5. Ability to upload configuration files and firmware revisions remotely to the controllers and auxiliary devices.
6. Ability to remotely retrieve video clips and log files.
7. Allow for remote vendor input.

At the Eklutna test site, the primary system shortcomings were all associated with the site isolation due to the inaccessibility.

### **IV. Controller**

- a. The Controller should have the capability to perform the fail-safe and fault detection logic as used at the test site to minimize false triggering. Note that fault detection here was bypassed frequently due to inadequate processing time due to the Sensor Array's too near proximity to the existing Blankout sign.
- b. Controller should trigger the Blankout Sign and Camera simultaneously as it did at the test site.
- c. Controller should be able to log trigger events, complete with timestamps. No such logging was included in the test design.

### **V. Site Layout Considerations:**

- a. a. Sensor Array: The Overheight Detector Array should be positioned so that the distance between transmitter and receiver heads are minimized to reduce power loss that in inclement weather (here: heavy Snowfall and dirty lenses) may create false triggers.

b. Loop Sensors should be placed before and aft of the detector beam so that false triggers can be minimized as attempted by the test site, using the logic that any trigger not generated in conjunction with the correct loop trigger sequence and count, is false. Loops also allow for speed and length calculation. Length determination is useful in that it allows for the filtering out of passenger cars, reducing false triggers. Speed determination provides for elegant sign triggering by calculating individual trigger display time and duration based on each individual target vehicles speed.

c. Sensor Array should be far enough in advance of the Blankout Sign to allow for adequate sort decision processing time. In the case of the Eklutna test site, results showed that for longer vehicles travelling in excess of 55 mph the processing time was not adequate for added fault detection. For shorter vehicles travelling substantially faster the same situation occurred resulting in the Blankout sign not displaying the advisory message. To determine the proper distance, a maximum target vehicle length and speed needs to be assumed and from the resulting calculated travel distance and additional 1 second should be added in travel distance. The additional 1 second should allow for processing and signal relays to perform.

\*Note that a solution for both items a. and c. was present at Eklutna during the original install. The array could have been moved upstream ~150' towards the bridge, which would have allowed the Overheight Transmitter head to have been located in the median, thereby reducing power loss by reducing the distance of separation. The Overheight mounting pole would have been protected by the bridge structure guard rails and the increased distance between Array and Blankout Sign could have been maximized for processing time.

## **VI. Additional Signing:**

The inclusion of an additional sign positioned at the end of the off ramp is a useful tool in communicating other structural obstacles for target vehicles to avoid within the travel area.

## **VI. Summary of Design Considerations for Distance of Separations Between System Devices Using Target Vehicles Assumed Speed of 60mph:**



Blankout Sign should be located at a minimum of 1760' upstream of the Off-ramp approach + an additional 800' per each additional travel lane. The Sensor Array should be located 308' (for display duration) + 88' (processing and relay trigger time) + the assumed maximum target vehicle length traveling 88' feet per second after it pulls off from the trailing edge of the downstream loop.