

Open Research Online

The Open University's repository of research publications and other research outputs

Larval ecology of benthic marine invertebrates at Signy Island, Antarctica

Thesis

How to cite:

Stanwell-Smith, Damon Peter (1997). Larval ecology of benthic marine invertebrates at Signy Island, Antarctica. PhD thesis. The Open University.

For guidance on citations see [FAQs](#).

© 1997 Damon Peter Stanwell-Smith

Version: Version of Record

Copyright and Moral Rights for the articles on this site are retained by the individual authors and/or other copyright owners. For more information on Open Research Online's [data policy](#) on reuse of materials please consult the policies page.

oro.open.ac.uk

**Larval ecology of benthic marine invertebrates at Signy
Island, Antarctica**

A thesis submitted in accordance with the requirements of the Open University for the
degree of

Doctor of Philosophy

by

Damon Peter Stanwell-Smith (BSc. Hons)

date of award: 30th June 1997

British Antarctic Survey
High Cross
Madingley Road
Cambridge CB3 0ET
England

May 1997

ProQuest Number: C616159

All rights reserved

INFORMATION TO ALL USERS

The quality of this reproduction is dependent upon the quality of the copy submitted.

In the unlikely event that the author did not send a complete manuscript and there are missing pages, these will be noted. Also, if material had to be removed, a note will indicate the deletion.



ProQuest C616159

Published by ProQuest LLC (2019). Copyright of the Dissertation is held by the Author.

All rights reserved.

This work is protected against unauthorized copying under Title 17, United States Code
Microform Edition © ProQuest LLC.

ProQuest LLC.
789 East Eisenhower Parkway
P.O. Box 1346
Ann Arbor, MI 48106 – 1346

Dedicated to Alistair Torr

**Alistair was killed in a plane crash on 25th August 1996, along with Marcie Miller and Struan Andrews,
whilst surveying game in the Okavango Delta, Botswana**

**“We learned to know why we did these things. The animals were very beautiful. Here was life from which
we borrowed life and excitement. In other words, we did these things because it was pleasant to do them.”**

John Steinbeck, The Log from the Sea of Cortez

Contents

	Page
Abstract	i
Acknowledgements	ii
<i>Chapter 1</i> General introduction	1
Figures	11
<i>Chapter 2</i> Survey of pelagic marine invertebrate larvae	
2.1 Introduction	15
2.2 Methods	18
2.3 Results	24
2.4 Discussion	29
Figures	39
<i>Chapter 3</i> Recruitment and growth on settlement panels	
3.1 Introduction	55
3.2 Methods	57
3.3 Results	61
3.4 Discussion	67
Figures	74
<i>Chapter 4</i> Seasonality of reproduction in the starfish, <i>Odontaster validus</i>	
4.1 Introduction	84
4.2 Methods	86
4.3 Results	88
4.4 Parasite observations	94
4.5 Discussion	97
Figures	104

	Page
Chapter 5	Temperature and embryonic development
	Temperature effects on development in three common Antarctic echinoderms
5.1	Introduction 115
5.2	Methods 117
5.3	Results 120
5.4	Discussion 124
	Figures 129
5.5	Spawning and development in the limpet <i>Nacella concinna</i> 137
	Figures 143
Chapter 6	Overview 146
References	151
Appendix	(Larval survey and settlement panel data) 174

Abstract

This project investigated four areas of larval ecology of marine invertebrates, between November 1992 and February 1995 at Signy Island, Antarctica (60°43'S 45°36'W).

- 1) Survey of pelagic larvae: a diver towed net and hand-held plankton pump were used, with regular samples (total=317) at five sites (6-30m). 131 morphologically distinct larval forms were identified, representing most benthic phyla present. Larval abundance was low throughout the year, although seasonality was observed in echinoderms (winter spawners) and annelids (summer spawners). These low larval abundances were possibly due to dilution in the Southern Ocean during their slow development.
- 2) Settlement panel experiment: identity, quantity and seasonal variation in recruiting invertebrate larvae were investigated. Longer-term community development was followed using monthly *in situ* photography of continuously immersed panels. Shorter-term (seasonal) variations in recruitment were studied by regular replacement of triplicate panels. Bryozoans and annelids were the dominant colonising taxa. Very low levels of colonisation were observed: <2% cover at 5m, <6% cover at 25m, after 15 months immersion. Growth was measured in encrusting bryozoans using image analysis (mean growth 1.7mm² to 7.1mm².mo).
- 3) Reproductive seasonality in the common antarctic cushion star, *Odontaster validus* was measured using tissue indices, induced spawning and elemental analysis. Data showed seasonal feeding (summer), winter spawning and long-lived planktotrophic larvae. 38% of the population studied was infected by the endoparasitic ascothoracid barnacle, *Dendrogaster antarctica*.
- 4) The effects of temperature on development was investigated in detail in three common antarctic echinoderms and the limpet, *Nacella concinna* (all possessing a pelagic larva), using a thermogradient block (14 steps, -2° to +3°C). A temperature window optimising development time and embryo mortality was observed in which an echinoid spawned (austral summer), despite having functionally identical larvae to the winter larvae of asteroids. Sea temperature rather than food availability was therefore possibly the constraining factor on larval seasonality for these echinoderms.

Acknowledgements

This project naturally divides into two sections: fieldwork in Antarctica and the writing in Cambridge. I would first like to thank the base members at Signy between 1992 and 1995 who made the fieldwork possible. In particular my fellow divers, Rob Wood and Simon Brockington were the team all the way through (liking it so much that they are back at Rothera now!), and Patty Brouwer who was there in 1992-93. Russ Manning, Andy Owen and Matt Chalmers drove the boats and hauled us out in all weathers. Nick Turner, Phill Bramham and Tim Hill built equipment whenever needed; and Liz PT... thank you for staying close, both in the UK and at Signy.

Once back in Cambridge, the writing up of papers was helped by Roger Missing and Tony Sylvester in the drawing office, Julie Leland with wordprocessing, Alistair Murray with the numbing stats, Ken Robinson with the SEM, Christine Phillips in the library and Tony Clarke in the information office. Alison Hood compiled the pictures and text for the larval fieldguide, with help from Alice Chapman. In addition, Nick Dulvy, Lucy Conway, Sara Lawrence, Dave Brown, Nadine Johnston, Amanda Nimon, Emma Hatfield, Andy Brierley and Phil Pugh have all been around to chat over problems and to offer advice.

There are people who have helped throughout: I cannot express adequately in words how grateful I am for the advice and support I have received from my supervisors Lloyd Peck and Chris Todd, and advisor, Andrew Clarke. I moved into Dave Barnes' office when I arrived at Signy; and again when I returned to Cambridge. Each time he set me straight with how to approach both fieldwork and writing; ever encouraging me to try and fill those big shoes (literal and metaphorical!) of his. For 18 months on Signy, and all the time at Cambridge, Chad Marshall has been there to sort out what exactly is going on.

Karen has put up with me in these last few months, as we both finish our projects; and my parents are ever supportive of my wanderings.

Thank you to you all, for making my time in Antarctica so very special, and my time in Cambridge so fulfilling.

Chapter 1 General Introduction

Background

By way of introduction to this project, perhaps a succinct starting point is presented in a passage from the initial British Antarctic Survey job description. It required research on Antarctic larval ecology:

“The extreme seasonality of the system poses a potentially severe ecological problem for any pelagic larva released into the water column. Indeed it has long been known that most polar marine invertebrates (in terms of species) avoid a planktonic larval stage (Thorson’s Rule). Interestingly, many of the common species do release a planktonic larva, and recent work by US scientists has questioned the general validity of Thorson’s Rule. This project will look at the timing and duration of the larval development of the more common larval types. It relates directly to present work on the biology of suspension feeders (primarily bryozoans) currently under way at Signy.”

If the assumption that there are so few pelagic larvae in the Southern Ocean is correct, how do remote locations such as Signy Island colonise after de-glaciation? The diversity in Antarctic benthic fauna is evident and recognised (Annaud 1974; Arntz 1994; Arntz et al, in press), but how do such communities persist in the face of perturbation from ice in an environment of climatic extremes? In comparison with temperate and tropical locations, there is a relative lack of polar data to answer questions such as these. An aim of this project was to contribute further evidence to test the hypotheses.

A brief history of Larval Ecology

In 1990, Craig Young wrote an eloquent and comprehensive history of larval ecology. He divided the 150y, or so, history of this subject into five eras:

(1) The 19th century: a period when larvae were recognised as being part of the complex life histories of other organisms, Thompson (1828, 1830) stood out as the discoverer of crustacean larvae, and as pointed out by Young (1990), also described the plankton net and plankton pump as the main tools for the study of larvae; as they are today. Müller (1846) also used plankton nets, discovering various larval forms including echinoplutei, ophioplutei, tornaria larvae and actinotrochs. Many other workers also collected larvae during this period, describing them in exhaustive detail in illustrated monographs, as was characteristic of the Victorian era (including: Milne-Edwards 1842; Sars 1844; Desor, 1851; Lacaze-Duthiers 1856-57; McCrady 1860; Hacker 1898).

(2) 1900-1930: During this period methods for rearing larvae were developed, and these were essential for further ecological study (Macbride 1900; Lebour 1933). Extensive studies on echinoderms were made in this period by Mortensen (1921), and on the culture of oyster larvae by the father and son team of Julius and Thurlow Nelson (eg. Nelson 1928). Nelson and Mortenson were also accredited with developing the theory of "delayed metamorphosis" of larvae (Young 1990).

(3) 1930-1950: The wartime era stimulated research into fouling organisms (e.g. Pomerat and Reiner 1942). It was also in this period that the Danish biologist Gunnar Thorson started work on larvae. He introduced the term "larval ecology" and carried out some of the most detailed larval work ever produced. His doctoral thesis was on the ecology of Arctic larvae, in NE Greenland. He over-wintered in 1931-32 and carried out a year-round survey of

monthly samples and published the results as the seminal work on polar larvae (Thorson 1936). He then studied the larval ecology of Danish and Swedish waters for several years, resulting in a now classic monograph (Thorson 1946). Thorson then published a review on the larval ecology of benthic invertebrates (Thorson 1950); even today this review forms the basis for most discussion of larval ecology.

(4) 1950-1970: In this period, the role of behaviour during settlement and the resulting community structure was extensively researched (Knight-Jones 1953; Ryland 1959; Wisely 1960; Crisp 1961; reviewed by Crisp 1984). The Russian oceanographer, Simeone Mileikovsky made several contributions to polar larval ecology (1968, 1970), culminating in the review which coined the phrase “Thorson’s Rule” (Mileikovsky 1971).

(5) 1970-present: Experimental larval ecology has flourished in recent years, with more emphasis on the study of larvae in their natural habitat (e.g. Olson 1985; Babcock 1986; Young 1986). More sophisticated techniques have been developed (for example direct tracking of larvae, reviewed by Levin 1990) and evolutionary aspects of larval life history strategy, and modelling have been extensively addressed (e.g. Vance 1973; Strathmann 1974; Jablonski 1986; Eckman 1996).

As can be seen in this precis of the last hundred years or so, there has been a pattern of description, followed by experimentation and the development of theories which then need validating. This project represents one such return to what could be considered basic science. On a broader scale this pattern of “back to basics” is reflected by the demand on traditional biological disciplines such as taxonomy, in the wake of biodiversity interest in recent years (Cotterill and Dangerfield 1997). Of the workers in the field of larval ecology, perhaps the most influential has been Gunnar Thorson for his contributions to both empirical study and developing theories. I found a majority of the evidence cited by larval strategy papers in the

literature searches conducted for the present project were directly or indirectly from Thorson's research. However, his conviction that polar marine invertebrates avoid a pelagic larval stage does beg the question: how do Antarctic benthic marine invertebrates disperse and colonise new areas?

Antarctica

From an anthropocentric point of view, the Antarctic represents one of the most inhospitable places on earth. This may be true for the terrestrial environment, but the richness of its surrounding seas suggest that the challenge of living there may not require the extreme adaptation perhaps assumed by a casual observer. Secondly, Antarctica is an isolated continent, surrounded by ocean; in contrast to the Arctic, an ocean surrounded by landmass. (Plate 1.1).

Plate 1.1

Computer simulation of polar regions (with false colour to represent elevation). The left image is the Arctic, the right the Antarctic.

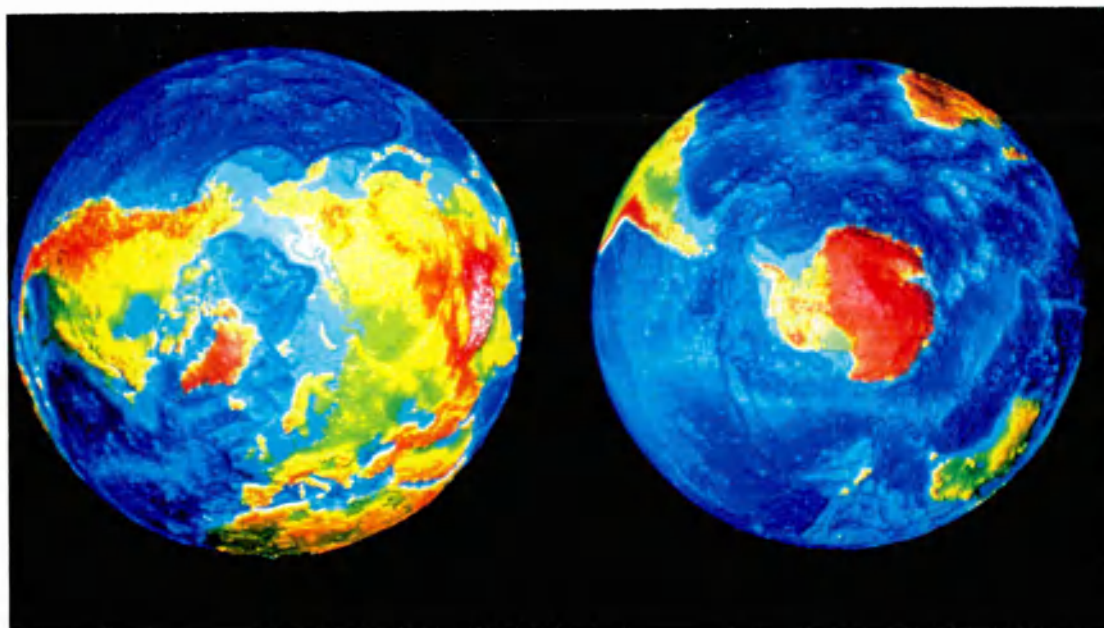

Water flows continuously around the Antarctic continent (the Antarctic circumpolar current, ACC), driven by surface winds. It extends to the Southern Ocean basins and transports more water than any other current system in the world (Foster 1984). It moves slowly with a mean current speed of $0.23\text{-}0.35\text{m}\cdot\text{s}^{-1}$ (Hofmann 1985). The ACC moves eastward, with a northerly component, with lesser currents and gyres also occurring around the continent. Treguer and Jacques (1992) have divided the Southern Ocean into three zones according to patterns of sea-ice cover and phytoplankton production: 1) the “permanently open ocean zone (POOZ), 2) the seasonal ice zone (SIZ) and 3) the coastal and continental shelf zone (CCSZ).

However the definition of an Antarctic Ocean, in terms of benthic ecology, is not straightforward. This has been emphasized by Dell (1972) and Clarke (1996b), especially for the islands of the Scotia Arc. The areas south of the oceanographic barrier, the Polar Frontal Zone (previously called the Antarctic Convergence), are deemed to be within the Southern Ocean and are therefore Antarctic habitats, as opposed to the sub-antarctic locations including Marion Island, Macquarie Island and Îles Kerguelen.

The location of Signy Island

Signy Island is located in the South Orkney Islands (Fig. 1.1a), which are one of the archipelagos that emerge as the peaks of a sub-sea mountain range that links the South American Andes and the Antarctic Peninsula: the Scotia Arc. At a latitude of $60^{\circ}43'\text{S}$, Signy is north of the Antarctic circle but south of the Polar Frontal Zone, lying in the region described as the maritime Antarctic (Holdgate 1967). Signy Island’s terrestrial biota comprises patches of moss and lichen, with mites as the largest permanent animal inhabitants.

Seasonal visits by larger animals include a growing population of non breeding fur seals currently numbering 20,000+, together with smaller numbers of Elephant, Weddell and Crabeater seals. Leopard seals also patrol the inshore waters during the austral summer, preying on the 100,000+ penguins that breed there. However the paucity of terrestrial fauna is in contrast to the rich and diverse benthic fauna of the shallow waters surrounding Signy Island. A range of sublittoral habitats are present, from rocky caves and smooth rock substrata to boulder fields, cobbles, pebbles and soft sediments; typical of the maritime Antarctic in general (Clarke 1996a). Most benthic taxa are represented, with the species richness of the more common taxa listed in Table 1.1.

From a SCUBA perspective, perhaps the most striking feature of the benthic fauna is the bright colour and high levels colonisation of any rocks not obliterated by the regular iceberg damage (Plate 1.2). Ice has a major influence on the inshore marine ecosystem of Antarctica; directly by ice scour and icebergs, and indirectly by glacial run-off and the effect of winter sea-ice (Clarke 1996a). Ice is also the dominant physical factor in habitat zonation, structure and succession in the shallow waters (Barnes 1995b,c).

Plate 1.2

A few of the diverse benthic fauna present in Signy waters. Conspicuous species present are: the echinoid, *Sterechinus neumayeri*; the purple starfish, *Odontaster validus*; and the yellow starfish, *Odontaster meridonalis*; all subjects of study in chapter 5.



The research station

The biological research station (Plate 1.3) was established on the site of a small whaling station dating from the 1920's. The first building was built in 1947, housing three people for the winter of 1948, during which time a complete elephant seal survey was carried out, the first biological work undertaken. At this time, the main duties were meteorological observations, and to maintain a British presence. Over the years, buildings were added and more personnel stayed year-round. Over the last 30 years or so, around 25-27 people lived at Signy in the austral summers, with 10-16 over-wintering. Signy station was re-built in 1996, with a new brief as a summer only facility, confined to conducting research on terrestrial and lake biology. The wintering Signy station therefore had a long tradition of marine work, and it is sad that this project represents the last marine biology PhD to be conducted there.

Plate 1.3

The station at Signy Island surrounded by sea ice in the winter. The lines radiating from the jetty show where snowmobiles have travelled onto other parts of the island and to dive-sites.



Diving at Signy was first carried out in 1962-63 and has been an integral part of base life ever since. In the early 1990's, Signy station was still only one of only a few Antarctic bases conducting a year round diving programme; with over 1300 person-dives completed per year. Diving in the waters at Signy involved similar equipment to temperate locations, with environmentally sealed SCUBA regulators and 8mm drysuits being the only concession to the cold (White 1995). Inflatable boats transported the divers to dive-sites, with snowmobiles and sledges being used during the winter months when the sea was frozen. At this time it was necessary to cut holes in the sea-ice using chainsaws, handheld motorized augers and axes. All of the sampling carried out in this project was undertaken by SCUBA, with 520 dives directly involved with the study.

Signy Island: Environment and Sites

The Southern Ocean marine ecosystem, and more specifically the shallow waters around Signy Island, are characterised by low, stable temperatures and intense seasonal peaks of primary production (Clarke 1988). Graphs of environmental data collected throughout this project are presented here for ease of reference, although relevant aspects of the environmental seasonality are presented in the data chapters. Fig. 1.2 is of sea temperature and Figs. 1.3a,b are of phytoplankton chlorophyll concentrations. These data were collected as part of routine sampling conducted by the nearshore marine biology section at the British Antarctic Survey (Clarke et al 1988; Clarke and Leakey 1996), and were invaluable to the associated research projects undertaken at the same time. Also presented is a map of the experimental site locations, descriptions of which are in the data chapters for the specific sites used in each experiment (Fig. 1.1 b. Table 1.2).

Objectives

The main aim of the project was to measure the seasonality and abundance of both pelagic larvae and benthic recruitment in the shallow waters around Signy Island. In addition, I wanted to investigate the reproductive seasonality and the effect of temperature on development, of a common benthic invertebrate that possessed a pelagic larva. Although the research station was old and some facilities were relatively basic, its great strength was the unparalleled opportunity for year-round sampling and observation. The techniques chosen were therefore simple but thorough, with minimal reliance on sophisticated equipment that could not be repaired during the winter period, and would not jeopardize the continuous nature of the survey. In summary, the key objectives were as follows:

- To conduct a year-round survey of the pelagic larvae present in the shallow waters around Signy Island.
- To measure recruitment, colonisation and growth of newly settled benthic invertebrate larvae.
- To measure the reproductive seasonality of a common benthic invertebrate that possessed a pelagic larva.
- To investigate in detail the effect of temperature on development time and embryo mortality in a range of common benthic invertebrates that possessed a pelagic larva.

Table 1.1

Species richness of some major groups of the Antarctic benthos. Data are adapted from Arntz et al (1994) and Dell (1972), where all original references are listed.

Order	Families	Genera	N ^o Species	Area
Gastropoda	26	69	145	Weddell Sea
Bivalvia	17	25	43	Weddell Sea
Mollusca	91	154	309	East Antarctica
Isopoda	25	121	346	Whole Antarctic
Amphipoda	74	304	808	Whole Antarctic
Decapoda	5	8	8	SE Weddell Sea
Holothuroidea	7	22	34	SE Weddell Sea
Asteroidea	12	29	50	SE Weddell Sea
Ophiuroidea	6	15	43	SE Weddell Sea

Table 1.2

The sites used throughout the project, with locations on Figure 1.1b. Depths separated by commas refer to different sites at the same locality.

Site	Depth	Substratum
Porny Rock	6-8m	Rock and Rubble, bordering soft sediment bay
Billie Rocks	11-14m	Soft, fine sediment
Bare Rock	5, 9-13m	Rocky, abundant benthic fauna
Polynesia Point	8, 7-11m	Overhanging rock and cave
Outer Island	24-30, 36m	Rock and macroalgae
Powell Rock	25m	Base of rocky cliff

Figure 1.1 a

Position of South Orkney Island group in the Maritime Antarctic. Inset shows Signy Island with Borge Bay marked.

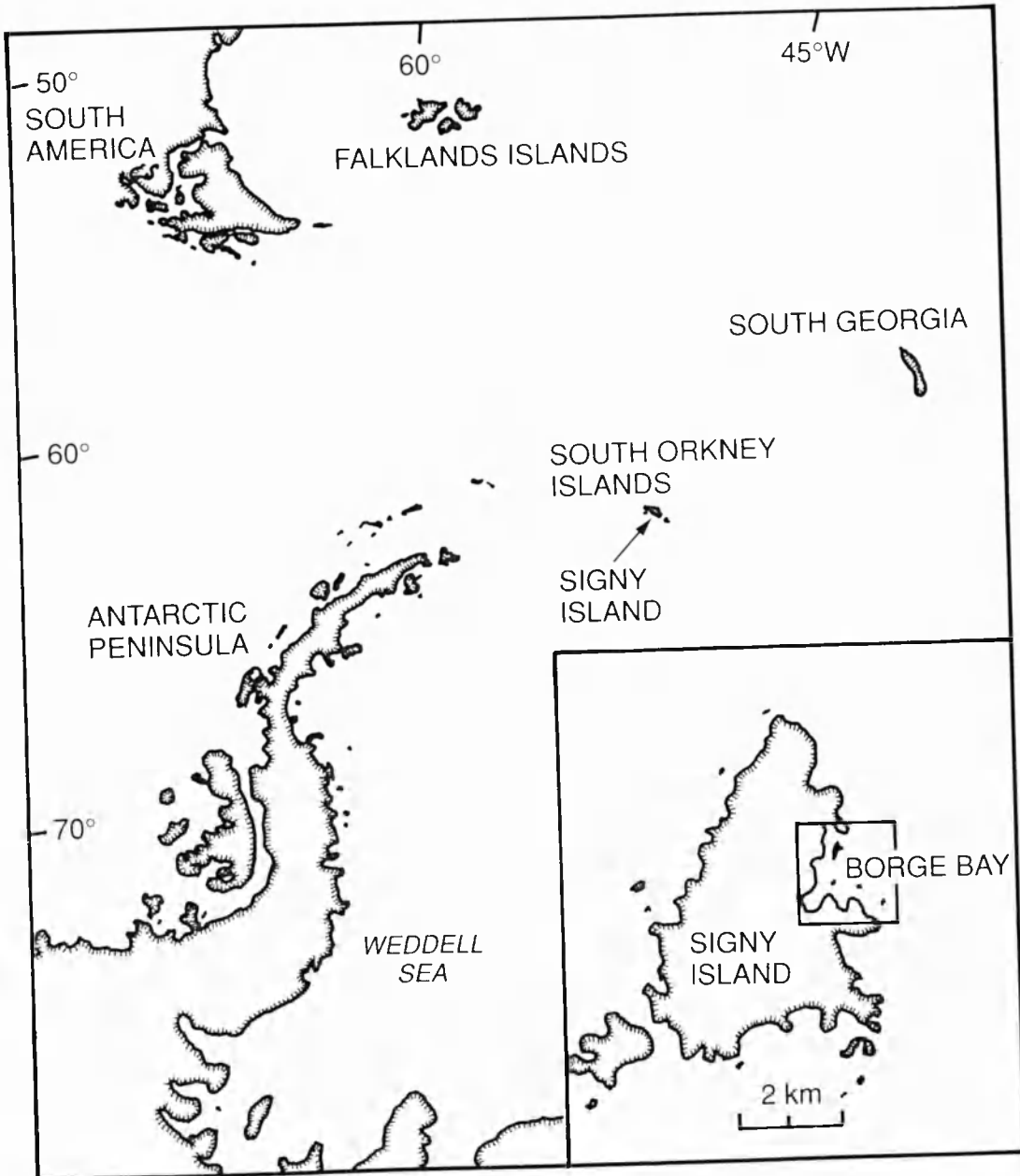

Figure 1.1 b

Borge Bay, with the study sites marked. 10m depth contours have been indicated. The larger typeface denotes sites from the larval survey.

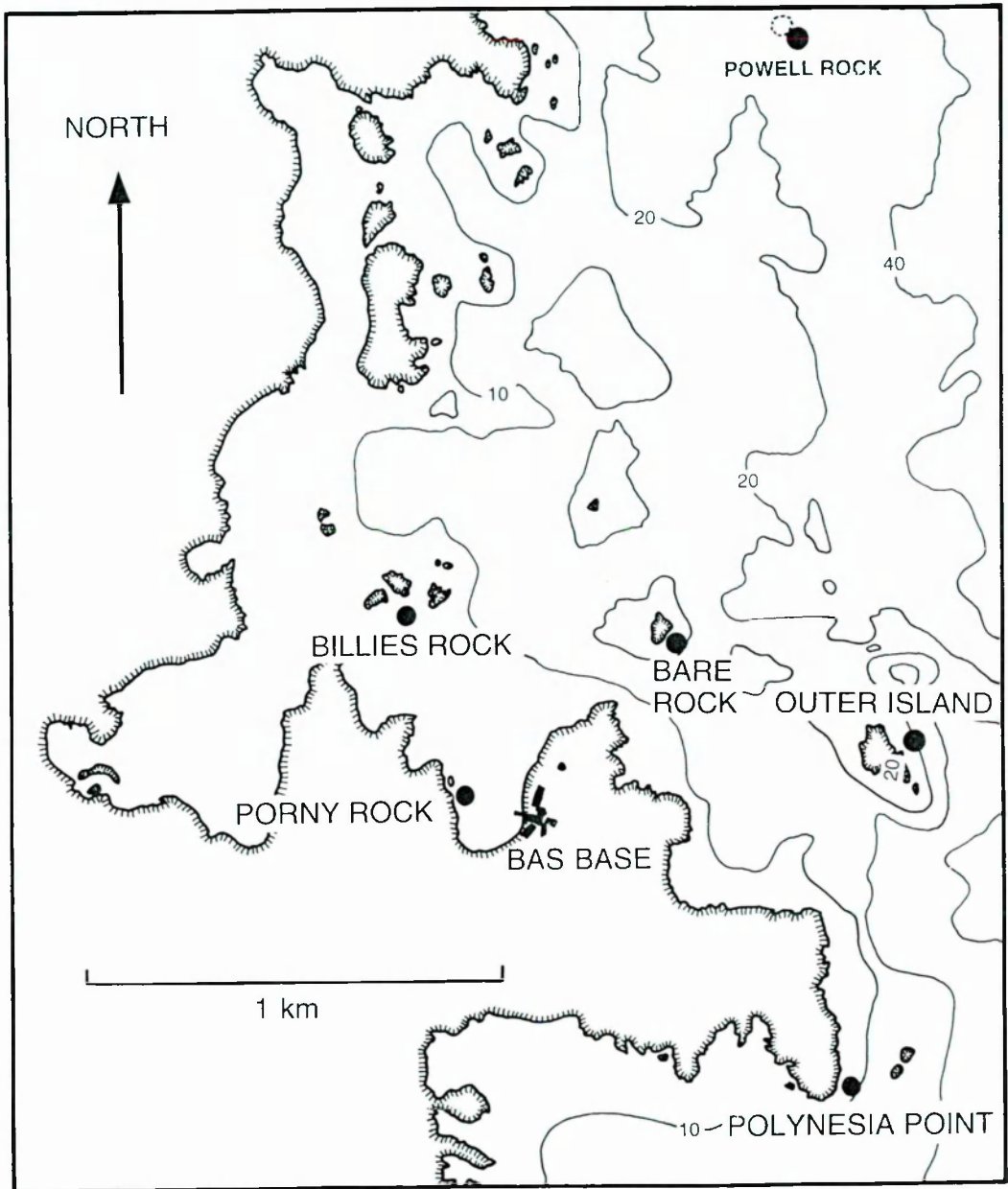

Figure 1.2

Sea temperature recorded at 10m depth in Borge Bay (Data from Clarke and Leakey 1996), with the bars showing the period for which winter fast-ice was present in the winters of 1993 and 1994.

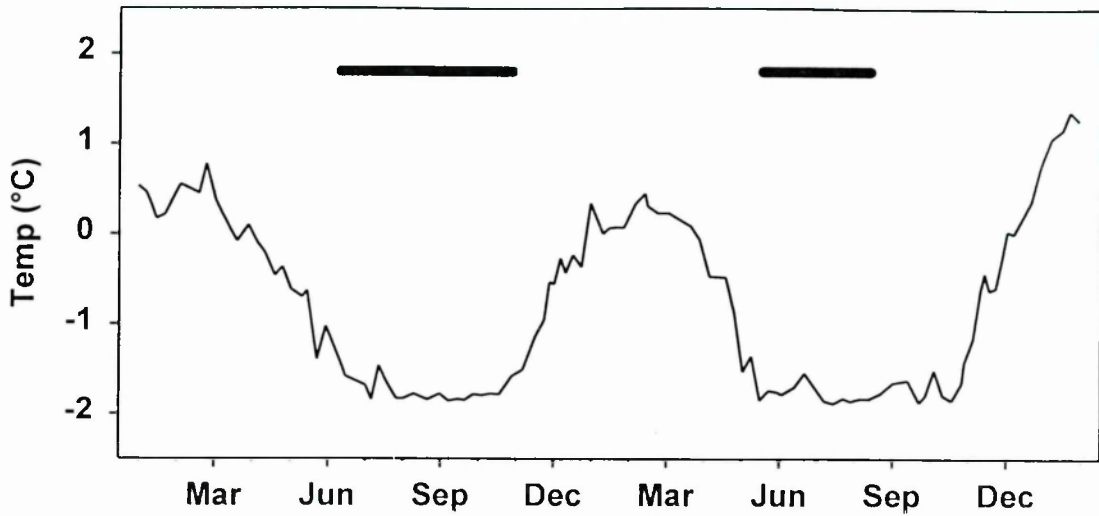
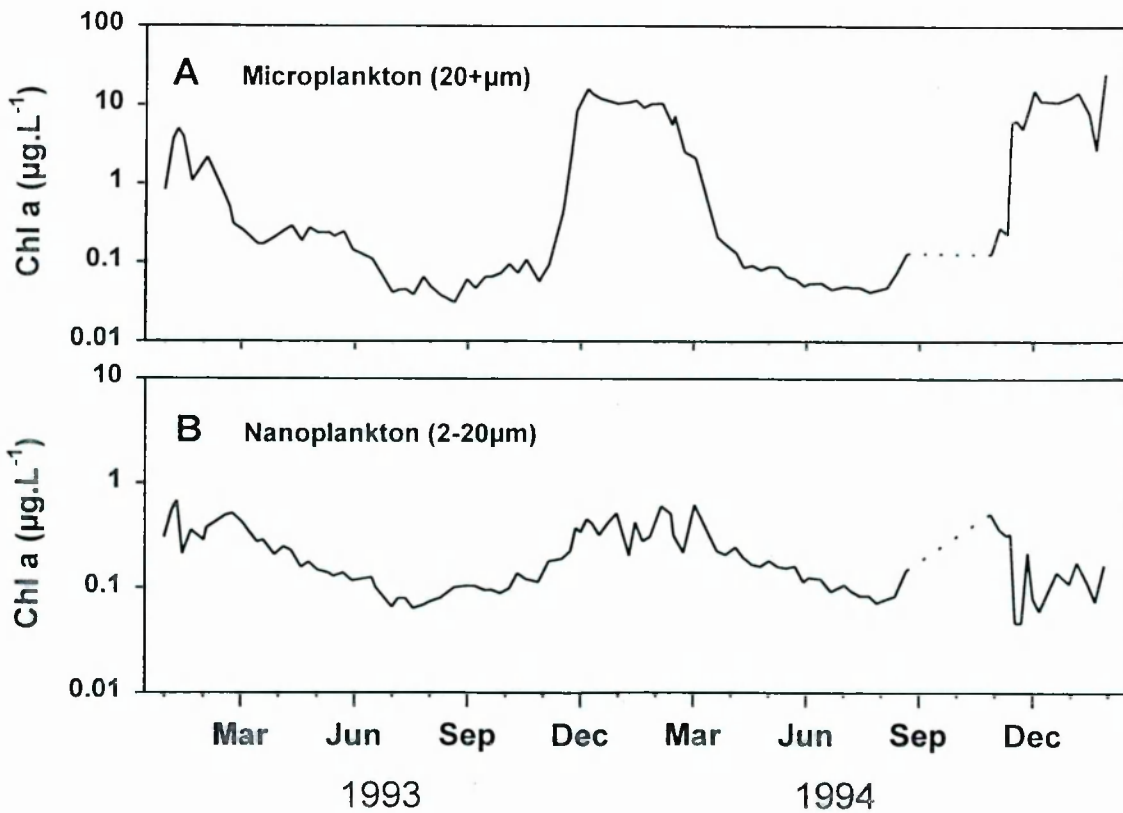

Figure 1.3 a,b

Seasonal variation in seawater chlorophyll concentration ($\mu\text{g}\cdot\text{L}^{-1}$) at 10m depth in Borge Bay (Data from Clarke and Leakey 1996). Data for microplankton ($>20\mu\text{m}$) and nanoplankton ($2-20\mu\text{m}$) shown separately. Note logarithmic axis for chlorophyll concentration (The dotted lines show a period for which data are missing).



Chapter 2 Survey of pelagic marine invertebrate larvae

Data also presented in: Stanwell-Smith D, Peck LS, Clarke A, Murray AWA, Todd CD (Submitted) The distribution, abundance and seasonality of pelagic marine invertebrate larvae in the maritime Antarctic. *Phil Trans Roy Soc B*

Larval descriptions in: Stanwell-Smith D, Hood A, Peck LS (1997) *A field guide to the pelagic invertebrate larvae of the maritime Antarctic*. British Antarctic Survey Press, Cambridge, UK, 162pp.

2.1 Introduction

Marine invertebrate larvae have fascinated observers since Aristotle and their ecology has been the object of study for many years (reviewed in Chapter 1). A considerable variety of forms exist, each maximising the colonisation chances of its species within the constraints of reproductive strategy and phylogeny (Levin and Bridges 1995). The first and arguably still the most comprehensive categorization of larval developmental patterns was that undertaken by Gunnar Thorson (1946, 1950), though many subsequent workers have modified Thorson's original classification (Mileikovsky 1971; Chia 1974; Jablonski and Lutz 1983; Levin and Bridges 1995). There is now a generally adopted classification scheme based on four different criteria: 1) method of larval nutrition (planktotrophy, lecithotrophy, osmotrophy, autotrophy), 2) site of development (pelagic, demersal, benthic, parental brooding), 3) dispersal potential (time in the water column: teleplanic to non-planktonic), and 4) morphogenesis (indirect: with larval stage, direct: no free-living larval stage). The diversity so evident in marine invertebrate reproductive strategies arises from the numerous possible combinations of these

factors.

There is no generally accepted definition of a “larva”; McEdward and Janies (1993) have even reasoned that a meaningful definition would be impossible because of the evolutionary diversification of larval types and continuous nature of development. They did, however, provide a description which satisfactorily defines a larva for the purposes of the present study. They defined a larva as “...an intermediate stage in the life cycle that is produced by post-embryonic morphogenesis and is eliminated by the metamorphic transition to the juvenile...”. A larval stage in the life history of benthic invertebrates enables the colonisation of new substrata and the maintenance of genetic variation (Havenhand 1995). This is somewhat paradoxical because the larva is the the most vulnerable stage in an organism’s life cycle, with perhaps the exception of the pre-fertilization stage. Larval mortalities prior to metamorphic competence typically are in excess of 95% and often greater than 99% (Strathmann 1985). The different environmental conditions existing in the world’s seas and oceans might therefore be expected to influence the reproductive and dispersal strategies of the local fauna.

The extent to which reproductive strategy varies with latitude has been a source of discussion for many years. The seminal work of Thorson (1936, 1950) in Greenland and Denmark suggested that polar marine invertebrates tended to avoid a pelagic larval phase. This work, based mainly on molluscs, echinoderms and some annelids, has formed the starting point for almost every subsequent study or debate in the literature. The term “Thorson’s rule” was coined by Mileikovsky (1971) to describe the inferred latitudinal cline in the proportion of species with pelagic larvae, from most species in the tropics to almost none in polar regions. The assumption of a latitudinal cline was based mainly on studies of prosobranch molluscs, and the trend was confirmed for Antarctic prosobranchs by Picken

(1980a). In contrast, studies of Antarctic echinoderms have shown pelagic lecithotrophy to be the dominant strategy, in apparent contradiction to Thorson's rule (Bosch and Pearse 1990; Pearse 1994). However, these are data from a single phylum which, as with Mileikovsky's analysis of prosobranch molluscs, may bias opinion too far in the other direction. (Pearse et al 1991).

The currently accepted view that fewer species have pelagic feeding larvae in polar regions compared with lower latitudes (Clarke 1992, 1996c) has mainly been deduced from observations of reproductive biology and eggsize. It was therefore timely to conduct a year round survey of the pelagic larvae present in Antarctic waters, to add these data to the observations made at McMurdo Sound (77° S 166° E) for one month's sampling of spring zooplankton (Foster 1987) and periodically during a 15 month study on echinoderms (Bosch 1989), and in the Bellingshausen Sea (~ 70° S, 85° W) over a two month period (Shreeve and Peck 1992).

A two year study was carried out at Signy Island using simple, repeatable methods for both open water and under sea-ice sampling. Reports of similar surveys at other latitudes are surprisingly scarce in the literature; most larval distributional data either comprise single species surveys or have been undertaken as components of macro-zooplankton collections. The survey of Helsingør and the Ven fjörd, Denmark (56° N 12° E), and the subsequent monograph by Thorson (1946) remains one of the few surveys dedicated to describing pelagic larvae of all taxa present, and is the only study which can be compared directly with the work reported here.

2.2 Methods

Study sites

Five sites were chosen in Borge Bay to represent the shallow littoral of Signy Island (Fig 1.1b). Both hard rock and soft sediment substrata were sampled, at a range of depths between 6 and 28 m (Table 2.1). The other factor in selecting sites was accessibility, since SCUBA was used for all sampling, often in inclement weather. Billie Rocks (site 2) and Bare Rock (site 3) were closely located and were representatives of soft and hard substrata respectively (White and Robins 1972; Barnes 1995 b,c). They were therefore deemed primary sites and given the highest priority for sampling if weather or other factors limited diver access to the water. The five sites were visited regularly: collections were made at the two primary sites every two weeks, with monthly collections at the other three sites.

Environmental variables including seawater temperature and salinity, sea-ice thickness and seasonal duration, chlorophyll standing crop and macronutrients (N, P, Si) have been continuously monitored for much of the past thirty years at Signy Island (Clarke et al 1988; Clarke and Leakey 1996). During the 23 month period of this study, the sea temperature varied between -1.88°C and $+0.78^{\circ}\text{C}$ and sea-ice was present for 332 days over two winters (between five and six months each year). Storms were typical of the area, with gale force winds recorded on 190 days.

Pelagic larval sampling: Diver towed net

The pelagic larval collections were taken by a diver-towed net of novel design (Fig 2.1).

Unlike boat deployment, SCUBA enabled the net to be used consistently in both open water and under sea ice. The optimal compromise between collecting a large sample volume and maintaining ease of use with two divers was found to be a net of mouth area of 0.25 m². The drag induced by a net of this size was not beyond the capabilities of reasonably fit divers. The effort required to tow the net and the consequent build up of carbon dioxide in the breathing apparatus precluded sampling at depths more than 30m. The use of a square net mouth, as against the more usual circular designs (Siferd and Conover 1992) meant that it was possible to manoeuvre the net over the seabed at a constant height. A 100µm mesh was used for all collections, with net evasion considered to be negligible for the size range of larvae captured (0.2-2mm). Removable 1000ml containers at the cod-end enabled consecutive discrete samples to be taken during a single dive.

Two General Oceanics 2030 R flowmeters were fitted to the net (Plate 2.1). These were fitted with low velocity rotors which had a threshold response of 2 cm.s⁻¹. Prior to use the flowmeters were filled with 70% methylated spirit in tapwater to prevent freezing during transit to dive sites, as air temperatures were often below -25°C. The flowmeter within the net allowed the volume of water filtered to be calculated and the outer flowmeter enabled an estimation of the distance towed. Filtration efficiency was calculated as [volume filtered / (net mouth area x distance towed)], which equated to [inner flowmeter reading / outer flowmeter reading]. Tows were made directly into the water flow during the few times when there were currents sufficiently strong to affect flowmeter readings, thus minimising erroneous measurements. There is a monotonic (and almost linear) positive relationship between filtration efficiency and tow speed at velocities of less than one knot (Tranter and Heron 1967), which is a realistic maximum speed for a diver-towed net. Care was taken to ensure as steady and reproducible a tow speed as possible in order to minimise variability in

sampling efficiency; with every collection dive involving the author.

Plates 2.1 a,b

Photographs of collection net in use under sea ice. The divers could manipulate the net over the sea-bed and along sea-ice contours to maintain a consistent distance from the substratum. The two flowmeters are clearly visible, one inside the net and the other outside it.

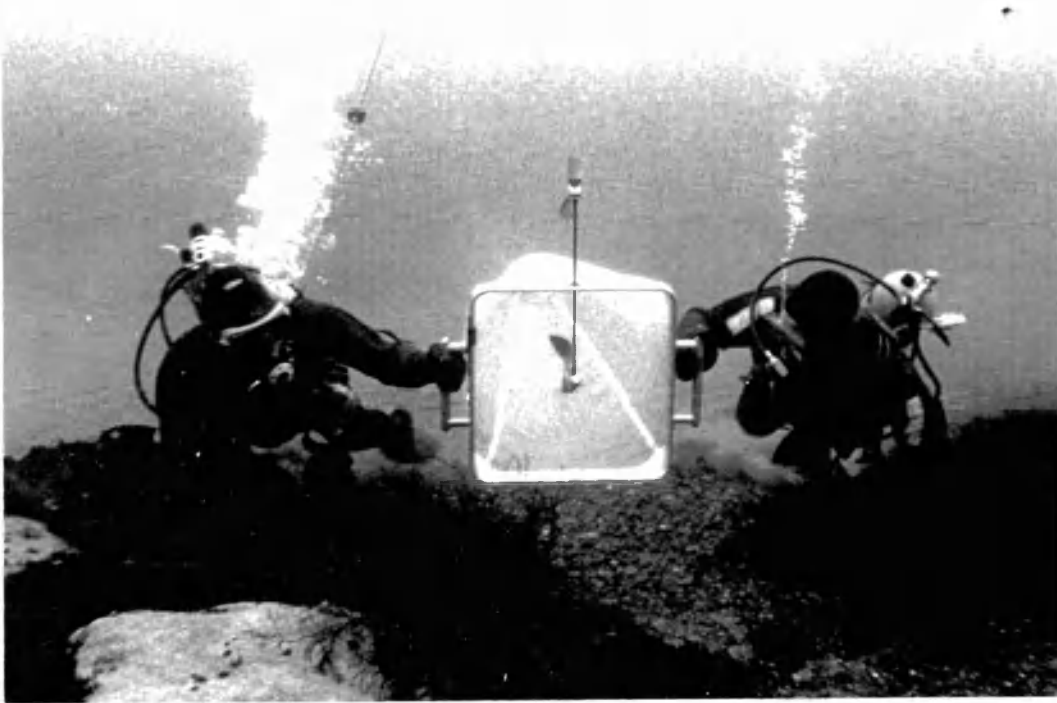

Each collection dive consisted of two tows, both of about 50m length. The first was 10-20 cm above the sea-bed and the second 10-20cm below the sea-surface, or under sea ice if it was present. Flowmeter readings were recorded to enable correction of larval counts for the actual volume filtered. During the peak of the austral summer phytoplankton bloom, the net was susceptible to clogging. To minimise this, the cod-end was replaced with a second sampling container halfway through each tow in the period December to February.

Demersal larval sampling: plankton pump

As a net was unlikely to collect truly demersal larvae, a hand-held diver-operated plankton pump was constructed to sample close to the seabed. Several designs of this type of apparatus are described in the literature (Dixon and Robertson 1986; Powlik et al 1991), although these surface mounted pump systems were not suitable when winter sea-ice was present. The device developed here (Fig. 2.2, Plate 2.2) was constructed around a 100 μ m mesh conical net and an inexpensive Rule 500 bilge pump (12 V, 2.4A, moving 23.5 l.min⁻¹)

Waterproof plugs and low-temperature cable (30m length) connected the pump to an insulated gel lead-acid battery. Because of the severe attenuation of battery performance in extreme low temperatures (< -35°C), an 85Ah battery was used, much larger than is necessary in tropical or temperate locations and consequently impractical to mount within the sampler as in a similar design from New Zealand (Taylor et al 1995). The pump was primed by flooding prior to each use and manipulated around and under rocks during each collection dive, which was usually of about 15 min duration. Longer sampling periods risked clogging the net and thus damaging specimens within it. Quantitative estimates of larval abundance were not possible because of the difficulty of estimating the areas sampled in cryptic

locations.

Plate 2.2

Photograph of hand-held plankton pump, cable and battery, on the jetty at Signy base.



Analysis protocol

The 1000 ml cod-end containers were returned to the station immediately after each collection dive and kept at ambient seawater temperature in the aquarium. Every sample from both net and pump was analysed within 24h to prevent degradation of delicate larval forms and damage from larval predators caught in the cod-end. The samples were filtered through a 100 μ m mesh lined cylinder, suspended in a seawater filled beaker to prevent particles retained

from drying out. The retained larvae and other planktonic constituents were then carefully washed into a petri dish with 1.2µm filtered (Whatman GF/C) seawater. They were examined at x20-x80 magnification with a stereo-microscope. All novel forms were drawn, photographed, fixed in 2.5% E.M. grade gluteraldehyde and stored in a 4% sodium cacodylate buffer for examination by scanning electron microscopy (SEM) in the UK. A few drops of 1% propylene phenoxytol and 7.5% magnesium chloride (in seawater) were used to relax and immobilise active individuals.

Every individual larva in every sample was measured and recorded. Many of the larval forms were unidentifiable beyond class and sometimes (for example planulae) even phylum. There are no taxonomic sources available for Antarctic larvae and only a few could be related to adult taxa. The larvae collected in this study were therefore classified into functional groups for analysis. These groups represent the highest taxonomic resolution that was consistently attainable. Larvae were therefore identified to the lowest taxonomic level possible, and classified into morphologically-defined operational taxonomic units (OTUs). All other planktonic components (for example diatoms or other phytoplanktonic taxa) were scored on a six level nominal abundance scale from occasional to very abundant (See Appendix). The data were analysed with both univariate and multivariate statistical techniques: by a Generalized Linear Model (GLM, Poisson distribution, log link function) and Principal Component Analysis (PCA) of the correlation matrix of $\log(x + 1)$ transformed data, respectively. Both analyses used routines in Genstat v.5.3 (Payne et al 1993). The data were also explored using ViSta, the visual statistics system for three-dimensional representation of multivariate analyses. ViSta was also used to interactively explore a range of data transformations (Box-Cox transform function), with the $\log(x + 1)$ transformation giving the best approximation to normality. (ViSta is available as public domain software on

the Internet at <http://forrest.psych.unc.edu>). Drawings, SEM's and notes on the larvae collected in this survey have also been compiled into a field-guide (Stanwell-Smith et al 1997).

2.3 RESULTS

Environmental seasonality

Seawater temperature and chlorophyll concentrations varied seasonally, both reaching maxima in the austral summers (Figs. 1.2, 1.3). The size-fractionated measurements of phytoplankton chlorophyll enabled the amount of food available for larval feeding to be estimated. Microplankton chlorophyll (>20 μ m) showed a single summer peak which generally exceeded 15 μ g.L⁻¹ and a low winter standing crop. The data for 1993-94 are typical for this site, although an occasional (once in the last 14 years, in 1992) distinct autumnal bloom occurred in February-March (Clarke and Leakey 1996). The nanoplankton chlorophyll (20 - 2 μ m) also showed a clear seasonal variation although the standing crop was an order of magnitude smaller than the microplankton, and the bloom was spread over a longer period. In winter (typically June to September), nanoplankton chlorophyll concentration usually exceeds that of microplankton (Clarke and Leakey 1996)

Seasonal larval distribution

In the 25 months of the survey, 317 net samples and 14 pump samples were successfully analysed. The mean tow length (\pm 1 SE) was 54.6 \pm 0.9m with a mean sampling efficiency of

42.3±0.6%, this meant that about 5000L of seawater were filtered per tow (mean volume=5736±122L). The larval counts for each tow were therefore corrected to a standard sampling volume of 5000L.

The number of morphologically distinct forms (OTUs) in each of the functional groups are listed in Table 2.1. In some cases these groups undoubtedly contain larvae from taxonomically unrelated adults, the most obvious example of this being the generally featureless planulae. Although 22 morphologically distinct planulae were distinguished, these probably include larvae from octocorals and sponges (both of which are common benthic taxa at Signy Island) together possibly with platyhelminthes. It is also possible that where larval functional groups represent different developmental stages, larval OTUs in more than one functional group may actually represent successive developmental stages of the same species. In such a case the total number of morphologically defined OTUs will exceed the real number of species involved. The converse problem, of many related species having morphologically indistinguishable larvae, results in the OTUs possibly underestimating the true species diversity.

The seasonal variation in abundance of the various larval functional groups is shown in Fig. 2.3, with data corrected to a standard volume of 5000L. This figure pools data for all sites and also pools data from surface and demersal tows. Some differences were detected between sites and depths (see next section) but these were generally small. No larval types occurred in the pump samples that were not also seen in adjacent net collections; because these data were also non-quantitative, they were not included in the analysis.

The planulae graph (Fig. 2.3a) pools the larvae from three phyla: Cnidaria, Porifera and Platyhelminthes. Planulae were present throughout the year, although higher numbers were caught in the early winter of 1993 than at other times of the survey. Barnacle cyprids

also occurred in higher numbers in the 1993 winter. Winter larvae of both years comprised mostly echinoderm gastrulae and bipinnaria, and gastropod veligers (Fig. 2.3b). Nemertean pilidia were present in low numbers throughout the survey, with peaks in June. In contrast, annelids were strongly seasonal and were present mostly in the austral summer. A late summer (February-March) spawning was evident in the annelid larvae, a functional group containing larvae other than the trochophores, metatrochophores and nectochaetes characteristic of annelids.

Fig. 2.4 shows the summed data from Fig. 2.3a,b, as total larvae each month throughout the survey. Peaks occurred in both austral summers, with smaller peaks in the winter and minima in the spring and summer periods. The pattern over the two years was broadly similar.

Generalized Linear Model (GLM)

Univariate statistics were used to model the two years of results to gain a clearer insight into the ecological patterns displayed by each group of larvae. The numbers and relative proportions of larvae at different sites and different tow types (surface or benthic) are presented in Table 2.2. Although some groups, such as brachiopod larvae, did not occur at all sites, most were ubiquitous. Relatively large numbers of bivalve veligers occurred at site 2 (Billie Rocks, 14m, soft sediment), consistent with the high density of bivalve infauna at that site. Of the larval groups that showed distinct patterns, echinoderms clearly occurred more often in surface waters (about 1m depth) than in benthic tows. Some of the annelid groups also tended to be surface dwelling.

The dominant ecological patterns, however, were the differing seasonality of the

various larval groups. Variability in larval occurrence meant that repeated peaks over the two years might not have been clear visually in Figs. 2.3a,b. Seasonal patterns were therefore distinguished by fitting the GLM. Deviances for each month revealed peaks of larval abundance (Table 2.3). This model confirms the winter larval strategy of echinoderms, the peak in early winter of some planulae, and in contrast, the austral summer peak of annelids. A trend common to most larval groups was the presence of at least a few larvae throughout the year.

Principal Components Analysis

Multivariate analyses were used to further dissect patterns in the occurrence of larval OTUs and relating these to the environmental variables. PCA was chosen because the biplots produced are conceptually simple to interpret. Analyses were hierarchical, with each successive analysis being conducted on increasingly aggregated data. First, each separate tow was considered. From this analysis, the differences between the five sites were found to be negligible, and so data from the five sites were pooled. Apart from the above observations for echinoderms, the next analysis revealed only negligible differences between surface and benthic tows, and so these data were also pooled. The results of the PCA analysis of the effect of season on the occurrence of larval OTUs is summarised in Fig. 2.6. This biplot shows that in contrast to the lack of separation for sites and depth, analysis of time of the year divided the larval functional groups into three clusters representing discrete periods of the year. The lengths of the biplot vectors represents the ordering of the original variables in PC space and the scores of the data points fell in the ellipses drawn in each quadrant of the biplot. The first five components accounted for 71% of the variance in the data, with the first two components

explaining 42% (26%, 16% respectively). This is a high value of explained variance considering the heterogenous set of 317 tows and 17 larval groups, and the sparse nature of larval occurrence. The PCA has therefore succeeded in revealing the main features of the dataset.

The biplot (Fig. 2.6) was interpreted as showing a clear divide (first principal component) between summer and winter larvae. The summer larvae are further divided (second principal component) into early summer and late summer larvae. The relative lengths of the vectors radiating from the origin were considered analogous to the intensity of seasonality, such that shorter vectors indicated groups that tended to have a year round presence, and longer vectors indicated sharper seasonal peaks of larval occurrence.

PCAs were also carried out on other data collected in the survey, all with variance dominated by seasonal patterns. Fig 2.7 shows a biplot of zooplankton, with a seasonal divide either side of the first PC separating summer and winter. All the variance in the data were explained with the first five components, with the first two explaining 58% (34%, 24% respectively). Copepods, phosphorescence and unknown embryos were associated with the winter, with crustacean nauplii and amphipods negatively associated with the first PC, suggesting a slight austral summer association. Fig 2.8 shows the environmental biplot, also showing seasonal patterns. The first five components accounted for 92%, with the first two explaining 69% (47%, 22% respectively). Of the variables presented, microplankton chlorophyll was associated with Dec-Jan, as might be expected. Fig 2.9 shows phytoplankton data, with another summer/winter divide in the nine diatom species presented. *Coscinodiscus*, *Odontella* and *Tricornis* diatoms were associated with the winter, and *Thalassiosira*, *Chaetoceros* and *Porosira* were summer diatoms. The first five components accounted for 93% of the variance, with the first two explaining 63% (38%, 24%).

2.4 Discussion

Diversity

The current debate over the validity of Thorson's rule hinges on two phyla which show geographical larval biology patterns entirely different from each other. Thorson (1950) and Mileikovsky (1971) essentially based their argument on molluscs (especially prosobranchs) which they regarded as a model phylum for benthic invertebrate reproductive strategies. In molluscs, a cline was found ranging from almost no pelagic larvae in Arctic regions to around 95% of species with a pelagic phase in tropical seas (Mileikovsky 1971). This was later supported by the work of Picken (1980a) in the Southern Ocean, who showed that of 30 prosobranch species at Signy Island, most reproduced by direct development and only one species, the limpet *Nacella concinna*, produced a pelagic larva. Echinoderms certainly do not fit into the pattern established for prosobranch molluscs, with similar percentages of species with pelagic larvae in Antarctica (73%), California (75%) and Greenland (82%) (Pearse et al 1991; Pearse 1994; reviewed by Clarke 1992). The real distinction in echinoderm pelagic larvae is between feeding and non-feeding: in California 20 of 36 (55%) species produce feeding larvae, with 8 species (22%) producing non-feeding larvae. In Greenland (high Arctic) and McMurdo Sound (high Antarctic) the proportions of feeding larvae are 17% (4 of 23 species) and 23% (7 of 32 species) respectively.

Several studies have reported high diversity in benthic fauna in southern polar latitudes (Dell 1972; Brey et al 1994; reviewed by Arntz et al 1994; Clarke and Crame, in press), although different groups vary in their contribution to overall diversity. Antarctic epifaunal suspension feeding communities, in terms of total macrofaunal species numbers

within assemblages, have been compared to coral reefs (Gutt 1991). This is in contrast to the intertidal zone which is a habitat characterised by high floral and faunal diversity in temperate and tropical locations, but is almost devoid of life in polar regions because of ice scour (Barnes 1995b). Arntz et al (in press) also highlight the disproportionate amount of sampling intensity in the more easily accessible climatic zones which exacerbates latitudinal comparisons between tropical, temperate and polar studies.

Nevertheless it is clear that there is a distinct cline in hard substratum epifaunal diversity in the northern hemisphere, at least partly because of the low overall diversity of the high Arctic (Thorson 1957; Dayton 1990; Clarke 1992). The latter is probably related to the relative youth of the Arctic marine ecosystem (Dunton, 1992), which is still undergoing active colonisation (Vermeij 1991). In contrast, evidence for a similar latitudinal cline in the southern hemisphere is equivocal at best (Clarke 1992; Gray 1997; Clarke and Crame in press). Although some groups are missing (for example brachyuran crabs) or very low in diversity (for example caridean decapods, teleost and cartilaginous fish), others are highly diverse (Arntz et al in press; Clarke and Crame in press). These differing patterns are of importance in interpreting the diversity of marine invertebrate larvae found in the Southern Ocean in this study.

The species richness of larvae in the present study was much higher than previously reported for other areas of the Antarctic. Research at McMurdo Sound has yielded 12 species with pelagic larvae, most of which were echinoderms (reviewed by Pearse et al 1991). A survey of invertebrate larvae in the Bellingshausen Sea found 12 types of larvae from seven phyla (as distinct from species numbers, which were not separated) (Shreeve and Peck 1995). The present study yielded 131 morphologically distinct larval forms (Table 2.1). The plateau in the shape of the species incidence curve (Fig. 2.10) indicates that this count was likely to

be representative of the survey area (Sutherland 1996). The conclusion therefore is that the total number of marine invertebrate species producing pelagic larvae in the maritime Antarctic is probably in the range 100-150.

A direct comparison with the study in Danish waters of Thorson (1946) shows that although the total of molluscan larval types in Denmark (~70 species) was higher than at Signy Island, the annelids and echinoderms were similar in terms of diversity (Table 2.4). The total number of species collected by Thorson was also comparable (~160), despite the large differences in larval development rates and environmental regime between the two sites.

There are very few data in the literature for other parts of the world with which to compare these data. To date, only two studies have been undertaken in the Arctic. A survey between 1958-61 of the Norwegian and Barents Seas (74° N) found about 70 species of pelagic larvae (Mileikovsky 1968). Thorson (1936) inferred from surveys of adult benthic invertebrates in East Greenland (68-77° N) that about 12 species comprising echinoderms, polychaetes, molluscs and one crustacean developed with pelagic larvae. Although the data are sparse, a preliminary conclusion is that whereas the maritime Antarctic (represented by Signy Island) has a diverse shallow-water benthic community and a diversity of larvae comparable with northern cold-temperate waters (as exemplified by Denmark), the Arctic is characterised by a low diversity of both adult taxa and larval forms. Geographic differences in the diversity of pelagic larvae are thus related to both variations in reproductive strategy and overall faunal diversity.

It is generally accepted that of the wide variety of benthic invertebrates that inhabit temperate seas, many have planktotrophic larvae. Thorson estimated the proportion to be 55-65% of the total number of species (Thorson 1950), but it is very difficult to find any other quantitative estimates in the literature. The most comprehensive compilation of the marine

fauna of NW Europe (Hayward and Ryland 1995) describes some 1400 species. This would suggest that if Thorson's estimate is correct, over 800 different pelagic larvae (many of which would be closely related species, probably with morphologically indistinguishable larvae) must be present. Only a fifth of that number (Table 2.4) were found in his survey of Øresund, Denmark (Thorson 1946). Thorson also suggested that 80-85% of tropical benthic invertebrates have planktotrophic, pelagic larvae (Thorson 1950). This estimate was based mostly on a study of prosobranch gastropods, and Thorson did recognise that the proportion of species releasing pelagic larvae might be lower in other taxa (Young and Chia 1987). As with the data for temperate regions, these estimates have been inferred from egg sizes in mature individuals rather than direct observations or surveys of larvae. Wickstead (1958) surveyed the zooplankton of the Singapore straits, noting in passing that almost no year-round plankton sampling had been undertaken in the tropics. Unfortunately he did not record pelagic larvae, and today there is still a dearth of year round data on larval diversity from tropical and temperate, as well as polar, sites.

One interesting ecological feature noted by Thorson (1936) in his studies of the East Greenland fauna was the tendency for those few species which reproduced by pelagic larvae to be the most abundant. The correlation between pelagic larval development and high abundance in polar invertebrates is also evident in the Southern Ocean (Clarke 1992), with many of the common and numerically abundant species having pelagic larvae. This is highlighted by the dominance in the shallow water Antarctic fauna of such species as the limpet, *Nacella concinna* (Picken 1980b), the cushion star, *Odontaster validus* (Pearse 1965) and the nemertean, *Parbolasia corrugatus* (Peck 1993), all of which reproduce via pelagic larvae.

Abundance

In contrast to larval diversity in geographic regions, larval abundance seems to follow clear geographic clines. Anecdotal references to the paucity of marine invertebrate larvae in the Southern Ocean go back to the earliest expeditions (Thomson 1878), indeed Hardy and Gunther (1935) stated: “the almost complete absence of any larval forms of bottom-living forms was a striking feature of the plankton samples throughout the area” (p.227). Data from the present investigation concur with previous studies (Foster 1987; Bosch 1989; Shreeve and Peck 1995) that the abundance of invertebrate larvae is very low in Antarctic waters (Figs. 2.3a,b). Thorson (1950) reported a maximum of 1400 larvae per 5000L in Venfjörd, compared with the maximum (mean monthly value) of 13.7 larvae (all groups) occurring in the austral summer at Signy Island, a hundred-fold difference. Similar monthly maximum abundance values for a temperate location were reported in plankton surveys at Port Erin (Isle of Man, 54°N), between 1907-1920, with 8400 larvae per 5000L (Johnstone et al 1924). A survey of the near shore waters of Porto Novo (SE India, 13° N) yielded a maximum larval density of $1.2 \times 10^5 \text{ m}^{-3}$ (Srikrishnadas et al 1993), and conspicuous slicks of coral larvae observed on tropical reefs have reached densities of $\sim 8 \times 10^6 \text{ m}^{-3}$ (Willis and Oliver 1990). No other quantitative estimates of larval abundance were found in the literature. With the caveat that the available data are so scarce, it appears that there may be a trend for lower larval abundances at higher latitudes. However, as with any form of dispersal, the time spent in the water column will dictate the level of dilution (Okubo 1994). With warm temperatures and fast development times, tropical pelagic larvae usually spend a very short period in the water column. However, occasional larvae defer metamorphosis and spend long periods drifting up to thousands of km. These have been termed teleplanic larvae (Scheltema 1971) and they

incidentally result in gene dispersal over large tracts of ocean. As pointed out by Sammarco (1994), when ecological communities are faced with periodic heavy disturbance, the capability to initiate new colonies well away from the source of disturbance is highly advantageous. Sammarco modelled the dispersal of corals in the face of physical disturbance such as ENSO events and cyclones, concluding that a combination of self-seeding with a few long distance dispersers was the optimal combination for the long-term survival of reef communities (Sammarco 1994).

Antarctic benthic communities are faced with regular and severe physical disturbances in the form of iceberg scour. In shallow waters and the intertidal there is also intense scour and disruption from brash-ice, fast-ice and the winter ice-foot (Barnes 1995b,c). The low temperatures increase development times up to 20-fold (Bosch et al 1987; Peck and Robinson 1994; see Chapter 5) but they also reduce the basal metabolic demands on larvae (Clarke 1983; Shilling and Manahan 1994). Together these factors result in much longer periods in the water column. The extreme temperatures and the marked environmental seasonality in the Southern Ocean impose severe constraints on reproductive activity (Clarke 1988; Pearse et al 1991). For example in many species there is a narrow temperature window of spawning for species with external fertilization. Spawning aggregation to maximise reproductive success occurs has been observed in the deep sea (Young et al 1992). It also occurs in the Antarctic (Picken and Allen 1983), and a key factor here may be the reduction of distance between parents for high fertilization success (Levitan 1991; Oliver and Babcock 1992) as a result of the increased viscosity effects on sperm motility in cold water (Vogel 1994).

The longer larval life-times of Southern Ocean marine invertebrates would appear to confer an incidental advantage in terms of recolonisation of habitat scoured by ice. In echinoids, Emler (1995) found no relationship between time in the water column of larvae and

species geographic range; rather he concluded that a strategy of pelagic larvae drifting for longer periods influenced geographic range indirectly by improving the chance of recovery from disturbance. Although many of the commonest and most widespread shallow water marine invertebrates in the Antarctic reproduce via a pelagic larva, there is widespread occurrence of brooding or direct development in many molluscs and echinoids (Arnaud 1974; Picken 1980a; Poulin and Féral 1996). This indicates that the existence of a free-swimming larva in the life-history is not a pre-requisite for successful colonisation of habitats disturbed regularly by ice.

The low levels of larval abundance in the present study may be the result of a much larger amount of dilution over a longer period and enhanced by the island location of the present survey. This is supported by the similar density figures found for larvae several hundred km offshore in the Bellingshausen sea (Shreeve and Peck 1995). A consequence of long larval life-times in the plankton would be the potential for long distance dispersal (Strathmann 1980; Scheltema 1986a,b). This would suggest that in areas such as the Antarctic Peninsula, where a complex but effectively linear habitat is swept by an along-shore current, gene-flow through larval dispersal would lead to genetic homogeneity over a large geographic scale (Poulin and Féral 1996)

The low abundance of larvae with long life-times may be a factor in the year-round but very slow recruitment to settlement panels observed at Signy Island (See Chapter 3). It has been suggested for some environments that oceanographic control of larval availability might limit community development (Roughgarden et al 1988, Grosberg and Levitan 1992). The data available from this study, albeit from a single site, would suggest a very different pattern of community dynamics in the maritime Antarctic. Rather than large pulses of larvae whose ability to settle and colonise new substrata is strongly influenced by oceanographic

factors during their short life-span, the Southern Ocean is characterised by a year-round but low abundance of long-lived, slow developing larvae, with a consequent low level of year-round recruitment to new substrata (see chapter 3)

Seasonality

The major variability in the overall data set was related to seasonality rather than site preference or depth. This might be explained by the long period of time that the larvae tend to spend in the water column, ensuring sufficient mixing within sites in the same locality. This was indicated by the presence of most larval types at all sites (Table 2.1). Interestingly, most larval groups (even those with significant seasonal peaks) also occurred in low numbers throughout the year. This may be related to delayed metamorphosis, but over a longer timescale (Todd and Doyle 1981), which would tend to smooth out the seasonality of larval occurrence even in species with a strongly seasonal pattern of spawning.

The multivariate analysis (Fig. 2.6) divided the larval groups into three main periods of occurrence. Annelids of different stages and molluscan trochophores tended to occur at the height of the phytoplankton bloom in mid-summer. This might suggest that these larvae are tied closely to the timing of the summer microphytoplankton bloom. Since this bloom increases in seasonality from the tropics to the poles, it may be a key factor in reducing the percentage of species reproducing by pelagic larvae in these groups. This is especially likely in prosobranch molluscs, the group which shows the clearest latitudinal cline in reproductive strategy (Thorson 1950; Mileikovsky 1971). The second 'season' of occurrence was that of echinoderms and nemertean pilidia whose peak occurrences are in the middle of winter. These larvae, although many are planktivorous, may also be the most adaptable to other

feeding sources such as osmotrophy (Manahan 1990) and bacterivory (Rivkin et al 1986). They may also be able to feed selectively on the nanophytoplankton, as their occurrence in the water column coincides exactly with the period when flagellate chlorophyll (20-2 μ m fraction) exceeds diatom chlorophyll (Clarke and Leakey 1996).

The third 'season' is one of a transitional nature, occurring in a period after the plankton bloom but before the temperatures drop to winter levels and sea-ice forms. Larvae whose abundance peaks in this period include echinoid plutei and sipunculid pelagosphaerae. Because these larvae tend to occur most at a time of transition, it is not at all clear what the key environmental factors might be involved.

Although the multivariate analyses revealed the three distinct periods of seasonality discussed above, these groups may draw attention away from a fourth group namely those larvae with no distinct seasonality at all. These larvae (for example the planulae) tend to be present year-round but at low densities. Because larvae classified as planulae will have originated from a variety of adult taxa (22 morphologically distinct types were detected in this study), pooling all data as 'planulae' may have obscured distinctly seasonal occurrences of particular planulae.

The multivariate analyses of the other environmental characteristics demonstrated the dominant effect that seasonality has overriding all other factors. The only clear patterns seen in Figs 2.6-2.9 were those of summer/winter divides, with a few subdivisions. With a well mixed water column and samples from shallow waters it is perhaps not surprising that the effect of sites and depth are not detected. The phosphorescence recorded on Fig 2.7 refers to a green glow observed when filtering cod-end contents. It was initially attributed to diatoms or dinoflagellates, but the PCA biplot (Fig. 2.7) indicates that it is strongly associated with copepod presence; highly likely in this location (Herring 1978). The phytoplankton presented

in Fig 2.5a demonstrated that the chaining centric diatom genera, *Thalassiosira* and *Chaetoceros* were dominant during the plankton bloom in the austral summers; as described by Whitaker (1982). Some diatoms occurred at low numbers throughout the year (eg. *Odontella weissfloggi*)

Conclusions

The species richness of pelagic larvae observed (131 morphologically distinct forms) is similar to that found in temperate waters. This diversity of larval types is much greater than has been found in the Arctic and runs counter to the hypothesis that a low diversity of larval types is a feature of polar habitats *per se*. Although some groups of organisms do contain fewer representatives reproducing via a pelagic larva at high latitudes (for example prosobranch molluscs and echinoids), the low diversity of larvae reported for the Arctic appears to be related primarily to the overall low diversity of the marine ecosystem at high northern latitudes. The Southern Ocean benthos overall is diverse, and the diversity of larvae detected in this study is comparable with cold-temperate rather than Arctic latitudes.

Densities of larvae found at any one time at high latitudes are reduced, which is probably related to protracted developmental periods resulting in greater dilution. This is clearly different from the common tropical strategy of synchronous mass release of gametes that form larvae and develop to metamorphosis rapidly. Overall numbers of larvae may not be as divergent but peak larval densities in polar waters may be lower because of dilution. Seasonality of larvae is not as obvious as for other parts of the world with many larval groups occurring throughout the year. However, there were three distinct 'seasons' of larval peaks observed. Larval abundances were not correlated with site or depth for most groups, and there

was little evidence of larvae being associated with sea-ice or the epibenthos.

Table 2.1

Taxonomic summary of the marine invertebrate larvae collected during a 25 month study at Signy Island, South Orkney Islands, Antarctica. Larvae were classified into morphologically-defined operational taxonomic units (OTU's), each identified to the lowest possible taxonomic level. The larval OTU's were then classified into functional groups.

Larval functional group	N ^o OTUs	Larval functional group	N ^o OTUs
Planulae (sponges, octocorals)	22	Molluscan trochophores	4
Nemertean pilidia	8	Gastropod veligers	16
Annelid trochophores	11	Bivalve veligers	10
Annelid metatrochophores	9	Brachiopod larvae	3
Annelid nectochaetes	12	Echinoderm gastrulae	8
Annelid larvae	4	Echinoderm bipinnaria	5
Sipunculid pelagosphaeras	2	Echinoid plutei	3
Cirripede cyprids	5	Holothurian pentaculæ	2
		Tunicate tadpoles	7
		Total	131

Table 2.2

GLM model predictions for the depth preference and presence of larvae at different sites.. Deviance values (Dev.) in bold indicate significance at $P \leq 0.05$. Bracketed deviance values show when the analysis indicates that the data might not be ideally represented by the model. The black circles in the Site column indicate larval presence (abundance level: low • → ● → ● high). n/s = not significant ($P > 0.05$)

Larval group	Dev.	Site					Dev.	Depth preference
	(site)	1	2	3	4	5	(depth)	
Planulae (sponges, octocorals)	2.3	•	•	•	•	●	0.5	n / s
Nemertean pilidia	6.8	•	•	•	•	●	2.7	n / s
Annelid trochophores	13.9	●	●	•	•	•	15.7	surface
Annelid metatrochophores	19.5	●	•	•	•	•	3.1	n / s
Annelid nectochaetes	6.4	•	●	●	•	•	1.5	n / s
Annelid larvae	15.6	•	•	•	•	•	47.2	surface
Sipunculid pelagosphaeras	(558.9)	•	•	•	•	•	(135.9)	surface
Cirripede cyprids	3.0	•	•	•	•	•	2.1	n / s
Molluscan trochophores	22.4	•	•	•	•	●	0.1	n / s
Gastropod veligers	6.5	•	•	•	●	●	3.7	n / s
Bivalve veligers	2.7	•	●	•	•	•	8.7	benthic
Brachiopod larvae	31.6	•					9.7	surface
Echinoderm gastrulae	3.9	•	•	●	•	•	1.7	n / s
Echinoderm bipinnaria	9.6	•	•	•	•	•	42.9	surface
Echinoid plutei	(168.8)	•			•	•	(139.6)	surface
Holothurian pentaculacae	16.4	•	•	•		•	108.6	surface
Tunicate tadpoles	8.5	•	•	•	•	•	3.1	n / s

Table 2.3

GLM model predictions for the presence of larvae throughout the year. All of the deviance values (Dev.) were significant at $P \leq 0.05$. Bracketed deviance values show when the analysis indicates that the data might not be ideally represented by the model. The symbols refer to: larval presence (○), small peak (●) and large peak (●).

Larval group	Dev. (month)	Months												
		J	F	M	A	M	J	J	A	S	O	N	D	
Planulae (sponges, octocorals)	4.2	○		○	○	○	○	●	○	○	○	○	○	○
Nemertean pilidia	5.2		○	○	○	○	○	●	○	○	○	●	○	○
Annelid trochophores	17.3	○	○			○	○	○		○			●	○
Annelid metatrochophores	28.7	○	○	○	○			○					○	●
Annelid nectochaetes	20.1	●	●	○	○	○			○	○	○		●	●
Annelid larvae	12.7	○	●	○	○	○	○		○		○	○	○	○
Sipunculid pelagosphaera	(1050)		●		○									
Cirripede cyprids	5.8	○	○	○	○	○	○	○	●	●	●	○	●	○
Molluscan trochophores	40.9	●	○											
Gastropod veligers	3.1	○	○	○	○	○	●	●	●	●	●	○	○	○
Bivalve veligers	3.5	○	○	●	○	○	○	○	○	○	○	○	○	○
Brachiopod larvae	25.9												○	●
Echinoderm gastrulae	28.2						○	○	●	●	○	○		○
Echinoderm bipinnaria	29.2							○	○	●	●	○		
Echinoid plutei	(103.3)	●	●											○
Holothurian pentaculac	47.1		●	●					○				○	
Tunicate tadpoles	12.7	●			○		○	○	○		○			●

Table 2.4

A comparison of the number of larval species found by Thorson (1946) and the present study. Difference in larval grouping reflects the ease of identification of some taxa.

Location	Øresund, Denmark		Signy Island, South Orkney Islands	
Description	Sound between Baltic Sea and the Kattegat Sea.		Small rocky island in archipelago, on Scotia Arc.	
Depth	Mostly 0-20m, deep channel		Inshore areas mostly 0-20m, at 40m dropping off to 200m (Fig 1.1b)	
Water Temp	+2.6°C (Feb) to +16.0°C (Aug)		-1.9°C (Jun-Nov) to +1.0°C (Feb)	
Lat / Long	(56°N 12°E)		(61°S 46°W)	
Nº Species	Polychaetes	41	Planulae	22
	Prosobranchs	34	Nemertean pilidia	8
	Opisthobranchs	15	Annelids	36
	Lamellibranchs	28-33	Molluscs	30
	Decapods	12	Decapods	0
	Echinoderms	16	Echinoderms	18
	Other	13	Tunicates	7
			Other	10
	Total	159-164	Total	131

Total for Ven fjord **121** (Sampled between August 1937 and August 1939)

Total for Helsingør **138** (Sampled between September 1941 and September 1942)

Figure 2.1

Diagram of diver-towed net. All dimensions in mm (not to scale).

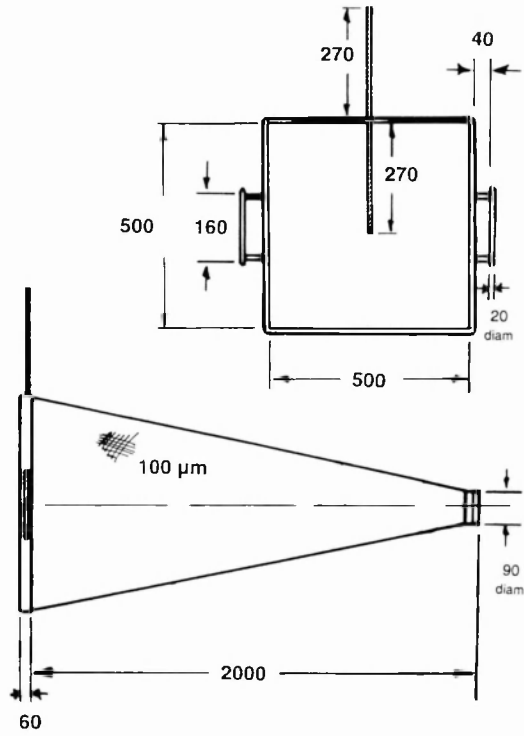

Figure 2.2

Diagram of pump sampler, all dimensions are in mm (not drawn to scale). Seawater was sucked into silicon hose “intake”, through the 100 μm mesh cone and out via the bilge pump through aperture labelled “exit”. Rubber gaskets sealed the cylinder to the endplates.

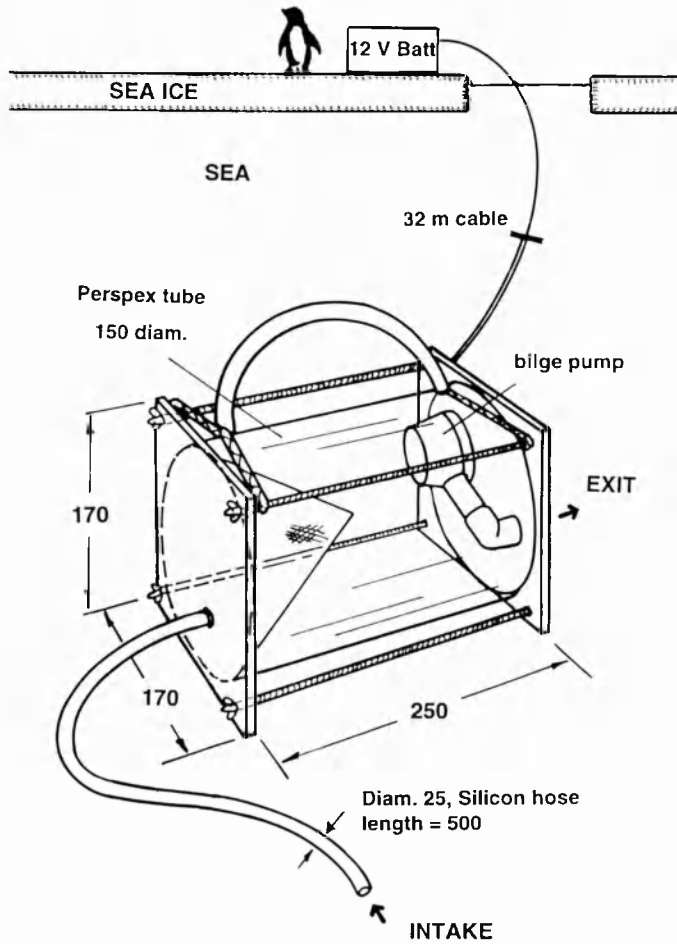

Figure 2.3 a

Graphs a, b show mean numbers of each larval group throughout the survey. The values have been corrected to a standard 5000L collection tow. Note the black and hatched colour change in the bars to clarify inter-annual differences.

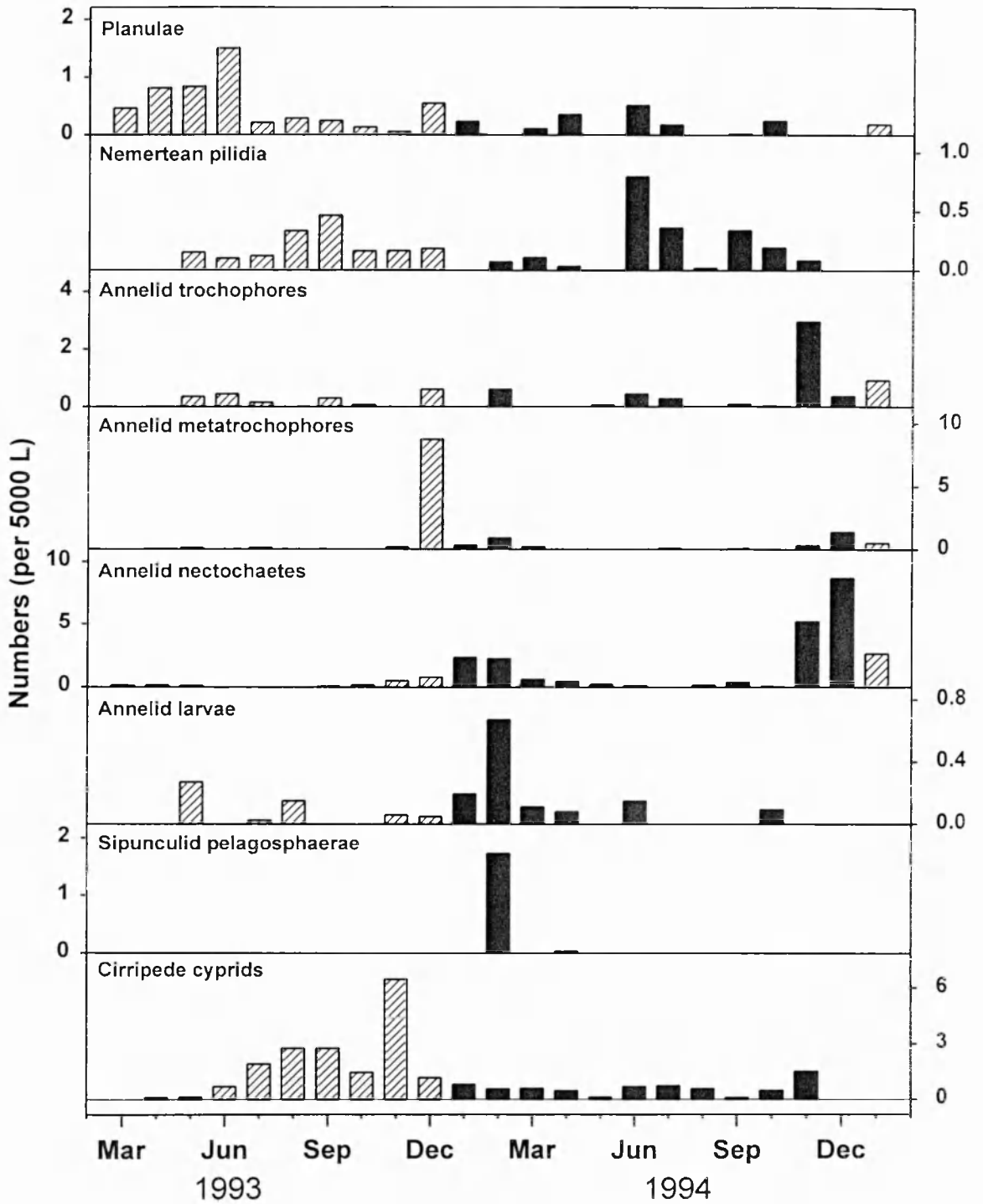

Figure 2.3 b

Graphs a, b show mean numbers of each larval group throughout the survey. The values have been corrected to a standard 5000L collection tow. Note the black and hatched colour change in the bars to clarify inter-annual differences.

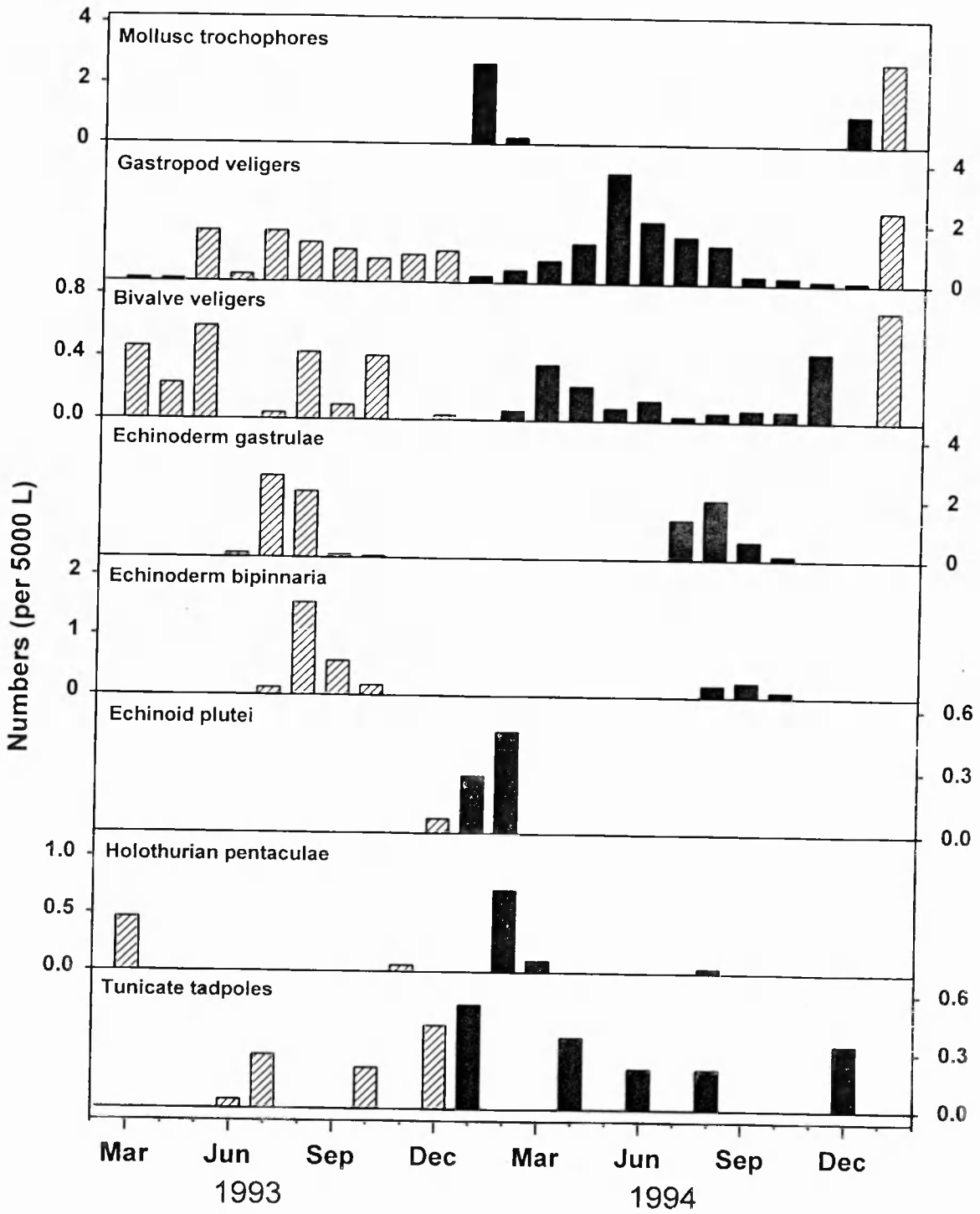

Figure 2.4

Mean monthly totals of larval numbers throughout the survey. The values have been corrected to a standard 5000L collection tow. Note the black and hatched colour change in the bars to clarify inter-annual differences.

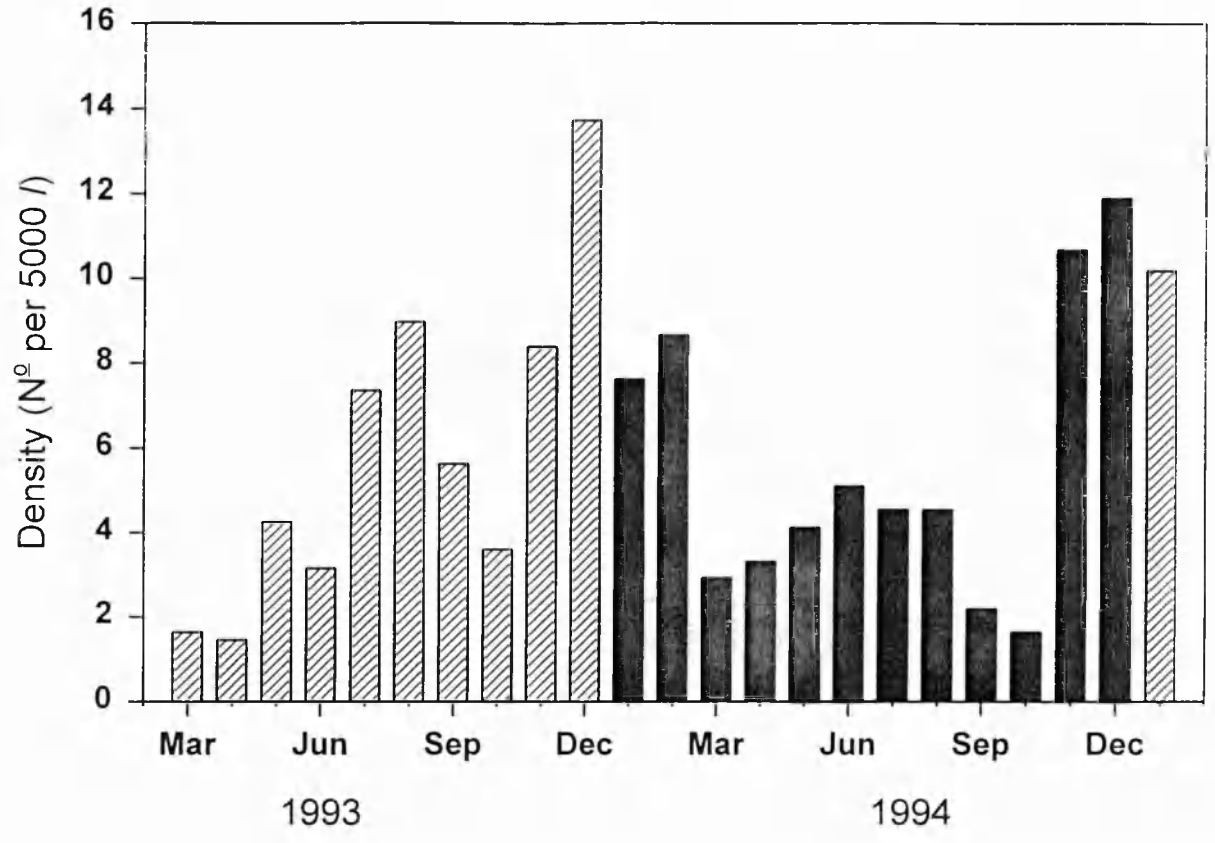

Figure 2.5 a

Monthly means of phytoplankton abundance throughout the survey. Nine diatom taxa have been presented, by nominal abundance ranking: 0 = absent, 1 = occasional (1 to 5 indivs), 2 = several, 3 = frequent (occur in every field of view), 4 = common (several in every field of view), 5 = abundant (hundreds to thousands), 6 = very abundant. Note the black and hatched colour change in the bars to clarify inter-annual differences.

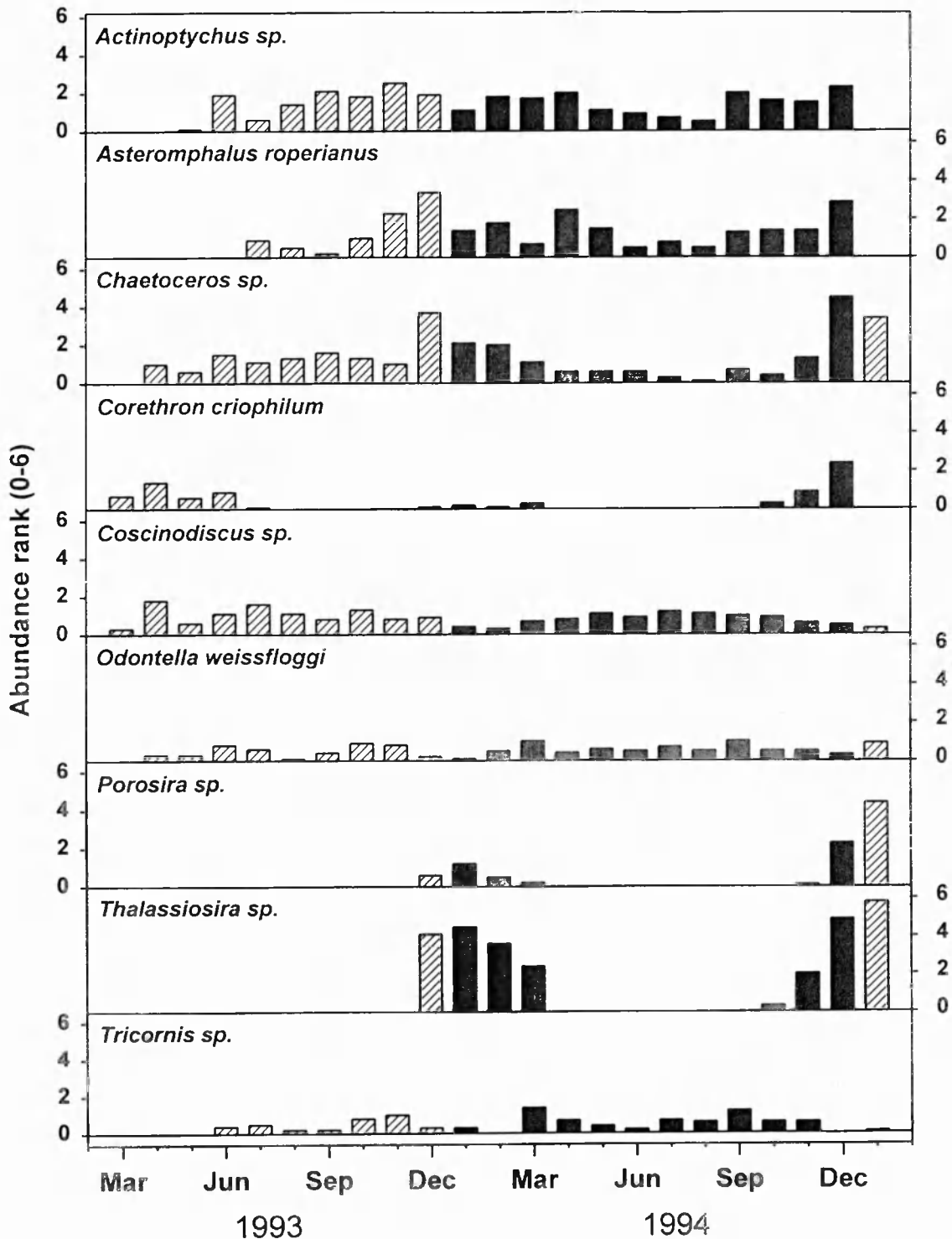

Figure 2.5 b

Monthly means of a few other zooplankton constituent abundances throughout the survey. Data for embryos, nauplii, amphipods and copepods have been presented by nominal abundance ranking: 0 = absent, 1 = occasional (1 to 5 indivs), 2 = several, 3 = frequent (occur in every field of view), 4 = common (several in every field of view), 5 = abundant (hundreds to thousands), 6 = very abundant. The phosphorescence was scored on an arbitrary, subjective scale. Diving visibility was much higher in the winter in the absence of a plankton bloom, as might be expected. Note the black and hatched colour change in the bars to clarify inter-annual differences.

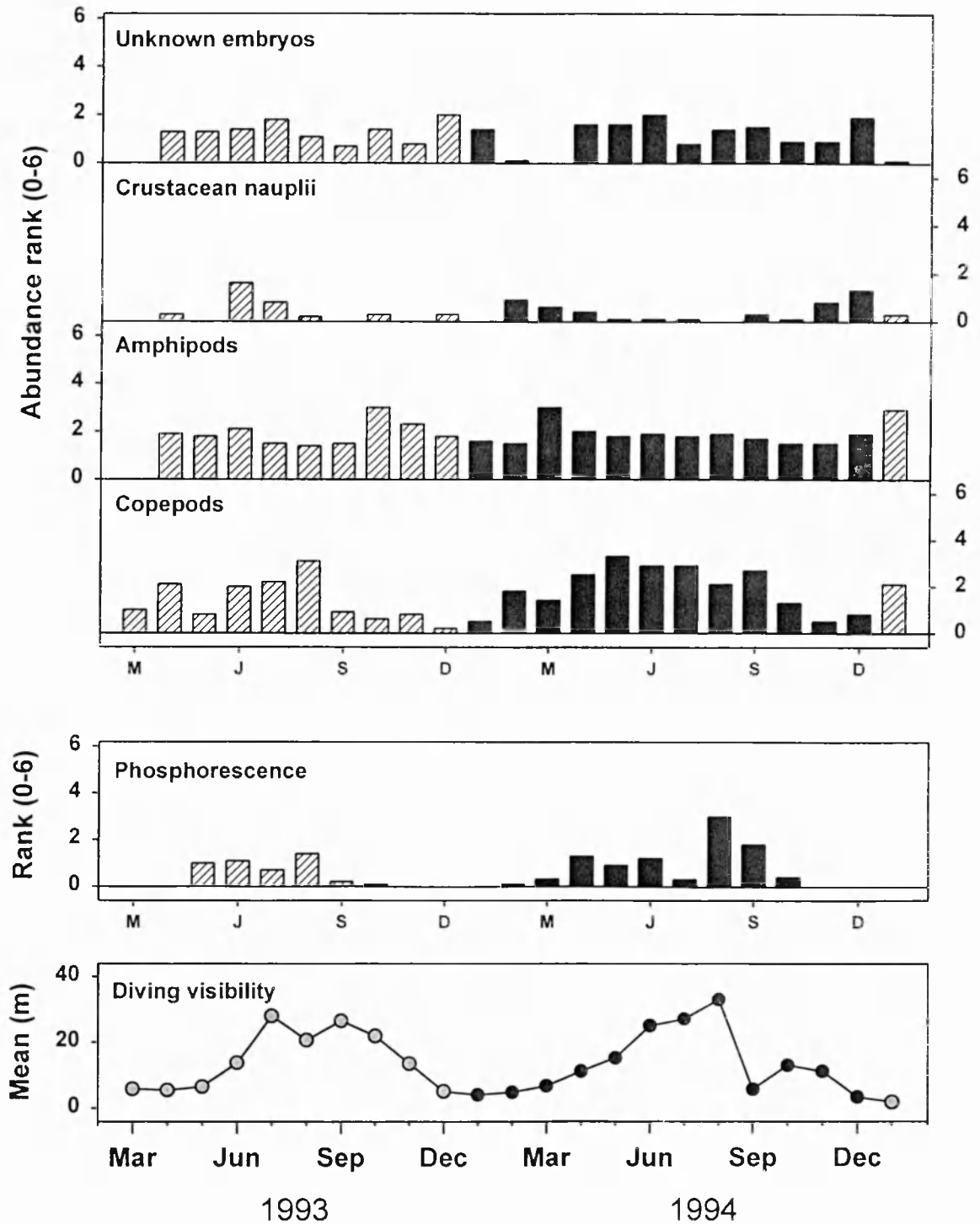

Figure 2.6

A biplot of the Principal Component Analysis of the larval data. The vectors represent the original variables, with the ellipses showing the area of the scores that fell in each quadrant of the biplot. The axis values are arbitrary units.

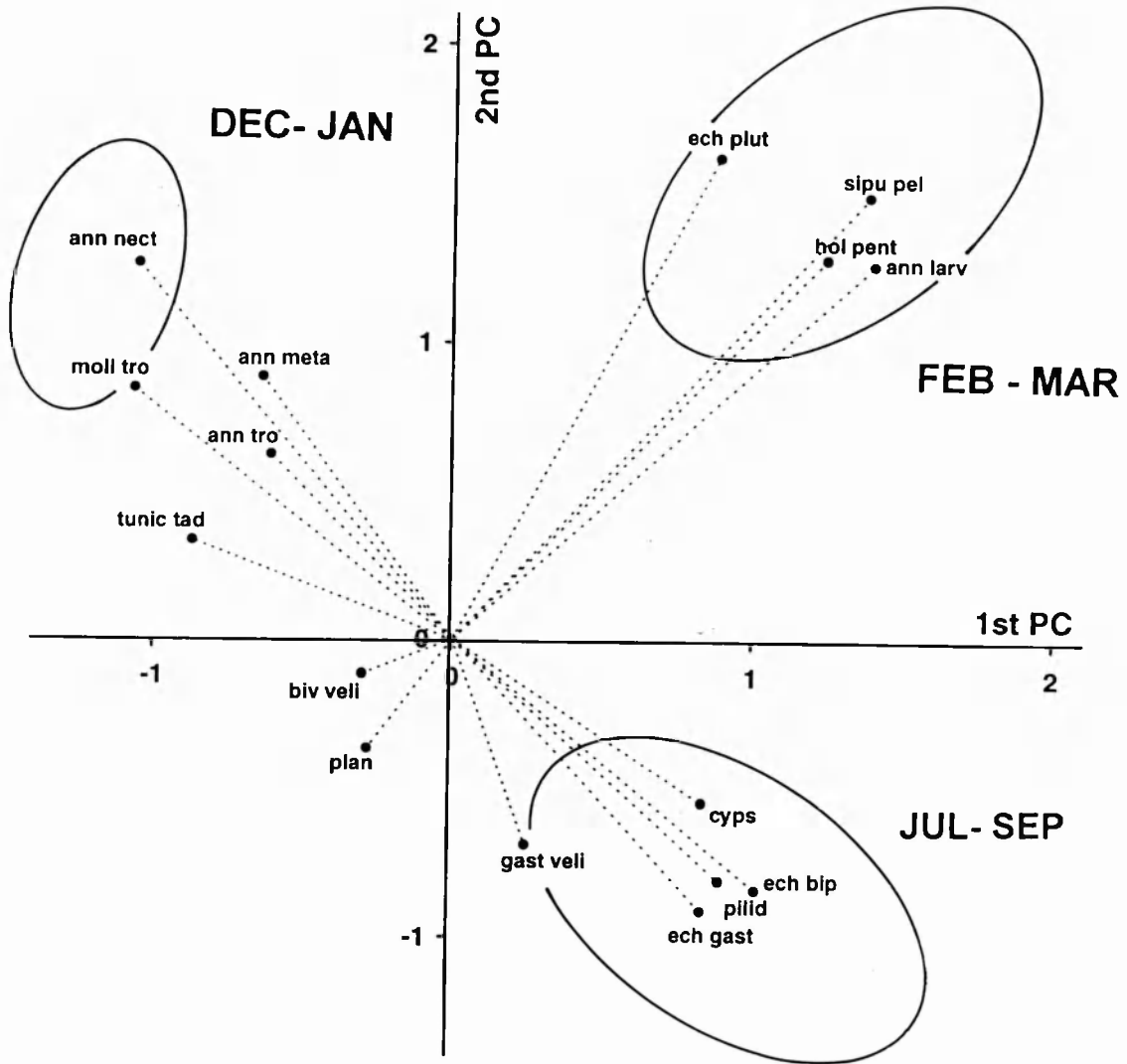

Figure 2.7

A biplot of the PCA on zooplankton data collected in the survey. The vectors represent the original variables, with the ellipses showing the area of the scores that fell in each quadrant of the biplot. The axis values are arbitrary units.

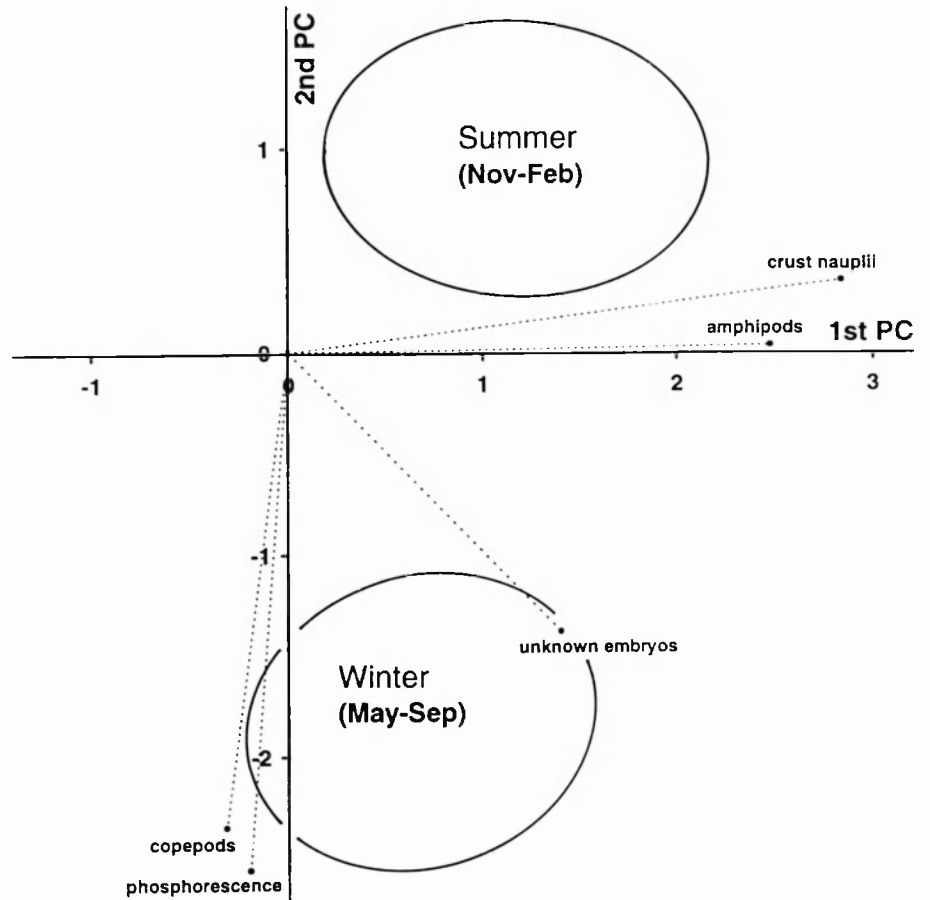

Figure 2.8

A biplot of the PCA on environmental data collected in the survey (data from Clarke and Leakey, 1996). The vectors represent the original variables, with the ellipses showing the area of the scores that fell in each quadrant of the biplot. The axis values are arbitrary units.

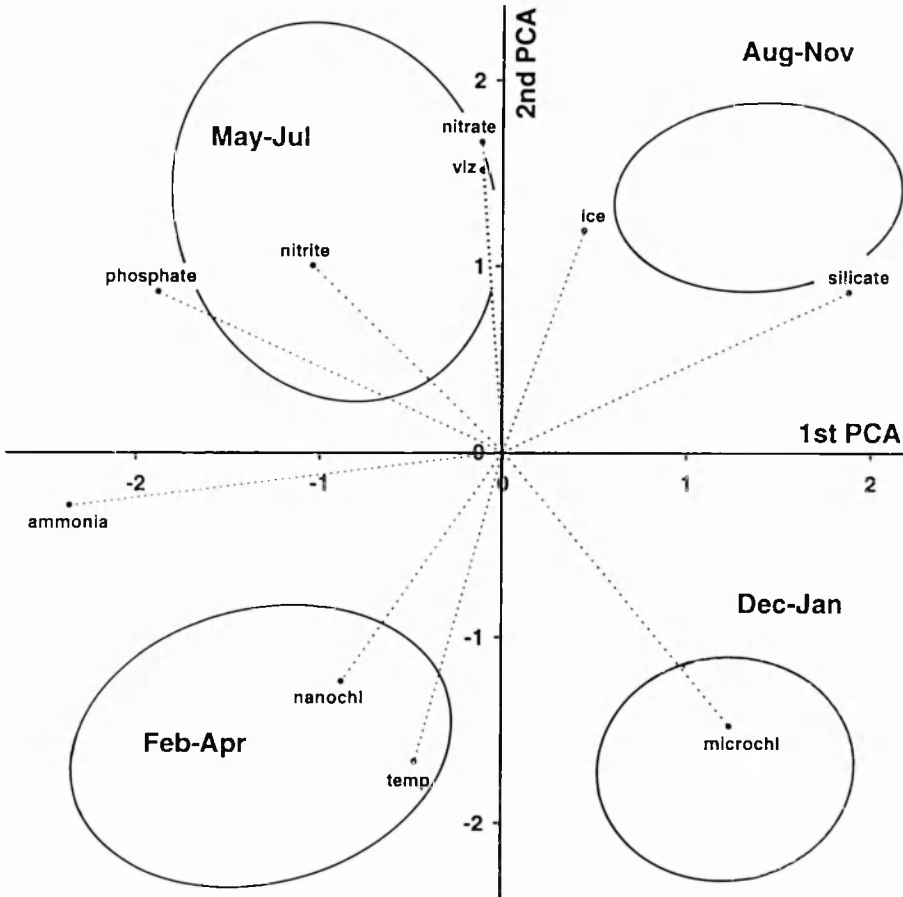

Figure 2.9

A biplot of the PCA on phytoplankton data collected in the survey. The vectors represent the original variables, with the ellipses showing the area of the scores that fell in each quadrant of the biplot. The axis values are arbitrary units.

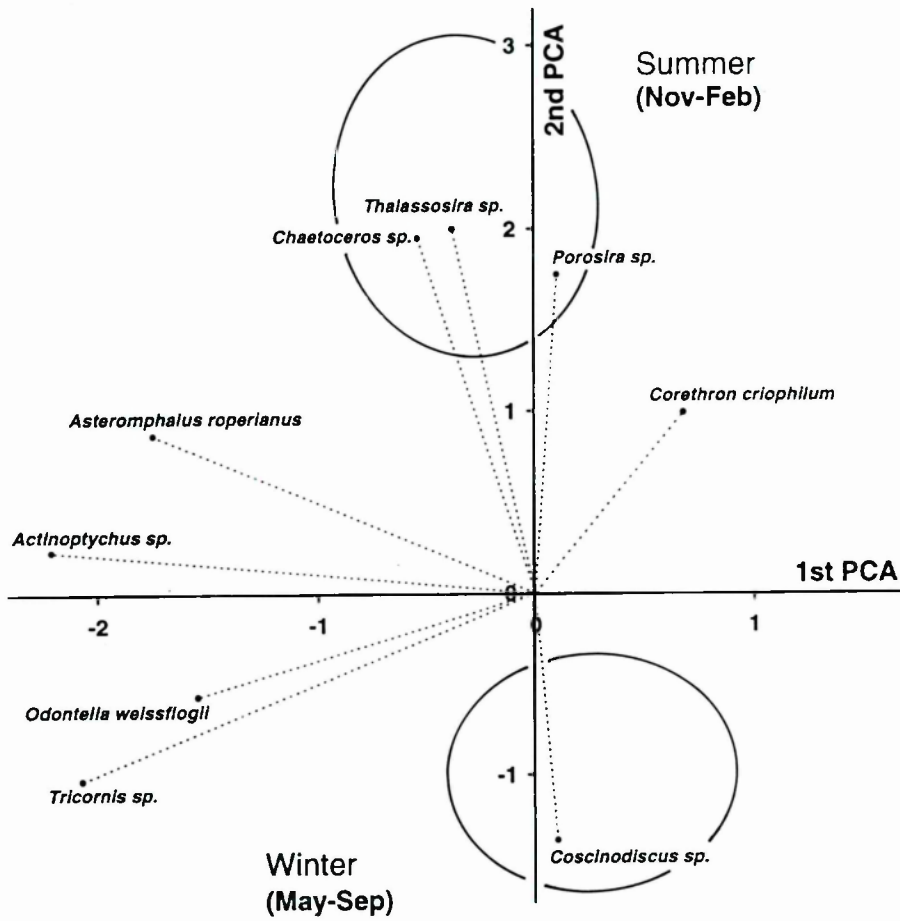
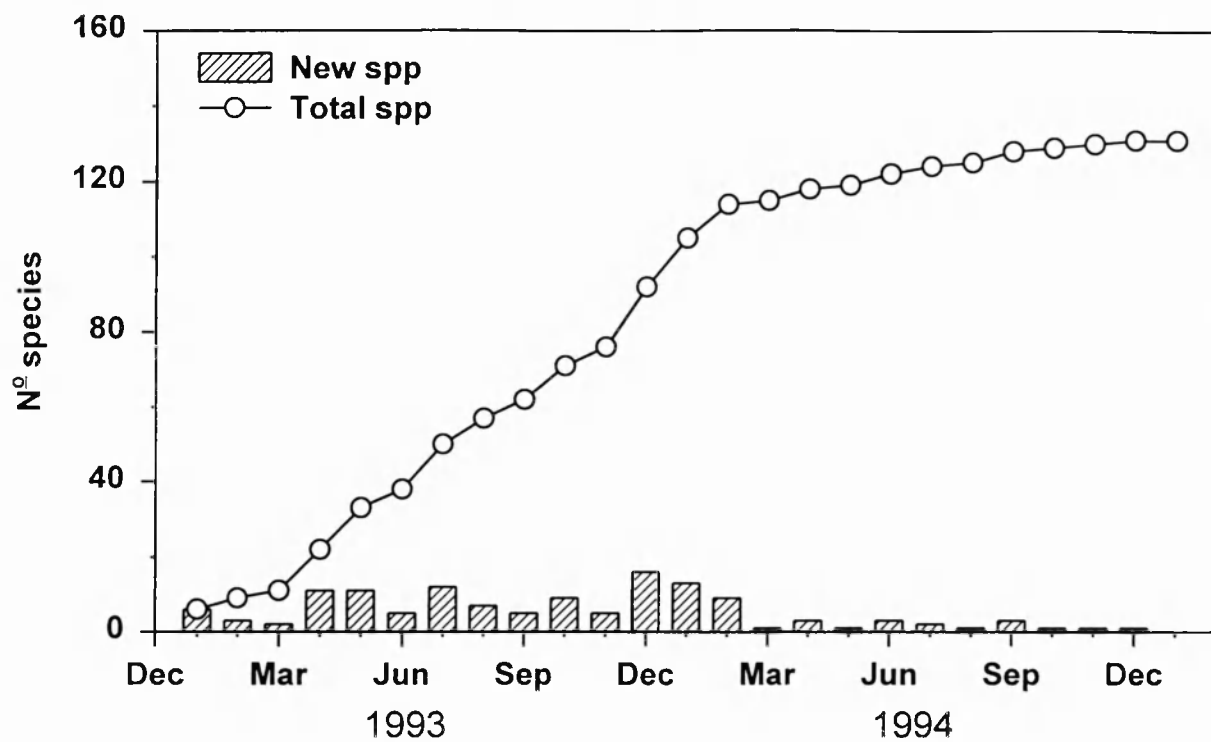

Figure 2.10

A species incidence curve of larval species collected throughout the survey. The line represents a cumulative species count.



Chapter 3 Recruitment and growth on settlement panels

Data also presented in: Stanwell-Smith D and Barnes DKA (1997) Benthic community development in Antarctica: recruitment and growth on settlement panels at Signy Island, *J Exp Mar Biol Ecol* **212**(1): 49-67

3.1 Introduction

A knowledge of recruitment and colonisation is essential for any understanding of early community development in marine benthic assemblages. The transition, in the subtidal, from bare substrata to complex and arguably “climax” assemblages has been shown to be influenced by many variables (Turner and Todd 1993). One of the most important is the availability of new recruits (Underwood and Denley 1984; Roughgarden et al 1988; Menge 1991). The marine environment of the maritime Antarctic is characterised by intense seasonality of primary production (Whitaker 1982), light availability and sea-ice cover (Clarke et al 1988) and activity of benthos (Gruzov 1977; Clarke 1988). Recent work at Signy Island has shown, however, that the brief super-abundance of microplankton (which forms the vast bulk of summer chlorophyll standing crop) has obscured the considerably greater duration of nanoplankton productivity (Clarke and Leakey 1996). Barnes and Clarke (1995) found that many suspension feeders (including bryozoans, polychaetes and hydroids) feed for nine or more months a year. Furthermore, growth may be year-round in some bryozoans (Barnes 1995a), bivalve molluscs and brachiopods (Peck et al, in press). The seasonality of the environment and its ecological implications have thus become of great interest in Antarctic waters over the last decade (Clarke 1988; Peck and Holmes 1989; Leakey et al 1994; Barnes and Clarke 1994, 1995).

Whilst many studies using settlement panels have been conducted in temperate waters (Withers and Thorp 1977; Keough 1983; Lopez-Gappa 1989; Todd and Turner 1986; Turner and Todd 1993) and at tropical latitudes (Goren 1979; Jackson 1977; 1979; Harriott and Fisk 1987), there is a paucity of high latitude data in the literature. Indeed, a recent review of Antarctic benthic research (Arntz et al 1994) cites Dayton (1989) as the only successful Antarctic settlement panel experiment reported. Dayton deployed panels in 1974 at McMurdo Sound (77° 51' S 166° 40' E) and recovered them in 1984, by which time they were well covered by benthic fauna. More recently, perspex panels have been deployed at Signy Island at depths of six, 12 and 25m over a 21 month period, yielding a maximum mean epifaunal area covered (at 25 m) of 6.5% (Barnes 1996).

Observation and / or manipulation of natural substrata are potentially ideal methods for the analysis of epifaunal community structure and development (Connell 1985) but often they present practical difficulties. Artificial substrata can, however, be tailored to individual studies and have been used extensively in investigations of settlement, recruitment, colonisation and community development. Panels allow a degree of simulation of conditions found in natural habitats whilst reducing substratum heterogeneity. Their uniformity also facilitates replication which is important in analyses of variation (e.g. between panels). Artificial panels offer advantages at polar latitudes because the short day length, weather extremes and SCUBA restrictions necessitate the rapid deployment, recording from and/or retrieval of apparatus. In addition, panel photography is straightforward.

The few previous studies reported (Dayton 1989; Rauschert 1991; Barnes 1996) have suggested that recruitment levels in Antarctic waters are very low and that to be of value, settlement experiments may need to be immersed for extended periods. Iceberg scour has been described as a major source of disruption of Antarctic near shore marine communities

(Rauschert 1991; Peck and Bullough 1993; Barnes and Clarke 1994). The deployment and recovery of equipment after an interval of months or years therefore risks damage from the destructive effects of ice. However, seasonal patterns can only be assessed from long-term panel deployment with regular monitoring.

The present study is aimed at the investigation of seasonal and inter-annual variation on the identity, quantity and timing of recruiting individuals. Regular panel replacement and *in situ* observation allowed for detailed analysis of the seasonality and mortality components of recruitment, as well as following growth of individual recruits. The term “recruitment” has been used in this study as describing successful settlement. This was defined as the organisms that settled onto the panels and had metamorphosed, thus making the beginnings of their sessile life (for example the calcareous skeleton of bryozoan ancestrulae).

3.2 Methods

Study Sites

The three study sites were located on rocky substrata of quartz mica schist in Borge Bay (Fig. 1.1b). Powell Rock, the deepest site at 25 m, was at the base of a vertical outcrop rising from pebble scree. The Polynesia Point site was at 8 m, in an open ended cave with moderate levels of water movement (Stanwell-Smith, pers obs). The shallowest site was Bare Rock at 5 m depth, on an area of rocky rubble at the base of overhangs (Plate 3.1). All three sites had a highly diverse and abundant natural encrusting fauna (White and Robins 1972; Barnes 1995 b,c).

Environmental variables including seawater temperature and salinity, sea-ice thickness

and seasonal duration, chlorophyll standing crop and macronutrients (N, P, Si) have been continuously monitored for most of the past thirty years at Signy Island (Clarke et al 1988; Leakey et al 1994; Clarke and Leakey 1996). During the experimental period of 720 days, the sea temperature varied between -1.88°C and $+0.78^{\circ}\text{C}$ and sea-ice was present for 332 days over two winters (five to six months each year). Storms were typical of the area, with gale force winds recorded on 190 days. Iceberg scour in Borge Bay has been described as having a major influence both on soft bottom (Peck and Bullough 1993) and hard substratum macrobiotic communities (Barnes 1995 b,c). Powell Rock, and to a lesser extent Bare Rock, were subjected to limited ice scour whilst the Polynesia Point site was sheltered by being in a cave. Wave activity was less pronounced at Powell Rock (25m) than at the two shallower sites (pers obs).

Plate 3.1

The panel array location at Bare Rock at 5m depth, with rocky overhang and dense encrusting benthic fauna.



Apparatus

Machined slate panels 150 x 150 x 12 mm were mounted on epoxy-resin coated steel frames at each site (Fig. 3.1). Nine panels were held in sets of three replicates, one set for each of the “treatments” of the experiment, on each frame. Stainless steel bolts were used to attach each set onto metal rails which were held in the frames with elasticated cord. Bolts were welded onto the four corners of the frames to raise the panels from the rock below. All three sites were horizontal and flat, therefore by adjusting the bolts, a 20 mm gap was maintained between the panels and substrata when deploying the frames. Rock-climbing pitons driven into cracks in the bedrock and climbing tape were used to anchor the frames, although their low profile and large mass (30 kg) made them stable under most conditions. The panels used, method and gap-size were adapted from Todd and Turner (1986).

In the laboratory, retrieved panels were examined under a dissecting microscope and photographs taken using a Nikon F301 camera with 55mm macro lens on a copy stand. Illumination was from a flashgun and two copy lights, using 100 ISO monochrome film. Underwater photographs were taken with a Nikonos V camera and 1:4.5 macro framer using 50 ISO colour transparency film. A 150mm metal ruler was attached to the framer for scaling the image. Area colonised was measured using a Seescan Sonata II image analyser, calibrated from the ruler in the photographs. A repeatable accuracy / resolution was tested at better than 0.01 % of the analysed area (< 1 mm² of 100 x 100 mm square).

Experimental Protocol

Prior to deployment, each panel was washed, scrubbed with a wire brush and air dried. A

non-toxic dark blue marker pen and template were used to colour a 100 x 100 mm area in the centre of each panel, to improve contrast for photographic records and ensure an identical area of analysis between panels (Plate 3.2). The panel undersides were the intended analysis substratum so the blue panel areas were immersed facing downwards. Of the nine panels placed at each site using SCUBA, three were kept underwater for the duration of the experiment and were photographed monthly *in situ*. In order to compare panels before and after retrieval, the panels also were photographed in the laboratory before deployment. These “permanent” panels occupied the central position on the frame. The two other sets of triplicates on each frame were replaced every 8 wk, being exchanged on alternate monthly visits. The overlap of periods allowed monthly changes in settlement to be identified. Care was taken to prevent the panels freezing in transit from the dive sites.

The recovered panels were photographed in a tray of 1µm filtered sea-water and then dried. Settled biota were counted and unknown forms were photographed and drawn for later identification. Once analysed, the panels were again scrubbed, washed and dried for re-use. At the end of the experimental period all frames were returned to the laboratory, constantly immersed in seawater. The permanent panels were photographed, dried and returned to the UK for identification of encrusting biota. Monochrome 200 x 200mm prints were produced on which individual bryozoan colonies and other taxa of the permanent panels were labelled for reference.

The area covered by each species on each permanent panel was calculated from the image analysis data in the UK. The number of colonies of each species was counted in the central blue area, between the blue area and panel edges, and around the sides of the panels (see Plate 3.2). The total area colonised was also measured on the photographs of the permanent panels taken at monthly intervals (Plate 3.3). Growth in terms of area covered of

individual colonies of four common bryozoan species was also estimated from the monthly photograph series.

Statistical analyses were limited by the experimental protocol. Seasonal changes in recruitment were clarified using ANOVA. Colonisation rates were compared between sites using regression analysis. The competitive hierarchy in relation to abundance of cheilostomatid bryozoans at Powell Rock was investigated using Spearman's rank correlation.

3.3 Results

Recruitment and colonisation

Frames were initially deployed at two sites, Powell Rock and Polynesia Point, during the austral summer of 1992-93. During the winter of 1993, access to Polynesia Point was restricted by poor ice conditions and so a third site, at Bare Rock, was added in October 1993. Recruitment was measured by the number of successful settlement events (i.e. undamaged skeletons of settlers) recorded on the bi-monthly panels (Figs. 3.2 a,b,c). Apart from a few exceptions, it was possible only to identify most bryozoan ancestrulae to class and they were therefore pooled into cheilostomatids and cyclostomatids. Other taxa occurred in negligible numbers, with ten thecate protozoans present at Powell Rock in April 1993 and between one and three colonial tunicates at Powell Rock from February to August 1993 and 1994. These minor colonising taxa have therefore been excluded from Fig.3.2 for clarity. The ancestrulae of two cheilostomatid bryozoan species and one genus were distinct in identification; their seasonal occurrence has been presented (Fig. 3.3). *Celleporella* spp. are represented by three common species in the settlement experiment, and show a possible trend of increased

recruitment in October to December, 1993. *Micropora brevissima* showed a peak at Powell Rock in the austral summer, and a peak in May at Bare rock. In contrast, *Inversiula nutrix* were recruiting in distinct summer peaks.

For cheilostomatid bryozoans, recruitment was higher between June and February than at other times, both at Powell Rock (ANOVA, $F=2.93$, $p<0.01$) and Polynesia Point (ANOVA, $F=8.04$, $p<0.01$), with some evidence of a peak in recruitment at Powell Rock between October and January; and July-September at Polynesia Point (Fig. 3.2 a,b). The pattern was not as clear at Bare Rock, the shallowest site although recruitment there in March, April and May was still significantly lower than the rest of the year (ANOVA, $F=5.79$, $p<0.05$).

There was no consistent temporal pattern of recruitment across sites for cyclostomatid bryozoans. There were significantly more recruits at Powell Rock (25m) throughout the year (ANOVA, $F=11.52$, $p<0.01$), with the exception of large single settlement events during the winter at each of the other two sites, in different years (Figs. 3.2 a,b,c). Spirorbinid recruitment also was highly variable both temporally and between sites. At the shallowest site (Bare Rock, 5m) peaks occurred in December 1993 and 1994, with another high value in August / September 1994. At Powell Rock (25m) there were no clear repeated patterns, although levels were higher in late summer and lower in mid-winter. At Polynesia Point (8m), however, higher recruitment occurred in 1993 than in 1994, although this did not prove statistically significant (ANOVA, $F= 3.68$, $p< 0.065$).

In contrast to the classification difficulties found for the bi-monthly panels, the extended immersion period of the permanent panels meant that of the 986 cheilostomatid bryozoans enumerated, all but six were identified to species using Hayward (1995). Colonisation on the permanent panels was measured both by the number of colonies of each

taxon and the percentage covered by each species of blue shaded area (Table 3.2). Plate 3.2 shows one of the replicate panels from Powell Rock (after 21 months of immersion at 25m); which yielded a covered area of 16.9 %. Permanent panels from Polynesia Point were not used in the analysis because the frame at this site was lost during storms in April, 1994. It was replaced and promptly lost again in storms during May, 1994. The bi-monthly panels were also lost for this period, hence the missing data points (on Fig. 3.2b).

Powell Rock had a sufficient level of species richness (defined here as the number of taxa present) on panels to investigate differences in cheilostomatid abundances. Species abundance was found to be inversely related to the hierarchical overgrowth ranking described by Barnes and Rothery (1996) (Spearman rank test, $T = 5.95$, $p < 0.01$).

The number of colonies was counted between the blue area and the edge of the panel and also around the sides of each permanent panel (Table 3.1). Cheilostomatid bryozoans accounted for over 50% of the successful recruits. Of these, species of the genus *Celleporella* were the most common in most of the panel areas measured and dominance increased towards the edges and sides of the panels.

On permanent panels the total cumulative area colonised at monthly intervals during the experimental period was calculated for Powell Rock and Bare Rock (Fig. 3.4). Between January and October 1993, the panels at Powell Rock (25 m) showed very little colonisation but percent area covered gradually increased over the following 10 months to peak at a mean of 11.4 % cover in August 1994. Panels were not deployed at Bare Rock (5 m) until nine months after Powell Rock panel deployment, thus precluding direct comparisons of colonisation. However, after 15 months at Bare Rock the mean cover of 1.7% was substantially lower than cover after an equivalent period at Powell Rock, measuring 5.8% after 15 months immersion. After 12 months the mean area covered at Powell Rock was

shown by regression analysis to have increased significantly ($F=30.28$, $df=1,6$, $p<0.05$); however the area covered at Bare Rock did not significantly change throughout the experimental period ($F=0.15$, $df=1,7$, $p=0.721$).

Plate 3.2

A panel from Powell Rock, immersed for 21 months at 25m. Note that at 16.9% cover, this was the most settlement seen on any of the panels during the experiment.

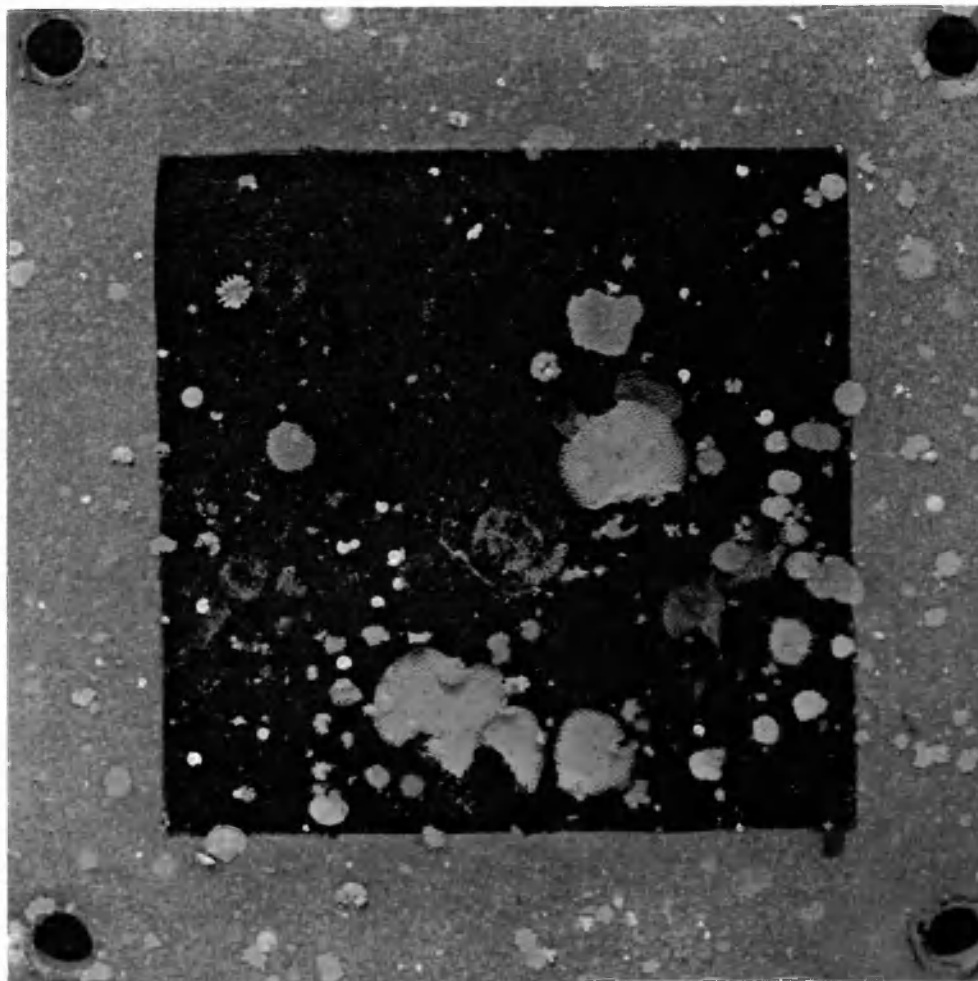

Growth

Analysis of the time sequence photographs of the permanent panels at Powell Rock allowed growth in individual colonies to be estimated (Plate 3.3). The Bare Rock panels had no colonies large enough for measures of incremental growth to be made. *Celleporella antarctica* (n=9), *Lacerna eatoni* (n=15), *Micropora brevissima* (n=4) and *Arachnopusia inchoata* (n=15) were chosen for analysis (Fig. 3.5). They represented, in ascending order, the range of competitive overgrowth rankings previously identified for that site (Barnes and Rothery 1996). All colonies larger than 2 mm² were measured. Any reductions in colony area between successive months have been taken as indicative of damage through physical disturbance or predation. Growth was calculated with and without colony damage, thus giving estimates of actual colony area increase and potential colony area increase (Table 3.4). Reduction in size of the colonies which were damaged during the experiment (the colonies with white symbols in Fig. 3.5) were discounted when calculating potential colony increase. *A. inchoata* exhibited the fastest growth, with one colony increasing from 9.3 mm² in December 1993 to 120.1 mm² in March 1994, a mean growth of 36.9 mm² / month (Fig. 3.5a). This colony was then damaged and reduced to 9.4 mm² in April 1994, growing again to 18.5 mm² by June, before being entirely destroyed in July. The mean percent increase in area also was calculated, with *A. inchoata* having the fastest increase, closely followed by *L. eatoni* (Table 3.4). Despite the rapid percent increase of colony size in *L. eatoni*, its mean growth was the lowest of the four species measured because of its relatively small colony size. Edge effects were minimised by only measuring colony growth in the blue area of the panels (Todd and Turner 1986).

Plate 3.3

Two of the monthly transparencies taken of the in situ panels, used in the image analysis for growth and colonisation. The metal rule allowed calibration. (Note that these panels are not from successive months, and so difference is exaggerated. Date of first panel: 17/12/93; second panel: 31/7/93)

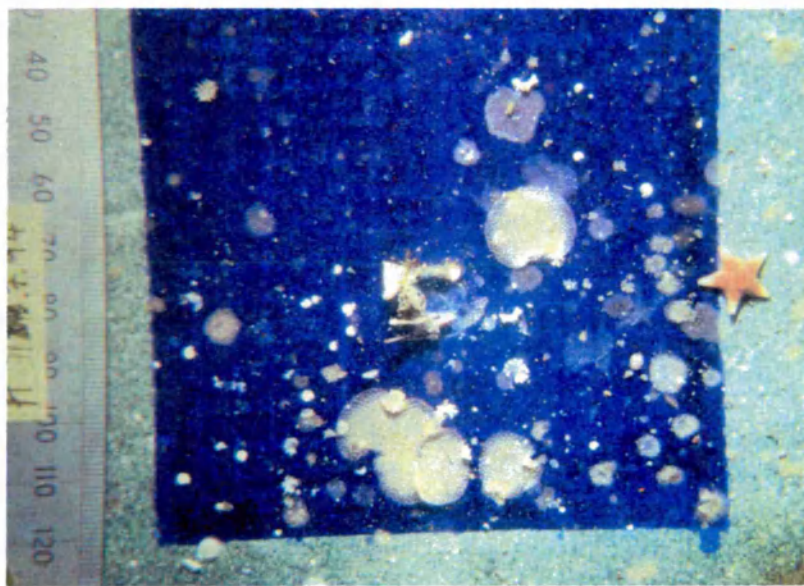
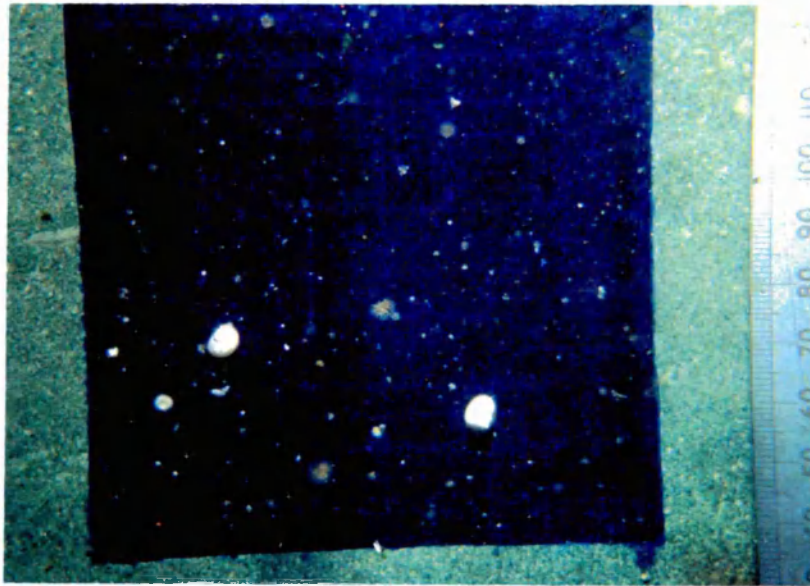

3.4 Discussion

Colonisation

There was significantly less colonisation in the present study at the shallow sites (5-8 m) than at 25m with cheilostomatid bryozoans dominating assemblages at all three sites. There was variation of area colonised between replicate panels (4.6 % to 16.9 % at 25m, 1.0 % to 2.4 % at 5m), although on one of the panels at 25 m, two *Arachnopusia inchoata* colonies accounted for 6.5% cover, i.e. over half the range of area colonised. Patchiness in the distribution of new recruits in the water column caused by stochastic factors (e.g. mortality) has been observed before (Keough 1983; Morgan 1995). This could explain much of the between-panel variation, emphasising the need for adequate replication in panel experiments. The slow and hierarchical colonisation of Antarctic substrata may therefore be another example of altered community development in situations of very low recruitment as proposed by Roughgarden et al (1988).

The low level of colonisation in the present study was comparable with other experiments in Antarctic waters. A study at Signy Island (1991-93) showed 0.7% at 6m and 6.5% cover at 25m, using roughened clear perspex panels of 300 x 300 x 12mm (Barnes 1996). This served as a pilot to the current experiment, which used a more "natural" substratum for the panels and more comprehensive sampling regime. Scrubbed boulders were placed at 5m depth at Signy Island during 1969, yielding less than 1% cover of spirorbinids and bryozoans after 12 months (White MG, pers comm). Panels deployed at McMurdo in 1974 had collected only two serpulid polychaete individuals by 1977, were bare when observed by a diver in 1979 but were "well colonised" by bryozoans, sponges and soft corals

when collected in 1984 (Dayton 1989).

The McMurdo data are the only published evidence suggesting significant interannual variation of recruitment in Antarctic environments and this has been explained by changes in large scale oceanography. However Antarctic settlement panel experiments have been concentrated at only a few shallow water sites (reviewed by Arntz et al 1994). These are primarily at high latitudes such as McMurdo Sound (77°S) in the Ross Sea and at maritime Antarctic stations such as Signy Island (60°S). The South Orkneys, including Signy Island are at the edge of influence of the Weddell Sea gyre (Murphy et al 1995). This oceanographic phenomenon moves backwards and forwards across the South Orkneys, perhaps introducing greater interannual variability than at other sites on the Antarctic continent. Despite this, continuous low levels of recruitment were observed here and in the 1991-93 Signy study. Unfortunately the McMurdo panels were not observed for the five years between 1979-84 and so year to year differences could not be calculated. In the absence of other literature, caution must be exercised when comparing such potentially different habitats.

On a broader scale, the mean level of colonisation recorded, in terms of area covered, (1.7% at 5m, 8.9% at 25m) was more than an order of magnitude lower than those found in panel experiments over similar periods of immersion at temperate and tropical latitudes (Fig. 3.6). A study in cold-temperate Argentinean Patagonia (47°45' S, 65°55' W) showed 75 % substratum colonisation after 9 months, of which 57% was attributed to bryozoans (Lopez Gappa 1989).

Barnes and Rothery (1996) calculated a hierarchy of overgrowth ability from a matrix of wins over losses from 4076 competitive interactions between 21 cheilostomatid species in an experiment at Powell Rock, Signy Island (1991-93). In that study, analysis of panels from 25m showed cheilostomatid bryozoan abundance was inversely proportional to overgrowth

strength (Spearman rank test, $T= 5.45$, $P<0.01$). The present study measured $T=5.95$, $P<0.01$ in a Spearman rank test using the Barnes and Rothery heirarchy, from the same site at Powell Rock, suggesting a similar community has recruited to the panels over the same time span. Most of the cheilostomatid species were common to both studies (13 of 17 at 25m). Natural substrata have been examined adjacent to the Powell Rock (25m) site yielding 21 species of cheilostomatids (Barnes et al 1996). Samples with 46 bryozoan species were collected from Dayton's study at McMurdo Sound (Moyano 1984). Information was not recorded on the time of immersion, panel material and size and the location relative to the seabed but the depth range was described as being 10-40m. About 70% of the species examined were endemic to Antarctica and *Celleporella antarctica* was the most abundant species present. In the present study *Celleporella* species also had the highest proportion of the total number of cheilostomatid colonies (Table 3.3), as did the 1991-93 Signy study.

The larval sampling described in chapter 2 was carried out in adjacent waters to the panel sites throughout the experimental period. Pelagic larvae of several phyla were caught, the majority being molluscs, annelids and echinoderms; however only one bryozoan cyphonautes larva was caught. Bryozoan coronate larvae may have occurred in the unidentified portion of the larvae captured or may have spent too short a period in the water column to be detected.

Seasonality of recruitment

The level of recruitment varied both seasonally and between the two years studied. Extensive discussion by Turner and Todd (1993) covered recruitment variation despite the high dispersal ability of pelagic larvae and the complexities of separating the factors that could be involved.

The intertwining effect on recruitment variation by larval abundance in the plankton, larval numbers in the vicinity of suitable settlement substrata, larval settlement behaviour and post-settlement mortality were also described. Pechenik (1987) identified six physiological stresses influencing larval mortality: extreme / variable temperatures and salinities, low levels of dissolved oxygen, pollution, UV radiation and poor nutrition. Of these, variation in salinity, nutrition and possibly UV radiation are the most likely to affect variation in Antarctic pelagic larvae.

When looking for seasonality in the current study, the reduction between January and June at all three sites is the most distinct pattern, a time between the peak of the phytoplankton bloom and into the early part of the austral winter. Huge swarms of ctenophores occurred in surface waters (<10 m) during this time (pers obs). At Powell Rock (25m), recruitment was not, however, completely suppressed. Such seasonal occurrence of gelatinous zooplankton may have the greatest potential as pelagic larval predators, with the relatively low number of pelagic planktivorous fish in the Southern Ocean, (Kock 1992) and specifically at Signy (North, pers comm). Predation may therefore be a factor in what otherwise seems to be faunal reproductive seasonality.

The increased level of recruitment that occurred at other periods of the year (i.e. between June and January) coincided with the austral winter period until the beginning of summer, before the phytoplankton bloom. A two month difference between Powell Rock and Polynesia Point was evident, although the standard error bars in Fig. 3.2 suggest large differences between the three replicate panels at each immersion. This may have been because of single species recruitment events or localised variation in the habitat, but was not consistent with any particular location within the frames. Random relocation of panels within the frame during the experimental period (Todd and Turner 1986) would have minimised the

effect of panel position relative to the substratum, but was not possible because of SCUBA operational constraints.

The recruitment of the three cheilostomatid species identifiable as ancestrulae (Fig. 3.3) show contrasting patterns. An annual recruitment event was detected by colony size cohorts of zooids (Barnes 1996) in both *Celleporella bougainvillei* and *Inversiula nutrix*; concurring with the peaks observed in the present study.

Comparing the number of recruits with number of colonies in the three cheilostomatid species with distinct ancestrulae showed no clear pattern. However, a suggestion of “supply side ecology” (Roughgarden et al 1988) lingers: at 25m, the ratio of *Celleporella:Micropora:Inversiula* ancestrulae recruiting was 25:15:1, compared to 21:5:1 respectively for colonies of the same species on the permanent panels removed at the end of the experiment. The trend of corresponding magnitude was not evident at 5m: 46:29:1 (recruiting), against 2:1:1 (colonies).

The dominance of bryozoans and polychaetes indicates their importance in early community development at this latitude in Antarctica. The lack of settlement and subsequent recruitment of “late” successional species such as sponges could be attributed to the low abundance of sponge planulae in the plankton (See chapter 2 and Fig. 2.3a). Alternatively, they may not be settling on sites with poorly developed communities. Perturbation from density independent factors such as from ice scour have a major influence on succession in localised areas (McCook and Chapman 1993; Barnes 1995b). Interspecific competitive interactions in polar regions may therefore be less important in community development than at lower latitudes.

Growth

The slow growth of polar marine benthos has been well documented (Clarke 1983; Arntz et al 1994), as have the few taxa that seem to grow relatively quickly, notably two sponges (Dayton 1989) and an ascidian (Rauschert 1991). Variation in growth has also been studied in colonial suspension feeders at high latitudes, particularly bryozoans (Barnes 1995a).

Colonial growth can occur in many forms (Lidgard 1985; McKinney and Jackson 1989). In this study absolute growth has been assessed in terms of percentage area of substratum covered by encrusting taxa. Although there is not a simple relationship between environmental factors and food supply, variation in food availability has been linked to growth in Antarctic sessile animals (Richardson 1979). The strongly seasonal nature of primary production in polar waters has led to an assumption of extremely low food availability during polar winters (Gruzov 1977; Clarke 1988). More recently, however, the few benthic suspension feeders that have been examined have been shown to feed for the majority of the year, for example erect bryozoans (Barnes and Clarke 1994). The bivalve mollusc, *Yoldia eightsii*, also grows throughout the year (Colman, unpubl data). The present experiment adds encrusting bryozoans to the list, with all four species studied growing throughout the year. Indeed, the cheilostomatid, *Arachnopusia inchoata*, has been observed to feed continuously (Barnes and Clarke 1994) and was the fastest growing of the species measured here.

The increased area of colony covered, including colony damage, were calculated to be on average 85% of colony area increase excluding damage (Fig. 3.5). The 15% difference indicates the level of mortality during the early stages of community development. The variation in growth after reduction of zooids did not follow a particular pattern, with some

colonies growing either faster or slower than before sustaining damage. Damage aside, one of the clear results from Fig. 3.5 is the intraspecific variability of growth performances of the bryozoans measured. Benthic predation, i.e. density dependent mortality, was rare although predation by the nudibranch, *Pseudotrironia gracilidens* Odhner, occurred during the experimental period (pers obs). Low levels of water flow were observed at all times except from possibly damaging wave action during storms. This, and other density independent mortality from ice scour and ice bergs, were common and indiscriminate in their removal of encrusting organisms.

Between March and April, 1994 one of the permanent panels at Powell Rock was reduced by a single physical damage/predation event from 15.51% to 10.85% cover, a removal of 30% of the colonised area of the panel. This, in turn, was evident in the reduction of mean percent cover at Powell Rock during that period (Fig. 3.4). The monthly photographs showed recovery of individual colonies from almost total destruction. Such damage would almost certainly be fatal to unitary organisms. The recoveries seen here reflect one advantage of colonial existence (Hughes 1989). The dominance of colonial taxa in sublittoral Antarctic hard substratum habitats may hinge upon this ability to withstand loss in the face of physical stresses such as ice scour.

Table 3.1

Deployment and retrieval of settlement panels.

Date	Powell Rock	Polynesia Point	Bare Rock
28 / 1 / 93	Deployed	Deployed	
26 / 10 / 93			Deployed
1 / 4 / 94		Lost in storm	
13 / 4 / 94		Redeployed	
25 / 4 / 94		Lost in Storm	
6 / 5 / 94		Redeployed	
21 / 9 / 94	Retrieved	Retrieved	
15 / 2 / 95			Retrieved
Immersion time	602 days	580 days	478 days

Table 3.2

The mean number of colonies and area covered by biota on the “permanent” settlement panels. Powell Rock (25 m) panels were immersed for 21 months, Bare Rock (5 m) panels were immersed for 15 months. Errors are ± 1 SE, n=3.

Taxa	Powell (25 m)		Bare Rock (5 m)	
	Mean N ^o Colonies (or recruits)	Mean area (percentage)	Mean N ^o Colonies (or recruits)	Mean area (percentage)
Cyclostomatida	57.67 \pm 16.23	1.36 \pm 0.34	12.33 \pm 3.76	0.11 \pm .03
Spirorbinids	17.67 \pm 7.51	0.40 \pm 0.25	119.33 \pm 8.84	1.12 \pm 0.29
Colonial tunicates	0.33	0	0.33	0
Unidentified ancestrulae	2.00 \pm 0.58	0.03	1.00	0
Cheilostomatida (total)	79.00 \pm 7.81	7.09 \pm 3.59	38.00 \pm 7.02	0.35 \pm 0.05
<i>Aimulostia antarctica</i>	12.33 \pm 4.33	0.10 \pm 0.03	12.00 \pm 2.08	0.11 \pm 0.05
<i>Amphiblestrum familiaris</i>	7.00 \pm 1.15	0.48 \pm 0.48	1.67 \pm .33	0.02
<i>Arachnopusia inchoata</i>	7.00 \pm 0.67	2.85 \pm 1.94	1.67	0.02
<i>Celleporella antarctica</i>	8.33 \pm 2.33	0.95 \pm 0.66	0.67 \pm 0.33	0
<i>Celleporella bougainvillei</i>	10.33 \pm 1.33	0.20 \pm 0.06	6.67 \pm 3.28	0.01
<i>Celleporella dicyota</i>	1.67 \pm 0.67	0.07 \pm 0.03	0	0
<i>Ellisina antarctica</i>	3.33 \pm 0.67	0.14 \pm 0.12	4.00 \pm 0.58	0.03 \pm 0.01
<i>Escharoides tridens</i>	11.00 \pm 1.15	0.42 \pm 0.06	2.33 \pm 0.67	0.01
<i>Fenestrulina rugula</i>	1.33 \pm 0.67	0.15 \pm 0.14	0	0
<i>Harpecia spinosissima</i>	0.33	0	0.33	0.03
<i>Inversiula nutrix</i>	1.33 \pm 0.67	0.06 \pm 0.05	4.33 \pm 0.33	0.03 \pm 0.01
<i>Lacerna eatoni</i>	9.33 \pm 3.33	1.11 \pm 0.36	0.33	0
<i>Largeneshara lyrulata</i>	0.33	0.05	0	0
<i>Micropora brevissima</i>	5.00 \pm 1.00	0.51 \pm 0.43	4.00 \pm 1.53	0.09 \pm 0.03
<i>Smittina rogickae</i>	0.33	0	0	0
Total	156.67 \pm 15.63	8.88 \pm 3.98%	171.00 \pm 17.32	1.67 \pm 0.41%

Table 3.3

The dominant taxa and cheilostomatid bryozoans on the “permanent” panels, as measured by the number of colonies / individuals. The blue area was the central 100 cm² of the panels, the edges refer to the area between the panel margins and the blue area. Refer to Table 1 for full cheilostomatid species names.

Powell (25 m)	Blue Area	Edges of panel	Sides of panel
Taxa	cheilostomatids (50 %) cyclostomatids (37 %) spirorbinids (11 %)	cheilostomatids (58 %) spirorbinids (24 %) cyclostomatids (18 %)	cheilostomatids (54 %) spirorbinids (32 %) cyclostomatids (14 %)
Dominant cheilostomatida	<i>C. antarctica</i> (16 %) <i>A. inchoata</i> (14 %) <i>C. bougainvillei</i> (13 %)	<i>E. tridens</i> (38 %) <i>A. familiaris</i> (16 %) <i>C. antarctica</i> (12 %)	<i>C. antarctica</i> (38 %) <i>C. bougainvillei</i> (31 %) <i>E. tridens</i> (12 %)

Bare Rock (5 m)	Blue Area	Edges of panel	Sides of panel
Taxa	cheilostomatids (56 %) spirorbinids (27 %) cyclostomatids (16 %)	cheilostomatids (54 %) spirorbinids (30 %) cyclostomatids (15 %)	cheilostomatids (56 %) spirorbinids (29 %) cyclostomatids (15 %)
Dominant cheilostomatida	<i>E. tridens</i> (30 %) <i>C. antarctica</i> (21 %) <i>C. bougainvillei</i> (16 %)	<i>C. antarctica</i> (29 %) <i>C. bougainvillei</i> (24 %) <i>E. tridens</i> (21 %)	<i>C. antarctica</i> (33 %) <i>C. bougainvillei</i> (27 %) <i>E. tridens</i> (26 %)

Table 3.4

Growth rates of selected species of cheilostomatids at Powell Rock (25 m). Errors represent ± 1 SE, n=3.

Species	N ^o Colonies	Mean growth (mm ² /month)	Mean increase (% / month)	Mean growth minus damage (mm ² /month)	Mean increase minus damage (% / month)
<i>Arachnopusia inchoata</i>	15	7.10 \pm 2.21	49 \pm 8 %	10.63 \pm 3.18	54 \pm 9 %
<i>Celleporella antarctica</i>	9	2.80 \pm 0.78	28 \pm 4 %	3.29 \pm 0.93	30 \pm 9 %
<i>Lacerna eatoni</i>	15	1.66 \pm 0.25	44 \pm 10 %	1.83 \pm 0.25	48 \pm 12 %
<i>Micropora brevissima</i>	4	4.12 \pm 1.93	28 \pm 5 %	4.12 \pm 1.93	28 \pm 5 %

Figure 3.1

Diagram of the settlement panels and frame deployed at each study site. Elasticated cord (not marked) was used to hold each set of three panels to the frame. The central set was permanently immersed, the outer sets were exchanged on alternate months. The distance from the panels to substratum was 20mm, and was set using the screw threads on the bolt locators at each corner.

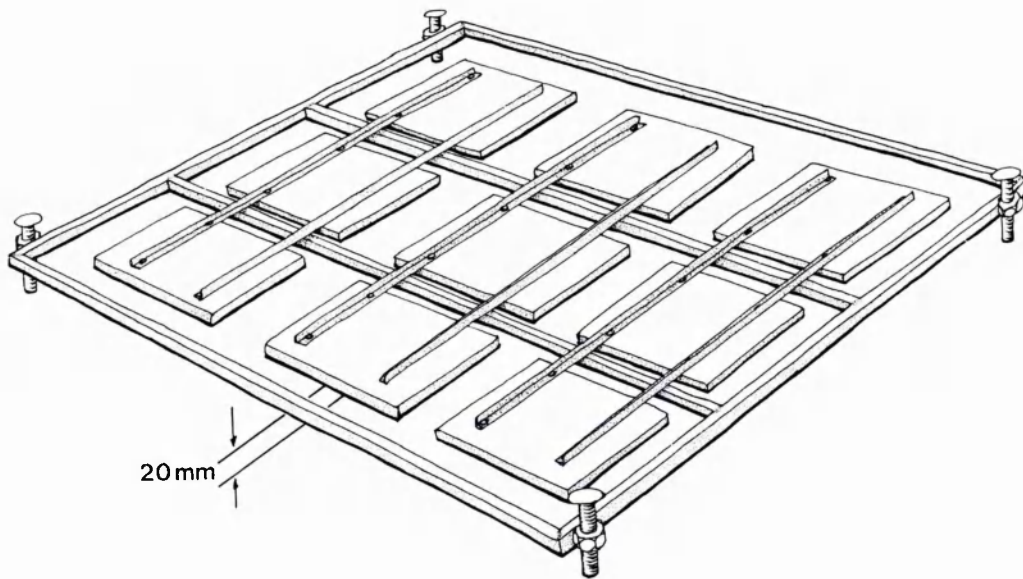

Figure 3.2

Recruitment numbers (means \pm SE, n=3) recorded from triplicate panels replaced every eight weeks during the study period; from 3a: Powell Rock (25m), 3b: Polynesia Point (8m), 3c: Bare Rock (5m). (● cheilostomatids, ○ cyclostomatids, ▲ spirorbinids).

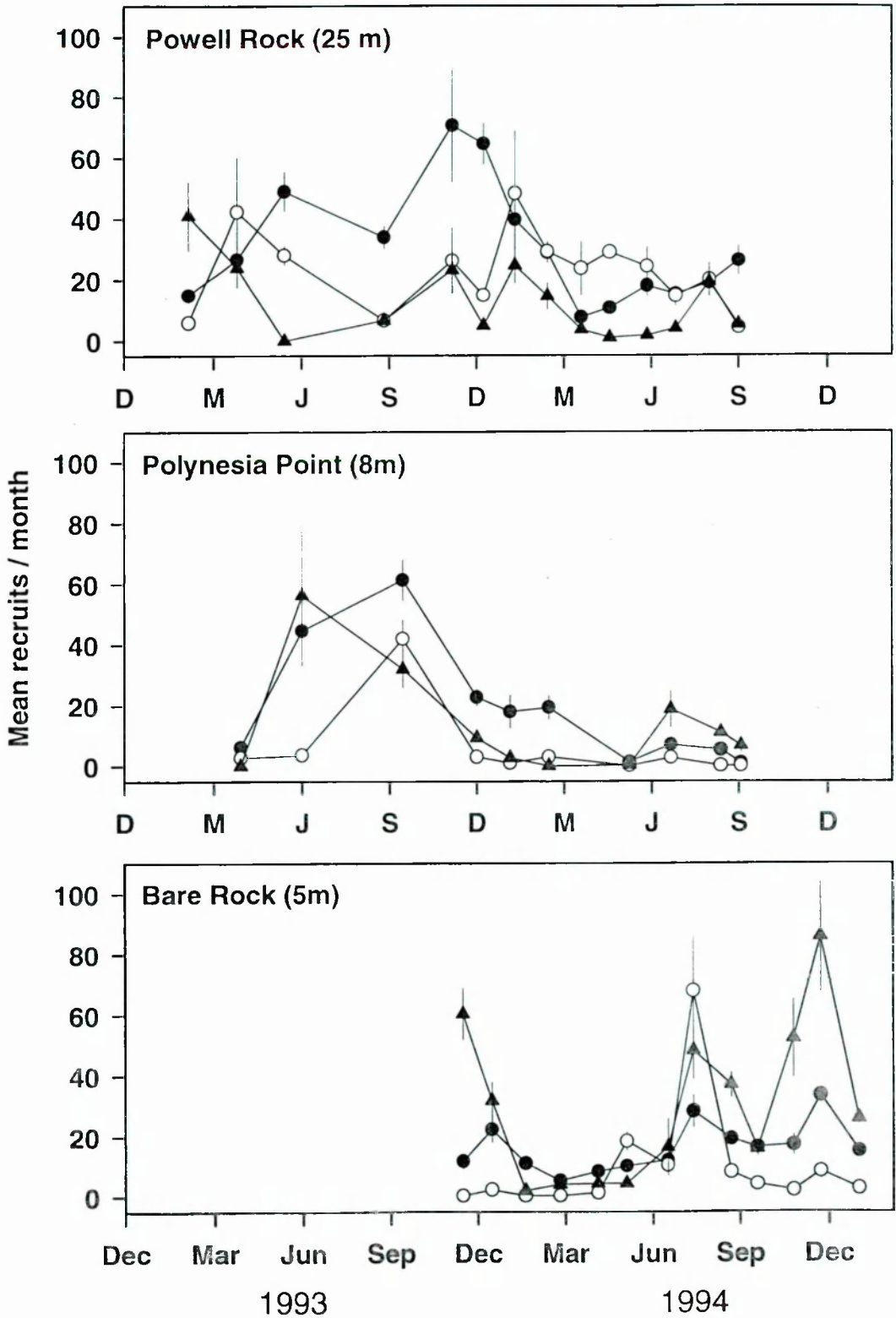

Figure 3.3

Recruitment numbers for three species of cheilostomatid bryozoan at the three study sites.

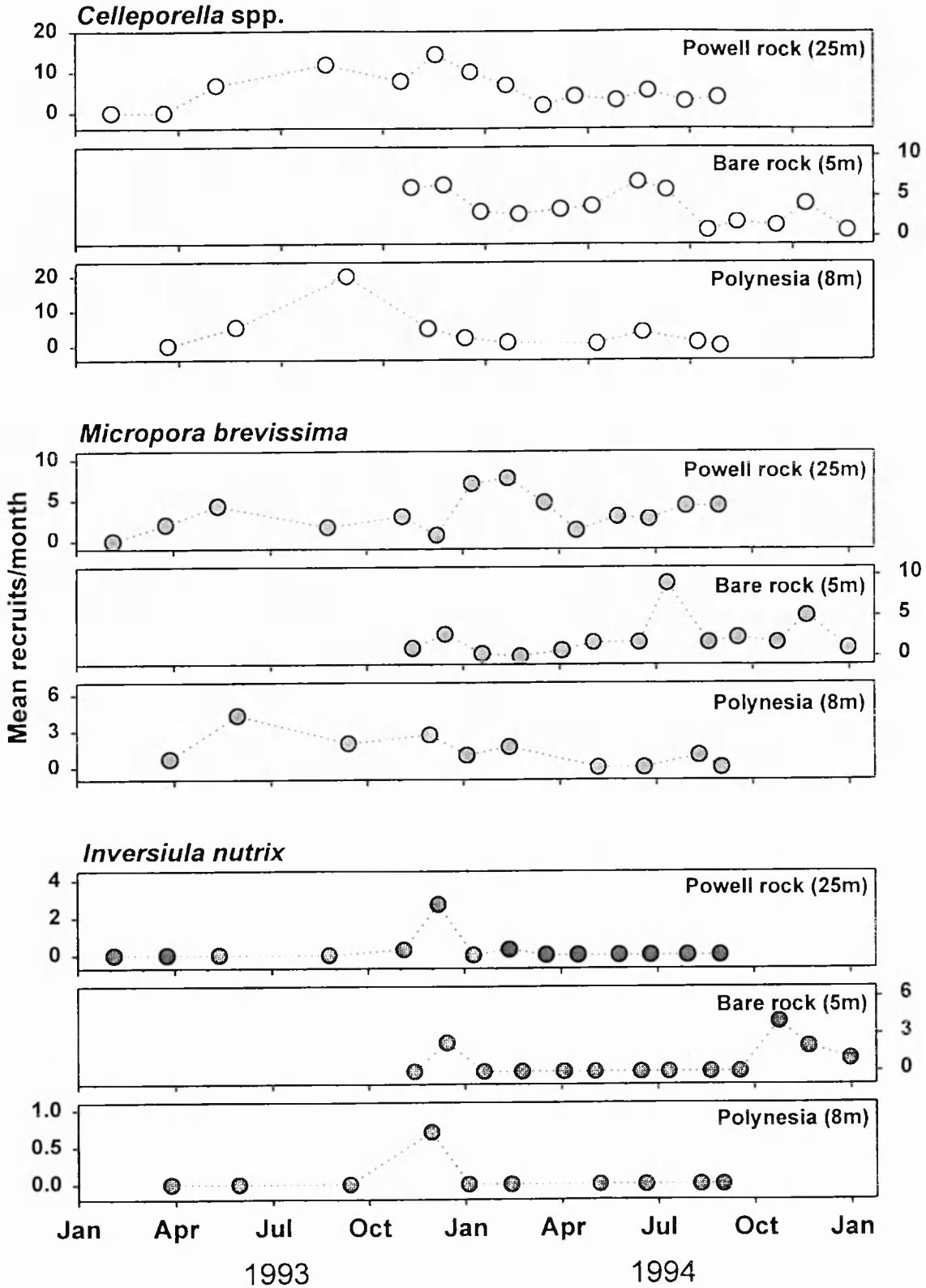

Figure 3.4

The total percentage cover (means \pm SE, n=3) measured on successive photographs of panels continuously immersed during the study period. Note that the error bars for Bare Rock are too small to be displayed. (● Powell Rock, at 25m; ○ Bare Rock, at 5m)

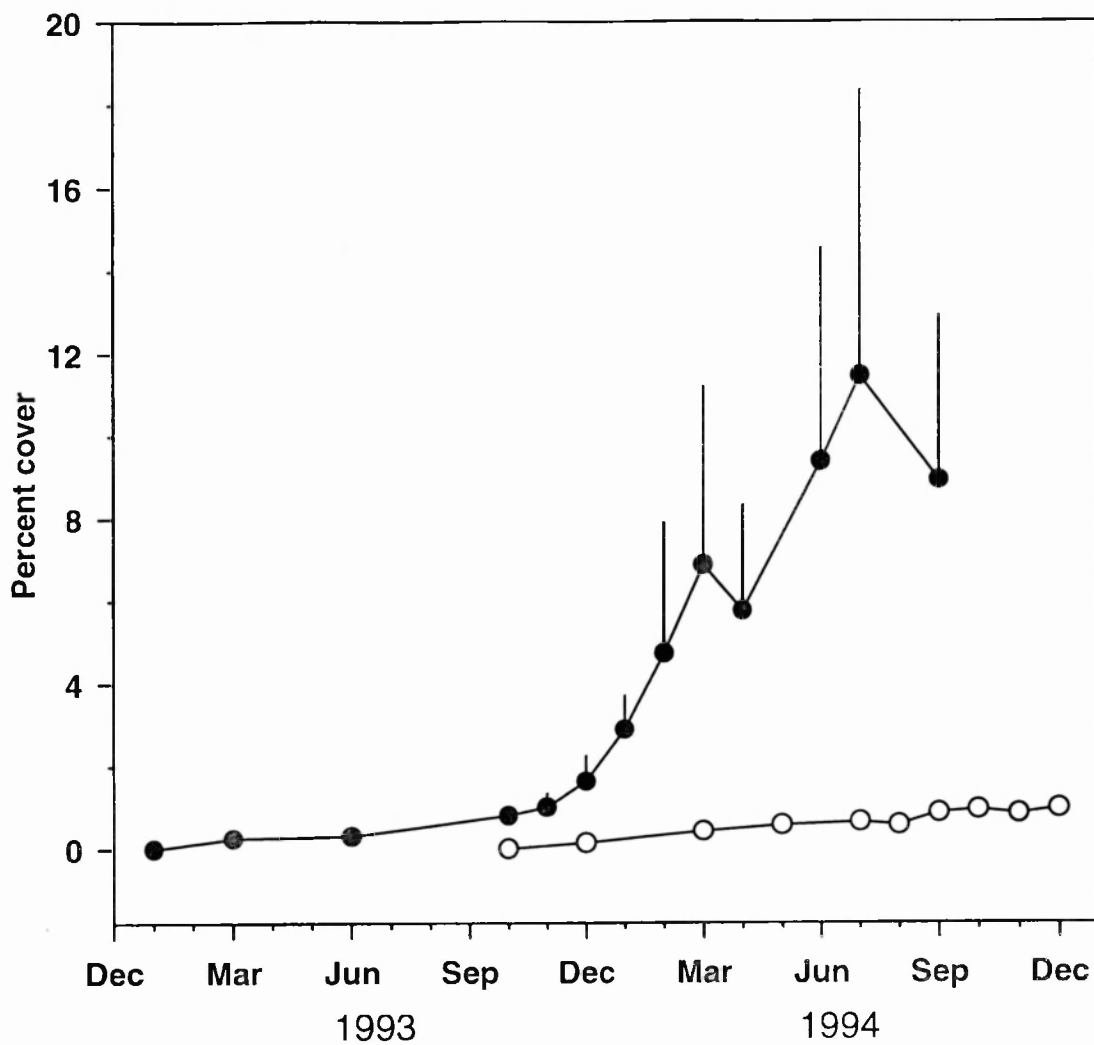

Figure 3.5

Area covered by individual colonies of four selected cheilostomatid bryozoan species, measured from successive monthly photographs of continuously immersed panels. Figs 3.5 a,c,d represent only eight colonies for clarity, showing the range of growth (Total colony numbers measured: A=15, B=4, C=15, D=9). Note different vertical axis scales (● undamaged colonies, ○ damaged colonies).

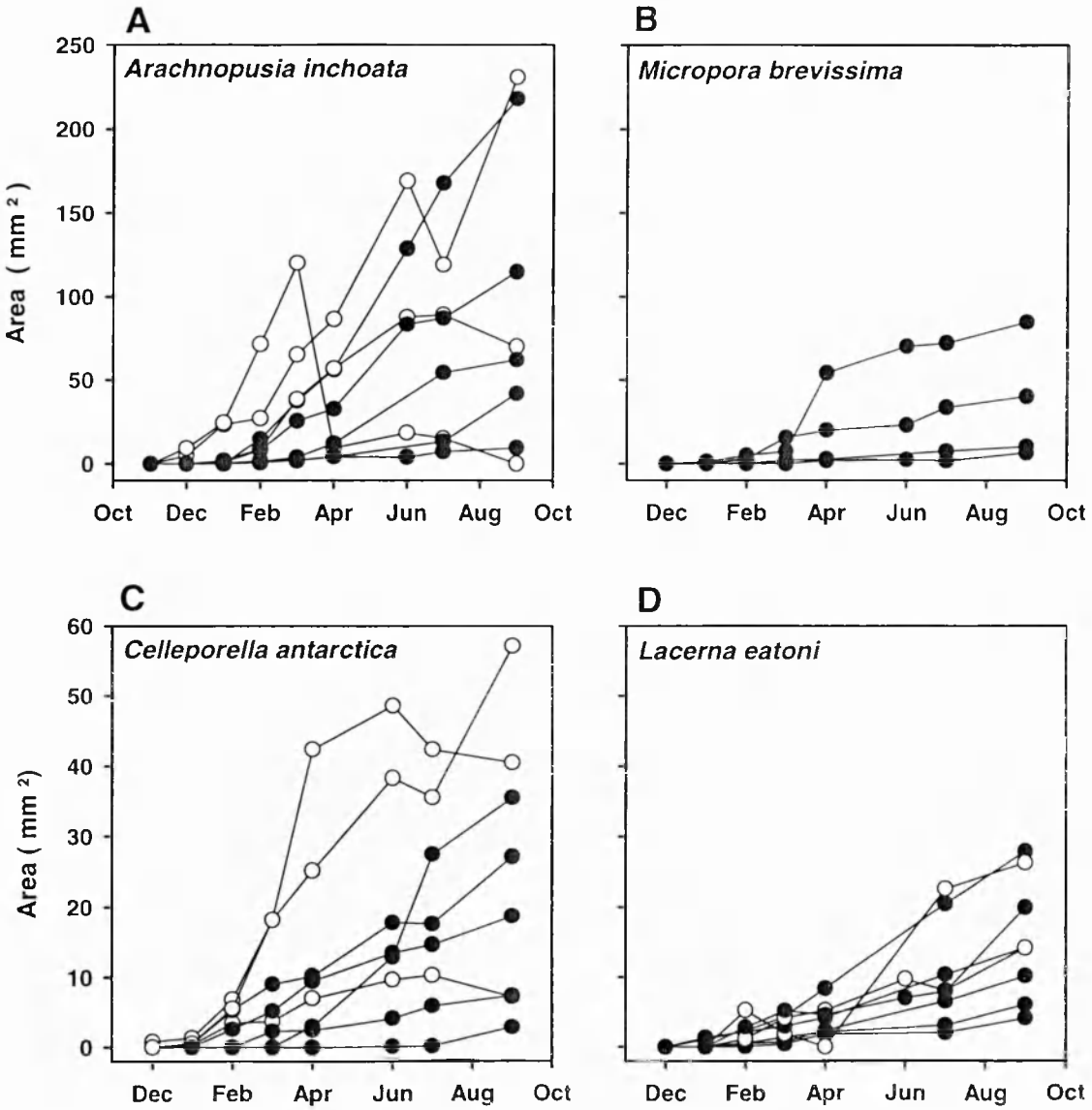
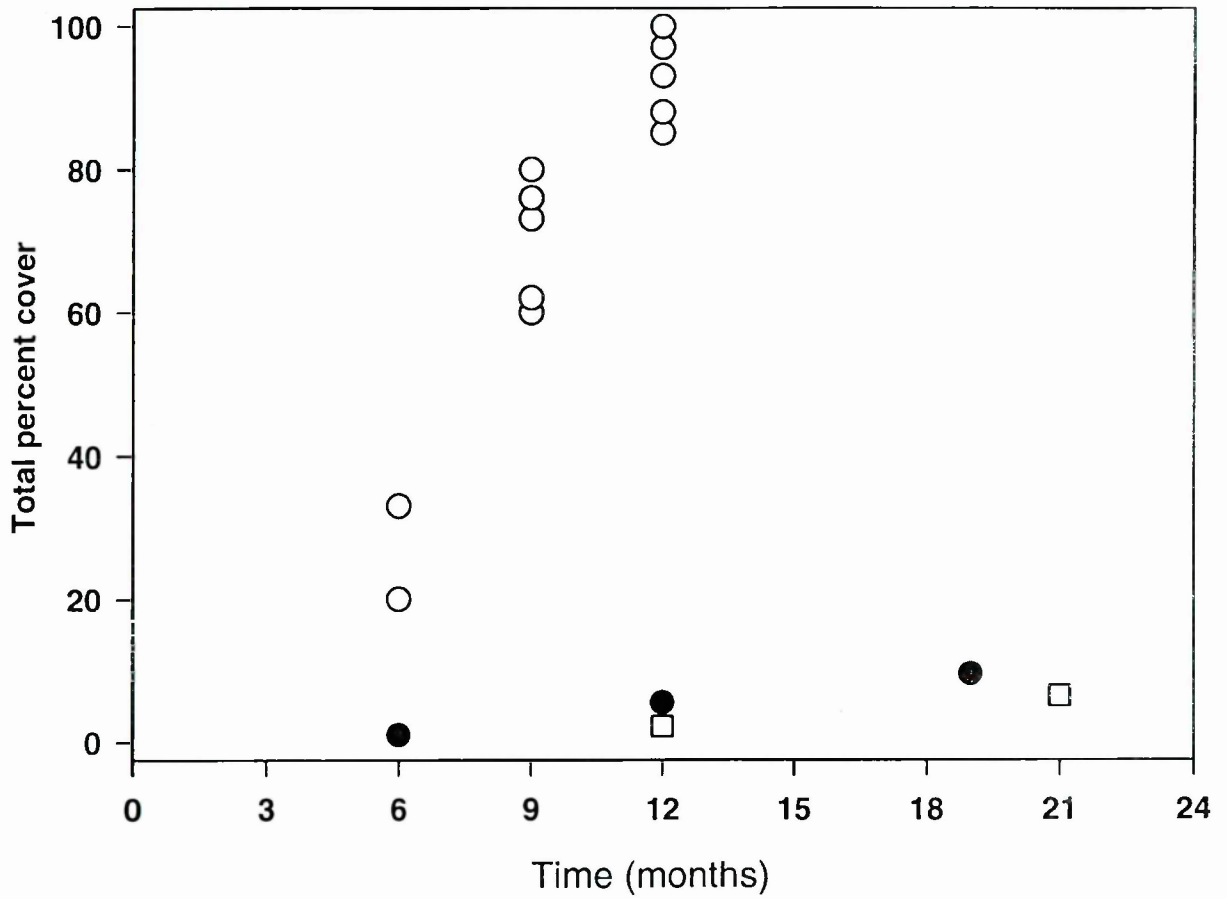

Figure 3.6

Total colonisation of sublittoral settlement panels with time and latitude. (○ temperate/tropical studies (Barkai and Branch 1988; Jackson 1977; Lopez Gappa 1989; Pisano and Boyer 1985; Todd and Turner 1986) □ Panel experiment at Signy Island, 1991-1993 (Barnes 1996), ● Results from present study). Colonisation is measured in percentage cover of panels. Adapted from Barnes (1996) with data from present, more detailed study added.



Chapter 4 Seasonality of reproduction in the cushion star, *Odontaster validus*

Data also presented in: Stanwell-Smith D and Clarke A (Submitted) Seasonality of reproduction in the Antarctic cushion star *Odontaster validus* at Signy Island, *Marine Biology*.

4.1 Introduction

It has long been recognised that the seasonality of marine ecosystems increases markedly from the tropics to polar latitudes. This seasonality is driven primarily by the annual cycle in received solar energy, and is exacerbated by winter sea-ice for marine ecosystems at high latitudes (Priddle et al 1986). Although the seasonality of primary production will influence herbivores and suspension feeders directly (Clarke 1983; Clarke and Peck 1991), it also permeates higher levels in the polar food-web (Clarke 1988).

Waters south of the Polar Front range over 25 degrees of latitude and although the Southern Ocean is frequently treated as a single ecological unit it differs markedly in character from north to south. Treguer and Jacques (1992) have divided the Southern Ocean into three zones according to patterns of sea-ice cover and phytoplankton production. Finer divisions are also possible, based on sea-ice dynamics and the steady gradient in photoperiod from north to south.

The cushion star, *Odontaster validus* Koehler, is a common member of the Antarctic benthic community, and it can be found throughout the Southern Ocean from South Georgia (54°S) to the highest marine latitudes at McMurdo Sound (78°S) (Clark 1963; McLintock et al 1988). *O. validus* has a wide bathymetric range, from the shallow sublittoral to almost

1000 m depth. It is an omnivorous feeder with a varied diet, being able to suspension feed, graze algae, scavenge and actively predate other benthic invertebrates (Pearse 1965). Its abundance and flexible feeding mode indicate that *O. validus* is ecologically very important in the Southern Ocean marine ecosystem (McLintock et al 1988). *O. validus* is a broadcast spawner, releasing large numbers of oocytes (0.17-0.19 mm diameter) that develop into feeding larvae (Pearse and Bosch 1986).

To date most ecological work on *O. validus* has been undertaken at McMurdo Sound in the high Antarctic (78°S); of particular importance have been studies of reproductive biology (Pearse 1965; Bosch and Pearse 1990) and population structure (McClintock et al 1988). A comparative study was therefore undertaken of the reproductive biology of *O. validus* at Signy Island (60°S), a site representative of the maritime Antarctic.

Signy Island has a less extreme photoperiod, a greater annual range of seawater temperatures and a shorter duration of winter sea-ice than McMurdo Sound (Clarke et al 1988; Clarke and Leakey 1996). Particular attention was paid to the seasonality of reproduction in the abundant population of *O. validus* at Signy, looking for differences in timing or pattern from McMurdo Sound. The proposed hypothesis was that the earlier, longer and more intense water column bloom coupled with the warmer summer temperatures would result in an earlier spawning and possibly also a shorter larval duration in the water column at Signy Island.

4.2 Methods

Site location

A preliminary SCUBA survey located a site with abundant *Odontaster validus* on a rocky slope at 36 m depth at Outer Island, Borge Bay (Fig. 1.1b). Twenty adult specimens were collected each month by hand between February 1993 and February 1995. An alternative site at Billie Rocks at 14m depth (Fig. 1.1b) was used occasionally when inclement weather prevented access to the Outer Island site. On collection, the animals were immediately placed in seawater to prevent them freezing in transit to the laboratory. They were then maintained in aquaria with flow-through seawater. Each of the twenty animals was measured (from the centre of the animal to the end of a ray, radial length: R), ten of which were then used to test for spawning competence and ten dissected to determine tissue indices.

Competence to spawn

To test whether an individual starfish was competent to spawn, between 1 and 2ml of 1-methyladenine (1-MA; 100 μ M in seawater) was injected into the coelom (Bosch and Pearse 1990). After injection each starfish was held in filtered seawater (1.2 μ m, Whatman GF/C) in a 1000ml beaker for 12 h held at environmental temperature on a flow-through seawater table. When spawning of both sexes occurred, eggs collected were washed in filtered seawater and mixed with a few drops of a dilute sperm suspension in 3000ml beakers on the seawater table. Larvae were reared unstirred, with water changes every 3-4 d. Once feeding, the larvae were transferred to an aquarium and held 2000ml plastic containers, with

50µm mesh at each end, allowing them to feed on natural seawater constituents. This timed series of samples provided a reference for recognising the development stages of wild larvae.

Tissue indices and energy content

The remaining ten animals collected each month were dissected to calculate tissue indices and energetic contents. The wet mass was measured after gentle blotting on a tissue to remove excess water retained between the tube-feet. All of the gonads and pyloric caeca were then excised and collected in pre-ashed (480°C for 30 min) aluminium foil boats of known mass. Any unusual looking gonads were collected and analysed separately. This prevented distortion of the results by the inclusion of gonads infested with the ascothoracid barnacle, *Dendrogaster antarctica*, which proved to be a common endoparasite in the *O. validus* populations sampled (see section 5.5).

The eviscerated wet mass was recorded, as was the wet mass of the dissected tissues. Dry mass was determined after 24h in oven at 60°C. Each sample was then finely ground and approximately 20-50mg was stored for elemental analysis in the UK. The remainder was re-dried, weighed, then ashed at 480°C for 24h to determine ash-free dry mass (AFDM). When insufficient replicates were available for the smaller tissue samples in winter, data were pooled over three months and the mean assigned to the middle months.

Samples were retained of oven dried tissues, which were crushed and a sufficient quantity stored to conduct elemental analysis once returned to the UK (approximately 1-4mg).

These samples were re-dried at Cambridge, and a known mass was put in the CHN foil “boats” used to measure Carbon, Hydrogen and Nitrogen content with a Carlo Erba 1108 elemental analyser. Acetanilide was used as a standard, with “standards as unknowns” for

calibration between every ten specimen unknowns. Despite the care taken to maintain the elemental analyser throughout the analysis, some results were initially erroneous. A build up of ash from the high carbonate content of the starfish skeletal tissues halved the working life of the combustion column in the analyser, preventing complete combustion of low carbon samples without affecting the standard calibrations. This error was noted and the affected samples repeated.

Field samples of pelagic larvae

Throughout the two-year study period, pelagic *Odontaster validus* larvae were collected from the water column over a variety of substrata at five sites using a diver towed net (see Chapter 2). The larvae of *O. validus* were one of the few species that was straightforward to identify, by comparing wild larvae with those of reference cultures maintained in the aquarium. The different developmental stages were separately recorded. Larval counts were corrected for the volume of seawater actually filtered as determined from the flowmeter readings, and expressed as concentrations (larvae per 5000L).

4.3 Results

Seasonality of environmental variables

During the study period, sea temperature varied from -1.88°C in winter to $+1.36^{\circ}\text{C}$ in summer. In the two austral winter periods (approximately six months per year) seawater temperatures were stable at -1.9°C (Fig. 1.2). At this latitude (60°S) day length varies from

5 to 19h. Solid fast-ice was present for 143d in 1993 and 87d in 1994 (a total of 230 days) although other more transient forms of sea-ice were present for almost 100 further days over the two winters (Clarke and Leakey 1996). Chlorophyll-a biomass in the water column was measured approximately weekly throughout the period of the study (Fig. 1.3a,b). Microphytoplankton chlorophyll (>20µm) varied from 30 ng.L⁻¹ during the austral winter months to over 16 µg.L⁻¹ during the summer blooms, a 500-fold increase attributed mostly to large diatoms and colonial forms. Nanophytoplankton (20-2µm) showed a similar seasonality, with chlorophyll concentrations varying from 60 ng.L⁻¹ to almost 700 ng.L⁻¹, a 10-fold increase, mainly because of a bloom of flagellates.

These data are typical for Signy Island (long-term data are summarised by Clarke et al 1988 and Clarke and Leakey 1996), and they emphasise the greater seasonal variability compared with McMurdo Sound (Littlepage 1965).

Tissue indices

Gonad indices and pyloric caeca indices were calculated using the following formula:

$$\text{Index} = \frac{\text{AFDM of tissue} \times 100}{\text{AFDM of eviscerated starfish body}}$$

where AFDM is the ash-free dry mass of the tissue, and the eviscerated tissue excludes the mass of the gonad (including the mass of the gonad in the denominator reduces the sensitivity of the index to small changes in relative organ size). Indices were calculated for starfish in the range 5.7 to 41.8g wet mass (mean=19.92±0.46g). Of the 230 animals dissected, 221

could be sexed, with 120 females, 95 males and 6 hermaphrodites. 85 starfish (38%) were found to be parasitised by the ascothoracid barnacle, *Dendrogaster antarctica* Grygier 1987. Because parasitism is likely to have affected patterns of resource allocation within the starfish body, parasitised animals were excluded from the data presented here.

The gonad index reflects the seasonality of reproductive activity, whereas that of the pyloric caeca, a food storage organ, relates primarily to temporal patterns of food availability. There was a clear peak in gonad index in May 1993 but this was less defined in 1994, when there was a general increase in gonad index between March and April (Fig. 4.1a). Male and female samples were determined separately. The large standard error (SE) bars indicate the large natural variability in gonad index, particularly during the spawning period. In addition to the more usual mean and SE presentation of gonad indices in Fig 4.1a, the data from which they were derived are in Fig 4.1b. It is clear that a few animals with extremely high gonad indices have skewed the means, thus the high standard errors. However, the low gonad indices after periods of high ones indicate clearly that spawning took place in April to June.

The pyloric caeca indices also peaked in the May-June period each year and thereafter showed a gradual reduction with time, reaching minima around November-December (Fig. 4.2). There was a steady increase in the pyloric caeca index from January to April 1994, matching the period of peak vertical flux of phytodetritus to the seabed (Clarke, data in preparation) rather than peak water column chlorophyll concentration (Fig. 1.3). The pattern was less clear in 1993, with low values in late summer (March, April) followed immediately by the early winter high. In the 1994/95 austral summer the peak values of pyloric caeca index were achieved in January after a period of steady increase from October. Overall these data suggest a general increase in reserves throughout summer, with the bulk of storage taking place in the second half of summer and reaching a peak in early winter. Thereafter, pyloric

caeca reserves are gradually utilised through the winter, suggesting that *O. validus* at Signy does not feed in winter.

Fig 4.3 was included to demonstrate the positive linear relationship between radial length and both the wet mass (of dabbed-dry whole animal) and ash-free dry mass of specimens. The experimental AFDMs were all calculated; but the mass of other animals collected could then be estimated from one simple measurement. As the regression does not pass through the origin, allometric growth occurs (as opposed to isometric growth). The care with which allometric growth data must be analysed when using tissue indices has been discussed by Packard and Boardman (1987).

Tissue composition and energy content

Carbon and nitrogen levels in the gonad, pyloric caeca and eviscerated body tissues are shown in Fig. 4.4. Analysis of variance indicated that there were no significant variations in the carbon content of gonad tissue (Carbon: $F=1.20$, $p=0.272$; Nitrogen: $F=0.9$, $p=0.587$), and linear regression showed no systematic trends ($P>0.05$ for both C and N). Gonad carbon content ranged between 40 and 45% dry mass, and nitrogen content generally between 10 and 12% dry mass (with the exception of data for June 1993). The lack of any systematic trend suggests that although *O. validus* gonads vary in size, their composition remains broadly similar throughout the adult reproductive cycle.

The pyloric caeca generally contained more carbon and less nitrogen than gonad tissue, and there was a distinct drop in both elements in June/July 1993. The reason for this change in elemental composition is not clear, although it does match a slight dip in gonad carbon content and coincides with the spawning period (Figs. 4.2, 4.4). The carbon and nitrogen

level of the remaining body tissue was low, reflecting the high skeletal mineral content.

Data for carbon, nitrogen and mineral ash content can be used to estimate proximate (protein, carbohydrate, lipid) biochemical composition (Gnaiger and Bitterlich 1984). This calculation assumes an average stoichiometry for marine invertebrate protein, carbohydrate and lipid, and allowance needs to be made for residual water in oven-dry tissue, inorganic carbon in skeletal carbonate and non-protein nitrogen from nucleic acids and other compounds. The mean elemental contents and the estimated proximate compositions of *O. validus* tissues are shown in Table 4.1.

The estimated compositions are typical of marine invertebrate tissue, being dominated by protein with smaller amounts of lipid and carbohydrate. The lower nitrogen and higher carbon contents of pyloric caeca tissue relative to gonad tissue are reflected in the lower protein content but higher lipid and carbohydrate contents. The body tissue is low in all organic constituents because of the high mineral ash content.

Energy contents can also be estimated stoichiometrically from organic carbon content (Gnaiger and Bitterlich 1984). Gonads and pyloric caeca had moderate energy contents, reflecting the relatively low carbon contents and the low proportion of lipid in the tissue.

Induction of spawning

On 20 dates between February 1993 and January 1995, samples of 10 starfish were injected with 1-MA to test their competence to spawn. Starfish injected covered the size (radial length, R) 28 to 58 mm (mean 38.54 ± 0.41 mm), equivalent to a wet mass range of 8.8 to 42.7g (mean 20.8g). Spawning could be induced between March and July 1993, with a peak in May, and between May and August 1994, with a peak in June (Fig. 4.5).

In both males and females, individuals induced to spawn were slightly larger than the mean size of starfish injected (5 males: $47.6 \pm 2.9\text{mm}$, 22 females: $40.7 \pm 1.3\text{mm}$). Even in peak months not all individuals could be induced to spawn. The animals collected for dissection were 43% male, 54% female and 3% hermaphrodite, but of those individuals which could be induced to spawn, 81% were female and 19% male.

Field collection of larvae

A combination of fortnightly and monthly tows for planktonic larvae were completed at the five sites. During the experimental period, 317 tows were completed. Slightly more larvae occurred in the surface tows than the benthic tows (Chapter 2, GLM: Table 2.3) but this difference was not significant overall ($P>0.05$) and the results have been pooled for clarity (Fig. 4.6). The laboratory cultures allowed three stages of development to be recognised easily in the wild *O. validus* larvae. Gastrulae with a typical planktotrophic echinoderm shape, and length of 0.45-0.5mm, were the most frequent stage recovered in the plankton tows (Fig. 4.6), and their appearance in the plankton was highly seasonal. The laboratory cultures took 170h to reach gastrula stage, although wild larvae may develop faster with higher water movement (Strathmann 1987). Early bipinnaria had a bi-lobed appearance and a length of 0.55-0.6mm. Late bipinnaria had developed rudimentary arms, fused left and right axohydrocoels within the mid-dorsal region of the larva, and a length of 0.9-1.1mm (Bosch 1989).

Wild gastrulae occurred in much higher numbers than bipinnaria, with more developed larvae tending to occur later. A few gastrulae were present in October of 1993 and 1994 but subsequent development was not observed.

4.4 Parasite observations

It has been estimated that more than 50% of all organisms are parasitic (Price 1977), of which many have been recorded in cold-temperate seas. It would therefore seem likely that parasites occur widely in benthic communities from Antarctic waters. Recognising them as such is not as straightforward. In particular, endoparasites have often been mis-identified. This section describes one such case occurring during the investigation of reproductive seasonality in *Odontaster validus*. Throughout the 25 month study of these starfish, routine dissections to ascertain gonad indices revealed what was initially thought to be a high level of hermaphroditism. A poster presentation to the 7th International congress on Invertebrate Reproduction at Santa Cruz, California in 1995 described this phenomenon, with 18-30% hermaphroditism reported in populations at Signy Island, and animals often apparently containing more than ten gonads. Nobody at the conference queried the result. I was later advised of my mistake (Tyler PA, pers comm), and now present a few observations on the ecology of an asteroid infesting endoparasite, back-calculated from the data presented in section 4.3.

The parasite encountered was an ascothoracid barnacle, first described by Grygier (1981). These highly specialised cirripedes live within the body cavity of their starfish hosts, and are difficult to distinguish from host gonads upon dissection, except by histological section. Specimens of the asteroid *Acodontaster conspicuus* Koehler, 1920 were collected by Dayton and colleagues in 1968, which yielded the ascothoracid barnacles of the species *Dendrogaster antarcticus* (Grygier 1981) and similar to the parasites in the present study. Grygier (1987) subsequently described an identical organism to the specimens found in the present study, collected from the Antarctic peninsula at 64°S 62°W. Previous ascothoracid

discoveries have even been mistaken for molluscs (Waren 1981). Much of the literature available on this order is taxonomic with scant ecological information, because of a) the limited inference possible from haphazard inspection of preserved specimens, and b) one of the few major workers in this field, VL Wagin, published almost entirely in Russian (eg. Wagin 1948; 1954).

Parasites found during dissection

Morphologically distinct gonads were weighed separately during the *Odontaster* study and so back-calculation of the raw data of section 4.3 yielded the following results. Of the 85 infestations, 52 were in females and 33 in males, with a total of 206 *Dendrogaster* collected. Unfortunately none were collected for further analysis in the UK. Figure 4.7a present the gonad indices of parasitized and "clean" animals, over the two years. Both categories show seasonal patterns, with vague maxima around May 1993 and April-Jun 1994. Figure 4.7b shows mean values (± 1 SE) of pyloric caeca indices with no significant difference between clean and parasitized animals (Paired t test, $t=-0.619$, 20 df, $P=0.54$). The load on the host starfish has been presented as a "parasite index" in Fig. 4.8. This was calculated from ash-free dry mass values in a similar way to tissue indices: [parasite mass/eviscerated host mass x 100]. A few hosts were carrying a load equivalent to their own mass in parasites (mean = 12.3 ± 2.1 SE, $n=85$). Fig. 4.9 is a frequency histogram of the number of infestations. No correlation was found between size of host (thus age) and either chance of parasite presence or the number of infestations.

Dendrogaster cyprids

On 16 March 1993, during one of the dissections, 14 parasites were found in one distended starfish. Plate 4.1 was taken of cyprids were observed in the coelom of this starfish, as were what looked like hundreds of developing cyprids. An identical cyprid was then collected in one of the larval survey samples (Chapter 2) at 0.5m depth, near Bare Rock on 7 April 1993.

Plate 4.1

Ascothoracid cyprids observed in dissection on 16/3/93. Length of cyprids 0.78mm; length of embryos on right of picture 0.72mm.



4.5 Discussion

Seasonality of reproduction in O. validus

The temporal patterns in female gonad index (Fig. 4.1 a,b), competence to spawn (Fig. 4.5) and the appearance of larvae in the plankton (Fig. 4.6) demonstrate that reproduction in *Odontaster validus* at Signy is distinctly seasonal. In 1993 the first gastrulae were detected in May, but peak numbers in the water column were not reached until July (Fig. 4.6). Laboratory cultures of larvae took about one week from fertilisation to hatching, and then about four weeks to reach the feeding gastrula stage, which would suggest that peak spawning in 1993 took place in June. This matches the data for induced spawning of freshly sampled animals in the laboratory, which peaked in May and June. The peak in female gonad index was also in May, with a decline over the period May to July, and a slight drop in gonad carbon level in June. A very similar picture is apparent for 1994, although the peak density of gastrulae in the water column was only half that in 1993.

These data indicate clearly that at Signy, *O. validus* reproduce via feeding pelagic larvae which are released into the water column in early winter. Intriguingly, this is just as phytoplankton levels are decreasing (Fig. 1.3). Data collected at weekly intervals at Signy Island from 1988 to 1994 indicated that during the period that *O. validus* larvae are feeding in the water column, mean microplankton (>20 μm) chlorophyll decreases from 350 to 40 ng.L^{-1} , and mean nanoplankton (20-2 μm) chlorophyll decreases from 170 to 70 ng.L^{-1} (Clarke and Leakey 1996). Although for much of this period chlorophyll available from smaller cells exceeds that available from diatom cells (and flagellate cell numbers greatly exceed those of diatoms), Rivkin and colleagues (1986) have shown that *O. validus* larvae make significant

use of bacterial carbon. It is not clear why *O. validus* (and other Antarctic echinoderms, see Chapter 2) release feeding larvae in winter, although this may be to avoid predation by suspension feeders or to avoid the period when the water column is dominated by large diatoms, colonial forms and mucilage from microalgae.

Although the larval abundance data indicate that at least some individuals spawn in any given year, the spawning competence data suggest that not all individuals are able to spawn that year. Oogenesis was described by Pearse (1965) as taking 18 to 24 months, with distinct overlapping generations of primary oocytes. This suggests that a gonad contains at least two generations of oocytes with only a proportion being spawned in any one year. Such a pattern would suggest why there is a distinct seasonality to the gonad index but that total gonad chemical composition remains broadly similar throughout the year.

Reproductive cycles taking longer than 12 months occur in polar marine invertebrates, having been reported in the amphipod *Bovallia gigantea* (>12 months), the brooding bivalve *Kidderia subquadratum* (15-19 months) the echinoid *Sterechinus neumayeri* (18-24 months) (Bone 1972; Shabica 1974; Pearse and Giese 1966, reviewed by Clarke 1988), and the brachiopod *Liothyrella uva* (Meidlinger et al in press).

Seasonality of feeding

Both the pyloric caeca and gonad showed distinct seasonality in relative size compared to eviscerated body mass (Figs. 4.1, 4.2) with some evidence for interannual variation. The late summer peaks in pyloric caeca index were followed by a gradual decline suggesting starvation, or at least a reduction in feeding during the winter months. The decline in pyloric caeca index during the 1993 winter corresponds to a carbon loss of $0.141 \text{ g} \cdot \text{mo}^{-1}$ (in a starfish

of mean dry mass= 11.6 ± 0.9 g). Previous studies on asteroids have found that seasonal changes in gonad index are usually, but not always, inversely related to changes in pyloric caeca (Chia and Walker 1991). In the present study pyloric caeca indices seemed to follow a similar seasonal pattern to that of the gonads.

In a major study of the biology of *Odontaster validus* at McMurdo Sound, Pearse (1965) found that diatoms and seal faeces made up a large proportion of the diet, with smaller contributions from detritus and scavenged animal material. During the winter months at Signy, the substratum occupied by the starfish was bare, although *O. validus* were seen to aggregate and feed upon the occasional injured animal on the benthos (pers obs). This would suggest that *O. validus* at Signy was only feeding consistently in summer. Although starfish were not observed feeding on seal faeces at Signy, the occurrence of seals at Signy is highly seasonal with a large (and increasing) population of subadult male southern fur-seals, *Arctocephalus gazella*, present from February to April (Smith 1988). In nearshore shallow waters benthic diatom blooms occur in spring and autumn (Gilbert 1991 a,b) but there is also a substantial flux of phytodetritus in late summer (Whitaker 1982; Gilbert 1991 a,b; Cripps and Clarke submitted).

Taken together these data would suggest that active feeding in *Odontaster validus* at Signy is probably confined to the summer months. This would match the seasonal pattern of pyloric caeca index (Fig. 4.2) which typically increased from December to March / April, and then declined over winter. alternatively, energy could be transferred from feeding straight to the gonads, rather than food being stored in the pyloric caeca.

The high level of parasitism found in this study raises three questions.

1) Are the *Dendrogaster* reducing the reproductive output of the *Odontaster*? Anecdotal comments suggest that *Dendrogaster* castrate their hosts, with partial castration observed in other ascothoracid barnacles (Grygier 1984). Fig. 4.7a suggests that parasitized animals do have developing gonads, although whether or not their gametes were viable was not ascertained. The pyloric caeca indices of Fig. 4.7b would indicate that feeding is unaffected, also noted by Grygier (1981).

2) Are the Signy population of *O. validus* unusual in this infection? Although hardly conclusive, dissections of 66 *O. validus* were made at the British Antarctic Survey station at Rothera, on Adelaide Island (68°S), yielding no *Dendrogaster* (Brockington, unpubl data). Unfortunately, more intensive sampling at Signy is not now possible, as marine work is no longer carried out there. Little is known about the life cycle of ascothoracids, including even the method of infestation. Cyprids may enter by burrowing through the coelom wall into the body cavity of the starfish, with male *Dendrogaster* possibly developing parthogenetically once within a host (Stone 1984). Cyprids are then released via rupture of the mantle wall of female parasites. The dissection that found the coelomic cavity full of cyprids supports this observation (Hickman 1959). The single cyprid seen in the water column suggests that pelagic dispersal is possible, but over what range is also not possible to estimate from the present observations. However, release may be around March, as the dissection yielding cyprids concurs with maxima in parasite indices (Fig. 4.8), and the pelagic cyprid at the beginning of April.

3) Are endoparasitic ascothoracids the niche that cirripedes occupying in Antarctica? The

presence of five morphologically distinct cyprid forms in the pelagic larval survey, but an absence of cirripedes among the benthic fauna remains a paradox. Very few observations of ascothoracid larvae have ever been made, with a single larva caught in Canada (McMurrich 1917) and a single larva caught in the U.S. Virgin Islands (Grygier 1983). More work is necessary.

Inter-annual variability in biology

Early studies of the ecology of Antarctic marine invertebrates were naturally drawn to the striking differences in biology between summer and winter in high latitudes. Seasonality is indeed a major feature of the biology of polar marine organisms (Clarke 1988), but it is now recognised that an important ecological role is also played by interannual variability. Long-term monitoring studies have demonstrated important variability in the physical and chemical environment (Murphy et al 1995; Clarke and Leakey 1996), and such variability is now being reported increasingly in biological processes.

Although this study only covered two years, significant inter-annual variation was observed in all aspects of *O. validus* biology studied. Inter-annual variation was most evident in the gonad index cycle, with a much smaller peak in 1994 compared with 1993. This could have been the result of a larger proportion of the population spawning. However, the mean gonad indices were influenced markedly by a few very high values, as indicated by the large standard errors. With only two years of data from animals collected at a single sampling location it is premature to speculate on the environmental factors that might have governed these differences.

Inter-annual variability was also evident in the population of larvae in the water

column, with the density of larvae in the 1993 winter being approximately twice that in 1994. It is tempting to match this with the larger gonad indices detected in 1993, but with only two years data little more can be said.

Despite the extended maturation cycle of oocytes, the use of pyloric caeca as an energy and nutrient store, and the varied diet, all of which might be expected to smooth any effects of inter-annual variability in the environment on the biology of *O. validus*, year-to-year variability in reproductive output remains significant.

Comparison with McMurdo Sound

This study, together with the classic early work of Pearse at McMurdo Sound in the 1960s (Pearse 1965), and subsequent studies (Bosch 1989) allow a comparison of the biology of *Odontaster validus* at two very different sites in Antarctica. The salient features of the environment and biology of *O. validus* at the two sites are summarised in Table 4.2.

Signy and McMurdo differ by almost 18 degrees of latitude, and are on opposite sides of the Antarctic continent, with Signy being in the maritime Antarctic and McMurdo in the high Antarctic. McMurdo is characterised by a more strongly seasonal photoperiod, a longer duration of winter fast-ice, and a greatly reduced seasonal variation in seawater temperature (Table 4.2). It is more difficult to compare the summer phytoplankton blooms at the two sites but the available data suggest that maximum chlorophyll concentrations are similar, although the season starts later and is of shorter duration at McMurdo.

Feeding would appear to be seasonal at both sites (see discussion above) although the pyloric caeca index shows seasonal variation only at Signy. The protein content of the pyloric caeca is also higher at Signy. Taken together, these two observations suggest either that

feeding conditions are better at Signy than at McMurdo, or that Signy is more seasonal in its food availability.

The gonad cycle appears to be similar at the two sites. Although a slightly later spawning season might be expected at McMurdo as a result of the later timing of the phytoplankton bloom, no such indication is apparent from the data (Table 4.2). The timing of the peak gonad index and spawning appears to be similar at the two sites. Development of the pelagic larvae is, however, faster at Signy and this is presumably simply a feature of the warmer seawater temperatures in the maritime Antarctic.

The data therefore support the initial hypothesis that larval duration would be shorter at Signy, but not the prediction that the reproductive cycle would be shifted. The data do, however, emphasise the fact that spatial heterogeneity in environmental factors result in biological differences throughout the Southern Ocean. They also demonstrate significant interannual variability in the biology of Antarctic benthic marine invertebrates.

Table 4.1

Elemental (carbon, nitrogen) composition of *Odontaster validus* sampled from 30 metres in Borge Bay, Signy Island. All data for 1993-95 pooled. Proximate biochemical composition was estimated stoichiometrically from elemental composition, assuming default values of 6% residual water and 5% non-protein nitrogen (Gnaiger and Bitterlich 1984). All data are expressed as a percentage of dry mass, and are presented as mean \pm SE.

	Gonad (n=47)	Pyloric Caeca (n=42)	Evisc. body (n=9)
Elemental composition (measured directly)			
Carbon	43.64 \pm 0.30	46.64 \pm 0.32	20.41 \pm 0.69
Nitrogen	10.92 \pm 0.24	10.13 \pm 0.09	4.03 \pm 0.25
Ash	13.90 \pm 0.18	9.26 \pm 0.26	59.94 \pm 0.99
Proximate composition (estimated stoichiometrically from elemental composition)			
Protein	59.96 \pm 1.32	55.60 \pm 0.26	22.13 \pm 1.34
Lipid	8.98 \pm 1.09	12.92 \pm 0.98	6.66 \pm 0.85
Carbohydrate	7.53 \pm 1.10	12.84 \pm 1.26	3.93 \pm 1.10
Energy content (kJ gDM ⁻¹)	-29.70 \pm 0.30	-29.83 \pm 0.49	-5.91 \pm 0.68

Table 4.2

Comparison of key environmental variables and aspects of the biology of *Odontaster validus* at Signy Island and McMurdo Sound. Data are from 1993-95 at Signy Island (this study) and McMurdo Sound 1960-61 (Pearse 1965) and 1984-85 (Bosch 1989). Additional environmental data from Littlepage (1965), Murphy et al. (1995) and Clarke and Leakey (1996).

	Signy Island	McMurdo Sound
Location	60°43' S 45°36' W	77°51' S 166°40' E
Collection depth	36 m (occasionally 14 m)	10 to 33 m
Sea Temperature	-1.9° to +0.5°C	-1.9° to -1.6°C (Littlepage 1965)
Sea Temperature	Winter: -1.9°C Summer: 0.5 to 1.5°C	Winter: -1.9°C Summer: -1.6°C
Daylight	5-19 hr	4 mth darkness to 4mth daylight
Sea Ice	135 ± 53 d	about 6 mth (Littlepage 1965)
Chlorophyll-a	Peak	Peak approx. 32 mg.m ⁻³
Gonad index	Peak in May / June	Gradual rise September to April, then gradual decline
Spawning date	June to September	June to September 1960-61 July to October 1984-85
Time to feeding	28 days	35 days
Pyloric caeca index	40 % rise, Jan to April, then gradual decline	Little change all year
Pyloric caeca protein (mean)	60.0 ± 1.3 % (n = 47)	46.9 ± 0.5 % (n = 50)
Hermaphrodites	3% (7 of 230)	0.3% (1 of 350)
Parasites	38% infection by ascothoracid <i>Dendrogaster antarctica</i>	One anecdotal reference to parasitism by barnacle <i>Dendrogaster</i> (Dayton unpubl data)

Figure 4.1-a, b

Seasonal variation in the gonad index of *Odontaster validus* at Signy Island, 1993-95. Data separate for testis (○) and ovary (●). (A) Data are plotted as mean and standard error; n for each month and sex ranged from 3 to 7. (B) Data are plotted as separate gonad index scores for each month, open circles represent male gonads, grey circles are female gonads.

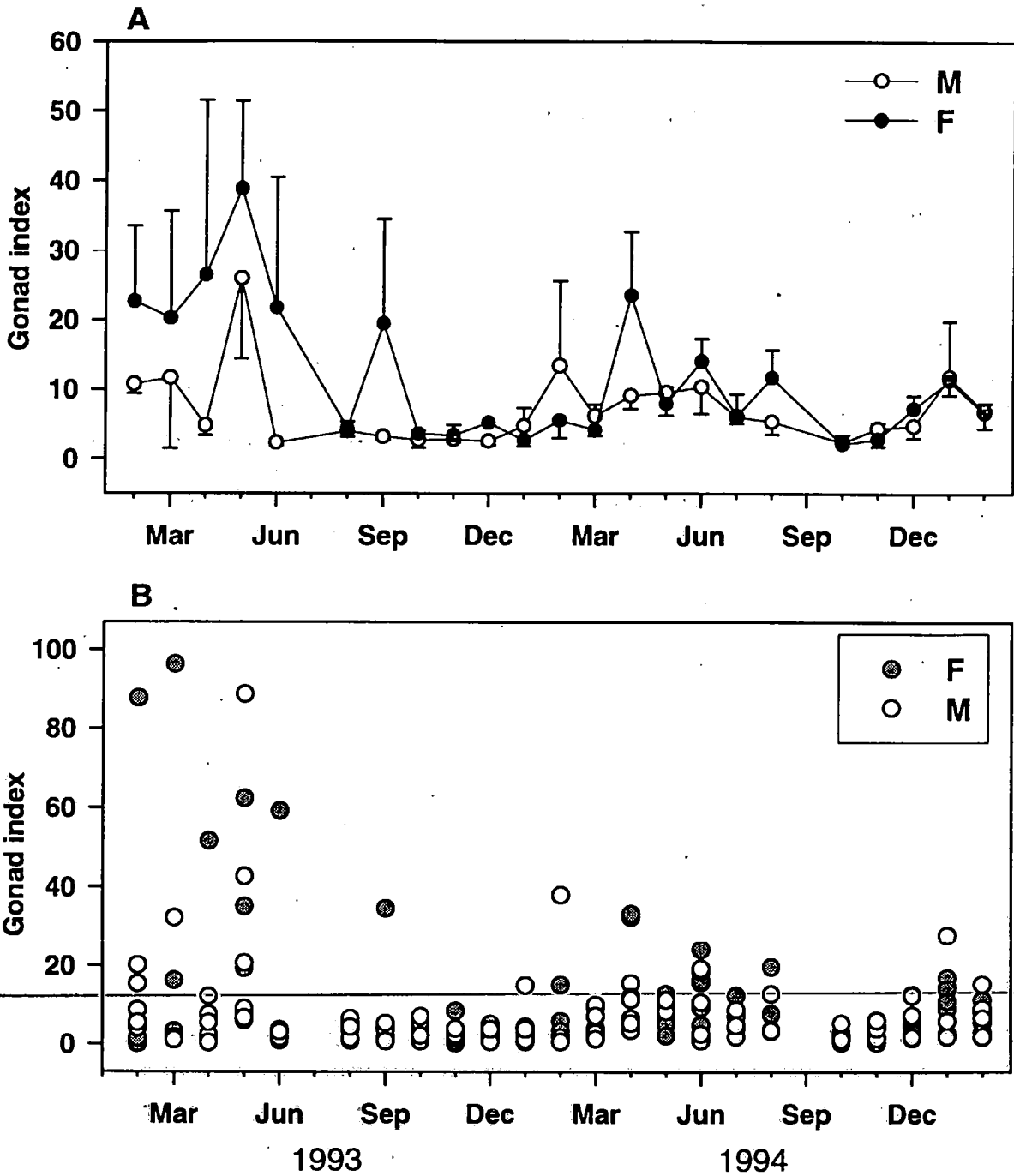

Figure 4.2

Seasonal variation in the pyloric caeca index of *Odontaster validus* at Signy Island, 1993-95. Data for males and females pooled for ANOVA indicated no significant differences ($P>0.05$). Data are plotted as mean and standard error ($n = 10$).

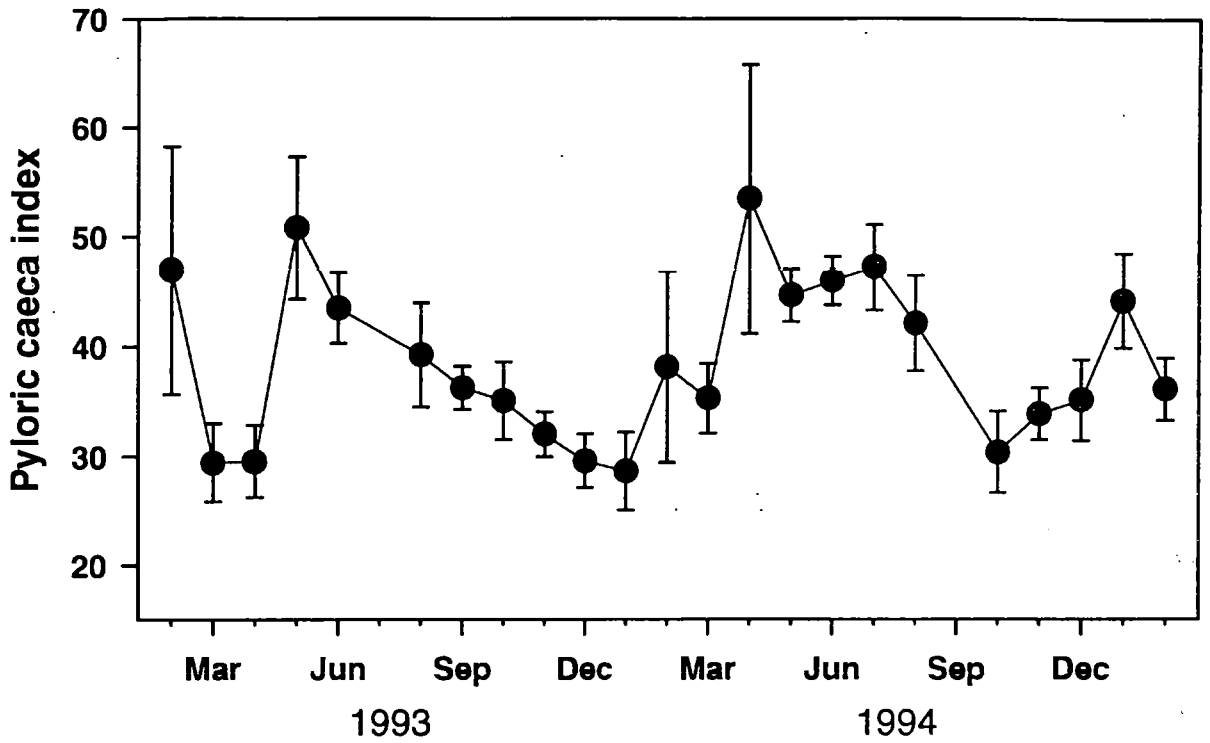

Figure 4.3 a, b

Linear regressions of tissue mass on radial length (R) of *Odontaster validus* specimens. (A) Regression of wet mass (whole animal, dabbed dry), (B) regression of Ash-free dry mass of eviscerated animal.

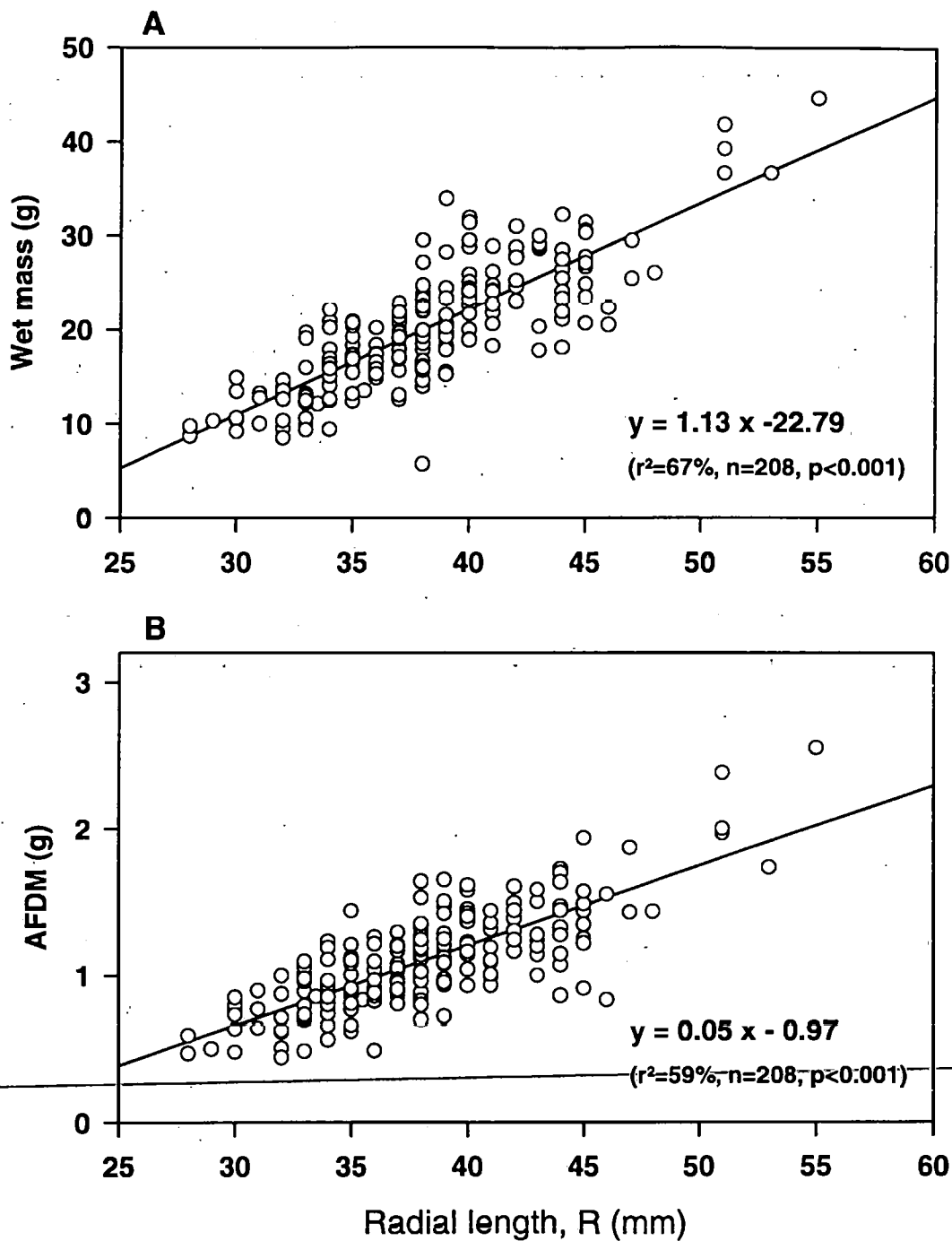

Figure 4.4

Seasonal variation in carbon and nitrogen content (both as % dry mass) of gonad, pyloric caeca and all other tissues in *Odontaster validus* at Signy Island, 1993-95. Data are plotted as mean and standard error (n = 10); where no error bars are shown these are smaller than the size of the plot symbol.

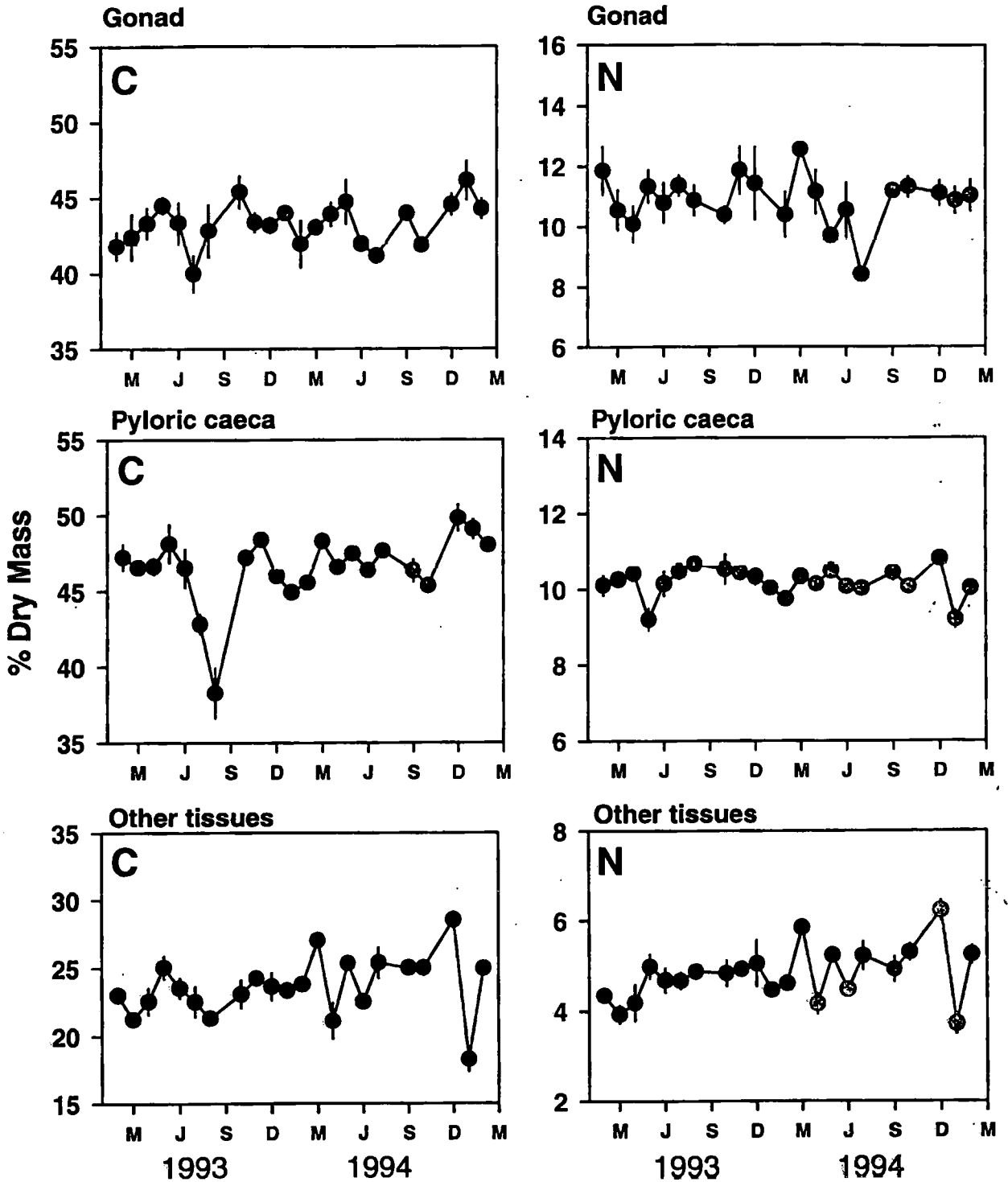

Figure 4.5

Seasonal variation in competence to spawn in *Odontaster validus* at Signy Island, 1993-95. Ten individuals were injected with 1-MA on dates shown by open circles; bars show the number of individuals which spawned in response.

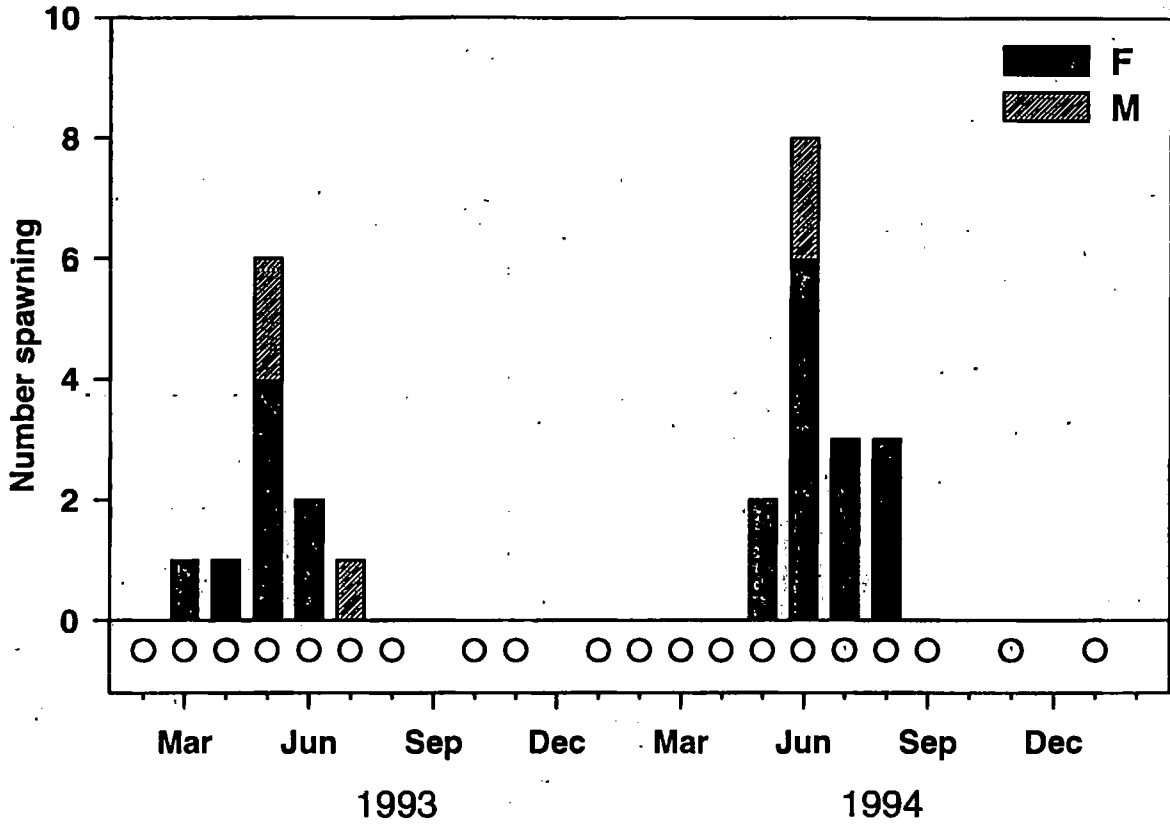

Figure 4.6

Seasonal variation in population of *Odontaster validus* larvae in the water column at Borge Bay, Signy Island, 1993-95. The graph shows the total number of larvae per 5000 litres (actual data corrected to standard volume from flowmeter counts). The kite diagrams show the comparative population densities of gastrulae (G), early bipinnaria (EB) and late bipinnaria (LB) larvae.

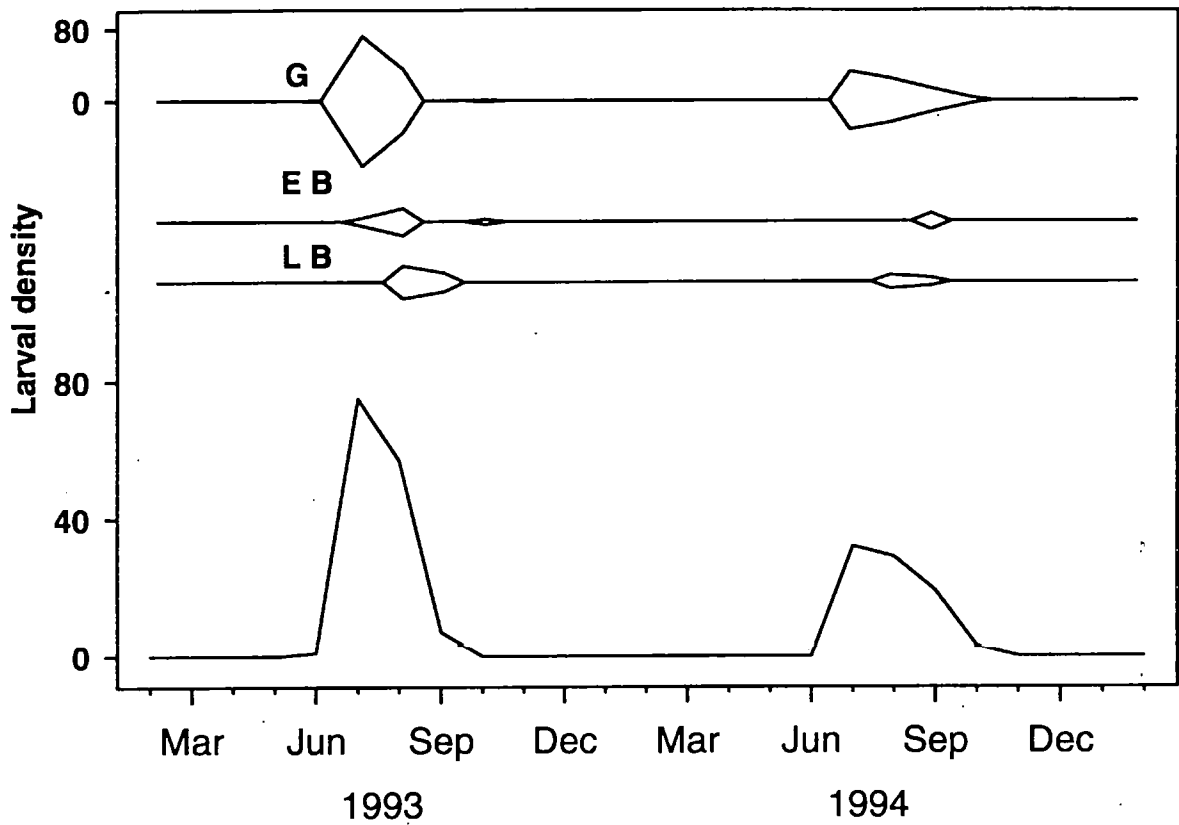

Figure 4.7

(A) Seasonal variation in gonad index of *Odontaster validus* at Signy Island, 1993-95. Data separate for parasitized and 'clean' starfish. Data are plotted as separate gonad index scores for each month.

(B) Seasonal variation in pyloric caeca index of *O. validus*. Data are separate for parasitized and 'clean' animals, plotted as mean and standard error; n = 3 to 7 for each point.

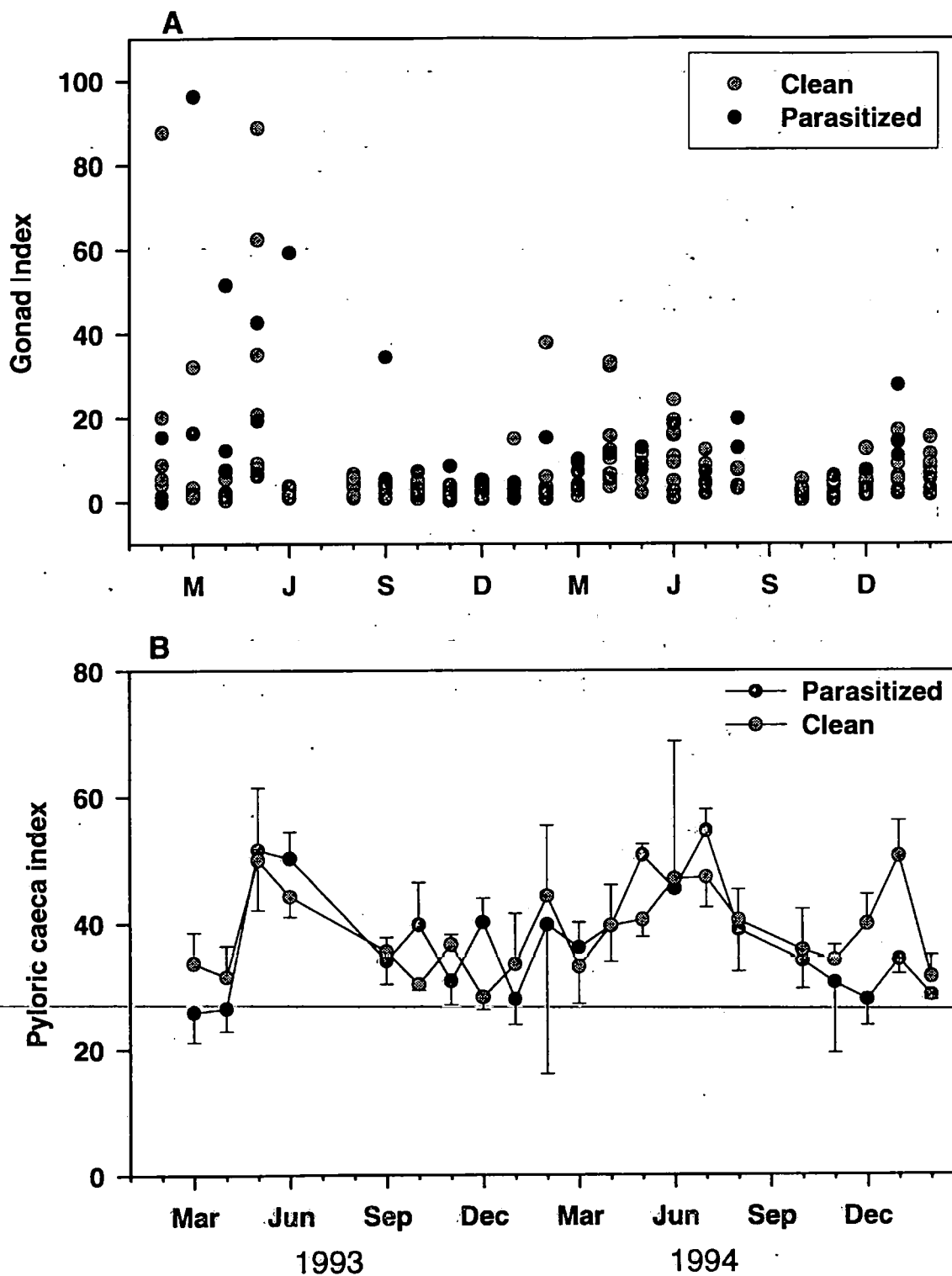
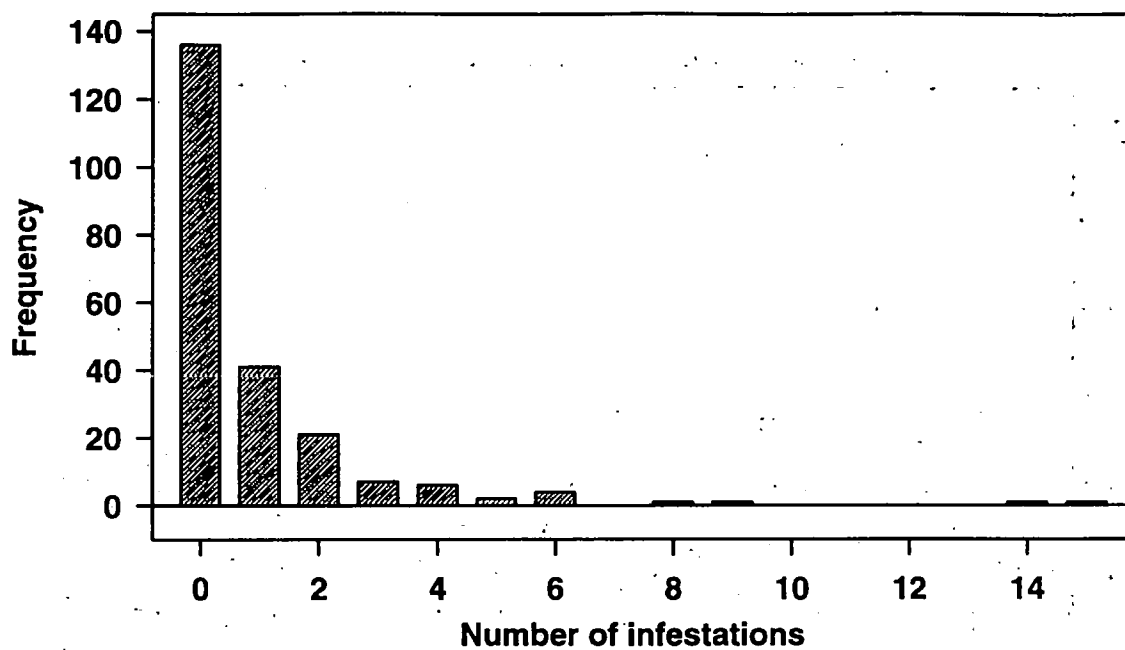

Figure 4:9

A frequency histogram of the number of ascothoracid infestations per host *O.validus*.



Chapter 5 Temperature and embryonic development of three common Antarctic echinoderms

Data also presented in: Stanwell-Smith D and Peck LS (in press) Temperature and embryonic development in relation to spawning and field occurrence of larvae of three Antarctic echinoderms. *Biological Bulletin*

5.1 Introduction

Temperature and food availability are recognized as the two major factors affecting marine invertebrate larval development (Thorson 1950). The thermodynamic effect of temperature on physiological rates is a fundamental structuring element in biological processes and is perhaps the most straightforward of the two factors to understand. The possible powerful effect of temperature on larval development has long been recognized (Orton 1920; reviewed by Pechenik 1987). Nutrient availability, from reserves in brooded and lecithotrophic larvae and via feeding by planktotrophic larvae, is also clearly essential to sustain development to competence. These factors should be of great importance in polar environments where temperatures are low and summer phytoplankton blooms short, although the relative importance of temperature and resource availability to Antarctic larvae is not yet generally agreed upon (Clarke 1992; Hoegh-Guldberg and Pearse 1995).

The aim of this study was to investigate how the interaction of these two factors influences geographical distributions and reproductive strategies. Echinoderms were chosen because many of their Antarctic representatives have planktonic larvae (Bosch and Pearse 1990). The three species used were the common cushion stars *Odontaster validus* Koehler and *Odontaster meridionalis* (Smith), and the regular urchin *Sterechinus neumayeri*

(Meisner). All are ubiquitous and abundant in Antarctic waters with distributions that overlap at Signy Island, and have been the subjects of previous research (McClintock et al 1988; Bosch and Pearse 1990; Brey et al 1995). Both *Odontaster* spp. have circum-antarctic distributions (McClintock et al 1988). *O. meridionalis* has a northerly limit at South Georgia (54° S 36°W) and Kerguelen Island (49°S 63°W), and occurs from 15-590 m depth; whereas *O. validus* has been reported as far north as Shag Rocks (53°S 42°W) and Bouvetøya (54°S 03°E), from 0-914 m (Clark 1963). The obligate sponge-feeding *O. meridionalis* usually occurs at much lower densities than the predatory or scavenging *O. validus* (Dayton et al 1974). *S. neumayeri* is a non-specific grazer (Pearse and Giese 1966) and has a circum-antarctic distribution as far north as Kerguelen Island, from 0-400m depth (Brey and Gutt 1991).

The larvae of both *Odontaster* and *Sterechinus* are pelagic and planktotrophic. Asteroid gastrulae develop into bipinnaria, whereas the echinoid gastrulae become plutei, both about 1mm long (Bosch 1989; Bosch et al 1987). *Odontaster* bipinnaria occur during the Antarctic winter, usually under the sea-ice and at a time when there is very little phytoplankton in the water column (Clarke and Leakey 1996). The possibility of starvation in *O. validus* larvae has been investigated by Olson et al (1987) and bacterivory has been proposed as a supplementary food source for asteroid larvae (Rivkin et al 1986). However, the plutei of *S. neumayeri* develop and feed during the austral summer, a period of high phytoplankton standing crop and many associated zooplanktonic larval predators (Morgan 1995). The larval phase of almost all marine invertebrates is the most vulnerable stage in their life history (Thorson 1950). The ecological question is therefore: why does such different seasonal timing occur in functionally similar echinoderm larvae from the same environment?

5.2 Methods

Spawning induction

Ten adults of each of the 3 species (*Odontaster validus*, *Odontaster meridionalis* and *Sterechinus neumayeri*) were collected at monthly intervals by SCUBA divers in Borge Bay (Fig. 1.1b). Table 5.1 lists the collecting periods, depths and dates. Each animal was immediately transferred to a flow-through aquarium at the British Antarctic Survey research station for about 24h, then put in 500ml beakers of 1.2 μ m filtered seawater (Whatman GF/C) standing in a shallow tank of running seawater. The starfish were injected with 1-2ml of 1-methyl adenine (1MA, 10⁻⁴M in seawater) into their gonad regions (Chia and Walker 1991). This readily induced spawning within a few hours if the animals were gravid (Bosch 1989). To induce spawning in *S. neumayeri*, about 2ml of 0.5M KCl in seawater was injected into the coelom (Bosch et al 1987); gravid individuals spawned within a few hours of the injection.

Culture methods

An aluminium thermogradient block with apertures for 70 universal tubes (30ml volume), in five rows of 14 tubes, was kept in a controlled temperature (CT) room set at +2°C. Thermocirculators at each end of the block were set at -2°C and +3°C respectively to represent the annual sea temperature range around the Antarctic Peninsula and sub-Antarctic Islands (Foster 1984). A 13 step temperature gradient was maintained with very low fluctuation. Construction notes and methodology, with illustrations, are given by Baker (1974). The overall temperature range and variation at each step were monitored during a

48 h period prior to each experiment, and data stored on a Grant Instruments "Squirrel" data logger. Throughout the experimental period a precision electronic thermometer was used to measure the temperature of each culture prior to sampling (Table 5.2). Two replicate larval cultures were maintained at each temperature step. The culture water was exchanged every 48 hours with pre-cooled and aerated 1.2 μ m filtered sea water (Whatman GF/C). To ensure that replacement water was at the same temperature as the cultures it was kept in universal tubes in adjacent apertures to the experimental tubes in the thermogradient block. The spare (fifth) tube at each temperature step was used for monitoring with the thermometer probe (layout in Table 5.2). The CT room was kept dark during the experimental period to minimise the possible conflicting effect of an artificial diurnal light pattern (Pearse et al 1986).

The development experiment was conducted on eggs and sperm collected from the field at the peak of spawning for each species. As peak spawning periods were different for each species dates for experiments also varied accordingly: incubation of *O. meridionalis* embryos was started on 22 July 1993 for 235h, the *O. validus* experiment started on 15 June 1994 for 244h and that for *S. neumayeri* embryos started on 17 October 1994 for 155h. Eggs were collected in 1000 ml beakers, and held in monolayers on the bottom of each beaker. Sperm were diluted with filtered seawater until translucent grey. The eggs were fertilized by stirring in a few drops of the sperm solution to each beaker (following Strathmann 1987). After a brief wash in filtered seawater, the newly fertilized eggs were immediately transferred to the pre-cooled universal (30ml) vials in the thermogradient block. Care was taken that no more than a monolayer of embryos was put in the bottom of each vial to prevent overcrowding (MacBride 1900); this equated to about 250 embryos per incubation tube.

The remaining embryos were kept as controls in two 3000ml beakers on a flow-through sea water table in the aquarium. A monolayer of eggs developed at ambient sea

temperature, being stirred at the same time as the experimental cultures were checked in the thermogradient block. Fertilization was confirmed after about 30min by the presence of a fertilisation membrane, as observed with a compound microscope at x400 magnification. Alternate cultures at each temperature were observed during the experiment, to minimise disturbance (Bosch et al 1987).

Culture observation

Observation of the cultures was carried out by pipetting about 100 embryos into a pre-cooled cavity slide and photographing them at x12 magnification with a Wild M5 microscope, set up in the CT room. The cultures were observed every four hours for the first 12h, then every 12h until the approach of hatching. When hatching was imminent, four hourly observations were reinstated. The control cultures were observed at the same intervals and by the same method as the experimental cultures. Photographs were taken on Ektachrome ISO 200 transparency film, which was subsequently projected for calculating the various stages of development. The use of photography enabled rapid assessments of development to be made with minimal disturbance to the embryos. The time for 50% of the embryos to reach eight cells, blastula and hatching was recorded, together with the number of eggs and embryos failing to develop.

Data for each species were analyzed with Arrhenius plots (log development rate as a function of the reciprocal of absolute temperature). Linear regressions were used where suitable, and compared using regression analysis (Sokal and Rohlf 1981) on Minitab v.10. A broken stick model (one break) was fitted to *S. neumayeri* development times on the Arrhenius plot by the maximum likelihood method, using Genstat v:5.3 (Payne et al 1993).

Field observation of larvae

A two year survey of the planktonic invertebrate larvae around Signy Island was carried out at the same time as the experiments described (see Chapter 2). Diver towed nets and a hand-held diver operated suction pump were used for regular samples. For the purposes of the present study all relevant data were pooled to produce overall values of larval abundance in the water column.

5.3 Results

Development and embryo viability

The embryos were transparent enabling easy identification of different development stages of each species. At the lowest incubation temperature (-2.02°C) the development times for *O. meridionalis* embryos were the longest, taking approximately 50h for 50% of the embryos to reach the 8 cell stage, and 240h for 50% to hatch (Fig. 5.1a). A steady reduction in development time with increasing temperature was also observed. For all three developmental stages measured, development times approximately halved over the experimental temperature range (-2.02°C to +2.83°C). The number of eggs remaining unfertilized had a strong positive correlation with temperature ($y=2.59x+11.15$, $r^2=0.95$) (Fig.

5.1b). Thus, the number of non-viable eggs increased with temperature from around 6% at -2.02°C to approximately 18% at +2.83°C; this was the opposite trend to that for development time. Development times for *O. validus* were similar to *O. meridionalis*, and the time to 50% hatching also shortened with increasing temperature (Fig. 5.2a). However, in contrast

to *O. meridionalis*, the percentage of non-viable eggs in *O. validus* was independent of temperature ($y = -0.31x + 12.87$, $r^2 = 0.03$) (Fig. 5.2 b), averaging around 13%. The eggs that failed to fertilize constituted over 95% of the embryos that did not hatch during the experimental period, the other 5% were comprised of occasional embryos which divided only once or twice before ceasing development.

The time taken for *S. neumayeri* embryos to reach the 8 cell stage was similar to that for the starfish, with an approximate halving of the development time over the experimental temperature range (Fig. 5.3a). Times to reach the blastula stage, however, appeared to be independent of temperature. Data for 50% hatching times presented a different picture. There was a rapid reduction in development time from 153h at -1.8°C , to 88h at $+0.2^\circ\text{C}$. Above 0.2°C times to hatching were independent of temperature. The percentage of non-viable eggs in *S. neumayeri* was very low and constant (about 1%) below $+1.7^\circ\text{C}$ (Fig. 5.3 b). Above 1.7°C the proportion of non-viable eggs rose rapidly to around 13% at $+2.83^\circ\text{C}$. The fitted break point in the broken stick model was at $+1.7^\circ\text{C}$, and the fit accounted for 94% of the variance in the data.

Arrhenius plot

An Arrhenius plot is a simple description of the relationship between reaction rate and absolute temperature. Although originally developed for estimating activation free energies in enzyme kinetics, Arrhenius plots are often applied to the temperature behaviour of complex biological systems (Clarke 1983). When development rates of the 50% hatch times (log transformed) for the three species were plotted against the reciprocal of absolute temperature (Fig. 5.4), data for both of the *Odontaster* spp. yielded straight line relationships and their

slopes were not significantly different from one another ($F=1.3$, $df=1, 24$, $P=0.27$). A common slope was calculated and fitted to the two data sets by analysis of covariance. The resulting intercepts were significantly different (difference=-0.0135, $t=-6.78$, $P<0.0001$) indicating that *O. validus* embryos were, on average, developing at a rate 1.15x faster than *O. meridionalis*.

The broken stick model fitted to the *S. neumayeri* development rate data (Fig. 5.4) explained 98% of the variance. Maximum likelihood showed the break point occurred at +0.2°C. Below this temperature, development rate decreased rapidly with lowering temperature ($y=0.242x-4.53$, $r^2=0.97$), but above it development was independent of temperature ($y =0.006x-4.47$, $r^2=0.23$).

*Q*₁₀ values

The *Q*₁₀ coefficient is a measure of the change in rate of a process with temperature (Cossins and Bowler 1987). It is expressed as the factorial rate change over a 10°C temperature step and was originally devised for biochemical systems. It is useful here for comparing development rates between species and emphasising differences between rates. In physiological systems *Q*₁₀ values are usually in the range 2-3 (Clarke 1983), and a *Q*₁₀ of 1 indicates no change with temperature. Although the temperature range here is narrow (approximately -2.0°C to +2.9°C), the *Q*₁₀ development rates of 50% hatch times were calculated. For *O. meridionalis* *Q*₁₀ = 3.8, *O. validus* *Q*₁₀ = 4.5, and *S. neumayeri* *Q*₁₀ = 13.6 below +0.2°C and 1.1 above +0.2°C.

Spawning and field observations

The results from the regular spawning trials were compared with environmental data from Clarke et al (1988) and Clarke and Leakey (1996), particularly for sea temperature and microplankton chlorophyll-a biomass for the period January 1993 to February 1995 at Signy Island (Fig. 5.5). Spawning was successfully induced in both the starfish species during the winter months (May-July). A few *S. neumayeri* individuals could be induced from June, although peak spawning induction in both sexes occurred in November. Of these, only males spawned in June, July and August with females being induced from September onwards. Field observations of gastrulae have been combined with those for bipinnaria (for asteroids) or plutei (for echinoids) in the kite diagrams (Fig. 5.5), giving values for overall pelagic larval abundances in the water column. *Odontaster* larvae occurred between June and September of both years at densities up to 0.76m^{-3} . *S. neumayeri* larvae were present between December and February in much lower numbers than the starfish (up to 0.09m^{-3}), and were observed only during the 1993 - 94 austral summer. It is clear that the timing of spawning induction closely matches the observed seasonal pattern of larval occurrence in the wild:

5.4 Discussion

A reduction in development time with temperature (=increasing development rate) was observed in all three species (Figs 5.1a, 5.2a, 5.3a). This was expected as development rates in Antarctic ectotherms are much lower than temperate and tropical species (Clarke 1992) and the present data for *S. neumayeri* below 0.2°C agree with the general relationship found for echinoids (Fig. 5.6) from all latitudes by Bosch et al (1987). Above 0.2°C the development rates depart from the general relationship. Development in *S. neumayeri* was 2 to 10 times slower than temperate and tropical species at their normal habitat temperatures.

The change in development rates with temperature of the *Odontaster* spp. were not significantly different from one another, but *O. meridionalis* was 1.15x slower at all measured temperatures (Fig. 5.4). Its slightly lower Q_{10} value may also indicate less influence of temperature on development rate. On temperature criteria alone, it might be advantageous for both species to release larvae in the warmer seas of the austral summer, when development would proceed at a rate ~ 1.5x faster than in winter (Figs. 5.1a, 5.2a). However, other factors must be considered. The number of non-viable embryos released by the two species varied. For *O. meridionalis*, as the temperature increased there was a significant increase in the number of fertilised eggs that did not develop further, from 7% at -2°C to 19% at +2.5°C (Fig. 5.1b). For *O. validus*, however, there was no increase in the number of non-viable embryos with temperature, averaging about 12.5% throughout. This would suggest that for *O. meridionalis* at least, there is some advantage in terms of survival of larvae by developing in the colder waters of winter.

From the field data (Fig. 5.5), it is clear that both *Odontaster* spp. spawn in the wild during the austral winter months and can be induced to spawn from May to August. Bosch

(1989) measured the interval for *O. meridionalis* and *O. validus* to reach feeding bipinnaria from fertilization at about 35 days, which agrees with the timing of larval presence in the water column in the present study (June to September). These starfish probably obtain advantages from reduced mortality resulting from the avoidance of pelagic predators, which are associated with the summer phytoplankton bloom (Clarke 1988). *O. meridionalis* also has reduced mortality at winter temperatures, as a result of the relationship between embryo viability and temperature (Fig. 5.1b). The disadvantages of a winter spawning strategy include development rates slowed by a factor of 1.5 and a reduced availability of food supplies. Slowed development rates may carry with them an extra energetic requirement in terms of an increased overall maintenance metabolic cost when summed from fertilisation to settlement (Clarke 1992). It is possible that higher overall metabolic costs and reduced food availability would be a disadvantage for winter larvae. However, Rivkin et al (1986) produced evidence that antarctic asteroid larvae could feed on bacteria and Peck (1993) found that larvae of the Antarctic nemertean *Parborlasia corrugatus* were capable of feeding on particles less than 1µm in diameter. Extremely low basal metabolic rates have been measured in *O. validus* embryos and larvae (Prothero-Thomas, data in preparation) together with enhanced capability for amino acid uptake from surrounding seawater (Manahan 1994) that indicate negligible nutritional demands during development. Irrespective of the disadvantages, this winter spawning strategy is clearly successful considering the wide distribution and abundance of *O. validus* and *O. meridionalis*.

The strategy of *S. neumayeri* is different from that of the asteroids in the study. Below +0.2°C, its development rate was strongly influenced by temperature. The calculated Q_{10} of 13.6 is very high, and beyond the range typically accepted as normal for biological systems (Clarke 1983). It suggests that this response is not that usually presented by an

enzyme mediated reaction system. Other factors such as changes in membrane permeability (Hochachka 1991) may be important at temperatures at the lower end of a species tolerance range; and in the case of the Signy population of *S. neumayeri*, below +0.2°C. This would also suggest that below the breakpoint for *S. neumayeri* development rate data in the Arrhenius plot (Fig. 5.4), development is occurring at the lower end of its range of temperature tolerance (Hoegh-Guldberg and Pearse 1995). Above +0.2°C the development rate was independent of temperature up to the maximum temperature in the investigation (+2.8°C). The inference from this is that development rate has reached its upper limit at 0.2°C and further temperature rises are incapable of increasing the rate.

From temperature alone it would seem that *S. neumayeri* would minimise its larval development time by spawning when the sea was at or above +0.2°C, as in the austral spring/summer period at Signy Island. Once again, however, the system is more complex than this. Embryo mortality in *S. neumayeri* is independent of temperature below +1.7°C, but increases rapidly above this, with a six-fold increase over the next 1°C rise in temperature. The results (Figs. 5.3b, 5.4) suggest there is a sea temperature window between +0.2°C and +1.7°C, where development rate and embryo viability are optimised. The field data (Fig. 5.5) concur, showing that *S. neumayeri* produces embryos and larvae within the proposed temperature window. It is competent to spawn and can be induced from May to October, when sea temperatures are in the range -1.8°C to -1.6°C. However, the period of maximum spawning competence was later than this, in November, when sea temperatures were approaching 0°C. Such optimal temperature windows for development were also observed by Orton (1920).

Wild larvae were only found in the water column around December-January, at temperatures around +0.5°C. Bosch et al (1987) measured the development time from

fertilisation to the pluteus stage as about 20 days, suggesting the successful larvae seen in the water column had developed from gametes released in November, and that earlier spawnings in field populations are absent or rare. The rising sea temperatures observed in November may therefore be a cue for spawning in the Signy Island *S. neumayeri* population. The phytoplankton levels are also increasing at this time and have been closely correlated with spawning times in the patellid limpet *Nacella concinna* (See section 5.5), thus suggesting another possible cue (Starr et al 1990).

S. neumayeri larvae were also observed in plankton samples from McMurdo Sound during the end of November and the beginning of December (Bosch et al 1987) which was within the same interval that *S. neumayeri* larvae were observed in the present study (Fig. 5.5). As the temperature at McMurdo Sound remains constant at about -1.9°C (Littlepage 1965), this does conflict with the suggestion of optimising a temperature “window”. Spawning synchrony maximises fertilization success in free spawning animals (Levitan 1995) and so high latitude populations would benefit from environmental spawning cues of some sort. In addition to spawning synchrony, pairing prior to gamete release occurs in at least one deep sea echinoid (Young et al 1992) The thermal stability at McMurdo Sound, as in the deep sea, suggests an alternative cue to temperature, perhaps phytoplankton?

Temperature and development have been investigated in *O. validus* and *O. meridionalis* from populations at McMurdo Sound, Antarctica by Hoegh-Guldberg and Pearse (1995). Their data showed a relationship that was different from these same species at Signy Island, but was similar in form to the data for *S. neumayeri* (Fig 5.4). Arrhenius plots of development rate were fitted with a broken stick model. The breakpoint in the Hoegh-Guldberg and Pearse (1995) data occurred at 0°C and the effect of temperature on development rate above the break point was small. The lack of a marked change in

development rate with temperature for the Signy Island starfish could be obtained by a translocation of the lower part of the broken stick relationship for the McMurdo Sound populations. The breakpoint for the embryos of the *Odontaster* spp. from Signy Island would, therefore, be above +2.8°C. A translation of this type might be expected (Precht et al 1973) between a population adapted to the stable McMurdo Sound (-1.9°C), to Signy Island where the annual temperature ranges from winter lows at -1.8°C to summer maxima between +0.5°C and +1.0°C. Applying the same logic to the McMurdo Sound *S. neumayeri* data would suggest that embryonic development rates in McMurdo Sound populations of this urchin should have a breakpoint at a temperature lower than that found in the present study (+0.2°C).

There are both advantages and disadvantages associated with the winter spawning strategy of the *O. validus* and *O. meridionalis* and the summer spawning strategy of the urchin, *S. neumayeri*. However, it is clear that neither the advantages or disadvantages are overwhelming as functionally similar occur at different times of the year. The data would therefore suggest that the important selection criteria for these echinoderms are not associated with predation from bloom-associated predators, or with the abundance of food supplies. Other factors which could be important are egg quality, which should be related to previous adult nutrition, and predation by benthic suspension feeders during the settlement phase.

The relationships found here between development rate and temperature, and embryonic mortality and temperature, may be important factors affecting distributions of Antarctic echinoderms. Variations in these characters between populations adapted to different temperature regimes clearly indicate their role in delineating a species' ability to colonise a given habitat. The study also shows evidence for local population adaptation in embryonic development.

Table 5.1

Collection dates and depths for spawning induction and experiments.

Species	Collection period	Depth
<i>Odontaster meridionalis</i>	January 1994 to February 1995	8 - 10 m
<i>Odontaster validus</i>	February 1993 to February 1995	36 m
<i>Sterechinus neumayeri</i>	February 1993 to February 1995	16 - 18 m

Table 5.2

Thermogradient block layout. The temperatures were measured with a precision thermometer in the vials of Row 3, at each culture observation (every 12 hours) during the experiments. Errors are ± 1 SE, $n = 30$.

Temp steps (°C)	<i>O. meridionalis</i>	<i>O. validus</i>	<i>S. neumayeri</i>
column 1	-2.02 ± 0.02	-1.93 ± 0.03	-1.83 ± 0.02
column 2	-1.51 ± 0.06	-1.48 ± 0.04	-1.38 ± 0.02
column 3	-1.10 ± 0.04	-0.98 ± 0.06	-0.94 ± 0.03
column 4	-0.65 ± 0.04	-0.57 ± 0.06	-0.54 ± 0.03
column 5	-0.27 ± 0.05	-0.19 ± 0.06	-0.19 ± 0.03
column 6	$+0.11 \pm 0.05$	$+0.18 \pm 0.07$	$+0.23 \pm 0.04$
column 7	$+0.48 \pm 0.06$	$+0.59 \pm 0.06$	$+0.60 \pm 0.06$
column 8	$+0.85 \pm 0.06$	$+0.85 \pm 0.03$	$+0.90 \pm 0.04$
column 9	$+1.18 \pm 0.06$	$+1.18 \pm 0.02$	$+1.21 \pm 0.05$
column 10	$+1.50 \pm 0.06$	$+1.50 \pm 0.01$	$+1.53 \pm 0.06$
column 11	$+1.82 \pm 0.05$	$+1.82 \pm 0.02$	$+1.85 \pm 0.04$
column 12	$+2.12 \pm 0.05$	$+2.14 \pm 0.01$	$+2.15 \pm 0.04$
column 13	$+2.43 \pm 0.04$	$+2.45 \pm 0.01$	$+2.45 \pm 0.04$
column 14	$+2.83 \pm 0.03$	$+2.90 \pm 0.02$	$+2.80 \pm 0.03$
controls (aquarium)	-1.33 ± 0.10	-1.27 ± 0.08	-1.42 ± 0.22

At each temperature step

Row 1	Cooling, aerated water (Whatman GF/C filtered)
Row 2	Larval culture 1
Row 3	Vials filled with water for temperature monitoring
Row 4	Larval culture 2
Row 5	Cooling, aerated water (Whatman GF/C filtered)

Figure 5.1

(a) The time taken for 50% of the *O. meridionalis* embryos to reach eight cells (□), blastulae (○) and to hatch (●), as indicated by the loss of the fertilization envelope (Chia and Walker, 1991). Data were taken from photographs of larvae in cultures. The control cultures times are also indicated (◻).

(b) The number of non-viable eggs in each culture at each temperature step. The line was fitted by linear regression ($y = 2.59x + 11.15$, $r^2 = 0.95$).

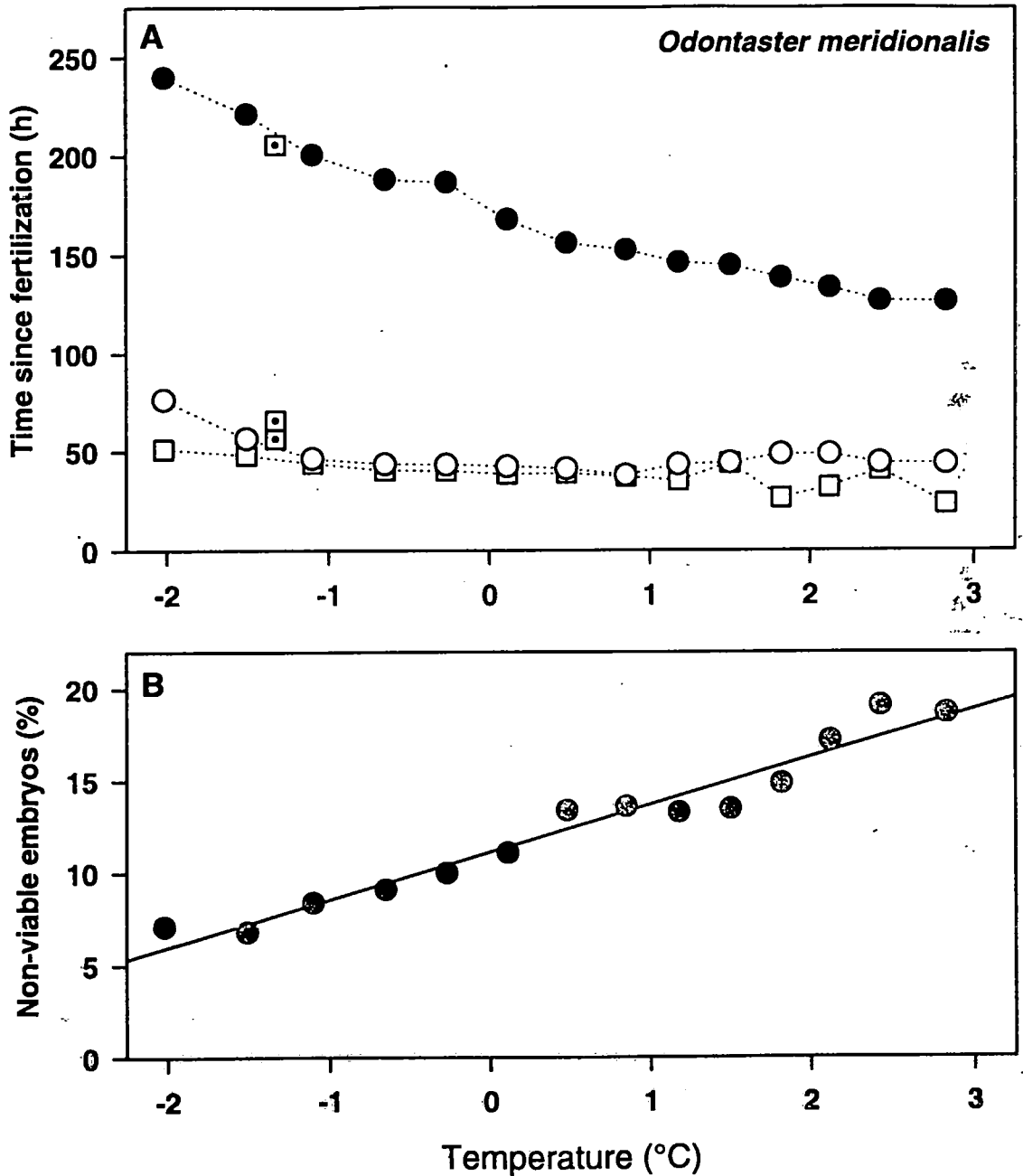

Figure 5.2

(a) The time taken for 50% of the *O. validus* embryos to reach eight cells (□), blastulae (○) and to hatch (●), as indicated by the loss of the fertilization envelope (Chia and Walker, 1991). Data were taken from photographs of larvae in cultures. The control cultures times are also indicated (◻).

(b) The number of non-viable eggs in each culture at each temperature step. The line was fitted by linear regression ($y = -0.31x + 12.87$, $r^2=0.03$).

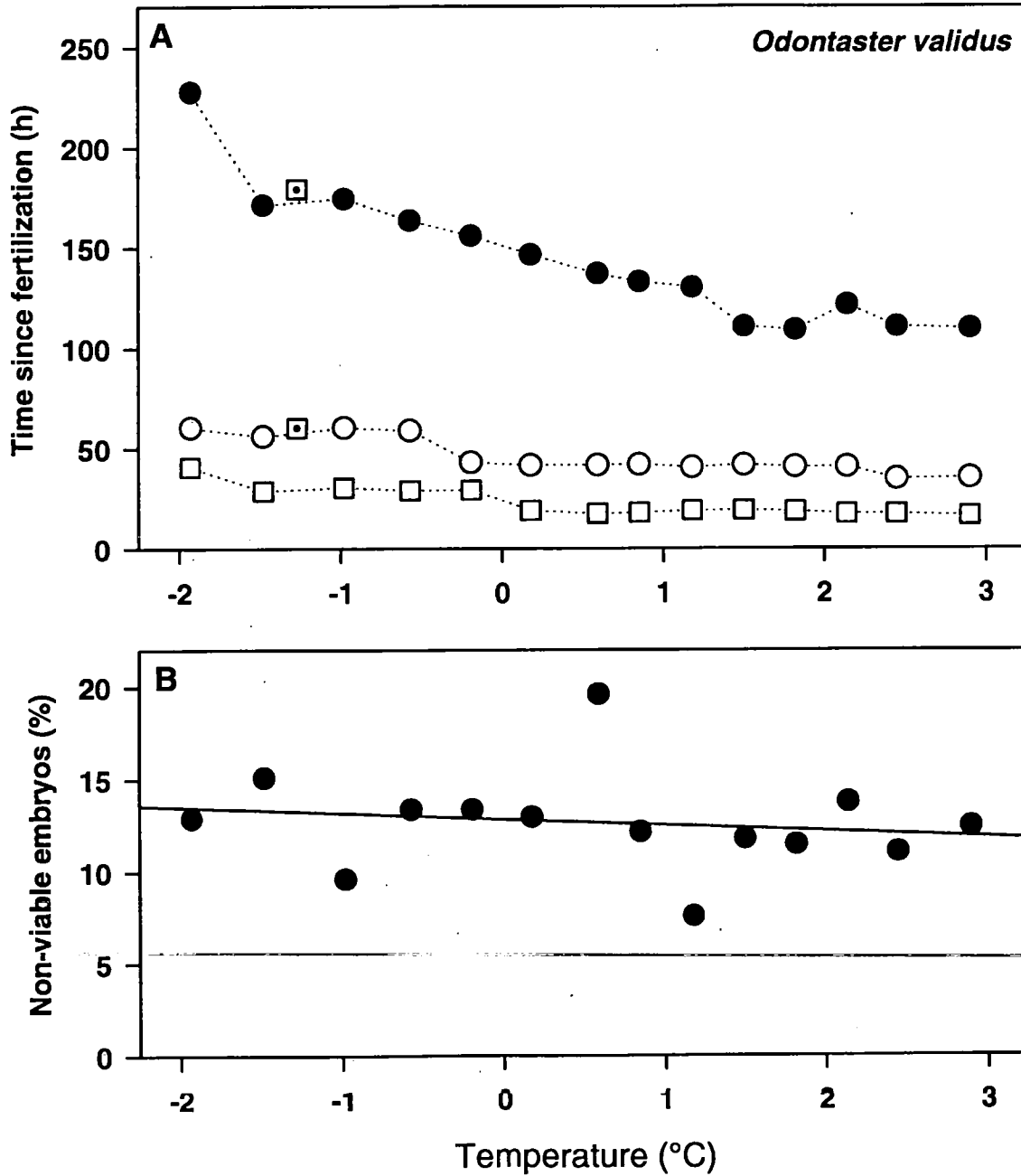

Figure 5.3

(a) The time taken for 50% of the *S. neumayeri* embryos to reach eight cells (\square), blastulae (\circ) and to hatch (\bullet), as indicated by the loss of the fertilization envelope (Chia and Walker, 1991). Data were taken from photographs of larvae in cultures. The control cultures times are also indicated (\square).

(b) The number of non-viable eggs in each culture at each temperature step. The broken stick model was fitted by the maximum likelihood method (94% of variance accounted for).

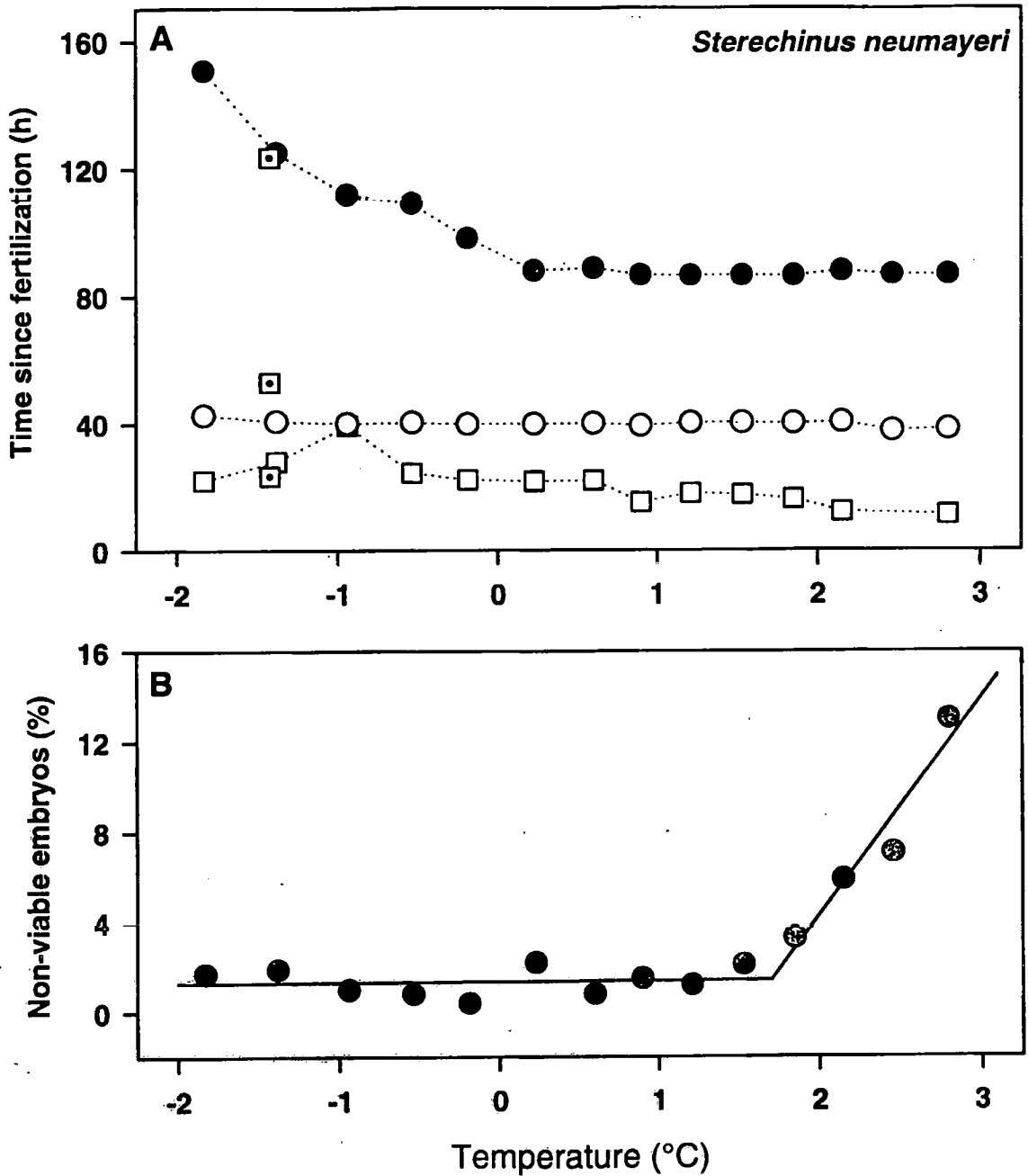

Figure 5.4

Arrhenius plot of the development rates of *O. meridionalis* (●), *O. validus* (○) and *S. neumayeri* (▲). Broken stick model fitted by the maximum likelihood method (98% of variance accounted for). Straight lines fitted by linear regression: *O. validus* ($y = 0.14x - 5.02$, $r^2 = 0.91$), *O. meridionalis* ($y = 0.13x - 5.16$, $r^2 = 0.98$). Actual temperatures are also shown on second axis for clarity. Development rate was calculated as the reciprocal time to 50% hatching.

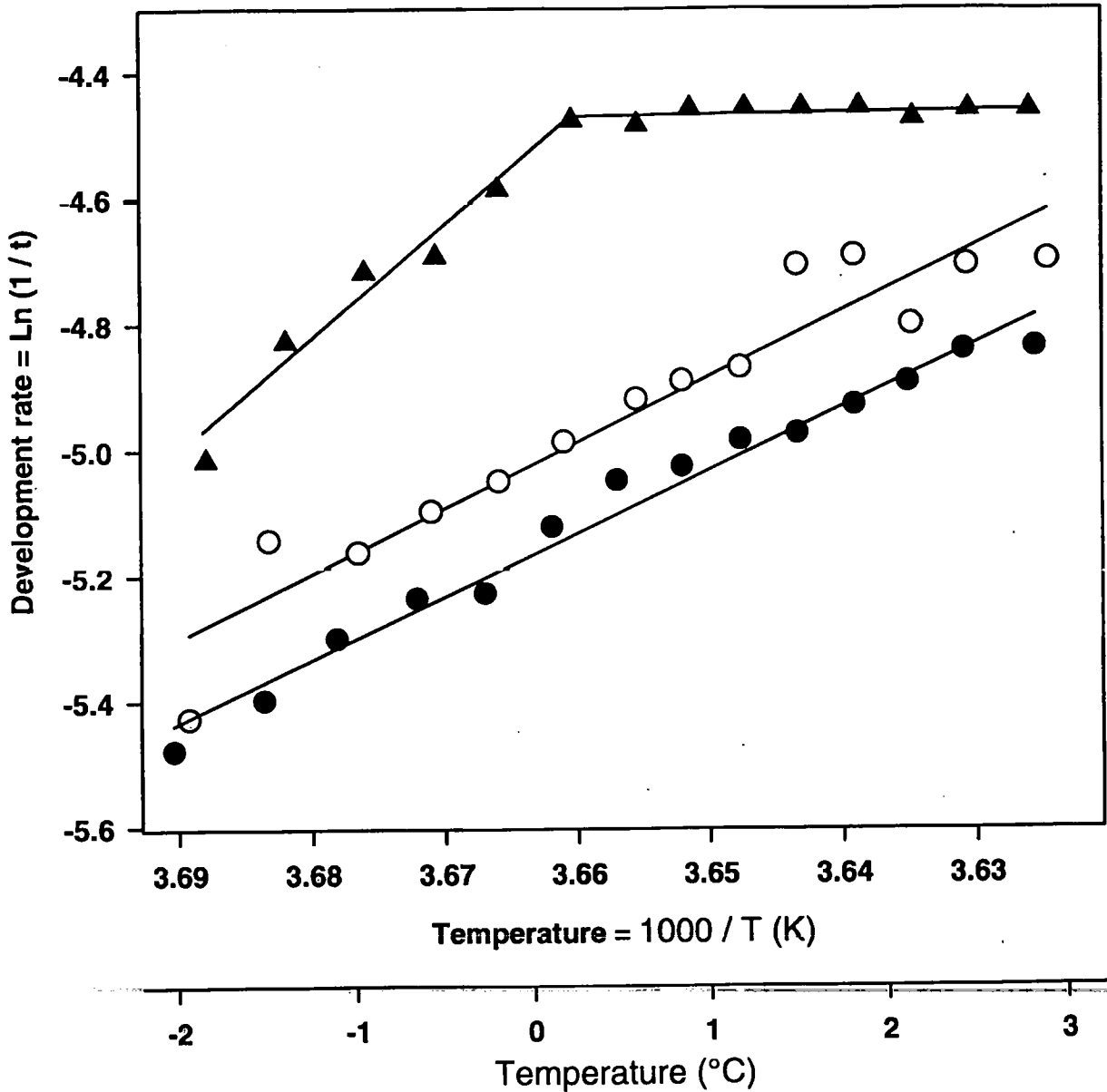

Figure 5.5

Field data collected between January 1993 and February 1995. The kite diagrams show the number of larvae caught (per 5000 L seawater filtered). The coloured bars show when spawning could be induced in the three echinoderm species: □ = 0 25% animals spawned, ▨ = 25 75% spawned, ■ = 75 100% spawned. Note that the entire length of the lines indicate experimental duration (*O. validus* was sampled for two years, *O. meridionalis* and *S. neumayeri* were only sampled during the second year of the study). The chlorophyll-a plot shows the microphytoplankton chlorophyll standing crop (>20 µm filter, mg.m⁻³), with a dotted line indicating missing data.

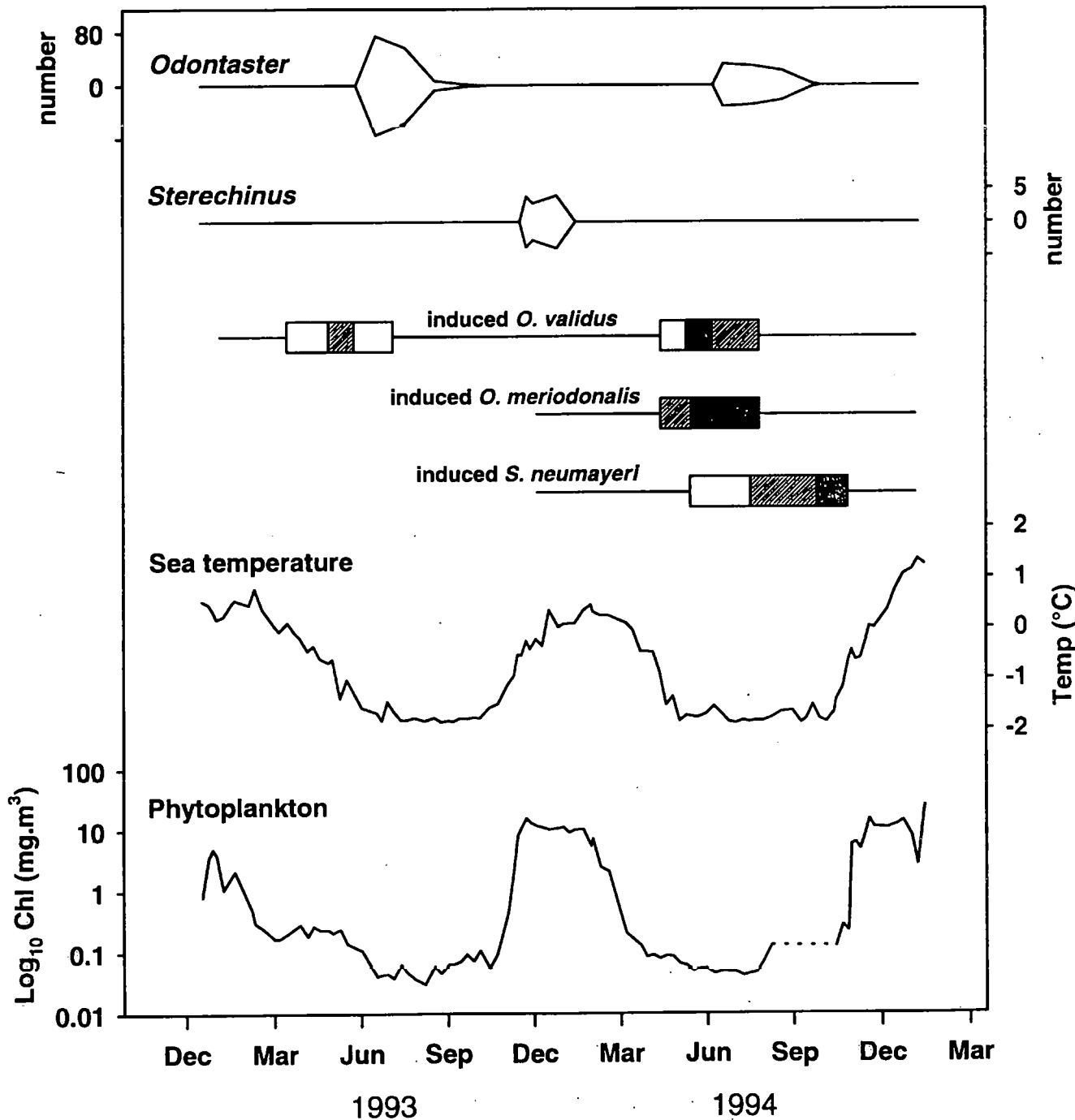
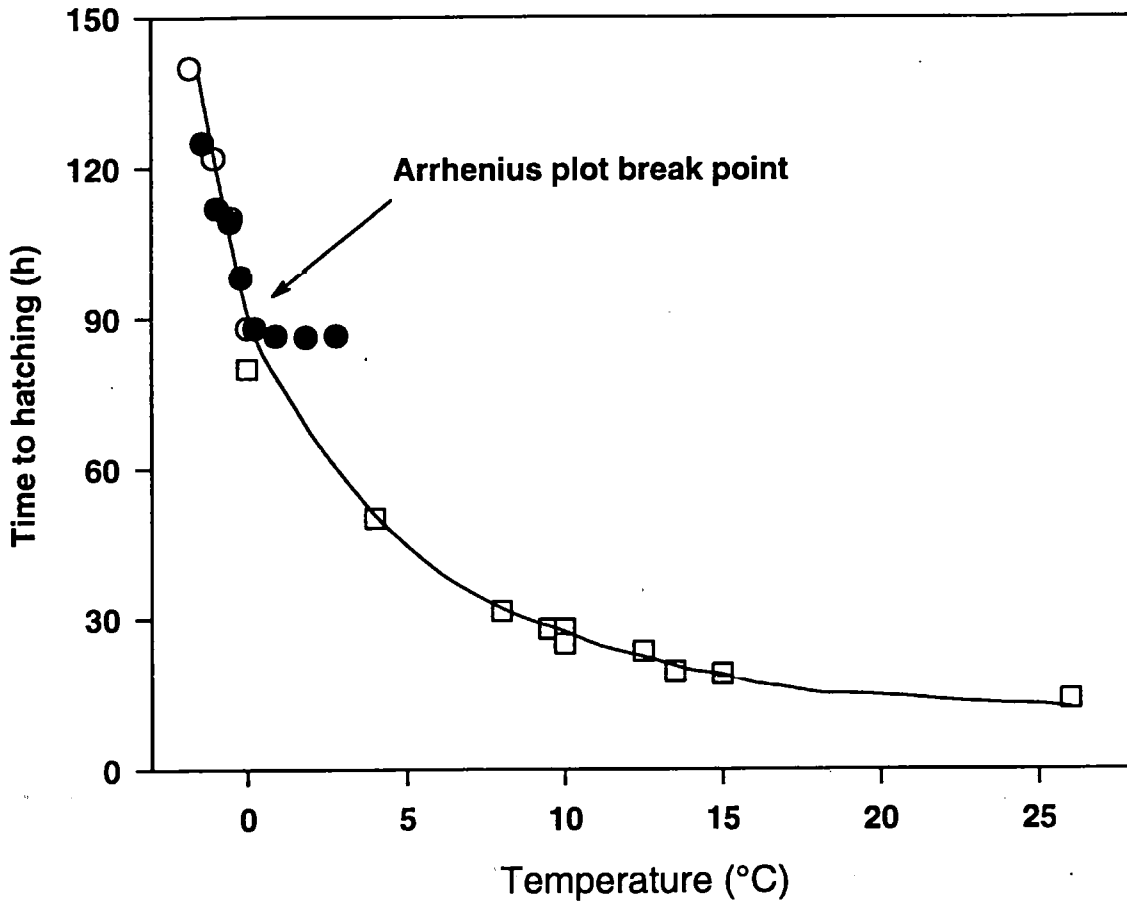

Fig. 5.6

Duration of embryonic development to hatching as a function of temperature of several species of echinoids at different latitudes (adapted from Bosch et al 1987). Results from tropical and temperate species (\square), *S. neumayeri* from McMurdo Sound (\circ), and *S. neumayeri* from the present study (\bullet). The line was fitted by eye.



Addition to chapter 5

A small opportunistic study was carried out on anecdotal observations made on spawning *Nacella concinna* in Factory Cove. Observations made by other members of Signy station were incorporated and have been accredited. As the apparatus was available for the experiments described earlier in this chapter, embryos also were reared at a range of temperatures.

5.5 Spawning and development in the limpet *Nacella concinna*

Data also presented in: Stanwell-Smith D and Clarke A (in press) The timing of reproduction in the Antarctic limpet *Nacella concinna* (Strebel, 1908) (Patellidae) at Signy Island, in relation to environmental variables. *J. Moll. Stud.*

Introduction

“...As the survey of spawning in various phyla of marine invertebrates has disclosed, correlation with temperature change is cited over and over again by investigators, seldom, however, with experimental evidence...” (Arthur Giese 1987)

The limpet *Nacella concinna* (Strebel 1908) is abundant around the Antarctic Peninsula and the islands of the Scotia arc, occurring from the intertidal to over 100m depth. It is a very common species in the near shore Antarctic environment, with a mean population density at Signy Island of $124 \pm 21 \text{ m}^{-2}$ (Picken 1980b). The distribution and reproductive ecology of *N. concinna* has been studied at Palmer station, Anvers Island (64° 43' S, 64° 05' W) (Shabica

1971; 1976); Esperanza Bay on the Antarctic Peninsula (63° 18' S, 56° 55' W) (Brêthes et al 1994); and at Signy Island, South Orkney Islands (60° 43' S, 45° 36' W) (Walker 1972; Picken 1980b). *Nacella concinna* is herbivorous, grazing algae and diatoms (Shabica 1976) and is a broadcast spawner with pelagic larvae. The present work describes field observations of spawning behaviour made predominantly between 1987 and 1994, together with experimental work conducted using the apparatus available from the study described in Chapter 5.

It has long been known from work at Signy (Picken and Allen 1983) that *N. concinna* has a unique spawning behaviour. It is a non-homing limpet which roams freely over a variety of hard and soft substrata (Picken 1980b). In early spring individuals aggregate in temporary stacks of up to 12 individuals. These stacks are usually visible on flat rocks for 7-10 days and consist of an apparently random mix of sexes. Spawning usually occurs in a very narrow time-frame, often on a single day of the year (Picken and Allen 1983) and after spawning the individuals disperse once more. This unusual behaviour would appear to be an adaptation to maximise fertilisation success. Spawning aggregation occurs in many molluscs (Webber 1977), and has also been observed in the deep sea where it reduces sperm dilution which increases fertilisation success (Young et al 1992). Previous workers (Shabica 1976; Picken 1980b) have proposed that the proximate environmental cue for spawning in *N. concinna* is temperature. Picken (1980b) noted that in the years of his study (1975 - 1976) spawning occurred about 3 weeks after the seawater temperature rose to -1.4°C, and he proposed this as a general result.

Spawning

Since 1987 regular observations of spawning behaviour have been made by SCUBA divers in Factory Cove, close to the British Antarctic Survey research station on Signy Island. Factory Cove is a sheltered bay of predominantly soft sediment, with patches of cobbles and boulders; and it has a dense population of *N. concinna* (Picken 1980b). From 1969 to 1983, and then from 1989 to 1994, regular measurements have been made in Factory Cove of a variety of environmental variables. These include seawater temperature, salinity, winter sea-ice duration and thickness, chlorophyll biomass and the major macronutrients (N, P, Si) (Clarke et al 1988; Clarke and Leakey 1996). These observations allow a comparison to be made between the timing of spawning and the year to year variation in the timing of key environmental variables that might cue spawning in *N. concinna*.

Fig. 5.7 shows the mean stack size of limpets in Factory Cove, observed during daily dives. Stacks contained 4 to 12 individuals in different years, although in 1994 clumps of up to 35 individuals were observed on soft sediment (Plate 5.1). The latter behaviour has not been reported before. As noted previously (Picken 1980b; Picken and Allan 1983), the stacks contained both sexes, as evident when spawning occurred. Also shown in Fig. 5.7 are the dates when seawater rose to -1.5°C (T1) and -0.5°C (T2), and when spawning (S) occurred. Winter seawater temperatures in Factory cove are typically -1.9°C and peak summer values are usually between $+0.3^{\circ}\text{C}$ and $+1.5^{\circ}\text{C}$ (Clarke et al 1988; Clarke and Leakey 1996). The two temperature thresholds shown on Fig. 5.7 thus mark the start and end of the spring period of rapid temperature change in Factory Cove; once the seawater has reached about -0.5°C , further warming is typically slower and more episodic (Clarke and Leakey 1996). This occurs consistently each year between October and December, although there is interannual variation

in the onset and duration of warming. It is immediately evident from these plots that there is little correspondence between the timing of the spring increase in seawater temperature and the timing of spawning. The one consistent aspect is that spawning is usually after T2.

Plate 5.1

A variation in the unique stacking behaviour of *N. concinna* (7) seen on soft sediment at 6m depth in Factory Cove, Signy Island on 22 November 1994. Both sexes were present randomly in the "ball", and spawning occurred in synchrony.



Pearson product moment correlations were calculated between the date of spawning and (i) the timing of the two temperature thresholds, (ii) the start of the summer microplankton chlorophyll (>20 μm) and nanoplankton chlorophyll (20-2 μm) blooms; and (iii) the date of break up of winter fast-ice in Factory Cove (Table 5.4). Although none were significant at the level $P \leq 0.05$, correlation between the onset of the microplankton bloom was almost so ($r = 0.754$, $P \leq 0.1$). It has been observed that many marine invertebrates cue their spawning with phytoplankton blooms (Starr et al 1990), even when the larvae released are lecithotrophic (Himmelman 1975).

It is not currently known if *N. concinna* has feeding larvae although the larvae of the similar temperate limpet *Patella vulgata* are trochophores which develop into planktotrophic veligers (Webber 1977). Lecithotrophy is believed to be a secondary (derived) feature in larval nutrition, having evolved from planktotrophy (Picken 1980a; Reid 1989); this may mean that the response to phytoplankton blooms is retained even in non-feeding larvae. The correlation between spawning and ice breakout was also almost significant, although the date of ice breakout does co-vary with the plankton bloom. This is probably because of the increased light levels following the loss of sea ice, allowing the water-column bloom to build.

Development

Gametes released during the 1994 spawning were collected and fertilised. They were then incubated at 14 temperature steps from -1.9°C to $+2.7^{\circ}\text{C}$ using a thermogradient block as described in section 5.2. Development was assessed by examining larvae under a dissecting microscope every 12h, and every 4h when hatching and trochophores were imminent. About 50 of the 300 or so embryos growing at each temperature were observed, and cumulative

frequency plots were used to determine the time when 50% had reached a particular development stage (Fig. 5.8). Previous work further south at Palmer station (Shabica 1976) had found that trochophores took 193h to develop at 0°C, whereas in the present study they took only 79h to reach the same stage; even the cultures at -1.9°C only took 137h. It is worth noting that the development time to reach trochophore stage increased noticeably below about -1°C. Similar sharp decreases in development rate at very low temperatures have been noted in other polar marine invertebrates: *Euphausia superba* (Ross et al 1988) and echinoderms (Pearse 1991; Hoegh-Guldberg and Pearse 1995; Section 5.3). It would appear that in *N. concinna* at Signy, summer temperatures between about 0.5°C and 1.5°C (the normal summer maxima) would result in a broadly similar development time to metamorphosis (between 66d and 76d to trochophore). Coupled with the lack of correlation between spawning and temperature (Fig. 5.7, Table 5.4), this would suggest that reproductive behaviour in *N. concinna* is fairly insensitive to the normal interannual variation in seawater temperature at Signy Island. The difference in the rate of development at the same temperature between Palmer (Shabica 1976) and Signy Island (this study) would indicate the possibility of some genetic component underlying development rate, although the relationship is in the wrong direction to indicate classical temperature compensation (which would predict faster rates in more southerly populations at any given temperature) (Cossins and Bowler 1987).

Conclusion

The data obtained over nine separate years at Signy Island would therefore suggest that reproduction in *N. concinna* is cued by the spring phytoplankton bloom and not temperature, and that larval development is relatively insensitive to typical summer seawater temperatures.

Table 5.4

Pearson product moment correlations of environmental parameters with spawning date between 1989 and 1994. (Other years had incomplete data). NS: not significant ($P > 0.10$). The critical value ($P = 0.05$, $n = 6$) is: $r = 0.811$.

Parameter	Pearson correlation coefficient	
Seawater reaching -1.5°C	0.387	NS
Seawater reaching -0.5°C	0.490	NS
Microplankton ($>20\ \mu\text{m}$) bloom threshold ($\geq 500\ \text{mg.m}^3$)	0.754	$0.10 > P > 0.05$
Nanoplankton ($20 - 2\ \mu\text{m}$) bloom threshold ($\geq 100\ \text{mg.m}^3$)	0.496	NS
Fast-ice breakout from Factory Cove	0.736	$0.10 > P > 0.05$

Figure 5.7

The timing of spawning in *Nacella concinna* in Factory Cove, Signy Island. The kite diagrams show the number of animals in individual stacks, seen on rocks in Factory Cove. The check marks indicate the dates when seawater temperature reached -1.5°C (T1) and -0.5°C (T2). Spawning is indicated by large check mark (S). Note the top kite diagram: *N. concinna* were observed to stack on soft sediment in 1994 (Plate 5.1), as discussed in text. Observations 1975-76 (Picken 1980a); British Antarctic Survey marine assistants, 1987-91 (BAS unpubl data); pers obs, 1992-94.

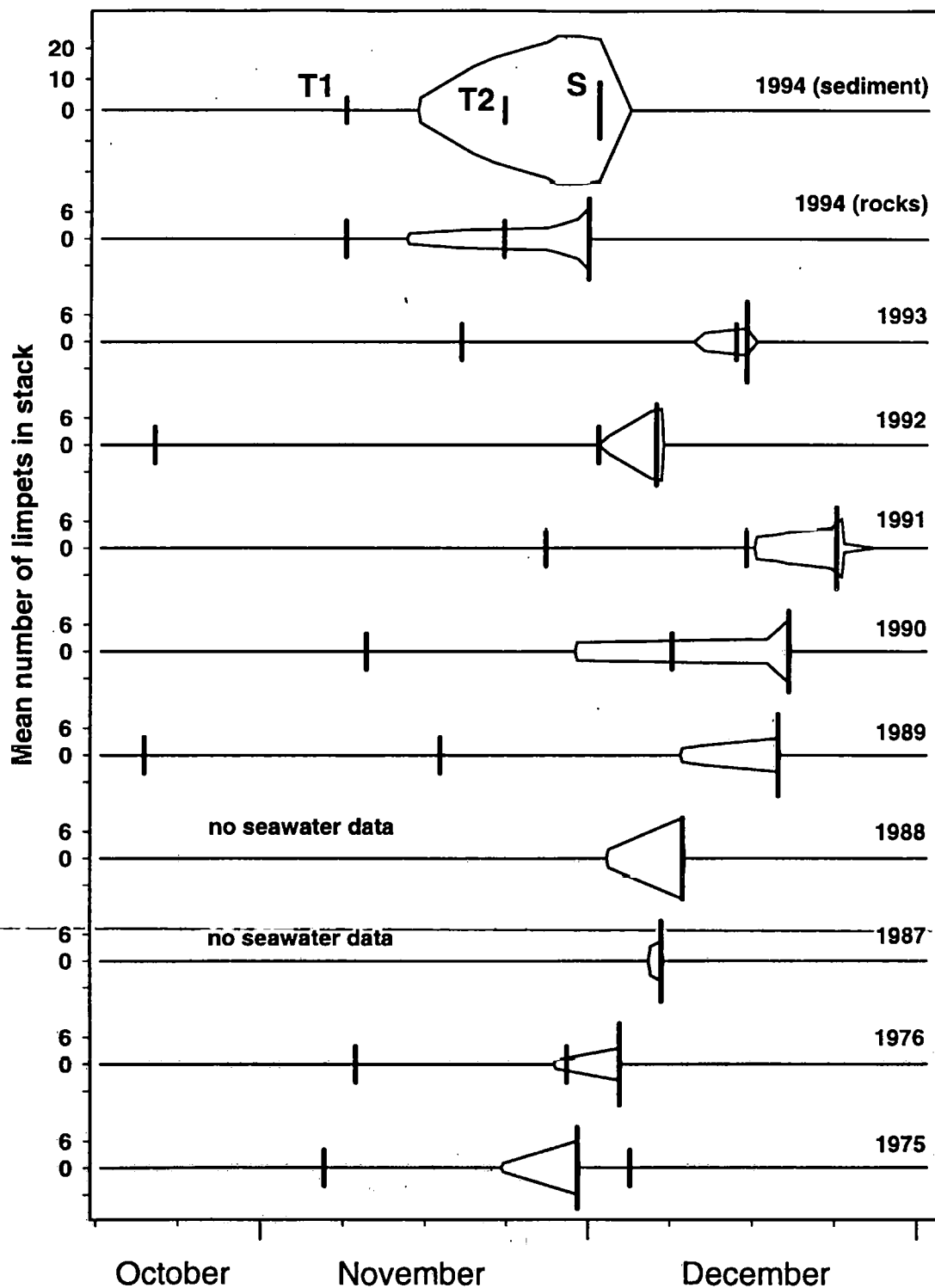
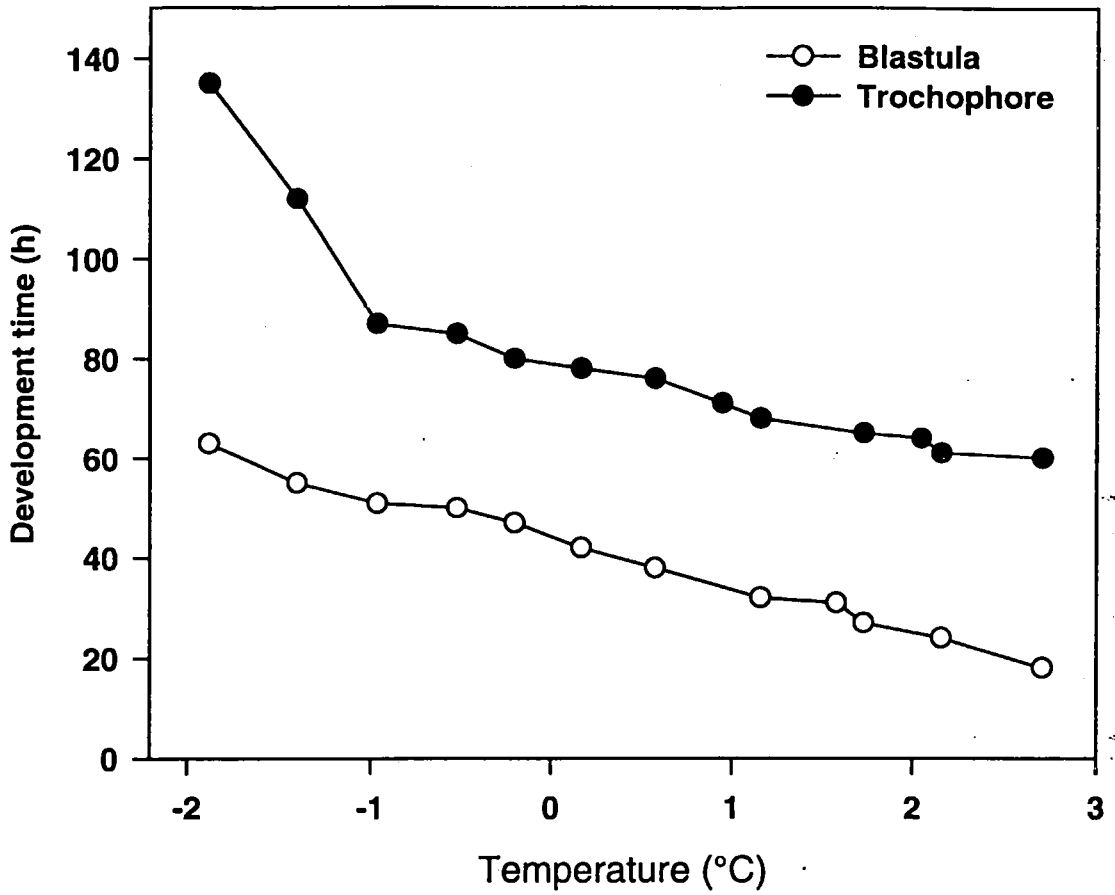

Figure 5.8

The development of *N. concinna* larvae between -1.9°C and $+2.7^{\circ}\text{C}$, incubated in a thermogradient block. Data show the time to 50% of larvae reaching blastula (○) and trochophore (●) stage at different incubation temperatures.



Chapter 6 Overview

In attempting to shed light on questions involving the larval ecology of marine invertebrates in the maritime Antarctic, disparate experiments have been completed. A few Antarctic “firsts” have been achieved, including the first year-round larval survey, the first measurement of seasonality of recruitment onto artificial substrata, and the first measurements of encrusting cheilostomatid bryozoan growth. However, these are not really novel, merely the application of tried and tested methods in a geographic location that has relatively little research conducted upon it. I hope that the true novelty in this project is seen to be the use of very simple techniques in a thorough manner (see Plate 6.1) to ask fundamental questions of the maritime Antarctic ecosystem.

Plate 6.1

An annelid trochophore amongst diatoms in a larval survey sample taken during the austral summer phytoplankton bloom. The larvae were very difficult to find at this time, each sample yielding tens of petri-dishes filled with a green soup that needed searching through.



Seasonality

As previously discussed, the seasonality of some environmental factors in the Antarctic override all other variation for many elements of its inhabitants' life cycles. The larval survey (Chapter 2) highlighted that the occurrence of pelagic larvae followed four strategies: In the summer bloom, after the summer bloom, during the winter, and aseasonal. Most larval groups showed at least some seasonal peaks of abundance, although almost all occurred at low levels throughout the year. This pattern was also observed in recruitment levels onto the settlement panels (Chapter 3). Low levels of colonisation occurred throughout the year, with different taxa each having seasonal peaks. It seems that the cold temperatures which lead to long developmental times are perhaps beneficial by allowing many taxa to maintain a larval presence in the water column throughout the year; advantageous in an environment characterised by regular, severe perturbation of the benthos by ice.

The studies on echinoderms add a little to this story. The most common starfish in Antarctica was observed to have a seasonal reproductive cycle (Chapter 4). Although this was not new, the differences (and similarities) in reproductive patterns of cosmopolitan species in relation to the environmental factors influencing geographically separated areas can be very useful. The functionally very similar larvae of two of the most common echinoderms in Antarctica occur at "opposite" times of the year, one in the summer and one in the winter (Chapter 5). Subtle differences in the effect of temperature on development times and embryo mortality in these species suggested that it was sea-temperature (rather than the usual inference of food availability) which produced divergent life cycles.

Abundance and diversity

The most striking result for me in this project has been the high diversity and low abundance of pelagic larvae. Thorson's rule, the inferred avoidance of a pelagic larva in polar regions, can now be described as a phenomenon of the North Atlantic and Arctic, but not of the Southern hemisphere. I think that the low abundance observed is a function of the high levels of dilution of long-lived larvae. Although the peaks of aggregated larval abundance in the tropics are several orders of magnitude higher than in the Antarctic, overall larval numbers are probably not as divergent because of the dilution effect, and larvae staying for longer duration in polar waters.

Dispersal

Data suggesting interannual differences have been reported in past work (Dayton 1989), and observed in the present study. Long term studies are the only way in which these patterns can be understood. As recently reiterated by Tony Underwood (pers comm), the "PhD" unit of three years field work, of which so many projects are based, can lead to artefactual interpretation of interannual variation. For example, Signy Island is located in a complex frontal system, with the mixing of the northerly flowing Weddell Sea Gyre and the easterly flowing Antarctic circumpolar current. In addition, Signy lies in the Weddell-Scotia Confluence, a boundary between the Weddell and Scotia Seas (Muench 1990). Genetic work suggests that nemertean populations at the South Orkneys could be recruiting from two distinct parent populations (Rogers et al, in press), associated with either the Weddell or Scotia Sea, depending on which side of the shifting Weddell-Scotia confluence Signy Island

is lying each year. The Fine Resolution Antarctic Model (FRAM) indicates that particles would take 100-150 days to reach the South Orkney Islands from the Northern Antarctic Peninsula. The nemertean populations might therefore not be recruiting locally, with the majority of the *Parbolasia* larvae drifting away from Signy in the prevailing eastward current flow (Rogers et al, in press). If this is the case, the pelagic larvae of other taxa may also be entrained in currents as the pilidia of these nemerteans are.

Strathmann (1985) concluded in his review of evolutionary larval development that extensive dispersal and enhanced gene flow is an accidental by-product of possessing a larva.

In disturbed habitats, pelagic larvae are perhaps selected for, as dispersal to avoid catastrophic losses is so important. In the maritime Antarctic, the fauna possessing pelagic larvae seem to be the most numerous, cosmopolitan, and the most successful inhabitants of this ecosystem. On the other hand, brooders have a lower dispersal potential; recent phylogenetic work on Antarctic echinoids has shown that many of the brooders have radiated from relatively few immigrants and speciated more rapidly than those with pelagic larvae (Poulin and Feral 1996).

While at Signy, I was fortunate to be working at the same time as an aerobiology project was being undertaken. This involved an eighteen month survey of the dispersing propagules and spores in the wind blowing to Signy Island, and the collection of deposition cores from recently de-glaciated areas (Marshall 1996; 1997a,b). The aerial biota was characterised by high diversity and low abundance of propagules, with most of material originated several 100s of km NW from Signy Island, in the direction of the prevailing wind. It was interesting to observe such a similar result to the marine environment, in a different medium.

Summary

- The year-round survey of pelagic larvae found 131 morphologically distinct larval forms, suggesting that there are 100-150 species of benthic marine invertebrates possessing a pelagic larva, in the waters around Signy Island.
- Pelagic larvae occurred in low abundance throughout the year, characterizing the Antarctic as an environment of high larval diversity, but highly diluted numbers.
- Colonisation was very slow, with low numbers of new recruits throughout the year. The growth measurements of encrusting bryozoans were highly variable.
- The common echinoderms measured had seasonal reproductive patterns, the timing of whose planktotrophic larvae is perhaps dictated by temperature, not food availability.

References

- Arnaud PM (1974)** Contribution a la bionomie marine benthique des regions antarctiques et subantarctiques. *Tethys* **6**: 465-656.
- Arntz WE, Brey T, Gallardo VA (1994)** Antarctic zoobenthos. *Ocean Mar Biol A Rev* **32**:251-304.
- Arntz WE, Gutt J and Klages M (in press)** Antarctic marine biodiversity. In: *Antarctic Communities: Species, Structure and Survival*, Battaglia B, Valencia J and Walton DWH (Eds), Cambridge University Press. 3-14.
- Babcock RC, Bull GD, Harrison PL, Heyward AJ, Oliver JK, Wallace CC and Willis BL (1986)** Synchronous spawnings of 105 scleractinian coral species on the Great Barrier Reef. *Mar Biol* **90**: 379-394.
- Baker JH (1974)** The use of a temperature-gradient incubator to investigate the temperature characteristics of some bacteria from Antarctic peat. *Br Antarct Surv Bull* **39**: 49-59.
- Barkai A and Branch GM (1988)** The influence of predation and substratal complexity on recruitment to settlement plates: a test of alternative states. *J Exp Mar Biol Ecol* **124**: 215-237.
- Barnes DKA (1995 a)** Seasonal and annual growth in erect species of Antarctic bryozoans. *J Exp Mar Biol Ecol* **188**: 181-198.
- Barnes DKA (1995 b)** Sublittoral epifaunal communities at Signy Island, Antarctica: I. The ice foot zone. *Mar Biol* **121**: 555-563.
- Barnes DKA (1995 c)** Sublittoral epifaunal communities at Signy Island, Antarctica: II.

Below the ice foot zone. *Mar Biol* **121**: 565-572.

Barnes DKA (1996) Low levels of colonisation in Antarctica: the role of bryozoans in early community development. *Bryozoans in Space and Time*, Gordon DP, Smith AM and Grant-Mackie JM. National Institute of Water and Atmospheric Research, Wellington. 442pp.

Barnes DKA and Clarke A (1994) Seasonal variation in the feeding activity of four species of Antarctic bryozoan in relation to environmental factors. *J Exp Mar Biol Ecol* **181**: 117-133.

Barnes DKA and Clarke A (1995) Seasonality of feeding activity in Antarctic suspension feeders. *Polar Biol* **15**: 335-340.

Barnes DKA and Rothery P (1996) Competition in encrusting Antarctic bryozoan assemblages: outcomes, influences and implications. *J Exp Mar Biol Ecol* **196**: 267-284.

Barnes DKA, Clarke A, Rothery P (1996) Colonisation and development in encrusting communities from the Antarctic intertidal and sublittoral. *J Exp Mar Biol Ecol* **196**: 251-265.

Bone DG (1972) Aspects of the biology of the Antarctic amphipod *Bovallia gigantea* Pfeffer at Signy Island, South Orkney Islands. *Br Antarct Surv Bull* **27**: 105-122.

Bosch I (1989) *Reproduction and development of shallow-water asteroids and an echinoid in McMurdo Sound, Antarctica*. PhD Thesis: University of California, Santa Cruz, 112 pp.

Bosch I and Pearse JS (1990) Developmental types of shallow-water asteroids of McMurdo Sound, Antarctica. *Mar Biol* **104**: 41-46.

- Bosch I, Beauchamp KA, Steele ME, and Pearse JS (1987)** Development, metamorphosis and seasonal abundance of embryos and larvae of the Antarctic sea urchin *Sterechinus neumayeri*. *Biol Bull* **173**: 126-135.
- Brêthes J-C, Ferreyra G, Vega S de la (1994)** Distribution, growth and reproduction of the limpet *Nacella (Patiginera) concinna* (Strebel 1908) in relation to potential food availability, in Esperanza Bay (Antarctic Peninsula). *Polar Biol* **14**: 161-170.
- Brey T, Klages M, Dahm, C, Gorny M, Gutt J, Haln, S, Stiller M, Arntz WE (1994)** Antarctic Benthic Diversity. *Nature* **368**: 297
- Brey T, Pearse JS, Basch L, McClintock JB and Slattery M (1995)** Growth and production of *Sterechinus neumayeri* (Echinoidea: Echinodermata) in McMurdo Sound, Antarctica. *Mar Biol* **124**: 279-292.
- Brey, T. and J. Gutt. 1991.** The genus *Sterechinus* (Echinodermata: Echinoidea) on the Weddell Sea shelf and slope (Antarctica): distribution, abundance and biomass. *Polar Biol* **11**:227-232
- Chia FS (1974)** Classification and adaptive significance of developmental patterns in marine invertebrates. *Thalassia Jugoslavica* **10**: 267-284.
- Chia FS and Walker CW (1991)** Echinodermata: Asteroidea. In: Giese AC and Pearse JS (eds) *Reproduction of marine invertebrates, Vol VI*. Boxwood Press, Pacific Grove, California, pp 301-353.
- Clark HES (1963)** The fauna of the Ross Sea. Part 3: Asteroidea. *NZ Dept Sci Ind Res Bull* **151**: 1-84.
- Clarke A (1983)** Life in cold water: the physiological ecology of polar marine ectotherms. *Oceanogr Mar Biol Annu Rev* **21**: 341-453.

- Clarke A (1988)** Seasonality in the Antarctic Marine environment. *Comp Biochem Physiol* **9(3)**: 461-473.
- Clarke A (1992)** Reproduction in the cold: Thorson revisited. *Invert Reprod Develop* **22**: 175-184.
- Clarke A (1996a)** Benthic marine habitats in Antarctica. *Antarct Res Ser* **70**: 123-133.
- Clarke A (1996b)** The distribution of Antarctic marine benthic communities. *Antarct Res Ser* **70**: 219-230.
- Clarke A (1996c)** Marine benthic populations in Antarctica: patterns and processes. *Antarct Res Ser* **70**: 373-388.
- Clarke A and Leakey RGJ (1996)** The seasonal cycle of phytoplankton macronutrients and the microbial community in a near-shore Antarctic marine ecosystem. *Limnol Oceanogr* **41(6)**: 1281-1294.
- Clarke A and Peck LS (1991)** The physiology of polar marine zooplankton. *Polar Res* **10(2)**: 355-369.
- Clarke A, Holmes LJ, White MG (1988)** The annual cycle of temperature, chlorophyll and major nutrients at Signy Island, South Orkney Islands, 1969-82. *Br Antarct Surv Bull* **80**: 65-86.
- Clarke A and Crame JA (in press)** Diversity, latitude and time: patterns in the shallow sea. In: *Marine Biodiversity; causes and consequences*. Ormond RFC, Gage J, Angel MV (eds), Cambridge University Press, Cambridge, UK.
- Connell JH (1985)** The consequences of variation in initial settlement vs. post-settlement mortality in rocky intertidal communities. *J Exp Mar Biol Ecol* **93**: 11-45.

- Cossins AR and Bowler K (1987)** *Temperature biology of animals*. Chapman and Hall, London. 339 pp.
- Cotterill FPD and Dangerfield JM (1997)** The state of biological knowledge. *Trends Ecol Evol* **12(5)**: 206.
- Cripps GC and Clarke A (Submitted)** Seasonal variation in the biochemical composition of particulate material collected by sediment traps at Signy Island, Antarctica. *Continental Shelf Res*
- Crisp DJ (1961)** Territorial behaviour in barnacle settlement. *J Exp Biol* **38**: 429-446.
- Crisp DJ (1984)** Overview of research on marine invertebrate larvae, 1940-1980. In: *Marine biodeteriation: an interdisciplinary study* Costlow JD & Tipper RC (eds), Spon Ltd, London, 103-126.
- Dayton PK (1989)** Interdecadal Variation in an Antarctic Sponge and its Predators from Oceanographic Climate Shifts. *Science* **245**: 1484-1486.
- Dayton PK (1990)** Polar Benthos. In: *Polar Oceanography, Part B: Chemistry, biology and geology*, Smith WO (ed), Academic Press, London, 631-685.
- Dayton PK, Robilliard GA, Paine RT, and Dayton LB (1974)** Biological accommodation in the benthic community at McMurdo Sound, Antarctica. *Ecol Monogr* **44**: 105-128.
- Dell RK (1972)** Antarctic benthos. *Adv Mar Biol* **10**: 1-216.
- Desor PJE (1851)** Untitled notes. *Proc Boston Soc Nat Hist* **3**: 11, 13-14.

- Dixon P and Robertson AI (1986)** A compact, self-contained zooplankton pump for use in shallow coastal habitats: design and performance compared to net samples. *Mar Ecol Prog Ser* **32**: 97-100.
- Dunton KH (1992)** Arctic biogeography - the paradox of the marine benthic fauna and flora. *Trends Ecol Evol* **7(6)**: 183-189.
- Ekman JE (1996)** Closing the larval loop: linking larval ecology to the population dynamics of marine benthic invertebrates. *J Exp Mar Biol Ecol* **200**: 207-237.
- Emlet RB (1995)** Developmental mode and species geographic range in regular sea urchins (Echinodermata: Echinoidea). *Evolution* **49(3)**: 476-489.
- Foster BA (1987)** Composition and abundance of zooplankton under the spring sea-ice of McMurdo Sound, Antarctica. *Polar Biol* **8**: 41-48.
- Foster TD (1984)** The marine environment. In: *Antarctic Ecology Vol. 2*. Laws RM (ed) Academic Press, London, 345-371.
- Giese AC and Kanatoni H (1987)** Maturation and Spawning. In: *Reproduction of Marine Invertebrates IX* (Giese AC and Pearse JS (eds), Boxwood Press, California. 251-329
- Gilbert NS (1991 a)** Microphytobenthic seasonality in near-shore marine sediments at Signy Island, South Orkney Islands, Antarctica. *Estuarine Coastal and Shelf Sci* **33(1)**: 89-104.
-
- Gilbert NS (1991 b)** Primary production by benthic micro algae in near-shore marine sediments at Signy Island, Antarctica. *Polar Biol* **11(5)**: 339-346.

- Gnaiger E and Bitterlich G (1984)** Proximate biochemical composition and caloric content calculated from elemental CHN analysis - a stoichiometric concept. *Oecologia* **62(3)**: 289-298.
- Goren M (1979)** Succession of benthic community on artificial substratum at Eilat (RedSea). *J Exp mar Biol Ecol* **38**: 19-40.
- Gray J (1997)** Marine Biodiversity: patterns, threats and conservation needs. *Biodiversity and Conservation* **6**: 153-175.
- Grosberg RK and Levitan DR (1992)** For adults only? Supply-side ecology and the history of larval biology. *Trends Ecol Evol* **7(4)**: 130-133.
- Gruzov EN (1977)** Seasonal alterations in coastal communities in the Davis Sea. In: *Adaptations within Antarctic ecosystems*, Llano GA (ed), Smithsonian Press, Washington, 263-278 pp.
- Grygier MJ (1981)** A representative of the genus *Dendrogaster* (Cirripedia: Ascothoracica) parasitic in an Antarctic starfish. *Antarct Res Ser* **32**: 1-15.
- Grygier MJ (1983)** A novel, planktonic ascothoracid larva from St. Croix (Crustacea). *J Plankt Res* **5(2)**: 197-202.
- Grygier MJ (1984)** The ascothoracid crustacean *Ascothorax gigas*: redescription, larval development, and notes on its infestation of the Antarctic ophiuroid *Ophionotus Victoriae*. *Antarct Res Ser* **41**: 43-58.
- Grygier MJ (1987)** Antarctic records of asteroid-infesting Ascothoracida (Crustacea), including a new genus of Ctenosculidae. *Proc Biol Soc Wash* **100(4)**: 711-712.
- Gutt J (1991)** Are the Weddell Sea holothurians typical representatives of the Antarctic benthos? *Meeresforschung* **33**: 312-29.

- Hacker V (1898)** Die pelagischen polychaeten und achaeten Larven der Plankton Expedition. *Ergeb Atlantic Ocean Plankton Exped 2*: 1-50.
- Hardy AC and Gunther ER (1935)** The plankton of the South Georgia whaling grounds and adjacent waters 1926-1927: Part IV. The zooplankton, section II. *Discovery Reports 11*:194-272.
- Harriott VJ and Fisk DA (1987)** A comparison of settlement plate types for experiments on the recruitment of scleractinian corals. *Mar Ecol Prog Ser 37*: 201-208.
- Havenhand JN (1995)** Evolutionary ecology of larval types. In: *Ecology of marine invertebrate larvae*, McEdward LR (ed), CRC Press, Florida, 79-122.
- Hayward PJ (1995)** *Antarctic Cheilostomatous Bryozoa*. Oxford University Press. 355 pp.
- Hayward PJ and Ryland JS (1995)** *Handbook of the marine fauna of North West Europe*. Oxford University Press, Oxford, UK. 800 pp.
- Herring PJ (1978)** *Bioluminescence in action*. Academic Press, London, 570 pp.
- Hickmann JL (1959)** *Dendrogaster tasmaniensis* sp. nov. (Ascothoracida) from the sea-star *Allostichaster polyplax* (Müller and Troschel). *Parasitology 49*: 316-329.
- Himmelman JH (1975)** Phytoplankton as a stimulus for spawning in three marine invertebrates. *J Exp Mar Biol Ecol 20*: 199-214.
-
- Hochachka PW (1991)** Temperature: The ectothermy option. Pp. 313-322 in *Biochemistry and molecular biology of fishes*, Vol. 1. Hochachka PW and Mommsen TP.(eds) Elsevier Science Press, Amsterdam.

- Hoegh-Guldberg O, and Pearse JS (1995)** Temperature, Food Availability, and the Development of Marine Invertebrate Larvae. *Amer Zool* **35**: 415-425.
- Hofmann EE (1985)** The large-scale horizontal structure of the Antarctic Circumpolar Current from FGGE Drifters. *J Geophys Res* **90(C4)**: 7087-7097.
- Holdgate MW (1967)** The Antarctic ecosystem. *Phil Trans Roy Soc. B* **252**: 363-383.
- Hughes RN (1989)** *A functional biology of clonal animals*. Chapman and Hall, London. 331 pp.
- Jablonski D (1986)** Larval ecology and macroevolution in marine invertebrates. *Bull Mar Sci* **39(2)**: 565-587.
- Jablonski D and Lutz RA (1983)** Larval ecology of marine benthic invertebrates: Paleobiological implications. *Biol Rev* **58**: 21-89.
- Jackson JBC (1977)** Habitat area, colonization and development of epibenthic community structure. In: *Biology of benthic organisms, Proc. 10th Mar. Biol. Symp.*, Keegan BF, O'Ceidigh P and Boaden PJS (eds), Pergamon Press, Oxford, 349-358.
- Jackson JBC (1979)** Overgrowth competition between encrusting cheilostome ectoprocts in a Jamaican cryptic reef environment. *Journal of Animal Ecology* **48**: 805-823.
- Johnstone J, Scott A, Chadwick HC (1924)** *The Marine Plankton with special reference to investigations made at Port Erin, Isle of Man during 1907-1914*. University Press of Liverpool, Hodder and Stoughton, London, 194 pp.
- Keough MJ (1983)** Patterns of recruitment of sessile invertebrates in two subtidal habitats. *J Exp Mar Biol Ecol* **66**: 213-245.

- Knight-Jones EW (1953)** Laboratory experiments on gregariousness during setting in *Balanus balanoides* and other barnacles. *J Exp Biol* **30**: 201-222.
- Kock K-H (1992)** *Antarctic fish and fisheries*. Cambridge University Press. 359 pp.
- Lacaze-Duthiers FHJ (1856-1857)** Histoire de l'organisation et du développement de la Dentale. *Annls Sci. Nat., Zool.* **46-47**: 5-51, 171-255.
- Leakey RJG, Fenton N, Clarke A (1994)** The annual cycle of planktonic ciliates in nearshore waters at Signy Island, Antarctica. *J Plankt Res* **16**: 841-856.
- Lebour MV (1933)** Rearing marine animals in a plunger jar. *Sci Progr Lond* **27**: 494-502.
- Levin LA (1990)** A review of methods for labelling and tracking marine invertebrate larvae. *Ophelia* **32(1-2)**: 115-144.
- Levin LA and Bridges TS (1995)** Pattern and diversity in reproduction and development. In: *Ecology of marine invertebrate larvae*, McEdward LR (ed), CRC Press, Florida, 1-48.
- Levitan DR (1991)** Influence of body size and population density on fertilization success and reproductive output in a free spawning invertebrate. *Biol Bull* **181**: 261-268.
- Levitan DR (1995)** The ecology of fertilization in free-spawning invertebrates. In: *Ecology of marine invertebrate larvae*. McEdward LR (ed) CRC Press, Florida, 123-156.
- Lidgard S (1985)** Zooid and colony growth in encrusting cheilostomatid bryozoans. *Palaeontology* **28**: 26-31.
- Littlepage JL (1965)** Oceanographic investigations in McMurdo Sound, Antarctica. *Antarct Res Ser* **5**: 1-37.

- Lopez Gappa JJ (1989)** Overgrowth competition in an assemblage of encrusting bryozoans settled on artificial substrata. *Mar Ecol Prog Ser* **51**: 121-130.
- MacBride EW (1900)** Note on the rearing of echinoid larvae. *J Mar Biol Assoc UK* **6**: 94-97.
- Manahan DT (1990)** Adaptations by invertebrate larvae for nutrient acquisition from seawater. *Am Zool* **30**: 147-160.
- Manahan DT (1994)** Energy metabolism and amino acid transport during early development of antarctic and temperate echinoderms. *Biol Bull* **187(3)**: 398-407.
- Marshall WA (1996)** Biological particles over Antarctica. *Nature* **383**: 680.
- Marshall WA (1997a)** Aerial dispersal of lichen soredia in the maritime Antarctic. *New Phytol* **134**: 523-530.
- Marshall WA (1997b)** Antarctic aerobiology and long-distance airborne transport. PhD Thesis, Open University, London, 237pp.
- McCook LJ and Chapman ARO (1993)** Community succession following massive ice-scour on a rocky intertidal shore: recruitment, competition and predation during early primary succession. *Mar Biol* **115**: 565-575.
- McCrary J (1860)** On the *Lingula pyramidata* described by Mr. W. Stimpson. *Amer. J. Sci.* **80**: 157-158.
- McEdward LR and Janies DA (1993)** Life cycle evolution in Asteroids, What is a larva?. *Biol Bull* **184**: 255-268.
- McKinney FK and Jackson JBC (1989)** *Bryozoan evolution*. University of Chicago Press, London. 238 pp.

- McLintock JB, Pearse JS, Bosch I (1988)** Population structures and energetics of the shallow-water antarctic sea star, *Odontaster validus* in contrasting habitats. *Mar Biol* **99**: 235-246.
- McMurrich JP (1917)** Notes on some crustacean forms occurring in the plankton of Passamaquoddy Bay. *Trans R Soc Can Sect IV* **11**: 47-61.
- Meidlinger K, Tyler PA, Peck LS (in press)** Reproductive patterns in the antarctic brachiopod *Liothyrella uva* (Broderip, 1833). *Mar Biol*
- Menge BA (1991)** Relative importance of recruitment and other causes of variation in rocky intertidal community structure. *J Exp Mar Biol Ecol* **146**: 69-100.
- Mileikovsky SA (1968)** Distribution of pelagic larvae of bottom invertebrates of the Norwegian and Barents Sea. *Mar Biol* **1**: 161-167.
- Mileikovsky SA (1970)** Seasonal and daily dynamics in pelagic larvae of marine shelf bottom invertebrates in nearshore waters of Kandalaksha Bay (White Sea). *Mar Biol* **5**: 180-194.
- Mileikovsky SA (1971)** Types of larval development in marine bottom invertebrates, their distribution and ecological significance: a re-evaluation. *Mar. Biol* **10**: 193-213.
- Milne-Edwards H (1842)** Observations sur les ascidies composees des cotes de la manche. *Mem Acad Sci Paris* **18**: 217-326.
- Morgan SG (1995)** Life and Death in the Plankton: Larval Mortality and Adaptation. In, *Ecology of marine invertebrate larvae*, McEdward LR (ed), CRC Press, Florida, 279-321.
- Mortensen T (1921)** *Studies of the development and larval forms of echinoderms*. Gad GEC, Copenhagen. 266pp.

- Moyano GH (1984)** On a small bryozoan collection from near Ross Island, Antarctica. *Serie Científica Instituto Antártico Chileno* **31**: 75-83.
- Muench RD (1990)** Mesoscale phenomena in the Polar Oceans. In: *Polar Oceanography, part A: Physical Science*, Smith WO (ed). Academic Press Ltd, London, 223-285.
- Müller J (1846)** Bericht über einige neue Thierformen der Nordsee. *Arch Anat Physiol und wiss Med* **1846**: 101-110.
- Murphy EJ, Clarke A, Simon C, Priddle J (1995)** Temporal variation in Antarctic sea-ice: analysis of a long term fast-ice record from the South Orkney Islands. *Deep-Sea research I*. **42(7)**: 1045-1062.
- Nelson TC (1928)** Pelagic dissoconchs of the common mussel, *Mytilus edulis*, with observations on the behaviour of the larvae of allied genera. *Biol. Bull.* **55**: 180-192.
- Okubo A (1994)** The role of diffusion and related physical processes in dispersal and recruitment of marine populations. In: *The bio-physics of marine larval dispersal* Sammarco PW and Heron ML (Eds) AGU Press. Washington, 5-32.
- Oliver J and Babcock R (1992)** Aspects of the fertilization ecology of broadcast spawning corals: sperm dilution effects and *in situ* measurements of fertilization. *Biol Bull* **183**: 409-417.
- Olson RR (1985)** In situ culturing of larvae of the crown-of-thorns starfish *Acanthaster planci*. *Mar Ecol Prog Ser* **25**: 207-210.
- Olson RR, Bosch I, and Pearse JS (1987)** The hypothesis of antarctic larval starvation examined for the asteroid *Odontaster validus*. *Limnol Oceanogr*, **32(3)**: 686-690.

- Orton JH (1920)** Sea-temperature, breeding and distribution in marine animals. *J Mar Biol Assoc UK* **20(2)**: 339-366.
- Packard GC and Boardman TJ (1987)** The misuse of ratios to scale physiological data that vary allometrically with body size. In: *New directions in ecological physiology*. Feder ME, Bennett AF, Burggren WW, Huey RB (eds), Cambridge University Press, Cambridge, UK. 216-239.
- Payne RW, Lane PW, Digby PGN, Harding SA, Leech PK, Morgan GW, Todd AW, Thompson R, Tunnicliffe WG, Welham SJ and White RP (1993)** *Genstat 5 Release 3 Reference Manual*, Oxford University Press, Oxford, UK. 796pp.
- Pearse JS (1965)** Reproductive periodicities in several contrasting populations of *Odontaster validus* Koehler, a common antarctic asteroid. *Antarct Res Ser* **5**: 39-85.
- Pearse JS (1994)** Cold-water echinoderms break "Thorson's rule". In, *Reproduction, larval biology and recruitment of the deep-sea benthos*. Young CR and Eckelbarger KJ (Eds), Columbia University Press, New York, 26-43.
- Pearse JS and Giese AC (1966)** Food, reproduction and organic constitution of the common Antarctic echinoid *Sterechinus neumayeri* (Meissner). *Biol Bull mar biol Lab, Woods Hole* **130**: 387-401.
- Pearse JS and Bosch I (1986)** Are the feeding larvae of the commonest Antarctic asteroid really demersal. *Bull Mar Sci* **39(2)**: 477-484.
- Pearse JS, McClintock JB and Bosch I (1991)** Reproduction of Antarctic benthic marine invertebrates: Tempos, modes and timing. *Amer Zool* **31**: 65-80.
- Pearse JS, Pearse VB and K.K. Davis KK (1986)** Photoperiodic regulation of gametogenesis and growth in the sea urchin *Strongylocentrotus purpuratus*. *J Exp Zool* **237**: 107-118.

- Pechenik JA (1987)** Environmental influences on larval survival and development, in *Reproduction of Marine Invertebrates*, Vol. IX, Giese AC and Pearse JS (eds), Academic Press, NY, 551-608.
- Peck LS (1993)** Larval development in the Antarctic nemertean *Parbolasia corrugatus* (Heteronemertea: Lineidae). *Marine Biology* **116**: 301-310.
- Peck LS and Holmes LJ (1989)** Seasonal and ontogenetic changes in tissue size in the antarctic brachiopod, *Liothyrella uva* (Broderip, 1833). *J Exp Mar Biol Ecol* **134**: 25-36.
- Peck LS and Bullough L (1993)** Growth and population structure in the infaunal bivalve *Yoldia eightsii* in relation to iceberg activity at Signy Island, Antarctica. *Mar Biol* **117**: 235-241.
- Peck LS and Robinson K (1994)** Pelagic larval development in the brooding Antarctic brachiopod *Liothyrella uva*. *Mar Biol* **120**: 279-286.
- Peck LS, Brockington S, Brey T (in press)** Growth and metabolism in the Antarctic brachiopod, *Liothyrella uva*. *Phil Trans Roy Soc B*.
- Picken GB (1980a)** *The nearshore prosobranch gastropod epifauna of Signy Island*. PhD thesis, University of Aberdeen, 148 pp.
- Picken GB (1980b)** The distribution, growth and reproduction of the antarctic limpet *Nacella (Patinigera) concinna* (Strebel, 1908). *J Exp Mar Biol Ecol* **42**: 71-85.
- Picken GB and Allen D (1983)** Unique spawning behaviour by the Antarctic limpet *Nacella (Patinigera) concinna* (Strebel, 1908). *J Exp Mar Biol Ecol* **71**: 283-287.
- Pisano E and Boyer M (1985)** Development pattern of an infralittoral bryozoan community in the western Mediterranean Sea. *Mar Ecol Prog Ser* **27**: 195-202.

- Pomerat CM and Reiner ER (1942)** The influence of surface angle and of light on the attachment of barnacles and their sedentary organisms. *Biol Bull* **82**: 14-25.
- Poulin E and Féral J-P (1996)** Why are there so many species of brooding antarctic echinoids? *Evolution* **50(2)**: 820-830.
- Powlik JJ, St. John MA and Blake RW (1991)** A retrospective of plankton pumping systems, with notes on the comparative efficiency of towed nets. *J Plankt Res* **13(5)**: 901-912.
- Precht H, Christophersen J, Hensel H and Larcher W (1973)** *Temperature and Life*. Springer-Verlag Press, Berlin, 779 pp.
- Price PW (1977)** General concepts on the evolutionary biology of parasites. *Evolution* **31**: 405-420.
- Pridde J, Heywood RB, Theriot E (1986)** Some environmental factors influencing phytoplankton in the Southern Ocean around South Georgia. *Polar Biol* **5(2)**: 65-79.
- Rauschert M (1991)** Ergebnisse der faunistischen Arbeiten im Benthos von King George Island (Südshetlandinseln, Antarktis). *Berichte zur Polarforschung* **76**: 1-75.
- Reid DG (1989)** The comparative morphology, phylogeny and evolution of the gastropod family Littorinidae. *Phil Trans R. Soc B* **324**: 1-110.
- Richardson MG (1979)** The ecology and reproduction of the brooding Antarctic bivalve *Lissarca miliaris*. *Br Antarct Surv Bull* **49**: 91-115.
- Rivkin RBI, Bosch I, Pearse JS, Lessard EJ (1986)** Bacterivory: A novel feeding mode for asteroid larvae. *Science* **233**: 1311-1314.

- Rogers AD, Clarke A, Peck LS (in press)** Population genetics of the Antarctic heteronemertean *Parbolasia corrugatus* (McIntosh 1876) from the South Orkney Islands. *Mar Biol*
- Ross RM, Quetin LB and Kirsch E (1988)** Effect of temperature on developmental times and survival of early larval stages of *Euphausia superba* Dana. *J Exp Mar Biol Ecol* **121**: 55-71.
- Roughgarden J, Gaines S, Possingham H (1988)** Recruitment dynamics in complex life cycles. *Science*. **241**: 1460-1466.
- Ryland JS (1959)** Experiments on the selection of algal substrates by polyzoan larvae. *J Exp Biol* **36**: 613-631.
- Sammarco PW (1994)** Larval dispersal and recruitment processes in Great Barrier Reef corals: analysis and synthesis. In: *The bio-physics of marine larval dispersal* Sammarco PW and Heron ML (Eds) AGU Press. Washington, 35-72.
- Sars M (1844)** Über die Entwicklung der Seesterne: Fragment aus meinen 'Beiträgen zur Fauna von Norwegen.' *Arch Naturgesch* **10**: 169-178.
- Scheltema RS (1971)** The dispersal of larvae of shoal-water benthic invertebrate species over long distances by ocean currents. In: *Fourth European Marine Biology Symposium*. Crisp D (Ed), Cambridge University Press, 7-28.
- Scheltema RS (1986a)** Long-distance dispersal by planktonic larvae of shoal-water benthic invertebrates among central pacific islands. *Bull Mar Sci* **39**: 241-256.
- Scheltema RS (1986b)** On dispersal and planktonic larvae of benthic invertebrates: an eclectic overview and summary of problems. *Bull Mar Sci* **39**: 290-322.

Shabica SV (1971) The general ecology of the Antarctic limpet *Patinigera polaris*. *Antarct J US* **6(5)**: 160-162.

Shabica SV (1974) Reproductive biology of the brooding antarctic lamellibranch *Kidderia subquadratum* Pelseneer. MSc Thesis, Oregon State University, USA.

Shabica SV (1976) The natural history of the Antarctic limpet *Patinigera polaris* (Hombron & Jacquinot). *PhD Thesis*, Oregon State University, USA.

Shilling FM and Manahan DT (1994) Energy metabolism and amino acid transport during early development of antarctic and temperate echinoderms. *Biol Bull* **187(3)**: 398-407.

Shreeve RS and Peck LS (1995) Distribution of pelagic larvae of benthic marine invertebrates in the Bellinghausen Sea. *Polar Biol* **15**: 369-374.

Siferd TD and Conover RJ (1992) An opening-closing plankton net for horizontal sampling through polar sea-ice. *Sarsia* **76**: 273-277.

Smith RIL (1988) Destruction of antarctic terrestrial ecosystems by a rapidly increasing fur seal population. *Biol. Conserv* **45**: 55-72.

Sokal RR and Rohlf FJ (1981) *Biometry*. 2nd Ed. Freeman. Oxford. 859 pp.

Srikrishnadhas B, Sundararaj V and Ramamoorthi K (1993) Zooplankton of the Porto Novo coastal zone with special reference to invertebrate larvae. *J Mar Biol Ass India* **35(1-20)**: 141-144.

Stanwell Smith D, Hood A and Peck LS (1997) *A field guide to the pelagic invertebrate larvae of the maritime antarctic*. British Antarctic Survey Press, Cambridge, 162 pp.

Starr M, Himmelmann JH and Therriault J-C (1990) Direct coupling of marine invertebrate spawning with phytoplankton blooms. *Science*. **247**: 1071-1074.

- Stone CJ (1984)** *Studies on the Dendrogastridae (crustacea: asgothoracida)*. MSc Thesis, University of Wales, 205 pp.
- Strathmann MF (1987)** *Reproduction and Development of Marine Invertebrates of the Northern Pacific Coast*. University of Washington Press, Seattle, 670 pp.
- Strathmann RR (1974)** The spread of sibling larvae of sedentary marine invertebrates. *Ann Nat.* **108**: 29-44.
- Strathmann RR (1980)** Why does a larva swim so long? *Paleobiology* **6(4)**: 373-376.
- Strathmann RR (1985)** Feeding and non-feeding larval development and life-history evolution in marine-invertebrates. *Ann Rev Ecol Syst* **16**: 339-361.
- Sutherland WJ (1996)** *Ecological census techniques*. Cambridge University Press. 336pp.
- Taylor RB, Blackburn RI and Evans JH (1995)** A portable battery-powered suction device for the quantitative sampling of small benthic invertebrates. *J Exp Mar Biol Ecol* **194**: 1-7.
- Thomson CW (1878)** Notice of some peculiarities on the mode of propagation of certain echinoderms of Southern seas. *J Linnean Soc Zool* **13**: 55-79.
- Thompson JV (1828)** On the metamorphoses of the crustacea, and on zoea, exposing their singular structure, and demonstrating that they are not, as has been supposed, a peculiar genus, but the larva of crustacea!! Zoological researches and illustrations; or natural history of nondescript or imperfectly known animals, *Memoir* **1**: 1-11.
- Thompson JV (1830)** On the cirripedes or barnacles; demonstrating their deceptive character; the extraordinary metamorphosis they undergo, and the class of animals to which they indisputably belong. *Zoological Research, Memoir* **IV**: 69-88.

- Thorson G (1936)** The larval development, growth, and metabolism of arctic marine bottom invertebrates compared with those of other seas. *Meddelelser om Grønland*; **100**:1-155.
- Thorson G (1946)** Reproduction and larval development of Danish marine bottom invertebrates, with special reference to the planktonic larvae in the sound (Øresund). *Meddr Danm Fisk og Havunders Ser Plankton* **4**: 1-523.
- Thorson G (1950)** Reproductive and larval ecology of marine bottom invertebrates. *Biol Rev* **25**: 1-45.
- Thorson G (1957)** Bottom Communities (sublittoral or shallow shelf). In: *Treatise on Marine Ecology and Paleoecology*, Hedgpeth JW(Ed), Geol. Soc. of America, pp. 461-534.
- Todd CD and Doyle RW (1981)** Reproductive strategies of marine benthic invertebrates: a settlement-timing hypothesis. *Mar Ecol Prog Ser* **4**: 75-83.
- Todd CD and Turner SJ (1986)** Ecology of intertidal and sublittoral cryptic epifaunal assemblages: I. Experimental rationale and the analysis of larval settlement. *J Exp Mar Biol Ecol* **99**: 199-231.
- Tranter DJ and Heron AC (1967)** Experiments on filtration in plankton nets. *Aust J Mar Freshwat Res* **18**: 89-111.
- Treguer P and Jacques G (1992)** Dynamics of nutrients and phytoplankton, and fluxes of carbon, nitrogen and silicon in the Antarctic Ocean. *Polar Biol* **12(2)**: 149-162.
- Turner SJ and Todd CD 1993** The early development of epifaunal assemblages on artificial substrata at two intertidal sites on an exposed rocky shore in St. Andrews Bay, N.E. Scotland. *J Exp Mar Biol Ecol* **166**: 251-272.

- Underwood AJ and Denley EJ, 1984.** Paradigms, explanations and generalizations in models for the structure of intertidal communities on rocky shores. In: *Ecological Communities: Conceptual Issues and the Evidence*. Strong DR et al (eds), Princeton University Press, Princeton, pp. 151-180.
- Vance R (1973)** On reproductive strategies in marine benthic invertebrates. *Am Nat* **107**: 339-352.
- Vermeij GJ (1991)** Anatomy of an invasion - The trans-arctic interchange. *Paleobiology*. **17(3)**: 281-307.
- Vogel S (1994)** *Life in moving fluids* (2nd Ed). Princeton University Press, New Jersey. 467 pp.
- Wagin VL (1948)** On the types of larval development in the Dendrogasteridae (ascothoracida, entomostraca). *Dokl Akad Nauk SSSR* **59**: 387-390 (in Russian).
- Wagin VL (1954)** On the structure, larval development and metamorphosis of dendrogastriids (parasitic crustaceans of the order ascothoracida). *Uch Zap Leningr Gos Univ Ser Biol Nauk* **172(35)**: 42-89 (in Russian).
- Walker AJM (1972)** Introduction to the ecology of the Antarctic limpet *Patiginera polaris* (Hombron & Jacquinot) at Signy Island, South Orkney Islands. *Br Antarct Surv Bull* **28**: 49-71.
- Waren A (1981)** *Ctensculum hawaiiense* Heath, an ascothoracican (cirripedia) described as a mollusc. *Crustaceana* **40(3)**: 310-313.
- Webber HH (1977)** Gastropoda: Prosobranchia. In: *Reproduction of Marine Invertebrates IV*, Giese AC and Pearse JS (eds), Academic Press, London, 1-97.

- White MG (1995)** Scientific diving by the British Antarctic Survey: 1962-1995. In: *Diving for Science - 1995*. Harper DE (ed), *Proc American Acad Underwater Sci* **15**: 137-144.
- White MG and Robins MW (1972)** Biomass estimates from Borge Bay, Signy Island, South Orkney Islands. *Bull Br Antarct Surv* **31**: 45-50.
- Whitaker TM (1982)** Primary production of phytoplankton off Signy Island, South Orkneys, the Antarctic. *Proc R. Soc Lond B* **214**: 169-189.
- Wickstead JH (1958)** A survey of the larger zooplankton of Singapore Straits. *J Conseil Int Explor de la Mer* **23(3)**: 340-353.
- Willis BL and Oliver JK (1990)** A review of methods for labelling and tracking marine invertebrate larvae. *Ophelia* **32(1-2)**: 145-162.
- Wisely B (1960)** Observations on the settling behaviour of larvae of the tube-worm *Spirorbis borealis* Daudin (Polychaeta). *Aust J Mar Freshwat Res.* **11**: 55-72.
- Withers RG and Thorp CH (1977)** Studies on the shallow sublittoral epibenthos of Langstone harbour, Hampshire, using settlement panels. In: *Biology of benthic organisms, Proc 10th Mar Biol Symp*, Keegan BF, O'Ceidigh P and Boaden PJ (eds), Pergamon Press, Oxford, 595-604.
- Young CM (1986)** Direct observations of field swimming behaviour in larvae of the colonial ascidian *Ecteinascidia turbinata*. *Bull-Mar-Sci* **39**: 279-289.
- Young CM (1990)** Larval Ecology of marine invertebrates: a sesquicentennial history. *Ophelia* **32(1-2)**: 1-48.

Young CM and Chia FS (1987) Abundance and distribution of pelagic larvae as influenced by predation, behaviour, and hydrographic factors. In: *Reproduction of marine invertebrates, Vol XI general aspects: Seeking unity in diversity*. Giese A, Pearse JS and Pearse VB (Eds) Boxwood Press, California. 385-463.

Young CM, Tyler PA, Cameron JL and Rumrill SG (1992) Seasonal breeding aggregations in low-density populations of the bathyal echinoid *stylocidaris lineata*. *Mar Biol* 113: 603-612.

Appendix

The results from the larval survey and settlement experiment have been compiled for future work / re-analysis.

Larval survey key [a: absolute value, r: rank (see below), c: count]

Nominal abundance ranks	0:	None present	3:	Frequent (occur in every field-of-view)
	1:	Occasional (1 to 5 indivs)	4:	Common (several in every field-of-view)
	2:	Several	5:	Abundant (hundreds to thousands)
			6:	Very abundant

Ref	a	Reference number for sample	D1	r	<i>Thalassiosira sp.</i>
Date	a	Date of sample	D2	r	<i>Chaetoceros sp.</i>
VZ	a	Diving visibility (in m)	D3	r	<i>Corethron criophilum</i>
Tow	-	Tow type (0: Surface, 1: Benthic, 2: Midwater)	D4	r	<i>Coscinodiscus sp.</i>
Ice	a	Ice thickness (in cm), if present	D5	r	<i>Odontella weissfloggi</i>
Dv	-	Diver accompanying Author	D6	r	<i>Actinoptychus sp.</i>
		1:Rob Wood, 2:Simon Brockington	D7	r	<i>Asteromphalus roperianus</i>
		3:Patty Brouwer, 5:David Barnes	D8	r	<i>Tricornis sp.</i>
		6:Luke Bullough, 7:Russ Manning	D9	r	<i>Porosira sp.</i>
		8:Lloyd Peck			
D	a	Depth of sample	FA	r	Filamentous algae
Dis	a	Distance of tow	CO	r	Copepods
Vol	a	Volume of seawater sampled (in litres)	CM	r	Copepods with eggs
%E	a	Percent filtration efficiency	CE	r	Copepod eggmasses
WT	a	Water temperature (°C)	AM	r	Amphipods
AT	a	Air temperature (°C)	AE	r	Amphipods with eggs
WD	a	Wind direction (Bearing in degrees)	CN	r	Crustacean nauplii
WS	a	Wind speed (in knots)	FH	r	Fur seal hairs
MC	a	Microplankton chlorophyll (20µm+), µg.l ⁻¹	T	r	Tintinnids
MP	a	Microplankton phaeo, µg.l ⁻¹	EB	r	Echinoderm blastulae
NC	a	Nanoplankton chlorophyll (2-20µm), µg.l ⁻¹	UM	r	Unknown eggmasses
NP	a	Nanoplankton phaeo, µg.l ⁻¹	UE	r	Unknown embryos
PC	a	Picoplankton chlorophyll (0.2-2µm), µg.l ⁻¹			
PP	a	Picoplankton phaeo, µg.l ⁻¹			
L1	c	annelid trochophores	L11	c	Bivalve veligers
L2	c	Molluscan trochophores	L12	c	Cirripede cyprids
L3	c	Unknown trochophores	L13	c	Annelid nectochaetes
L4	c	Nemertean pilidia	L14	c	Annelid metatrochophores
L5	c	Planulae	L15	c	Annelid larvae
L6	c	Echinoderm gastrulae	L16	c	Tunicate tadpoles
L7	c	Echinoderm bipinnaria	L17	c	Bryozoan cyphonautes
L8	c	Echinoid plutei	L18	c	Sipunculid pelagosphaerae
L9	c	Holothurian pentaculæ	L19	c	Brachiopod larvae
L10	c	Gastropod veligers	L20	c	Other unknown larvae
TOT	c	Total of larval numbers			

BEST COPY AVAILABLE

VERY SMALL PRINT

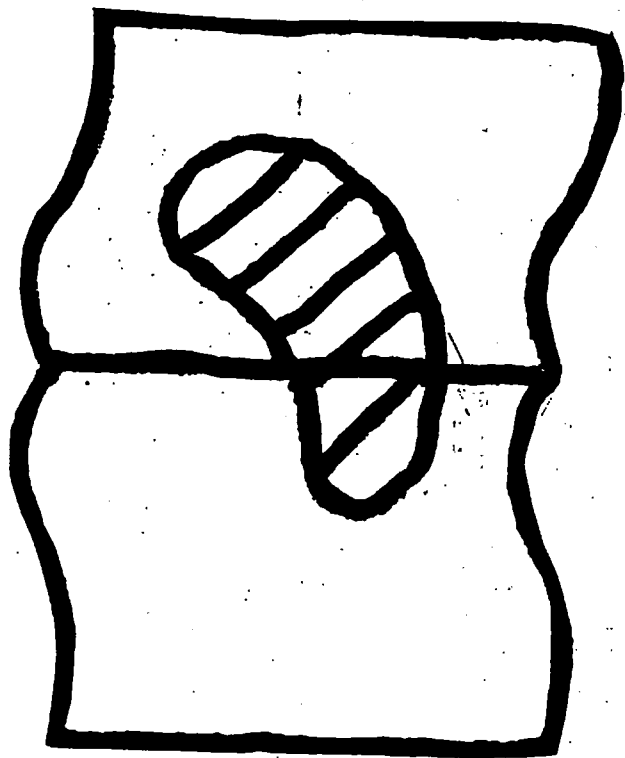

Site 1: PORNY ROCK (6m DEPTH)

Ref	Date	VZ	T	Ice	Dv	D	Dis	Vol	%E	WT	AT	WD	WS	MC	MP	NC	NP	PC	PP
11	27/01/83	5	1	0	5	8	50.0			0.17	6.5	20	2		1.389	0.209	0.391	0.424	0.187
12	27/01/83	5	0	0	5	1	50.0			0.17	6.5	20	2		1.389	0.209	0.391	0.424	0.187
27	04/03/83	3	1	0	1	8	56.1	3880	28.4	0.45	1.8	300	22	3.911	1.389	0.209	0.391	0.424	0.187
28	04/03/83	3	0	0	1	1	54.9	5395	39.3	0.45	1.8	300	22	0.640	0.676	0.489	0.575	0.087	0.218
35	14/04/83	3	1	0	7	8	51.5	5000	38.8	0.10	-1.5	0	0	0.208	0.223	0.025	0.294	0.104	0.108
36	14/04/83	3	0	0	7	0.5	68.2	6888	40.5	0.10	-1.5	0	0	0.208	0.223	0.025	0.294	0.104	0.108
55	08/08/83	12	1	0	2	5	64.2	6250	38.9	-1.40	-12.5	240	5	0.243	0.159	0.137	0.148	0.105	0.033
56	08/08/83	12	0	0	2	0.5	60.1	7041	48.9	-1.40	-12.5	240	5	0.243	0.159	0.137	0.148	0.105	0.033
59	11/08/83	0	1	0	1	8	83.7	10995	48.9	-1.02	-5.2	300	12	0.143	0.048	0.118	0.054	0.112	0.044
60	11/08/83	0	0	0	1	0.5	46.9	6122	52.2	-1.02	-5.2	300	12	0.143	0.048	0.118	0.054	0.112	0.044
67	13/07/83	30	1	30	1	8	63.8	6008	37.7	-1.68	-1.7	300	32	0.041	0.031	0.065	0.074	0.034	0.013
68	13/07/83	30	0	30	1	0.5	54.5	4413	32.4	-1.68	-1.7	300	32	0.041	0.031	0.065	0.074	0.034	0.013
81	04/08/83	25	1	0	1	8	59.3	6888	48.4	-1.64	-0.4	330	18	0.039	0.025	0.063	0.610	0.034	0.015
82	04/08/83	25	0	0	1	0.5	43.2	4974	48.1	-1.64	-0.4	330	18	0.039	0.025	0.063	0.610	0.034	0.015
93	16/09/83	40	1	6	1	8	73.1	7538	41.3	-1.78	-23.3	150	2	0.061	0.025	0.103	0.068	0.043	0.028
94	16/09/83	40	0	6	1	0.3	39.1	4872	49.8	-1.78	-23.3	150	2	0.061	0.025	0.103	0.068	0.043	0.028
102	04/10/83	30	1	30	1	8	78.8	7283	37.9	-1.85	0.1	290	24	0.065	0.025	0.095	0.064	0.044	0.022
103	04/10/83	30	0	30	1	0.5	63.3	6020	38.0	-1.85	0.1	290	24	0.065	0.025	0.095	0.064	0.044	0.022
104	04/10/83	20	1	30	1	7	53.8	5038	37.6	-1.85	0.1	310	19	0.065	0.025	0.095	0.064	0.044	0.022
105	04/10/83	20	0	30	1	0.5	49.9	5370	43.0	-1.85	0.1	310	19	0.065	0.025	0.095	0.064	0.044	0.022
116	28/10/83	20	1	45	1	7	64.2	9630	45.7	-1.78	0.2	290	27	0.073	0.021	0.136	0.081	0.060	0.021
117	28/10/83	20	0	45	1	0.6	53.9	6350	47.1	-1.78	0.2	290	27	0.073	0.021	0.136	0.081	0.060	0.021
128	03/12/83	8	1	0	1	6	40.9	7232	70.8	-1.14	2.2	200	3	0.411	0.228	0.187	0.145	0.057	0.030
129	03/12/83	8	0	0	1	0.5	34.1	5089	59.6	-1.14	2.2	200	3	0.411	0.228	0.187	0.145	0.057	0.030
142	03/01/84	2	1	0	1	7	47.4	3099	26.2	-0.36	0.0	210	11	11.157	6.080	0.410	0.529	0.080	0.138
143	03/01/84	2	0	0	1	0.5	24.7	3699	59.8	-0.36	0.0	210	11	11.157	6.080	0.410	0.529	0.080	0.138
152	03/02/84	4	1	0	1	8	41.0	3087	30.1	0.08	2.8	120	17	9.273	3.290	0.277	0.482	0.056	0.103
153	03/02/84	4	0	0	1	0.5	34.9	4400	50.4	0.08	2.8	120	17	9.273	3.290	0.277	0.482	0.056	0.103
168	14/03/84	2	1	0	1	8	50.6	3138	24.8	0.24	-0.3	250	9	2.127	2.101	0.608	1.463	0.083	0.246
169	14/03/84	2	0	0	1	0.5	36.8	4630	50.8	0.24	-0.3	250	9	2.127	2.101	0.608	1.463	0.083	0.246
176	08/04/84	8	1	0	1	7	46.9	4974	42.4	0.09	0.5	140	9	0.209	0.160	0.221	0.344	0.074	0.102
177	08/04/84	8	0	0	1	0.5	45.7	6543	57.3	0.09	0.5	140	9	0.209	0.160	0.221	0.344	0.074	0.102
183	10/05/84	15	1	0	1	7	56.1	5957	42.5	-0.88	-5.0	270	2	0.080	0.019	0.157	0.192	0.055	0.031
184	10/05/84	15	0	0	1	0.5	43.7	6928	63.4	-0.88	-5.0	270	2	0.080	0.019	0.157	0.192	0.055	0.031
208	07/08/84	25	1	8	1	8	56.1	7525	51.8	-1.78	-22.8	290	9	0.061	0.021	0.158	0.123	0.068	0.019
209	07/08/84	25	0	8	1	0.5	57.7	5497	38.1	-1.78	-22.8	290	9	0.061	0.021	0.158	0.123	0.068	0.019
219	03/07/84	20	1	10	1	8	55.3	5538	40.0	-1.55	-13.8	100	1	0.045	0.049	0.091	0.120	0.037	0.004
220	03/07/84	20	0	10	1	0.5	39.3	4222	42.9	-1.55	-13.8	100	1	0.045	0.049	0.091	0.120	0.037	0.004
231	01/08/84	35	1	40	1	8	58.5	7003	47.9	-1.88	-13.3	310	18	0.048	0.005	0.063	0.072	0.042	0.008
232	01/08/84	35	0	40	1	0.5	51.0	5880	48.1	-1.88	-13.3	310	18	0.048	0.005	0.063	0.072	0.042	0.008
248	05/08/84	1	1	0	1	7	45.6	5791	50.8	-1.77	-5.1	260	14	0.130	0.154	0.145	0.162	0.041	0.018
249	05/08/84	1	0	0	1	0.5	47.5	5829	49.1	-1.77	-5.1	260	14	0.130	0.154	0.145	0.162	0.041	0.018
268	05/10/84	20	1	0	1	7	46.5	6097	52.4	-1.87	-12.8	240	11						
269	05/10/84	20	0	0	1	0.5	50.7	7853	60.4	-1.87	-12.8	240	11						
278	09/11/84	15	1	8	1	8	50.2	5850	45.1	-1.66									
279	09/11/84	15	0	8	1	0.5	39.6	4209	42.5	-1.66									
290	05/12/84	5	1	0	1	6	39.9	2717	27.2	-0.60				5.008	2.354				
291	05/12/84	6	0	0	1	0.5	31.3	3673	47.0	-0.60				5.008	2.354				
302	05/01/85	1	1	0	1	6	45.2	1837	16.3	0.36	-1.9	280	6	11.022	6.250				
303	05/01/85	1	0	0	1	0.5	33.4	2360	28.2	0.36	-1.9	280	6	11.022	6.250				

Site 1: PORNY ROCK (6m DEPTH)

Ref	D1	D2	D3	D4	D5	D6	D7	D8	D9	FA	CO	CM	CE	AM	AE	CN	FH	T	EB	UM	UE	L1	L2	L3	L4
11													1								1	0	0	0	0
12																						0	0	0	0
27										5	6	4	1				5					0	0	0	0
28			4	1						1	4	1					2					0	0	0	0
35			4	1							6	2	4	5				1				0	0	0	0
36			4	1							4	2	3	5			4	4				0	0	0	0
55		3	4	4							3	1	3				2	3				0	0	0	0
56		3	3	1	1	2		1			4	1	1					1			3	0.71	0	0	0
59		1		3	1			1				3	3	4	4						1	0.455	0	0	0
60				3	1	3		2				5	5			4					1	1.633	0	0	1.633
67				3	4		1	2					1									0	0	0	0
68				3	1			1					4		1							0	0	0	0
81				1	1		1	1			4	3	1						1			0	0	0	1.452
82				1							4	3	4						1			0	0	0	0
93		3			1	3		1					3								1	1.99	0	0	0.663
94		3			3						1		4								1	1.026	0	0	3.079
102		1		1	2	1		1			1		3	1								0	0	0	2.746
103		3		1	1	2	1	1					5								2	0	0	0	0
104				1	1								4	1								0	0	0	0
105				1	1	1		1					6	1							1	0	0	0	0
116				1	4	1	1	1					5	4								0	0	0	0
117				1	3			2					4	1					1			0	0	0	0
128	4	4					4				2		3	1								0.691	0	0	0
129	1	2	1	2			4	1					3	2							3	0.983	0	0	0
142	5	4	2	2					2				4	3			4				5	0	0	0	0
143	5	4	2	1		3	3		4				4	3			5				4	0	0	0	0
152	4	3			2						3		3		1							0	1.62	0	0
153	4	3			2	2	3				2		2									0	0	0	0
168	2	3		2	3	3		3	1			3		4	2		3					0	0	0	0
169	1	2		2	2	1	3	3	1			2		4								0	0	0	0
176				1	1	2	3	1			3		3				3					0	0	0	0
177				1	1	3	3	1		1		3	1	3			3					0	0	0	0
193				2	2		2	2			4		2								2	0	0	0	0
194				1	1		1				6		1									0	0	0	0
206				1	1						6		2								1	0	0	0	0
209											6		1									0	0	0	0
219				1	2						2		2									0	0	0	0.903
220				1	1			1			5		1	1								1.2	0	0	0
231				2	2	1	1	2			3		2	1		2					1	0.714	0	0	0
232				1	1	1	1	1			3		2	1							1	0	0	0	0
248				1	2	2	1	1			2		3								2	0	0	0	0
249				1	1	3		1			3		1								2	0	0	0	0
268				2	1	1	1						2									0	0	0	0
269				1	1	1	1				1	1										0	0	0	0
278					1	2	1						4		2							0	0	0	0
279					1	1					1											22.57	0	0	0
290	5	4	4			3	4						2		2						2	0	0	0	0
291	5	4	3			2	4						2					2			2	0	0	0	0
302	6				2				4		3		4									0	16.33	0	0
303	6				3				4		4		3									2.119	0	0	0

Site 1: PORNY ROCK (6m DEPTH)

Ref	C	L5	L6	L7	L8	L9	L10	L11	L12	L13	L14	L15	L16	L17	L18	L19	L20	TOT
11	1.00	0	0	0	0	0	0	0	0	1	1	0	0	0	0	0	0	2
12	1.00	0	0	0	0	0	0	0	0	0	0	0	0	0	0	0	0	0
27	1.26	0	0	0	0	0	0	0	0	0	0	0	0	0	0	0	0	0
28	0.93	2.78	0	0	0	2.78	0	0	0	0.927	0	0	0	0	0	0	0	6.487
35	1.00	0	0	0	0	0	0	0	0	0	0	0	0	0	0	0	0	0
36	0.73	0.726	0	0	0	0	0	0	0	1.452	0	0	0	0	0	0	0	2.178
55	0.80	1.6	0	0	0	0	0	0	0	0	0	0	0	0	0	0	0	1.6
56	0.71	0	0	0	0	0	0	0	0	0	0	0	0	0	0	0	0	0.71
59	0.45	0	0	0	0	0	1.819	0	0	0	0	0	0	0	0	0	0	2.274
60	0.82	4.084	0	0	0	0	0	0	0	0	0	0	0	0	0	0	0	7.35
67	0.83	0.832	0	0	0	0	1.664	0	0	0	0	0	0	0	0	0	0	2.496
68	1.13	0	0	0	0	0	0	0	0	0	1.133	0	0	0	0	0	0	1.133
81	0.73	0	0	0	0	0	0	0.726	2.904	0	0	0	0	0	0	0	0	5.082
82	1.01	0	0	0	0	0	0	0	20.11	0	0	0	0	0	0	0	0	20.11
93	0.66	1.327	0	1.327	0	0	0	0	0.663	0	0	0	0	0	0	0	0	5.97
94	1.03	0	0	3.079	0	0	0	0	1.026	0	0	0	0	0	0	0	0	8.21
102	0.69	0	0	0.687	0	0	0.687	0	0.687	0	0	0	0	0	0	0	0	4.807
103	0.83	0	0	0	0	0	0	0	0.831	0	0	0	0	0	0	0	0	0.831
104	0.99	0.992	0	0	0	0	1.984	0	1.985	0	0	0	0	0	0	0	0	4.981
105	0.93	1.862	0	0.931	0	0	0	0	7.449	0	0	0	0	0	0	0	0	10.24
116	0.52	0.519	0	0	0	0	1.039	0	1.038	0	0	0	0	0	0	0	0	2.596
117	0.79	0	0	0	0	0	1.575	0	0	0	0	0	0	0	0	0	0	1.575
128	0.89	0.891	0	0	0	0	2.765	0	0	0	49.78	0	0	0	0	0	0	53.93
129	0.96	1.965	0	0	0	0	2.948	0	1.965	0	15.72	0	0	0	0	0	0	23.58
142	1.61	0	0	0	0	0	0	0	6.454	0	0	0	1.613	0	0	0	0	8.067
143	1.35	0	0	0	1.352	0	0	0	0	0	0	0	1.352	0	0	0	0	2.704
152	1.62	0	0	0	0	0	1.62	0	0	1.62	0	0	0	0	0	0	0	4.86
153	1.14	0	0	0	0	0	1.136	0	0	1.136	0	0	0	0	1.136	0	0	3.408
168	1.59	0	0	0	0	0	0	0	1.593	0	0	0	0	0	0	0	0	1.593
169	1.06	0	0	0	0	0	0	0	0	0	0	0	0	0	0	0	0	0
176	1.01	1.005	0	0	0	0	5.026	0	1.005	0	0	0	0	0	0	0	0	7.036
177	0.78	0	0	0	0	0	0.784	0	0	0	0	0	0	0	0	0	0	0.784
193	0.84	0	0	0	0	0	0.839	0	0	0	0	0	0	0	0	0	0	0.839
194	0.72	0	0	0	0	0	0	0	0	0	0	0	0	0	0	0	0	0
208	0.86	0	0	0	0	0	3.322	0	0	0	0	0	0	0	0	0	0	3.322
209	0.91	0.91	0	0	0	0	0.91	0	1.819	0	0	0	0	0	0	0	0	3.639
219	0.90	0	0	0	0	0	0.903	0	0	0	0	0	0	0	0	0	0	1.806
220	1.20	0	0	0	0	0	3.6	0	0	0	0	0	0	0	0	0	0	4.8
231	0.71	0	3.57	0	0	0	0.714	0	0	0	0	0	0	0	0	0	0	4.998
232	0.85	0	8.503	0	0	0	3.401	0	1.701	0	0	0	0	0	0	0	0	13.61
248	0.86	0	0	0	0	0	0	0	0.863	0	0	0	0	0	0	0	0	0.863
249	0.86	0	0.858	0	0	0	0	0	0	0	0	0	0	0	0	0	0	0.858
268	0.82	0	0	0	0	0	0	0	0	0	0	0	0	0	0	0	0	0
269	0.85	0	0	0	0	0	0.653	0	0	0	0	0	0	0	0	0	0	0.653
278	0.88	0	0	0	0	0	0.885	3.54	0	0	0	0	0	0	0	0	0	4.425
279	1.19	0	0	0	0	0	0	0	4.752	2.378	0	0	0	0	0	0	0	29.7
290	1.64	0	0	0	0	0	0	0	9.201	1.84	0	0	0	0	0	0	0	11.04
291	1.36	0	0	0	0	0	0	0	2.723	4.084	0	0	0	0	0	1.361	0	8.168
302	2.72	0	0	0	0	0	0	0	0	0	0	0	0	0	0	0	0	16.33
303	2.12	0	0	0	0	0	0	0	8.475	0	0	0	0	0	0	0	0	10.59

Site 2: BILLIES ROCK (14m DEPTH)

Ref	Date	VZ	T	I	Dv	D	Dls	Vol	%E	WT	AT	WD	WS	MC	MP	NC	NP	PC	PP
3	14/01/93	6	0	0	2	1	50.0			0.53	1.5	300	17	0.823	0.441	0.299	0.811	0.018	0.411
4	14/01/93	6	1	0	2	11	50.0			0.53	1.5	300	17	0.823	0.441	0.299	0.811	0.018	0.411
15	03/02/93	3	1	0	1	12	40.0			0.22	0.6	250	14	1.077	0.367	0.351	0.410	0.012	0.136
17	13/02/93	4	1	0	1	11	23.0	5855		0.50	1.8	300	21	1.905	0.698	0.283	0.383	0.004	0.089
18	13/02/93	4	0	0	1	1	20.0			0.50	1.8	300	21	1.905	0.698	0.283	0.383	0.004	0.089
25	04/03/93	3	1	0	1	10	74.0	4528	24.5	0.45	1.8	300	22	0.840	0.676	0.489	0.575	0.087	0.218
26	04/03/93	3	0	0	1	1	51.0	4515	35.5	0.45	1.8	300	22	0.840	0.676	0.489	0.575	0.087	0.218
31	29/03/93	6	1	0	1	10	64.5	6441	39.9	0.78	-1.3	290	24	0.307	0.395	0.510	0.534	0.051	0.205
32	29/03/93	6	0	0	1	1	40.4	5408	53.5	0.78	-1.3	290	24	0.307	0.395	0.510	0.534	0.051	0.205
39	26/04/93	10	1	0	1	9	82.1	8178	39.8	-0.20	-1.0	310	21	0.289	0.207	0.225	0.210	0.098	0.084
40	26/04/93	10	0	0	1	0.5	58.3	8046	41.5	-0.20	-1.0	310	21	0.289	0.207	0.225	0.210	0.098	0.084
45	19/05/93	6	1	0	3	12	53.5	5383	40.2	-0.82	1.3	300	24	0.235	0.098	0.146	0.110	0.019	0.028
46	19/05/93	6	0	0	3	0.5	41.6	4082	39.3	-0.82	1.3	300	24	0.235	0.098	0.146	0.110	0.019	0.028
51	02/06/93	6	1	0	2	14	75.6	7513	38.8	-0.83	-3.8	310	12	0.212	0.102	0.128	0.103	0.099	0.058
52	02/06/93	6	0	0	2	0.5	43.5	5434	50.0	-0.83	-3.8	310	12	0.212	0.102	0.128	0.103	0.099	0.058
57	10/06/93	20	1	5	3	10	63.8	6790	42.4	-1.40	-9.2	280	3	0.243	0.159	0.137	0.148	0.105	0.033
58	10/06/93	20	0	5	3	0.5	45.8	4643	40.6	-1.40	-9.2	280	3	0.243	0.159	0.137	0.148	0.105	0.033
63	10/07/93	30	0	35	1	0.5	68.6	6250	42.6	-1.80	-0.4	310	6	0.054	0.053	0.079	0.093	0.034	0.020
64	10/07/93	30	1	35	1	12	114.8	16492	57.5	-1.80	-0.4	310	6	0.054	0.053	0.079	0.093	0.034	0.020
73	24/07/93	35	1	30	1	11	68.0	6429	37.8	-1.84	-13.3	290	9	0.044	0.022	0.079	0.082	0.037	0.018
74	24/07/93	35	0	30	1	0.5	51.1	3827	29.9	-1.84	-13.3	290	9	0.044	0.022	0.079	0.082	0.037	0.018
85	20/08/93	20	0	0	1	10	52.7	7482	56.7	-1.83	-8.9	160	2	0.049	0.072	0.074	0.106	0.035	0.029
86	20/08/93	20	0	0	1	0.5	64.4	6722	41.8	-1.83	-8.9	160	2	0.049	0.072	0.074	0.106	0.035	0.029
89	14/09/93	20	1	0	1	11	48.5	5448	44.9	-1.78	-8.2	240	4	0.061	0.025	0.103	0.068	0.043	0.026
90	14/09/93	20	0	0	1	0.5	47.4	5357	45.2	-1.78	-8.2	240	4	0.061	0.025	0.103	0.068	0.043	0.026
100	30/09/93	25	1	25	3	11	42.8	5025	42.8	-1.84	-10.4	290	26	0.065	0.034	0.094	0.091	0.043	0.035
101	30/09/93	25	0	25	3	0.5	41.7	3610	41.7	-1.84	-10.4	290	26	0.065	0.034	0.094	0.091	0.043	0.035
108	09/10/93	20	1	35	1	14	87.4	8801	40.3	-1.78	3.8	320	12	0.072	0.020	0.088	0.050	0.039	0.023
109	09/10/93	20	0	35	1	0.5	55.0	5838	39.0	-1.78	3.8	320	12	0.072	0.020	0.088	0.050	0.039	0.023
114	25/10/93	20	1	40	1	12	75.4	8023	42.6	-1.78	-0.5	290	24	0.073	0.021	0.136	0.081	0.060	0.021
115	25/10/93	20	0	40	1	0.5	72.1	8929	49.5	-1.78	-0.5	290	24	0.073	0.021	0.136	0.081	0.060	0.021
126	02/12/93	10	1	0	8	11	73.9	9881	52.4	-1.14	5.4	130	9	0.411	0.228	0.187	0.145	0.057	0.030
127	02/12/93	10	0	0	8	0.5	80.3	7827	50.6	-1.14	5.4	130	9	0.411	0.228	0.187	0.145	0.057	0.030
136	18/12/93	3	1	0	1	12	55.1	2334	16.9	-0.56	-0.2	110	17	11.171	4.819	0.338	0.400	0.114	0.109
137	18/12/93	3	0	0	1	0.5	21.0	2105	38.3	-0.56	-0.2	110	17	11.171	4.819	0.338	0.400	0.114	0.109
144	07/01/94	5	1	0	1	14	76.8	3584	18.7	-0.36	5.2	290	17	11.157	8.080	0.410	0.529	0.080	0.138
145	07/01/94	5	0	0	1	0.5	38.1	4171	43.6	-0.36	5.2	290	17	11.157	8.080	0.410	0.529	0.080	0.138
154	04/02/94	5	1	0	1	13	58.8	3712	25.2	0.08	2.4	130	11	8.273	3.290	0.277	0.482	0.056	0.103
155	04/02/94	5	0	0	1	0.5	48.1	5025	43.6	0.08	2.4	130	11	8.273	3.290	0.277	0.482	0.056	0.103
160	17/02/94	6	1	0	1	16	47.4	3112	26.2	0.33	4.4	310	19	10.495	4.458	0.595	0.766	0.229	0.274
161	17/02/94	6	0	0	1	0.5	33.6	3810	42.9	0.33	4.4	310	19	10.495	4.458	0.595	0.766	0.229	0.274
164	04/03/94	5	1	0	2	13	48.0	3635	31.6	0.23	0.7	310	21	2.535	1.253	0.214	0.367	0.053	0.070
165	04/03/94	5	0	0	2	0.5	51.2	5408	42.2	0.23	0.7	310	21	2.535	1.253	0.214	0.367	0.053	0.070
178	09/04/94	9	1	0	1	11	60.9	7538	49.5	0.08	3.3	360	5	0.167	0.171	0.203	0.251	0.073	0.084
179	09/04/94	9	0	0	1	0.5	45.0	5714	50.8	0.08	3.3	360	5	0.167	0.171	0.203	0.251	0.073	0.084
182	22/04/94	12	1	0	1	13		7500	40.0	-0.47	-8.2	130	12	0.131	0.167	0.238	0.270	0.079	0.058
183	22/04/94	12	0	0	1	0.5	45.8	6365	55.6	-0.47	-8.2	130	12	0.131	0.167	0.238	0.270	0.079	0.058
191	07/05/94	15	1	10	1	12	70.6	7513	42.6	-0.88	-6.1	280	7	0.080	0.018	0.157	0.192	0.055	0.031
192	07/05/94	15	0	10	1	1	44.3	4823	44.5	-0.88	-6.1	280	7	0.080	0.018	0.157	0.192	0.055	0.031
202	25/05/94	20	1	5	1	12	75.9	9158	48.3	-1.36	-2.5	140	12	0.087	0.127	0.157	0.151	0.070	0.045
203	25/05/94	20	0	5	1	0.5	50.8	6263	49.3	-1.36	-2.5	140	12	0.087	0.127	0.157	0.151	0.070	0.045
206	08/06/94	30	1	10	1	12	41.3	4974	48.1	-1.78	-6.9	0	0	0.061	0.021	0.158	0.123	0.066	0.019
207	08/06/94	30	0	10	1	0.5	40.6	4719	46.5	-1.78	-6.9	0	0	0.061	0.021	0.158	0.123	0.066	0.019
214	27/06/94	20	0	0	1	0.5	58.7	5714	39.0	-1.70	-1.3	140	15	0.055	0.025	0.120	0.144	0.049	0.011
215	27/06/94	20	1	0	1	12	53.4	6378	47.8	-1.70	-1.3	140	15	0.055	0.025	0.120	0.144	0.049	0.011
223	16/07/94	30	1	30	1	12	43.0	5204	47.7	-1.70	-33.4	120	6	0.050	0.011	0.104	0.112	0.038	0.010
224	16/07/94	30	0	30	1	0.7	47.2	7959	67.4	-1.70	-33.4	120	6	0.050	0.011	0.104	0.112	0.038	0.010
229	29/07/94	35	1	45	1	11	78.5	7640	40.0	-1.88	-3.6	320	26	0.048	0.005	0.083	0.072	0.042	0.008
230	29/07/94	35	0	45	1	0.5	48.9	5587	45.7	-1.88	-3.6	320	26	0.048	0.005	0.083	0.072	0.042	0.008
240	18/08/94	35	1	50	1	12	44.5	5683	50.9	-1.83	2.3	300	22	0.048	0.002	0.078	0.048	0.031	0.000
241	18/08/94	35	0	50	1	1	47.3	5625	47.8	-1.83	2.3	300	22	0.048	0.002	0.078	0.048	0.031	0.000
246	27/08/94	25	1	45	1	11	43.7	5523	50.6	-1.83	-7.9	20	17	0.070	0.049	0.081	0.078	0.032	0.000
247	27/08/94	25	0	45	1	0.7	56.3	5906	41.9	-1.83	-7.9	20	17	0.070	0.049	0.081	0.078	0.032	0.000
252	18/09/94	3	1	0	1	12	38.6	4375	45.1	-1.66	-9.9	280	7						
253	18/09/94	3	1	0	1	12	57.7	7349	51.0	-1.66	-9.9	280	7						
254	18/09/94	3	1	0	1	12	73.0	6084	33.3	-1.66	-9.9	280	7						
255	18/09/94	3	0	0	1	0.5	42.8	5693	53.0	-1.66	-9.9	280	7						
256	18/09/94	3	0	0	1	0.5	51.9	6020	48.4	-1.66	-9.9	280	7						
257	18/09/94	3	0	0	1	0.5	59.3	7584	51.0	-1.66	-9.9	280	7						
264	01/10/94	6	1	0	1	12	57.4	5804	42.4	-1.87	-10.1	280	18						
265	01/10/94	6	0	0	1	0.5	52.3	7194	55.0	-1.87									

Site 2: Billa Rocks (14m DEPTH)

Ref	D1	D2	D3	D4	D5	D6	D7	D8	D9	FA	CO	CM	CE	AM	AE	CN	FH	T	EB	UM	UE	L1	L2	L3	L4		
3																						0	0	0	0		
4	1	1																				0	0	0	0		
15																						0	0	0	0		
17																						0	0	0	0		
18																						0	0	0	0		
25														3			1					0	0	0	0		
26																						0	0	0	0		
31																						0	0	0	0		
32																						0	0	0	0		
39			1		1						4	4	1	5				1				3	0	0	0		
40				1									1	2								4	0	0	0		
45	3		1	1							2	1		1								2.787	0	0	0		
48				1							4		1									0	0	0	1.225		
51	3		1	1	1		1							4				4			2	0.666	0	0	0		
52	3	1	2	1										1				4			1	3.68	0	0	0		
57		3	1	1		3								1	1	4		3			1	0	0	0	0		
58	4	3				1		1			1		1	1	2		1				1	0	0	0	0		
63				1										2								0	0	0	0		
64	1	1	1			1		1			3		2	1							1	0	0	0	0.303		
73							1				2			2		1		1				0	0	0	0		
74				1	1						3											1	0	0	0		
85	1					3						3		2				1				0	0	0	0.67		
86	3		1			1		1				4						1			1	0	0	0	0.744		
89			3	1	3	1		1						3	2							0	0	0	1.84		
90	4			1	1									3							1	0	0	0	0		
100			1	2	1						3			1	1						1	0	0	0	0		
101	3		1	1	1						2			1	1							0	0	0	0		
106			2	1	1		1							4	3	1						1.136	0	0	0	0	
109														4								0	0	0	0		
114				1	2	3	1	1						5	3							0	0	0	0		
115		1		1	1	1	1							3	1							0	0	0	0		
126	4	4		1	1	4	4			1				2	1						3	0	0	0	0.516		
127	3	5		1	3	4								1	3						3	0	0	0	0.311		
136	6	3				3	1							2	1			3				2.142	0	0	0	0	
137																						0	0	0	0		
144																						0	0	0	0		
145																						0	0	0	0		
154	4				1	3		1	1					2	1							0	0	0	0		
155	4		1	1	2	3		1	1	2				2		1					1	0	0	0	0		
160			1			3								3		1					2	0	0	0	0		
161					2	3				2				3							1	0	0	0	0		
164	2				1		1		1		3		3									0	0	0	0		
165	3					1		1		3		3		3				2				0	0	0	0		
176				2	2	3	1			3				2							1	0	0	0	0		
179		2		1		2	3	1		1	2			2							2	0	0	0	0		
182			1	1	2	2	1			2	2			2	1	1						3	0	0	0	0	
183					1	1				1	2			3	1							1	0	0	0	0	
191			2	2	1					5				2								0	0	0	0	0	
192			2		1	2				4				2								0	0	0	0	0	
202			1	1	1	2				1				2								0	0	0	0	0	
203			1	1	1	1				2				3								1	0	0	0	0	
206		2		1	1					2								1				2	0	0	0	0	
207			1	2	1					4				2				3				2	0	0	0	0	
214				1	1					4				1								3	0	0	0	0	
215		1		1	1					2												2	0	0	0	0	
223			1	2		1	1			1				1		1						2	0.961	0	0	0	0
224			2	1	1		1			4				1								2	0	0	0	1.256	
229			2	2		2	1			2				3								2	0	0	0	1.309	
230			1	1		1	1			4				1								1	0	0	0	0	
240			1			1				2				2	1							0.883	0	0	0	0	
241			1							2				2								0	0	0	0	0	
246			1	1										2								1	0.905	0	0	0	0
247			1											2					2			2	0	0	0	0	
252			2			2	1	2		5				2								1	0	0	0	0	
253			2			2	1	1		5				2	1							1	0	0	0	0.68	
254				1	2	2	1			5				2								2	0	0	0	0	
255		1		1	2	2	1			2				1								1	0	0	0	0.883	
256			1		2	2	2			2				2					2			1	0	0	0	0	
257			1		2	2	1			2				1								2	0	0	0	1.322	
264			1	1	1	2	2			5				1								0.861	0	0	0	0	
266			1		2	3	1			2				2	1							0	0	0	0	0	
272			1	1	2	1				1			1	2				1				1	0	0	0	0	
275			1	1	1					1				2								4	0	0	0	0	
274		1			2		1			2				2								3	0	0	0	0	
275			1		1	2	2	1		1	1			1								3	0	0	0	0.648	
282	2	2	2		1	1	1			1				2	1	1						2	0	0	0	0	
283	2	3	1		2	1		1	1					1	2	1		3				2	0	0	0	0	
286	5	2	3	2	1	3	3			2				2		1		3				2	1.273	0	0	0	0
287	5				3					2				3								2	0.942	0	0	0	0
296	6	6		2	1			3		4				2								3	0	2.096	0	0	0
297	6	6		3		3		3		3				1	1							2	0	6.759	0	0	0
300	6	5			2			4	2					4								0	0	0	0	0	
301	6	5			1			5	2					4								4.216	0	0	0	0	
306	6	4			2			5	2	3				3								5.092	0	0	0	0	
307	6	4		1	2			5	2	4				3								5.574	1.858	0	0	0	
308	6	4						5	2	3				4								0	1.815	0	0	0	
309	6	4						1	5	1	2			3								0	1.588	0	0	0	
310	6	5						4	1	3				4								0	0	0	0	0	
311	6	5						4	1	3																	

Site 2: Billie Rocks (14m DEPTH)

Ref	C	L5	L6	L7	L8	L9	L10	L11	L12	L13	L14	L15	L16	L17	L18	L19	L20	TOT
3	1.00	0	0	0	0	0	0	0	0	0	0	0	0	0	0	0	0	0
4	1.00	0	0	0	0	0	1	0	0	0	2	0	0	0	0	0	0	3
15	1.00	0	0	0	0	0	0	0	0	0	0	0	0	0	0	0	0	0
17	0.85	0	0	0	0	0	0	0	0	0	0	0	0	0	0	0	0	0
18	1.00	0	0	0	0	0	0	0	0	0	0	0	0	0	0	0	0	0
25	1.10	0	0	0	0	0	1.104	4.417	0	0	0	0	0	0	0	0	0	5.521
26	1.11	0	0	0	0	0	0	1.107	0	0	0	0	0	0	0	0	0	1.107
31	0.78	0	0	0	0	0	0	0	0	0	0	0	0	0	0	0	0	0
32	0.82	0	0	0	0	0	0	0	0	0	0	0	0	0	0	0	0	0
39	0.81	0	0	0	0	0	0	0.612	0	0	0.612	0	0	0	0	0	0	1.224
40	0.83	1.654	0	0	0	0	0.827	1.654	0	0	0	0	0	0	0	0	0	4.135
45	0.93	1.858	0	0	0	0	0.929	0	0	0	0.929	0.923	0	0	0	0	0	7.426
46	1.22	0	0	0	0	0	0	0	0	0	0	1.225	0	0	0	0	0	2.45
51	0.67	1.997	0	0	0	0	0	0	0	0	0	0	0	0	0	0	0	2.663
52	0.92	0	0	0	0	0	0	0	0	0	0	0	0	0	0	0	0	3.68
57	0.74	2.219	0	0	0	0	0	0	8.676	0	0	0	0.74	0	0	0	0	11.84
58	1.08	2.153	0	0	0	0	0	0	0	0	0	0	0	0	0	0	0	2.153
63	0.80	0	0.8	0	0	0	0	0	0	0	0	0	0	0	0	0	0	0.8
64	0.30	0	0	0	0	0	0	0	6.064	0	0	0	0	0	0	0	0	6.367
73	0.78	0	0	0	0	0	0	0	0.778	0	0	0	0	0	0	0	0	0.778
74	1.31	0	0	0	0	0	0	0	7.84	0	0	0	0	0	0	0	0	7.84
85	0.67	0	0	0	0	0	0	0	0	0	0	0	0	0	0	0	0.67	1.34
86	0.74	0	1.488	2.231	0	0	5.207	0	0.744	0	0	1.488	0	0	0	0	0	11.9
89	0.92	0	0	0	0	0	0	0.918	1.836	0	0	0	0	0	0	0	0	4.594
90	0.93	0	1.887	0.933	0	0	0	0.833	2.8	0	0	0	0	0	0	0	0	6.533
100	1.00	0.995	0	0	0	0	0	0	1.99	0.995	0	0	0	0	0	0	0	3.98
101	1.39	1.385	0	0	0	0	1.385	0	0	0	0	0	0	0	0	0	0	2.77
108	0.57	0	0	0	0	0	0	1.136	6.817	0	0	0	3.409	0	0	0	0	12.5
109	0.89	0	0	0	0	0	0.887	0	0.887	0	0	0	0	0	0	0	0	1.774
114	0.62	0	0	0	0	0	0	2.493	1.87	0	0	0	0	0	0	0	0	4.363
115	0.58	0	0	0	0	0	0	0	0	0	0	0	0	0	0	0	0	0
126	0.52	0	0	0	0	0	0.517	0	1.033	1.549	2.582	0	0	0	0	0	0	6.197
127	0.66	0	0	0	0	0	0	0	1.656	0	26.22	0	0	0	0	0	0	28.19
136	2.14	0	0	0	0	0	0	0	2.142	2.142	0	0	0	0	0	0	0	8.426
137	2.38	0	0	0	0	0	0	0	0	0	0	0	0	0	0	0	0	0
144	1.40	0	0	0	0	0	0	0	0	0	0	0	0	0	0	0	0	0
145	1.20	0	0	0	0	0	0	0	0	0	0	0	0	0	0	0	0	0
154	1.35	0	0	0	0	1.347	1.347	0	0	0	0	0	0	0	0	0	0	2.694
155	1.00	0	0	0	0	0.995	0	0.995	1.99	0	0	0	0	0	0	0	0	3.98
160	1.61	0	0	0	0	0	0	0	0	0	0	0	0	0	3.213	0	0	3.213
181	1.39	0	0	0	0	2.77	0	0	0	1.385	0	1.385	0	0	4.155	0	0	9.695
164	1.38	0	0	0	0	0	0	1.378	0	1.378	0	0	0	0	0	0	0	2.752
165	0.62	0	0	0	0	0.625	0	0	2.774	0.625	0	0	0	0	0	0	0	4.624
178	0.66	0	0	0	0	0	0.663	0	0	0	0	0	0	0	0	0	0	0.663
179	0.88	0	0	0	0	0	0	0	0.875	0	0	0	0	0	0	0	0	0.875
182	0.67	0	0	0	0	0	0.667	0	0	0	0	0	0	0	0	0	0	0.667
183	0.79	0	0	0	0	0	0	0	0.786	0	0	0	0	0	0.786	0	0	1.572
191	0.67	0	0	0	0	0	0	0	1.331	0	0	0	0	0	0	0	0	1.331
192	1.02	0	0	0	0	0	1.016	1.016	1.016	0	0	0	0	0	0	0	0	3.048
202	0.55	0	0	0	0	0	0	0	0	0	0	0	0	0	0	0	0	0
203	0.80	0	0	0	0	0	0.798	0	0	0	0	0	0	0	0	0	0	0.798
206	1.01	0	0	0	0	0	0	0	1.005	0	0	0	0	0	0	0	0	1.005
207	1.06	0	0	0	0	1.06	1.06	3.179	0	0	0	0	0	0	0	0	0	5.299
214	0.88	0	0	0	0	0	7	0	2.625	0	0	0	0	0	0	0	0	9.625
215	0.78	0	0	0	0	0	0	1.566	0.784	0	0	0	0	0	0	0	0	2.352
223	0.96	0	1.922	0	0	0	3.843	0	7.686	0	0	0	0	0	0	0	0	14.41
224	0.63	0	0.628	0	0	0	0	0.629	1.256	0	0	0	0	0	0	0	0	3.789
229	0.65	0	7.199	0	0	0	0	0	1.31	0	0	0	0	0	0	0	0	9.818
230	0.89	0	6.285	0	0	0	0	2.685	0	1.79	0	0	0	0	0	0	0	10.74
240	0.68	0	0	1.768	0	0	0	0	0	0	0	0	0	0	0	0	0	2.649
241	0.89	0	0	0	0	0	0	0.889	1.778	0	0	0	0	0	0	0	0	2.667
246	0.91	0	0	0	0	0	0	0	0	0	0	0	0	0	0	0	0	0.905
247	0.85	0	0	0	0	0	0	0	2.54	0	0	0	3.386	0	0	0	0	5.926
252	1.14	0	0	0	0	0	0	0	0	0	0	0	0	0	0	0	0	0
253	0.68	0	0	0	0	0	0	0	0	0	0	0	0	0	0	0.68	0	1.36
254	0.82	0	0	0	0	0	0	0.822	0	0	0.828	0	0	0	0	0	0	1.65
255	0.88	0	0	0	0	0	0	0	0	0	0	0	0	0	0	0	0	0.883
256	0.83	0	2.492	0	0	0	0	0	0.831	0	0	0	0	0	0	0	0	3.323
257	0.68	0	1.322	0.681	0	0	0	0	0	0	0	0	0	0	0	0	0	3.305
264	0.86	0	0	0	0	0	0	0	0	0	0	0	0	0	0	0	0	0.861
265	0.70	0.695	0	0	0	0	0	0	1.39	0	0	0	0	0	0	0	0	2.085
272	0.81	0	1.616	0	0	0	0	0	0	0	0	0	0	0	0	0	0	1.616
273	0.76	0	0	0	0	0	0	0.763	0	0	0	0	0	0	0	0	0	0.763
274	1.01	0	0	0	0	0	0	0	0	1.013	0	0	0	0	0	0	0	1.013
275	0.65	0	0	0	0	0	0	0	0	0	0	0	0	0	0	0	0	0.648
282	0.92	0	0	0	0	0	0	0	0	12.82	0	0	0	0	0	0	0	12.82
283	0.85	0	0	0	0	0	0	0	0	0.949	0	0	0	0	0	0	0	0.949
286	1.27	0	0	0	0	0	0	0	0	31.82	0	0	0	0	0	0	0	33.09
287	0.94	0	0	0	0	0	0	0	0	13.19	0	0	0	0	0	0	0	14.14
296	2.10	0	0	0	0	0	0	0	0	6.289	0	0	2.096	0	0	0	0	10.48
297	1.69	0	0	0	0	0	0	0	0	1.69	0	0	0	0	0	0	0	8.449
300	2.23	0	0	0	0	0	0	0	0	11.14	0	0	0	0	0	0	0	11.14
301	2.11	0	0	0	0	0	0	0	0	23.19	0	0	0	0	0	0	0	27.4
306	1.70	0	0	0	0	0	1.697	0	0	0	3.394	0	0	0	0	0	0	10.16
307	1.86	0	0	0	0	0	1.858	0	0	0	5.574	0	0	0	0	0	0	14.86
308	1.81	0	0	0	0	0	0	0	0	5.445	0	0	0	0	0	0	0	7.26
309	1.57	0	0	0	0	0	14.11	0	0	0	0	0	0	0	0	0	0	15.68
310	1.77	0	0	0	0	0	19.42	0	0	1.768	0	0	0	0	0	0	0	21.19
311	1.83	0	0	0	0	0	15.45	0	0	3.862	0	0	0	0	0	0	0	23.17

Site 3: BARE ROCK (9m DEPTH)

Ref	Date	VZ	T	Ice	Dv	D	Dis	Vol	%E	WT	AT	WD	WS	MC	MP	NC	NP	PC	PP
1	05/01/83	4	1	0	5	10	50.0			0.78	4.6	130	5	38.950	8.977	0.703	0.792	0.188	0.388
2	05/01/83	4	0	0	5	1	50.0			0.78	4.6	130	5	38.950	8.977	0.703	0.792	0.188	0.388
7	18/01/83	8	1	0	3	9	50.0			0.53	2.2	100	4	0.823	0.441	0.299	0.811	0.018	0.411
8	18/01/83	8	0	0	3	1	50.0			0.53	2.2	100	4	0.823	0.441	0.299	0.611	0.018	0.411
23	17/02/83	5	1	0	6	10		5676		0.55	2.4	95	5	2.130	1.093	0.370	0.689	0.072	0.267
24	17/02/83	5	0	0	6	1		6181		0.55	2.4	95	5	2.130	1.093	0.370	0.689	0.072	0.267
33	07/04/83	4	1	0	2	10	40.8	5168	50.5	-0.08	0.6	0	0	0.171	0.153	0.284	0.248	0.075	0.051
34	07/04/83	4	0	0	2	0.5	49.1	4311	35.0	-0.08	0.6	0	0	0.171	0.153	0.284	0.248	0.075	0.051
43	12/05/83	2	1	0	3	10	63.8	3852	24.2	-0.37	-9.5	250	5	0.272	0.171	0.174	0.148	0.083	0.020
44	12/05/83	2	0	0	3	0.5	49.2	4881	38.1	-0.37	-9.5	250	5	0.272	0.171	0.174	0.148	0.083	0.029
53	04/08/83	8	1	0	2	15	83.0	6178	51.9	-1.40	-11.8	240	7	0.243	0.159	0.137	0.148	0.105	0.033
54	04/08/83	8	0	0	2	0.5	58.8	7181	48.8	-1.40	-11.8	240	7	0.243	0.159	0.137	0.148	0.105	0.033
85	12/07/83	30	1	40	2	11	85.0	10089	47.5	-1.68	-1.9	290	23	0.041	0.031	0.065	0.074	0.034	0.013
86	12/07/83	30	0	40	2	0.5	51.8	2755	21.3	-1.68	-1.9	290	23	0.041	0.031	0.065	0.074	0.034	0.013
75	27/07/83	15	1	0	1	11	82.4	6462	41.8	-1.48	-5.3	290	15	0.045	0.029	0.079	0.072	0.035	0.012
76	27/07/83	15	0	0	1	0.5	56.4	6390	45.3	-1.48	-5.3	290	15	0.045	0.029	0.079	0.072	0.035	0.012
83	17/08/83	18	1	0	1	11	101.5	10408	41.0	-1.83	1.4	90	5	0.049	0.072	0.074	0.106	0.035	0.029
84	17/08/83	18	0	0	1	0.5	58.0	7768	55.5	-1.83	1.4	90	5	0.049	0.072	0.074	0.106	0.035	0.029
86	24/08/83	25	1	25	3	13	48.5	4911	40.5	-1.85	-14.9	280	9	0.046	0.032	0.103	0.085	0.048	0.033
89	24/08/83	25	0	25	3	0.4	33.2	3291	39.8	-1.85	-14.9	280	9	0.046	0.032	0.103	0.085	0.048	0.033
108	08/10/83	20	1	30	2	14	79.3	8635	43.8	-1.78	-2.2	310	21	0.072	0.020	0.088	0.050	0.039	0.023
107	08/10/83	20	0	30	2	0.5	49.4	6263	50.7	-1.78	-2.2	310	21	0.072	0.020	0.088	0.050	0.039	0.023
110	12/10/83	15	1	40	1	9	103	11820	44.9	-1.78	0.9	300	23	0.072	0.020	0.088	0.050	0.039	0.023
111	12/10/83	15	0	40	1	0.5	80.7	6110	40.3	-1.78	0.9	300	23	0.072	0.020	0.088	0.050	0.039	0.023
120	15/11/83	12	1	0	1	11	48.3	7334	60.7	-1.58	0.0	290	22	0.056	0.023	0.113	0.071	0.033	0.024
121	15/11/83	12	0	0	1	0.5	47.8	7436	62.3	-1.58	0.0	290	22	0.056	0.023	0.113	0.071	0.033	0.024
130	04/12/83	6	1	0	1	11	85.5	8559	40.1	-0.98	2.2	290	10	2.382	0.848	0.223	0.112	0.095	0.025
131	04/12/83	6	0	0	1	0.5	83.5	6888	43.4	-0.98	2.2	290	10	2.382	0.848	0.223	0.112	0.095	0.025
136	21/12/83	2	1	0	1	14	78.6	3699	18.8	-0.27	1.1	20	16	15.860	7.359	0.448	0.381	0.068	0.047
139	21/12/83	2	0	0	1	0.5	48.4	4222	34.2	-0.27	1.1	20	16	15.860	7.359	0.448	0.381	0.068	0.047
148	17/01/84	5	1	0	1	11	48.7	3533	29.0	0.34	1.1	220	10	10.387	3.891	0.510	0.748	0.144	0.192
149	17/01/84	5	0	0	1	0.5	44.0	3854	35.9	0.34	1.1	220	10	10.387	3.891	0.510	0.748	0.144	0.192
156	07/02/84	4	1	0	1	10	90.5	3839	17.0	0.08	2.9	320	18	10.248	4.118	0.304	0.577	0.083	0.127
157	07/02/84	4	0	0	1	0.5	32.1	3214	40.0	0.08	2.9	320	18	10.248	4.118	0.304	0.577	0.083	0.127
162	28/02/84	7	1	0	1	13	55.5	3520	25.4	0.31	0.3	280	17	7.186	2.996	0.310	0.550	0.058	0.130
163	28/02/84	7	0	0	1	0.5	30.8	4209	55.1	0.31	0.3	280	17	7.186	2.996	0.310	0.550	0.058	0.130
172	22/03/84	10	1	0	1	11	50.0	5000	40.0	0.24	4.5	190	5	2.127	2.101	0.608	1.483	0.093	0.248
173	22/03/84	10	0	0	1	0.5	45.0	5063	45.0	0.24	4.5	190	5	2.127	2.101	0.608	1.483	0.093	0.248
180	11/04/84	10	1	0	1	12	57.8	6480	44.8	-0.06	-2.8	290	6	0.167	0.171	0.203	0.251	0.073	0.084
181	11/04/84	10	0	0	1	0.5	56.6	7411	52.3	-0.06	-2.8	290	6	0.167	0.171	0.203	0.251	0.073	0.084
187	28/04/84	15	1	0	1	13	64.9	7168	44.2	-0.48	-5.4	280	9	0.086	0.075	0.191	0.178	0.081	0.034
188	28/04/84	15	0	0	1	0.5	48.0	6939	57.9	-0.48	-5.4	280	9	0.086	0.075	0.191	0.178	0.081	0.034
195	12/05/84	16	1	0	1	12	62.8	7474	47.8	-0.88	-4.8	290	20	0.080	0.019	0.157	0.192	0.055	0.031
196	12/05/84	16	0	0	1	0.5	42.3	7015	66.3	-0.88	-4.8	290	20	0.080	0.019	0.157	0.192	0.055	0.031
200	23/05/85	18	1	0	1	12	68.8	8023	48.2	-1.36	-5.5	270	8	0.087	0.127	0.157	0.151	0.070	0.045
201	23/05/85	18	0	0	1	0.5	57.9	7959	55.0	-1.36	-5.5	270	8	0.087	0.127	0.157	0.151	0.070	0.045
204	05/06/84	20	1	10	1	13	59.6	7895	42.2	-1.78	-14.3	240	6	0.061	0.021	0.158	0.123	0.088	0.019
205	05/06/84	20	0	10	1	1	45.7	5204	45.8	-1.78	-14.3	240	6	0.061	0.021	0.158	0.123	0.088	0.019
210	18/06/84	30	1	20	2	10	68.2	8285	48.5	-1.78	-16.8	250	9	0.054	0.023	0.123	0.125	0.065	0.016
211	18/06/84	30	0	20	2	0.5	45.8	5383	47.0	-1.78	-16.8	250	9	0.054	0.023	0.123	0.125	0.065	0.016
221	05/07/84	16	1	5	1	13	68.5	7321	44.1	-1.55	-8.3	280	3	0.045	0.049	0.091	0.120	0.037	0.004
222	05/07/84	16	0	5	1	0.5	41.8	5306	50.1	-1.55	-8.3	280	3	0.045	0.048	0.091	0.120	0.037	0.004
227	25/07/84	30	1	40	2	10	60.7	6088	40.0	-1.88	-34.5	130	5	0.048	0.005	0.083	0.072	0.042	0.008
228	25/07/84	30	0	40	2	0.5	41.7	4798	46.0	-1.88	-34.5	130	5	0.048	0.005	0.083	0.072	0.042	0.008
233	10/08/84	30	0	40	1	11	44.3	3321	30.0	-1.88	-11.8	300	21	0.044	0.001	0.071	0.063	0.036	0.000
234	10/08/84	30	1	40	1	0.7	52.7	5270	40.0	-1.88	-11.8	300	21	0.044	0.001	0.071	0.063	0.036	0.000
235	13/08/84	30	1	45	1	11	61.0	10650	69.9	-1.86	-6.0	310	12	0.044	0.001	0.071	0.063	0.036	0.000
236	13/08/84	30	0	45	1	0.7	45.4	3189	28.1	-1.86	-6.0	310	12	0.044	0.001	0.071	0.063	0.036	0.000
244	24/08/84	35	1	50	1	10	80.9	8482	42.0	-1.83	-9.0	170	4	0.070	0.049	0.081	0.078	0.032	0.000
245	24/08/84	35	0	50	1	1	43.2	4732	43.9	-1.83	-9.0	170	4	0.070	0.049	0.081	0.078	0.032	0.000
250	07/09/84	15	1	0	1	12	60.8	8329	54.8	-1.77	-9.7	210	5	0.130	0.154	0.145	0.182	0.041	0.018
251	07/09/84	15	0	0	1	1	68.3	7742	45.3	-1.77	-9.7	210	5	0.130	0.154	0.145	0.182	0.041	0.018
256	28/09/84	12	1	0	1	13	67.2	8081	48.0	-1.63	-2.3	270	11						
259	28/09/84	12	1	0	1	13	83.2	9882	47.9	-1.63	-2.3	270	11						
260	28/09/84	12	1	0	1	13	72.4	9082	50.1	-1.63	-2.3	270	11						
261	28/09/84	12	0	0	1	0.5	40.4	5842	57.8	-1.63	-2.3	270	11						
262	28/09/84	12	0	0	1	0.5	56.4	7525	53.3	-1.63	-2.3	270	11						
263	28/09/84	12	0	0	1	0.5	55.0	6824	49.8	-1.63	-2.3	270	11						
270	08/10/84	20	1	0	1	11	71.2	8444	47.4	-1.80	-0.5	300	19						
271	08/10/84	20	0	0	1	0.5	47.5	5689	47.9	-1.80	-0.5	300	19						
276	28/10/84	12	1	0	1	12	66.5	7449	44.8	-1.80	-3.8	130	10						

Site 3: Bare Rock (9m DEPTH)

Ref	D1	D2	D3	D4	D5	D6	D7	D8	D9	FA	CO	CM	CE	AM	AE	CN	FH	T	EB	U ₁	U ₂	U ₃	U ₄	L1	L2	L3	L4
1													1											0	0	0	0
2																								0	0	0	0
7														2										0	0	0	0
8										1				2										0	0	0	0
23																								0	0	0	0
24																								0	0	0	0
33		4	4								3		2										0	0	0	0	
34				1	3						3		1										0	0	0	0	
43				4	1	1						4	1	4							1	1	0	0	0	0	
44																							0	0	0	0	
53						3					4		1					4				2	0	0	0	0	
54						2					2							2				2	0	0	0	0	
65		3		1		2		1			1		3									2	0	0	0	0	
66		1		1	1	1	1				4						3					1	0	0	0	0	
75						3					3		2			2		1				2	0	0	0	0	
76						1					3		1			1						1	0	0	0	1.585	
83				1		3					4	1	4									4	0	0	0	0.48	
84		3		1		3					1		1					1				1	0	0	0	0	
88		1		1		3	2				1	1	1										0	0	0	0	
99														1									0	0	0	0	
106		1				1	2				1		1	1								1	0	0	0	0	
107		2		1	1	3	3				3											1	0	0	0	0	
110				1							1			4		1							0	0	0	0	
111				2				1						3									0	0	0	0.818	
120						1		1			1		1	2									0	0	0	0	
121		3			1	3	3	1			1		3									1	0	0	0	0.672	
130	4	5		3		4	4				2		3	3				3				2	1.168	0	0	0	
131	5	6		1		4	4						3					4				3	0.726	0	0	0	
138	6	5				3			2				2									3	0	0	0	0	
139	6	4						1	2				2					3				3	1.184	0	0	0	
146	5	5				3			2				2									1	0	0	0	0	
149	5	4				1	3				3		1									1	0	0	0	0	
156	3	2	1			1	3		2	1	3		2	1									0	0	0	0	
157	4	3				1	3		1	1	2		3										4.667	0	0	0	
162	3					1					3		1										0	0	0	0	
163	3	2				2					3		3										0	0	0	1.188	
172	2				2	3					3		3										0	0	0	0	
173	2				1	3				1	3		3			1	3						0	0	0	0	
180				1		2	3	2			3		1	2								2	0	0	0	0	
181	2		1	1		2	3			2	3		2	3			1					2	0	0	0	0	
187	1		1		2	2	2				2											3	0	0	0	0	
188	2		1		2	3					3						1					2	0	0	0	0.728	
195						2	2				3		3	1		2						2	0	0	0	0	
198				1	1	2	2			1	3		2			1						3	0	0	0	0	
200		1				2	2				1		2	1								2	0.623	0	0	0	
201		1		1		1	2	1		1	3		2									3	0	0	0	0	
204	2		1	1		1	1						2	2								3	0	0	0	0.633	
205	2		1			2	2				2		2	2									0.961	0	0	0	
210	1		1			2	1				2		1									4	0	0	0	0.605	
211			1			2	1				2		2									2	0	0	0	0	
221	1		1			1	1				2		2									2	0	0	0	0	
222	1		1			2	2				3											1	0	0	0	2.827	
227	1		1	1	1	1	1				3		2									2	0	0	0	0	
228			2			1	1	1			4		1									1	0	0	0	0	
233			2	1		1	1	1			4		3									1	0	0	0	0	
234			1	3			1	1			2		3									3	0	0	0	0	
235								1			2		2									3	0	0	0	0.469	
236				1							3		2									2	0	0	0	0	
244		1		1		1	1				1		1								2	2	0	0	0	0	
245						1					3		1								3	3	0	0	0	0	
250				1	1			3			3		2	1								2	0.6	0	0	1.201	
251				1		1		1			3		1									1	0	0	0	1.937	
258		1				2	2	1			1		2	1	1						1	2	0	0	0	0	
259		1		1		2	3	1			2		2	1	1						2	2	1.004	0	0	0.502	
260		1		1	1	3	2	1		1			2	1	1						1	2	0	0	0	0	
261		2				1	2	1					1										0	0	0	0	
262		2		1		1	2	1		1												1	0.664	0	0	0.664	
263		2		1		2	2	1		1												2	0	0	0	0	
270				1	2	2		1			5		3	1								1	0	0	0	0	
271				1		2		1			2										1	1	0	0	0	0	
276	2			1		2		1					1								1		0	0	0	0	
277	2	2	1			2		1					1										0	0	0	0	
284	3	2	2	1		2		2			1				2						2	1	0	0	0	0	
285	3	3	3		1	3	2				1										1	2	3	0	0	0	0
288	5	3	2			3	3	2			1		2		1							2	0	0	0	0	
289	5	3	1			3	3	1		1	1		1		1						3	1	0	0	0	0	
294	6	5	4			4	4	4			4		2								1	2	0	0	0	0	
295	6	6	3			3	4				4	2									3	3	0	0	0	0	
298	6	5				3	1				3		3									1	0	0	0	0	
299	6	5				4	1				4	1	4									1	0	0	0	0	
312	5	4				5	1				2		3										0	0	0	0	
313	5	4				5	1				2		2										0	0	0	0	
314	5	4		1	1					4	3		2			1							1.425	1.425	0	0	
315	5	4		1						4	3		2										0	3.004	0	0	
316	5	4								4	2		3										0	6.223	0	0	
317	5	4								4	3		3			1							0	1.531	0	0	

Site 3: Bare Rock (9m DEPTH)

Ref	C	L5	L6	L7	L8	L9	L10	L11	L12	L13	L14	L15	L16	L17	L18	L19	L20	TOT
1	0.20	0	0	0	0	0	0	0	0	0	0	0	0	0	0	0	0	0
2	0.20	0	0	0	0	0	0	0	0	0	0	0	0	0	0	0	0	0
7	0.20	0	0	0	0	0	0	0	0	1	0	0	0	0	0	0	0	1
8	0.20	0	0	0	0	0	0	0	0	0	0	0	0	0	0	0	0	0
23	0.18	0	0	0	0	0	0	0	0	0	0	0	0	0	0	0	0	0
24	0.18	0	0	0	0	0	0	0	0	0	0	0	0	0	0	0	0	0
33	0.19	0	0	0	0	0	0	0	0	0	0	0	0	0	0	0	0	0
34	0.23	0	0	0	0	0	0	0	1.18	0	0	0	0	0	0	0	1.18	2.32
43	0.26	0	0	0	0	0	0	0	0	0	0	0	0	0	0	0	0	0
44	0.21	0	0	0	0	0	0	0	0	0	0	0	0	0	0	0	0	0
53	0.12	1.835	0	0	0	0	0	0	0	0	0	0	0	0	0	0	0	1.835
54	0.14	0.696	0	0	0	0	0	0	0	0	0	0	0	0	0	0	0	0.696
65	0.10	0.496	0	0	0	0	0	0	2.478	0	0	0.496	0	0	0	0	0	3.47
66	0.36	0	0	0	0	0	0	0	5.445	0	0	0	1.815	0	0	0	0	7.26
75	0.15	0	12.32	0	0	0	0.77	0.77	0	0	0	0	0	0	0	0	0	13.66
76	0.16	0	8.607	2.347	0	0	0	0	0.782	0	0	0	0.782	0	0	0	0	14.08
83	0.10	0.48	4.325	0	0	0	0	0.961	0	0	0	0	0	0	0	0	0	6.246
84	0.13	0	5.793	4.506	0	0	0	2.575	0	0	0	0	0	0	0	0	0	12.87
98	0.20	0	0	0	0	0	0	0	11.2	0	0	0	0	0	0	0	0	11.2
99	0.30	0	0	0	0	0	0	0	0	0	0	0	0	0	0	0	0	0
106	0.12	0	0	0	0	0	0	0	0	0	0	0	0	0	0	0	0	0
107	0.18	0	0	1.597	0	0	0	0.799	0.799	0	0	0	0	0	0	0	0	3.185
110	0.09	0	0	0	0	0	1.721	0.43	0.861	0.43	0	0	0	0	0	0	0	3.442
111	0.16	0	0.818	0	0	0	2.455	1.636	2.455	1.64	0	0	0	0	0	0	0	9.822
120	0.14	0	0	0	0	0	0	0	0.682	0	0	0	0	0	0	0	0	0.682
121	0.13	0	0	0	0	0	0	0	0.672	1.345	0	0	0	0	0	0	0	2.689
130	0.12	0.584	0	0	0	0	0.584	0.584	0.584	2.337	1.168	0	0	0	0	0	0	7.009
131	0.15	0	0	0	0	0	0	0	0.726	1.45	4.355	0	0	0	0	0	1.452	6.709
138	0.27	0	0	0	0	0	0	0	0	1.35	0	0	0	0	0	0	0	1.35
139	0.24	0	0	0	0	0	2.369	0	0	3.551	0	0	5.921	0	0	0	2.369	15.39
148	0.28	0	0	0	0	0	0	0	0	2.83	0	0	0	0	0	0	0	2.83
149	0.25	0	0	0	0	0	0	0	0	3.794	0	0	0	0	0	0	0	3.794
156	0.28	0	0	0	0	0	0	0	0	6.512	7.815	0	0	0	3.907	0	0	18.23
157	0.31	0	0	0	0	0	0	0	3.111	3.111	1.556	1.556	0	0	0	0	0	14
162	0.28	0	0	0	0	0	0	0	0	0	0	0	0	0	0	0	0	0
163	0.24	0	0	0	0	1.188	0	0	0	1.188	1.188	0	0	0	0	0	0	4.752
172	0.20	0	0	0	0	0	3	0	0	1	0	0	0	0	0	0	0	5
173	0.20	0.968	0	0	0	0	0.968	0	0	0.968	1.975	0.968	0	0	0	0	0	5.927
180	0.15	0	0	0	0	0	0.772	0	1.543	0	0	0	0	0	0	0	0	2.315
181	0.13	0	0	0	0	0	0	0	1.349	0	0	0	0	0	0	0	0	1.349
187	0.14	2.79	0	0	0	0	2.083	0	0	0.696	0	0	0	0	0	0	0	5.581
188	0.14	0.721	0	0	0	0	0.721	0	0.721	0.721	0	0	0	0	0	0	0	3.61
195	0.13	0	0	0	0	0	1.338	0	0	0	0	0	0	0	0	0	0	1.338
196	0.14	0	0	0	0	0	0	0	0	0.713	0	0	0	0	0	0	0	0.713
200	0.12	0	0	0	0	0	3.118	0.623	0	0	0	0	0	0	0	0	0	4.362
201	0.13	0	0	0	0	0	0	0	0	0	0	0	0	0	0	0	0	0
204	0.13	0	0	0	0	0	0	0	0.633	0	0	0	0	1.267	0	0	0	2.533
205	0.19	1.822	0	0	0	0	1.822	0	0	0	0	0.961	0	0	0	0	0	5.766
210	0.12	0	0	0	0	0	1.21	0	0	0	0	0	0	0	0	0	0	1.815
211	0.19	0	0	0	0	0	0	0	0	0	0	0	0	0	0	0	0	0
221	0.14	0	1.366	0	0	0	4.781	0	0	0	0	0	0	0	0	0	0	6.147
222	0.19	0	0.942	0	0	0	0.942	0	0	0	0	0	0	0	0	0	0	4.711
227	0.18	0	2.473	0	0	0	2.473	0	0.824	0	0	0	0	0	0	0	0	5.77
228	0.21	0	4.71	0	0	0	3.128	0	0	0	0	0	0	0	0	0	0	7.838
233	0.30	0	10.54	0	0	0	3.011	0	0	3.011	0	0	0	0	0	0	0	16.56
234	0.19	0	0	0	0	0	1.898	0	0	0.949	0	0	0	0	0	0	0	2.847
235	0.09	0	0.469	0.939	0	0	0.939	0	0	0	0	0	0	0	0	0	0	2.818
236	0.31	0	0	0	0	0	0	0	0	0	0	0	0	0	0	0	0	0
244	0.12	0	0.589	0	0	0	0	0	0	0	0	0	0	0	0	0	0	0.589
245	0.21	0	0	1.057	0	1.057	2.113	0	0	0	0	0	0	0	0	0	0	4.227
250	0.12	0	1.201	2.401	0	0	1.201	0	1.201	0	0	0	0	0	0	0	3.001	10.81
251	0.13	0	3.875	1.262	0	0	3.229	0.646	0	0	0	0	0	0	0	0	2.583	13.56
258	0.12	0	1.241	0	0	0	0.62	0	0	1.241	0	0	0	0	0	0	0	3.102
259	0.10	0	0	0	0	0	0.502	0	0	0.502	0	0	0	0	0	0	0	2.51
260	0.11	0.551	0	0	0	0	1.101	0	0	0.551	0	0	0	0	0	0	0	2.203
261	0.17	0	0	0	0	0	0	0	0	1.712	0	0	0	0	0	0	0	1.712
262	0.13	0	0	0.664	0	0	0	0	0	1.329	0	0	0	0	0	0	0	3.321
263	0.15	0	0	0.732	0	0	0	0	0	0	0	0	0	0	0	0	0	0.732
270	0.12	0	0	0	0	0	0	0.592	2.369	0	0	0.592	0	0	0	0	0	3.553
271	0.18	0.879	0	0	0	0	0	0	4.394	0	0	0.879	0	0	0	0	0	6.152
276	0.13	0	0	0	0	0	0	0	0	0	0	0	0	0	0	0	0	0
277	0.11	1.084	0	0	0	0	0	0	0	0	0	0	0	0	0	0	0	1.084
284	0.13	0	0	0	0	0	0.648	0	0	0	0	0	0	0	0	0	0	0.648
285	0.22	0	0	0	0	0	0	0	0	0	0	0	0	0	0	0	0	0
289	0.18	0	0	0	0	0	0	0	1.806	9.935	0	0	0	0	0	0	0	11.74
289	0.28	0	0	0	0	0	0	0	5.522	0	0	0	0	0	0	0	0	5.522
294	0.21	0	0	0	0	0	0	0	0	0	0	0	0	0	0	0	0	0
295	0.29	0	0	0	0	0	0	0	0	1.446	0	0	0	0	0	0	0	1.446
298	0.38	0	0	0	0	0	0	0	0	44.2	0	0	0	0	0	0	0	44.2
299	0.33	0	0	0	0	0	0	0	0	14.7	0	0	1.633	0	0	0	0	16.33
312	0.31	0	0	0	0	0	0	0	0	16.78	0	0	0	0	0	0	0	16.78
313	0.30	0	0	0	0	0	0	0	0	4.524	1.506	0	0	0	0	0	0	6.032
314	0.29	1.425	0	0	0	0	0	0	0	4.276	1.425	0	0	0	0	0	0	9.976
315	0.30	0	0	0	0	0	0	0	0	1.502	0	0	0	0	0	0	0	4.506
316	0.31	3.111	0	0	0	0	0	0	0	0	0	0	0	0	0	0	0	9.334
317	0.31	0	0	0	0	0	0	0	0	0	0	0	0	0	0	0	0	1.531

Site 4: POLYNESIA POINT(10m DEPTH)

Ref	Date	VZ	T	Ice	Dv	D	Dis	Vol	%E	WT	AT	WD	WS	MC	MP	NC	NP	PC	PP
9	22/01/93	5	1	0	1	10	50.0			0.48	2.8	144	14	3.628	1.339	0.553	0.499	0.039	0.258
10	22/01/93	5	0	0	1	1	50.0			0.48	2.8	144	14	3.628	1.339	0.553	0.499	0.039	0.258
21	17/02/93	4	1	0	6	11		5625		0.55	2.4	200	8	2.130	1.093	0.370	0.689	0.072	0.267
22	17/02/93	4	0	0	6	1		5400		0.55	2.4	200	8	2.130	1.093	0.370	0.689	0.072	0.267
37	18/04/93	6	1	0	1	9	97.2	11390	48.0	-0.10	1.1	300	3	0.251	0.140	0.244	0.238	0.112	0.035
38	18/04/93	6	0	0	1	0.5	50.8	4413	34.7	-0.10	1.1	300	3	0.251	0.140	0.244	0.238	0.112	0.035
47	25/08/93	10	1	0	1	11	125.0	12933	41.4	-0.70	-6.3	310	7	0.236	0.103	0.137	0.124	0.098	0.022
48	25/08/93	10	0	0	1	0.5	47.0	4949	42.1	-0.70	-6.3	310	7	0.236	0.103	0.137	0.124	0.098	0.022
61	30/08/93	20	1	0	1	8	72.3	7679	42.5	-1.58	-2.7	120	19	0.108	0.017	0.125	0.058	0.062	0.013
62	30/08/93	20	0	0	1	0.5	42.4	4745	44.8	-1.58	-2.7	120	19	0.108	0.017	0.125	0.058	0.062	0.013
69	16/07/93	25	1	0	3	8	70.2	6760	38.5	-1.68	-3.4	310	14	0.041	0.031	0.065	0.074	0.034	0.013
70	16/07/93	25	0	0	3	0.5	39.3	4872	49.6	-1.68	-3.4	310	14	0.041	0.031	0.065	0.074	0.034	0.013
77	30/07/93	25	1	0	2	8	72.0	8214	45.1	-1.64	-3.6	290	22	0.039	0.025	0.063	0.061	0.034	0.015
78	30/07/93	25	0	0	2	0.5	48.3	5076	42.0	-1.64	-3.6	290	22	0.039	0.025	0.063	0.061	0.034	0.015
87	27/08/93	10	1	0	3	8	62.6	6939	44.4	-1.78	-4.6	310	12	0.038	0.021	0.079	0.095	0.040	0.012
88	27/08/93	10	0	0	3	0.5	40.5	4885	48.2	-1.78	-4.6	310	12	0.038	0.021	0.079	0.095	0.040	0.012
91	15/09/93	15	1	200	1	7	70.6	7691	43.6	-1.78	-11.3	110	8	0.061	0.025	0.103	0.068	0.043	0.026
92	15/09/93	15	0	200	1	2	51.7	6620	51.6	-1.78	-11.3	110	8	0.061	0.025	0.103	0.068	0.043	0.026
118	03/11/93	20	0	200	1	2	69.2	6811	39.4	-1.78	-3.4	140	21	0.108	0.074	0.119	0.082	0.038	0.028
119	03/11/93	20	1	200	1	8	80.0	8546	45.0	-1.78	-3.4	140	21	0.108	0.074	0.119	0.082	0.038	0.028
124	22/11/93	10	1	0	1	9	79.0	10803	54.7	-1.51	-0.5	140	21	0.093	0.077	0.176	0.113	0.058	0.033
125	22/11/93	10	0	0	1	0.5	74.2	10625	57.3	-1.51	-0.5	140	21	0.093	0.077	0.176	0.113	0.058	0.033
132	08/12/93	4	1	0	1	9	75.1	5217	27.8	-0.98	-0.5	270	7	2.382	0.848	0.223	0.112	0.095	0.025
133	08/12/93	4	0	0	1	0.5	44.1	5357	48.6	-0.98	-0.5	270	7	2.382	0.848	0.223	0.112	0.095	0.025
140	27/12/93	2	1	0	1	8	52.4	4694	35.6	-0.43	2.9	360	2	13.601	6.748	0.409	0.499	0.078	0.140
141	27/12/93	2	0	0	1	0.5	28.9	3673	50.9	-0.43	2.9	360	2	13.601	6.748	0.409	0.499	0.078	0.140
150	28/01/94	4	1	0	8	8	72.9	4949	27.2	0.07	3.5	70	4	11.395	6.894	0.421	0.599	0.096	0.194
151	28/01/94	4	0	0	8	0.5	74.0	5204	28.1	0.07	3.5	70	4	11.395	6.894	0.421	0.599	0.096	0.194
166	09/03/94	8	1	0	2	8	51.3	5408	42.2	0.23	3.9	300	15	2.535	1.253	0.214	0.367	0.053	0.070
167	09/03/94	8	0	0	2	0.5	43.7	5459	49.9	0.23	3.9	300	15	2.535	1.253	0.214	0.367	0.053	0.070
174	05/04/94	10	1	0	1	7	52.7	6339	48.2	0.09	3.1	280	15	0.209	0.160	0.221	0.344	0.074	0.102
175	05/04/94	10	0	0	1	0.5	39.7	5140	51.7	0.09	3.1	280	15	0.209	0.160	0.221	0.344	0.074	0.102
189	06/05/94	12	1	0	1	8	77.1	4962	25.7	-0.88	-6.6	320	5	0.060	0.019	0.157	0.182	0.055	0.031
190	06/05/94	12	0	0	1	0.5	35.3	4235	48.0	-0.88	-6.6	320	5	0.060	0.019	0.157	0.182	0.055	0.031
212	17/08/94	30	1	25	1	7	50.7	5523	43.6	-1.78	-23.5	0	0	0.054	0.023	0.123	0.125	0.055	0.016
213	17/08/94	30	0	25	1	0.5	47.5	5459	48.0	-1.78	-23.5	0	0	0.054	0.023	0.123	0.125	0.055	0.016
225	22/07/94	25	1	150	1	7	70.4	6161	35.0	-1.85	-22.9	0	0	0.048	0.009	0.093	0.094	0.038	0.004
228	22/07/94	25	0	150	1	2	39.6	4184	42.3	-1.85	-22.9	0	0	0.048	0.009	0.093	0.094	0.038	0.004
242	22/08/94	35	1	150	1	8	58.6	7143	48.8	-1.83	-5.4	80	7	0.048	0.002	0.076	0.048	0.031	0.000
243	22/08/94	35	0	150	1	2	69.1	6224	36.0	-1.83	-5.4	80	7	0.048	0.002	0.076	0.048	0.031	0.000
266	02/10/94	6	1	0	1	7	66.3	8342	50.3	-1.87	-11.7	240	8						
267	02/10/94	6	0	0	1	0.5	49.1	6900	56.2	-1.87	-11.7	240	8						
280	11/11/94	20	1	0	1	7	81.1	7296	47.8	-1.43				0.128	0.079	0.504	0.183	0.124	0.039
281	11/11/94	20	0	0	1	0.5	44.7	5812	50.2	-1.43				0.128	0.079	0.504	0.183	0.124	0.039
292	10/12/94	4	1	0	2	7	75.2	5791	30.8	-0.28	-6.0	50	13	8.865	2.350				
293	10/12/94	4	0	0	2	0.5	50.5	4541	40.0	-0.28	-6.0	50	13	8.865	2.350				
304	12/01/95	1	1	0	1	9	44.9	4082	36.4	0.83	4.0	300	14	12.568	6.323				
305	12/01/95	1	0	0	1	0.5	27.2	2500	36.8	0.38	4.0	300	14	12.568	6.323				

Site 4: Polynesia Point (10m DEPTH)

Ref	D1	D2	D3	D4	D5	D6	D7	D8	D9	FA	CO	CM	CE	AM	AE	CN	FH	T	EB	UM	UE	L1	L2	L3	L4	
9										6			4									0	0	0	0	
10																						0	0	0	0	
21	1	5	1										2									0	0	0	0.889	
22																						0	0	0	0	
37				1									2					5			1	0	0	0	0	
38		4		1									2	1				5				0	0	0	0	
47		1		1								4	4					1				0	0	0	0	
48		1										1	4					1				0	0	0	0	
61		1		1		1		1			1	1	2					1			1	0	0	0	0	
62						1					3											0	0	0	0	
69				2							3			3				1	3		3	0	0	0	0	
70		1	1	2		1								1			3	1	4		4	0	0	0	0	
77				1							4						1	1	1		2	0	0	0	0.609	
78				1		3					4							1	2		2	0	0	0	0	
87						3					6											0	0	0	0	
88		3		3		1					5	1						1				0	0	0	0	
91		3		1		3					1			1	1							0	0	0	0	
92				1		3					1			2							1	0	0	0	0	
118				1		3	3	1			1			6								0	0	0	0	
119		1		3		1	3	1			1										1	0	0	0	0	
124				1	1	4	4	1						4								0	0	0	0	
125				1	1	3	4														1	0	0	0	0	
132	5	4		2		4					1			2	1			4		1	1	2.875	0	0	0.958	
133	4	4		1										1	1			4			1	0.933	0	0	0.933	
140	6					4	4		3					3	2						1	0	0	0	0	
141	6	4		1		4	4		3					1							2	0	0	0	0	
150	5					2	3	2		1	1			2							1	0	0	0	0	
151	4					2	2		1	2	2			2							1	0	0	0	0	
168	4	3	2	1		2	1	2						3	1	2	1					0	0	0	0	
167	4		1	1		1	2	2		1				2		2						0	0	0	0	
174				1		2	3				3			2							3	0	0	0	0	
175				1		2	3				3			2							1	0	0	0	0	
189				1		1	2				5			3							2	0	0	0	0	
190				1		1	2				4			2							1	0	0	0	0	
212				2							4			2								3	0	0	0	1.811
213						2					4			3							2	1.832	0	0	5.496	
225				2		1					3			3								0.812	0	0	0	0
228							1				4			2								0	0	0	0	0
242				1							2			2							1	0	0	0	0	0
243				1							2			2							1	0	0	0	0	0
268						1	2			1				2								0	0	0	0	0.599
267						2	3	1						2								0	0	0	0	0.725
280		1		1		1		2						2	2							0	0	0	0	0.885
281				2		1	1	1						1								0	0	0	0	0
292	5	4	3			4	3		1		1			2	1	3		4				3	0.883	2.59	0	0
293		4	4			2	4		2							3		3				3	0	1.101	0	0
304	6	5							4					3								0	0	0	0	0
305	6	5							5	1				3							1	0	0	0	0	0

Site 4: Polynesia Point (10m DEPTH)

Ref	C	L5	L6	L7	L8	L9	L10	L11	L12	L13	L14	L15	L16	L17	L18	L19	L20	TOT
9	0.20	0	0	0	0	0	0	0	0	0	1	0	0	0	0	0	0	1
10	0.20	0	0	0	0	0	0	0	0	0	0	0	0	0	0	0	0	0
21	0.18	0.889	0	0	0	0	0.889	0	0	0.889	0	0	0	0	0	0	0	3.556
22	0.18	0	0	0	0	0	0	0	0	0	0	0	0	0	0	0	0	0
37	0.08	0.439	0	0	0	0	0	0	0	0	0	0	0	0	0	0	0	0.439
38	0.23	2.266	0	0	0	0	0	0	0	0	0	0	0	0	0	0	0	2.266
47	0.08	0.773	0	0	0	0	3.48	0	0	0	0	0	0	0	0	0	0	4.253
48	0.20	4.041	0	0	0	0	9.093	0	1.01	1.01	0	0	0	0	0	0	1.01	16.16
61	0.13	1.302	0	0	0	0	0	0	0	0	0	0	0	0	0	0	0	1.302
62	0.21	2.107	1.054	0	0	0	1.054	0	1.054	0	0	0	0	0	0	0	1.05	6.319
69	0.15	1.479	0.74	0	0	0	2.219	0	0.74	0	0	0	0	0	0	0	0	5.178
70	0.21	0	4.105	0	0	0	1.028	0	0	0	0	0	0	0	0	0	0	5.131
77	0.12	0.609	17.04	0	0	0	0.609	0	0	0	0	0	0	0	0	0	0	18.87
78	0.20	0	10.84	0	0	0	1.97	0	1.97	0	0	0	0	0	0	0	0	14.78
87	0.14	0	0.721	0	0	0	1.441	0	0	0	0	0	0	0	0	0	0	2.162
88	0.20	0	0	0	0	0	2.047	0	3.071	0	0	0	0	0	0	0	0	5.118
91	0.13	0	0	0	0	0	3.901	0	0.65	0	0	0	0	0	0	0	0	4.551
92	0.15	0	0	0.755	0	0	2.286	0	0	0	0	0	0	0	0	0	0	3.021
118	0.15	0	0	0	0	0	0.734	0	1.488	0	0	0	0	0	0	0	0	2.202
119	0.12	0	0	0	0	0	2.925	0	45.05	0	0	0	0	0	0	0	0	47.98
124	0.08	0.463	0	0	0	0.483	3.24	0	2.314	1.389	1.389	0.463	0	0	0	0.926	0	10.65
125	0.08	0	0	0	0	0	0.471	0	0	0	0	0	0	0	0	0	0	0.471
132	0.19	0	0	0	0	0	0.958	0	6.709	0	0.858	0.958	0	0	0	0	0	13.42
133	0.19	0.933	0	0	0	0	0	0	0.933	0	0	0	0	0	0	0	0	3.732
140	0.21	0	0	0	0	0	1.065	0	7.458	0	1.065	0	0	0	0	0	0	9.586
141	0.27	0	0	0	1.381	0	0	0	0	2.723	8.168	0	2.723	0	0	0	0	14.98
150	0.20	0	0	0	0	0	1.01	0	7.072	1.01	2.021	0	1.01	0	0	0	0	12.12
151	0.19	0.961	0	0	0	0	0	0	0.961	0.961	0	1.922	0	0	0	0	0	4.805
166	0.18	0	0	0	0	0	2.774	0.925	0.925	0.925	0	0	0	0	0	0	0	5.549
167	0.18	0	0	0	0	0	0	0	0.916	0	0	0	0	0	0	0	0	0.916
174	0.18	0.781	0	0	0	0	0.789	1.578	0	0	0	0.789	0	0	0	0	0	5.937
175	0.19	0	0	0	0	0	0.973	0	0	0	0	0	0	0	0	0	0	0.973
189	0.20	0	0	0	0	0	10.08	0	0	0	0	0	0	0	0	0	0	10.08
190	0.24	0	0	0	0	0	18.89	0	0	0	0	0	0	0	0	0	0	18.89
212	0.18	0	0	0	0	0	0.905	0	0	0	0	0	0	0	0	0	0	2.716
213	0.18	0	0	0	0	0	2.748	0	0.818	0	0	0	0	0	0	0	0	10.99
225	0.16	0.812	0.812	0	0	0	0	0	0.812	0	0	0	0	0	0	0	0	3.248
228	0.24	0	0	0	0	0	1.195	0	0	0	0	0	0	0	0	0	0	1.195
242	0.14	0	0	0	0	0	3.5	0	0.7	0	0	0	0	0	0	0	0	4.2
243	0.16	0	0	0	0	0	0	0	0	0	0	0	0	0	0	0	0	0
268	0.12	0	0.589	0	0	0	0.589	0	0	0	0	0	0	0	0	0	0	1.797
267	0.14	0.725	0	0.725	0	0	0.725	0	0	0	0	0	0	0	0	0	0	2.9
280	0.14	0	0	0	0	0	0	0	7.538	0	0	0	0	0	0	0	0	8.223
281	0.18	0	0	0	0	0	0	0	3.584	0	0	0	0	0	0	0	0	3.584
292	0.17	0	0	0	0	0	0.863	0	0	5.18	1.727	0	0.863	0	0	0	0	12.09
293	0.22	0	0	0	0	0	0	0	1.101	3.303	0	0	0	0	0	0	0	5.505
304	0.24	0	0	0	0	0	0	3.675	0	0	0	0	0	0	0	0	0	3.675
305	0.40	0	0	0	0	0	2	2	0	0	0	0	0	0	0	0	0	4

Site 6: OUTER ISLAND (28m DEPTH)

Ref	Date	VZ	T	Ice	Dv	D	Dts	Vol	%E	WT	AT	WD	WS	MC	MP	NC	NP	PC	PP
5	18/01/83	10	1	0	3	28	50.0			0.53	1.5	135	6	0.823	0.441	0.299	0.611	0.018	0.411
6	18/01/83	10	0	0	3	1	50.0			0.53	1.5	135	6	0.823	0.441	0.299	0.611	0.018	0.411
13	03/02/83	3	1	0	1	24	50.0			0.22	-0.1	230	5	1.077	0.367	0.351	0.410	0.012	0.163
14	03/02/83	3	0	0	1	1	50.0			0.22	-0.1	230	5	1.077	0.367	0.351	0.410	0.012	0.163
19	15/02/83	4	1	0	3	21		7040		0.50	0.0	140	5	1.905	0.666	0.283	0.383	0.004	0.089
20	15/02/83	4	0	0	3	1		1887		0.50	0.0	140	5	1.905	0.666	0.283	0.383	0.004	0.089
29	12/03/83	10	1	0	3	25	68.8	6888	39.8	0.78	-5.1	0	0	0.307	0.395	0.510	0.534	0.051	0.205
30	12/03/83	10	0	0	3	1	52.7	5308	40.2	0.78	-5.1	0	0	0.307	0.395	0.510	0.534	0.051	0.205
41	28/04/83	4	1	0	1	24	46.5	6543	56.3	-0.21	-8.2	260	9	0.289	0.207	0.225	0.210	0.098	0.064
42	28/04/83	4	0	0	1	1	56.0	5510	39.4	-0.21	-8.2	260	9	0.289	0.207	0.225	0.210	0.098	0.064
49	30/05/83	8	1	0	1	24	76.4	7398	38.7	-0.63	-9.6	250	12	0.212	0.102	0.128	0.103	0.099	0.058
50	30/05/83	8	0	0	1	0.5	60.1	6378	42.4	-0.63	-9.6	250	12	0.212	0.102	0.128	0.103	0.099	0.058
71	17/07/83	30	1	3	3	24	39.7	3367	33.9	-1.68	-16.9	310	6	0.041	0.031	0.065	0.074	0.034	0.013
72	17/07/83	30	0	3	3	0.5	52.9	4758	36.0	-1.68	-16.9	310	6	0.041	0.031	0.065	0.074	0.034	0.013
79	03/08/83	30	1	0	2	24	84.9	9400	44.4	-1.64	-1.8	60	2	0.039	0.025	0.063	0.061	0.034	0.015
80	03/08/83	30	0	0	2	0.5	47.1	8181	52.3	-1.64	-1.8	60	2	0.039	0.025	0.063	0.061	0.034	0.015
95	22/09/83	30	1	200	1	21	64.7	5191	32.1	-1.65	-17.5	290	8	0.046	0.032	0.103	0.085	0.048	0.033
96	22/09/83	30	0	200	1	2	36.3	2908	32.0	-1.85	-17.5	290	8	0.046	0.032	0.103	0.085	0.048	0.033
97	23/09/83	30	1	200	1	20	50.8	5344	42.0	-1.85	-18.7	310	35	0.046	0.032	0.103	0.085	0.048	0.033
112	19/10/83	30	1	220	1	28	68.3	7781	44.9	-1.79	-4.8	130	28	0.094	0.041	0.097	0.079	0.038	0.026
113	19/10/83	30	0	220	1	0.5	73.2	7436	40.7	-1.79	-4.8	130	28	0.094	0.041	0.097	0.079	0.038	0.026
122	18/10/83	15	1	0	2	24	67.1	8061	48.1	-1.51	2.0	50	17	0.093	0.077	0.176	0.113	0.058	0.033
123	18/10/83	15	0	0	2	0.5	51.8	8406	65.2	-1.51	2.0	50	17	0.093	0.077	0.176	0.113	0.058	0.033
134	13/12/83	3	1	0	1	25	58.8	2105	14.3	-0.54	-0.1	190	5	8.335	3.234	0.369	0.348	0.128	0.099
135	13/12/83	3	0	0	1	0.5	39.8	2436	24.6	-0.54	-0.1	190	5	8.335	3.234	0.369	0.348	0.128	0.099
146	10/01/84	4	1	0	1	26	63.1	3533	22.4	0.34	5.1	50	2	10.387	3.891	0.510	0.748	0.144	0.182
147	10/01/84	4	0	0	1	0.5	40.8	4324	42.4	0.34	5.1	50	2	10.387	3.891	0.510	0.748	0.144	0.182
158	11/02/84	4	1	0	1	25	31.8	2686	33.7	0.06	6.4	320	12	10.246	4.118	0.304	0.577	0.063	0.127
159	11/02/84	4	0	0	1	0.5	45.6	3865	33.9	0.06	6.4	320	12	10.246	4.118	0.304	0.577	0.063	0.127
170	16/03/84	10	1	0	1	30	47.7	4031	35.9	0.24	-1.7	100	13	2.127	2.101	0.608	1.463	0.093	0.246
171	16/03/84	10	1	0	1	0.5	37.4	4222	45.1	0.24	-1.7	100	13	2.127	2.101	0.608	1.463	0.093	0.246
184	23/04/84	15	1	0	1	25	38.9	5038	51.8	-0.48	-9.9	250	10	0.086	0.075	0.191	0.178	0.061	0.034
185	23/04/84	15	2	0	1	12	36.8	4018	43.9	-0.48	-9.9	250	10	0.086	0.075	0.191	0.178	0.061	0.034
188	23/04/84	15	0	0	1	0.5	35.5	4821	54.3	-0.48	-9.9	250	10	0.086	0.075	0.191	0.178	0.061	0.034
197	18/05/84	15	1	0	1	27	72.7	8250	34.4	-1.53	3.9	110	6	0.068	0.051	0.178	0.135	0.059	0.031
198	18/05/84	15	2	0	1	13	71.6	2079	11.6	-1.53	3.9	110	6	0.068	0.051	0.178	0.135	0.059	0.031
199	18/05/84	15	0	0	1	0.5	36.9	6338	68.7	-1.53	3.9	110	6	0.068	0.051	0.178	0.135	0.059	0.031
216	30/06/84	20	1	5	1	24	41.4	4617	45.0	-1.70	-0.2	330	3	0.055	0.025	0.120	0.144	0.049	0.011
217	30/06/84	20	2	5	1	12	30.7	2525	32.9	-1.70	-0.2	330	3	0.055	0.025	0.120	0.144	0.049	0.011
218	30/06/84	20	0	5	1	0.5	46.8	4707	40.4	-1.70	-0.2	330	3	0.055	0.025	0.120	0.144	0.049	0.011
237	15/08/84	35	0	50	1	24	55.0	7092	51.6	-1.83	-0.6	290	30	0.048	0.002	0.076	0.048	0.031	0.000
238	15/08/84	35	2	50	1	12	30.9	3597	46.5	-1.83	-0.6	290	30	0.048	0.002	0.076	0.048	0.031	0.000
239	15/08/84	35	1	50	1	1	65.5	5323	22.3	-1.83	-0.6	290	30	0.048	0.002	0.076	0.048	0.031	0.000

Site 5: Outer Island (28m DEPTH)

Ref	D1	D2	D3	D4	D5	D6	D7	D8	D9	FA	CO	CM	CE	AM	AE	CN	FH	T	EB	UM	UE	L1	L2	L3	L4
5													2									0	0	0	0
8	4	5											2									0	0	0	1
13																						0	0	0	0
14																						0	0	0	0
19																						0	0	0	0
20																						0	0	0	0
28																						0	0	0	0
30																						0	0	0	0
41		1	4	2							1	1	1									3	0	0	0
42				1								1										2	0	0	0
49				1		1								1					5			4	0	0	0
50			1								4	1						4				4	0	0	0
71		3		2			1				3			1								3	1.485	0	0
72		3		2			3				3					2		1				4	0	0	0
79				1			1	1			3	1		3		1		1	1			1	0	0	0
80		3		1			2				4	2				1						3	0	0	0
95		1		1		1					1			1								1	0	0	0
96				1		1					1			1								1	0	0	0
97		2		1		3					1			3	1							1	0	0	0
112		1		1		1		1			1			1	1							4	0	0	0
113		1		1		4		1			1			3	1							8	0	0	0
122				1		3										4							0	0	0
123		3				3	1				1			1									0	0	0
134	5	3				2	3					1		1		2		1				3	0	0	0
135	5	4					3							1					3			3	0	0	0
146	5	4						1	4						1				3			0	7.076	0	0
147	5	5		1		3			3		1								1			1	0	19.66	0
158	4	3				2			2							2							0	0	0
159	4	3				3			2							2						2.587	0	0	0
170	3	3				1				1	2			2									0	0	0
171	2					2				1	1			1									0	0	0
184		2		1		3	2	1		2	2			2		1	1					3	0	0	0
185		1		2		2	2			1	4			3	1	1						4	0	0	0
186						1	2			1	2			1		1						2	0	0	0
197		2		1		2	1	1			2			1								2	0	0	0
198				1		2	2	1		1	1			2	1							2	0	0	0
199		2				2	2			1	2			1	2	1						2	0.789	0	0
216		1		1		1		1						2			1					2	2.166	0	0
217				1		1	1							2								2	0	0	0
218		2		1		1	2	1						3		1		1				2	0	0	0
237				1		2	1	1						2								2	0.705	0	0
238		1		2		2	1	1						2	1							2	0	0	0
239		1		1		1	1	1			3											0	0	0	0

Site 5: Outer Island (28m DEPTH)

Ref	C	L5	L6	L7	L8	L9	L10	L11	L12	L13	L14	L15	L16	L17	L18	L19	L20	TOT
5	0.20	1	0	0	0	0	0	0	0	3	0	0	0	0	0	0	0	4
6	0.20	0	0	0	0	0	0	0	0	1	0	0	0	0	0	0	0	2
13	0.20	0	0	0	0	0	0	0	0	0	0	0	0	0	0	0	0	0
14	0.20	0	0	0	0	0	0	0	0	0	0	0	0	0	0	0	0	0
19	0.14	0	0	0	0	0	0	0	0	0	0	0	0	0	0	0	0	0
20	0.53	0	0	0	0	0	0	0	0	0	0	0	0	0	0	0	0	0
29	0.15	0	0	0	0	0	0	0	0	0	0	0	0	0	0	0	0	0
30	0.19	0	0	0	0	0	0	0	0	0	0	0	0	0	0	0	0	0
41	0.15	3.057	0	0	0	0	0	0	0	0	0	0	0	0	0	0	0	3.057
42	0.18	0	0	0	0	0	0	0	0	0	0	0	0	0	0	0	0	0
49	0.14	0	0	0	0	0	0	4.731	0	0	0	0	0	0	0	0	0	4.731
50	0.18	0	0	0	0	0	0	0	0	0	0	0	0	0	0	0	0	0
71	0.30	0	0	0	0	0	4.455	0	5.94	0	0	0	1.485	0	0	0	0	13.37
72	0.21	0	0	0	0	0	7.356	0	0	0	0	0	0	0	0	0	0	7.356
79	0.11	0	4.787	2.129	0	0	1.064	0	0.532	0	0	0	0	0	0	0	0	8.511
80	0.18	2.435	4.87	6.492	0	0	3.246	0	0	0	0	0	0	0	0	0	0	17.04
95	0.19	0	0	0	0	0	0	0	0	0	0	0	0	0	0	0	0	0
98	0.34	0	0	0	0	0	3.439	0	8.597	0	0	0	0	0	0	0	0	12.04
97	0.19	0	0	0	0	0	0.936	0	3.743	0	0	0	0	0	0	0	0	4.679
112	0.13	0	0	0	0	0	0	0	0.843	0	0	0	0	0	0	0	0	0.843
113	0.13	0	0	0	0	0	2.017	0	0	0	0	0	0	0	0	0	0	2.017
122	0.12	0	0	0	0	0	1.861	0	0.62	0.62	0	0	0	0	0	0	0	3.101
123	0.12	0	0	0	0	0	0	0	0	0	0	0	0	0	0	0	0	0
134	0.48	0	0	0	0	0	0	0	0	0	0	0	0	0	0	0	0	0
135	0.41	2.053	0	0	0	0	2.053	0	0	0	0	0	0	0	0	0	0	4.106
146	0.26	1.415	0	0	1.415	0	0	0	1.415	1.415	0	1.415	0	0	0	0	0	14.15
147	0.23	0	0	0	0	0	1.156	0	6.936	0	0	0	0	0	0	0	0	27.75
158	0.38	0	0	0	0	0	0	0	1.875	0	1.875	0	0	0	1.875	0	0	5.825
159	0.26	0	0	0	3.881	2.587	0	0	9.056	0	3.881	0	0	5.175	0	0	0	27.17
170	0.25	0	0	0	0	0	0	0	0	0	0	0	0	0	0	0	0	0
171	0.24	0	0	0	0	0	0	0	0	0	0	0	0	0	0	0	1.184	1.184
184	0.20	0	0	0	0	0	1.985	0	0.992	2.977	0	0	0	0	0	0	0	5.954
185	0.25	0	0	0	0	0	1.244	1.244	0	1.244	0	0	7.486	0	0	0	0	11.2
186	0.21	0	0	0	0	0	1.037	0	0	0	0	0	0	0	0	0	0	1.037
197	0.18	0	0	0	0	0	0.8	0	0	0	0	0	0	0	0	0	0	0.8
198	0.48	0	0	0	0	0	4.81	0	2.405	0	0	0	0	0	0	0	0	7.215
199	0.18	0	0	0	0	0	0.789	0	0.789	0	0	0	0	0	0	0	0	2.367
216	0.22	3.249	0	0	0	0	2.166	0	0	1.083	0	0	1.083	0	0	0	0	9.747
217	0.40	0	0	0	0	0	8.901	0	0	0	0	1.98	0	0	0	0	0	11.88
218	0.21	0	0	0	0	0	0	0	0	0	0	0	2.124	0	0	0	0	2.124
237	0.14	0	0	0	0	0	2.115	0	0	0	0	0	0	0	0	0	0	2.82
238	0.28	0	0	0	0	0	0	0	0	0	1.39	0	0	0	0	0	0	1.39
239	0.19	0.939	0	0	0	0	0	0	0	0	0	0	0	0	0	0	0	0.939

Settlement experiment key

Note that panels were held in triplicate (see chapter 3). All values are counts.

Ref	Reference number	u1	Unknown settler 1
Date	Date of immersion	u2	Unknown settler 2
IM	Nº days of immersion	u3	Unknown settler 3
		u4	Unknown settler 4
TP	Thecate protozoans	u5	Unknown settler 5
		u6	Unknown settler 6
SP	Spirorbinid worms	u7	Unknown settler 7
a1	Unknown annelid 1	u8	Unknown settler 8
a2	Unknown annelid 2	u9	Unknown settler 9
a3	Unknown annelid 3	u10	Unknown settler 10
		u11	Unknown settler 11
t1	colonial tunicate 1	u12	Unknown settler 12
t2	colonial tunicate 2	u13	Unknown settler 13
		u14	Unknown settler 14
m1	unknown mollusc 1	u15	Unknown settler 15
Mb	<i>Micropora brevis</i> ancestrulae	ch6	Cheilostomatid ancestrula 6
IN	<i>Inversiula nutrix</i> ancestrulae	ch7	Cheilostomatid ancestrula 7
		ch8	Cheilostomatid ancestrula 8
Ce	<i>Celleporella sp.</i> ancestrulae	ch9	Cheilostomatid ancestrula 9
		ch10	Cheilostomatid ancestrula 10
ch1	Cheilostomatid ancestrula 1	ch11	Cheilostomatid ancestrula 11
ch2	Cheilostomatid ancestrula 2	ch12	Cheilostomatid ancestrula 12
ch3	Cheilostomatid ancestrula 3	ch13	Cheilostomatid ancestrula 13
ch4	Cheilostomatid ancestrula 4	ch14	Cheilostomatid ancestrula 14
ch5	Cheilostomatid ancestrula 5	ch15	Cheilostomatid ancestrula 15

A: POWELL ROCK (25m DEPTH)

Ref	Date	IM	TP	SP	a1	a2	a3	t1	t2	m1	Mb	IN	Ce	ch1	ch2	ch3	ch4	ch5	ch6	ch7	ch8
7	28-Jan-93	68		5						1			0	4	1	1	1				
8	28-Jan-93	68	6	72									0			2	3	9	1		3
9	28-Jan-93	68		46									0		1	1	14	3			
10	07-Mar-93	87		3	1						1		0				1	3			
11	07-Mar-93	87	4	28							2		0			1	13	1			1
12	07-Mar-93	87		41		1					19		2			1	27	1			5
22	07-Apr-93	116	3					10			13		0			1	6				9
23	07-Apr-93	116	5			2					26		2			4	2	4	1		3
24	07-Apr-93	116	3			2					11		40			3	1				1
34	02-Aug-93	79		4							1		1								1
35	02-Aug-93	79		7				1			21		5				1	2			2
36	02-Aug-93	79		9							11		1				2				2
40	18-Oct-93	59		38				1			4		5								2
41	18-Oct-93	59		27							11		9				1	1			4
42	18-Oct-93	59		5							13		38				7	6		3	3
55	17-Nov-93	61		7							3		11				2			4	1
56	17-Nov-93	61		4							3	1	17					1		12	1
57	17-Nov-93	61		4							4		34					9		4	
64	17-Dec-93	63		7		1			1				10								4
65	17-Dec-93	63		26									15								9
66	17-Dec-93	63		41									17					2			8
73	18-Jan-94	62		28				3					12				2				11
74	18-Jan-94	62		14									4				2				9
75	18-Jan-94	62		2									4					4			0
79	19-Feb-94	65		4									2					1			5
80	19-Feb-94	65		2				1					0								3
81	19-Feb-94	65		5				1					0								6
88	22-Mar-94	58		1								1	2					1			3
89	22-Mar-94	58		1						1			3					1			
90	22-Mar-94	58		1				1				1	0					1			1
100	26-Apr-94	63		3									4					1			
101	26-Apr-94	63		2				1			2		4					1			2
102	26-Apr-94	63									1		14								7
115	20-May-94	71		5									2					1			4
116	20-May-94	71		2									2				1	2			3
117	20-May-94	71		5									3			1		3			1
118	29-Jun-94	56		32									4								3
119	29-Jun-94	56		19							3		3				1				5
120	29-Jun-94	56		7									14					1			5
127	31-Jul-94	51		3							10		5					1			12
128	31-Jul-94	51		6							3		6					3			1
129	31-Jul-94	51		1					2		4		2					2			

B: POLYNESIA POINT (8m DEPTH)

Ref	Date	IM	TP	SP	a1	a2	a3	t1	t2	m1	Mb	IN	Ce	ch1	ch2	ch3	ch4	ch5	ch6	ch7	ch8
19	24-Mar-93	58											6			2					
20	24-Mar-93	58											2								
21	24-Mar-93	58											4			5					2
25	19-Apr-93	126	13	20							12		1			8			1		5
26	19-Apr-93	126		13				1			11		1			7		1			2
27	19-Apr-93	126		136							6		17			2		3			6
37	24-Aug-93	70		36							4		12								2
38	24-Aug-93	70		48							2		13							1	1
39	24-Aug-93	70		12				1					20					1			3
52	03-Nov-93	74		8									10								5
53	03-Nov-93	74		10									4								3
54	03-Nov-93	74		10							1		11								
61	04-Dec-93	78		3							1		9								1
62	04-Dec-93	78											2								
63	04-Dec-93	78		5		1							30								2
70	17-Jan-94	66											7								1
71	17-Jan-94	66											12					1			1
72	17-Jan-94	66											28								3
97	13-Apr-94	52		1									1								
98	13-Apr-94	52											0								
99	13-Apr-94	52											1								
103	06-May-94	89		20									1					1			
104	06-May-94	89											2								
105	06-May-94	89		36									1								
121	06-Jul-94	64		8									0					1			1
122	06-Jul-94	64		12							1		4								1
123	06-Jul-94	64		13									0			1					1
130	04-Aug-94	47		9									1								
131	04-Aug-94	47											0								
132	04-Aug-94	47		11									0								

A: POWELL ROCK (25m DEPTH)

Ref	ch9	ch10	ch11	ch12	ch13	ch14	ch15	CY	u1	u2	u3	u4	u5	u6	u7	u8	u9	u10	u11	u12	u13	u14	u15
7								12	1	1	1	4	3					2					
8								14	3			4		1		2							
9								21			1	5			1	3							
10								12															
11								35	2			5			1								
12								157	1			5											
22								58				1											
23	9							48									1						
24	11							20				2						1					
34	13	1			4			12				4											
35	9	2		1	2	2		17															
36	10				8			13															
40	3	1	1	7	7			5															
41	3			10	5	2		11				2											
42	14	2	2	10	10	1		66													1		
55	11	2		4	3	26		18													1		
56	10	6		1	7			11									2				7		
57	7	7		3	6	4		21															
64	10	14		4	6	9		123															1
65		3			6	3		15															1
66		3		2	3			10											1				
73	2	8		2	2			37													1		
74	2	4		3	3			32															
75	4			5				25				1											
79	1							6				1											
80			1					11															
81	4							54				3											
88	4	2	2	1	1			37															
89			2	1	1			28															1
90	6							23															
100	2			1	1			9															
101	2		2	2				48															
102	4		2		1			19														1	
115	6			1	5			27															
116	5		1					11				1											
117	5							7															
118	2		1		2			15															
119				1	2			7															
120	6			1	2	1		43															
127	4	1		3	5			7															
128	3	2	1	2	4			3															
129	1			2	2			4															

B: POLYNESIA POINT (8m DEPTH)

Ref	ch9	ch10	ch11	ch12	ch13	ch14	ch15	CY	u1	u2	u3	u4	u5	u6	u7	u8	u9	u10	u11	u12	u13	u14	u15
19								3															
20								4															
21								1															
25		2	1					15															
26	4		6					6												1			
27	9	1	1	16	3			15															
37	10	2		16	1			30				1											
38	13	2	1	17	3			35															
39	25	8		25	2			63															
52	1	7		7	1			6				1											
53		1		5				2													2		
54	4	1	1	2	1		1	2															
61	4			1				1															
62	1							2															
63		2		1				1															
70	1				1			1															
71	1							2															
72	1				1			7															
97	2							0															
98								0															
99								0															
103								5															
104	3							2															
105	9		1	3				1												1			
121				1				0															
122	1			1				0															
123	2				1			0										1					
130								0															
131				1	1			0							1								
132								0															

C: BARE ROCK (5m DEPTH)

Ref	Date	IM	TP	SP	a1	a2	a3	t1	t2	m1	Mb	IN	Ce	ch1	ch2	ch3	ch4	ch5	ch6	ch7	ch8	
49	26-Oct-93	61	1	73					4				7				2					2
50	26-Oct-93	61	6	77							3		8				3					2
51	26-Oct-93	61	3	31									3									1
58	22-Nov-93	65	4	33							6	4	3				1				2	10
59	22-Nov-93	65	4	49							2	1	2									3
60	22-Nov-93	65		13								2	14				1				1	
67	22-Dec-93	70	1	1		1					1		3				2					5
68	22-Dec-93	70		3					2				5						4			3
69	22-Dec-93	70		2									1									
76	27-Jan-94	67					2						1									1
77	27-Jan-94	67		4									0				1					1
78	27-Jan-94	67	1										7									3
85	03-Mar-94	71		5							2		4				3					2
86	03-Mar-94	71		6									5				1					2
87	03-Mar-94	71		2									1									2
94	04-Apr-94	63		4							3		4				1					4
95	04-Apr-94	63	4	4							1		3									
96	04-Apr-94	63	1	5			1	1			1		4				2					1
106	14-May-94	65		10					1		2		2									
107	14-May-94	65	2	12				1			1		6				1					1
108	14-May-94	65	1	27							2		12				1					3
112	07-Jun-94	66	7	24				3			9		6			2	3					
113	07-Jun-94	66	15	79				7			16		9			1		2			1	1
114	07-Jun-94	66		41							2		2								1	2
124	19-Jul-94	58		30							2		1		1		1				7	3
125	19-Jul-94	58		51							3		1				3				5	2
126	19-Jul-94	58		29									0				1				9	1
133	13-Aug-94	58	1	8							4		0								3	1
134	13-Aug-94	58		17							2		1				4				4	
135	13-Aug-94	58	2	22							1		4				3				3	4
142	14-Sep-94	65		8							1	1	0		1	1					1	
143	14-Sep-94	65		67							3	7	1				4				1	5
144	14-Sep-94	65	1	81							1	4	3								1	6
158	11-Oct-94	63	1	134							7		1			1	3				3	9
159	11-Oct-94	63		98							3	5	1			3	2				7	1
160	11-Oct-94	63		25							5	1	10			3	2				6	1
167	19-Nov-94	59		23								2	2								7	5
168	19-Nov-94	59		22							1	1	0								3	3
169	19-Nov-94	59		32							2		0								7	5
154	06-Oct-94	61	5	8	2	5					6		18			1					7	
155	06-Oct-94	61	0	1	1	4					1		5									
156	06-Oct-94	61	1	45		2					3	4	2			1					2	1
164	11-Nov-94	77		49							3	4	5			1						3
165	11-Nov-94	77		15							1	4	38			1	1					3
166	11-Nov-94	77		36							19	1	8			2	5				8	20
161	08-Oct-94	84		34							13	1	17			4					18	5
152	08-Oct-94	84	3	4							3		6									
153	08-Oct-94	84		16							1		2								1	
161	11-Nov-94	77		98							25	7	5				9				9	11
162	11-Nov-94	77		33							1	2	2								1	3
163	11-Nov-94	77		68									0				4				1	

C: BARE ROCK (5m DEPTH)

Ref	ch9	ch10	ch11	ch12	ch13	ch14	ch15	CY	u1	u2	u3	u4	u5	u6	u7	u8	u9	u10	u11	u12	u13	u14	u15
49				2		1		0															
50				1		2		1			1								1				
51								1									1						
58	1	1	1	6				4			1									1	1		
59				2				2															
60						4		1			2												
67			1		1			1			1												
68					4			0										1					
69			3					0										1					
76			1					0						2			1						
77								0															1
78			1					1						1									
85		1		2				2															
86								1															
87								1															2
94		3						23															
95			1					24															
96				2				9															
106								12															
107			1	1		1		10							1						1		
108				2				11															
112			1	4				117								1							
113		3	9	2		1		74			2												
114				7				12															
124		1		1				6															
125		4	1					8															
126		5	2	3				10															
133		1		5				5															
134								4															
135			1	8				5															
142		1				1		1															
143	1			4	1			4												1			
144				2				1															
158			3	6		2		5															
159		1	2			2		3															
160	1	1		7		3		17										1					
167		1						2										3		1			
168		1		1				4			1							2		1			
169		3				1		4										1					
154				2		41		62															
155						29		22											1				
156						2		33										5					
164		4	1	4				5			1				1								
165		1	1	2				10															
166		6	4	1		1		3										1	1				
151		2		1		5		45															
152				1				9															
153								0															
161		14	6	5				3															
162				2				1															
163								2															