

STUDIES OF REACTION MECHANISMS
IN ORGANIC CHEMISTRY
USING RADIOCHEMICAL TECHNIQUES

Thesis

submitted for the degree of

DOCTOR OF PHILOSOPHY

of the

University of Glasgow

by

Zeinab. M. Hashish, B.Sc. (Cairo)

July, 1968

ProQuest Number: 11011852

All rights reserved

INFORMATION TO ALL USERS

The quality of this reproduction is dependent upon the quality of the copy submitted.

In the unlikely event that the author did not send a complete manuscript and there are missing pages, these will be noted. Also, if material had to be removed, a note will indicate the deletion.



ProQuest 11011852

Published by ProQuest LLC (2018). Copyright of the Dissertation is held by the Author.

All rights reserved.

This work is protected against unauthorized copying under Title 17, United States Code
Microform Edition © ProQuest LLC.

ProQuest LLC.
789 East Eisenhower Parkway
P.O. Box 1346
Ann Arbor, MI 48106 – 1346

ACKNOWLEDGEMENT

It is a pleasure to acknowledge with thanks the help of my supervisor, Dr. I. M. Hoodless, who suggested and guided this work, and also to Dr. S. J. Thomson for helpful discussion.

Appreciation is also expressed to the Egyptian Ministry of Higher Education for a Research Studentship.

ABSTRACT

An investigation of the mechanism of dehydrogenation of a hydroaromatic compound, 1:4,dihydronaphthalene, by a quinone, tetrachloro-1:4,benzoquinone, has been made. The reaction has been studied by kinetic measurements, spectroscopic measurements and by the determination of tritium isotope effects. The measurements were carried out at 80°C and phenetole was used as the solvent for the reaction mixture.

In previous work in these types of systems second order kinetics are generally observed and the bulk of the experimental evidence suggests that the reaction proceeds by an ionic rather than a free radical mechanism. Transfer of a hydride ion has been postulated as the rate determining step. The present work does not entirely support this viewpoint; second order kinetics were only observed in the later stages of the reaction and in the initial reaction period the kinetic data suggest the mechanism is more complex than has previously been supposed. In addition, during the time over which the reaction was normally followed, i.e. 120 minutes, the amount of naphthalene formed is equivalent to approximately half of the 1:4,dihydronaphthalene consumed.

The isotope effect measurements, using partially tritiated 1:4,dihydronaphthalene, have given a value of $k_T/k_H = 1.16 \pm 0.16$.

This result does not support the view that fission of the carbon-hydrogen bond is the rate-determining step, i.e. hydride ion transfer. The result is interpreted in terms of the first step in the reaction being the establishment of an equilibrium involving the formation of a charge-transfer complex and the value of k_T/k_H greater than unity results from an inverse secondary isotope effect. The spectroscopic measurements prove the existence of charge-transfer complexes in the reaction mixture and indicate that the formation of these complexes is the initial step in the reaction.

The extra consumption of 1:4-dihydronaphthalene in the reaction is ascribed to the formation of a chloro-substituted quinone in which a chlorine is replaced by monohydronaphthalene group. This by-reaction would lead to the production of hydrogen chloride and the latter has been detected among the reaction products. It has been observed that significant amounts of hydrogen chloride do have a small catalytic effect on the reaction.

The present work suggests that the reaction proceeds by an ionic mechanism but modifications in the earlier schemes are required. The following scheme is suggested for the reaction of the hydroaromatic compound (RH_2) with the tetrachloroquinone (QCL_4):

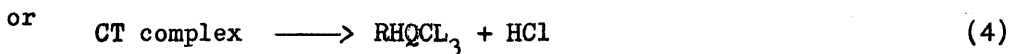
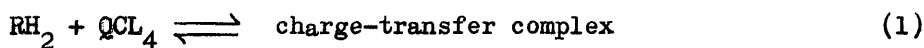

In systems where the quinone has a low redox potential, or where there is substantial steric hindrance, the formation of the charge transfer complex, step (1), can be rate determining, while with quinones of high redox potential step (1) is relatively rapid and step (2) is the rate determining step.

CONTENTS

CHAPTER I

<u>INTRODUCTION</u>	1
1.1 Transfer of Hydrogen in Organic Systems.	1
1.2 Some Observations on the Reaction Mechanism of the Dehydrogenation of Hydroaromatic Hydrocarbons with Quinone.	3
1.2 (a) The Free Radical Mechanism Approach.	3
(b) The Hydride Ion Transfer Mechanism Approach.	6
1.3 Aims of the Present Work.	13
1.4 The Theoretical Approach to Kinetic Isotope Effect.	15
1.4 (a) The Origin of Kinetic Isotope Effect.	16
(b) Fundamentals of the Theory of Absolute Reaction Rates.	20
(c) Isotope Effect in the Transition State Theory.	23
1.5 Outline of Experimental Techniques and Calculations.	30
1.5 (a) The Arrangement of Experiments with Isotopic Hydrogen (Tritium).	30
(b) Arrangement of Experiments for Measurement of Kinetics.	33

CHAPTER II

<u>EXPERIMENTAL</u>	
2.1 Sources and Purification of Materials.	34
2.1 (a) The Quinone.	34
(b) The Hydrocarbon.	34
(c) Tritiation of 1:4,dihydronaphthalene.	36

2.1	(d) The Solvent.	38
2.2	General Kinetic Procedure.	38
2.2	(a) The Kinetic Apparatus.	38
	(b) Dehydrogenation: General Procedure.	39
	(c) Method of Sampling.	40
2.3	The Quinone Analysis.	40
2.3	(a) Introduction.	40
	(b) Reagents and Procedure.	41
2.4	The Hydrocarbon (1:4,DHN) Analysis.	42
2.4	(a) Gas-Liquid Chromatographic Analysis	42
	(b) Procedure of the Chromatographic Quantitative Analysis.	45
2.5	Isotopic Analysis.	45
2.5	(a) The Apparatus.	46
	(b) Calibration of the Apparatus.	47
	(c) Techniques Adopted in the Experiments with Tritiated 1:4,DHN.	48

CHAPTER III

	<u>RESULTS</u>	52
3.1	Concentration/Time Curves.	52
3.2	The Stoichiometry of the Reaction.	57
3.3	The Kinetics of the Reaction.	61
3.4	The Kinetic Isotope Effect Measurements.	62
3.5	General Comments on the Kinetic and Isotope Effect Results.	65

3.6	Proposed Investigations for Side Reactions.	70
3.6	(a) The Significance of the Chlorine-substitution in the Quinone.	71
	(b) Spectrophotometric Investigations.	71
	(c) Detection of Higher Hydrocarbons.	72

CHAPTER IV

	<u>INVESTIGATIONS OF SIDE REACTIONS</u>	74
4.1	Estimation of Evolution of HCl in the Reaction Mixture	74
4.1	(a) Detection of Evolution of HCl.	74
	(b) Estimation of HCl Evolved Quantitatively.	74
	(c) Results.	76
4.2	Effect of Addition of HCl gas on the Rate of the Reaction.	80
4.3	Spectroscopic Investigations.	87
	(a) Investigation of Charge-transfer Complex.	87
	(b) Estimation of Quinone Consumed in the Reaction Mixture.	96
	(c) Spectroscopic Detection of Possible By-Products in the Reaction Mixture.	100
4.4	G.L.C. Investigations for Higher Hydrocarbons.	103
4.5	Preparative Experiments.	104
4.6	Identification of the By-Products Observed in the Reaction Mixture.	106
4.6	(a) The evolution of HCl.	106
	(b) Identification of the new absorption maxima.	106

CHAPTER V

DISCUSSION

5.1	Summary of the Results	(109)
5.1	(a) Kinetics and Isotope Effect of the Reaction	(109)
	(b) The Stoichiometry of the Reaction	(109)
	(c) The Spectroscopic Results	(111)
5.2	Comparison of the Present Results with the Proposed Reaction Mechanisms	(112)
5.3	The Assessment of the Present Results in Relation to Possible Reaction Mechanisms	(114)
5.3	(a) The Isotope Effect	(114)
	(b) The Charge-Transfer Complexes	(125)
	(c) A Possible Reaction Mechanism	(133)
	(d) Comparison of the Mechanism with other Dehydrogenation Studies	(141)

APPENDIX

(a)	(148)
(b)	(150)
(c)	(152)
(d)	(153)
(e)	(154)
(f)	(157)

REFERENCES

(158)

CHAPTER I

INTRODUCTION

PART 1

1.1 Transfer of Hydrogen in Organic Systems

The term hydrogen-transfer is used in a very wide sense, to include both intramolecular and intermolecular reactions of organic compounds in which covalently bonded hydrogen atoms change their site of attachment. Processes of this type are of great importance in synthetic organic chemistry as well as in biological systems, and many examples have, of course, already been studied very extensively.

The majority of hydrogenation-dehydrogenation reactions involve the use of a solid phase catalyst. Frequently the main reaction is accompanied by side reactions and the elucidation of the reactions mechanisms has proved difficult. As with any mechanistic or kinetic study involving solid catalysts, catalyst reproducibility and the exact nature of the chemisorbed species present major problems.

In addition to these heterogeneously catalysed reactions, which essentially involve molecular hydrogen, there is an important group of processes in which pairs of hydrogen atoms are transferred from one molecular species to another. These are the so-called homogeneous thermal hydrogen transfer reactions and can be represented by

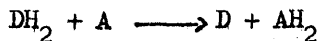

where DH_2 and A are respectively the donor and acceptor molecules.

Typical hydrogen donors are hydroaromatic and hydroheterocyclic compounds. The most commonly used acceptor molecules are sulphur and selenium, but these have the disadvantage that dehydrogenation only proceeds at a measurable rate at high temperatures. Many side reactions may also occur, such as splitting off or migration of alkyl groups, ring contraction, ring enlargement and so on.⁽¹⁾ By contrast, dehydrogenation by quinones seems to be rather attractive. It was found that quinones are a class of very powerful acceptors and would react under both catalytic and non-catalytic conditions. In some of the earliest work on dehydrogenation by quinones, Clar and John⁽²⁾ used phenanthraquinone in boiling nitrobenzene or chloranil in boiling xylene as convenient reagents for the smooth dehydrogenation of hydroaromatic hydrocarbons. The same method has since been extended by Criegee⁽³⁾ and by Arnold and Collins.⁽⁴⁾ The latter workers pointed out that as a cheap, clean, dehydrogenating agent, chloranil (tetrachloro-1:4,benzoquinone) is often superior to selenium, which reacts only at much higher temperatures. In many instances the quinones are better than catalysts for selective dehydrogenation reactions.

The thermal dehydrogenation of hydroaromatic hydrocarbons with quinones, which is the object of the present work, is of considerable interest because of the possible significance of these types of compounds in the chemistry of biological systems.⁽⁵⁾ Many of these systems have been investigated⁽²⁻²³⁾ but it is surprising that relatively few investigations have been primarily concerned with the mechanisms of these

reactions. Most attempts to determine the mechanism have been based on the analysis of the reaction products rather than by kinetic studies and as a consequence there is some controversy as to the actual reaction mechanism. In view of the importance of these types of reaction it was decided to make a thorough mechanistic investigation. In the following the various mechanisms characteristic to these type of reactions are represented.

1.2 Some Observations on the Reaction Mechanism of the Dehydrogenation of Hydroaromatic Hydrocarbons with Quinones.

There are two main schools of thought concerning the mechanism of the transfer reaction of hydroaromatic compounds with quinones. The first which is the earliest approach is that proposed by Waters⁽⁹⁾ and Dost and Van Nes⁽¹⁵⁾. In this approach the nature of the reaction products in some systems has led to the proposal that these type of reactions are homolytic (free radical mechanism), involving the abstraction of a hydrogen atom by the quinone to give a semiquinone radical. The second approach which is more recent and the only one based on detailed kinetic investigations is that of Braude et al⁽¹⁸⁾ in which the kinetic studies made have been interpreted in terms of initial hydrogen transfer as the hydride ion.

(a) The Free Radical Mechanism Approach

This type of mechanism was proposed by Waters⁽⁹⁾ to account for the fact that quinones were known to inhibit the autoxidation of tetralin

(1,2,3,4,tetrahydronaphthalene). He suggested that initially the quinone abstracted a hydrogen atom to form a semiquinone radical, and considered the inhibition to be due to the facile combination of the α -tetralyl and the semiquinone radicals forming quinol tetralyl ether $\text{ROC}_6\text{H}_4\text{OH}$, which leads to enhanced chain breaking of the oxidation cycle.

Literature data supporting this view are still very scarce; the majority of the evidence in favour of this mechanism is based on the similarity of the reaction products of the quinone dehydrogenation with those obtained by dehydrogenation with agents which are known to react according to a free radical mechanism. In particular, the roles of oxygen and chloranil as hydrogen abstractors are frequently compared. (24,25) For instance, the oxidation of olefins by elemental oxygen, so-called auto-oxidation, is likewise a homolytic process, dependent on the di-radical nature of molecular oxygen (the atoms of which possess two unpaired electrons); in these processes it is known that the point of oxygen attack is the methylene group adjacent to the double bond. (26,27) Similarly Dost and Van Nes⁽¹⁵⁾ found that chloranil primarily attacks loosely bound hydrogen, viz. at -C-H group adjacent to double bond or an aromatic nucleus, yet under the same conditions it does not dehydrogenate perhydro-aromatic or saturated aliphatic compounds. They found a striking similarity between the ability of various hydrocarbons to absorb oxygen and the relative yields of dehydrogenated products when the same hydrocarbons were reacted with chloranil, Table I. (28)

TABLE I

Comparison of the Oxygen Absorbed by Some Hydrocarbons and the
Yield of Dehydrogenated Products of the Same Hydrocarbons

<u>Hydrocarbon</u>	<u>Oxygen absorbed under influence of Cu-stearate at 110° in cm³ O₂ per cm³ hydrocarbon per hour</u>	<u>Yield of dehydrogenation product after treatment with chloranil at 140°C in xylene during 16 hours</u>
tetralin	125 cm ³	80%
phenylethane	7.5 cm ³	7%
decalin	4.3 cm ³	2%
Paraffins	0.25cm ³	no reaction

If the assumption, that chloranil reacts in a similar way to oxygen is correct, then a semiquinone radical will first be formed. After this secondary reactions proceed. One reaction product could be a hydroquinone ether (A) formed by the combination of hydroquinone and hydrocarbon radicals.

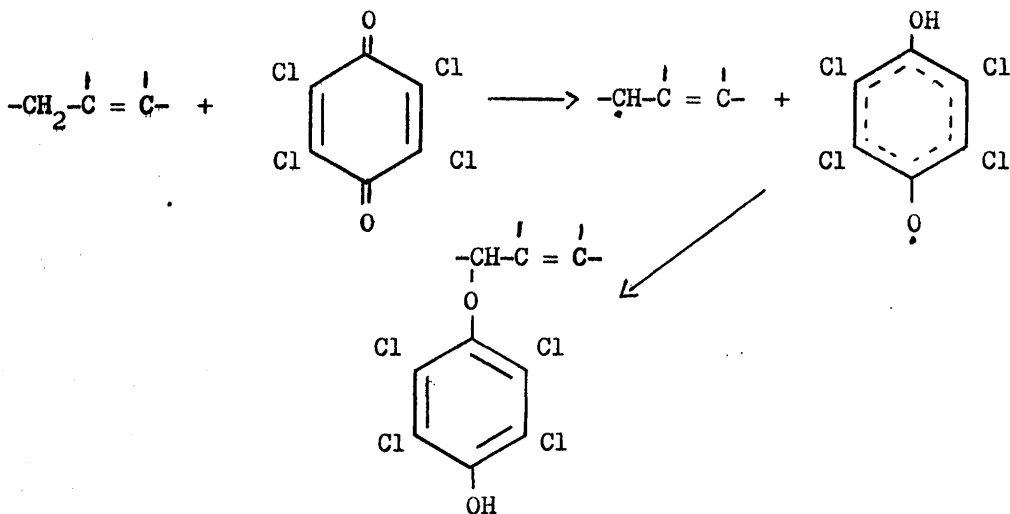

(A)

Ethers of this type have been isolated by Criegee⁽³⁾ in the dehydrogenation of tetralin and cyclohexene with chlorodiquinone.

The above literature data are in line with the view that the formation of a free radical by hydrogen abstraction forms the rate determining step in the dehydrogenation.

However, conclusive evidence for a free radical mechanism is lacking. The reaction rate is unaffected by U.V. radiation⁽¹⁵⁾ or by the incorporation of radical producing agents, e.g. peroxides, into the mixture.⁽¹⁸⁾ Moreover, the results of some preliminary kinetic investigations by Dimroth⁽⁶⁾ and by Dost and Van Nes⁽¹⁶⁾ although interpreted in terms of a free radical mechanism, did show a correspondence between the reaction rate and the redox potential of the quinone. A more detailed investigation of this relationship which will be discussed in the next section, has led to the proposal that the reaction proceeds by an ionic mechanism.⁽¹⁸⁾

The only established example of a free radical mechanism in the thermal dehydrogenation by a quinone in solution is the conversion of 3:3:4 4-tetraphenylhexane into diphenylethylene⁽²⁵⁾ but this is because homolytic dissociation into diphenylpropyl radicals precedes transfer, so that the actual donor is itself a free radical. Homolytic hydrogen-transfer is known to occur when the acceptor is the stable free radical diphenyl picryl hydrazyl.⁽²¹⁾

(b) The Hydride Ion Transfer Mechanism Approach

Braude et al.⁽¹⁸⁻²³⁾ have studied the kinetics of the dehydrogenation

of different types of hydroaromatic donors by a wide range of quinones. In general second order kinetics, i.e. unimolecular in each component, was observed although deviations from second order kinetics due to catalytic effects of the products 'quinol' or side reactions were frequently observed. This is in agreement with the two earlier investigations made by Dimroth⁽⁶⁾ and Dost and Van Nes.⁽¹⁶⁾ In particular the dehydrogenation of 1:2, and 1:4, dihydronaphthalenes by the various quinones has been the subject of much of Braude et al's investigations.^(18,19,23) They have shown that the rate constants and activation energies for the reaction of 1:4, dihydronaphthalene with ten/^{1:4,}quinones exhibit a linear logarithmic relationship with the redox potentials of the quinones. The relative reactivities of the quinones towards 1:4, dihydronaphthalene could be expressed by a linear free-energy equation relating oxidation potentials to ease of dehydrogenation.

$$\Delta G_{25^{\circ}}^{\ddagger} = 38 - 16E_{25}^{\circ}$$

where $\Delta G_{25^{\circ}}^{\ddagger}$ is the free energy, in K.cal.mole⁻¹, of the reaction at 25°C and E° is the redox potential of the quinone in volts. This indicates that the quinones are acting as electron acceptors in the thermal hydrogen transfer and consequently an ionic mechanism has been proposed. Support for this type of mechanism has come from an investigation of the influence of solvent on the reaction rate. An increase in rate with increasing polarity of the solvent was observed.

Braude et al.⁽¹⁸⁾ have suggested two possible ionic mechanisms to

explain their results. The first is that the reaction involves the abstraction of a hydride ion from the hydrocarbon by the quinone through a linear transition state (forming the rate determining step) followed by the rapid transfer of a proton from the conjugate acid of the dehydrogenation product to the hydroquinone anion possibly via the solvent. This is illustrated in the following equation for the case of p-benzoquinone and 1,4-dihydrobenzene.

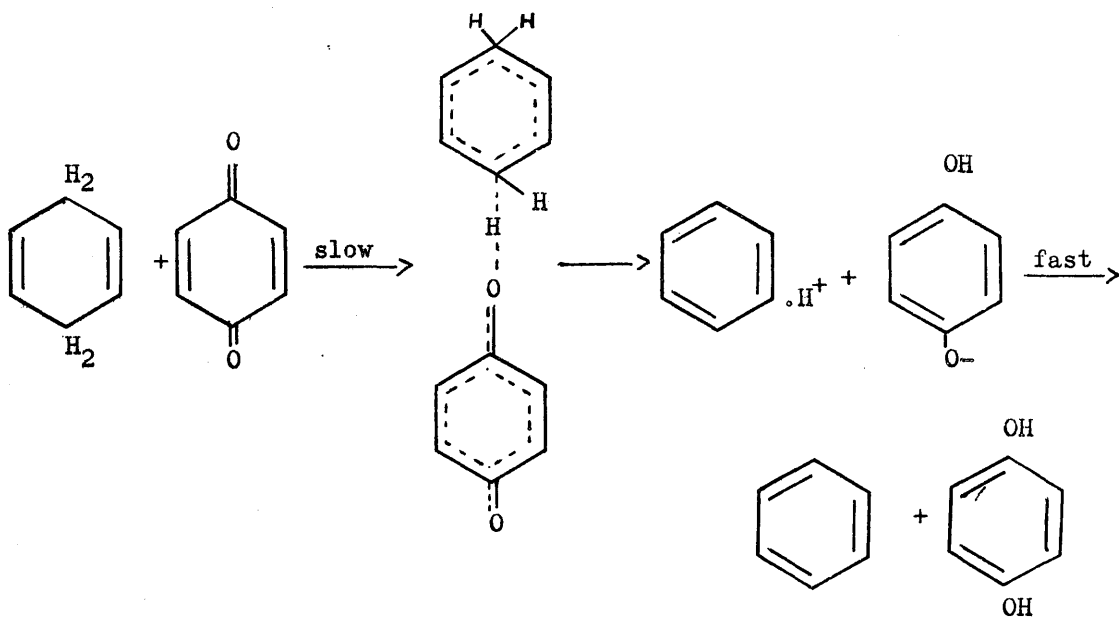

The second proposal involves the concerted transfer of both hydrogens by means of the formation of a cyclic transition state,

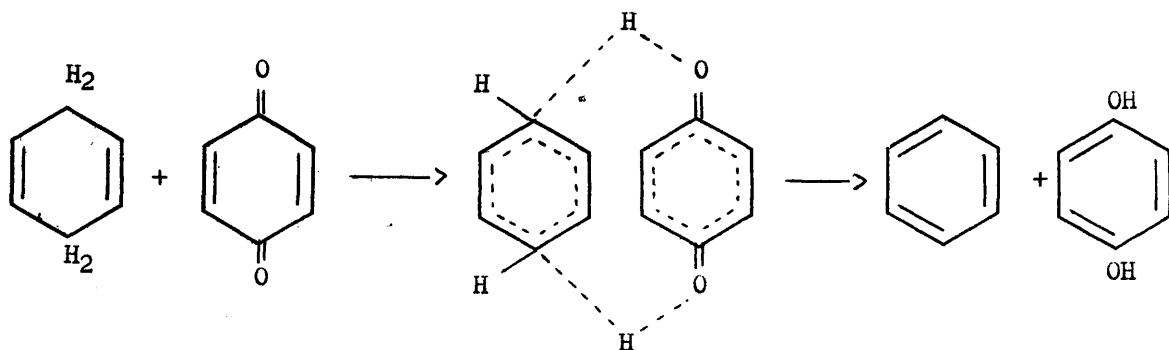

This mechanism must be differentiated from one of the free radical type. It is suggested that it is a polar transition state. One carbonyl acts as an electrophilic and the other as a nucleophilic reagent. This means that, in the transition state, the first C-H bond is broken to a much greater extent than the second C-H bond, but the two events are linked to a high degree, while in the two-step mechanism, the first mechanism, the two C-H bond fissions are essentially independent.

The one-step mechanism has gained support from the fact that unsymmetrically substituted methyl- and chloro-quinones were found to react faster than their symmetrically substituted counterparts.⁽¹⁸⁾ It would be easier to realise the formation of the polar condition (for the transition state) in the former type of quinone. But the fact that quinols were found to catalyse transfer to low potential quinones⁽¹⁸⁾ is considered to vitiate the one step mechanism. It was also shown that other weak proton donors (e.g. p-nitrophenol) which had the ability to complex with the quinone, in addition to their acidic properties, catalysed the reaction, as did the very strong proton donor perchloric acid. Braude et al. suggested

that this is strong evidence for validity of the two-step mechanism. They have ascribed this to the fact that, as the addition of a proton to the hydrocarbon could not possibly assist in its dehydrogenation the catalytic effect must depend on the partial conversion of the quinone to its conjugate acid which has a much greater affinity for the hydride ion. They proposed a modification of the two-step ionic mechanism to account for this increased rate, and this is represented by:

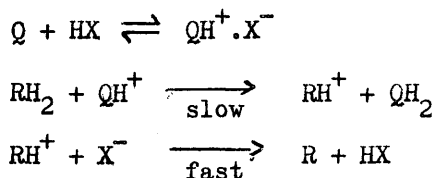

It would be expected that for the concerted transfer of hydrogens the rate of reaction would be very dependent on the geometric relationship between the donor and acceptor. A comparison of the relative rates of dehydrogenation of 1:2, and 1:4, dihydronaphthalenes⁽²³⁾ in which the internuclear separation of the two transferable hydrogen atoms are 2.1 and 3.2 Å⁰ respectively with tetrachloro-1:2-benzoquinone, tetrachloro-1:4-benzoquinone (chloranil) and 3,3',5,5'-tetrachloro-4,4'-diphenoquinone in which the oxygen-oxygen internuclear distances are 3.5, 5, and 8 Å⁰ respectively is shown in Table 2. The data provided indicates that even with the 1:2-quinone simultaneous removal of both hydrogen atoms does not seem to occur to a significant extent. A possibly sharper diagnostic test to distinguish between the two proposals would be to measure the hydrogen

isotope effect for the reaction. This will be discussed later in the introduction.

TABLE 2

Relative Rates of Dehydrogenation of 1:4- and 1:2-
Dihydronaphthalenes at 100°

	<u>Tetrachloro-o-</u> <u>benzoquinone</u>	<u>Chloranil</u>	<u>Tetrachloro-</u> <u>diphenoquinone</u>
k(1:4-DHN)/k(1:2-DHN)	29.1 ± 1.7	182 ± 10	30.2 ± 2.4

It is significant that, although the results of these recent kinetic investigations can be explained in terms of a simple ionic mechanism, some anomalies remain. The view that certain quinols catalyse the reaction must be treated with some caution; for example, in the dehydrogenation of 1:4, dihydronaphthalene with thymoquinone⁽¹⁸⁾ the addition of 50% more quinol only increases the rate by approximately 20%. Also, the correlation of the reaction rate with the redox potential is not valid for all the quinones investigated. Chloroquinones are much more effective than the corresponding bromo- or iodo- substituted quinones, yet there are not significant differences in their redox potential. In Table 3 the relative efficiencies of various quinones for the dehydrogenation of 1:4, dihydronaphthalene are compared with their redox potentials.

The relatively weak dehydrogenating power of the bromo- and the unreactivity of the iodo- substituted quinones has also been observed in

TABLE 3

The Relative Efficiencies of Various Quinones for the

Dehydrogenation of 1:4-Dihydronaphthalene
(based on the results of Braude et al. (18-23))

<u>Quinones in order of dehydrogenating power</u> (Top is best, bottom is poorest)	<u>E_{25}° (volts)</u>	
2:3,dichloro-5:6-dicyano-1:4-benzoquinone	~ 1.0	
tetrachloro-1:2-benzoquinone	0.87	
tetrachloro-1:8-diphenoquinone	> 0.95	
tetrabromo-1:8-diphenoquinone	> 0.95	
2:3,dicyano-1:4-benzoquinone	0.97	side reactions
2:5,difluoro-1:4-benzoquinone	0.95	side reactions
1:2,naphthaquinone	0.58	increase in rate with reaction
tetrachloro-1:4-benzoquinone (chloranil)	0.70	
1:8,diphenoquinone	0.95) rate decreases with increase reaction
trichloro-1:4-benzoquinone	0.726	
2:6,dichloro-benzoquinone	0.748	
mono-chloro-benzoquinone	0.736	
tetrabromo-1:2-benzoquinone	> 0.87	
1:4,Benzoquinone	0.71	
1:4,naphthaquinone	0.493	decrease in rate with reaction
tetrabromo-1:4-benzoquinone	0.746	
tetraiodo-1:4-benzoquinone	0.742	unreactive

the dehydrogenation of amines by Buckely and Henbest⁽²⁹⁾. These workers have suggested that hydride ion transfer represents the overall reaction, but it is not necessarily the rate-determining step. It could result from a single-electron transfer followed by hydrogen atom transfer. They have observed the formation of a charge-transfer complex between the amines and the quinones. This led them to the suggestion that the oxidation-reduction step takes place within this molecular complex. They came to the conclusion that both, a suitable redox potential of the quinone and the formation of the complex are the two main factors which must be fulfilled before the dehydrogenation reaction could take place.

More detailed discussion of the redox potentials is hampered by the lack of knowledge of the nature of the rate-determining hydrogen transfer step; also the possibility that different pairs of components may react by different mechanisms must also be kept in mind. The general conclusion so far is that, on balance, the experimental evidence is in favour of an ionic mechanism but a free radical mechanism cannot be entirely ruled out. Further investigations are required.

1.3 Aims of the Present Work

It is the aim of this investigation to carry out a more detailed study of quinone dehydrogenation of a hydroaromatic compound. The majority of the evidence is in favour of a hydride ion transfer mechanism yet this type of transfer is comparatively rare in organic chemistry. There are some indications that the mechanism is more complex than this.

Firstly it has been pointed out earlier that the chloro-substituted quinones are more efficient dehydrogenating agents than their bromo- and iodo- counterparts; on the basis of redox potentials this difference in reactivity would not be expected.

Secondly, the previous investigations of the reaction kinetics have been mainly restricted to equimolar concentrations of reactants and the kinetics determined by measuring the change in concentration of one compound, i.e. either the quinone or the quinol. A recent paper⁽²³⁾ indicates that when the hydroaromatic compound is present in excess the reaction does not readily follow the pattern of the equimolar reactant case.

The system chosen for this study was the dehydrogenation of 1:4-dihydronaphthalene with tetrachloro-1:4-benzoquinone (chloranil). This reaction proceeds at a measurable rate below 100°C and it is intended to measure the concentration changes in both a reactant, the hydroaromatic compound, and a product, the quinol. In this system the quinone is fully substituted with chlorine and it was hoped that significance of this substituent, as opposed to bromine and iodine, could be investigated.

It is also intended to measure the hydrogen-tritium isotope effect in the reaction. An isotope effect is to be expected if the C-H bond is broken in the rate determining step. Moreover, although a two-step hydrogen transfer is more likely, the single-step mechanism is not ruled out by stereochemical considerations in this system. The internuclear

distance between the transferable hydrogens is $3.2 \overset{\circ}{\text{A}}$ and the oxygen-oxygen internuclear distance in the quinone is $5 \overset{\circ}{\text{A}}$. The magnitude of the isotope effect might be expected to resolve which of these mechanisms, if either, is more likely. The theoretical foundation of the influence of isotopic mass on the reaction velocity will be discussed in Part 2 of the introduction.

PART 2

1.4 The Theoretical Approach to Kinetic Isotope Effect

The term "isotope effect" refers to the fact that under certain conditions in a chemical reaction one isotope of an element can react at a slightly different rate from another. For quite some time after the recognition of the existence of isotopes it was generally considered that the isotopes of any given element were identical chemically in spite of their differences in masses or radioactive properties. However, after the separation of hydrogen isotopes in 1932-3⁽³⁰⁾ and the study of their properties in exchange reactions, small variations in equilibrium constants were found between the several isotopic species. These early investigations came at a time when the absolute rate theory was under great development, and so, it was predicted by Cremer and Polanyi⁽³¹⁾ and Eyring and Sherman⁽³²⁾ that this difference in the reactivities of the isotopic molecules can be mainly attributed to the difference in the zero-point energies of the respective isotopes. The zero-point energy is related to the reduced mass of the molecule, and to a crude approximation this will vary as the inverse square root of the mass of the isotope.

Since the chemistry of a species is generally thought to depend upon its electronic configuration rather than on the mass of its nucleus or nuclei, the existence of this "isotope effect" may perhaps be puzzling, so to understand its cause a general review will be given first and then the detailed and specified theoretical treatment for it will be discussed.

(a) The Origin of Kinetic Isotope Effect

Generally speaking, there are three main factors which contribute to the lower reactivity of the bonds to the heavier isotope as compared with the corresponding bonds to the lighter one. These are:-

- (i) the difference in zero-point energy,
- (ii) the effect of difference in mass on the velocity of passage over the potential energy barrier, and
- (iii) the possibility for non-classical penetration of the energy barrier. (34,35)

(i) Zero-point energy difference

The major factor which contributes to the free energy difference is the difference in zero-point energy between a bond to the heavier isotope and the corresponding bond to the lighter one. Quantum mechanically the potential energy curves (Morse curve Fig. 1) for a bond to a lighter isotope (say hydrogen) as compared to the corresponding bond to the heavier isotope (say deuterium), are essentially identical. (This could be seen from the fact that the ratio of the infra red stretching frequencies for the two bonds is almost exactly proportional to the ratio of the square

roots of the masses of deuterium and hydrogen). The shape of the bottom of the potential energy curve governs the force constant for the stretching vibration, and this is related to the frequency by Hook's law expression

$$\nu = \frac{1}{2\pi C} \sqrt{\frac{f}{\mu}} \quad (1.1)$$

where f is the force constant and μ is the reduced mass.

According to quantum theory, the energy of a vibrating system can never fall to zero, even at absolute zero, each vibration will have the energy $\frac{1}{2} h \nu$ which is the lowest energy level for any bond; this lowest energy level is known as the zero-point energy. The difference in the vibrational energy levels is such that at room temperature most of the bonds are in this lowest vibrational energy level. There is a difference in zero-point energy for a bond to hydrogen and the corresponding bond to deuterium which arises from the effect of the difference in masses on the stretching frequencies, equation (1.1).

The differences in zero-point energy has two consequences. The dissociation energy (or the activation energy) of a compound is the difference between E_1 in Fig. 1 and the zero-point energy. Since the heavier isotopic compound will have the lower zero-point energy, it will be more stable than the lighter analogue.

Similarly, in a rate process, if one considers the curve relating the potential energy of the system with distance along the reaction coordinate, Fig. 2, and if we assume the bond undergoing fission to be

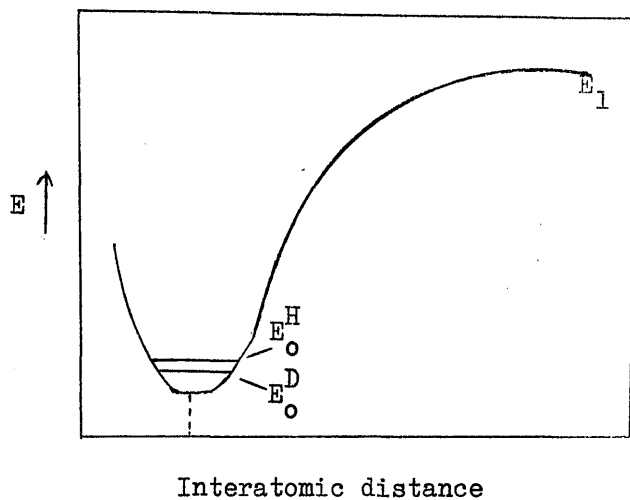

Fig. 1. Morse curve relating potential energy and interatomic distance.

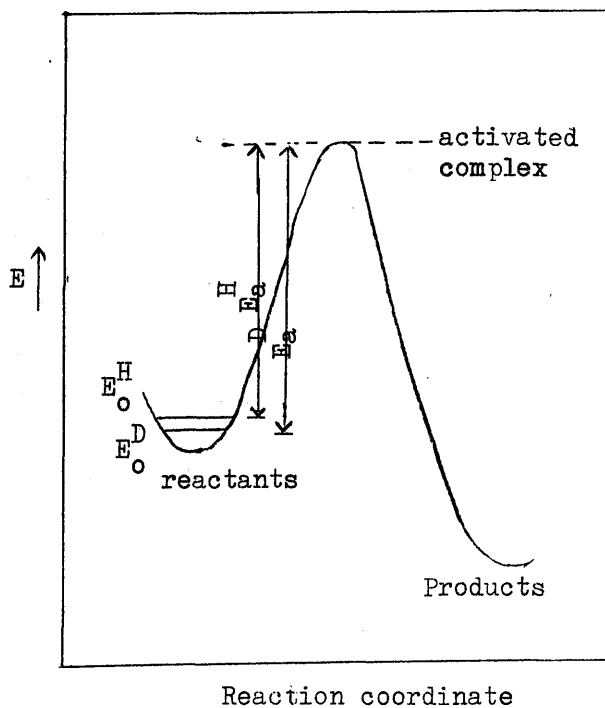

Fig. 2. Potential energy profile.

relatively weak in the activated complex in comparison with the reactant, the effect of zero-point energy on the rate becomes apparent. The weak bond in the activated complex reflects a low force constant, and since the difference in zero-point energy decreases with decreasing force constant, the difference in zero-point energy for this bond in the activated complex will usually be small. So, the difference in zero-point energy in the reactants will result in a difference in the height of the potential energy barrier for the reaction, i.e. a difference in the activation energy of the two isotopic compounds. Consequently in a rate process the heavier isotopic compound will require a greater energy of activation to surmount the energy barrier.

(ii) Effect of mass

The difference in mass can also affect the velocity of passage over the potential energy barrier. This is in systems in which the reactants are light molecules like hydrogen molecules. However, in the case of heavier molecules unless the effect of the mass is exercised via the vibration frequency of the zero-point energy, the effect (on passage over the potential energy barrier) will be negligible since in most reactions the isotopic atoms form a relatively small part of a much heavier molecule.

(iii) Leakage through energy barrier

According to the classical treatment the reacting molecules must surmount the energy barrier before they can pass to the product state, but quantum mechanically there is a definite probability that molecules with a

smaller amount of energy could succeed in getting from the initial to the final state. Since it is considered energetically impossible that such particles can go over the energy barrier it is suggested that they go through the energy barrier. This effect is, therefore, known as tunnelling. The smaller the mass of the particle the greater is its deviation from classical behaviour, and so, the tunnel effect will be more pronounced for reactions involving for instance proton transfer than for those involving deuteron transfer. This should lead to the reaction rate of the lighter isotopic compounds being greater than for the corresponding heavier isotopic compounds. However, the leakage effect is generally small and can usually be neglected without serious error. Bell and Caldin⁽³⁶⁾ have found that the influence of tunnelling on hydrogen isotope effect is negligible at normal temperatures, but at lower temperatures this factor may become more important.

So far, the major factor of the kinetic isotope effect is the contribution to the activation energy arising from changes in zero-point energy which occurs when the reactants are converted to an activated complex.

This is a simplified method which cannot easily account for cases of small isotopic rate constant ratio which have been observed in many organic reactions. The more rigorous approach to kinetic isotope effect is along the lines of the absolute rate theory by Eyring,⁽³⁷⁾ where a knowledge of the potential energy surface of two isotopic reacting systems enable one to

calculate the isotopic rate constant ratio, that is the isotope effect, by methods of statistical mechanics.

The calculation of the isotope effect using the absolute rate theory has become well known and Bigeleisen and Wolfsberg,^(34,38) Eyring and Cagle⁽³⁹⁾ and Melander⁽⁴⁰⁾ have given detailed accounts of the treatment. In the following the main features of this theory will be given first in order to form the basis for the discussion of the influence of atomic mass, and then its application for the elucidation of the kinetic isotope effect will be discussed following Melander's approach.

(b) Fundamentals of the Theory of Absolute Reaction Rates

The fundamental postulate of the theory of absolute reaction rates, is that the "activated complex", i.e. the configuration of the highest potential energy, which the reactants have to pass in order to form the products, may be regarded mainly as an ordinary molecule thermodynamically, which is in equilibrium with the reactants.

There is however, one important difference. The complex might be said to be unstable towards one of its modes of vibration, for the corresponding movement will lead to decomposition into the products. This is formally treated by the introduction of a translational degree of freedom and correspondingly one of the vibrational degrees of freedom is lost.

It is assumed that the equilibrium between the reactants and the activated complex is maintained by so rapid a mechanism that the decomposition into the products does not disturb the former. It is then

possible to calculate the concentration of the activated complex by the method of statistical thermodynamics if the energy levels of the reactants and the activated complex itself are known.

When the complex is treated as outlined above, it is found that of all the activated complexes present those crossing the barrier in unit time constitute a fraction, which has a universal value for all reactions. The rate of reaction may be written:

$$\text{Rate of reaction} = C_{\ddagger} \frac{kT}{h} \kappa \quad (1.2)$$

where C_{\ddagger} is the concentration of the activated complex and $\frac{kT}{h}$ is a universal frequency factor composed of k Boltzmann's constant, T the absolute temperature and h Plank's constant. κ is the transmission coefficient which takes into account the possibility that not every activated complex at the top of the potential energy barrier is converted into one of the reaction products.

If k is the specific rate of the reaction under consideration say,

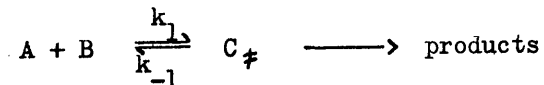

then it is given by the expression

$$\text{Rate of reaction} = k C_A C_B \quad (1.3)$$

from eq. (1.2) and (1.3)

$$k = \kappa \frac{kT}{h} \cdot \frac{C_{\ddagger}}{C_A C_B} \quad (1.4)$$

or

$$= \kappa \frac{kT}{h} K^\ddagger \quad (1.5)$$

where K^\ddagger is the equilibrium constant between the reactants and the activated complex.

K^\ddagger , as any other equilibrium constant, can be calculated according to statistical mechanics in terms of partition functions,

$$K^\ddagger = \frac{k_1}{k_{-1}} = \left(\frac{[C^\ddagger]}{[C_A][C_B]} \right)_{eq} = \frac{Q^\ddagger}{Q_A Q_B} e^{-E_c/RT} \quad (1.6)$$

In this expression the Q s are the partition functions of the molecules A, B, C^\ddagger and E_0 is the energy increase ~~(energy of activation)~~ *at 0°K, (taking as zero the minimum in the potential energy curve),* ~~absolute zero~~ when one mole of the activated complex is formed.

Substituting eqn. (1.6) in (1.5)

$$\therefore k = \kappa \frac{kT}{h} \frac{Q^\ddagger}{Q_A Q_B} e^{-E_0/RT} \quad (1.7)$$

This is the complete expression for the absolute reaction rate for any reaction. Recalling that Q^\ddagger the partition function of the activated complex omitting the vibration along the path of decomposition.

The complete partition function Q for unit volume of an ordinary molecule is to a first approximation the product of the translational, rotational and vibrational partition functions. For a polyatomic molecule

the partition functions are given by:

$$Q = q_{\text{trans.}} \times q_{\text{rot.}} \times q_{\text{vib.}}$$

where, for translation

$$q_{\text{trans.}} = \frac{(2\pi M kT)^{3/2}}{h^3}$$

where M is the mass and k , T and h have their usual significance. The rotational partition function for a non-linear polyatomic molecule is given by,

$$q_{\text{rot.}} = \frac{g_{\text{el.}} g_{\text{nuc.}}}{S} \frac{8\pi^2 (8\pi^3 ABC)^{1/2} (kT)^{3/2}}{h^3}$$

where $g_{\text{el.}}$, $g_{\text{nuc.}}$ account for the electronic statistical weight of the ground state and degeneracy due to different orientation of the nuclear spins, respectively. S is the symmetry number, i.e. the number of indistinguishable orientations the molecule can assume in one complete rotation. A, B, C, are the principle moments of inertia. The vibrational partition function is given by,

$$q_{\text{vib.}} = \prod_i e^{-\frac{1}{2} h\nu_i / kT} (1 - e^{-h\nu_i / kT})^{-1}$$

where ν is a mode frequency (the frequency of vibration).

(c) Isotope Effect in the Transition State Theory

The application of the transition state theory to the calculation of isotope effects can be illustrated by considering two isotopic reactions

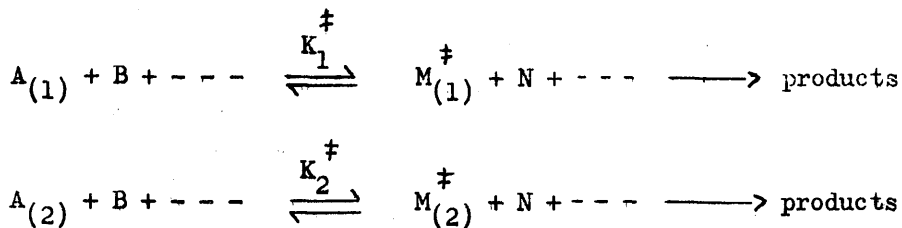

The subscripts (1) and (2) denote the two isotopic species of the reactant A, assuming it to be the only reactant present in two isotopic forms. K_1^\ddagger and K_2^\ddagger are the equilibrium constant between the activated complex and the reactants for the two isotopic reactions.

From eqn. (1.5), neglecting any isotope effect arising from tunnelling or the transmission coefficient, the ratio of the rate constants is given by:

$$\frac{k_1}{k_2} = \frac{K_1^\ddagger}{K_2^\ddagger} = \frac{Q_1^\ddagger}{Q_2^\ddagger} \times \frac{Q_{A(2)}}{Q_{A(1)}}$$

Substituting the values for the partition functions omitting the degree of freedom leading to decomposition from the partition function of the activated complex gives:

$$\frac{k_1}{k_2} = \left(\frac{M_1^\ddagger}{M_2^\ddagger} \right)^{3/2} \frac{S_2^\ddagger}{S_1^\ddagger} \left(\frac{A_1 B_1 C_1^\ddagger}{A_2 B_2 C_2^\ddagger} \right)^{1/2} \frac{\prod_{i=1}^{3n^\ddagger-7} \left(\frac{e^{-1/2u_1^\ddagger}}{e^{-1/2u_2^\ddagger}} \times \frac{1-e^{-u_2^\ddagger}}{1-e^{-u_1^\ddagger}} \right)}{\prod_{i=1}^{3n-6} \left(\frac{e^{-1/2u_2}}{e^{-1/2u_1}} \times \frac{1-e^{-u_1}}{1-e^{-u_2}} \right)} \quad (1.8)$$

$h\nu/kT$ has been replaced by the symbol u for the sake of brevity, the other symbols have their usual significance. As in any type of equilibrium, the factors $g_{\text{nuc.}}^\ddagger$ cancel each other within each K^\ddagger , and the $g_{\text{el.}}$ factors are cancelled between the two transition states and between the two molecules of type A, respectively, because isotopic species have the same electronic structure. The transmission coefficient ratio for the two isotopic species is cancelled, since κ is less than unity or probably close to unity in most of the reactions. Hirschfelder and Wigner⁽⁴¹⁾ have considered the problem and concluded that at not too low temperatures isotopic deviations should not be serious.

Equation (1.8) can be rearranged to the form:

$$\frac{k_1}{k_2} \times \frac{S_2}{S_1} \times \frac{S_1^\ddagger}{S_2^\ddagger} = \left(\frac{M_1^\ddagger}{M_2^\ddagger} \times \frac{M_2}{M_1} \right)^{3/2} \left(\frac{A_1 B_1 C_1^\ddagger}{A_2 B_2 C_2^\ddagger} \times \frac{A_2 B_2 C_2}{A_1 B_1 C_1} \right)^{1/2} \times$$

$$\times \frac{3n-7}{\prod} \frac{1-e^{-u_2}}{1-e^{-u_1^\ddagger}} \frac{3n-6}{\prod} \frac{1-e^{-u_1}}{1-e^{-u_2}} \times$$

$$\times \exp \left\{ -\frac{1}{2} \left[\sum^{3n-7} (u_1^\ddagger - u_2^\ddagger) - \sum^{3n-6} (u_1 - u_2) \right] \right\} \quad (1.9)$$

This is the main equation and from this point the discussion will be specified as required by the nature of the problem.

In the study of the primary hydrogen isotope effect, i.e. isotope effects of reactions in which hydrogen is directly involved, the substitution of an atom of deuterium or tritium for the hydrogen at the reactive centre in a large organic molecule such as 1:4, dihydronaphthalene will have little effect on the molecular mass M or moment of inertia in eqn. (1.9). Thus the two parentheses of eqn. (1.9) containing the molecular masses and moments of inertia could be approximated to unity. The symmetry numbers are fairly trivial and will cause no isotope effect.

The vibrational term can also be approximated to unity since, for a big molecule the energy spacing between the vibrational levels will generally be considerably larger than kT at room temperature. This

means that most oscillators are in their zero-point levels. The exponential e^{-u} will be small compared to unity. This discussion holds for both the reactants and the transition state although in the latter some of the vibrational modes may behave differently. The vibration corresponding to movement along the decomposition coordinate is already excluded, but there are for instance, also bending vibrations in these bonds.

The hydrogen isotope effect can then be considered as being due entirely to the zero-point energy differences. Cancelling all partition functions in eqn. (1.9) gives:

$$\frac{k_1}{k_2} = \exp \left\{ -\frac{1}{2} \left[\sum^{3n^\ddagger-7} (u_1^\ddagger - u_2^\ddagger) - \sum^{3n-6} (u_1 - u_2) \right] \right\} \quad (1.10)$$

If the reaction is the breaking of a X-H bond, $u_1 = u_2$ for all modes except that of the bond to be broken, for which u_1^\ddagger and $u_2^\ddagger = 0$.

Thus eqn. (1.10) reduces to:

$$\frac{k_1}{k_2} = \exp \left\{ \frac{1}{2}(u_1 - u_2) \right\} \quad (1.11)$$

This assumes that the bending frequencies of the X-H are the same in the transition state as in the reactants. If the bending vibrations of the cleaving bond behave differently, e.g. they have their frequency increased in the transition state, this increase of the zero-point energy on

passing into the transition state might more or less cancel the influence of the extra term in the zero-point energy of the reactant, a weakening of the isotope effect being the result.

The other extreme is that if we assume the bending frequencies of the cleaving bond are lost too. In this case the assumptions leading from eqn. (1.9) to eqn. (1.10) are no longer valid. Two factors of the type $(1-e^{-u_2^\ddagger})/(1-e^{-u_1^\ddagger})$ cannot be approximated by unity. Such a factor approaches the value $u_2^\ddagger/u_1^\ddagger$ when the force constant and hence the u's approach zero. Since we have assumed that the hydrogen is attached to a heavy residue, we can approximate this ratio by $(m_{H_1}/m_{H_2})^{1/2}$. The two bending modes will thus introduce a factor m_1/m_2 .

Since two vanishing frequencies have been assigned to the transition state, there will now be three unmatched terms in the zero-point energy of the reactant giving:

$$\frac{k_1}{k_2} = \frac{m_1}{m_2} \exp \left\{ \frac{1}{2} \sum^3 (u_1 - u_2) \right\} \quad (1.12)$$

If the stretching frequencies of both isotopic bonds are not known, one might be calculated from the other by means of the reduced masses of the systems hydrogen plus heavy residue. To a crude approximation the small mass will be the decisive and so the hydrogen mass is used for the reduced mass, thus:

$$\frac{u_1}{u_2} = \frac{v_1}{v_2} = \left(\frac{m_D}{m_H} \right)^{1/2} \quad (1.13)$$

eqn. (1.11) and (1.12) has been used for calculation of k_D/k_H and k_T/k_H for C-H bonds by Melander. (40)

Table 4 shows the rate constant ratios for different temperatures.

TABLE 4
Hydrogen Isotope Effects Calculated by Means of
Equations (1.11), (1.12) and (1.13)

°C	k_D/k_H		k_T/k_H	
	eqn. (1.11)	eqn. (1.12)	eqn. (1.11)	eqn. (1.12)
0	0.10	0.042	0.035	0.011
25	0.12	0.058	0.047	0.018
50	0.14	0.077	0.059	0.027
75	0.16	0.097	0.073	0.038
100	0.18	0.12	0.087	0.051
120	0.20	0.14	0.10	0.066
150	0.22	0.17	0.12	0.083

The previous discussion can now be applied to the two mechanisms proposed by Braude et al. (18) If deuterium or tritium is substituted

for the transferable hydrogens in the donor molecules then it may be possible to distinguish between the two mechanisms on the basis of the magnitude of the isotope effect. In the two step mechanism it is suggested that the hydride ion transfer constitutes the rate determining step and in this case eqn. (1.11) should be applicable. On the other hand the single-step mechanism might be expected to lead to considerable strain in the C-H bonds in the transition state. This would introduce a bending mode of vibration in the C-H bond and the magnitude of the isotope effect would depend critically on the bending frequencies in the transition state. If these tend to zero and the bond is broken, eqn. (1.12) should be applicable but if their frequencies are increased then the increase of the zero-point energy on passing into the transition state will tend to cancel the influence of the extra term in the zero-point energy of the reactant molecule. A low isotope effect would be expected.

1.5 Outline of Experimental Techniques and Calculations

(a) The Arrangement of Experiments with Isotopic Hydrogen (Tritium)

One method of comparing the reaction velocities of hydrogen isotopes would be to carry out two reactions, one using 1:4, dihydro-naphthalene and chloranil and the other with the tritiated hydrocarbon and chloranil. This would require the preparation of macroscopic amounts of the initial substance containing only tritium at least in all positions accessible for dehydrogenation.

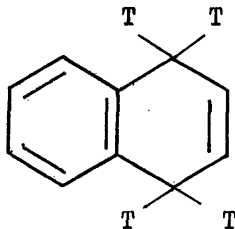

However, since it is possible to carry out accurate radio-assays on unweighable amounts of the tritiated compound, the reaction can be investigated by arranging a competition process, in this case between the small amounts of partially tritiated compound and the bulk of the normal hydrocarbon in the same reaction mixture.

Generally more than one position will come into question for dehydrogenation and when monotritiated molecules are used, competition occurs both within the molecules containing tritium and between these and the bulk, containing no tritium. The reaction mixture will contain the hydrocarbon in three isotopic forms:

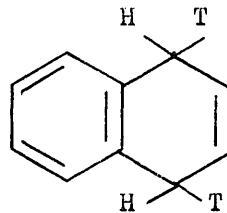
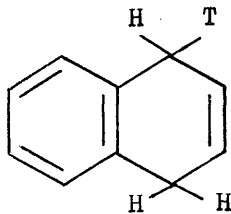
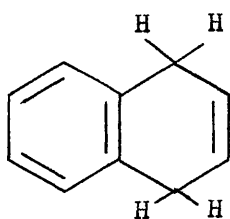

Tritiated dihydronaphthalene was prepared by an adaptation of Huckel and Hans Schlee's⁽⁴²⁾ method using tritiated benzoic acid. Detailed description of the method is given in the experimental section. The method of analysis was to find the isotopic molar content of the remaining dihydronaphthalene after a known degree of reaction. This was accomplished using gas-liquid chromatography (G.L.C.) technique for the separation of the dihydronaphthalene, and a liquid scintillation counter to estimate the activity of the tritiated dihydronaphthalene. The calculation of the isotopic rate constant ratio, k_T/k_H , is given by Melander,⁽⁴⁰⁾ eqn. (1.14),

$$\frac{a_1/a_2}{a_1^0/a_2^0} = \frac{a_1/a_1^0}{a_2/a_2^0} = \frac{1 - x_1}{1 - x_2} = (1 - x_2)^{\left(\frac{k_1}{k_2} - 1\right)} \quad (1.14)$$

where a_1^0/a_2^0 is the isotopic ratio of the original substrate and a_1/a_2 is that after a stoichiometrically measured fraction x_2 has reacted. The formula may be readily obtained from the simple first order equations.

It is usually desirable to make measurements of a_1/a_2 at relatively low x_2 values (up to 50% at most), since the error in determining k_1/k_2 (i.e. k_T/k_H) varies with x_2 (the over all fraction of reaction), increasing as x_2 increases. This is discussed more fully by

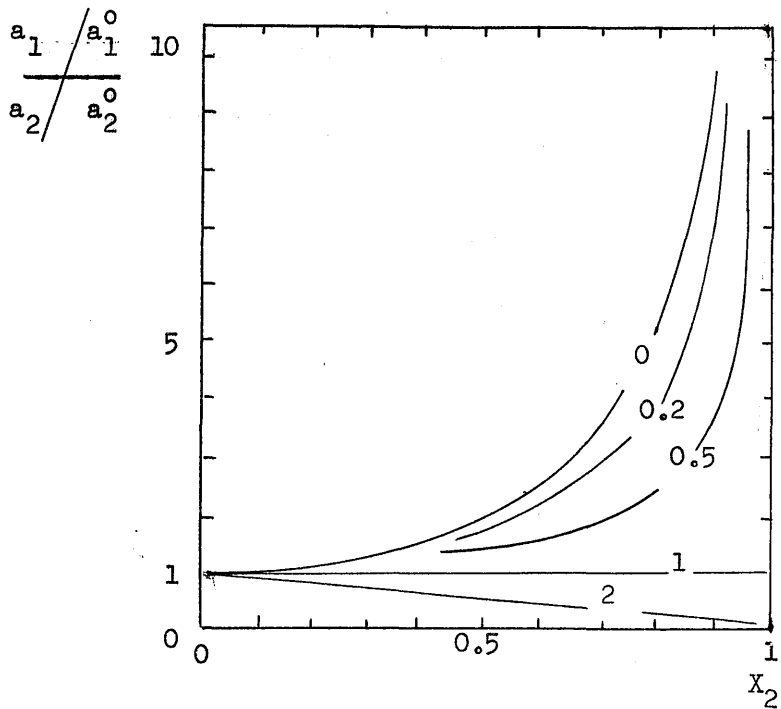

Fig. 3. Relation between the relative tracer content of remaining reactant and the amount of reaction, cf. Eq(1.14). The figures in the curves indicate the rate constant ratio k_1/k_2 .

Bigeleisen and Allen⁽⁴³⁾ and the variation is shown in Fig. 3.

(b) Arrangement of Experiments for Measurement of Kinetics

The overall kinetics of the reaction has been previously studied under a variety of conditions. Dost and Van Nes⁽¹⁶⁾ have studied the reaction by following the disappearance of the quinone (chloranil) colorimetrically making use of the very intense colouration of chloranil with N-dimethyl aniline. Braude, Jackman and Linstead⁽¹⁸⁾ have studied the reaction by following the disappearance of the quinone, either by titration of the quinol formed in the reaction with ceric sulphate or by reduction of the quinone with titanous chloride. In both cases the overall kinetics of the reaction was followed only by estimating one of the reactants or one of the products, and in both cases second order kinetics was assumed on this basis.

As the object of the present work was to carry out a more detailed investigation for the reaction mechanism, it was decided to study the kinetics of the reaction by following the disappearance of the dihydronaphthalene and in addition estimating the quinol reaction product. This was accomplished by using gas-liquid chromatography technique to follow the disappearance of the dihydronaphthalene and the estimation of the quinol was accomplished by titration with ceric sulphate.

In future throughout the thesis we will refer to 1:4, dihydronaphthalene as 1:4, DHN and to tetrachloro-1:4, benzoquinone as T₄Q.

CHAPTER II

EXPERIMENTAL

2.1 Sources and Purification of Materials

(a) The Quinone

Chloranil (tetrachloro-1:4,benzoquinone) was obtained from B.D.H. Ltd. Purification was effected by recrystallization from benzene; the melting point (289-290°C) of the recrystallized material was in good agreement with the values previously reported in the literature.⁽⁴⁴⁾

(b) The Hydrocarbon

1:4,dihydronaphthalene was prepared by the reduction of naphthalene with sodium in alcoholic solution.⁽⁴⁵⁾ 0.5 mole (64 g.) of naphthalene and 2.0 mole (46 g.) of sodium, cut into small pieces, were placed in a three-necked flask equipped with a stirrer, a dropping funnel, and a long condenser. The mixture was heated on an oil-bath at 140-145°C and as the naphthalene and sodium melted, the mixture was stirred vigorously until a thorough emulsion was obtained. The stirring was continued and the mixture was allowed to cool to a bath temperature of 60°C when 150 ml. of dry (A.R.) benzene was slowly added. The bath temperature was then raised to 90-100°C to effect moderate refluxing of the benzene, and 600 ml. of absolute alcohol was added at such a rate as to maintain well-controlled reflux. The mixture was allowed to cool and the precipitated sodium ethylate was

decomposed by pouring the reaction product into a solution of 225 g. concentrated HCl in 1.5 L. of crushed ice. The upper benzene layer was removed and the aqueous layer was extracted with two 100 ml. portions of benzene. The combined benzene extracts and the original portion were washed with saturated sodium bicarbonate solution and dried over sodium sulphate.

The dihydronaphthalene was separated from the benzene layer by fractionation through a column, and the fraction boiling at 210-212°C, containing the 1:4,DHN, was collected.

The major impurities in the fraction are unreduced naphthalene, a trace of isomeric 1:2,DHN and tetralin. Two methods have been employed for their removal. The first was the technique originally used by Sand and Genssler,⁽⁴⁶⁾ involving the formation of the mercuric acetate derivative of the 1:4,DHN. This was formed by dissolving the crude compound in ether and shaking with an aqueous solution of mercuric acetate for 24 hours. Long needle-like crystals of the acetate were formed (m.p. after crystallization from benzene was 122°C). The crystals were filtered off and the pure 1:4,DHN compound was regenerated by treating the derivative with cold 30% HCl. After filtration the pure 1:4,DHN was collected by vacuum distillation at 18 mm and 96°C.

This method gave very low yields, usually about 10%. The main difficulty lay in the regeneration of the 1:4,DHN compound from the

mercury derivative.

A more satisfactory method of purification was to simply vacuum distil the crude product collecting the fraction containing the dihydro compound. This fraction was again vacuum distilled. Using this method, the final yield was approximately 50%. The purity was checked by u.v. spectroscopy and the spectra compared satisfactorily with those reported in the literature.⁽⁴⁷⁾ The purity has also been checked by gas-liquid chromatographic analysis (to be discussed later) and only trace amounts of naphthalene were found.

(c) Tritiation of 1:4,dihydronaphthalene

The method was essentially the same as that used for the preparation of the unlabelled material; naphthalene was reduced by tritiated benzoic acid and sodium in ethereal solution.⁽⁴²⁾

(i) Tritiated benzoic acid (C_6H_5COOT) was prepared from benzoyl chloride in the following way. 20 ml. of benzoyl chloride was boiled in a 50 ml. conical flask fitted with a long condenser. 5 ml. of tritiated water, which was obtained from the Radiochemical Centre, Amersham, was slowly added to the chloride and the mixture boiled under reflux for 20 minutes. On cooling the HCl was separated from the crystals of tritiated benzoic acid by vacuum filtration. The melting point of the tritiated acid was 122.5-123°C.

The effectiveness of this method for the labelling of hydrogen on carboxylic groups has been demonstrated by Hadzi and Sheppard.⁽⁴⁸⁾ The infra-red spectra of the deuterated acid prepared by this method has shown almost complete deuteration of the COOH group.

(ii) 0.031 mole (4 g.) of naphthalene and 0.43 mole (10 g.) sodium were placed in a three-necked, 500 ml. conical flask, fitted with a stirrer, condenser and a dropping funnel. Following the same procedure as in the preparation of the inactive 1:4,DHN compound, the mixture was heated to 140-145°C on an oil-bath and the melt vigorously stirred and then cooled to 30-28°C. 200 ml. of ether was then added, and the temperature was raised to 90-100°C. 14 g. tritiated benzoic acid prepared as above, in 250 ml. ether were added gradually with continuous stirring under moderate reflux and the mixture allowed to cool. The precipitated sodium benzoate was filtered off and washed several times with ether. The filtrate, containing the labelled 1:4,DHN together with impurities of the reduction products of naphthalene (unreduced naphthalene, isomeric 1:2,DHN and tetralin), was evaporated to dryness under vacuum.

The crude tritiated 1:4,DHN was purified by quantitative gas-liquid chromatography (discussed later). Final purification was not carried out until immediately before the material was required for the kinetic investigations. The specific activity of the final product was 0.13 μCg^{-1} .

It is worthwhile at this point to discuss the method of storage of the 1:4,DHN since, as will be shown later, this does affect the kinetic measurements. In the early work the hydrocarbon was stored under vacuum at 0°C; this is the method used by earlier workers. However, it was found in the present work that this method of storage was unsatisfactory; the crystals, originally colourless, became yellow over the period of a few weeks. This necessitated frequent purification of the hydrocarbon prior to its use in the kinetic measurements. In the later work the hydrocarbon was stored at -10°C and it was found that this method prevented the colouration over periods in excess of a year.

(d) The Solvent

The solvent used in the majority of kinetic experiments was phenetole, which has good solvating powers for a wide variety of quinones and quinols and is stable for prolonged periods at the elevated temperatures required in these experiments. In this laboratory, phenetole, obtained from B.D.H. Ltd., was purified by refluxing over sodium for about an hour and then distilled, the fraction of boiling point 168-170°C being collected and used as the solvent.

2.2 General Kinetic Procedure

(a) The Kinetic Apparatus

The reaction vessel Fig. 4 is a modification of the type used

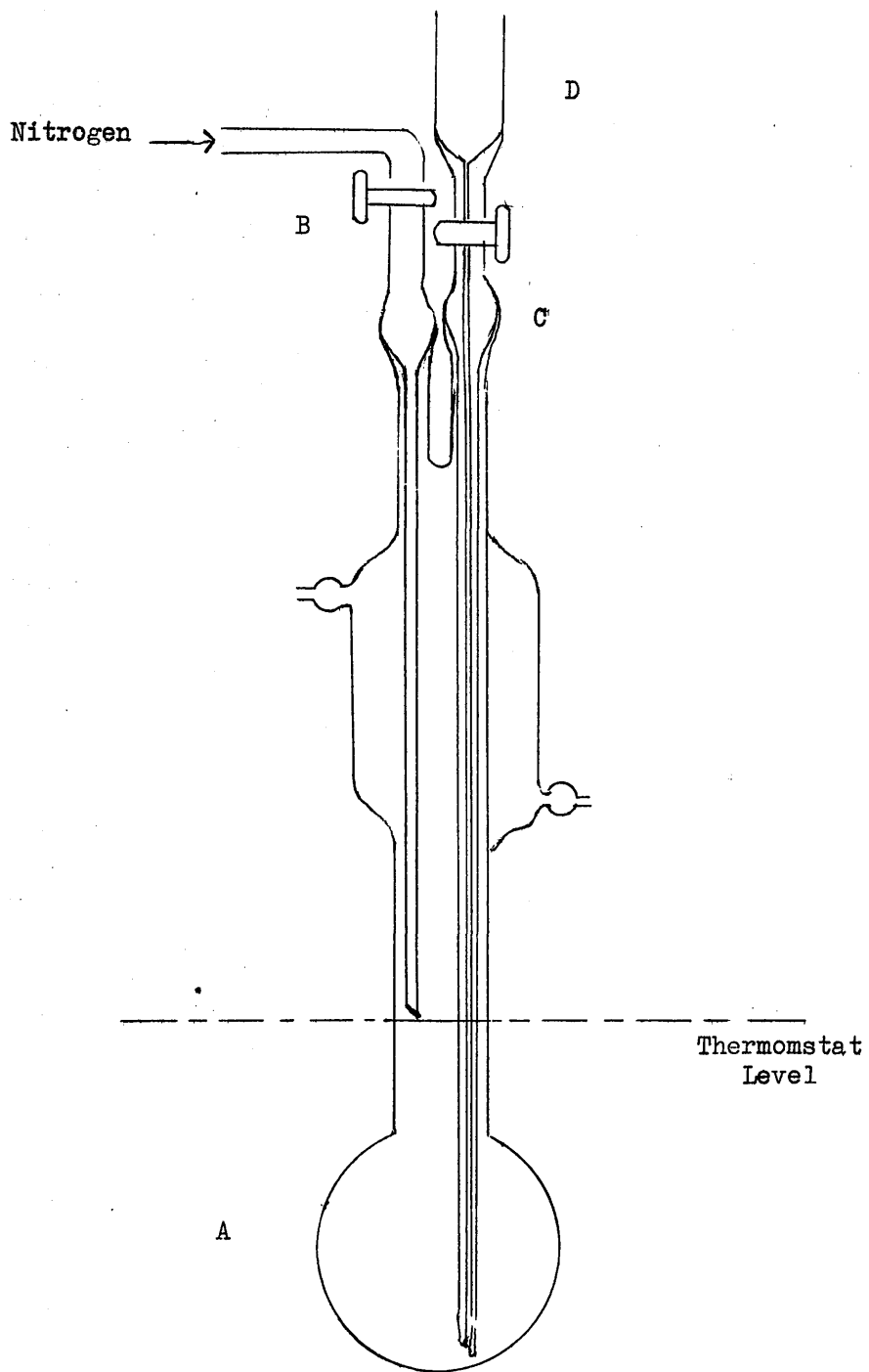

Fig. 4. The Kinetic Apparatus.

by Braude et al. (18,49) The long-necked flask allows complete immersion of the bulb, A, (ca. 100 ml.) in the bath and avoids glass joints in the vicinity of the reaction mixture. The reaction flask (containing the reactants) was immersed in a water bath the temperature of which was controlled by a "Tecam" Tempunit thermostat. The temperature could be controlled to $\pm 0.5^{\circ}\text{C}$ of the desired value (80°C). A film of paraffin oil spread over the surface of the water reduced considerably the evaporation of water. In order to maintain an inert atmosphere in the reaction vessel, a stream of nitrogen, purified and dried by successively passing through bubblers containing alkaline pyrogallol, sodium anthraquinone-2-sulphonate, sodium hydrosulphite, and concentrated H_2SO_4 is led into the vessel via the capillary inlet tube B, and allowed to leak out via the slightly raised capillary sampling tube C.

(b) Dehydrogenation: General Procedure

Before a run was carried out, the empty vessel was flushed with nitrogen through tube B. A solution of approximately 0.3 M, 1:4,DHN in phenetole, usually 25 ml., was pipetted into the vessel via C. Tube C was replaced in a slightly-raised position to allow slow leakage of nitrogen and the mixture allowed to reach thermal equilibrium at the required temperature (80°C) (ca. 2 hours). A small glass tube, containing sufficient finely ground quinone to give approximately 0.1 M. solution was dropped into the flask through the side of tube C

which was then replaced. The reaction mixture was immediately shaken vigorously until all the quinone had dissolved (ca. 1.5min.). Subsequently 1 ml. samples were withdrawn at appropriate intervals through the sampling tube C and analysed either for the quinone or the 1:4,DHN as described below. Analysis of the quinone was done immediately after sample withdrawal, to prevent any aerial oxidation of the quinol formed in the reaction. The samples for hydrocarbon analysis were placed in stoppered 1 ml. volumetric tubes and kept at 0°C until required.

(c) Method of Sampling

Throughout the reaction the sampling tube C was slightly raised to permit a slow outward leakage of nitrogen, and, at the moment of sampling, tube C was firmly fixed into the socket so that there was no leakage of nitrogen. The pressure of nitrogen in the flask forces the reaction mixture into the capillary tube C and a 1 ml. sample was withdrawn from D with 1 ml. syringe. Tube C was then restored to its original position to permit slow leakage of nitrogen as before and to allow the solution to return to flask A.

2.3 The Quinone Analysis

(a) Introduction

In general three types of analysis can be applied for the estimation of the quinone concentrations in this reaction. In the first type the quinone concentration is determined by direct reduction

of aliquot portions with titanous chloride.⁽⁵⁰⁾ The alternative method is to estimate the quinone concentration spectrophotometrically. Both methods have been used by Braude et al^(18,23) who have shown that they are of limited application. The spectroscopic method have given inconsistent results probably due to the overlap of the absorption spectra of the reaction components, and the titanous chloride method can only be used satisfactorily for quinones with a high redox potential.

An indirect method, but one of much more general applicability is to estimate the quinone by oxidizing the quinol formed in the reaction using a suitable oxidizing agent. Ceric ammonium sulphate with diphenylamine as indicator has been found to be a satisfactory oxidant.⁽¹⁸⁾ Complications can arise since some quinones can be attacked by ceric ions, but this is usually a slow process and does not lead to a serious error in the estimation.

In this laboratory, after unsuccessful attempts to apply the titanous chloride method, the method finally adopted was that of oxidation of the quinol with ceric sulphate.

(b) Reagents and Procedure

Approximately 0.1 N $\text{Ce}(\text{SO}_4)_2$ was prepared in acid solution and standardised against accurate 0.1 N sodium oxalate (A.R.) solution using the $\text{Ce}(\text{SO}_4)_2$ as a self-indicator. 0.04 N $\text{Ce}(\text{SO}_4)_2$ solutions were prepared from the original solution by accurate dilution.

The titration of the quinol present in the reaction mixture with $\text{Ce}(\text{SO}_4)_2$ solution was carried out in the following way:

0.9 ml. of the reaction mixture, 1 ml. acetic acid, 2 ml. water and two drops of the indicator 1% sodium diphenylamine sulphonate, were placed in a glass-stoppered 10 ml. conical flask and standardized $\text{Ce}(\text{SO}_4)_2$ solution (ca. 0.04 N) was run in slowly from a micro burette with constant shaking, until a permanent violet colour persisted on shaking for at least 30 seconds.

2.4 The Hydrocarbon (1:4,DHN) Analysis

This constitutes the major analytical problem in this research. It was not only desirable to find out quantitatively the amount of the hydrocarbon (1:4,DHN) concentrations in the reaction mixture for the kinetic studies, but also, in order to carry out isotopic analysis, it was necessary to separate quantitatively a sufficient amount for radiotracer assay. Gas-liquid chromatographic analysis (G.L.C.) proved to be the best technique for both identification and quantitative separation of the 1:4,DHN. Accordingly the concentrations of the reactants (mentioned before) in the kinetic procedure, and, the method of analysis of the hydrocarbon (1:4,DHN) were designed in such a way as, to meet these requirements.

(a) Gas-Liquid Chromatographic Analysis

The chromatographic apparatus was a Griffin and George v.p.c. Mark II. Fig. 5 shows the flow diagram in block form. The column was in the form of a u-shaped pyrex tube 36" in length and 1" diameter.

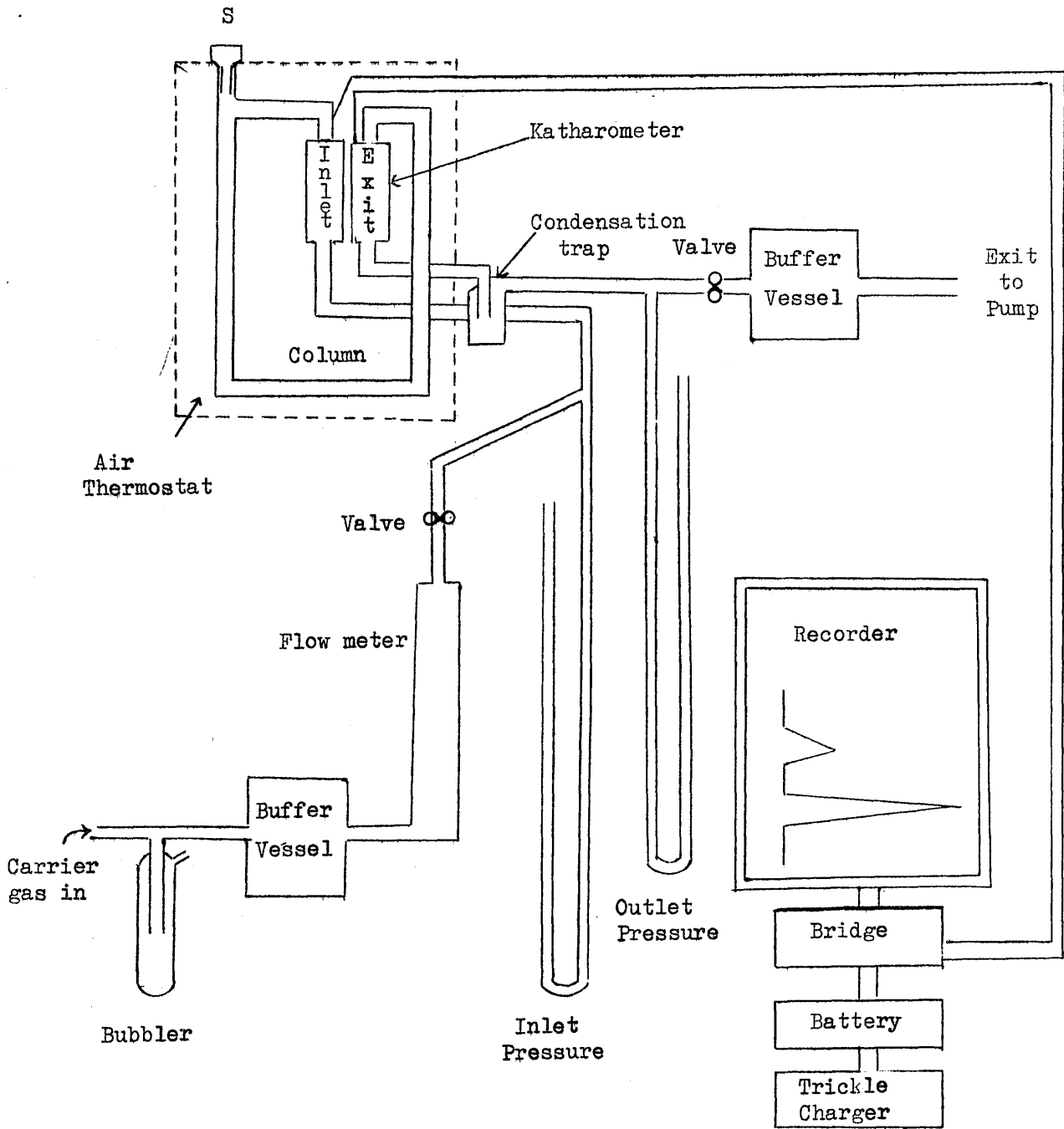

Fig. 5. Flow Diagram of G.L.C.

This was packed with 44/85 mesh graded brick dust as the support material on which was coated 20% carbowax (polyethylene glycol "600"). To prepare the coated solid, the required amount of the stationary phase (20 g.) was dissolved in a volatile solvent such as acetone and the corresponding weight of the support material (80 g.) stirred in. The solvent was removed by gentle warming (on a boiling water bath) with thorough agitation of the mixture to ensure even deposition of the stationary phase. Finally the coated solid was dried in an air oven (40°C) for several hours. A correctly packed column was vital for efficient operation. Great care was taken to ensure an even filling. While the column is gently tapped, the packing material was slowly poured through a funnel until no more could be accommodated and the two ends of the column were plugged with glass wool. Before use, the packed column was heated in the chromatographic apparatus under continuous flow of nitrogen and at a temperature slightly higher than the operating temperature for at least five hours to remove any volatile impurities.

The sample for analysis was injected into the column at point S through a rubber serum cap and was carried by nitrogen (the mobile phase) through the column, where partitioning takes place. The column was maintained at a temperature of $120 \pm 0.5^{\circ}\text{C}$ and the inlet and the outlet pressure of the carrier gas and its flow rate maintained at 22 cm. Hg; 4 cm. Hg and 3L./hour respectively. The retention times

for specific components being different, each component emerges from the column separated from the others. They pass with the carrier gas through the exit side katharometer cell where they are detected by the resulting difference in the thermal conductivity of the gas stream. The two cells of the Katharometer are arms of a wheatstone bridge type circuit and the off-balance signal in the exit cell is automatically recorded on a strip chart which presents the data on a series of peaks along a horizontal time axis (speed of recorder 12"/hour.) The area under the peaks is proportional to the concentration of the hydrocarbon components in the effluent gas. A typical elution chromatogram with a synthetic mixture of 1:4,DHN, tetralin and naphthalene in phenetole is shown in Fig. 6 and Table 5 shows the retention data for the three hydrocarbons.

TABLE 5

Retention Data for the Hydrocarbons (1:4,DHN, Tetralin
and Naphthalene) on Carbowax 20% Column

<u>Hydrocarbon</u>	<u>*Peak distance from injection point (in cm) to the peak maximum</u>
tetralin	16.5
1:4,DHN	27.1
naphthalene	43.0

* Distance data may vary \pm 2.5 cm depending on column packing

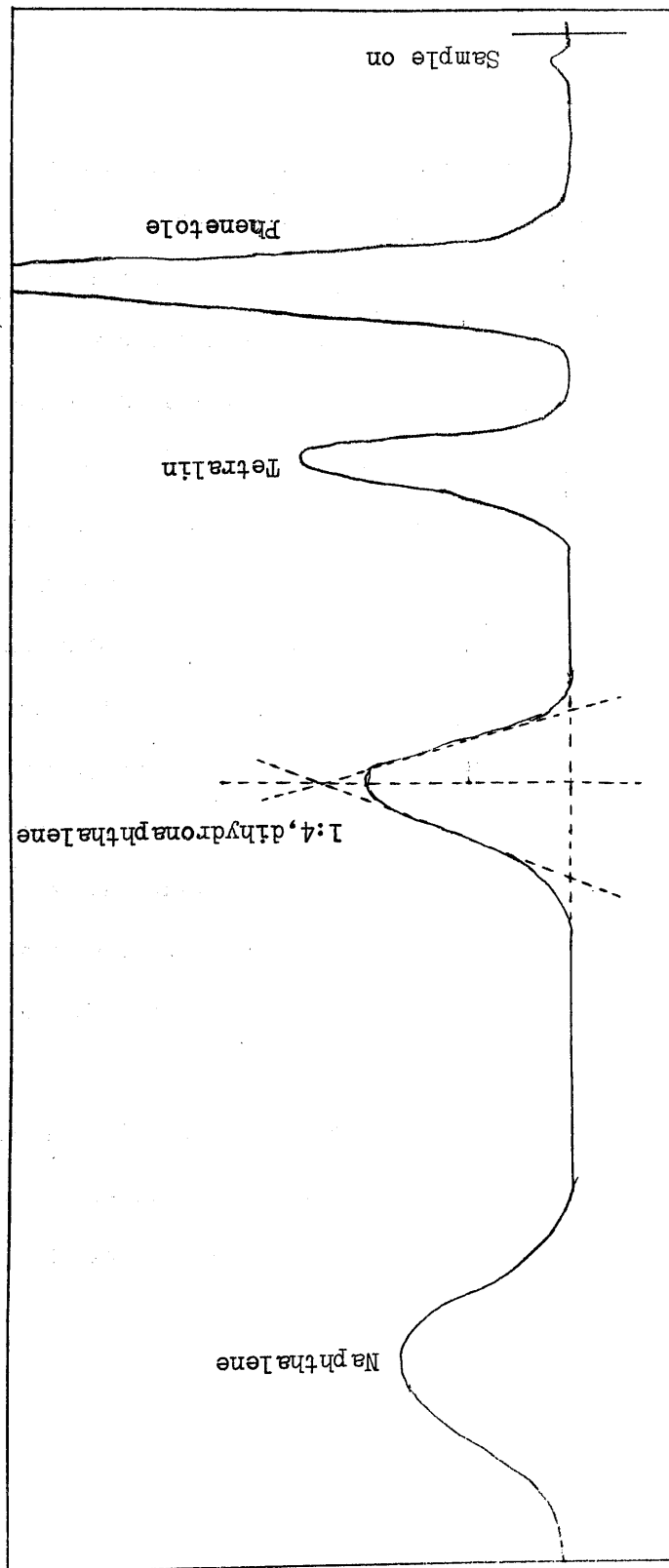

Fig. 6. Elution Chromatogram for 1:4, dihydronaphthalene, Tetralin and Naphthalene.

(b) Procedure of the Chromatographic Quantitative Analysis

The quantitative analysis for the 1:4,DHN initially required the accurate determination of calibration curves under the operating conditions. This was carried out by injecting a known series of concentrations of the 1:4,DHN, from 0.025 to 0.005 g., present in a constant volume of the solvent 0.4 ml. on to the column. The area under the resolving peaks was taken as equivalent to the amount of 1:4,DHN present and calibration curves could be drawn by plotting the grams present in 0.4 ml. against the corresponding peak area. These areas were determined by taking half the product of the peak height and the width given by the inflection tangents at the base; this is illustrated in Fig. 6 for 1:4,DHN peak. Fig. 7 represents a typical calibration curve. The calibration figures for all the calibration curves of newly packing columns with indication of the corresponding runs for which they have been used, are given in appendix (a).

In each kinetic run the concentration of 1:4,DHN was estimated by injection of 0.4 ml. of the reaction mixture sample taken at appropriate intervals into the column. The area under the peak was estimated and using the corresponding calibration curve the amount of 1:4,DHN in the reaction mixture was deduced.

2.5 Isotopic Analysis

In order to calculate the relative rate constants k_1/k_2 of the

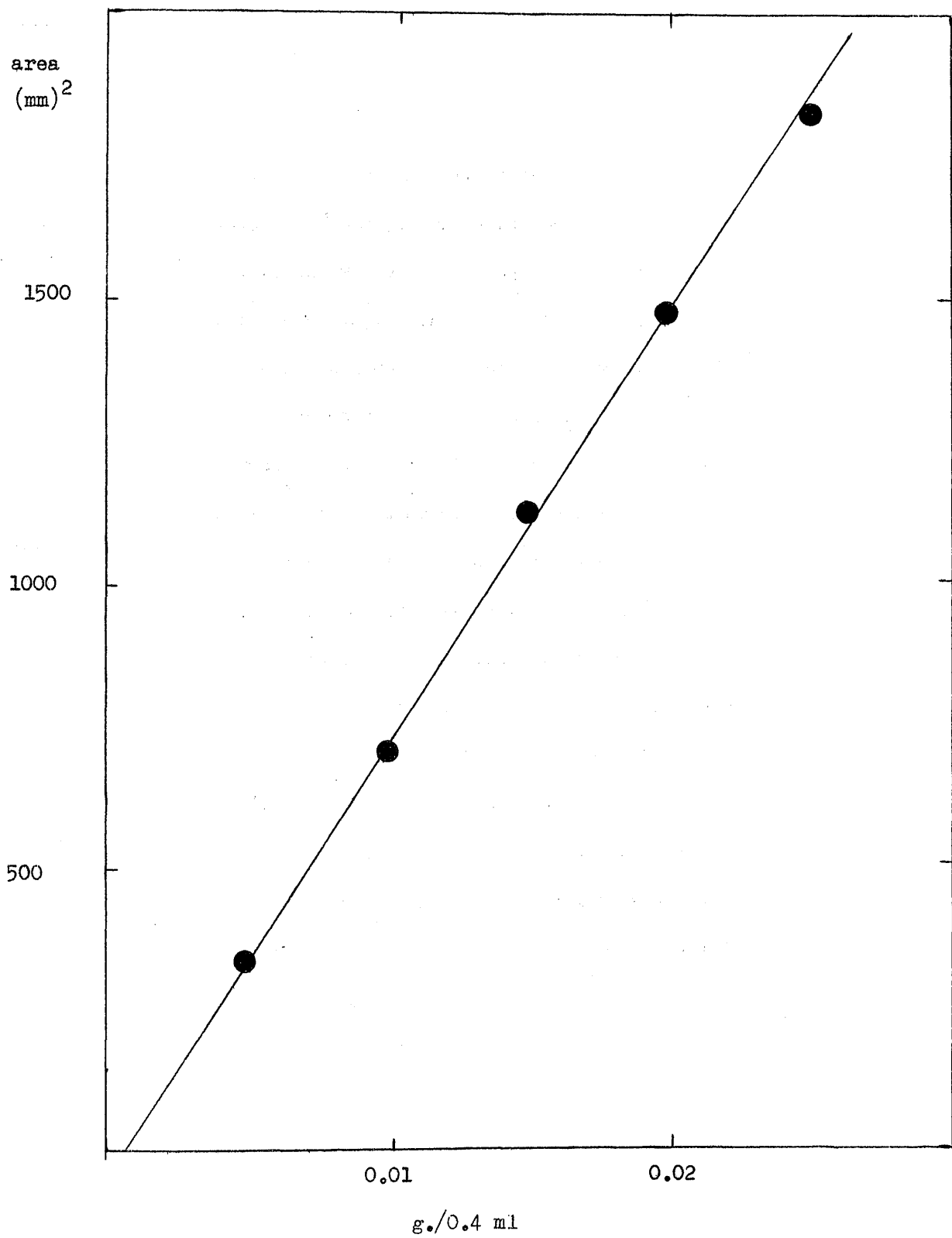

Fig. 7. Calibration Curve for 1:4, DHN

tracer and unlabelled hydrocarbon, the specific activity (a_1/a_2 in eqn. 1.14) of the reactant must be determined. If the tracer is radioactive, as in the present work, then the estimation can be carried out by end-window g-M. counting, proportional gas counting or scintillation counting. The first of these methods is unsuitable for tritium since it is a β -emitter of very low energy (5,700 eV). Even with very thin counter windows (1-2 mg cm.⁻²) absorption of the β -particles would be substantial and there would be major problems of self-absorption in the sample. Gas counting is a much more efficient method of estimation but this would require the burning of the sample to carbon dioxide and water vapour. In addition it is difficult to introduce each sample into the counter under identical conditions and the process would probably require the determination of the counting conditions for each sample. Although the method is an efficient one it would be very laborious for the present experiments. Liquid scintillation counting appeared to be the most suitable method for the present purpose. The samples could easily be dissolved in the scintillator and the absence of oxygenated compounds should ensure satisfactory counting efficiencies.

(a) The Apparatus

The apparatus is shown in Fig. 8. The scintillator liquid is contained in a small beaker of approximately 7 cm high and 2.8 cm in diameter; the beaker was specially constructed from quartz, having a

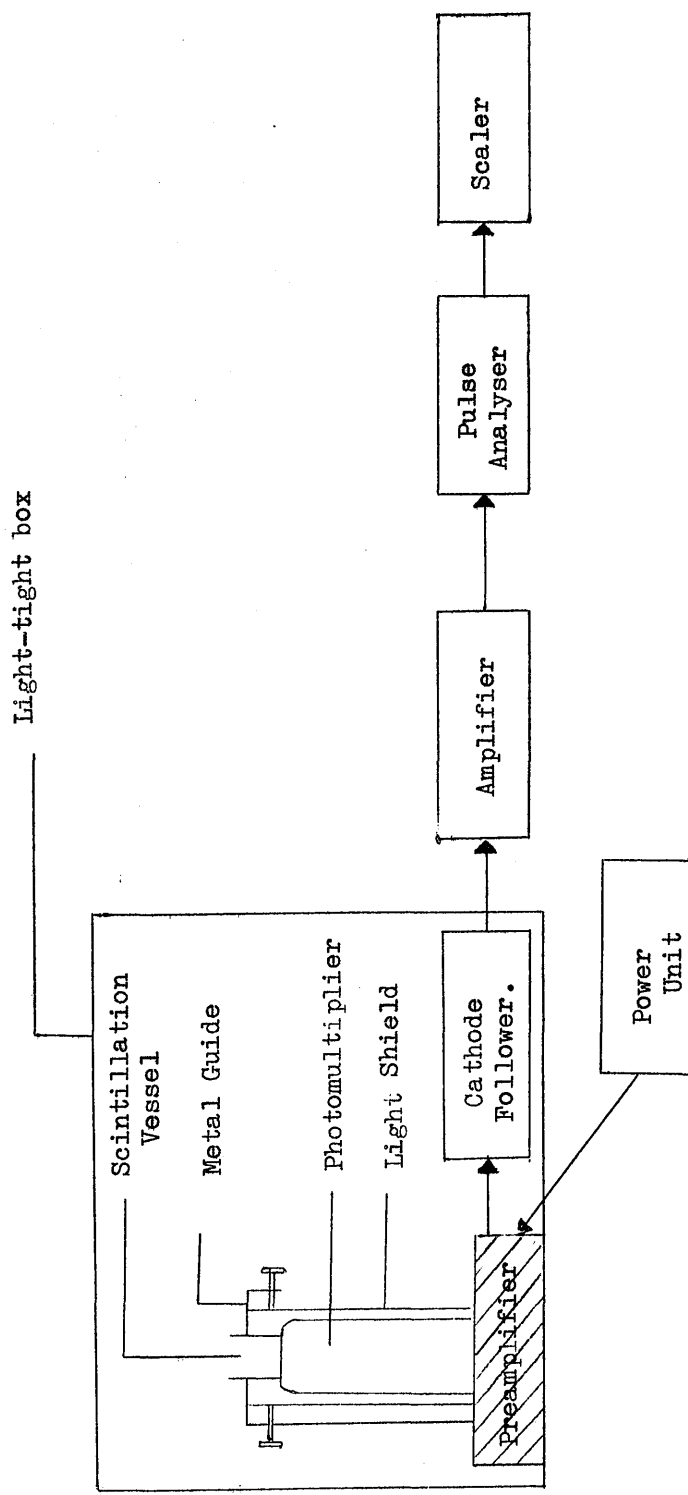

Fig. 8. Scintillation Counter Unit. Block Diagram.

very low content of natural radioisotopes, e.g. K^{40} , to reduce background. The outside of the vessel was coated with metal film and dark adapted in order to reflect light back into the counter and thus minimise light loss. The scintillation vessel had an optically flat base and it was "sealed" to the face of an E.M.I. 6097B photomultiplier tube with silicone oil. The latter produced a good optical contact. A metal guide fitted to the photomultiplier tube ensured that the scintillation vessel could be mounted in a reproducible position. A light-tight shield enclosed the photomultiplier tube and coil of polythene tube surrounded the shield. Tap water was continuously passed through the coil to minimise thermal emission of electrons from the photocathode. The entire assembly was located in a light-tight box which was only opened when illumination was provided by a weak red light.

Power was supplied to the photomultiplier from a stabilised Dynatron N 103 unit and the output from the photomultiplier was amplified by a Dynatron 1430A cathode follower and amplifier. The signal was discriminated on a Dynatron N 101 pulse height analyser and the final output recorded on an Ecko N 529C scaler.

(b) Calibration of the Apparatus

The optimum working conditions for the counting unit was determined using a standard tritiated source (n-hexadecane-1-2-T). Count rates as a function of the voltage, the pulse height, the channel

Fig. 9. Calibration of Scintillation Counter

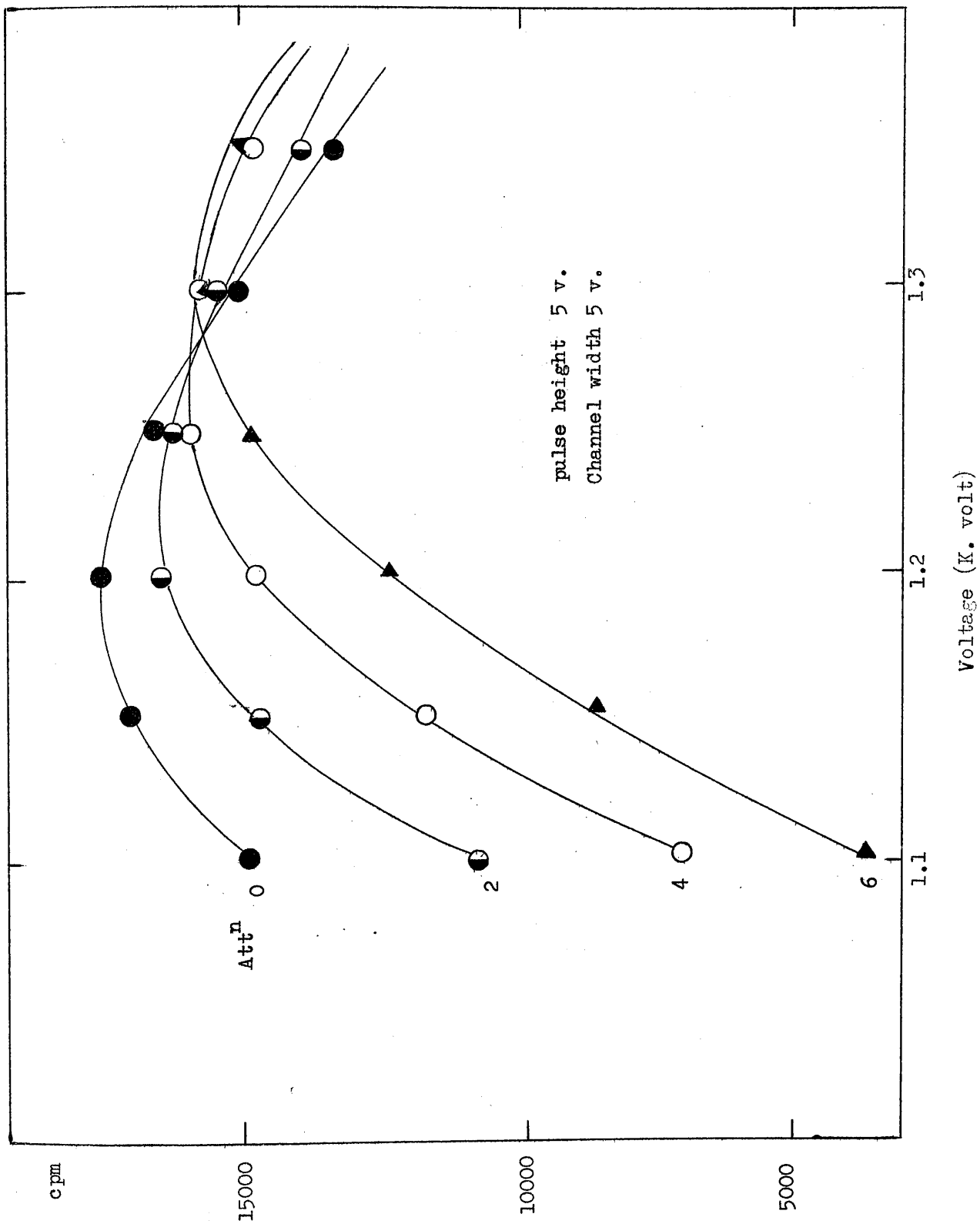

width and the amplification were measured; a typical set of results is shown in Fig. 9 and the best working conditions found from the measurements are:

working voltage 1.150-1.250 K.volts; pulse height 5 volts;
channel width 5 volts; attenuation 2; differentiation time
constant 250 micro sec. integration time constant 0.08 micro sec.

The counting unit was then calibrated under these pre-set conditions using the standard reference material n-hexadecane-1-2-T which was provided by the Radiochemical Centre, Amersham, (its specific activity was $1.5 \mu\text{C/g.} \pm 4\%$, i.e. 20 mg. dissolved in scintillation medium would give 6.9×10^4 disintegrations per minute).

The standard source was prepared by dissolving 20.9 mg. of the n-hexadecane-1-2-T in 10 ml. of the scintillator liquid, nuclear enterprices N.E. 213, in a scintillation vessel and this was sealed with a plastic cap. This standard source was used as a reference material in all the work. Using this source of known activity the efficiency of the counting unit was estimated to be 18%.

(c) Techniques Adopted in the Experiments with Tritiated 1:4,DHN

(i) Chromatographic separation of tritiated 1:4,DHN for isotopic analysis

It has been indicated earlier in this chapter that one of the factors, governing the analytical method and the choice of initial reactants concentrations, was that the 1:4,DHN should be recovered

in sufficient quantity for isotopic analysis. The 0.4 ml. aliquots of the reaction mixture contained 0.015 g. to 0.009 g. of 1:4,DHN and this could be quantitatively extracted from the column. When the reactant passed through the detector (indicated by the trace recording) the gas was diverted through a collection trap surrounded by solid carbon dioxide. The collection traps were designed to afford ready access to the condensed sample and are easily cleaned for further use. The gas flow was re-directed when the trace showed the complete removal of the 1:4,DHN from the column.

(ii) Preparation of tritiated 1:4,DHN samples for counting

Two processes have been followed in the treatment of the tritiated dihydro-compound before transference to the scintillation counter. In the first method unsuccessful attempts were made to find out the amount of 1:4,DHN separated by weighing the sample before transferring to the counting vessel. This was accomplished by dissolving the sample in ether while it was still in the collecting trap. The ethereal solution was quantitatively transferred to a flask and the ether was evaporated using a water pump. This operation was carried out for each sample but it was found that there were large errors in the determination of the weights of the samples. This was due to the inefficiency of the evaporation process.

In the second process, which was generally adopted, the samples were passed through the chromatographic column in duplicate. One

sample was used to estimate the amount of 1:4,DHN, from the area under the peak, and the second sample was used to isolate the hydrocarbon. The amount of 1:4,DHN from the first sample was taken as equivalent to the amount of 1:4,DHN collected out of the second sample, since in both cases 0.4 ml. of the reaction mixture were injected.

The tritiated 1:4,DHN was transferred directly from the collection trap to the scintillation vessel by dissolving the sample in 1 ml. of A.R. toluene (the scintillation liquid is made in toluene) and 0.5 ml. of this was added to a 10 ml. of the scintillation liquid, the mixture was stirred and then counted. All activities were corrected for the background and the absolute value for each sample was estimated with reference to the standard source.

The accuracy of the second process was checked by injecting three samples from the same solution of tritiated 1:4,DHN into the chromatographic column and collecting the 1:4,DHN fraction as described above. The tritium in the samples was estimated, using the standard source as reference material, and the results are shown in Table 6.

TABLE 6

The Accuracy of both Chromatographic and Counting
Rate Measurement Techniques

<u>Sample</u>	<u>Concentration of 1:4,DHN</u> <u>from Chromatogram</u> <u>(mole/L.)</u>	<u>Activity in 1:4,DHN sample</u> <u>(cpm./g.)</u>
1	0.2955	28.16×10^4
2	0.3049	28.85×10^4
3	0.2934	30.65×10^4

Stock solution of 1:4,DHN by wt. = 0.2997 M.

CHAPTER III

RESULTS

3.1 Concentration/Time Curves

The majority of the runs were carried out using initial concentrations of 0.3 M. 1:4,DHN and 0.1 M. TCQ but, in order to allow comparison with the earlier work of Braude et al.,⁽¹⁸⁾ some investigations were made with initial concentrations of 0.1 M. 1:4,DHN and 0.1 M. TCQ. The reaction temperature in all cases was 80°C.

The concentration/time curves for 1:4,DHN in the 0.3 M./0.1 M. (hydrocarbon/quinone) mixtures are shown in Fig. 10 and the important feature of each curve is summarised in Table 7. The results in detail are listed in appendix (b). It should be noted that in most of the reactions there is a drop in the hydrocarbon concentration during the incubation period. In some cases this concentration decrease is within the estimated error of the analytical measurements.

The concentration/time curves exhibit two distinct regions. In the first 30 minutes approximately there is a relatively rapid disappearance of the parent hydrocarbon. It is difficult to decide on the shape of the curve for this reaction period; the results can be fitted to an S-type curve, typical of autocatalytic reactions, but if the errors in the hydrocarbon analysis are slightly greater than that estimated from the calibration experiments, i.e. $\pm 5\%$ as opposed $\pm 3\%$, then a smooth curve can be drawn in this region. The results,

after the initial 30 minutes of reaction, can be fitted to a smooth curve. A more detailed consideration of the results will be given in the discussion section but it is interesting to note that an S-type curve could not be fitted in the initial period in the mixture of equimolar quantities of reactants, Fig. 11, nor is there any evidence of the two regions in the concentration/time curves for the formation of the quinol Fig. 12. The latter results are summarised in Table 8.

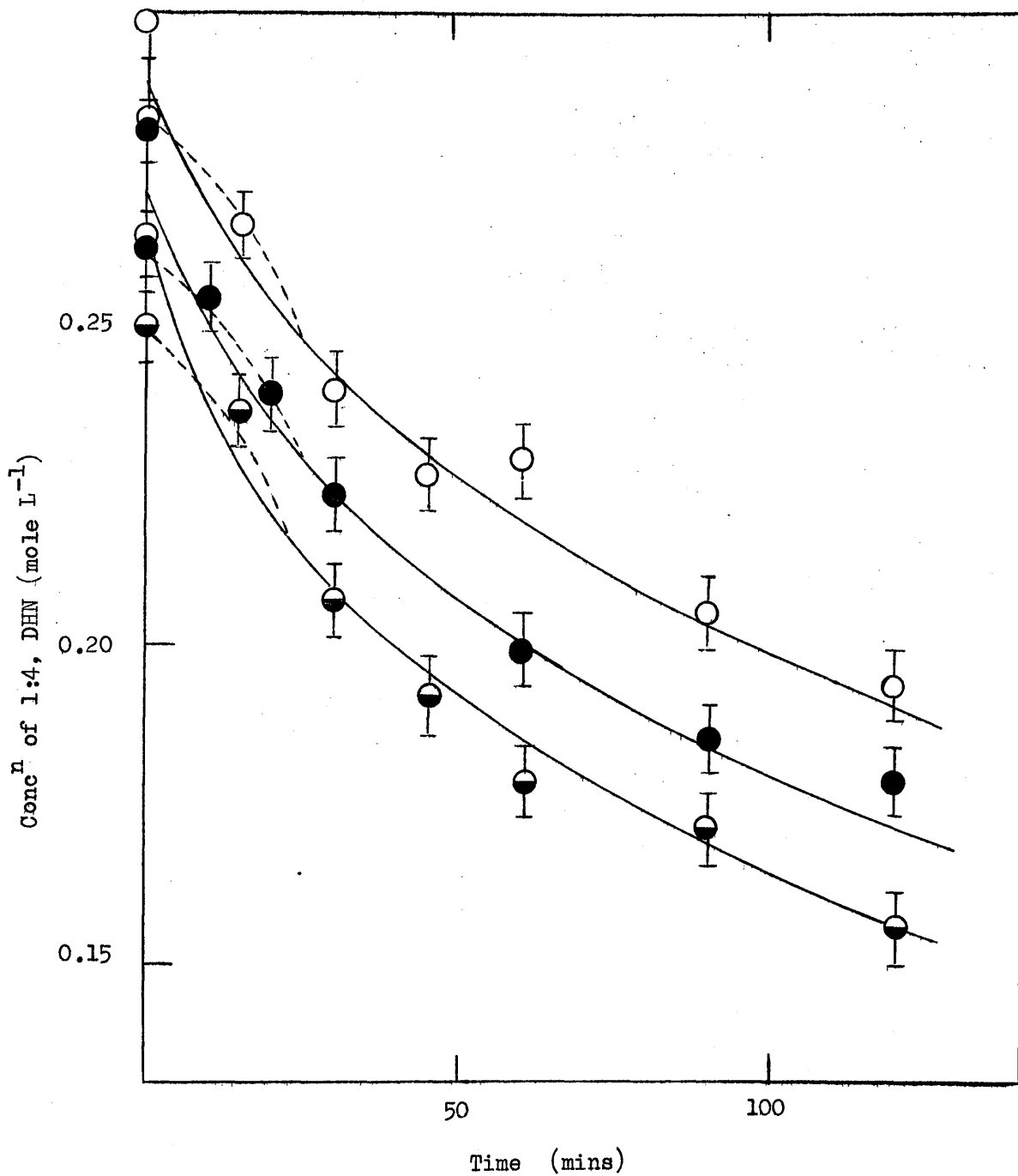

Fig. 10. Concentration/Time Curves for 1:4,DHN
0.3/0.1 moleL⁻¹, 1:4, DHN/TCQ

runs 1, —●—
3, —○—
4, —●—

TABLE 7

Concentration/Time Data for 1:4,DHN

<u>Run No.</u>	<u>Initial Concentrations</u> <u>1:4,DHN/TCO</u> <u>(mole L⁻¹)</u>	<u>Time</u> <u>(minutes)</u>	<u>1:4,DHN</u> <u>(mole L⁻¹)</u>
1	0.30/0.1041	initial	0.2795
		0 (after 2 hrs. inc.)	0.2627
		10	0.2545
		20	0.2391
		30	0.2228
		60	0.1984
		90	0.1844
		120	0.1778
2	0.3002/0.1042 and 0.30 M naphthalene	initial	0.2852
		0 (after 2 hrs. inc.)	0.2679
		10	0.2507
		20	0.2205
		30	0.2187
		60	0.1905
		90	0.1696
		120	0.1621
*3	0.3004/0.1042	initial	0.2984
		0 (after 2 hrs. inc.)	0.2823
		15	0.2661
		30	0.2401
		45	0.2267
		60	0.2290
		90	0.2049
		120	0.1930

TABLE 7 (continued)

<u>Run No.</u>	<u>Initial concentrations</u> <u>1:4,DHN/TCO</u> <u>(mole L⁻¹)</u>	<u>Time</u> <u>(minutes)</u>	<u>1:4,DHN</u> <u>(mole L⁻¹)</u>
*4	0.2997/0.0975	initial	0.2638
		0 (after 2 hrs. inc.)	0.2497
		15	0.2359
		30	0.2065
		45	0.1921
		60	0.1774
		90	0.1711
		120	0.1543
5	0.1105/0.10	initial	0.1100
		30	0.0827
		60	0.0728
		90	0.0664
		135	0.0598
		180	0.0533
		240	0.0461

* Runs with tritiated 1:4,DHN

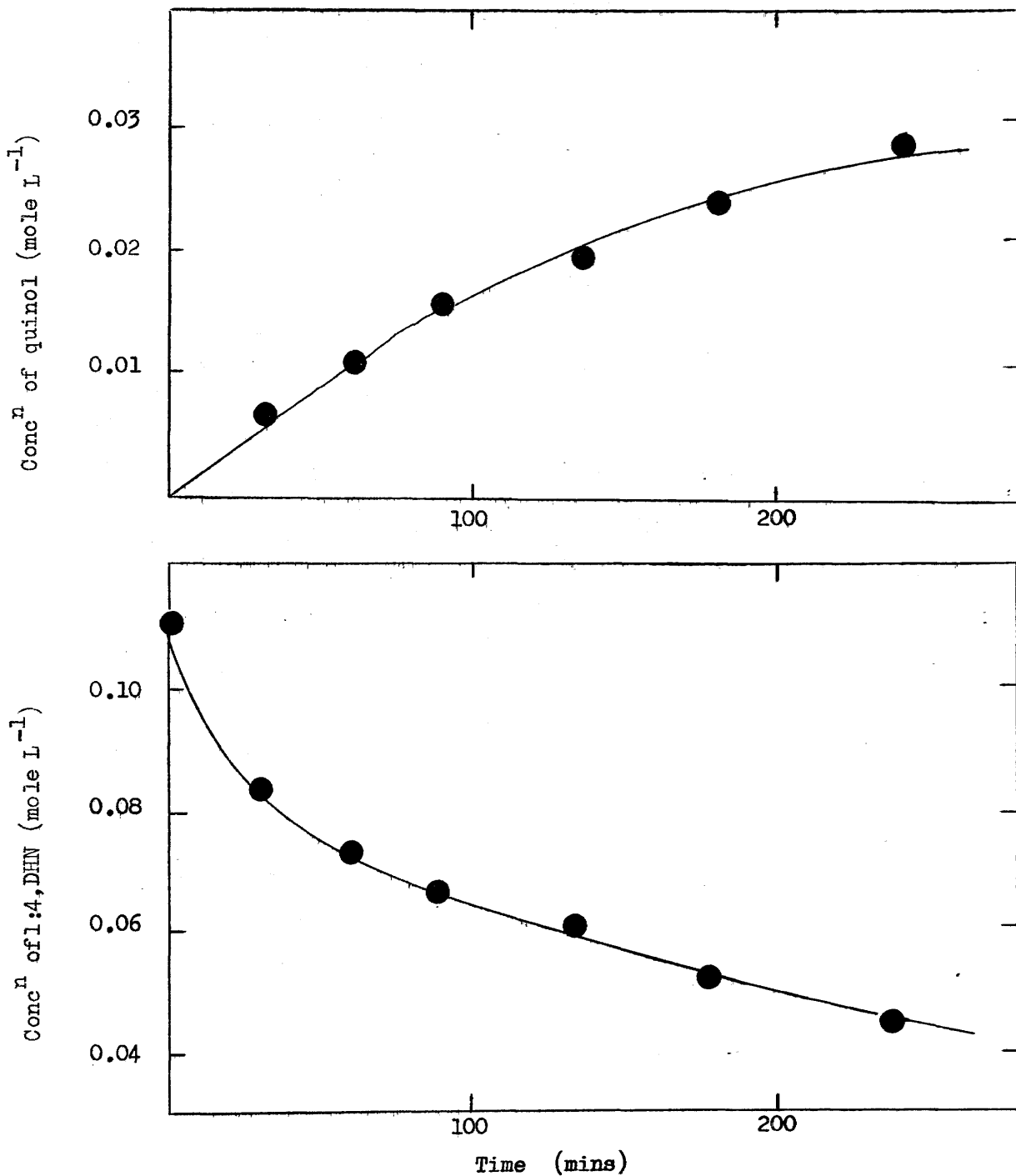

Fig. 11. Concentration/Time Curves for 1:4, DHN and Quinol 0.1/0.1 mole L⁻¹, 1:4.DHN/TCQ

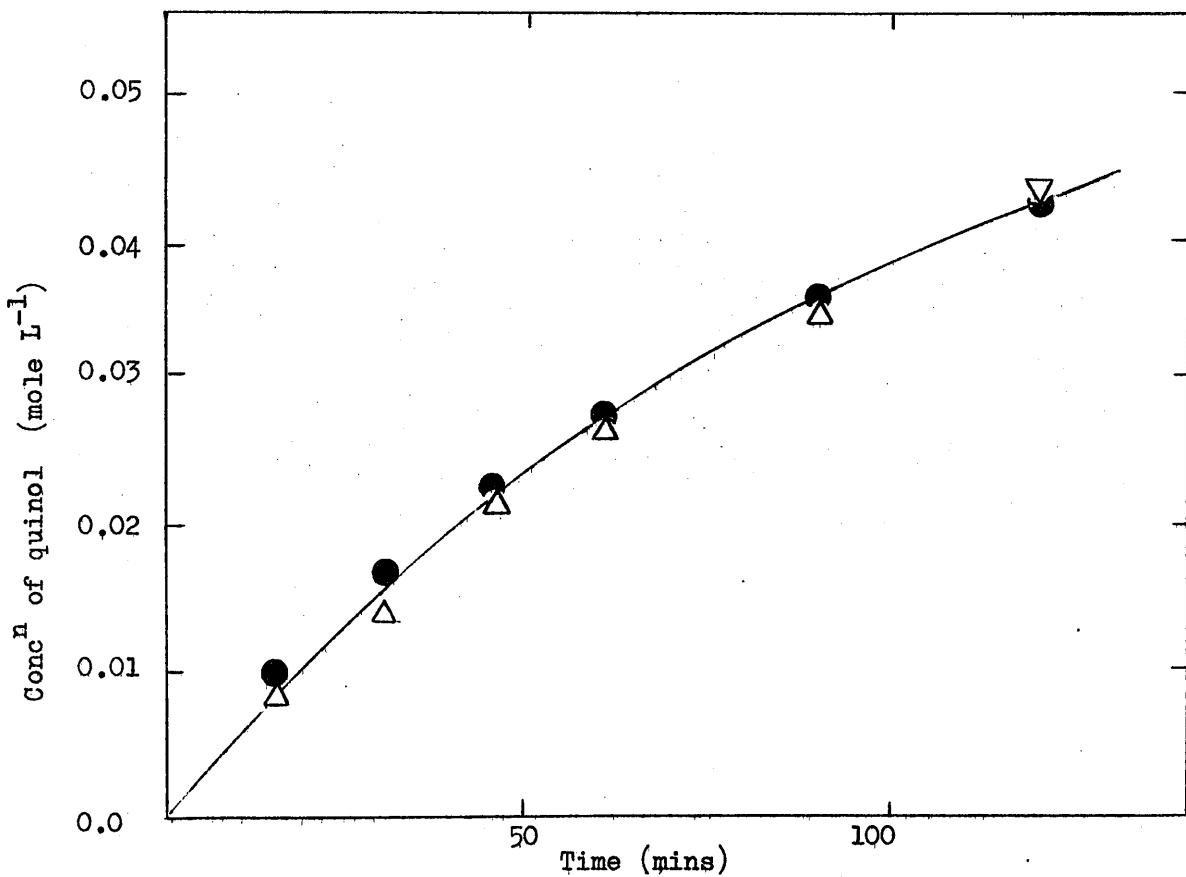

Fig. 12. Concentration/time curves for Quinol
 0.3/0.1 mole L⁻¹, 1:4, DHN/TCQ

runs 7. —●—
 6. —△—

TABLE 8

Concentration/Time Data for Quinol Formation

<u>Run No.</u>	<u>Initial Concentrations</u> <u>1:4, DHN/TCO</u> <u>(mole L⁻¹)</u>	<u>Time</u> <u>(minutes)</u>	<u>Quinol</u> <u>(mole L⁻¹)</u>	<u>TCO</u> <u>(mole L⁻¹)</u>
2	0.3002/0.1042 and 0.30 M naphthalene	0 (after 2 hrs. inc.)	-	0.1042
		10	0.0128	0.0914
		20	0.0148	0.0894
		30	0.0200	0.0842
		60	0.0286	0.0756
		90	0.0367	0.0675
		120	0.0478	0.0564
5	0.1105/0.10	initial	-	0.1000
		30	0.0074	0.0926
		60	0.0115	0.0885
		90	0.0160	0.0840
		135	0.0203	0.0797
		180	0.0246	0.0754
		240	0.0290	0.0710
6	0.3010/0.1043	0 (after 2 hrs. inc.)	-	0.1043
		15	0.0092	0.0951
		30	0.0149	0.0894
		45	0.0220	0.0823
		60	0.0272	0.0771
		90	0.0356	0.0687
		120	0.0424	0.0619
7	0.3004/0.1042	0 (after 2 hrs. inc.)	-	0.1042
		15	0.0101	0.0941
		30	0.0167	0.0875
		45	0.0224	0.0818
		60	0.0272	0.0770
		90	0.0362	0.0680
		120	0.0419	0.0623

3.2 The Stoichiometry of the Reaction

Before dealing with the kinetics, it is necessary to discuss the stoichiometry of the reaction. In previous work⁽¹⁸⁾ it has been assumed that the overall reaction could be represented by,

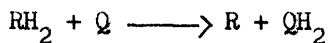

i.e. the reaction of one molecule of 1:4,DHN with one molecule of quinone. The basis for this assumption was that when the reaction was carried out in a sealed tube at 131°C for 72 hours, a near quantitative conversion of 1:4,DHN to naphthalene was achieved.⁽¹⁸⁾

In this case the reaction conditions are very different to those used in the present investigations and an examination of our results shows that 1:1-stoichiometry is not obtained during the reaction time over which the measurements were made. A comparison of the amount of 1:4,DHN consumed with the amount of quinol formed in the reaction is given in Table 9. Since two regions of reaction have been identified from the concentration/time curves the stoichiometry in the two regions has also been investigated, Table 9.

In order to investigate the kinetics, however, it is the ratio of the amounts consumed of 1:4,DHN and TCQ which is important. It is believed that the amount of quinol formed in the reaction corresponds directly with the amount of quinone consumed. This assumption is based on the following experimental observations.

(i) The amount of 1:4,DHN consumed in the first 120 minutes of the reaction is approximately 0.1 mole L^{-1} , which is the initial quinone concentration, yet there is no indication that the reaction is nearing completion. This would indicate that unreacted quinone is still present in the reaction mixture after 120 minutes and hence the overall reaction cannot be bimolecular.

(ii) The amount of naphthalene formed, as deduced from G.L.C. appears to be less than the amount of 1:4,DHN consumed. It was difficult to determine quantitatively the naphthalene concentration in the reaction mixture from the chromatograms and attempts to measure it by passing the reaction mixture through an alumina column followed by the precipitation of the naphthalene picrate⁽¹⁸⁾ have been unsuccessful. However, Braude et al.⁽¹⁸⁾ have observed that the addition of naphthalene has no effect on the reaction rate and in one of the reaction runs (No. 2) in the present work naphthalene was added to the reaction mixture to enhance its G.L.C. peak. The amount of naphthalene formed in the reaction was found to coincide with that of the quinol, Table 10.

These results imply that the reaction of the "extra" 1:4, DHN does not involve the oxygen grouping on the quinone.

TABLE 9

Consumption of 1:4,DHN and TCQ in the System

1:4,DHN-TCQ in Phenetole at 80°C

<u>Run No.</u>	<u>Amount of 1:4,DHN Consumed in reaction period 0-120 (mins.)</u>	<u>Amount of quinol* formed in the reaction period 0-120 (mins.)</u>	<u>Ratio of 1:4,DHN consumed/quinol formed</u>
1	0.0933	-	2.214
2	0.1099	0.0478	2.299
3	0.0960	-	2.278
4	0.1105	-	2.311
6		0.0424	
7		0.0419	
	<u>Period 0-30 (mins.)</u>	<u>Period 0-30 (mins.)</u>	
1	0.0483	-	3.056
2	0.0533	0.0200	2.663
3	0.0489	-	3.094
4	0.0583	-	2.913
6		0.0149	
7		0.0167	
	<u>Period 30-120 (mins.)</u>	<u>Period 30-120 (mins.)</u>	
1	0.0450	-	1.708
2	0.0566	0.0278	2.036
3	0.0471	-	1.787
4	0.0522	-	1.878
6		0.0275	
7		0.0252	
	<u>Period 0-240 (mins.)</u>	<u>Period 0-240 (mins.)</u>	
5	0.0639	0.0290	2.202
	<u>Period 0-60 (mins.)</u>	<u>Period 0-60 (mins.)</u>	
5	0.0372	0.0115	3.232
	<u>Period 60-240 (mins.)</u>	<u>Period 60-240 (mins.)</u>	
5	0.0267	0.0175	1.526

* The concentration of 1:4,DHN at 0 time was obtained by extrapolation of the smoothed curves to 0. To find the ratio 1:4,DHN consumed/quinol formed, the amount of quinol formed in run 2 was also used for run 4 and the mean of that of runs 6 and 7 was used for runs 1 and 3.

TABLE 10

Concentration/Time Data for Naphthalene Formation

<u>Run No.</u>	<u>Initial concentration</u> <u>1:4, DHN/TCO</u> <u>and naphthalene</u> <u>(mole L⁻¹)</u>	<u>Time</u> <u>(minutes)</u>	<u>Naphthalene</u> <u>(mole L⁻¹)</u>	<u>Net amount of</u> <u>naphthalene formed</u> <u>(mole L⁻¹)</u>
2	0.3002/0.1042	2 hrs (inc.)	0.3432	-
	and 0.30	10	0.3522	0.0090
		20	0.3326	-
		30	0.3651	0.0219
		60	0.3724	0.0292
		90	0.3804	0.0372
		120	0.3861	0.0429

It would therefore appear that during the reaction period 30-120 minutes the overall reaction is

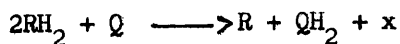

where x is an unidentified product as yet. There is less certainty about the stoichiometry in the first 30 minutes of reaction because of the doubt in the shape of the reaction curve. However the average stoichiometry is given by

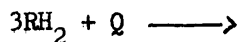

3.3 The Kinetics of the Reaction

Earlier kinetic investigations have, as mentioned previously, assumed a 1:1-stoichiometry for the reaction. A direct comparison with the earlier work can be made with the results for the mixture of equimolar quantities of reactants (run 5). If the amount of 1:4,DHN used is estimated from the amount of quinol formed (assuming a 1:1-relationship) then the second-order rate plot, shown in Fig. 13, gives a rate constant of $k_{(60-240 \text{ mins.})} = 0.01556 \text{ L.mole}^{-1} \text{ min}^{-1}$. Braude et al. have determined the rate constant at 90, 100, 110, 119, 131°C and the interpolated rate constant for 80°C is 0.01730 $\text{L.mole}^{-1} \text{ min}^{-1}$. To this extent, therefore, the present results are consistent with those of Braude et al. (18)

Attempts have been made to fit the results to second and third order kinetics (keeping in mind the stoichiometry of the reaction), i.e. $2\text{DHN} + 1\text{TCQ}$. This has proved to be a difficult procedure because errors in the estimations of the two components become significant since the inclusion of the term for the ratio of the reactant concentrations, i.e. $\log \frac{[1:4, \text{DHN}]}{[\text{TCQ}]}$, tends to magnify any experimental errors. We have therefore chosen to attempt to identify the kinetic order by using "smoothed" values taken from the reaction curves (the concentration/time curves) rather than the experimental points. A comparison of the second order plot for the "smoothed" values and the experimental values shows reasonable agreement, Fig. 14, which indicates that the procedure

can be justified.

In view of the shape of the concentration/time curves and the overall stoichiometry of the reaction it is obvious that the reaction is more complex than had been previously supposed. It is therefore not surprising that the results do not fit accurately second-order or third-order kinetics over the entire reaction period. Over the reaction period 30-120 minutes an approximate fit can be made in both cases. The values for the rate constants are given in Table 11. In general, it appears from these rate constants that the reaction approximates to second order kinetics in this region, Fig. 14 and 15, but large deviations from either type of kinetics are observed in the first thirty minutes of the reaction.

3.4 The Kinetic Isotope Effect Measurements

Two runs were made with the tritiated 1:4,DHN under the same reaction conditions as in the previous measurements. In the first run (run no. 3) the 1:4,DHN was separated by G.L.C. and the weight of the parent hydrocarbon determined as described on page 49, before transference to the scintillation counter. The disadvantages of the method have been discussed earlier and the measurements are subject to large errors. In the second run (run no. 4) the separated 1:4,DHN was transferred directly to the counter. This proved a more satisfactory procedure and it is believed that the results of this run are much more reliable. The count rates were corrected for background

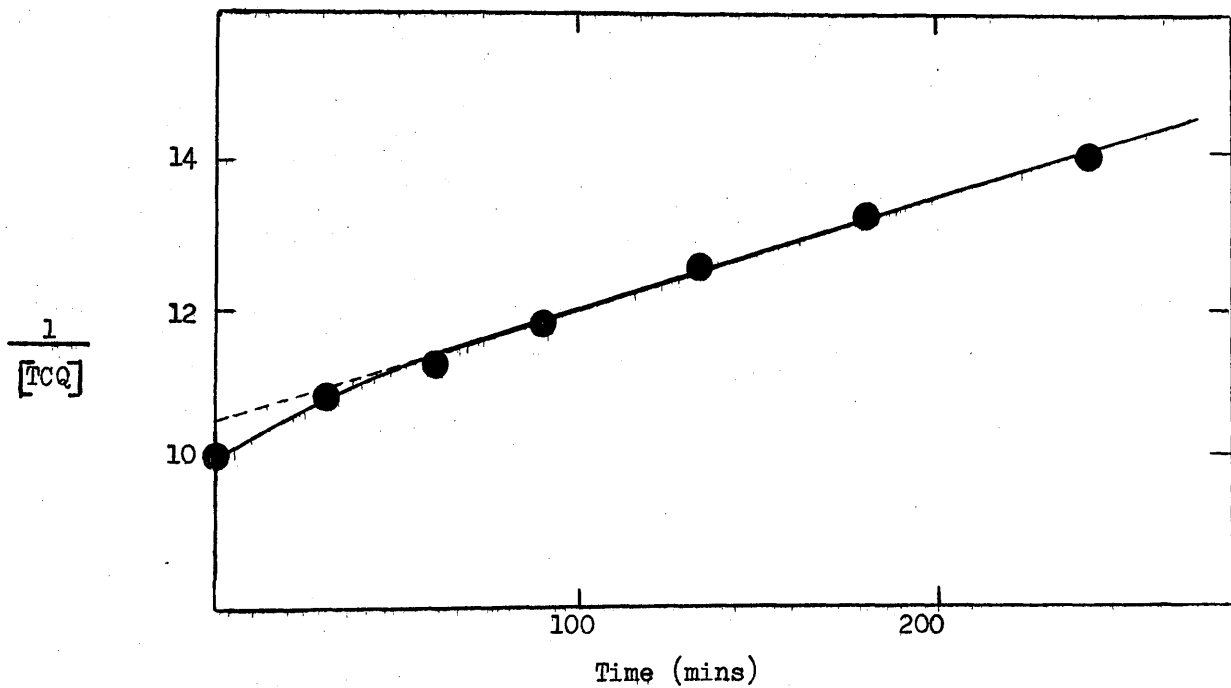

Fig. 13. Simple Second Order Plot for Equimolar Concⁿ
(run 5.) at 80° (experimental points)

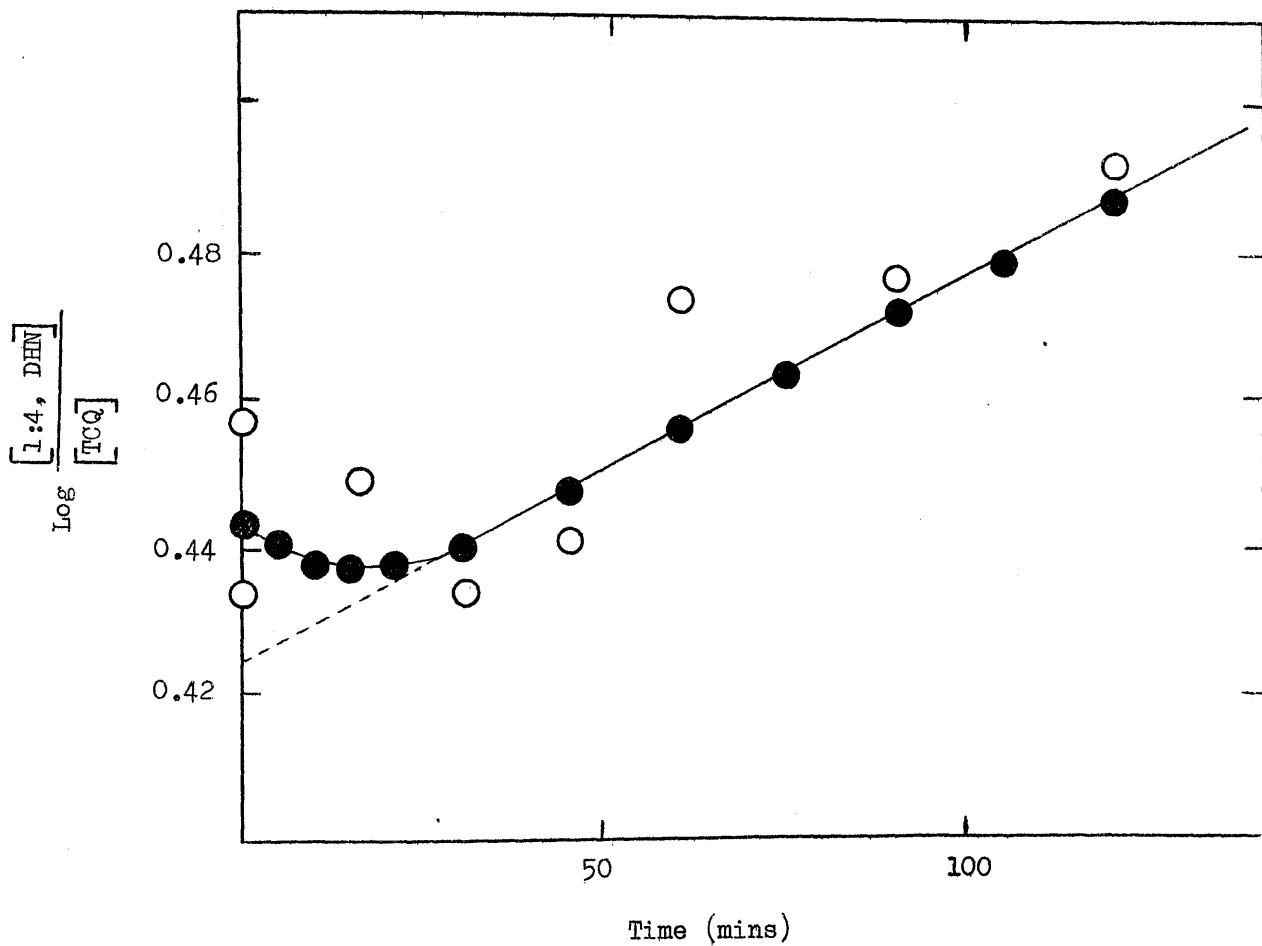

Fig. 14. Second Order Plot assuming 2/1 Stoichiometry
 1:4, DHN 0.3M / TCQ 0.1M, for run no. 3.

- Smoothed values.
- Experimental values.

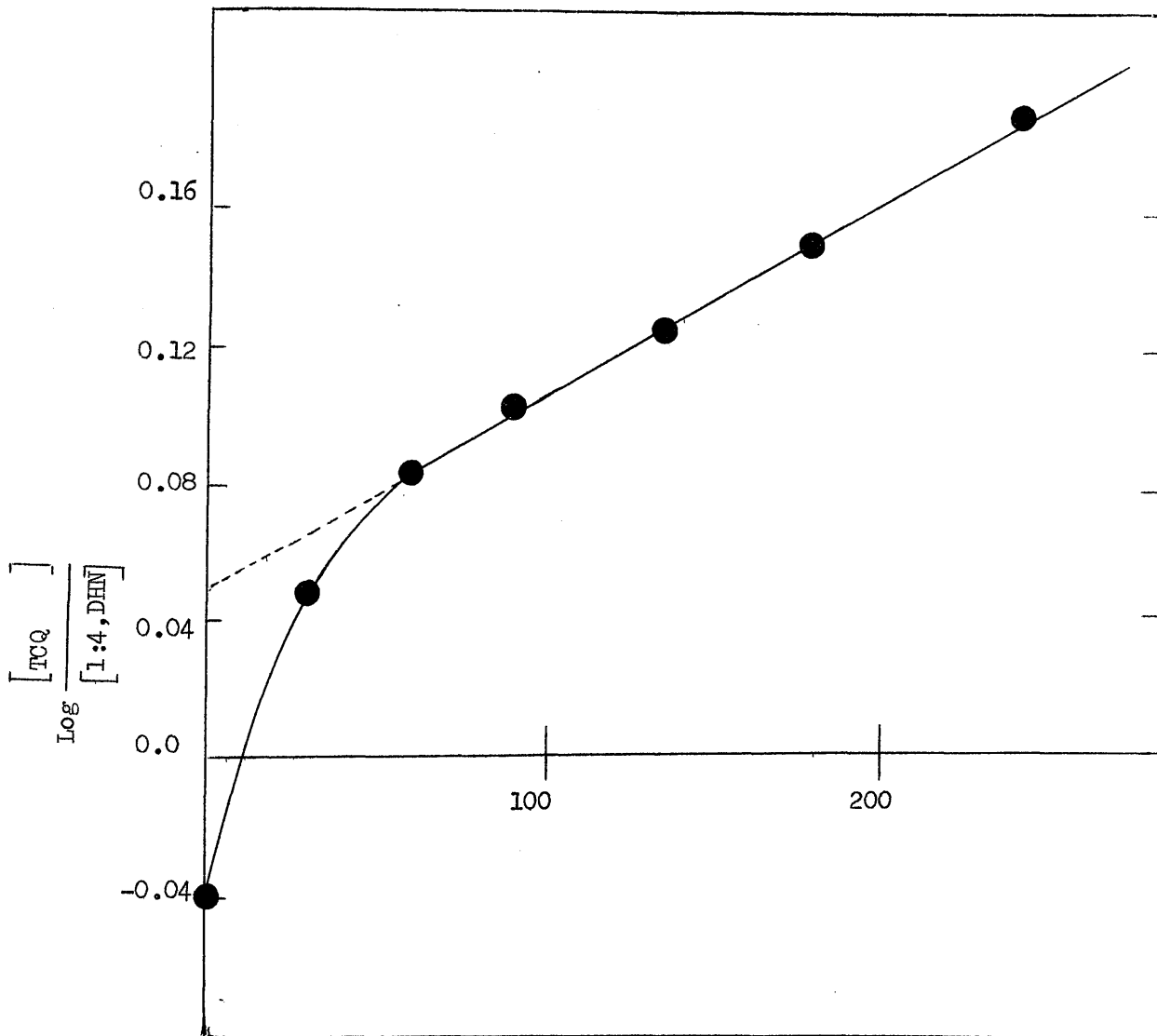

Fig. 15. Second Order Plot assuming 2/1 Stoichiometry
 1:4, DHN 0.1M / TCQ 0.1M ; for run no.5.
 (experimental values)

TABLE 11

*Second and Third-Order Rate Constant Data of Stoichiometry 2/1
for the System 1:4,DHN-TCQ in Phenetole at 80°C

<u>Run</u> <u>No.</u>	<u>Time</u> <u>(minutes)</u>	<u>1:4,DHN concⁿ</u>		<u>second-order</u> <u>rate constant</u>	<u>third-order</u> <u>rate constant</u>
		<u>Smoothed</u> <u>mole L⁻¹</u>	<u>Smoothed</u> <u>mole L⁻¹</u>		
				$\frac{k_2}{-1}$ L.mole ⁻¹ min ⁻¹	$\frac{k_3}{-2}$ L ² .mole ⁻² min ⁻¹
1	0	0.2711	0.1043	-	-
	5	0.2605	0.1011	-	-
	10	0.2513	0.0981	-	-
	15	0.2429	0.0953	-	-
	20	0.2353	0.0927	-	-
	30	0.2233	0.0880	used as 0 time	
	45	0.2110	0.0821	0.0370	0.0440
	60	0.2011	0.0770	0.0399	0.1470
	75	0.1922	0.0725	0.0411	0.1875
	90	0.1844	0.0685	0.0416	0.2119
	105	0.1773	0.0650	0.0408	0.2069
	120	0.1707	0.0618	0.0400	0.1974
2	0	0.2720	0.1042	-	-
	5	0.2576	0.0998	-	-
	10	0.2454	0.0961	-	-
	15	0.2343	0.0928	-	-
	20	0.2252	0.0898	-	-
	30	0.2120	0.0845	used as 0 time	
	45	0.1993	0.0785	0.0378	0.0467
	60	0.1893	0.0735	0.0411	0.0810
	75	0.1805	0.0690	0.0436	0.1640
	90	0.1725	0.0650	0.0436	0.1763
	105	0.1655	0.0615	0.0436	0.1925
	120	0.1590	0.0583	0.0436	0.2012
3	0	0.2890	0.1042	-	-
	5	0.2784	0.1011	-	-
	10	0.2688	0.0981	-	-
	15	0.2606	0.0953	-	-
	20	0.2538	0.0927	-	-

TABLE 11 (continued)

Run No.	Time (minutes)	1:4,DHN conc ⁿ		TCQ conc ⁿ		second-order	third-order
		Smoothed mole L ⁻¹	Smoothed mole L ⁻¹	rate constant k ₂	rate constant k ₃		
				L, mole ⁻¹ min ⁻¹	L, mole ⁻² min ⁻¹		
3	30	0.2424	0.0880	Used as 0 time			
	45	0.2300	0.0821	0.0347	0.0769		
	60	0.2200	0.0770	0.0363	0.1263		
	75	0.2110	0.0725	0.0370	0.1464		
	90	0.2030	0.0685	0.0368	0.1525		
	105	0.1960	0.0650	0.0364	0.1575		
	120	0.1894	0.0618	0.0360	0.1564		
4	0	0.2648	0.1042	-	-		
	5	0.2503	0.0998	-	-		
	10	0.2378	0.0961	-	-		
	15	0.2274	0.0928	-	-		
	20	0.2190	0.0898	-	-		
	30	0.2070	0.0845	Used as 0 time			
	45	0.1948	0.0785	0.0453	0.1280		
	60	0.1848	0.0735	0.0457	0.1820		
	75	0.1758	0.0690	0.0461	0.2088		
	90	0.1678	0.0650	0.0461	0.2222		
	105	0.1608	0.0615	0.0456	0.2246		
120	0.1543	0.0583	0.0456	0.2322			
5	0	experimental conc ⁿ		-	-		
	30			-	-		
	60	Data have been		Used as 0 time			
	90			0.0264	0.6040		
	135	used		0.0238	0.5398		
	180			0.0244	0.5707		
240			0.0252	0.6084			

* The mean of the concentration data of runs 6 and 7 have been used to construct one concentration/time curve for TCQ, the smoothed values of which have been used with those of 1:4,DHN of runs 1 and 3 respectively to construct the kinetic data. The smoothed values of TCQ of run 2 have also been used with the 1:4,DHN of run 4.

radiation and referred to the standard source to give absolute values. A summary of the results is given in Table 12 and the detailed results are in appendix (d).

The kinetic isotope effect was calculated from equation (1.14) (page 32). Values for k_1/k_2 i.e. k_T/k_H are given in Table 12.

3.5 General Comments on the Kinetic and Isotope Effect Results

A detailed consideration of the results will be given in the Discussion Section but it is convenient at this point to make some general observations on the kinetic and isotope effect determinations.

The results of both the kinetic and isotope effect measurements indicate that the reaction is more complex than has previously been supposed. The measured isotope effect of 1.16 ± 0.16 (for reasons given earlier emphasis is placed on the second of kinetic isotope effect runs) is not consistent with a simple reaction scheme involving fission of carbon-hydrogen bond, i.e. hydride ion transfer, as the rate-determining step. In the present work the isotope effect measurement is only qualitative in the sense that in most molecules not all of the equivalent hydrogens were replaced by tritium. It was intended in the present work to measure the isotope effect for 1:4,DHN, with all the equivalent hydrogens tritiated, but in the light of the initial results this did not appear to be necessary. An isotope effect of less than unity should have resulted with the partially tritiated molecules if the simple hydride ion transfer mechanism was operative.

TABLE 12

Tritium Isotope Effect in the Dehydrogenation of

1:4,DHN with TCQ in Phenetole at 80°C

<u>Run</u> <u>No.</u>	<u>Time</u> <u>(minutes)</u>	$\frac{a_2}{1:4,DHN}$ mole L ⁻¹	$\frac{a_1}{cpm}$ mole L ⁻¹	$\frac{x_2}{-}$	$\frac{a_1/a_1^0}{a_2/a_2^0}$	$\frac{k_T/k_H}{-}$
3	0	*0.2890	126.60 x 10 ⁵	-	-	-
	15	0.2661	100.70	0.07924	0.8638	2.7765
	30	0.2401	92.12	0.1692	0.8758	1.7155
	45	0.2267	103.60	0.2156	1.0432	0.8275
	60	0.2290	65.86	0.2076	0.6565	2.8081
	90	0.2049	64.82	0.2910	0.7221	1.9465
	120	0.1930	101.10	0.3322	1.1959	0.5564
						Av. 1.7717 ± 0.74 (average error)
4	0	*0.2648	145.40 x 10 ⁵	-	-	-
	15	0.2359	125.90	0.1091	0.9719	1.2470
	30	0.2065	110.10	0.2202	0.9710	1.1184
	45	0.1921	92.23	0.2745	0.8743	1.4189
	60	0.1774	96.85	0.3301	0.9943	1.1437
	90	0.1711	81.89	0.3538	0.8717	1.3147
	120	0.1543	97.59	0.4173	1.1519	0.7379
						Av. 1.1634 ± 0.16 (average error)

* Obtained by extrapolation of the smoothed concentration curves to 0.

In the absence of other types of information, the results of the kinetic studies, do not allow the formulation of a reaction mechanism. We have shown that the rate law approximates to second order kinetics after the initial 30 minutes of reaction and, bearing in mind the stoichiometry, this type of behaviour could result from two consecutive reactions.

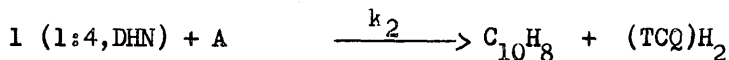
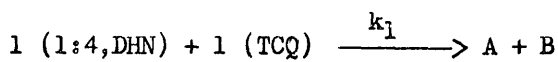

A is a reactive intermediate and B is a product of the reaction.

Second order kinetics would be observed if the rate of the first reaction was very much slower than the second, i.e. $k_2 \gg k_1$. However the results for the first 30 minutes of reaction indicate that the mechanism is more complex than this and it would obviously be more satisfactory at this stage to attempt to identify the other products or intermediates in the reaction before carrying out a more detailed analysis of the kinetics.

The kinetic isotope effect indicates that the cleavage of the carbon-hydrogen bond is unlikely to be the first step in the reaction and the stoichiometry of the reaction indicates that there is at least one other reaction product. There are several possible side reactions which could account for the latter results. The first possibility is the formation of hydroquinone ethers of the type

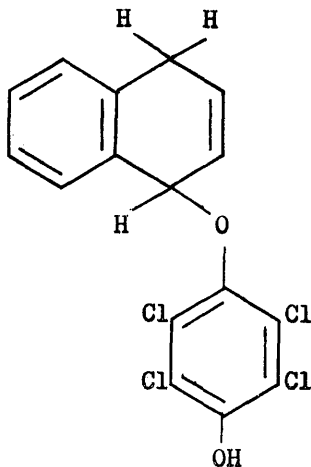

Criegee⁽³⁾ has isolated ethers of this type on the dehydrogenation of both tetralin and cyclohexene with chlorodiquinone and more recently Bickel and Waters⁽⁵¹⁾ were able to isolate the mono- and diethers of tetrachlorohydroquinone on reacting chloranil with the free radicals $\text{Me}_2\text{C} \cdot \text{CO}_2\text{Me}$ and $\text{Me}_2\text{C} \cdot \text{CN}$.^(see also "52") If a hydroquinone ether is formed in the present reaction system, this could account for the consumption of the second molecule of 1:4,DHN, but a corresponding increase in the amount of quinol formed should be observed. The OH group in this compound should be readily titrated with $\text{Ce}(\text{SO}_4)_2$. It seems likely therefore that the product does not involve bonding to a quinol via the oxygen grouping.

The second possibility for a side reaction is located in the activity of the chlorine atoms of chloranil. The bonding of the

hydrocarbon to the quinone or quinol could be through what was initially a chlorine site in the molecule. In contrast to the other bromo- and iodo-substituted quinones, which act as an inhibitor to chain reactions, chloranil sometimes acts as chain propagating agent. Price⁽⁵³⁾ has drawn attention to this in free radical polymerisation reactions, where the substituted chlorine atoms of chloranil could act as chain propagator. Also addition reactions of quinone in which the addition products often split off HCl have been reported.⁽⁵⁴⁾ Buckley and Henbest⁽²⁹⁾ have suggested this type of addition reactions in the dehydrogenation of tertiary amines with chloranil giving amino vinyl quinones and the amine hydrochloride salt.

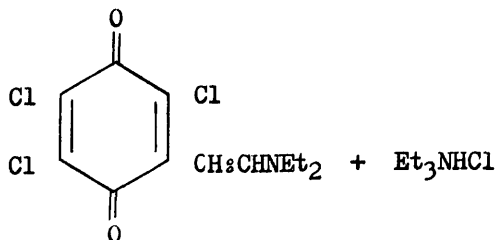
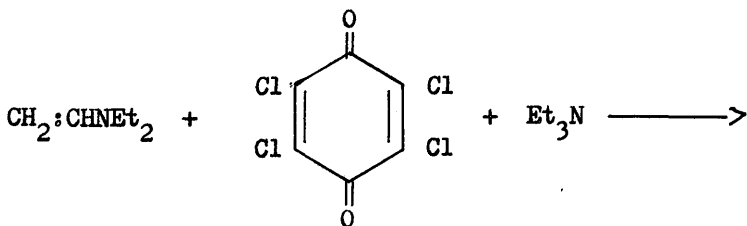
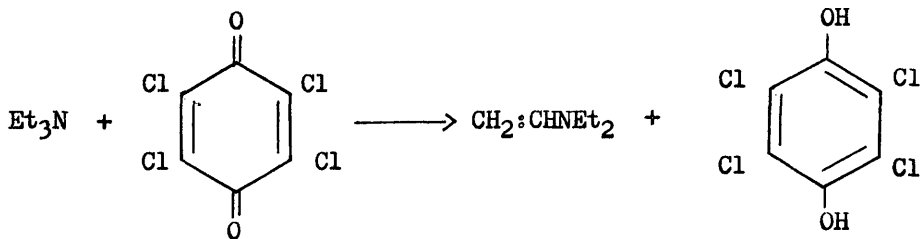

Similar addition compounds have been obtained in the photochemical dehydrogenation involving chloranil and acetaldehyde;⁽⁵⁵⁾ chloride ions were detected in the products suggesting the evolution of HCl. There is some evidence for a similar type of reaction in the present work. The reaction mixture increased its acidity as the reaction proceeded and HCl was detected in the system. Further investigation is required.

A further, and very likely, interaction involving the quinone is the formation of a charge-transfer complex with either the reactant or the product hydrocarbon. These complexes between chloranil and aromatic hydrocarbons have been extensively studied particularly with naphthalene.^(56,57) The molecular complexes are regarded as π -co-ordination compounds in which an electron pair from π -molecular orbital of the hydrocarbon is partially donated to the antibonding molecular orbital of the quinone.⁽⁵⁸⁾ In the present reaction the red colour of the solution is indicative of the formation of a charge-transfer complex. This could be the result of the interaction of the quinone with naphthalene,^(56,57) phenetole,⁽⁵⁹⁾ or the 1:4,DHN.

3.6 Proposed Investigations for Side Reactions

The previous discussion has outlined the need for further quantitative and qualitative study of the reaction system. It was therefore necessary to extend the investigation along three main lines.

(a) The Significance of the Chlorine-substitution in the Quinone

Preliminary experiments have shown that HCl is evolved in the present reaction system. This could result from the reaction of the hydrocarbon with the quinone or the quinol at the chlorine site in the latter and could account for the consumption of the "extra" molecule of 1:4,DHN. If this is the case then the amount of HCl evolved should be equivalent to the "extra" 1:4,DHN used. A quantitative determination of the HCl is required.

The presence of HCl in the reaction mixture can lead to complications since it has been suggested that the acid has a catalytic effect on the dehydrogenation reaction.⁽¹⁸⁾ It is therefore proposed to study both the kinetics of evolution of HCl, since this may explain the anomalous results in the initial 30 minutes of reaction, and the effects of the deliberate addition of HCl on the reaction kinetics.

(b) Spectrophotometric Investigations

Charge-transfer complexes are characterised by having a new absorption band at higher wave length than the two components, usually in the visible region. The energy of this band can be estimated and consequently the degree of stability of these quinone complexes can be found. It has been stated earlier that there are three possible complexes which the quinone can form with the other components in the reaction mixture. It is therefore relevant to investigate the

stabilities of the complexes and attempts were made to measure the equilibrium constants for the formation of these. In addition spectroscopic studies in the u.v. could provide information on by-products formed in the reaction and also provides a technique for the direct estimation of the quinone concentration as opposed to the earlier method based on the measurement of quinol concentrations.

(c) Detection of Higher Hydrocarbons

The discussion of the consumption of the "extra" molecule of 1:4,DHN have been centred around hydrocarbon-quinone reactions. However there is the possibility that the 1:4,DHN could polymerise, via a free-radical mechanism to form higher hydrocarbons. There was no evidence of this in the chromatographic analysis at 120°C but higher temperatures may be required to elute them from the column. An investigation of this possibility is to be made using a PYE-Argon chromatographic apparatus.

Finally, it would be interesting to carry out a preparative experiment by taking the reaction system to near completion. The overall amount of the main products, the quinol or the naphthalene, could be estimated and this could be a decisive experiment in gaining information on the nature and stability of any by-product that exists in the earlier stages of the reaction. It would be expected that both a by-product of a hydroquinone ether type and the other additive by-product to the chlorine site of the quinone molecule would be

unstable on carrying the reaction for a longer period of time or at higher temperatures. Braude et al.⁽¹⁸⁾ have obtained almost 90% naphthalene and quinol in preparative experiments for 1:4,DHN with benzoquinone in diethylene glycol diethyl ether, and with TCQ in phenetole respectively, the experiments being carried out at 131°C in sealed tubes.

CHAPTER IV

INVESTIGATIONS OF SIDE REACTIONS

4.1 Estimation of Evolution of HCl in the Reaction Mixture.

(a) Detection of Evolution of HCl

A preliminary experiment was carried out in which the evolution of HCl gas from the reaction mixture was detected. In this experiment, the kinetic run was carried out as described before p. 39, with the same initial concentrations of the reactants (0.3 M. 1:4,DHN and 0.10 M. TCQ) and under the same conditions, but no samples were withdrawn during the time of the reaction. Instead, the emergent nitrogen gas was passed into a test tube containing about 5 ml. 0.1 N. AgNO_3 solution. The reaction was followed for the usual time (ca. 2 hours). A white precipitate formed in the nitrate solution after the first 20-25 minutes of the reaction, and this became more dense as the reaction period increased. On exposure to day light for sometime the precipitate turned violet and coagulated.

(b) Estimation of HCl Evolved Quantitatively

Two sets of runs were made in an attempt to quantitatively estimate the amount of HCl formed in the reaction. This was accomplished by following the run as described above, but, the outlet current of nitrogen coming from the reaction flask was passed through a conical flask containing 60 ml. of $\sim 0.1\text{N}$ standardised NaOH solution. At appropriate time intervals aliquots portions of 5 ml. of the

hydroxide solution were withdrawn and titrated with standard 0.1003N HCl solution using phenolphthalein as indicator. The results obtained from this experiment, Table 13 (run 8), show that the amount of HCl evolved is small compared to the concentrations of the other reaction products. This could be due to the fact that HCl is dissolved to some extent in phenetole. From literature data, HCl is known to be very soluble in ethers.⁽⁶⁰⁾ Accordingly in the second set of runs the reaction mixture was extracted with water in an attempt to remove the dissolved HCl.

The reaction was carried out as usual but the apparatus was adapted so that there was no evaporation of the caustic soda solution during the reaction time. A single estimation was made of the total amount of HCl evolved during the reaction period by titration of the resultant NaOH solution (originally 25 ml. 0.0497N.) with 0.0499N standardized HCl using methyl red as indicator. Extraction of more HCl from the reaction mixture was accomplished in the following way: At the end of the time of the reaction (ca. 2 hours), the reaction flask was taken out of the thermostat and 100 ml. of distilled water was added. The mixture was shaken vigorously and left to settle and to cool to room temperature. This operation was made under continuous flow of nitrogen and the reaction mixture was left under these conditions for over night. The reaction mixture was then transferred to a separating funnel (ca. 250 ml.), and shaken vigorously several times.

The water extract was separated and titrated with standard 0.0497 N NaOH solution, and the equivalent amount of HCl extracted was estimated. Extraction was repeated several times and the total amount of HCl evolved off the reaction mixture was estimated, Table 13 (run 9).

This method gave an increased yield of HCl, but the amount was substantially less than expected on the basis of the stoichiometry of the reaction. Leaving the reaction mixture in contact with water for a longer time (in another run) increased the yield, Table 13 (run 10) and use of an electric shaker improved the yield to some extent, Table 13 (run 11). The general conclusion is, however, that the yield of HCl determined in this way is appreciably smaller than might have been expected.

It is worth noting that some interesting colour changes occurred during the extraction. The first portion of the water extract for HCl was coloured faint violet; and the second portion was coloured very faint yellow which turned violet on standing at room temperature. Further extracts were colourless as indicated in Table 13. (U.V. spectra measurements of the violet water extract have indicated that the colour results from the partial solvation of a trace amount of the quinol and phenetole in water).

(c) Results

The amount of HCl evolved is quoted in arbitrary units as mole/L. reaction mixture. In the first run (run 8) correction for the

mls. of standard HCl equivalent to HCl evolved was made for each sample as a function of the withdrawal of 5 ml. of the hydroxide solution at the appropriate time intervals.

TABLE 13

Data of Estimation of Evolution of HCl

Run No.	Initial Conc ⁿ 1:4, DHN/TCQ mole L ⁻¹	H ₂ O extract ml.	NaOH ml. ≈ 0.1N	HCl ml. 0.1003N	HCl ml. 0.1003N	Amount of HCl evolved mole L ⁻¹
8	0.3004/0.1042	-	5	5.04	-	-
		-	"	5.04	-	-
		-	"	5.03	0.10	0.418 x 10 ⁻³
		-	"	5.01	0.28	1.170 "
		-	"	4.97	0.60	2.507 "
		-	"	4.95	0.74	3.091 "
		-	"	4.87	1.22	5.098 "
		-	"	4.78	1.67	6.977 "
			0.0497N	0.0499N	0.0499N	
9	0.3003/0.1041	-	25	24.89	-	-
		-	25	22.10	2.790	5.794 x 10 ⁻³
		violet extract	1.677	-	1.673	4.552 "
		yellow extract	0.520	-	0.519	10.346 x 10 ⁻³
					Total	
			0.0406N	0.0501N	0.0501N	
10	0.3012/0.1040	-	25	20.25	-	-
		-	25	18.32	1.930	4.025 x 10 ⁻³
		violet extract	1.770	-	-	-
		yellow extract	0.230	-	-	-
		colourless ext.	0.185	-	-	-
		"	0.452	-	3.432	7.158 "
		"	0.260	-	-	-
		"	1.130	-	-	-
		"	0.203	-	-	-

TABLE 13 (continued)

Run No.	Initial Conc ⁿ 1:4, DHN/TCQ mole L ⁻¹	Time (mins)	H ₂ O extract ml.	ml. NaOH 0.0505N	ml. HCl 0.0500N	ml. HCl 0.0500N	eqv. to HCl evolved	Amount of HCl evolved mole L ⁻¹
10 (cont.)		colourless ext.	185-187	0.176	-	-	-	
		"	"	0.160	-	-	-	
		"	"	0.190	-	-	-	
		"	"	0.352	-	1.784	3.713 x 10 ⁻³	
		"	"	0.239	-	-	-	
		"	"	0.260	-	-	-	
		"	"	0.390	-	-	-	
				Total		14.896 x 10 ⁻³		
11	0.2998/0.1037	0 (2 hrs. inc.)	-	0.0499N	0.0502N	0.0502N		
	120	after	-	25	24.55	-		
	violet extract	"	149	25	21.60	2.95	6.170 x 10 ⁻³	
	"	"	115	0.879	-	-		
	colourless ext.	"	140	0.800	-	-		
	"	"	"	0.393	-	2.818	5.893	
	"	"	"	0.461	-	-		
	"	"	"	0.302	-	-		
				Total		12.063 x 10 ⁻³		

4.2 Effect of Addition of HCl gas on the Rate of the Reaction

The reaction was followed as described before, p. 39, using the same initial concentrations of the reactants (0.3 M. 1:4,DHN and 0.1 M. TCQ), at the same temperature 80°C, and for the usual period of time (ca. 2 hours). After the 2 hours incubation, HCl gas was bubbled through the reaction mixture for 7 minutes. This was accomplished by connecting to the side arm C of the reaction vessel, a flask containing some solid NaCl to which concentrated H₂SO₄ is added from a dropping funnel. The flow of nitrogen gas in the apparatus was maintained but tube B of the reaction vessel was slightly raised to allow slow leakage of both the excess HCl gas which had bubbled through the reaction mixture solution and nitrogen. After saturating with HCl gas, the quinone was added to the reaction mixture and the reaction followed as described previously. The disappearance of 1:4,DHN was followed by chromatographic analysis using G.L.C. as described before p.42 , and the quinol formed was estimated by titration with Ce(SO₄)₂ solution p.41 .

During the sampling process, it was noticed that in the later stages of the reaction (at 75-120 mins.) the red colour of the reaction mixture faded much more rapidly than in the ordinary runs. Also crystals of quinol rapidly formed in the reaction mixture and this led to problems in taking samples. This is an indication that the quinol is formed in a greater amount, i.e. more quinone is

consumed than in the normal runs. This can be seen in the results, Table 15. Some difficulty was also encountered during the titration of the samples of the reaction mixture with $\text{Ce}(\text{SO}_4)_2$, particularly those samples from the later stages of the reaction (120 mins.). Although the end point was sharp it was a deep dark violet colour which turned to dark green very quickly on standing. This was repeatedly observed in four successive runs contrary to the case with the normal runs where the end point was deep violet and the aqueous layer of the titration solution turned brownish on standing for a few days.

Results

Fig. 16 represents the concentration/time curves for both 1:4,DHN and TCQ, determined from the titration of quinol. The concentration/time curve for the quinone is the mean of four successive runs. It is noticed that the two concentration curves are fairly parallel even in the first 30 minutes of the reaction but in the later periods, after ~ 90 minutes, the concentration curve of the quinone shows a rapid decrease. This will be discussed later. The main features of each curve is represented in Tables 14 and 15 and the results in detail are listed in appendix (e).

The stoichiometry of the reaction was examined in the same manner as described before; this is represented in Table 16. The reaction gave a stoichiometry of 2:1 for the ratio 1:4,DHN/TCQ consumed over the entire reaction period of 0-90 minutes. Furthermore,

the amount of quinone consumed (i.e. quinol formed) during the first 30 minutes was found to increase in comparison to that of the ordinary runs (22.28% compared to 15.58%) and as indicated before a marked increase in the amount of quinone consumed after 90 minutes is also observed. Surprisingly these changes are not observed in the case of 1:4, DHN.

Second and third order kinetic equation for stoichiometry 2:1 were applied using the "smoothed" concentration figures, Table 17. Fig. 17 represents the second order plot of $\log \frac{[1:4, \text{DHN}]}{[\text{TCQ}]}$ against time using both the "smoothed" concentration values to construct the type of straight line (or curve), and the experimental values showing the deviations from this. The two distinct regions, before and after 30 minutes of the reaction, still exist but the curvature in the first 30 minutes of reaction is much less than for the normal runs Fig. 14, and in the opposite direction, the values of the rate constants k_2 and k_3 for the region 30-90 minutes are given in Table 17.

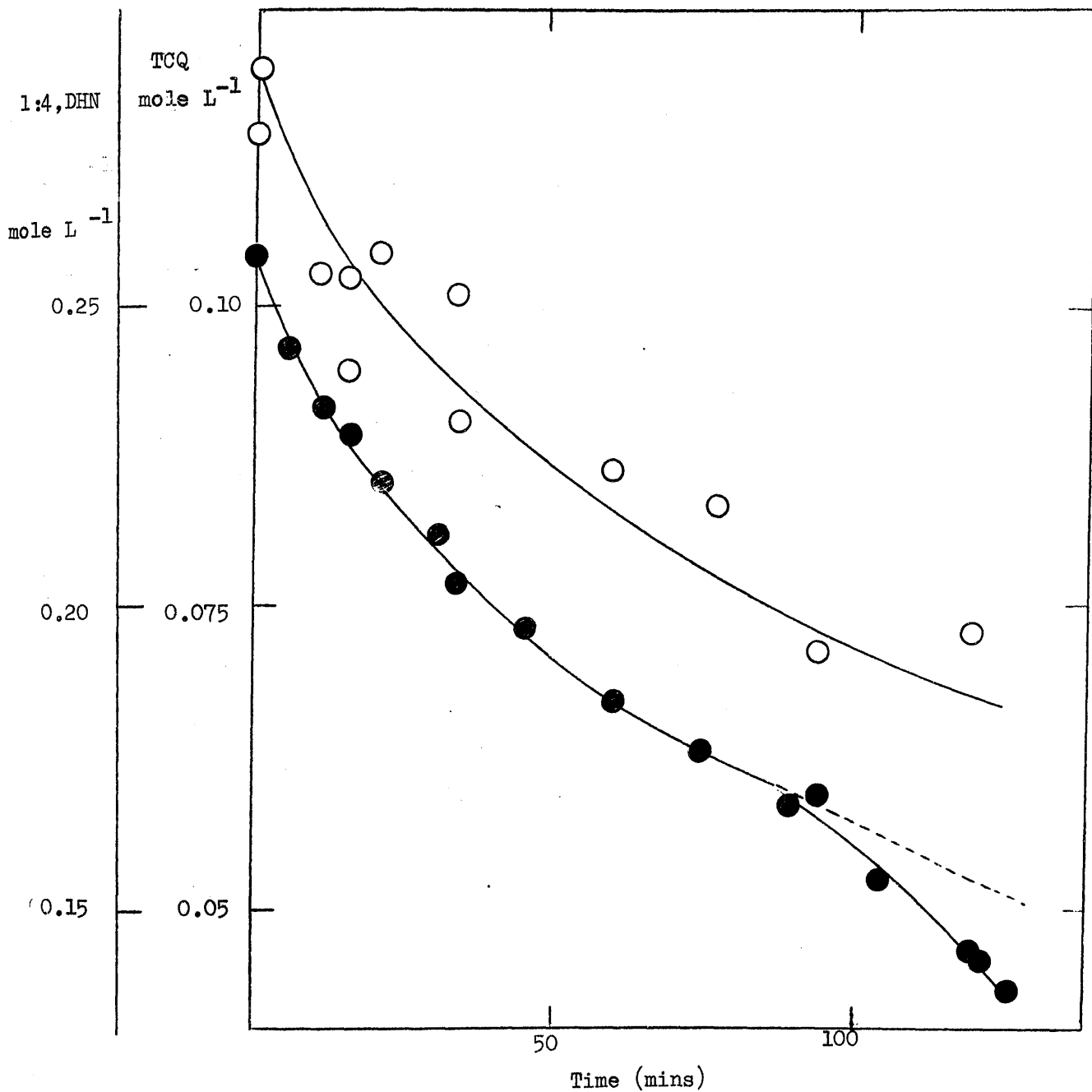

Fig. 16. Concentration/Time Curves for 1:4,DHN and TCQ and Hcl. 0.3/0.1 mole L⁻¹, 1:4, DHN/TCQ

—○— 1:4,DHN,
 —●— TCQ, (mean of four runs)

TABLE 14

Concentration/Time Data for 1:4,DHN for the System

1:4,DHN, TCO and HCl

<u>Run</u> <u>No.</u>	<u>Initial Concⁿ</u> <u>1:4,DHN/TCO</u> <u>mole L⁻¹</u>	<u>Time</u> <u>(mins.)</u>	<u>1:4,DHN</u> <u>mole L⁻¹</u>
12	0.3005/0.1041	Initial	0.2790
		0(after 2 hrs.inc.)	0.2880
		10	0.2558
		15	0.2389
			0.2546
		20	0.2587
		33	0.2522
			0.2311
		60	0.2228
		78	0.2174
		95	0.1936
		120	0.1963

TABLE 15

Concentration/Time Data for TCO for the System

1:4,DHN -TCO and HCl

<u>Run</u> <u>No.</u>	<u>Initial Concⁿs</u> <u>1:4,DHN/TCO</u> <u>mole L⁻¹</u>	<u>Time</u> <u>(mins.)</u>	<u>TCO</u> <u>mole L⁻¹</u>
Average of runs	0.3011/0.1041	0(after 2 hrs.inc.)	0.1041
13, 14, 15 and		5	0.0964
16.		10	0.0916
(appendix (e))		15	0.0889
		20	0.0854
		30	0.0809
		33	0.0770
		45	0.0732
		60	0.0673
		75	0.0630
		90	0.0585
		95	0.0594
		105	0.0526
		120	0.0468
		122	0.0461
		126	0.0436

TABLE 16

Consumption of 1:4,DHN and TCO in the System

1:4,DHN-TCO and HCl in Phenetole at 80°C

<u>Run No.</u>	<u>Amount of 1:4,DHN Consumed in reaction period 0-90 (mins)</u>	<u>Amount of quinol formed in the reaction period 0-90 (mins)</u>	<u>Ratio of 1:4,DHN Consumed / quinol formed</u>
12	*0.0905	-	1.985
Average of runs 13, 14, 15 and 16	-	0.0456	
	<u>period 0-30(mins)</u>	<u>period 0-30(mins)</u>	
12	*0.0505	-	2.177
Average of runs 13, 14, 15 and 16	-	0.0232	
	<u>period 30-90(mins)</u>	<u>period 30-90(mins)</u>	
12	*0.0400	-	1.786
Average of runs 13,14, 15 and 16.	-	0.0224	

* Obtained from the smoothed concentration/time curve.

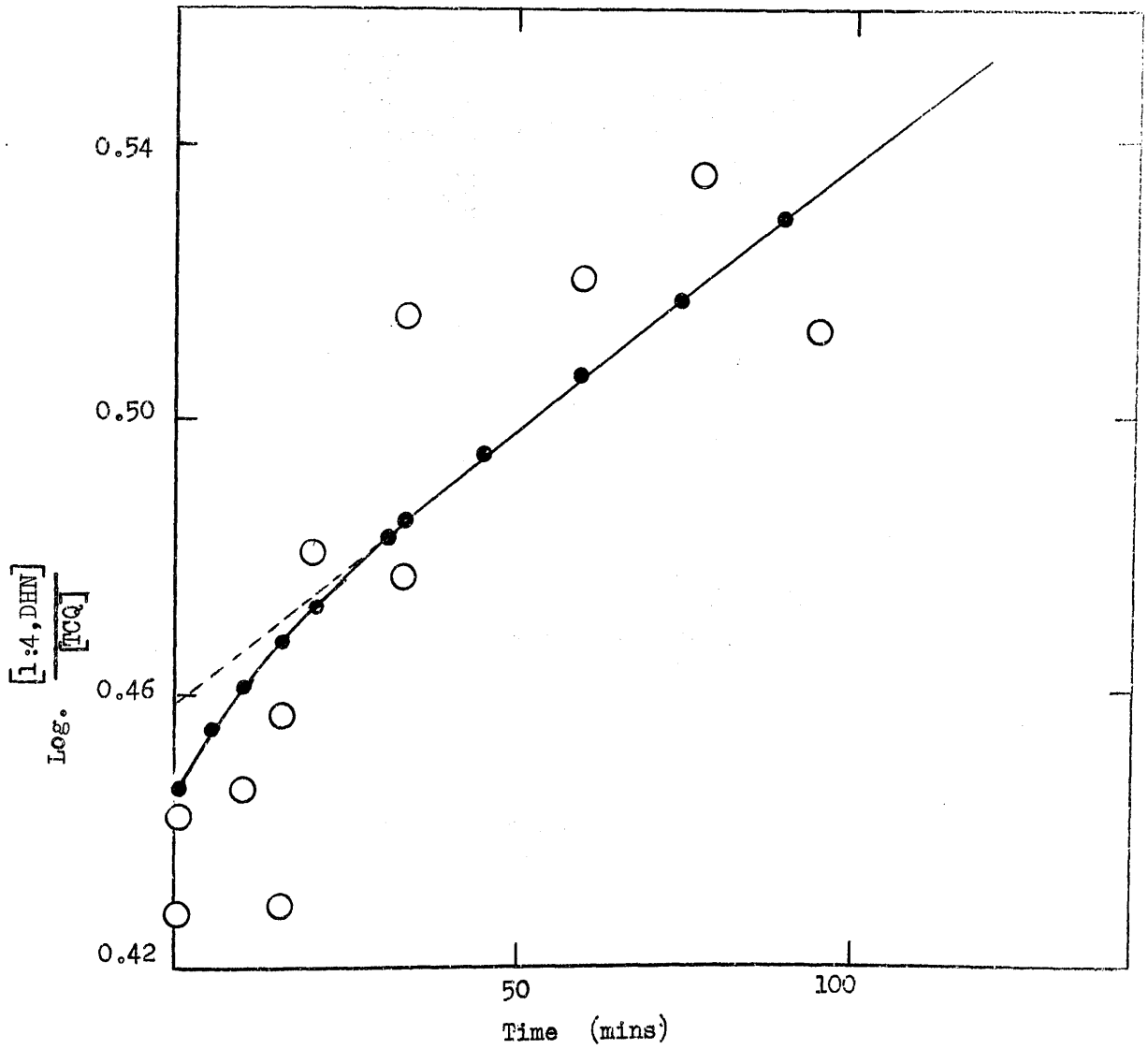

Fig. 17. Second Order Plot Assuming 2/1 Stoichiometry
 1:4, DHN 0.3 M / TCQ 0.1 M, and HCl

—●— Smoothed values
 —○— Experimental values

TABLE 17

Second and Third-Order Rate Constant Data of Stoichiometry

2/1 for the System 1:4, DHN-TCQ and HCl in phenetole at 80°C

Run No.	Time (mins)	1:4, DHN Conc ⁿ s Smoothed mole L ⁻¹	TCQ Conc ⁿ s Smoothed mole L ⁻¹	Second-order rate constant $\frac{k_2}{L \cdot \text{mole}^{-1} \cdot \text{min}^{-1}}$	Third-order rate constant $\frac{k_3}{L^2 \cdot \text{mole}^{-2} \cdot \text{min}^{-1}}$
12	0	0.2905	0.1041	-	-
(for 1:4, DHN)	5	0.2758	0.0969	-	-
with the	10	0.2663	0.0921	-	-
average of	15	0.2582	0.0881	-	-
runs 13, 14,	20	0.2513	0.0847	-	-
15 and 16	30	0.2400	0.0790	-	-
(for TCQ)	33	0.2374	0.0777	-	-
	45	0.2272	0.0728	taken as 0 time	taken as 0 time
	60	0.2170	0.0677	0.0449	0.1740
	75	0.2080	0.0632	0.0449	0.1677
	90	0.2000	0.0592	0.0444	0.1830
				0.0435	0.1829
				0.0434	0.1911

4.3 Spectroscopic Investigations

(a) Investigation of Charge-transfer Complex

(i) Apparatus and procedure

The absorption spectra were measured by means of a recording "Unicam" ultraviolet spectrophotometer model SP. 800. Extinction measurements made with this instrument were reproducible to 1%.

Exploratory absorption measurements of solutions of each of the main components of the reaction mixture (1:4, DHN, naphthalene, quinol, TCQ and phenetole) in chloroform were made using quartz cells. A matched pair of $\frac{1}{2}$ cm. quartz cells was then used for most of the subsequent measurements.

The measurements were made by first filling the cells with the solvent "chloroform" and obtaining a blank tracing over the desired spectral region; the solvent in one of the cells was replaced by the component solution to be investigated and a second tracing obtained over the same region. The absolute value of $\log \frac{I_0}{I}$ (or "A" the absorbance) at any given wave length, could be obtained directly from the difference in the two tracings. In making up the solutions, a relatively concentrated solution was first prepared by weighing out a known amount of the component in a glass stoppered 25 ml. volumetric flask and making up to the volume with the appropriate solvent. The final solution was then prepared by accurate dilution of portions of

this concentrated solution. All solutions were freshly prepared before absorption measurements, particularly those of the charge transfer complexes; these were measured within 30 minutes of their preparation.

(ii) Results

Ultra-violet spectra for the reaction components

The ultra-violet spectra for each of the components of the reaction mixture (1:4,DHN, naphthalene, tetrachloroquinol, TCQ and phenetole) were measured as described above and the Extinction Coefficient for the spectra of each was estimated using the relation

$$\epsilon = \frac{A}{b \times c} \quad (4.1)$$

where ϵ is the molar extinction coefficient, A the absorbance, b, the cell thickness in cm. and c, the concentration in mole/L. The wave length of the maxima " λ_{\max} " and log ϵ values for each of the components compared satisfactorily with those in literature with the exception of the extinction coefficient of 1:4,DHN which was slightly higher than previously reported. This could be attributed to contamination with some naphthalene impurity. The results of the absorption measurements on the principle peaks are summarized in Table 18 and Fig. 18 and 19 show the absorption curves.

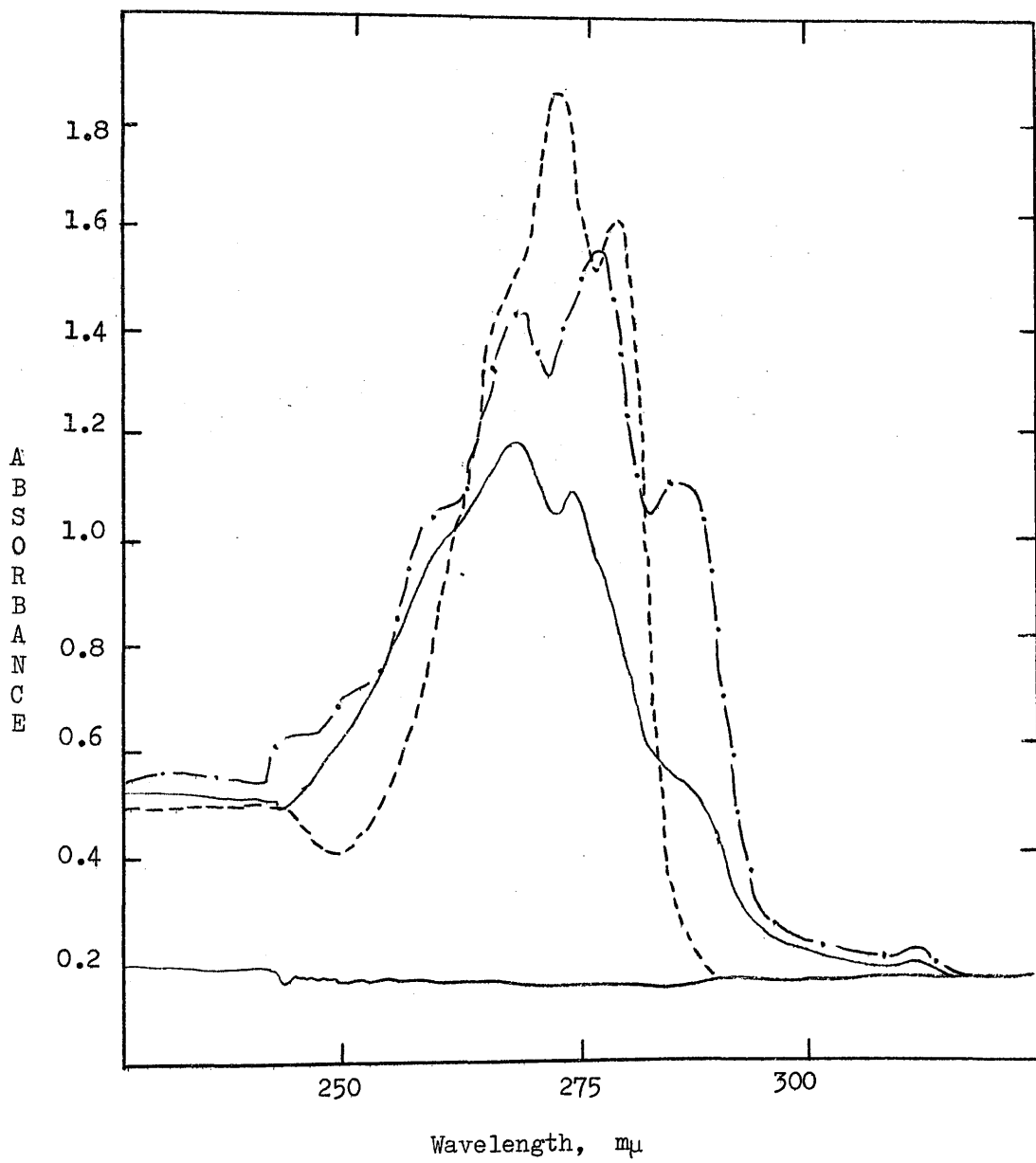

Fig. 18. Absorption Curves of ——— 1:4,DHN
 - . - Naphthalene
 - - - Phenetole
 in Chloroform.

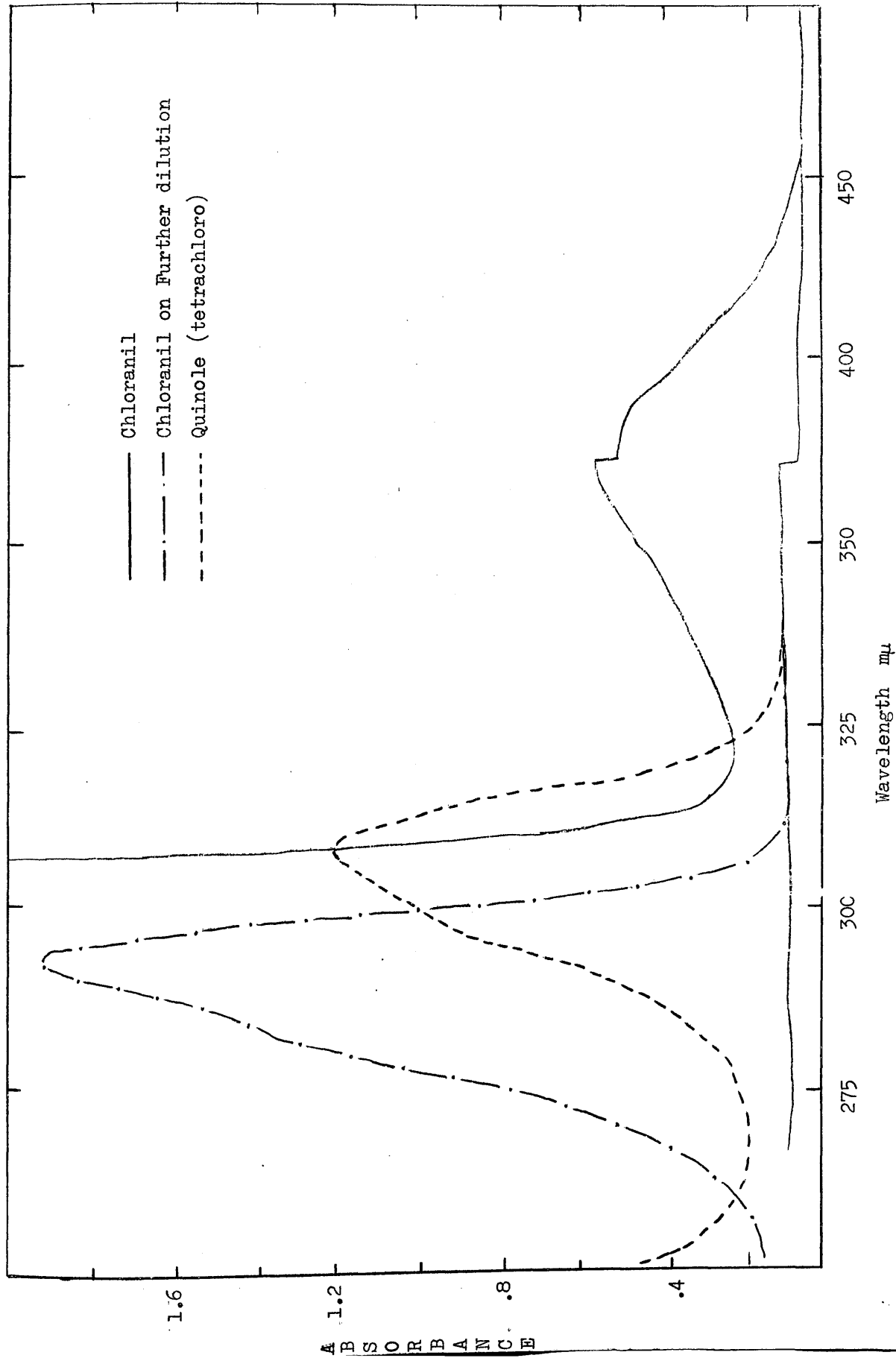

Fig. 19. Absorption Spectra of Chloranil and Quinol (tetrachloro) in Chloroform

TABLE 18

Principle Peaks in the Ultra-Violet Spectra of the Reaction Components

Component	Solvent	λ_{\max}	$\log \epsilon$	λ_{\max}	$\log \epsilon$	λ_{\max}	$\log \epsilon$	λ_{\max}	$\log \epsilon$	λ_{\max}	$\log \epsilon$	Ref.
		m μ		m μ		m μ		m μ		m μ		
1:4,DHN	hexane	262	2.7	267	2.9	274	2.93	287	2.00	311	.756	47
	EtOH	260	2.92	267	2.98	274	2.96	285	2.50	-	-	61
	chloroform	260 ^s	3.20	268	3.30	274.5	3.26	287 ^s	2.88	311.3	1.58	present work
naphthalene	hexane	256.5	3.7	265.5	3.78	275.5	3.9	286.5	3.74	311	2.54	47
	EtOH	257	3.6	266	3.7	275	3.5	286	3.6	311	2.40	62
	EtOH	258 ^s	3.57	266	3.71	275.5	3.76	286	3.59	312	2.24	63
	chloroform	260 ^s	3.58	268.4	3.74	278	3.78	287	3.62	311.3	2.41	present work
phenetole	EtOH	-	-	-	-	272	3.4	280	3.3	-	-	64
	EtOH	219.5	3.98	-	-	272	3.28	277	3.18	-	-	65
	hexane	-	-	-	-	271	3.29	-	-	-	-	66
	chloroform	-	-	267.5 ^s	3.235	273	3.34	279.2	3.27	-	-	present work

TABLE 18 (continued)

Component	Solvent	λ_{\max}	$\log \epsilon$	λ_{\max}	$\log \epsilon$	λ_{\max}	$\log \epsilon$	λ_{\max}	$\log \epsilon$	Ref.
		$m\mu$		$m\mu$		$m\mu$		$m\mu$		
quinone tetrachloro	CHCl ₃	283	4.3	291	4.3	-	-	371	2.5	67
	CHCl ₃	285	4.0	-	-	-	-	375	2.5	68
	CHCl ₃	282 ^s	4.2	292.2	4.36	-	-	376	2.34	present work
hydro- quinone tetrachloro	CHCl ₃	-	-	-	-	305	3.7	-	-	68
	CHCl ₃	-	-	-	-	307.9	3.79	-	-	present work

s = shoulder (or inflection)

Charge-transfer complex measurements

The absorption spectra of mixtures of naphthalene, phenetole, and 1:4,DHN on the one hand (as donors in the formation of the complex) and TCQ (as acceptor) were measured in chloroform as described above. In making up the solutions the donors were made in a higher concentration than the acceptor; also, a constant concentration of the quinone was used for each set of measurements.

The absorption spectra for naphthalene and phenetole with chloranil solutions show a new absorption broad band on the long wave length side of the characteristic absorption bands of the constituents. The position of λ_{max} of these bands could be localized between 470 and 500 μ for the naphthalene-quinone mixture, and at 450 μ for the phenetole-quinone mixture. The absorption curves in comparison to that of chloranil in chloroform are represented in Fig. 20.

The 1:4,DHN-quinone mixture solution has not shown such distinct broad band; but in comparison with the quinone peak (at 376 μ) a smooth increase in absorption could be observed in the same region as that of the naphthalene-quinone complex peak. Furthermore, some observations characteristic of charge-transfer complex formation were noticed. For example, the 1:4,DHN-quinone solution was the same red colour as observed for naphthalene or phenetole with the quinone. On dilution it tended to turn yellow which is the original colour of the quinone. However, on leaving its solution standing at room

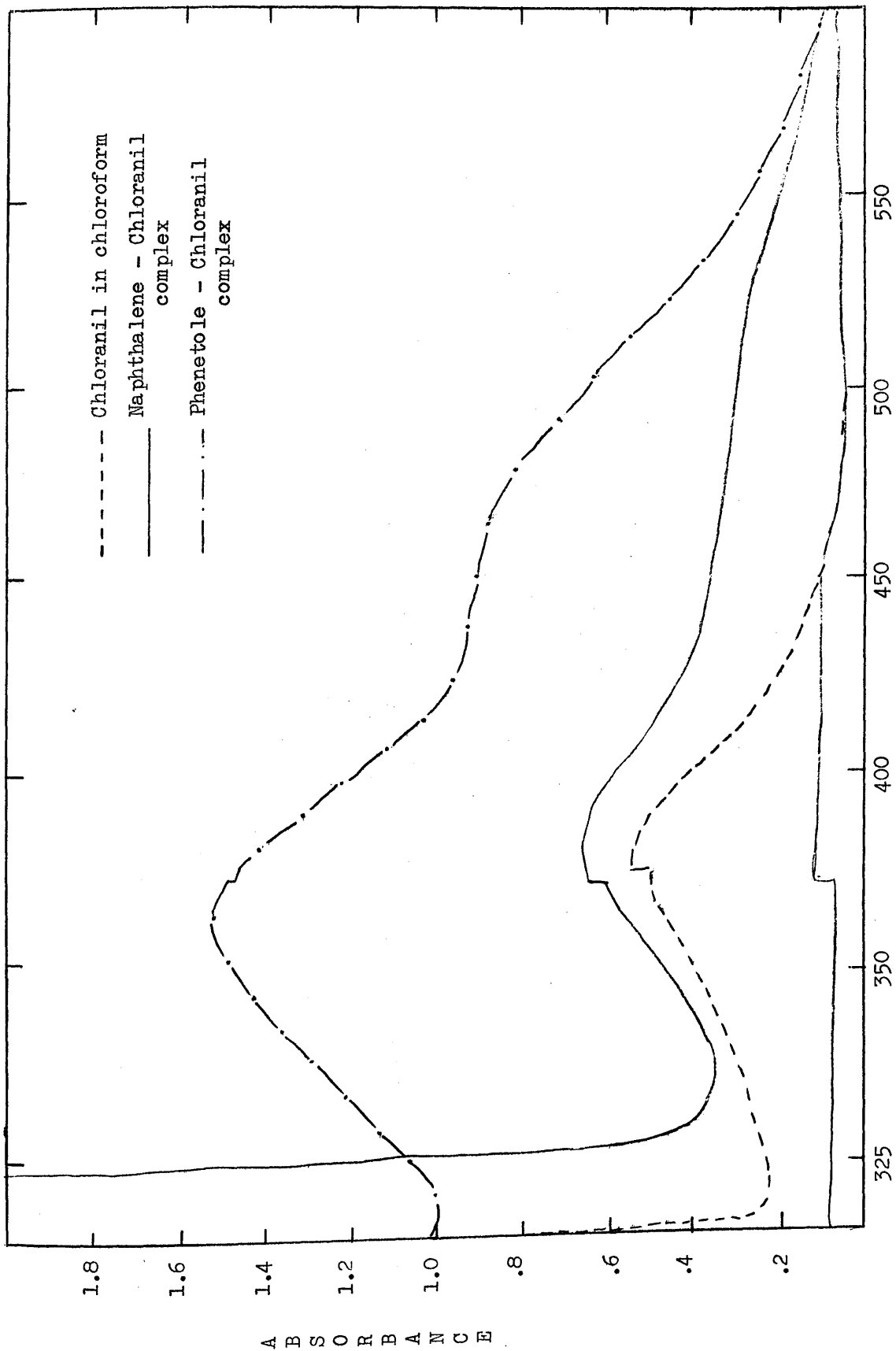

Fig. 20. Charge-transfer complex Spectra for Naphthalene; Phenetole with Chloranil in Chloroform.

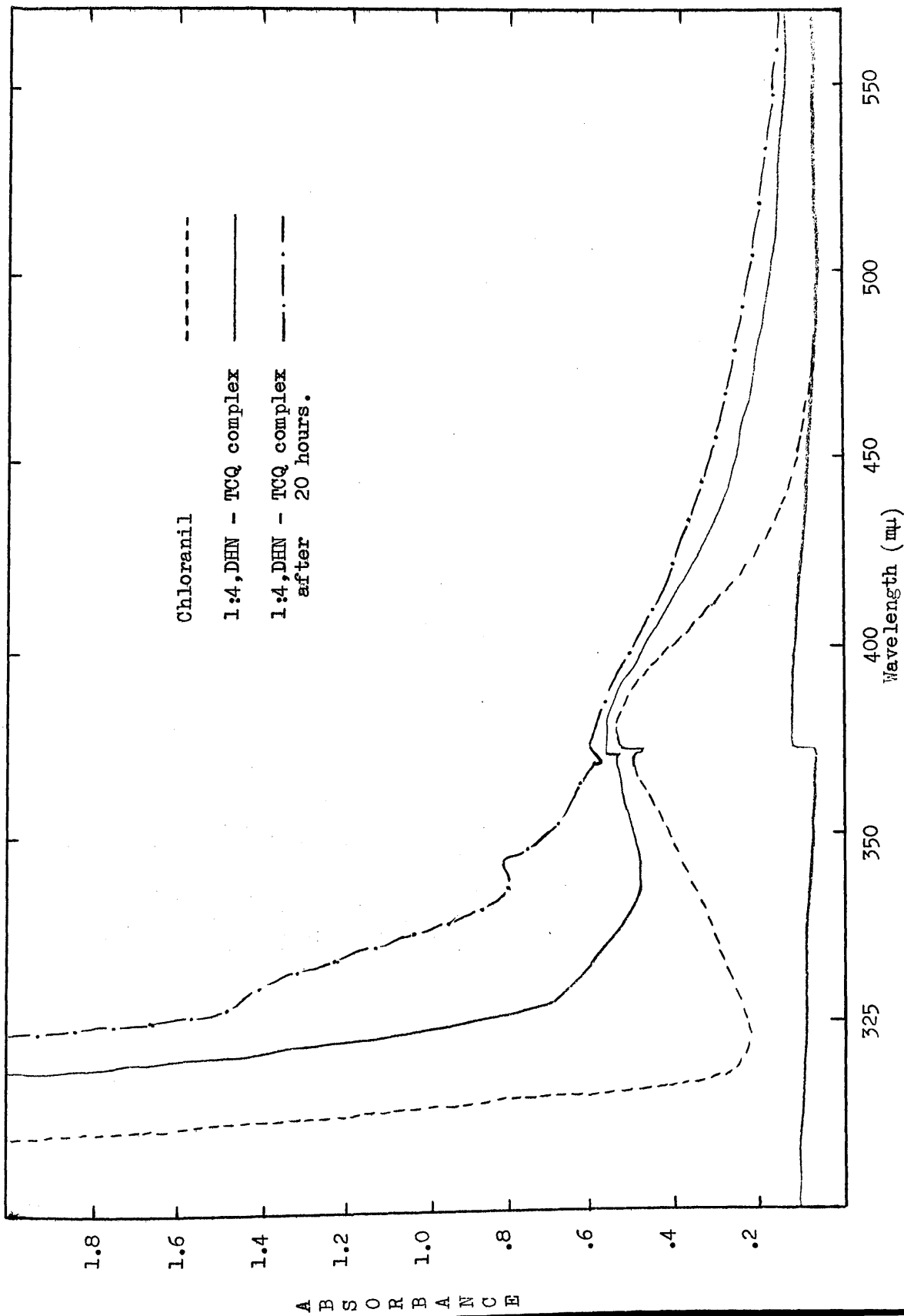

Fig. 21. Spectra of Charge-transfer Complex for 1:4,DHN - TCQ in Chloroform

temperature for over night a new maxima in the near ultraviolet region (λ_{\max} 346.5) developed, Fig. 21. This latter effect was not observed in the case of naphthalene and phenetole solutions, and this could indicate that some secondary reaction possibly involving transfer of electron occurs in the 1:4,DHN-quinone system. This will be discussed later.

The equilibrium constant for complex formation for both naphthalene-quinone and phenetole-quinone complexes were calculated using the relation (69)

$$\frac{Qb}{A} = (1/K\epsilon_c) 1/D + 1/\epsilon_c \quad (4.2)$$

where K is the equilibrium constant for the formation of the complex



Q is the molar concentration of the acceptor (the quinone); D is the molar concentration of the donor (naphthalene or phenetole); A is the absorption at λ_{\max} of the charge-transfer complex band; b is the cell thickness in cm. and ϵ_c is the molar extinction coefficient of the complex.

When $\frac{Qb}{A}$ was plotted against $1/D$, good straight lines were obtained, Fig. 22, and this indicates that 1:1-complex is formed. K and ϵ_c were calculated respectively from the slope and intercept of the linear plot.

It is interesting to note that when eqn (4.2) is applied to the spectral measurements for the 1:4,DHN complex spectra, using the same region as for the naphthalene-quinone calculations, the plot of $\frac{Qb}{A}$ against $1/D$, Fig. 22, also gives a straight line. The data for the three systems are represented in Table 19. It should be pointed out that in these results no correction for the quinone absorption at the charge-transfer peak was made in the calculation of K_s .

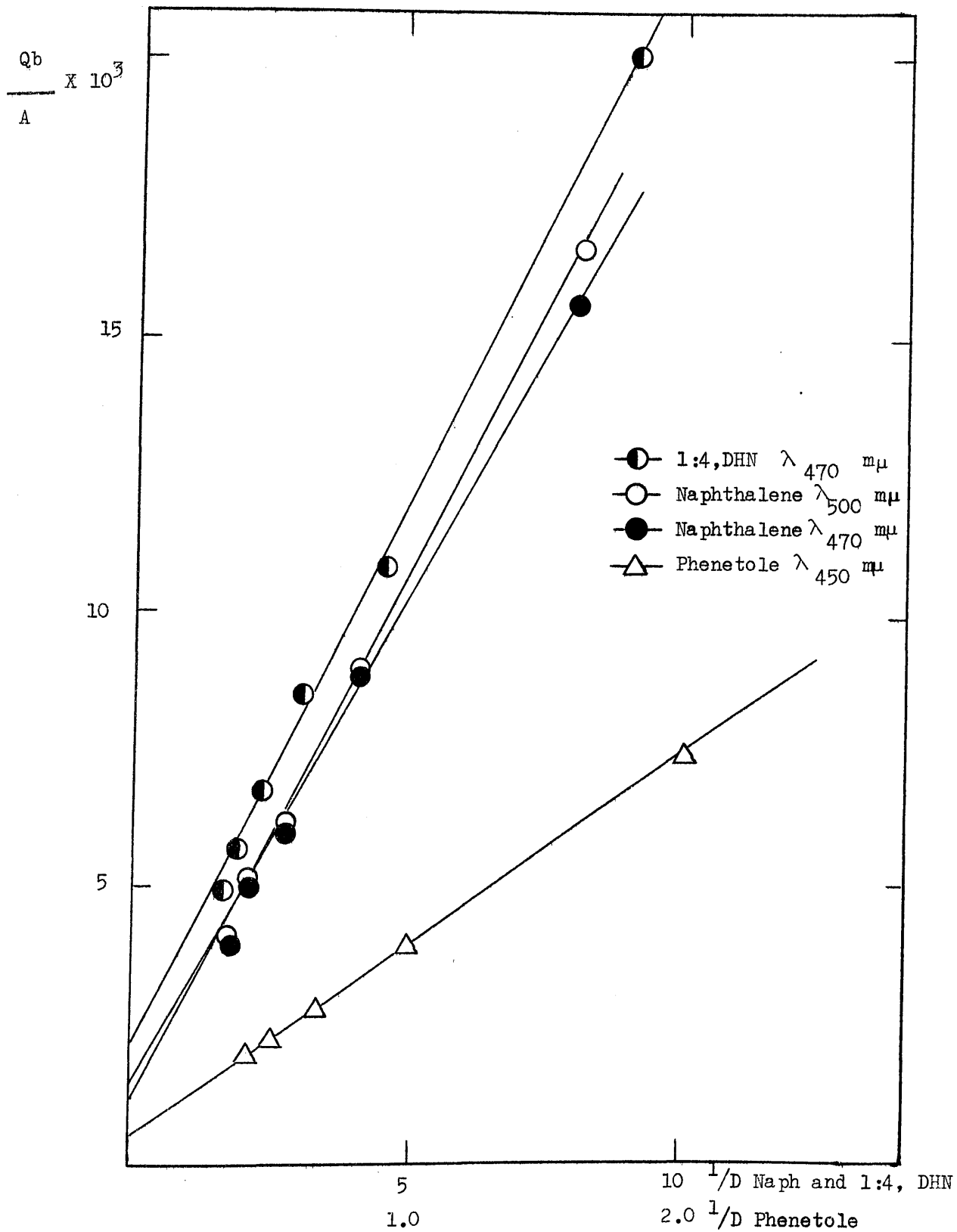

Fig. 22. Equilibrium Constant Plot for Naphthalene Phenetole and 1:4, DHN complexes with TCQ

TABLE 19

Equilibrium Constant Data for Charge-transfer Complex

Formation between Naphthalene; Phenetole; 1:4,DHN and ICQ

Hydrocarbon Conc ⁿ mole L ⁻¹	ICQ Conc ⁿ mole L ⁻¹	Absorbance			$\frac{1}{D}$
		λ_{\max} 470 m μ	λ_{\max} 500 m μ	λ_{\max} 470 m μ	
Naphthalene				$\frac{A}{\lambda_{\max} 470 \text{ m}\mu}$	
0.625	0.0025	0.315	0.302	3.968×10^{-3}	1.60
0.500	"	0.255	0.246	4.903	2.00
0.375	"	0.208	0.202	6.009	2.67
0.250	"	0.144	0.140	8.680	4.00
0.125	"	0.080	0.075	15.630	8.00
		$\epsilon_c(\lambda_{\max} 500 \text{ m}\mu) = 862.0$			
		$K(\lambda_{\max} 470 \text{ m}\mu) = 0.679 \text{ L.mole}^{-1}$			
		$K(\lambda_{\max} 500 \text{ m}\mu) = 0.6032 \text{ L.mole}^{-1}$			
Phenetole		$\lambda_{\max} 450 \text{ m}\mu$	$\lambda_{\max} 450 \text{ m}\mu$	$\lambda_{\max} 450 \text{ m}\mu$	
2.500	0.0063	1.564		1.999×10^{-3}	0.400
2.003	"	1.386		2.255	0.499
1.501	"	1.117		2.800	0.666
0.9997	"	0.805		3.884	1.000
0.4998	"	0.420		7.444	2.001

$\epsilon_c(\lambda_{\max} 540 \text{ m}\mu) = 1961$ $K(\lambda_{\max} 450 \text{ m}\mu) = 0.1489 \text{ L mole}^{-1}$

TABLE 19 (continued)

Hydrocarbon Conc ⁿ mole L ⁻¹	ICQ Conc ⁿ mole L ⁻¹	Absorbance $\lambda_{\max} \text{ 470 m}\mu$	$\frac{Qb}{A}$ $\lambda_{\max} \text{ 470 m}\mu \times 10^{-3}$	$\frac{1}{D}$
<u>1:4, DHN</u>				
0.6619	0.0024	0.243	4.910	1.511
0.5516	"	0.211	5.654	1.812
0.4413	"	0.177	6.741	2.267
0.3309	"	0.140	8.523	3.022
0.2206	"	0.111	10.750	4.533
0.1104	"	0.059	20.220	9.059

$$\epsilon_c(\lambda_{\max} \text{ 470 m}\mu) = 487.7 \quad K(\lambda_{\max} \text{ 470 m}\mu) = 1.023 \text{ L. mole}^{-1}$$

(b) Estimation of Quinone Consumed in the Reaction Mixture

As the previous charge-transfer complex measurements for the reaction components with TCQ have indicated the existence of a new band at a longer wave-length than that of the constituents, this facilitates the location of a suitable point, at which measurements for the quinone concentration could be made free from any interference of absorbance due to the other components of the reaction. As phenetole is the predominant constituent of the reaction mixture the charge-transfer complex peak of the reaction mixture will correspond mainly to that of phenetole with TCQ. Any drop in the absorbance value at a suitable wave-length of the charge-transfer peak during the reaction will then correspond to the drop in the quinone concentration.

A kinetic study was made as described before, p. 39, using the same initial reactant concentrations and the same reaction temperature as previously. The rate was followed by determining spectroscopically the concentration of the quinone at appropriate time intervals by taking 0.8 ml. of the reaction mixture and diluting with chloroform to 10 ml. The spectroscopic measurements were made as described previously, p. 87.

The absorbance at λ 500 μ was chosen as a suitable point for the quinone estimation and a calibration curve was made. A stock solution containing 0.1252 g. chloranil in 10 ml. phenetole was prepared and from this subsequent portions of the desired concentrations

were withdrawn and diluted to 10 ml. chloroform in a separate volumetric flask. The absorbance of these solutions against a blank of an equivalent proportion of phenetole in chloroform was measured. All measurements are made at room temperature 21^oC.

Results

Fig. 23, shows the calibration curve, and absorbance and concentration data are represented in Table 20. Table 21 shows the data for a typical run.

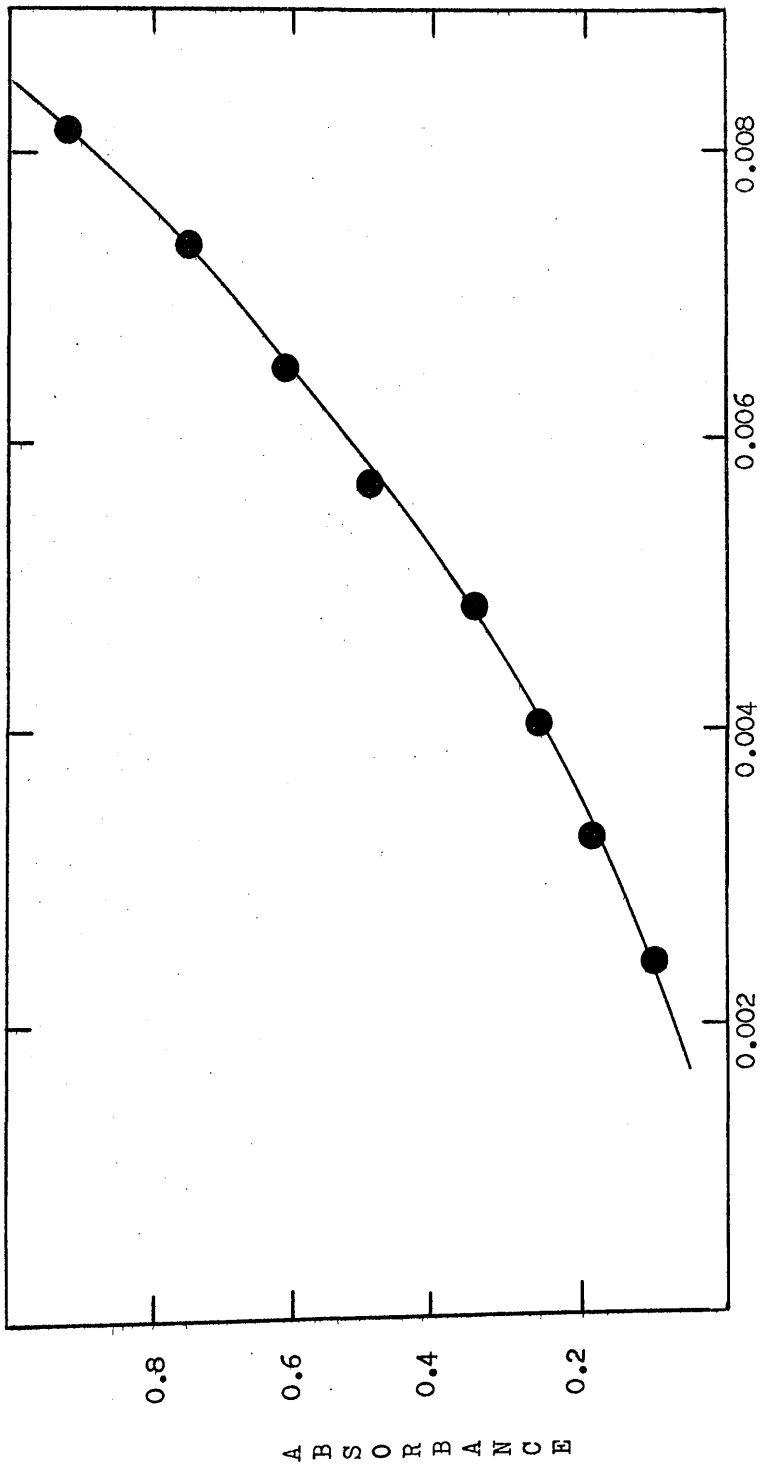

Fig. 23. Spectroscopic Calibration Curve for TCQ
(λ 500m μ ; $\frac{1}{2}$ cm cells)

TABLE 20

Data for the Spectroscopic Calibration Curve for TCQ

<u>ml. stock* TCQ solution raised to 10 ml. chloroform</u>	<u>TCQ mole L⁻¹ in chloroform</u>	<u>Absorbance ($\frac{1}{2}$ cm. cells) λ 500 mμ</u>
1.60	0.00814	0.921
1.44	0.00733	0.752
1.28	0.00652	0.612
1.12	0.00570	0.494
0.96	0.00488	0.351
0.80	0.00407	0.258
0.64	0.00326	0.184
0.48	0.00244	0.100

* Stock solution 0.1252 g. TCQ in 10 ml. phenetole

TABLE 21

Data for the Spectroscopic Estimation of ICQ

in 1:4, DHN-ICQ system

Run No.	Initial Conc ⁿ s. 1:4, DHN/ICQ mole L ⁻¹	Time (minutes)	Reac ⁿ mix ml. → 10ml. chloroform	Absorbance ($\frac{1}{2}$ cm. cells) λ 500 m μ	ICQ mole L ⁻¹
17	0.3110/0.1043	0 (after 2 hrsinc.)	—	—	0.1043
		5	0.8	0.619	0.0820
		10	"	0.591	0.0798
		17	"	0.592	0.0799
		22	"	0.560	0.0775
		33	"	0.563	0.0777
		61	0.75	0.460	0.0745
		90	0.798	0.490	0.0723
		120	0.8	0.444	0.0684

Total amount of ICQ consumed = 0.0359 mole L⁻¹

(c) Spectroscopic Detection of Possible By-Products in the Reaction Mixture

In addition to the studies of the charge-transfer complexes described earlier, some attempts were made to identify other reaction products in the U.V. spectra. Below λ 300 μ any absorbance by the products is overshadowed by the absorbance of the solvent phenetole and consequently the only accessible region for analysis is in the range λ 300-600 μ . This region is, of course, dominated by the charge-transfer spectra and these latter effects can be reduced by measuring the reaction mixture against a blank made of an amount of TCQ in phenetole equivalent to that of the reaction mixture.

The reaction was carried out as described previously, and at appropriate intervals, aliquots of the reaction mixture were removed (0.8 ml.), diluted with chloroform, and their spectra were measured against (i) a blank of an equivalent volume of phenetole in chloroform (these will be referred to as type A measurements), (ii) a blank of an equivalent amount of TCQ and phenetole, which had been subjected to the same reaction conditions, also made up in chloroform (type B). A third measurement was made after leaving these latter solutions together with the reaction mixture solutions standing at room temperature for periods in excess of 24 hours and then after a week (type C). All spectroscopic measurements were carried out with the Unicam S.P. 800 spectrophotometer.

Attempts to investigate the products in the reaction mixture using r.m.r. techniques were unsuccessful because the spectra of p. enetole, which is, of course, present in high concentration, completely overshadowed any product spectra.

Results

Typical spectra for type A and type B measurements on one reaction run are shown in Fig. 24. The use of type A measurements in the estimation of the quinone concentration has been discussed previously. In the type B spectra a notable feature is the occurrence of a new peak with a maxima at λ 311.5 μ ; the absorbance in this region increases with the reaction time as shown both in Fig. 24 and 25. The absorbance shows a very rapid increase in the first 30 minutes of the reaction followed by a much slower increase over the remainder of the reaction period. This could suggest that the peak is associated with a product from the 1:4,DHN since the disappearance of the latter has a similar time dependence.

The type C spectra show the development of a new peak with a maximum at λ 346.5 μ , Fig. 26. This is similar to the peak observed in the measurement of 1:4,DHN-TCQ charge-transfer complex. The peak height increases linearly with the reaction time, Fig. 27. Absorption data for Fig. 25 and 27 are in Table 22.

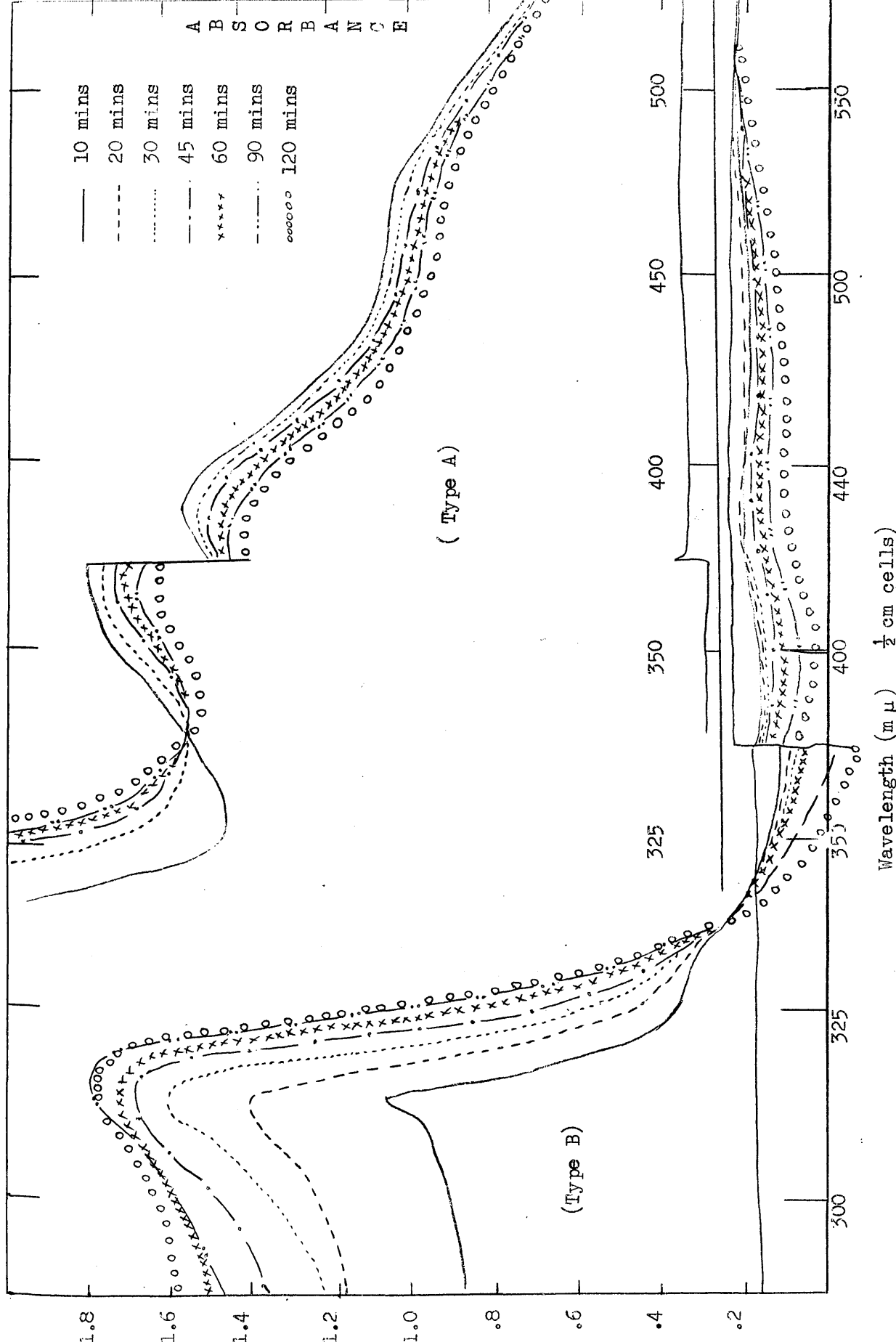

Fig. 24. Absorption Spectra for the Reaction mixture 1:4, DHN-TCQ.
 Type A: Reaction mixture against phenetole in chloroform.
 Type B: Reaction mixture against blank test in chloroform.

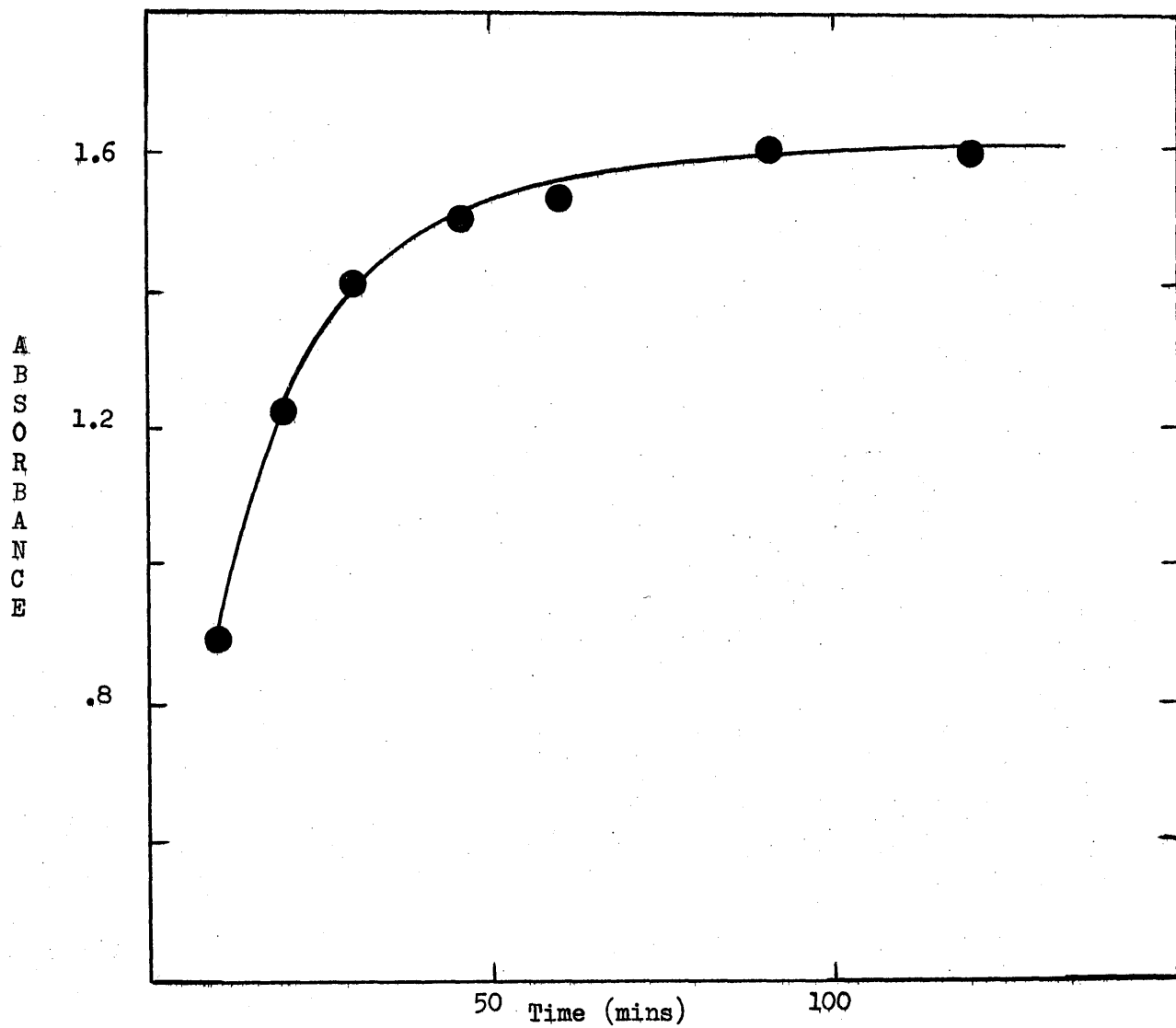

Fig. 25. Absorbance at $\lambda = 311.5 \text{ m}\mu$ as a function of reaction time

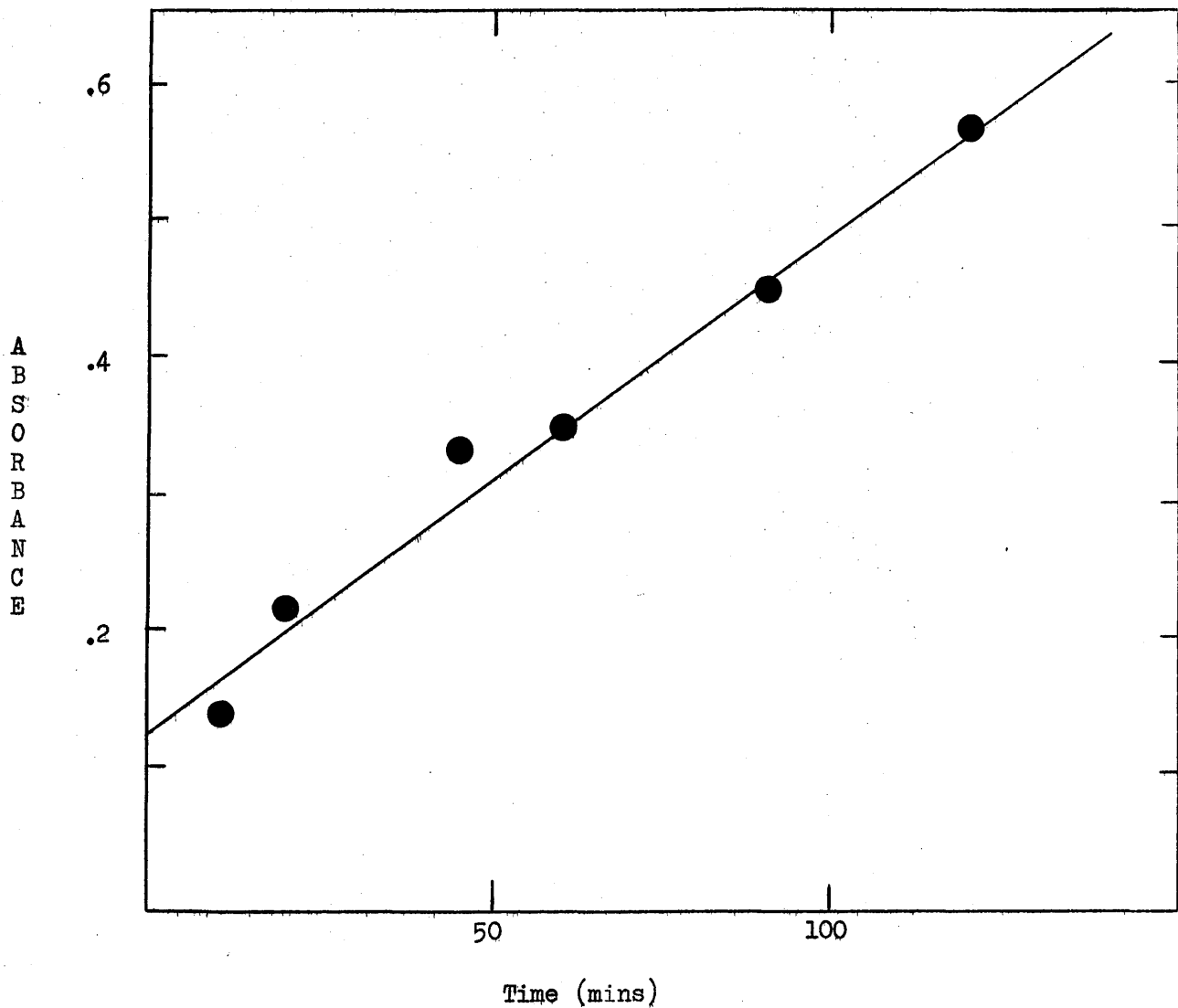

Fig. 27. Absorbance at λ 346.5 $m\mu$ as a function of the reaction time.

TABLE 22

Spectroscopic Measurements for the System 1:4, DHN-TCQ

<u>Run No.</u>	<u>Initial Concⁿs</u> <u>1:4, DHN/TCQ</u> <u>mole L⁻¹</u>	<u>Time</u> <u>(mins.)</u>	<u>Type B measurements</u> <u>Absorbance at</u> <u>λ311.5 μ</u> <u>($\frac{1}{2}$ cm. cells)</u>	<u>Type C measurements</u> <u>Absorbance at</u> <u>λ346.5 μ</u> <u>(2 mm. cells)</u>
18	0.3008/0.100	10	0.891	0.140
		20	1.228	0.213
		30	1.415	-
		45	1.502	0.334
		60	1.535	0.347
		90	1.602	0.450
		120	1.597	0.567

4.4 G.L.C. Investigations for Higher Hydrocarbons

As was previously mentioned, the extra consumption of 1:4,DHN in the reaction mixture relative to the consumption of the quinone could be the result either of a polymeric type of reaction giving rise to higher hydrocarbons or of the bonding of 1:4,DHN or naphthalene to the quinone or quinol via a side linkage, i.e. via a chlorine site and not via an oxygen linkage.

A PYE-Argon G.L.C. apparatus in conjunction with a β -ionisation detector was used to investigate the possibility of these higher molecular weight compounds being formed in the reaction. The β -ionisation detector is more sensitive than the thermal conductivity detector and hence small quantities of materials could be resolved. The stationary phase in the column was apiazon L. (10%) coated on celite the supporting material. Exploratory measurements showed that the hydrocarbons and the solvent (phenetole) are eluted at 75°C, the order of elution being the same as was previously observed with the Griffin and George apparatus. Elution of TCQ and the quinol required much higher temperatures ($\sim 170^\circ\text{C}$) and, in addition, identification could only be achieved with the detector operating at near maximum sensitivity.

A sample of the reaction mixture taken after 120 minutes of reaction was injected, after the appropriate dilution with chloroform, on to the column. Elution at 75°C gave only peaks corresponding to

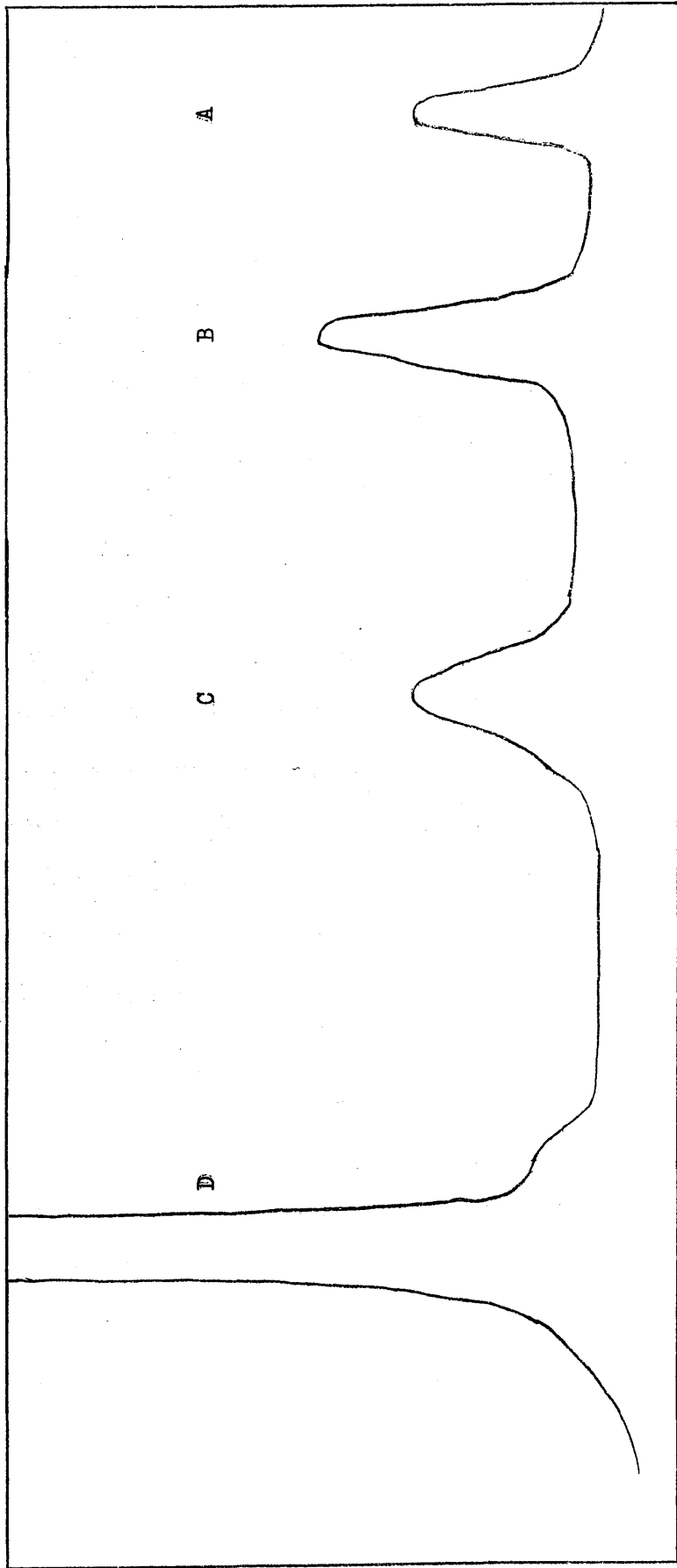

Fig. 28. Elution Chromatogram for the Reaction Mixture 1,4,DHN - TCQ System
"The Second Stage"

1:4,DHN, naphthalene and the solvents. The column temperature was then gradually increased to 170°C. Four components are resolvable in this second elution stage, Fig. 28. It is difficult to categorically identify the peaks since it was not possible to obtain exact correspondence in the heating times for the standard individual component runs and the reaction mixture run. These standard runs do however, indicate that peak D is the quinone and this is supported by the fact that it is the major peak. Peak C is identified with the quinol. The other two peaks cannot be identified with any of the main reactants or products and since they appear in the quinone-quinol region, i.e. at temperatures approaching 170°C, it seems reasonable to assume that they have polar groupings. A strong possibility is that these peaks correspond to hydrocarbon-quinone (or quinol) compounds as discussed earlier.

4.5 Preparative Experiments

It has been pointed out earlier that a great deal of the previous studies of the 1:4,DHN-TCQ system are based on the assumption that there is a quantitative conversion of the hydrocarbon and that the reaction involves one molecule of the hydrocarbon and one molecule of the quinone. Quantitative conversion of the hydrocarbon has been achieved by allowing the reaction to proceed for long periods⁽¹⁸⁾ but it has not been established that an equimolar amount of quinone is used in this conversion.

Two experiments have been carried out aimed at the quantitative conversion of one or other of the reactants. In the first experiment a solution of ≈ 0.3 M. 1:4,DHN and ≈ 0.1 M. TCQ in phenetole (25 ml.) was sealed in a long-necked ampoule under vacuum and immersed in the thermostat at 80°C . The reaction was allowed to proceed for 47.5 hours at which time the reaction mixture became colourless indicating that all the quinone had been consumed. The ampoule was removed and immediately three 1 ml. samples were taken and titrated with $\approx 0.04\text{N}$ $\text{Ce}(\text{SO}_4)_2$ solution, as in the previous estimations of the quinol. The results are given in the appendix and a summary in Table 23.

The second experiment was carried out in the same way but in this case the reactant concentrations were both ≈ 0.1 molar and the reaction was allowed to proceed for approximately 90 hours. The reaction mixture was still coloured (red), indicating the presence of the quinone, but qualitative G.L.C. measurements gave no indication of any 1:4,DHN in the reaction mixture. The quinol concentration was determined as before. The results are given in the appendix and a summary in Table 23.

TABLE 23

<u>Run</u> <u>No.</u>	<u>Initial Concⁿs</u> <u>1:4,DHN/TCQ</u> <u>mole L⁻¹</u>	<u>Time</u> <u>(hrs.)</u>	<u>Quinol</u> <u>mole L⁻¹</u>
19	0.3024/0.1002	47.50	0.0979
20	0.1002/0.0991	89.66	0.0636

4.6 Identification of the By-Products Observed in the Reaction Mixture

In an attempt to investigate further the nature of the side reactions which occur, two types of measurements have been carried out:

- (a) the investigation of the reaction which produces HCl by studying the reactions of pairs of the reactants and products, and
- (b) the identification of the new absorption maxima which have been previously observed Fig. 24 and 26.

(a) The evolution of HCl

The evolution of HCl could result from the reaction not only of 1:4,DHN and TCQ, but also from possible reactions involving the quinone or quinol with any of the other components in the system. This was examined by attempting to detect the evolution of HCl in the following mixtures which were subjected to the normal reaction conditions:

- (i) TCQ-phenetole (\approx 0.1 M. in 25 ml.)
- (ii) 1:4,DHN-quinol-phenetole (\approx 0.3 M.; 0.05 M. in 25 ml.)
- (iii) naphthalene-TCQ-phenetole (\approx 0.1 M.; 0.05 M. in 25 ml.)
- (iv) TCQ-quinol-phenetole (\approx 0.06 M.; 0.03 M. in 25 ml.)

The emergent gas, i.e. nitrogen plus any HCl, was passed through a 0.1N. AgNO_3 solution. No HCl was detected in any of these systems.

(b) Identification of the new absorption maxima

Earlier in this chapter, it has been shown that in the U.V. spectra of the reaction mixture two peaks appear which cannot be directly

identified with the main reactants or products. One peak occurs with its maximum at λ 311.5 μ and the only known reactants or products which could give rise to a peak in this region are naphthalene and 1:4,DHN. The latter can be excluded since the peak height increases with reaction time. Possible identification with naphthalene has been attempted by making up a series of solutions of naphthalene in phenetole corresponding to the concentration range found over the reaction period. These solutions were diluted with chloroform and measured under the same conditions as used previously. Comparison of the peak heights for these solutions with that found for the reaction mixture indicates that even a naphthalene concentration of 0.1 M., Fig. 29, could not account for the 311.5 μ peak of the reaction mixture; and hence it is extremely likely that this peak is mainly associated with a by-product.

The other reaction mixture peak with a maximum at λ 346.5 μ may be the result of 1:4,DHN-TCQ interaction, but could be due to the interaction of either naphthalene with TCQ or 1:4,DHN with the quinol. The latter two possibilities have been eliminated by a U.V. study of the mixtures made from these components under the normal reaction conditions. The previous procedures were adopted in that measurements of the mixtures in chloroform was made with,

- (i) a phenetole in chloroform blank,
- (ii) a phenetole-TCQ in chloroform blank for the naphthalene-TCQ

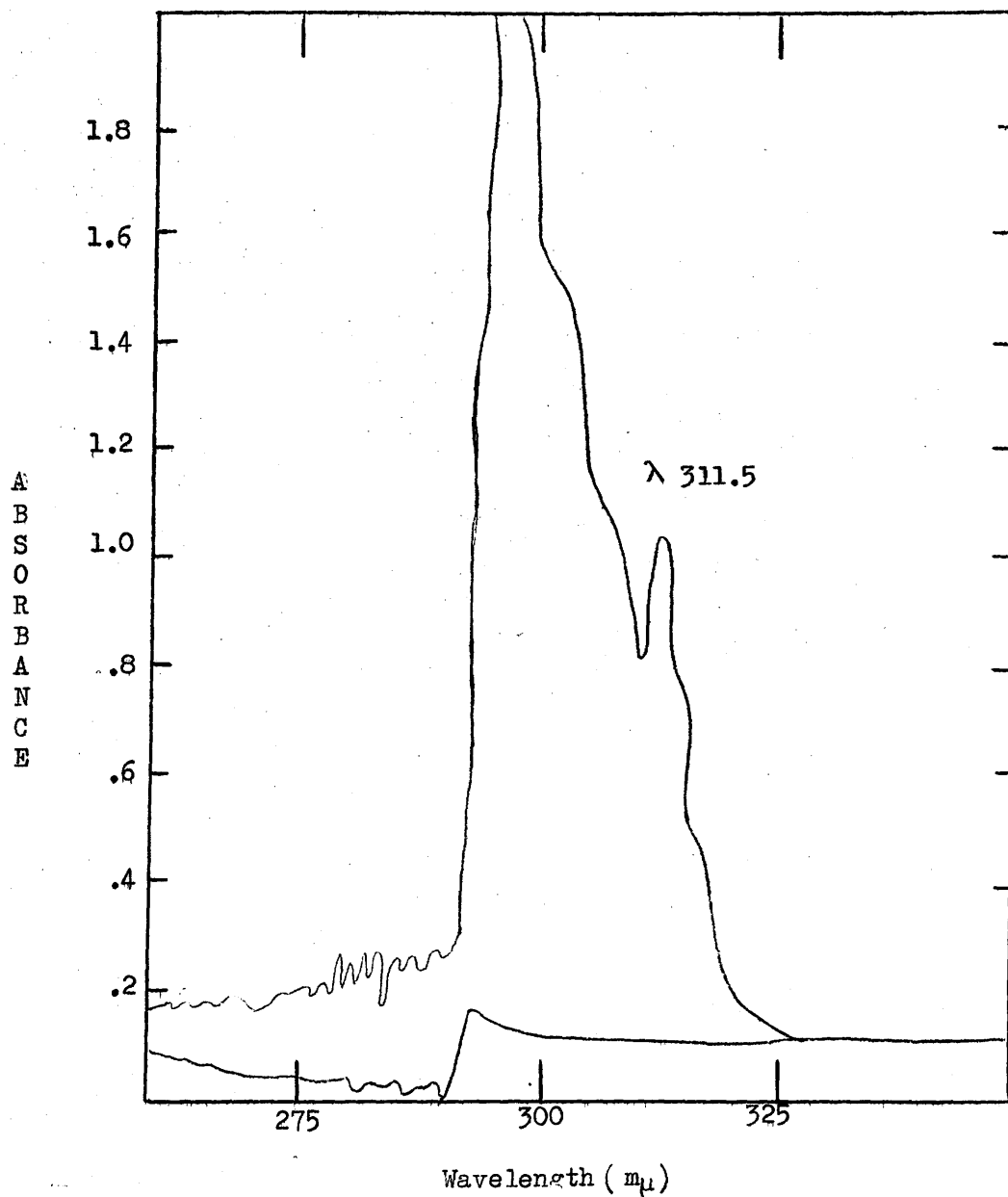

Fig. 29. Naphthalene (.1M) in Phenetole in Chloroform

system, and a phenetole-quinol blank for the 1:4,DHN-quinol system.

(iii) the mixtures against (ii) after leaving overnight standing at room temperature.

Apart from the charge-transfer and the chloranil peaks (for the system naphthalene-TCQ) there was no indication of the development of a peak at λ 346.5 m μ or λ 311.5 m μ , but it is important to mention that on leaving the 1:4,DHN-quinol mixture solution in chloroform standing for a week the solution gradually changes in colour from colourless to red and only then the 346.5 m μ maximum starts to develop. The change of the solution to red colour is probably due to the partial oxidation of the quinol to quinone (probably by atmospheric oxygen) which forms a charge transfer complex with both 1:4,DHN and phenetole, but the development of the 346.5 m μ maximum only at that stage is a strong evidence that this maximum must be a result of the interaction of the main reactant components 1:4,DHN and TCQ. This will be discussed in more detail later in the discussion section.

CHAPTER V

DISCUSSION

5.1 Summary of the Results

Since the present work involves several different experimental approaches it is convenient to summarise the results at this point.

(a) Kinetics and Isotope Effect of the Reaction

The kinetics of the reaction can be fitted to a second order rate equation after the initial thirty minutes of the reaction. However, there is no sharp break in the concentration-time curves at 30 minutes, Fig. 10, and this suggests that a new type of reaction does not begin at this time but rather that it is a single reaction which is being observed and this approximates to second order kinetics at longer times.

The isotope effect studies gave a value for k_T/k_H of 1.16 ± 0.16 and this is not in accord with the fission of the C-H bond being the rate determining step.

(b) The Stoichiometry of the Reaction

Earlier investigations have suggested that the only products of the reaction are naphthalene and the quinol. This is not the case in the present work since the analysis by G.L.C. has shown that two molecules of 1:4,DHN are consumed for every molecule of naphthalene formed. Furthermore the rate of production of naphthalene is

approximately the same as that of the quinol, Fig. 30, while the rate of disappearance of the quinone (as measured spectrophotometrically) is in agreement with the rate of formation of the quinol (see Tables 8 and 21). It should also be noted that the rate of appearance of the quinol is in very good agreement with Braude et al's⁽¹⁸⁾ results so there is little doubt that the same reaction is being observed. The overall reaction may be represented by:

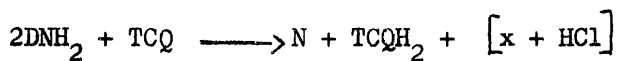

(N for naphthalene)

Hydrogen chloride is evolved throughout the reaction but quantitative estimation of the amount could not be made since it is too readily soluble in the solvent. Additional experiments have also shown that this must be generated by interaction of the reactants (no evolution of HCl was observed in TCQ-phenetole; quinol-phenetole; TCQ-quinol-phenetole, TCQ-naphthalene-phenetole and 1:4,DHN-quinol-phenetole mixtures).

The problem of identification of x will be dealt with later, but it is important to note that it is not a higher hydrocarbon and probably involves the bonding of the quinone or quinol to the hydrocarbon via a site which was originally occupied by a chlorine atom. x is not as stable a product as the naphthalene or the quinol. When the reaction was carried out in a sealed tube for a longer time a

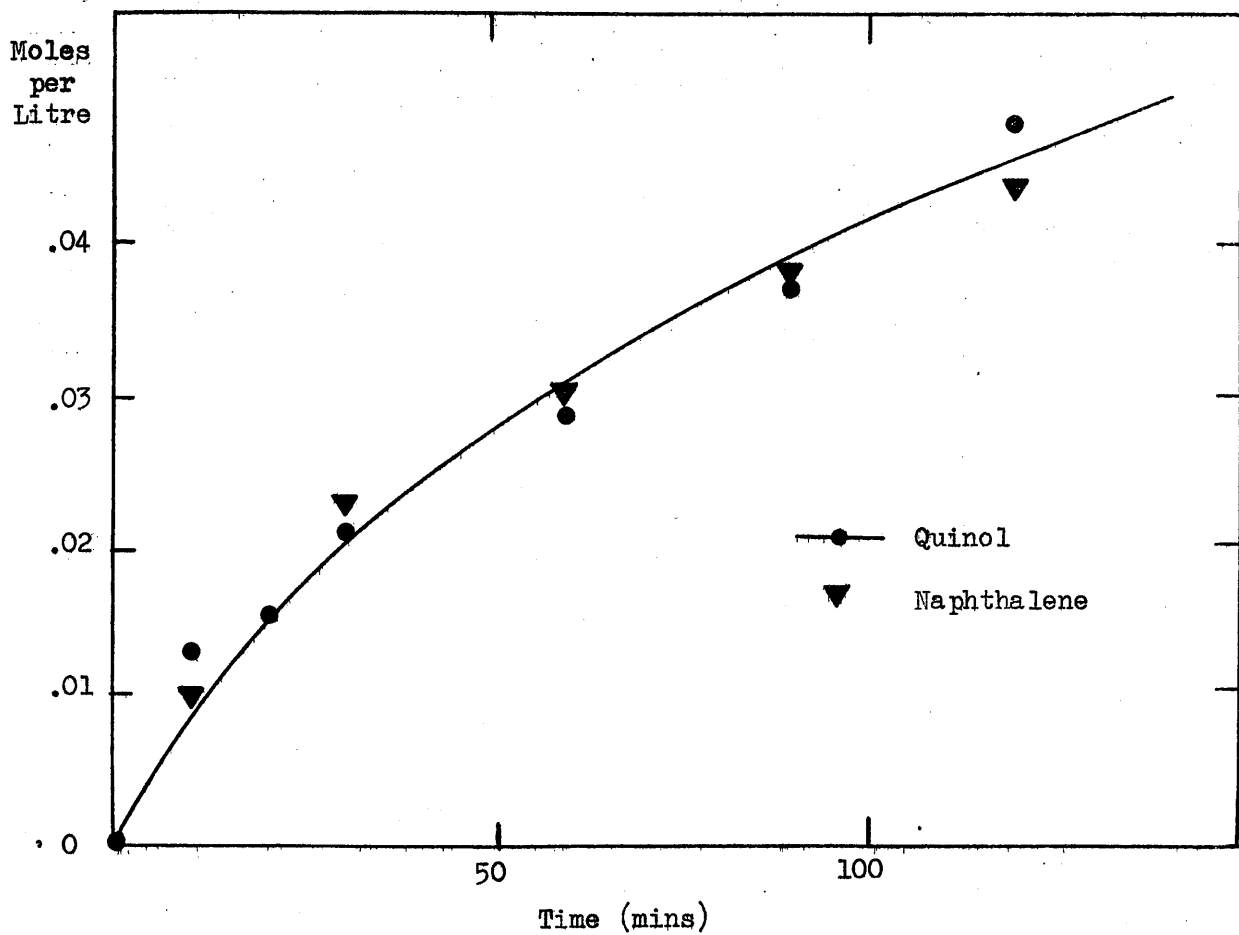

Fig. 30. Concentration curves for Naphthalene and Quinole

quantitative conversion of TCQ to the quinol was obtained. In similar preparative experiments by Braude et al⁽¹⁸⁾ complete conversion of the quinone to the quinol was obtained at higher temperature (131°C) for 72 hours and also quantitative conversion of the 1:4,DHN to naphthalene was obtained when using benzoquinone.

The effect of adding HCl gas (in large excess) is to increase the rate of formation of the quinol and naphthalene, but it has no effect on the rate of consumption of 1:4,DHN. This is going to be discussed later.

(c) The Spectroscopic Results

The predominant feature of the U.V. spectrum of the reaction mixture is the presence of the broad band in the 450-550 mμ region, which is typical of charge-transfer complexes. Preparative experiments have shown that the TCQ can complex with naphthalene, phenetole and probably 1:4,DHN. Investigations of the complex formation for these possible pairs has shown that the stability of the TCQ-naphthalene complex is greater than the corresponding TCQ-phenetole complex. In the case of TCQ-1:4,DHN, a peak maximum is not observed but there is a substantial increase in absorption in the charge-transfer region. The colour of the solution is strong evidence of charge-transfer complex formation. Possible reasons for the absence of a maximum associated with charge-transfer in this system will be discussed later.

A new peak also appears with a maximum at λ 311.5 μ . The peak height increases with time of reaction, Fig. 24 and 25. A second peak at λ 346.5 μ develops when the reaction mixture in chloroform is left at room temperature for long periods, Fig. 26.

5.2 Comparison of the Present Results with the Proposed Reaction Mechanisms

Earlier explanation of the reaction mechanism have been developed in terms of either a free radical reaction or a hydride ion transfer reaction. A simple free radical mechanism appears unlikely to account for the present results. A reaction of this type would be expected to give rise to higher hydrocarbons by a polymerisation process, yet the G.L.C. measurements, which are very sensitive to small amounts of hydrocarbons, gave no evidence of any higher hydrocarbons.

The second and more probable mechanism, in the light of the recent results of Braude et al⁽¹⁸⁾, is that the transfer of a hydride ion is the rate determining step. Two possible mechanisms have been proposed,

(i) two-stage process

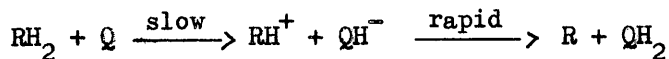

(ii) single-stage process involving a cyclic transition state

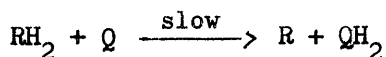

The present investigation shows that, at least in the 1:4,DHN-TCQ system, the reaction is more complex than indicated above. Both of the mechanisms would give rise to second order kinetics and Dimroth⁽⁶⁾, Dost and Van Nes⁽¹⁶⁾ and Braude et al⁽¹⁸⁾ have all observed this kinetic behaviour. In the present work second order kinetics were only obtained after the initial 30 minutes of reaction. Furthermore, the stoichiometry of the reaction, during the initial 120 minutes, indicates that more 1:4,DHN than TCQ is consumed. Neither of the above mechanisms would predict this.

Perhaps the strongest evidence against the proposed mechanisms is the isotope effect results. If the hydride ion is transferred as in mechanism (i) and this is the rate determining step, a large isotope effect would have been observed. Some possible reasons for low isotope effects are discussed later but a value of k_T/k_H so close to unity casts considerable doubt on mechanism (i). A low isotope effect might be expected with mechanism (ii) but this mechanism would give a quantitative conversion of 1:4,DHN to naphthalene at any stage in the reaction.

One further point may be considered at this stage. The U.V. spectra results show the importance of the charge-transfer complexes and on this basis it could be expected that the first-step in the reaction would be the formation of the complex although, of course, this need not be the rate determining step.

It is concluded therefore that none of the previously suggested mechanisms are completely consistent with the present results and it is proposed to examine the results in detail with a view to suggesting a possible reaction mechanism.

5.3 The Assessment of the Present Results in Relation to Possible Reaction Mechanisms

(a) The Isotope Effect

The isotope effect result casts considerable doubt on the earlier proposed mechanisms. As was stated earlier in the thesis a maximum isotope effect would not be observed since in the tracer molecule not all the reactive hydrogens were tritiated. However, in the present case, a value of k_T/k_H of substantially less than unity would have been expected.

The errors in our isotope effect determinations are such that the value could be regarded as either close to unity or unity or an inverse isotope effect. Considering the first case, i.e. treating it as a very low isotope effect, it is interesting to note that similar low isotope effects have been frequently observed in hydride ion transfer reactions. In fact it was at one time considered a characteristic for these types of reaction.⁽⁷⁰⁾ Swain⁽⁷¹⁾ obtained a value of 0.36 for k_D/k_H in the oxidation of isopropyl alcohol with bromine and a value of 0.56 for k_D/k_H ⁽⁷²⁾ was obtained in the Cannizzaro reaction.

Several explanations have been advanced to account for these low isotope effects. One suggestion is that the C-H bond is only partially cleaved in the transition state but, if this view is correct, it is difficult to justify the absolute rate theory approach to isotope effects since this requires that the vibration in the bond be entirely converted to translation.

A more reasonable explanation is that a low isotope effect could be expected if there was considerable bending of the C-H bonds in the transition state where it may more nearly be said that a bending rather than a stretching mode of vibration is converted to translational motion in the transition state. Since vibration frequencies for bending are much lower than those for stretching, the zero-point energy lost in the transition state (and hence the contribution of zero-point energy to the activation energy) will be small and a low isotope effect is the result. This would be more likely in the concerted mechanism (ii) proposed by Braude et al⁽¹⁸⁾ where the participation of a big molecule like the quinone (TCQ) would lead to considerable steric strain on the C-H bonds in the transition state creating bending mode of vibration and the magnitude of the isotope effect would depend critically on the bending frequencies in the transition state.

In the 1:4,DHN-TCQ system it is likely that steric effects would preclude such a transition state but in any event it is

difficult to explain the observed stoichiometry of the reaction by this mechanism; a quantitative conversion to naphthalene and quinol should be obtained. Moreover, the rate determining step is still the cleavage of the C-H bond and the bending vibrations would not be expected to reduce the isotope effect to unity.

An alternative explanation is the formation of a three centered transition state. This type arises when the acceptor for the hydrogen, is directly involved in the transition state in which the new bond is formed as the old bond is broken. In this case there will be a difference in zero-point energy in the activated complex which will in part cancel the difference in zero-point energy in the reactants. This type of transition state has been previously suggested to be the best picture of various hydrogen-abstraction reactions.⁽⁴⁰⁾ Melander⁽⁴⁰⁾ and more mathematically, Westheimer⁽⁷³⁾ have discussed the problem in detail.

This explanation has been advanced for the case of the hydride ion transfer in the hydrolysis of triphenylsilane-T in moist piperidine.⁽⁷⁴⁾ A weak isotope effect of $k_T/k_H = .796 \pm .004$ was observed and it was suggested that the displacement of the hydride ion is such that a H-H bond of considerable strength is present in the transition state of the reaction.

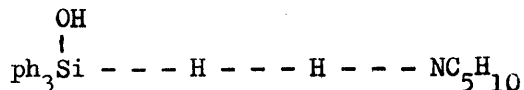

Moreover, the only observation of an inverse primary isotope effect, i.e. $k_D/k_H > 1$ has been interpreted in this way.^(75,76) Although this could account for the present results, normal isotope effects have been observed very recently in hydrogen transfer to quinones⁽⁷⁷⁾ and it is difficult to see why the 1:4,DHN-TCQ system should be different in this way.

A more obvious conclusion, for an isotope effect near to unity, would be that a C-H bond is not broken in the rate determining step. The absence of an isotope effect was first interpreted in terms of the formation of an equilibrium step (as the rate determining step), prior to the C-H fission, by Melander⁽⁷⁸⁾ in the nitration of toluene. He postulated that the rate-controlling step in nitration is the addition of NO_2^+ to the aromatic system to produce the equilibrium step intermediate, no isotope effect would be observed, since a C-H bond is not broken in the rate controlling step.

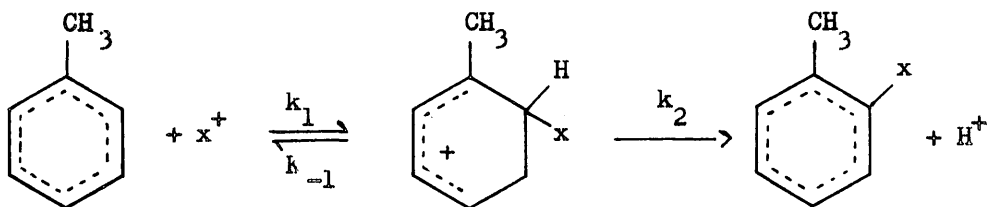

This explanation has received strong support from other results in similar systems.⁽⁷⁹⁾ In the present case this could be represented by

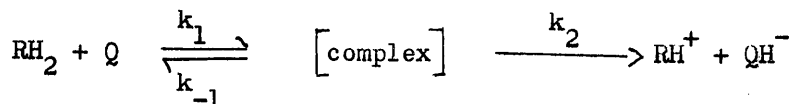

It should be noted however, that the equilibrium must be almost irreversible, i.e. $k_2 \gg k_{-1}$, for the primary isotope effect to be absent. Our spectrophotometric studies would suggest that this pre-equilibrium involves the formation of a charge-transfer complex.

If the suggestion of an initial equilibrium is correct then it should be possible to observe secondary isotope effects. This type of effect has been the subject of many recent investigations and inverse secondary effects, i.e. $k_{\text{D}/\text{H}} / k_{\text{T}/\text{H}} > 1$, have frequently been observed.

This discussion of isotope effects has been previously restricted to primary isotope effects, i.e. the effect of isotopic substitution in the bond to be broken. However, the ease of cleavage of say a C-H bond does to some extent depend on the nature of other groupings in the molecule. Thus isotopic substitution in these groupings can affect the reaction rate and hence give rise to a small isotope effect, the secondary isotope effect. This subject has been comprehensively reviewed by Halevi.⁽⁸⁰⁾

Halevi⁽⁸¹⁾ has drawn attention to the fact that the vibrational anharmonicity causes the average C-H bond distance to be somewhat different for the different hydrogen isotopes (even in the vibrational ground state). Thus an increase in the atomic mass of the hydrogen

is accompanied by a decrease in the bond length, and consequently by an increase in electron density at the carbon atom, i.e. D (or tritium) is electron-supplying relative to H. Thus the inductive effect of a C-D bond is greater than a C-H bond and in the formation of carbonium ions substitution of deuterium for hydrogen, in other than the bond to be broken, should enhance the reaction, i.e. it will give rise to inverse secondary isotope effects.

Isotopic substitution can also affect hyperconjugation in the molecule. It has been known for several years that the replacement of hydrogen in a hyperconjugating position by a deuterium (or tritium) atom generally leads to a diminution in the rate in reactions involving carbonium ions. Lewis⁽⁸²⁾ suggested that when electrons are withdrawn from a C-H bond by hyperconjugation, the force constant for the vibration of the C-H bond is reduced. A reaction with a change in hyperconjugation on activation would then be a process with different force constants of the C-H bond in the starting material and in the activated complex. This substitution of D (or T) for H will produce a difference in the change of zero-point vibrational energies on activation for the D and H compounds. This difference will in turn be reflected in different activation energies and different rates for the two compounds. When a reaction results in an increase in hyperconjugation on activation, it will be expected to involve a loss in zero-point vibrational energy which will be greater for protium

compound than the deuterium (or tritium) compound, hence the protium compound will react more rapidly.

The third and a very important factor in secondary isotope effect is of steric origin. The introduction of deuterium (or tritium) atoms in a molecule modifies its geometry; Bartell^(83,84) has considered in detail interactions between non bonded atoms as a factor in secondary isotope effects. His qualitative statement is that the smaller average size of a C-D bond than a C-H bond gives rise to an isotopic energy difference, i.e. a force constant change will be "felt" more by H than by D because H vibrates into regions of greater volume (since it has greater zero-point energy). The lower zero-point energy of D signifies a smaller amplitude of vibration and, effectively, a smaller van der Waals radius than that of protium. Accordingly, reactions which involve an increase in bond angles and/or a decrease in coordination number at the reaction center should exhibit secondary deuterium isotope effects with k_D/k_H less than unity since relief of non-bonded interactions should be more pronounced in the more congested molecule, i.e. the one containing protium in place of deuterium. Conversely, a decrease in bond angles and/or an increase in the coordination number would imply a k_D/k_H greater than unity.

Much of the recent work on secondary isotope effects has been concerned with the formation of π - and σ - type complexes.

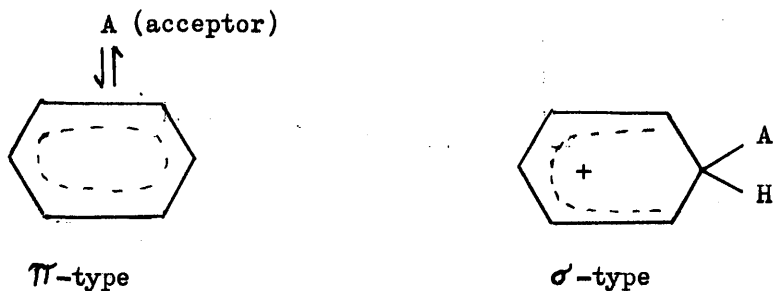

The situation in the π -type complex is particularly interesting. If we consider the case of an olefin and an acceptor forming a π -complex,

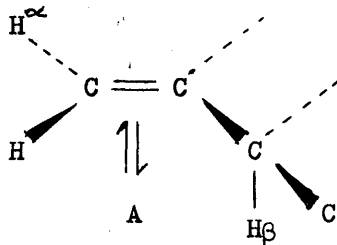

The effect of replacing the α hydrogen by deuterium could be to increase the stability of the complex since the inductive effect of the deuterium would favour electron transfer to the acceptor. Secondly, since the C-D bond is on average shorter than the C-H bond steric effects would be reduced again leading to increased stability. The replacement of the β hydrogen by deuterium would have a similar but much weaker effect. However, if hyperconjugation is important then the substitution of deuterium should lead to reduced stability. It

is significant that either normal or inverse secondary isotope effects can be observed in π -complexes formation but only normal secondary isotope effects are obtained in σ -complex formation.

In the system represented above (olefin-acceptor complex) inverse secondary isotope effects have been observed with the Ag^+ ion as an acceptor. (85) This effect of deuteration of the olefin on the stability of the complex can be represented by:

$$K_{\text{D}/\text{K}_\text{H}} = 1.04 n_\alpha + 1.01 n_\beta$$

(deuterium increases complex stability), where n_α and n_β are the number of deuterium atoms in the α and β positions respectively.

The position in regard to π -complexes involving aromatic compounds is less clear. Deuteration of the methyl group of toluene increases the stability of the toluene-HCl complex; and isotope effect of $K_{\text{D}/\text{K}_\text{H}} = 1.02$ was observed. (86) Similarly ring-deuteration of toluene or use of C_6D_6 versus C_6H_6 leads to inverse effects ($K_{\text{D}/\text{K}_\text{H}} > 1$). However, deuteration of the methyl group of toluene produces a normal secondary isotope effect for toluene-chloranil complex formation. (87,88) This has been ascribed to a hyperconjugation effect, although the steric factors should be even more important in the chloranil complex, since chloranil is larger than HCl.

Studies of complex formation in media of varying dielectric constant suggest that an equilibria exists between the aromatic compounds, the π -complex and the σ -complex



We can visualize two possible extremes in the potential energy diagram, Fig. 31, (96)

- (i) the π -complex formation is rate determining (- - - -)
or (ii) the transformation from $\pi \rightarrow \sigma$ complex is rate determining step.

An inverse secondary isotope effect is only observed in (i).

In the present system 1:4,DHN-TCQ the value of $k_{T/K_H} = 1.16 \pm 0.16$ could be regarded as an inverse secondary isotope. This effect could be taken as evidence of π -complex formation being the rate determining step (i.e. dotted curve in Fig. 31). It would be expected that the inductive effect would be increased by tritium substitution and the steric effects reduced (this will be discussed later). The presence of the double bond in the hydroaromatic ring would reduce any tendency to hyperconjugation (since the double bonds are separated by more than one single bond so the π molecular orbitals at the double bond would not be able to overlap significantly and give a polycentric molecular orbital). Hence it would be expected that K_{T/K_H} would be greater than unity.

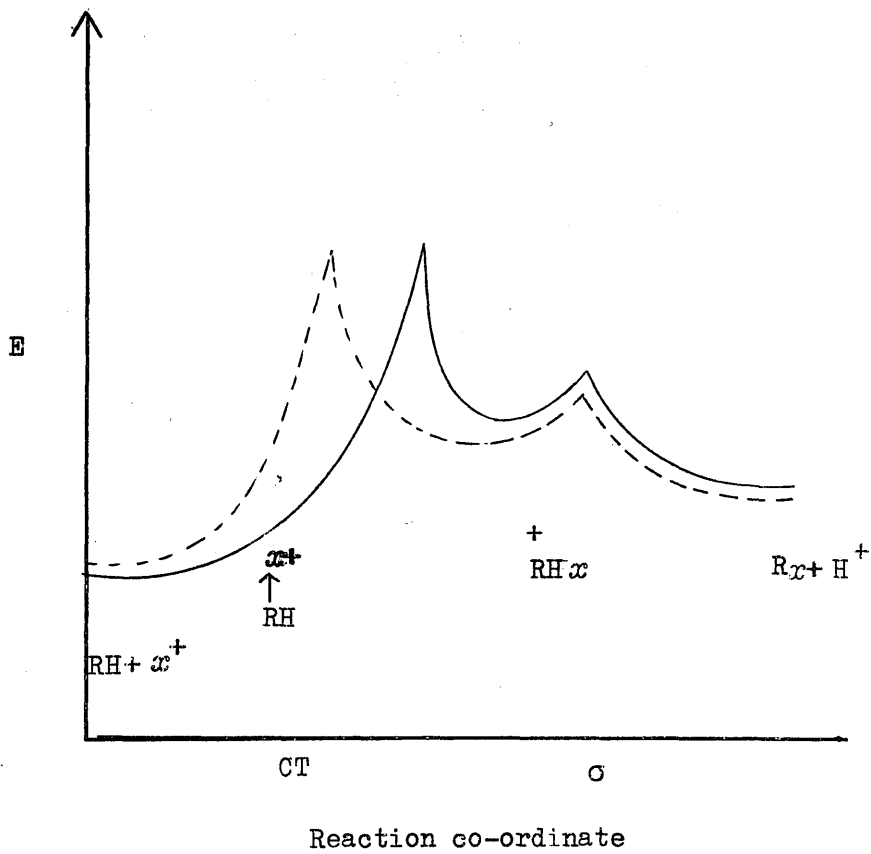
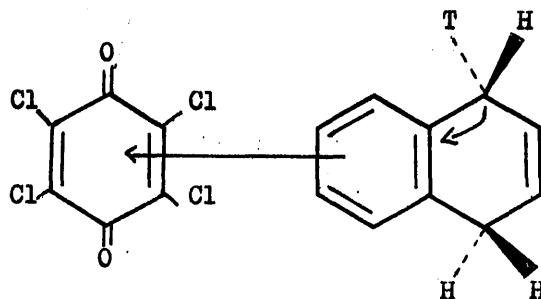

Fig. 31. Equilibria between aromatic compounds; π complexes and σ - complexes.



inductive effect

It necessarily follows that if the π -complex is formed in the rate determining step, then an inverse secondary isotope effect

($k_T/k_H > 1$) could be observed in the reaction rate.

Explanations of this type have been advanced to account for the nitration of thiophen and α -tritiated thiophen ($k_T/k_H = 1.14$)⁽⁸⁹⁾ and the chlorination of benzene.⁽⁹⁰⁾

(b) The Charge-Transfer Complexes

The Benesi and Hildebrand equation (eqn. 4.2) has been applied to evaluate the equilibrium constants for the systems 1:4,DHN-TCQ; naphthalene-TCQ and phenetole-TCQ. The graphs, Fig. 22, are linear in all cases indicating the existence of 1:1-complexes in these systems. K values (the equilibrium constant) for the three systems are in the order 1:4,DHN-TCQ complex > naphthalene-TCQ complex > phenetole-TCQ complex. The 1:4,DHN-TCQ complex is going to be discussed separately since from the experimental observations it could be of a different type.

The peak maximum and the equilibrium constant for the naphthalene-TCQ complex are in quite good agreement with the values previously reported in literature, Table 24.

TABLE 24

Absorption Maxima and Equilibrium Constant for
Naphthalene-TCQ Complex in Chloroform

<u>Reference</u>	λ_{max} (<u>mμ</u>)	K (<u>mole⁻¹l.</u>)
Chakrabarti and Basu (57)	470	0.83 (27°C)
Present work	470	0.68 (22°C)

The lower value, in the present work could be due to the fact that no correction for the absorption of the TCQ at the charge-transfer maxima

was made. Charge-transfer complex formation between naphthalene or similar aromatics and quinones have been extensively studied^(56,57) and it is now well established that they are a π -co-ordination compounds in which an electron pair from π -molecular orbital of hydrocarbon is partially donated to the antibonding molecular orbital of the quinone. The charge-transfer transition energy obeys the Mulliken relationship⁽⁵⁸⁾

$$h\nu = I - E - \Delta$$

ν is the frequency at the peak of the charge-transfer absorption band, I the ionization potential of the donor, E the electron affinity of the acceptor and Δ the stabilization energy of the ion-pair. Complexes with TCQ are an interesting case; Chowdhury⁽⁵⁶⁾ has found that the charge-transfer energy, $h\nu$, for the quinone complex is higher than that of the tetrachloro-quinone complex. The same is true for phthalic anhydride and tetrachloro-phthalic anhydride complexes. The stronger acceptor property of the tetrachloro-derivative was interpreted to be presumably due to electron-deficiency in the ring caused by the inductive effect of the chlorine atoms. Also Chakrabarti and Basu⁽⁵⁷⁾ have found that for the isolated complexes of aromatic hydrocarbons with haloquinone, the charge-transfer interaction is in the order $h\nu(\text{iodanil}) > h\nu(\text{bromanil}) > h\nu(\text{chloranil})$.

No comparison with earlier work could be made in the case of the phenetole-TCQ complex. The only charge-transfer study made for

phenetole⁽⁵⁹⁾ does not provide any direct information about the equilibrium constant. Michaelis and Granick⁽⁵⁹⁾ have investigated the charge-transfer bands for phenols and phenol ethers including phenetole with quinones. In the case of phenetole (which is the ethyl ether of the phenol) the absorption maximum for the complex was observed at 350 m μ , but the type of quinone used is not specified and presumably it was P-benzoquinone. In the present investigation the absorption maximum of the complex is at 450 m μ and it is clear from the spectra, Fig. 20, that the peak at 350 m μ is in the region of the absorption of the TCQ itself. Hence, any attempt at comparison of the present work with the previous work is prohibited. However, one feature of the earlier work is worth mentioning in that it showed that the affinity of the quinone for the phenolic compound in solution is not essentially altered by alkylation of the phenolic OH group. This led them to the conclusion that the rings of the two components are superimposed upon each other and are not coplanar, and that no hydrogen bond plays any essential role in the establishment of these complexes.

The absence of a well defined maximum in the spectra of 1:4,DHN-TCQ complex is rather surprising. Certainly there is increased absorbance in the 450-550 m μ region, Fig. 21, which is indicative of charge-transfer interaction. The absence of the maximum may be due to the fact that it is contact charge-transfer complex or it may be

that the peak maximum occurs at lower wave length and strong absorbance of the quinone in this region is masking the maximum. The developing of a new maximum at 346.5 μ on standing the reaction mixture at room temperature for a long time is actually not surprising for a system like 1:4,DHN-TCQ, since further interaction between the two components is expected to take place. A change of optical density of a charge-transfer complex with time have been previously observed in the case of azahydrocarbon-quinone complexes⁽⁵⁶⁾ and it was difficult to detect a maximum in their spectra. It is interesting to note that the rate of change is much more pronounced in the case of chloro-quinones complexes than those of the other quinones. This change could indicate that some secondary reaction involving transfer of electron is taking place in these systems and this could be the case in the 1:4,DHN-TCQ system. There will also be steric consideration in the 1:4,DHN-TCQ system which are absent in the cases of TCQ complexes with naphthalene and phenetole. It is commonly supposed as shown before, that, ~~for~~ the charge-transfer complexes involving benzene rings, in the donor and acceptor the aromatic rings are in direct alignment, i.e.

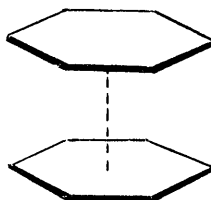

This cannot be the case. The complexes are the result of the overlap of the highest filled orbital of the donor and the lowest unfilled orbital of the acceptor. If we consider the case of benzene then the highest filled orbitals can be represented by ⁽⁹¹⁾

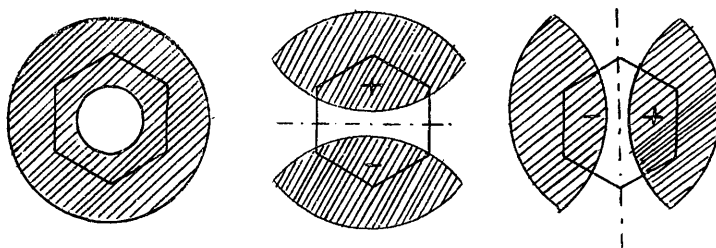

and the lowest unfilled orbitals are

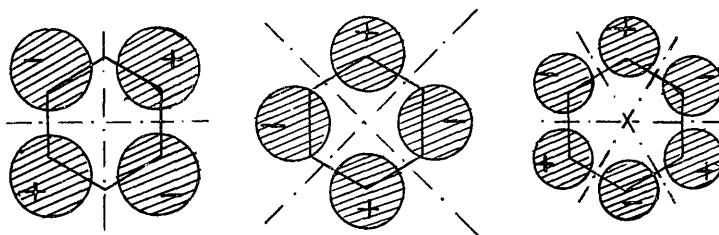

It can be seen therefore that for maximum overlap between the unfilled (acceptor levels) and filled (donor levels) the symmetry requirements are such that the donor molecule cannot be directly above or below the acceptor molecule, rather it must be slightly off-set particularly in

a case of acceptor like TCQ where the accepting center of the molecule would be the part containing the carbonyl group. Substituents in aromatic rings will obviously affect the orbitals but the general picture is the same. This has been confirmed by X-ray structure determinations of the solid complexes.⁽⁹²⁾ The bonding involved in the complexes is of the π -type.

Considering 1:4,DHN-TCQ a possible form of the complex could be

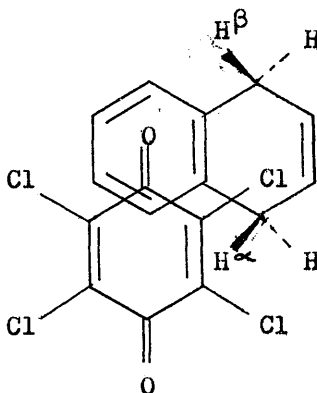

"The quinone will be in plane above the hydrocarbon. The distance between planes is approximately 3\AA ^o (93) in many complexes"

A complex like this is formulated on the following grounds:

(i) the position of the quinone is tending to the position of maximum overlap for charge-transfer. It cannot reach the ideal position because,

(ii) with the quinone in position as shown in the diagram there will be interaction, in addition to charge-transfer, due to the dipole

in the C=O bond and the induced dipole in the benzene ring,

(iii) there will be some repulsion between the H_{α} and Cl groups and the quinone situation will be such as to reduce this repulsion. This would not be evident in the TCQ complexes with naphthalene and phenetole.

Before concluding this section we must justify the use of our spectroscopic results in the elucidating of the reaction mechanism. Three factors can be questioned (i) the use of spectroscopic data at 22°C for a reaction mechanism at 80°C. (ii) the use of chloroform as a solvent for spectroscopic measurements yet phenetole is the solvent in the reaction mixture and (iii) the use of structures for solid complexes for reaction in solution.

The temperature differential between the spectroscopic measurements and the reaction temperature should not be a serious factor since the enthalpies of formation of charge-transfer complexes are relatively low ($\sim 5\text{kcal mole}^{-1}$). The effect of change of solvent to phenetole would be that 1:4,DHN and naphthalene complexes would be reduced because of phenetole interaction with TCQ but since phenetole is not consumed in the reaction this should not invalidate the results in chloroform solvent. The use of solid-state structures seems reasonable since in most of the structures studied the arrangement is such that the molecules are in positions for maximum charge-transfer

overlap and dipole-induced dipole interactions. Packing factors in the solid are relatively unimportant and so it may be assumed that the structures in solution fairly closely resemble solid structures although of course thermal effects will be much greater.

(c) A Possible Reaction Mechanism

We have seen that the present results are inconsistent with the simple mechanism of Braude et al⁽¹⁸⁾ and it is the intention now to discuss modifications of this mechanism which would be compatible with our results.

The information available from the isotope effect and spectroscopic measurements can be taken as indicative of:

- (i) a pre-equilibrium step which is rate determining
- (ii) the inverse secondary isotope effect is consistent with π -complex formation.
- (iii) the spectroscopic results indicate charge-transfer complexes which would involve π bonding.

On the basis of these observations we might formulate the following reaction steps:

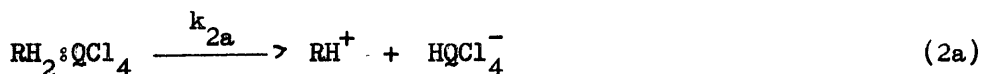
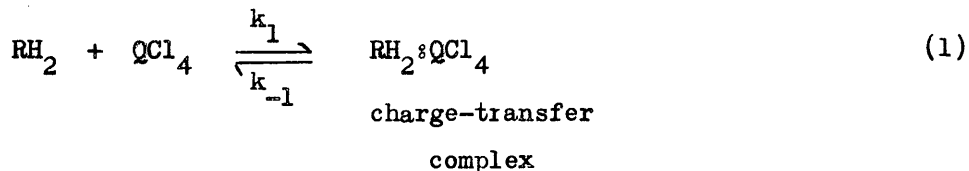

However, since the charge-transfer complex involves partial electron transfer it may well be that the electron is completely transferred

before the hydrogen as suggested by Henbest et al. (29)

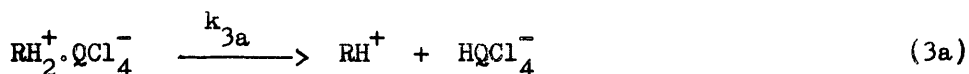
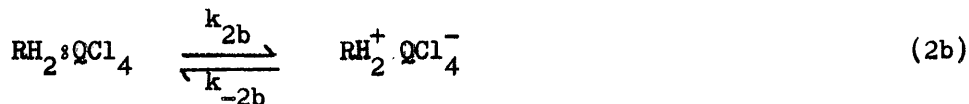

Both courses, i.e. (2a) or (2b) and (3a) present some steric difficulties but in the latter course it could well be that step (2b) is rate determining rather than step (1). In this discussion steps (2b) and (3a) will be considered but much the same considerations can be applied to (2a).

If we accept the previously formulated structure for the charge-transfer complex, i.e. I the complete transfer of the electron leads to a positive charge on the hydroaromatic ring and a negative charge on the quinone; ion pair attraction will result. However, the Cl and H_α are in approximately the same position in space and so any tendency for the ions to move closer together is restricted by this steric consideration. If the H_α is removed than it is extremely likely that it could remove the Cl to give HCl and compound IIIb.

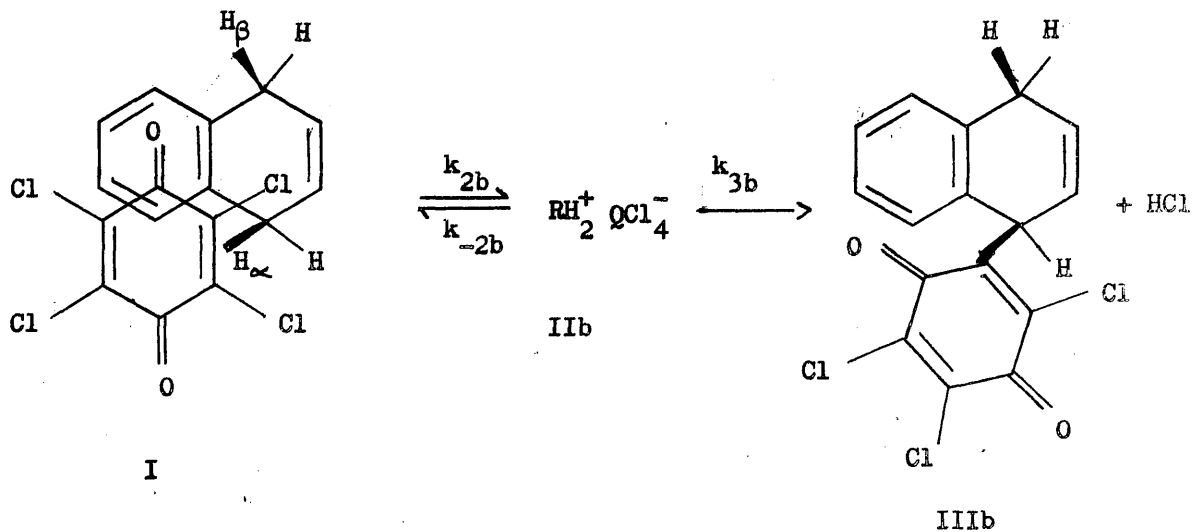

However, if H_β is removed it will cause the semi-quinone to rearrange itself and then it could remove H_α , i.e. the normal reaction.

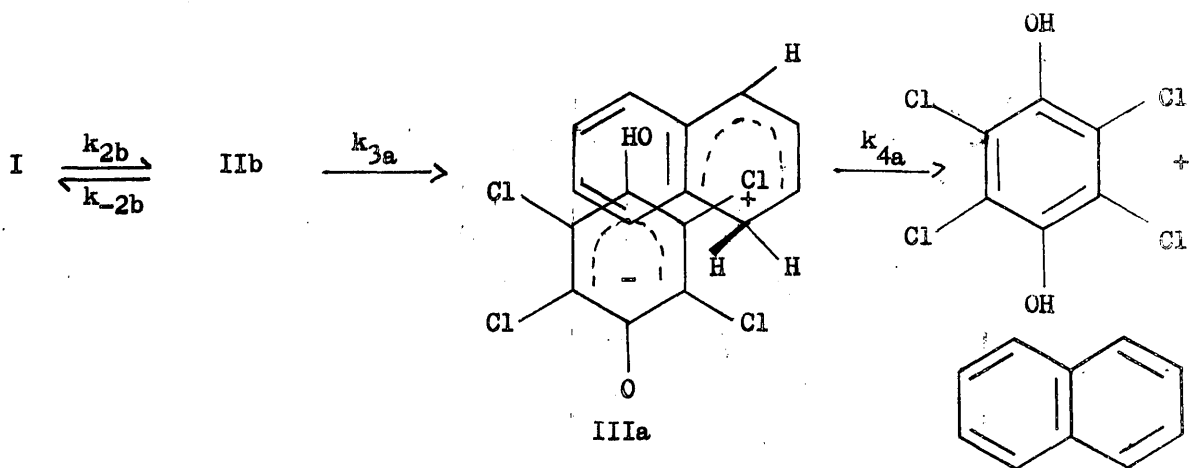

A similar result could have been obtained from step (2_a) by considering whether H_α or H_β is the first hydrogen removed. We can therefore

formulate the overall mechanism as:

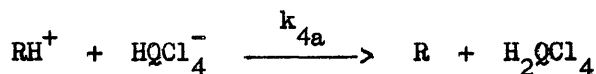
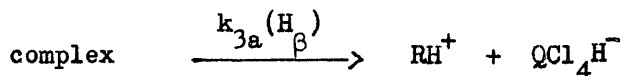
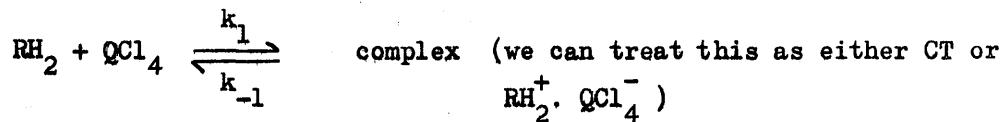

or

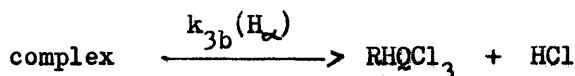

IIIb

It would not be expected that IIIb would be very stable so on heating at higher temperature or for a longer time (as indicated in the sealed tube experiments),

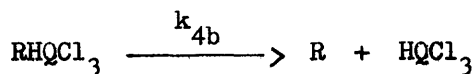

This will be a very slow reaction but it is significant to note that the trichloroquinone has approximately the same redox potential as its tetrachlor-counterpart and hence it could then engage in the dehydrogenation. Clar⁽⁹⁴⁾ has pointed out that in the use of

chloranil in preparative dehydrogenation less than the equivalent amount of the quinone is required for complete dehydrogenation.

The following points about the mechanism can be noted if it is accepted that step (4b) is very slow:

(i) Naphthalene and quinol are only formed in step (4a), therefore the rates of formation of these will be identical. This is observed experimentally.

(ii) Since IIIb will have a typical quinonoid spectra the amount of quinone consumed, as determined spectrophotometrically, will be equivalent to the amount of quinol formed which is in agreement with the experimental observations.

(iii) If k_{3a} and k_{3b} are approximately the same then the overall stoichiometry is

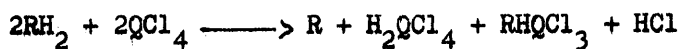

$RHQCl_3$ will behave essentially as a quinone hence,



(iv) Second order kinetics would be expected for this type of mechanism. If the complex establishes equilibrium with the reactants then

$$[\text{complex}] = K [RH_2] [QCl_4]$$

The rate of formation of the complex is therefore:

$$\frac{d[\text{complex}]}{dt} = k_1 [\text{RH}_2][\text{QCl}_4] - k_{3a} [\text{complex}] - k_{3b} [\text{complex}]$$

The step $k_{-1} [\text{complex}]$ is ignored since isotope effect results indicate this must be a very slow reaction.

$$\frac{d[\text{complex}]}{dt} = [\text{RH}_2][\text{QCl}_4] (k_1 - Kk_{3a} - Kk_{3b})$$

$$\frac{d[\text{R}]}{dt} = \frac{d[\text{H}_2\text{QCl}_4]}{dt} = k_{3a} K [\text{RH}_2][\text{QCl}_4]$$

(assuming k_{4a} is very fast) i.e. a second order kinetic reaction.

(v) Deviations from second order kinetics would be observed during the initial stages when the complex is building up to its equilibrium concentration.

(vi) The amount of HCl evolved is significantly less than would be expected from the above mechanism. This has been ascribed to the solubility of HCl in the solvent. The HCl can however take part in the reaction. It was mentioned earlier in the thesis that Braude et al⁽¹⁸⁾ have suggested some slight catalytic effects of acid which would lead to increased production of naphthalene and quinol. This is observed in

our experiments with added HCl, Fig. 16. In view of the modified mechanism suggested by Braude et al.⁽¹⁸⁾ the effect could be represented by:

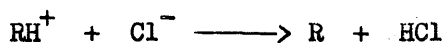
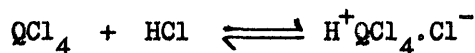

Relatively large amounts of acid are required for significant increases in the reaction rate. This is shown, Fig. 16, where catalysis is much more pronounced in the quinone concentration/time curve at the later stage of the reaction, presumably after the building up of suitable concentration of HCl. It may well be that the HCl forms a π -complex with 1:4,DHN (this has been observed with benzene).

(vii) Strong supporting evidence for this mechanism would be the identification of product IIIb. The structure suggested is based on the fact that any type of quinol structure would have been estimated in the ceric ion titrations and since the G.L.C. measurements indicated that the product involves either quinone-hydrocarbon or quinol-hydrocarbon coupling the former is the more likely.

Identification of the new peaks observed in the spectra of the reaction mixture is difficult. The product IIIb would be expected to have a typical quinoid spectra, i.e. a peak maximum at 292.5 μ , and

another at 376 $m\mu$, but the effect of substituting a hydrocarbon for the Cl in the molecule could shift the peak at 292.5 $m\mu$ to longer wavelengths. The peak observed at 311.5 $m\mu$ could be due to IIIb. The change in wavelength, 19 $m\mu$, is not exceptional when other quinones are considered; substitution of a methyl group for a hydrogen in p-benzoquinone shifts the peak maximum by 30 $m\mu$.⁽⁹⁵⁾

The peak at 346.5 $m\mu$, which is obtained when the reaction mixture is left in a chloroform solution for long periods, may well be due to aerial oxidation of the quinol with resultant charge transfer interaction with other components in the mixture. However, it could possibly arise from the decomposition of product IIIb via some charge-transfer reaction. The kinetic data indicate that this is a very slow reaction but in the periods over which the mixture was allowed to stand substantial decomposition could have taken place.

(d) Comparison of the Mechanism with other Dehydrogenation Studies

The basis of the present mechanism is in the ability to form a charge-transfer complex. This will be determined by the ionisation potential of the donor, the electron affinity of the acceptor and steric considerations.

In comparing chloranil, bromanil and iodanyl which have similar redox potentials, the reactivity decreases along the series. This can be explained in the ease with which they can form charge-transfer complexes with 1:4,DHN. It has been pointed out earlier that the Cl and H are very close to one another in the complex. Replacement of Cl by the bigger Br and I atoms must lead to an increased steric hindrance which will reduce the ease of formation of the complex. It would be expected that the same situation would be obtained with tetracyano-1:4,benzoquinone. However, this has a higher electron affinity and so this could result in the formation of the complex, i.e. the increased donor-acceptor attraction overcomes the steric hindrance.

It is significant in this context to note the very recent work of Trost.⁽⁷⁷⁾ He has investigated the following reactions.

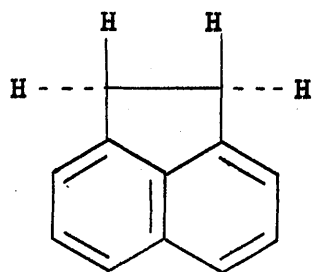

and

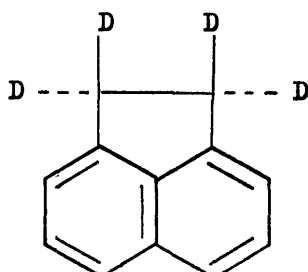

(acenaphthene)

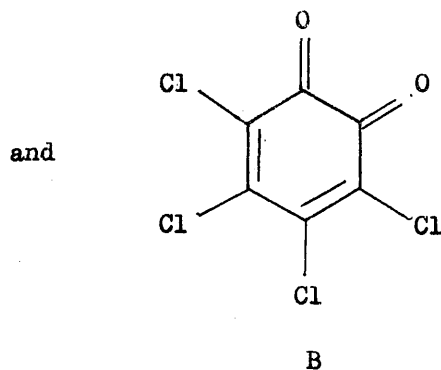
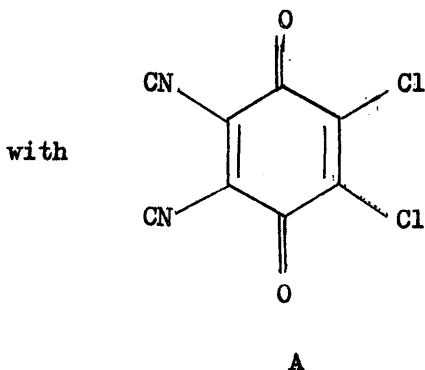

2:3,dichloro-5:6-dicyanobenzoquinone

tetrachloro-o-benzoquinone

In both cases a primary isotope effect was observed, with A, $k_{D/k_H} = 0.29$ and with B $k_{D/k_H} = 0.24$. A, is the best quinone for dehydrogenation (its redox potential is greater than 0.95 volts) and B, has a redox potential of 0.87 volts. Both are significantly greater than TCQ ($E = 0.70$ volts).

In both cases charge-transfer complex can be formed without significant steric hindrance from the side groups. It would be

expected that overlap of the donor filled orbitals with unfilled acceptor orbitals will be such that the acceptor, the quinone, will be in a plane above both rings of the acenaphthene molecule as opposed to above only one ring in the case of 1:4,DHN. One could suggest the following arrangement:

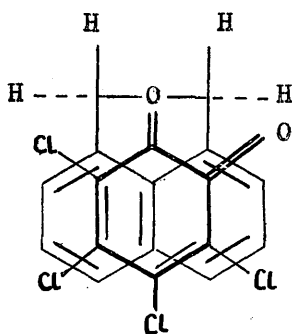

complex with B

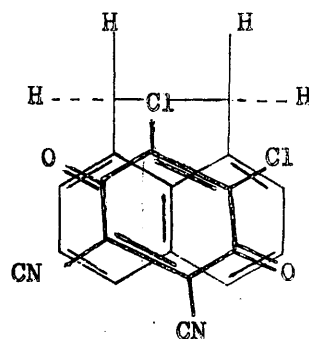

complex with A

Hence in the complex with B, the oxygens would be in ideal positions for the acceptance of hydrogen while in the complex with A, one of the oxygens could be in a neighbouring position to a removable hydrogen. An additional factor in A is that since the C-CN bond is much stronger than the C-Cl bond, the occurrence of side reactions of the type found in chloranil would be considerably reduced.

In both cases therefore the charge-transfer complex is more easily formed and the oxygen positions in the complex are such that they are readily accessible to the removable hydrogen. The isotope

effect results indicate that step (1) is no longer rate determining but it is the fission of the C-H bond.

The results of Trost's work in conjunction with the present results would suggest that in the context of the proposed reaction mechanism,

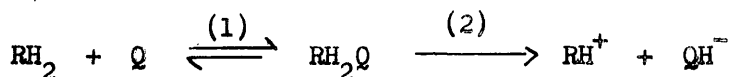

the rate determining step will depend on the ease of the formation of the charge-transfer complex. In systems where the quinone has a relatively low redox potential, the formation of complex and electron transfer are rate determining while with quinones of higher redox potential the complex is readily formed and step (2) becomes rate determining.

Finally, in most of the proposed reactions with TCQ, in which HCl evolves as a result of side reactions, are free radical mechanisms. Actually on the basis of the experimental evidence observed here and in Braude et al's work,⁽¹⁸⁾ a free radical mechanism at least in this system is not likely to be the case. If the assumption that the charge-transfer complex formed could lead to the formation of a hydrocarbon and semi-quinone radicals is possible, the subsequent reaction scheme will depend considerably on the activity of these radicals. As in any free radical reaction the possibility of

formation of many by-products exists. The formation of an ether similar to that mentioned, p. 68, is a possible case, also the formation of another addition by-product of the hydrocarbon to the quinol similar to that to the quinone IIIb is another possibility. In both cases this could be oxidised by the ceric ion and hence the estimation of the quinol would have been larger than observed experimentally. Also the formation of additive higher hydrocarbon by-product, such as

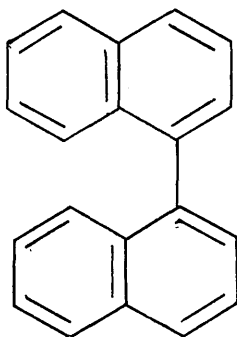

is possible, but this would have been easily detected chromatographically. The experimental evidence of this work and Braude et al's work⁽¹⁸⁾ indicate that the reaction mechanism is an ionic one but the formation of the ions is probably not the rate determining step.

Dehydrogenation with chloranil (TCQ) has proved to be a particularly different and interesting case compared with other types of quinones. Further investigations are still required of which

structural X-ray examination of the complex would be an interesting problem. Also spectroscopic investigations particularly with N.M.R. could clarify the actual nature of the by-product IIb or any other by-product but first the problem of the separation of the solvent (phenetole) from the reaction mixture requires some considerations.

APPENDIX

(a) Calibration Curves Data for 1:4,DHN and Naphthalene

TABLE 25

<u>Calibration curve No. for 1:4,DHN</u>	<u>1:4,DHN g./0.4 ml. phenetole</u>	<u>Area/0.4 ml. (mm²)</u>	<u>The corresponding runs for which it has been used</u>
1	0.025	1822	1, 2
	0.020	1475	
	0.015	1118	
	0.010	703	
	0.005	339	
2	0.025	1410	3, 5
	0.020	1073	
	0.015	795	
	0.010	582	
	0.005	211	
3	0.02505	1570	4
	0.02004	1251	
	0.01503	926	
	0.01002	592	
	0.00501	213	
4	0.02505	1443	12
	0.02004	1068	
	0.01503	766	
	0.01002	458	
	0.00501	173	

TABLE 26.

<u>Calibration curve</u> <u>No</u> <u>for naphthalene</u>	<u>Naphthalene</u> <u>g./0.4 ml.</u> <u>phenetole</u>	<u>Area/0.4 ml.</u> <u>(mm²)</u>	<u>The corresponding</u> <u>runs for which</u> <u>it has been used</u>
1	0.02496	2018	2
	0.01997	1652	
	0.01497	1242	
	0.00998	765	
	0.00499	320	

(b) Chromatographic Data for Estimation of 1:4,DHN and Naphthalene Concentrations.

TABLE 27

<u>Run No.</u>	<u>Time (minutes)</u>	<u>Area of 1:4,DHN per 0.4 ml. (mm²)</u>	<u>1:4,DHN g./0.4 ml.</u>
1	Initial	1053	0.01455
	0(2 hrs(inc.))	987	0.01368
	10	956	0.01325
	20	896	0.01245
	30	832	0.01160
	60	736	0.01033
	90	677	0.00960
	120	653	0.00926
2	Initial	1076	0.01485
	0(2 hrs(inc.))	1007	0.01395
	10	943	0.01306
	20	822	0.01148
	30	814	0.01139
	60	704	0.00992
	90	605/0.39 ml.	0.00861/0.39 ml.
	120	590	0.00844
3	Initial	833	0.01554
	0(2 hrs(inc.))	780	0.01470
	15	730	0.01385
	30	651	0.01250
	45	608	0.01180
	60	439/0.30 ml.	0.00894/0.30 ml.
	90	543	0.01067
	120	505	0.01005
4	Initial	839	0.01374
	0(2 hrs(inc.))	789	0.01300
	15	752/0.405 ml.	0.01244/0.405 ml.
	30	642	0.01075
	45	589	0.01000
	60	539	0.00924
	90	521	0.00891
	120	461	0.00803

TABLE 27 (Continued)

<u>Run No.</u>	<u>Time (minutes)</u>	<u>Area of 1:4, DHN per 0.5 ml. (mm²)</u>	<u>1:4, DHN g./0.5 ml.</u>
5	Initial	340	0.00730
	30	227	0.00538
	60	187	0.00474
	90	166	0.00432
	135	138	0.00389
	180	114	0.00347
	240	86	0.00300

TABLE 28

<u>Run No.</u>	<u>Time (minutes)</u>	<u>Area of Naphthalene per 0.4 ml. (mm²)</u>	<u>Naphthalene g./0.4 ml.</u>
2	0(2 hrs(inc.))	1436	0.01760
	10	1482	0.01806
	20	1388	0.01706
	30	1538	0.01872
	60	1572	0.01910
	90	1566/0.39 ml.	0.01902/0.39 ml.
	120	1633	0.01980

(c) Titration Data for Estimation of Quinol Concentrations

TABLE 29

<u>Run No.</u>	<u>Ce(SO₄)₂ N.L⁻¹</u>	<u>Time (minutes)</u>	<u>Reaction mix (ml.)</u>	<u>Ce(SO₄)₂ (ml.)</u>
2	0.03888	10	1	0.66
		20	"	0.76
		30	"	1.03
		60	"	1.47
		90	"	1.89
		120	"	2.46
5	0.04019	30	0.9	0.330
		60	"	0.515
		90	"	0.715
		135	"	0.910
		180	"	1.100
		240	"	1.300
6	0.0395	15	0.9	0.42
		30	"	0.68
		45	"	1.00
		60	"	1.24
		90	"	1.62
		120	"	1.93
7	0.0395	15	0.9	0.46
		30	"	0.76
		45	"	1.02
		60	"	1.24
		90	"	1.65
		120	"	1.91

(d) Counting Data for Isotope Effect Measurements

TABLE 30

<u>Run No.</u>	<u>Time (minutes)</u>	<u>B.g. c.p.m.</u>	<u>Standard source c.p.m.</u>	<u>1:4,DHN in scintillator (0.5 ml.) c.p.m.</u>
3	0(2 hrs(inc.))	723	14932	1222
	15	657	14468	1043
	30	698	13876	1035
	45	739	14467	1134
	60	739	14467	990
	90	757	14095	991/0.39 ml. ⁿ (Reac ⁿ mix inj.)
	120	544	8844	777
4	Initial	294	12316	779
	15	302	11838	710
	30	318	12563	692
	45	339	12447	649
	60	306	11949	619
	90	351	12716	632
	120	337	12528	667

- (e) Original Data for Estimation of the Concentrations of 1:4,DHN and TCQ in the 1:4,DHN-TCQ and HCl system.

TABLE 31

Chromatographic Data for Estimation of 1:4,DHN Concentrations

<u>Run No.</u>	<u>Time (minutes)</u>	<u>Area of 1:4,DHN per 0.4 ml. (mm²)</u>	<u>1:4,DHN g./0.4 ml.</u>
12	Initial	736	0.01453
	0(2 hrs(inc.))	765	0.01500
	10	665	0.01332
	15	610	0.01244
		420/0.28 ml.	0.00928/0.28 ml.
	20	673	0.01347
	33	653	0.01313
		335/0.26 ml.	0.00782/0.26 ml.
	60	560	0.01160
	78	543	0.01132
	95	468	0.01009
	120	477	0.01022

TABLE 32
Titration Data for Estimation of Quinol (and TCQ) Concentration

Run No.	Initial Con ⁿ s 1:4, DHN/TCQ (mole L ⁻¹)	Ce(SO ₄) ₂ N.L ⁻¹	Time (minutes)	Reac ⁿ mix (ml.)	Ce(SO ₄) ₂ (ml.)	Quinol (mole L ⁻¹)	TCQ (mole L ⁻¹)
13	0.3036/0.1042	0.0399	0 (2 hrs.inc.)	1	-	-	0.1042
			10	0.9	0.610	0.0135	0.0907
			15	"	0.757	0.0168	0.0874
			20	"	0.865	0.0192	0.0850
			33	"	1.227	0.0272	0.0770
			45	"	1.490	0.0330	0.0712
			60	"	1.726	0.0382	0.0660
			75	"	1.830	0.0405	0.0637
			90	"	1.985	0.0440	0.0602
			120	"	2.727	0.0604	0.0438
14	0.3007/0.1039	0.0402	0 (2 hrs.inc.)	0.9	-	-	0.1039
			5	"	0.338	0.0075	0.0964
			10	"	0.465	0.0104	0.0935
			15	"	0.615	0.0137	0.0902
			30	"	0.990	0.0221	0.0818
			45	"	1.328	0.0296	0.0743
			79	"	1.820	0.0406	0.0633
			95	"	1.993	0.0445	0.0594
			135	0.85	2.471	0.0584	0.0455
			137	"	2.556	0.0570	0.0469

TABLE 32 (continued)

Run No.	Initial Con ⁿ 1:4, DHN/TCQ (mole L ⁻¹)	Ce(SO ₄) ₂ N.L. ⁻¹	Time (minutes)	Reac ⁿ mix (ml.)	Ce(SO ₄) ₂ (ml.)	Quinol (mole L ⁻¹)	TCQ (mole L ⁻¹)
15	0.2998/0.1041	0.0397	0(2 hrs.inc.)	0.9	-	-	0.1041
			5	"	0.347	0.0077	0.0964
			10	"	0.612	0.0135	0.0906
			15	"	0.688	0.0152	0.0889
			20	0.85	0.800	0.0187	0.0854
			30	0.90	1.090	0.0240	0.0801
			45	"	1.420	0.0313	0.0728
			60	"	1.700	0.0375	0.0666
			75	"	1.897	0.0418	0.0623
			90	"	2.100	0.0463	0.0578
			105	"	2.222	0.0490	0.0551
			120	"	2.512	0.0554	0.0487
			122	"	2.660	0.0587	0.0454
16	0.3002/0.1042	0.0398	0(2 hrs.inc.)	0.9	-	-	0.1042
			10	"	0.574	0.0127	0.0915
			15	"	0.687	0.0152	0.0890
			20	"	0.828	0.0183	0.0859
			30	"	1.060	0.0235	0.0807
			45	"	1.346	0.0298	0.0744
			60	"	1.580	0.0350	0.0692
			90	0.8	1.880	0.0468	0.0574
			105	0.7	1.903	0.0541	0.0501
			120	0.9	2.550	0.0564	0.0478
			122	"	2.598	0.0575	0.0467
			126	"	2.738	0.0606	0.0436

(f) Titration Data for Estimation of Quinol Concentration in the Preparative Experiments

TABLE 33

<u>Run</u> <u>No.</u>	<u>Ce(SO₄)₂</u> <u>N. L⁻¹</u>	<u>Sample</u> <u>No.</u>	<u>Reaction mix</u> <u>(ml.)</u>	<u>Ce(SO₄)₂</u> <u>(ml.)</u>
19	0.0395	1	1	5.00
		2	1	4.90
		3	1	4.97
20	0.0395	1	1	3.217
		2	1	3.240
		3	1	3.210

REFERENCES

1. Plattner, P. A., "Newer Methods of Preparative Organic Chemistry", Interscience Publishers Inc., New York, (1948) p. 21-59.
2. Clar, E. and John, F., Ber., 63, 2967 (1930).
3. Creigee, R., Ber., 69, 2758, (1936).
4. Arnold, R. T. and Collins, C. J., J. Am. Chem. Soc., 61, 1407, (1939).
5. Morton, R. A., (ed.), 'Biochemistry of Quinones', Academic Press, London and New York (1965).
6. Dimroth, O., Angew. Chem., 46, 571 (1933); 51, 404, (1938).
7. Campbell, N., et al., J. Chem. Soc., 530 (1945); 1555 (1949); 2511 (1951).
8. Crawford, H. M. and Nelson, H. B., J. Am. Chem. Soc., 68, 134 (1946).
9. Waters, W. A., Trans. Faraday Soc., 42, 184 (1946): "The Chemistry of Free Radicals", Oxford Univ. Press, (1946).
10. Braude, E. A., Jones, E. R. H., Sondheimer, F. and Toogood, J. B., J. Chem. Soc., 607 (1949).
11. Tucker, S. H., *ibid*, 2182 (1949).
12. Buu-Hoi et al., J. Org. Chem., 14, 492, 802 (1949).
13. Barnes, C. S., Pausacker, K. H. and Schubert, C. J., J. Chem. Soc., 1381 (1949).
14. Buchta, V. E. and Kallert, W., Ann. Chem., 573, 220 (1951).
15. Dost, N. and Van Nes, K., Rec. Trav. Chim., 70, 403 (1951).
16. *idem*, *ibid*, 71, 857 (1952).
17. Holzer, Siegler, Zincke, Wiesenberger and Sobotka, Monatsh., 83, 180 (1952).
18. Braude, E. A. Jackman, L. M. and Linstead, R. P., J. Chem. Soc., 3548 (1954).

19. idem, *ibid*, P. 3564.
20. Braude, E. A., Brook, A. G. and Linstead, R. P. *ibid*, P. 3569.
21. idem, *ibid*, P. 3574.
22. Barnard, J. R. and Jackman, L. M., *ibid*, 3110 (1960).
23. Braude, E. A., Jackman, L. M. Linstead, R. P. and Shannon, J. S., *ibid*, 3116 (1960).
24. Schmidlin, J., Wohl, J. and Thommen, H., *Ber.*, 43, 1298 (1910).
25. Ziegler, K., and Deparade, W., *Ann.*, 567, 123 (1950).
26. Waters, W. A., *Annual Reports, Chem.Soc.*, 42, 131, (1945).
27. Farmer, E. H., *Trans.Faraday Soc.*, 38, 340 (1942).
28. Frank, C. E., *Chem.Revs.*, 46, 161 (1950). Taken from George, P. and Robertson, A., *J.Inst. Petroleum*, 32, 400 (1946).
29. Buckley, D., Dunstan, S., Henbest, H. B., *J.Chem.Soc.*, 4880 (1957).
30. Washburn, E. R., and Urey, H. C., *Proc.Natl.Acad.Sci.*, 18, 496 (1932).
31. Cremer, E. and Polanyi, M., *Z.Physik.Chem.*, B 19, 443 (1932).
32. Eyring, H., *Proc.Natl.Acad.Sci.*, 19, 78 (1933).
33. Eyring, H. and Sherman, A., *J.Chem.Phys.*, 1, 435 (1933).
34. Bigeleisen, J., *J.Chem.Phys.*, 17, 675 (1949).
35. Glasstone, S., Laidler, K. J. and Eyring, H., "The Theory of Rate Processes", pp. 153-201. McGraw-Hill Book Company, Inc., New York (1941).
36. Bell, R. P. and Caldin, E. F., *Trans. Faraday Soc.*, 47, 50 (1951).
37. Eyring, H., *J.Chem.Phys.*, 3, 107 (1935); for a detailed discussion see ref. 35.

38. Bigeleisen, J., and Wolfsberg M., *Advances in Chemical Physics*, Vol. I, Interscience Publishers, Inc., New York, p. 15 (1958).
39. Eyring, H., and Cagle, JR. F. W., *J.Phys.Chem.*, 56, 889 (1952).
40. Melander, L., "Isotope Effects on Reaction Rates", Ronald Press, New York (1960).
41. Hirschfelder, J. O., and Wigner, E., *J.Chem.Phys.*, 7, 616 (1939).
42. Huckel, W., and Hans Schlee, *Ber.Chem.*, 88, 349 (1955).
43. Bigeleisen, J., and Allen, T. L., *J.Chem.Phys.*, 19, 760 (1951).
44. *Handbook of Chemistry and Physics*, 44th Edition, Chemical Rubber Publishing Company.
45. Cook, E. S., Hill, A. J., *J.Am.Chem.Soc.*, 62, 1995 (1940).
46. Sand and Genssler, *Ber.*, 36, 3705 (1903).
47. Morton, R. A., de Gouveia, A. J. A., *J.Chem.Soc.*, 916 (1934).
48. Hadzi, D. and Sheppard, N., *Proc.Roy.Soc.*, (London) 216A, 247 (1953).
49. Braude, E. A. et al., *J.Chem.Soc.*, 396 (1946).
50. Knecht, and Hibbert, "New Reduction Methods in Volumetric Analysis", Longmans, Green and Co., London, p. 89 (1910).
51. Bickel, A. F. and Waters, W. A., *J.Chem.Soc.*, 1764 (1950).
52. Ziegler, K., Deparade, W. and Meye, W., *Ann.*, 567, 142 (1950).
53. Price, C. C., *Mechanism of reactions at carbon-carbon double bonds*. Interscience Publ.Inc., New York, 1946, p. 87.

54. Butz, L. W., in Organic reactions. Vol. V. John Wiley and Sons Inc., New York, p. 147.
55. Bruce, J. M. and Ellis, J. N., J.Chem.Soc.(C), 1624 (1966).
56. Chowdbury, M., Trans.Faraday Soc., 57, 1482 (1961).
57. Chakrabarti, S. K. and Basu, S., Trans.Faraday Soc., 60, 465-75 (1964).
58. Mulliken, R. S., J.Physic.Chem.,56. 801 (1952).
59. Michaelis, L. and Granick, S., J.Amer.Chem.Soc., 66, 1023 (1944).
60. Seidell, A., "Solubilities of Inorganic and Metal Organic Compounds", Vol. I. fourth edition, 1958, D. Van Nostrand Co., Inc., Princeton, New Jersey.
61. Vejdelek, Z. J. and Kakac, B., Collection Czech.Chem.Commun., 20, 571 (1955).
62. Clar, E. and Marshalk, C., Bull.Soc.Chim. France [5] 17, 433 (1950).
63. Daghish, C., J. Am.Chem.Soc., 72, 4859 (1950).
64. Gagnon, P. E., Boivin, J. L. and Jones, R. N., Can.J.Research, 27B, 190 (1949).
65. Bowden, K. and Braude, E. A., J.Chem.Soc., 1068 (1952).
66. Baddeley, G. and Vichars, M. A., J.Chem.Soc., 4665 (1958).
67. Martynoff, M., Bull.Soc.Chim. France, [5] 16, 258 (1949).
68. Pummerer, R., Schmidutz, G. and Seifert, H., Chem.Ber., 85, 535 (1952).
69. Benesi, H. A. and Hildebrand, J. H., J.Am.Chem.Soc., 71, 2703 (1949).
70. Wiberg, K. B., J.Am.Chem.Soc., 76, 5371 (1954).
71. Swain, C. G., et al., J.Am.Chem.Soc., 83, 1945 (1961).
72. Wiberg, K. B., J.Am.Chem.Soc., 76, 5371 (1954).

73. Westheimer, F. H., Chem.Rev., 61, 265 (1961).
74. Kaplan, L. and Wilzbach, K. E., J.Am.Chem.Soc., 74, 6152 (1952).
75. Gilman, H., Dunn, G. E. and Hammond, G. S., J.Am.Chem.Soc., 73, 4499 (1951).
76. Swain, C. G., et al., J.Am.Chem.Soc., 83, 1951 (1961).
77. Trost, B. M., J.Am.Chem.Soc., 89, 1847 (1967).
78. Melander, L., Arkiv.Kemi, 12, 211 (1950).
79. Zollinger, H., et al., Helv.Chim.Acta, 38, 1617 (1955); 41, 1816 (1958); 41, 2274 (1958).
80. Halevi, E. A., Progr.Phys.Org.Chem., 1, 109-221 (1963).
81. Halevi, E. A., Tetrahedron, 1, 174 (1957).
82. Lewis, E. S., Tetrahedron, 5, 143 (1959).
83. Bartell, L. S., J.Am.Chem.Soc., 83, 3567 (1961).
84. Bartell, L. S., Tetrahedron, 17, 177-90 (1962).
85. Cvetanovic, R. J., et al., J.Am.Chem.Soc., 87, 1827 (1965).
86. Halevi, E. A. and Ravid, B., Pure Appl.Chem., 8, 339 (1964).
87. Halevi, E. A. and Nussim, M., J.Chem.Soc., 876 (1963).
88. Halevi, E. A. and Nussim, M., Tetrahedron, 5, 352 (1959).
89. Ostman, B., Arkiv Kemi, 19, 499-514 (1962).
90. Olah, G. A., J.Am.Chem.Soc., 86, 1055 (1964).
91. Seel, F., "Atomic Structure and Chemical Bonding", Methuen and Co. Ltd., London, 1963.
92. Wright, J. D., Private Communication.
93. Ferguson, L. N., "The Modern Structural Theory of Organic Chemistry", Prentice-Hall, Inc., Englewoods Cliffs, New Jersey, 1963.

94. Clar, E., Private Communication.
95. Phillips, J. P. and Nachod, F. C., "Organic Electronic Spectral Data, Vol. IV., p. 108 (1963). Interscience pub. John Wiley and Sons, Inc. London.
96. Laszlo, P. and Welvart, Z., Bull. De La Soc.Chim. De France, 7, 2412 (1966).