



<https://theses.gla.ac.uk/>

Theses Digitisation:

<https://www.gla.ac.uk/myglasgow/research/enlighten/theses/digitisation/>

This is a digitised version of the original print thesis.

Copyright and moral rights for this work are retained by the author

A copy can be downloaded for personal non-commercial research or study,  
without prior permission or charge

This work cannot be reproduced or quoted extensively from without first  
obtaining permission in writing from the author

The content must not be changed in any way or sold commercially in any  
format or medium without the formal permission of the author

When referring to this work, full bibliographic details including the author,  
title, awarding institution and date of the thesis must be given

Enlighten: Theses

<https://theses.gla.ac.uk/>  
[research-enlighten@glasgow.ac.uk](mailto:research-enlighten@glasgow.ac.uk)

STUDIES ON THIOXO- AND SELENOXO- MALONATES.

A Thesis presented in part fulfillment  
of the requirement for the Degree of  
Doctor of Philosophy

by

William McPhillimy McGregor.

Department of Chemistry,  
University of Glasgow.

© W. M. McGregor. October, 1989.

ProQuest Number: 11003320

All rights reserved

INFORMATION TO ALL USERS

The quality of this reproduction is dependent upon the quality of the copy submitted.

In the unlikely event that the author did not send a complete manuscript and there are missing pages, these will be noted. Also, if material had to be removed, a note will indicate the deletion.



ProQuest 11003320

Published by ProQuest LLC (2018). Copyright of the Dissertation is held by the Author.

All rights reserved.

This work is protected against unauthorized copying under Title 17, United States Code  
Microform Edition © ProQuest LLC.

ProQuest LLC.  
789 East Eisenhower Parkway  
P.O. Box 1346  
Ann Arbor, MI 48106 – 1346

## ACKNOWLEDGEMENTS

My thanks are due to my supervisor, Prof. Gordon W. Kirby, for his continual help and advice, and my gratitude due to the Loudon Fellowship which financed my Studentship. Thanks also to the staff of the technical services for their skillful efforts and to everyone in the Loudon Laboratory for their good company over the years.

DEDICATION

" ... in a time when RADIATION threatens de Earth  
and bombs are built instead of homes,  
when WAR replaces reason,  
and for some strange reason we have no say in de matter,  
I will have to dedicate dis book to all peace-loving people.

Dedicated to all peace-loving people, worldwide. "

- Benjamin Zephaniah.

QUOTATION

"I have often had cause to feel that my hands are cleverer than my head. That is a crude way of characterising the dialectics of experimentation. When it is going well, it is like a quiet conversation with Nature. One asks a question and gets an answer; then one asks the next question, and gets the next answer. An experiment is a device to make Nature speak intelligibly. After that one has only to listen."

- George Wald.

CONTENTS

<u>Chapter 1:</u> "The Synthesis and Reactions of Diethyl Thioxomalonate."	1
Introduction	2
Stability of Thiocarbonyl groups	3
The Discovery and Synthesis of Thioketones	5
Reactions of the Thiocarbonyl Group	17
Discussion	27
Synthesis of Diethyl Thioxomalonate	28
Regeneration of Diethyl Thioxomalonate by retro-Diels-Alder Reaction	38
Conclusions	49
<u>Chapter 2:</u> "The Synthesis and Reactions of Diethyl Thioxomalonate <u>S</u> -Oxide. "	50
Introduction	51
Stability of Sulphines	52
The Discovery and Synthesis of Sulphines	55
Reactions of Sulphines	68
Discussion	76
Synthesis of Diethyl Thioxomalonate <u>S</u> -Oxide	77

Generation of Diethyl Thioxomalonate <u>S</u> -Oxide by retro-Diels-Alder Reaction	81
Conclusions	101
<u>Chapter 3</u> : "The Synthesis and Reactions of Diethyl Selenoxomalonate."	102
Introduction	103
Stability of Selenocarbonyl groups	104
The Discovery and Synthesis of Selenoketones	107
Reactions of the Selenocarbonyl Group	118
Discussion	125
Synthesis of Diethyl Selenoxomalonate	126
Conclusions	137
<u>Chapter 4</u> : Experimental Section	138
General Procedures	139
Preparation of Cycloadducts of Diethyl Thioxomalonate	141
Transfer Reactions of Diethyl Thioxomalonate	146
Preparation of Cycloadducts of Diethyl Thioxomalonate <u>S</u> -Oxide	154
Transfer Reactions of Diethyl Thioxomalonate <u>S</u> -Oxide	159
Preparation of Cycloadducts of Diethyl Selenoxomalonate	170
References	177



ABSTRACT

Thermally labile cycloadducts of diethyl thioxomalonate (46) were found to be most easily synthesised, in reasonable yields, by heating the corresponding ketone (48) with phosphorus pentasulphide in pyridine. The cyclopentadiene adduct (93) and, more usefully, the anthracene adduct (95) were found to dissociate on heating to regenerate diethyl thioxomalonate which then reacted regiospecifically in situ with other dienes (retro-Diels-Alder reaction) or with (-)- $\beta$ -pinene ('ene' reaction). These labile cycloadducts (93) and (95) were oxidised with peracid to the corresponding S-oxides (173) and (172). These S-oxides also dissociated on heating, to give diethyl thioxomalonate S-oxide (148) which reacted in situ, regioselectively, with other dienes. Flash vacuum pyrolysis of the anthracene adduct (172) also liberated (148), free of anthracene, which enabled studies on the 'isolated' species (148) at lower temperatures.

Less success was achieved in synthesising cycloadducts of diethyl selenoxomalonate (229). This species was generated in situ by treating either diethyl selenocyanatomalonate (244) or the selenosulphate (250) with triethylamine in the presence of a diene. However, only the cyclopentadiene adduct (230) and the 2,3-dimethyl-1,3-butadiene adduct (244) were successfully synthesised, in poor to moderate yields with low reproducibility.

CHAPTER 1

"THE SYNTHESIS AND REACTIONS OF DIETHYL THIOXOMALONATE."

## INTRODUCTION

## STABILITY OF THIOCARBONYL GROUPS

Consideration of the recent reviews on thiocarbonyl compounds<sup>I-9</sup> indicates the relative rarity of true thioketones, or thiones. The difficulty in making such species lies in the instability of the (2p-3p)  $\pi$ -bond between the "small" oxygen 2p and the "large" sulphur 3p orbitals; this poor orbital overlap leads to a weak  $\pi$ -bond.

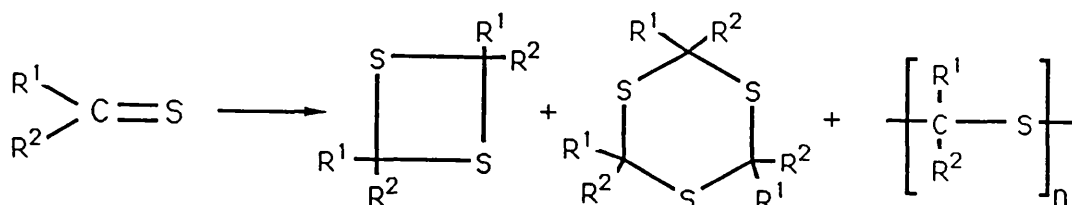

Scheme 1

Early attempts to isolate thioketone monomers produced, instead, oligomers or polymers of the thioketone (Scheme 1). The presence of an electron-donating group can stabilise the thiocarbonyl group by delocalisation and there are examples of stable thioamides<sup>I0(1)</sup>, thionoesters<sup>I (2)</sup> and dithionoesters (3) and their corresponding acids.<sup>I1</sup>

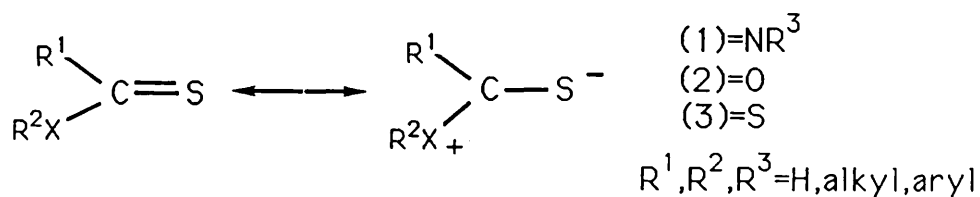

A good example of this kind of stabilisation was reported by Grishchuk in 1967 who produced the stable thioamide dithioester (4) shown in Scheme 2.<sup>I2</sup>

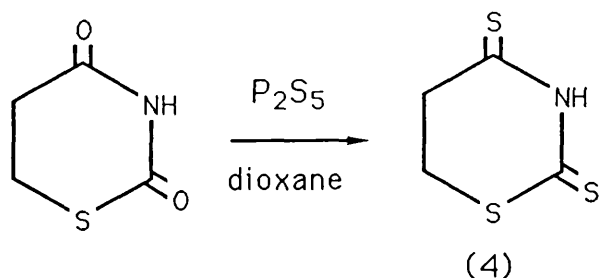

Scheme 2

In contrast, thiocarbonyl compounds with electron-withdrawing groups in the  $\alpha$ -position are even rarer in the chemical literature. The electron-withdrawing group reduces the energy and size mismatch in the (2p-3p)  $\pi$ -bond, thus destabilising further an inherently unstable species. Some examples include those thiocarbonyl compounds with attached ketonic<sup>I3</sup> (5), ester<sup>I4-I7</sup> (6), and para-nitrophenyl<sup>I5</sup> (7) groups.

- (5)  $Z=COR^2$   
 (6)  $Z=CO_2R^2$   
 (7)  $Z=p-NO_2C_6H_4$

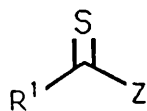

An alternative source of stability in thioketones is found when steric congestion prevents rapid polymerisation, eg. both benzophenone<sup>I8</sup> (8) and thiocamphor<sup>I9</sup> (9) are stable and blue (due to  $n-\pi^*$  transitions).

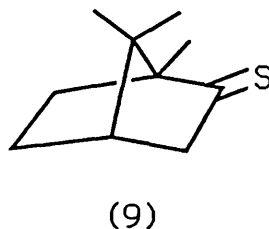
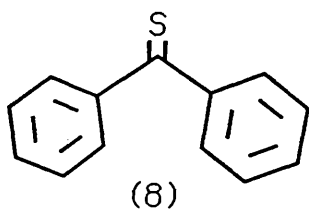

## THE DISCOVERY AND SYNTHESIS OF THIOKETONES

The first report of a polymerised thioketone was by Hofmann<sup>20</sup>, in 1868, who treated formaldehyde (10) with  $\text{H}_2\text{S}$  and  $\text{HCl}$ , and obtained the trimer (11) of thioformaldehyde<sup>21</sup> (12) as displayed in Scheme 3.

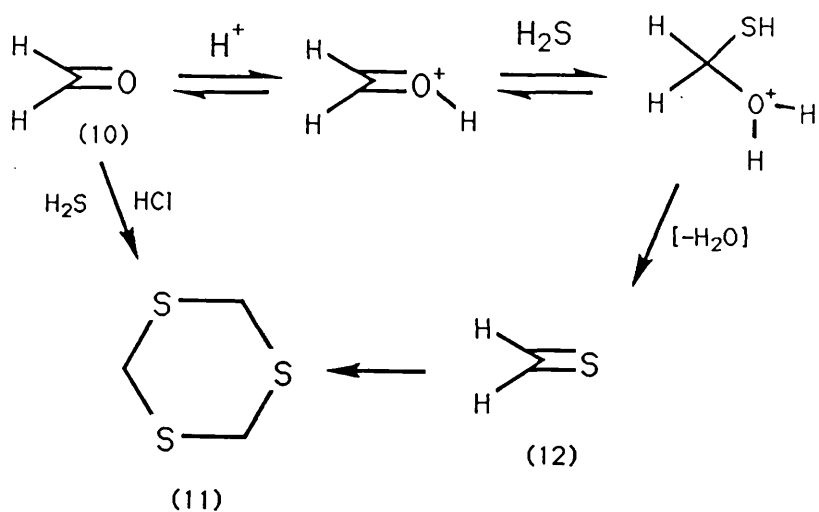

Scheme 3

Although  $\text{H}_2\text{S}$  and  $\text{HCl}$  have been used more recently<sup>22</sup> to generate thioketones, a wide range of other methods<sup>23</sup> has been developed for the synthesis of thioketones, perhaps the most successful being the use of phosphorus pentasulphide (in fact  $\text{P}_4\text{S}_{10}$ ). This reagent was first used<sup>23,24</sup>, in 1886, on the ketone (13) to generate Michler's thione (14) in good yield

(Scheme 4). The thione (14) is stable because of the delocalisation of the nitrogen lone pairs onto the sulphur atom via the conjugated ring system, and also because of steric hindrance of polymerisation by the bulky aromatic groups.

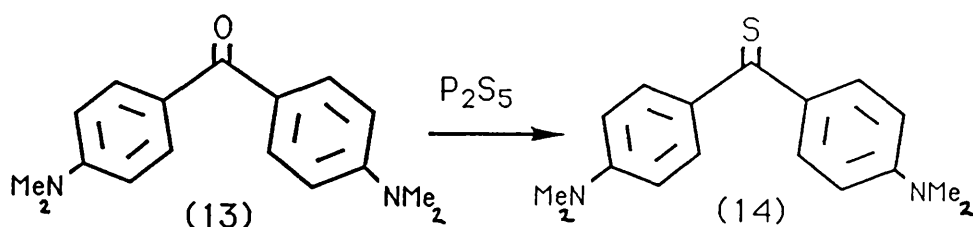

#### Scheme 4

The utility of phosphorus pentasulphide as a thionating agent has been studied extensively in the synthesis of stable thioamides (1). The best results appear to be achieved by using pyridine or diglyme as the solvent<sup>25</sup> as phosphorus pentasulphide is appreciably soluble in both. However, in other solvents where the  $P_2S_5$  is present as a solid phase, the essentially heterogeneous reaction can achieve successful results, especially if the reaction is accelerated by the application of ultrasound<sup>26</sup>.

Alternatively, addition of sodium bicarbonate to phosphorus pentasulphide, in pyridine or diglyme, liberates the proposed active species,  $S_2PS^-$ , (Scheme 5) which thionates amides in good yields<sup>27</sup>.

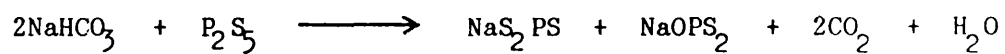

Scheme 5



GENERATION OF THIOCARBONYL COMPOUNDS BY RETRO DIELS-ALDER REACTION.

The earliest generation of a thioaldehyde by the retro-Diels-Alder reaction was achieved by Baldwin and Lopez<sup>28</sup> in 1983. They generated thiobenzaldehyde (20) by thermolysis of the thiosulphinate (18) and trapped it in situ with anthracene in high yield (Scheme 6). This anthracene adduct (22) on heating liberated thiobenzaldehyde (20) which was trapped with 2,3-dimethyl-1,3-butadiene quantitatively to give (25). They also formed thioacetaldehyde (21) from the thiosulphinate (19) and trapped it in situ in high yields with both anthracene to give (23), and with 9,10-dimethyl anthracene to give (24). As shown in Scheme 6, only the 9,10-dimethyl anthracene adduct (24) dissociated on heating to give thioacetamide (21) which was trapped in situ with 2,3-dimethyl-1,3-butadiene to give (26) quantitatively.

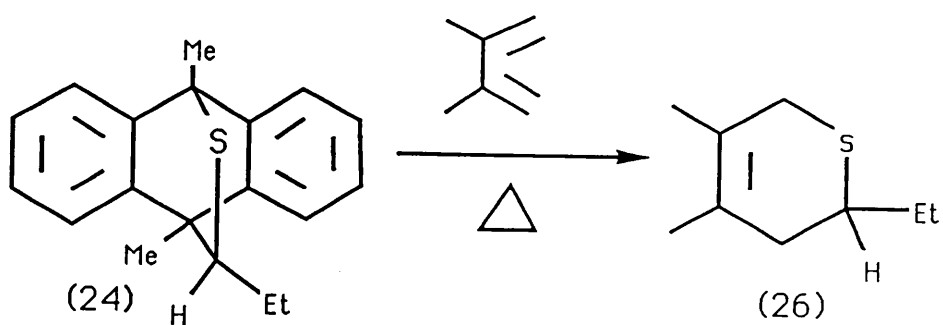
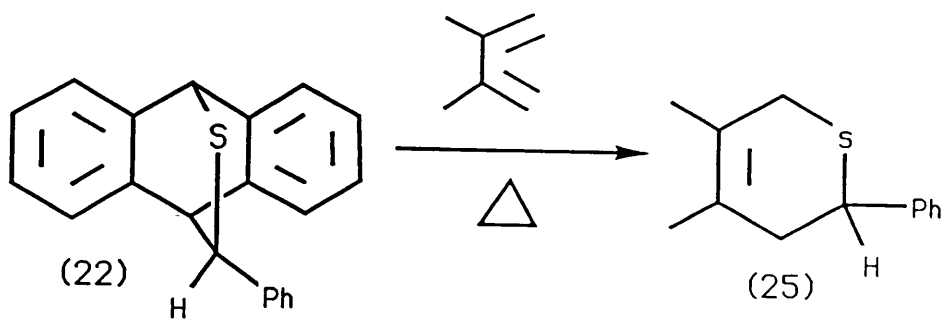
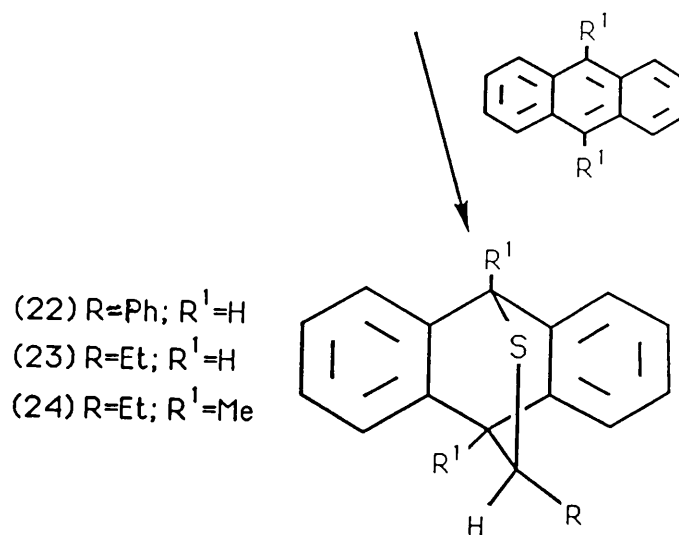
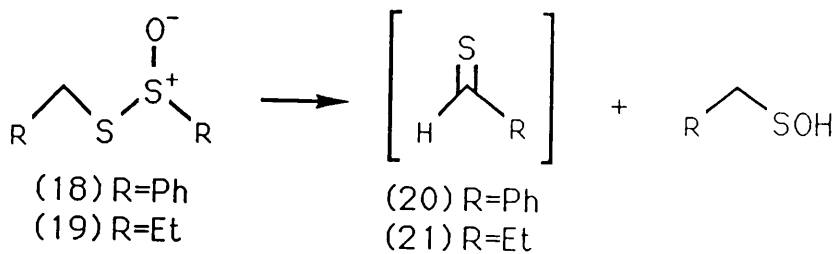

Scheme 6

It was later demonstrated by Kirby et al <sup>I5,I6</sup> (Scheme 7) that the anthracene adduct (27) dissociated reversibly on heating to liberate ethyl thioacetate (28) which was then trapped in situ with 2,3-dimethyl-1,3-butadiene to give (29) quantitatively. Similarly, the cyclopentadiene adducts (30) of a variety of thioaldehydes <sup>I6</sup> dissociated on heating to liberate the thioaldehydes (31) which were again trapped with 2,3-dimethyl-1,3-butadiene to give (32).

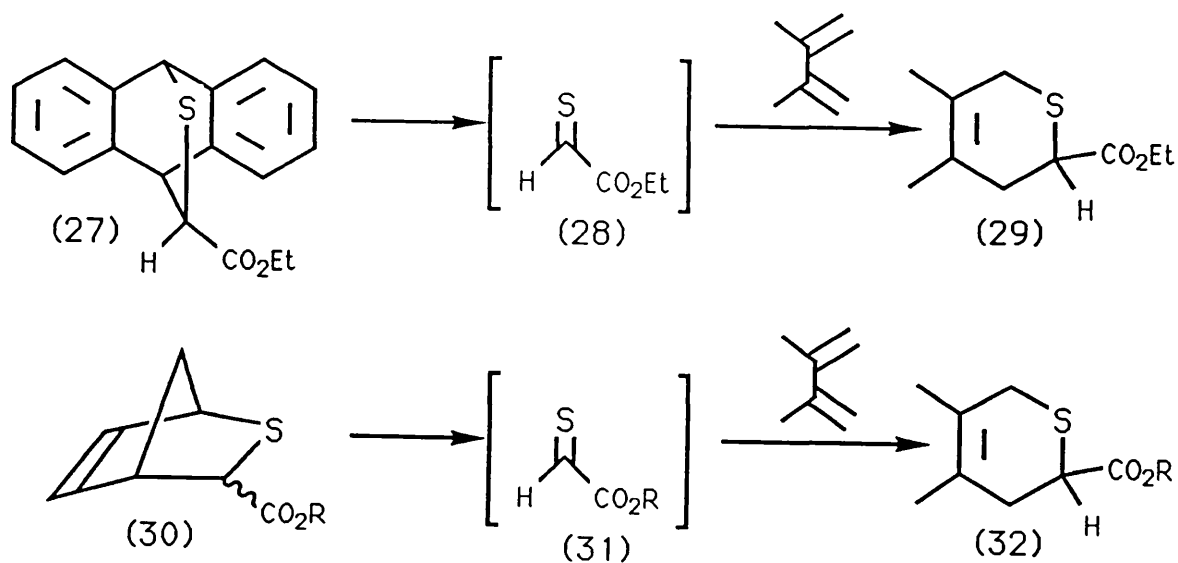

R=CO<sub>2</sub>Et  
 CONHPh  
 CPh  
 CN  
 p-NO<sub>2</sub>C<sub>6</sub>H<sub>4</sub>

Scheme 7

$\alpha$ -OXO THIOCARBONYL COMPOUNDS.

Amongst the thiocarbonyl compounds so far synthesised,  $\alpha$ -oxo-thiocarbonyl derivatives are rather uncommon. It was not until 1975 that Hohne synthesised such a species<sup>I3</sup> by treating the dibromo compound (33) with potassium O-ethyl xanthate (Scheme 8) to give an unstable  $\alpha$ -oxo-thioketone (34) which could be trapped in situ with 2,3-dimethyl-1,3-butadiene to give the heterocycle (35) by Diels-Alder [4+2] cycloaddition.

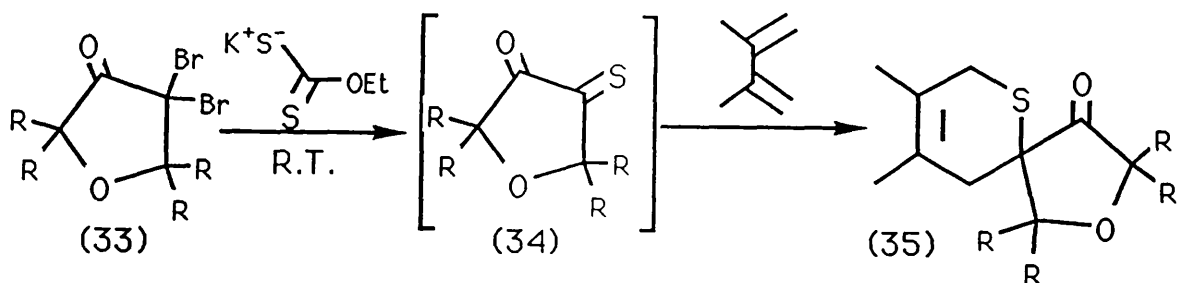
Scheme 8

Some thioaldehydes with  $\alpha$ -ester groups have also been synthesised.<sup>I4-I7</sup> One of the better synthetic routes involved base-catalysed elimination of a phthalimido derivative of a mercaptoacetate<sup>I5</sup> (36) to generate the unstable thioaldehyde (28) which was again trapped in situ with a conjugated diene, such as 2,3-dimethyl-1,3-butadiene to give (29) or with anthracene to give (27) as illustrated in Scheme 7. When (28) formed in

this manner was trapped with cyclopentadiene a 7:3 mixture of the endo adduct (37) and the exo adduct (38) was produced.

An alternative and "cleaner" way to generate (28) under neutral conditions<sup>I5</sup> is by heating either the anthracene adduct (27) or the cyclopentadiene adducts (37) and (38), all of which underwent retro-Diels-Alder reaction to liberate (28), which was then transferred quantitatively to another conjugated diene (Schemes 7 and 9).

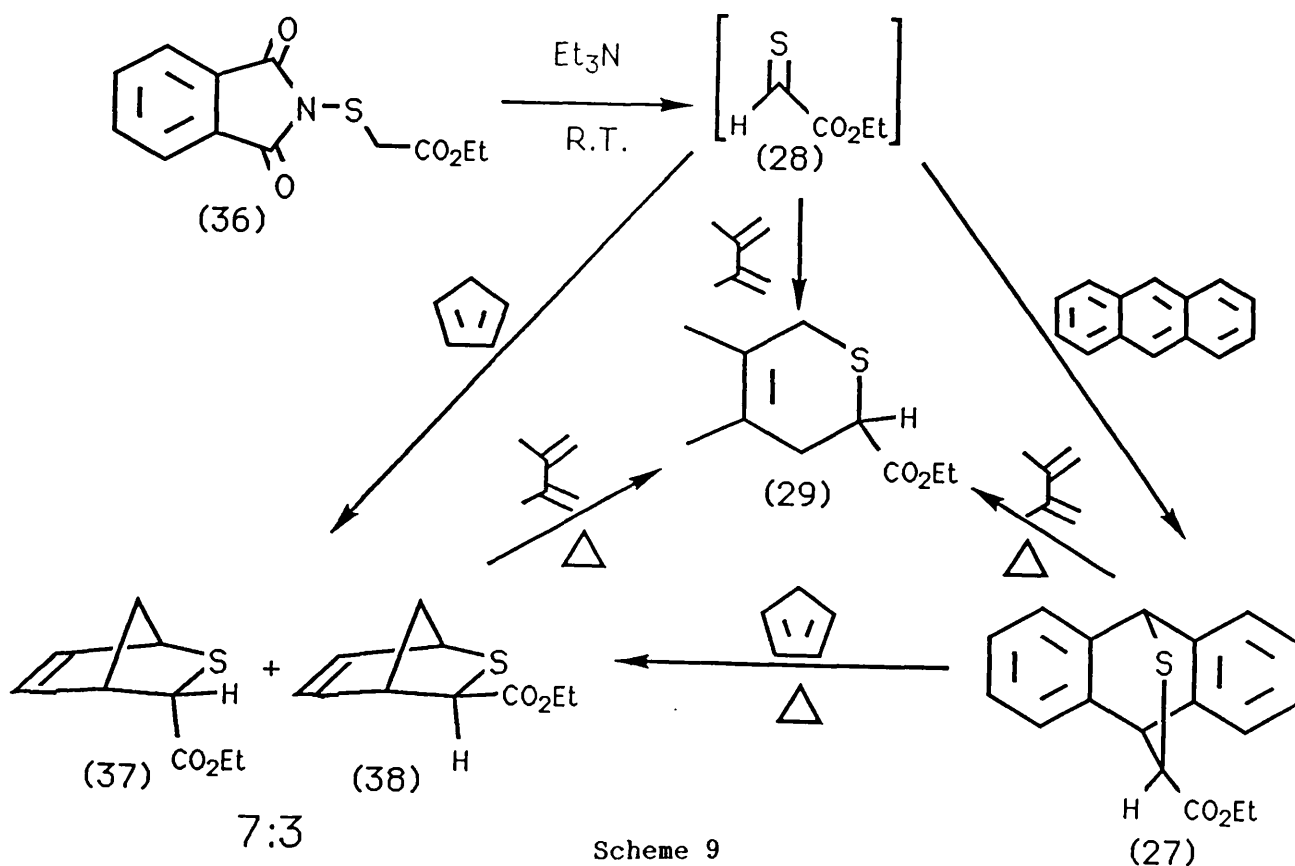

The cycloaddition of (28), formed in this case from the sulphenyl chloride (39), to thebaine (40) gave as the major product <sup>I6</sup> (41) under kinetic control (Scheme 10). This has the regioselectivity correctly predicted by simple frontier molecular orbital theory. However, on heating in refluxing toluene (41) dissociated then reassociated, eventually giving the thermodynamically more stable isomer (42).

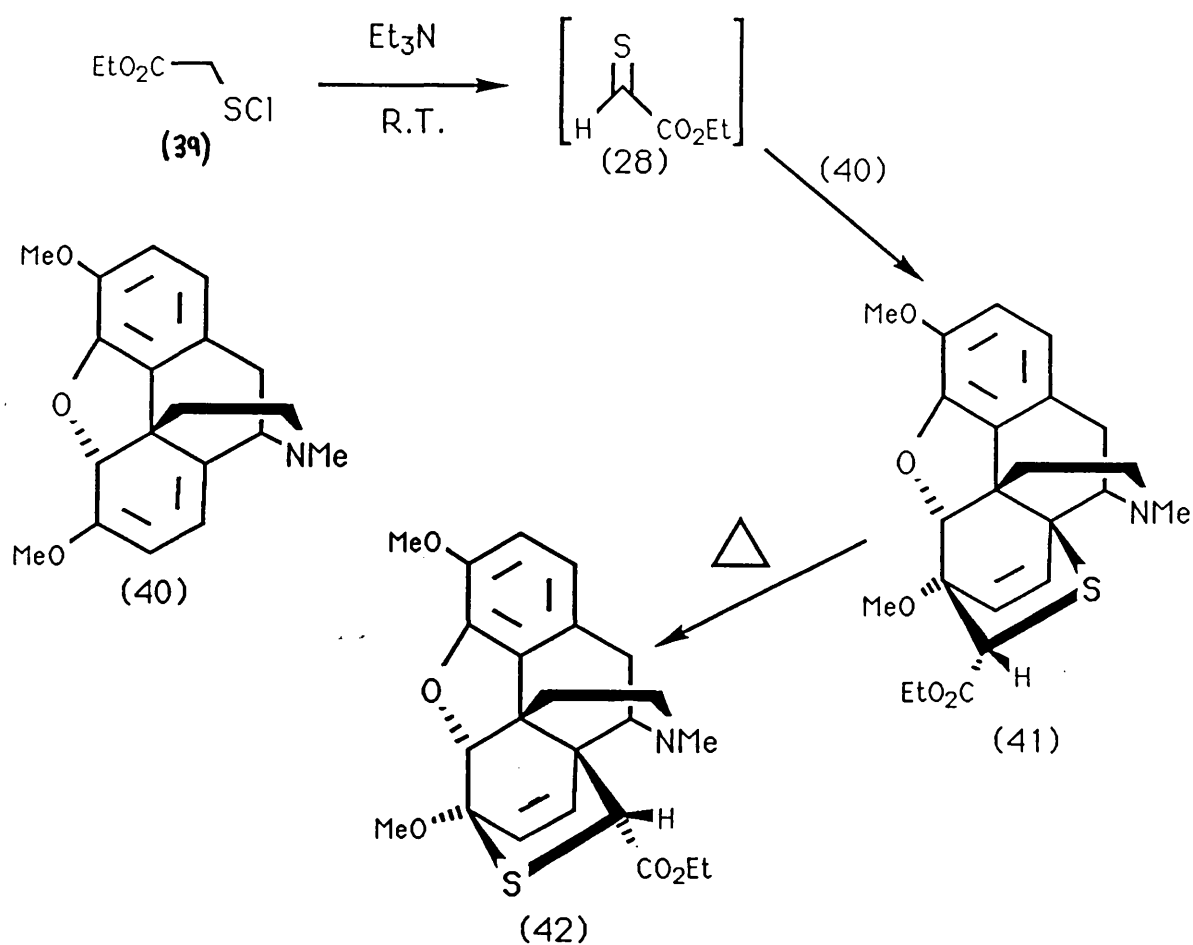

Scheme 10

Another convenient route to the thioester (28) involves heating a triphenyl phosphonium ylid (43) with elemental sulphur<sup>17</sup> (Scheme 11). The intermediate thioaldehyde apparently underwent in situ nucleophilic attack at carbon by morpholine to give the stable thioamide (44). The thioester (28) produced in this manner has, however, not been trapped in any other way.

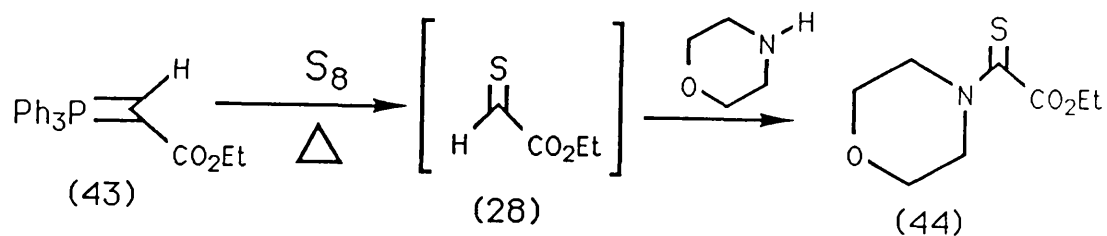

Scheme 11

THIOXOMALONATE ESTERS.

Very little work has been published on thioxomalonates, the thioketones related to oxomalonate esters. Their rarity is, of course, due to the considerable destabilising influence of having two electron-withdrawing groups attached to the thiocarbonyl group which makes thioxomalonates very highly reactive. Hence, it was not until 1978 that diethyl thioxomalonate (46) was first synthesised by Beelitz et al<sup>29</sup> who treated the dibromomalonate (45) with potassium *O*-ethyl xanthate (Scheme 12) to give (46) which then reacted in situ with 2,3-dimethyl-1,3-butadiene to give the cycloadduct (47) in 70% yield.

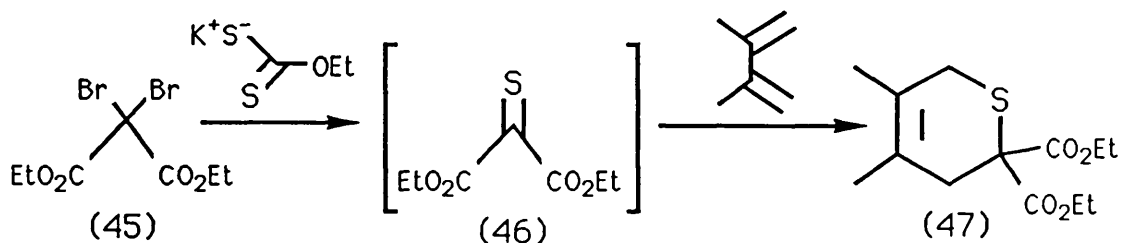

Scheme 12



Diethyl thioxomalonate (46) also featured in the, as yet, incomplete synthetic route<sup>30</sup> to thiathromboxanes (51) displayed in Scheme 13.

Generation of (46) from diethyl oxomalonate (48) with  $P_2S_5$  and subsequent hydrolysis, with spontaneous decarboxylation, of the adduct (49) gave the diacid (50).

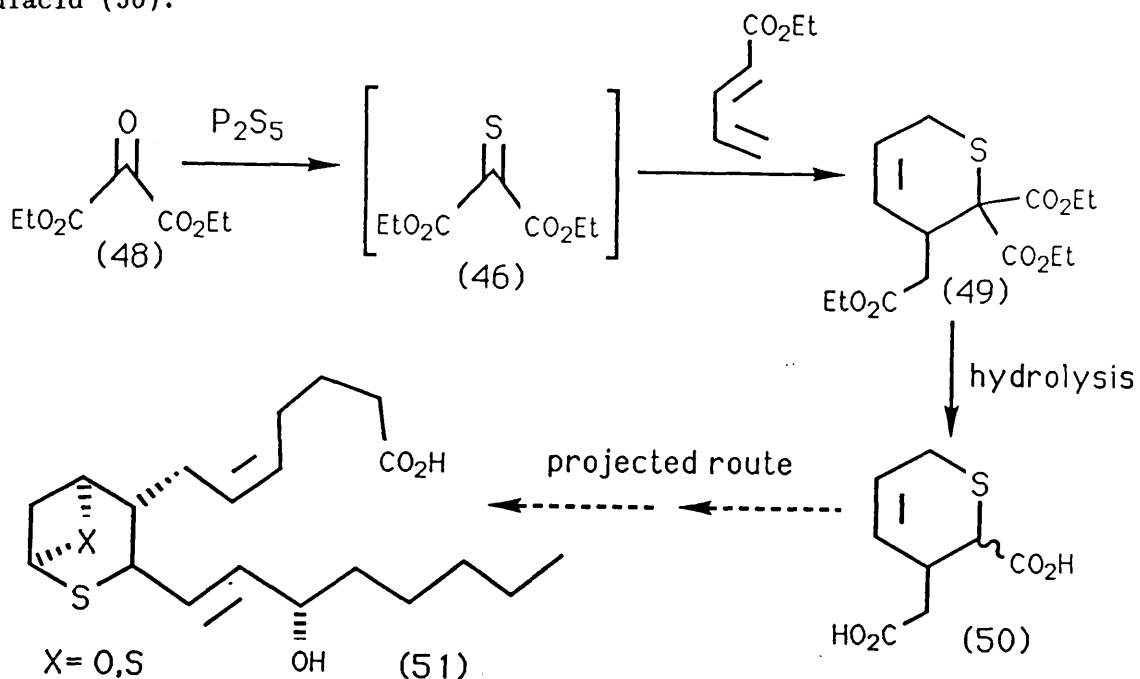

## REACTIONS OF THE THIOCARBONYL GROUP

Most of the studies on thiocarbonyl reactivity have been conducted, for convenience, on stable thiocarbonyl compounds<sup>31</sup>. These studies have shown that thiocarbonyl chemistry is, in general, analogous to that of the corresponding carbonyl compounds, except that the inherent instability of the C-S  $\pi$ -bond increases rates of reaction. For example, thiobenzophenone (8) reacts with phenylhydrazine (Scheme 14) 2000 times faster<sup>32</sup> than benzophenone (52), to give the same hydrazone product (53).

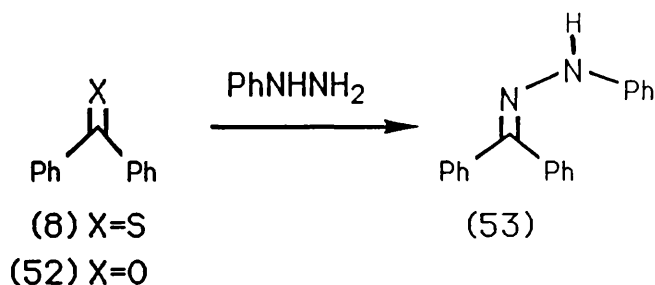

Scheme 14

Similarly, reduction of thioketones (54) to thiols (56) with sodium borohydride (Scheme 15) proceeds much faster<sup>1,32</sup> than the corresponding reduction of carbonyls (55) to alcohols (57).

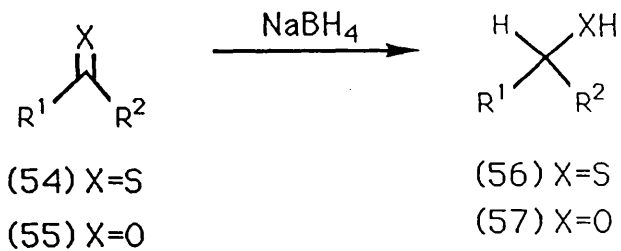

Scheme 15

Marked differences in chemistry are, however, observed between the reactions of thiocarbonyl and carbonyl groups in the following cases: oxidation (which gives sulphines from thiocarbonyl compounds - see Chapter 2), reactions involving nucleophiles, and reactions with dienes or mono-olefins.

(a) REACTIONS OF THIOCARBONYL GROUPS WITH NUCLEOPHILES.

With carbonyl compounds most nucleophilic reactions occur with attack at the carbonyl carbon. Analogous reactions involving thioketones<sup>1,2</sup> include the formation (Scheme 16) of acetals (58) and thioacetals (59).

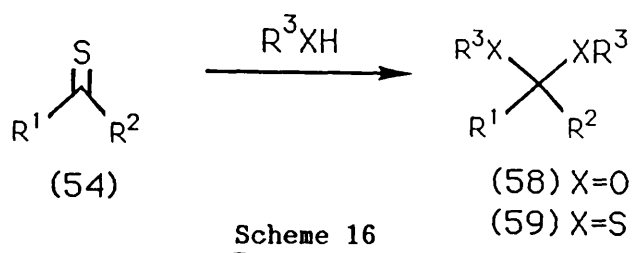

However, contrasting nucleophilic attack at sulphur (Scheme 17) can occur on treatment of thioketones with phenyl-lithium<sup>1,2</sup> to give thioethers (60), and with sodium bisulphite to give thiosulphates (61).

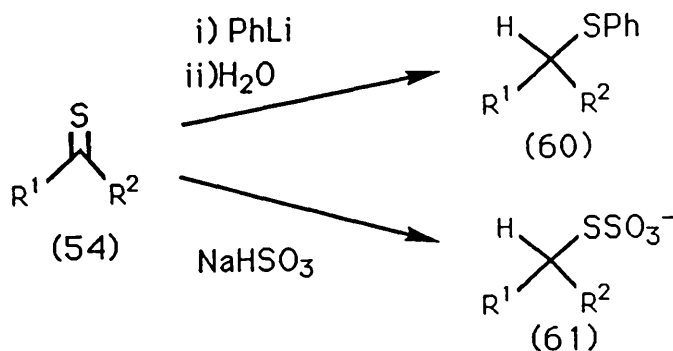

(b) REACTIONS OF THIOCARBONYL GROUPS WITH CONJUGATED DIENES.

Although carbonyl compounds can undergo Diels-Alder cycloadditions, thiocarbonyl compounds react much faster<sup>33</sup> and in many cases where the corresponding carbonyl compound is unreactive, the thioketone will be reactive towards conjugated dienes. For example, in Scheme 18, hexafluoro<sup>thio</sup>acetone (62) reacts with 1,3-butadiene at  $-78^{\circ}\text{C}$  to give the heterocycle (63) by Diels-Alder cycloaddition, whereas hexafluoroacetone (64) has to be heated with a more reactive diene in order to obtain the product (65).

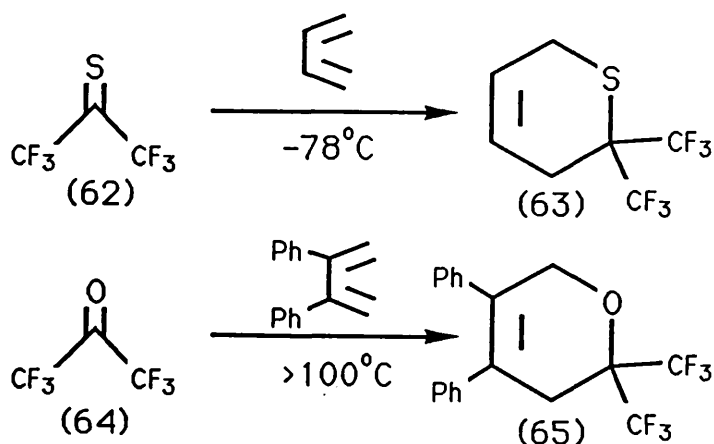
Scheme 18

Thus the high reactivity of thioketones (and thiocarbonyl compounds in general) towards conjugated dienes provides a useful method of "trapping" unstable thioketones produced in situ before they polymerise<sup>9</sup>.

Regiochemistry of Diels-Alder Reactions.

Frontier molecular orbital theories predict that the regioselectivity<sup>34</sup> of cycloaddition reactions involving thioketones with electron-withdrawing groups (Z) should be as shown in Scheme 19, with the adduct (66) as the major product. The presence of electron-donating groups (X) on the diene will accelerate the reaction.

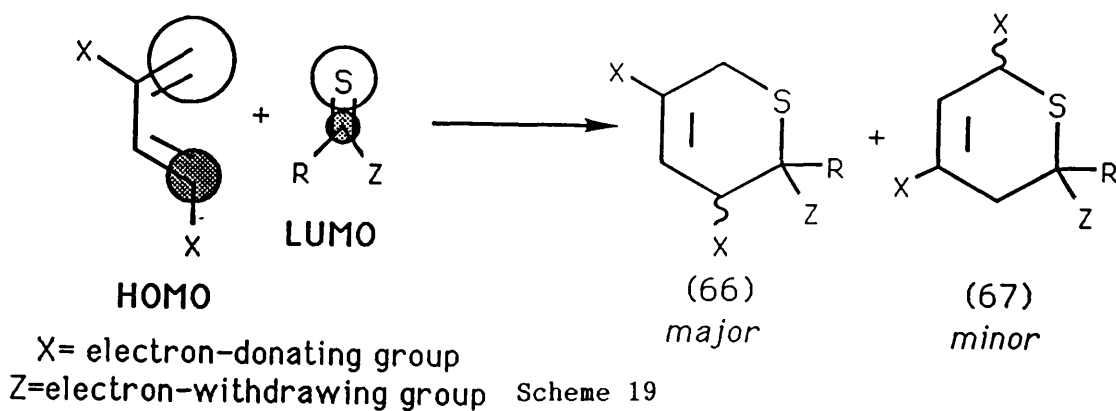

An early example of this kind of regioselectivity was observed in the reaction of the dithioester (68) with 1-methoxy-1,3-butadiene (Scheme 20) to give a 4:1 mixture of the regioisomers (69) and (70).<sup>35</sup>

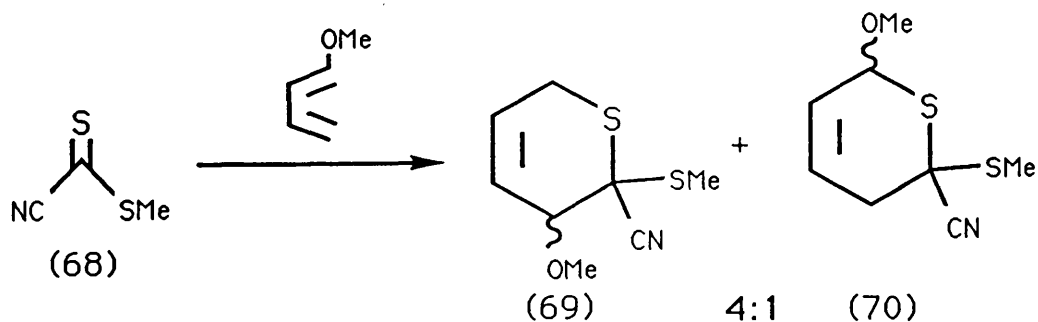

Scheme 20

Vedejs and coworkers<sup>28,34,36</sup> showed, more comprehensively (Scheme 21), that the presence of an electron-withdrawing group will promote the regiochemistry predicted in Scheme 19. They showed that addition in situ of (71) to (72) will produce (73) by Path A as the major product. Conversely, when the thioaldehyde (72) has no electron-withdrawing group, the inverse regioselectivity was observed by Path B to give mainly (74).

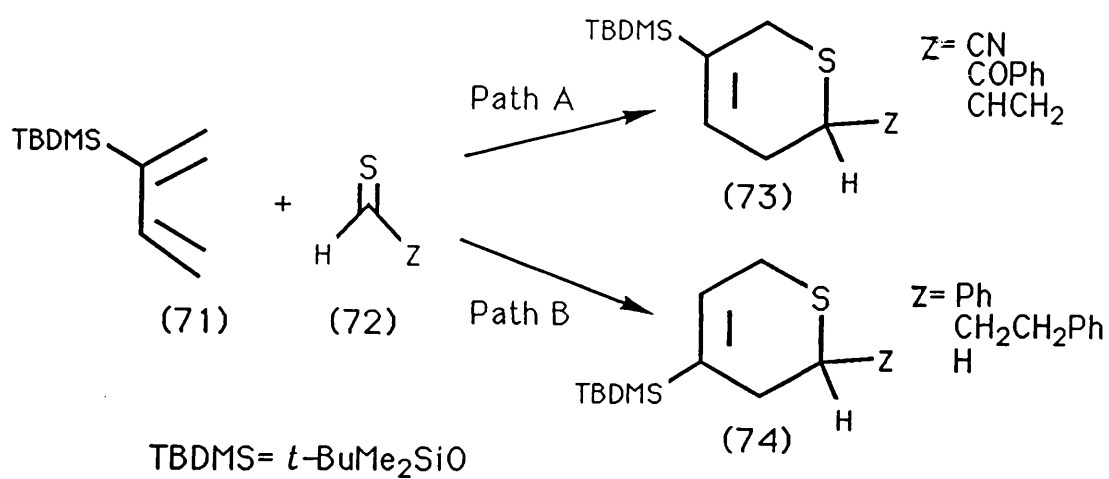

Scheme 21

(c) REACTIONS OF THIOCARBONYL COMPOUNDS WITH MONO-OLEFINS.

Thiocarbonyl compounds can also undergo 'ene' reactions with suitable olefins. The dithionoester (68) was shown by Snider<sup>37</sup> in 1976 to undergo such a reaction (Scheme 22) with various olefins (75), exclusively with C-S bond formation (to give a thioacetal (77) and no thiol). In those cases where  $R^2=R^4=H$ , the product was formed predominately with a trans double bond, as can be predicted from the conformation of the transition state (76). Experiments with highly substituted or endocyclic alkenes (e.g. cyclohexene) gave little or no 'ene' product.

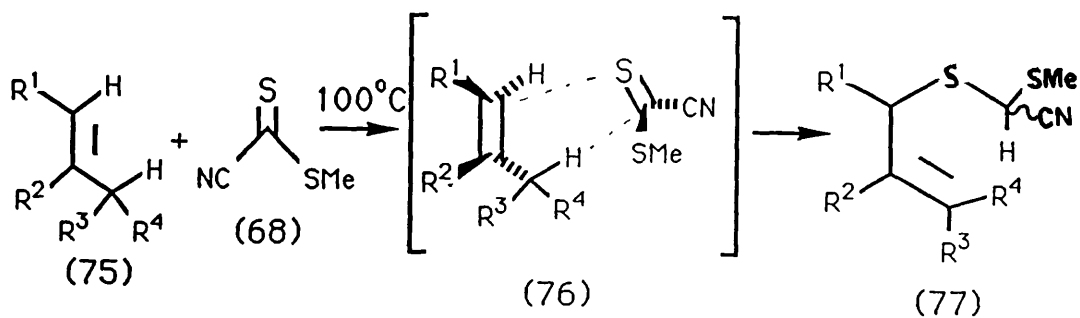
Scheme 22



Baldwin and Lopez<sup>28</sup> formed thiobenzaldehyde (20), by the method in Scheme 6, which underwent an 'ene' reaction (Scheme 23) with (-)- $\beta$ -pinene (78) give a 1:2 mixture of (79) and (80) in moderate yield. This preference for C-C bond formation is analogous to that observed for carbonyl compounds<sup>38</sup>.

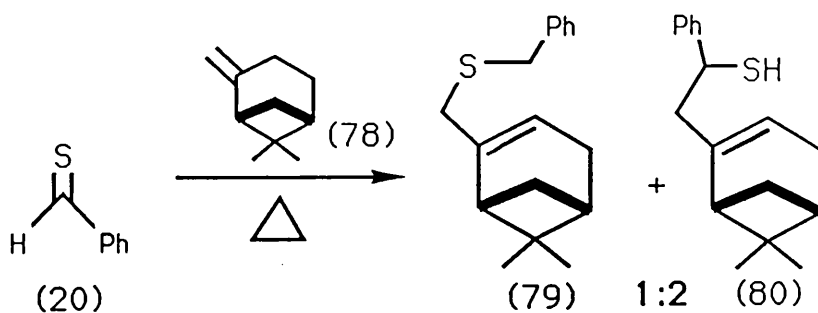

Scheme 23

Similarly, ethyl thioacetate (28), formed by retro-Diels-Alder cleavage of the anthracene adduct (27), as in Scheme 7, underwent an 'ene' type<sup>16,36</sup> reaction (Scheme 24) in situ with (-)- $\beta$ -pinene (78) to give the products (81) with C-S bond formation, and (82) with C-C bond formation, in a 4:1 ratio.

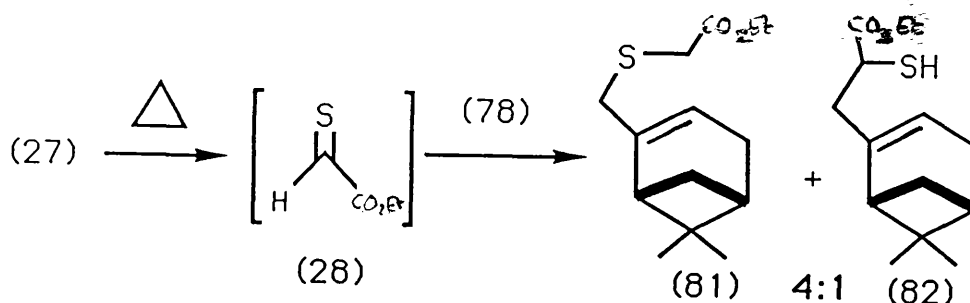

Scheme 24

This compares with the 1:2 ratio observed in Scheme 22, and demonstrates that the presence of an electron-withdrawing group enhances the reactivity of the thioaldehyde, and increases the regiochemical preference for C-S bond formation.

The preference for C-S bond formation in the 'ene' reactions of thioacetates can, however, be reversed in intramolecular reactions. Thus (83) cyclised preferentially<sup>39</sup> with C-C bond formation (Scheme 25) to give the thiol (84) purely for conformational reasons.

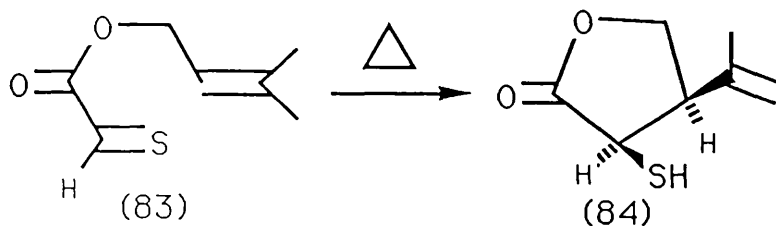

Scheme 25

Similarly the thioaldehyde (85), on heating, gave exclusively (Scheme 26) the thiol (86) in good yield<sup>36</sup>, again demonstrating a preference for C-C bond formation because of conformational constraints.

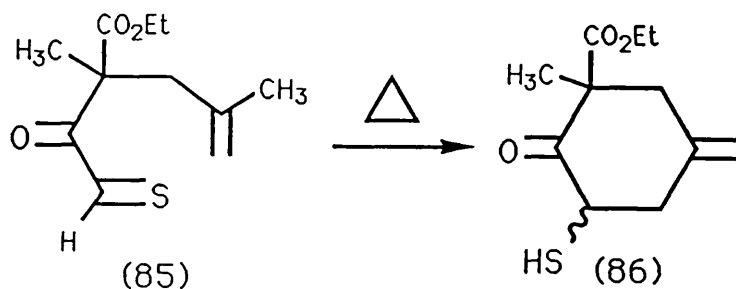

Scheme 26

## DISCUSSION

## SYNTHESIS OF DIETHYL THIOXOMALONATE (46)

Diethyl thioxomalonate (46) is of potential synthetic utility because of the flexibility of the malonate moiety. Once the thione (46) has been synthetically incorporated into a structure (87), the two ester groups provide convenient sites for further synthetic manipulation (Scheme 27), e.g. hydrolysis and decarboxylation to give a monoacid (88), which could be esterified to (89) or reduced to the alcohol (90). The acid (88) should be readily susceptible to electrophilic attack at the  $\alpha$ -position via the corresponding carbanion.

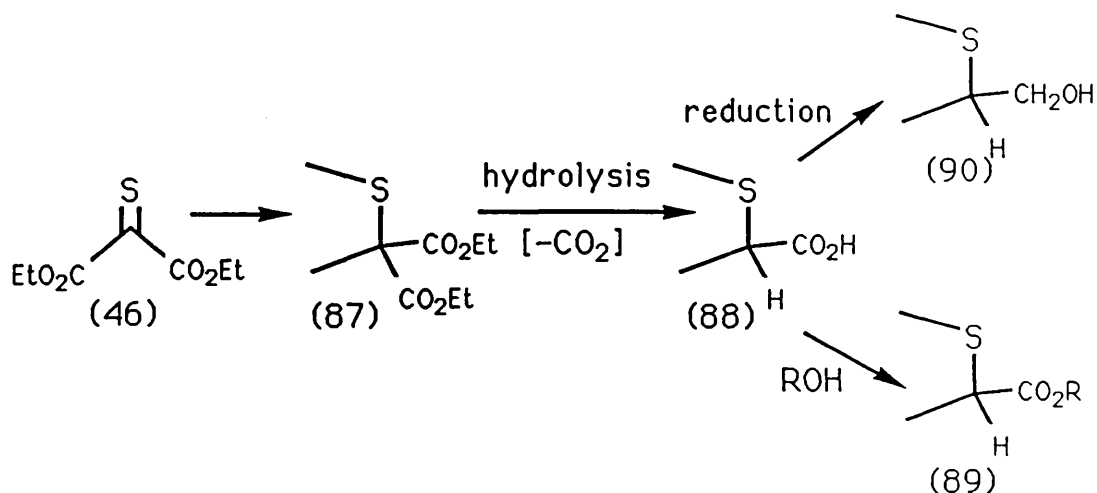

Scheme 27

It was already known<sup>40</sup> (Scheme 28) that diethyl 2-bromomalonate (91) reacted with sodium thiosulphate to give the thiosulphate salt ester, or "Bunte" salt, (92). This salt (92), on treatment with triethylamine, gave the thione (46) which was trapped in situ with cyclopentadiene to give the cycloadduct (93). Some decarboxylated product (30) was also obtained. It is unlikely that this method could be extended to trap (46) in situ with anthracene: generally "Bunte" salts need to be used with reactive dienes such as cyclopentadiene.

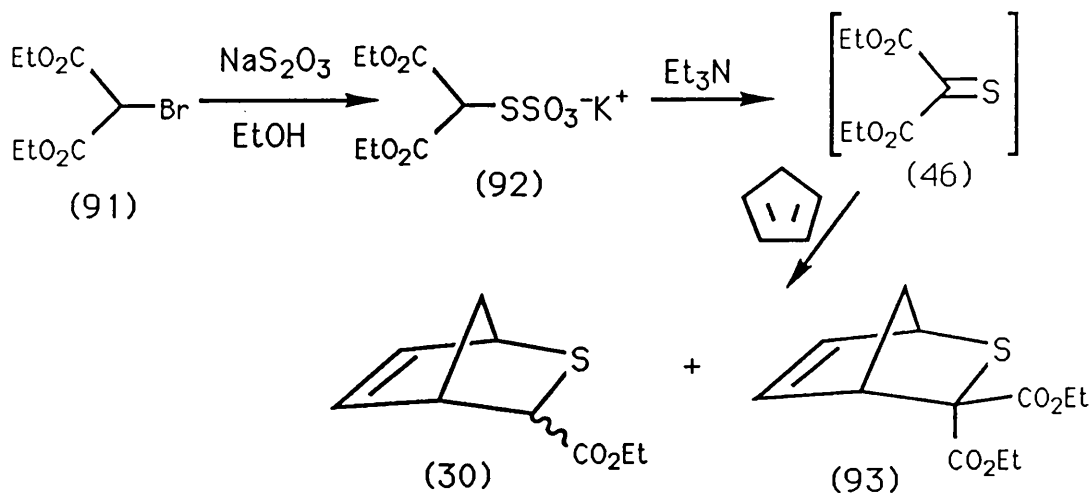

Scheme 28

A literature preparation <sup>29</sup> of diethyl thioxomalonate (46) involves (Schemes 12 and 29) treatment of diethyl 2,2-dibromomalonate (45) with two molar equivalents of *O*-ethyl xanthate <sup>41</sup> (94). The diester (45) is most conveniently prepared by reacting two moles of bromine with diethyl malonate in carbon tetrachloride under strong light <sup>42</sup>. The thione (46) generated in situ by this method was trapped by 2,3-dimethyl-1,3-butadiene (15 mol. equiv.) at 0°C in acetone to give the cycloadduct (47) in 70% yield.

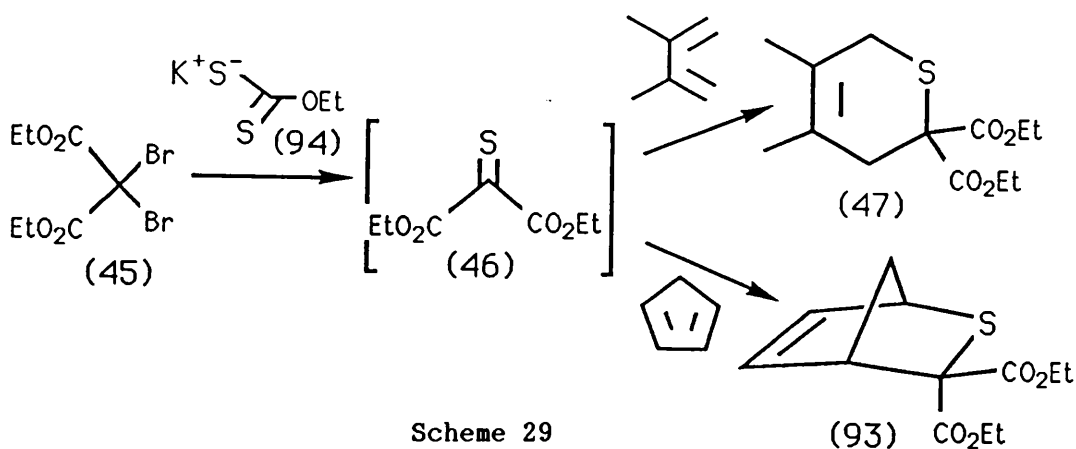

This procedure was successfully repeated and extended (Scheme 29) to include trapping the thione (46) at 0°C with cyclopentadiene (15 mol. equiv.) to give (93) in 59% yield. However, with anthracene as the "trapping diene" no cycloaddition product was observed, even when the reaction was carried out under reflux for 1h. Presumably, anthracene is insufficiently reactive to trap the thioketone (46) in the presence of nucleophiles, such as the xanthate (94).

It had also been shown<sup>43</sup> that diethyl oxomalonate (48), which is commercially available, will react with phosphorus pentasulphide (in fact,  $P_4S_{10}$ ) in refluxing benzene overnight (Scheme 30) in the presence of anthracene to give (95) in low yield (5-10%). Presumably, the thioketone (46) is again an intermediate. Hydrolysis of the diester (95) with aqueous sodium hydroxide gave, with spontaneous decarboxylation, the corresponding monoacid (96).

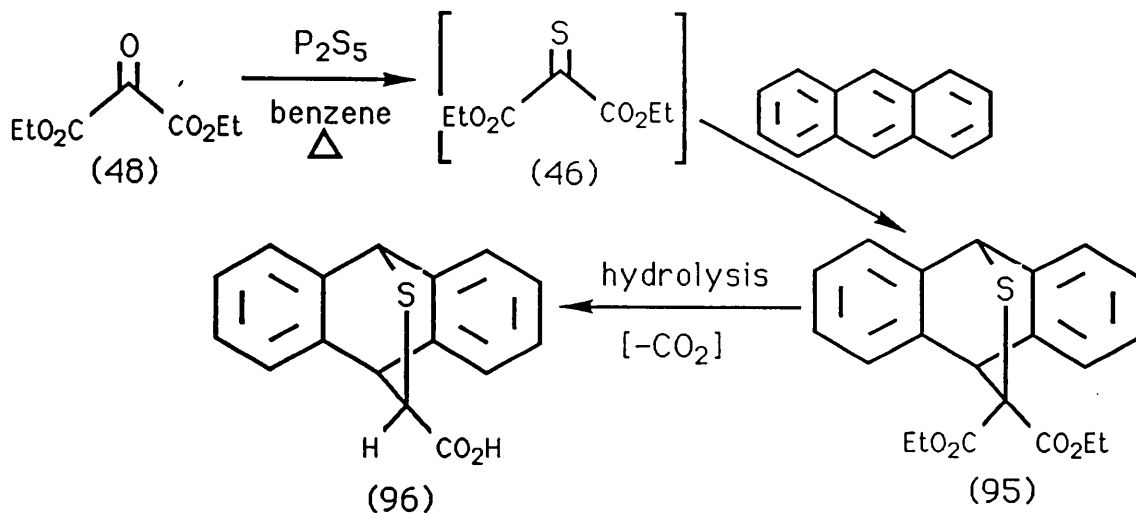

Scheme 30



After considering the methods already known for the synthesis of the thioxomalonate (46), and particularly since we required the anthracene adduct (95), we needed an improved synthesis of (95), especially with an increase in yield. Potential difficulties in improving the reaction in Scheme 30 included the sensitivity of both the starting ketone (48), and especially of phosphorus pentasulphide, to moisture, necessitating the use of carefully dried solvents. A potentially greater problem was the insolubility of the reagent in most organic solvents: for example, the reaction was essentially heterogeneous in refluxing benzene.

Various approaches, described as follows, were tried in order to improve the synthesis of the anthracene adduct (95).

(a)

ULTRASONIC IRRADIATION.

It is well documented that, in certain cases, ultrasonic irradiation can accelerate heterogeneous reactions<sup>44</sup>. A relevant case was reported by Raucher and Klein<sup>26</sup>, who showed that the rates of reaction of phosphorus pentasulphide in tetrahydrofuran (THF) at room temperature, with a variety of amides, was substantially increased, giving the corresponding thioamides in high yields.

However, when a suspension of phosphorus pentasulphide (0.2 mol. equiv. -i.e. 1 equiv. of S atoms) and anthracene (3 mol. equiv.) in dry benzene containing diethyl oxomalonate (48) was irradiated at room temperature for 6h in a Mettler Electronics ME1.5 Ultrasonic Cleaning Bath, only a low yield (5-10% determined spectroscopically) of the desired anthracene adduct (95) was obtained. Similarly, experiments using dry THF or dry benzene/THF gave only low yields of (95) under these conditions.

(b)

USING P<sub>2</sub>S<sub>5</sub>/NaHCO<sub>3</sub>.

It was known that the thionation of uracils could be improved by the addition of sodium bicarbonate to a solution of phosphorus pentasulphide in hot diglyme<sup>27</sup> (phosphorus pentasulphide is reasonably soluble in diglyme). This liberates the proposed active species, S<sub>2</sub>PS<sup>-</sup> (Scheme 5). Emulating this method, sodium bicarbonate (1 mol. equiv.) was added (sufficiently slowly to control effervescence) to a stirred solution of phosphorus pentasulphide (0.2 mol. equiv.) and diethyl oxomalonate (48) (1 mol. equiv.) and cyclopentadiene (5 mol. equiv.) in diglyme at ca.100°C. (Because of the low yields obtained so far with anthracene, it became more convenient to use cyclopentadiene as a "trapping agent" to investigate these reactions.) Heating was continued for 24h. This experiment gave only a low yield (20-30% determined spectroscopically) of the cyclopentadiene adduct (93). This yield was too discouraging to merit investigation into the use of these conditions in making the anthracene adduct (95).

(c)

USING P<sub>2</sub>S<sub>5</sub> IN PYRIDINE.

Several thionation reactions have been successfully performed in a solution of phosphorus pentasulphide in pyridine<sup>25</sup>. We have found that this homogeneous reagent is very useful in the synthesis of diethyl thioxomalonate (46).

Cyclopentadiene or 2,3-dimethyl-1,3-butadiene (5 mol. equiv.) and phosphorus pentasulphide (0.4 mol. equiv. -i.e. 2 equiv. of S atoms) were dissolved in refluxing dry pyridine, and diethyl oxomalonate (48) (1 mol. equiv.) was added. After a further 1h heating the corresponding Diels-Alder cycloadducts, (93) and (47), of diethyl thioxomalonate (46) were isolated, both in yields of ca.60% (Scheme 31).

Refluxing pyridine is apparently too hot for the synthesis of the anthracene adduct (95), since no (95) was isolated from the foregoing conditions with anthracene replacing the other dienes. However, when diethyl oxomalonate (48) (1 mol. equiv.) was added to anthracene (3 mol. equiv.) and phosphorus pentasulphide (0.4 mol. equiv.) in dry pyridine at 70-80°C and heated for a further 1h, the desired anthracene cycloadduct (95) was obtained (Scheme 31) in improved yield (25-30% ex MeOH). This lower yield is a reflection of the poorer reactivity of anthracene<sup>45</sup> as a dieneophile, when compared to cyclopentadiene or 2,3-dimethyl-1,3-

-butadiene. This is in accordance with the observation that (95) does not decompose when heated alone at 80°C in pyridine and that, therefore, the lower yield is not due to decomposition of the product (95).

Yields of all three adducts (47), (93), and (95) are, however, substantially reduced if the pyridine is not carefully dried before use, largely because of the sensitivity of phosphorus pentasulphide to moisture.

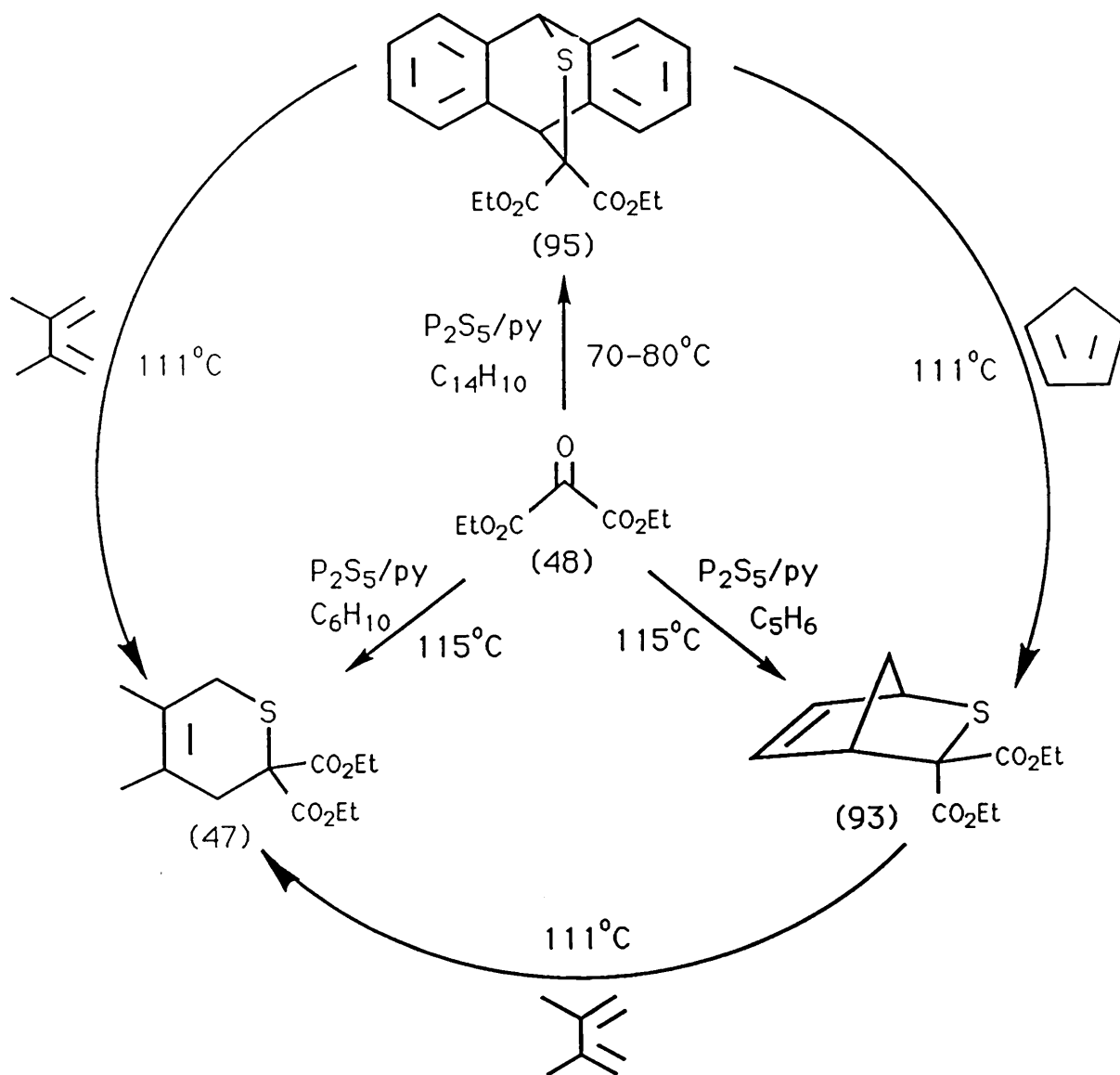
Scheme 31

## REGENERATION OF DIETHYL THIOXOMALONATE (46) BY RETRO-DIELS-ALDER REACTION

The anthracene and cyclopentadiene adducts, (95) and (93), of the thione (46) are thermally labile and act as convenient "clean" precursors to the thione (46) on heating. As will be described, the rate of dissociation of the anthracene adduct (95) is faster than that of the cyclopentadiene adduct (93). This, in conjunction with the convenience of working with a crystalline adduct, makes the anthracene adduct (95) the preferred precursor to diethyl thioxomalonate (46).

Both the anthracene adduct (95) and the cyclopentadiene adduct (93) dissociate and recombine on heating. When there are no other reactants present, the cycloadducts are regenerated. Thus after 24h in refluxing toluene the cyclopentadiene adduct was recovered quantitatively, and the anthracene adduct recovered in good yield (75%).

The anthracene adduct (95) dissociated in refluxing toluene (Scheme 31) to liberate the thione (46), which was trapped in situ, over 1h, by either cyclopentadiene or 2,3-dimethyl-1,3-butadiene (5 mol. equiv.) to give the adducts (93) or (47), quantitatively. Similarly, the cyclopentadiene adduct (93) dissociated in refluxing toluene (Scheme 31) to give the thione (46) which was trapped in situ, over 1h, by 2,3-dimethyl-1,3-butadiene (5 mol. equiv.) to give the adduct (47) quantitatively.

(a) COMPETITION EXPERIMENT.

Cyclopentadiene undergoes a Diels-Alder reaction with maleic anhydride, at 30°C, ca.275 times faster<sup>45</sup> than does 2,3-dimethyl-1,3-butadiene. Thus, it would be expected that in a competition experiment between these two dienes for such a dieneophile, the only isolated product would be the cyclopentadiene adduct. However, we were interested to see if this would still be the case using diethyl thioxomalonate (46) as the dieneophile.

To this end, a mixture of cyclopentadiene and 2,3-dimethyl-1,3-butadiene (3 mol. equiv. of each) was used to trap diethyl thioxomalonate (46), generated in situ by heating the anthracene adduct (95) (1 mol. equiv.) in refluxing toluene (Scheme 32). The reaction was complete after 1h and <sup>I</sup>H n.m.r. spectroscopy showed the presence of the adducts (93) and (47) in a 3:2 ratio. To consider the value of this result, a control experiment was conducted: the cyclopentadiene adduct (93) was heated in refluxing toluene (Scheme 32) for 1h in the presence of 2,3-dimethyl-1,3-butadiene (3 mol. equiv.). The thione (46) was partially transferred to give a mixture of adducts (93) and (47) in a 2:3 ratio.



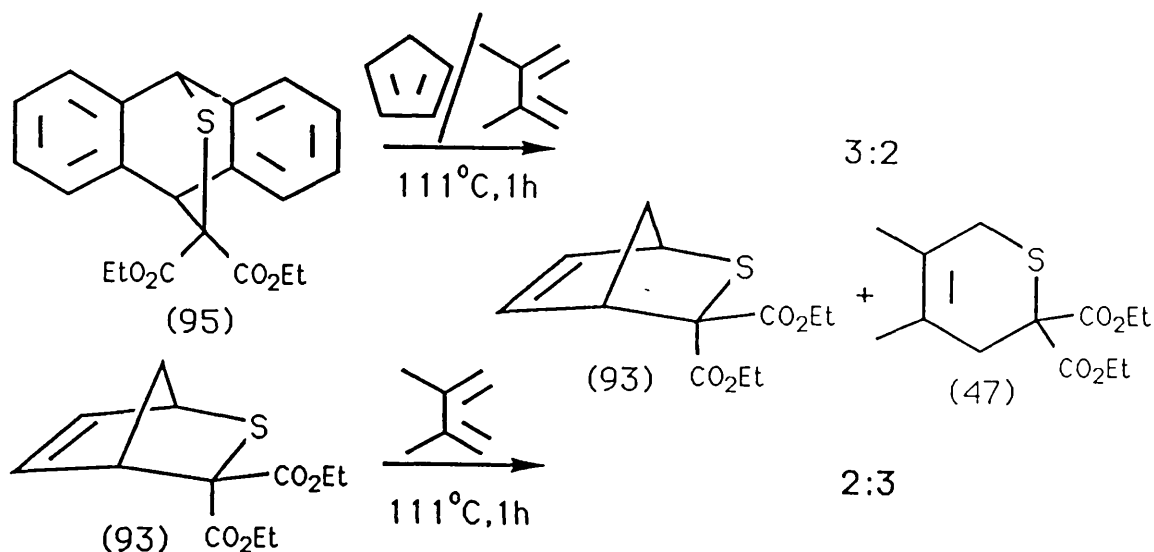

Scheme 32

Clearly then, the essentially quantitative thermal transfer of the thione (46) from the anthracene adduct (95) to the mixture of dienes does not give us the relative rates of cycloaddition of (46) to cyclopentadiene and 2,3-dimethyl-1,3-butadiene. Formation of the bridged, and consequently strained, adduct (93) is reversible while, very probably, the monocyclic adduct (47) is not formed reversibly at the reaction temperature. Thus the observed 3:2 ratio of (93) and (47) serves only to give a lower limit to the relative rates of reaction of the thione (46) with these dienes.

Graph 1. Determination of rate constant (k) of dissociation of the anthracene adduct (27) of ethyl thioacetate (28) at 100°C from the slope of  $\ln(A-A_t)$  against time.

A = absorbance at 355nm at 24h.

$A_t$  = absorbance at 355nm at time, t.

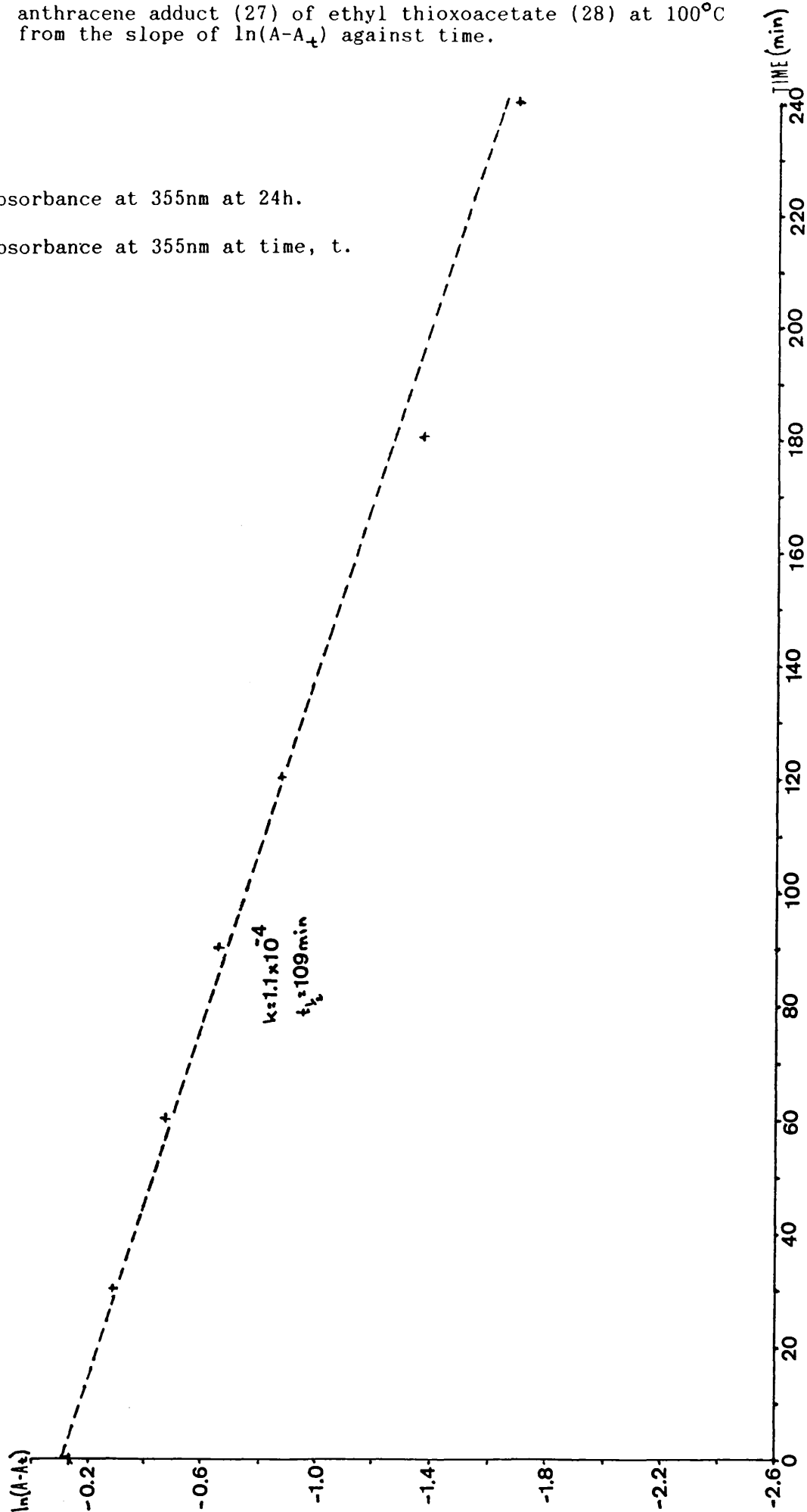

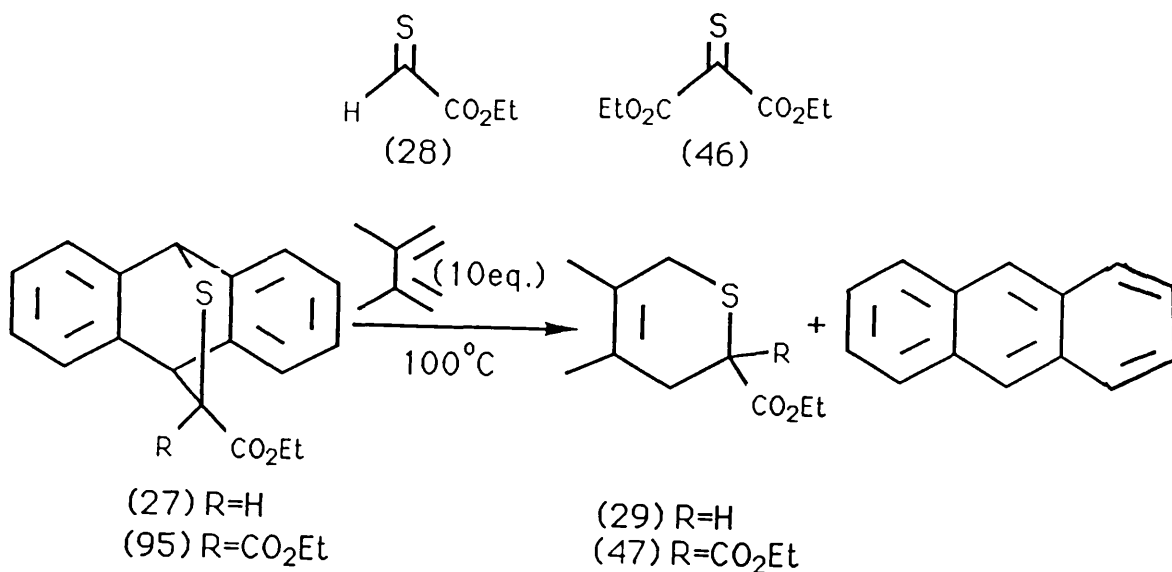
(b) RATES OF DISSOCIATION OF THE ANTHRACENE CYCLOADDUCTS (27) AND (95).Scheme 33

A series of kinetic experiments<sup>46</sup> were conducted on the transfer of the thioacetate (28) and the thioxomalonate (46) (and their S-oxides - see Chapter 2) from their anthracene adducts (27) and (95) to 2,3-dimethyl-1,3-butadiene (Scheme 33). Both reactions were monitored by the ultraviolet absorbance ( $\lambda_{\text{max}}$  355 nm) of the liberated anthracene.

Both transfer reactions were carried out in toluene, at 100°C, with a large excess of 2,3-dimethyl-1,3-butadiene (10 mol. equiv.) in order to

Graph 2. Determination of rate constant ( $k$ ) of dissociation of the anthracene adduct (95) of diethyl thioxomalonate (46) at  $100^{\circ}\text{C}$  from the slope of  $\ln(A-A_t)$  against time.

$A$  = absorbance at 355nm at 24h.

$A_t$  = absorbance at 355nm at time,  $t$ .

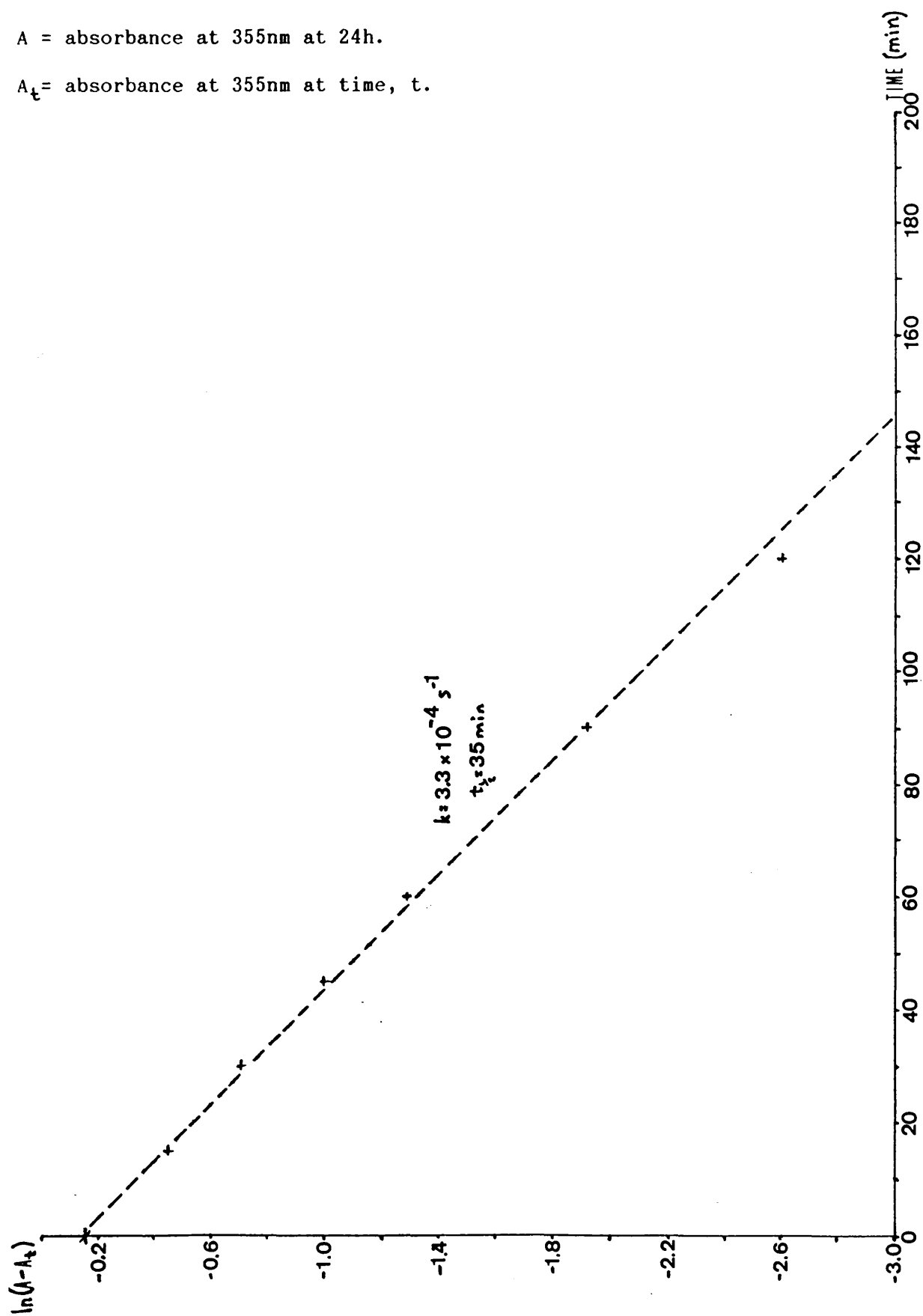

simplify the kinetics. That is, the concentration of this diene did not diminish significantly during the experiments, and recapture of the dieneophile (28) or (46) by anthracene is assumed to be insignificant. Both reactions were shown to follow approximately first-order kinetics, with respect to the concentration of (95) - see Graphs 1 and 2. Significantly the measured rate constants (Table 1) show that the presence of the second ester group in (95) increases the rate of dissociation of the anthracene adduct (95) by a factor of ca.3 compared with the anthracene adduct (27).

**Table 1.** Dissociation rates ( $k$ ) of the anthracene adducts, (27) and (95), of ethyl thioacetate (28) and diethyl thioxomalonate (46) at 100°C in toluene.

Thiocarbonyl compound	$k$ ( $s^{-1}$ )	$t_{\frac{1}{2}}$ (min)
Ethyl thioacetate (28)	$1.1 \times 10^{-4}$	109
Diethyl thioxomalonate (46)	$3.3 \times 10^{-4}$	35

The observation that both reactions obey first-order kinetics means that the rate determining step is the unimolecular decomposition of the anthracene adduct.

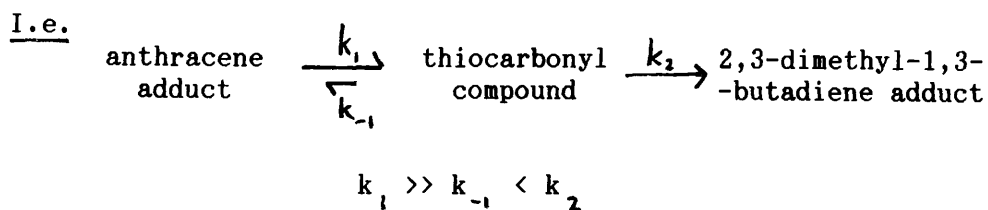

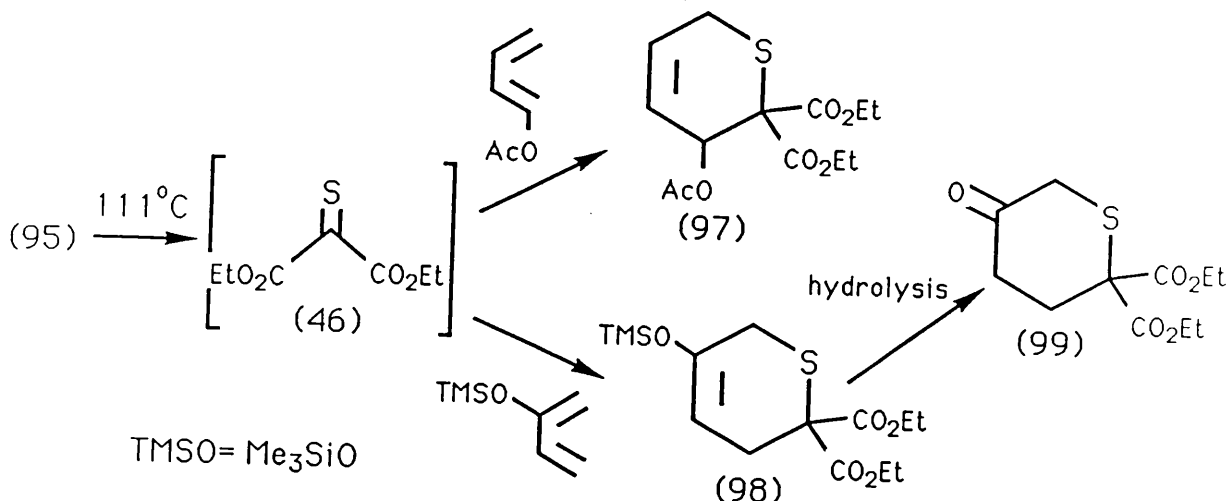
(c) REGIOCHEMISTRY OF DIELS-ALDER ADDITIONS OF DIETHYL THIOXOMALONATE (46)Scheme 34

Diethyl thioxomalonate (46), generated in situ by heating the anthracene adduct (95) in refluxing toluene for 1h, reacted with 1-acetoxy-1,3-butadiene (2 mol. equiv.) regioselectively to give only the adduct (97) and anthracene (Scheme 34). The regiochemistry was determined as discussed in the following section.

Similarly, the thione (46) was trapped in situ with 2-trimethylsilyloxy-1,3-butadiene (2 mol. equiv.) to give only the moisture-sensitive adduct (98) regioselectively, which was easily hydrolysed to the ketone (99). Again the regiochemical assignment will be discussed in the following section.

Table 2.  $^1\text{H}$  n.m.r. data for cycloadducts of ethyl thioacetate (28) and diethyl thioxomalonate (46) [ $\delta(\text{CDCl}_3)$ ].

compound		(97)	(97)	(47)	(98)	(99)
$^1\text{H}$	nucleus	ca. 6.1	ca. 5.8	2.67 (s)	2.89	2.60 or 2.71
	3-H ( $\text{H}_2$ )					
	6- $\text{H}_2$	3.61	3.91, 3.23	3.06 (s)	3.12 (s)	3.30 (s)
$^{13}\text{C}$	4-H ( $\text{H}_2$ )	5.83, 6.15	5.61, 6.08	N/A	4.95	2.60 or 2.71
	5-H				N/A	N/A

### Notes

- a Data supplied by M.S. Rahman <sup>47</sup>.
- b Values for each 6-H are averaged between stereoisomers.
- c Assignments are undetermined. All possible values are given.

It is worth noting at this stage that these observed regiospecificities are directly in agreement with the predictions made by frontier molecular orbital (f.m.o.) theory (Scheme 19). The presence of two electron-withdrawing groups, instead of only one as displayed in Scheme 19, on the dieneophile would be expected to enhance the regioselectivity.

Assignment of the regiochemistry of the cycloadduct (97) and the ketone (99).

Assignment of the structures (97) and (99) was made using  $^1\text{H}$  n.m.r. spectroscopy only. As neither of these adducts are crystalline x-ray structure determination was not possible.

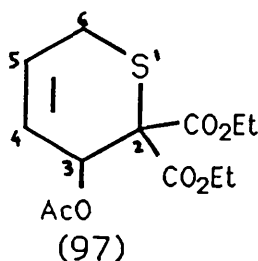

The table of n.m.r. data (Table 2) gives information on five relevant compounds, including the ethyl thioacetate adducts<sup>47</sup> (100). The stereoisomers of (100) are very similar to (97), except for the vicinal coupling between the 2-H and 3-H, which allows unambiguous assignment of the regiochemistry of (100). As can be seen from Table 2, the  $^1\text{H}$  chemical



shifts for the 6-methylene protons and the 3-H in (100) and (97) are very similar. This observation, and also the similar chemical shifts for the 6-methylene protons in (97) and (47), are the basis for assigning the structure (97) to the cycloadduct, having the acetoxy group at the 3- rather than at the 6-position.

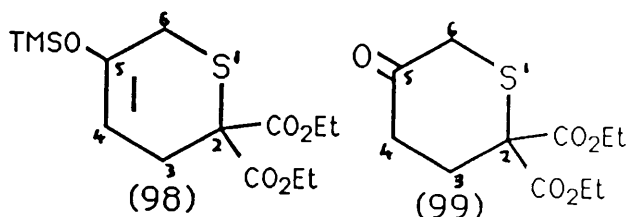

The regiochemistry (98) for this cycloadduct, and the corresponding structure (99) for its hydrolysis product, were also assigned by n.m.r. spectroscopy (Table 2). The signal at  $\delta$ 3.30 in the  $^1\text{H}$  n.m.r. spectrum of the ketone (99) was a singlet. Its multiplicity and chemical shift indicated that it arose from an isolated 6-methylene group and not from an isolated 3-methylene group, as would arise in the (unknown) 4-oxo regioisomer. This is confirmed by the n.m.r. of the cycloadduct (98) which also shows a singlet with an appropriate chemical shift for the 6-methylene group.

(d) AN 'ENE' REACTION OF DIETHYL THIOXOMALONATE (46).

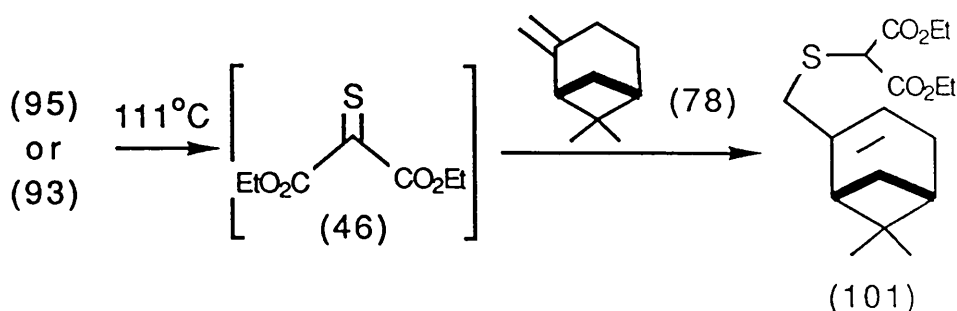

Scheme 35

Both the anthracene adduct (95) and the cyclopentadiene adduct (93) dissociated in refluxing toluene to liberate the thione (46), which acted as the 'ene' component in a reaction with (-)-β-pinene (78) (3 mol. equiv.) to give (101) as the exclusive product (Scheme 35). Only C-S bond formation was observed, which is analogous to the findings of Snider<sup>37</sup> (Scheme 22) with the dithioester (68). This also complements the finding that ethyl thioacetate (28) reacts with (-)-β-pinene (78) mainly with C-S bond formation<sup>16,36</sup> (Scheme 24).

The anthracene adduct (95) reacted faster, as expected, giving (101) in 61% yield after 1h, but the cyclopentadiene adduct (93) required 4h to give (101) in a rather lower yield (30%). The structure of the oily

product (101) was established by  $^1\text{H}$  n.m.r. spectroscopy. In particular, signals at  $\delta$ 3.25 [bs, S-CH] and  $\delta$ 4.11 [s, S-CH(CO<sub>2</sub>Et)] were diagnostic. The alternative (and unknown) product (102) would have shown corresponding signals for a methylene group at higher field, and a thiol group, exchangeable with deuterium oxide, neither of which were observed.

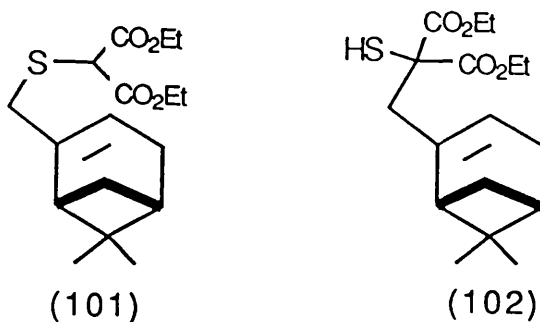

Considering the HOMO of an olefin (103) and the LUMO of the heterodieneophile (104)<sup>48</sup>, application of simple f.m.o. theory gives a pictorial representation of the 'ene' reaction shown in Scheme 36.

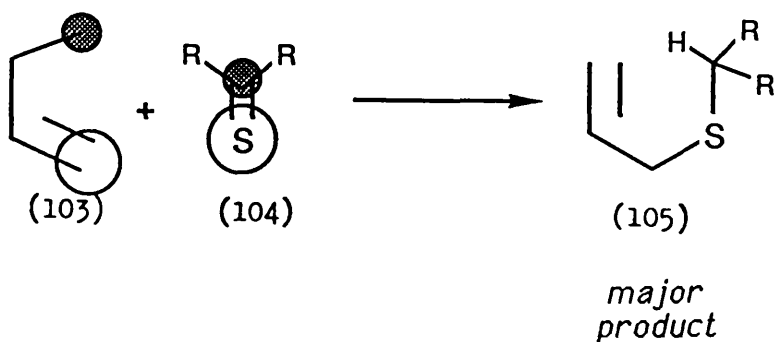

Scheme 36

When one or both of the groups (R) on the thioketone (104) are electron-withdrawing, this lowers the energy of the LUMO, accelerating the reaction. It also reduces the orbital coefficient at carbon, encouraging greater regioselectivity in favour of C-S bond formation.

This accounts for the regiospecificity of the reaction of diethyl thioxomalonate (46) with (-)- $\beta$ -pinene (78) (Scheme 35), and also for the trends observed in 'ene' reactions of thiocarbonyl compounds. For example, ethyl thioacetate (28) reacts with (-)- $\beta$ -pinene (78) to afford a 4:1 mixture of C-S and C-C formation products (Scheme 24). As expected, thiobenzaldehyde (20) exhibits less selectivity, reacting with (78) to give a 1:2 mixture of products, now favouring C-C bond formation (Scheme 23), which is analogous to the regiochemical preference shown by ketones in 'ene' reactions.<sup>38</sup>

## CONCLUSIONS.

The cyclopentadiene adduct (93) and particularly the anthracene adduct (95) of diethyl thioxomalonate (46) are useful auxiliary precursors, liberating the electrophilic thioketone (46) on heating. This thione (46) can be 'transferred' to other dienes quantitatively, or can react with (-)- $\beta$ -pinene (78) in an 'ene' reaction. Both the Diels-Alder cycloadditions of diethyl thioxomalonate (46) to unsymmetrical dienes and also the 'ene' reaction, were regiospecific; only a single product was detected in each case.

## CHAPTER 2

"THE SYNTHESIS AND REACTIONS OF DIETHYL THIOXOMALONATE S-OXIDE."

## INTRODUCTION

## STABILITY OF SULPHINES.

Sulphines (106), or thiocarbonyl s-oxides, are more stable than their thiocarbonyl equivalents (107). This is related to the strength of the C-S  $\pi$ -bond. The overlap between the carbon 2p and the sulphur 3p orbitals is better in sulphines than in thiocarbonyl compounds because the positive charge on the sulphur atom in sulphines reduces the energy of the 3p orbital. This makes it more similar in size and energy to the carbon 2p orbital, improving orbital overlap.

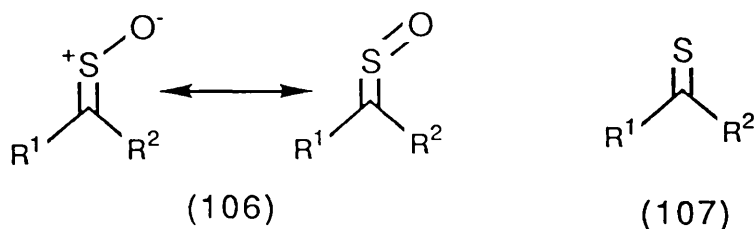

Because the C-S-O system is bent<sup>49</sup> sulphines can exist in two geometric forms<sup>50</sup>. These Z and E forms are not readily interconvertible, indicating a significant double bond character between the carbon and sulphur.

Consideration of the more recent reviews on sulphine chemistry indicates that the same trends apply to sulphines as to thiocarbonyls in



how the stability of the moiety is affected by substituent groups.

Electron-donating groups tend to stabilise sulphines: thus the S-oxides of thioamides<sup>56,57</sup> (108) and dithioesters<sup>II,58,59</sup> (109) are especially stable.

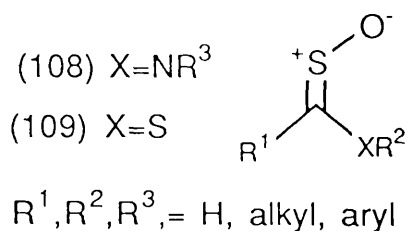

Conversely, electron-withdrawing groups destabilise sulphines, as they do thiocarbonyl compounds, and examples of highly reactive and unstable sulphines with attached ketonic<sup>55,60</sup> (110), or ester groups<sup>55,61</sup> (111) are to be found in the chemical literature.

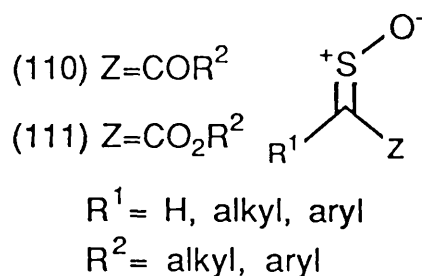

Several examples of sulphines stabilised by steric crowding have been synthesised, such as fluorenylidene sulphine<sup>62</sup> (113), which was made by 1,2-dehydrochlorination of the sulphonyl chloride (112) with base (Scheme 37). Another example is di-*t*-butyl sulphine (115) which can be made from the thione (114) by treatment with either a peracid<sup>63</sup> or ozone<sup>64</sup> (Scheme 37). Both are crystalline and are stable for several days.

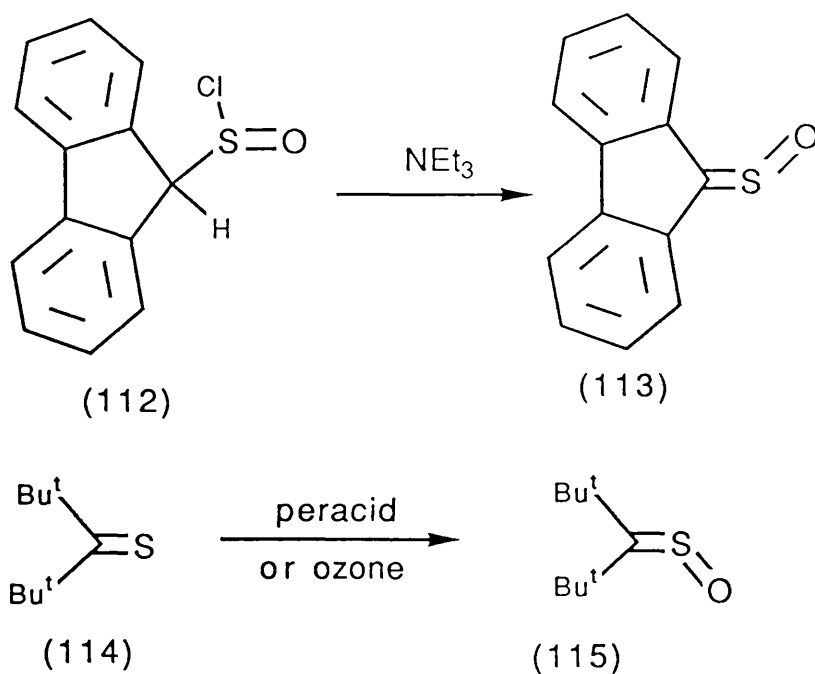

Scheme 37

## THE DISCOVERY AND SYNTHESIS OF SULPHINES.

Sulphines have been of interest to chemists since 1923 when Wederkind et al synthesised the stable sulphine<sup>65</sup> (119) by a rather esoteric reaction of camphor-10-sulphonyl chloride (116) with base (Scheme 38); the structure remained uncertain until settled in 1963 by King and Durst<sup>66</sup>.

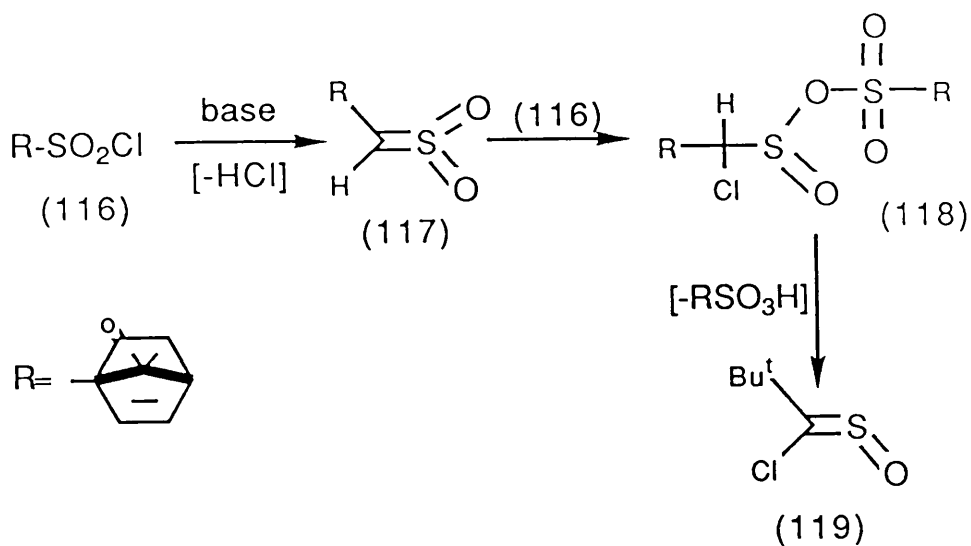

Scheme 38

A more direct synthesis of stable sulphines (Scheme 39) was achieved by Kitamura<sup>67</sup> in 1938 who used hydrogen peroxide to oxidise thioamides (1), although the correct structure of their products was not deduced until 1960 by Walter<sup>68</sup>.

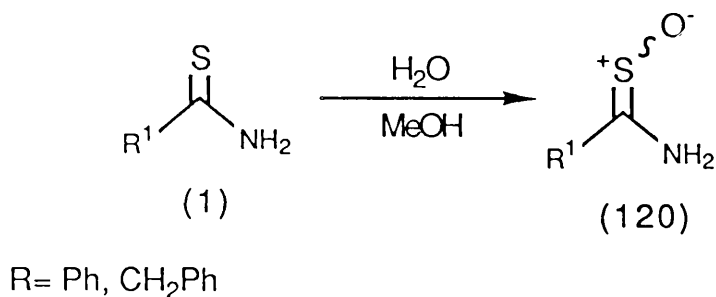

Scheme 39

Sulphine chemistry became of biochemical importance in the 1960's with the discovery by Wilkens that thiopropanal S-oxide (121) is the lachramatory factor in onions<sup>69</sup>, and the subsequent discovery that thioacetamide S-oxide (122) is a metabolite of thioacetamide (123), and is toxic. As a result thioacetamide was banned from use as a preservative for citrus fruit<sup>57</sup>.

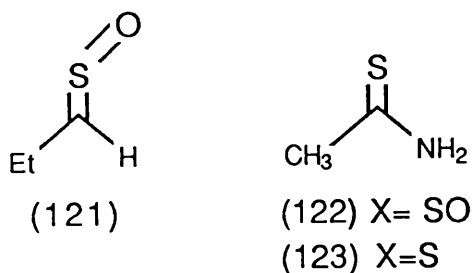

The first synthesis of a thioketone S-oxide was achieved in 1964 when Sheppard and Dieckmann<sup>62</sup> synthesised (113), as already discussed (Scheme 37). An analogous reaction gave the first thioaldehyde S-oxide (124) to be synthesised<sup>62</sup> (Scheme 40).

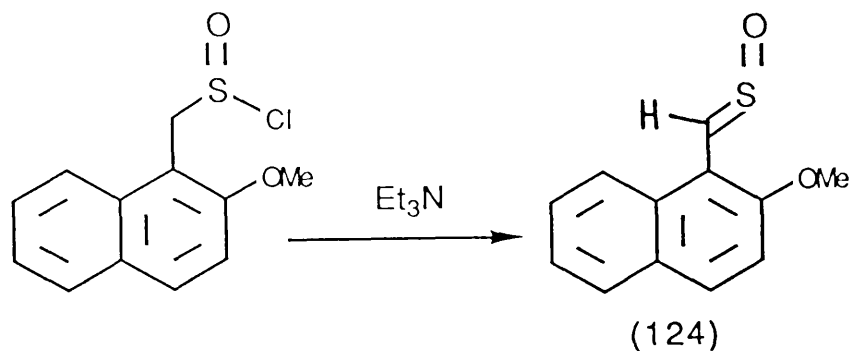

Scheme 40

GENERATION OF SULPHINES BY RETRO-DIELS-ALDER REACTION.

The first generation of a sulphine by the retro-Diels-Alder reaction was achieved by Elsasser and Sundermeyer<sup>70</sup> in 1985. They generated the sulphine (126) quantitatively by heating its anthracene adduct (125) at 180°C (Scheme 41).

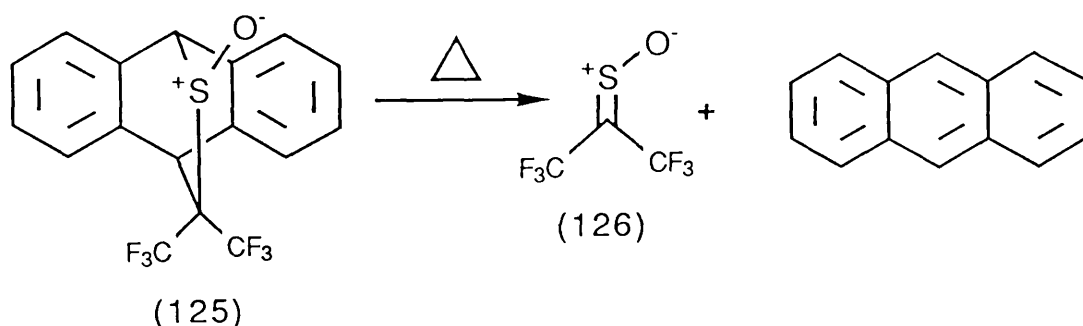

Scheme 41

In 1987 it was shown<sup>61</sup> (Scheme 42) that the trans-anthracene adduct (127) dissociated reversibly at 60°C to liberate the (E)-sulphine (129) and that the cis-anthracene adduct (128) dissociated reversibly at 80°C to liberate the (Z)-sulphine (130). In both cases the released sulphines were trapped in situ with 2,3-dimethyl-1,3-butadiene, in high yields, to give the adducts (131) and (132) with retention of stereochemistry. Only the (E)-sulphine was successfully trapped in situ with cyclopentadiene to give (133) and with thebaine (40) to give (134), both in high yields.

The trans-cyclopentadiene adduct (133) was isomerised with base to the cis-adduct (135). Both of these adducts, on heating, liberated a sulphine, which was trapped in situ by 2,3-dimethyl-1,3-butadiene. The trans-cyclopentadiene adduct (133) gave only the trans-product (131) but the cis-cyclopentadiene adduct gave a mixture of cis- and trans-products (131) and (132).

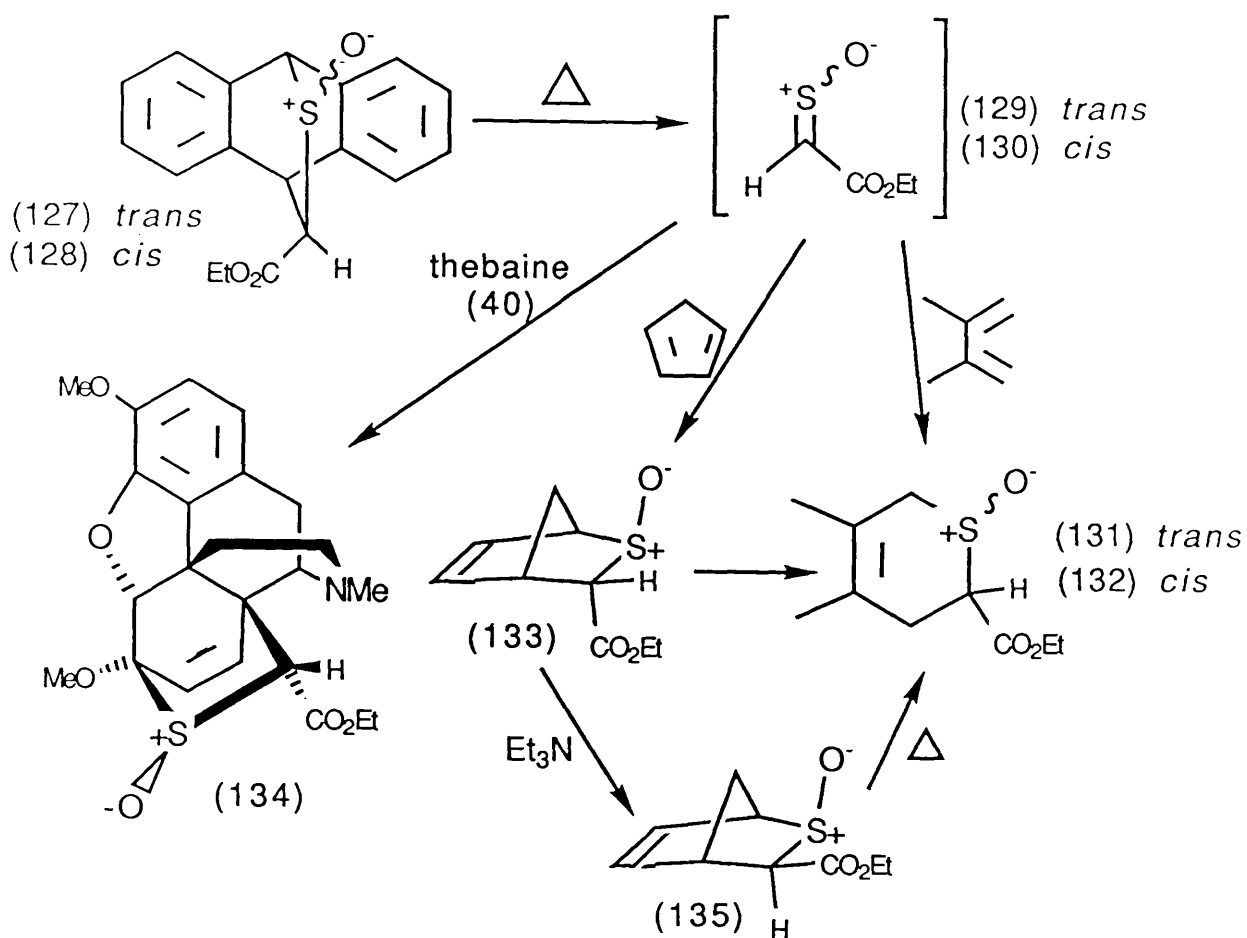

SYNTHESIS OF ANTHRACENE AND CYCLOPENTADIENE ADDUCTS OF SULPHINES.

The anthracene adduct (125) of bis(trifluoromethyl) sulphine (126) was most easily synthesised <sup>7I</sup> (Scheme 43) by the oxidation of the Diels-Alder cycloadduct (136) of hexafluoroacetone with m-chloroperoxybenzoic acid (mCPBA).

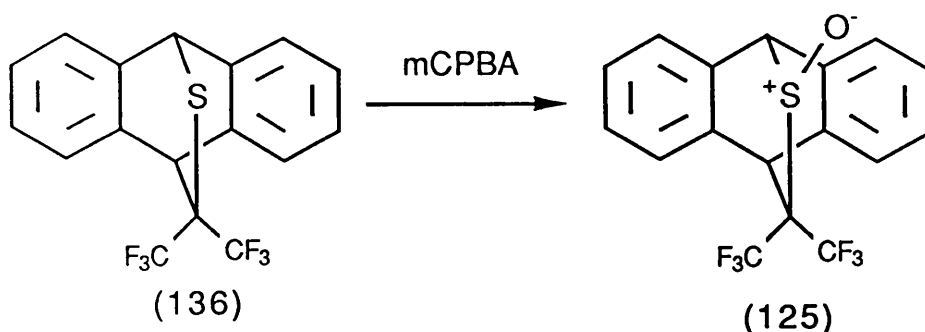

Scheme 43

Similarly the cycloadducts of ethyl thioacetate S-oxides (129) and (130) were synthesised <sup>6I</sup> by oxidation of the corresponding sulphides with mCPBA. The ratios of trans- to cis-oxides are given in Scheme 44. As can be seen trans-S-oxides are generally predominant. However in the cyclopentadiene case, the only reported cyclopentadiene adducts both have the S-O bond exo even though this gives a cis-S-oxide in the case of (135).

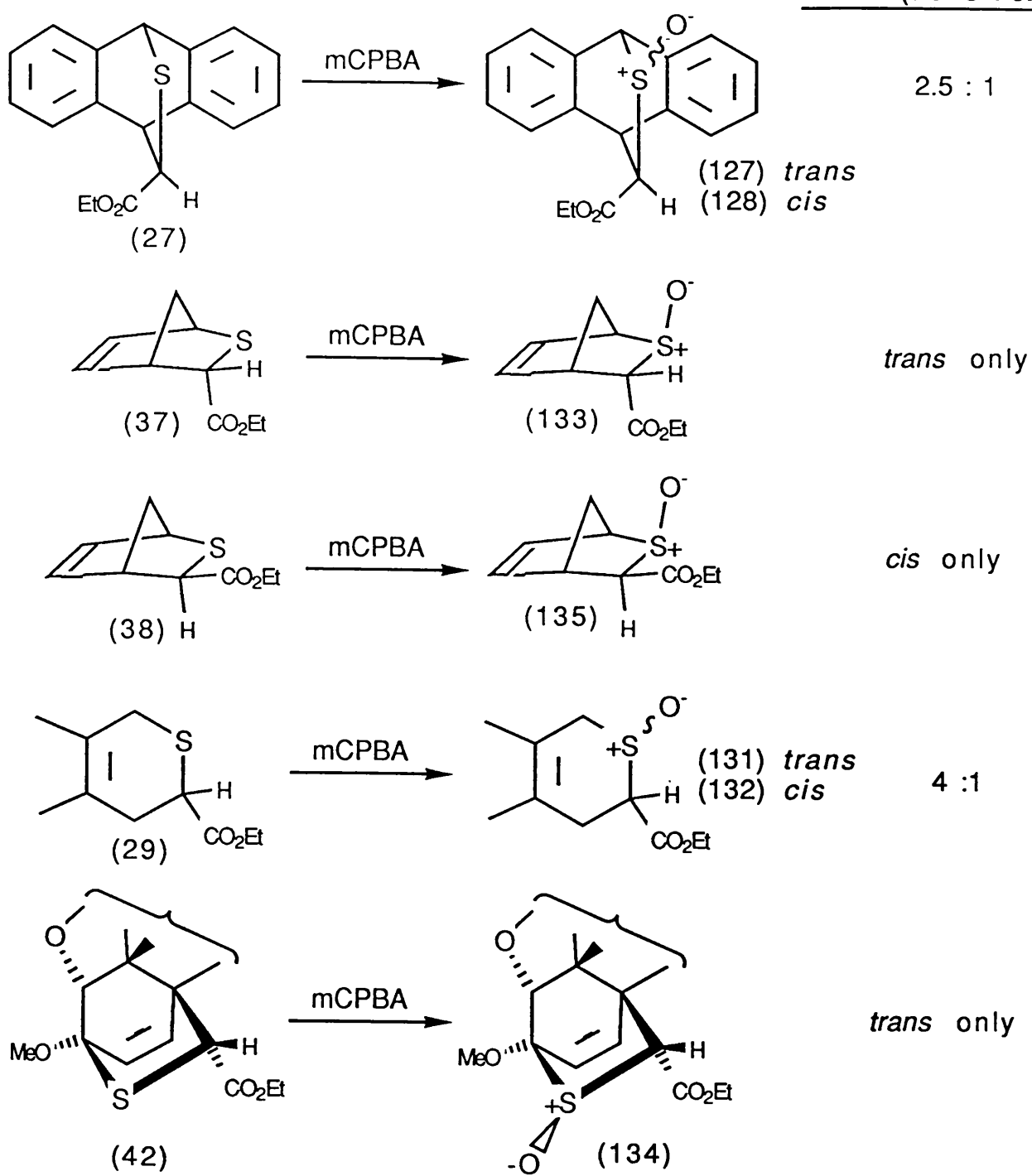

RATIO (trans : cis )

Scheme 44

Similarly, Block and Wall<sup>72</sup> showed that the sulphide (137) gave only the exo-S-oxide (138) when treated with mCPBA (Scheme 45), and that the adduct was stable to prolonged heating and so was useless as a source of (E)-propane sulphine (139). They also showed that (Z)-propane sulphine (140) could be trapped in situ with cyclopentadiene at  $-78^{\circ}\text{C}$  to give the cis-cyclopentadiene adduct (141) with the S-O bond endo. However at  $0^{\circ}\text{C}$  the adduct (141) underwent a [2,3]-sigmatropic rearrangement to give the stable sultene (142) quantitatively.

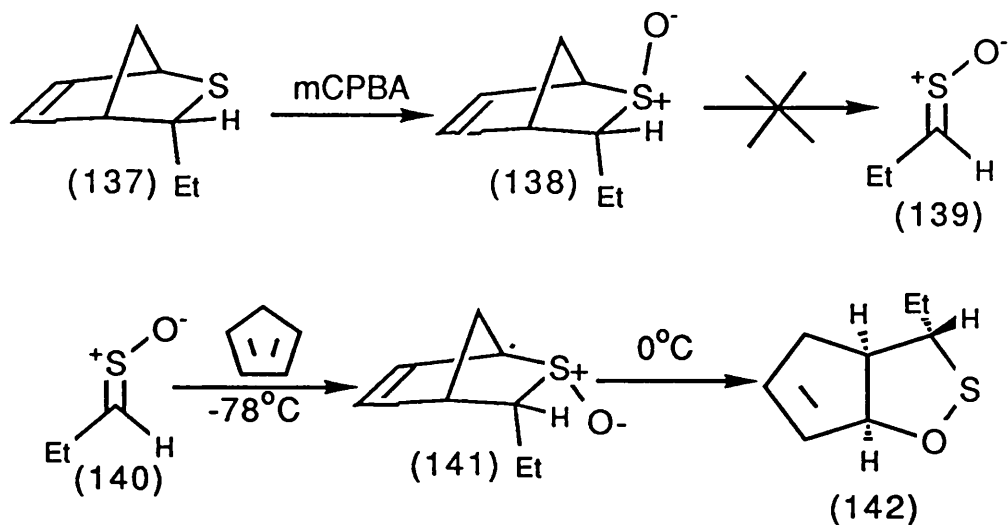

Scheme 45

$\alpha$ -OXOSULPHINES.

$\alpha$ -oxosulphines<sup>5I</sup>, other than those derived from thioamides<sup>56</sup>, are highly reactive species and are usually "trapped" in pericyclic reactions to give stable derivatives. An example illustrating a general route to such species is shown in Scheme 46. The silyl enol ether (143) was treated with thionyl chloride to give the unstable sulphine (144) which was then trapped in situ to give the heterocyclic product (145) by Diels-Alder cycloaddition. The entire reaction sequence was carried out at 20°C or below.

Alternately,  $\alpha$ -oxosulphines can be generated from retro-Diels-Alder reactions of appropriately labile cycloadducts<sup>6I</sup> (Scheme 42).

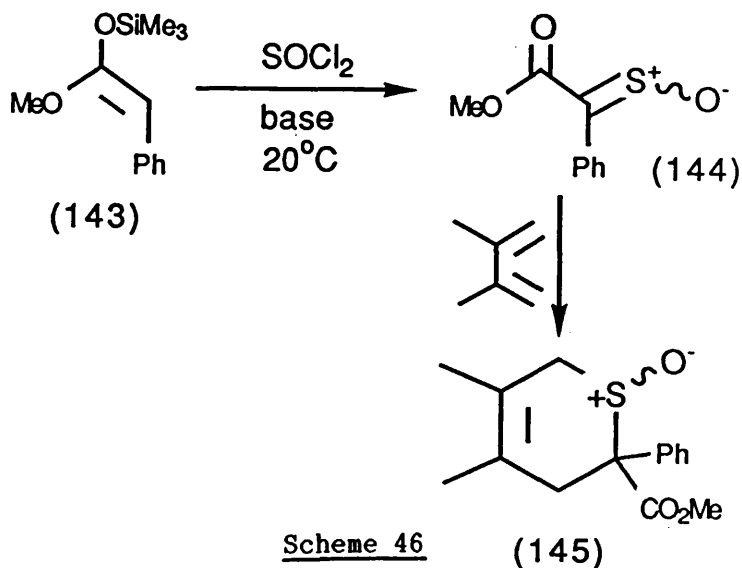

THIOXOMALONATE S-OXIDES.

The electron-withdrawing groups attached to the sulphine residue of thioxomalonates, e.g. (148), considerably destabilises the molecule. For this reason references to thioxomalonate S-oxides are relatively rare in the chemical literature. The first synthesis of a thioxomalonate S-oxide was by Rozendaal and Zwanenburg<sup>55,73</sup> in 1985 (Scheme 47) who treated the silyl enol ether (146) with thionyl chloride to give the desired sulphine (148) which reacted in situ with 2,3-dimethyl-1,3-butadiene to give the S-oxide (149) in 53% yield. Care must be taken to avoid the unwanted side-reaction of the silyl enol ether (146) with the intermediate sulphinyl chloride (147) to give (150).

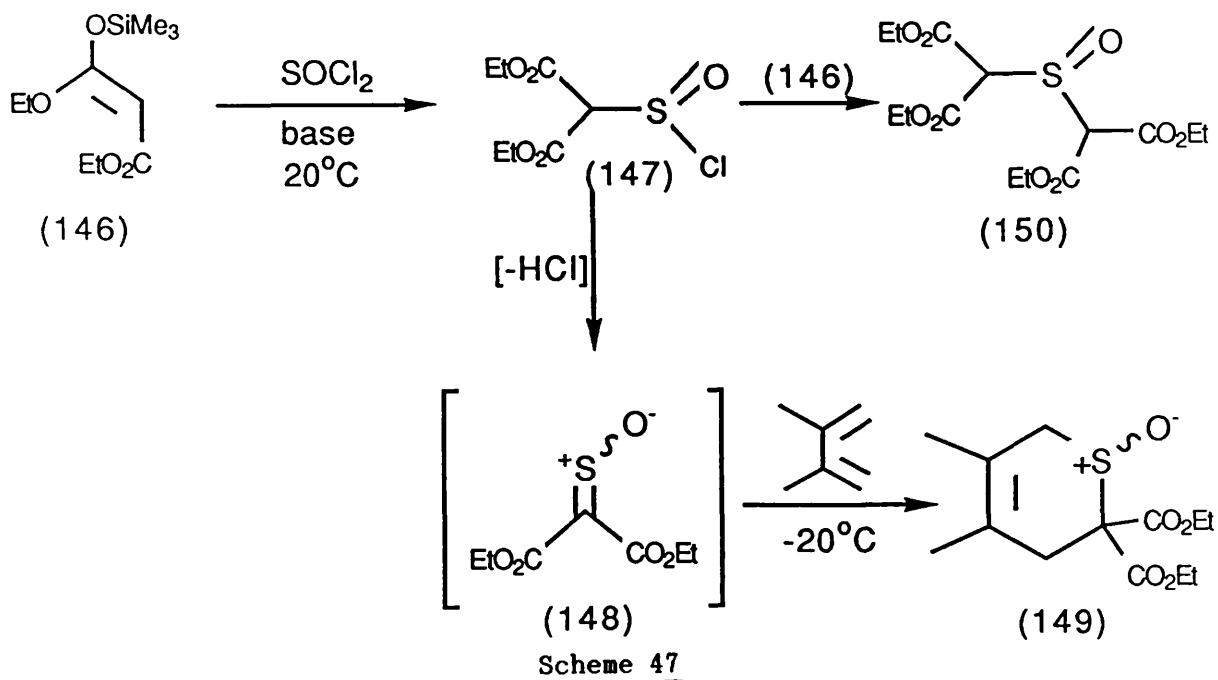

At almost the same time, Saalfrank and Rost<sup>74</sup> published an alternative synthesis of the sulphine (148) from the reaction of the allene (151), a malonic ester dianion equivalent, with thionyl chloride (Scheme 48). The initially formed sulphinyl chloride (152) gave the thioxomalonate S-oxide (148) which was trapped at  $-50^{\circ}\text{C}$  with 2,3-dimethyl-1,3-butadiene to give the sulphoxide (149) in 42% yield.

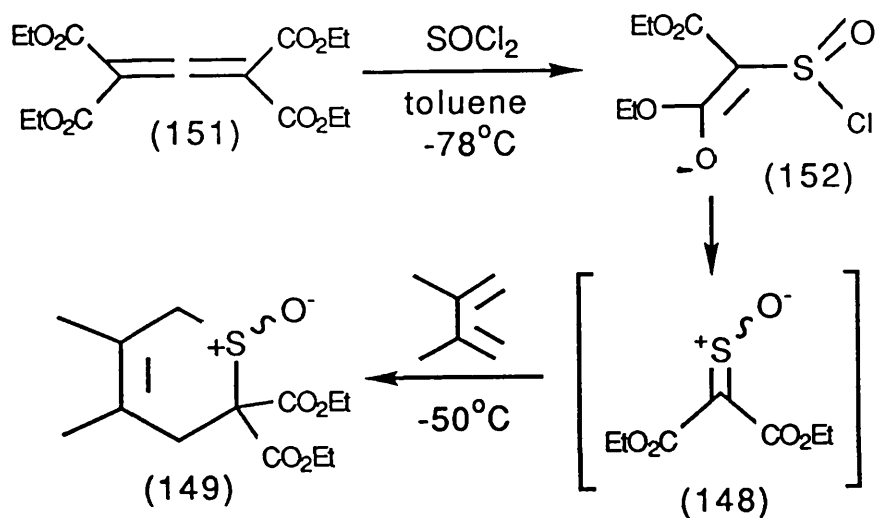

Scheme 48

The most notable byproduct of this reaction was tetraethyl ethene tetracarboxylate (155), which is presumed to be formed (Scheme 49) via the sulphine dimer<sup>75</sup> (153) by elimination of sulphur dioxide to give the episulphide (154), then by loss of sulphur<sup>76</sup> to give the olefin (155) in 31% yield.

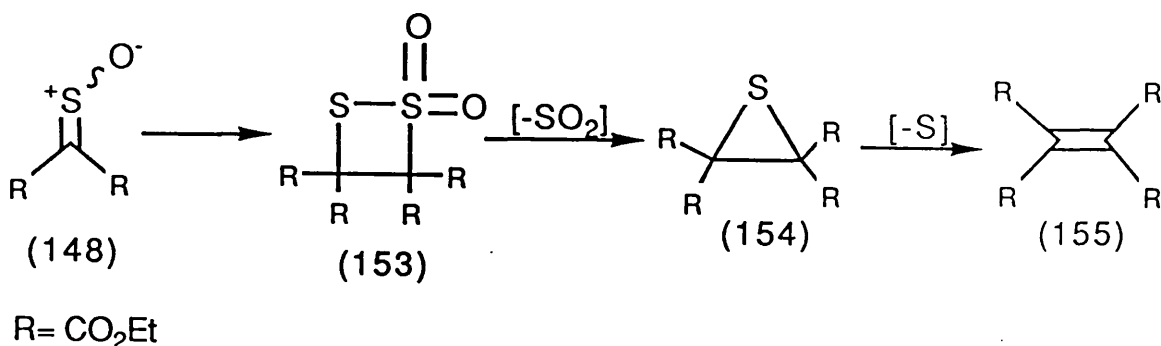

Scheme 49

Supporting evidence for this side-reaction is the thermal decomposition (Scheme 50) of the sulphine (126) to give the alkene<sup>54</sup> (156).

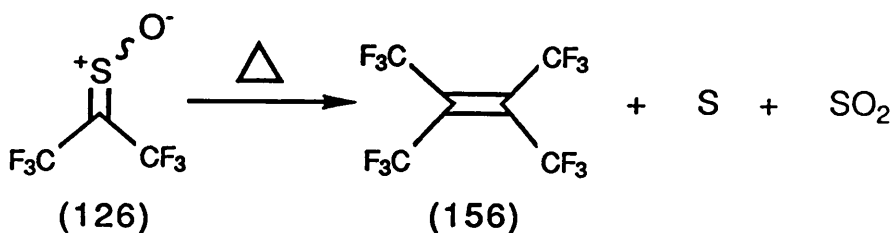

Scheme 50

The heterocycle (47) was also produced as a byproduct, in 22% yield, by reduction of the S-oxide (149). It was suggested by the authors that this reduction was effected by elemental sulphur (produced in Scheme 49) but it seems more likely that the excess of thionyl chloride used is the reducing agent <sup>77</sup> in this case.

## REACTIONS OF SULPHINES.

Most of the studies on sulphine chemistry have been conducted on stable sulphines <sup>51-55</sup> and, in general, the reactions of sulphines are quite markedly different from those of the corresponding thiocarbonyl compounds. A characteristic reaction of many sulphines (106) is the loss of elemental sulphur (Scheme 51) to give ketones <sup>53</sup> (158), presumably via the oxathirane (157). This contrasts with the decomposition shown in Schemes 49 and 50 to give olefins which is the preferred mode of decomposition of sulphines with electron-withdrawing groups.

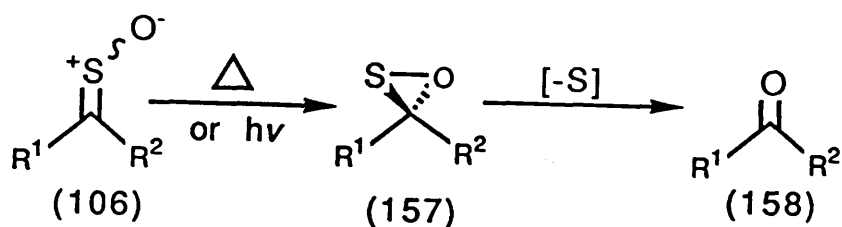
Scheme 51



Other common reactions of sulphines (106) include their reduction to thiocarbonyl compounds (107) with either  $P_2S_5$  or  $PSBr_3$  <sup>78</sup> (Scheme 52).

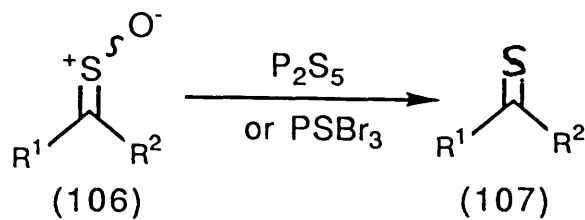

Scheme 52

(a) REACTIONS OF SULPHINES WITH NUCLEOPHILES.

Attack at sulphur (Scheme 53) is usual in reactions of sulphines (106) with nucleophiles. For example, aryl- and alkyl- lithium reagents react with sulphines to give carbanions (159), which can be quenched with water to give sulphoxides (160) in high yields<sup>78,79</sup>. Reactions of sulphines with an electrophile ( $E^+$ ) give products substituted at carbon<sup>80</sup> (161).

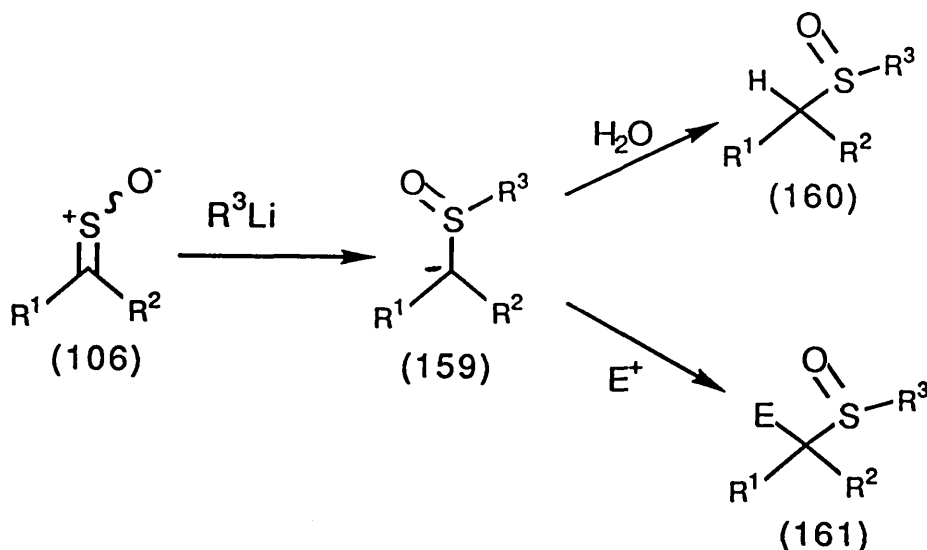
Scheme 53

Much less common are reactions involving nucleophilic attack at the sulphine carbon. One such reaction is the hydrolysis of sulphines (106) (Scheme 54). Protonation of the sulphine sulphur atom (under acidic conditions) is followed by nucleophilic attack at carbon by water to give

a ketone<sup>53</sup> (158). Alternatively, for sulphines with an electron-withdrawing group (162) a reduction product is obtained, under neutral conditions, by nucleophilic attack by water at carbon and subsequent expulsion of sulphur dioxide to give a product containing a methylene group<sup>55</sup> (163).

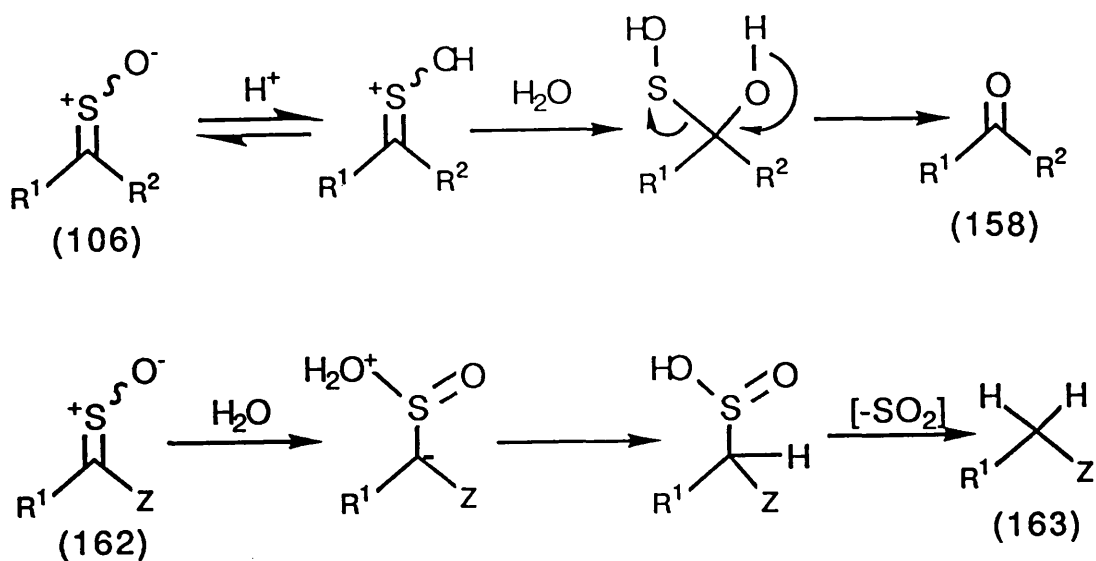

Z = electron-withdrawing group

Scheme 54

(b)

REACTIONS WITH CONJUGATED DIENES.

Because sulphines can exist as Z and E geometric isomers<sup>50</sup> the stereochemistry of their cycloadditions is of particular interest. With 2,3-dimethyl-1,3-butadiene as the 4 $\pi$ - component (Scheme 55), it is observed that the stereochemistry of the sulphine (106) is predominately retained<sup>81</sup> in the Diels-Alder cycloadduct (164). Electron-withdrawing groups enhance the reactivity, and sterically bulky groups retard the reactivity, of sulphines in Diels-Alder reactions<sup>53</sup>.

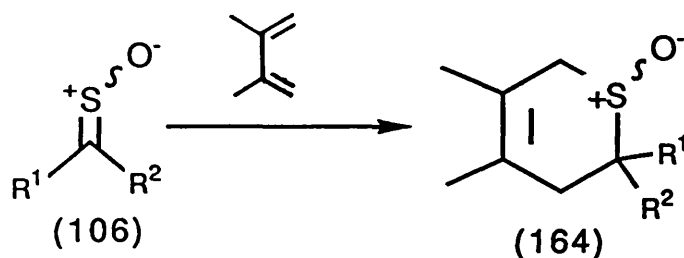
Scheme 55

Regioselectivity of Diels-Alder Reactions Involving Sulphines.

Calculations on sulphines<sup>82</sup> indicate that they are best represented as zwitterions (148) with a positive charge on sulphur and a negative charge on oxygen. If it is then assumed that the orbital coefficients on the sulphur are reduced by the presence of a positive charge, it becomes very difficult to make predictions about the relative magnitudes of the C,S and O coefficients in the  $\pi$ -system. In particular, calculations<sup>83</sup> indicate that the LUMO coefficients of sulphines are very similar in magnitude over the three atoms. Thus it is difficult to apply elementary frontier molecular orbital theory to the cycloaddition reactions of sulphines in order to predict the regiochemistry of Diels-Alder reactions involving asymmetric dienes.

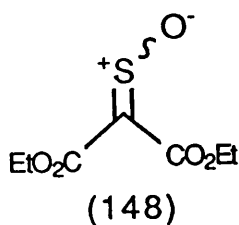

One example of such a cycloaddition is the reaction of dichlorosulphine (165) with 2-(trimethylsiloxy)-1,3-butadiene (Scheme 56) to give the adducts (166) and (168), which are readily hydrolysed to (167) and (169).<sup>53</sup> The major product was shown to be (169).

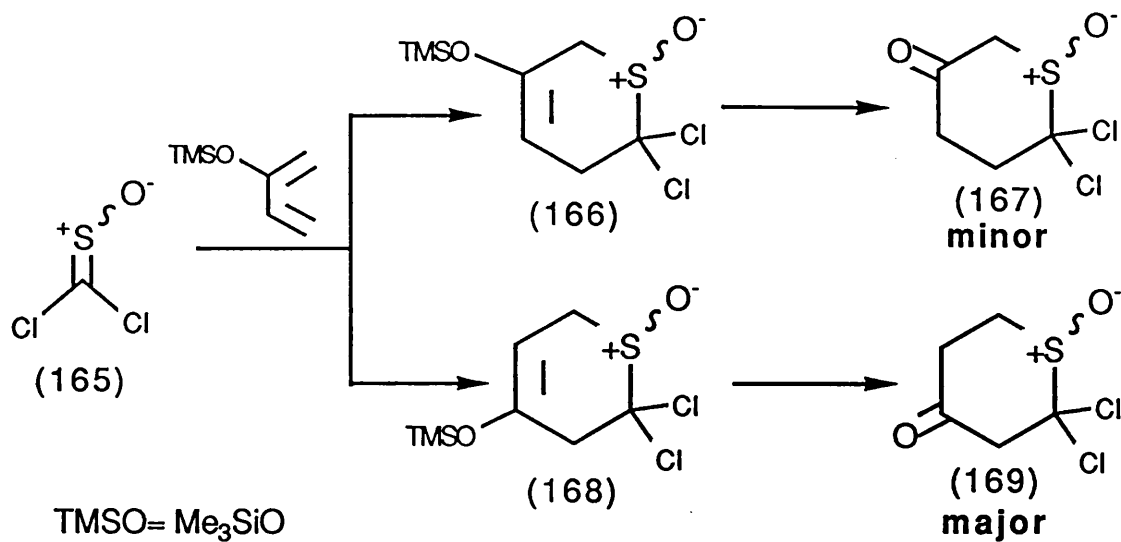

Scheme 56

(c)

REACTIONS WITH MONO-OLEFINS.

Sulphines with an  $\alpha$ -oxo group can act as the  $4\pi$ - component in [4+2]-cycloaddition reactions with electron-rich olefins<sup>77</sup>. For example, (Scheme 57) ethyl vinyl ether reacted with the sulphine (170), which is stabilised by delocalisation, to give the sulphoxide (171) in good yield.

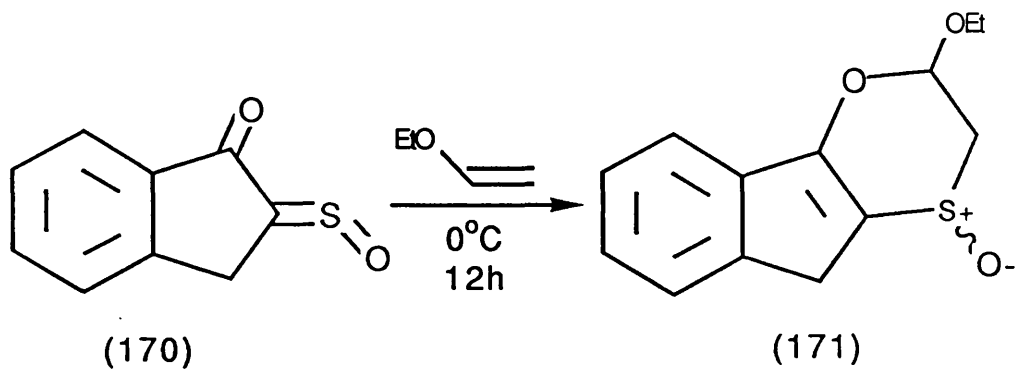
Scheme 57

## DISCUSSION



## SYNTHESIS OF THE CYCLOADDUCTS OF DIETHYL THIOXOMALONATE S-OXIDE (148).

The chemistry of diethyl thioxomalonate S-oxide (148) has not been extensively studied, despite the synthetic flexibility associated with malonate systems.

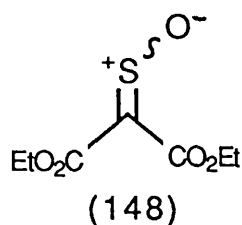

It is, of course, highly reactive because the two electron-withdrawing groups considerably destabilise the sulphine system. The synthesis of (148) has, however, been made both by 1,2-dehydrochlorination of a sulphonyl chloride<sup>74</sup>, and also from a silyl enol ether<sup>73</sup>, both of which are well documented general routes<sup>51-55</sup> for making sulphines. Moreover, it was desirable to produce a convenient labile precursor which would allow the sulphine (148) to be generated, reversibly, in situ under neutral conditions.

The projected labile adducts of the sulphine (148) were quantitatively synthesised, in the first instance, not by cycloadditions involving (148), but by oxidation, at room temperature, of the corresponding adducts (95) and (93) of diethyl thioxomalonate (46) (Scheme 58). The adduct (149), a non-labile

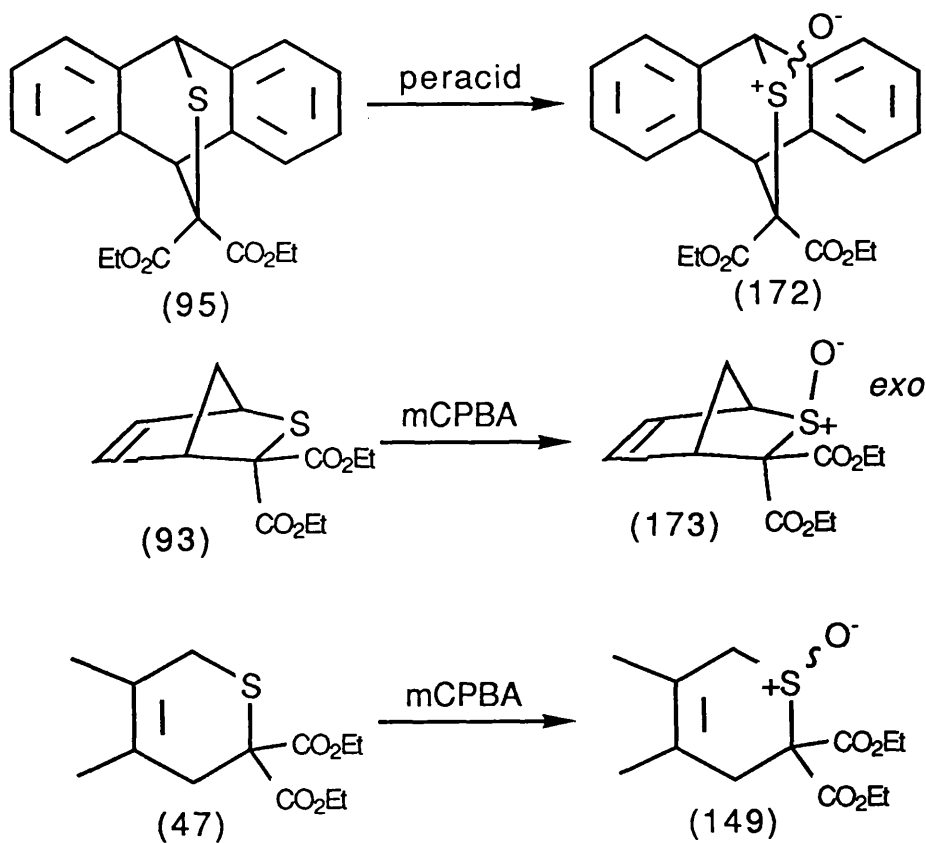

product of trapping (148) with 2,3-dimethyl-1,3-butadiene, was synthesised likewise.<sup>73,74</sup>



Scheme 58

In each case only a single product was obtained. In the cyclopentadiene case, oxidation of (93) could potentially give two products, either or both of the *exo*- and *endo*-S-oxides. However, only the *exo*-S-oxide was produced, which is analogous to various

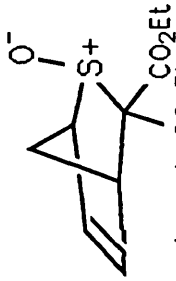
Table 3.  $^1\text{H}$  n.m.r. data for the *exo*-cyclopentadiene adduct (173) and related adducts (133) and (135). [ $\delta$  ( $\text{CDCl}_3$ )]

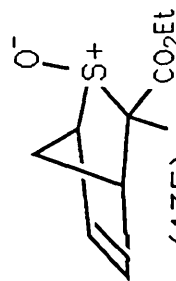
Compound	 (173) $\text{CO}_2\text{Et}$ $\text{CO}_2\text{Et}$	 (133) $\text{CO}_2\text{Et}$ $\text{H}$ <i>endo</i>	 (135) $\text{H}$ $\text{CO}_2\text{Et}$ <i>exo</i>
Nucleus			
7- $\text{H}_a$	2.35(dt, J 12.2Hz)	2.26(dt, J 11.3Hz)	2.28(dq, J 11, ca. 2Hz)
7- $\text{H}_b$	3.04(d, J 12Hz)	2.51(d, J 11Hz)	2.86(d, J 11Hz)
$\Delta(\delta\text{H}_a - \delta\text{H}_b)$	0.69	0.25	0.58

literature reports<sup>61,72</sup> where exo-S-oxidation of cyclopentadiene adducts was found to be preferred. It is difficult to say why this is the case, but exo-adducts of cyclopentadiene are generally thermodynamically preferred, and so steric control of the oxidation would seem to be operating.

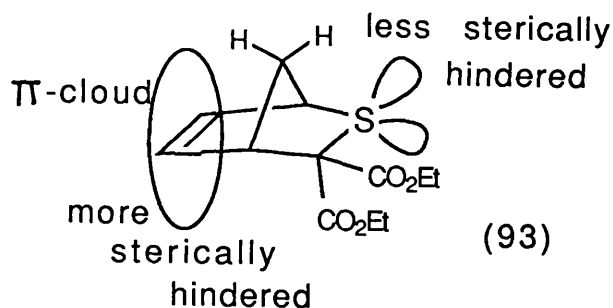

The stereochemistry of (173) was assigned as an exo-S-oxide by comparison of the <sup>1</sup>H n.m.r. with reference compounds (Table 3). The 7-H<sub>2</sub> was most informative. Note particularly the large separations (0.58 and 0.69) between the 7-H<sub>a</sub> and -H<sub>b</sub> signals in (135) and (173). If the S-O bond in (173) were endo this separation would be much smaller (cf. (133) where the endo-ethoxycarbonyl group gives a small  $\Delta(\delta H_a - \delta H_b)$  for the 7-H<sub>2</sub> ).

The cyclopentadiene adduct (93) and the 2,3-dimethyl-1,3-butadiene adduct (47) were both repeatably oxidised with m-chloroperoxybenzoic acid (mCPBA) in dichloromethane to give the S-oxides (173) and (149) quantitatively. However,

oxidation of the anthracene adduct (95) proved to be more erratic.

Although the anthracene adduct (95) was successfully oxidised to the S-oxide (172) with mCPBA in dichloromethane at room temperature, this reaction eventually proved to be irreproducible. This coincided with renewing the supply of mCPBA. Neither washing the mCPBA with a phosphate buffer<sup>84</sup>, nor titrating it to take account of its percentage purity (ca. 70-80% w/w), facilitated the repeated oxidation of (95). Curiously, this new batch of mCPBA did successfully oxidise the cyclopentadiene adduct (93).

This problem was eventually circumvented by changing the peracid used. Instead of mCPBA, a solution of peracetic acid (ca. 30% w/w) was used to oxidise the anthracene adduct (95). Although this reaction was, for a time, successful using dichloromethane as a solvent, again on renewing the supply of the peracid, attempts to reproduce previous oxidations failed. Distillation of the peracid and titration of the distillate failed to eliminate this problem. Inexplicably, when the solvent was changed from distilled dichloromethane to distilled diethyl ether, the S-oxidation of (95) with peracetic acid (distilled) proceeded successfully and has since proven consistently reproducible.

## GENERATION OF (148) BY RETRO-DIELS-ALDER REACTION.

(a) TRAPPING THE SULPHINE (148) WITH 2,3-DIMETHYL-1,3-BUTADIENE.

Both the anthracene adduct (172) and the cyclopentadiene adduct (173) dissociated when heated to liberate the sulphine (148), reversibly, which was trapped in situ with 2,3-dimethyl-1,3-butadiene (Scheme 59) to give the cycloadduct (149). As would be expected from the behaviour of the S-oxides of ethyl thioacetate adducts (Scheme 42), the anthracene adduct (172) dissociated faster than the cyclopentadiene adduct (173), the former dissociating in refluxing benzene (80°C) and the latter in refluxing toluene (111°C). A small amount (ca.5%) of the sultene (174) was also produced in the reaction from (173). The mechanism by which this was produced will be discussed in the following section (Scheme 61).

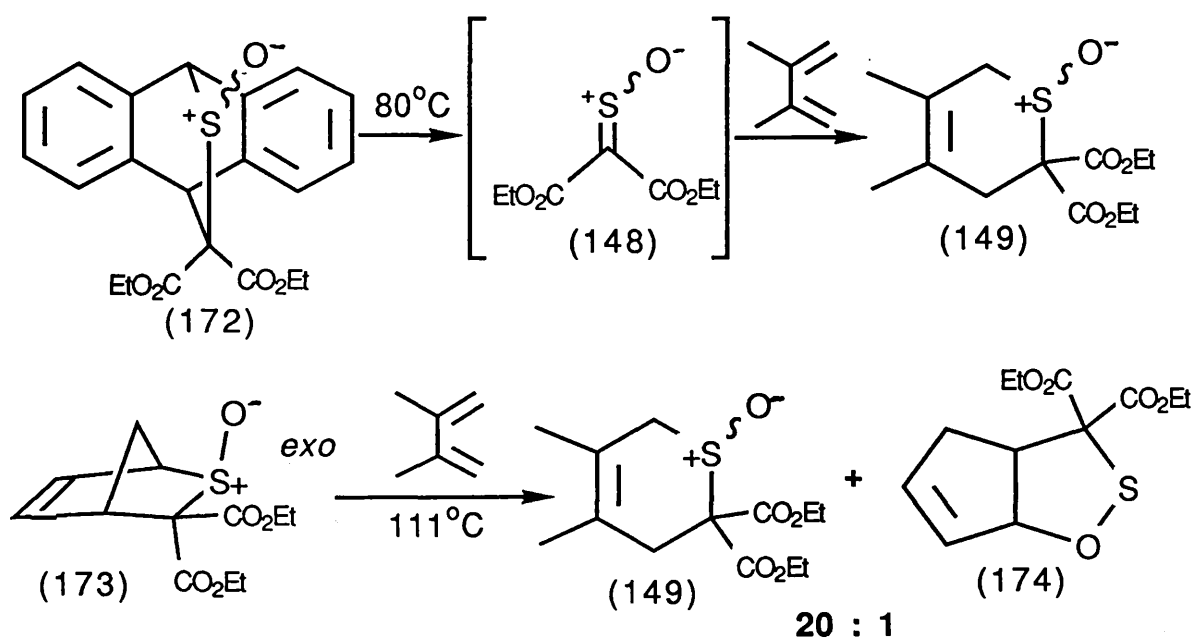

Scheme 59

(b) TRAPPING THE SULPHINE (148) WITH CYCLOPENTADIENE.

The anthracene adduct (172) liberated the sulphine (148), in refluxing benzene, which was quantitatively transferred over 1h to cyclopentadiene (5 mol. equiv.) to give a 2:1 mixture of products (Scheme 60). The product ratio was determined by  $^1\text{H}$  n.m.r. spectroscopy at 200MHz and the products determined to be the exo-cyclopentadiene adduct (173) (major product) and the sultene (174) (minor product). The sultene is presumably produced by a [2,3]-sigmatropic rearrangement of the endo-cyclopentadiene adduct (175) (not detected) as shown in Scheme 61. When (173) was heated in refluxing benzene with excess 2,3-dimethyl-1,3-butadiene for 1h, no (149) was formed indicating that the exo-cyclopentadiene adduct (173) is stable in refluxing benzene. It is not known whether the endo-cyclopentadiene adduct (175) dissociates at this temperature or simply rearranges. In refluxing toluene, heating (172) with 2,3-dimethyl-1,3-butadiene (5 mol. equiv.) gave only the sultene (174) (Scheme 60).

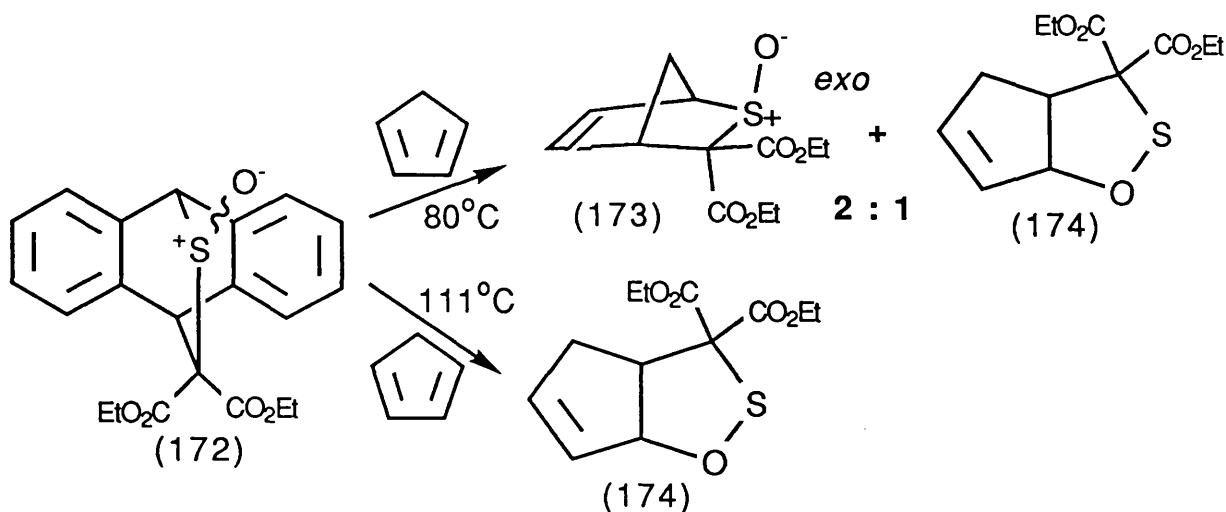

Scheme 60

The cyclopentadiene adduct (173) on heating in refluxing toluene, over 1h, gave the sultene (174) quantitatively. Presumably, this involves generation of the sulphine (148), which could be trapped by liberated cyclopentadiene to give either the exo- or endo-adducts. The endo-adduct (175) then could undergo a [2,3]-sigmatropic rearrangement<sup>72</sup> (Scheme 61) to give the stable sultene (174). This thermodynamic "potential well" means that an equilibrium mixture of exo- and endo- adducts cannot be reached, and that eventually all the exo-adduct (173) would be converted to the isomeric sultene (174). It is not known whether the endo-adduct dissociates at these temperatures, nor whether a 1,3-dipolar cycloaddition<sup>77</sup> of the sulphine (148) to one double bond of cyclopentadiene is involved as an alternative route to (174).

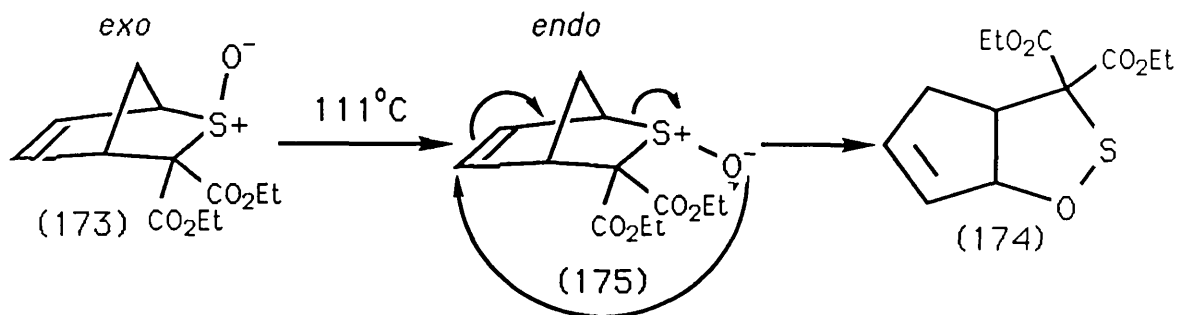

Scheme 61(c) COMPETITION EXPERIMENT.

The anthracene adduct (172), cyclopentadiene (3 mol. equiv.) and 2,3-dimethyl-1,3-butadiene (3 mol. equiv.) were heated at 80°C in refluxing benzene. This gave, after 1h, a mixture identical to that of the transfer at 80°C, shown in Scheme 60. That is, a 2:1 mixture of (173) and (174) was produced. None of the 2,3-dimethyl-1,3-butadiene adduct (149) was detected, as expected since cyclopentadiene is typically two orders of magnitude more reactive than 2,3-dimethyl-1,3-butadiene<sup>45</sup>.

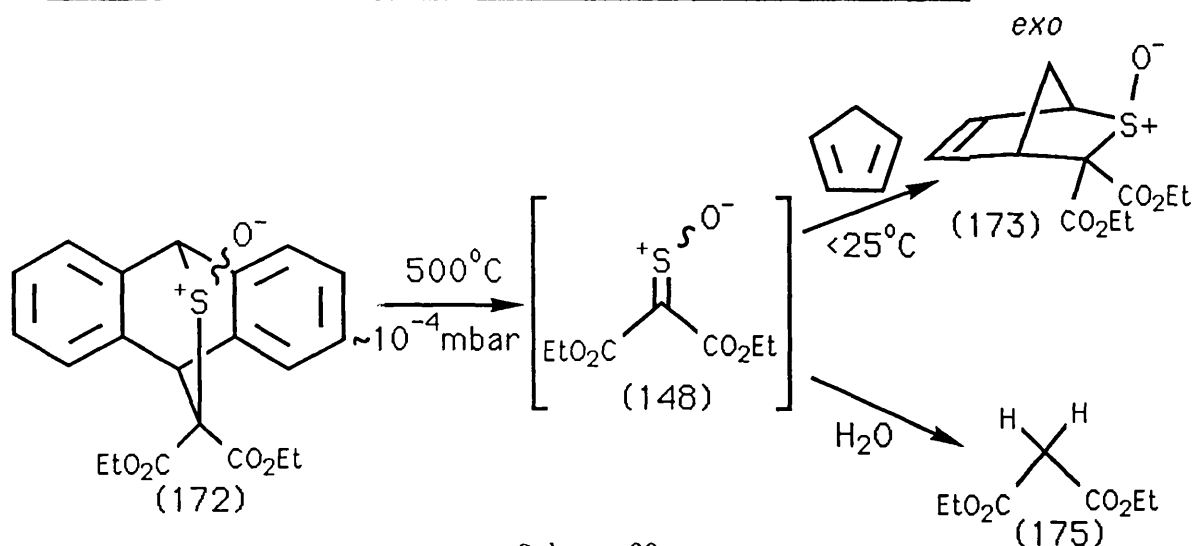
(d) FLASH VACUUM PYROLYSIS OF THE ANTHRACENE ADDUCT (172).Scheme 62

The anthracene adduct (172) (1 mol. equiv.), deposited onto powdered, anhydrous magnesium sulphate by evaporation of a solution in dichloromethane, was sublimed under high vacuum (160°C at ca. 10<sup>-4</sup> mbar) and allowed to pass through a quartz tube heated to 500°C. The adduct presumably dissociated in the hot tube, to give the sulphine (148) and anthracene. The latter was observed to solidify on the walls of the tube immediately after the oven, effectively separating it from the free sulphine (148), which was condensed in a cold trap (liquid-nitrogen temperature)

i) Reacting (148) with cyclopentadiene.

In the first experiment, cyclopentadiene (10 mol. equiv.) was condensed in the cold trap prior to generating the sulphine. Thus the sulphine was caught in the cold trap on a deposit of cyclopentadiene. The mixture was allowed to warm up to room temperature under a nitrogen atmosphere, and was dissolved in dichloromethane with more cyclopentadiene (10 mol. equiv.) for work-up. This experiment gave a mixture of products, the major product being the exo-cyclopentadiene adduct (173) in 47% yield. No endo-adduct was detected by  $^1\text{H}$  n.m.r. ; however an unknown byproduct(s) was observed and will be discussed shortly (p90).

ii) Reacting (148) with water.

Water (20 mol. equiv.) was frozen in the cold trap prior to trapping of the sulphine. The mixture was dissolved in dichloromethane and worked-up to give diethyl malonate (175) as the major product, identified by  $^1\text{H}$  and  $^{13}\text{C}$  n.m.r. spectroscopy, in a ratio of 3:2 with the byproduct(s) as in i) (ratio calculated from integration of the carboxyethyl signals in the  $^1\text{H}$  n.m.r.). No tetraethyl ethylenetetra-carboxylate (155) was detected (using an authentic reference sample of (155)<sup>74</sup>). Elemental sulphur was, however, detected on t.l.c. This will be discussed shortly.

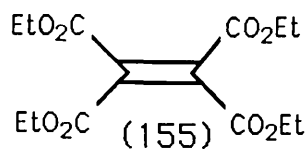

iii) Warming (148) to room temperature alone.

The sulphine (148) was caught in an empty, dry cold trap and allowed to warm to room temperature under a nitrogen atmosphere. This experiment gave some diethyl malonate (175) (from traces of moisture) and also the unknown byproduct(s) already mentioned in a ratio of 2:3 (calculated from integration of the carboxyethyl signals in the  $^1\text{H}$  n.m.r.). Again no tetraethyl ethylenetetracarboxylate (155) was detected. Elemental sulphur was, however, detected on t.l.c.

#### Comments.

The observation that none of the endo-cyclopentadiene adduct (175) was detected, indicates a strong kinetic preference for exo addition of diethyl thioxomalonate S-oxide (148) to cyclopentadiene. This can be explained by addition of the sulphine

(148) to cyclopentadiene in the preferred conformation shown in Scheme 63. It is assumed that for a fast pericyclic reaction, the sulphine group and one of the ester carbonyl groups should be coplanar (for maximum overlap of p-orbitals). Because of steric repulsion between the sulphine oxygen and an ester group, the trans ester carbonyl group will be coplanar with, and the cis ester group orthogonal to, the sulphine group.

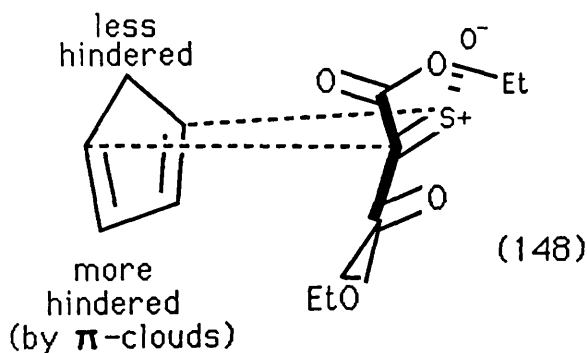

Scheme 63

The trans ester group should then be endo in the transition state, as is usual in Diels-Alder reactions. Moreover, exo approach of the orthogonal ester group might be favoured on steric grounds, since in general exo cycloadducts are more stable thermodynamically than the corresponding, kinetically favoured, endo adducts.

However, the ratio of the exo- (173) and endo- (175) cyclopentadiene adducts formed at 80°C in refluxing benzene was ca.2:1 ( the endo-adduct (175) was isolated as its rearrangement product (174) ). Also, the exo-adduct (173) was stable on heating at this temperature. This means that the relative rates of exo and endo cycloaddition must change with temperature (this is true even if some of the endo-adduct (175) is converted into the exo-isomer (173) before it can isomerise to the sultene (174) ). This would happen if the rate of endo addition changed more rapidly with temperature than that of the exo addition. That is, if the endo addition had the greater Arrhenius activation energy,  $E_a$ .

$$\ln k = -\frac{E_a}{RT} + \text{constant}$$

$$\therefore \frac{d \ln k}{dT} = \frac{E_a}{RT^2}$$

$k$  = rate constant

$E_a$  = activation energy

$R$  = universal gas constant

$T$  = temperature (K)

Table 4 : Some Mass Spectral Data for the Unknown Pyrolysis Product  
Derived from the Sulphine (148).

measured $m/z$	possible formula	calculated mass	possible structure
382.0751	$C_{14}H_{22}O_8S_2$	382.0805	(178)
380.0604	$C_{14}H_{20}O_8S_2$	380.0557	(176)
368.1134	$C_{14}H_{24}O_9S$	368.1205	(180)
350.1045	$C_{14}H_{22}O_8S$	350.0945	(179)
336.0284	$^{12}C_{12}^{13}CH_{15}O_7S_2$	336.0372	(177)

Less easily resolved is the structure of the aforementioned byproduct(s) formed by flash vacuum pyrolysis of (172). This pyrolysis product was presumably derived from the sulphine (148), and was presumably polymeric. The  $^1\text{H}$  n.m.r. spectra of the various samples from these experiments showed only broad signals due to ethoxycarbonyl groups. The  $^{13}\text{C}$  n.m.r. spectra showed signals for an ethoxycarbonyl group overlapping with those of diethyl malonate. Any signals arising from quaternary carbons were too weak to be positively identified (the sample was small). The high resolution EI mass spectrum did, however, prove most informative (Table 4).

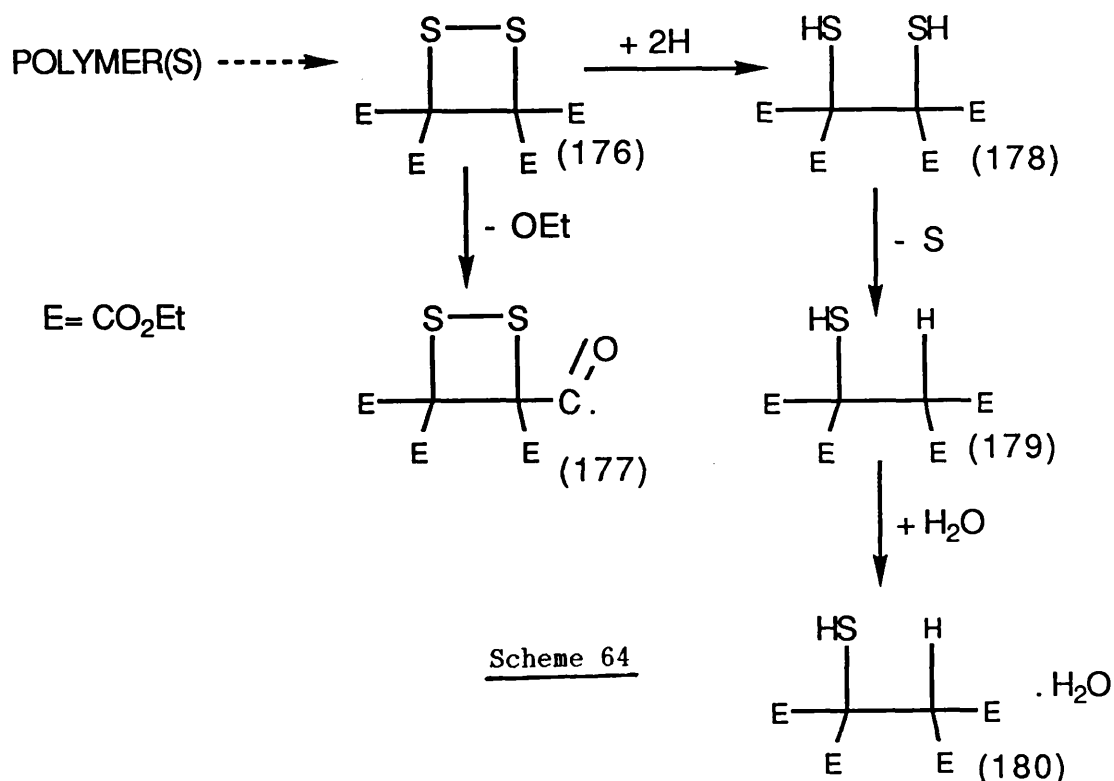



The mass spectral peaks in Table 4 are those of the highest  $m/z$  values and it is suggested that they arise due to the decomposition of a polymer forming all or part of the unknown pyrolysis product(s) (a possible decomposition route is shown in Scheme 64). However, the detection of elemental sulphur on t.l.c. indicates that loss of sulphur has occurred and it may be that the unknown product(s) are a mixture of oligomeric/polymeric material and decomposed oligomer/polymer. Note however that decomposition by the route suggested in Scheme 49 could not have taken place as no (155) was detected <sup>74</sup> .

Graph 3. Determination of rate constant ( $k$ ) of dissociation of the anthracene adduct (172) of diethyl thioxomalonate  $S$ -oxide (148) at  $60^\circ\text{C}$  from the slope of  $\ln(A-A_t)$  against time.

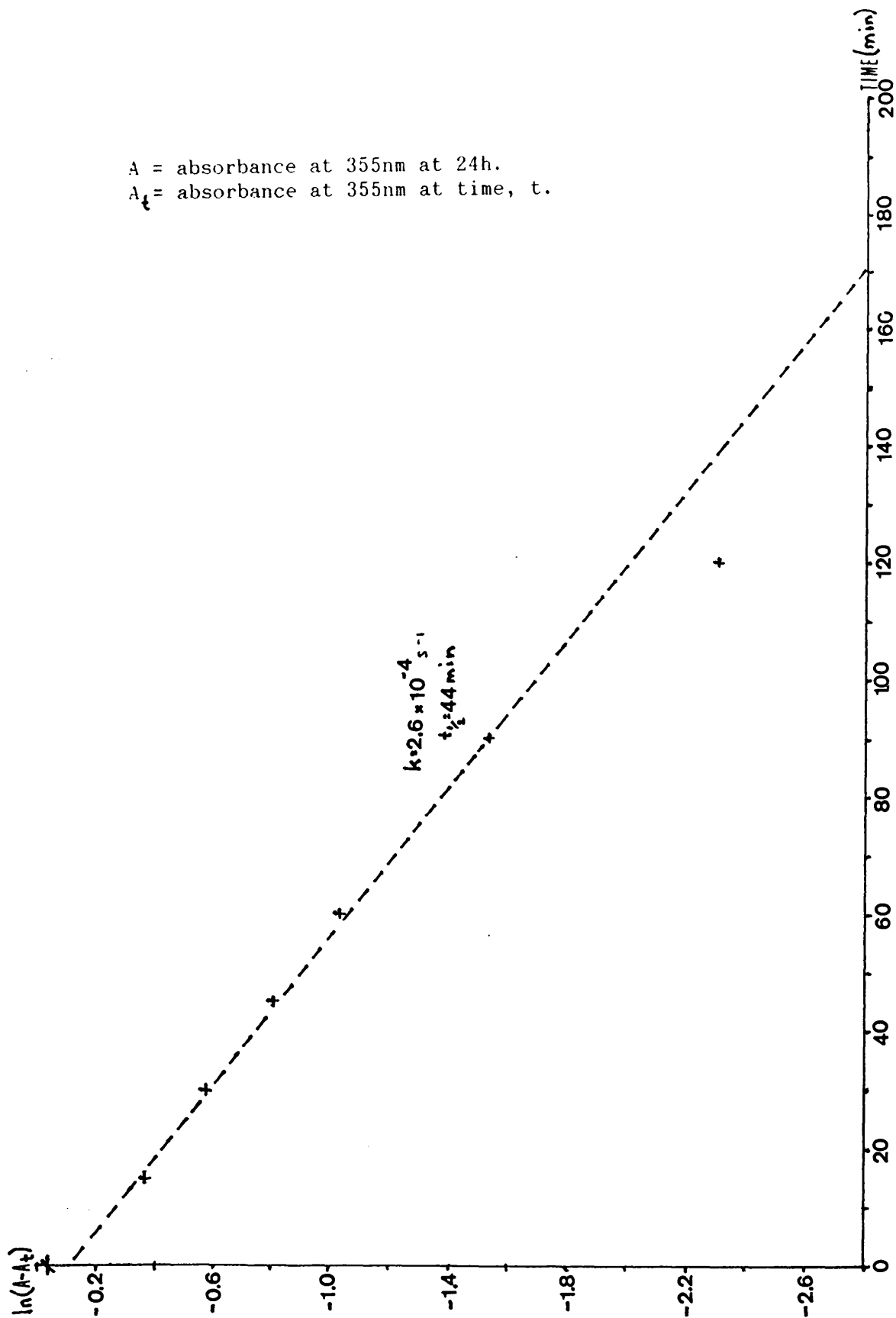

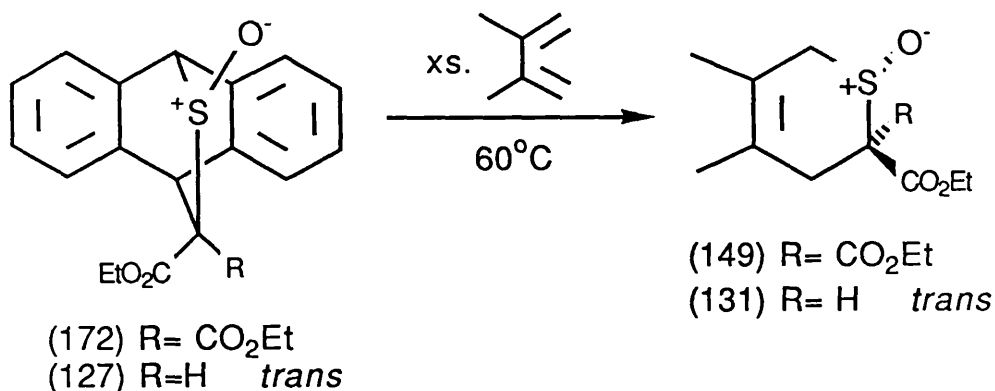
(e) RATES OF DISSOCIATION OF THE ANTHRACENE ADDUCTS (127) AND (172).Scheme 65

The transfer reaction of the sulphine (148), generated at 80°C from the anthracene adduct (172) and transferred to 2,3-dimethyl-1,3-butadiene to give (149) has already been discussed (Scheme 59). This reaction was also studied at 60°C in benzene using a tenfold excess of 2,3-dimethyl-1,3-butadiene (Scheme 65). The kinetics of this reaction were measured (as for the corresponding thione (46) transfer - p42) by following the increase in an anthracene u.v. absorbance (355.0nm) with time at 60 ± 1°C, in a water bath equipped with a thermostatic water heater and mixer, and removing aliquots at specific time intervals. Thus the reaction was shown to be approximately first order (Graph 3) with a measured rate constant as shown in Table 5. This compares with

the rate of the corresponding "transfer" reaction of ethyl thioacetate (E)-S-oxide (129) from anthracene to 2,3-dimethyl-1,3-butadiene at 60°C (Scheme 65) to give (131) which was also shown<sup>61</sup> to be approximately first order. The latter reaction was approximately half as fast as the former (Table 5).

This means the reaction is unimolecular (cf. p42) and also the faster rate reflects the greater reactivity associated with two electron-withdrawing groups on the sulphine (cf. p77).

Table 5. Dissociation rates ( $k$ ) of the anthracene adducts, (127) and (172), of ethyl thioacetate (E)-S-oxide (129) and diethyl thioxomalonate S-oxide (148), at 60°C in benzene.

Sulphine	$k$ (s <sup>-1</sup> )	$t_{1/2}$ (min)
a Ethyl thioacetate ( <u>E</u> )- <u>S</u> -oxide (129)	$2.82 \times 10^{-4}$	41
Diethyl thioxomalonate <u>S</u> -oxide (148)	$1.53 \times 10^{-4}$	76

Note

a Using only 2 mol. equiv. of 2,3-dimethyl-1,3-butadiene.<sup>61</sup>

(f) REGIOSELECTIVITY OF DIELS-ALDER REACTIONS INVOLVING DIETHYL THIOXOMALONATE S-OXIDE (148).

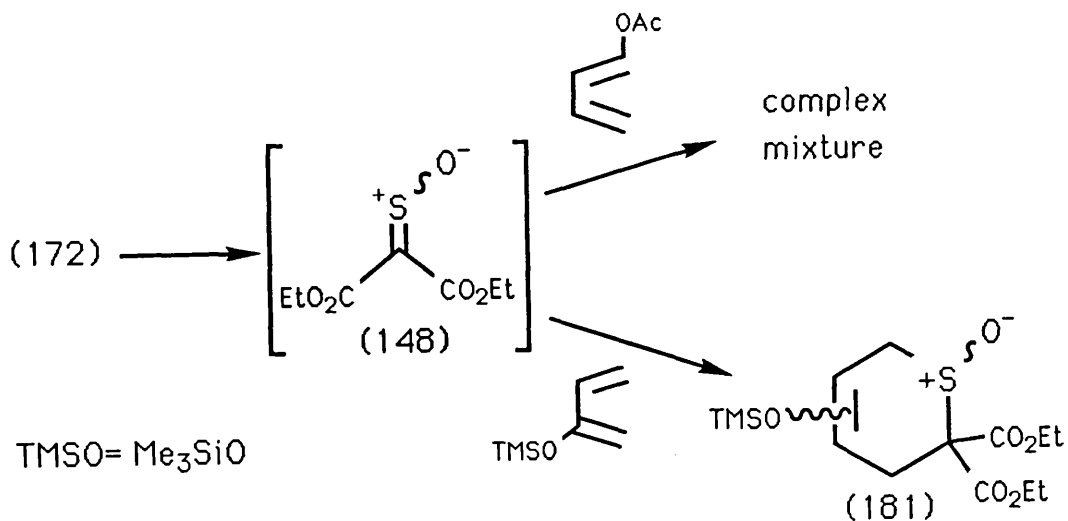

Scheme 66

The sulphine (148) was liberated in situ in refluxing benzene from the anthracene adduct (172) and trapped in turn with 1-acetoxy-1,3-butadiene and then with 2-(trimethylsilyloxy)-1,3-butadiene (Scheme 66). The former diene gave a mixture consisting of three or four components, which could not be separated by t.l.c. and were not easily analysed by n.m.r. spectroscopy. This reaction was abandoned as unnecessarily complex for our purposes. The reaction of the sulphine (148) with 2-(trimethylsilyloxy)-1,3-butadiene (Scheme 66) proved much simpler to study because, unlike the previous reaction with 1-acetoxy-1,3-butadiene, only one chiral centre can be produced. The mixture of products (181) was easily hydrolysed<sup>85</sup> to give stable ketones.

Reaction of Diethyl Thioxomalonate S-Oxide (148) with  
2-(trimethylsilyloxy)-1,3-butadiene

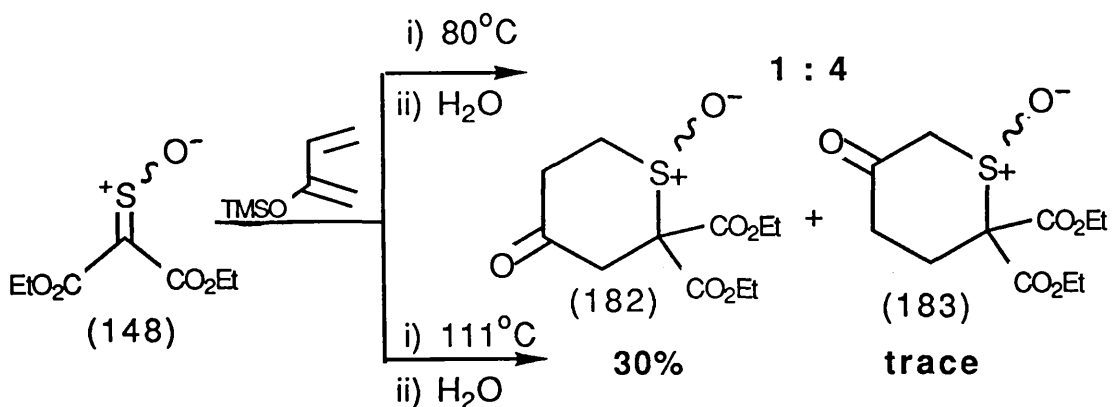

Scheme 67

i) in refluxing benzene ( $80^\circ\text{C}$ ).

The anthracene adduct (172) (1 mol. equiv.) was heated in benzene under reflux, for 1h, in the presence of 2-(trimethylsilyloxy)-1,3-butadiene (2.5 mol. equiv.) under a nitrogen atmosphere. The products were then hydrolysed<sup>85</sup> with water and potassium fluoride in THF overnight to give a ca.1:4 mixture of the 4-oxo (182) and 5-oxo (183) regioisomers (in a combined yield of 48%) as shown in Scheme 67. The mixture was characterised by  $^1\text{H}$  and  $^{13}\text{C}$  n.m.r. spectroscopy, as will be discussed shortly. The assignment of regiochemistry will also be justified shortly.

ii) in refluxing toluene (111°C).

The anthracene adduct (172) (1 mol. equiv.) was heated in toluene under reflux, for 1h, in the presence of 2-(trimethylsilyloxy)-1,3-butadiene (3 mol. equiv.) under a nitrogen atmosphere. The products were then hydrolysed<sup>85</sup> with water and potassium fluoride in THF overnight to give the 4-oxo-regioisomer (182) in 30% yield as shown in Scheme 67. Only a trace of the 5-oxo-regioisomer (183) was detected by <sup>1</sup>H and <sup>13</sup>C n.m.r. spectroscopy.

#### Comments

The switchover in the major product when the temperature is changed from mainly (183) at 80°C to almost entirely (182) at 111°C can be explained in several ways. First, the rates of trapping of the sulphine (148) may show very different dependancies on temperature, that is the formation of each of the regioisomers have very different Arrhenius activation energies. Second, the adduct (183) could be labile, and redissociates to give (148) and the diene then reassociates to give (182). This requires (182) to be the thermodynamically more stable isomer. This second explanation is disfavoured, as non-bridged cycloadducts are not normally expected to undergo retro-Diels-Alder reaction as there is

no conformational strain to accelerate ring cleavage. A third explanation is that the adduct (183) is largely decomposed at 111°C, but (182) is more stable. This is not considered likely in view of the yield (30%) of (182) which is higher than would be expected if this explanation were true.

It was hoped to distinguish between these explanations by heating the 1:4 mixture of cycloadducts, formed initially in refluxing benzene, in refluxing toluene to see if the ratio of products changed. Unfortunately, when the mixture of cycloadducts was heated in refluxing toluene for 1h, the resulting mixture was complex. A second attempt also gave a complex product mixture, possibly due to the presence of moisture in the reaction. Lack of time prevented further research into this problem.

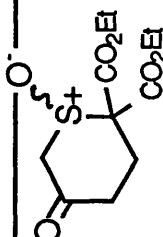
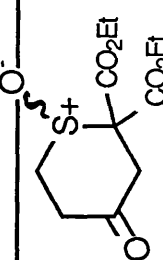

Table 6.  $^1\text{H}$  and  $^{13}\text{C}$  n.m.r. data on the ketones (182) and (183). [ $\delta$ (CDCl $_3$ )]

Compound		(183)	(182)
Nucleus			
$^1\text{H}$	3-H $_2$	2.50-3.22(m)	3.31(J 15.8Hz) 3.63(J 15.7Hz)
	4-H $_2$		
	<del>5-H<math>_2</math></del>		
	6-H $_2$	3.64(dd, H $_{eq}$ , J 14.5, 1.3Hz) 4.09(d, H $_{ax}$ , J 14.4Hz)	5-H $_2$ 6-H $_2$
			2.38-3.20(m)
$^{13}\text{C}$	C-2	71.3	70.2
	C-3	25.6	30.2
	C-4	37.1	38.2
	C-5	198.7	201.9
	C-6	57.6	44.2

Assignment of regiochemistry.

The sulphide (99) (1 mol. equiv.), which has been assigned regiochemistry with the ketonic group in the 5-position (p45), was oxidised with peracetic acid (1.2 mol equiv.) in diethyl ether at room temperature, over 1h. This gave diethyl 5-oxothiane 2,2-dicarboxylate S-oxide (183) quantitatively. The spectra for this oxidation product were identical to those for the major component formed in refluxing benzene [ i ) p95 ]. This S-oxide (183) is apparently "locked" into one conformation within the n.m.r. timescale as we see no conformational averaging in the  $^1\text{H}$  n.m.r. spectrum (Table 6), as described below. The preferred conformation (Scheme 68) is likely to have the S-O bond in the axial position <sup>86</sup> (183a) because of stereoelectronic effects mechanistically related to the "gauche effect" <sup>87</sup> .

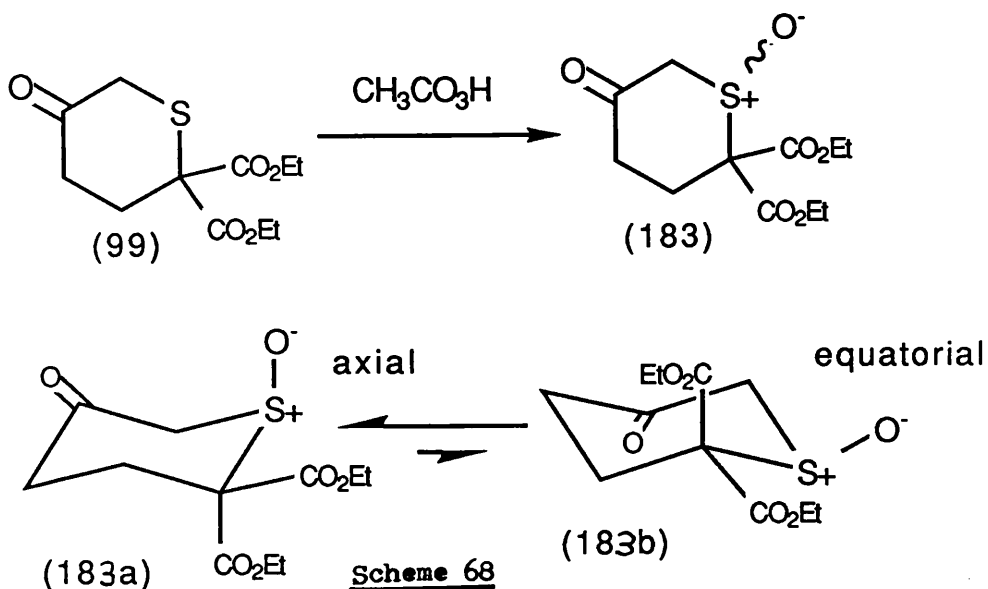
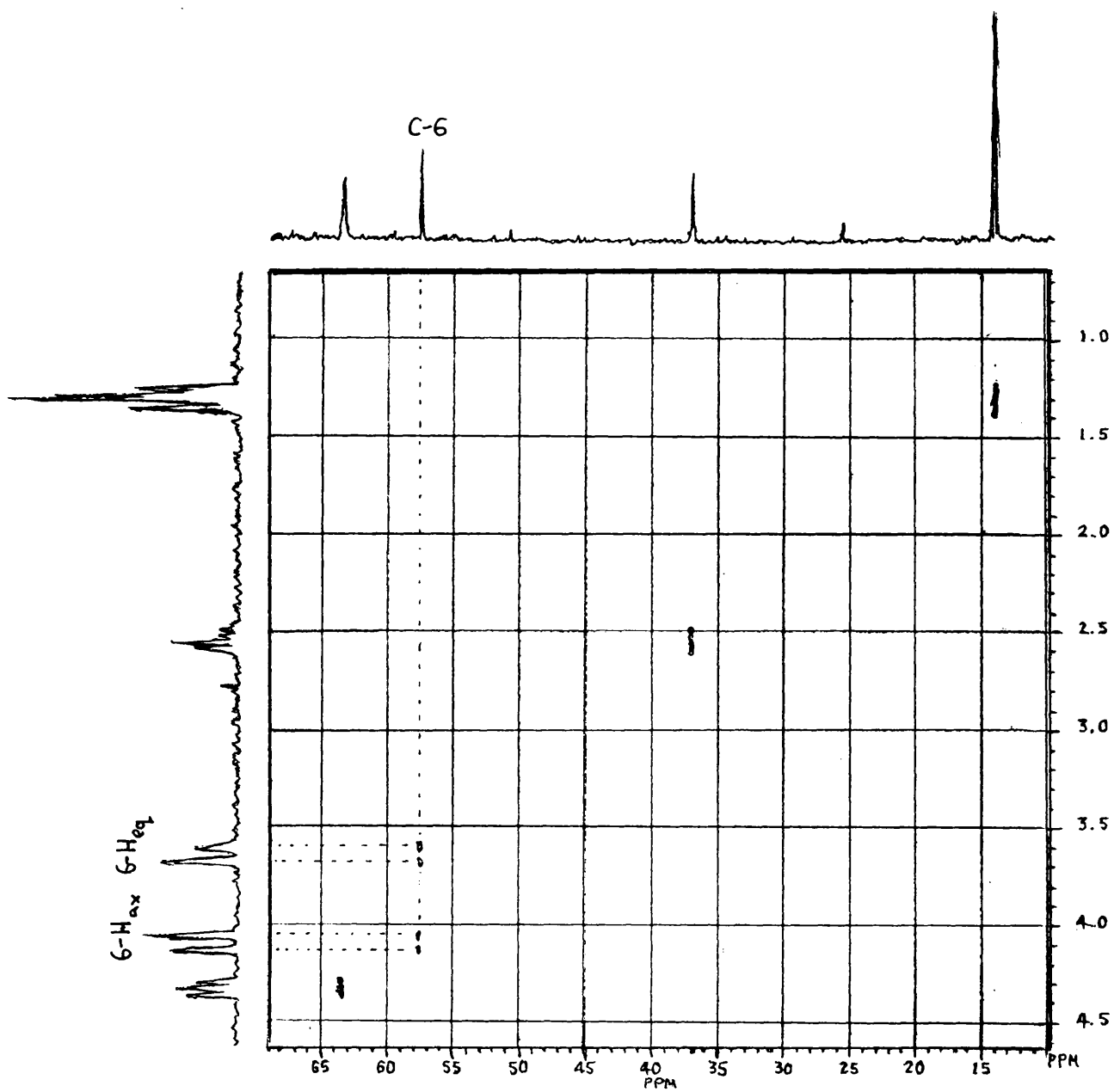

Figure 1.  $^1\text{H}$ - $^{13}\text{C}$  direct shift correlation for (183). [ $\delta$ ( $\text{CDCl}_3$ )]



The  $^1\text{H}$  n.m.r. and  $^{13}\text{C}$  n.m.r. spectra of the ketone products (182) and (183) alone are insufficient (Table 6) to justify saying which represents the 4-oxo- and which the 5-oxo- regioisomer. However, the structure (183) was unambiguously assigned to the 5-oxo-isomer (as has been assumed in preceding discussion) by  $^1\text{H}$ - $^{13}\text{C}$  correlation n.m.r. (COSY) spectroscopy (Figure 1) on a sample of (183) formed by oxidation of the corresponding sulphide (99) as above.

The AB-quartets  $\delta$ 3.64 and 4.09 in one isomer and  $\delta$ 3.13 and 3.63 in the other must arise from isolated methylene groups (Table 6). To decide which AB-quartet arises from an isolated  $3\text{-H}_2$  and which from an isolated  $6\text{-H}_2$ , we must correlate them to the appropriate carbon nucleus. Firstly, we must know which carbon signal is C-6 in the sample obtained by oxidation of (99). This was assigned by comparison with the spectra for the sulphide (47) and its S-oxide (149). These have their C-6 signals at  $\delta$ 37.7 and 50.6 respectively and C-3 signals at  $\delta$ 30.8 and 27.7 respectively. Thus the highly deshielded signal at  $\delta$ 57.6 is assigned to C-6 of the oxidation product. Once this was realised, a COSY experiment (Figure 1) showed that the C-6 signal at  $\delta$ 57.6 was directly coupled (one-bond coupling) to the methylene group at  $\delta$ 3.64 and 4.09, which as it is a simple AB-quartet, means that the 6-methylene group is adjacent to the ketonic group; that is, this sample is the 5-oxo-isomer

(183). This unambiguously assigned the regiochemistry of the preceding reactions. Also, as expected for a compound having a single, predominant conformation (183a) or (183b), a W-coupling (1.3Hz) was observed between the equatorial hydrogens on C-6 and C-4.

## CONCLUSIONS.

The anthracene adduct (172) and, to a lesser extent, the exo-cyclopentadiene adduct (173), of diethyl thioxomalonate S-oxide (148) are useful auxiliary precursors, liberating the electrophilic sulphine (148) on heating. This sulphine can then be 'transferred' to other dienes. The endo-cyclopentadiene adduct (175) was not detected and presumably rearranges rapidly to the stable sultene (174). Flash vacuum pyrolysis of the anthracene adduct (172) is a good method of generating the free sulphine (148), but this method is limited by the susceptibility of (148) to rapid hydrolysis and oligomerisation/polymerisation. The regiochemistry of cycloaddition of the sulphine (148) was also studied and the product ratios shown to be temperature dependent.

## CHAPTER 3

"THE SYNTHESIS AND REACTIONS OF DIETHYL SELENOXOMALONATE."

## INTRODUCTION



## STABILITY OF SELENOCARBONYL GROUP.

Studies of the chemistry of selenocarbonyl compounds have been rather limited and reviews are sparse<sup>88-92</sup>. Due to poor orbital overlap and different spacial symmetry, the (2p-4p)  $\pi$ -bond in such compounds is expected to be less stable than the  $\pi$ -bond in corresponding thiocarbonyl compounds, and much less stable than in carbonyl compounds. However, calculations based on <sup>77</sup>Se and <sup>17</sup>O n.m.r. data on stable selenoketones (selones) and on ketones indicate that the bond order of selenocarbonyl and carbonyl groups are comparable<sup>93</sup>, and that selenocarbonyl groups are genuinely C-Se doubly bonded.

Although the C-Se  $\pi$ -bond is extremely reactive (most reactions involve the ready interconversion of the C-Se double bond into a single bond), there are examples of selenocarbonyl compounds stabilised by resonance; so that selenoamides<sup>94-96</sup> (184) are isolable compounds.

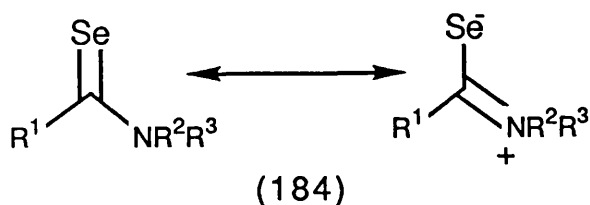

In contrast, with electron-withdrawing substituents in the  $\alpha$ -position, selenocarbonyl compounds become even more reactive, because the energy of the carbon 2p orbital is reduced. These unstable selenocarbonyl compounds include those with attached ketonic<sup>97-99</sup> (185), ester<sup>97-100</sup> (186), p-nitrophenyl<sup>97,99,100</sup> (187), and cyano<sup>97,99</sup> (188) groups.

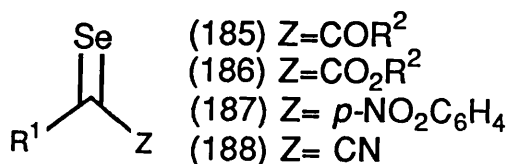

An alternative source of stability in selenoketones is found in sterically congested molecules, for example (189)<sup>101</sup> and (190)<sup>101,102</sup>, both of which are stable and blue (due to  $n \rightarrow \pi^*$  transitions). However, in the presence of oxygen and light, sterically hindered selones precipitate elemental selenium and give the corresponding ketone<sup>101</sup>.

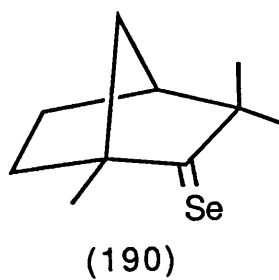
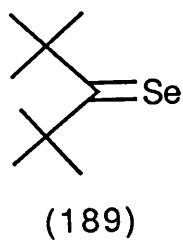

## THE DISCOVERY AND SYNTHESIS OF SELENOKETONES.

The earliest reactions which produced selenoketones gave dimers of the selone<sup>102,103</sup>. In an earlier example<sup>93</sup>, treatment of benzaldehyde (191) with hydrogen selenide (Scheme 69) gave, presumably, selenobenzaldehyde (192) which underwent both reduction by the excess of hydrogen selenide to give the selenol (194), which oxidises in air to the diselenide (195), and simultaneous trimerisation to give (196), presumably as a mixture of stereoisomers.

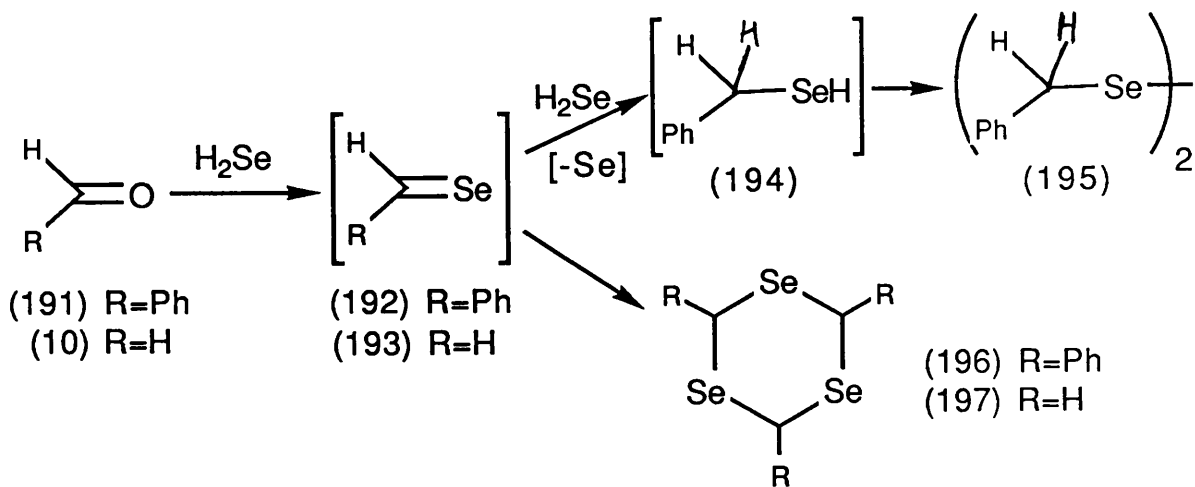
Scheme 69

Similar treatment<sup>94</sup> of (unhindered) formaldehyde (10) with hydrogen selenide gave only the trimer (197), presumably via selenoformaldehyde (193) (Scheme 69).

The earliest well-documented formation of a selenoketone<sup>101</sup> involved treating the phosphoranylidene hydrazone (198) with selenium powder at 120°C to give the sterically hindered, di-t-butyl selone (189) (Scheme 70).

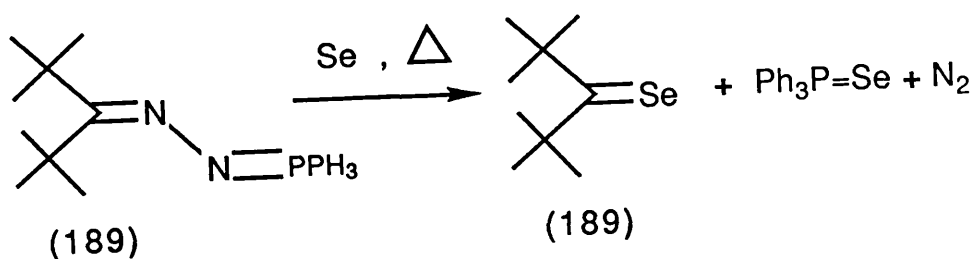

Scheme 70

Of these methods hydrogen selenide has proven to be somewhat too unpleasant and toxic to use<sup>92,104</sup>, and has had little successful application to the synthesis of selenoketones, often acting as a reducing agent to give diselenides<sup>103</sup>.

Phosphorus pentaselenide has also been of limited utility in selone synthesis<sup>92,105</sup>, often decomposing with moisture to give hydrogen selenide gas. Conflicting evidence surrounds its<sup>96,106-108</sup> structure and even its colour. It is generally prepared by heating gray selenium and red phosphorus at high temperatures<sup>96,108</sup>, but often is generated in situ in reactions to form selones<sup>94</sup>. A good example of its successful use was provided by Rae and Wade<sup>95</sup> in 1976. They heated various amides with phosphorus pentaselenide and barium carbonate in refluxing xylene for 24h; for example (199) gave the selenoamide (200) in 61% yield (Scheme 71).

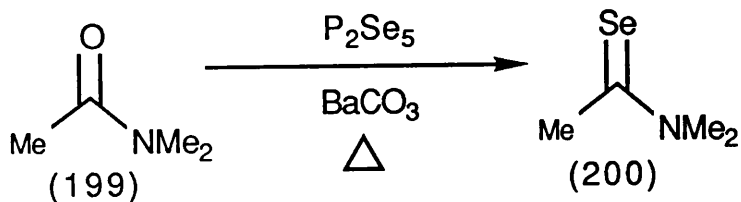

Scheme 71

Replacement of sulphur by selenium seems to be more favourable (because of the reactivity of thiocarbonyl groups) and Mickey and Zingaro<sup>96</sup> showed that 1-alkyl-4-thiouracils (201) could be selenated by heating with phosphorus pentaselenide in refluxing pyridine for 24h to give (202), but in very low yields (Scheme 72).

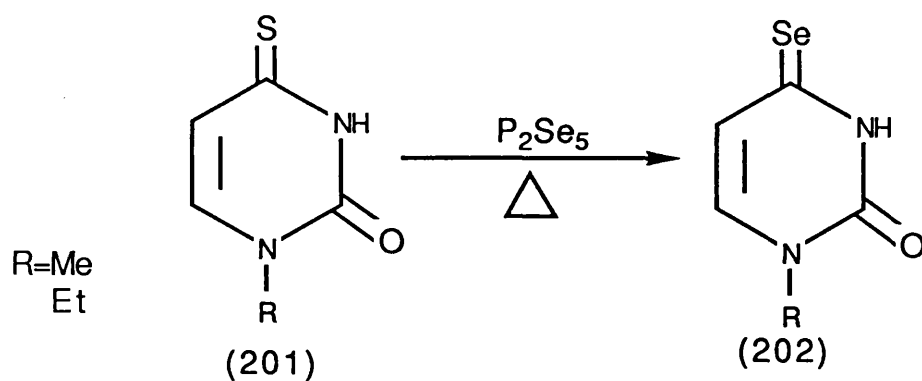

Scheme 72

The reported yields of such reactions of phosphorus pentaselenide vary from good to poor; this may be attributed to the variable quality of this reagent which, it seems cannot be recrystallised.<sup>107,108</sup>

Many of the other methods of preparing selones (206) involve directly treating species such as (203), (204) or (205) with elemental selenium (Scheme 73).

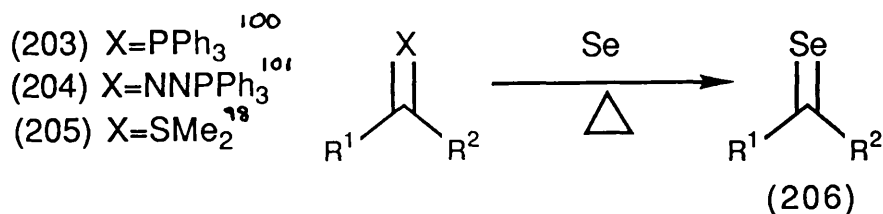

Scheme 73

Similarly, the hydrazone derivative (207) has been used<sup>109,110</sup> for the synthesis of sterically hindered selones such as (190) by treatment with selenium halides (Scheme 74). However this method has not been successfully extended to the synthesis of more reactive selones.

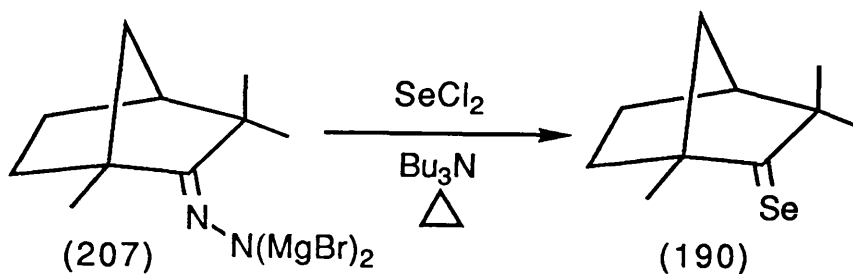

Scheme 74



For completeness, the first report of the synthesis of a transient telluroaldehyde deserves inclusion<sup>111</sup>. Treatment with a phosphonium ylid (208) with elemental tellurium at 105°C. gave tellurobenzaldehyde (209) which was trapped *in situ* with 2,3-dimethyl-1,3-butadiene to give the moisture-sensitive cycloadduct (210) in 11% yield (Scheme 75). This cycloadduct was characterised by mass spectroscopy and n.m.r. spectroscopy, the spectra being compared with the corresponding selenium and sulphur derivatives.

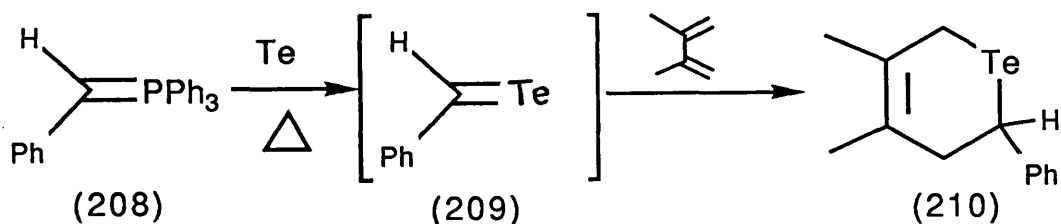

Scheme 75

Recently, good reagents for the direct selenation of ketones have been developed (Scheme 76). They are bis(tricyclohexyltin) selenide<sup>101,112</sup>, which selenated fenchone (211) to give selenofenchone (212) in 90% yield, and bis(trimethylsilyl) selenide,<sup>113</sup> which gave a variety of unstable selenoaldehydes (214) which were trapped in situ with cyclopentadiene to give the cycloadducts (215) in ca. 70% yield.

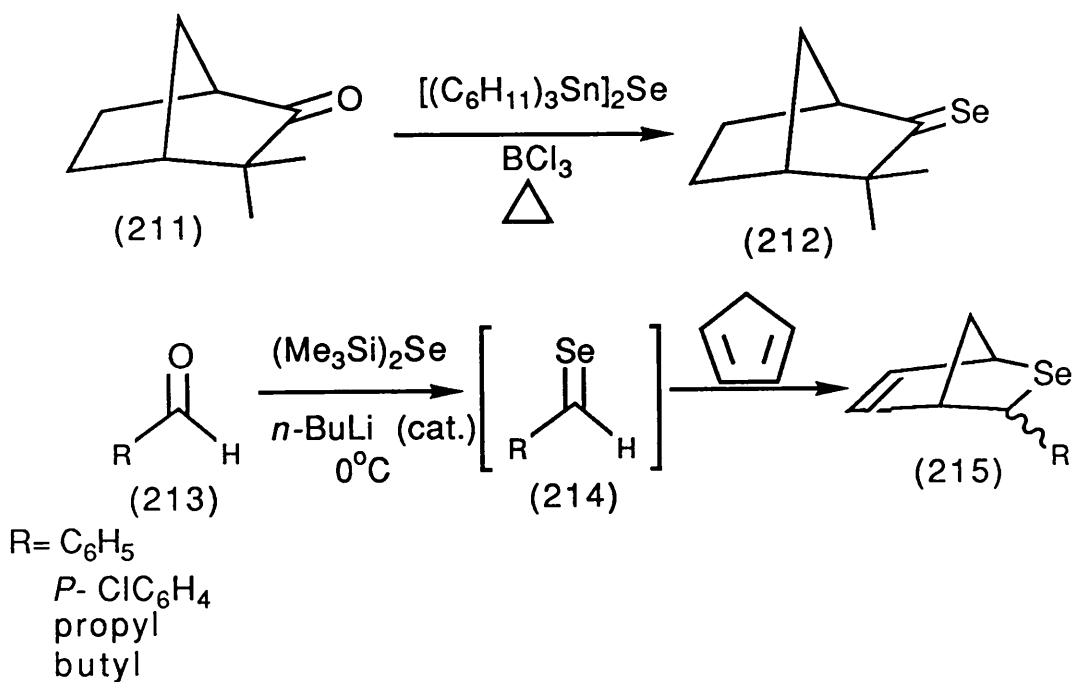

Scheme 76

GENERATION OF SELENOCARBONYL COMPOUNDS BY RETRO-DIELS-ALDER REACTION

To date, the only generation of selenoaldehydes by the retro-Diels-Alder reaction has been by Kirby and Tretheway<sup>99</sup> (there have been no reports of selenoketones being generated in retro-Diels-Alder reactions). They prepared anthracene, 9,10-dimethylantracene and cyclopentadiene adducts of various selenoaldehydes, formed in situ by elimination of HX from selenenyl derivatives,  $ZCH_2SeX$  (Scheme 78). They found that the anthracene adducts (216) dissociated on heating to give the selenoaldehydes (217) which were trapped in situ with 2,3-dimethyl-1,3-butadiene to give adducts (218) in high yields (Scheme 77). Also the cyclopentadiene adducts (219), as a 1:1 mixture of endo- and exo-isomers, dissociated thermally to give the selenoaldehydes (220) which again were trapped to give the adducts (221) in high yield. Generally the  $\alpha$ -substituents, Z in  $ZCH_2Se$ , were electron-withdrawing.

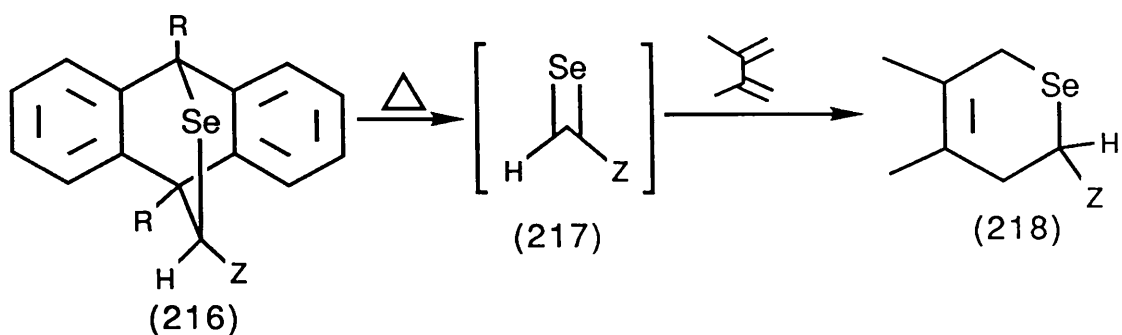

R= H or Me ; Z=CO<sub>2</sub>Et  
 R=Me ; Z= C<sub>6</sub>H<sub>5</sub>, CN

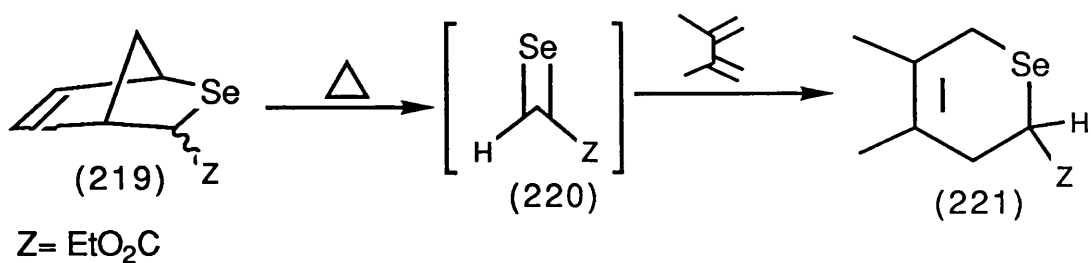

Scheme 77

$\alpha$ -OXOSELENOCARBONYL COMPOUNDS.

$\alpha$ -Oxoselenoaldehydes (223) have been generated (Scheme 78) by elimination of HX from appropriate selenenyl compounds<sup>97,99</sup> (222). The selenoaldehydes (223) were then trapped in situ with a suitable diene, eg. cyclopentadiene to give (224), in moderate yields.

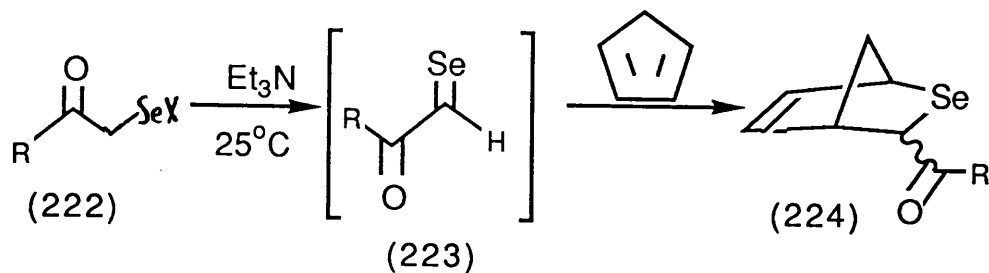

Scheme 78

A route to  $\alpha$ -oxoselenoketones has also appeared in the literature<sup>98</sup>. This involves the reaction of a dimethyl sulphonium ylid (225) with elemental selenium in refluxing *o*-dichlorobenzene (Scheme 79). The first formed selenoketone (226) was then trapped with a suitable diene, eg. 2,3-dimethyl-1,3-butadiene, to give stable adducts (227) in moderate to high yields.

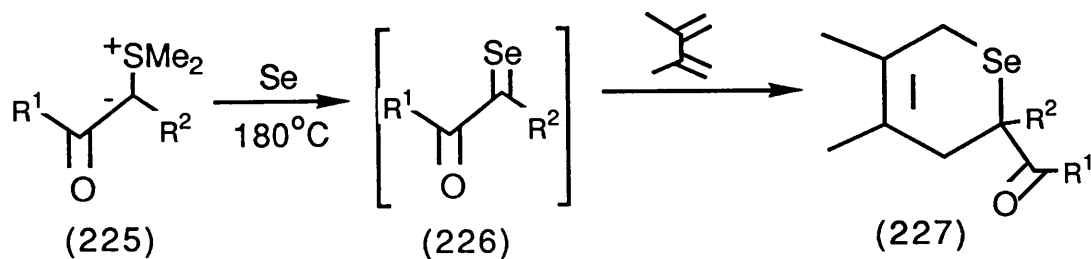

Scheme 79

SELENOXOMALONATES.

The method shown in Scheme 80 for the synthesis of  $\alpha$ -oxoselenocarbonyl compounds was applied<sup>98</sup>, after our own studies had commenced, to the synthesis of diethyl selenoxomalonate (229). Heating the ylid<sup>114</sup> (228) in o-dichlorobenzene under reflux with elemental selenium generated the corresponding selone (229) which was trapped with cyclopentadiene (formed in situ from dicyclopentadiene), to give the cycloadduct (230) in 78% yield (Scheme 80). Remarkably, this product survived the prolonged heating at ca. 180°C.

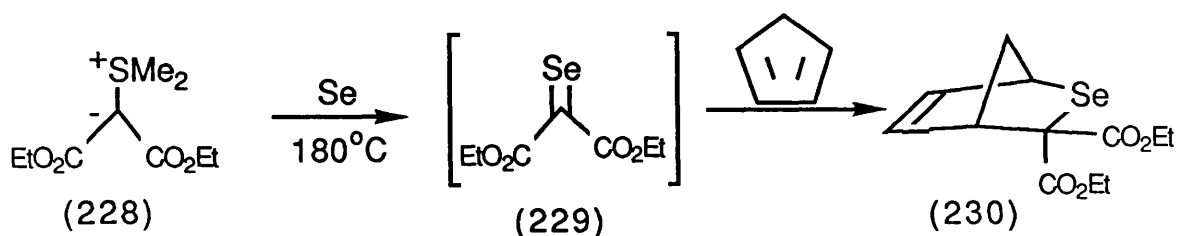
Scheme 80

## REACTIONS OF THE SELENOCARBONYL GROUP.

Studies of the reactions of selenocarbonyl compounds have been mostly conducted on stable selenoketones<sup>92</sup>. Some similarities are shown to the chemistry of thiocarbonyl compounds, in that most of the reactions centre around the instability of the C-Se  $\pi$ -bond. Thus the primary difference between seleno- and thio-carbonyl compounds is that selenocarbonyl compounds generally react faster.

For example, in an analogous manner to thiocarbonyl and carbonyl compounds, selones (206) can be quantitatively reduced<sup>101</sup> (Scheme 81) with sodium borohydride to selenols (231) which are air-sensitive and so give stable diselenides (232) upon work-up.

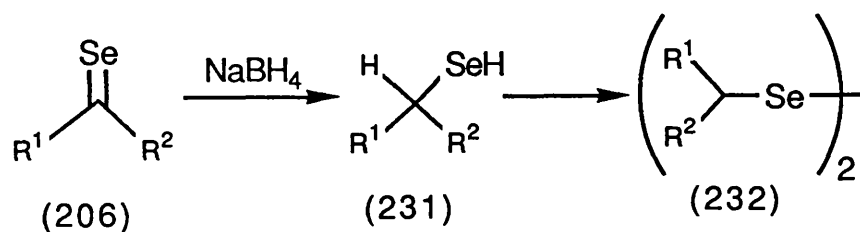

Scheme 81

Treatment of selones (206) with a slight excess of sulphur<sup>115</sup> or phosphorus pentasulphide<sup>116</sup> generally gives the corresponding thiones (54) in good yield (Scheme 82).

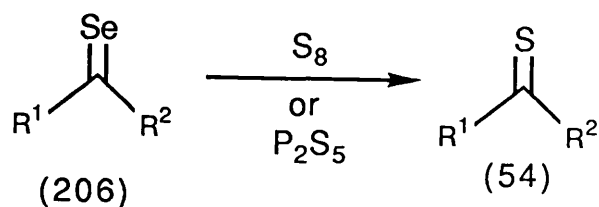

Scheme 82



(a) REACTIONS OF SELENOKETONES WITH NUCLEOPHILES.

Sterically hindered selones react with organometallic compounds, often giving selenols (which oxidise in air to diselenides)<sup>92</sup> as well as undergoing "selenophilic" addition. Di-t-butyl selone (189) reacts<sup>92</sup> with phenyl lithium to give only the "selenophilic" addition product (233), whereas the corresponding thione (114) gives a mixture<sup>117</sup> of thiophilic, to give (234), and carbophilic, to give (235), addition (Scheme 83).

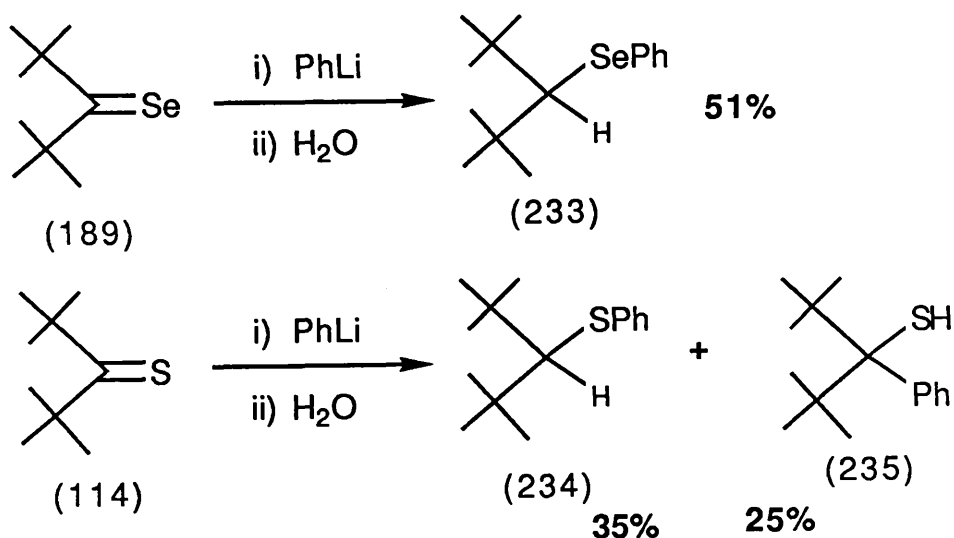
Scheme 83

(b) REACTIONS OF SELENOCARBONYL COMPOUNDS WITH CONJUGATED DIENES.

Transient selenoaldehydes and selenoketones have been studied by generating them as reactive intermediates, and then trapping them <sup>97-101,109</sup> in situ with conjugated dienes, such as cyclopentadiene.

Regiochemistry of Diels-Alder Reactions.

Meinke and Krafft <sup>97</sup> studied the reactions of a variety of reactive selenoaldehydes with asymmetric dienes. For example, they showed that the selenoaldehyde (237), generated in situ from the selenocyanate (236), reacted with 2-ethoxy-1,3-butadiene to give a 19:1 mixture of regioisomers (238) and (239) in 75% yield (Scheme 84).

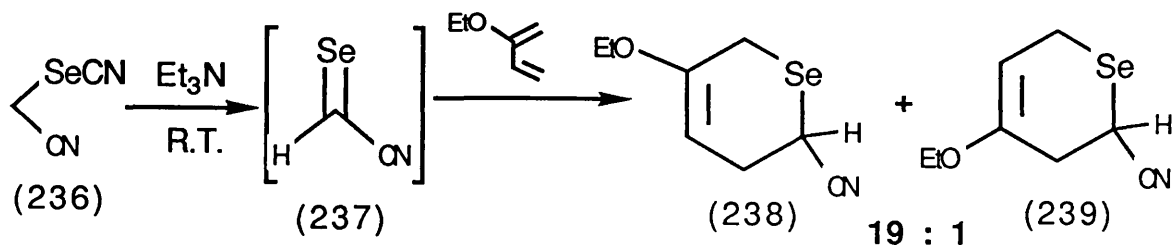
Scheme 84

They suggest that the major route of such reactions should be controlled by the HOMO of the diene and the LUMO of the selenoaldehyde, as shown in Scheme 85. The presence of an electron-donating group(s) on the diene will accelerate the reaction and increase its regioselectivity.

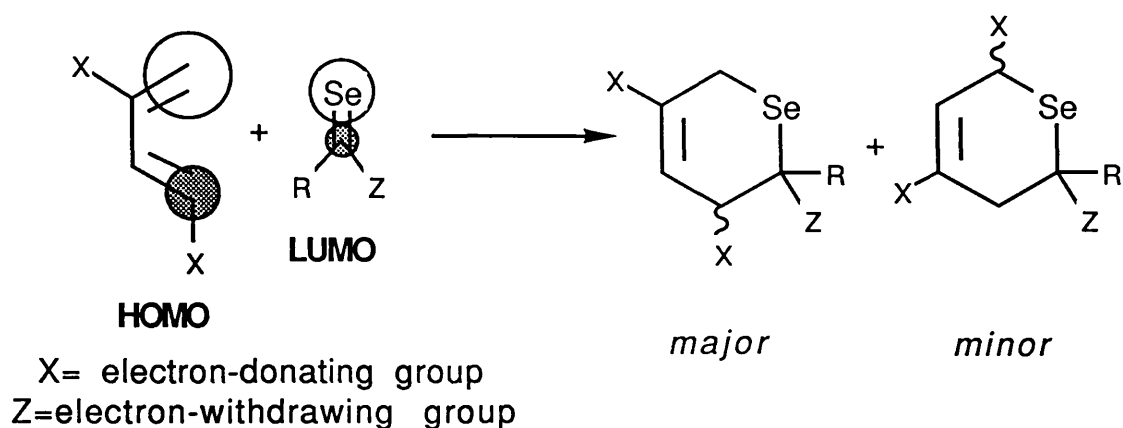

Scheme 85

An example of this kind of regioselectivity was demonstrated (Scheme 86) by Kirby and Tretheway<sup>99</sup> who generated ethyl selenoacetate (220) from the selenosulphate (240). The selenoaldehyde (220) was trapped with thebaine (40) to give regiospecifically a ca. 1:1 mixture of the epimeric endo and exo adducts (241).

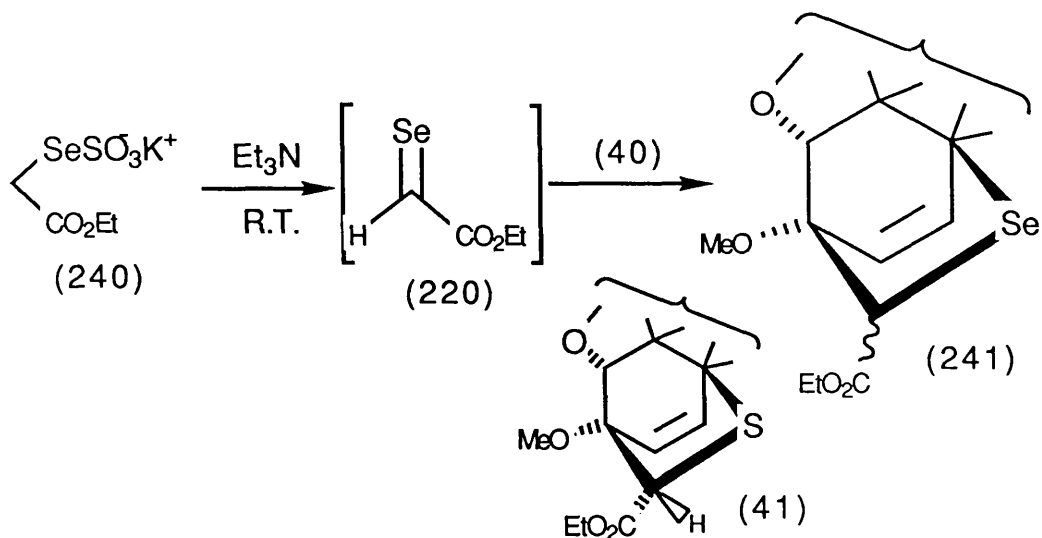

Scheme 86

Ethyl thioacetate (28) added to thebaine highly regioselectively in the same sense (Scheme 10) to give very largely the endo epimer (41). A similar reduction in stereoselectivity of ethyl selenoacetate (220) compared with ethyl thioacetate (28) was observed in their cycloaddition to cyclopentadiene and cyclohexadiene<sup>99</sup>. It was suggested that the selenium compound was more reactive and this led to cycloaddition via an "earlier", more reactant-like transition state resulting in smaller secondary orbital interactions. The longer C-Se bond length may also be a contributing factor.

(c)

OXIDATION OF SELONES.

Oxidation of di-t-butyl selone (189) with m-chloroperoxybenzoic acid (mCPBA) at low temperature gave, presumably, the selenine (242) which however decomposed at  $-20^{\circ}\text{C}$  to give the ketone (243) and elemental selenium<sup>101,118</sup> (Scheme 87). This is the only report of a selenine in the chemical literature. This contrasts sharply with the known stability of the sulphur analogue<sup>63,64</sup> (115) formed in Scheme 37.

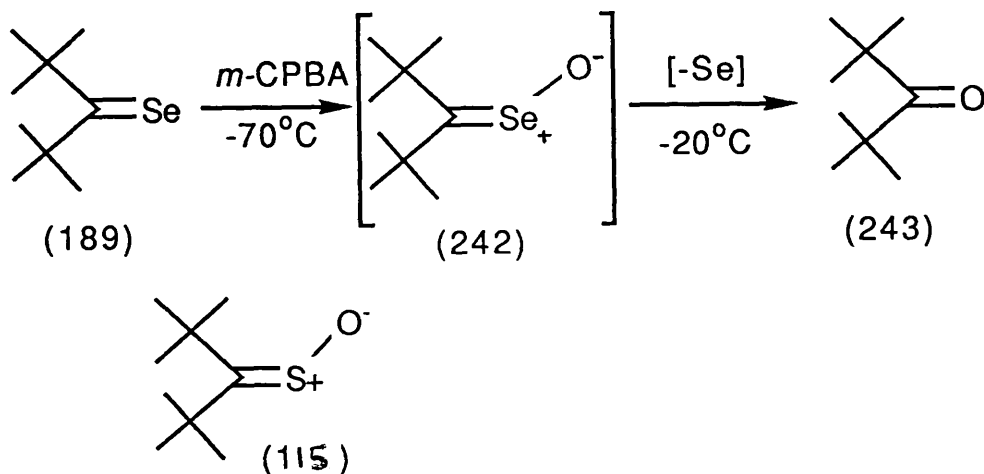
Scheme 87

## DISCUSSION

## SYNTHESIS OF DIETHYL SELENOXOMALONATE (229).

Diethyl selenoxomalonate (229) has only appeared once in the chemical literature <sup>98</sup> and remains more difficult to make than its sulphur counterpart. It is expected to be less stable than the corresponding thioketone (46) because the  $\pi$ -bond is formed by overlap between the selenium 4p and carbon 2p orbitals, which gives a genuine  $\pi$ -bond <sup>93</sup>, although the gross mismatch in size and energy of the p-orbitals make it highly reactive.

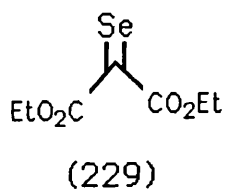

The cyclopentadiene and anthracene cycloadducts of (229) were considered to be potentially useful auxiliary precursors for this selone, presumably liberating (229) on heating by retro-Diels-Alder reaction. So some synthetic approaches to these adducts were explored.

(a) APPROACHES FROM PHOSPHORUS PENTASELENIDE.

Because of the contradictory reports regarding the quality and nature of phosphorus pentaselenide, and its tendency to decompose to hydrogen selenide gas, it was considered preferable to attempt to generate it in situ <sup>94</sup> .

Treatment of diethyl oxomalonate (48) (1 mol. equiv.) with intimately ground red phosphorus (1 mol. equiv.), gray selenium (1 mol. equiv.), and barium carbonate (1 mol. equiv.) in dry pyridine, in the presence of cyclopentadiene (5 mol. equiv.), at reflux over 24h, in a nitrogen atmosphere, gave only quantitative recovery of the starting ketone (48). When o-dichlorobenzene (b.pt. 180°C) was used instead of pyridine, the same negative result was obtained. Similarly, N-methyl pyrrolidin-2-one <sup>95</sup> could not be selenated under equivalent conditions.



(b) APPROACHES FROM DIETHYL SELENOCYANATE (244).

It was known at the start of this investigation<sup>119</sup> that diethyl selenocyanatomalonate (244) could be made from diethyl bromomalonate (91), by treatment with potassium selenocyanate in refluxing ethanol (Scheme 88).

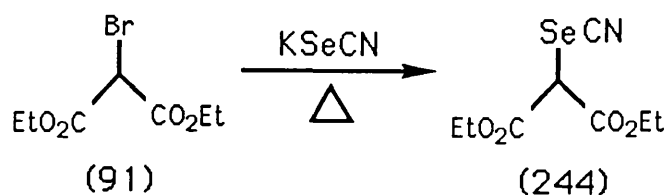
Scheme 88

It was also known that treatment of this selenocyanate (244) with triethylamine, in ethanol containing calcium chloride (to remove cyanide ions by precipitation), at room temperature in the presence of cyclopentadiene gave, unexpectedly, the cyclopropyl compound (248). Two mechanisms were considered for this reaction (Scheme 89). The first involved generation of a carbene (245) and cheletropic addition to one double bond of the diene (Path A). The second involved generation of the selenoketone (229), trapping in

situ to give the desired cycloadduct (230), and subsequent rearrangement with loss of elemental selenium to give the cyclopropane (248) either thermally (Path B) or catalysed by base (Path C). However the recent preparation of the cyclopentadiene adduct (230) demonstrates its high thermal stability<sup>98</sup>, even at 180°C. Addition of a radical inhibitor to, and exclusion of light from, the reaction mixture had no effect on the outcome.

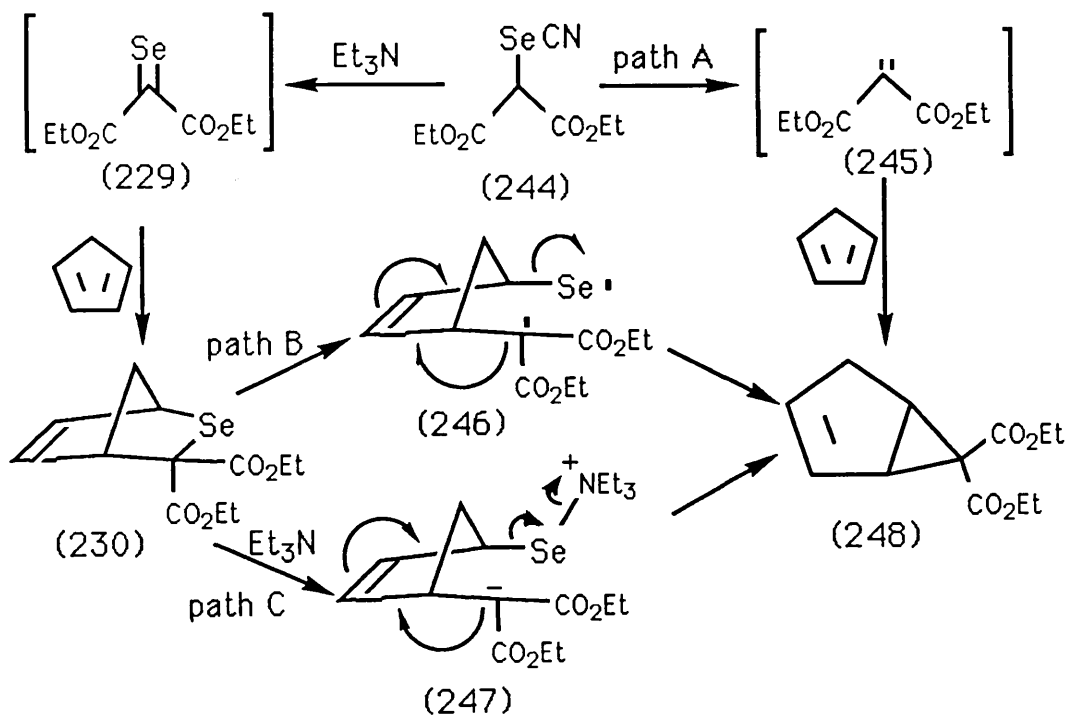

Scheme 89

To extend these preliminary findings, the selenocyanate (244) was prepared, as before, from diethyl bromomalonate and potassium selenocyanate in refluxing ethanol over 1h. It was found that diethyl malonate was always formed as a byproduct, the selenocyanate being separated by fractional distillation under vacuum, and obtained as a vile-smelling yellow oil. This selenocyanate (244) was heated, as before, with triethylamine in the presence of 2,3-dimethyl-1,3-butadiene to give the cycloadduct (249) in 43% yield (Scheme 90). This would suggest that a mechanism involving the production of the cyclopentadiene cycloadduct (230) is involved, since cyclopentadiene is generally much more reactive than 2,3-dimethyl-1,3-butadiene<sup>45</sup>. Bearing in mind the thermal stability of (230), as is now known<sup>98</sup>, it is difficult to draw any clear conclusions, because repeated attempts to effect El Naggar's synthesis of (248) produced, at the best only minimal amounts of the cyclopropane derivative (248). The reason for this remains unclear.

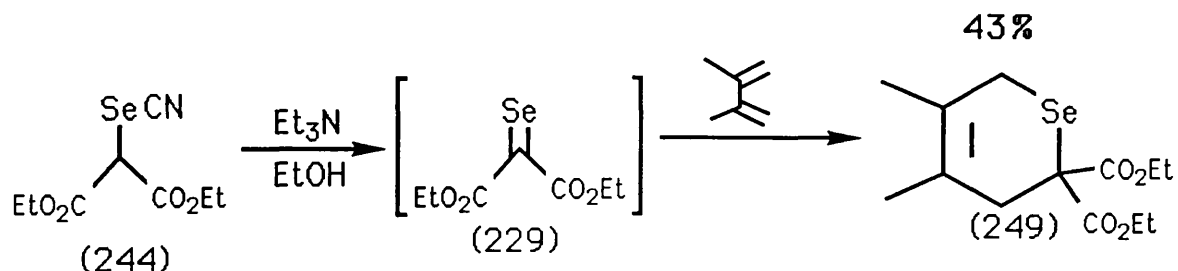

Scheme 90

Fortunately, when the selenocyanate (244) was treated with base in dichloromethane <sup>97</sup>, the selenoketone (229) could be successfully trapped in situ both with cyclopentadiene and with 2,3-dimethyl-1,3-butadiene at room temperature overnight (Scheme 91).

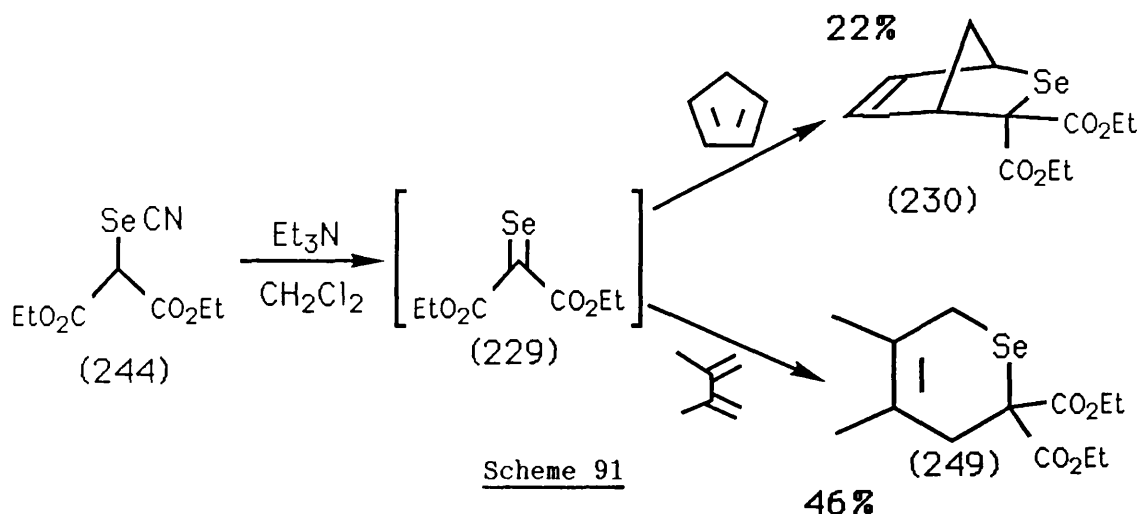

However, yields of (230) were disappointing, and purification by t.l.c. was difficult, though possible, and reproducibility has since proven to be a problem. Because of this low stability, a competition experiment between the two dienes for the selone (229) could not be done, nor could the cyclopentadiene adduct be used to attempt to generate (229) by the retro-Diels-Alder reaction, and transfer the selone to another diene. The only experiments performed on the small quantities of (230) available allowed its stability to be tested exhaustively. Neither heating (230) in refluxing toluene, nor in refluxing ethanol in the presence of

triethylamine (6 mol. equiv.), had any effect and the cycloadduct (230) was recovered quantitatively. This stability, similar to the conditions in Scheme 89 suggests that the cyclopropane (248) is not produced by Path B or C. Despite this, the isolation of the 2,3-dimethyl-1,3-butadiene adduct (249) is clear evidence for the production of the selone (229) under these conditions.

Unfortunately, this leaves the mechanism of formation of the cyclopropane (248) (Scheme 89) still unresolved.

(c) APPROACHES FROM THE SELENOSULPHATE (250).

An alternative route to the cyclopentadiene adduct (230) was sought. Treatment of diethyl bromomalonate with potassium selenosulphate in 75% aqueous ethanol gave the selenosulphate (250) (Scheme 92). However, (250) proved not to be isolable, and was generated and used in solution in a "one-pot" reaction. On treatment with triethylamine, in 75% aqueous ethanol, the selenoketone (229) was formed and trapped in situ with cyclopentadiene (5 mol. equiv.) to give (230), or with 2,3-dimethyl-1,3-butadiene (5. mol. equiv.) to give (249), both in low yields (<10%) (Scheme 92).

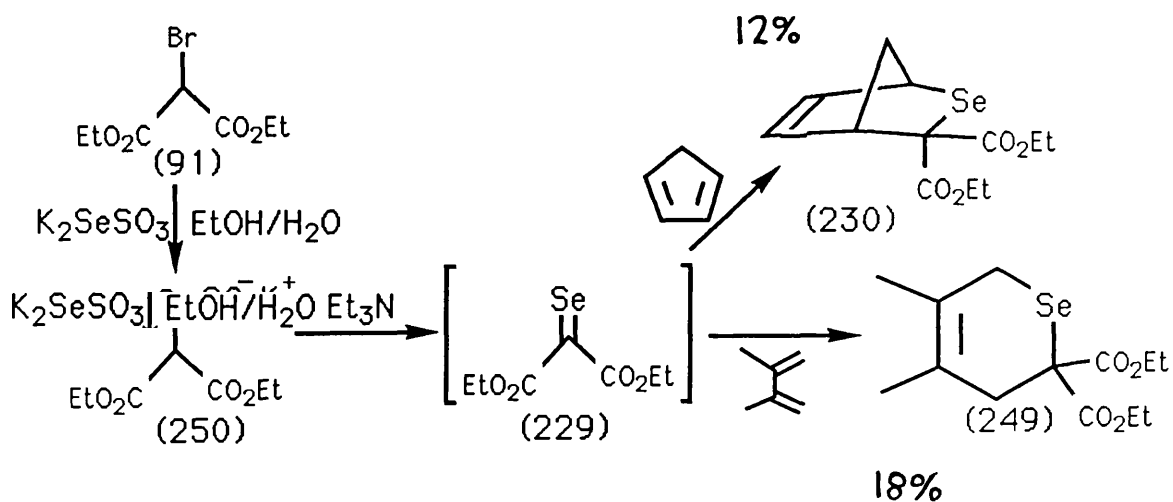
Scheme 92

Once again the reproducibility of these reactions proved to be disappointingly poor, and insufficient quantities of (230) were obtained to permit experiments on the projected retro-Diels-Alder reaction.

On one occasion, a sample of the crude product from the reaction of the selenosulphate (250) with cyclopentadiene, in the presence of triethylamine, exhibited signals for the presence of the cycloadduct (230) in the  $^1\text{H}$  n.m.r. spectrum. Also precipitated selenium, formed as a byproduct was apparently present, giving the mixture a black colour. This mixture was stored for approximately one year, and then purified. However, none of the cycloadduct (230) was isolated, instead a small amount of the diselenide (252) was obtained (Scheme 93).

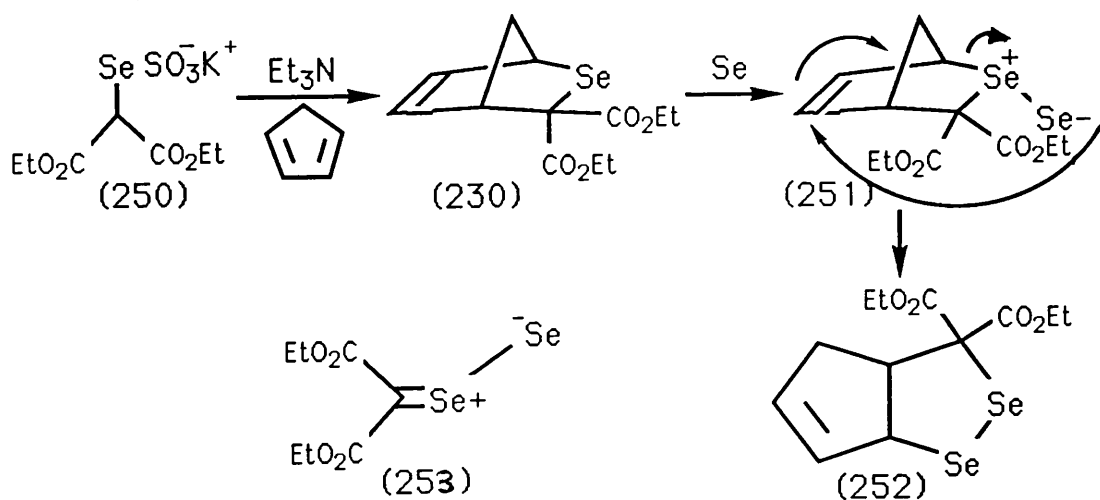

Scheme 93

Figure 2. Mass Spectrum of (252).

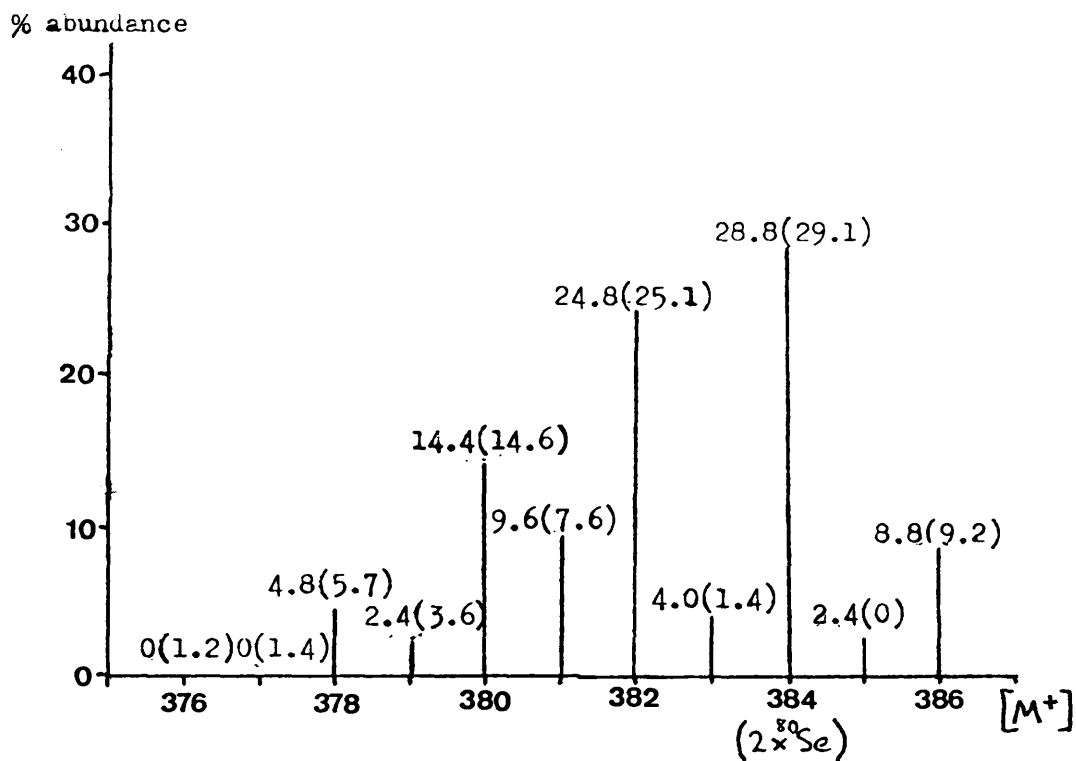

Notes.

Observed  $M^+$  peaks are given as percentage intensities (totalling 100%) with calculated natural abundances ( $2 \times \text{Se}$ ) in brackets.  
 120 Natural abundance of selenium:-

${}^{74}\text{Se}$ (0.87%),  ${}^{76}\text{Se}$ (9.0%),  ${}^{77}\text{Se}$ (7.6%),  ${}^{78}\text{Se}$ (23.5%),  ${}^{80}\text{Se}$ (49.8%),  ${}^{82}\text{Se}$ (9.2%)



The composition of this oily product (252) was determined to be  $C_{12}H_{16}O_4Se_2$ , initially by microanalysis. Mass spectrometry showed the isotopic distribution pattern unambiguously associated with 2 selenium atoms per molecule<sup>121</sup> (Figure 2), the small discrepancies being attributable to the small natural abundance of  $^{13}C$ , which becomes significant for a  $C_{12}$  molecule. From this formula, two possible structures were considered (252) and (254).

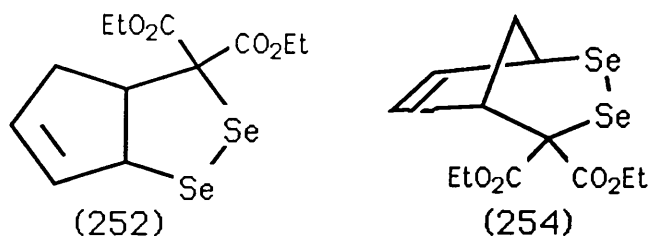

Structure (252) was assigned to the byproduct using  $^1H$  and  $^{13}C$  n.m.r. spectroscopy, with the aid of data on related compounds (Table 7). Most significantly, the coupling constant of the methylene group was measured as 16.9Hz, which is similar to the value of 17.8Hz observed for the sultene (174), and differs from the value of 12Hz in the cyclopentadiene adduct (230). This established the structure (252) for the diselenide. This structure is formally a cycloadduct of cyclopentadiene and the 1,3-dipole (253). However it is not known whether (252) was formed as a byproduct in the original reaction, or by decomposition of the

Table 7.  $^1\text{H}$  and  $^{13}\text{C}$  n.m.r. data for the diselenide (252) and related compounds. [ $\delta$  ( $\text{CDCl}_3$ )]

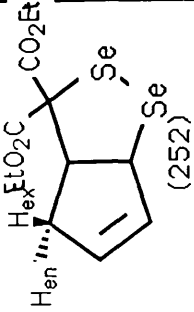
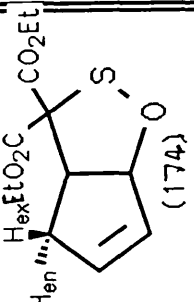
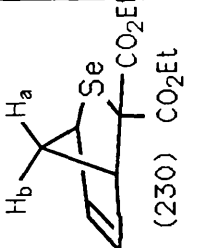
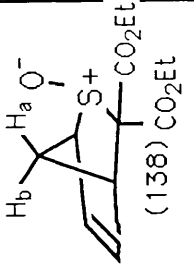
Compound	$^1\text{H}$	$^{13}\text{C}$
 (252)	5.09 obscured 2.52 J 16.9Hz 2.33 J 16.9Hz	60.4 59.7 53.4 36.7
 (174)	5.54 3.63 2.56 J 17.8Hz 2.19 J 17.8Hz	97.6 76.0 48.7 36.1
 (230)	4.42 3.61 2.23 J 12Hz 1.97 J 12Hz	
 (138)	obscured 3.62 3.04 J 12Hz 2.35 J 12Hz	47.8 83.0 69.0 45.7
nucleus		
1-H		1-H
5-H		4-H
6-H <sub>ex</sub>		7-H <sub>a</sub>
6-H <sub>en</sub>		7-H <sub>b</sub>
C-1		C-1
C-4		C-3
C-5		C-4
C-6		C-7

cyclopentadiene adduct (230) on prolonged storage with selenium. One proposed mechanism involves the endo compound (251) as an intermediate (Scheme 93). This is essentially the same as the reaction of the endo-sulphoxides formed by Block et al <sup>72</sup>, and also finds analogy with the homologation of allylic sulphides when heated with elemental sulphur <sup>122</sup>, also involving a sigmatropic rearrangement (Scheme 94).

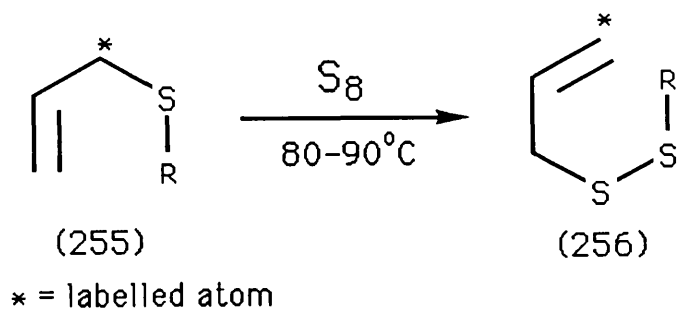

Scheme 94

## CONCLUSIONS.

The cycloadducts of diethyl selenoxomalonate (229) proved to be difficult to synthesise, but the cyclopentadiene adduct (230) and the 2,3-dimethyl-1,3-butadiene adduct (249) were made both from the selenocyanate (244) and the selenosulphate (250) in poor to moderate yields. Reproducibility was, however, poor and the results were therefore unsatisfactory. The generally better yields of cycloadduct achieved with 2,3-dimethyl-1,3-butadiene than with cyclopentadiene are rather unusual, as cyclopentadiene is usually the more reactive diene<sup>45</sup>. It may be that cyclopentadiene reacts directly with the selenoketone precursor. Perhaps this might also explain the anomalous formation of the cyclopropane derivative.<sup>119</sup>

CHAPTER 4  
EXPERIMENTAL SECTION.

GENERAL PROCEDURES.

Melting points were measured with a Reichert hot-stage apparatus and are uncorrected.  $^1\text{H}$  N.m.r. spectra were recorded on a variety of instruments; 90MHz spectra were recorded on a Perkin-Elmer R32 continuous wave spectrometer, 200MHz spectra on Bruker WP200 SY instruments, in the pulsed F.T. mode.  $^{13}\text{C}$  N.m.r. spectra were recorded on a Varian XL-100 spectrometer at 25.1MHz, and  $^{13}\text{C}$  DEPT spectra on the Bruker instruments at 50.3MHz. All n.m.r. spectra were run with the sample dissolved in deuteriochloroform, with (on the low field instruments) tetramethylsilane as the internal standard, or (on the high field instruments) residual chloroform as the internal standard. The high field spectra were run by Dr. D. S. Ryecroft, Mr. J. H. Gall, and Mr. J. A. McIver. High resolution mass spectra were recorded on an AEI-GEC 9 mass spectrometer by Mr T. Richie. Infrared spectra were recorded on Perkin Elmer 983 and 580 Infrared Spectrophotometers by Mr. G. M. McCulloch and staff. Ultraviolet spectra were recorded on a Pye Unicam SP8-100 Ultraviolet Spectrophotometer. Microanalyses were exacted by Mrs. K. Wilson using a KLM Elemental Analyser, and titrometric techniques.

Analytical thin layer chromatography (t.l.c.) was carried out on 0.2mm plastic-backed silica gel 60 F 254 plates, commercially available from Merck. Spots were located by u.v. light and/or

immersion of the eluted plates in iodine vapour. Preparative t.l.c. separations were carried out on 20 x 20cm glass plates coated with a 1mm layer of silica gel GF<sub>254</sub>, available from Fluka. Organic solutions were dried with anhydrous magnesium sulphate. Solvents were evaporated on a Buchi Rotavapor evaporator at water pump pressures. Compounds were dried in a vacuum desiccator over silica gel (except where phosphorus pentoxide is used to remove pyridine) at oil-pump pressures.

PREPARATION OF CYCLOADDUCTS OF DIETHYL THIOXOMALONATE (46).

Preparation of Diethyl 3,6-Dihydro-4,5-dimethylthiopyran-  
-2,2-dicarboxylate (47) from Diethyl Oxomalonate (48).

Diethyl oxomalonate (2.08g, 11.7mmol) in dry pyridine (25ml) was added dropwise over 10min to a refluxing solution of phosphorus pentasulphide (0.99g, 4.45mmol) and 2,3-dimethyl-1,3-butadiene (5.12g, 62.4mmol) in dry pyridine (100ml) in a nitrogen atmosphere. Refluxing was maintained for a further 1h, then the solution was cooled, treated with 5% hydrochloric acid (100ml) and left to stand for 10min. This mixture was extracted with diethyl ether (100ml) and the ether layer was then washed successively with 5% hydrochloric acid (2 x 50ml), 5% aqueous sodium hydrogen carbonate (50ml), and water (50ml). The ether layer was then dried (magnesium sulphate) and filtered. The filtrate was evaporated to dryness under reduced pressure and the residue dried over phosphorus pentoxide under vacuum to give a yellow oil (2.48g). This oil was fractionally distilled to yield the cycloadduct (47)<sup>29</sup> (1.94g, 56%), b.p. 112°C (0.2mm Hg). [Found: C, 57.35; H, 7.76; S, 12.10%;  $m/z$  272.1074. Calc. for  $C_{13}H_{20}O_4S$ : C, 57.33, H, 7.40; S, 11.73%;  $M^+$ , 272.1076.];  $\nu_{max}$  (thin film) 1735 $cm^{-1}$ ;  $\delta_H$  (90MHz) 1.23(t,  $J$  7Hz,  $OCH_2CH_3$ ), 1.70(bs, 4- and 5-Me), 2.67(bs, 3-H), 3.06(bs, 6-H), 4.22(q,  $J$  7Hz,  $OCH_2CH_3$ );  $\delta_C$  (DEPT 50.3MHz) 13.9(2 x  $OCH_2CH_3$ ),



19.1 & 20.0(4- and 5-Me), 30.8(C-3), 37.7(C-6), 56.7(C-2),  
62.2(2 x  $\text{OCH}_2\text{CH}_3$ ), 122.4 & 125.4(C-4 and -5), 168.8(2 x  $\text{CO}_2$ ).

Preparation of Diethyl 2-Thiabicyclo[2.2.1]hept-5-ene-  
-3,3-dicarboxylate (93) from Diethyl Oxomalonate (48) [Method A] or  
Potassium O-Ethyl Xanthate (94) [Method B].

Method A:-

Diethyl oxomalonate (2.01g, 11.6mmol) in dry pyridine (25ml) was added dropwise over 10min to a refluxing solution of phosphorus pentasulphide (0.98g, 4.41mmol) and cyclopentadiene (3.71g, 56.2mmol) in dry pyridine (100ml) in a nitrogen atmosphere. Refluxing was maintained for a further 1h, then the solution was cooled, treated with 5% hydrochloric acid (100ml) and left to stand for 10min. This mixture was then worked up as described for (47) to give a yellow oil (3.63g). This oil was fractionally distilled to yield the cycloadduct (93) (1.76g, 60%), b.p. 106°C (0.08mm Hg). [Found: C, 55.95; H, 6.45; S, 12.81%;  $m/z$  256.0770.  $\text{C}_{12}\text{H}_{16}\text{O}_4\text{S}$  requires C, 56.23, H, 6.29; S, 12.5%;  $M^+$ , 256.0770.];  $\nu_{\text{max}}$  (thin film) 1750 and 1740 $\text{cm}^{-1}$ ;  $\delta_{\text{H}}$  (200MHz) 1.23(t,  $J$  7.1Hz,  $\text{OCH}_2\text{CH}_3$ ), 1.24(t,  $J$  6.7Hz,  $\text{OCH}_2\text{CH}_3$ ), 1.81 & 2.05(ABq,  $J$  9.6Hz, 7-H<sub>2</sub>), 3.85(bs, 1- or 4-H), 4.10(bs, 4- or 1-H), 4.09-4.25(m, 2 x  $\text{OCH}_2\text{CH}_3$ ), 5.84(dd,  $J$  5.5 and 3.1Hz, 5- or 6-H), 6.52(dd,  $J$  5.5 and 2.9Hz, 6-

or 5-H);  $\delta_c$  (DEPT 50.3MHz) 13.9 & 14.0(OCH<sub>2</sub>CH<sub>3</sub>), 51.4(C-7), 52.5 & 52.8(C-1 and -4), 62.1 & 62.3(OCH<sub>2</sub>CH<sub>3</sub>), 131.3 & 140.2(C-5 and -6), 168.8 & 170.2(2 x CO<sub>2</sub>).

#### Method B:-

Potassium O-ethyl xanthate (94) (0.65, 4.06mmol) and cyclopentadiene (2.02g, 30.6mmol) were stirred in acetone (15ml), cooled in an ice-water bath, and diethyl dibromomalonate (0.52g, 2.05mmol) in acetone (10ml) was added dropwise over 10min to the solution, which was stirred for a further 2h. The mixture was allowed to warm to room temperature overnight and was then filtered and evaporated under reduced pressure. The residue was desiccated over silica gel under vacuum to give a brown solid (958mg). This was separated by preparative t.l.c. with ether-light petroleum (3:7) as eluant and gave the cycloadduct (93) (310mg, 59%). The product gave a <sup>1</sup>H n.m.r. spectrum identical with the material produced by method A.

#### Preparation of Diethyl

9,10-Dihydro-10,9-(epithiomethano)anthracene-12,12-dicarboxylate  
(95) from Diethyl Oxomalonate (48).

Diethyl oxomalonate (1.25g, 7.02mmol) in dry pyridine (10ml) was

added dropwise over 10min to a hot solution (70-80°C) of phosphorus pentasulphide (0.72g, 3.24mmol) and anthracene (6.30g, 35.4mmol) in dry pyridine (90ml) in a nitrogen atmosphere, with mechanical stirring. Heating was maintained for a further 1h, then the solution was cooled, treated with 5% hydrochloric acid (100ml) and left to stand for 10min. This mixture was extracted with diethyl ether (150ml) and the ether layer was then filtered to remove undissolved excess anthracene before being washed successively with 5% hydrochloric acid (2 x 50ml), 5% aqueous sodium hydrogen carbonate (50ml), and water (50ml). The ether layer was then dried (magnesium sulphate) and filtered. The filtrate was evaporated to dryness under reduced pressure and the residue dried overnight over phosphorus pentoxide under vacuum to give a yellow solid (5.48g). This was then shaken with methanol (2 x 50ml) and the combined methanolic extracts were filtered and evaporated under reduced pressure with heating to give a yellow solid (1.93g). This was then dissolved in boiling methanol (30ml) and filtered while hot, then left in a fridge at ca.5°C overnight to crystallise. The resultant crystals were removed by filtration and washed twice with light petroleum (2 x 10ml) to give the pure cycloadduct (95) (617mg, 24%) as white plates, m.p. 150-152°C. [Found: C, 68.35; H, 5.36; S, 8.93%;  $\underline{m}/\underline{z}$  368.1075.  $C_{21}H_{20}O_4S$  requires: C, 68.46, H, 5.47; S, 8.70%;  $M^+$  368.1078.];  $\nu_{max}$  (thin film) 1745 $cm^{-1}$ ;  $\delta_H$  (200MHz) 1.16(t,  $\underline{J}$  7.1Hz, 2 x  $OCH_2CH_3$ ), 4.06(ABq,  $\underline{J}$  10.8 and 7.2Hz,

$\text{OCH}_2\text{CH}_3$ ), 4.10(ABq,  $J$  10.8 and 7.1Hz,  $\text{OCH}_2\text{CH}_3$ ), 5.14(s, 9- or 10-H), 5.34(s, 10- or 9-H), 7.1-7.5(m, Ar-H);

$\delta_C$  (DEPT 50.3MHz) 13.8(2 x  $\text{OCH}_2\text{CH}_3$ ), 46.7 & 50.7(C-9 and -10), 62.3(2 x  $\text{OCH}_2\text{CH}_3$ ), 68.6(C-12), 122.0-143.1(Ar), 168.2(2 x  $\text{CO}_2$ ).

TRANSFER REACTIONS OF DIETHYL THIOXOMALONATE (46).(a) From the anthracene adduct (95)

i) to give the cyclopentadiene adduct (93).

The anthracene adduct (95) (84.0mg, 0.23mmol) and cyclopentadiene (84.4mg, 1.28mmol) were refluxed in dry toluene (20ml), under a nitrogen atmosphere, for 1h. The solution was cooled and evaporated to dryness under reduced pressure with heating, and the residue was dried over silica gel under vacuum to give a yellow solid (132mg), which was purified by preparative t.l.c. using dichloromethane-light petroleum (1:1) as elutant to give the cycloadduct (93) (49.3mg, 84%) as a yellow oil. The  $^1\text{H}$  n.m.r. spectrum was identical to that of (93) made from (48).

ii) to give the 2,3-dimethyl-1,3-butadiene adduct (47).

The anthracene adduct (95) (150mg, 0.41mmol) and 2,3-dimethyl-1,3-butadiene (169mg, 2.06mmol) were refluxed in dry toluene (30ml), under a nitrogen atmosphere. for 1h. The mixture was worked up as in i) to give, after preparative t.l.c., the cycloadduct (47) (33.6mg, 72%) as a yellow oil. The  $^1\text{H}$  n.m.r.

spectrum was identical to that of (47) made from (48).

(b) From the cyclopentadiene adduct (93) to give the 2,3-dimethyl-1,3-butadiene adduct (47).

The cyclopentadiene adduct (93) (105mg, 0.41mmol) and 2,3-dimethyl-1,3-butadiene (210mg, 2.6mmol) were refluxed in dry toluene (20ml) for 4h. The mixture was then cooled and evaporated to dryness under reduced pressure with heating and desiccated over silica gel under vacuum to give (47) as a yellow oil (110mg, 99%). The  $^1\text{H}$  n.m.r. spectrum was identical to that of (47) made from (48).

(c) Competition Experiment.

The anthracene adduct (95) (69.6mg, 0.19mmol), cyclopentadiene (44.2mg, 0.67mmol) and 2,3-dimethyl-1,3-butadiene (55.4mg, 0.68mmol) were refluxed in dry toluene (20ml), under a nitrogen atmosphere, for 1h. The solution was cooled and evaporated to dryness under reduced pressure with heating, and the residue was dried over silica gel under vacuum to give a yellow solid. Integration of the  $^1\text{H}$  n.m.r. spectrum (90MHz) gave the ratio of (93) to (47) as 3:2.

Control experiment:- the cyclopentadiene adduct (42.7mg, 0.17mmol) and 2,3-dimethyl-1,3-butadiene (41.1mg, 0.50mmol) were refluxed in dry toluene (15ml), under a nitrogen atmosphere, for 1h. The solution was cooled and evaporated to dryness under reduced pressure with heating, and the residue was dried over silica gel under vacuum to give a yellow solid. Integration of the  $^1\text{H}$  n.m.r. spectrum (90MHz) gave the ratio of (93) to (47) as 2:3.

(d) Measurement of rates of transfer

In General:-

An anthracene adduct (1 mol. equiv.) and 2,3-dimethyl-1,3-butadiene (10 mol. equiv.) were dissolved in dry toluene in a standard flask (50.0ml). Eight portions (2.0ml each) were taken and arranged in separate test-tubes, each fitted with a nitrogen-filled balloon. The test-tubes were suspended in a constant volume, boiling water bath at  $100 \pm 1^\circ\text{C}$  and removed at set time-intervals and cooled immediately in ice-water.

The portions were then each diluted with hexane in individual standard flasks (10.0ml) and the amount of liberated anthracene determined by ultraviolet spectroscopy. All absorbances were measured at  $\lambda_{\text{max}}$  355.0nm in a 10mm cell. The absorbances were taken

from 0min and at regular intervals until 24h (taken as complete reaction).

i) from the anthracene adduct (27) of ethyl thioacetate (28).

The anthracene adduct (27) (12.6mg, 0.044mmol) and 2,3-dimethyl-1,3-butadiene (35.9mg, 0.44mmol) were used as described above. The reaction was thus shown to be approximately first-order with respect to the concentration of (27), with a rate-constant,  $k$ , of  $1.06 \times 10^{-4} \text{ s}^{-1}$ .

ii) from the anthracene adduct (95) of diethyl thioxomalonate (46).

The anthracene adduct (95) (23.6mg, 0.064mmol) and 2,3-dimethyl-1,3-butadiene (51.4mg, 0.63mmol) were used as described previously. The reaction was thus shown to be approximately first-order with respect to the concentration of (95), with a rate-constant,  $k$ , of  $3.28 \times 10^{-4} \text{ s}^{-1}$ .



(e) Regioselectivity of transfer reactions of diethyl thioxomalonate (46)

i) to 2-(trimethylsiloxy)buta-1,3-diene to give (98).

The anthracene adduct (95) (144mg, 0.39mmol) and 2-(trimethylsiloxy)buta-1,3-diene (0.10ml, 1.0mmol) were refluxed in dry toluene, for 1h, under nitrogen, then the solution was cooled and evaporated under reduced pressure with heating to give a yellow solid (290mg), which was determined by n.m.r. to be the moisture-sensitive adduct (98).  $\delta_{\text{H}}$  (200MHz) 0.17(s,  $\text{Me}_3\text{SiO}$ ), 1.27(t,  $\underline{\text{J}}$  7Hz, 2 x  $\text{OCH}_2\text{CH}_3$ ), 2.89(dt,  $\underline{\text{J}}$  4.5, 2.5Hz, 3- $\text{H}_2$ ), 3.12(d,  $\underline{\text{J}}$  1.4Hz, 6- $\text{H}_2$ ), 4.22(q,  $\underline{\text{J}}$  7Hz, 2 x  $\text{OCH}_2\text{CH}_3$ ), 4.95(t,  $\underline{\text{J}}$  4.5Hz, 4-H);  $\delta_{\text{C}}$  (DEPT 50.3MHz) 1.85( $\text{Me}_3\text{SiO}$ ), 13.8(2 x  $\text{OCH}_2\text{CH}_3$ ), 28.3(C-3), 32.3(C-6), 55.4(C-2), 62.3(2 x  $\text{OCH}_2\text{CH}_3$ ), 102.8(C-4), 146.2(C-5), 168.2(2 x  $\text{CO}_2$ ). This crude product was dissolved in THF (10ml) and potassium fluoride (58mg, 0.85mmol) and three drops of water (ca. 200mg) was added. The solution was stood at room temperature for 24h, and then evaporated to dryness under reduced pressure. The resultant solid was extracted with dichloromethane (20ml), and the solution washed with water (2 x 20ml), and dried (magnesium sulphate), filtered and evaporated to dryness under reduced pressure. Extraction of the resultant solid with methanol (20ml)

gave, after desiccation, an orange solid (145mg), which was purified by preparative t.l.c. using dichloromethane/light petroleum (2:3) as elutant. This gave diethyl

5-oxothiane-2,2-dicarboxylate (99) as a yellow oil (52mg,

51%). [Found  $\underline{m}/\underline{z}$  260.0713.  $C_{11}H_{16}O_5S$  requires  $M^+$  260.0711.];

$\nu_{\max}$  (thin film)  $1730\text{cm}^{-1}$ ;  $\delta_{\text{H}}$  (200MHz) 1.24(t,  $\underline{J}$  7.1Hz, 2 x  $\text{OCH}_2\text{CH}_3$ ), 2.60 & 2.71(m, 3- and 4- $\text{CH}_2$ ), 3.30(s, 6- $\text{H}_2$ ), 4.24(q,  $\underline{J}$  7.1Hz, 2 x  $\text{OCH}_2\text{CH}_3$ );  $\delta_{\text{C}}$  (DEPT 50.3MHz) 13.9(2 x  $\text{OCH}_2\text{CH}_3$ ), 33.2 & 35.7 & 36.4(m, 3- and 4- and 6- $\text{CH}_2$ ), 56.0(C-2), 62.7(2 x  $\text{OCH}_2\text{CH}_3$ ), 168.4(2 x  $\text{CO}_2$ ), 203.0(C-5).

ii) to 1-acetoxy-1,3-butadiene to give (97).

The anthracene adduct (95) (95mg, 0.26mmol) and 1-acetoxy-1,3-butadiene (94mg, 0.82mmol) were refluxed in toluene, for 1 h, under nitrogen, and then cooled and evaporated to dryness under reduced pressure with heating. The resultant solid was desiccated under vacuum to give a white solid (116mg), which gave, after preparative t.l.c. using dichloromethane/light petroleum (1:1) as elutant, diethyl 3-acetoxy-3,6-dihydrothiapyran-

-2,2-dicarboxylate (97) as an orange oil (48mg, 58%). [Found  $\underline{m}/\underline{v}$  302.0817.  $C_{13}H_{18}O_6S$  requires  $M$  302.0819.];  $\nu_{\max}$  (thin film) 1750, 1735 $\text{cm}^{-1}$ ;  $\delta_{\text{H}}$  (90MHz) 1.23(t,  $\underline{J}$  7Hz, 2 x  $\text{OCH}_2\text{CH}_3$ ), 2.00(s, AcO), 3.16(bs, 6- $\text{H}_2$ ), 4.24(q,  $\underline{J}$  7z, 2 x  $\text{OCH}_2\text{CH}_3$ ), 5.83 & 6.15(m, 4- and

5-H), ca.6.1(3-H) ).

(f) 'ene' reaction of diethyl thioxomalonate (46) to give (-)-6,6-dimethyl-2-(diethyl-3,3-dicarboxylate-2-thiapropane)-bicyclo[3.3.1]hept-2-ene (101).

i) from the anthracene adduct (95) of diethyl thioxomalonate (46).

The anthracene adduct (95) (260mg, 0.71mmol) and (-)- $\beta$ -pinene (250mg, 1.8mmol) were refluxed in dry toluene (25ml), for 1h, under nitrogen. The solution was cooled and evaporated to dryness under reduced pressure with heating, then desiccated under vacuum to give a yellow solid (450mg). Preparative t.l.c. using dichloromethane/light petroleum (1:1) as elutant gave (101) as a yellow oil (140mg, 61%). [Found: C, 62.34; H, 7.92; S, 10.01%;  $m/z$  326.1571.  $C_{17}H_{26}O_4S$  requires C, 62.55; H, 8.03; S, 9.88%;  $M^+$  326.1565.]; [ $\alpha_D^{22}$ -8°(MeOH);  $\nu_{max}$  (thin film) 1745, 1730 $cm^{-1}$ ;  $\delta_H$  (90MHz) 0.80 & 1.24(s, 2 x 6-Me), 1.26(t,  $J$  7Hz, 2 x  $OCH_2CH_3$ ), 2.01-2.45(m, 1- and 5- H, 4- and 7-H), 3.25(bs,  $CH_2S$ ), 4.11(s, CHS), 4.22(q,  $J$  7Hz, 2 x  $OCH_2CH_3$ ), 5.47(bs, 3-H).

ii) from the cyclopentadiene adduct (93) of diethyl thioxomalonate (46).

The cyclopentadiene adduct (93) (114mg, 0.45mmol) and (-)- $\beta$ -pinene (180mg, 1.3mmol) were refluxed in dry toluene (10ml), for 4h, under nitrogen. The solution was cooled and evaporated to dryness under reduced pressure with heating, then desiccated under vacuum to give a brown oil (189mg). Preparative t.l.c. using dichloromethane/light petroleum (1:1) as elutant gave (101) as a yellow oil (43mg, 30%). The  $^1\text{H}$  n.m.r. spectrum was identical to that of material produced in i).

PREPARATION OF CYCLOADDUCTS OF DIETHYL THIOXOMALONATE S-OXIDE.

Preparation of Diethyl 3,6-Dihydro-4,5-dimethylthiopyran-2,2-dicarboxylate S-oxide (149).

m-Chloroperoxybenzoic acid (mCPBA) (1.15g, 6.69mmol) in dichloromethane (10ml) was added dropwise with shaking, over 15min, to a solution of (47) (1.47g, 5.40mmol) in dichloromethane (10ml) at room temperature. The solution was left standing for 1h, then diluted with dichloromethane (30ml), and washed with 10% aqueous potassium sulphite (2 x 30ml), then water (30ml). The dichloromethane solution was then dried (magnesium sulphate), filtered and evaporated to dryness under reduced pressure, and desiccated over silica gel under vacuum to give the S-oxide (149) as a yellow oil (1.41g, 91%)<sup>55,73,74</sup>, b.pt. 140°C (0.1mm Hg). [Found: C, 54.11; H, 6.81; S, 11.41%;  $m/z$  288.1032. Calc. for  $C_{13}H_{20}O_5S$  C, 54.15; H, 6.99; S, 11.12%;  $M^+$  288.1032.];  $\nu_{max}$  (thin film) 1750, 1730 $cm^{-1}$ ;  $\delta_H$  (90MHz) 1.15 & 1.25(2 x t,  $J$  7Hz, 2 x  $OCH_2CH_3$ ), 1.63 & 1.96(s, 5- and 6-Me), 2.78-3.52(m, 3- $H_2$  and 6- $H_2$ ), 4.15 & 4.25(2 x q,  $J$  7Hz, 2 x  $OCH_2CH_3$ );  $\delta_C$  (DEPT 50.3MHz) 13.5(2 x  $OCH_2CH_3$ ), 18.8 & 19.9(4- and 5- Me), 27.7(C-3), 50.6(C-6), 62.2 & 62.5(2 x  $OCH_2CH_3$ ), 70.0(C-2), 115.7 & 124.9(C-4 and -5), 184.9 & 185.3(2 X  $CO_2$ ).

Preparation of *exo*-Diethyl 2-Thiabicyclo[2.2.1]hept-5-ene-3,3-dicarboxylate *S*-Oxide (173).

*m*-Chloroperoxybenzoic acid (mCPBA) (0.94g, 5.47mmol) in dichloromethane (10ml) was added dropwise with shaking, over 15min, to a solution of (93) (1.29g, 5.04mmol) in dichloromethane (10ml) at room temperature. The solution was left standing for 1h, then diluted with dichloromethane (30ml), and washed with 10% aqueous potassium sulphite (2 x 30ml), then water (30ml). The dichloromethane solution was then dried (magnesium sulphate), filtered and evaporated to dryness under reduced pressure, and desiccated over silica gel under vacuum to give the *S*-oxide (173) as a yellow oil (1.21g, 89%), b.pt. >200°C (0.1mm Hg). [Found: C, 52.74; H, 6.20; S, 11.80%;  $\underline{m/z}$  277.0715.  $\text{C}_{12}\text{H}_{16}\text{O}_5\text{S}$  requires C, 52.93; H, 5.92; S, 11.77%;  $\text{M}^+$  272.0719.];  $\nu_{\text{max}}$  (thin film) 1735 $\text{cm}^{-1}$ ;  $\delta_{\text{H}}$  (90MHz) 1.14 & 1.24(2 x t,  $\underline{J}$  7Hz, 2 x  $\text{OCH}_2\text{CH}_3$ ), 2.35(dt,  $\underline{J}$  12, 2Hz, 7-H), 3.04(d,  $\underline{J}$  12Hz, 7-H), 3.62(bs, 1- or 4-H), 4.02-4.32(m, 1- or 4-H and 2 x  $\text{OCH}_2\text{CH}_3$ ), 5.94 & 6.29(m, 5- and 6-H);  $\delta_{\text{C}}$  (DEPT 50.3MHz) 13.9 & 14.0(2 x  $\text{OCH}_2\text{CH}_3$ ), 45.7(C-7), 47.8(C-4), 62.3 & 62.7(2 x  $\text{OCH}_2\text{CH}_3$ ), 69.0(C-1), 83.0(C-3), 130.2 & 141.1(C-5 and -6), 164 & 166(2 x  $\text{CO}_2$ ).

Preparation of Diethyl 9,10-Dihydro-10,9-(epithiomethano)anthracene-12,12-dicarboxylate S-Oxide (172)

(a) with mCPBA in dichloromethane.

m-Chloroperoxybenzoic acid (mCPBA) (238mg, 1.38mmol) in dichloromethane (5ml) was added dropwise with shaking, over 15min, to a solution of (95) (410mg, 1.12mmol) in dichloromethane (10ml) at room temperature. The solution was left standing for 1h, then diluted with dichloromethane (30ml), and washed with 10% aqueous potassium sulphite (2 x 30ml), then water (30ml). The dichloromethane solution was dried (magnesium sulphate), filtered and evaporated to dryness under reduced pressure, and desiccated over silica gel under vacuum to give the S-oxide (172), recrystallised from methanol as white plates (336mg, 79%), m.pt. 94-98°C.  $\nu_{\max}$  (thin film) 1735 $\text{cm}^{-1}$ ;  $\delta_{\text{H}}$  (200MHz) 1.10 & 1.20(2 x t,  $\underline{\text{J}}$  7Hz,  $\text{OCH}_2\text{CH}_3$ ), 3.91-4.36(m, 2 x  $\text{OCH}_2\text{CH}_3$ ), 5.26 & 5.78(2 x s, 9- and 10-H), 7.21-7.56(m, Ar-H);  $\delta_{\text{C}}$  (DEPT 50.3MHz) 13.9(2 x  $\text{OCH}_2\text{CH}_3$ ), 49.7(C-9), 62.5(2 x  $\text{OCH}_2\text{CH}_3$ ), 68.1(C-10), 82.7(C-12), 125.3-132.9(Ar), 162.9 & 165.8(2 x  $\text{CO}_2$ ).

(b) with peracetic acid in dichloromethane.

A solution of peracetic acid (34% w/w in acetic acid) (1.03g, 4.61mmol) in dichloromethane (5ml) was added dropwise with shaking, over 10min, to a solution of (95) (1.41g, 3.67mmol) in dichloromethane (15ml) at room temperature. The solution was left standing for 1h, then diluted with dichloromethane (30ml), washed with 5% aqueous sodium hydrogen carbonate (2 x 50ml), and water (50ml). The dichloromethane solution was then dried (magnesium sulphate), filtered and evaporated to dryness under reduced pressure, and desiccated over silica gel under vacuum to give the S-oxide (172) as white plates (ex. MeOH) (1.29g, 88%). The material had an identical  $^1\text{H}$  n.m.r. spectrum to material made in (a).

(c) with peracetic acid in diethyl ether.

A solution of peracetic acid (27% w/w in acetic acid) (201mg, 0.75mmol) in diethyl ether (5ml) was added dropwise with shaking, over 10min, to a solution of (95) (270mg, 0.73mmol) in diethyl ether (30ml) at room temperature. The solution was left standing for 1h, then evaporated to dryness, redissolved in dichloromethane (50ml) and worked up as in (b) to give (172) as white plates (242mg, 86%). The material had an identical  $^1\text{H}$  n.m.r. spectrum to material made in (a).



Preparation of Diethyl 5-Oxothiane-2,2-dicarboxylate S-Oxide (183).

A solution of peracetic acid (27% w/w in acetic acid) (80mg, 0.30mmol) in diethyl ether (5ml) was added dropwise with shaking, over 10min, to a solution of (98) (66mg, 0.25mmol) in diethyl ether (30ml) at room temperature. The solution was left standing for 1h, then evaporated to dryness, redissolved in dichloromethane (50ml) and worked up as in (b) to give the S-oxide (183) as a pale yellow oil (54mg, 77%).  $\delta_{\text{H}}$  (200MHz) 1.29(t,  $\underline{\text{J}}$  7.1Hz,  $\text{OCH}_2\text{CH}_3$ ), 1.31(t,  $\underline{\text{J}}$  7.1Hz,  $\text{OCH}_2\text{CH}_3$ ), 2.50-3.22(m, 3-H and 4-H<sub>2</sub>), 3.64(dd,  $\text{J}$  14.5, 1.3Hz, 6-H<sub>2</sub>), 4.09(d,  $\underline{\text{J}}$  14.4Hz, 6-H<sub>2</sub>), 4.25-4.41(m, 2 x  $\text{OCH}_2\text{CH}_3$ );  $\delta_{\text{C}}$  (DEPT 50.3MHz) 13.9Hz(2 x  $\text{OCH}_2\text{CH}_3$ ), 25.6(C-3), 37.1(C-4), 57.6(C-6), 63.4 & 63.6(2 x  $\text{OCH}_2\text{CH}_3$ ), 71.3(C-2), 164.2 & 165.9(2 x  $\text{CO}_2$ ).

TRANSFER REACTIONS OF DIETHYL THIOXOMALONATE S-OXIDE.

(a) From the anthracene adduct (172)

i) to cyclopentadiene in refluxing toluene to give the sultene (174).

The anthracene adduct (172) (60mg, 0.16mmol) and cyclopentadiene (53mg, 0.81mmol) were refluxed in dry toluene (10ml), under a nitrogen atmosphere, for 1h. The solution was cooled and evaporated to dryness under reduced pressure with heating. The residue was extracted with cold methanol (2ml) and the methanolic solution was filtered and evaporated to dryness under reduced pressure, then desiccated over silica gel under vacuum to give the sultene (174) as a yellow oil (30mg, 71%), b.pt. >250°C (0.1mm Hg)

[Found:  $\underline{m/z}$  272.0724.  $C_{12}H_{16}O_5S$  requires  $M^+$  272.0718.];

$\nu_{\max}$  (thin film) 1790, 1735 $cm^{-1}$ ;  $\delta_H$  (200MHz) 1.24(t,  $J$  7.0Hz,  $OCH_2CH_3$ ), 1.25(t,  $J$  7.2Hz,  $OCH_2CH_3$ ), 2.19(ddq,  $J_{en,ex}$  17.8,  $J$  4.6, 2.3Hz,  $6_{ex}$  -H), 2.56(ddt,  $J_{en,ex}$  17.8,  $J$  8.6Hz,  $J_{5,6en} = J_{8,6en}$  2.2Hz,  $6_{en}$  -H), 3.63(ddd,  $J_{1,5}$  8.5Hz,  $J_{6ex,5}$  4.6Hz,  $J_{6en,5}$  2.2Hz, 5-H), 4.21(q,  $J$  7.1Hz,  $OCH_2CH_3$ ), 4.23(q,  $J$  7.1 Hz,  $OCH_2CH_3$ ), 5.54(dt,  $J_{5,1}$  8.5Hz,  $J_{8,1} = J_{6en,1}$  2.4Hz, 1-H), 5.68(dt,  $J_{8,7}$  5.9Hz,  $J_{1,8} = J_{6en,8}$  2.2Hz, 8-H), 6.10(dd,  $J$  5.9Hz,  $J_{7,6en}$  1.9Hz, 7-H);  $\delta_C$  (25.1MHz) 14.0(2 x  $OCH_2CH_3$ ), 36.1(C-6), 48.7(C-5), 62.5(2 x  $OCH_2CH_3$ ), 76.0(C-4), 97.6(C-1),

128.2(C-8), 138.2(C-7), 166.0 & 168.8(2 x CO<sub>2</sub>).

ii) to cyclopentadiene in refluxing benzene to give 2:1 (173) and (174).

The anthracene adduct (172) (31mg, 0.08mmol) and cyclopentadiene (27mg, 0.42mmol) were refluxed in dry benzene (5ml), under a nitrogen atmosphere, for 40min (reaction complete). The solution was cooled and evaporated to dryness under reduced pressure, with heating, to give a white solid (33mg). This was shown by <sup>1</sup>H n.m.r. spectroscopy to contain no starting material (172), but contained anthracene, and a mixture of the exo-cyclopentadiene adduct (173) and the sultene (174) in a ratio of 2:1.

iii) to 2,3-dimethyl-1,3-butadiene to give (149).

The anthracene adduct (172) (68mg, 0.18mmol) and 2,3-dimethyl-1,3-butadiene (73mg, 0.89mmol) were refluxed in dry benzene (15ml), under a nitrogen atmosphere, for 1h. The solution was cooled and evaporated to dryness under reduced pressure, with heating, then desiccated over silica gel under vacuum to give a yellow solid (88mg). This solid was purified by preparative t.l.c. on a silica plate using diethyl ether as elutant to give the cycloadduct (149) as a yellow oil (32mg, 64%).

(b) From the exo-cyclopentadiene adduct (173) to give the 2,3-dimethyl-1,3-butadiene adduct (149).

The exo-cyclopentadiene adduct (173) (120mg, 0.44mmol) and 2,3-dimethyl-1,3-butadiene (183mg, 2.24mmol) were refluxed in dry toluene (20ml), under a nitrogen atmosphere, for 1h. The solution was cooled and evaporated to dryness under reduced pressure, with heating, then desiccated over silica gel under vacuum to give an orange oil (127mg). <sup>1</sup>H n.m.r. spectroscopy showed ca. 5% of this mixture to be the sultene (174). This solid was purified by preparative t.l.c. on a silica plate using diethyl ether as elutant to give the cycloadduct (149) as a yellow oil (102mg, 80%).

(c) On heating the exo-cyclopentadiene adduct (173) alone.

The exo-cyclopentadiene adduct (173) (3.10g, 11.4mmol) was refluxed in dry toluene (100ml), under a nitrogen atmosphere, for 1h. The solution was cooled and evaporated to dryness under reduced pressure, with heating, then desiccated over silica gel under vacuum to give the sultene (174) as a yellow oil (2.72g, 88%). The <sup>1</sup>H n.m.r. spectrum of this material was identical to that produced in (a) i).

(d) Competition experiment.

The anthracene adduct (172) (116mg, 0.30mmol), cyclopentadiene (61mg, 0.92mmol) and 2,3-dimethyl-1,3-butadiene (76mg, 0.93mmol) were refluxed in dry benzene (20ml), under a nitrogen atmosphere, for 1h. The solution was cooled and evaporated to dryness under reduced pressure, with heating, to give a white solid (141mg). This was shown by <sup>1</sup>H n.m.r. spectroscopy to contain no starting material (172), but contained anthracene, and a mixture of the exo-cyclopentadiene adduct (173) and the sultene (174) in a ratio of 2:1. No 2,3-dimethyl-1,3-butadiene adduct (149) was observed.

(e) Measurement of rates of transfer

The anthracene adduct (172) (15.7mg, 0.041mmol) and 2,3-dimethyl-1,3-butadiene (32.9mg, 0.401mmol) were dissolved in dry benzene in a standard flask (50.0ml). Eight portions (2.0ml each) were taken and arranged in separate test-tubes, each fitted with a nitrogen-filled balloon. The test-tubes were suspended in a thermostatted water bath at 60 C and removed at set time-intervals and cooled immediately in ice-water.

The portions were than each diluted with hexane in individual standard flasks (10.0ml) and the amount of liberated anthracene determined by ultraviolet spectroscopy. All absorbances were measured at  $\lambda_{\max}$  355.0nm in a 10mm cell. The absorbances was taken from 0min and at regular intervals until 24h (taken as complete reaction).

The reaction was thus shown to be approximately first-order with respect to the concentration of (172), with a rate-constant, k, of  $2.82 \times 10^{-4} \text{ s}^{-1}$ .

(f) Flash Vacuum Pyrolysis (F.V.P.) of the anthracene adduct (172).In general:-

The anthracene adduct (172) was dispersed onto freshly dried

Figure 3. Flash Vacuum Pyrolysis Apparatus.

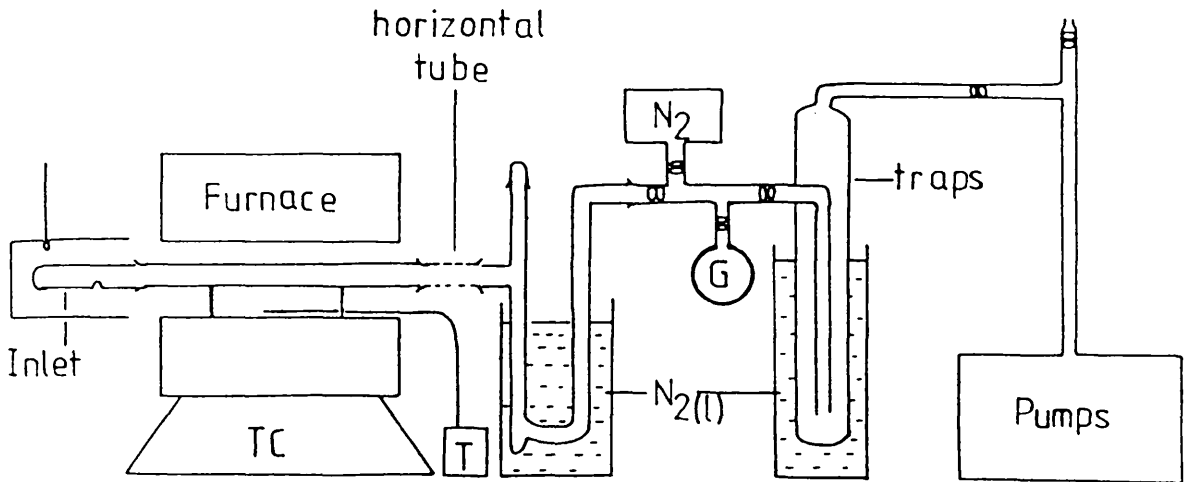

G:Gauges      T:Thermocouple

TC:Temperature control unit

and ground magnesium sulphate by first dissolving (172) in dichloromethane, then adding the magnesium sulphate, and evaporating to dryness under reduced pressure and desiccating the residue over phosphorus pentoxide under vacuum. This sample was placed in the sample chamber of the F.V.P. apparatus<sup>123</sup> (Figure 3), the apparatus flushed with nitrogen, and the adduct (172) was then volatilised under high vacuum by heating the sample chamber at ca.160°C for 10min. Volatilised (172) then passed through the oven (preheated to 500°C), and the pyrolysis product(s) were caught in a cold trap at liquid nitrogen temperatures (anthracene invariably solidified onto the glass tube before the cold trap effectively separating it from any other products). In some experiments, a large excess of either cyclopentadiene or water was already present in the cold trap, having previously been distilled into the system under high vacuum. In all cases byproduct(s) consistent with oligomer(s)/polymer(s) of the sulphine (148) were obtained. Elemental sulphur was also always produced (detected on analytical t.l.c. by spraying with 5% silver nitrate in aqueous acetone).

- i) Trapping the sulphine (148) in cold trap in presence of cyclopentadiene.

The anthracene adduct (172) (122g, 0.32mmol) on magnesium



sulphate (0.63g) was volatilised and passed through an oven at 500 C ( $3 \times 10^{-4}$  mbar), and the more volatile products (free of anthracene) were trapped in a cold trap in the presence of cyclopentadiene (212mg, 3.2mmol). The system was filled with nitrogen to atmospheric pressure and cyclopentadiene (208mg, 3.2mmol) in dichloromethane (10ml) was added to the cold trap under nitrogen, and the mixture allowed to warm up to room temperature. The resultant solution was evaporated to dryness under reduced pressure, and desiccated under vacuum to give a yellow oil (57mg). <sup>1</sup>H n.m.r. spectroscopy showed that, from integration of the signals due to carboxyethyl groups, ca.70% of the sulphine trapped had formed a cycloadduct with cyclopentadiene (giving the exo-isomer only). The other ca.30% had formed byproduct(s) related to oligomer(s)/polymer(s) of the sulphine (analysed by mass spectroscopy). Only a trace of diethyl malonate was observed in the <sup>1</sup>H n.m.r. spectrum. Preparative t.l.c. of the mixture gave the exo-cyclopentadiene adduct (173) as a yellow oil (41mg, 47%).

ii) Trapping the sulphine (148) in cold trap in presence of water.

The anthracene adduct (172) (92g, 0.24mmol) on magnesium sulphate (0.94g) was volatilised and passed through an oven at 500°C ( $2 \times 10^{-4}$  mbar), and the more volatile products (free of

anthracene) were trapped in a cold trap in the presence of water (82mg, 4.6mmol). The system was filled with nitrogen to atmospheric pressure and dichloromethane (10ml) was added to the cold trap under nitrogen, and the mixture allowed to warm up to room temperature. The resultant solution was evaporated to dryness under reduced pressure, and desiccated under vacuum to give a yellow oil (30mg).  $^{13}\text{C}$  &  $^1\text{H}$  n.m.r. spectroscopy showed that, from integration of the signals due to carboxyethyl groups, ca.60% of the sulphine trapped had been hydrolysed to give diethyl malonate (175). The other ca.40% had formed byproduct(s) related to oligomer(s)/polymer(s) of the sulphine (as in i)).

iii) Trapping the sulphine (148) in cold trap alone.

The anthracene adduct (172) (89g, 0.23mmol) on magnesium sulphate (0.92g) was volatilised and passed through an oven at 500°C ( $2 \times 10^{-4}$  mbar), and the more volatile products (free of anthracene) were trapped in a cold trap. The system was filled with nitrogen to atmospheric pressure and dichloromethane (10ml) was added to the cold trap under nitrogen, and the mixture allowed to warm up to room temperature. The resultant solution was evaporated to dryness under reduced pressure, and desiccated under vacuum to give a yellow oil (20mg).  $^{13}\text{C}$  &  $^1\text{H}$  n.m.r. spectroscopy showed that, from integration of the signals due to carboxyethyl groups, ca.40%

of the sulphine trapped had been hydrolysed to give diethyl malonate (175). The other ca.60% had formed byproduct(s) related to oligomer(s)/polymer(s) of the sulphine (as in i)).

(g) Regioselectivity of transfer reactions of diethyl thioxomalonate S-oxide (148).

i) in refluxing benzene to give a 4:1 mixture of (183) and (182).

The anthracene adduct (172) (149mg, 0.39mmol) and 2-(trimethylsilyloxy)-1,3-butadiene (0.10ml, 1.0mmol) were refluxed in dry benzene (35ml) for 1h, under a nitrogen atmosphere. The solution was then cooled and evaporated to dryness under reduced pressure with heating to give a white solid (322mg). This residue was dissolved in tetrahydrofuran (10ml) with potassium fluoride (68mg) and three drops of water (ca. 200mg) and left to stand at room temperature overnight. The mixture was evaporated to dryness under reduced pressure and dissolved in dichloromethane (20ml), washed with water (2 x 20ml) and dried (magnesium sulphate). The solution was filtered, evaporated to dryness and desiccated over silica gel under vacuum to give an orange solid (138mg) which was purified by preparative t.l.c. using ethyl acetate-light petroleum (3:2) as elutant to give an orange oil (51mg, 48%). This oil was determined by  $^1\text{H}$  and  $^{13}\text{C}$  n.m.r. to be a 4:1 mixture of the 5-oxo-

isomer (183) and the 4-oxo-isomer (182). The n.m.r. contained identical peaks to those for (183) made by peracid oxidation of (98).

ii) in refluxing toluene to give (182).

The anthracene adduct (172) (313mg, 0.82mmol) and 2-(trimethylsilyloxy)-1,3-butadiene (0.25ml, 2.5mmol) were refluxed in dry benzene (50ml) for 1h, under a nitrogen atmosphere. The solution was then cooled and evaporated to dryness under reduced pressure with heating to give a white solid (614mg). This residue was dissolved in tetrahydrofuran (15ml) with potassium fluoride (140mg) and four drops of water (ca. 300mg) and left to stand at room temperature overnight. The mixture was evaporated to dryness under reduced pressure and dissolved in dichloromethane (40ml), washed with water (2 x 40ml) and dried (magnesium sulphate). The solution was filtered, evaporated to dryness and desiccated over silica gel under vacuum to give a brown solid (326mg) which was purified by preparative t.l.c. using ethyl acetate-light petroleum (3:2) as elutant to give an orange oil (66mg, 30%). This oil was determined by  $^1\text{H}$  and  $^{13}\text{C}$  n.m.r. to be a almost entirely diethyl 4-oxothiane-2,2-dicarboxylate S-oxide (182) (with only a trace of the 5-oxo-isomer (183) ).  $\delta_{\text{H}}$  (200MHz) 1.2-1.4(m, 2 x  $\text{OCH}_2\text{CH}_3$ ), 2.38-3.20(m, 5-H<sub>2</sub> and 6-H<sub>2</sub> ), 3.13(d,  $\underline{J}$  15.8Hz, 3-H), 3.63(d,

$J$  15.7Hz, 3-H), 4.1-4.4(m 2 x  $\text{OCH}_2\text{CH}_3$ );  $\delta_c$ (DEPT 50.3MHz) 13.9(2 x  $\text{OCH}_2\text{CH}_3$ ), 30.2(C-3), 38.2(C-5), 44.2(C-6), 62.3 & 62.9(2 x  $\text{OCH}_2\text{CH}_3$ ), 70.2(C-2), 163 & 165(2 x  $\text{CO}_2$ ).

PREPARATION OF CYCLOADDUCTS OF DIETHYL SELENOXOMALONATE (229).Preparation of Diethyl Selenocyanatomalonate (244) from Diethyl Bromomalonate (91).

Diethyl bromomalonate (91) (28.71g, 0.120 mol) in ethanol (50ml) was added dropwise over 10min to potassium selenocyanate (32.14g, 0.223mol) in ethanol (200ml) at reflux. This solution was refluxed for a further 1h, and then was cooled and evaporated under reduced pressure with heating to give an orange oil, which was then dissolved with ether (100ml). This solution was washed with 5% aq. hydrochloric acid (2 x 30ml), then with water (2 x 30ml). The ether layer was dried (magnesium sulphate), filtered and evaporated under reduced pressure to give a yellow oil, which was fractionally distilled to give diethyl selenocyanatomalonate (244) (9.39g, 30%) as a yellow oil, b.pt. 85°C (0.1mm Hg). [Found: C, 36.34; H, 3.92%;  $\underline{m/z}$  ( $^{80}\text{Se}$ ) 264.9856.  $\text{C}_8\text{H}_{11}\text{NO}_4\text{Se}$  requires C, 36.4; H, 4.2%;  $\text{M}^+$  ( $^{80}\text{Se}$ ) 264.9855.];  $\nu_{\text{max}}$  (thin film) 1730 $\text{cm}^{-1}$ ;  $\delta_{\text{H}}$  (90MHz) 1.32(t,  $\underline{J}$  7.3Hz,  $\text{OCH}_2\text{CH}_2$ ), 4.33(q,  $\underline{J}$  7.3Hz,  $\text{OCH}_2\text{CH}_2$ ), 4.93(s, HCSe). The first fraction from the distillation contained mainly diethyl malonate, the major byproduct, identified by  $^1\text{H}$  n.m.r. and boiling point.

Preparation of Diethyl 3,6-Dihydro-4,5-dimethyl-selenopyran-  
-2,2-dicarboxylate (249).

(i) from Diethyl Selenocyanatomalonate (2244).

Method A:-

Diethyl selenocyanatomalonate (244) (1.86g, 7.05mmol), 2,3-dimethyl- 1,3-butadiene (1.71g, 20.9mmol) and calcium chloride dihydrate (0.99g, 6.73mmol) in ethanol (15ml) were heated to reflux. Triethylamine (0.74g, 7.33mmol) in ethanol (15ml) was added dropwise over 15min to the refluxing solution. After a further 1h at reflux, the solution was cooled and evaporated to dryness under reduced pressure with heating. The residue was dissolved in chloroform (50ml) and washed with 5% aq. hydrochloric acid (2 x 50ml), then with water (2 x 50ml). The chloroform solution was dried (magnesium sulphate), filtered and evaporated to dryness to give a yellow oil (1.87g). Chromatography on a silica (t.l.c. grade) column with chloroform as elutant gave the selenopyran (249) (0.97g, 43%) as a yellow oil, b.pt. 115°C (0.03mm Hg). [Found: C, 48.86; H, 6.21%;  $m/z$ ( $^{80}\text{Se}$ ) 320.0527.  $\text{C}_{13}\text{H}_{20}\text{O}_4\text{Se}$  requires C, 48.9; H, 6.3%;  $M^+$ ( $^{80}\text{Se}$ ) 320.0527.];

$\nu_{\text{max}}$  (thin film) 1730 $\text{cm}^{-1}$  ;  $\delta_{\text{H}}$  (90Mhz) 1.23(t,  $J$  7.3Hz,  $\text{OCH}_2\text{CH}_3$ ), 1.77(bs, 4- and 5-Me), 2.73(bs, 3-H<sub>2</sub>), 3.14(bs, 6-H<sub>2</sub>), 4.20(q,  $J$  7.3Hz,  $\text{OCH}_2\text{CH}_3$ ).

Method B:-

Diethyl selenocyanatomalonate (244) (170mg, 0.64mmol), and 2,3-dimethyl-1,3-butadiene (213mg, 2.6mmol) were dissolved in dichloromethane (5ml) at room temperature. Triethylamine (67mg, 0.65mmol) in dichloromethane (5ml) was added dropwise over 15min with stirring. After a further 24h stirring, the solution was washed with water (2 x 20ml). The solution was dried (magnesium sulphate), filtered and evaporated to dryness to give a yellow oil (102mg). Preparative t.l.c. on a silica plate using ether/light petroleum (3:7) as elutant gave the selenopyran (249) (96mg, 46%) as a yellow oil. The  $^1\text{H}$  n.m.r. spectrum of this oil was identical with that of material made by method A.

(ii) via Potassium Se,Se-Di(ethoxycarbonyl) Selenosulphate (250).

Potassium sulphite (5.01g, 31.7mmol) and grey selenium (2.07g, 26.2mmol) were heated under reflux in water (50ml) for 30min, cooled and filtered to give a solution containing potassium selenosulphate. Diethyl 2-bromomalonate (91) (5.98g, 25.0mmol) in ethanol (75ml) was added to this solution at room temperature and the mixture was shaken briefly before addition of 2,3-dimethyl-1,3-butadiene (10.24g, 125mmol) and calcium chloride dihydrate (3.71g, 25.2mmol) in ethanol (50ml). Lastly, triethylamine (2.56g, 25.3mmol) in ethanol (25ml) was added



dropwise over 5min with stirring. After a further 1h stirring at room temperature, the resulting red solution was evaporated to dryness under reduced pressure with heating. The residue was dissolved in diethyl ether (50ml) and washed with aq. hydrochloric acid (50ml) and then water (50ml). The ether layer was dried (magnesium sulphate), filtered and evaporated to dryness under reduced pressure to give, after desiccation under vacuum, a yellow oil (1.82g). Preparative t.l.c. on silica plates using ether/light petroleum (3:7) as elutant gave the pure selenopyran (249) as a yellow oil (18%). The  $^1\text{H}$  n.m.r. spectrum of this oil was identical with that of material made in (i).

Preparation of Diethyl 2-Selenabicyclo[2.2.1]hept-5-ene-3,3-  
-dicarboxylate (230).

(i) from Diethyl Selenocyanatomalonate (244) [Method B].

Diethyl selenocyanatomalonate (244) (69.2g, 0.26mmol), and cyclopentadiene (93.8g, 1.42mmol) were dissolved in dichloromethane (5ml) at room temperature. Triethylamine (34.5mg, 0.34mmol) in dichloromethane (5ml) was added dropwise over 15min with stirring. After a further 24h stirring, the solution was washed with water (2 x 20ml). The solution was dried (magnesium sulphate), filtered and

evaporated to dryness to give a yellow oil (97mg). Preparative t.l.c. on a silica plate using ether/light petroleum (3:7) as elutant gave the adduct  $9^8$  (230) (17.6mg, 22%) as a yellow oil, b.pt.  $110^\circ\text{C}$  (0.02mm Hg). [Found: C, 47.58; H, 5.39%;  $m/z$  ( $^{80}\text{Se}$ ) 304.0207. Calc. for  $\text{C}_{12}\text{H}_{16}\text{O}_4\text{Se}$  : C, 47.54, H, 5.32%;  $M^+$  ( $^{80}\text{Se}$ ) 304.0209.];  $\nu_{\text{max}}$  (thin film) 1730 and 1755 $\text{cm}^{-1}$ ;  $\delta_{\text{H}}$  (90MHz) 1.24 & 1.25(2 x t,  $J$  7Hz, 2 x  $\text{OCH}_2\text{CH}_3$ ), 1.97 & 2.23(ABq,  $J$  12Hz, 7- $\text{H}_2$ ), 3.61(bs, 1- or 4-H), 4.20 & 4.22(2 x q,  $J$  7Hz, 2 x  $\text{OCH}_2\text{CH}_3$ ), 4.42(bs, 4- or 1- H), 5.74 & 6.57(2 x dd,  $J$  6 and 3Hz, 5- and 6-H).

(ii) via Potassium Se,Se-Di(ethoxycarbonyl) Selenosulphate (250).

Potassium sulphite (4.96g, 33.7mmol) and grey selenium (2.29g, 29.0mmol) were heated under reflux in water (50ml) for 30min, cooled and filtered to give a solution containing potassium selenosulphate. Diethyl 2-bromomalonate (91) (6.01g, 25.1mmol) in ethanol (75ml) was added to this solution at room temperature and the mixture was shaken briefly before addition of cyclopentadiene (4.00g, 60.6mmol) and calcium chloride dihydrate (3.75g, 25.5mmol) in ethanol (50ml). Lastly, triethylamine (2.48g, 24.5mmol) in ethanol (25ml) was added dropwise over 5min with stirring. After a further 1h stirring at room temperature, the resulting red solution was evaporated to dryness under reduced pressure with heating. The residue was dissolved in diethyl ether (50ml) and washed with aq.

hydrochloric acid (50ml) and then water (50ml). The ether layer was dried (magnesium sulphate), filtered and evaporated to dryness under reduced pressure to give, after desiccation under vacuum, a black oil (3.60g). Preparative t.l.c. on silica plates using ether/light petroleum (3:7) as elutant gave the pure cycloadduct (230) as a yellow oil (12%). The  $^1\text{H}$  n.m.r. spectrum of this oil was identical with that of material made in (i).

Isolation of Diethyl 2,3-Diselenabicyclo[3.3.0]oct-7-ene-4,4-dicarboxylate (252).

A portion (564mg) of the black oil, containing the cycloadduct (230), obtained from the selenosulphate (250) as described above, was left standing at room temperature for about a year before being purified by preparative t.l.c. on silica plates using ether/petroleum ether (3:7) as elutant. The cycloadduct (230) was absent, and the major component isolated was the diselenide (252) as an orange oil (30.2mg, 2% based on the selenosulphate). [Found: C, 37.73; H, 4.16%;  $m/z$  ( $2 \times ^{80}\text{Se}$ ) 383.9384.  $\text{C}_{12}\text{H}_{16}\text{O}_4\text{Se}_2$  requires C, 37.52; H, 4.20%;  $M^+$  ( $2 \times ^{80}\text{Se}$ ) 383.9379.];  $\nu_{\text{max}}$  (thin film)  $1740\text{cm}^{-1}$ ;  $\delta_{\text{H}}$  (200MHz) 1.25(t,  $J$  6.9Hz,  $\text{OCH}_2\text{CH}_3$ ), 1.26(t,  $J$  7.1Hz,  $\text{OCH}_2\text{CH}_3$ ), 2.33(ddq,  $J_{\text{ex, en}} = 16.9\text{Hz}$ ,  $J_{5,6\text{ex}} = 6.4\text{Hz}$ ,  $J_{1,6\text{ex}} = J_{7,6\text{ex}} = J_{8,6\text{ex}} = 2.4\text{Hz}$ ,  $\delta_{\text{ex}} -\text{H}$ ), 2.52(ddtd,  $J_{\text{ex, en}} = 16.9\text{Hz}$ ,  $J_{7,6\text{en}} = 8.3\text{Hz}$ ,  $J_{8,6\text{en}} = J_{1,6\text{en}} = 2.3\text{Hz}$ ,  $J_{5,6\text{en}} = 0.7\text{Hz}$ ,  $\delta_{\text{en}} -\text{H}$ ), ca. 4.1-4.4 (obscured, 5-H), 4.22(q,  $J$

7.1Hz,  $\text{OCH}_2\text{CH}_3$ ), 4.25(q,  $J$  7.2Hz,  $\text{OCH}_2\text{CH}_3$ ), 5.09(d,  $J_{5,1}$  7.1Hz, 1-H), 5.71 & 5.84(m, 7- and 8-H);  $\delta_c$  (DEPT 50.3MHz) 13.9 & 14.1(2 x  $\text{OCH}_2\text{CH}_3$ ), 36.7(C-6), 53.4(C-5), 59.7(C-4), 60.8(C-1), 62.3 & 63.0(2 x  $\text{OCH}_2\text{CH}_3$ ), 129.6 & 133.3(C-7,8), 167.6 & 168.3(2 x  $\text{CO}_2$ ).

REFERENCES.

1. F. Duus in "Comprehensive Organic Chemistry", ed. D. H. R. Barton and W. D. Ollis, Vol. 3, p373 (Pergamon 1979).
2. E. Campaigne in "The Chemistry of the Carbonyl Group", ed. S. Patai, Vol. 1, p936 (Wiley-Interscience, 1966).
3. R. Mayer in "Organosulphur Chemistry", ed. M. J. Janssen, p219 (Wiley-Interscience, 1967).
4. R. Mayer, J. Morgenstern, J. Fabian, Angew. Chem. (Ger.), 3, 157, (1964).
5. A. Wagner in "Methoden der Organische Chemie", ed. E. Millar, Vol. 9, p699 (Verlag, 1955).
6. E. Campaigne, Chem. Rev., 39, 1 (1946).
7. A. Ohno in "Organic Chemistry of Sulfur", ed S. Oae, p189 (Plenum, 1977).
8. D. Paquer, Int. J. Sulfur Chem. (B), 7, 269 (1972); 8, 173 (1973).
9. S. M. Weinreb, R. R. Staib, Tet., 3087 (1982).
10. W. Walter, J. Voss in "The Chemistry of the Amide Group", ed J. Zabichez, p383 (Wiley-Interscience, 1970).
11. S. Scheithauer, R. Mayer in "Topics in Sulfur Chemistry", ed. A. Senning, Vol. 4 (Thieme, 1979).
12. <sup>S. W. BARANOV, T. E. GORIZDRA AND I. D. KOMARITSA,</sup>  
A. P. Grischchuk ~~et al~~, Chem. Abs., 67, 116869c (1967).
13. <sup>F. MARSHNER, H. PRAEFKE, AND P. WEYERTH,</sup>  
G. Hohne ~~et al~~, Chem. Ber., 108, 673 (1975).
14. C. M. Bladon, I. E. G. Ferguson, G. W. Kirby, A. W. Lohead, D. C. McDougall, J. Chem. Soc. Chem. Comm., 423 (1983).
15. G. W. Kirby, A. W. Lohead, J. Chem. Soc. Chem. Comm., 1325 (1983);

- G. W. Kirby, A. W. Lothead, G. W. Shelldrake, ibid., 922, 1469 (1984).
16. C. M. Bladon, I. E. G. Ferguson, G. W. Kirby, A. W. Lothead, D. C. McDougall, J. Chem. Soc. Perkin Trans. 1, 1541 (1985).
17. K. Okuma, Y. Komiga, H. Ohta, Chem. Lett., 1145 (1988).
18. H. Staudinger, H. Fraudenberger, Chem. Ber., 61B, 1176 (1928).
19. D. C. Sen, J. Indian Chem. Soc., 12, 647, 751 (1935).
20. A. W. Hofmann, Ann., 145, 360 (1868).
21. A. W. Hofmann, Chem. Ber., 2, 152 (1869); T. Poleck, K. Thummel, ibid., 22, 2871 (1889).
22. R. Mayer, H. Berthold, Chem. Ber., 96, 3096 (1963); R. M. Olofson <sup>L. A. BAKER, R. F. GADALLAN AND R. A. SKIRROW</sup> et al, J. Org. Chem., 29, 1355 (1964).
23. S. O. Lawesson <sup>I. THOMAS, V. CHAUSSER, S. SCHNEIDER, AND</sup> et al, Org. Synth., 62, 158 (1984) and references therein.
24. Badische Anil-u Sodafabrik, German Patent no. 3,8074, (1886).
25. E. Klingsberg, D. Papa, J. Am. Chem. Soc., 73, 4988 (1951); J. Voss, Ann., 746, 92 (1971); D. H. R. Barton, Chem. Abs., 87, 53490n (1977); P. Beslin <sup>D. LAGAIN, S. JIALLE AND C. MINOT</sup> et al, Tet., 37, 3839 (1981).
26. S. Raucher, P. Klein, J. Org. Chem., 46, 3558 (1981).
27. H. Alper, J. K. Currie, R. Sachdeva, Angew. Chem. Int. Ed. Engl., 17, 689 (1978); A. R. Lapucha, Synthesis, 3, 256 (1987).
28. J. E. Baldwin, R. C. Lopez, Tet., 39, 1487 (1983).
29. K. Beelitz, G. Hohne, K. Praefcke, Z. Naturforsch. B., 33, 417 (1978).

30. Prof. J. K. Sutherland, Department of Chemistry, University of Manchester, personal communication (1986).
31. E. Vedejs, D. A. Perry, J. Am. Chem. Soc., 105, 1683 (1983).
32. J. C. Powers, F. H. Westheimer, J. Am. Chem. Soc., 82, 5431 (1960).
33. J. Hamer, J. A. Turner in "1,4- Cycloaddition Reactions", ed. J. Hamer, Ch. 8 (Academic Press).
34. E. Vedejs, D. A. Perry, K. N. Houk, N. G. Rondan, J. Am. Chem. Soc., 105, 6999 (1983).
35. D. M. Vyas, G. W. Hay, J. Chem. Soc. Perkin Trans. 1, 180 (1975).
36. E. Vedejs, T. H. Eberlein, R. G. Wilde, J. Am. Chem. Soc., 2220 (1988).
37. B. B. Snider, H. J. Hrib, L. Fuzesi, J. Chem. Soc., 98, 7115 (1976).
38. Arnold, Veeravagne, J. Am. Chem. Soc., 82, 5411 (1960); Gill, Wallace, J. Chem. Soc., Chem. Comm., 380, 382 (1977).
39. G. W. Kirby, S. S.-M. Choi, J. Chem. Soc. Chem. Comm., 177 (1988).
40. G. El. Nagaar, G. W. Kirby, Department of Chemistry, University of Glasgow, personal communication (1986).
41. A. I. Vogel in "A Textbook of Practical Organic Chemistry.", 3rd. ed., p499 (Longmans, 1986).
42. cf. C. S. Palmer, P. W. McWherter, Organic Synthesis, Collective Volume 1.
43. G. W. Kirby, M. C. McGuire, Department of Chemistry, University of Glasgow, personal communication (1986).



44. A. P. Cracknell in "Ultrasonics.", p180 (Wykeham Publications, 1980).
45. J. Sauer, D. Lang, A. Mielert, Angew. Chem. (Ger.), 74, 352 (1962).
46. cf. P. Horsewood, G. W. Kirby, R. P. Sharma, J. G. Sweeney, J. Chem. Soc., Perkin Trans. 1, 1802 (1981).
47. G. W. Kirby, M. S. Rahman, Department of Chemistry, University of Glasgow, personal communication (1989).
48. I Fleming in "Frontier Molecular Orbitals and Organic Chemical Reactions.", p164 (Wiley-Interscience, 1976).
49. <sup>H. BLOCK, E. MICHMAN, P. RIZMAN, AND B. LUTZ.</sup> E. Block ~~et al~~, Angew. Chem. Int. Ed. Engl., 15, 383 (1976).
50. J. F. King, T. Durst, J. Am. Chem. Soc., 85, 2676 (1963); B. Zwanenburg, J. Strating, Quart. Rep. Sulfur Chem., 5, 79 (1970).
51. I. W. J. Still, D. V. Frazer, D. K. T. Hutchison, J. F. Sawyer, Can. J. Chem., 368 (1989).
52. E. Block in "Organic Sulfur Chemistry.", ed. R. Kh. Freidlina, A. E. Skorova, p15 (Pergamon Press).
53. B. Zwanenburg, Recl. Trav. Chim. Pays-Bas, 101, 1 (1982).
54. W. Sundermeyer, Synthesis, 349 (1988).
55. B. Zwanenburg in "Reviews on Heteroatom Chemistry", ed. S. Oae, Vol. 1, p219 (MYU Tokyo, 1989).
56. W. Walter, G. Randau, Ann. Chem., 681, 55 (1965); W. Walter, K. D. Bode, *ibid.*, 231 (1982).
57. R. Ammon, H. Berninger, H. J. Haas, I. Landsberg, Arzneim. Forsch., 17, 521 (1967); A. L. Hunter, M. A. Holscher, R. A. Neal, J.

- Pharmacol. Exp. Ther., 200, 439 (1977).
58. B. Zwanenburg, L. Thijs, J. Strating, Tet. Lett., 21, 2871 (1968).
59. P. Metzner, T. N. Pham, J. Chem. Soc., Chem. Comm., 390 (1988).
60. B. G. Lenz, H. Regling, H. L. M. van Rozendaal, J. Org. Chem., 50, 2930 (1985).
61. A. A. Freer, G. W. Kirby, R. A. Lewis, J. Chem. Soc., Chem. Comm., 718 (1987).
62. W. A. Sheppard, J. Dieckmann, J. Am. Chem. Soc., 86, 1891 (1964).
63. T. Back, D. Barton, M. Britten-Kelly, F. Guziec, J. Chem. Soc., Perkin Trans. 1, 3, 2079 (1976).
64. N. Ramnath ~~et al~~, Chem. Lett., 89 (1982).
65. E. Wederkind, D. Schenk, R. Stusser, Ber., 56, 633 (1923).
66. J. F. King, T. Durst, Tet. Lett., 585 (1963).
67. J. Strating, Recl. Trav. Chim. Pays-Bas, 83, 94 (1964); J. F. King, Acc. Chem. Res., 8, 10 (1975).
68. W. Walter, Ann, 633, 35 (1960).
69. W. Wilkens, Ph.D. Thesis, Cornell University, Ithaca N. Y. (1961); A. I. Virstanen, Angew. Chem, 74, 374, (1962).
70. A. Elsasser, W. Sundermeyer, Chem. Ber., 118, 4553 (1985).
71. W. J. Middleton, E. G. Howard, W. H. Sharkey, J. Org. Chem., 30, 1384 (1985); T. Kitazume, N. Ishikawa, Chem. Lett., 267 (1973).
72. E. Block, A. Wall, J. Org. Chem., 52, 809 (1987).
73. H. L. M. van Rozendaal, B. Zwanenburg, J. Org. Chem., 50, 2930 (1985).

74. R. W. Saalfrank, W. Rost, Angew. Chem. Int. Ed. Engl., 24, 855 (1985).
75. E. Block, A. A. Bazzi, L. K. Revelle, J. Am. Chem. Soc., 102, 2490 (1980).
76. S. S. Battacharjee, H. Ila. Junjappa, Synthesis, 249 (1984).
77. I. W. J. Still, F. J. Ablenos, J. Chem. Soc., Chem. Comm., 542 (1985).
78. J. A. M. Kuipers, B. H. A. Lammerink, I. W. J. Still, and B. Zwanenburg ~~et al.~~, Synthesis, 295 (1981).
79. A. G. Schultz, R. H. Schlessinger, J. Chem. Soc., Chem. Comm., 747, 748 (1970).
80. G. E. Veentra, B. Zwanenburg, Tet., 34, 1585 (1978).
81. G. E. Veentra, B. Zwanenburg, Recl. Trav. Chim. Pays-Bas, 95, 28 (1976).
82. E. Flood, J. E. Boggs, J. Mol. Struct., 34, 147 (1976).
83. J. P. Snyder, J. Org. Chem., 38, 3965 (1973); I. Fleming in "Frontier Orbitals and Organic Chemical Reactions.", p147 (Wiley-Interscience, 1976).
84. A. I. Vogel in "A Textbook of Practical Organic Chemistry.", 3rd. ed., p303 (Longmans, 1986).
85. M. E. Jung, C. A. McCombs, Tet. Lett., 2935 (1976).
86. cf. E. Juaristi, J. S. Cruz-Sanchez, A. Peterson, R. S. Glass, Tet., 44, 5653 (1988) and references therein.
87. A. J. Kirby in "The Anomeric Effect and Related Stereoelectronic Effects at Oxygen.", p31 (Verlag, 1983).

88. W. H. H. Gunther in "Organic Selenium Compounds: Their Chemistry and Biology.", ed. D. L. Klayman and W. H. H. Gunther, p59 (Wiley-Interscience, 1973); R. B. Silverman, ibid., p245; K. A. Jenson, ibid., p263; K. G. Mautner, ibid., p473.
89. K. J. Irgolic, M. V. Kudchadker in "Selenium.", ed. R. A. Zingaro and W. C. Cooper (Van Nostrand Reinhold, 1974).
90. "Organic Compounds of Sulphur, Selenium and Tellurium.", vols. 1-6, (Specialist Periodical Reports; The Chemical Society: London, 1970-81).
91. C. Paulmier in "Selenium Reagents and Intermediates in Organic Synthesis.", ed. J. E. Baldwin, p58 (Pergamon Press, 1986).
92. F. J. Guziec Jnr. in "Organoselenium Chemistry.", ed. D. Liotta, p277 (Wiley-Interscience, 1987).
93. T. C. Wong, F. J. Guziec Jnr., C. A. Moustakis, J. Chem. Soc., Perkin Trans. 2, 1471 (1983).
94. H. E. Hallen, C. M. Jones, J. Chem. Soc. (A), 1033 (1969).
95. I. D. Rae, M. J. Wade, Int. J. Sulphur Chem., 8, 519 (1976).
96. C. D. Mickey, R. A. Zingaro, ibid., 8, 557 (1976).
97. P. T. Meinke, G. A. Krafft, Tet. Lett., 28, 5121 (1987).
98. J. Nakajama, K. Akimoto, J. Niijima, M. Hoshino, Tet. Lett., 28, 4423 (1987).
99. G. W. Kirby, A. N. Tretheway, J. Chem. Soc., Perkin Trans. 1, 1913 (1988).
100. J. SAKATA, Y. TACHI BAZA, T. HONDA AND H. OHTA.  
K. Okuma ~~et al.~~, Tet. Lett., 6649 (1987); Chem. Lett., 1145  
K. OKUMA, Y. KOMIYA AND H. OHTA.

- (1988).
101. T. Back, D. Barton, M. Britten-Kelly, F. J. Guziec Jr., J. Chem. Soc., Chem. Comm., 539 (1975); J. Chem. Soc., Perkin Trans. 1, 3, 2079 (1976).
102. T. W. Campbell, H. G. Walker, G. M. Cappinger, Chem. Rev., 50, 279 (1952).
103. D. S. Margolis, R. W. Pittman, J. Chem. Soc., 799 (1957).
104. W. H. H. Gunther in "Organic Selenium Compounds: Their Chemistry and Biology.", ed. D. L. Klayman and W. H. H. Gunther, p35 (Wiley-Interscience, 1973).
105. *ibid.*, p45
106. A. A. Kudryavtsev in The Chemistry and Technology of Selenium.", p57 (Collet's, 1974).
107. H. Grimm, H. Metzner, Ber., 69B, 1356 (1936).
108. W. H. H. Gunther in "Organic Selenium Compounds: Their Chemistry and Biology.", ed. D. L. Klayman and W. H. H. Gunther, p44 (Wiley-Interscience, 1973).
109. R. Okazaki, A. Ishii, N. Inamoto, J. Chem. Soc., Chem. Comm., 1429 (1983).
110. cf. F. J. Moustakis, C. A. Moustakis, J. Org. Chem., 49, 189 (1984); R. Okazaki, K. Inoue, N. Inamoto, Tet. Lett., 3673 (1979).
111. G. E. Erker, R. Hock, Angew. Chem. Int. Ed. Engl., 28, 179 (1989).
112. K. Steliou, M. Mrani, J. Am. Chem. Soc., 104, 3104 (1982).
113. M. Segi ~~et al.~~, J. Am. Chem. Soc., 110, 1976 (1988).  
T. NAKASIMA, S. SUGA, S. MURAI, I. RYU, A. OGAWA AND N. SONODA,

114. D. G. ALMON, W. H. WATSON, D. CRAIG, C. GUIBRY, R. MCKELHAR,  
AND A. L. ~~TERNA~~<sup>JNR.</sup>, J. Heterocyclic Chem., 20, 399 (1983).
115. C-P. Klages, J. Voss, Angew. Chem. Int. Ed. Engl., 16, 725 (1977).
116. G. Traverso, Ann. Chim. (Rome), 47, 3 (1957).
117. K. NAKAMURA, M. UOHAMA, S. OKA, T. YAMAGI, AND S. NAGATA,  
A. Ohno ~~et al.~~, Bull. Chem. Soc. Jpn., 48, 3718 (1975).
118. P. de Mayo, G. L. R. Patrasiumas, A. C. Weedon, Tet. Lett., 4621  
(1978).
119. G. W. Kirby, G. M. A. Naggar, personal communication, 1986.
120. J. G. Stark, H. G. Wallace in "Chemistry Data Book.", 2nd ed., p13  
(John Murray, 1982).
121. G. W. Kirby, A. N. Tretheway, personal communication, 1988.
122. J. Sauer, D. Lang, A. Mielert, Angew. Chem., 74, 352 (1962).
123. cf. R. C. Brown in "Pyrolytic Methods in Organic  
Chemistry: Applications of Flow and Flash Vacuum Pyrolysis  
Techniques." (Academic Press, 1980).