

Morphological Study Of Epoxy Resin After Electrical Tracking

by Abdul Syakur

Submission date: 06-Jan-2020 03:11PM (UTC+0700)

Submission ID: 1239488591

File name: Study_Of_Epoxy_Resin_After_Electrical_Tracking_no_abstract.pdf (1.3M)

Word count: 2482

Character count: 13327

Morphological Study of Epoxy Resin after Electrical Tracking

Abdul Syakur*, Juningtijastuti

I. INTRODUCTION

Epoxy resin is a thermosetting polymeric material. This material is very good for application of high or extra high voltage outdoor insulator in electrical power system. Epoxy resin polymeric insulating material has several advantages, i.e. high dielectric strength, light weight, high mechanical strength, easy to blend with additive, and easy maintenance if compared to that of porcelain and glass outdoor insulators which are commonly used especially in Indonesia. However, epoxy resin material also has several disadvantages, i.e. it has hydrophilic property, and the surface is very sensitive to aging so easily degraded when there is a flow of contaminants on its surface[1], [2].

Since the development of power systems, more than a hundred years ago, insulation design for polluted conditions has involved the modification of the size, spacing and shape of the individual insulators, or sheds, to obtain as much leakage

distance per unit length as possible, while maintaining high dielectric strength to avoid puncture by lightning impulses. Although parameters such as shed spacing, shape and diameter are important, leakage distance has become the single most important design parameter and has been the key to achieving optimal performance. Recently, polymeric insulating materials such as epoxy resin and silicon rubber have been widely used in the distribution and transmission lines for their good dielectric properties, light weight and compact, when compared to the porcelain or glass insulators[3]. Epoxy resin is an important electrical insulating material. It is a thermoset polymer which two components are mixed to eventually form a glassy product at room temperature. Epoxy is widely used for the housings of distribution apparatus such as transformer bushing, fused cut-outs, insulators, switches etc. When polymeric insulating materials used as outdoor insulator showed degradation due to climate stresses such as ultraviolet in sunlight, moisture, temperature, humidity, acid rain and the other contaminants so that the surface discharge, tracking, and erosion can occur, and degradation may reduce the performance[4], [5]. This reduction is actually the result of chemical and physical changes taking place on the surface of polymer. The presence of contaminants on the surface of the insulator becomes a serious problem. Different materials have different contamination performance. Generally, polymeric insulators perform better than ceramics when new. Berahim [6] has investigate that epoxy resin is a hydrophilic material, therefore in particular in tropical area: humidity, temperature, ultraviolet radiation and rainfall play an important role in accelerating of degradation process on the surface of the insulator.

Contamination layer will be formed on the surface of the insulator and it would spread on the surface[7]. Surface tracking can occur and lead leakage current increase, especially when the insulator surface wet caused by fog, dew or light rain. Leakage current initiates a process of heat conduction which occurs on the surface of an insulator and will be formed tracking on surface insulator before insulation breakdown occurred.

This paper will explain the morphological of epoxy resin test samples after electrical tracking during 6 minutes. The morphological analysis was done based on images from SEM devices.

II. FUNDAMENTAL THEORY

A. Diglycidyl Ether Bisphenol A (DGEBA)

Epoxy resin is a liquid which has low viscosity property, it is easy to be mixed (enter stage thermoset) in the manufacturing. Epoxy/oxsyrana/alkena oxide are cyclic ethers contains three atoms. The simplest epoxy is ethylene oxide, and trimethylene oxide and tetrahydrofuran are another examples [8]. The basic chemical structure of the epoxy resin is shown in the following Figure:

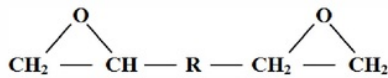

Fig. 1. Chemical structure of epoxy resin.

DGEBA (*Diglycidyl Ether of Bisphenol A*) is sold commercially as a clear liquid, it can be changed into thermoset product if is reacted with ripening agent, with room temperature vulcanized (RTV) between 5°C until 80°C. DGEBA as a solid product can be process in higher temperature vulcanized (HTV) between 100°C-300°C. Base material of epoxy resin insulation, DGEBA, can be obtained from the reaction of epichlorohydrin and bisphenol-A cannot create crosslink, it must be reacted with curing agent or hardener, through vulcanized room temperature or high temperature.

B. Metaphenylene Diamine (MPDA)

Ripening of the epoxy resin can be divide into three main groups, there are: Hidroxil group (R-OH), Amine group and Acid Anhydride group. Each group has so many types. Every type has different level on the mixture process. Ripening reaction occurs through the epoxy groups from base material and reactive groups from reinforcement material. Reaction between base-material of epoxy resin with ripening agent of acid anhydride a group is a more complex reaction than the ripening agent of amine group. The test uses ripening agent from amine groups that is Metaphenylene-diamine (MPDA) because MPDA included the most chemical that is used as ripening agent of epoxy resin [8]

MPDA is a material colors light yellow which has molecule weight is 108, and chemical structure can be seen in Figure 2:



Fig. 2. Chemical structure of diamine

C. Silicon Rubber (SiR) as Mixture Material

Silicon rubber is a material resistant to high temperature; usually it is used to cable insulation and high voltage insulator material. Physical property of this thing can be improved by mix the filler material, is like silica sand.

Silicon rubber is safe to use at -55°C – 200°C temperature. It has good barrier to the ozone, corona, and water. This has well resistant against the alcohol, salt and oil. Silicon rubber $[(CH_3)_2SiO]$ is formed by cyclic siloxane monomers that created polydimethylsiloxane. The hydrophobic property of it gives a high surface obstacle in the humid condition and contaminated

D. Silicon Dioxide (SiO₂) as Filler Material

Silica sand or quartz sand is excavated materials composed of crystals - crystalline silica (SiO₂) and contains a compound impurities carried during the deposition process. Silica sand or quartz having a combined composition of SiO₂, Fe₂O₃, Al₂O₃, TiO₂, CaO, MgO and K₂O translucent white or other colors depending on the compound impurities. Combination of silicon with oxygen to form crystal formation depends on the temperature of the called silica[9].

Silica is an insulating material that is often used in ceramics. Packaging atoms enclosed in the bonding of silicon and oxygen, making the structure tends to be stable in general does not decline to environmental changes. This means that the insulator is not easily damaged by ultraviolet, electrical treatment such as providing a voltage gradient on the insulator and environmental conditions such as temperature, humidity and so forth. Insulator will be more resistant to aging

E. Scanning Electron Microscope (SEM)

The surface degradation in the form of erosion, cracking and liming on the polymer insulation material that is to characterize the surface of the insulating materials. One method can be used for this purpose is the technique SEM [10]. SEM technique is essentially an examination and analysis of surface micro structures. The data obtained from the surface layer thickness of about 20 μm provides topographical images with any form of protrusions and indentations surface captured and processed by the secondary electrons emitted by the specimen [11]. Work scheme of SEM was showed in Fig 3 as follow:

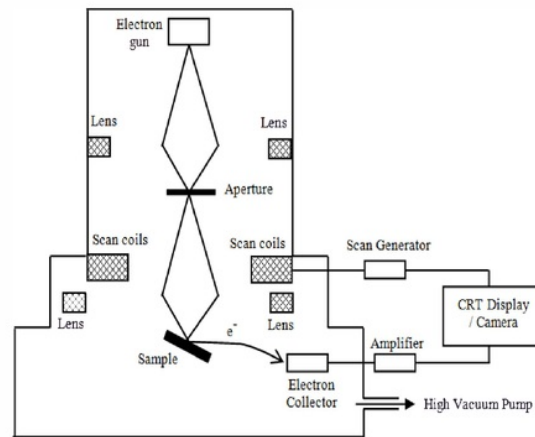

Fig. 3. Scanning Electron Microscope diagram

III. EXPERIMENTAL TEST SETUP

This test setup consists of epoxy resin test samples, and SEM equipment for imaging surface of test samples.

A. Research Materials

The approach used to analyze the degradation of the surface of the insulation material in the research by using experimental studies was conducted in the laboratory. There are 5 samples test used in this experiment with samples code i.e. RTV₂₁, RTV₂₂, RTV₂₃, RTV₂₄ and RTV₂₅ as shown at Table I and Fig. 4.

TABLE I. CODE AND COMPOSITION OF SAMPEL TESTS

Test sample code	DGEBA (% pbw)	MPDA (% pbw)	Filler (% pbw)		
			Silicon Rubber	Silica sand	Filler Total
RTV ₂₁	45	45	5	5	10
RTV ₂₂	40	40	10	10	20
RTV ₂₃	35	35	15	15	30
RTV ₂₄	30	30	20	20	40
RTV ₂₅	25	25	25	25	50

Dimension of the test samples were made rectangular with a length of 120 mm and a width of 50 mm with a thickness of 5 mm made with DGEBA and MPDA weight ratio is 1: 1, and silicon rubber mixed with silica sand in the ratio 1: 1 with a varied percentage is 10 %, 20%, 30%, 40% and 50%.

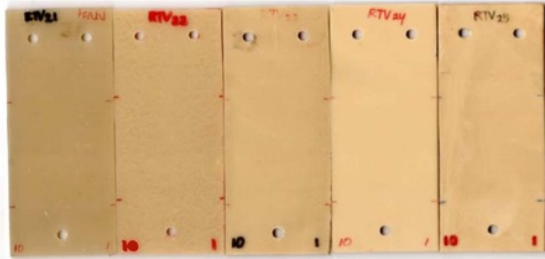

Fig. 4. Test samples of Epoxy Resin

B. Inclined Plane Tracking test

Inclined plane tracking test was used to evaluate of test sample surface condition. Equipment for measurement of tracking mechanism on test sample surface i.e. transformer test with 220 Volt input voltage and output 50 kV with a capacity of 5 kVA, table controls to adjust the applied voltage, high voltage probes, voltmeter, voltage divider, arresters, oscilloscope, peristaltic pumps, hoses, measuring cups, digital camera, flash and computer as shown at this Fig. 5.

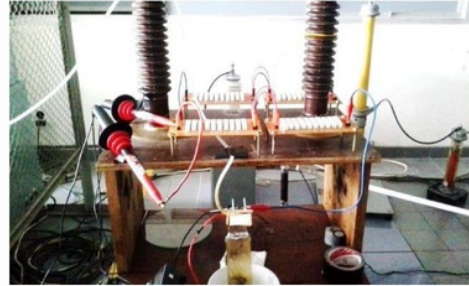

Fig. 5. Inclined Plane Tracking test

C. Equipment for SEM Imaging

SEM imaging was conducted in Laboratorium Terpadu, Diponegoro University. Each test samples must be coated by platinum for SEM imaging. SEM image processes in Laboratory is shown in Fig 6 as follow:



a)

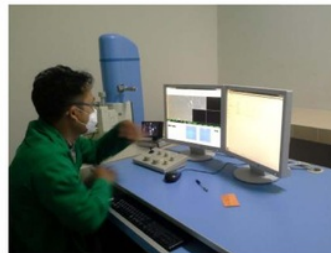

b)

Fig. 6. Detect of imaging SEM; a) coating processes; b) Taken place of Image with SEM monitor

IV. RESULTS AND DISCUSSION

A. Mechanism of Electrical Tracking

Mechanism of the result of surface degradation of epoxy resin insulation material experimentally which done in laboratory showed on Fig. 7 step by step.

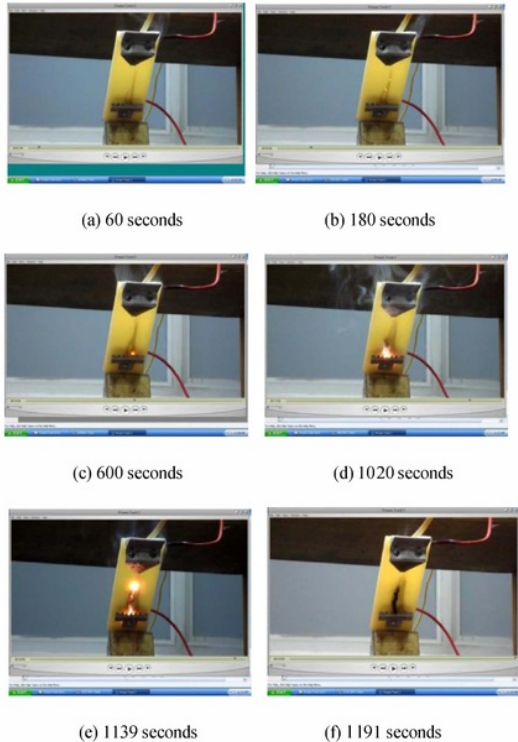

Fig. 7. Step of mechanism of surface tracking

Formation of electric tracking on the surface of epoxy resin material caused the heating that wasn't homogeny. Heating of surface material caused by leakage current flow at the same time with the erosion. When the first time applied the 3.5 kV AC voltage, it has not created the carbon way yet on the material surface. After 60 seconds, slowly appeared the carbon way which was very soft. The 120 seconds there was two ways has created by it, one was the main way and another way was the branch. It occurred because contaminant flow was not always flow through one main way, but it because electrical discharge happened randomly around the field where the contaminant flow. Spark that occurred spread during the carbon tracking and made branches which were similar to the trees that named "treeing" [12].

The formation of carbon path remains on the surface of the test material connects the upper electrode with the lower electrode. Sparks occur always at the bottom electrode, and the condition of the worst damage was in the lower electrode. This occurs due to the electric field strength is higher in the lower electrode in terms of the geometry of the electrodes are inclined tapered. Required initial electrons that will initiate the next discharge and initial electrons arise because the electric field strength is very high. The use of high voltage AC source to make the polarity of the electrodes is always changing between Cathode and Anode. The geometry of the lower electrode tends tapered at the surface, so that sparks or early

discharge is kept up starting from the bottom electrode. Starting from second to 60 and eventually burned down in seconds to 1020 and ended in second to 1191.

Electrical tracking process on the surface of the insulating material will then cause erosion on the surface of the insulation. Sarathi [12] explains that tracking is a phenomenon that occurs when the surface degradation of contaminants passing on the surface of the insulation. Leakage current causes non-uniform heating form a dry area as shown in Fig 8.

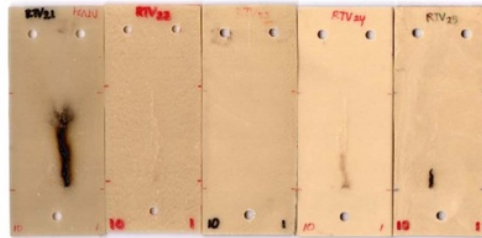

Fig. 8. Surface degradation due to electrical tracking during 6 minutes

B. SEM Image Analysis

Surface degradation on epoxy resin insulation materials after aging has been observed by using Scanning Electron Microscope (SEM). Results of Analytical Scanning Electron Microscope for epoxy resin insulating material surface made from silicon rubber and silica filler using JSM-6510LA type instrument with a magnification of 500 times are shown in the following figures.

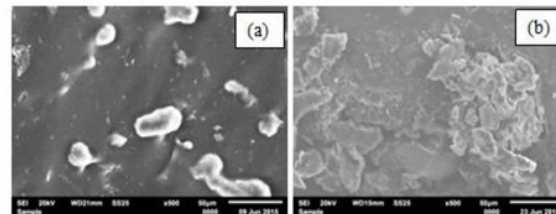

Fig. 9. SEM photos epoxy resin insulating material with silicon rubber filler and silica 10%, respectively (a) RTV₂₁ referral and (b) RTV₂₁ aging electricity for 6 minutes

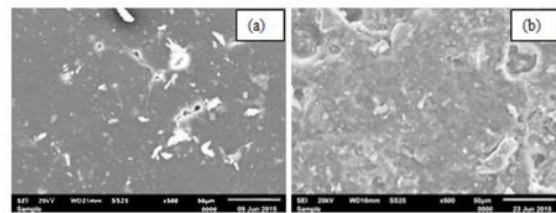

Fig. 10. SEM photos epoxy resin insulating material with silicon rubber filler and silica 20%, respectively (a) RTV₂₂ referral and (b) RTV₂₂ aging electricity for 6 minutes

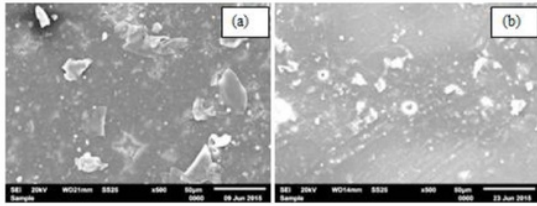

Fig. 11. SEM photos epoxy resin insulating material with silicon rubber filler and silica 30%, respectively (a) RTV₂₃ referral and (b) RTV₂₃ aging electricity for 6 minutes

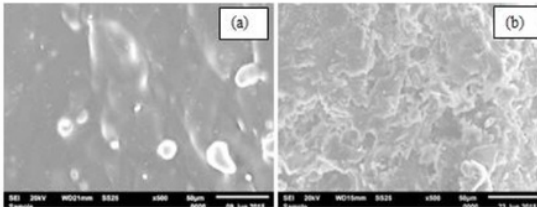

Fig. 12. SEM photos epoxy resin insulating material with silicon rubber filler and silica 40%, respectively (a) RTV₂₄ referral and (b) RTV₂₄ aging electricity for 6 minutes

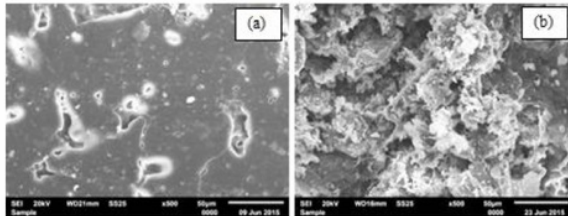

Fig. 13. SEM photos epoxy resin insulating material with silicon rubber filler and silica 50%, respectively (a) RTV₂₅ referral and (b) RTV₂₅ aging electricity for 6 minutes

The surface of the epoxy resin insulation materials made from silicon rubber and silica filler as a reference looks much smoother surface on the composition of the lower filler material that is at RTV₂₁ and RTV₂₂. The addition of silicon rubber and silica in epoxy resin material causes the surface became rougher because of the quantity of silica sand are increasing, as well as increasing silicon rubber, causing methyl element content at the surface increases. When the low molecular weight silicon rubber containing methyl groups increasingly lead to more rough surface, such as the SEM images that have been done [1] on the polymer insulation materials EP-RHA for the RHA + polysiloxane composition of 30% and 50%.

Based on the SEM images in this research, epoxy resin material with silicone rubber filler composition and silica 30% did not experience significant damage after tested by the method Inclined Plane Tracking

V. CONCLUSION

Based on analysis and discussion we can conclude that the mechanism of electrical tracking always began from high electric field electrode. From SEM image can be understood that epoxy resin material with silicone rubber filler composition and silica 30% did not significant damage after electrical tracking by Inclined Plane Tracking method test.

ACKNOWLEDGMENT

The authors would like to thank Dean of Engineering Faculty and Head of Terpadu Laboratory UNDIP have supported the implementation of this research.

Morphological Study Of Epoxy Resin After Electrical Tracking

ORIGINALITY REPORT

17%

SIMILARITY INDEX

14%

INTERNET SOURCES

12%

PUBLICATIONS

2%

STUDENT PAPERS

PRIMARY SOURCES

- 1** Syakur, Abdul, Hamzah Berahim, and Tumiran Rochmadi. "Leakage current monitoring for silane epoxy resin insulator under tropical climate conditions", 2012 IEEE International Conference on Condition Monitoring and Diagnosis, 2012.
Publication **6%**
 - 2** article.sapub.org
Internet Source **5%**
 - 3** www.science.gov
Internet Source **4%**
 - 4** E.A. Cherney. "RTV silicone-a high tech solution for a dirty insulator problem", IEEE Electrical Insulation Magazine, 1995
Publication **1%**
 - 5** citee2015.jteti.ft.ugm.ac.id
Internet Source **1%**
-

Exclude quotes Off

Exclude bibliography Off

Exclude matches < 1%

Morphological Study Of Epoxy Resin After Electrical Tracking

GRADEMARK REPORT

FINAL GRADE

/0

GENERAL COMMENTS

Instructor

PAGE 1

PAGE 2

PAGE 3

PAGE 4

PAGE 5
