



<https://theses.gla.ac.uk/>

Theses Digitisation:

<https://www.gla.ac.uk/myglasgow/research/enlighten/theses/digitisation/>

This is a digitised version of the original print thesis.

Copyright and moral rights for this work are retained by the author

A copy can be downloaded for personal non-commercial research or study,
without prior permission or charge

This work cannot be reproduced or quoted extensively from without first
obtaining permission in writing from the author

The content must not be changed in any way or sold commercially in any
format or medium without the formal permission of the author

When referring to this work, full bibliographic details including the author,
title, awarding institution and date of the thesis must be given

Enlighten: Theses

<https://theses.gla.ac.uk/>
research-enlighten@glasgow.ac.uk

pH ELECTRODES:- STUDIES AND APPLICATIONS IN THE UPPER G.I. TRACT

VOLUME I OF TWO VOLUMES

BY

GORDON McLAUCHLAN, ©

B.Sc. (1st Class Hons. Glasgow),

M.B., Ch.B. (Glasgow),

F.R.C.S. (Glasgow).

Thesis presented to the University of Glasgow

for the Degree of Doctor of Medicine

from the

University Department of Medicine,

Western Infirmary,

Glasgow

and the

Gastrointestinal Centre,

Southern General Hospital,

Glasgow.

Submitted January, 1989.

ProQuest Number: 10999321

All rights reserved

INFORMATION TO ALL USERS

The quality of this reproduction is dependent upon the quality of the copy submitted.

In the unlikely event that the author did not send a complete manuscript and there are missing pages, these will be noted. Also, if material had to be removed, a note will indicate the deletion.



ProQuest 10999321

Published by ProQuest LLC (2018). Copyright of the Dissertation is held by the Author.

All rights reserved.

This work is protected against unauthorized copying under Title 17, United States Code
Microform Edition © ProQuest LLC.

ProQuest LLC.
789 East Eisenhower Parkway
P.O. Box 1346
Ann Arbor, MI 48106 – 1346

PREFACE

Over the past three and a half years, I have had the privilege of working with Dr. Kenneth McColl in the fascinating field of gastroenterological research. His clinical and scientific advice have been invaluable and his personal interest in my career most encouraging. My research has taught me important principles ranging from the setting up of laboratory experiments to the conducting of clinical trials and of critically evaluating the results of my own work and that of others.

Some of this work has been published and a list of these publications is submitted with the thesis. Collaboration with a number of colleagues has been necessary as described in the formal acknowledgements. The work presented has been carried out in its entirety by myself.

The writing of this thesis is my own work.

CONTENTS

VOLUME I

	<u>Page Numbers</u>
Title Page	(i)
Preface	(ii)
Table of Contents	(iii)
List of Tables	(v)
List of Figures	(vi)
Acknowledgements	(viii)
Relevant Publications	(x)
Summary	(xi)

SECTION I - STUDIES OF pH ELECTRODES 1

Chapter 1	- An overview of techniques available for measuring gastrointestinal pH.	2
Chapter 2	- In vitro comparison of glass and antimony sensing electrodes and effect of positioning of reference electrode.	15
Chapter 3	- Comparison of gastric pH measured by in situ electrode with pH of gastric aspirate.	25
Chapter 4	- Possible pH sensing devices of the future.	31

SECTION 2 - ACCURATE LOCALISATION OF pH ELECTRODES IN THE UPPER G.I. TRACT 36

Chapter 5	- The problem of maintaining pH electrodes in a constant position in the upper G.I. tract.	37
Chapter 6	- Development of a new endoscopic technique to allow accurate localisation of electrodes in the upper G.I. tract.	43
Chapter 7	- A 24 hour ambulatory study of regional variations in intragastric pH in healthy volunteers.	50

Chapter 8	- Further studies to assess whether dual intragastric pH monitoring may be a useful means of detecting duodenogastric reflux.	59
------------------	---	----

SECTION 3 - STUDIES OF DUODENAL pH	68
---	----

Chapter 9	- Studies to validate measurement of duodenal pH by in situ electrodes.	69
------------------	---	----

Chapter 10	- Effect of omeprazole on gastric and duodenal pH in patients with exocrine pancreatic insufficiency.	82
-------------------	---	----

Chapter 11	- Conclusions.	97
-------------------	----------------	----

References	100
-------------------	-----

VOLUME II

Video Cassette of Endoscopic Clip-fixing Technique.

LIST OF TABLES

		<u>Page Before</u>
1.	Response times of different types of electrodes.	19
2.	Sensitivity and drift of different types of electrodes.	20
3.	Details of normal volunteers in dual intragastric pH study.	50
4.	Effect of meal on pH of gastric body and antrum.	52
5.	Daytime and nocturnal pH of gastric body and antrum.	53
6.	Details of patients in exocrine pancreatic insufficiency pH study.	83
7.	Effect of omeprazole on gastric and duodenal pH in patients with exocrine pancreatic insufficiency.	87

22.	Effect on pH of adding gastric juice to duodenal juice.	60
23.	Experimental model for examining effect of duodenogastric reflux on intragastric pH.	62
24.	pH recording during simulated duodenogastric reflux.	63
25.	Dual intragastric pH recording and pH of gastric aspirate overnight in patient with suspected duodenogastric reflux.	65
26.	Effect of close mucosal contact on recorded pH in patient with ileostomy.	70
27.	Design of in vitro study of effect of electrode guard on recorded pH.	72
28.	Results of in vitro study of effect of electrode guard on recorded pH.	73
29.	Apparatus designed to assess effect of mucosal contact on recorded duodenal pH.	75
30.	X-ray showing apparatus for assessing effect of mucosal contact in duodenum.	75
31(a-e).	Simultaneous record of duodenal pH with guarded and unguarded electrodes.	76
32.	Correlation of in situ duodenal pH versus that of aspirated duodenal juice.	79
33.	Cumulative frequency distribution of gastric and duodenal pH in patients with pancreatic insufficiency on placebo and omeprazole.	87
34.	Tracing of gastric and duodenal pH of patient well controlled on omeprazole 20mg/day.	88
35.	Tracing of gastric and duodenal pH of patient not controlled on omeprazole 40mg/day.	88
36.	Plasma omeprazole concentrations in patient No. 1.	90
37.	Plasma omeprazole concentrations in patient No. 2.	91

ACKNOWLEDGEMENTS

The work presented in this thesis has only been possible through the helpful co-operation of many colleagues. I have had the privilege of conducting my research under the supervision of Dr. Kenneth McColl. His irrepressible enthusiasm and encouragement when seemingly insurmountable obstacles presented themselves generated the momentum which carried all before it. Many of the patients studied were provided by his G.I. Clinic.

The selfless provision of his own laboratory facilities and technical advice from Dr. Michael Lucas, an international authority on pH monitoring, was an unexpected bonus. The many hours of his own time spent in session and his honest criticism and proof reading of my work are greatly appreciated.

Dr. Rory McCloy generously shared his own extensive experience in pH-metry and provided electrodes and recording equipment of his own design which enabled me to get started.

Dr. Gerry Crean provided endoscopic facilities, helpful and well-trained nursing staff and sage advice throughout the project.

Radiometer, Ormed Ltd., and Synectics generously supplied electrodes for the initial studies.

Mike Daly, of Astra Pharmaceuticals, supplied omeprazole and provided facilities for serum measurements of the drug.

I am most grateful to Mrs. Dorothy Ronney for secretarial assistance and for typing this thesis.

The preparation of the illustrations was performed by the Departments of Medical Illustration at the Western Infirmary and the Southern General Hospital. Additional equipment necessary for the production of the video cassette was provided by Key Med.

Last, but by no means least, is the invaluable contribution of my wife, Joan, whose word processing skills were put to the test in the preparation of the earlier drafts of the thesis. Much midnight oil was burnt during this time and for her co-operation and encouragement I am deeply indebted.

RELEVANT PUBLICATIONS

McLauchlan G, Rawlings J M, Lucas M L, McCloy R F, Crean G P, McColl K E L. Electrodes for 24-hour pH monitoring - a comparative study. *Gut*, 1987; 28: 935-939.

McLauchlan G, Buchanan N M M, Crean G P, McColl K E L. An endoscopic procedure for accurate localisation of intraluminal pH electrodes. *Endoscopy*, 1987; 19: 124-126.

McLauchlan G, Lucas M L, McColl K E L. Twenty-four hour ambulatory oesophageal pH monitoring: an update. *British Journal of Surgery*, 1987; 74: 758.

McLauchlan G, Rawlings J M, Lucas M L, McCloy R F, Crean G P, McColl K E L. Choice of electrode for ambulatory pH monitoring. *Gastroenterology*, 1987; 92: 1528 (Abstract).

McLauchlan G, Buchanan N M M, Crean G P, McColl K E L. A new endoscopic technique for the accurate localisation of intraluminal pH electrodes. *Gastroenterology*, 1987; 92: 1528 (Abstract).

McLauchlan G, Crean G P, McColl K E L. Effect of low-dose omeprazole on gastric secretion in duodenal ulcer. *Alimentary Pharmacology and Therapeutics*, 1988; 2: 161-167.

McLauchlan G, McColl K E L. Effect of omeprazole on gastric and duodenal pH in patients with exocrine pancreatic insufficiency. *Gut*, 1988; 28: A1340 (Abstract).

McLauchlan G, Fullarton G M, Crean G P, McColl K E L. Comparison of gastric body and antral pH: A 24 hour ambulatory study in healthy volunteers. *Gut* (in press).

Fullarton G M, McLauchlan G, Macdonald A, Crean G P, McColl K E L. Rebound nocturnal hypersecretion after 4 weeks H₂ antagonist therapy. *Gut* (in press).

SUMMARY

The use of electrodes for measuring pH in the gastrointestinal tract is on the increase. Improvement in electrode manufacturing techniques has coincided with the miniaturisation of recording equipment and the widespread availability of personal computers. Commercial software packages of ever increasing sophistication enable the clinician to analyse data recorded from these electrodes with an ease which would scarcely have been thought possible only a decade ago. The temptation to use these systems to generate data without a full understanding of their limitations is a real one. I have set out to clarify some of these fundamental problems.

The thesis opens with an overview of the currently available methods for measuring G.I. pH. The advantages and disadvantages of aspiration, in situ titration, dialysis and ion-exchange resins are discussed. The theoretical basis of pH electrodes, both ion-selective and metal-metal oxide, along with methods of recording and display are then presented.

The two electrodes most commonly used in clinical practice are glass and antimony. A comparative study is presented in which the in vitro operating characteristics (response, sensitivity and drift) of glass are shown to be superior to those of antimony. This study also investigates the influence of the siting of the reference electrode on recorded pH values and concludes that combined electrodes should be used in preference to electrodes with either a skin or buccal reference electrode.

Measurement of pH using aspiration and electrodes are then compared by passing two electrodes and a feeding tube to the same level in the stomach of a volunteer. Both techniques are used simultaneously to follow pH changes during fasting and after ingestion of liquids and solids. This study shows close correlation between the two methods as long as aspiration is possible. In the fasting state there may not be sufficient gastric content for aspiration and after a solid meal the tube can obstruct. For these reasons, the glass electrode is superior to aspiration. The difference between hydrogen ion concentration and activity and the significance of bile staining in the acid stomach are also discussed.

An account of recent developments in pH sensor technology is then given. The working principles of two devices that, although at present unavailable for clinical use, may become useful in the future are described. These are ion-selective field effect transistors and optrodes.

Steep pH gradients are characteristic of the proximal duodenum and many attempts have been made to maintain electrode position there. After reviewing these various methods, it is concluded that to date there is no satisfactory means of achieving this goal. There follows an account of debate surrounding regional variations in intragastric pH. There is no agreement in the literature as to which areas of the stomach are characterised by high or low pH and some authors question the existence of these differences.

In order to answer these questions, the author has developed a new technique which enables accurate placement and fixation of pH electrodes at any point in the upper G.I.T. within the range of a gastroscope. The electrodes are localised endoscopically and held in place by stainless steel clips applied through the biopsy channel of a wide-channel gastroscope. Preliminary studies on cadaver stomachs to assess the safety of the technique are described, as are the results of attempted fixation of pH electrodes for a period of 24 hours in the antrum of 40 patients. Refinements which converted an initial success rate of one only out of the first ten to the point where failure is now virtually unknown are enumerated. A bound video cassette showing details of the technique with examples of its use in two patients constitutes Volume II of the thesis.

This technique is then applied to study the regional variations in gastric pH in 9 normal volunteers. Several interesting and unexpected features emerge. Intra-gastric pH often remains high for up to 2 hours after an endoscopy. Body and antral pH response differs both in magnitude and time scale to the ingestion of a meal. Postprandial antral pH rises more slowly and to a less degree than body pH. In 2 subjects, considerable pH rises are seen at night, usually more marked in the distal electrode. Biopsies of antral mucosa taken during the procedure reveal that histological evidence of gastritis is present in 4 subjects of which 3 are positive for campylobacter-like organisms. The non-uniformity of pH within the stomach is thus established.

A series of experiments is then undertaken in an attempt to explain the nocturnal elevations of pH noted above and in particular to see if they could be attributed to duodenogastric reflux. Preliminary benchwork evaluates different possible mechanisms and a volunteer study is described in which overnight aspiration of antral contents accompanies dual pH monitoring. It is demonstrated that high pH is not necessarily indicative of duodenogastric reflux. Envelopment of the electrode by antral mucosa may be a significant factor.

Attention is then turned from the stomach and then focussed on the duodenum. Before embarking on any clinical studies, it is of paramount importance to establish that the fluctuations in pH commonly seen in the duodenum are not merely due to the electrode making contact first with the luminal contents and then the mucosa. A study involving 2 volunteer patients with ileostomies suggests that this effect could be significant. Construction of a guard for the electrode is described and show that the guard does not significantly impair electrode performance. A volunteer study concludes that the neutral pH values often recorded by bare electrodes are not artifactual. Guards can introduce slowing of electrode response and are unnecessary.

This validates the techniques used in the final study in which an application of pH monitoring to pharmacological studies is demonstrated. A technique of maintaining one electrode in the body of the stomach and one in the distal second part of duodenum using a

mercury-filled latex bag made by the author is described. The clipping technique is not necessary in this experiment as some electrode movement can be accepted. In 6 patients with pancreatic insufficiency and malabsorption not responsive to pancreatic supplements and H₂ blockers, omeprazole, an H⁺/K⁺ ATP-ase inhibitor and the most powerful anti-secretory agent currently available, is shown to be capable of maintaining gastric and duodenal pH above 4 for 24 hours. Supplementary pharmacokinetic investigations in 2 patients requiring high doses of omeprazole for suppression suggest that low duodenal pH may reduce drug bioavailability.

The extent to which this work has contributed to the field of pH-metry is discussed and areas of continuing uncertainty and future research outlined.

SECTION ONE

STUDIES OF pH ELECTRODES

CHAPTER ONE

AN OVERVIEW OF TECHNIQUES AVAILABLE FOR MEASURING GASTROINTESTINAL pH

Acid and alkali fluctuations in the upper GIT are of interest to the gastroenterologist because they may be directly related, by cause or effect, to many common diseases. Knowledge of these fluctuations can also enhance our understanding of certain disorders of digestion, since each digestive enzyme functions optimally at one specific pH and can be inactivated or even irreversibly denatured at another. The extensive ulceration seen in Zollinger-Ellison syndrome, for example, is the result of excessively high gastric acid output, whereas achlorhydria is the effect of pernicious anaemia. The need to know normal physiological values of pH or secretory capacity as a precondition for detecting abnormality has led to a bewildering variety of investigative techniques. The origins of gastric analysis procedures and their subsequent development up to 1939 have been comprehensively reviewed by Hollander and Penner and the interested reader is referred to this source for an appreciation of the early use of many techniques still in use today (Hollander & Penner, 1939a; Hollander & Penner, 1939b; Hollander & Penner, 1939c). This review will concentrate on technical improvements to those techniques and recent developments which may ultimately supersede them. The following discussion of presently available techniques aims to inform the reader of their deficiencies and the reasons for embarking on the research projects presented in this thesis.

ASPIRATION

Passage of a nasogastric tube to the desired region of the GIT and aspirating the intraluminal contents is commonly used, particularly in tests of stimulated secretion, e.g., gastric acid output (using pentagastrin) or pancreatic exocrine output (using a Lundh test meal or secretin). Numerous objections to the use of this technique to obtain a profile of variations in pH over an extended period have been raised as listed below:

- (1) The tube may be displaced from its original position (Reynolds et al, 1986; Baron, 1963).
- (2) The discomfort produced can be considerable and the resultant nausea and distress may vitiate the physiological situation (Connell & Waters, 1964; Fimmel et al, 1985).
- (3) Variation in values at a fixed site has been found to be high (Benn & Cooke, 1971) and the churning produced by the tube and by aspiration can lead to values which are global rather than representative of pH at the desired site (Eyerly & Breuhaus, 1939; Eyerly, 1940).
- (4) If intraluminal volumes are small, e.g., during fasting or with pharmacological inhibition, sampling may be impossible or difficult to interpret because of the effect of the dead-space of the tube (Fimmel et al, 1985; Benn & Cooke, 1971).
- (5) During antacid administration aspirated gastric contents may not reflect the juxtamucosal pH (Meiners et al, 1982).
- (6) Short-term fluctuations in pH, a particular feature of the duodenum (McCloy et al, 1980), are missed by aspiration.

- (7) Continuous aspiration may result in contents of adjoining areas flowing down the resulting pressure gradient (McCloy et al, 1980). For example gastric aspiration may cause duodenogastric reflux. To counteract this problem in the stomach Hobsley has derived a mathematical correction formula to compensate for ingress of duodenal contents and transpyloric loss of gastric secretions (Hobsley & Silen, 1969; Hobsley, 1978).
- (8) The homeostatic mechanisms which govern release of GIT hormones and consequently acid secretion may be upset by the removal of gastric or duodenal juices (Kearney et al, 1941; Rovelstad et al, 1951; Rovelstad, 1956; Dubey & Nundy, 1983; Greenberg et al, 1982).

IN SITU TITRATION

The problems of aspiration, as listed above, coupled with the reliance on exogenous stimuli for tests of secretory function, led to a search for methods which would yield information more representative of events during normal conditions of fasting and eating. Fordtran and Walsh, 1973, introduced the technique of in situ gastric titration. The stomach contents are completely evacuated, then isotonic saline at a specific pH is instilled, at first as a bolus of known volume and then as a slow infusion throughout the duration of the test. Small aliquots of gastric contents are withdrawn frequently during the study period through one lumen of the tube and through another sodium bicarbonate of known molarity passed to keep the pH up to its original level. A

modification of this technique has been applied to simultaneous measurement of gastric acid and duodenal alkali secretion using hydrochloric acid to keep the duodenal pH constant (Dubey & Nundy, 1983).. The authors appreciated that gastric and duodenal emptying and hormonal release may be affected by the distension caused by the titration process. A comparison of aspiration and in situ titration (Feldman, 1979) revealed large differences between the two, with titration resulting in acid secretion rates more than double those obtained during aspiration. The likeliest explanation was felt to be stimulation of gastric secretion by the gastric distension produced by the infusate.

DIALYSIS

A particular situation in which aspiration can lead to erroneous conclusions was highlighted by Rune (Rune & Koster, 1963). He wished to study the pattern of acid secretion from the gastric remnant in patients who had undergone gastrectomy with Bilroth I or Bilroth II anastomosis. In these patients, reflux from duodenum or jejunum can neutralise unknown quantities of acid. He used a dialysis bag attached to the end of a nasogastric tube which was lowered into the stomach then filled with distilled water. The water was retrieved and hydrogen ion content measured. Although successful where the augmented histamine test had failed, this cumbersome technique has a very slow response time, only about 30% of diffusion having taken place within fifteen minutes.

ION EXCHANGE

The methods discussed up to this point all involve introduction of tubes through the nose or mouth. In order to eliminate any error which may be introduced by the presence of the tube alone, Segal introduced the use of ion exchange resins. Hydrogen ions, in contact with certain ion exchange resins, can displace substances from these resins. This principle has been used to differentiate between the presence, absence or a borderline response to gastric stimuli (Segal & Miller, 1955; Segal, 1982; Segal et al, 1955). The resin is swallowed and if hydrogen ions are present the displaced moiety of the resin (quinine, azure A, Diagnex Blue) is absorbed into the bloodstream and the excretion measured in the urine. Although circumventing the use of the nasogastric tube, this method has many inaccuracies. For example, if gastric emptying is rapid, there will be little time for ion exchange to take place in the stomach and even if hydrogen ion activity is high, absorption and secretion of the indicator will be low. A similarly falsely low value can result if renal function is impaired.

pH MONITORING

The advantages of direct measurement of pH in a given region of the GIT had been appreciated as far back as 1915 when an in situ hydrogen electrode was used (McClendon, 1915a,b,c). The use of glass electrodes in the stomach was first reported some 25 years later (Eyerly & Breuhaus, 1939; Eyerly, 1940; Flexner et al, 1939; Flexner & Kniazuk, 1940) and since then many studies involving the use of a

variety of pH electrodes have been reported. Broadly speaking, two distinct types of sensor have been used and a brief description of both types must be included in this thesis to allow a fuller understanding of the reasoning which led to the final choice of system.

Ion-Selective Electrodes

If a membrane which is selectively permeable to only one ion is placed in contact with a solution containing that ion, diffusion from the solution will take place down the resulting concentration gradient. This movement of ions of the same charge will result in an electrical gradient across the membrane opposing further diffusion of ions across the membrane. An equilibrium will be achieved between the chemical gradient and the opposing electrical gradient. If the "driving force" on the ion in solution is raised by increasing the activity, more of the ion will cross the membrane and greater will be the resulting transmembrane potential difference. If a wire electrode immersed in an electrolyte solution is enclosed by the membrane, the composition of electrolyte will remain constant and stable contact with the membrane will be obtained at all times. This assembly is known as the "indicator" or "sensing" electrode and the relationship between the potential difference "seen" by it and the activity of the ion to be measured in solution conforms in varying degrees to the ideal relationship described by Nernst:

$$E = \text{constant} + 2.3 \frac{RT}{zF} \log \underline{I} \quad (1)$$

where R is the gas constant, T is the temperature in degrees Kelvin, F is Faraday's number, I is the ion-activity and z is its charge, including sign.

To complete the electrical circuit a reference electrode is required. This consists of a central wire immersed in an electrolyte solution and enclosed in an inert casing in which a very small opening allows contact with the sample solution.

To record potential difference fluctuations across the membrane, leads from each electrode are connected to a high-impedance voltmeter. The complete system is represented diagrammatically in Figure 1.

In pH measurement, I is the hydrogen ion activity, and since $\text{pH} = -\log_{10} [\text{H}^+ \text{ activity}]$ equation (1) reduces to

$$E = \text{constant} + S \cdot \text{pH}$$

i.e., an "ideal" electrode produces a voltage which varies with pH in a linear fashion. S is used here as an abbreviation for slope which from (1) has a specific value at any given temperature and ionic strength of solution.

Two main ion-selective membranes are used currently in biological applications. The first of these is glass, whose outstanding characteristics of sensitivity, stability and long lifetime have been

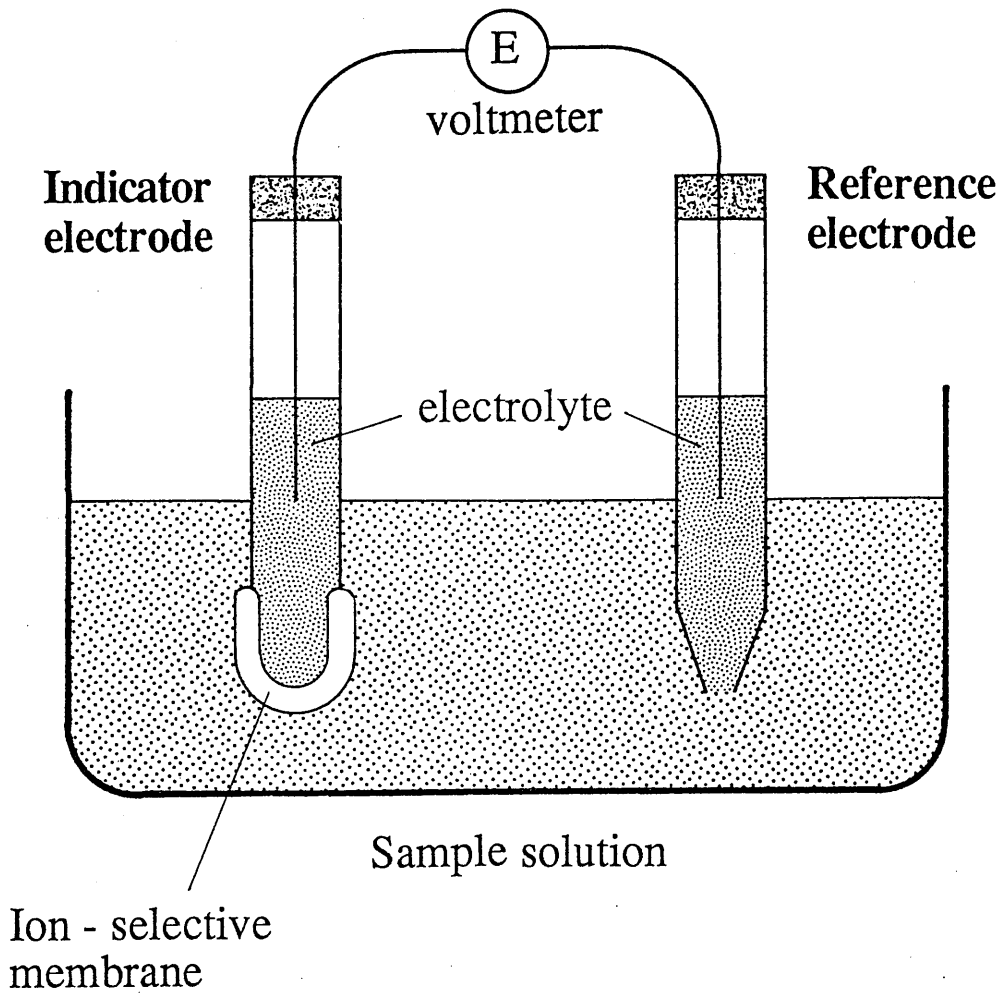

FIGURE 1

Diagrammatic representation of the components of an ion-selective electrode.

appreciated since the 1920's. For a full account of theoretical basis and types of ion-selective electrodes based on mobile ligands in liquid membranes, the reader is referred to Koryta's excellent monograph (Koryta, 1975). More detailed aspects of glass electrode electrochemistry are available in a similarly useful compendium of papers (Hebert, 1970). Precisely why glass electrodes work is not fully understood (Rechnitz, 1973) but it is believed that when they are introduced into a solution, ion exchange at the membrane interface triggers a rapid chain reaction of ionic movement across the glass, resulting in the measured potential. Whatever the mechanisms, the development of glass electrodes has been refined to such a degree that for hydrogen ions they can exhibit a Nernstian response within the extremely wide pH limits of 0.5 to 12. This represents an exceptionally high degree of ion selectivity over the entire pH range liable to be encountered in the GIT.

Another group of ion-selective electrodes consists of the plastic membrane electrodes. These are constructed by adding a selective complexing agent (ligand) into a plastic membrane. When the membrane is placed in a solution containing the ion of interest, some of the ions diffuse into the plastic, bind with the complexing agent and then migrate across the membrane, establishing a potential difference. For the detection of ionic activity in biological fluids, these electrodes have been widely used in the research field, not only for hydrogen ion detection, but also for sodium (Lucas & Cannon, 1983), calcium (Fry & Williams, 1979; Cattrall & Freiser, 1971) and potassium (Linton et al, 1982 & Cattrall et al, 1974). In their ease of preparation, low resistance and handling safety, they

have advantages over glass in the area of pH monitoring but although their selectivities are impressive, they are still inferior to glass because of their susceptibility to interference from other ions. In addition, their useful pH-measuring range is restricted to the vicinity of the pK of the ligand (the pH at which the ligand-ion complex is exactly 50% dissociated). Although of no great significance in intracellular (Ammann et al, 1981) or intravascular (Leblanc et al, 1976; Cobbe & Poole-Wilson, 1979, 1980; Chakrabarti et al, 1983) use, this leads to problems in the GIT where the pH range is much greater. Construction of plastic pH electrodes for use in the GIT has now been achieved (Rawlings & Lucas, 1985) and further developments (Oesch et al, 1986) suggest that it is possible to produce a plastic electrode with a near-Nerstian slope over a wide pH-range.

In summary, glass electrodes at the present time are superior to plastic electrodes which, although promising, are not yet commercially available.

Metal-Metal Oxide Electrodes

When a metal wire or crystal (M), in combination with its oxide (MO) is placed in a solution containing hydrogen ions, the following equation can be used to describe the reaction:

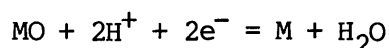

If this is now connected to a voltmeter with a reference cell to complete the circuit as before, the measured potential between the metal/metal oxide and a reference electrode can also in theory be a linear function of the pH value of the solution with a Nernstian slope. The ease of miniaturisation of such electrodes is appealing, as is their sturdy nature and low impedance. Palladium (Karagounis et al, 1986) and iridium (Katsube et al, 1982) have been used in the clinical setting.

Antimony electrodes have been known for over fifty years, but have been notorious for poor stability, resolution, repeatability and sensitivity to complex-forming ligands in the sample solution (Glab et al, 1981). Interest in antimony was rekindled when the influence of the crystalline properties of antimony on the electrode potential became clear (Edwall, 1979). The poor results obtained in the past involved polycrystalline antimony but if a single crystal of antimony is used, the performance is greatly improved (Edwall, 1978). This electrode is prepared with pure antimony without the oxide, and the potential generated at the interface with the sample solution is probably a corrosion potential determined by the conversion of Sb to Sb^{3+} which produces insoluble corrosion products (presumably Sb_2O_3) on the surface. Further improvement can be obtained by removing virtually all impurities from the antimony (Jongren & Edwall, 1980).

The only commercially produced pH sensor currently available whose development has reached the stage of allowing it to be considered a real alternative to glass, therefore, is the monocrystalline antimony electrode.

The output from all of the electrodes described above has to be transmitted to a recording device in one of two ways. Firstly, a wire lead passing through the nose or mouth can connect the indicating electrode to the recorder. Since the reference electrode merely has to be in electrical contact with the indicating electrode, it does not necessarily require to be swallowed. Other options are contact with the buccal mucosa or contact with the skin. These points will be considered again in a later section.

The second mode of transmission from the sensor is by telemetry to a receiver which remains outside the body. The first example of this system (Jacobson & MacKay, 1957) used a capsule whose wall comprised a copolymer resin which changed dimension with change in pH. The authors appreciated that the very slow response obtained was far from ideal, but the technology of the day was insufficiently advanced to allow for glass capsules to be used. The first electrode to be used in this way was constructed from antimony (Von Ardenne & Sprung, 1958) and was used extensively (Connell & Waters, 1964; Noller, 1959; Nagumo et al, 1962; Watson et al, 1966; Watson & Paton, 1965). The capsule can be swallowed and its progress traced throughout the gut. Alternatively, it is attached to a length of string, lowered to the desired level in the GIT, distal displacement being prevented by tethering the string at the angle of the mouth. Patient discomfort is thus minimal. Glass capsules were developed by Watson (Watson & Kay, 1965) and Kitigawa (Kitigawa et al, 1966) and used by Meldrum (Meldrum et al, 1972) to describe a profile of pH from stomach to colon.

Problems with signal loss and activation of the capsule were considerable. An improved capsule (Colson et al, 1981) and receiving system (Evans et al, 1974) have gone some way towards solving these problems and have been used in oesophageal pH monitoring (Branicki et al, 1982). Another improved system has been described (Vitale et al, 1985) but even here signal loss forced the investigators to repeat the tests in 12% of the patients. While telemetry could still become a useful investigative aid in the future, technical problems limit its present-day use.

Having decided on the type of measuring device and method of transmission of the signal, completion of the pH-monitoring system requires a device for displaying the output. This can be achieved by simply connecting the leads to a paper chart recorder. The main disadvantage of the analogue format is that subsequent quantitative analysis of data is laborious and time-consuming. Recognition of this deficiency and of the advantages to be gained from digital recording and storing led McCloy (McCloy et al, 1980) to construct the first digital data-logging unit. This could be mounted on a trolley to give the patient some freedom of movement. The storage was on punched paper tape. For the first time, analysis of mean or median pH values, hydrogen ion activity, log mean hydrogen ion activity and percentage of total number of readings between any chosen pH levels, tasks which would have taken many hours to perform previously, could be completed within seconds.

Since this time, commercial interest in pH monitoring has been considerable and a vast array of pH electrodes and recording systems has appeared. An international symposium in Zurich in 1986 has provided a timely assessment of this alarming situation (Emde et al, 1987). One of the interesting features of this symposium was the awareness that, despite the technological advances in pH monitoring equipment, much work at the basic level remained to be done. This thesis has set out to answer some of these questions. In particular:

1. What electrode should be used?
2. Is there a way to position electrodes accurately?
3. How is gastric pH best measured?
4. What are normal values of gastric pH at different sites during fasting, eating and sleeping?
5. To what extent can gastric pH-monitoring be of use in the recognition of disease?
6. Does continuous pH-monitoring contribute to the interpretation of pharmacological studies?

CHAPTER TWO

IN VITRO COMPARISON OF GLASS AND ANTIMONY SENSING ELECTRODES AND EFFECT OF POSITIONING OF REFERENCE ELECTRODE

As mentioned in the previous chapter, the two most suitable electrodes for GIT studies are antimony and glass. To date there has been no independent information concerning the relative merits of these two materials. Studies reported in this chapter were designed to compare the performance of these two types of electrodes.

As some electrodes have integral reference electrodes and others employ skin or buccal reference electrodes, we have also assessed any effect which the siting of the reference electrode could have on the pH reading.

METHODS

Materials

The following 3 electrodes were examined (Fig. 2):

- (1) Antimony electrodes (Synectics Medical, No. 0011) employing a remote reference electrode.
- (2) Glass electrodes (Microelectrodes Inc., MI 506) employing a remote reference electrode.
- (3) Glass electrodes (Radiometer, GK 2801C) with combined sensing and reference electrodes.

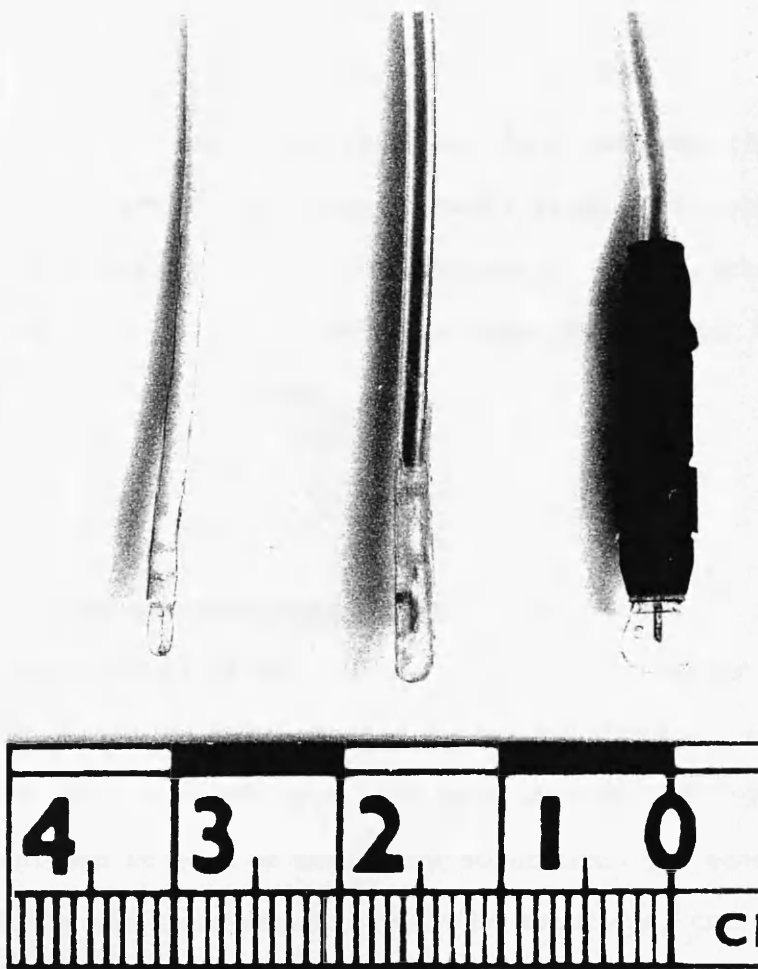

FIGURE 2

Microelectrodes Inc. glass electrode is shown on the left, the Synectics antimony electrode in the centre, and the Radiometer combined glass electrode on the right. Each division on the scale represents 1 cm.

In Vitro Studies

The basic operating characteristics, i.e., response time, sensitivity and drift of the three different types of electrodes were assessed. For electrodes other than radiometer glass electrodes which have their own reference, a calomel electrode with an agar bridge was used as the reference electrode.

Response

Response time was measured by transferring the electrodes between stirred buffers of pH 7 (Synectics No. 5001) and pH 1 (Synectics No. 5002) at 37°C. In the situations where the calomel electrode was used as a reference, two agar bridges led from the calomel electrode to each of the buffer solutions. The sensing electrode alone was transferred between the solutions, thereby eliminating from the response time any component due to the response of the reference electrode. Leads from both the sensing and reference electrodes were connected across a high-impedance electrometer (Keithley 610C) and the results plotted using a paper chart recorder (Speedomax XL682). As the presence of artifact at the time of transfer of the electrodes may obscure the tracing (Fig. 3) the response time was defined as the time taken for the electrode voltage to go from 10% to 90% of its final value. Six models of each type of electrode were examined and measurements made in triplicate on each individual electrode to obtain an average value per electrode. Values for a group of similar electrodes are presented as the mean and standard error of these average values. The study was repeated in unstirred buffers at 22°C.

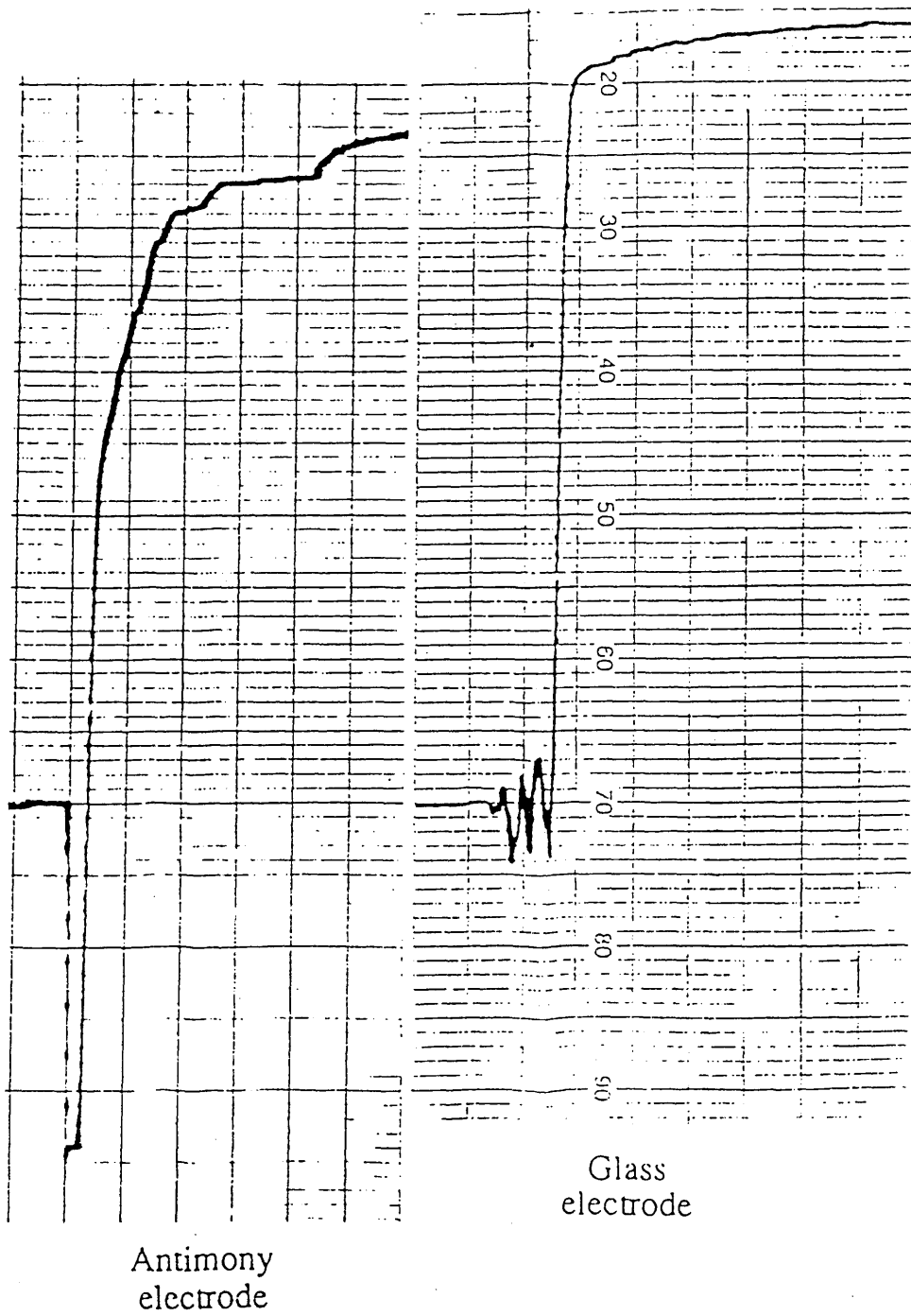

FIGURE 3

Comparison of speed of response when glass and antimony electrodes are switched from buffer pH 1 to buffer pH 7. Note artefact at time of removal from pH 1 buffer.

The effect on response time of gastric juice, duodenal juice and a combined antacid/local anaesthetic preparation (Mucaine: Wyeth Laboratories) was investigated by transferring the electrodes from each of these solutions to a stirred buffer of known pH at 37°C.

Sensitivity

Sensitivity, i.e. mV response per pH unit, was assessed in six electrodes of each type over the pH range 1 to 7. The antimony electrode is irreversibly damaged by many of the standard buffers normally used in calibration, e.g., phosphate, phthalate (Glab et al, 1981). Stable buffers compatible with the antimony electrode are only available for pH 1 and pH 7. For this reason a titration method was used for each electrode to measure sensitivity between these pH values. To minimise the error unavoidable in titration methods, namely the dilution effect produced by adding volume to the buffer, concentration of acid or alkali added was high (0.1M) so that only very small volumes were required to produce the requisite pH change. The recorded potential difference (mV) of the various electrodes were plotted against pH recorded with a standard glass electrode (Pye-Unicam 401) during titration from pH 7 to pH 1 and back at 37°C.

The sensitivity of the two types of glass electrode in mV/pH unit was calculated from the slope of the resultant graph. This was not possible for the antimony electrode because of the non-linear characteristics obtained and therefore the sensitivity was calculated by dividing the difference in readings (mV) at pH 1 and 7 by 6.

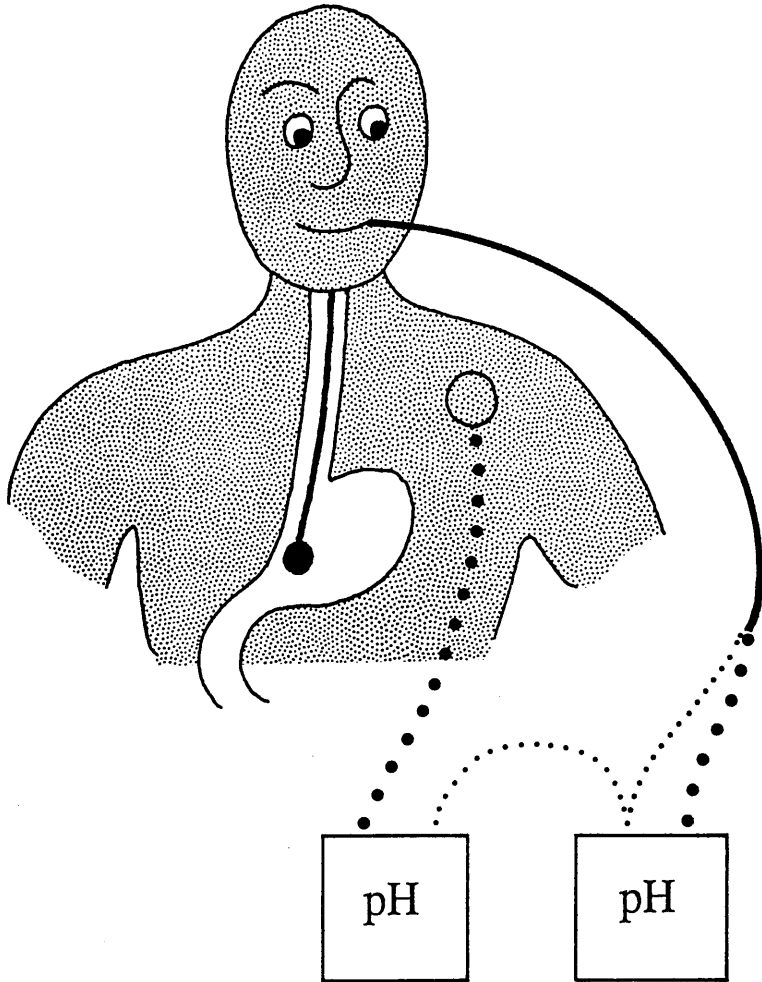

FIGURE 4

Experimental design to allow simultaneous comparison of upper GIT pH measured with the use of a skin versus intraluminal reference electrode.

Drift

After calibration in buffers at pH 7 and pH 1, a single continuous 24-hour recording was made from each electrode during immersion in a stirred buffer at 37°C. Once again, 6 examples of each type were studied. Drift was defined as the maximum excursion in pH readings over the 24 hours.

Human Studies

The extent to which the siting of the reference electrode leads to differences in recorded pH was examined in 5 fasted healthy human volunteers. This involved the use of a combined glass electrode (Radiometer, GK 2801C), an Ag/AgCl skin reference electrode and gel (Hellige GMBH, D7800 Freiburg iB., Germany) and two digital recorders (Digitrapper MKII, Synectics Medical). The pH sensing electrode of the combined glass electrode was connected to both recorders. The intraluminal reference electrode of the combined glass electrode was connected to one recorder and the skin reference electrode to the other. This permitted simultaneous recording from the same pH electrode using different reference sites (Fig. 4). The electrode was passed into the duodenum under X-ray screening and recordings made from duodenum, stomach and oesophagus. The study was then repeated using an Ag/AgCl buccal reference electrode (Pye-Unicam 340) in place of the skin reference electrode.

The statistical significance of differences in the mean values was assessed using the non-parametric Mann-Whitney U test.

RESULTS

In Vitro Studies

Response Time

Each of the electrodes had a rapid response time of less than 0.5 sec on transfer from pH 7 to pH 1 (Table 1). The response times of the Microelectrodes Inc., and Radiometer glass electrodes, on transfer from pH 1 to pH 7 were similar, being 0.5 ± 0.1 sec (mean \pm SEM) and 0.8 ± 0.1 sec respectively. However, the response of 3.4 ± 0.8 sec for the antimony electrode over the same pH range was significantly slower ($p < 0.025$) than either of the glass electrodes.

When the pH 1 to pH 7 response times were repeated using unstirred buffers at 22°C, in place of the stirred buffers at 37°C, they were all prolonged, at 3.25 ± 1.0 sec, 20 ± 8 sec and 160 ± 24 sec for Microelectrodes Inc., Radiometer and antimony electrodes respectively (Table 1).

For each electrode the response time on moving from duodenal juice (pH 6.5) to buffer pH 1 was similar to transfer from buffer pH 7 to buffer pH 1 (Table 1). Likewise, the response time on moving from gastric juice (pH 1.5) to buffer pH 7 was similar to transfer from buffer pH 1 to buffer pH 7. However, each electrode showed a slower response on moving from Mucaine (pH 7.6) to buffer pH 1 than on transfer from buffer pH 7 to buffer pH 1. In comparison to their response times of < 0.5 sec on transfer from buffer pH 7 to buffer pH

Table 1

Response times of the 3 types of electrodes under different conditions

		10-90% RESPONSE TIME (Secs)		
<u>From</u>	<u>To</u>	<u>Glass</u> <u>(Microelectrodes Inc)</u>	<u>Glass</u> <u>(Radiometer)</u>	<u>Antimony</u> <u>(Synectics)</u>
Buffer pH7	Buffer pH1	< 0.5	< 0.5	< 0.5
Buffer pH1	Buffer pH7	0.5 ± 0.1	0.8 ± 0.1	3.4 ± 0.8
Buffer pH1 (unstirred 22°C)	Buffer pH7 (unstirred 22°C)	3.25 ± 1	20.8 ± 8	160 ± 24
Duodenal juice pH6.5	Buffer pH1	< 0.5	< 0.5	< 0.5
Gastric Juice pH1.5	Buffer pH7	1.0 ± 0.2	0.8 ± 0.1	4.5 ± 0.7

Values are mean ± SEM

For significance values see text

All experiments were performed in stirred solutions at 37°C except where indicated to contrary in parenthesis.

1, the response time of each electrode was prolonged on transfer from Mucaine to buffer pH 1 with values ranging from 1 sec to 54 sec. The Mucaine affected the 3 types of electrodes to a similar degree, though there were marked differences between individual electrodes and even between the same electrode studied on different occasions.

Sensitivity

The Microelectrodes Inc., and Radiometer glass electrodes were similar with respect to sensitivity, with values of 54.9 ± 1.7 and 55.1 ± 1.7 mV/pH unit respectively. The antimony electrode was less sensitive than either glass electrode ($p < 0.02$) with a value of 47.6 ± 1.0 mV/pH unit (Table 2). Both glass electrodes showed a linear response over the pH range 1 to 7 (Fig. 5), but that of antimony was non-linear and showed a consistent hysteresis (Fig. 6).

Drift

The drift of both glass electrodes was similar [0.11 ± 0.01 (range 0.0 - 0.25) and 0.13 ± 0.05 (range 0.0 - 0.2) pH units/24 hours for Microelectrodes Inc., and Radiometer respectively] and less than that of antimony [0.47 ± 0.13 (range 0.1 - 0.6) pH units/24 hours] ($p < 0.05$), (Table 2).

Human Studies

Using the Radiometer electrode with its own (intraluminal) reference electrode, the median duodenal pH recorded was 6.4 (range 5 - 7.5), the median gastric pH 1.5 (range 1 - 2) and the median

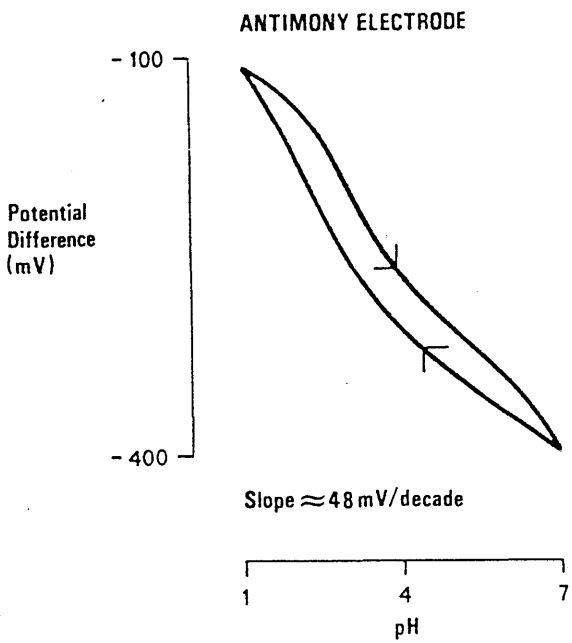

FIGURE 5

Sensitivity of representative antimony electrode. Note the hysteresis effect.

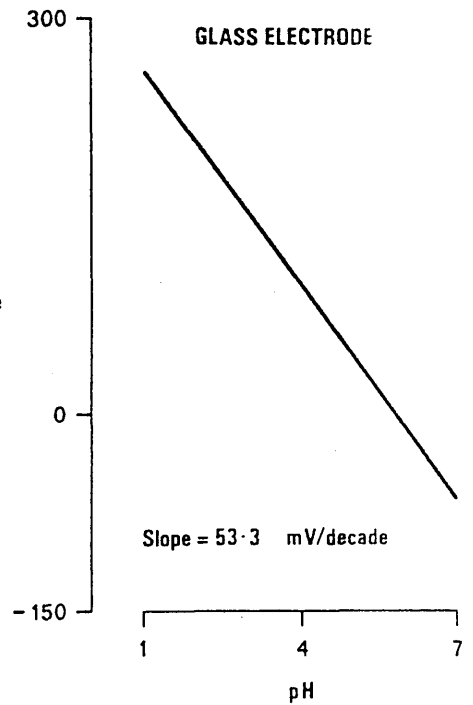

FIGURE 6

Sensitivity of representative glass electrode.

Table 2

COMPARISON OF THE SENSITIVITY AND DRIFT OF THE 3 TYPES OF ELECTRODES

ELECTRODE TYPE	SENSITIVITY (mV/pH unit)	DRIFT (pH units/24h)
Antimony	47.6 ± 1.0	0.47 ± 0.13
Glass (Microelectrodes)	54.9 ± 1.7**	0.11 ± 0.01*
Glass (Radiometer)	55.1 ± 1.7**	0.13 ± 0.05*

Values are mean ± SEM

* significantly different from antimony value at $p < 0.05$

** significantly different from antimony value at $p < 0.02$

oesophageal pH 6.8 (range 6 - 7.5). The simultaneous pH readings obtained with the skin reference electrode were different, being lower by a mean of 0.65 pH units (range 0.5 - 0.8) in the duodenum, higher by a mean of 0.3 pH units (range 0 - 0.6) in the stomach and lower by a mean of 0.3 pH units (range 0 - 0.6) in the oesophagus (Fig. 7).

When a buccal reference was used, the duodenal recordings were lower by a mean of 0.7 pH units (range 0.2 - 1), those from the stomach higher by a mean of 0.2 pH units (range 0 - 0.4) and those from the oesophagus lower by a mean of 0.3 pH units (range 0 - 0.6) compared to the recordings obtained from the combined electrode.

DISCUSSION

In spite of the lack of properly controlled comparative studies, it has been claimed that antimony electrodes are comparable or even superior to the more conventional glass electrodes both in their basic electrode characteristics and also in the ease with which they can be used in a clinical practice (Ask et al, 1982). This study shows that the performance of the antimony electrode is inferior to that of glass electrodes with respect to response time, sensitivity and drift.

Although each of the 3 types of electrodes showed a rapid response on moving to a more acid pH, the antimony electrode was significantly slower than the glass electrodes on moving to a more alkaline pH. These response times were obtained under the optimal conditions of a stirred solution at 37°C. In unstirred solutions at 22°C, the response time of the Microelectrodes Inc. electrode was only

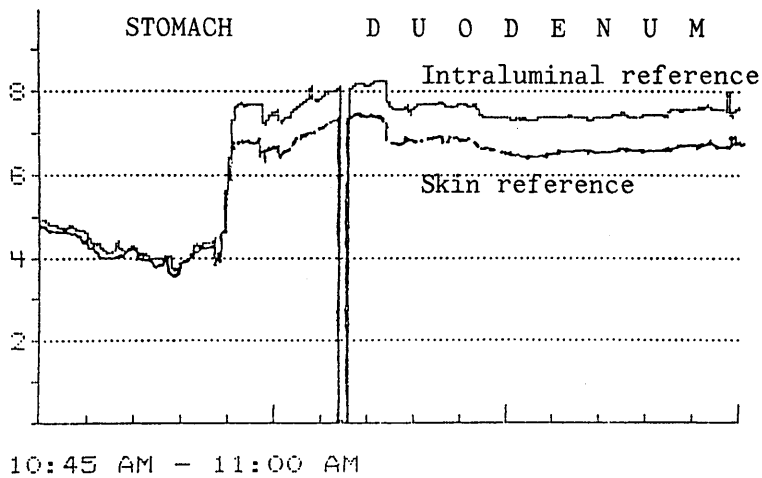
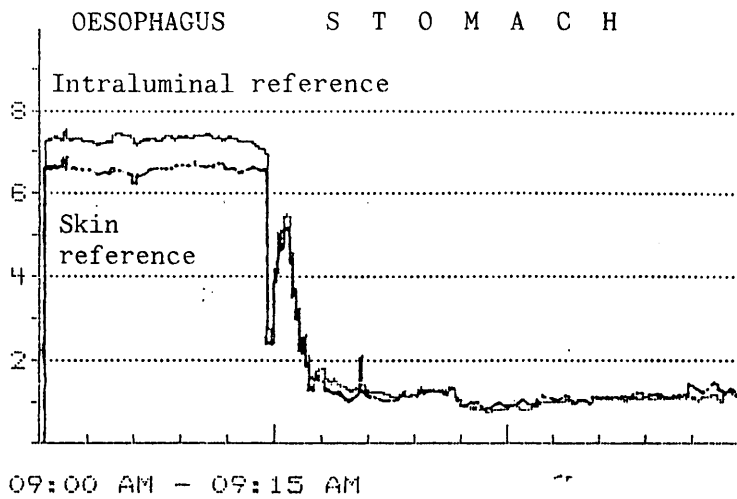

FIGURE 7

Simultaneous pH recordings using a glass electrode as a combined electrode (with intraluminal reference electrode) and with a skin reference electrode. In the oesophagus and duodenum the pH recorded by the combined electrode is higher than that recorded using the skin reference.

slightly prolonged by approximately 3 sec, that of the Radiometer by 20 sec, whereas that of antimony was markedly prolonged by 160 sec. The difference in response times between the glass electrodes in unstirred solutions is most probably explained by the greater volume of buffer carried by the larger electrode during transfer. The argument does not hold for the small antimony electrode, the longer response time of which may reflect local unstirred layer effects at the sensing surface. The shape of the electrode may alter the adherent volume close to this surface. Another factor may be the local accumulation of the products of the oxidation-reduction reaction known to occur at the surface of this electrode. Whatever the reason, it is noteworthy that these electrodes would have shown a slower response time in conditions likely to occur during in vivo measurement. In addition, the temperature dependence of antimony is such that a difference of 0.55 pH unit exists between readings at 37°C and 22°C, compared to a difference of only 0.05 pH unit for glass (Ask et al, 1986). In an area of the gastrointestinal tract like the stomach, in which there is incomplete mixing of contents and marked variations in temperature, the discrepancy between glass and antimony electrodes may be even greater.

The observation that the response times of the 3 electrodes were unaffected by gastric or duodenal juices, is in agreement with previous studies (Fimmel et al, 1985; McCloy, 1982). The prolongation of the response time by Mucaïne is of particular relevance to ambulatory oesophageal pH studies as use of this medication could complicate their interpretation. The effect of other mucosal coating agents requires to be studied.

The commercially available systems using antimony electrodes assume linearity between pH 1 and 7, but this was found not to be the case. The resultant error is compounded by the hysteresis effect. This means that if the electrode moves to a solution of, e.g., pH 4 from a solution of pH 7 a different reading will be obtained than if the electrode had been transferred from a solution of pH 1. These differences in the pH range 3 to 6 were often in the order of 20mV, which would represent a difference of 0.4 pH units. Such an error in recorded pH would significantly affect the assessment of oesophageal reflux which is usually defined in terms of duration and frequency below pH 4. Glass electrodes, in contrast, showed a linear response and hysteresis was absent.

The more marked drift of the antimony electrode may be due to oxidation of the antimony surface over the 24 h recording period (Edwall, 1979). As a result of this visible surface damage, the antimony electrode requires careful cleaning to maintain its performance. Glass electrodes are unaffected by such chemical reactions.

Our human studies highlight the large differences in recorded pH which may occur when skin reference electrodes are used as opposed to intraluminal reference electrodes. This effect has been previously noted and attributed largely to transmucosal potential differences which vary between oesophagus, stomach and duodenum (Rovelstad et al, 1951; Archambault et al, 1967; Anderson & Grossman, 1965). Buccal

reference electrodes have been used in preference to skin electrodes in an attempt to overcome this problem (Tomenius & Williams, 1960), but our study shows that they have no advantage. Though the difference in recorded pH with skin and intraluminal reference electrodes may be partly explained by the transmucosal potential difference, the different junction potentials at the skin reference electrode and intraluminal reference electrode may also contribute to the discrepancy (Read & Fordtran, 1979; Christiansen, 1986).

In summary, the *in vitro* performance of glass electrodes is superior to that of antimony electrodes. The inferior operating characteristics of antimony will contribute a larger error to clinical recordings, particularly when there are rapid changes in pH or when recordings are analysed as time above or below a specific pH value. In addition, significant differences in recorded pH occur when skin or buccal reference electrodes are employed in place of intraluminal electrodes. In order to improve accuracy, the use of glass electrodes is recommended and to allow comparison of results from different centres, combined glass and reference electrodes are recommended for prolonged monitoring.

CHAPTER THREE

COMPARISON OF GASTRIC pH MEASURED BY INSITU ELECTRODE WITH pH OF GASTRIC ASPIRATE

Before embarking on clinical studies of intragastric pH, it was felt that a comparison of pH values recorded by an in-situ electrode with those obtained by aspiration had to be undertaken. The aim was to validate the technique of intragastric pH-metry and to elucidate any discrepancies between the two methods. To maximise the information obtained during this study, the relationship between titratable acidity and hydrogen ion activity of an aspirated specimen was also examined.

MATERIALS AND METHODS

A healthy 30 year old male volunteer agreed to participate. At 11:30 a.m. and with the subject fasted, an assembly consisting of 2 combined glass electrodes (Radiometer GK2802C) and a size 7F feeding tube (Viomedex) was passed orally into the stomach. These were bound together with adhesive tape so that the glass bulbs of the electrode and the open end of the feeding tube were at the same level. Over the next 7 hours, continuous pH recordings from the electrode were stored in the Digitrappor Mark II (Synectics). At frequent intervals during this period samples of gastric content were aspirated. Immediately their pH was measured using a glass pH meter and titratable acidity calculated using an autotitrator. During the course of the study, fluids were consumed on 2 occasions and solid meals on 2 occasions.

On one occasion, the fluid consisted of a high protein stimulus (2 'OXO' cubes dissolved in 180 ml water) and the other a carbonated drink (Irn Bru 350 ml). The first solid meal consisted of a meat and egg salad with potatoes followed by bread and 1 cup of tea. The second meal contained turkey, potatoes, stuffing, tea, bread and creamed rice. For the 20 minutes preceding the second meal, the subject was allowed to smell the food but not eat it. After each meal or drink no further oral intake was allowed until the pH values had returned to basal levels.

On each aspirated sample, pH values were converted to H^+ activity and plotted against the corresponding titratable acidity. H^+ activities were calculated as follows:

$$\text{Let } X = [H^+] \text{ (mmols)}$$

$$\text{Then the } H^+ \text{ activity} = X/1000 \text{ moles}$$

$$\text{Since } pH = -\log_{10} [H^+ \text{ activity in moles}]$$

$$pH = -\log_{10} [X/1000]$$

$$= -[\log_{10} X - 3]$$

$$\text{i.e. } \log_{10} X = 3 - pH$$

$$\text{or } X = \text{antilog } [3 - pH]$$

Statistical comparison of values was performed by linear regression analysis.

RESULTS

The data obtained from the comparison of aspirated and in-situ pH values are presented graphically in Fig. 8. This shows good agreement for most of the time. Complete agreement would occur if all points on the graph were on a straight line through the origin of gradient +1. The two lines on the graph represent deviation of ± 1 pH unit from this line. It can be seen that 26 of the 30 points lie between these two lines.

Two further points of note emerged from this experiment. The first aspiration of the test period had a pH of 6.6 and was noted to be largely mucus. The electrode at this time was recording pH values between 1.5 and 2.0. Secondly, some of the aspirated samples despite being bile-stained had a low pH. An example of this is the second aspirate which had a pH between 1 and 1.5. Finally, obtaining sufficient aspirate for pH and titratable acidity to be performed can be difficult. This problem arises either when the stomach is empty and when the end of the tube impinges on the mucosa or when, after a meal, the nature of the ingested food defies its withdrawal. On one occasion 8 minutes were necessary to obtain enough aspirate for pH measurement and even then the volume was insufficient for titratable acidity measurement. In these situations the corresponding pH was taken as the median value over the time of aspiration, the event marker having been activated at the beginning and end of the aspiration.

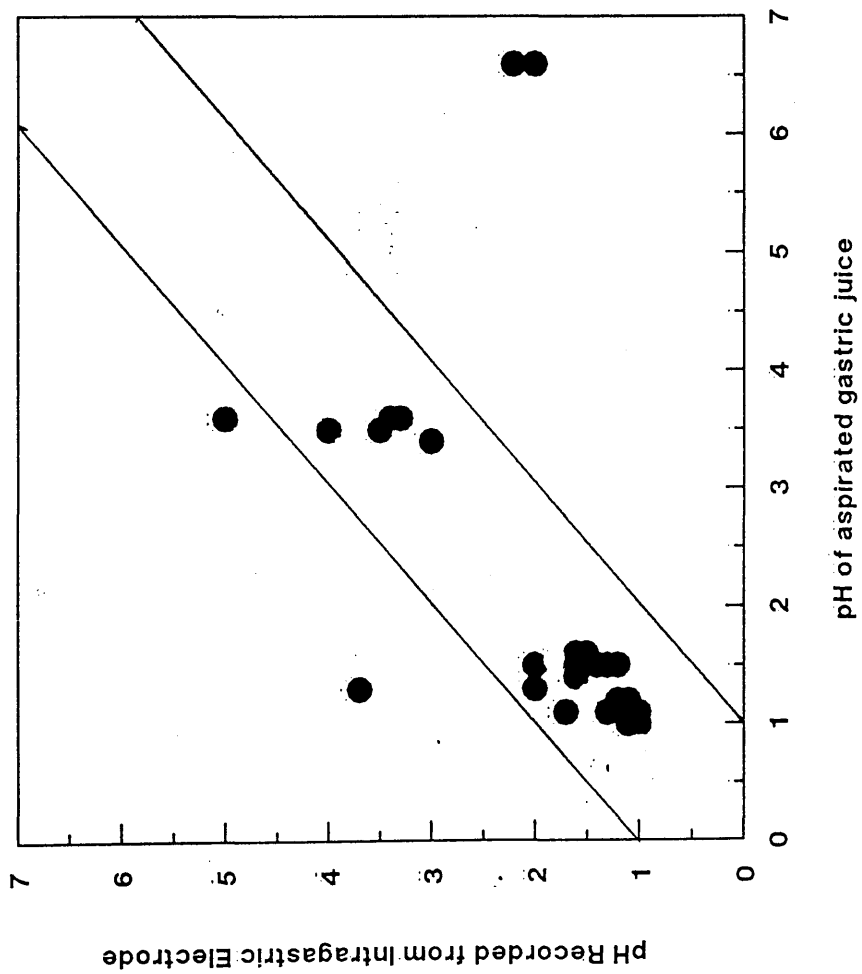

FIGURE 8

Comparison of gastric pH recorded by in situ electrode versus that of aspirated gastric juice.

Figure 9 shows the relationship between titratable acidity and H^+ activity of the aspirated specimens. It is clear that the measurements are not equivalent. In general, titratable acidity is greater than H^+ activity and in 3 cases was measurable despite H^+ activity of 0.

DISCUSSION

The finding that a close correlation exists between aspirated and in-situ pH is in agreement with other studies (Reynolds et al, 1986; Fimmel et al, 1985; Savarino et al, 1987). Savarino, using antimony electrodes over a 24 h period claims "excellent" results but closer analysis of his figure reveals that 27% of his values lie outside the area between the lines 1 pH unit on either side of the regression line with some as far as 5.5 pH units in either direction (Savarino et al, 1987). Reynolds used a radiotelemetry capsule for his study on 4 patients but experienced problems both with the capsule and dislodgement of the nasogastric tube (Reynolds et al, 1986).

In all the above studies, divergent results are sometimes seen. No mention is made of when these differences arose. In this study, only the result of the first aspiration produced a major discrepancy, possibly as a result of the trapping of mucus in the tube on its passage through the oesophagus. Even if the electrodes were coated in mucus it has been shown earlier (Chapter 2, p 19,20) that this would not affect the electrodes' ability to measure the true acid gastric pH.

FIGURE 9

Comparison of hydrogen ion concentration measured by titration versus the calculated value obtained from recorded pH.

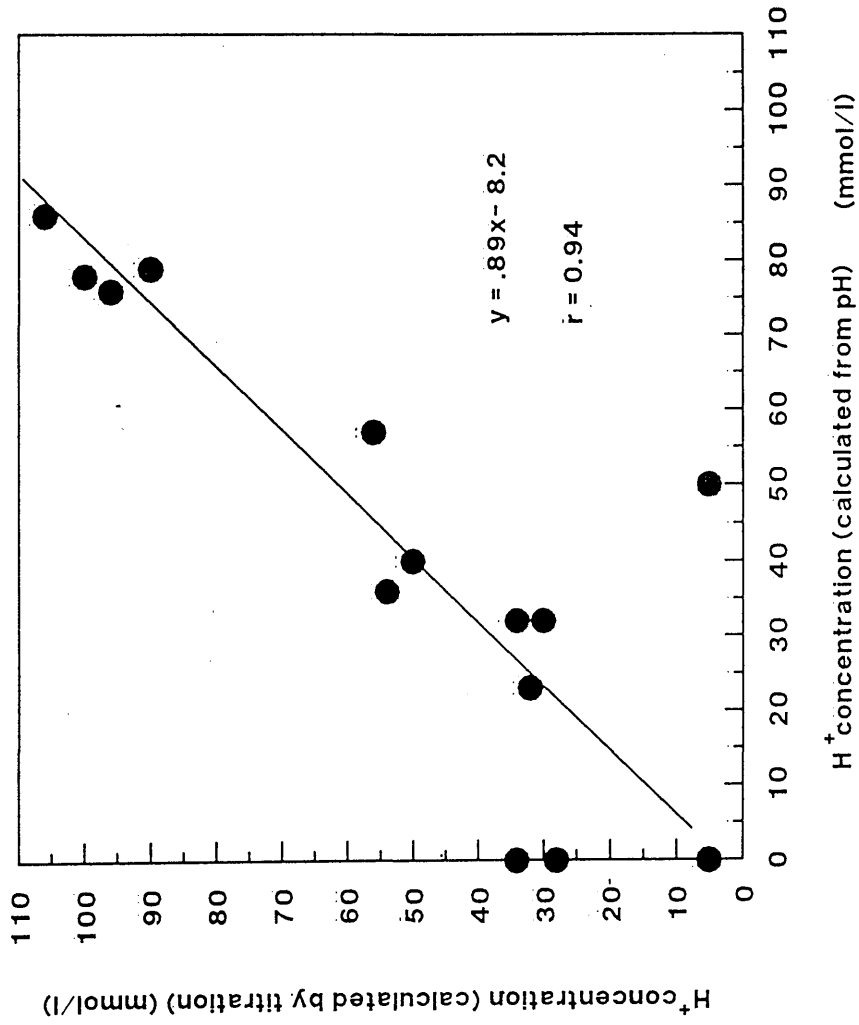

The presence of bile-staining at low pH is in keeping with previous studies (Rhodes et al, 1969; Hoare et al, 1978; Stoker et al, 1988) and suggests that pH monitoring in the stomach would not be a good means of detecting small quantities of duodenogastric reflux.

Difficulty in aspirating sufficient material for analysis was mentioned by Savarino (Savarino et al, 1987) who used the mean value of pH during an extended aspiration as the representative value. In cases where there is little in the stomach, prolonged aspiration can introduce inaccuracies by causing influx of duodenal or oesophageal secretion (McCloy et al, 1980).

This study also demonstrates that the hydrogen ion concentration is not equivalent to H^+ activity. The former is measured by titrating the sample with 0.1 M NaOH until neutrality (pH 7) is reached. H^+ activity is measured by the pH electrode. Hydrogen ions can either be associated in buffer systems in gastric juice or "obscured" by being present in high concentration. Titration neutralises the "inactive" as well as the "active" protons and this accounts for the finding that titratable acidity exceeds H^+ activity.

CONCLUSION

The preceding experiment covers the three eventualities of the stomach being in the fasting state, full of liquid and containing a solid meal. In the first of these, because of the paucity of gastric

content, aspiration can be impossible and pH electrodes have obvious advantages. When the stomach is full of fluid, there is little to choose between the two methods. Inaccuracies are unavoidable after a solid meal with both techniques. The dimensions of the naso-gastric tube may be insufficient to allow retrieval of gastric contents but adherence of particulate matter to the bulb of the electrode renders accurate interpretation impossible. The glass electrode, if one is aware of this potential for inaccuracy, is superior to aspiration. This fact, coupled with the ease of operation, stimulated the search for a means by which accurate positioning of pH electrodes could be achieved.

CHAPTER FOUR

POSSIBLE pH SENSING DEVICES OF THE FUTURE

Although glass is the best electrode currently available, it is not ideal. It has a high resistivity (of the order of 10^{10} ohms) and resultant noise if not properly screened. Fabrication of pH-sensitive glass is difficult and consequently expensive. In addition it must be looked after meticulously or breakage and damage may occur. There is, therefore, an on-going search for improved pH-sensing devices. The following is a description of the characteristics of the two most promising advances in this field.

ION-SELECTIVE FIELD EFFECT TRANSISTORS

The use and development of ion-selective field effect transistors (ISFET's) for electrophysiology were described by Bergveld (Bergveld, 1972). A detailed description of their geometry and fabrication was later published (Bergveld, 1979) but is beyond the scope of this thesis. A brief summary of some theoretical aspects will be given at this point to allow an understanding of their function.

A transistor can be thought of as an electrical switching device. If a particular voltage (the drain-source potential) is applied across the transistor, a current flows. Between the input and output terminals lies the gate. This gate controls the current flow and is in turn affected by its own (gate-source) voltage. As the gate

voltage changes in one direction, the gate allows more or less current through the transistor.

An alternative arrangement is for a constant current to flow through the transistor, monitored via a feedback circuit. When the gate voltage changes, the potential difference across the transistor varies.

The gate of a transistor can be constructed in such a way as to render it sensitive to the ionic content of a solution with which it is in contact. If this sensitivity can be made selective to a particular ion (for example H^+) it is known as an ISFET.

A diagrammatic representation of an ISFET which has been used to measure intravascular pH is shown along with its characteristics in Fig. 10. The gate can be coated with a metal oxide (Schepel et al, 1984) or overlaid with a neutral carrier in PVC. The reactions of these materials to pH change has been described earlier (Chapter 1, p 9-11). pH-sensitive glass has been tried (Szonntag, 1978; Afromowitz & Yee, 1978) but technical problems render it unsatisfactory (Baucke, 1977).

The attraction of ISFET's are their short response time, low impedance, low cost, durability, ease of miniaturisation and mass production. However, many problems remain to be solved. The uncoated ISFET's useful life is not long (Schepel et al, 1984). Much work remains before successful miniaturisation of coated ISFET's is

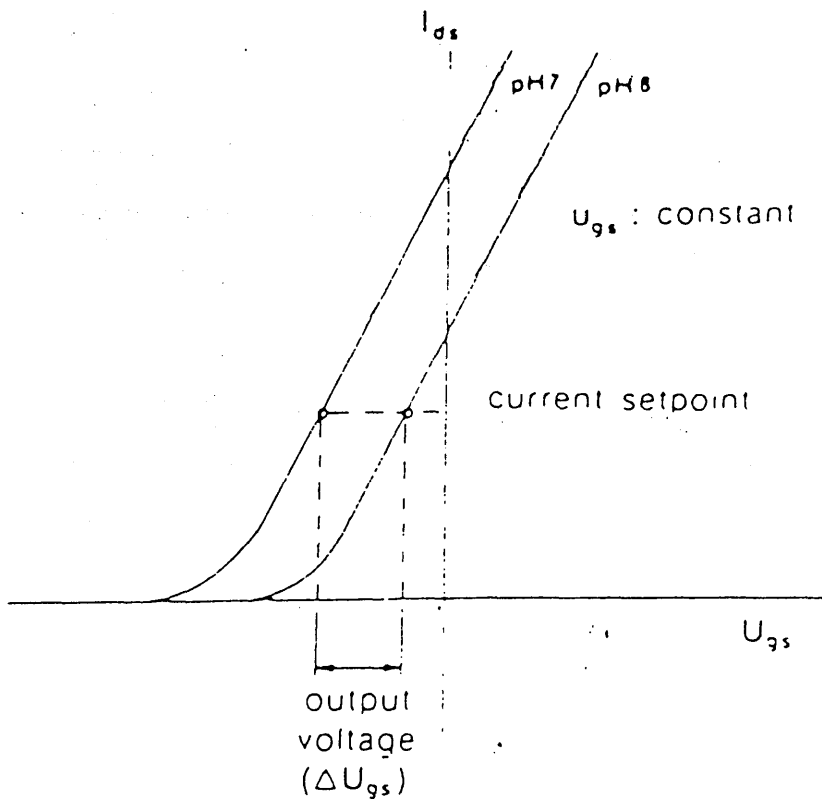
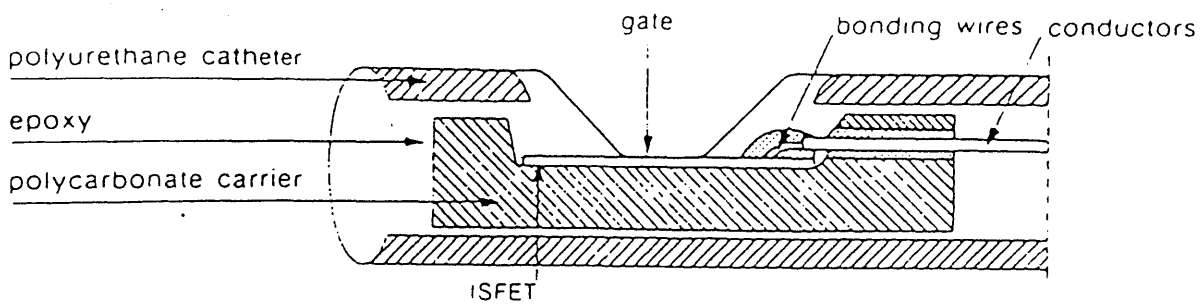

FIGURE 10

(Top) Diagrammatic representation of Ion-Selective Field Effect Transistor (ISFET)

(Bottom) Operating characteristic of ISFET

obtained (Rhodes, 1986). PVC tends to pull away from the underlying layers.

Another major problem is the deleterious effect of moisture on integrated circuits and before these devices can be useful in the G.I. tract, encapsulation must be adequate. There is also no suitable solid-state reference electrode. Attempts to produce a completely integrated sensor have been made (Smith & Scott, 1986), but reference electrode drift was considerable, impedance was not easily controlled and pH sensitivity was encountered. An acceptable degree of reproducibility can only be achieved when the formation mechanism and structure of porous silicon is better understood.

OPTRODES

The application of optical reflectance and fluorescence to pH monitoring is another exciting avenue of research (Goldstein et al, 1980; Gehrich et al, 1986; Opitz et al, 1978; Opitz & Lubbers, 1983). Luminescence results from the emission of light energy from certain molecules when their electrons return from an excited state to a ground state. Fluorescence is a special type of luminescence (photoluminescence) where the excitation of the electrons to higher energy states is derived from light energy. In summary, a fluorescent substance absorbs excitation energy which raises electrons to a higher energy state. Energy is then emitted when the electrons return to their ground state. Since some energy is lost in this process, the emitted energy is less than the excitation energy and therefore has a longer wavelength.

A fluorescence-based pH sensor uses a dye which is itself a weak electrolyte. The degree of dissociation is pH-dependent, i.e., the proportion of dye existing in the protonated and deprotonated forms shifts with alterations in hydrogen ion activity. A schematic illustration of an optrode is shown in Fig. 11.

A single optical fibre, made of fused silica, can be used to deliver and receive light energy from the sensing dye. For clinical use the dye must have suitable absorption and emission wavelength characteristics, be non-toxic, lend itself to attachment to an optical fibre, have high fluorescent intensity (signal strength) and sufficient intensity variation over the physiological measurement range (sensitivity). The fluorescence of the dye must not be affected by drugs or G.I. contents and must be stable.

Figure 12 shows the fluorescence spectra of a pH-sensitive dye. In the basic form it has a maximum excitation at 460 nm and in the acidic form it has a maximum excitation at 410 nm. For both cases, the emission frequency peaks at 520 nm. Thus the ratio of fluorescence intensity at 520 nm measured with 460 nm excitation to that measured with 410 nm excitation is a measure of the relative concentration of the basic and acid forms of the dye.

Excellent agreement with bench pH meters has been obtained in measuring in vivo blood pH and is being extended to G.I. applications. The advantages which this system promises are immunity

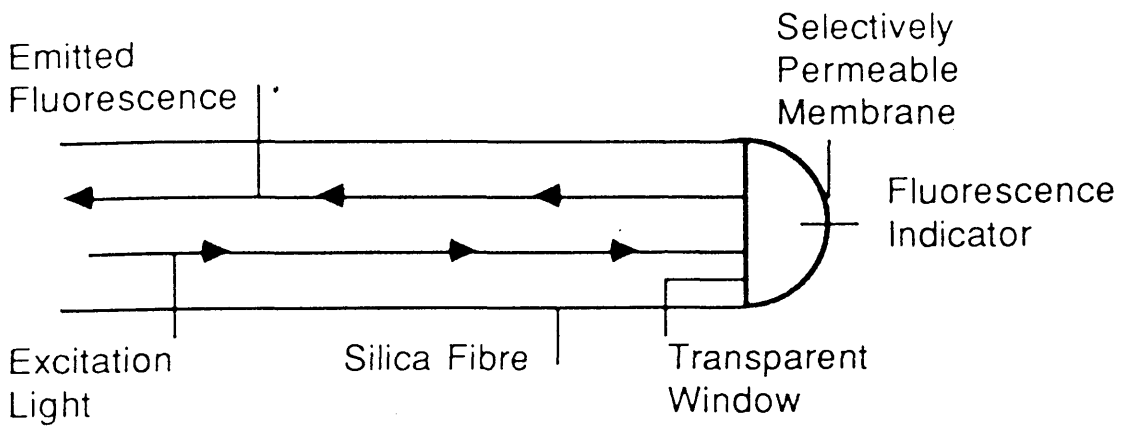

FIGURE 11

Diagrammatic representation of fluorescence-based pH sensor or "Optrode"

- A - Excitation Spectrum of acid form of dye
- B - Excitation Spectrum of basic form of dye
- C - Emission Spectrum of acid and basic form of dye

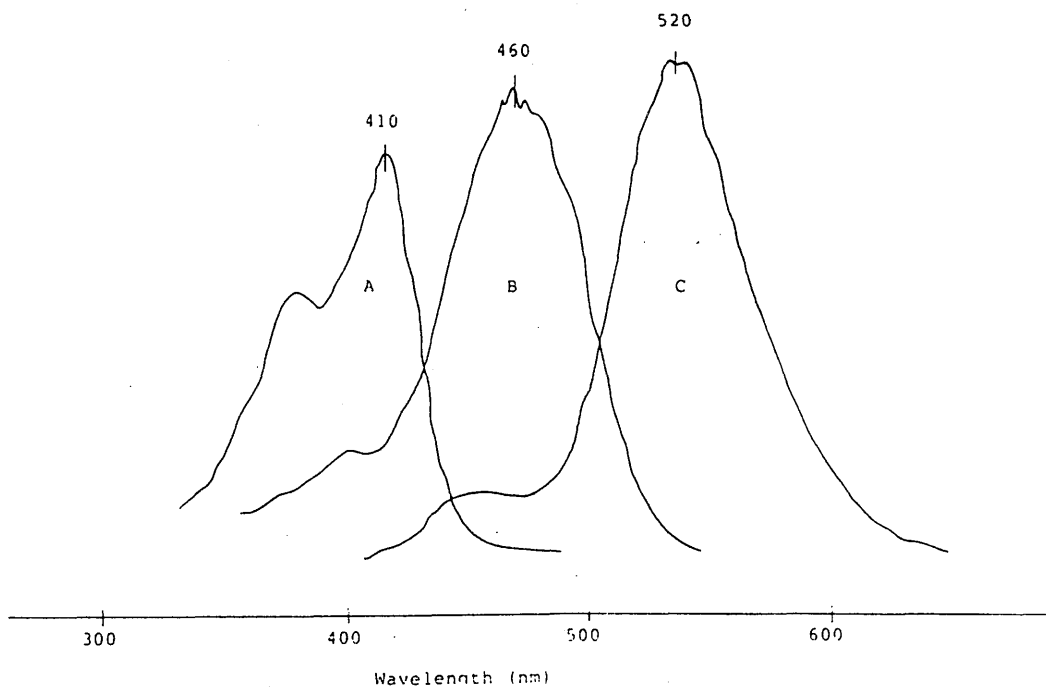

FIGURE 12

Fluorescence spectra of pH sensitive dye.

from external interference, potential for low cost and unique ability for miniaturisation.

CONCLUSION

The developments outlined above are potentially of great value in the future. However, their clinical application has been hampered by basic technological problems and they must still be considered as being at the research stage.

SECTION TWO

ACCURATE LOCALISATION OF pH ELECTRODES IN THE UPPER GI TRACT

The pH electrode is a glass electrode which is sensitive to the concentration of hydrogen ions in the solution. It is used to measure the pH of a solution. The pH of a solution is a measure of its acidity or alkalinity. The pH scale ranges from 0 to 14, with 7 being neutral. Solutions with a pH below 7 are acidic, and solutions with a pH above 7 are basic. The pH of a solution can be measured using a pH electrode, which is a glass electrode that is sensitive to the concentration of hydrogen ions in the solution. The pH of a solution can be measured using a pH electrode, which is a glass electrode that is sensitive to the concentration of hydrogen ions in the solution.

The pH of a solution can be measured using a pH electrode, which is a glass electrode that is sensitive to the concentration of hydrogen ions in the solution. The pH of a solution can be measured using a pH electrode, which is a glass electrode that is sensitive to the concentration of hydrogen ions in the solution.

CHAPTER FIVE

THE PROBLEM OF MAINTAINING pH ELECTRODES IN A CONSTANT POSITION IN THE UPPER GI TRACT

Having determined the best of the currently available pH sensors, a method of accurate placement of these probes in the area of interest was sought. The importance of solving this problem before embarking on any clinical studies can only be appreciated by enumerating the currently available techniques. The following review of the special problems associated with pH measurements in duodenum and stomach serves to inform the reader of the difficulties to be overcome.

DUODENUM

In the proximal duodenum, marked variation in pH of 3 units or more can occur over a few centimetres (Rhodes & Prestwich, 1966; Bircher et al, 1965) and therefore precise localisation of pH devices with respect to the pylorus is essential. The positioning of tubes or electrodes in the duodenum would be facilitated if precise localisation of the pylorus could be achieved and several attempts have been made to this end.

Attempts at localising the pyloric sphincter by means of pressure measurements analogous to the lower oesophageal sphincter have failed (Anderson & Grossman, 1965). Seldom is any pressure change seen as the balloon traverses the pylorus. Although a sharp pH rise often occurs on moving from stomach to duodenum, there may be a

considerable overlap in values between antrum and duodenal bulb (Rovelstad et al, 1951; Archambault et al, 1967; Andersson & Grossman, 1965) especially during active gastric secretion, when antral pH is low (Rovelstad et al, 1951; Andersson & Grossman, 1965). This is not, therefore, a good indicator of position. One group, however, did find it to be useful (Rhodes et al, 1966). In their study, using two electrodes 4 cm apart, a steady recording in the proximal electrode associated with a fluctuating recording in the distal electrode was taken as evidence that the distal electrode was in the duodenal bulb and the proximal one in the antrum. Even when this was combined with X-ray screening, the control of position was found to be difficult, especially after large meals when the stomach lengthened. Patients were therefore kept in bed and given only small meals.

The potential difference occurring across the gut wall has been discussed before (Chapter 2, p 23-24). The sharp change which takes place on crossing the pylorus (Archambault et al, 1967; Andersson & Grossman, 1965; Dennis et al, 1959; Rune & Viskum, 1969) is regarded as the most accurate and consistent means of localising the pylorus. However, although providing information about position, it does not by itself maintain position and frequent adjustment is required (Archambault et al, 1967; Rune & Viskum, 1969). The change in potential difference has also been found on occasion to collapse after a meal (Rune & Viskum, 1969).

The most commonly employed means of identifying the whereabouts of the measuring device is by X-ray, which may involve prohibitively

lengthy exposure to radiation (Archambault et al, 1967; Rhodes & Prestwich, 1966). Radio-opaque media (Barium, Gastrografin) have also been used to assist in outlining the pyloric region, but despite the small volumes used, their presence can affect the pH readings (Archambault et al, 1967; Rhodes & Prestwich, 1966). There is no agreement in the literature as to the frequency with which this should be performed. As an example of the variance which is encountered, suggested values are 3 or 4 times during a 6 hour test (Rhodes et al, 1966), every 3 hours (Atkinson & Henley, 1955), every 5 minutes (Rhodes & Prestwich, 1966) and constant cineradiography during the period of measurement (Bircher et al, 1965). Special X-ray techniques have been advocated. Fluoroscopy with spot X-rays in several projections at frequent intervals, especially with oblique projections have been used (Rovelstad & Maher, 1962). This, however, requires expert radiological assistance. Some groups have performed the whole pH study with the subjects on the X-ray table to allow for frequent screening (Rune & Viskum, 1969), sometimes with the patients prone and tilted to encourage gastric emptying.

Placement of an electrode in the duodenal bulb has been variously judged to be impracticable (Rovelstad, 1956) or very complicated technically although until localisation is established, comparison of results is not possible (Rune, 1973).

Recently, attempts to solve this problem have been made by Rune (Rune, 1981; Hannibal & Rune, 1983; Ovesen et al, 1986) who has developed a system for recording duodenal pH in which a string of up

to six pH electrodes straddles the pylorus. This method uses the transpyloric potential difference changes for localisation purposes. A multichannel recorder and analyser allow compensation for electrode movement as follows. If one of the electrodes crosses from the duodenal bulb to the antrum, the change in skin-enteric potential difference is detected. The system then automatically switches over to recording the electrode immediately distal in the chain as the bulb pH. In view of its complexity, this system can only be used for short-term studies in non-ambulatory subjects.

McCloy (McCloy et al, 1980; McCloy et al, 1984) has developed a system whereby a tapered latex bag containing mercury is attached to an electrode by a 20 cm length of silk thread. The bag is positioned under X-ray control past the D-J flexure, the slack is taken up and the electrode manoeuvred into place in the duodenal bulb. In 7 out of 41 studies, unacceptable movement occurred, five electrodes dislodging proximally and 2 distally. He feels, along with Rhodes (Rhodes et al, 1966), that even if the electrode is in the duodenal bulb, its precise position cannot be determined.

STOMACH

That the distribution of pH in the stomach is not uniform was established over 70 years ago (McLendon, 1915b), but there is not general agreement on the nature of the regional variations or of the effect of food intake.

In the fasting state, the pH of the fundus has been found to be between 0.2 and 0.5 pH units lower than the rest of the stomach by Kristensen (Kristensen, 1965). Even larger differences, of up to 3 pH units in the same direction have been recorded (Tomenius & Williams, 1960; Krawiec et al, 1983). Others, however, have found the antrum to be more acid than the fundus (Eyerly & Breuhaus, 1939; Eyerly, 1940) whereas Fimmel (Fimmel et al, 1985) found no difference.

After a meal, McClendon found that "the pylorus became acid more rapidly than the rest of the stomach, but it is not true that the pylorus is always more acid than the fundus." (McClendon, 1915a). He also found that mixing is complete in about 2-3 hours. The behaviour of the stomach after food has been likened not to a churn but to a hopper with the cardia and fundus acting as the body and the pylorus as the mouth (Eyerly & Breuhaus, 1939). In a small series of 4 patients, in whom gastric pH was measured by 2 electrodes, one in the fundus and one in the antrum, pH changes towards neutrality were found to be more immediate and significantly greater in the fundus than in the antrum (Fimmel et al, 1985). The effect of moving from a lateral to a supine position after antacid administration was demonstrated by Tomenius (Tomenius & Williams, 1960), who showed that large differences in pH could be recorded from a single intragastric electrode (pH 6 - pH 3.5).

Kristensen suggests that the variation described above render placement and maintenance of position mandatory to compare techniques of measurement (aspiration vs. pH-monitoring), to compare patients or to test the influence of drugs (Kristensen, 1965).

Reynolds et al, 1986, state that "all investigations of intragastric acidity assume that intragastric pH is the same at various sites of the stomach and that complete mixing of gastric contents occurs. Transmucosal potential changes from region to region in the stomach are insufficiently large or consistent to be used for localisation purposes and there has been no alternative but to use X-rays for localisation purposes." While this may be true, this implies that, since there is no good method of localising pH electrodes in the stomach except by using X-rays and since this is impractical for ambulatory studies, any pH variations which may exist will have to be disregarded. In view of the reports of occasional substantial variations noted above, this is obviously a highly unsatisfactory situation.

CHAPTER SIX

DEVELOPMENT OF A NEW ENDOSCOPIC TECHNIQUE TO ALLOW ACCURATE LOCALISATION OF ELECTRODES IN THE UPPER GIT

The previous chapter has emphasised the importance of maintaining accurate positioning of pH electrodes in the upper GI tract. To date there have been no reliable means of achieving this. As a result, very few long-term ambulatory studies, i.e., of 24 hours duration, have appeared in the literature (McCloy et al, 1980; McCloy et al, 1984; Hostein et al, 1987) and of these, none has been entirely successful. This chapter describes an endoscopic technique which was developed in order to achieve and maintain accurate localisation of electrodes in the upper GI tract over a 24 h period.

METHODS

Materials

The Olympus HX-2L clip-fixing device was used in conjunction with an Olympus IT10 endoscope. The device is loaded with a stainless steel clip (Olympus MA401) and then retracted into its polythene sheath before passing through the biopsy channel of the endoscope. Manual controls on the proximal end of the clip-fixing device allow the clip to be protruded and then opened in the stomach (Fig. 13). Further manoeuvres allow the clip to be firmly closed and detached.

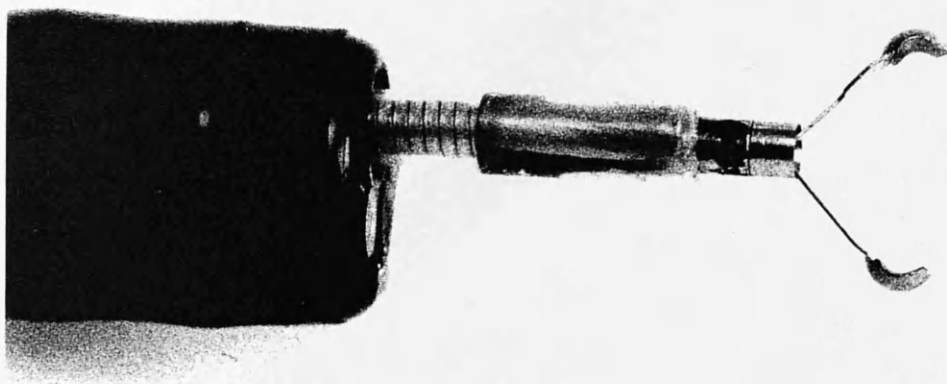

FIGURE 13

Clip-fixing device protruding from biopsy channel of endoscope with clip fully opened.

Two combined glass electrodes (Radiometer GK2801C) were used. Their cables were bound together using Micropore with the tip of one electrode 10 cm proximal to the other. The distal electrode was further prepared (Fig. 14) by tying two loops of 3-0 Prolene to the electrode 1.5 cm from its tip and a third 1 cm proximal to this.

Cadaveric Studies

Preliminary studies were performed to determine the depth of penetration of the clip. In these, 2 fresh post mortem human stomachs from patients with no evidence of upper GI pathology were opened longitudinally at the pylorus and clips were forcibly fixed to antrum, pylorus and duodenum to ensure maximum depth of clipping. The portions of the gut containing the clips were excised and fixed in formalin. The clips were then carefully removed without damaging the overlying mucosa and the tissue sectioned. In all, six sections were examined from each of stomach, pylorus and duodenum.

Human Studies

Patients requiring endoscopy as part of their upper gastrointestinal investigations were invited to participate in the study. They were sedated with a combination of Pethidine and Midazolam (Hypnovel), up to a maximum of 50 mg and 10 mg respectively. Hyoscine (Buscopan) was also given in a dose of 20 mg. Prior to passing the endoscope, a length of nylon was fed through the biopsy channel, through the proximal loop of Prolene on the distal electrode and back through the biopsy channel. With the distal electrode tip just behind the end of the gastroscope, both were passed together into the body of the stomach. Pulling the free ends of the nylon line

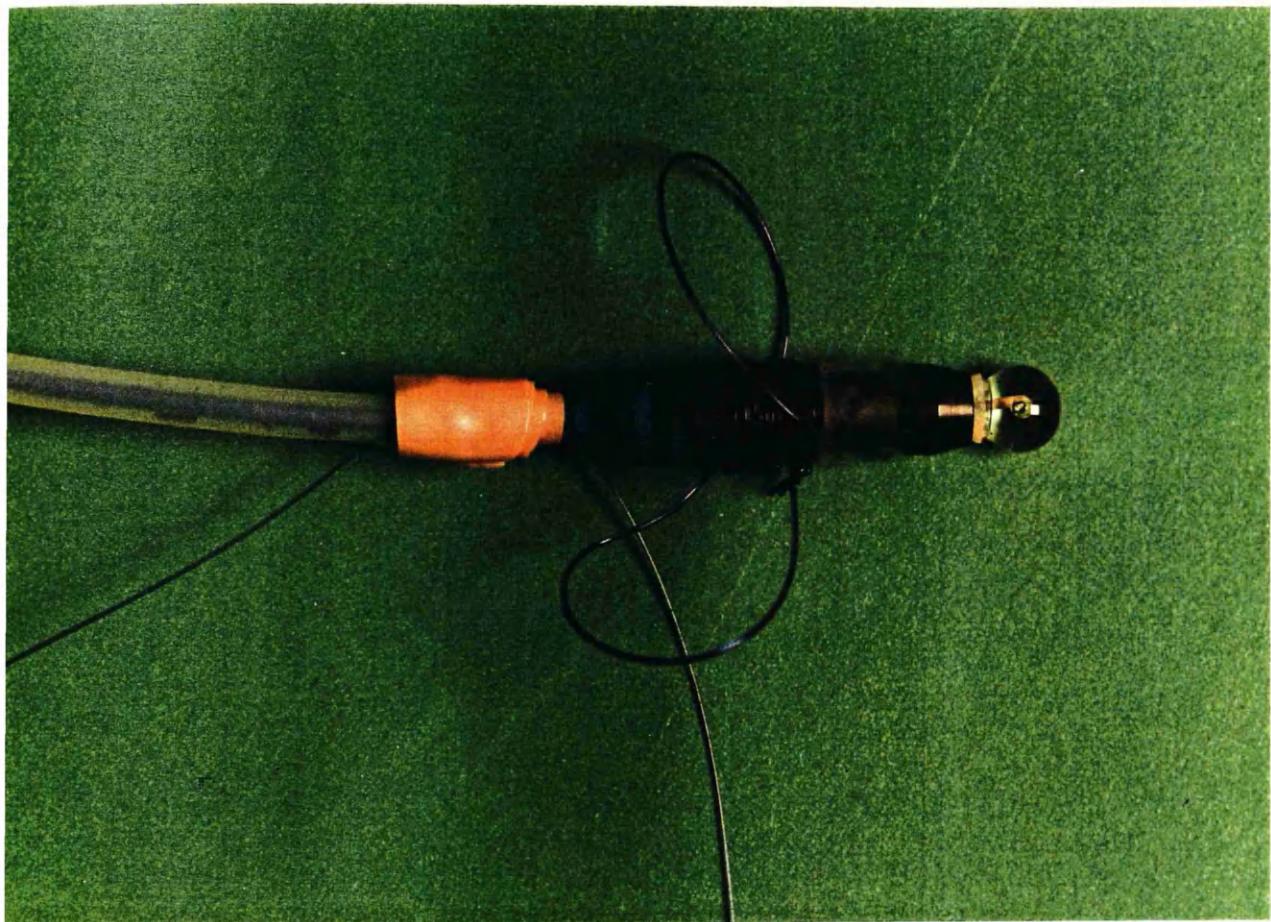

FIGURE 14

Preparation of the Radiometer electrode to permit fixation. The proximal loop of prolene allows tethering of the electrode to the endoscope during passage of the instruments. The two distal loops are each clipped to the mucosa thus anchoring the electrode.

protruding from the biopsy channel advanced the electrode into view and allowed it to be carried by the endoscope into the desired position in the stomach or duodenum.

The electrode, having been correctly positioned, was detached from the endoscope by completely withdrawing the nylon line. A loaded clip-fixing device was then introduced via the biopsy channel and the clip opened and advanced to grasp one of the distal Prolene loops on the electrode. Final adjustment to the electrode's position could thus be made before clipping the loop to the mucosa. The second distal loop was fixed in a similar fashion. Before withdrawing the endoscope, the clips were inspected to ensure that the electrode was well anchored. The electrode cables were held firmly at the mouth during withdrawal of the endoscope. In order to confirm that the electrodes had remained fixed to the mucosa, a repeat endoscopy was performed 24 hours after clipping.

The study was approved by the Hospital Ethical Committee and all patients gave fully informed, signed consent.

A fuller account of the technique, along with examples of its use in two patients, is presented on the attached video cassette.

RESULTS AND DISCUSSION

Cadaveric Studies

In each of the 18 sections examined, the clip had penetrated beyond the muscularis mucosae into the submucosa but in no case did the clip reach the outer muscle layer of the gut wall (Fig. 15).

Human Studies

During the development phase of this technique, a total of 40 patients participated over a two-year period. Out of 10 attempts in the first year, only one was successful. In addition to the learning curve for any new technical procedure, several problems were encountered.

Originally, attempts were made to pass the electrode through the nose into the stomach before the patient was taken to the endoscopy suite. Almost invariably, the electrode had either become buried in folds of mucosa or had coiled up in the fundus of the stomach, resisting all attempts to be repositioned more distally. This approach regrettably had to be abandoned. Regrettably, because it was felt that the patient would have been more comfortable with nasal than oral intubation. Even when the electrode was passed perorally alongside the endoscope, difficulty was encountered controlling the position of the electrode in the stomach. This was overcome by tethering the electrode to the tip of the endoscope with the nylon thread.

Another problem was dislodgement of the clipped electrode on withdrawing the endoscope which occurred even when the electrode cable was held firmly at the mouth. The extra rigidity obtained by splinting two electrodes together surmounted this problem and gave the additional advantage of dual pH monitoring.

As a result of these refinements, the procedure was successful in each of the next 20 patients, with the electrode firmly anchored to the mucosa at repeat endoscopy 24 hours later. As the electrodes were withdrawn, the mucosa tented and then with further traction, the clips dislodged, leaving bleeding points similar to those produced by a standard endoscopic biopsy. The clips remain closed and are retrieved attached to the electrode. No complications have occurred with the procedure.

Since completion of this study, further improvements have been introduced which make the procedure easier to perform and more comfortable for the patient. The distal two loops on the electrode to be fixed are now of 3-0 PDS, whereas the proximal loop is still of 3-0 prolene. The difference in appearance of the two suture materials (PDS is deeper blue and thicker) avoids confusion when deciding upon which loop to clip. The proximal loop is now longer, so that when the endoscope and electrode are passed, some of this loop lies within the biopsy channel of the endoscope. Occasionally with the previous system, that part of the nylon line which protruded from the distal end of the endoscope caught around the electrode and the nylon line could not be withdrawn without damage to the electrode. This cannot now happen.



FIGURE 15

Histological section of gastric mucosa showing tract left after clip has been carefully removed.

Optimum sedation is now achieved with Midazolam alone. Pethidine has not been required in the last year and Hyoscine is reserved for cases which would simply be impossible otherwise. In fact, the flattening of the mucosa which occurs after administration of Hyoscine can make the clipping more difficult than when the normal stomach mucosal folds are present. If the Micropore used to splint the electrodes together extended too proximally, the patients complained of pharyngeal irritation. To surmount this problem, while still allowing the endoscope to be safely withdrawn, a 25 cm length of polythene tubing slit longitudinally on one side is positioned around the cables of the two electrodes before passing the endoscope (Fig. 16). Whenever the endoscope has to be withdrawn, the tubing, tapered at the "patient end" is fed over the electrode cables and over the back of the tongue. The cables are held firmly where they emerge from the other end of the tubing to prevent retraction with the endoscope. Coiling of the cables in the mouth cannot then occur and only a short length of Micropore is used distally to hold the electrodes together. Considerable improvement in patient comfort has thus been achieved.

The endoscopic procedure described above is unique in achieving precise electrode placement and fixation under direct vision. The ability of the clip to remain firmly attached for 24 hours is probably due to its penetration through the muscularis mucosa into the submucosa in a pincer fashion without impairing the blood supply to the overlying tissue. Penetration of the outer muscle layers of the gut wall does not occur, thus avoiding the risk of perforation. Although

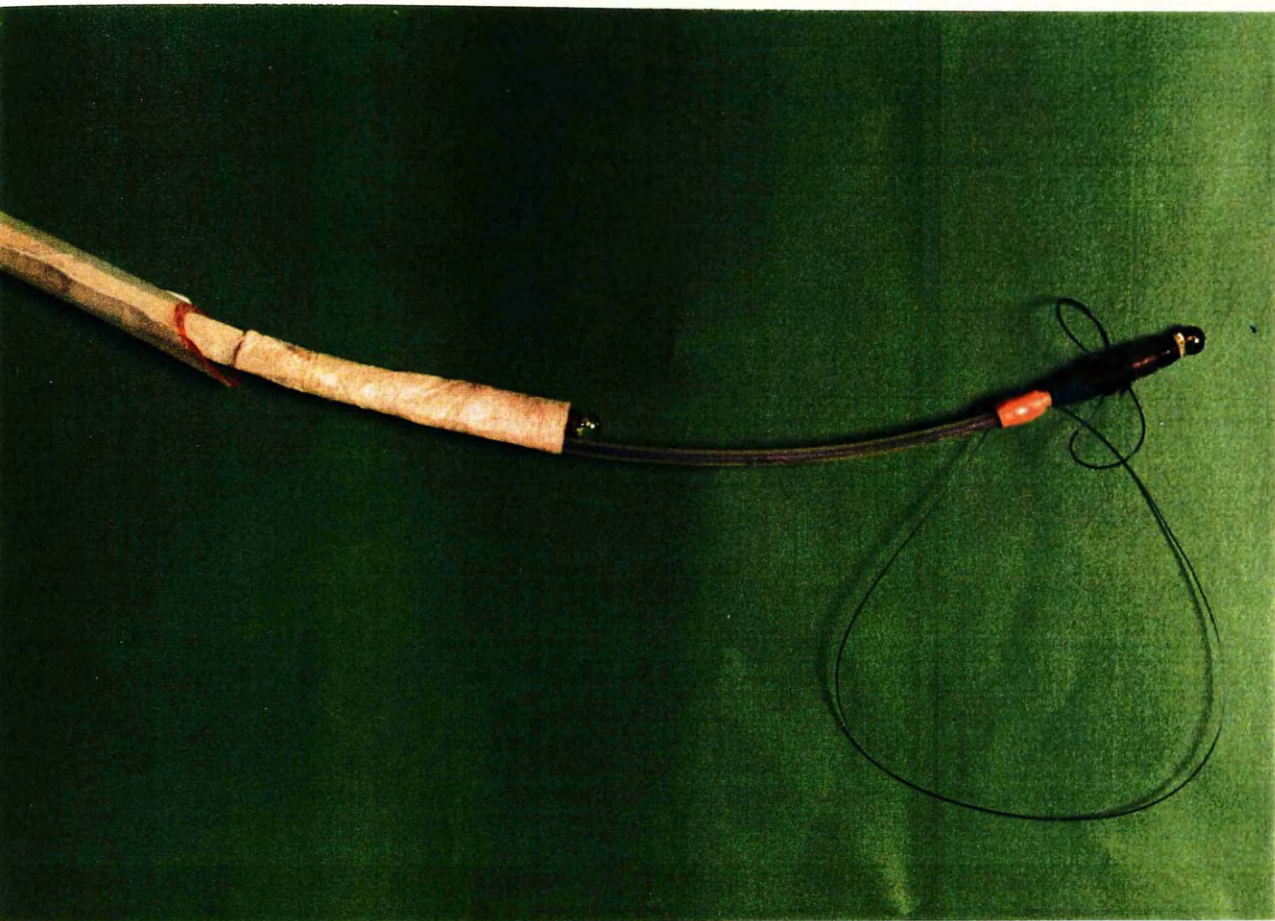

FIGURE 16

Plastic cover to be used to prevent dislodgement of electrode on withdrawing endoscope.

for the purpose of this study patients were re-endoscoped after 24 hours, this will not be required routinely and a fluoroscopy check before removal of the electrode should be adequate.

This procedure should allow, for the first time, the accurate documentation of the pH of different regions of the human upper gastrointestinal tract both under physiological circumstances and in various disease states.

CHAPTER SEVEN

A 24 HOUR AMBULATORY STUDY OF REGIONAL VARIATIONS IN INTRAGASTRIC pH IN HEALTHY VOLUNTEERS

Having developed a method allowing accurate positioning of in-situ electrodes in the upper GI tract, we are now able for the first time to study regional variations in intragastric pH over a 24 h period. This chapter describes simultaneous monitoring of gastric body and antral pH in healthy volunteers over a 24 h period.

MATERIALS AND METHODS

Subjects

Four male and five female healthy volunteers ranging in age from 20 - 56 years were studied. None had any GIT symptoms or history of gastrointestinal problems. Their individual details are shown in Table 3.

Study Design

The volunteers were admitted to our investigational Unit for the 24 hours of the study. At approximately 09.00 h, and with the subjects fasted since the previous evening, two combined glass electrodes (Radiometer 2802C) were positioned endoscopically with one anchored to the antral mucosa and the other 10 cm proximal in the body of the stomach. The two electrodes were attached to each other by Micropore tape so that one was 10 cm distal to the other and two short loops of nylon thread were attached to the distal electrode. The

TABLE 3

DETAILS OF THE 9 HEALTHY VOLUNTEERS WHO PARTICIPATED IN THE STUDY

SUBJECT NO.	AGE	SEX	CIGARETTES	ANTRAL HISTOLOGY	CAMPYLOBACTER LIKE ORGANISMS
1	35	M	3/day	Normal	-ve
2	27	F	15/day	Gastritis	+ve
3	45	F	0	Gastritis	+ve
4	26	F	0	Normal	-ve
5	56	F	0	Gastritis	-ve
6	35	M	0	Normal	-ve
7	30	M	0	Normal	-ve
8	30	M	10/day	Normal	-ve
9	20	F	5/day	Gastritis	+ve

electrodes were then passed orogastrically alongside a wide channel endoscope (Olympus 1T10) and the distal electrode secured in the antrum by clipping both nylon loops to the mucosa using a clip fixing device (Olympus HX-2L). At the time of the endoscopy a biopsy of the antrum was taken for histological examination. All subjects received Midazolam (Hypnovel) 4 mg i.v. immediately prior to the endoscopic procedure.

After withdrawal of the endoscope the electrodes were connected to a Digitrapper Mark II Gold (Synectics) solid state instrument which records the pH from each electrode every 4 seconds. On recovery from the sedation, the subjects were fully ambulatory and the pH recordings continued until the following morning. They consumed the normal hospital meals consisting of breakfast (taken 1 h after the endoscopy), mid-morning tea and biscuit, lunch, mid-afternoon coffee and biscuit, dinner and evening snack. They went to bed between 22.00 h and 23.00 h and rose between 06.00 h and 07.00 h. At the end of the 24 h recording period the electrodes were withdrawn, with the fixation clips still attached, by traction on the leads.

The data from the Digitrapper was stored on an Amstrad PC 1512 microcomputer and analysed using the Gastrosoft package (Synectics). Detailed analysis was performed of daytime and night-time pH. Daytime pH was taken as 12.00 h - 23.00 h as the period prior to 12.00 h was affected by the endoscopic procedure. Night-time pH was taken as 23.00 h - 05.00 h so that it included only that time when patients were recumbent in bed. The pH changes associated with the evening meal and with the endoscopy were analysed in greater detail.

The gastric biopsies were examined in a single blind fashion using Haematoxylin and Eosin stain. Campylobacter-like organisms were identified by the Fast Cresyl Violet stain.

RESULTS

In each subject the electrodes were confirmed to have remained firmly anchored in place by observing transient resistance to dislodgement on removal of the electrodes and by the presence of fresh blood and tissue in the retrieved clips. Malfunction of the recording equipment prevented analysis of the daytime pH in one subject and of the night-time pH in another subject.

pH Immediately Following Endoscopy

The pH of both the antrum and body was higher immediately following the endoscopy compared with other fasting periods. Thirty minutes after the placement procedure, the antral pH ranged from 1.5 - 7.0 (mean 4.0) and body pH from 1.5 - 7.0 (mean 4.2). In contrast, preprandial antral pH (median pH value for each individual over the hour prior to the evening meal) ranged from 1.2 - 2.5 (mean 1.9) and preprandial body pH from 1.3 - 2.8 (mean 1.9) (Table 4). Following the endoscopy, the mean time for the pH to return to preprandial values was 56 minutes (range 0 - 110) for the antrum and 57 minutes (range 0 - 120) for the body. There was no significant difference between the pH readings in the antrum and body following endoscopy. The pH tracing of subject No. 3 illustrating the effect of the endoscopy is shown in Fig. 17.

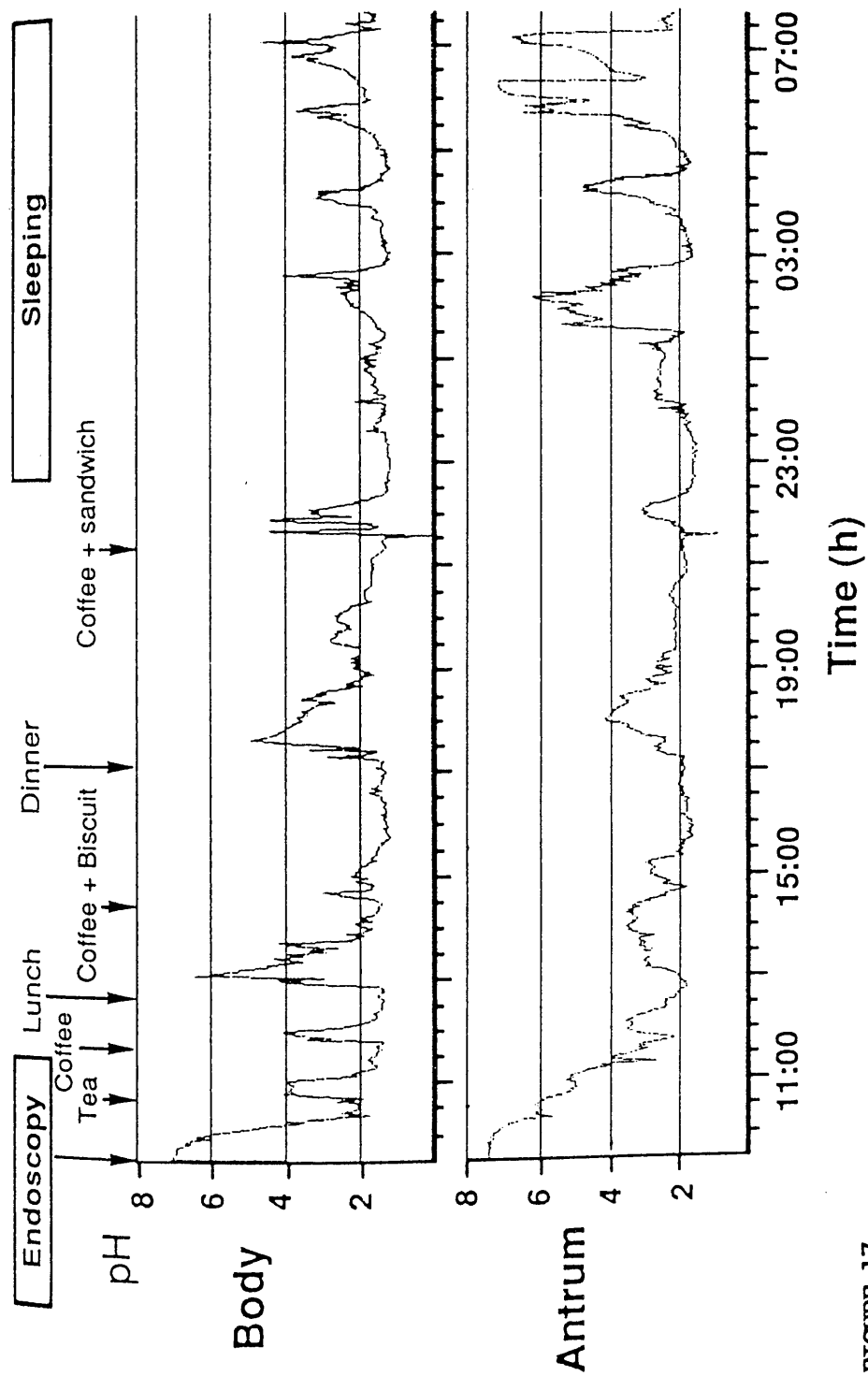

FIGURE 17

Simultaneous ambulatory pH recording of gastric antrum and body in subject number 3. This demonstrates the increased pH following the endoscopy and the fact that eating increases body pH more than antral pH. In contrast, episodes of increased nocturnal pH are more pronounced in the antrum than in the body.

TABLE 4

EFFECT OF EVENING MEAL ON THE pH OF THE GASTRIC BODY AND ANTRUM

SUBJECT NO.	PREPRANDIAL pH	DELAY IN pH RISE AFTER STARTING MEAL (min)	TIME TO REACH PEAK pH AFTER STARTING MEAL (min)	PEAK pH DURING MEAL	TIME TO RETURN TO BASAL pH AFTER STARTING MEAL (min)	
1	Body	2.2	45 (sec)	21	4.4	210
	Antrum	2.0	30 (min)	45	2.4	210
2	Body	2.8	16 (sec)	12	6.6	63
	Antrum	2.5	11 (min)	28	4.5	86
3	Body	1.4	8 (sec)	24	6.4	95
	Antrum	1.9	1 (min)	43	4.1	126
4	Body	1.4	240 (sec)	20	6.6	127
	Antrum	1.5	6 (min)	40	4.2	136
5	Body	2.1	60 (sec)	7	6.2	121
	Antrum	2.1	6 (min)	13	4.5	201
6	Body	2.2	16 (sec)	16	6.7	130
	Antrum	2.2	9 (min)	53	6.2	94
7	Body	1.8	16 (sec)	8	4.4	120
	Antrum	1.6	6 (min)	30	2.4	126
8	Body	1.3	50 (sec)	6	4.4	45
	Antrum	1.2	2 (min)	34	3.0	37
MEAN	Body	1.9	30 (sec)	14	6.3	120
	Antrum	1.9	6 (min) [*]	37 [*]	4.1 ⁺	126

* Significantly greater than body with $p = 0.01$ + Significantly less than body with $p < 0.01$

Preprandial pH represents the median value over the hour prior to the evening meal

Daytime pH

In 7 of the 8 subjects with complete daytime tracings, the daytime pH (i.e., median pH value between 12.00 h and 23.00 h) which included prandial and postprandial periods was lower in the antrum than in the body (Table 5). The mean daytime pH of the 8 subjects was 2.7 (range 1.8 - 4.5) for the body compared with 2.0 (range 1.6 - 2.6) for the antrum ($p < 0.05$). Likewise, the percentage daytime pH < 3 was higher for the antrum (mean = 87%) than for the body (mean = 60%) ($p < 0.05$).

More detailed analysis showed that the difference in daytime pH between the body and antrum was not due to differences in the preprandial pH but in the pH response to meals. The preprandial pH (median value over the hour prior to commencing the evening meal) of the 8 subjects ranged from 1.3 to 2.8 (mean = 1.9) for the body which was similar to the values for the antrum (range 1.2 - 2.5; mean = 1.9) (Table 4). After eating, the antral pH was slower than the body pH in rising and also in reaching its peak pH (Table 4). The mean time for the body pH to begin to rise after the start of the evening meal was 56 seconds (range 8 - 60 seconds) compared with 9 minutes (range 2 - 30 minutes) for the antrum ($p = 0.01$), and the mean time for the body to reach its peak prandial pH was 14 minutes (range 6 - 24 minutes) compared with 36 minutes (range 13 - 53 minutes) for the antrum ($p = 0.01$). The two regions of the stomach also differed with respect to the peak pH achieved during the evening meal. The peak pH values for the body ranging from 4.4 - 6.7 (mean = 5.7) and for the antrum 2.4 - 6.2 (mean = 3.9) ($p < 0.01$). The time for the pH to return to preprandial levels following the evening meal was similar in the body

TABLE 5

DAYTIME AND NIGHTIME pH OF GASTRIC BODY AND ANTRUM

SUBJECT NO.	DAYTIME (12:00h-23:00h)		NIGHTIME (23:00h-05:00h)		DAY + NIGHT (12:00h-05:00h)		
	MEDIAN pH	%pH < 3	MEDIAN pH	%pH < 3	MEDIAN pH	%pH < 3	
1	Body	3.2	46	1.6	100	2.7	65
	Antrum	2.2	92	1.5	97	1.8	94
2	Body	2.5	27	1.7	88	2.3	48
	Antrum	2.4	95	1.7	89	2.2	91
3	Body	2.0	81	2.0	89	2.0	84
	Antrum	1.8	83	3.2	60	2.2	75
4	Body	1.8	79	1.3	100	1.6	87
	Antrum	1.9	77	1.5	98	1.6	85
5	Body	3.1	56	3.6	46	3.2	53
	Antrum	2.6	64	4.4	34	3.1	53
6	Body	3.0	63	1.1	100	1.6	70
	Antrum	2.0	89	1.2	100	1.7	93
7	Body	1.9	87	1.1	100	1.7	93
	Antrum	1.7	100	1.2	84	1.6	94
8	Body	4.5	39	-	-	-	-
	Antrum	1.6	96	-	-	-	-
9	Body	-	-	1.3	100	-	-
	Antrum	-	-	1.3	100	-	-
MEAN	Body	2.7	60	1.7	90	2.1	71
VALUES	Antrum	1.9*	87 ⁺	2.0	83*	2.0	85

* Significantly less than Body with $p < 0.05$ + Significantly greater than Body with $p < 0.05$

(mean = 114 minutes) and antrum (mean = 102 minutes). The actual pH tracing during the evening meal of volunteer No. 7 showing the typical pH response in the antrum and body is shown in Fig. 18.

Night-time pH

The night-time pH (median value between 23.00 h and 05.00 h) of the individual subjects varied from 1.2 - 4.4 (mean = 2.0) for the antrum and was similar for the body, range 1.1 - 3.6 (mean = 1.7). However, there were clear differences in the night-time pH among the 8 individuals with complete tracings. In 6 of them the night-time pH showed little, if any, fluctuation with the pH of the body being less than 3 for more than 88% of the time and the pH of the antrum being less than 3 for more than 84% of the time (Table 5). The pH tracing for patient No. 7 who showed this pattern is shown in Fig. 19. Two of the female subjects (Numbers 3 and 5) showed a different pattern, having well defined episodes of elevated antral and body pH throughout the night (Fig. 17 and Fig. 20). On each of the occasions, the rise in pH was evident in both electrodes although usually more marked and prolonged in the antral electrode. The duration of the episodes of elevated pH recorded by the antrum electrodes in these two patients varied from 40 - 90 minutes and the peak pH reached during the episodes varied from 3.5 - 7. The episodes of elevated pH were more pronounced in patient No. 5 who was the oldest patient studied (56 years) than in patient No. 3 who was the second oldest (45 years).

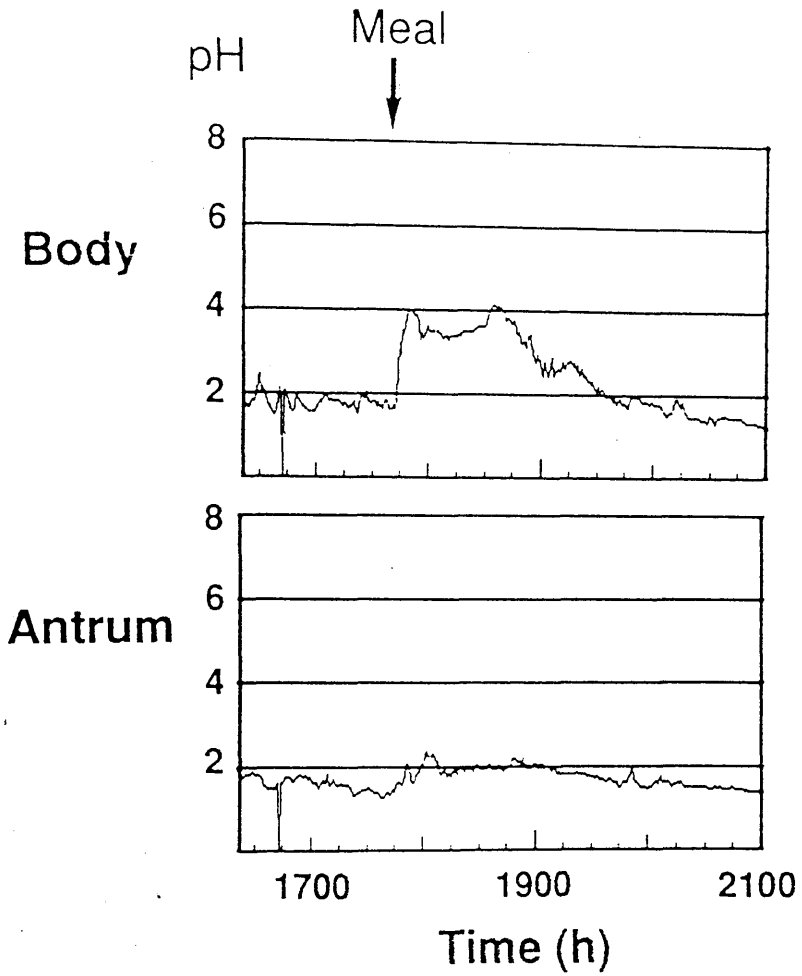

FIGURE 18

Effect of evening meal on the pH of the gastric antrum and body of subject No. 7 whose tracings are representative of the subjects studied.

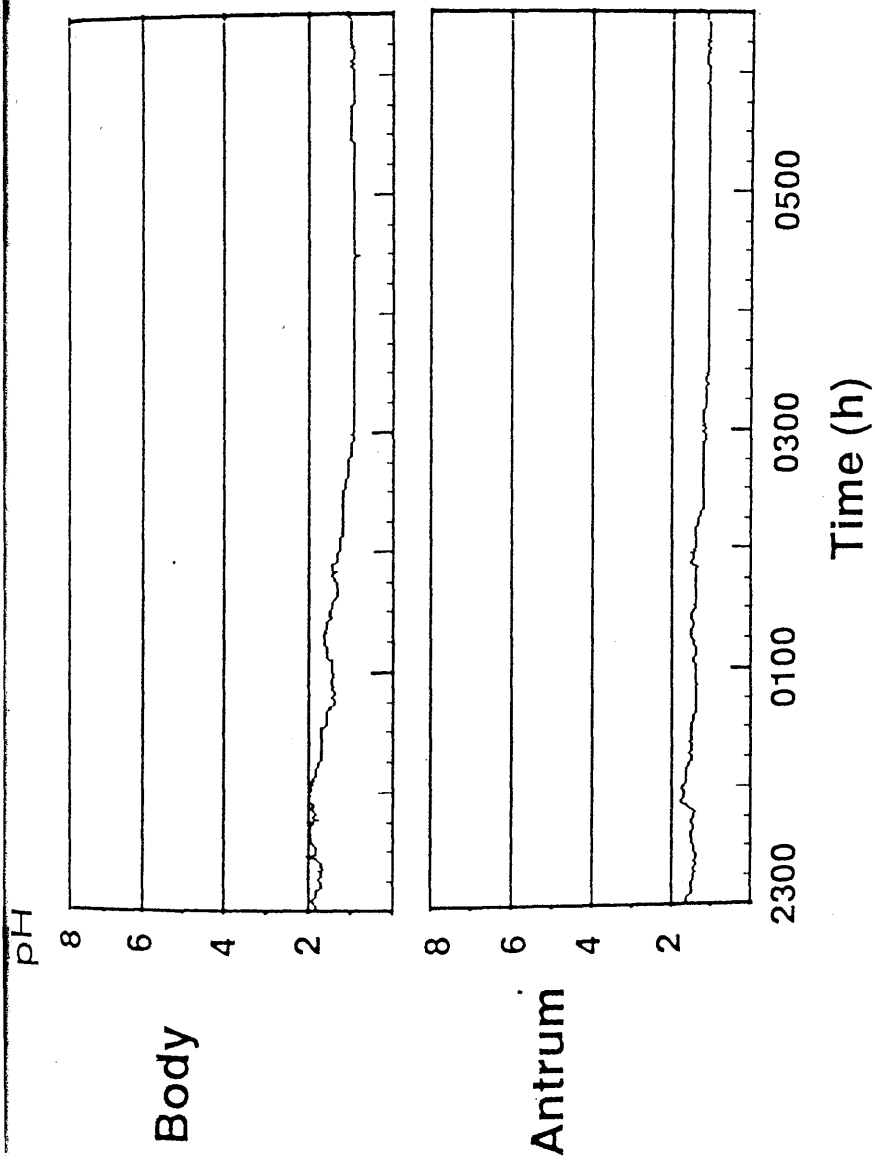

FIGURE 19

Night-time gastric antral and body pH of subject No. 7 whose tracings are representative of the 6 subjects who showed steady low night-time pH.

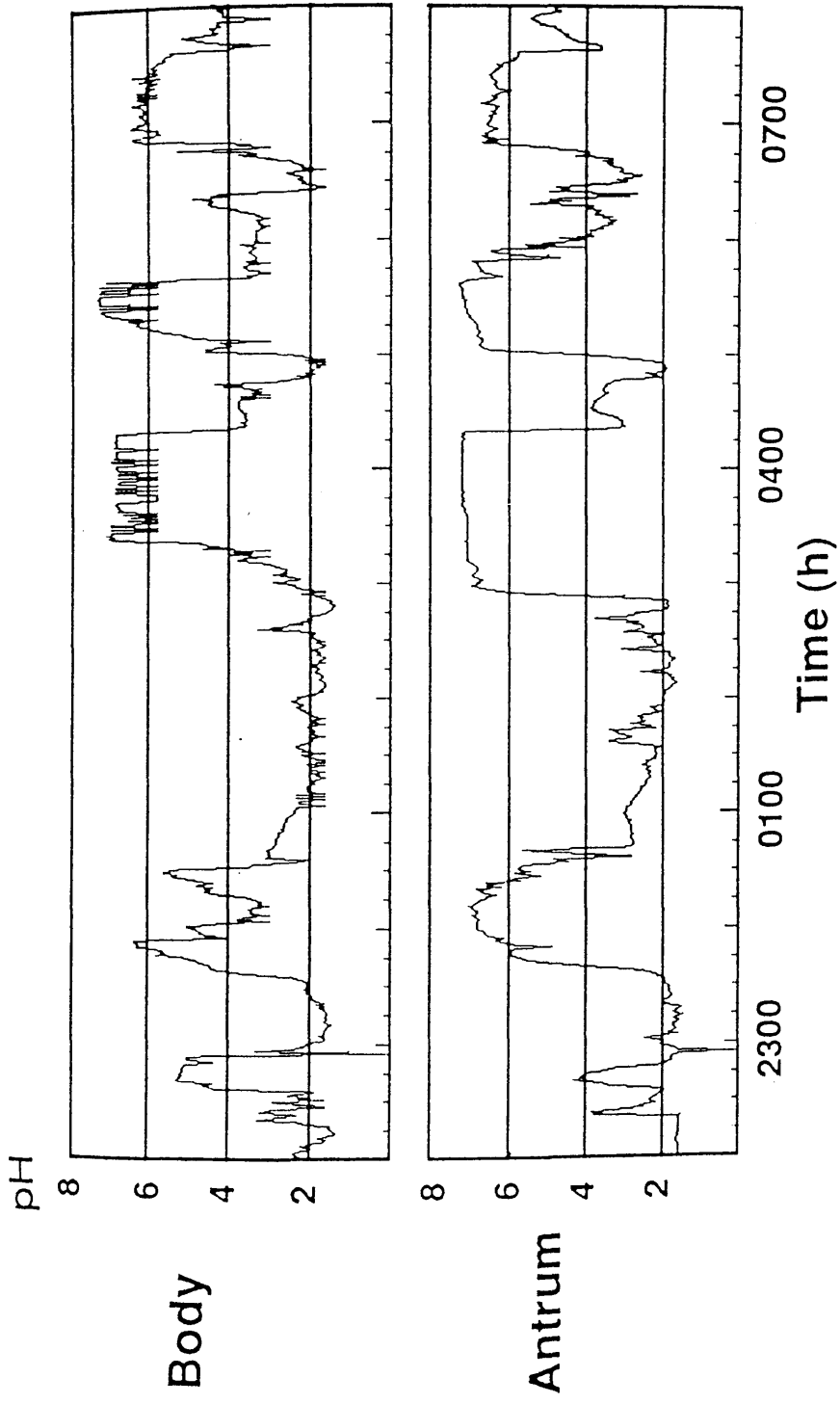

FIGURE 20

Night-time gastric antral and body pH of subject No. 5 showing episodes of markedly increased pH.

Daytime and Night-time pH Combined

When the median pH values were calculated for each individual for the entire daytime and night-time period (12.00 h - 05.00 h) there was no significant difference between the body and antrum, the values ranging from 1.6 - 3.2 (mean 2.1) for the former and 1.6 - 3.1 (mean 2.0) for the latter (Table 5).

Antral Biopsies

The histology of the antral biopsies was normal in five of the subjects but in four there was evidence of chronic superficial gastritis with infiltration of lymphocytes and plasma cells in the lamina propria. Campylobacter-like organisms were present in 3 of these 4 subjects with gastritis. Both of the subjects with periods of elevated night-time pH had gastritis and in subject No. 5 who had the most pronounced episodes of elevated night-time pH the gastritis was not associated with Campylobacter-like organisms.

DISCUSSION

The first unexpected finding from this study was that intragastric pH when measured using in-situ glass electrodes, is markedly increased following upper gastrointestinal endoscopy and may reach neutral values. The reason for this is not clear. Midazolam, which was the only premedication used, is not known to interfere with gastric secretion or motility. The high pH readings could be related to the aspiration of the gastric juice and insufflation of air during the endoscopic examination. In addition, retching during the

endoscopy is likely to cause duodenogastric reflux of alkaline juices. Whatever the explanation, the observations should be borne in mind if pH readings are taken for diagnostic or research purposes at endoscopy as they do not reflect normal fasting gastric values. Because of the effect of the endoscopic procedure, detailed analysis of our data was commenced at 12.00h , three hours after the procedure.

The pre-meal daytime pH was similar in the antrum and body but the rise in pH with eating was more immediate and more marked in the body. Though there has been no previous study of regional variations in gastric pH using fixed electrode position, Fimmel et al monitored body and antral pH in 4 healthy volunteers using electrodes positioned fluoroscopically (Fimmel et al, 1985; Bauerfeind et al, 1985). They found also that the pH of the two regions was similar during fasting and that eating resulted in a more marked rise in pH in the body than in the antrum. Intra-gastric pH rises on eating due to the buffering effect of the food exceeding the meal-stimulated increase in acid secretion. As the latter does not peak until 60-90 minutes after the commencement of eating (Fordtran & Walsh, 1973), the rise in intra-gastric pH is most pronounced shortly after the meal is begun when the buffering effect of the food predominates. In the present study the rise in gastric body pH was maximum 14 minutes after eating and then fell even though gastric emptying of a solid meal does not usually begin until 27 minutes after starting the meal (Robinson et al, 1988). This subsequent fall in pH can be explained by the increasing acid output overwhelming the buffering capacity of the food. Our finding that the rise in pH was later and less in the

antrum compared with the body can be explained by previous scintigraphic observations that a solid meal is initially concentrated in the body and then "fed" into the antrum (Robinson et al, 1988). By the time the food reaches the antrum its buffering effect will be largely overcome by the increasing acid secretion. In addition the slower rate of delivery of the food into the antrum will minimise its buffering effect. The differences in gastric body and antral pH observed following the solid meal are consistent with the observation made by Eyerly and Breuhaus 50 years ago that the stomach acts more like a hopper than a churn (Eyerly & Breuhaus, 1939).

The night-time pH in most of the subjects was low and showed little fluctuation consistent with the fasting state. However, in the two oldest subjects studied the pH rose considerably for variable periods of time throughout the night. The fact that the distal electrode was secured in the antrum and also that the rise in pH affected both electrodes means that the changes could not be explained by displacement of the electrode into the duodenum or oesophagus. Interestingly, the rise in pH in the antrum was usually more marked than that in the more proximal body electrode, this pattern being opposite to that occurring after a meal. These observations would be consistent with the rises in gastric pH being due to duodenogastric reflux of alkaline juices. Fimmel et al, 1985, studied 24 h intragastric pH using a single unfixed electrode in normal volunteers and noted similar periods of elevated pH in a proportion of their subjects which they also attributed to duodenogastric reflux. A similar interpretation of this phenomenon was given by Little et al, 1984. Previous studies have demonstrated duodenogastric reflux in

healthy volunteers both in the fasting state and following meals (Muller-Lissner et al, 1983; Keane et al, 1981; Heading, 1983).

In spite of the fact that all our patients were asymptomatic healthy volunteers, four of the nine antral biopsies showed evidence of gastritis and in three of these *Campylobacter*-like organisms were also identified. This is consistent with the studies by Jones et al and Wyatt et al which demonstrated circulating antibodies to *Campylobacter* in 16 - 49% of healthy volunteers (Jones et al, 1986; Wyatt et al, 1988). A high correlation exists between the antibody and the presence of the bacterium and gastritis in antral biopsies (Jones et al, 1984). Duodenogastric reflux has been suggested as a cause of gastritis (O'Connor et al, 1986; Niemela et al, 1987; Ritchie, 1984) and in this study the two subjects with episodes of elevated nocturnal gastric pH both had evidence of gastritis. In the subject with the most marked episodes of elevated nocturnal pH, the gastritis was not associated with *Campylobacter*.

By demonstrating marked differences in the pH of the antrum and body of the stomach during the day and night this study emphasises the fact that intragastric pH is not uniform. In addition, it indicates that gastric pH monitoring using fixed electrode position may provide a means for detecting duodenogastric reflux through the night or during other periods of fasting.

CHAPTER EIGHT

FURTHER STUDIES TO ASSESS WHETHER DUAL INTRAGASTRIC pH MONITORING MAY BE A USEFUL MEANS OF DETECTING DUODENOGASTRIC REFLUX

One interesting finding in the previous study of gastric antral and body pH in healthy volunteers was the episodic rise in nocturnal pH in 2 of these subjects. The fact that this was more marked in the antral electrode suggested that it might indicate alkaline duodenogastric reflux. It was, therefore, decided to undertake some further studies to determine whether dual intragastric pH monitoring might provide a useful means of detecting duodenogastric reflux.

This chapter describes further studies which were performed to assess the potential value of dual intragastric pH monitoring in detecting duodenogastric reflux.

(1) STUDY OF pH CHANGES ON MIXING DUODENAL AND GASTRIC JUICES

In vitro studies were performed in order to determine the effects of adding varying amounts of duodenal juice on the pH of gastric juice. This would give some idea of the volume of duodenogastric reflux required to significantly affect intragastric pH.

METHODS

Into three stirred beakers, each containing 30 ml of gastric juice, samples of duodenal contents from 3 different patients

were titrated at room temperature. The specimens of duodenal juice had been obtained at the time of pancreatic function testing, either by Lundh meal or by secretin stimulation. The gastric juice was obtained from patients undergoing tests of stimulated acid secretion. All had been stored at -20°C . Titration was continued until 60 ml of duodenal juice had been used. The choice of 30 ml for the volume of gastric juice was based on a review of the resting volumes of gastric contents of patients attending the G.I. Centre for secretion studies.

In the second part of the experiment, samples of gastric juice from 2 patients were titrated at room temperature into 2 stirred beakers, each containing 10 ml of duodenal juice. Titration continued to a volume of 20 ml of gastric juice. In all of the above experiments, pH was measured using a combined glass electrode (Pye-Unicam 401).

RESULTS

Figure 21 shows that even after titration of 60 ml of duodenal juice, i.e., twice the volume of gastric juice, pH had risen only to approximately 5. The second part of the experiment was undertaken to see how quickly the pH of duodenal juice would fall on titration with gastric juice. Figure 22 shows that a rapid fall occurs even with small volumes of gastric juice such that, at equal volumes, the pH was around 6. When the volume of gastric juice was increased to 20 ml (twice the volume of duodenal juice), pH in both samples was less than 3.

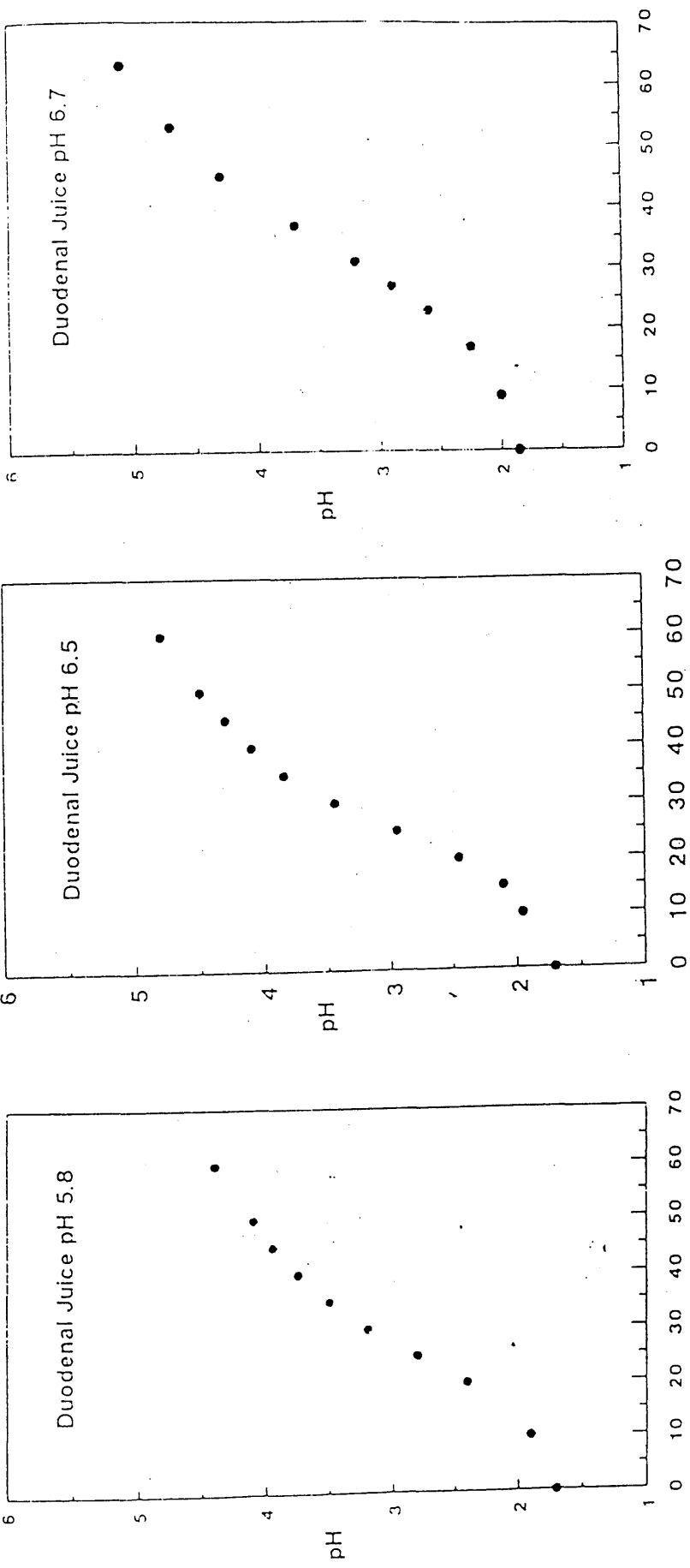

Volume of duodenal juice added (ml) to 30ml gastric juice

FIGURE 21

Three experiments showing the pH change that occurs when duodenal juice is added to gastric juice.

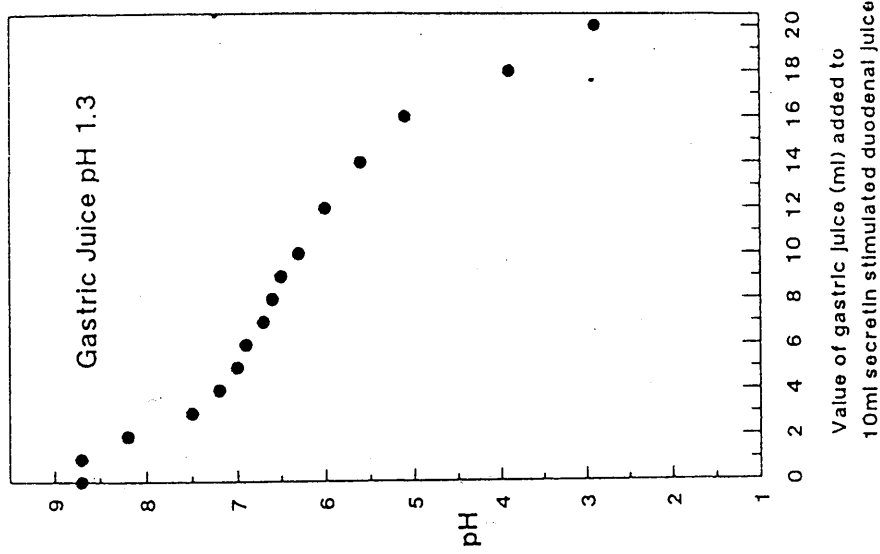
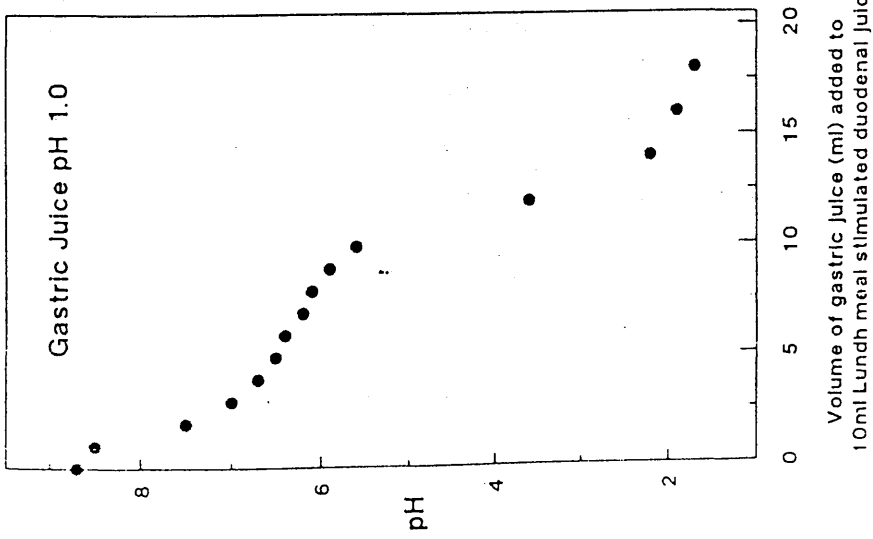

FIGURE 22

Two experiments showing the pH change that occurs when gastric juice is added to duodenal juice.

DISCUSSION

The volume of duodenal juice which can be aspirated from the fasting subject without stimulation is low. It would therefore be difficult, if not impossible, to obtain enough to perform the above experiment under ideal conditions, i.e., immediately after removal of unstimulated gastric and duodenal juice at 37°C, which would closely mimic the situation in the fasting stomach at night. The most important problem with this study is a loss of buffering capacity of duodenal juice with time due to loss of CO₂ and the results of these experiments must be interpreted with this in mind. The properties of the gastric and duodenal juices were obviously not uniform. For example, in the first experiment at equal volumes of gastric juice and duodenal juice the pH was between 3 and 4. In the second experiment this value was around pH 6. This could be expected from inter-subject variation, differences in technique of stimulating the pancreas and possible contamination of gastric contents by duodenal contents or vice versa. In both experiments, when the volume of gastric juice was double that of duodenal juice, the pH was always less than 3. This implies that large volumes of duodenal contents must reflux to neutralise gastric contents completely. Since it is known that bile secretion is reduced at night (Davenport, 1982), more information is necessary to substantiate the claims that nocturnal alkalinisation in the stomach is due to duodenogastric reflux.

CONCLUSION

These experiments suggest that if a rise in nocturnal intragastric pH is due to duodenogastric reflux, either

- (1) large volumes are refluxing
 - (2) there is little acid in the stomach at the time of reflux
- or
- (3) the refluxed duodenal contents do not mix with the gastric contents.

(2) STUDY OF MIXING OF GASTRIC AND DUODENAL JUICES

The possibility of incomplete mixing of refluxed duodenal juice and gastric contents was raised during earlier benchwork when it was noticed that complete mixing of bile and gastric juice was not always easy to achieve. The following experiment was designed to test this theory.

MATERIALS AND METHODS

A standard Latex surgical glove was modified as shown in Figure 23. The four fingers were tied off and a hole was made in the tip of the thumb. Gastric juice at 37°C was poured into the glove to a depth of 1 inch. A 20 ml syringe containing duodenal juice also at 37°C projected into the glove at the wrist and was tied in position. The glove was then suspended in a

water bath at 37°C. Two combined glass electrodes (Radiometer GK2802C) were placed in the gastric juice through the hole in the thumb. They were free to move independently. pH recording was then begun on the Digitrapper Mark II (Synectics). With both electrodes together, low in the gastric juice, basal values were recorded. Duodenal juice was then infused into the glove. Recording was continued over a 70 minute period during which the electrodes were moved up and down, at first together and then separately. At the end of the experiment, the contents of the glove were vigorously agitated and the electrodes continued to record for a further hour.

RESULTS

The pH recordings during the experiment are shown in Figure 24. With the electrodes at the bottom of the glove and immersed in gastric juice, both read pH values of 1. When the duodenal juice was infused, it could be seen settling to the bottom, displacing the gastric juice upwards and the pH of both electrodes rose to 8. When all the duodenal juice had been injected, two clearly visible layers were discernible with the gastric juice floating on top. Raising the electrodes up into the upper layer of gastric juice was accompanied by a fall in pH back to 1. When both electrodes were moved up and down close to the interface between the 2 juices, fluctuations in pH could be seen. One electrode was then kept high in the glove and recorded a pH value of around 2. The other electrode was moved up and down between the two layers and great variation in recorded pH

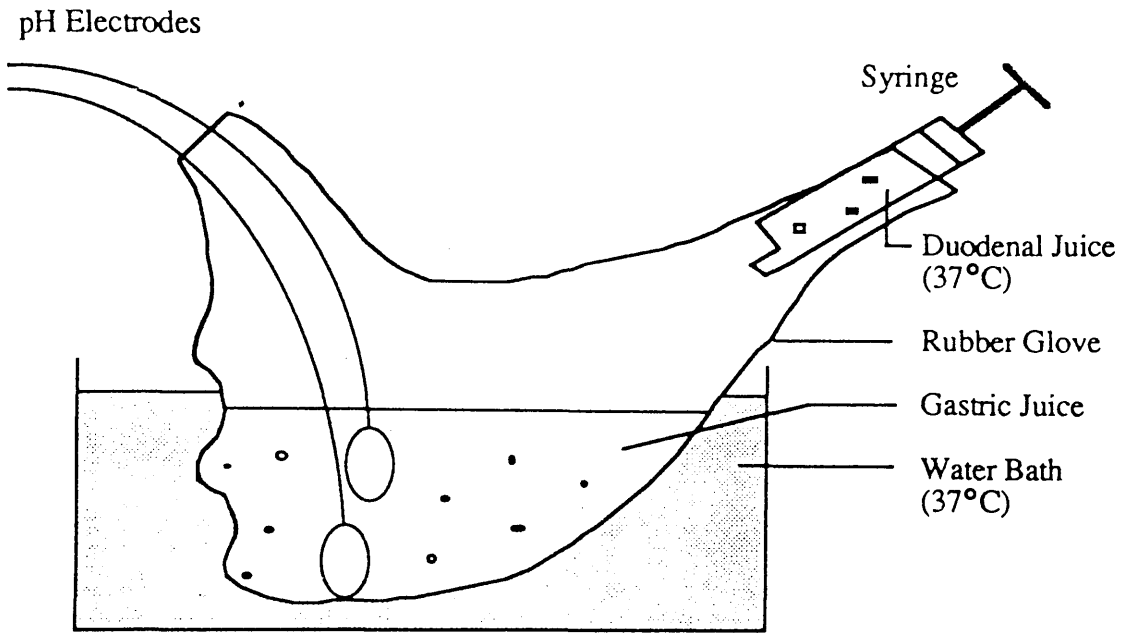

FIGURE 23
Diagrammatic representation of experimental model for invitro studies of changes in intragastric pH caused by duodenogastric reflux

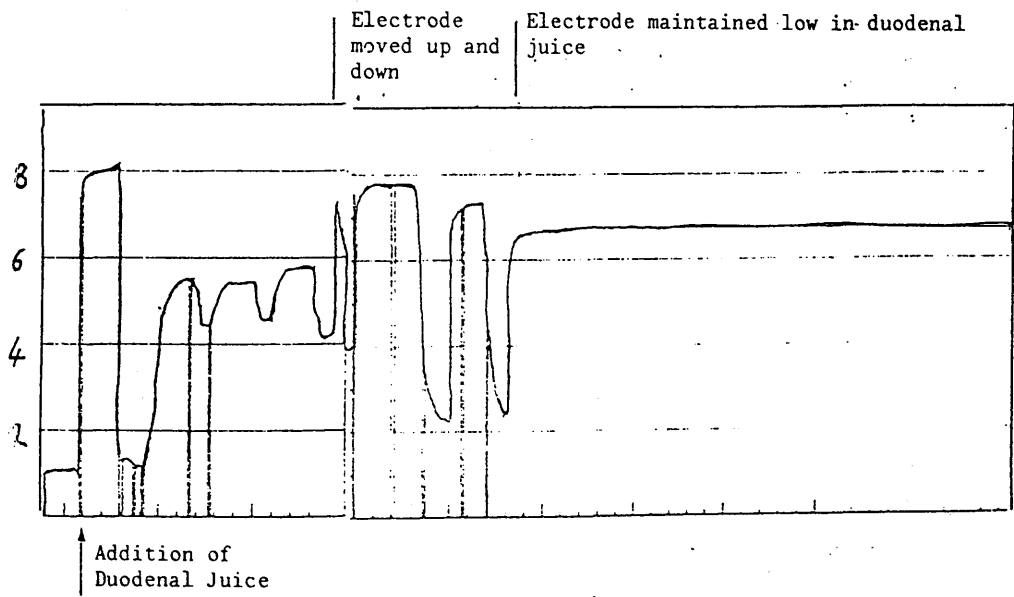
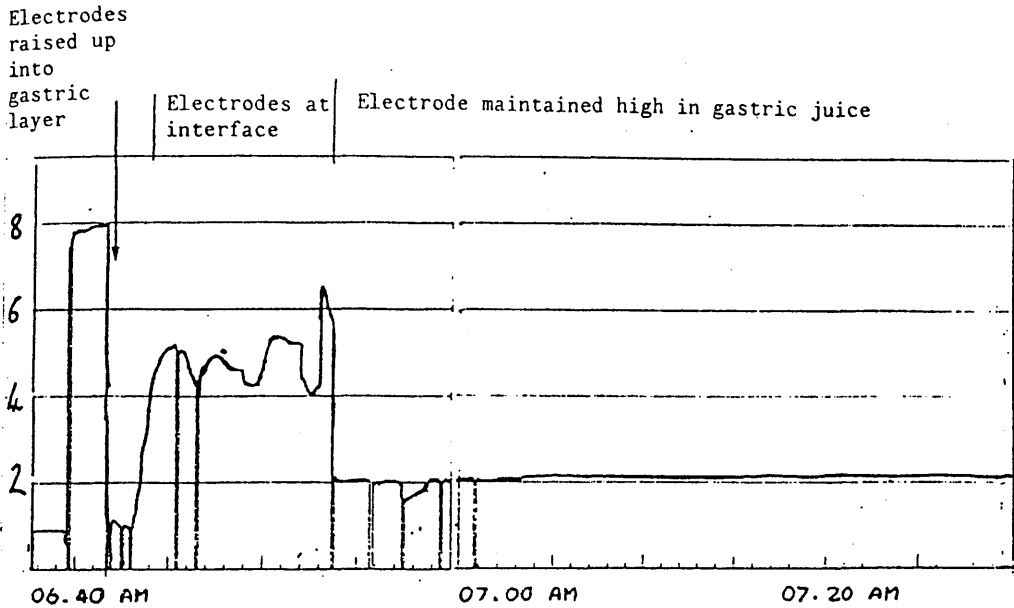

FIGURE 24

pH recorded by two separate electrodes in simulated stomach containing 20ml gastric juice to which 20ml duodenal juice added

were seen. One electrode was then maintained in the upper layer when it recorded a steady pH of 2 while the other electrode was maintained in the lower layer where it recorded a steady pH of 6.5. When the glove was vigorously agitated mixing of the gastric and duodenal juices occurred and both electrodes recorded the same pH value of 4.5.

SUMMARY

This experiment demonstrates that duodenal juice is more dense than gastric juice and can remain separated from it until agitation takes place. This could explain why one electrode can detect large variations in gastric pH while another electrode can be little affected. If this is true in vivo, reflux of large volumes of duodenal juice would not be necessary to raise pH at one point in the stomach to values of 7 or more.

(3) STUDIES OF GASTRIC ASPIRATE AND DUAL INTRAGASTRIC pH IN SUBJECT WITH EPISODES OF ELEVATED NOCTURNAL pH.

In order to determine whether episodes of elevated nocturnal pH did represent in vivo alkalinization of the gastric juice, studies were performed in a healthy volunteer noted to have this pH pattern.

METHODS

Dual intragastric glass electrodes were positioned endoscopically in the stomach with the distal electrode clipped in the antrum and the other electrode 10 cm proximal in the body as previously described. A Viomedex aspiration tube was fastened to the electrode apparatus before it was passed so that the aspiration port lay 3 cm proximal to the distal electrode. Throughout the night from 24:00h - 08:00h the pH recorded by the electrodes was constantly measured and spot samples of gastric juice aspirated whenever the pH changed. The gastric aspirate inspected for any green or yellow discolouration due to bile and its pH measured.

RESULTS

The results are shown in Figure 25. Three patterns emerged in this study: (1) On some occasions there was marked elevation of pH recorded by the antral electrode and simultaneous but less marked elevation of pH recorded by the body electrode. At these time points aspiration of gastric juice was possible and the pH of this was also elevated lying midway between that recorded by the in situ electrodes; (2) The second pattern seen was marked elevation of pH recorded by the antral electrode but no concurrent elevation of pH recorded by the body electrode. On these occasions no gastric juice could be aspirated for pH determination; (3) The third pattern observed was an absence of elevation of pH recorded by either electrodes. Aspiration of

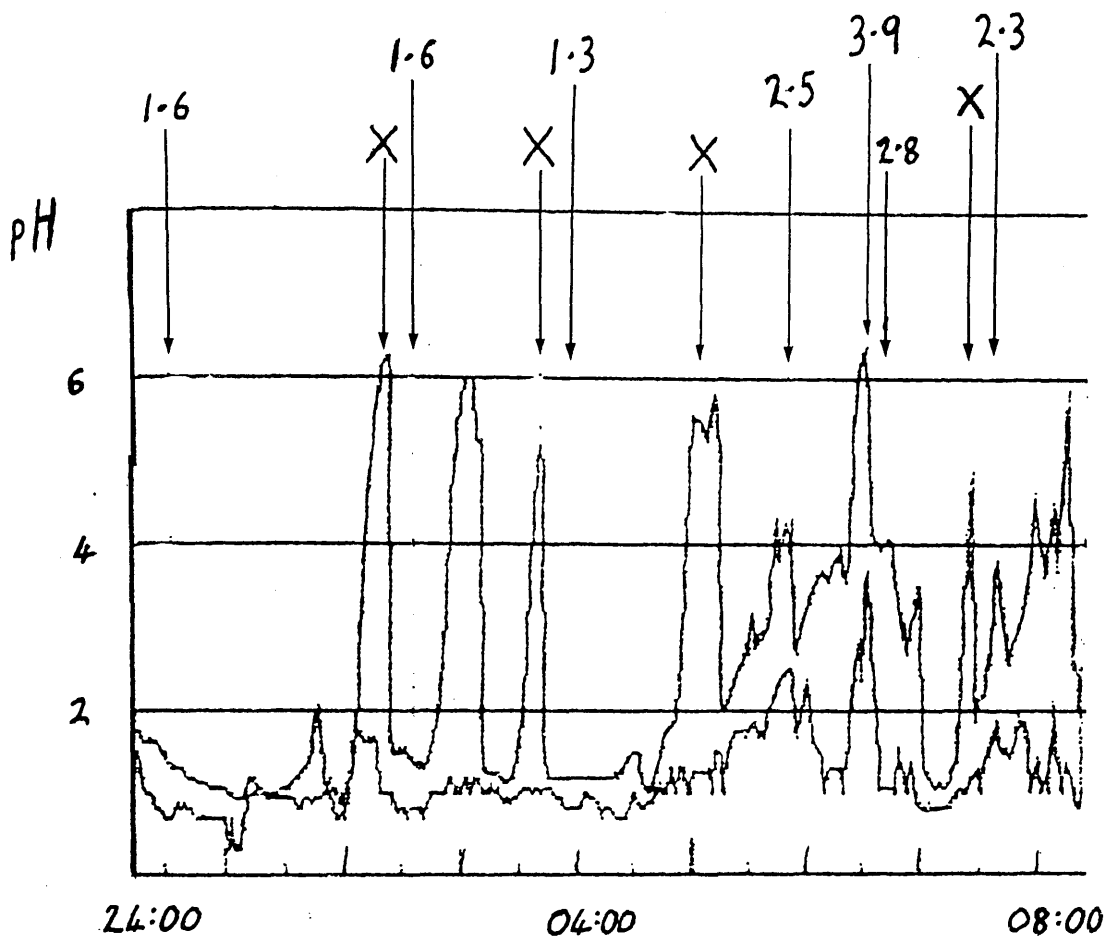

FIGURE 25

Simultaneous overnight monitoring of antral and body pH in subject with episodes of elevated intragastric pH. The antral tracing is the one recording the higher pH values. The arrows indicate the pH of gastric fluid aspirated at that time point. 'X' indicates that it was impossible to aspirate gastric fluid.

gastric juice was usually possible at this time and the pH of the aspirate was low and similar to that recorded by the two in situ electrodes.

On no occasion was there any evidence of discolouration of the gastric aspirate to suggest contamination by bile.

DISCUSSION

The finding that the pH of the aspirated juice was elevated at the time when the pH recorded by the 2 intragastric electrodes was elevated would be consistent with these episodes representing neutralization of gastric juice. The mechanism of this episodic neutralization is unclear. Episodic outpouring and swallowing of saliva or alternatively reflux of duodenal juice could explain it. The fact that the elevation of pH was more pronounced in the antral electrode would favour the latter.

The explanation for the occasional elevation of pH recorded only by the antral electrodes is also unclear. It could represent episodic duodenal reflux only affecting the antrum and not reaching the body. This, however, seems unlikely as it was not impossible to aspirate any juice at these times even though the aspiration port was only a few centimetres proximal to the antral electrode. Another possibility is that the antral electrode was intermittently protruding into the duodenum. If this were so, the pH should have increased to 7 or 8 and not just

to 5 or 6. A further possibility is that these episodes represent contraction of the antrum. This could force the electrode against the mucosal wall causing it to record mucosal pH rather than luminal pH. This explanation would also account for the inability to aspirate gastric juice at these times due to the contraction temporarily occluding the aspiration port.

In some ways, this study raises more problems than it answers by indicating that episodes of elevated nocturnal pH may be accounted for in a variety of ways. It is clear that attributing them to duodenogastric reflux is an oversimplification. pH monitoring cannot be regarded as a means of detecting duodenogastric reflux.

SECTION THREE

STUDIES OF DUODENAL PH

CHAPTER NINE

STUDIES TO VALIDATE MEASUREMENT OF DUODENAL pH BY IN SITU ELECTRODES

There are several potential problems in measuring duodenal pH using in situ glass electrodes. The main one is to know whether the pH recorded is that of the duodenal luminal contents or that of the duodenal mucosa. As the duodenum is a much narrower, tubular structure than the stomach, the possibility of the electrode being fully enveloped by the mucosa and therefore registering mucosal pH is not remote. It is possible that the rapid fluctuations between pH 5 and neutrality which commonly occur when recording duodenal pH could merely be due to the electrode intermittently being in contact with duodenal luminal contents and duodenal mucosa. "To guard or not to guard" has been a contentious point in the literature for many years. Guards have been advocated by some (Bircher et al, 1965; Eyerly, 1940; Tomenius & Williams, 1960; Rune, 1968; Rovelstad, 1952). More recently, opinion has shifted towards using bare electrodes (Benn & Cooke, 1971; Rhodes et al, 1966; Rovelstad, 1962). It is noteworthy that Rune & Rovelstad, keen protagonists of the guard in their earlier work, have now abandoned their use. There is to date no published human study which answers this question. When one considers the sophistication and expense of the technology now in use to record and analyse signals emanating from pH electrodes, it is remarkable how little work has been done on this fundamental question which could so radically affect the results.

The following studies were undertaken in an attempt to determine whether in situ duodenal electrodes measure mucosal pH, luminal pH or both.

(1) STUDIES OF EFFECT OF MUCOSAL CONTACT ON RECORDED pH

SUBJECTS

The effect of mucosal contact on electrode recordings was assessed in 2 patients with ileostomies. Both had undergone panproctocolectomy for Crohn's disease.

METHODS

The tip was removed from a 5 ml syringe, leaving only the barrel. With the patient recumbent, the syringe was applied vertically to the mucosa. A combined glass electrode was then lowered onto the mucosa and left in contact for some minutes in patient No. 1. Phosphate buffer of pH 4 was poured into the syringe (Fig. 26). pH was recorded as the electrode was raised into the buffer and lowered to touch the mucosa on several occasions. Care was taken not to push the electrode so firmly that it would become embedded in the mucosa.

RESULTS

The results in both patients are shown in Fig. 26. In both recordings, deflections in pH to values > 6 occurred, despite a portion of the glass bulb being exposed to the overlying buffer.

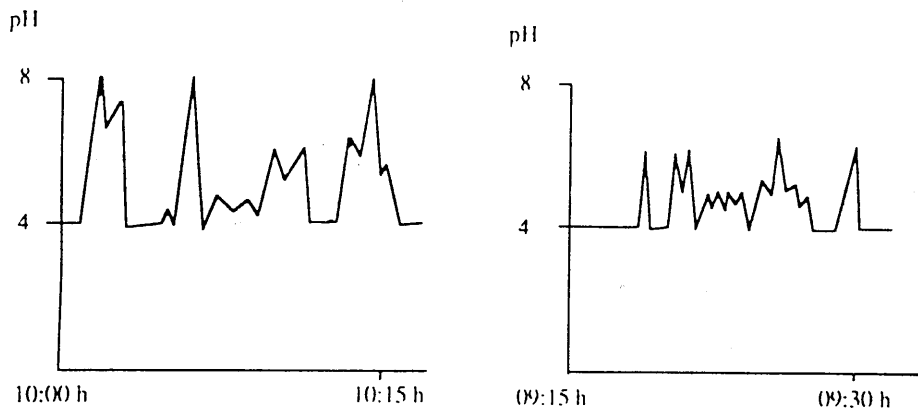
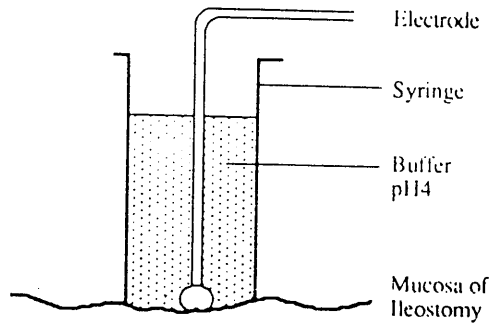

FIGURE 26

- (Top) Experimental design used to examine the effect of mucosal contact on recorded pH
- (Lower) Studies in two patients showing rise in recorded pH when electrode intermittently pushed against mucosa

CONCLUSION

Contact of the pH electrode with ileal mucosa can alter the recorded pH. This raises doubts as to the validity of assuming that pH values recorded with unguarded electrodes in the duodenum are a true reflection of the intraluminal contents. Further studies were undertaken to clarify the situation.

(2) CONSTRUCTION OF ELECTRODE GUARD TO PERMIT IN VIVO STUDIES OF EFFECT OF MUCOSAL CONTACT ON RECORDED pH

To construct a guard which would enable assessment of the effect of mucosal contact to be made, certain conditions had to be satisfied:

- (1) It should be of small enough dimensions for easy ingestion.
- (2) It should not impede the flow of bowel contents around the bulb of the electrode in either direction.
- (3) It should be non-toxic and non-irritant.
- (4) It should not allow any contact between the mucosa and electrode bulb.

After several unsatisfactory attempts, the following design was found suitable. A length of stainless steel wire was turned on a lathe into the form of a spring. The distance between the coils of the spring was large enough for fluids to pass easily through but not large enough for mucosa to pass through and make contact with the glass bulb of the electrode. A blob of epoxy

was placed at one end to incorporate the potentially abrasive free end of the steel wire and impart some streamlining. When the guard was positioned over the electrode, the proximal portion fitted snugly around the reference port and no further fixation was required. To ensure that the response of the electrode would not be affected by the guard, the following experiment was performed.

(3) IN VITRO STUDIES ELECTRODE WITH GUARD

A twelve inch length of Paul's tubing was closed off at one end with a steel clip. A filter funnel was placed at the other end, tied in place and held with a bench clamp so that the tubing hung from the filter funnel. The tubing was filled with duodenal juice. Two "strings" of three electrodes were passed into the tubing with each string consisting of a proximal, distal and middle electrode at 5 cm spacing (Fig. 27). The middle electrode of one group was guarded. A length of feeding tube was passed to a point just proximal to the middle electrodes. This arrangement enables the constituents of the tubing to be altered completely by opening the clip at the bottom, releasing the contents, closing it again and refilling. Rapid fluctuations in pH, as occur in the duodenum, could also be mimicked by injecting fluids of appropriate pH through the feeding tube. The fluids used in this experiment were gastric juice and duodenal juice, both at 37°C. The influence of the guard could be studied by comparing the pH recordings from the middle electrodes. Since incomplete mixing of gastric and duodenal juices has been demonstrated previously (Chapter 8, p 62-65) and could theoretically account

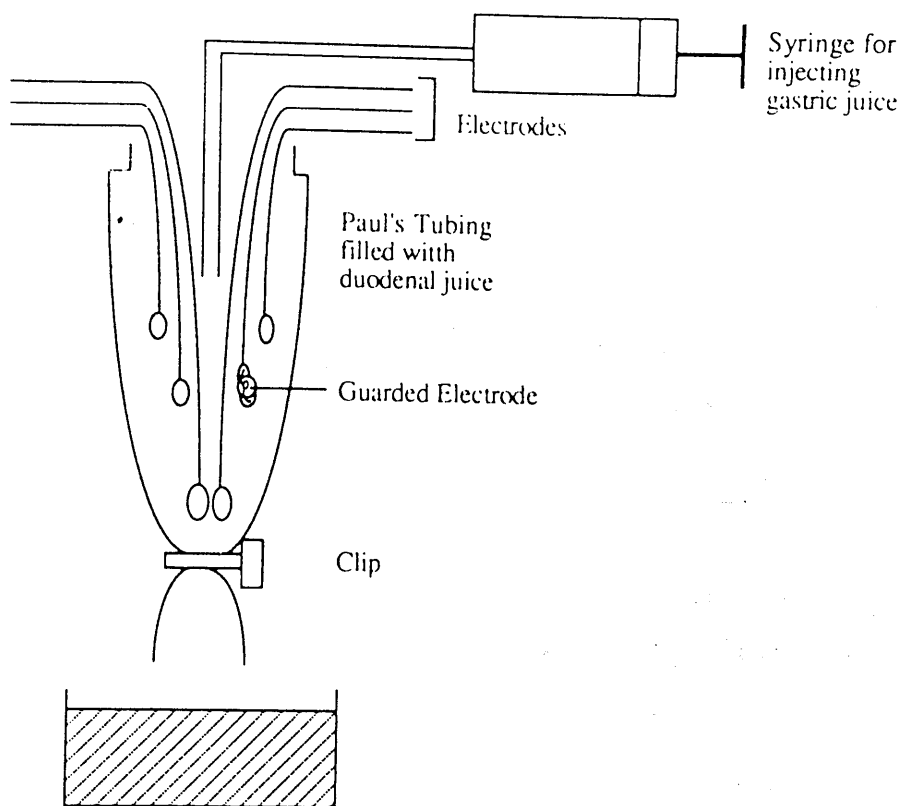

FIGURE 27

Experimental design of study to check invitro effect of electrode guard

for differences in readings, the proximal and distal electrodes were included as controls.

RESULTS

Fig. 28 shows the recorded pH values from both middle electrodes, along with an explanation of the events producing the pH changes. The tracings were similar during most of the experiment, even during the period of alternate injections of gastric and duodenal juice through the feeding tube. The subsequent recording gives the impression that the unguarded electrode may be responding better than the guarded one but differences in proximal and distal electrode pairs followed a similar pattern. These differences could therefore be attributed to non-uniformity of mixing.

CONCLUSION

The presence of the guard described above does not significantly influence electrode response to changes in pH in a liquid medium consisting of varying proportion of gastric and duodenal juices.

(4) IN VIVO STUDIES WITH ELECTRODE GUARD

pH recording in the duodenal bulb characteristically reveals rapid fluctuations, especially after a meal (McCloy et al, 1980). In the more distal parts of the duodenum wide variations can also

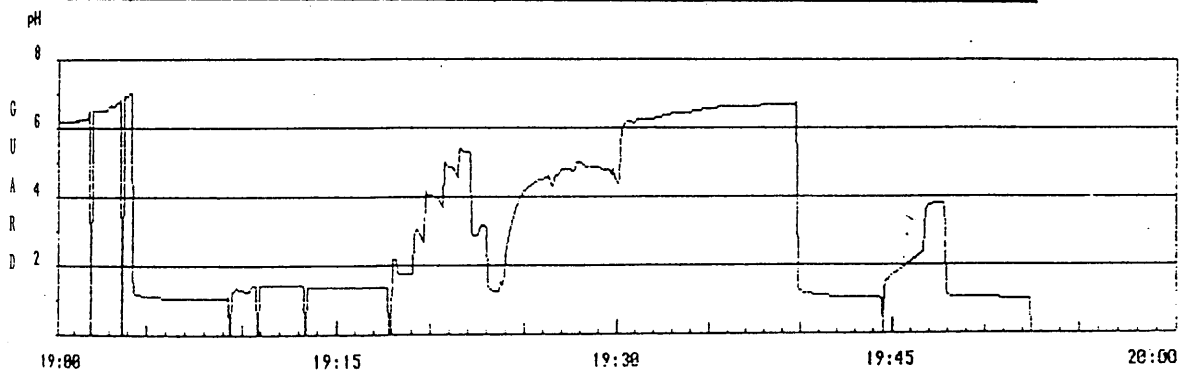
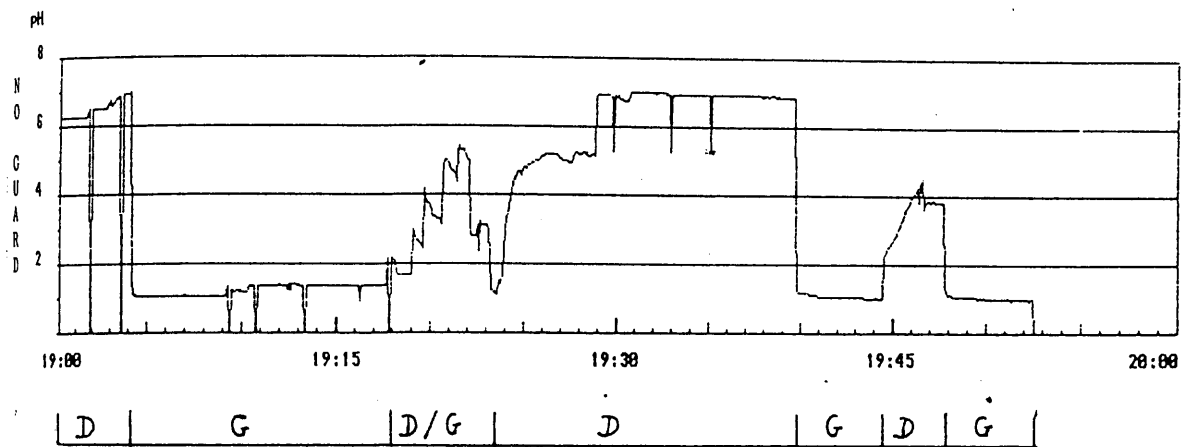

D - Injection of duodenal juice
 G - Injection of gastric juice
 D/G - Rapidly alternating injections of duodenal
 and gastric juices

FIGURE 28

In vitro study of effect of electrode guard on recorded pH of gastric and duodenal juices

occur, although with a lower frequency (Ovesen et al, 1986). It is also known that embedding an electrode into duodenal mucosa, even in the presence of acidic luminal contents, can produce large elevations of pH (Bircher et al, 1965). Before attributing a rise of duodenal pH to genuine neutralisation of gastric contents and not to mucosal contact, it seemed necessary to show that similar fluctuations could occur when the electrode was prevented from touching the mucosa.

MATERIALS AND METHODS

Three electrodes were bound together with the bulbs 3 cm apart. The middle electrode was guarded. A Viomedex feeding tube was attached to the electrodes with the opening exactly level with the bulb of the middle electrode. Latex bags containing mercury were manufactured by the author in the following way: A piece of glass tubing (outside diameter 5.5 mm, inside diameter 5 mm) was sealed at one end, blown into a shape of a small bulb and used as a mould. It was dipped into latex rubber (Strand Glass Company, Glasgow) and allowed to dry. This was repeated on two more occasions. The latex bag so formed was now peeled from the glass tubing (after powdering the outside surface with talcum) and filled with mercury. Two grooves were cut in a piece of stainless steel using a turning lathe and a hole drilled at the end. This was now placed in the mouth of the mercury bag and tied in position by linen thread. After trimming the excess rubber, the bag was dipped again into the latex a further 7 times, covering the linen threads on each occasion.

The wall of the latex bag was therefore 10 layers thick. It was estimated that with 10 coatings bursting of the bag would be unlikely although it is known that ingestion of mercury in this form carries no risk (Wright et al, 1980).

One of the mercury bags was attached to the distal electrode using a 10 cm length of linen thread. The arrangement of electrodes, feeding tube and mercury bag is shown in Fig. 29.

A "normal" male volunteer (the author) having fasted from the previous evening swallowed the electrode assembly. Recording was begun as soon as the distal electrode had entered the stomach. This could be judged from the sudden drop in pH as the electrode left the oesophagus. This is possible since the Digitrapper MKII can be used as a pH-meter before recording begins simply by pushing the event marker and reading the digital display. Recording continued for 4¹/₂ hours during which frequent aspirations were performed through the aspiration tube which opened beside the middle electrode. For the first hour, the position of the electrodes was checked fluoroscopically until the middle electrode was in mid-second part of duodenum. The proximal electrode was then in the area of the bulb and the distal electrode at the junction of second and third parts of duodenum (Fig. 30). At 11:15 h a stimulus to gastric acid secretion in the form of a high protein drink (Bovril 2 cubes dissolved in 180 ml water) was then given. Later, at 13:26 h, a solid meal (pork chops, potatoes and milk) was consumed. Shortly

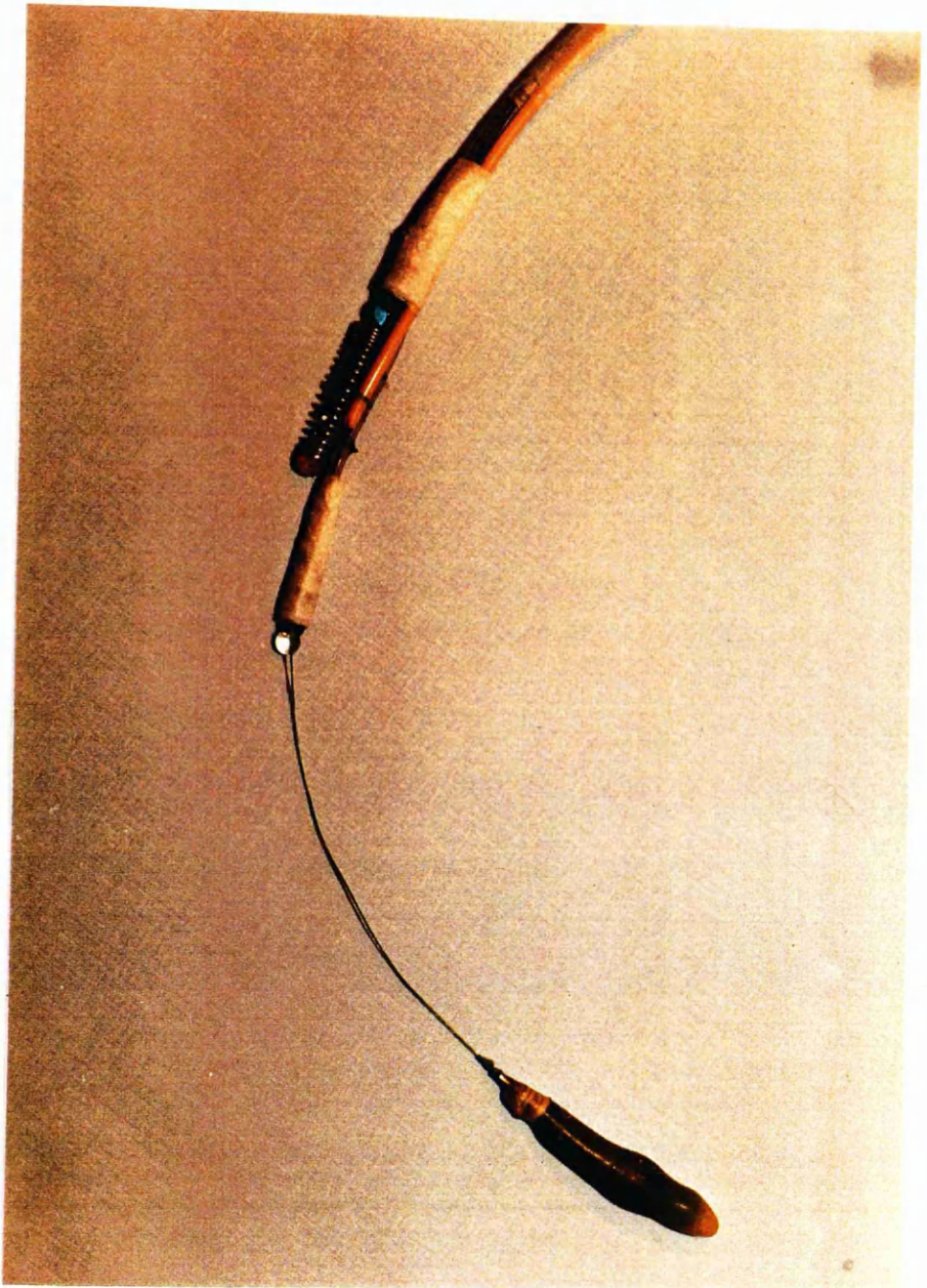

FIGURE 29

Apparatus designed for assessing effect of duodenal mucosal contact on recorded pH. The middle electrode is "guarded" by stainless steel spring. The mercury-filled bag is used to anchor the electrode in position.

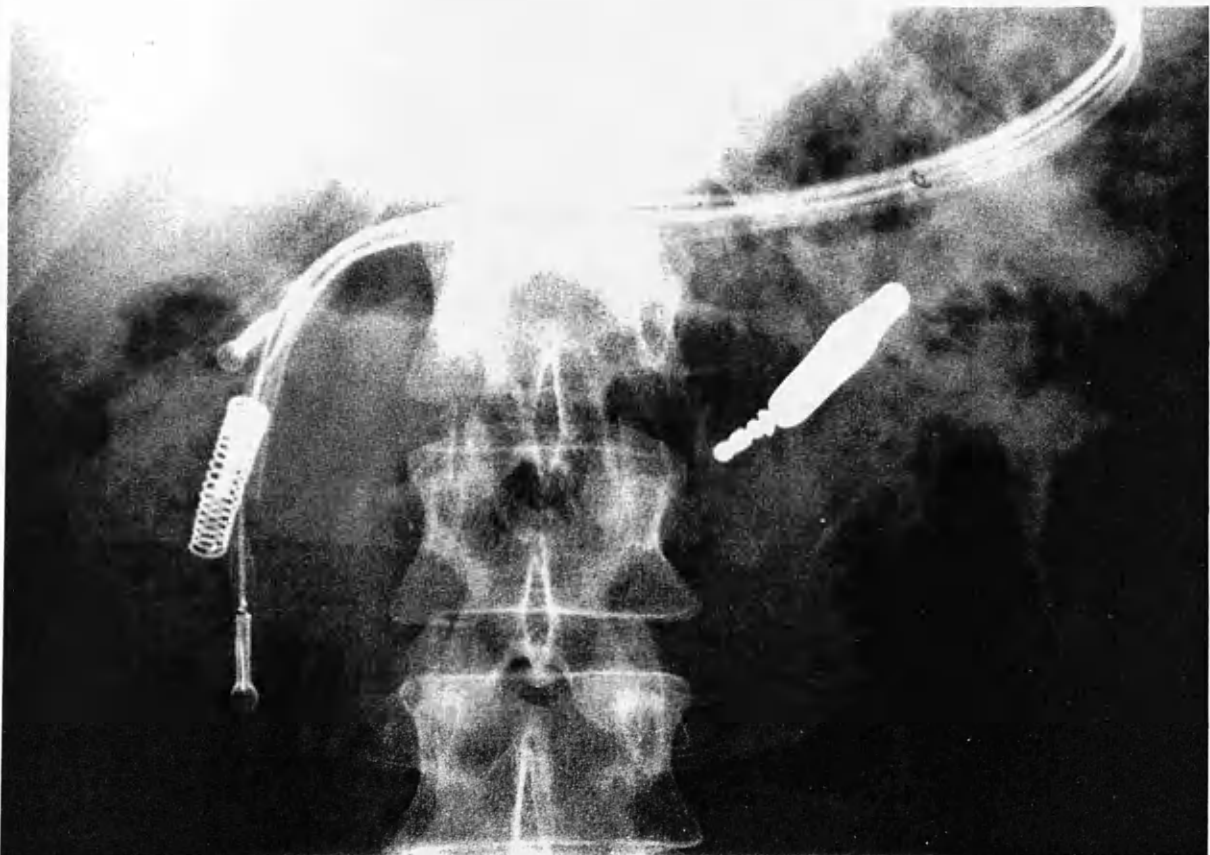

FIGURE 30

Abdominal X-ray of author showing apparatus used to assess effect of duodenal mucosal contact on recorded pH in situ.

after this meal, at 14:00 h, the electrodes slipped back into the stomach and recording was discontinued. After the electrodes had been removed, an end-calibration was performed.

RESULTS

The simultaneous tracings from all 3 electrodes and the pH of the aspirates are shown in Fig. 31 a - e.

At 10:45 h all 3 electrodes were positioned in the second part of duodenum and a 30 minute recording was obtained before taking the Bovril drink. Over this fasting period, each of the 3 electrodes gave a very similar and steady pH reading of between 6.5 and 7.5. There was also good correlation with the pH of the duodenal aspirates which were 6.1 and 7.2 and gold/green in colour (Fig. 31 a,b).

The Bovril drink was consumed between 11:15 h and 11:19 h. During the drink and over the 10 minute period after it, there was no change in the pH pattern with each electrode continuing to record values between 6 and 7.5 and correlating well with each other. The duodenal aspirate obtained immediately on completion of the drink and another 5 minutes later appeared to consist mainly of Bovril and there was good agreement between the pH of the aspirate and that recorded by the duodenal electrodes. From 11:29 h until 11:44 h (10 - 25 min after completing the Bovril drink) a fluctuating pH pattern emerged with the pH recorded by each in situ electrode spiking down to pH 3.5 - 4.0 (Fig. 31b).

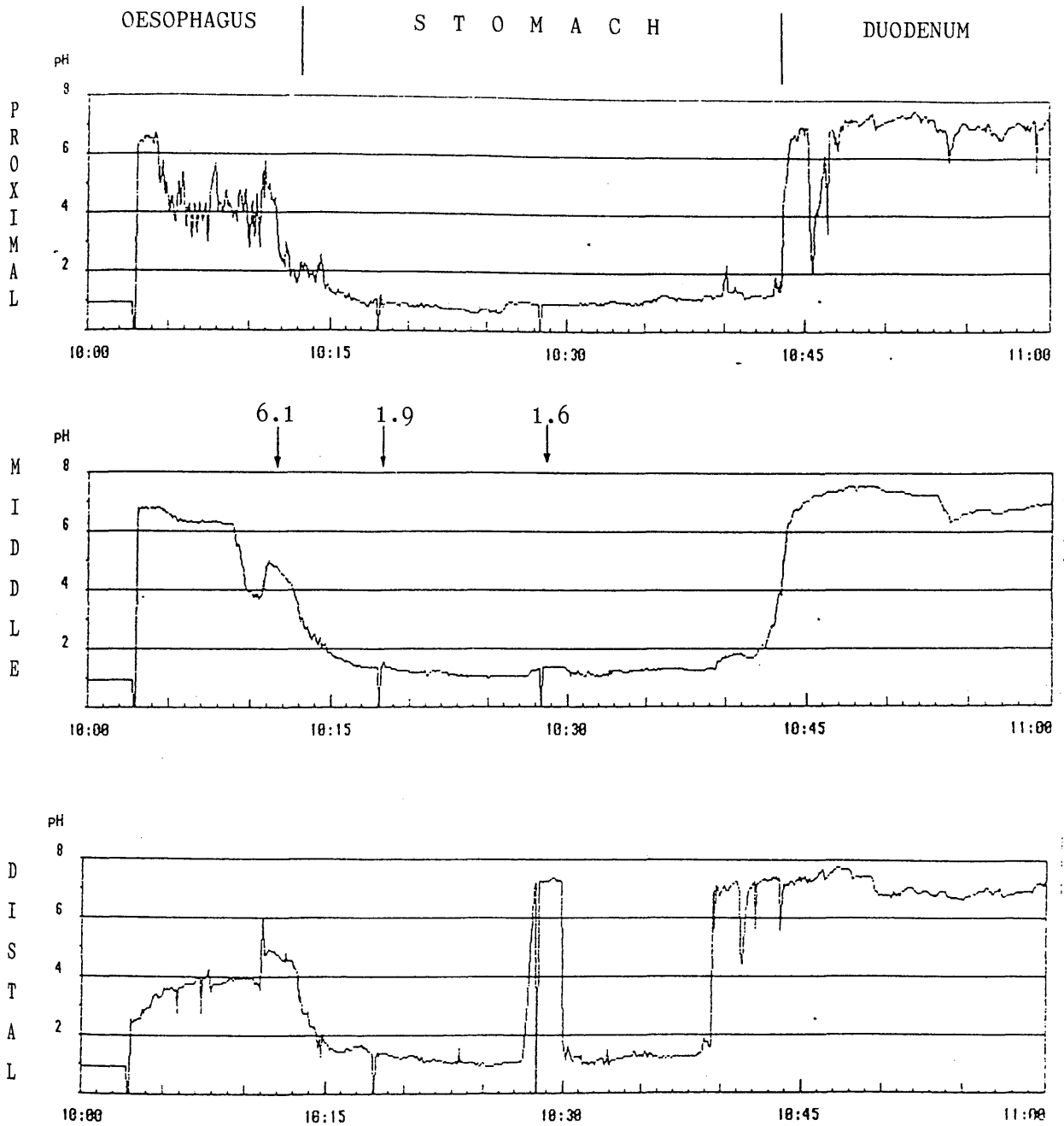

FIGURE 31a

Simultaneous recording of upper GI pH with 3 electrodes each 3cm apart and the middle one protected by "guard". The numbers against the vertical arrows indicate the pH of aspirate at that time point.

OXO DRINK

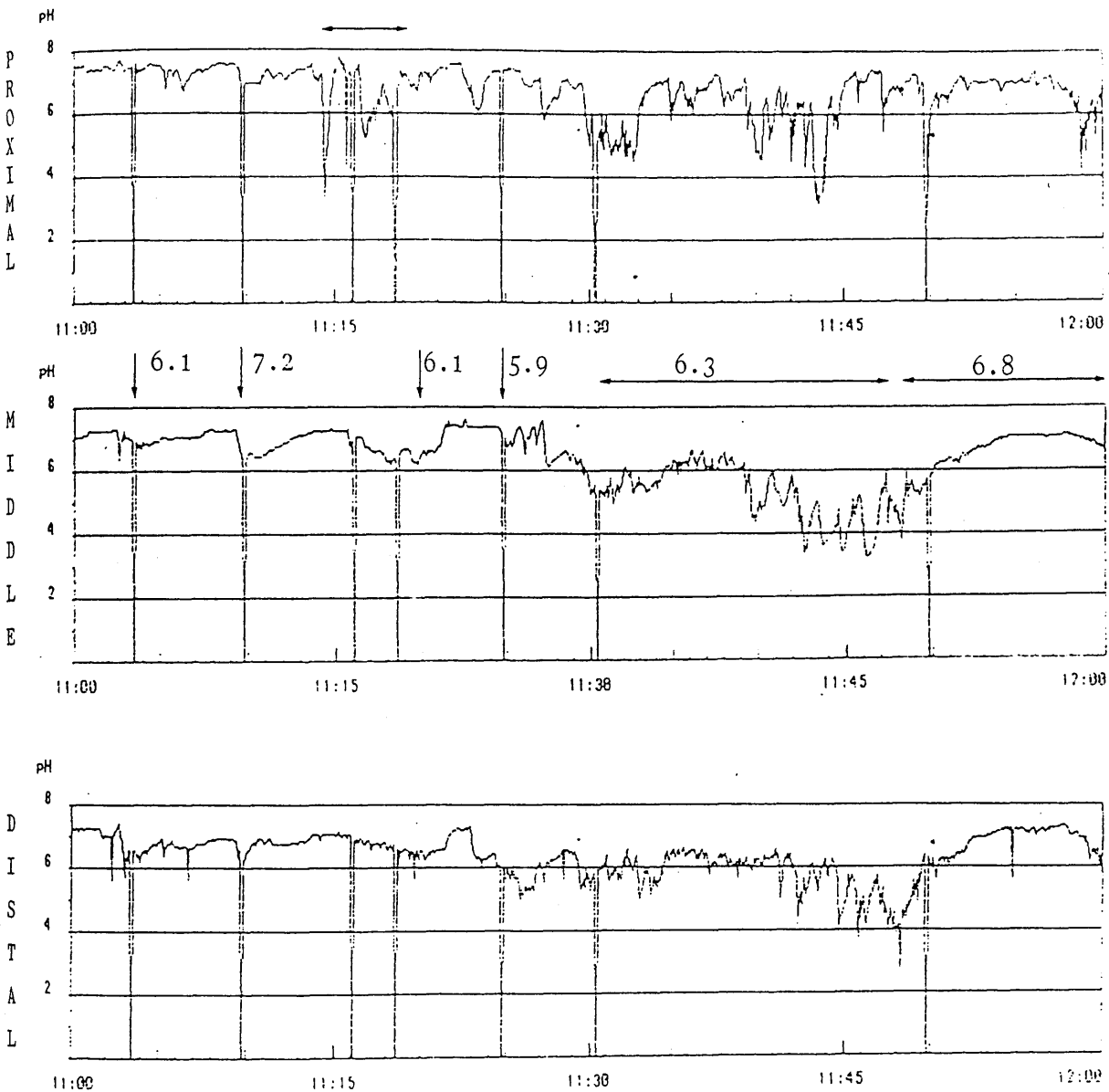

FIGURE 31b

Simultaneous recording of duodenal pH with 3 electrodes each 3cm apart. The middle electrode is fitted with guard. The numbers against vertical arrows indicate pH of aspirate at that time point. The numbers against horizontal arrows indicate pH of aspirate collected with difficulty over that time span.

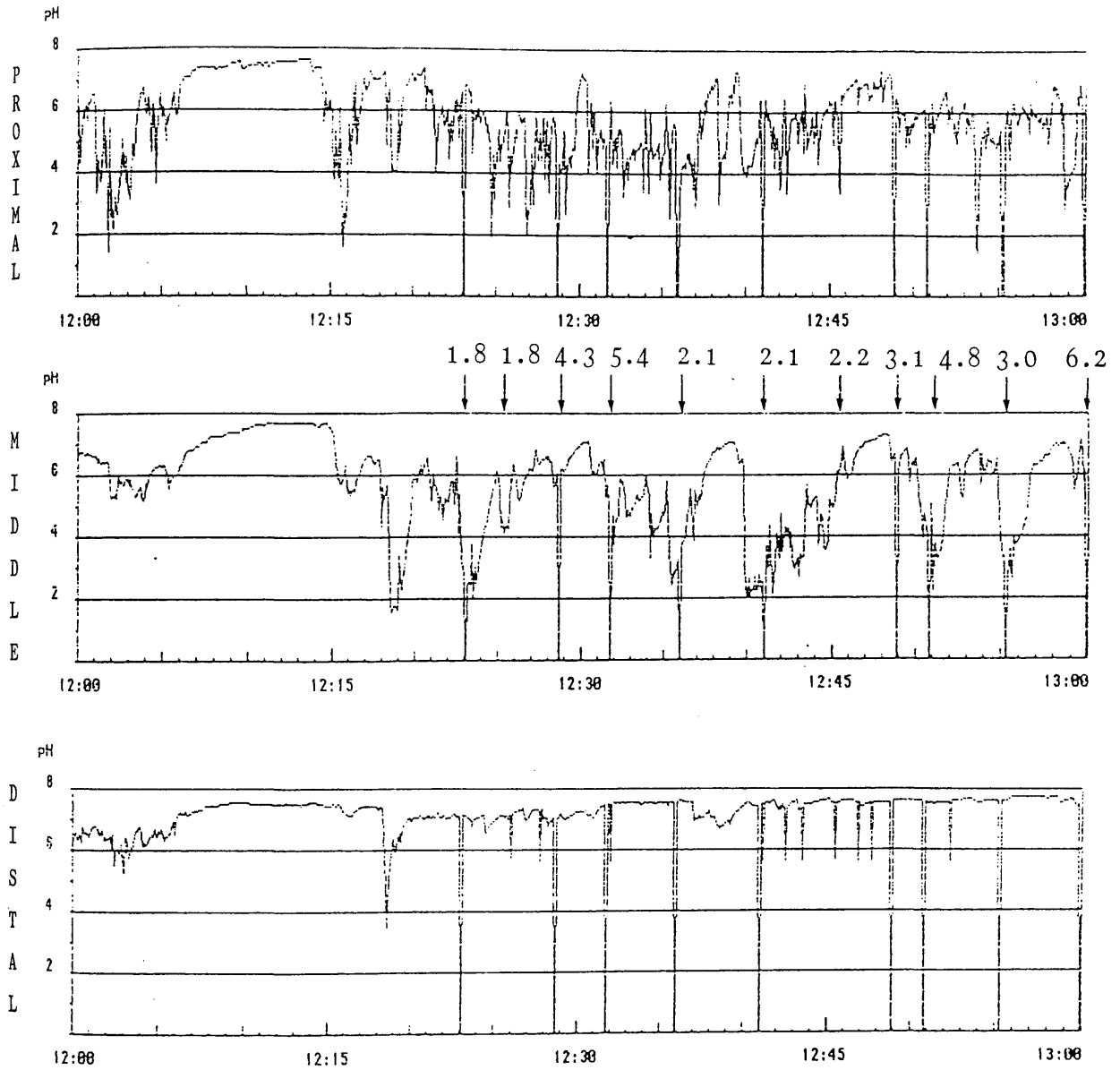

FIGURE 31c

Simultaneous recording of duodenal pH with 3 electrodes each 3cm apart. The middle electrode is fitted with guard. The numbers against the vertical arrows indicate pH of duodenal aspirate at that time point.

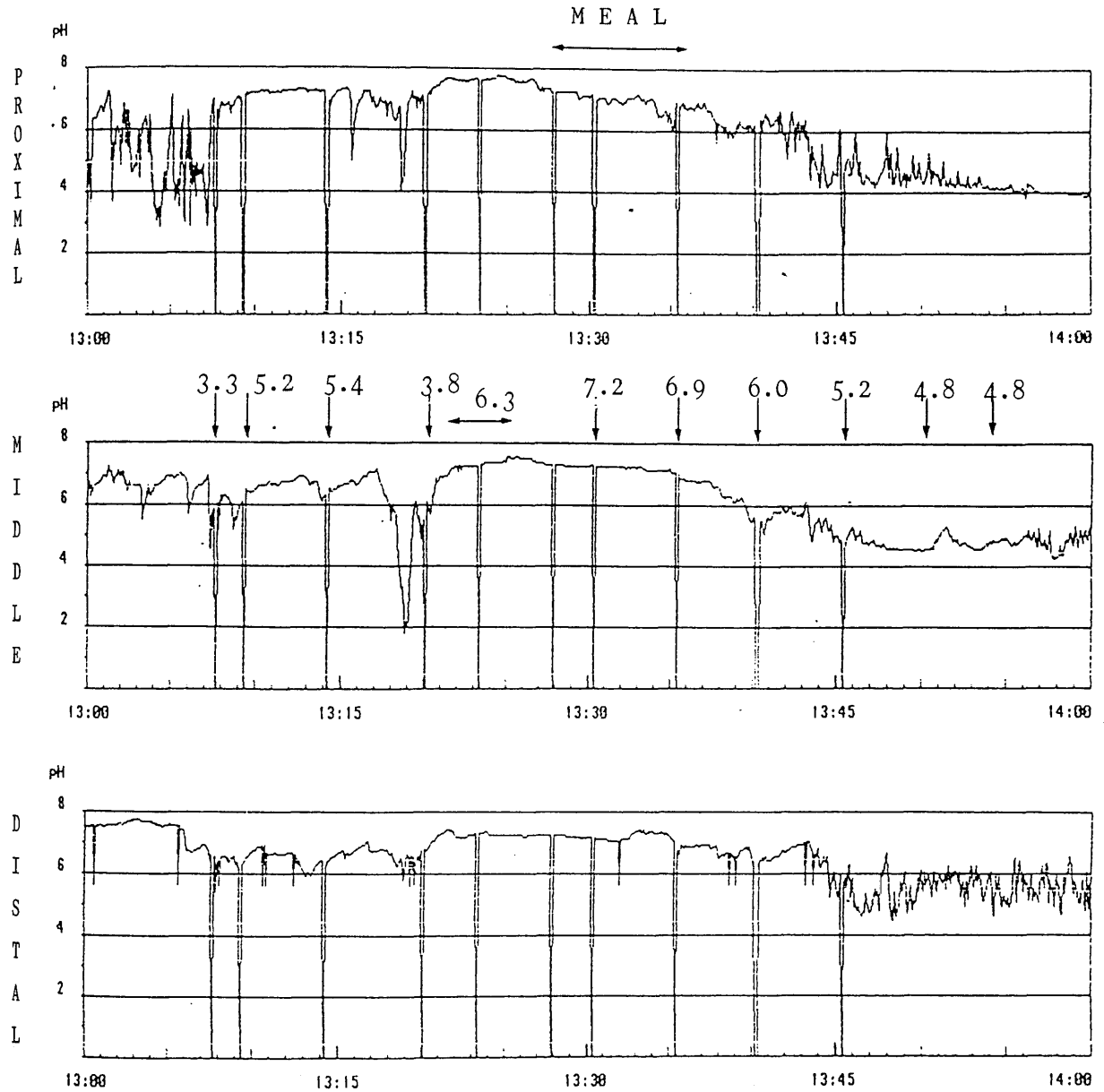

FIGURE 31d

Simultaneous recording of duodenal pH with 3 electrodes each 3cm apart. The middle electrode is fitted with guard. The numbers against the vertical arrows indicate pH of duodenal aspirate at that time point.

D U O D E N U M

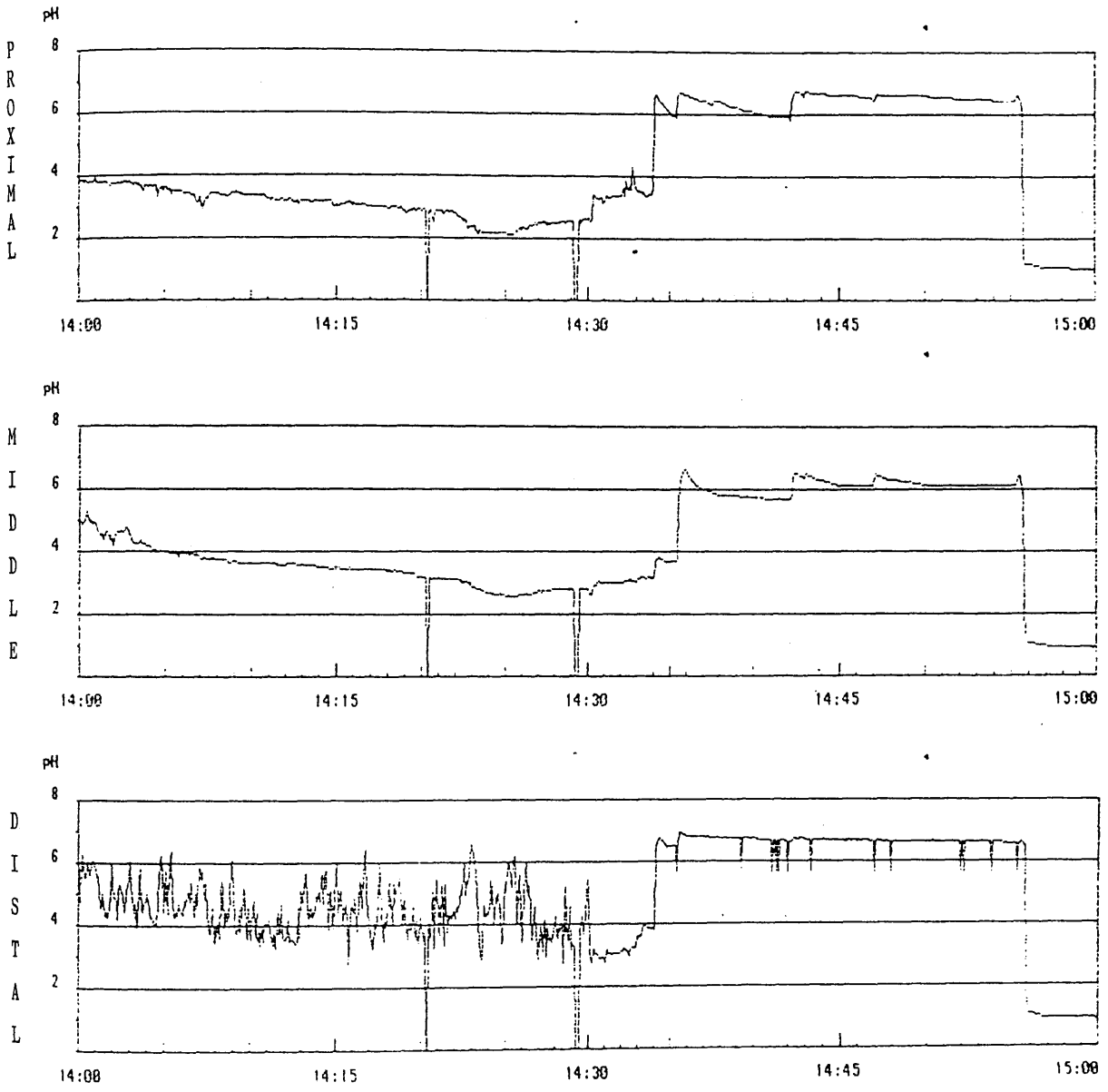

FIGURE 31e

Simultaneous pH recording as electrodes slip back into stomach.

It proved difficult to obtain an aspirate over this time period in spite of constant suction. When enough aspirate for analysis was finally obtained, it again looked like Bovril and its pH was 6.3 which was similar to the higher pH values recorded by the in situ electrodes rather than the troughs.

At 11:44 h, 25 minutes after the Bovril drink, the recording obtained from each of the duodenal electrodes returned to a steady reading of about pH 7 which persisted for 15 minutes (Fig. 31b). Then, there was another burst of acid spikes lasting 5 minutes (Fig. 31c). The depth of these acid spikes was greater in the proximal electrodes where they fell to pH 2 and least in the distal electrode where they only fell to pH 5.2. This burst of activity was followed by a 5 minute period when all 3 electrodes recorded steady pH between 6.5 and 7.5.

Over the next 50 minutes, from 12:15 h until 13:10 h a new pattern emerged (Fig. 31c,d). Throughout this time, the pH recorded by the proximal duodenal electrode showed rapid fluctuations between pH 3 and 7. Similar fluctuations of pH were recorded by the middle electrode though the frequency of the fluctuations was slower resulting in a coarser pattern. The distal electrode recorded a steady pH of between 6.5 and 7.5 throughout this time. The pH of the duodenal aspirate varied between 1.8 and 6.2 showing good correlation with the pH recorded by the middle and proximal electrode.

From 13:10 h until commencement of the solid meal at 13:28 h the pH recorded by each of the 3 electrodes was again steady at between 6.5 and 7.5 apart from one fall in pH at 13:18 h which was most marked in the middle electrode (Fig. 31d). Throughout this time period there was again good correlation between pH recorded by the electrodes and the pH of the duodenal aspirate.

Throughout the 8 minutes taken to consume the solid meal the pH recorded by each of the duodenal electrodes remained steady between 6.5 and 7.5. At 13:40 h, 5 minutes after completing the meal, the pH recorded by the proximal and distal electrodes adopted a fine fluctuating pattern with the pH oscillating between 4 and 6 at a frequency of approximately 2/minute. The same frequency of oscillation could be detected in the middle guarded electrode but the amplitude of each oscillation was much reduced, being only about 0.1 - 0.2 pH unit. The pH recorded by the middle electrode was midway between the median values of the proximal and distal electrodes. There was also good correlation between the middle electrode pH and the pH of the aspirate. This pH pattern continued until the study was terminated at 14:00 h due to the electrodes dislodging into the stomach (Fig. 31e).

When the 3 electrodes were withdrawn partially digested food was present on each. When they were placed in buffer pH 7 for end-calibration, their response was sluggish until the buffer was stirred. The proximal and distal electrodes then assumed values near 7 but the middle guarded electrode was unaffected. The guard was noted to be clogged up with partially digested food and

only when this was removed by vigorous shaking did the pH rise to 7.

Figure 32 illustrates the correlation between the pH recorded by the middle in situ electrode and the pH of the simultaneously aspirated duodenal juice. Nineteen of the 27 points lay within 1 pH unit of the ideal through the origin and of gradient +1.

DISCUSSION

This human study was performed to determine whether the fluctuating pH pattern sometimes recorded by duodenal electrodes might be artifactual due to mucosal contact and to assess the benefit of using an electrode guard. A fluctuating duodenal pH pattern with values ranging between pH 7 and 3.5 was first noted between 10 and 25 minutes after completing the Bovril drink. The fact that the pattern was similar in the guarded and unguarded electrodes indicates that the high pH values are a true measurement of luminal pH and not merely due to the electrodes intermittently recording neutral mucosal pH.

A fluctuating pH pattern was again observed between 12:15 h and 13:15 h in the proximal and middle electrodes with the pH fluctuated between pH 7 and 3. The magnitude of the pH changes was similar in these electrodes but the frequency of fluctuation was higher in the unguarded one. The simultaneous recording by the distal electrode was completely different giving a steady pH

FIGURE 32

Correlation of pH recorded by electrode in second part duodenum and pH of aspirated duodenal juice.

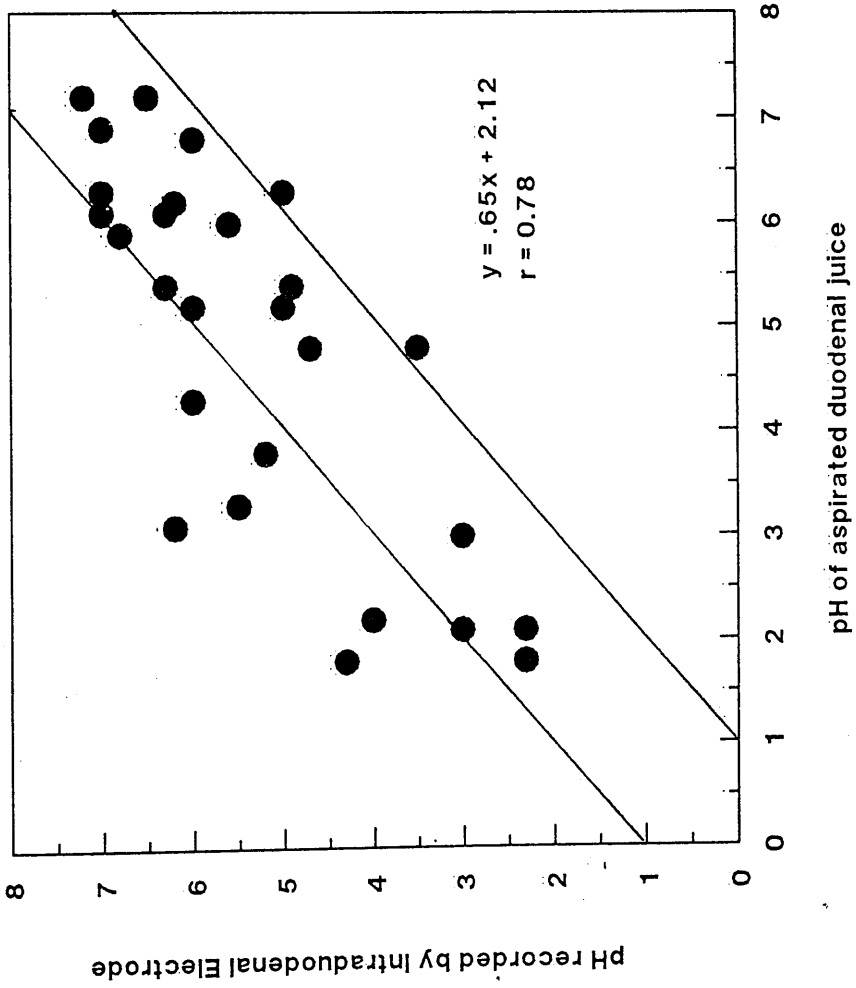

reading of about 7. The pH of the duodenal aspirate varying between 1.8 and 6.2 correlating well with the range in pH observed by the proximal and middle electrodes. The fact that similar fluctuations in pH were recorded by the guarded electrode and in the duodenal aspirate to those seen in the proximal electrode again indicate that the latter are not artifactual. The fact that the frequency of the oscillations were more in the proximal electrode may be explained by its more proximal position as fluctuations were completely absent from the distal unguarded electrode presumably due to the complete alkalisation of the gastric juice by pancreatic and duodenal secretions. Alternatively, the slower oscillations in pH recorded by the middle electrode may be explained by the damping effect of mucus lodged within the guard and encasing the electrode. This slower response time of the middle electrode due to mucus and food lodged within the guard was evident during the end-calibration.

A final period of fluctuating pH was observed following the solid meal. The magnitude of the pH fluctuations was much less than those recorded after the liquid Bovril meal or during the fasted period with a maximum amplitude of only about 1 - 2 pH units in the proximal and distal electrodes and a much reduced amplitude of only about 0.1 - 0.2 pH unit in the middle guarded electrode. This reduced amplitude of pH fluctuation following the solid meal may be explained by the gastric juice being injected into the duodenum being of a higher pH (due to the buffering effect of the food) than at periods of fasting. The

much reduced amplitude of oscillation seen in the guarded electrode can again be explained by the damping effect of food clogged in the guard.

In conclusion, the fluctuations apparent in duodenal pH using in situ electrodes are not artifactual and must reflect rapid acidification of duodenal juice by gastric emptying and rapid re-alkalinisation. Routine use of a guard is unnecessary and best avoided as it slows the electrode's reponse time.

CHAPTER TEN

EFFECT OF OMEPRAZOLE ON GASTRIC AND DUODENAL pH IN PATIENTS WITH PANCREATIC STEATORRHOEA

INTRODUCTION

This final chapter describes a clinical study of 24 h ambulatory monitoring of gastric and duodenal pH in patients with pancreatic steatorrhoea. The control of steatorrhoea in patients with exocrine pancreatic insufficiency is not always satisfactory. This is partly due to inactivation of endogenous pancreatic enzyme supplements by gastric acid (Heizer et al, 1965). In addition, increased fasting (Benn & Cooke, 1971) and postprandial duodenal acidity (Dubey & Nundy, 1983; DiMagno et al, 1977; Dutta et al, 1979; Bommelaer et al, 1984) due to inadequate pancreatic bicarbonate secretion (Angelini et al, 1986) may inactivate endogenous, as well as exogenous, pancreatic enzymes and precipitate bile salts (Zentler-Munro et al, 1984). For these reasons, H₂-receptor antagonists, antacids and enteric coating have been employed in the management of pancreatic steatorrhoea (Lankisch et al, 1986; Gow et al, 1981; Regan et al, 1977; Durie et al, 1980) but without uniform success (Dutta et al, 1983; Staub et al, 1981; Graham, 1982). Omeprazole is the most effective inhibitor of gastric acid secretion currently available and could have a role in the management of malabsorption due to pancreatic insufficiency (Lamers & Jansen, 1986). It may also be a valuable tool in assessing the contribution that gastric and duodenal acidity make to this form

of malabsorption. However, the dose required for optimal control of pH in these patients is unknown. With this in mind, the effect of omeprazole on gastric and duodenal pH in patients with pancreatic steatorrhoea has been studied

PATIENTS

Three women and three men with malabsorption due to exocrine pancreatic insufficiency were studied. Their mean age was 53 years (range 35 - 69) and mean weight 59.6kg (range 47.7 - 73). The pancreatic disease was due to previous alcohol abuse in two patients and was idiopathic in the remainder (Table 6). Only two patients (Nos. 1 and 2) had pain related to their chronic pancreatitis at the time of the study. The mean faecal fat excretion on no therapy was 76mmol/24h (range 28 - 128) (normal < 20mmol/24h) (Table 6). All subjects had impaired exocrine pancreatic function confirmed by Lundh test meal. None had co-existing upper gastrointestinal or hepatic disease.

METHODS

The study was performed in double-blind fashion with each patient receiving 8 days treatment with omeprazole 40mg/day, omeprazole 20mg/day and placebo in random order and with 2-week washout periods. The drugs were administered as enteric-coated granules in a gelatin capsule. They were taken orally with 60 ml water at 08:30 h which was 15 mins before breakfast. On the 7th day of each treatment period 24 h gastric and duodenal pH monitoring was performed. For this, two

TABLE 6

DETAILS OF PATIENTS STUDIED

Patient No.	Age	Sex	Wt (kg)	Aetiology	Faecal Fat (mmol/24h)	Pancreatic Pain	Acid Output (mmol/h)
							BASAL MAXIMAL
1	56	F	47.7	Idiopathic	71	+	3.1 19.9
2	35	M	73	Alcohol	128	+	12.8 31.0
3	63	F	49.1	Idiopathic	28	-	2.9 25.2
4	69	F	54.5	Idiopathic	78	-	- -
5	58	M	63.5	Alcohol	104	-	- -
6	36	M	70	Idiopathic	47	-	6.7 19.2

combined glass electrodes (Radiometer GK2802C), after calibration in buffers of pH 7.01 (Synectics 5001) and pH 1.07 (Synectics 5002), were tied together with the recording tip of one 15 cm distal to the other. A latex bag containing mercury was attached to the distal electrode by a 10 cm length of linen thread to allow anchoring of the duodenal electrode in position. This is a modification of the technique used by McCloy et al, 1980. The apparatus was passed perorally and positioned under X-ray screening so that the distal electrode lay in the distal second part of the duodenum with the mercury bag beyond the duodenojejunal flexure and the proximal electrode in the body of the stomach. Prevention of displacement distally was ensured by fixation of the electrode cables to the cheek with Micropore tape (3M) after taking up any slack. Ambulatory recording was then performed over the next 24 h using a Digitrapper Mark II Gold (Synectics) which registers the pH at both sites every 4 seconds. The position of the electrodes was checked by X-ray screening at 4, 8 and 24 h.

On the day that pH was monitored, breakfast was omitted and other meals standardised with respect to timing and content. In addition, on these days, no smoking was allowed and pancreatic extracts were not taken. No other acid inhibitory agent was taken throughout the entire treatment period. As meals were taken between noon and 22:00 h, detailed analysis was performed on the pH data obtained between noon and midnight which included a combination of prandial and postprandial periods. The software package Gastrosoft (Synectics) was used in conjunction with the Amstrad PC1512 microcomputer for analysing the pH data.

Gastric Secretion Studies

One month after completion of the pH studies, 4 of the patients consented to undergo gastric acid secretion studies which were performed at least one week after stopping all drug therapy. They reported, fasted, at 0900 h and a 16 French gauge vented nasogastric tube positioned with its tip in the body of the stomach. Four x 15 min basal collections of gastric juice were obtained. Pentagastrin 6ug/kg was administered intramuscularly and a further 4 x 15 min stimulated collections obtained. Hydrogen ion concentration was measured by titration to pH 7 with 0.1 M NaOH. Results were expressed as basal acid output and maximal acid output, i.e., total over the hour following pentagastrin administration.

Supplementary pH and Pharmacokinetic Studies

pH Studies

Two of the 3 patients (Nos. 1 and 2) whose postprandial gastric and duodenal pH was not maintained above 4 in the main study consented to undergo further investigations to establish why they were less responsive and to see if an effective dosage regimen could be found. After discontinuing all therapy for at least one week, the effect of a single I.V. dose was studied. The gastric and duodenal pH electrodes were positioned as previously described and basal recordings made between 09:00 h and 10:00 h. Patient No. 1 then received 40 mg omeprazole I.V. and patient No. 2, 20 mg I.V. and pH recording continued for a further 14 h. The timing and content of meals were similar to the previous study days.

Twenty-four hour pH studies were performed in both patients after 7 days treatment with omeprazole 20 mgs b.d., and in patient No. 2 also after 7 days on omeprazole 40 mgs b.d. The evening dose was taken at 20:00 h.

Pharmacokinetic Studies

In patients Nos. 1 and 2 plasma concentrations of omeprazole were studied following 20 mg orally, having been on no acid-inhibitory agent for the previous week and also after 20 mg orally taken 5 h following a 40 mg intravenous dose of omeprazole. The oral doses were taken at 08:30 h and the patients remained fasted until noon. On each occasion gastric and duodenal pH were checked immediately prior to administration of the oral dose. In addition, in patient No. 1, plasma concentrations were also studied on the final day of 7 days treatment with 20 mg omeprazole b.d.

On each occasion that omeprazole levels were studied, 10 ml venous blood were withdrawn every 15 mins for 2 h after dosing and thereafter at 30 min intervals for the next 2 h, and at hourly intervals for a further 4 hours. On the days when the oral dose was preceded by the intravenous dose or by the week of b.d. dosing, plasma levels were checked at 15 min intervals for the hour before oral administration. The blood was immediately centrifuged and the plasma stored at -20°C . Plasma concentration was determined by A.B. Haessle using liquid chromatography as previously described (Persson et al, 1985).

Correlations were performed by linear regression analysis and comparisons of median pH and percentage of time pH < 4 were made by the Mann Whitney U test.

The study was approved by the Hospital Ethical Committee and all patients gave fully informed, written consent. Haematological and biochemical screening tests were performed before and after the study.

RESULTS

pH Studies

A summary of the pH data of all 6 patients in the initial study over the period 12:00 h - 24:00 h is shown in cumulative frequency distribution format in Figure 33.

Placebo

On placebo the median intragastric pH ranged from 1.4 - 3.8 and the median intraduodenal pH from 5.1 - 6.4 (Table 7). The percentage of this time that the intragastric pH was < 4 ranged from 64.2% - 99.4% and for the duodenum ranged from 0% - 15.4%. There was no significant correlation of faecal fat excretion with either median duodenal or median gastric pH.

Omeprazole 20 mg once per day

Compared with placebo, omeprazole 20mg/day increased the median intragastric pH in each of the 6 patients, though it remained

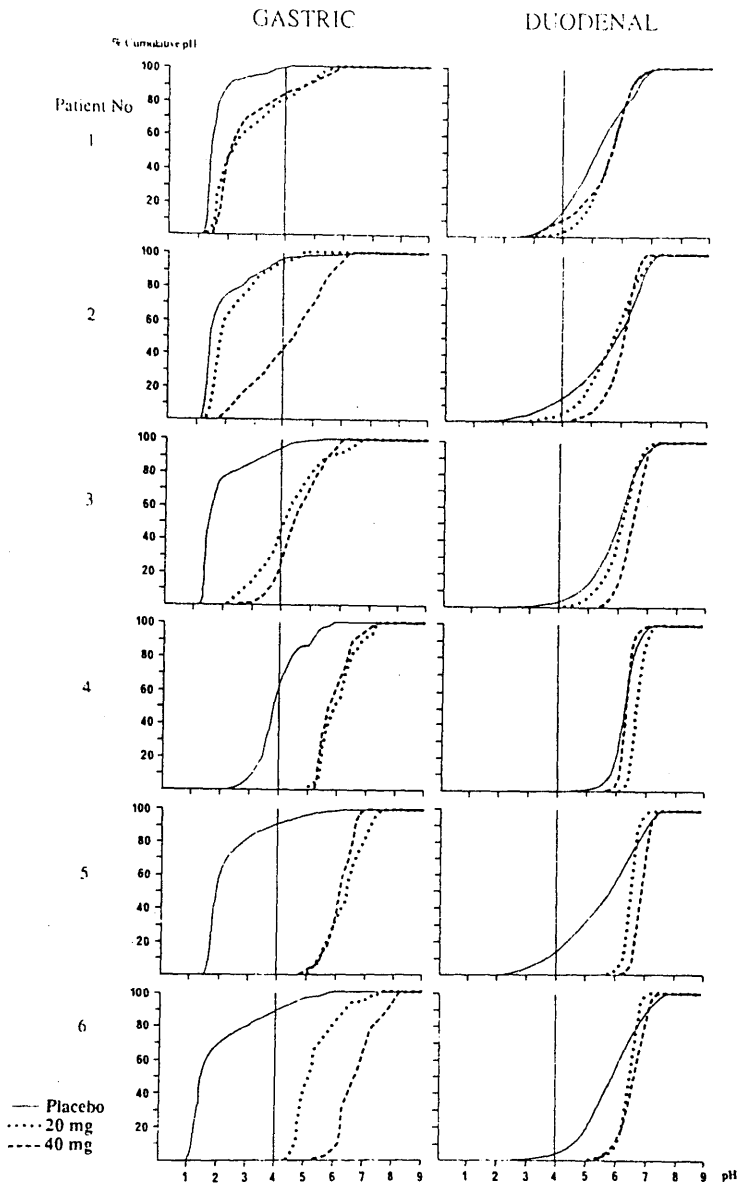

FIGURE 33

Cumulative frequency distribution of gastric and duodenal pH between 12:00h and 24:00h in each patient after 7 days treatment with placebo, omeprazole 20mg/day and omeprazole 40mg/day. Where the curve crosses the vertical line at pH4 the height of crossing indicates the percentage of time that the pH < 4. When the curve is completely to the right of the vertical line the pH was constantly maintained above 4.

TABLE 7
EFFECT OF 7 DAYS TREATMENT WITH PLACEBO AND VARIOUS DOSES OF OMEPRAZOLE ON PRANDIAL AND POSTPRANDIAL (12:00h - 24:00h) GASTRIC AND DUODENAL pH IN 6 PATIENTS WITH PANCREATIC STENOTRIKIA.

Patient	PLACEBO		OMEPRAZOLE 20MG		OMEPRAZOLE 40mg		OMEPRAZOLE 20mg		OMEPRAZOLE 40mg		
	Median pH	% < 4	Median pH	% < 4	Median pH	% < 4	Median pH	% < 4	Median pH	% < 4	
1	Gastric	1.5	99.4	2.2	80.8	2.1	84.2	5.7	17.2	—	—
	Duodenal	5.1	15.4	5.6	2.6	5.6	10.6	6.2	0.0	—	—
2	Gastric	1.5	96.6	1.8	93.7	4.3	42.8	3.6	66.5	5.9	0
	Duodenal	5.8	12.4	5.8	4.3	6.1	0.5	6.0	0.7	6.5	0.0
3	Gastric	1.4	95.0	4.0	50.0	4.4	32.4	—	—	—	—
	Duodenal	5.9	2.9	6.1	0.3	6.5	0.0	—	—	—	—
4	Gastric	3.8	64.2	5.8	0.0	5.6	0.0	—	—	—	—
	Duodenal	6.4	0.0	6.8	0.0	6.4	0.0	—	—	—	—
5	Gastric	1.8	91.1	6.4	0.0	6.1	0.0	—	—	—	—
	Duodenal	5.8	13.8	6.6	0.0	6.9	0.0	—	—	—	—
6	Gastric	1.4	85.8	5.1	0.0	6.6	0.0	—	—	—	—
	Duodenal	5.9	2.0	6.5	0.0	6.7	0.0	—	—	—	—

relatively low in two of them, being 2.2 (patient No. 1) and 1.8 (patient No. 2) (Table 7). The median duodenal pH was also increased in 5 patients but unaltered in 1 (patient No. 2). In 3 of the patients, omeprazole 20 mg maintained both gastric and duodenal pH > 4 throughout the 12 h period (Table 7). The actual gastric and duodenal tracings on placebo and omeprazole 20mg/day of patient No. 5 whose pH was controlled on this therapy are shown in Fig. 34. In patients Nos. 1, 2 and 3 gastric pH remained < 4 for 81%, 94% and 50% of the time respectively and duodenal pH < 4 for 2.6%, 4.3% and 0.3% of the time respectively.

Omeprazole 40 mg once per day

Compared with placebo, omeprazole 40mg/day increased the median gastric pH in each subject. Median duodenal pH was increased in 5 subjects and unaltered in 1. There was no significant difference between omeprazole 40 mg and 20 mg. The median gastric pH on 40 mg ranged from 2.1 - 6.6 compared with 2.2 - 6.4 on 20 mg (Table 7). Likewise, median duodenal pH on 40 mg ranged from 5.6 - 6.7 compared with 5.6 - 6.8 on 20 mg. In 3 of the patients gastric and duodenal pH was maintained above 4 on the 40 mg dose. However, in patients Nos. 1, 2 and 3 the gastric pH was < 4 for 84%, 43% and 32% of the time respectively and the duodenal pH < 4 for 10.6% and 0.5% in patients Nos. 1 and 2 respectively. The actual gastric and duodenal tracings on placebo and omeprazole 40mg/day of patient No. 1 whose pH was not maintained above 4 on this therapy is shown in Figure 35.

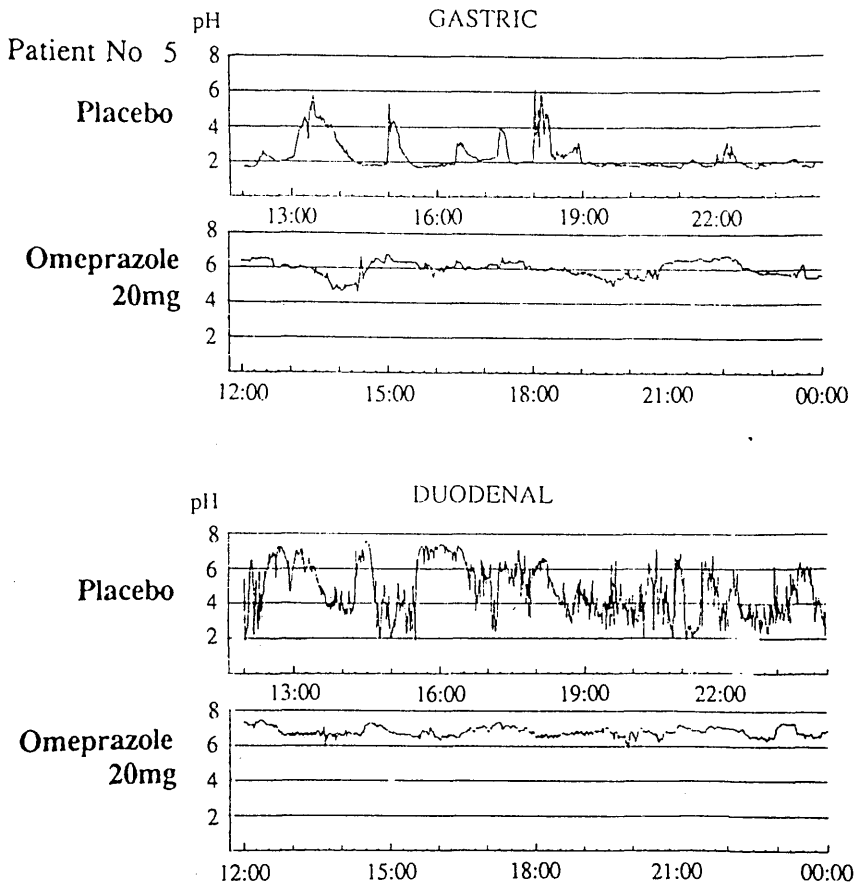

FIGURE 34

Gastric and duodenal pH tracings after 7 days treatment with placebo and omeprazole 20mg/day in patient No. 5 whose gastric and duodenal pH was maintained above 4 on this dose of omeprazole.

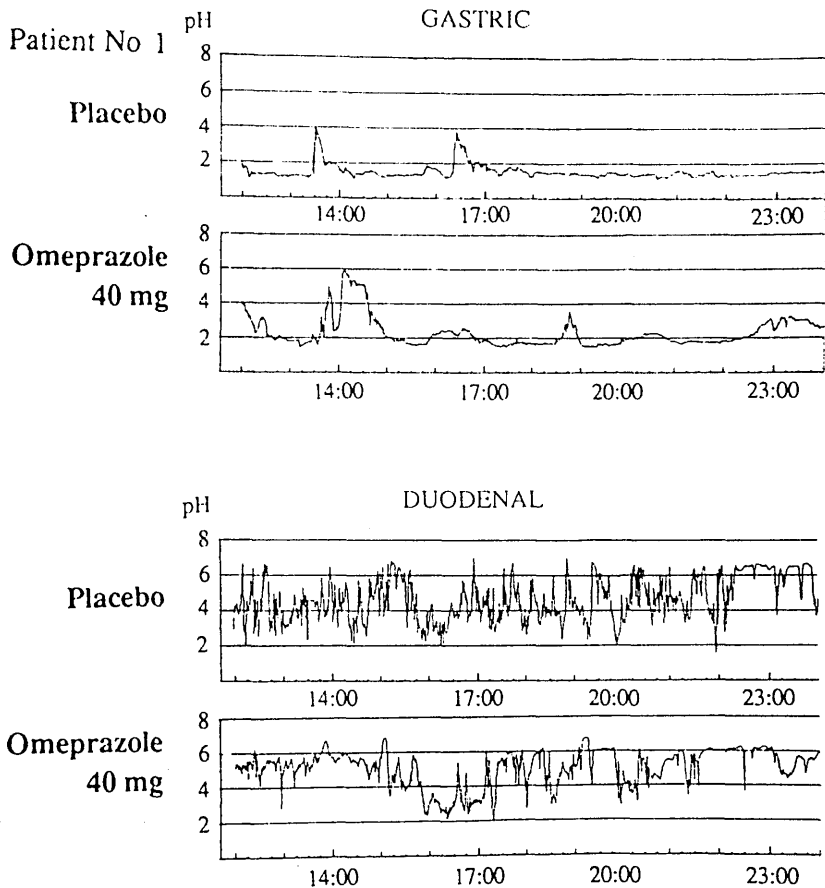

FIGURE 35

Gastric and duodenal pH tracings after 7 days treatment with placebo and omeprazole 40mg/day in patient No. 1 whose gastric and duodenal pH was not maintained above 4 on this dose of omeprazole.

Gastric Secretion Studies

In the 4 subjects studied, the basal acid output ranged from 3.1 - 12.8 mmol/h and maximum acid output from 19.2 - 31mmol/h (Table 6).

Supplementary pH and Pharmacokinetic Studies

pH Studies Following IV Dosing

In patient No. 1, 40 mg omeprazole I.V. increased intragastric pH from 2 - 7 within 30 min of administration and remained at this value for 2 h before slowly returning to placebo pH values 13 h post dosing. Following this intravenous dose, the median intragastric pH between noon and midnight was 4.1 which was higher than that achieved after 7 days treatment with either 20 mg orally (median pH 2.2) or 40 mg orally (median pH 2.1). Following the 40 mg intravenous dose, the duodenal acid spikes were virtually eliminated, the duodenal pH being less than 4 for only 0.4% of the 12 h period compared with 2.6% and 10.6% after 7 days oral treatment with 20 mg and 40 mg respectively (Table 7). In patient No. 2 the single 20 mg intravenous dose of omeprazole had a similar effect to 7 days treatment with 20 mg once/day orally with respect to median gastric and duodenal pH and percentage time pH < 4 (Table 7).

pH Studies Following B.D. Dosing

In patient No. 1, one week's treatment with omeprazole 20 mg b.d. was more effective in reducing postprandial gastric and duodenal acidity than one week's treatment with single daily doses of either 20 mg or 40 mg (Table 7). The median intragastric pH was 5.7 on

omeprazole 20 mg b.d. compared with 2.1 on omeprazole 40 mg once/day and the percentage time gastric pH < 4 was 17.2% versus 84.2%. The median duodenal pH with omeprazole 20 mg b.d. was 6.2 compared with 5.6 on omeprazole 40 mg once/day and the percentage time duodenal pH < 4 was 0 compared with 10.6% with 40 mg once/day.

In patient No. 2, omeprazole 20 mg b.d. was more effective than 20 mg once/day but no more effective than 40 mg once/day with respect to gastric and duodenal median pH and in percentage time gastric and duodenal pH > 4 (Table 7). This patient required 40 mg twice/day to maintain postprandial gastric and duodenal pH above 4.

Pharmacokinetic Studies

In patient No. 1 the area under the plasma concentration time curve (AUC) following a single oral dose of omeprazole taken when fasted and having had no previous medication in the past week was 454 nmol. h/l (Fig. 36). At the time of dosing the intragastric pH was 1.4 and duodenal pH 5.0. When this oral dose was taken 5 h after an I.V. dose of 40 mg omeprazole, the AUC was increased to 906 nmol. h/l. On this occasion the intragastric pH was 2.9 and duodenal pH 6.4 at the time of oral dosing. No omeprazole was detectable in plasma 4 h following the I.V. dose.

In patient No. 1 the AUC following the morning dose of 20 mg omeprazole taken as the final dose of 7 days treatment with omeprazole 20 mg b.d. was 1,826 nmol. h/l (Fig. 36). The intragastric and duodenal pH values immediately prior to the morning dose of omeprazole

Patient No 1

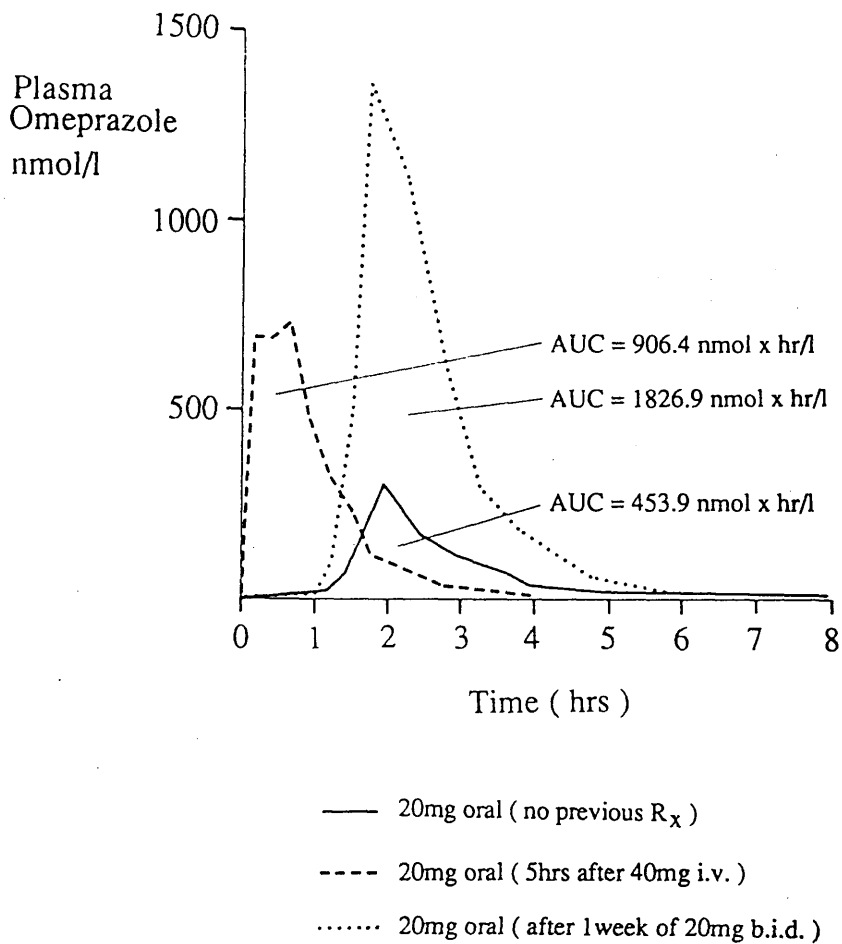

FIGURE 36

Plasma omeprazole concentrations in patient No. 1 following 20mg oral dose taken:

- (1) with no previous therapy,
- (2) with 40mg omeprazole i.v. 5h before and
- (3) with 20mg omeprazole b.d. for 7 days.

on the seventh day of b.d. regimen were 2.7 and 6.9 respectively which were both higher than those immediately before omeprazole 20 mg once/day (gastric 1.6, duodenal 6.3) or omeprazole 40 mg once/day (gastric 1.8, duodenal 6.0).

In patient No. 2 the AUC following a single oral dose of omeprazole 20 mg taken fasted when gastric pH was 1.0 and duodenal pH 5.4 was 210 nmol. h/l (Fig. 37). When the same oral dose was taken 5 h after omeprazole 40 mg I.V. when the gastric pH was 1.7 and the duodenal pH was 6.2 the AUC increased to 697 nmol. h/l. As with patient No. 1, plasma omeprazole was undetectable in the plasma during the hour before the oral dose.

Patient Tolerance

One patient (No. 4) developed a facial rash during omeprazole administration which subsided after the drug stopped. There were no abnormalities in the screening tests before or after omeprazole therapy.

DISCUSSION

Omeprazole is the most powerful acid inhibitory agent presently available and in normal subjects a one-week course of 40 mg once/day will reduce acid output by more than 99% (Naesdal et al, 1984). It has also been shown to maintain postprandial gastric pH above 4 in 5 out of 6 normal subjects (Wilson et al, 1986). Since pancreatic enzymes are degraded in an acid medium of pH < 4 (Heizer et al, 1965), this drug was used in an attempt to keep postprandial gastric pH above

Patient No 2

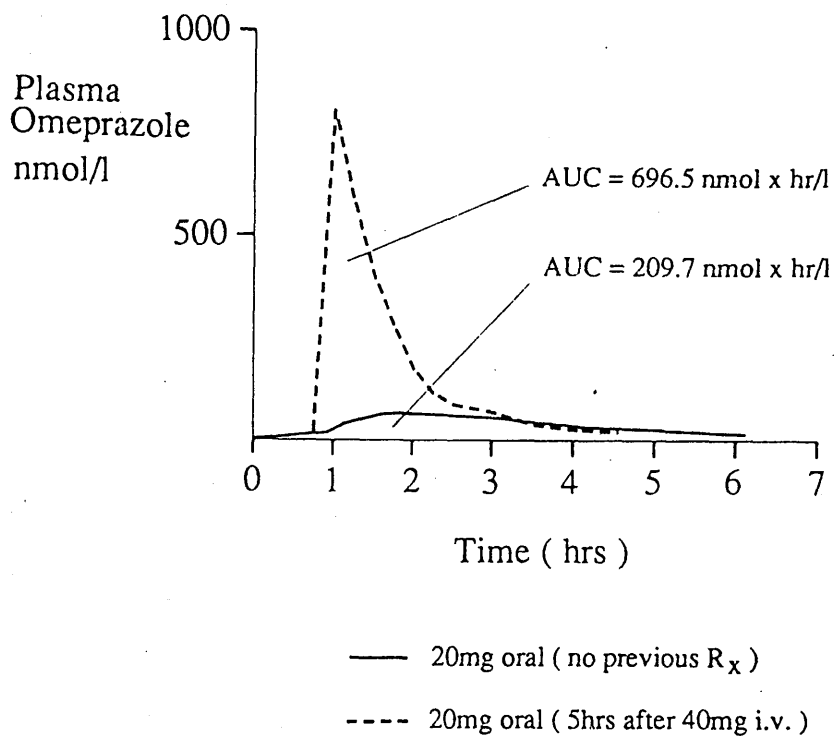

FIGURE 37

Plasma omeprazole concentrations in patiente No. 2 following 20mg oral dose taken: -

- (1) with no previous therapy
and
- (2) with 40mg omeprazole i.v. 5h before

4 and to prevent the duodenal pH from dipping below 4 in patients with chronic pancreatic insufficiency. The findings indicate that omeprazole is able to achieve this degree of control of pH in these patients though the dose required varies considerably. In 3 of the 6 patients a once/day dose of 20 mg was sufficient, though one of these patients already had elevated gastric and duodenal pH on placebo. In the other 3 patients, doubling the dose to 40 mg once/day still failed to maintain gastric and duodenal pH above 4 and in one, the desired pH control was only achieved with 40 mg twice/day.

Several reasons could explain the marked variation in response to omeprazole in these patients with pancreatic insufficiency. Poor compliance is unlikely as regular tablet counts were performed and dosing was observed on each of the study days. Likewise, difference in body weight cannot explain the findings as the mean weight of the 3 patients whose pH was controlled on omeprazole 20 mg once/day was more than that of the patients requiring larger doses. The severity of steatorrhoea also seems unimportant as there was no correlation between the faecal fat excretion on placebo and subsequent response to omeprazole. Some patients with exocrine pancreatic insufficiency have increased gastric acid output (Gullo et al, 1983; Saunders et al, 1978) but the 3 patients who were least responsive to omeprazole had normal basal and pentagastrin stimulated acid output.

A more likely explanation for the reduced effectiveness of omeprazole in some of our patients is reduced bioavailability as a consequence of increased duodenal acidity. Patients with exocrine

pancreatic insufficiency have been shown to have an abnormally low duodenal pH (Benn & Cooke, 1971; Dubey & Nundy, 1983; DiMagno et al, 1977; Dutta et al, 1979; Bommelaer et al, 1984) which may be explained by reduced secretion of bicarbonate by the diseased pancreas (Angelini et al, 1986). Omeprazole is rapidly degraded at low pH and for this reason is administered as enteric-coated granules so that it can pass through the stomach before being released in the duodenum and absorbed in the upper small intestine. The granules are designed to release 90% of their contents at pH 6.5 within 15 min (Pilbrant & Cederberg, 1985). Delayed release of pH sensitive enteric-coated pancreatic enzyme preparations has been reported in patients with pancreatic steatorrhoea (Dutta et al, 1983). In some of our patients with pancreatic insufficiency it is possible that decreased duodenal pH is delaying the release of omeprazole from its enteric coating until it is too far down the small intestine for adequate absorption. In addition, the more marked fluctuations of duodenal pH could result in omeprazole being released from its enteric coating when the pH rises above 6 only to be destroyed as the pH dips below and 4 and before there has been time for it to be absorbed. Omeprazole is degraded at pH values below 4 with a half-life of < 10 min (Pilbrant & Cederberg, 1985). Acid inhibition with omeprazole in normal volunteers reaches its maximum after 3 - 4 days of therapy (Lind et al, 1983) and this is thought to be due to increased absorption as acid secretion is inhibited (Pritchard et al, 1985).

The additional pH and pharmacokinetic studies were performed in patients Nos. 1 and 2 to determine whether absorption was being reduced as a result of increased duodenal acidity. In both these

patients reducing gastric and duodenal acidity by pre-treatment with intravenous omeprazole significantly increased the bioavailability of the oral dose. However, the percentage increase in bioavailability seen in our patients has also been observed in normal volunteers with repeated daily dosing (Pritchard et al, 1985).

In patient No. 1, much more acid inhibition was achieved with a single I.V. dose of 40 mg omeprazole than after 7 days oral treatment with omeprazole 40 mg/day, indicating that bio-availability was not increasing with once daily oral treatment. In this patient 20 mg b.d. achieved more effective control of pH than 40 mg once/day. This could be explained by the acid inhibition achieved by the 20 mg dose after 12 h being greater than that of the 40 mg dose after 24 h, and thus progressive increase in drug absorption would then be facilitated by the twice daily dose. The marked increase in AUC with b.d. dosing is also consistent with this mechanism. The fact that this patient had the lowest duodenal pH on placebo is in keeping with duodenal acidity being at least partly responsible for the reduced response to oral therapy.

In patient No. 2, it is unlikely that impaired bio-availability was the reason for the reduced response because the acid suppression achieved with a single intravenous dose of 20 mg omeprazole was similar to that observed after 7 days of oral treatment with the same dose. In addition, twice daily dosing with omeprazole 20 mg was no better than 40 mg once/day and eventual control of pH required 40 mg b.d.

The first stage in the metabolism of omeprazole in the liver utilises oxidative pathways, induction of which has been shown to occur in patients with pancreatitis (Sandle et al, 1985). This would contribute to a lowering of both effectiveness and duration of action and could, in part, account for the results in our less responsive patients.

If impaired response to omeprazole in some of the pancreatic patients was caused by inactivation of the drug by low duodenal pH then a similar effect would be expected in patients with the Zollinger-Ellison syndrome in whom pH values of less than 3 have been reported in duodenum and upper jejunum (Malagalada, 1980). In 5 patients with the Zollinger-Ellison syndrome, Lamers (Lamers et al, 1984) studied the acid inhibitory effect of a single 80 mg oral dose of enteric-coated omeprazole. At 6 h post dosing 3 patients were achlorhydric but 2 showed only 26% and 30% inhibition of acid output and had very low plasma omeprazole levels. Interestingly, 1 of these 2 patients also had exocrine pancreatic insufficiency and eventually required a b.d. dose of omeprazole to achieve satisfactory acid suppression (Lamers, 1986).

Whatever the cause of the variable response to omeprazole, our results indicate that the dose necessary to maintain gastric and duodenal pH above 4 in patients with pancreatic insufficiency will have to be determined in each individual patient by monitoring its effect. This dose may vary from 20mg/day to 40mg b.d. Patients with exocrine pancreatic insufficiency have an increased incidence of

duodenal ulcer disease (Schulze et al, 1983) and their variable response to omeprazole should be considered if it is employed for treating their ulcer disease.

CHAPTER ELEVEN

CONCLUSIONS

In the Introduction to this thesis, six objectives were outlined (page 14). In concluding, the degree to which these objectives have been met will now be discussed.

(1) **What electrode should be used?**

The inescapable conclusion of Chapters 1, 2 and 3 is that the combined glass pH electrode is the best device now available. There will be situations when readings are corrupted, e.g., by the presence of food particles adherent to the glass bulb but in these situations all other systems would also fail.

(2) **Is there a way to position electrodes accurately?**

The thesis introduces in Chapter 6 a new technique which, for the first time, enables electrodes to be positioned and held at a specific point in stomach and duodenum. This technique need not be confined to pH electrodes and the author is at present investigating its application to electrode positioning for gastric electrical activity measurements.

(3) How is gastric pH best measured?

There is no "best" method of measuring gastric pH but this thesis demonstrates, in Chapter 7, that one must take into account the position of the electrode because of the nonhomogeneity of intragastric pH both by day and by night. The use of a second electrode, at a different level, introduced originally to solve the problem of electrode withdrawal after clipping, gives valuable additional information and adds a new "dimension" to the interpretation of the results.

(4) What are normal values of gastric pH at different sites during fasting, eating and sleeping?

Normal values of gastric pH cannot be established from the study of 9 healthy volunteers outlined in Chapter 7. However, this study did demonstrate the relationship which may exist between body and antral pH and led to some unexpected observations regarding pH immediately after endoscopy, nocturnal alkalinisation and high incidence of campylobacter-positive antral gastritis in asymptomatic "normals".

(5) To what extent can gastric pH-monitoring be of use in the recognition of disease?

The only application of the technique of gastric pH monitoring in the thesis was to the investigation of nocturnal antral alkalinisation. This is not a sensitive indicator of bile reflux. Bile can appear in gastric juice of low pH and conversely high pH can be recorded in the

absence of bile. The future development of an electrode which can continuously measure changes in bile acid concentrations is eagerly awaited. Research in this field is taking place in the United States, England and Scotland but as yet no clinically applicable device is available.

I believe this technique can be of value in the investigation of certain disorders. Studies are under way to describe pH changes in stomach and duodenum in patients with haematemesis; patients with post-gastrectomy problems are being studied in the hope of separating problems due to persistent hyperacidity from those of alkaline reflux; a study of post-highly selective vagotomy patients is planned.

(6) Can continuous pH-monitoring contribute to the interpretation of pharmacological studies?

The omeprazole study in Chapter 10 demonstrates one of the great advantages of this technique over aspiration — namely the ability to continuously (and with minimal patient discomfort) monitor pH changes over an extended time period. This type of study places drug therapy on a scientific and rational basis. In view of the potency of omeprazole, the lack of success of acid suppression in 3 of the 6 patients studied came as a surprise. This prompted the unscheduled additional studies. I believe that, used in this way, pH electrode studies can greatly enhance our understanding of the mechanism of action of anti-secretory drugs.

Afromowitz M A, Yee S S. Fabrication of pH-sensitive implantable electrodes by thick film technology.

J Bioeng, 1978; 1: 55-60.

Ammann D, Lanter F, Steiner R A, Schulthess P, Shijo Y, Simon W. Neutral carrier based hydrogen ion selective microelectrodes for extra and intra-cellular studies.

Anal Chem, 1981; 53: 2267-2269.

Andersson S, Grossman M I. Profile of pH, pressure and potential difference at gastroduodenal junction in man.

Gastroenterol, 1965; 49: 364-371.

Angelini G, Merigo F, Antolini G et al. Pnacreatic secretion of zinc. Effects of alcohol and chronic pancreatitis.

Ital J Gastroenterol, 1986; 18: 7-12.

Archambault A P, Rovelstad R A, Carlson H C. In situ pH of duodenal bulb contents in normal and duodenal ulcer subjects.

Gastroenterol, 1967; 52: 940-947.

Ask P, Edwall G, Johansson K-E, Tibbling L. On the use of monocrystalline antimony pH electrodes in gastro-oesophageal functional disorders.

Med Biol Eng Comput, 1982; 20: 383-389.

Ask P, Edwall G, Johansson K-E. Accuracy and choice of procedures in 24-hour oesophageal pH monitoring with monocrystalline antimony electrodes.

Med Biol Eng Comput, 1986; 24: 602-608.

Atkinson M, Henley K S. Levels of intragastric and intraduodenal acidity.

Clin Sci, 1955; 14: 1-14.

Baron J H. Studies of basal and peak acid output with an augmented histamine test.

Gut, 1963; 4: 136-144.

Bauckle F G K. Contribution to the electrochemistry of pH glass electrode membranes.

In Ion-Selective Electrodes, E. Pungor, Ed., 1977; 215-234.

Bauerfeind P, Cilluffo T, Fimmel C J et al. Die intragastrale Langzeit-pH-Metrie.

Schweiz med Wschr, 1985; 115: 1630-1641.

Benn A, Cooke W T. Intraluminal pH of duodenum and jejunum in fasting subjects with normal and abnormal gastric or pancreatic function.

Scand J Gastroenterol, 1971; 6: 313-317.

Bergveld P. Development, operation and application of the ion sensitive field effect transistor as a tool for electrophysiology. IEEE Trans, 1972; BME-19: 342-351.

Bergveld P. Electronic-circuit-design principles for parameter control of i.s.f.e.t.s. and related devices. Med Biol Eng Comput, 1979; 17: 655-661.

Bircher J, Mann C V, Carlson H C, Code C F, Rovelstad R A. Intraluminal and juxtamucosal duodenal pH. Gastroenterol, 1965; 48: 472-477.

Bommelaer G, Benque A, Moreau J, Bouisson M, Ribet A. pH-metrie duodenale durant 24 heures dans les pancreatites chroniques. Gastroenterol Clin Biol, 1984; 8: 403-406.

Branicki F J, Evans D F, Ogilvie A L, Atkinson M, Hardcastle J D. Ambulatory monitoring of oesophageal pH in reflux oesophagitis using a portable radiotelemetry system. Gut, 1982; 23: 992-998.

Cattrall R W, Freiser H. Coated wire ion-selective electrodes. Anal Chem, 1971; 43: 1905-1906.

Cattrall R W, Tribuzio S, Freiser H. Potassium ion responsive coated wire electrodes based on valinomycin. Anal Chem, 1974; 46: 2223-2224.

Chakrabarti M K, Cobbe S M, Loh L, Poole-Wilson P A. Measurement of pulmonary venous and arterial pH oscillations in dogs using catheter tip pH electrodes.

J Physiol, 1983; 336: 61-71.

Christiansen T F. The Achilles' heel of potentiometric measurements, the liquid junction potential.

IEEE Trans Biomed Eng, 1986; 33: 79-82.

Cobbe S M, Poole-Wilson P A. A catheter tip pH electrode for use in man.

J Physiol, 1979; 289: 3P-4P.

Cobbe S M, Poole-Wilson P A. Catheter tip pH electrodes for continuous intravascular recording.

J Med Engng Technol, 1980; 4: 122-124.

Colson R H, Watson B W, Fairclough P D et al. An accurate long-term pH-sensitive radio pill for ingestion and implantation.

Biotel Patient Monitor, 1981; 8: 213-227.

Connell A M, Waters T E. Assessment of gastric function by pH telemetering capsule.

Lancet, 1964; 2: 227-230.

Davenport H W. Physiology of the Digestive Tract (Vth edition).

Year Book Medical Publishers Inc., Chicago, 1982; 167.

Dennis W H, Canosa C, Rehm W S. Potential difference across the pyloric antrum.

Am J Physiol, 1959; 197: 19-21.

DiMagno E P, Malagelada J R, Go V L W, Moertel C G. Fate of orally ingested enzymes in pancreatic insufficiency.

N Engl J Med, 1977; 296: 1318-1322.

Dubey P, Nundy S. Simultaneous measurement of gastric acid and duodenal alkali secretion by in situ titration in health and disease.

Gut, 1983; 24: 1126-1129.

Durie P R, Bell L, Linton W, Corey M L, Forstner G G. Effect of cimetidine and sodium bicarbonate on pancreatic replacement therapy in cystic fibrosis.

Gut, 1980; 21: 778-786.

Dutta S K, Russel R M, Iber F L. Influence of exocrine pancreatic insufficiency on the intraluminal pH of the proximal small intestine.

Dig Dis Sci, 1979; 24: 529-534.

Dutta S K, Rubin J, Harvey J. Comparative evaluation of the therapeutic efficacy of a pH-sensitive enteric coated pancreatic enzyme preparation with conventional pancreatic enzyme therapy in the treatment of exocrine pancreatic insufficiency.

Gastroenterology, 1983; 84: 476-482.

Edwall G. Improved antimony - antimony (III) oxide pH electrodes.
Med Biol Eng Comput, 1978; 16: 661-669.

Edwall G. Influence of crystallographic properties on antimony
electrode potential - 1. Polycrystalline material.
Electrochimica Acta, 1979; 24: 595-603.

Emde C, Garner A, Blum A L. Technical aspects of intraluminal pH-
metry in man: current status and recommendations.
Gut, 1987; 28: 1177-1188.

Evans D F, Foster G E, Hardcastle J D, Slater E. Proceedings of the
third international ambulatory monitoring symposium.
Davos, 1974. Basel: Karger, 1974; 67-70.

Eyerly J B, Breuhaus H C. A method of measuring acidity and protein
digestion within the human stomach.
Am J Dig Dis, 1939; 6: 187-192.

Eyerly J B. Comparative pH values within the stomach, pylorus and
duodenum in antacid therapy.
Am J Dig Dis, 1940; 7: 431-434.

Feldman M. Comparison of acid secretion rates measured by gastric
aspiration and by in vivo intragastric titration in healthy subjects.
Gastroenterology, 1979; 76: 954-957.

Fimmel C J, Etienne A, Cilluffo T et al. Long-term ambulatory gastric pH monitoring: validation of a new method and effect of H₂-antagonists.

Gastroenterology, 1985; 88: 1842-1851.

Flexner J, Kniazuk M, Nyboer J. A method for the continuous recording of gastric pH in situ.

Science, 1939; 90: 239-240.

Flexner J, Kniazuk M. A method for the continuous recording of gastric pH in situ. II experimental details.

Am J Dig Dis, 1940; 7: 138-140.

Fordtran J S, Walsh J H. Gastric acid secretion rate and buffer content of the stomach after eating.

J Clin Invest, 1973; 52: 645-657.

Fry C H, Williams A J. Measurement of ionic exchange in organelle suspensions with ion-selective electrodes.

J Physiol, 1979; 289: 2P-3P.

Gehrich J L, Lubbers D W, Opitz N et al. Optical fluorescence and its application to an intravascular blood gas monitoring system.

IEEE Trans, 1986; BME-33: 117-132.

Glab S, Edwall G, Jongren P A, Ingman F. Effects of some complex-forming ligands on the potential of antimony pH-sensors.

Talanta, 1981; 28: 301-11.

Goldstein S R, Peterson J I, Fitzgerald R V. A miniature fiber optic pH sensor for physiological use.

J Biomech Eng, 1980; 102: 141-146.

Gow R, Bradbear R, Francis P, Shepherd R. Comparative study of varying regimens to improve steatorrhoea and creatorrhoea in cystic fibrosis: effectiveness of an enteric-coated preparation with and without antacids and cimetidine.

Lancet, 1981; Vol. 2: 1071-1074.

Graham D Y. Pancreatic enzyme replacement. The effect of antacids or cimetidine.

Dig Dis Sci, 1982; 27: 485-490.

Greenberg G R, McCloy R F, Baron J H, Bryant M G, Bloom S R. Gastric acid regulates the release of plasma secretin in man.

Eur J Clin Invest, 1982; 12: 361-372.

Gullo L, Corinaldesi R, Casadio R et al. Gastric acid secretion in chronic pancreatitis.

Hepato-gastroenterol, 1983; 30: 60-62.

Hannibal S, Rune S J. Duodenal bulb pH in normal subjects.

Eur J Clin Invest, 1983; 13: 455-460.

Heading R C. Duodenogastric reflux.

Gut, 1983; 24: 507-509.

Heizer W D, Cleaveland C R, Iber F L. Gastric inactivation of pancreatic supplements.

Bull Johns Hopkins Hosp, 1965; 116: 261-270.

Hebert, 1970

Hoare A M, Keighley M R B, Starkey B, Alexander-Williams J.

Measurement of bile acids in fasting gastric aspirates: an objective test for bile reflux after gastric surgery.

Gut, 1978; 19: 166-169.

Hobsley M, Silen W. Use of an inert marker (phenol red) to improve accuracy in gastric secretion studies.

Gut, 1969; 10: 787-795.

Whitfield P F and Hobsley M. A standardized technique for the performance of accurate gastric secretion studies.

Agents and Actions, 1979; 9: 327-332.

Hollander F & Penner A. History and development of gastric analysis procedure (first instalment).

Am J Dig Dis, 1939a; 5: 739-743.

Hollander F & Penner A. History and development of gastric analysis procedure (second instalment).

Am J Dig Dis, 1939b; 5: 786-791.

- Hollander F & Penner A. History and development of gastric analysis procedure (third instalment).
Am J Dig Dis, 1939c; 6: 22-25.
- Hostein J, Bost R, Faure H, Lachet B, Fournet J. Valeur diagnostique de la pHmetrie gastrique au cours du reflux duodenogastrique.
Gastroenterol Clin Biol, 1987; 11: 206-211.
- Jacobson B, MacKay R S. A pH-endoradiosonde.
Lancet, 1957; 272: 1224.
- Jones D M, Lessells A M, Eldrige J. Campylobacter like organisms on the gastric mucosa: culture, histological and serological studies.
J Clin Pathol, 1984; 37: 1002-1006.
- Jones D M, Eldridge J, Fox A J, Sethi P, Whorwell P J. Antibody to the gastric campylobacter-like organism ("Campylobacter pyloridis") - clinical correlations and distribution in the normal population.
J Med Microbiol, 1986; 22: 57-62.
- Jongren P A, Edwall G. Evaluation of the influence of impurities on the oxygen sensitivity of monocrystalline antimony electrodes.
Electrochimica Acta, 1980; 25: 1585-1590.
- Karagounis V A, Liu C C, Neuman M R, Romankiw L T, Leary P A, Cuomo J J. A Pd-Pdo film potentiometric pH sensor.
Biomed Engng, 1986; 33: 113-116.

Katsube T, Lauks I, Zemel J N. pH sensitive sputtered iridium oxide films.

Sensors and Actuators, 1982; 2: 399-410.

Keane F B, Dimagno E P, Malagelada J R. Duodenogastric reflux in humans: its relationship to fasting antroduodenal motility and gastric, pancreatic and biliary secretion.

Gastroenterology, 1981; 81: 726-731.

Kearney R W, Comfort M W, Osterberg A E. Hydrogen ion concentration of the duodenal contents under fasting conditions in normal persons and in patients with duodenal ulcer: a comparative study.

J Clin Invest, 1941; 20: 221-227.

Kitigawa K, Nishigori A, Murata N, Nishimoto K, Takada H. Radiotelemetry of the pH of the gastrointestinal tract by glass electrode.

Gastroenterol, 1966; 51: 368-372.

Koryta J. Ion-selective electrodes. London: Cambridge University Press, 1975.

Krawiec J, Odes H S, Schwartz B, Lamprecht S A. Regional differences in ambient intraluminal gastric acidity after cimetidine monitored by intragastric pH-metry.

Am J Gastroenterology, 1983; 78: 272-275.

Kristensen M. Continuous intragastric pH determination.

Act Med Scand, 1965; 177: 415-425.

Lamers C B H W, Lind T, Moberg S, Jansen J B M J, Olbe L. Omeprazole in Zollinger-Ellison syndrome.

New Engl J Med, 1984; 310: 758-761.

Lamers C B H W. Present experience with omeprazole in the Zollinger-Ellison syndrome.

Scand J Gastroenterol, 1986; 21 (Suppl 118): 123-127.

Lamers C B H W, Jansen J B M J. Omeprazole as adjunct to enzyme replacement treatment in severe pancreatic insufficiency.

Br Med J, 1986; 293: 994.

Lankisch P G, Lemboke G, Goke B, Creutzfeldt W. Therapy of pancreatogenic steatorrhoea: Does acid protection of pancreatic enzymes offer any advantage?

Gastroenterologie, 1986; 24: 753-757.

Leblanc Jr O H, Brown Jr J F, Klebe J F, Niedrach L W, Slusarczuk G M J, Stoddard Jr W H. Polymer membrane sensors for continuous intravascular monitoring of blood pH.

J Appl Physiol, 1976; 40: 644-647.

Lind T, Cederberg C, Ekenved G, Haglund U, Olbe L. Effect of omeprazole - a gastric proton pump inhibitor - on pentagastrin stimulated acid secretion in man.

Gut, 1983; 24: 270-276.

Linton R A F, Lim M, Band D M. Continuous intravascular monitoring of plasma potassium using potassium-selective electrode catheters.

Critical Care Medicine, 1982; 10: 337-340.

Little A G, Martinez E I, DeMeester T R, Blough R M, Skinner D B. Duodenogastric reflux and reflux oesophagitis.

Surgery, 1984; 96: 447-454.

Lucas M L, Cannon M J. Measurement of sodium ion concentration in the unstirred layer of rat small intestine by polymer Na⁺-sensitive electrodes. Biochim Biophys Acta, 1983; 730: 41-48.

Malagalada J R. Pathophysiological responses to meals in the Zollinger-Ellison syndrome: 2. Gastric emptying and its effect on duodenal function.

Gut, 1980; 21: 98-104.

Meiners D, Clift S, Kaminski D. Evaluation of various techniques to monitor intragastric pH.

Arch Surg, 1982; 117: 288-291.

Meldrum S J, Watson B W, Riddle H C, Bown R L, Sladen G E. pH profile of gut as measured by radio telemetry capsule. Brit Med J, 1972; 2: 104-106.

Muller-Lissner S A, Fimmel C J, Sonnenberg A et al. Novel approach to quantify duodenogastric reflux in healthy volunteers and in patients with type 1 gastric ulcer. Gut, 1983; 24: 510-518.

McClendon J F. New hydrogen electrodes and rapid methods of determining hydrogen ion concentrations. Am J Physiol, 1915a; 38: 180-185.

McClendon J F. Acidity curves in the stomachs and duodenums of adults and infants, plotted with the aid of improved methods of measuring hydrogen ion concentration. Am J Physiol, 1915b; 38: 191-199.

McClendon J F. A direct reading potentiometer for measuring hydrogen ion concentrations. Am J Physiol, 1915c; 38: 186-190.

McCloy R F, Vickery J C, Baron J H. Long-term recording and computer analysis of simultaneous gastric and duodenal pH under normal conditions in man. Clin Phys Physiol Meas, 1980; 1; 151-162.

McCloy R F. Duodenal pH.

MD Thesis, University of London, 1982.

McCloy R F, Greenberg G R, Baron J H. Duodenal pH in health and duodenal ulcer disease: effect of a meal, Coca-Cola, smoking and cimetidine.

Gut, 1984; 25: 386-392.

Naesdal J, Bodemar G, Walan A. Effect of omeprazole, a substituted benzimidazole, on 24-h intragastric acidity in patients with peptic ulcer disease.

Scand J Gastroenterol, 1984; 19: 916-922.

Nagumo J, Uchyama A, Kimoto S et al. Echo capsule for medical use.

IRE Trans Med Electron, 1962; 9: 195-199.

Niemela S, Karttunen T, Heikkila J, Lehtola J. Characteristics of reflux gastritis.

Scand J Gastroenterol, 1987; 22: 349-354.

Noller H G. Proceedings of the second international conference on medical electronics.

Paris: Springfield, 1959; 296.

O'Connor H J, Wyatt J I, Dixon M F, Axon A T R. Campylobacter like organisms and reflux gastritis.

J Clin Pathol, 1986; 39: 531-534.

Oesch U, Brzozka Z, Xu A et al. Design of neutral hydrogen ion carrier for solvent polymeric membrane electrodes of selected pH-range.

Anal Chem, 1986; 58: 2285-2289.

Opitz N, Lubbers D W, Speiser P P, Bisson H J. pH nanoelectrodes as probes for fluorescence photometrical determination of hydrogen ion activities in biological structures of nm size. In D W Lubbers, C Eisenman, M Kessler, W Simon eds. Theory and application of ion-selective electrodes in physiology and medicine.

Arzneim-Forsch (Drug Research), 1978; 28: 715-716.

Opitz N, Lubbers D W. New fluorescence photometrical techniques for simultaneous measurements of ionic strength and hydrogen ion activities.

Sensors and Actuators, 1983; 4: 473-479.

Ovesen L, Bendtsen F, Tage-Jensen U, Pedersen N T, Gram B R, Rune S J. Intraluminal pH in the stomach, duodenum and proximal jejunum in normal subjects and patients with exocrine pancreatic insufficiency. *Gastroenterol*, 1986; 90: 958-962.

Papeschi G, Merigliano S, Zaninotto G, Baessato M, Ancona E, Larini M. The iridium/iridium oxide electrode for in vivo measurement of oesophageal and gastric pH.

J Med Engng Technol, 1984; 8: 221-223.

Persson B A, Lagerstrom P O, Grundevik I. Determination of omeprazole and metabolites in plasma and urine.

Scand J Gastroenterol, 1985; 20 (Suppl 108): 71-77.

Pilbrant A, Cederberg C. Development of an oral formulation of omeprazole.

Scand J Gastroenterol, 1985; 20 (Suppl 108): 113-120.

Pritchard P J, Yeomans N D, Mihaly G W et al. Omeprazole: A study of its inhibition of gastric pH and oral pharmacokinetics after morning or evening dosage.

Gastroenterology, 1985; 88: 64-69.

Rawlings J M, Lucas M L. Plastic pH electrodes for the measurement of gastrointestinal pH.

Gut, 1985; 26: 203-207.

Read N W, Fordtran J S. The role of intraluminal junction potentials in the generation of the gastric potential difference in man.

Gastroenterol, 1979; 76: 932-938.

Rechnitz G A. Mechanistic aspects of ion-selective membrane electrodes. A subjective view.

Pure and Applied Chemistry, 1973; 36: 457-471.

Regan P T, Malagelada J R, DiMagno E P, Glanzman S L, Go V L W.

Comparative effects of antacids, cimetidine and enteric coating on the therapeutic response to oral enzymes in severe pancreatic insufficiency.

N Engl J Med, 1977; 297: 854-858.

Reynolds J R, Walt R P, Hardcastle J D, Clark A G, Smart H L, Langman M J S. 24-hour intragastric pH: continuous monitoring or nasogastric aspiration?

Digestion, 1986; 33: 219-224.

Rhodes J, Apsimon H T, Lawrie J H. pH of the contents of the duodenal bulb in relation to duodenal ulcer.

Gut, 1966; 7: 502-508.

Rhodes J, Prestwich C J. Acidity at different sites in the proximal duodenum of normal subjects and patients with duodenal ulcer.

Gut, 1966; 7: 509-514.

Rhodes J, Barnardo D E, Phillips S F, Rovelstad R A, Hofmann A F. Increased reflux of bile into the stomach in patients with gastric ulcer.

Gastroenterology, 1969; 57: 241-252.

Rhodes R K. Development of low-drift pH electrodes based on neutral carrier in PVC overlaid metallizations.

IEEE Trans, 1986; BME-33: 91-97.

Ritchie W P. Alkaline reflux gastritis: a critical reappraisal.
Gut, 1984; 25: 975-987.

Robinson P H, Clarke M, Barrett J. Determinants of delayed gastric emptying in anorexia nervosa and bulimia nervosa.
Gut, 1988; 29: 458-464.

Rovelstad R A, Owen Jr C A, Magath T B. Factors influencing the continuous recording of in situ pH of gastric and duodenal contents.
Gastroenterology, 1951; 20: 609-624.

Rovelstad R A. Continuously recorded in situ pH of gastric and duodenal contents in patients with and without duodenal ulcers.
Gastroenterology, 1956; 31: 530-537.

Rovelstad R A, Maher F T. Problems associated with assessment of the effects of diet, antacids and anticholinergic agents on gastric and duodenal acidity, as measured by the glass electrode in situ.
Gastroenterol, 1962; 42: 588-594.

Rune S J, Koster K H. Gastric acidity measured by dialysis.
Lancet, 1963; 2: 1180-1183.

Rune S J. An electrode for pH measurement in the gastrointestinal tract.
Scand J Gastroenterol, 1968; 28: 91-94.

Rune S J, Viskum K. Duodenal pH values in normal controls and in patients with duodenal ulcer.

Gut, 1969; 10: 569-571.

Rune S J. pH in the human duodenum.

Digestion, 1973; 8: 261-268.

Rune S J. Problems associated with in situ measurement of duodenal pH.

In Magen und Magenkrankheiten ed. Domschke W, Wormsley K G.

Stuttgart: Thieme Verlag, 1981; 150-161.

Sandle L N, Acheson D W K, Hunt L P, Gowenlock A H, Braganza J M. Methods to assess "enzyme induction" in patients with idiopathic pancreatitis.

Gut, 1985; 26: A1133.

Saunders J H B, Cargill J M, Wormsley K G. Gastric secretion of acid in patients with pancreatic disease.

Digestion, 1978; 17: 365-369.

Savarino V, Mela G S, Scalabrini P et al. 24-h comparison between pH values of continuous intraluminal recording and simultaneous gastric aspiration.

Scand J Gastroenterol, 1987; 22: 135-140.

- Schepel S J, de Rooij N F, Koning G, Oeseburg B, Zijlstra W G. In vivo experiments with a pH-ISFET electrode. *Med Biol Eng Comput*, 1984; 22: 6-11.
- Schulze S, Pederson N T, Jorgensen M J, Mollmann K M, Rune S J. Association between duodenal bulb ulceration and reduced exocrine pancreatic function. *Gut*, 1983; 24: 781-783.
- Segal H L, Miller L L. Present status and possibilities of ion exchange compounds as tubeless agents for determining gastric acidity. *Gastroenterology*, 1955; 29: 633-640.
- Segal H L, Miller L L, Plumb E. Tubeless gastric analysis with an azure A ion-exchange compound. *Gastroenterology*, 1955b; 28: 402-408.
- Segal H L. The diagnex blue tubeless gastric analysis test. *J Clin Gastroenterol*, 1982; 4: 287.
- Siu K F, Lee N W, Wong J. A simple method of endoscopy-guided insertion of nasogastric tubes. *Endoscopy*, 1984; 16: 24-25.
- Smith R L, Scott D C. An integrated sensor for electrochemical measurements. *IEEE Trans*, 1986; BME-33: 83-90.

Staub J L, Sarles H, Soule J C, Galmiche J P, Capron J P. No effect of cimetidine on the therapeutic response to oral enzymes in severe pancreatic insufficiency.

N Engl J Med, 1981; 304: 1364-1365.

Stoker D L, Williams J G, Dewar E P, Colin-Jones D G. Oesophageal bile reflux - is it alkaline?

Gastroenterology, 1988; 94: A446.

Szonntag E L. Sputtered solid-state pH glass electrodes. In Proc 154th Meet Electrochem Soc.

Pittsburgh, PA 1978; paper 229.

Tomenius J, Williams G. Continuously recorded pH of gastric and duodenal contents in situ with an evaluation of the efficacy of some antacids in vivo.

Acta Med Scand, 1960; 166: 25-34.

Vitale G C, Sami Sadek F, Tulley M et al. Computerized 24-hour oesophageal pH monitoring: a new ambulatory technique using radio-telemetry.

J Lab Clin Med, 1985; 105: 686-693.

Von Ardenne Von M, Sprung H B. Über den verschluckbaren intestinalsender für pH-wert-signalisierung.

Naturwissenschaften, 1958; 45: 564-565.

- Watson B W, Kay A W. Radio-telemetry with special reference to the gastrointestinal tract.
In: Kenedi R M, ed. Biomechanics and related bioengineering topics. Oxford: Pergamon, 1965; 111-127.
- Watson W C, Paton E. Studies on intestinal pH by radiotelemetry. *Gut*, 1965; 6: 606-612.
- Watson W C, Watt J K, Paton E, Glen A, Lewis G J T. Radiotelemetry studies of jejunal pH before and after vagotomy and gastroenterostomy.
Gut, 1966; 7: 700-705.
- Wilson J A, Boyd E J S, Wormsley K G. The effect of omeprazole on acid and pepsin secretion in duodenal ulcer patients.
Scand J Gastroenterol, 1986; 21 (Suppl 118): 147-149.
- Wright N, Yeoman W B, Carter G F. Massive oral ingestion of elemental mercury without poisoning.
Lancet, 1980; 1: 206.
- Wyatt J I, Rathbone B J, Heatley R V, Losowsky M S. *Campylobacter pylori* and history of dyspepsia in healthy blood donors.
Gut, 1988; 29: A706.

Zentler-Munro P L, Fitzpatrick W J F, Batten J C, Northfield T C.
Effect of intrajejunal acidity on aqueous phase bile acid and lipid
concentrations in pancreatic steatorrhoea due to cystic fibrosis.
Gut, 1984; 25: 500-507.