



<https://theses.gla.ac.uk/>

Theses Digitisation:

<https://www.gla.ac.uk/myglasgow/research/enlighten/theses/digitisation/>

This is a digitised version of the original print thesis.

Copyright and moral rights for this work are retained by the author

A copy can be downloaded for personal non-commercial research or study,
without prior permission or charge

This work cannot be reproduced or quoted extensively from without first
obtaining permission in writing from the author

The content must not be changed in any way or sold commercially in any
format or medium without the formal permission of the author

When referring to this work, full bibliographic details including the author,
title, awarding institution and date of the thesis must be given

Enlighten: Theses

<https://theses.gla.ac.uk/>
research-enlighten@glasgow.ac.uk

SEASONAL VARIATIONS IN ENERGY BALANCE
IN RURAL WORKING WOMEN.

SANDRA DRUMMOND.

A THESIS SUBMITTED FOR THE DEGREE OF
DOCTOR OF PHILOSOPHY.

INSTITUTE OF PHYSIOLOGY
UNIVERSITY OF GLASGOW.

MAY, 1988.

ProQuest Number: 10997936

All rights reserved

INFORMATION TO ALL USERS

The quality of this reproduction is dependent upon the quality of the copy submitted.

In the unlikely event that the author did not send a complete manuscript and there are missing pages, these will be noted. Also, if material had to be removed, a note will indicate the deletion.



ProQuest 10997936

Published by ProQuest LLC (2018). Copyright of the Dissertation is held by the Author.

All rights reserved.

This work is protected against unauthorized copying under Title 17, United States Code
Microform Edition © ProQuest LLC.

ProQuest LLC.
789 East Eisenhower Parkway
P.O. Box 1346
Ann Arbor, MI 48106 – 1346

SEASONAL VARIATIONS IN ENERGY BALANCE IN RURAL INDIAN WOMEN

©

ACKNOWLEDGEMENTS

I wish to thank the European Economic Community and the Overseas Development Agency for the funding of this project.

I also wish to thank my supervisor, Professor J V G A Durnin for the support and encouragement he gave me while collecting the data and for his advice in writing up this thesis.

Last, but not least, I wish to thank my parents for their constant moral support given during my stay in India, without which I would have found it difficult to "keep my pecker up".

CONTENTS

Page Number

4	Summary
11	Introduction
73	Methodology:
78	Anthropometry
97	Food Intakes
111	Basal Metabolic Rates
126	The Step Test
141	Activity Patterns
143	Results and Discussion:
146	Anthropometry
181	Food Intakes
204	Basal Metabolic Rates
234	The Step Test
253	Activity Patterns
267	Conclusions
272	References
296	Appendix

PLATES

<u>Plate</u>	<u>Page</u>	
1	82	Two subjects from the study from the low Socio-economic group. (Working Women)
2	108	Measurement of Food Intake
3	116	The "Laboratory", Edulabad Village
4	120	Measurement of Basal Metabolic Rate
5	138	Measurement of Aerobic Capacity: The Step Test

SUMMARY

There have been relatively few studies performed in Third World countries which have examined the seasonal variation in food intake and the physiological adaptations made by those subjected to them; and gaps still remain in our knowledge of the energy and nutrient needs for these populations. Most of the studies that have been carried out involve the male population, or, if the female population is included, then more often than not the researchers examined only the effects of restricted energy intake on pregnancy and lactation.

Hopefully, therefore, this study will give some insight into the situation for non-pregnant, non-lactating, hard-working women in southern India.

The investigation was carried out in Edulabad, a village in the state of Andhra Pradesh, South India. A group of around 100 low-income female agricultural labourers were studied throughout two harvest and two lean seasons for changes in body composition by measuring their body weight, 5 skinfold thicknesses and 4 limb circumferences at 6 weekly intervals.

A smaller group of 30 middle income housewives living in the same village were also measured at the same time as the working women, for comparison.

These measurements were carried out in 1985 and repeated in 1986. Also in 1986, the variation in energy intake of 30 working women was measured in the harvest season, and the lean season. This was carried out using the individual weighed inventory method over a three day period, and the average of the three days intake was taken to represent the woman's daily intake for that season. The intake of 10 middle income housewives was also measured by the same method, for comparison.

Using indirect calorimetry (Douglas Bag method) the basal metabolic rates of the same group of 30 working women were determined, again in the harvest and lean seasons. On the same days they performed a 3 level step test of increasing work intensity, to determine their aerobic work capacity. Finally, the working women were followed for 3 days by a local observer who recorded their activities minute by minute. This was carried out twice, at the same time as the food intake measurements.

The women's activities were divided into ten major categories: lying in bed; sitting; sitting activities; standing; standing activities; personal needs; housework; walking; manual work; field work.

In summary the results showed that the working women in this study tended to lose weight after the harvest season when there was restricted food availability and when what was available was more expensive to buy ie they lost 0.5 kg - from 40.0 kg to 39.5 kg, and 0.4 kg - from 39.7 kg to 39.3 kg in 1985 and 1986 respectively.

These working women fell below the FAO/WHO/UNU 1985 recommendations for desirable weight for height and body mass index. There was a small fall in total skinfold thicknesses from the harvest to the lean season, 1985. Similarly in 1986 where there was a bigger reduction in total skinfold thicknesses, from 43.3 mm to 40.8 mm in the harvest and lean season respectively. This was reflected in a significant drop in percentage body fat in 1986, from 21.4 to 20.1 per cent. These values obviously represent a population with very little body fat.

Limb circumferences were reduced significantly in 1985 in the buttocks thigh and calf measurements, and also tended to decrease in 1986, but failed to reach significance.

There were no significant differences between the sets of measurement on the middle income 'control' women between the seasons. This absence of difference may indicate that a greater reliability can be placed on the data for the working women which do exhibit seasonal changes.

The middle income women were found to be 10 kg heavier than the working women, with a higher percentage body fat - around 30%. These women did fall into the FAO/WHO/UNU desirable ranges for weight for height, and BMI.

There was found to be a significant difference in energy intake in the working women between seasons - 2030 Kcal/day in the harvest season and 1890 Kcal/day in the lean season. Therefore a situation seems to exist where food availability is decreased as an effect of the seasons. The middle income women had an intake much less than the working women, of 1760 Kcal/day, which would be expected since they were not involved in any manual labour.

Comparing these results with the relative energy requirements of women of similar age and weight as given by FAO/WHO/UNU 1985, the middle income women fall into the low end of the range in level of activity, whereas the working women are classified as involved in "very heavy" activity.

Very low measurements of Basal metabolic rate were obtained from the group of working women with a slight reduction (of around 5 per cent) during the lean season ie from 0.61 Kcal/minute to 0.58 Kcal/minute. These values fall below the range of predicted values, from equations based on their height and weight (FAO/WHO/UNU 1985). When these working women's BMR Factor was calculated:

Energy Intake

BMR

a very high value was obtained which would classify them as very active, according to FAO/WHO/UNU (1985).

A comparative study was carried out in Glasgow on a group of 15 Indian women to test whether or not there was any ethnic component in determining the BMR. Their mean BMR

was 0.900 Kcal/min - very much higher than measured in Hyderabad, but when corrected for weight it was only slightly higher than the rural Hyderabad women (16.2 Kcal/kg/min and 15.8 Kcal/kg/min respectively). The mean BMR value for the Indian women living in Glasgow was lower than that predicted using the FAO/WHO/UNU 1985 equations, but within the normal range. The Glasgow Indian women's BMRs were significantly higher than the working women from Hyderabad, indicating perhaps a climatic or nutritional factor involved in determining the BMR.

The exercise capacity test - the Step Test - was validated as a viable test to measure aerobic capacity in a comparative study in Glasgow, with the treadmill test. The results indicated however that the Step Test underestimated the aerobic capacity by around 9 per cent. In India the results showed that the working women's value of fitness (when corrected by 8.6%) fell into the 'good' category of fitness as given by the Palo Alto Preventive Medicine Centre fitness classification or 'average' category, as given by Astrand (1960). There was a slight, but not significant, fall in maximum aerobic capacity as predicted using the step test in lean season - from 39.5 ml/kg/min to 37.6 ml/kg/min.

There were several large and significant changes in pattern of activity, as would be expected. For example, in the lean season the working woman spent on average around 80 minutes extra in the field work, almost half the amount of time lying down (between the hours of 6 am and 9 pm) compared to the harvest season, but more time standing and sitting, with a reduction of around 100 minutes per day involved in sitting activities.

Therefore, since the energy intakes were lower in the lean season than the harvest season in spite of the increased work load of the working women this could explain the loss in body weight.

Overall however the findings did not support the largely anecdotal notion of very large seasonal swings in body weight as a result of the effect of season on food availability. This may be due to the sum of many small metabolic and behavioural adaptations with a resultant conservation of energy.

INTRODUCTION

CONTENTS

Page Number

13	Energy Requirements And Their Implications
16	Adaptations to Low Food Intakes
20	Early Experiments on Reduced Intakes
35	Seasonal Changes in Food Intake
39	Seasonal Changes in Energy Expenditure
42	Adaptation to Seasonal Reductions in Food Intake
42	a. Changes in body weight and size
45	b. Changes in basal metabolic rate
47	c. Basal metabolic rate of Indians
52	d. Reduced metabolic response to food and activity
55	e. Behavioural adaptation

Page Number

55	i. Reduction in voluntary activity
59	ii. Unconscious economy of activity
61	Work Capacity of Undernourished Populations
63	The Importance of Women in the Indian Village
66	Location of the Study
67	Agricultural Calendar
68	Lifestyle of the Rural Working Woman
70	Problems Encountered in Carrying Out Research in India

ENERGY REQUIREMENTS AND THEIR IMPLICATIONS

The area of human energy metabolism and requirement is of considerable interest, especially in the planning of food and nutrition policy in the developing countries.

Unfortunately, for many years, energy deficiencies have led to widespread starvation in many third world countries, especially in certain parts of Africa.

Starvation in Africa has received wide publicity recently and a great deal of public concern has been expressed.

However, another related area in energy requirements and one which is just as important to the long term solution of these problems of starvation and mal nutrition is the widespread occurrence of marginal energy deficiency and the consequent adaptation mechanisms which develop in many not so well publicised countries.

At the present time there is insufficient scientific data on the subject of marginal energy deficiency to allow its influence and implications to be properly understood and appreciated. In practical terms, this area of energy metabolism is extremely important when assessing and understanding the actual level of energy requirement of many people in the third world and their limits of

possible adaptation. An investigation on this subject would therefore provide much needed information, essential for governments in the planning of food and agricultural policies in the third world.

It was therefore the purpose of this research project to determine the degree of adaptation which occurs in rural women in situations where the amount of food available to them is intermittently inadequate, ie seasonal variations in food intake. These energy saving adaptations would result in a reduction in total daily energy expenditure. They may involve an increased efficiency of external work, a reduced pace of physical activity, an improved economy of movement or a decrease in their basal metabolism.

The project was financed by the European Economic Community, and the Overseas Development Agency, for a period of just over two years. It was carried out by three Institutes: in Glasgow, Scotland; in Rome, Italy; and in Wagenigen, Holland; in collaboration with three Institutes in the third world countries under investigation namely, India, Ethiopia and Benin.

The field work and collection of data was carried out in Hyderabad, India with the help of a team of local personnel from the National Institute of Nutrition.

The parameters measured and followed throughout an entire seasonal cycle were changes in body weight and fat stores, in energy intake, in basal metabolic rates, in work capacity and in activity pattern of a group of rural women.

ADAPTATIONS TO LOW FOOD INTAKES

The fact that large numbers of people in third world countries today subsist on diets significantly lower in calories than those in the more developed countries indicates the ability of the human body to survive and adapt to limited calorie intake.

The definition of a successful adaptation in a nutritional context is "a process by which a new or different steady state is reached in response to a change or difference in the intake of food and nutrients" (FAO/WHO/UNU, 1985).

However, the adaptation must result in a state which is "acceptable" and this has to allow for activities other than work, or "occupational" activities, and include recreational and socially desirable, or "discretionary", activities.

The consequences of the adaptation on general health, mental health of the subject and the social interactions of the population has to be considered also. Therefore, although there is a wide range of adapted states of

metabolic rate, body weight etc, the effect on the overall well being of the population should not be overlooked.

The adaptations important in situations of low food intake are of three types:

1. Biological/Genetic - ie any adaptations, such as low basal metabolic rate, which have been inherited.
2. Behavioural/Social - the most likely adaptation here is a reduction in physical activity. Although this may conserve some of the limited amount of energy available it may have disadvantages as well. For example, a reduced level of exploratory activity in undernourished children may inhibit the development of his/her mental and social abilities.
3. Physiological/Metabolic - this includes a wide range of possible adaptations, including a reduction in body weight, a decrease in basal metabolic rate, and perhaps an increased work efficiency.

It is difficult in fact to assess how wide the variation is between normal individuals and the range of this normal variation. It is important to assess and take into account the normal individual variability in BMR and

work efficiency and then define the adaptive mechanisms by which man adapts to low levels of nutrition, or to know exactly how much food energy man needs to maintain minimal standards of health and activity, to enable the planning of food and agricultural policies for the undernourished populations. For example, it is still unclear why there are large differences in food intake between similar people involved in similar activities. There is the classic study of the two-fold range between highest and lowest intakes of a group of similar people (Widdowson 1962). It has been suggested that perhaps those populations in third world countries surviving on very low food intakes just lie at the lower end of the normal range of people in the developed countries.

Apart from this inter-individual variation, there is also the intra-individual variation. Sukhatme and Margen (1982) claim that the coefficient of variation of intake in the same subject from day to day was 20% and that an individual can adapt to a variation of +/- 30% in his/her energy intake with no cost or ill effect. Sukhatme states that it is important not to think of the human being existing in a fixed or constant state.

However, these figures have been obtained theoretically with little experimental data to confirm them. Even if this adaptation was possible in the short term, it is almost certainly not possible in the long term and could be potentially disastrous if their figures were adopted by the planners of food distribution for third world countries. It is therefore obvious that the human being can adapt to large variations in food intake, but the range of this adaptation which may be acceptable to the subject is much more difficult to assess.

EARLY EXPERIMENTS ON REDUCED INTAKES

Many of the classical experiments on reduced food intake were performed on professional fasters. Lusk (1917) has summarised much of the work done on these men, observing the nitrogen and carbon dioxide excretion over successive days of fasting.

Cathcart in 1906, while working at the University of Glasgow, studied the nitrogen excretion, body weight, pulse and respiratory rate, body temperature and blood pressure of the professional faster Beate during a two week fast. The parameter most affected was the nitrogen excretion which fell sharply on the first day of the fast, rose sharply again on the second day then fell steadily to around half the original excretion level on the tenth day.

In 1915 a report was published by Benedict on his study of a 31 day fast by Levanzin. Benedict measured weight, carried out blood tests, measured blood pressure, alveolar air, heart rate, rectal temperature, urine analysis and water balance. Levanzin's metabolic rate was also measured, indirectly, on at least three occasions and also while engaged in various activities.

Nitrogen lost from the skin was measured from extraction from his clothing and distilled water baths. For each day of the fast the body materials which were catabolised were computed from the measured nitrogen in the urine and the respiratory exchange. The energy expenditure was then divided between carbohydrates, fat and protein. Results showed there was a peak in nitrogen excretion on the fourth day of the fast, followed by a slow decline. The total metabolic rate decreased as the fast progressed, with carbohydrates providing an insignificant amount of energy after the third day, while energy obtained from fats contributed a growing proportion as the fast continued - from around 73% on the first day to 86% on the last day. There was a drop in total energy provided by protein - from a peak of 19.4% on the fourth day to 14.4% on the last (31st) day.

Earlier, Benedict (1907) carried out studies on short term fasting, from two day fasts to eight day fasts. These results also showed the change in the percentages of energy obtained from carbohydrates, protein and fat as the fasting continued, ie on the first day 13% of energy was derived from protein, 65% from fat and 22% from

carbohydrates. Whereas, on the third day of fasting 17% of energy was derived from protein, 78% from fat and less than 5% from carbohydrates.

These early studies established several facts about the effects of total fasting in the human subject, ie a drop in energy derived from protein and more markedly from carbohydrates as the limited glycogen stores were expended, with an increased percentage of energy obtained from fats. Also noted with fasting was a decline in resting heart rate, changes in morphology and a decline in metabolic rate.

An experiment in chronic undernutrition, as opposed to total starvation was carried out in 1919 (Benedict, Miles, Roth and Smith - 1919) and was known as the Carnegie Experiment. Its goal was to throw some light on the problems of famine relief and food shortage. The objective was to produce a weight loss of around 10% over several months. It was believed that such a loss would be enough to demonstrate the changes in metabolism and various functions which characterise famine and semi-starvation conditions. However, Benedict and colleagues seemed anxious to avoid discomfort and inconvenience in their subjects, so much so that the

experiment failed to provide conditions properly comparable to those seen in severe food shortages, such as existed in Central Europe around the same time.

As a whole though, the Carnegie experiment was directed towards proving the adaptation of the organism to a restricted diet, rather than documenting quantitatively the disability, distress or discomfort resulting from undernutrition. Their main interest was the change in metabolic rate, and their experiment was expected to show whether the basal metabolic rate would reduce with reduced energy intake, whether this will be in proportion to loss of body weight and whether the body can obtain nitrogen and carbon equilibrium at a lower level. They were also interested in the cost of muscular exercise on reduced intakes and the effect of foodstuffs on reduced body weights.

Two groups of twelve men took part. Group A lived for 120 days on a diet which was reduced by one half to one third of their normal intake. Their diet was reduced after a short control period of eleven days, but was interrupted by periods of uncontrolled intake during holidays (especially Christmas) and alternate weekends. The final loss of body weight obtained by this group was 10.7%

Group B had a three month control period, then lived on approximately 1500 Kcal per day for twenty days. This group lost around 6.6% of their body weight. Physical activity was not controlled for either group A or B. The refectory food which fed the two groups was restricted and samples of the food were analysed for nitrogen and energy content.

Group A lived on a diet of 2200 Kcal per day for ten days, then 1600 - 1700 Kcal per day for twenty one days. When the desired body weight was achieved the intake was increased until nitrogen and body weight was in equilibrium - this occurred around 2000 - 2200 kcal per day. (The pre-experimental control energy intake period was estimated to have been 3800 kcal per day.)

As a result of these energy intake restrictions, decreases in limb circumferences and body dimensions were recorded. Keys and his colleagues in 1950 later reviewed some of this data and carried out some statistical tests on the data. They concluded that only in Group B, who had a shorter and more severe period of restriction, was there a significant drop in body temperature, perhaps as a result of their rapid, but smaller, weight loss

compared to the slower weight loss of Group A. However, all subjects experienced an increased sensitivity to cold.

Basal metabolic rates (BMR) were measured by indirect calorimetry. All subjects in Group B showed a decline in BMR - by 11% when expressed as BMR/kg body weight, and 9% when expressed as BMR/m surface area. Group A showed a continuous decline in BMR, with this reduction exceeding the reduction in body weight and even more so that of the body surface. The maximum reduction of the BMR as determined in the group respiration chamber was greater than that recorded in the individual experiments - it amounted to 11.5% (individual) and 18.2% (respiration chamber) per kg and 16.2% (individual) and 22.1% (respiration chamber) per square metre of surface. The absolute heat production, determined in individual experiments decreased from an average of 1686 Kcal per 24 hours in the control period, to 1367 Kcal per 24 hours at the end of the experiment - a reduction of 19%. They found no decrease in energy expenditure when walking on a treadmill.

During this period of weight loss for all subjects there was a tendency to lose nitrogen, ie they were in negative nitrogen balance (around 3 g per day), with a bigger loss in Group B who had a larger and better controlled

reduction in their diet. However, the caloric value of the protein corresponding to the nitrogen loss cannot account for any appreciable percentage of the total energy lost from the body, although there was a good correspondence between the cumulative nitrogen losses and the loss of body weight.

The authors found no change in respiratory quotient, respiratory rate, tidal volume and alveolar air composition during the course of the experiment. However, there was a drop in blood pressure for all subjects and pulse rate at rest. Also noted were some irregularities during exercise on the treadmill, such as an initial overshoot in heart rate, but the recovery of the heart rate to normal after exercise was normal. No changes were seen in many sensory functions such as pitch discrimination and reaction time with dietary restriction. Endurance in static types of work (eg holding the arms out at an angle of 45 degrees) was not altered with semi-starvation. However the number chin-ups achieved dropped markedly. Also, a factor which must be given full importance is the effect this dietary restriction had on the men subjectively. They all reported a tiredness (especially in the legs) and they were found to be quite irritable during this semi-starvation period. Many of these findings are related to

this study in Hyderabad, India. As expected there was a loss in body weight and reduction in limb circumferences with the reduced food intake. Also of relevance was the drop in basal metabolic rate - ie a metabolic adaptation to the reduction in food intake. The reduction in the number of chin-ups achieved after food restriction in the Carnegie experiment may be important in situations where heavy muscular work has to be performed, as in the field situation in India.

Therefore, although these experiments are very artificially produced in the laboratory, their findings can be related to the real life situations of reduced food intake.

In 1950 another experiment on semi-starvation of this magnitude was attempted. Keys and his colleagues used 36 young male students in their Minnesota Experiment - a study on the effects of severe dietary restriction for 24 weeks. The subjects lived at the laboratory of Physiological Hygiene where their food was strictly controlled (unlike the Carnegie experiment) for twelve weeks control period, twenty four weeks semi-starvation and twelve weeks rehabilitation period.

The semi-starvation was intended to produce a decrease in body weight which would be comparable to the observed losses in severe famine areas, ie losses of 25% - 30%. The subject's intake was decreased from 3500 Kcal per day (from the control period) to an average daily intake of 1570 Kcal per day. This was varied slightly for each subject in order to achieve a roughly equivalent starvation stress in each of the subjects. In addition to this energy restriction the subjects took part in 15 hours per week of project duties (eg laboratory work) walked around 20 miles per week outdoors, 25 hours per week in an education programme and performed an exercise test which involved walking on a treadmill at 3.5 m.p.h. at a 10% gradient for half an hour.

The weight loss obtained during the twenty four weeks semi-starvation decreased with time, decreasing to zero at the end of the semi-starvation period.

Many changes in the major body compartments occurred. For example, there was an increase in percentage extra-cellular fluid, from 20% - 25% to 34% after the twenty four weeks. A large drop in body fat was also observed - from 13.9% during the control period to 5.2%

after 24 weeks. Also seen in starvation subjects is the proportional loss of weight in various major organs (Keys et al - 1950). In other studies where cadavers have been dissected and examined it has been shown that there is also atrophy of skeletal muscle, cardiac muscle and smooth muscle. There are large weight losses in the heart, spleen and, most markedly, the liver. Calculation of the average daily breakdown of body fat and protein for the first and second halves of the semi-starvation period led to the result that in the first twelve weeks the average daily fat catabolism yielded 504 Kcal per day and protein yielded 107 Kcal per day. Both dropped during the second twelve week period, with fat yielding 136 Kcal per day and protein 33 Kcal per day.

As in the Carnegie experiment, a decrease in blood pressure, resting heartrate and a decrease of 45% in cardiac output was seen at the end of the twenty four weeks.

The largest deterioration in physical performance occurred in tests in which the state of the muscles was the limiting factor. In the work capacity tests on the treadmill, Keys found that during the semi starvation period the test was more difficult for the subject, compared to the control period. This was indicated by a

larger work pulse rate increment, and the concentration of blood sugar during the last two minutes was decreased both at the twelfth and twenty fourth week. The deterioration was more marked in the exercise test which involved running to exhaustion. By the end of the twenty four week period the average fitness score was only 28% of the control value and the maximal oxygen uptake was decreased by 25% when corrected for body weight. Keys et al attributed this to the decreased cardiac output, a deterioration of capillary function in the muscles and a loss of strength.

However, the important result that came out of this experiment is that at the end of the twenty four week period of restricted dietary intake, the subjects were in fact in energy balance. This was achieved by several adaptations - most importantly the reduction in body weight of around 24%. This alone accounts for a large saving in energy expenditure in that the maintenance energy required is less, and the cost of physical activity is less. A large energy saving was also achieved due to the drop in voluntary spontaneous activity.

The drop in work capacity in acute fasting conditions seen by Keys in 1950 was also recorded a few years later by Henschel et al (1954) when two groups of male subjects underwent either a two and a half day fast (Group 1) or a four and a half day fast (Group 2). Both groups performed several hours of work daily. Group 1 lost 4.5 kg and Group 2 lost 5.5 kg, which seems excessive.

The energy deficit necessary to produce a weight loss of 4.5 kg over two and a half days can be calculated:

loss of 1 kg adipose tissue = 7000 Kcal deficit

loss of 4.5 kg adipose tissue = 31500 Kcal deficit

This deficit over two and a half days represents a daily deficit of 12,600 which is clearly not possible.

Similarly, for Group 2 a daily deficit of around 8600 Kcal would be necessary to produce the recorded weight loss. This is also unacceptable if not impossibly high.

However, they also recorded that on the first day there was little loss of fitness seen during the work capacity test on a treadmill at 3.5 m.p.h. at a 10% gradient for several hours. On the second day there was an increase of 10 - 15 beats per minute in their work pulse rate.

The ventilation increased and the blood sugar dropped by 25 mg/100 ml. By the fourth day their average Harvard fitness score was 40% of the control value.

However this was an extreme experiment of total starvation where there would be an early depletion of the carbohydrate reserves. Experiments on the effects of low intake on work capacity were carried out by Taylor and colleagues in 1957. One group of their subjects consumed 580 Kcal per day of carbohydrate for 12 days, another group consumed 1010 Kcal per day carbohydrate for 24 days. Both groups maintained both their aerobic and anaerobic capacity well although there was some deterioration in Group 1's pulmonary ventilation during work, oxygen debt and pulse rate responses, but this was not observed in Group 2.

The effect of starvation was summarised by Grande in 1964 and he concludes that a large amount of the adaptation necessary to survive is achieved passively as a consequence of the loss of body weight. The absolute daily weight loss changes with time, tending to be proportional to body weight. Grande states that all organs except the central nervous system participate in this weight loss and the energy content of the lost

tissue is related to the duration of undernutrition. Initially there is a large proportion of water lost and therefore the energy density of the tissue lost is low. However, as starvation progresses the proportion of fat and protein lost increases, with a consequent lowering of the basal metabolic rate.

Keys et al (1950) comment on one interesting point in the adaptation to under-nutrition in that women have a lower mortality rate in famines than men. They quote several instances of famines occurring after wars where the deaths by starvation were very much higher in males than females. This probably is largely due to the higher percentage of fat in females compared to males, as there is little experimental evidence for any metabolic differences in conditions of starvation between men and women.

As stated before with regard to the Carnegie experiment, these later experiments again look at many of the parameters studied in this investigation - the reduction in body weight, the drop in percentage body fat, the decrease in basal metabolic rate, the deterioration in physical performance and a drop in average fitness scores.

The former changes are important for any population under energy restriction, but the latter changes, ie the drop in physical performance and fitness score, is especially important in populations who have to perform manual labour in order to survive. It is therefore important to take these studies further ie into the actual field situation, to measure the effect of, in this case seasonal, variations in food intake, and what adaptations both metabolic and behavioural are made in response.

SEASONAL CHANGES IN FOOD INTAKE

On the topic of adaptation to low food intakes many authors quote the famous Keys experiment of 1950 in Minnesota, ie the semi-starvation of originally well fed American men for twenty four weeks and the consequent metabolic and behavioural changes that took place.

However, not so much work has been done on the shorter term reductions in food intake which occurs between harvests in agriculturally dependant populations. This continues over the years and generations, through pregnancies, illnesses and often when the hardest physical work has to be carried out.

This situation is a much more common one and therefore it is more relevant to study the adaptive changes seen in these populations rather than in well fed Americans.

In many developing countries the majority of the population is involved in agricultural labour, cultivating cash crops as well as crops for their own consumption. Between harvests therefore there is a decrease in food availability. This results in a rise in food prices as the scarcity increases, thus adding to the problems of the poorer of the population in buying what

little food is available (Huffman et al, 1985). In Hyderabad in Southern India, the prices of food stuffs were found to increase at certain times of the year, coinciding with seasons and harvests. In fact, in the winter season prior to the harvest there was a reduction in availability of almost all foods - fruit and vegetables, cereals and pulses, meat and fish (Pasricha et al, 1983), and a corresponding increase in price.

In a study in Bangladesh, Huffman and colleagues looked at the nutritional status of non-pregnant women and noted a variation in body weight of up to +/- 1.5 kg which corresponded to the seasons and availability of food. As might be expected, the women gained weight at the time of the Aman harvest from November to January, (The Aman harvest accounts for 60% of all rice produced in Bangladesh), and lost weight in the summer months as the availability of food decreased. (The Aus harvest in September accounts for only 25% of the rice production in the country.).

In a study on a group of Nomadic pastoralists in Niger, Loutan et al (1984) reported a decrease in weight which corresponded to the dry season. At the end of the dry season their weight was around 5% lower than that during

the rainy season. During this 'hungry' season there is a lack of milk, so that the pastoralists are dependant on millet and sorghum, which is insufficient to meet their energy demands. However, the decrease in weight is probably not solely due to a decrease in energy intake but also to an increase in energy expenditure - for example, the distance to walk for water increased from 500 metres in the rainy season to 10 - 20 kilometres in the dry season and the pastoralists were also involved in digging and maintaining wells at this time of year.

Therefore, this change in weight is not only due to a decrease in energy intake but also to an increase in energy output, either for water collection or preparing the ground for the next crop. In the Huffman study in Bangladesh she notes that when the women increased their weight from November to January, their energy expenditure probably increased also. The large harvest at this time of year therefore was not only sufficient to allow for this increase in energy output but was more than adequate and resulted in a weight gain. In the summer months however the second harvest is much smaller and is obviously not sufficient to meet the womens' energy needs, hence the weight loss.

However, whether the energy deficit is a result of low energy intake or high energy expenditure does not matter, it is whether there is a real overall deficit from either with the corresponding weight loss which is of importance.

SEASONAL CHANGES IN ENERGY EXPENDITURE

Bleiberg et al (1980) carried out a study in Upper Volta where they measured the duration of activities and energy expenditure of fifteen female farmers in the dry season when there is no agricultural activity and in the rainy season when heavy physical work is performed. These women had an average BMI of 20.5 and a percentage body fat comparable to European females; but the tricep skinfold thickness was 60% below standard values. They found that the type of activities and the period of time spent on each activity changed significantly with the season. The mean energy output rose from 2320 Kcal per day in the dry season to 2890 Kcal per day in the rainy season. In the dry season the women were involved in around three hours per day of handicraft activities which was 'replaced' in the rainy season by around four hours per day of agricultural activities. There was no significant difference found in resting activities and housework between the two seasons.

In a follow-up study in 1981 Bleiberg et al measured the food intake as well as the energy expenditure of eleven male and fourteen female farmers, again in Upper Volta, six days after the harvest. In the male group, the mean energy intake of 2148 Kcal per day was in good agreement

with their average output of 2130 Kcal per day. However, the female group had an average intake of only 1515 Kcal per day which was significantly lower than their measured daily expenditure of 1930 Kcal and very much lower than seen in their previous study where daily intakes of 2900 Kcal were recorded. Since this deficit was only seen in women farmers it emphasises the important role women play in the developing countries, not only in household activities but in the production of food stuffs which involves hard physical labour. In fact, women in Central Africa work, on average, eight hours per day (domestic and agricultural work) whereas men work only five and a half hours per day (Berio, 1981).

Bleiberg et al conclude that there was a significant negative mean energy deficit ($P < 0.005$) for these women since the difference between intake and expenditure exceeded 400 Kcal. These measurements were only made in the dry season, 6 days after the harvest, so in the rainy season when the energy expenditure of the female farmers is greater, there is likely to be an even larger deficit between energy intake and expenditure. So although Bleiberg and her colleagues did not find a significant variation in food intake throughout the seasons, there is obviously an increase in energy requirements during the rainy season and hence for some part of the year the

women farmers of Upper Volta are in negative energy balance. Bleiberg comments that despite the relative availability of food after the harvest the intake of the female farmers was much lower than expected. Several investigators have also reported low energy intakes among female African farmers (Ghana Food and Nutrition Board 1961, Thomson et al 1966) and weight loss during the rainy season (Thomson et al 1966, Hunter 1967, Whithead et al 1978).

However, it is also necessary to bear in mind the fact that the record of food intake may not be strictly representative of their normal intake and the women may, for some social or cultural reason want to minimise the amount of food they are seen to eat, and alter their food intakes at the time of measurement. The reverse can be said of the measurements of energy expenditure - the women may work harder when the measurements are being carried out. The deficit, therefore, between energy intake and energy expenditure may be exaggerated, but it is clear that for a large part of the year these women have to rely on their own energy stores, as the loss of weight seen by many investigators suggests.

ADAPTATION TO SEASONAL REDUCTIONS IN FOOD INTAKE

A. Changes in body weight and size

A reduction in body weight is the most obvious manifestation of inadequate food intake and, according to James and Shetty (1982), it is the most important form of adaptation, as it represents the utilization of the body constituents as a source of energy. The daily rate of weight loss decreases with time, the weight loss tending to be proportional to body weight at the time. When calorie deficiency is increased by combining low intakes with physical work, the decrease in body weight can be very marked in short periods of time. Of course, with the decrease in weight there is a concomitant fall in the energy cost of any physical activity, which adds to the conservation of energy at times when energy intake is reduced.

However, body weight varies, obviously, with height but even at a given height there is a range of weights consistent with health, therefore body weight may not always be fixed or constant and a moderate decrease in body weight as a result of a lower food intake should be treated as an acceptable adaptation.

The FAO/WHO/UNU report (1985) proposes an acceptable range for the body mass index (BMI):

$$\text{BMI} = \frac{\text{weight (kg)}}{\text{height (m)}^2}$$

which takes height into account and is between 19 and 25. Above this there is an increased risk of morbidity and mortality due to obesity; however this has been the subject of some controversy. A lower limit to this range however is more difficult to define. In many third world countries the average BMI is 18 - 19 (Eveleth et al 1976). Therefore the usual range of +/- 2 standard deviations would result in a range of 15 - 23. However, is a BMI of 15 compatible with an acceptable functional capacity? Shetty (1984) found that it was.

He studied a group of poor Indian labourers with a mean BMI of 15 - 16 and found they were able to carry out manual work in their normal 8 hour shifts each day and they performed well in standard fitness tests. These workers have obviously achieved some sort of adaptation to their years of low food intake. The same could not be

said of Key's subjects in 1950, who had similar BMI values after only 24 weeks of a reduced energy intake, but were unable to perform manual work.

In children a reduced energy intake results in stunted growth. There is controversy as to whether this is a disadvantage to the subject or whether they are "small but healthy" (Seckler 1984) as Waterlow considers in a review on metabolic adaptations (1986). The fact that they are smaller, reduces their energy requirements and the more likely they are to survive. This can only be considered acceptable if their level of functional capacity is at an acceptable level and they are not disadvantaged in any other way. However, the FAO/WHO/UNU consultations(1985), when estimating the energy and protein requirements for children, feel that the growth potential of the children should be fully expressed, and hence the requirements allow for this, and as Gopalan (1978) states "cultural adaptation to under-nutrition by poor communities is not normal nor acceptable".

B. Changes in Basal Metabolic Rate

To prevent huge weight losses occurring during prolonged energy deficits some sort of adaptation has to take place, whether metabolic or behavioural. There has been little work carried out on the seasonal variations in metabolic rates but the drop in basal metabolic rate with experimental restricted intakes or in long term under-nutrition has been well documented (Keys et al, 1950; Edmondson, 1980; Shetty, 1984).

The fall in basal metabolic rate with restricted energy intake can largely be explained by the fall in body mass alone and possibly there is an extra metabolic adaptation (ie whether there is an enhanced metabolic efficiency of the active tissue mass) over and above this.

However in the Minnesota experiment (Keys et al, 1950) the gross BMR fell by 38.9% after twenty four weeks semi-starvation, whereas the BMR per Kg fell 19.8%. When the caloric production was related to the active tissue mass from measurements of body density and extracellular space, the mean decrease was 15.5%.

Therefore in this case, the decrease in BMR cannot be explained by the loss of active tissue alone, and indicates the metabolic rate of the active tissue remaining in the body decreased. Grande et al (1958)

claim that the decrease in metabolic rate of the liver can explain most of the decrease in basal metabolic rate observed in semi-starvation; and that the drop in BMR is probably due to a fall in the metabolic rate of the tissues in the body with a high metabolic rate, rather than a general decrease of the metabolic rate of all the cells of the body.

A reduction of BMR is obviously a very important adaptation when it is considered that it probably accounts for more than half the total energy expenditure for people in most occupations. The pattern of fall of BMR is also interesting. James (1981) studied the effect of reduced intake on BMR and saw, in general, that there is a rapid initial fall in BMR in response to an artificial but severe drop in food intake, then a slower decrease which reflected the slow decrease in body weight. This slow decrease is more important in relation to long term adaptation.

C. Basal Metabolic Rate of Indians

It has been suggested that populations living in the developing countries have a genetically lower basal metabolic rate than western populations. There have been several studies on Indian populations by Mason (1934, 1964, 1972). He carried out multiple regressions of BMR against age, weight, height, creatin~~e~~ and muscle mass of both Indian females living in Madras and European females living in Madras. He found the regression lines of these two populations to be parallel and therefore "the racial differences in BMR cannot be explained by differences in age, weight, height, muscle mass or creatin^e". He concludes therefore that there is a definite racial factor in determining a person's BMR, and that the western BMR standards are too high - by about five per cent - for Indian populations.

In 1964 Mason carried out a study measuring the basal metabolic rates of young Indian females, aged between 15 and 24 years from the 'middle' class in Bombay. Their skinfolds were slightly higher than those reported for Canadian females, considerably lower than American females of the same age, but similar to young Philipino girls. He concludes the arm musculature of the Indian females was low compared with western females and

therefore the Indian subject's thinness for their height is related to muscle as well as fat. He found that the BMR for the Indian woman was lower than all western standards for the same height and also different from western women living in Bombay. He therefore emphasises that the prediction of the normal BMR for Indian women should not be made on the basis of a flat percentage reduction of western standards, but on standards based on Indian data.

Mason, in 1934 suggested that the low basal metabolic rate of Indian subjects was due to a greater degree of relaxation during the measurement, compared to the western population. Therefore, he postulated that the fall in metabolic rate during sleep would be less pronounced than in European subjects. However, this was not the case - he found that during sleep the metabolic rate of Indian subjects dropped by about 10% which was similar to that of Europeans.

Another source of adaptation which has been suggested is that there is a greater drop in metabolic rate during sleep in subjects on a reduced energy intake. So perhaps in the 'hungry' season the metabolic rates during sleep are lower than during the 'plenty' season. However, as yet no work has been done in developing countries on the seasonal variation in metabolic rate during sleep.

In a study in 1981, Schofield et al measured the BMR's of normal - not undernourished - Indian medical students and also found that for the same body weight, the Indians have a lower BMR than Europeans.

Later in 1985 Schofield et al reviewed around 30 references on basal metabolic rate, more than half of which came from India. They concluded from the assessment of these studies that the BMR of Indians is in fact significantly lower, by about 9% than Europeans, or at least lower than the expected BMR using equations based on their weight and height.

This could be the result of many factors for example - climate, diet or ethnic differences, but there is still no clear answer. However, studies on Europeans living in the tropics suggest that climate only has a very small effect on BMR and consequently there has been no "Climatic factor" (FAO/WHO, 1974) included in estimations of energy requirements.

In 1984 Shetty studied the adaptive changes in resting metabolic rate and lean body mass with chronic under-nutrition. He compared fourteen chronically under-nourished Indian labourers with fourteen healthy controls and measured various anthropometric parameters

and skinfolds to obtain the Body Mass Index, percentage fat, lean body mass and body surface area. Their BMRs were measured in both groups 12 - 14 hours after their last meal. The controls were found to be taller, heavier, had a larger body surface area, a higher BMI and skinfolds value. The daily intake for the controls was 2250 Kcal and 1520 Kcal for the Indian labourers. The very low value for the Indian labourers is similar to those reported in other studies in New Guinea, Ethiopia, Upper Volta etc where apparently healthy individuals can survive on very low energy intakes. These fourteen labourers were also found to have a significantly lower resting metabolic rate than the controls. In absolute terms the resting metabolic rate was 26% lower for the labourers, ie 1566 Kcal per day for the controls and 1160 Kcal per day for the labourers. Even when corrected for body weight there is still a significant difference between the controls and the labourers - 26.4 Kcal per kg per day and 25.0 Kcal per kg per day respectively ($P < 0.01$). It was also significantly lower in terms of unit body surface area and Shetty calculated it to be 17% lower than the expected value for Caucasians at the same body weight. An interesting point is that these chronically undernourished labourers had a good general fitness when performing a step test.

However, James and Shetty (1982) compared the BMR of Kaul women (data from Morgan et al, 1982) with that of women from Cambridge, and when corrected for weight (Kcal/kg/day) they compared well. This suggests that no metabolic adaptation - other than that can be explained by low body weight - was present in the Kaul women.

However, if it is the case that Indians have a lower BMR, then in times of food shortage these populations would have an advantage in survival and this could be one of the adaptations that has developed over the generations in India.

D. Reduced Metabolic Response to Food and Activity

Other areas where adaptation may occur, that have been suggested, are the metabolic response to activity and the thermic response to food, which are reduced during periods of low energy intake. Passmore and Durnin (1955) for example, saw that the dietary induced thermogenesis (D.I.T.) changes depended on the nutritional state of the subject, ie if the subject is satiated, the dietary induced thermogenesis is higher than if the subject is hungry. James et al (1981) saw that the D.I.T. is higher in people tending to be lean than in people tending to be obese. Also diet restriction is said to result in a reduction of D.I.T. (Apfelbaum et al, 1969). Children with a low BMR due to severe malnutrition were found to exhibit no D.I.T., but it re-appeared when appetite was restored and the children began to increase their weight (Montgomery, 1962; Brook et al, 1974).

It was also noted that in India and many other third world countries only two meals a day are eaten with very few snacks, therefore the period over which D.I.T. can operate is reduced in these countries compared with developed countries where it is common to eat three meals a day, plus snacks.

However, although there are those who are in favour of this thermogenesis idea for the maintenance of energy balance (Miller, 1975; Miller and Wise, 1975; Stock, 1980) there are those who found no evidence to support this idea (Garby et al, 1977, Dallosso and James, 1982).

For example, Ashworth in 1968 found that Jamaican protein - calorie malnourished children had as great an increment in heat production after a standard meal as when they were subsequently studied when fully recovered, with the same meal. Therefore Ashworth concludes that prolonged malnutrition does not seem to alter the thermic response to food.

It has also been suggested that lean people increase their heat production more than obese people in response to cold, and that malnourished subjects have a lower core temperature. So perhaps the activity of the thyroid has a role to play in the maintenance of energy balance, but it would be a subtle role, and only relevant in the long term maintenance of energy balance.

Similarly a reduction in D.I.T. may only save around 100 Kcal per day (Waterlow, 1986) (if the D.I.T. is about 10% of the total energy value of the meal, and there is a 50%

reduction), but over a period of around three months even this would add up to a significant saving of around 8,000 Kcal.

Another suggested saving is a decreased response to activity in both the amount of energy expended when performing certain tasks, and the actual amount of activity undertaken by the subject. However as yet there is very little data on this subject, so little can be said about the adaptive mechanisms in response to exercise.

E. Behavioural Adaptation

i. A Reduction in Voluntary Activity

One marked adaptation which is noted by many authors is the behavioural adaptation. There has been seen to be a decrease in spontaneous physical activity with a reduction in food intake. Keys described his subjects in the Minnesota experiment in 1950 as "listless". Apathy is also a common characteristic of an individual on an inadequate energy intake, with the subjects tending to be dull and unresponsive.

Keys recorded that their energy expenditure fell from 1613 Kcal per day to 488 Kcal per day (over and above the basal metabolic rate). Part of this reduction in energy expenditure may be due to the decreased metabolic cost of activity with the decrease in weight, but the majority of the reduction would be more likely to be due to a decrease in spontaneous movement.

In fact overall these men saved 1922 Kcal per day at the end of their twenty four weeks semi-starvation. One third of the energy was due to a decrease in the cost of activity by decreasing the amount of spontaneous activity, as well as the actual cost of activity due to

the drop in body weight. Keys states that the decrease in voluntary activity is quantitatively more important than the reduction in cost of a particular activity, due to weight reduction.

Much earlier Benedict et al (1919), observed that free-living male college students when restricted to a diet of 1600 Kcal - 1800 Kcal per day spent more time sitting and less time standing than a group of well fed control students.

The theory that agricultural activities and activities compulsory for survival (occupational activities) are not curbed and take priority over the social, non-compulsory activities (discretionary activities) during periods of reduced energy intake is supported by a study of Guatemalan agricultural workers (Viteri and Tourin, 1975) who were given food supplements for a period of three years. However, no increase in their weight or agricultural productivity was seen, but what was observed was that the workers spent less time resting and sleeping after work than a control group of unsupplemented workers. There was also an improvement in their sense of well being. The supplemented workers even worked at home, played football and walked round town after

finishing work. When they were assigned a work task they performed it at a higher rate than the control unsupplemented group.

In a similar study in Mexico, food supplements were given to undernourished children. However, no increase in weight was observed but there was a significant increase in the playing activities and exploratory behaviour of the supplemented children compared to a control group of unsupplemented children (Chavex et al, 1979).

Conversely, children in Guatemala were found to decrease their energy expenditure without changing their growth rate when their dietary energy was reduced by 10% (Viteri et al, 1981), illustrating the 'sparing effect' of reduced activity, sparing the energy for more important maintenance of growth.

Also, in a study by Venkateharam et al (1960) in India, supplementation failed to produce changes in maternal body composition of pregnant women on very low food intakes. However, the nutritional supplementation may have benefitted the women in ways not measured. Since this is an agricultural population where women's labour is important, any increase in energy intake may have enabled pregnant and lactating women to maintain their

normal output. Gambian women who showed no improvement in lactational performance with nutritional supplements stated they had more energy for farming (Prentice, 1984).

A drop in social activities was also noted by Brun (1984) in Sahaese female farmers during the wet season when they had to perform heavy physical work at a time of reduced energy intake. At this time of year they still managed to spend on average seven hours a day in the field (or travelling to and from it), at the expense of spending on average only 15 minutes in the market and ten minutes involved in social and non-productive activities.

Therefore, in adults, where agricultural work still has to be performed, there may not be the same scope to vary their physical activity as seen in the Mexican children. They may, however, conserve energy by restricting their movements only to those necessary in performing their work activities and avoiding any 'wasteful' movements. This would probably be very difficult to measure and as yet little work has been carried out investigating the seasonal variation in work efficiency or even the variation in the quality of life outside working hours. But the latter idea is outside the scope of the physiologist and would be more suited for a social anthropologist.

So these discretionary activities can be curbed as an adaptation to low food intake, without any harm to the subjects physical well being, but they should not be considered dispensible since these activities (such as attending social gatherings, religious meetings, taking part in festivals and games etc) contributes to the intellectual well being of the individual or group. The FAO/WHO/UNU consultation (1985) are aware of this fact, and in their energy allowance recommendations, they take these discretionary activities into consideration.

ii. Unconscious Economy of Activity

In many tropical countries there have often been recordings of the smoothness and economy of effort with which the people seem to move, and they seem to avoid any unnecessary movements when performing a task. In a study on pregnant women in the Gambia, Lawrence et al (1984) noted that the women seemed to carry out their activities without any superfluous movements. This was also commented on by Edmundson (1980) of the Javanese farmers.

The speed at which people work may also be of importance in conserving energy - it may be more economical to work at one particular speed - and is therefore another possible area for adaptation.

Viteri et al (1971) and Viteri and Tourin (1975) looked at two groups of Guatemalan agricultural workers. One group had protein and calorie supplements, the other had no supplements. They observed that the unsupplemented workers took longer to return from work, worked at a slower pace with more rest periods and took siestas after work (two to three hours). Lusk in 1917 saw that three subjects on low calorie intake (1628 Kcal per day) completed walks at very slow pace and developed excessive fatigue and exhaustion after these walks which ordinarily would have been easily undertaken.

WORK CAPACITY OF UNDERNOURISHED POPULATIONS

Many studies on the maximum aerobic power (VO_2 max.) of adults and children in developing countries, have often found that the poorer, undernourished people have a lower absolute VO_2 max. than the wealthier and better fed groups. However, their VO_2 max. in terms of body weight may be similar, as Spurr et al (1983) saw in marginally nourished school-aged Columbian boys. He also reports that there was no difference in gross efficiency (ie efficiency per Kg body weight) of walking on a treadmill between marginally malnourished and normal Colombian boys (1984).

The study involving three groups of men with varying degrees of malnutrition, from mild to severe, Spurr et al (1984) saw that maximum aerobic power was progressively less as the degree of malnutrition increased. Using multiple regressions it was seen that the height/weight ratio, log sum of triceps and subscapular skinfolds, total body haemoglobin and daily creative excretion (all indicators of nutritional status) all contributed significantly to the variation in VO_2 max., 80% of the difference in VO_2 max. between mild and severe subjects was due to a reduction in muscle cell mass, the remaining

difference, Spurr suggests, may be due to a decreased capacity for oxygen transport either due to low Hb levels or decreased cardiac output.

The VO_2 max. is of great importance in populations who are dependant on manual labour for their income. In populations with a low VO_2 max. a given work load relative to their VO_2 max. is higher and therefore presents a greater stress to the subject, and hence, not surprisingly, a decreased VO_2 max. correlates with a decreased work productivity.

Parizkova (1983) concludes that in standardized activities there is no increase in efficiency in subjects with low food intakes, when related to Kg bodyweight.

Studies on productivity, as in agriculture, in the third world countries have been almost exclusively concerned with the male population, despite the fact that in some cultures it is the women who are the primary food gatherers and producers. Apart from the restrictions on energy intake there is the added energy drain of child bearing and rearing which also influences the work ability of women.

THE IMPORTANCE OF WOMEN IN THE INDIAN VILLAGE

Apart from the obvious importance of women in the family situation ie having and bringing up the children, the housework and home care and the preparation of food for her family, she is also very important as a work force on the farms and in agricultural development. Women work in the fields, they feed and milk the buffalos and tend to the poultry: therefore they are at least as important as men on Indian farms. Yet it is the men who are taught the improved techniques and the women are disregarded. It is often thought that there would be a more rapid improvement in food production if it were the women who were taught the new techniques, as it is they who, more often than not, do the work.

The statistics for the distribution of rural workers between cultivators and agricultural labourers over the last few years show that a higher proportion of women workers than men workers are agricultural labourers (Devaki Jain, 1985).

Even on Indian public work sites (National Rural Employment Sites) more women report and register for work

than men. In very low income households the women are desperate for work - if they cannot get agricultural work then they are willing to build roads and dig wells.

Their work on the farm is very important as they perform many jobs that would not be considered by the men.

Although the men will plough the fields and do certain types of irrigation work, it is the women who plant the seeds, weed the land and cut the plants - all time consuming activities.

Women often have three to four different jobs over the year, ranging from field work to construction work (houses or roads), to poultry and livestock keeping, to paid domestic work.

Often these low income rural women have more than one occupation in the course of a day. Several women in this study performed domestic work in another household early in the morning, then worked for a landlord in the fields for the rest of the day.

Often statisticians and economists consider the man's income as the primary income into the household, but when income is considered it is apparent that it is the woman's income that is primary and the man's secondary,

especially in the very poor households. The man's wage does not tend to come into the household since a large part of it is spent on alcohol and non-food items.

It was seen in two studies (Stavrakis et al, 1978;, Myntti, 1978) that it is the woman's earnings that are used to feed the family and, even if their husband's income is increased, it is not necessarily used for additional food but rather for increased consumption of alcohol and stimulants and for the purchase of prestige goods such as transistor radios. Therefore in the low socioeconomic group, the woman's income is usually essential for family survival.

Therefore it can be seen that the role of the women in the rural Indian village is vital, both in agriculture and in the provision of food and for the well being of her family. It is therefore important to study her needs as opposed to the more commonly documented needs of the less hard working male population.

LOCATION OF THE STUDY

Edulabad, Southern India

The whole study was conducted in one village - EDULABAD in Southern India. Edulabad lies about 30 km east of the main city of Hyderabad in the state of Andhra Pradesh. It is a fairly large village, consisting of around 700 households and about 4,000 inhabitants.

The land surrounding the village is used purely for agriculture, and is composed of 700 acres of wet land, which is used for growing rice, the staple food, and 2,000 acres of dry land which is used for growing dry crops such as maize, jowar, rava and groundnut. Also a variety of vegetables are grown such as spinach, ladies finger and bringal. The local diet consisted almost entirely of rice, supplemented by this limited range of vegetables. Often the rice was just flavoured with chilli powder and onions. Poultry, mutton, pork and eggs were consumed very rarely, if at all. Milk was also rarely taken; surprisingly so as many of the villagers owned a buffalo. However the milk was sold for money rather than drunk by the family.

The villagers did not have their own water supply, but depended on communal wells; they had no sanitation nor electricity - usually an open fire fuelled by cow dung cakes or wood collected from the surrounding area was used for cooking purposes.

Agricultural Calendar

As in most of India two main crops of rice are cultivated each year. The planting of the first wet and dry crops start in June and July, with the dry crops being harvested in October and November and the wet crops harvested in November and December. If there is enough water available then during January the second wet crop is planted. If there is no water the groundnut, a dry crop, is usually sown instead. The second wet crop would be harvested in April and May.

Lifestyle of the Rural Working Woman

The busiest time in terms of agricultural work, therefore, is during the harvest season and the planting seasons. The women are involved in all aspects of the cultivation of the crops, from weeding and preparing the land, to planting the paddy plants, to harvesting the grown plants, including threshing and winnowing the paddy. The only area of work which engaged the men was ploughing the fields - usually a hand plough driven by one or two oxen.

During the months of agricultural work the women's day was fully occupied. She would awaken around 5.30 am - 6.00 am each morning and spend a few hours involved in housework, cooking and child care. Around 9 am - 10 am she would walk to her work in the field, which was often several kilometers away, and remain there until 6 pm having her lunch in the fields. When she returned home she would cook the evening meal, attend to her children and carry out general housework. She would sleep around 9.30 pm - 10 pm.

When there was little or no work to be done in the fields, as was the case during the hot summer months, the working rural women would have a similar pattern of

eating and sleeping, housework and child care, but they would spend more time looking after any livestock or poultry. Another activity that occupied a large part of their day was preparing cow dung into small manageable pieces which were dried and then used for fuel for cooking.

Alternatively, some women collected fire wood from the surrounding area. During this time there seemed to be more time for leisure, for the women to sit and chat with neighbours and spend more time with their children. Several of the women in this study during this time were employed by the wealthier families in the village as domestic workers for two - three hours each morning.

PROBLEMS WHICH WERE ENCOUNTERED WHEN CARRYING OUT
RESEARCH IN INDIA

Carrying out research in a developing country involves many more difficulties than a similar project in a developed country. Firstly, due to the involvement of the National Institute of Nutrition in Hyderabad in the project, ie a national institution, it was necessary to obtain government permission before the project could proceed. It was originally thought this would be granted in 1984; it was still not granted by March 1985. However, it was decided that the project should proceed and some small pilot studies and basic anthropometric measurements were initiated in April 1985.

Unfortunately, due to the miles of red tape in the Indian government offices, the official permission was still not granted in October 1985 and the project was stopped and I returned home. Fortunately in February 1986, the official permission was granted and the project finally got underway in April, 1986.

Secondly, for the period I was living in Hyderabad the temperature ranged from 33°C - 44°C, which was, to say the least, unpleasant. The housing was very basic, as are the majority of Indian homes, with no air conditioning, and often in the very hot months of April - June, there

was no running water. Although these unpleasant conditions were not impossible to live with, they did very little for the morale of the investigator!

These things combined with various illnesses that one comes to expect and accept when living in unhygienic surroundings are often not appreciated as real difficulties, and part of the problems of research in the third world, by those carrying out research in developed countries.

Thirdly, the speed at which things are carried out in India is very much slower than in the rest of the world - it seems. The official permission is one example, but the pace of every operation or procedure was very slow, from persuading the subjects in the village to agree to take part in the study, to arranging for a faulty oxygen analyser to be fixed. There were also various small set backs from day to day which would not be encountered in a more developed country. Often the electricity would be cut off, which prevented any measurements of BMR being completed. The means of transport to the village was by no means reliable - neither the van nor the driver.

However, with perseverance, research in developing countries is perfectly possible, but I would recommend to anyone who was thinking of carrying out research in India to arrange it in the "cooler" months - and go armed with a large supply of Diocalm, a few sick bags and an awful lot of patience!

METHODOLOGY

CONTENTS

Page Number

75	Summary of Methodology
78	<u>Anthropometry:</u> Subjects
82	Plate 1
83	Height and Bone Diameters
85	Assessment of Body Composition
92	Weight, Skinfold Thicknesses and Limb Circumferences
97	<u>Food Intake:</u> Subjects
98	Methods of Measuring Food Intake
107	Apparatus and Procedure
108	Plate 2
111	<u>Basal Metabolic Rate:</u> Various Methods of Measurement
113	Conditions for Measurement
115	Subjects
116	Plate 3
117	Principle of the BMR Measurement
117	Apparatus and Procedure
120	Plate 4

Page Number

121	Gas Analysis
122	Calculation of Metabolic Rate
125	Day to Day Variation in BMR
	<u>The Step Test:</u>
126	The Importance of Evaluating Work Capacity
127	Assessment of Physical Performance
127	Tests of Maximal Aerobic Power
135	Subjects and Procedure
138	Plate 5
139	Local Problems Encountered with the Exercise Test
141	<u>Activity Patterns: Procedure</u>

SUMMARY OF METHODOLOGY

Anthropometry

Body weight, five skinfold thicknesses and four limb circumferences were measured on the same group of women (around 80 - 100 working women and 30 middle income women) over two seasons in 1985 and repeated in 1986.

In 1985 two sets of measurements were made, one in the harvest season, one in the lean season, approximately three months apart. In 1986 four sets of measurements were made, approximately at six weekly intervals starting at the beginning of the harvest season until the end of the lean season.

In 1986 a local girl was trained to take the measurements. This may introduce some inter-observer variation into the collection of data. Therefore no significance tests were carried out between the years, only within each year between the two seasons. However, it is still possible to look for similar trends in both 1985 and 1986. The height and bone diameters of the middle income and working women were measured once, at the beginning of the study in 1985.

Energy Intake

Energy intake was measured in 40 working women and 10 middle income women by locally trained observers using the individual weighed inventory method. The average intake over three days was taken to represent the habitual intake for the woman at that particular time.

The energy intake was measured once in the harvest season and once in the lean season (1986). The middle income women's energy intake was measured once, between the harvest and lean season (1986) as it was assumed they would not be affected by the same seasonal variations in food intake. Paired sample t-tests were carried out for the working women and their energy intake was found to be significantly less during the lean season.

Basal Metabolic Rate

Twenty nine of the most co-operative working women were chosen for measurement of their BMR. This was measured over two days in the harvest season and repeated in the lean season (1986) by indirect calorimetry (Douglas Bag Method). The subjects arrived at the 'lab' in the village at approximately 6 am and were supervised throughout the measurement to ensure the women lay still, but didn't fall asleep. The mean of the two days

measurement in the harvest season was compared with the mean of the two days measurement in the lean season using a paired sample t-test. There was found to be a slight drop in BMR in the lean season but it failed to reach significance. No measurements of BMR were made on the middle income women.

Step Test

Seventeen working women agreed to take part in a three level step test in the harvest season and again in the lean season (1986). It was performed just after the measurement of their BMR early in the morning in the 'lab' at their village. Their expired air was collected in a Douglas bag and analysed for its oxygen content. To obtain a predicted $\dot{V}O_{2\max}$ it was necessary to assume a value for the Respiratory quotient (RQ), because unfortunately a carbon dioxide analyser was not available. Therefore an $RQ = 1.00$ was assumed, and their maximum aerobic capacity was calculated in the harvest and lean season. A paired sample t-test was carried out and although there was a slight decrease in $\dot{V}O_{2\max}$ in the lean season it was not significant.

SUBJECTS

Two groups of women were chosen for this study.

1. Working Women: these women were selected from the lower social groups in the village, many of them being from the "Harigen" or "untouchable" caste. They lived on the outskirts of the village in mud, thatched huts, or in brick and corrugated iron houses built by the Government of Andhra Pradesh for these very poor people.

They owned very little or no land of their own (less than 0.5 acre) and therefore were dependent on the income from their agricultural labour in the fields surrounding the village. These fields were owned by the wealthier people in the village.

The subjects had to satisfy certain criteria for their selection into this study:

- i. Age: subjects had to be between 20 - 45 years, ie ages during which the maximum work load

is supposed to exist, in connection with domestic duties, wage earning occupations and reproductive function.

- ii. Family Status: they were either married or widowed with children.

- iii. Reproductive Status: Subjects were initially chosen only if they were not pregnant and not lactating. However, since in India it is common for a woman to breast feed her children for up to three years, then women in late lactation (ie more than 10 months) were also included.

It is becoming popular in southern India for women to be sterilised after they have borne three or four children and a large proportion of the subjects chosen had in fact had the operation.

- iv. Socio-economic and 'Occupational' Status:

All subjects were involved in agricultural tasks, mainly as seasonal labourers. Only a few were involved in other work such as house construction in the village and a few subjects owned a buffalo or goats and

therefore could supplement their income from the sale of buffalo or goat milk. Although these subjects were from the lower social groups in the village they all had their own home and there was no shortage of manual labour which provided them with an income, for at least part of the year.

- v. Health Conditions: All subjects were healthy and not suffering from any obvious disability or disease and therefore were capable of manual field work. A pool of 100 working women were selected for the anthropometric measurement. They were measured a total of six times, over a period of eighteen months - twice in 1985 - once during the harvest season, once during the 'lean' season and four times in 1986 - twice during the harvest season and twice during the lean season.

2. Middle Income Women

A smaller group of thirty women from a higher socio-economic group were chosen for the purposes of comparison with the large group of working women. These women satisfied the same criteria as mentioned for the

working women except condition No. iv. They were not involved in any agricultural or manual work and did not have to work for a living. These women were the wives of land owners (who owned more than 5 acres wet land ie rice fields) and lived in large brick and tile houses in the centre of the village. The only activity they were involved in was child care and light housework in their own homes.

These women were also measured a total of six times, as for the working women above.

PLATE ONETwo Subjects from the Study from the Low Socio-Economic
Group (Working Women)

Subjects: Left - Ventkatamma and her son

Right - Pentamma

Location: Outside Ventkatamma's home in Edulabad village



HEIGHT AND BONE DIAMETERS

Unlike the other anthropometric measurement, height and bone diameter measurements were made only once, at the beginning of the study, as it was assumed that there would be no change in these measurements during the course of the study.

The following measurements were performed:

Height: using a stadiometer the subject stood, shoeless with her heels together and with the frankfurt plane of the head in a horizontal position. The subject breathed in deeply and reached up to a maximum height with her legs stretched but her feet flat on the ground. Readings were taken to the nearest 10 mm. This procedure helps to reduce variability in the measurement of height.

Bone Diameters

1. Biacromial Diameter:

The subject stood with her shoulders relaxed and using the anthropometer rod, the measurer standing behind the subject measured the distance between the outer edges of the acromian processes.

2. Bi-iliac Diameter:

The subject stood with her heels together and the maximum distance across the iliac crests was measured, again using the anthropometer rod.

3. Bicondylar Femur:

The width across the outer most parts of the lower end of the right femur was measured using the Harpenden Vernier sliding calipers, with the subject standing with equal weight on both legs. Usually this measurement is taken with the subject seated and the leg hanging freely. However, in many of the subjects' houses there were no chairs, tables or benches. Therefore in order to standardise the measurements for all the subjects this bone diameter was taken with the subject standing.

4. Ulnar:

Using the Harpenden sliding calipers the breadth of the right wrist was taken across the styloid process.

In each of those four bone diameter measurements pressure was applied to compress the overlying tissue.

ASSESSMENT OF BODY COMPOSITION

The measurement of fat content and body composition of a subject is important both physiologically and medically, as it can influence morbidity and mortality and affect the ability to withstand exposure to cold and starvation and also gives an indication of the size of the person's energy reserves.

Densitometry

It is common practice to assess the subject only in terms of his or her height:weight ratio. However, this simplistic method has its drawbacks as Behnke realised years ago when he saw very strong muscular men being refused entry into the armed forces on account of being "too heavy" for their height. He therefore looked for a new way of assessing body composition. He experimented using Archimedes principle, ie that fat and fat free mass (FFM) have different densities.

Fat (lipid) has a density of 900 Kg/m^3 and FFM has a density of 1100 Kg/m^3 . From Siris equation:

(4.95 - 4.5)

$$\% \text{ age Fat} = \frac{\text{-----}}{D} \times 100\%$$

where D = density of the subject when weighted under water, the fat content of the subject could be determined as a percentage body weight.

However, the assumption that the FFM is a constant 1100 Kg/m may not be the case for all types of people. For example, an individual with a relatively high or low proportion of bone, which has a high density compared with the rest of the fat free mass, may have their fat content over or under estimated respectively by these methods. The same applies, but to a lesser extent, to those with a very high or low proportion of muscle. Also, women have a FFM of lower density than men and, in ageing, there are changes in the composition of the skeleton and hence the density of FFM decreases. There are several other methods available for the determination of body composition.

Total Body Potassium

Since there is no potassium present in fat and the potassium content of FFM is 68 mmol/KG, then by measuring the emission of the naturally occurring isotope of potassium - ^{40}K , which is present in the body at a concentration of 0.012%, the total body potassium can be determined. From this the FFM and percentage body fat can be calculated.

However, the assumption that the potassium content of FFM is 68 mmol/Kg FFM may be a vast over-simplification, since a range of 55 - 70 mmol/Kg FFM is possible. (10% less for females).

This method also involves the use of expensive equipment which may not be suitable to use in the field situation.

Total Body Water

Two radioactive isotopes of water have been used to determine total body water - tritium and Antipyrine but the most common labelled water used is Deuterium - a non-radioactive isotope of water.

Seventy two percent of FFM is water, ie 720 g water per Kilo FFM, and of course there is no water present in the fat stores in the body.

Therefore, using this assumption and measuring total body water both the fat content and FFM of the subject can be calculated. However, it is a laborious procedure and not suitable for most field situations. Total body water also can vary up to 6% and varies from day to day, eg a normal fluctuation in body weight of 2 Kg can occur on a daily basis due to water.

Skinfold Thickness

This is the only direct measurement of fat and its accuracy depends on the assumption that the proportion of subcutaneous fat is constant with respect to the total fat content of the body. The skinfold thickness is measured using calipers at four different sites on the body - biceps, triceps, subscapular and supra-iliac. The sum of these four sites are then converted to a percentage of body fat using tables by Durnin and Womersley (1974). They assessed the fat content of a total of 481 men and women with a wide age range (16 - 72 years) and fat content range (5% - 61%) from total body density measurements and also from skinfold measurements. After taking the logarithm of the skinfold measurements they achieved a linear relationship with body density and could derive a table where the percentage body fat could be read off, corresponding to the value for the total of the four standard skinfolds.

These are the major methods of determining a subject's body composition , as mentioned above. There are many more, but these, when carried out with care are the most accurate. Body densitometry is accepted as the best method but of course in many field situation this method cannot be used since it requires a large water tank and highly controlled conditions. The skinfold thickness technique is therefore adopted for many situations since there is a high correlation between skinfold measurements

and other laboratory techniques. The equations used in converting the total skinfold thickness to percentage body fat is also based on the densitometry equations. It has other advantages for the field situation in that it takes a very short time to complete - 4 to 5 minutes at the maximum; the equipment is portable and economical; the measurements are simple and when carried out by a trained measurer they are reproducible.

Therefore, for the purpose of this study, body composition was determined by measurement of four skinfold thicknesses.

WEIGHT, SKINFOLD THICKNESSES AND LIMB CIRCUMFERENCES

Weight, skinfold thicknesses and limb circumferences were measured six times in total in both groups of women to demonstrate any changes in body composition which might have occurred over the two seasons.

Weight

Weight was measured using a beam balance which was calibrated every morning using a standard weight. The subjects were weighed early in the morning, usually between 6 am and 9 am after an overnight fast and before their morning meal. Their weight was recorded to the nearest 0.1 kg.

Due to social constraints the women were weighed wearing their saris. However, most of these women only had one or two saris of very similar style and material, therefore the extra weight of the sari (about 500 g) would be constant throughout the project.

Skinfold Thickness

Harpenden calipers were used throughout the study. They were calibrated using stainless steel blocks of standard lengths and the pressure of the caliper jaws were adjusted to give a constant pressure of 10 grams per square millimeter over its entire operating range.

The skinfold thicknesses were measured on the right side of the body. The thumb and forefinger of the left hand of the measurer picked up a fold of skin and subcutaneous tissue and held it away from the underlying muscle. The calipers were applied to the fold a little below the point where the skinfold was being held and the caliper jaws were allowed to exert their full pressure on the skinfold. A reading to the nearest 0.2 mm was recorded. It was important not to leave the caliper jaws closed on the skinfold for more than 2 - 3 seconds as this resulted in a squeezing of the subcutaneous tissue and a lower value being recorded. At each site of measurement this procedure was carried out in triplicate, with the average value being finally recorded. In total five skinfolds thickness were measured.

1. Biceps: - the skinfold was picked up on the front of the arm directly above the centre of the cubital fossa. The calipers were applied to the skinfold at the level of the midpoint (or the "belly") of the biceps muscle.

2. Triceps: - the skinfold was taken at the back of the arm halfway between the inferior border of the acromian process and the tip of the olecranon process directly in line with the point of the elbow and the acromian process.

3. Subscapular: - the skinfold was picked up just below the tip of the right scapula at an angle of 45 degrees downwards from the spine.

4. Supra-iliac: - the vertical skinfold was picked up immediately above the anterior superior iliac spine in the mid axillary line.

5. Thigh: - the subject stood with her weight on the leg not being measured ie the left leg. The skinfold was picked up at the front of the thigh half way between the mid inguinal point and the upper border of the patella.

Limb Circumferences

A total of four limb circumferences were measured, at the same time as the skinfold and weight measurements and repeated six times over the eighteen month period. A Holtain plastic measuring tape was used for these measurements. The subjects were told to stand with their feet fairly close together in a relaxed manner, to prevent the subject from contracting their muscles.

1. Upper Arm Circumference: - this was measured horizontally at the same level as the triceps skinfold thickness.
2. Buttocks: - the maximum circumference over the buttocks was measured with the subject standing with her feet together.
3. Thigh: - the subject stood with her legs slightly apart, with equal weight on both legs. The circumference was measured around the right thigh at the level of the gluteal fold.

4. Calf: - the maximum circumference was recorded with the subject standing with equal weight on both legs. Usually this circumference is taken with the subject seated, but, for reasons stated above, all subjects stood for the calf circumference measurement.

FOOD INTAKE

SUBJECTS

From the large pool of women selected for the anthropometric measurements forty of the most co-operative working women and ten of the most co-operative middle income women were selected for measurement of their food intake.

Since this involved an intensive three day study during the harvest season and repeated during the lean season, several steel vessels were presented to each woman, as an incentive at the beginning and at the end of the study.

Methods of Measuring Food Intake

There are several different methods used in the measurement of food intake each with varying degrees of accuracy. The usefulness of each method and validity achieved have to be assessed against the objectives of the study. However, whatever method used it is important to remember as Widdowson in 1947 stated, "The aim of all dietary surveys, whether made on individuals or on groups is to discover what the persons under investigation are in the habit of eating. Their diets must be those to which they are accustomed and which they freely choose."

Methods for measuring food intake range from the detailed weighing of present food intake to questions recalling dietary intakes covering several years. The most exact method for measuring the present intake of an individual is the precise weighing technique. Here, all ingredients used in the preparation of the dishes are weighed as well as the indelible wastage, then the cooked weight of the individual's portion and table waste is also recorded. The analysis of the diet can be chemically determined from aliquot samples or may be calculated using tables of food composition for the raw weights of the food.

Although this is the most accurate method, it does demand a high degree of co-operation from the individual and is not suitable when the subject eats away from home.

Since the complexity of the collection and analysis has restricted the use of this method to only the most co-operative volunteers, it can be modified slightly by not collecting aliquot samples for chemical analysis but instead using values for raw foods from food composition tables, and also having the subject record the weights herself. Also the extent to which the presence of the investigator in the subject's home alters the normal food intake of the subject is difficult, if not impossible, to determine. However, if it is assumed the subject is eating her normal food then in terms of validity and reliability of the measurement, this is the best method possible. A modified version of the precise weighing technique is the weighed inventory method. Here, the food is prepared and cooked and only weighed immediately before consumption and any plate waste is weighed at the end of the meal. The analysis is calculated, using food composition tables in which cooked foods and made up dishes are included.

If the subject is literate then the weighing can be carried out by the subject herself using balances provided. Here less supervision is required and therefore less interference by the investigator but a little of the accuracy is lost when using these standard cooked values from food composition tables.

To quote Marr (1971) "A balance should be sought between a great deal of supervision received for the weighed inventory method with consequent interference with the home routine and very little (perhaps inadequate) supervision in an attempt not to upset the usual pattern in the home."

A less demanding method is to record the present intake in terms of household measures. These descriptive terms can then be converted to weights and from this the nutrient and caloric intake can be calculated from food tables. Although there is a loss of precision, a higher degree of co-operation may be achieved when using this less time consuming method.

If the study involves just classifying the types of food eaten by an individual or a group of individuals then their intake can be recorded as a menu, where no weights or measures are used.

Another method of food intake measurement is recording the foods actually eaten by the subject in the past as remembered at an interview or on a self completion questionnaire. It can be recorded as a menu or in household measures. Usually a twenty four hour recall period is used, although periods of up to one week have been used. However, Hueneman et al (1961) found that in some cases four days constituted the maximum period for which specific meals could be recalled. Recall methods can be used to investigate specific areas of a diet - for example, the intake of vitamin D, therefore only foods containing vitamin D would be investigated. Supervision has to be high, involving a detailed inquiry by a trained interviewer.

In 1967 Taskar et al carried out a statistical study to compare the efficiencies of a random day and a three day weighment of food intake measurement and compared the results to the more conventional seven day study. The study was carried out at the National Institute of Nutrition, Hyderabad, India and the subjects were from the low socio-economic classes, who subsisted on monotonous diets with little day to day variation.

After studying a total of 566 families, they concluded that the results from the random day and the average of seven day food intake agreed very well, with no significant difference between them, and a correlation co-efficient of 0.96 for calories.

However, after applying Tippets Table (which takes into account the ranges and the population standard deviation for different sample sizes) they conclude that the most appropriate duration to conduct the diet survey was a period of three days, and no gain was observed by extending the survey for more than three days.

This may only apply to the poorer populations, from low socio-economic classes where there is very limited day to day variation in the food consumption pattern.

Flores (1962) also found in her dietary studies on "Non Modernized Societies" that three and four day averages agreed well with those of the seven day method. The three day weighment method is advantageous both to the subject and to the observer in that it saves time, energy, cost and perhaps enables a wider coverage of the population.

A common technique for estimating usual dietary intake is the History method or Burke method (Burke, 1947). It is in three parts:

1. An investigation by interview of the normal overall pattern of eating and what was actually eaten on the day in question, with quantities recorded in household measures.
2. A cross check with questions on likes and dislikes, purchasing of food items etc.
3. A menu recorded by the subject for three days. This again requires a trained nutritionist and for the subject herself to be aware of her dietary patterns and usual eating habits.

Each method has its own aims and objectives and any comparison therefore must take into account the purpose for which the methods were designed and the validity of each method must depend on how far it measures what was intended.

Another important factor in measuring food intake is the repeatability of the measurement. However, this depends on two things - "one depending on within-subject

variation (true or biological variation) and the other on measurement variability." (Rose and Blackburn, 1968). Repeated measurements can be carried out and, although the results will not be exactly the same, it would be hoped that they would be similar, assuming the individual does not change drastically in the period of time between the two measurements. Although it is possible there may be some variation in some food types in the diet reflecting within-subject variation in choice of food. Calories and proximate principles are more likely to be similar and therefore are an appropriate test for the measurement and variability.

Even in western countries, the season has to be considered when measuring food intake. In 1966 Marr saw that the winter calorie intake for the majority of a group of twenty three male bank staff was higher than the summer calorie intake, due to a higher intake of animal fat during the winter months. However, there are also findings that intakes may be higher in the summer months, corresponding to heavy harvest work of farmers in Italy (Fidanza et al, 1964).

The length of time to record dietary intakes is very important. It is necessary for it to be long enough to yield representative results of the normal intake of the

subject, but not so long as to interfere with the subjects normal lifestyle and perhaps decrease co-operation from the subject.

One day food intakes are not recommended and often one week food intakes are measured. However, both Heady (1961) and Fidanza et al (1967) agree that three days is appropriate and that little information is lost when using the first three days only of a seven day survey, as the averages of the first three days are very similar to the averages of seven days.

Food Intake - Method Used in This Study

Since the objective of this study was to detect the changes in food intake over the seasons within the individual and not just looking at the general level of energy intake, the most precise and accurate method of measuring food intake was required. Therefore, the individual weighed inventory technique was used.

Studies at the National Institute of Nutrition (Hyderabad, India) had shown that due to the repetitiveness and lack of variation in the normal rural diet even a one day food intake measurement was very similar to the mean intakes over a longer period of time. Therefore, it was decided that a three day period would be suitable for the purposes of this study - long enough to achieve an accurate assessment of their habitual intakes, but not too long as to put the subjects off taking part in this study.

Apparatus and Procedure

1. Salter Spring Balances - these battery operated digital read-out balances had a weighing capacity of 1 gram to 1 kilogram, with an accuracy of 1 gram. They were calibrated with standard weights and were checked frequently. These balances were used for weighing all the raw ingredients of the curries eg onions, tomatoes, spices, the raw rice and also the individual's portion of both the cooked rice and cooked curry.
2. Local Large Balance - this balance was used for weighing the total cooked rice. Often the subject would cook more than 1 kg of raw rice for her family, which when cooked weighed 3 - 4 kilos. It was not acceptable to the subject to split the rice up into smaller portions and into various vessels to weigh on the small digital balance, therefore the local large scales were purchased for this purpose.

Standard weights were also bought - 3 kg, 2 kg, 1 kg, 2 x 200 g, 100 g, 50 g, 2 x 20 g, 10 g, 5 g, 2 x 2 g, 1 g.

PLATE TWO

Measurement of Food Intake

Subject: Pushpamma
Observer: Sravanthi
Location: Subject's home, Edulabad



Procedure

For three consecutive days, at every meal and meal preparation, an observer was present in the subject's home.

Since all the subjects were illiterate it was necessary for the observer to record the details of the food prepared and eaten. Therefore the observer recorded the weight of the total raw, prepared food before cooking, the weight of the total food after cooking and the individual portion for the subject. If the subject left any food on her plate at the end of her meal, this was also weighed and subtracted from her individual portion. All these weights were recorded in a booklet provided, which had ample space for any small calculations. Each day the calculations and recordings of the observer were checked and they were asked various questions to cross check the accuracy of their recordings.

The subject usually had three meals per day:

Breakfast around 9 am;

Lunch around 2 pm; and

Dinner around 8 pm.

If the subject was working in the fields, she would prepare her lunch in the morning at the same time as breakfast and carry it with her, in a box, to the field. She was asked to bring back any leftovers to be weighed again in the evening. Occasionally a subject would not have lunch if she was working the the fields, but instead have a large breakfast at 10 am and dinner at 6 pm when she returned. Since the subject lived in this rural village there were no shops to buy snacks, therefore it made the measurement of their food intake very easy, since they only ate at meal times.

Occasionally, however the subject would drink the locally fermented alcohol called Toddy, which is made from the sap from palm trees. They usually drank it on their way home from the fields. They were asked to keep the bottle from which they drank the alcohol and to indicate to the observers how much they drank from it.

The observers were young literate girls. Two were from the village of Edulabad itself and two were from the surrounding area. Therefore the subjects were very relaxed and at ease in the observer's company and conversed easily with the girls.

BASAL METABOLIC RATES

VARIOUS METHODS OF MEASUREMENT

To measure metabolic rate - either basal, resting or during activity there are several methods the investigator could adopt.

1. Direct Calorimetry: - this involves the measurement of heat output from the subject, working on the principle that all types of energy are eventually converted to heat. However, this procedure is very expensive and complex due to the high degree of precision needed to yield accurate results.
2. Indirect Calorimetry (respiratory calorimetry): - instead of heat output being measured, energy expenditure is determined from the amounts of oxygen consumed and carbon dioxide produced by the subject. The circuit may be a) 'open' - the subject breathing air from the outside and the expired air being collected, or b) 'closed' - the subject breathing pure oxygen, expired air being passed through soda lime to remove the carbon dioxide and then being re-used. One closed circuit method is the respiration chamber, in which a subject usually sits for several hours. This is a very accurate method but expensive and difficult

to use. The respiratory quotient (RQ) can be calculated from the oxygen consumed through a meter and carbon dioxide absorbed in the soda lime.

Another method is the Benedict-Roth Spirometer, but the RQ cannot be measured since the CO₂ production is not measured. However, using this method there is no need for analysis of gases since O₂ consumption can be read off directly from the reduction in volume of oxygen in the spirometer.

Open Circuit Methods

These are most commonly used methods in studies on Energy Expenditure, due to the apparatus being light, inexpensive and portable.

The Douglas Bag method is often the method of choice in the laboratory and in the field situation. The entire volume of expired air is collected, a small sample analysed for oxygen and carbon dioxide content and the volume of air expired then measured by a meter.

Another method - the Kofranyi-Michaelis or Max Planck Meter is often used for measuring energy expenditure during activity in the field situation. The volume of air expired is measured continuously by the meter and a

fixed proportion, either 0.3% or 0.6% of the air expired in each breath is collected in a rubber bag for subsequent analysis of O₂ and CO₂ content.

CONDITIONS FOR MEASUREMENT

Although there are several different methods used in the measurement of Basal Metabolic Rate (BMR), certain conditions have to be fulfilled in each case. These conditions are very important for obtaining reproducible accurate results and to allow comparison of data from different laboratories.

The conditions are:

1. The subject must abstain from gross muscular activity; ^{have} had at least eight hours sleep and have a rest period for thirty minutes before the first measurement.
2. Subject must be in the post-absorptive state ie. the measurement can only take place at least twelve hours after their last meal. This includes tea, coffee, alcohol and tobacco.

3. The room or laboratory in which the measurement is taking place must neither be too hot nor too too cold ie thermally neutral.
4. Emotional disturbances must be minimal.
5. The subject must be relaxed but awake, as sleep depresses BMR by about 10%.
6. The subject must be free of fever or infection, as this invalidates the test.

It is also important that the subject is familiar and at ease with the apparatus. If these conditions are met then a measurement of Basal Metabolic Rate can be obtained. If even one condition is not met, eg if the subject had a snack in the morning of the experiment, then the measurement cannot be classified as a BMR.

The method chosen for measuring BMR in this study was the open circuit Douglas bag method. This is by far the least complicated, most inexpensive and portable, yet yields highly accurate and reproducible results as long as the conditions stated above are fulfilled.

Subjects

From the large pool of women selected for the anthropometric measurements, forty of the most co-operative working women were selected for BMR measurement. As for food intake measurements, an incentive was given to encourage the subjects to complete, in total, four measurements of BMR. A sari was given to each subject on completion of the four measurements of BMR.

A house in the village was rented for the duration of the project in which a laboratory was set up. Here the analysis of the gases were carried out. In an adjoining, but screened off room were two beds where the subjects lay during the BMR measurements.

PLATE 3

The "Laboratory", Edulabad Village



PRINCIPLE OF BMR MEASUREMENT

After thirty minutes of lying down resting, the subject's nose is clamped with a nose clip, and she passes all her expired air through a mouthpiece into an airtight bag. Two one-way valves allow her to inspire only the outside air, and to expire only into the bag. The total pulmonary ventilation in a given time is measured by passing the contents of the bag through a gas meter and samples are taken for analysis of oxygen content.

Apparatus and Procedure

Two 100 litre capacity Douglas bags, complete with a three-way tap and light weight tubing connecting the Douglas bag to the Rudolf valve and rubber mouth piece. This three-way valve allows either of two circuits for the subjects expired air ie from the mouth, through the Rudolf valve and light tubing to the three-way valve and either to the outside air or into the Douglas bag.

Prior to the actual measurement, all Douglas bags, valves and tubing had been checked for leaks or any malfunction.

A local village girl was employed to collect the subjects at their houses at 6 am and to bring them to the "lab". She sat with the subjects throughout the measurement, ensuring that the subject did not talk, fall asleep or move about. (The presence of the village girl also helped to convince the subjects to take part in the study).

After thirty minutes of lying down resting in a quiet room, the subject was asked to insert the mouthpiece and attach the noseclips comfortably to ensure she was breathing only through the Rudolf valve. To check this, she was asked to try to breath through her nose alone. Many of the subjects wore noserings which could not be removed which made the fitting of the nose clips quite difficult, so extra care was taken to ensure that the nose clips were in fact obstructing all airflow from the nose.

An empty Douglas bag (100 litre capacity) was attached to the mouthpiece via one meter of light weight tubing. The three-way tap was in a position such that the subject was breathing to the outside air. After a three minute run-in period during which the subject becomes accustomed to breathing through the apparatus the three-way tap is turned and the subject's expired air is collected in the

Douglas bag. Simultaneously the stop watch is started and a sample of expired air is collected for 10 minutes exactly.

The subject is then allowed to take out the mouthpiece and remove the nose clips for a few minutes and the Douglas bag of expired air is taken for analysis.

The whole procedure was repeated again and if the two results agreed to 3% then the average value was taken to represent the subject's BMR. If they did not agree, a third measurement was carried out and on average of all three results was taken to represent her BMR.

PLATE 4

Measurement of Basal Metabolic Rate

Observer: Shantakumari

Subject : Laxmamma

Location: The "Lab", Edulabad Village



GAS ANALYSIS

A sample of expired air was passed through a servomex oxygen analyser (model 570A) and after about half a minute when the reading had stabilised, the percentage O_2 in expired air was noted.

The total volume of expired air was measured using a dry gas meter (Singer American Meter Div. 807 DTM 325) and, taking into account the room temperature and Barometric pressure, a correction factor was applied to obtain the pulmonary minute ventilation at standard temperature, pressure and saturation (STPD).

Calibration of O_2 Analyser

The Servomex O_2 analyser was calibrated every morning. Oxygen free nitrogen was collected in a rubber bladder and passed through the analyser, which was adjusted until a reading of zero was obtained. The analyser was then spanned using atmospheric O_2 of 20.93%. The zero was then checked a second time followed by a second span.

Frequently this procedure was double checked using the Scholander microgas analyser. Samples of expired air were analysed using the Servomex and checked on the Scholander.

Therefore, the mid range oxygen concentrations ie 15% - 19% were also calibrated for. The percentage oxygen determined by the Scholander and Servomex analysers were very similar, if not identical - on average the percentage difference between these two methods was 0.05%.

CALCULATION OF METABOLIC RATE

The estimation of metabolic rate by indirect calorimetry is so awkward that the effect of protein metabolism is commonly ignored and the RQ used is the non-protein RQ, to assign the oxygen consumed a caloric value. However, J B DeV Weir (1949) showed that the effect of protein metabolism can be included with the minimum of trouble and if the protein metabolism lies between 10% and 14% of the total metabolism then the error using his equations is less than 0.2%. (It was calculated that the subject's protein intake in this study was around 10% of their total intake). When using all types of open respiratory apparatus for determining energy expenditure eg Douglas bag, the calorie output is most simply found by multiplying the volume of expired air by the caloric value per litre of expired air.

In Weir's 1949 paper he concludes that the calorie output is five times the apparent oxygen usage, ie

$$\text{Kcal} = \frac{\text{O}_i - \text{O}_e}{20} \times 100$$

Where O_i = atmospheric oxygen (%)

O_e = oxygen expired (%)

Weir states that the calorie values of oxygen based on the assumption that a fixed percentage of the total calories arise from protein metabolism is adequate because it is unnecessary and impractical to make the exact protein correction from the urinary nitrogen.

He therefore suggests a standard correction be made on the assumption that protein produces about 12.5 % of the total calories and the error - if any - is negligible. The total volume of expired air was converted from a saturated gas volume at body temperature and pressure to dry volume at 0 °C and 760 mmHg (STPD) using the nomogram given in Physiological Measurements of Metabolic Functions in Man by Consolazio et al (1963). The corrected volume was then divided by the number of

minutes of the sample and hence the minute volume was obtained. Using this nomogram and Weirs formula the Kcalories per minute could be calculated.

DAY TO DAY VARIATION IN BMR

Since there may be some normal fluctuation in BMR on a day to day basis, it was necessary to carry out repeat measurements on the subjects on more than one day in the same season. Therefore the subjects were asked to return the following day after their first BMR measurement. This was the procedure in both the harvest season and the lean season.

The average of the two day measurements were taken to represent the subject's BMR for that season.

WORK CAPACITY : THE STEP TEST

THE IMPORTANCE OF EVALUATING WORK CAPACITY

In developing countries functional capacity and fitness represents the ability to perform muscular work, which often is essential for the survival of many of third world populations. Therefore, in developing countries proper development of muscular strength is important, along with an efficient cardiovascular, neuromuscular and respiratory system.

If environmental factors, such as reduced energy intake, has a detrimental effect on a subject's work capacity, then work productivity may be affected. However, more important to the individual, is the subjective effect of reduced work capacity. For example, if the individual has to perform specific field work tasks, the same task will be more stressful when the subject's work capacity is lowered.

It is therefore important to be able to assess the work capacity of individuals in developing countries under various environmental conditions to look, not only at the effect of work productivity as a whole, but the well being of the individual.

In this study the effect of the seasonal reduction in food availability on the ability of a group of rural working women to perform a specific work task was investigated.

Assessment of Physical Performance

The most common method used in the assessment of physical performance or work capacity is the measure of the maximal oxygen uptake of the subject (VO_2 max). VO_2 max. or maximal aerobic power, is defined as the highest oxygen uptake an individual can attain during physical work while breathing air at sea level, and is measured in millilitres of oxygen per kg body weight per minute. The higher this value, the 'fitter' the subject, and the higher the subject's work capacity.

Tests of Maximal Aerobic Power

Direct Determination:

There are three methods of producing standard workloads:- running on a treadmill, cycling on a bicycle ergometer and using a steptest.

Several methodological criteria have to be fulfilled if the determination of the real VO_2 max. is to be achieved.

1. The work should involve large muscle groups, for example, the leg muscles.
2. The measurement of the oxygen uptake should be taken after the work has proceeded for a few minutes to allow the oxygen uptake to reach its maximum.
3. Preferably several sub-maximal work tests should be performed.
4. During the period of maximum exercise the heart rate must be at a maximum for the subject (depending on age) and the RQ must be more than 1.00.

There have been studies to investigate whether or not each type of work gives the same maximal oxygen uptake value. It has been found that running up-hill on the treadmill (3 degree inclination) may produce a maximal oxygen uptake; whereas running horizontally results in a lower VO_2 max. Taylor et al (1955), and other studies, have shown that bicycling and arm cranking both produce lower VO_2 max. values than that produced while running

uphill on the treadmill. The steepest produces a VO_2 max. of very similar value to the treadmill, just slightly lower, by 3% (Kasch et al, 1966).

It is important that local fatigue is avoided in the direct determination tests of maximal aerobic power. This is most common in the cycling tests where the feeling of local fatigue or the sensation of pain in the knees or thighs may cause the work effort to be interrupted before the oxygen transporting organs have been fully taxed.

Motivation is another important factor in determining a true measure of maximal aerobic power. Since the test is not a very pleasant one, the subject must be prepared to give his best attempt since a half-hearted attempt will result in a much reduced VO_2 max. value, and will not represent his or her true VO_2 max.

For this reason, a direct measurement of the VO_2 max is not the best method to use in the field situation, where the rural populations are not familiar with the technique, nor can the investigator be sure they are giving their best attempt, since they are not a highly motivated group, as would be a group of athletes for example. An alternative measure of aerobic capacity is the predicted VO_2 max obtained from submaximal tests.

One method of evaluating functional capacity is to measure the heart rate response to standardized work, either on a treadmill, bicycle ergometer or using the step test and from nomograms the maximal oxygen uptake can be predicted.

These submaximal tests usually consist of performing three levels of exercise of varying intensity, and measuring the oxygen uptake and heart rate at each level. These three points are plotted on a graph of heart rate against oxygen uptake, and extrapolated to an age-related predicted maximal heart rate. The corresponding maximal VO_2 is then obtained.

For example:

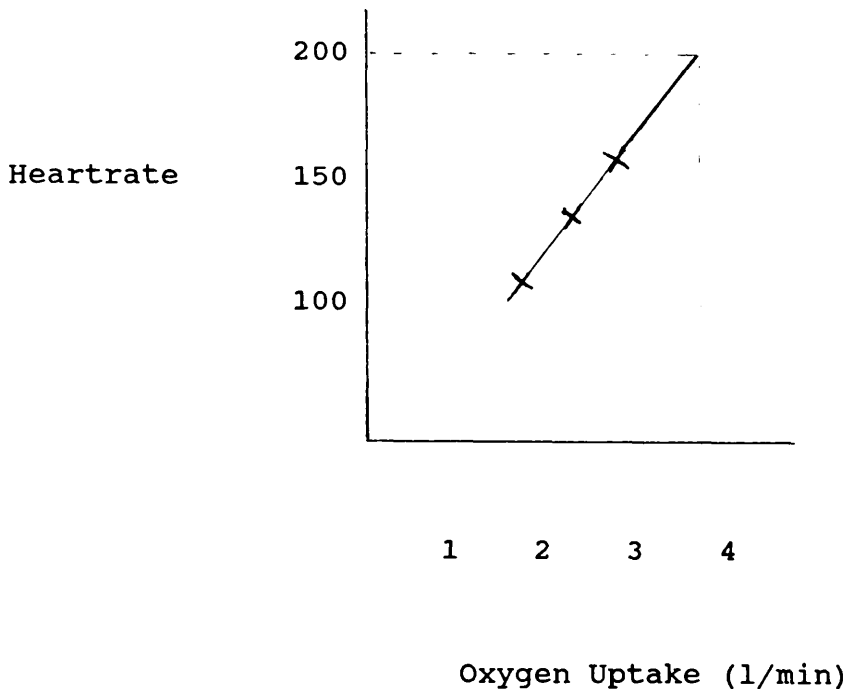

X = real value obtained at three submaximal work loads.

However, there are many assumptions involved, and therefore sources of error in predicting the maximal oxygen uptake from submaximal tests.

These assumptions are as follows:

1. It is assumed that the increase in heart rate with increase in oxygen uptake is linear. This may not be strictly true in some cases where the oxygen increases relatively more than the heart rate when

the work load becomes very heavy. This may be due to a more efficient redistribution of blood at high levels of exercise or a more efficient uptake of oxygen by the working muscles.

Therefore the predicted VO_2 max. would result in an underestimation of the subject's maximal aerobic capacity.

2. The predicted maximal heart rate may not be the real maximal heart rate. If the maximal heart rate is over predicted, an over prediction of maximal oxygen uptake results, and similarly if it is underpredicted an underprediction of maximal oxygen uptake results.
3. The cardiac output is not strictly related to the oxygen uptake but shows individual variations.

However, although the submaximal tests may not yield such an accurate measurement of an individual's VO_2 max., it has certain advantages. It is not an unpleasant test and it takes a relatively short period of time.

For this study in India, it would have been virtually impossible to persuade the rural working women to perform a maximal test due to the amount of time, effort and motivation required on the part of the subject.

A submaximal test is in many ways a more relevant test to perform in the field situation, where the levels of exercise in the test are not dis-similar to the levels of exercise the rural women are involved in each day.

In this study the changes in aerobic capacity over the two seasons was the important factor - not the absolute VO_2 max. value - therefore any of the errors mentioned above that may have occurred, will be present in both measurements in the harvest and lean season and therefore have no bias on either set of data. Comparison of the aerobic capacity of the working women in each season was therefore studied using the three level sub-maximal steptest.

However it was important to validate that the values obtained by the steptest method should be comparable to the more commonly documented treadmill values.

Therefore in 1984 a study was conducted in Glasgow comparing the steptest and treadmill methods in the assessment of work capacity in a group of forty Glasgow women: see Appendix 1.

THE EXERCISE CAPACITY TEST - THE STEP TEST

Subjects and Procedures

The forty working women who had taken part in the BMR measurements were also encouraged to perform a step test. Unfortunately only seventeen women agreed to complete the test.

Shortly after the completion of the BMR measurement and before they had eaten breakfast, which was supplied for them, they took part in a three level submaximal steptest, as described in Appendix 1, ie they performed three blocks of four minute exercise involving a very light exercise task, a moderate exercise task and a moderately strenuous exercise task in succession.

During the last minute of each level of exercise their expired air was collected by the Douglas bag method and analysed for percentage oxygen. The setup for collecting the expired air while the subject was exercising is shown in Plate 5.

The stepping rate was initiated at fifteen steps per minute, for the first level, with a step height of 23 cm. The stepping rate was increased for the second level of

exercise to twenty steps per minute again with the 23 cm step. The final four minutes of exercise involved stepping at a rate of 20 steps per minute with a slightly higher step of 33 cm. (The dimensions of the step can be seen in Figure 1 and is visible in Plate 5.)

These three levels of exercise often elicited heartrates ranging from 100 - 120 beats per minute at the first level, to around 175 beats per minute at the third level. However, these exercise levels were not strictly adhered to and were changed to suit the subject, in order to elicit the required range of heart rates necessary in this submaximal test.

The only variation between the method used in India and the method used in Glasgow, which is described in full in the Appendix, was the use of a Cranlea heart-rate monitor, instead of the three lead electrocardiogram for measuring heart rate. The Cranlea Monitor consisted of an earpiece which contained a light source and a photo electric sensor. As the pulse of blood passed through the subject's earlobe, the light source was cut off. This interruption in the light source was picked up by the sensor and the heart rate was displayed digitally on a small hand piece.

DIMENSIONS FOR THE DOUBLE STEP USED IN THE STEP-TEST

Fig. 1

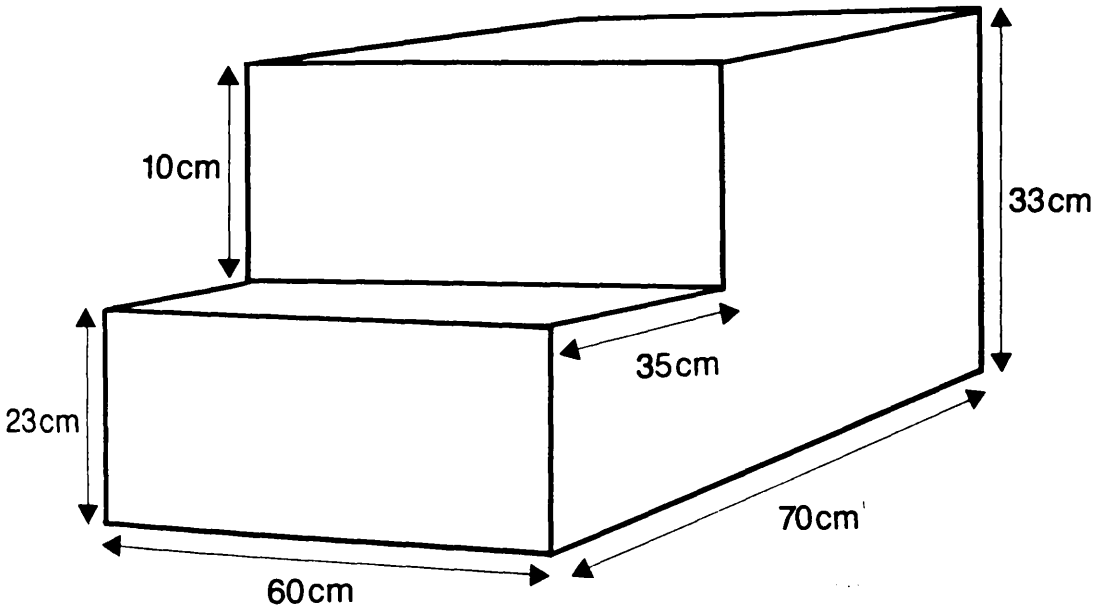

This type of heart rate monitor also had a built-in metronome which would emit a bleep at a pre-determined rate ie either fifteen beats per minute or twenty beats per minute.

Also in India, each subject was given a few minutes extra practice at stepping in time to the metronome and only when they looked relaxed and at ease with the stepping did the test begin.

PLATE FIVE

Measurement of Aerobic Capacity : The Step Test

Observer : Shantakumari

Subject : Laxmamma

Location : The "Lab", Edulabad Village



LOCAL PROBLEMS ENCOUNTERED WITH THE EXERCISE TEST

There were a few local problems in persuading the subjects to perform this three level of exercise steptest.

Many of the subjects were not accustomed to 'stepping' although often there was either one or two steps into their homes. However they had difficulty in stepping in time with the metronome, ie difficulty in maintaining a constant stepping rate.

Unfortunately the steptest was the only available test to use in the village in this study, due to a limited amount of funds to enable a treadmill be used, and a bicycle would not have been socially acceptable to these rural Indian women.

Also, persuading the women to exercise at the third level of exercise was difficult, due to their superstitious impression that they were "losing all their air" and would never get it back and this they thought would result in illness.

However, seventeen very co-operative women from the 'Harigen' section of the village (the poorest women) complied, and completed the step test both in the harvest and lean season of 1986.

ACTIVITY PATTERNS

PROCEDURE USED IN THIS STUDY

To record the activity patterns of the rural women and to detect any changes from harvest season to lean season a minute by minute activity diary was completed for each subject.

A local literate boy from the same village and known by the subject was employed to carry out the recording of the subject's activity.

Since it was not possible for the local boy to follow the subject for twelve hours continuously in one day, the day was split into three, five hour portions, which were randomly allotted over three days for example:

6 am to 11 am	Day Three
11 am to 4 pm	Day One
4 pm to 9 pm	Day Two

Usually most subjects got up around 5.30 am - 6 am and went to bed around 9 pm, sometimes earlier. At maximum, an hour in the morning and an hour after 9 pm may be unaccounted for, but since the actual energy expenditure

is not being calculated, just changes in activity pattern over the two seasons, hopefully this may not have much significance.

The observer was equipped with a digital watch and a recording pad and pen. He wrote down a description of all the subjects activities, the time at which she commenced that particular activity and the time she stopped. He also noted her posture, eg sitting or standing. At all times he observed her from a distance, to minimise the effect of his presence on the subject.

From the observers records, the subject's activities were coded into ten key activities, eg standing activities, walking, sitting, field work etc, thus enabling a comparison of the main activities of the subjects between the harvest season and the lean season.

The observer was randomly assigned the order to follow and the subject was not told in advance when she would be studied. Therefore hopefully over the three days the normal pattern of activity of the subjects could be determined.

RESULTS AND DISCUSSION

CONTENTS

<u>Page Number</u>	<u>Anthropometry</u>
146	Weights, Heights and Bone Diameters of Middle Income and Working Women
148	Table 1
151	Seasonal Changes in Weight and Skinfold Thicknesses of Working Women
151	Weight Changes
152	Table 2
156	Indian Body Weights Compared to Western Standards
158	Skinfold Thicknesses of Working Women
164	Limb Circumferences of Working Women
165	Table 3
166	An Alternative Statistical Test
167	Table 4
170	Seasonal Changes in Weight and Skinfold Thicknesses of Middle Income Women
172	Table 5
173	The Control Group Skinfold Thicknesses and Percentage Fat
175	Circumferences of Middle Income Women
176	Table 6
177	Summary of Anthropometric Measurements

Page NumberFood Intake

181	Details of the Working Women Involved in the Food Intake and Basal Metabolic Rate Measurements
181	Table 7
184	Table 8
185	Seasonal Changes in Energy Intake in Working Women
187	Table 9
189	A Comparison with Middle Income Women
190	Table 10
196	Other Studies in Developing Countries
	<u>Basal Metabolic Rate</u>
204	Energy Requirements and Basal Metabolic Rate
205	Determinants of Energy Requirements
209	Table 11
214	An alternative Statistical Test
215	Table 12
219	A Comparison Study of Basal Metabolic Rates of Indian Women in Glasgow
220	Table 13
229	BMR Factor
230	Table 14

Page Number

234	<u>Exercise Capacity Test: The Steptest</u>
236	Respiratory Quotient and True Oxygen
237	Steptest Subjects
238	Table 15
240	Table 16
244	Table 17
245	Table 18
246	Other Studies of Work Capacity in Developing Countries
251	Summary of Metabolic and Food Intake Study
	<u>Activity Pattern</u>
253	Seasonal Activity Patterns
255	Activity Categories
261	Measurement of Energy Expenditure
262	Table 19

ANTHROPOMETRY

WEIGHTS, HEIGHTS AND BONE DIAMETERS OF MIDDLE INCOME AND
WORKING WOMEN

At the start of the study in 1985 every woman was weighed and her height and bone diameters measured. Therefore it was possible to compare the skeletal frame size and weights of the two groups of women. (The two groups were of the same mean age, ie 34 years). From the results in Table 1 the most apparent difference between the middle income and the working women is their weight, the working women weighing almost 10 kg less than the middle income women.

This can largely be accounted for by the difference in percentage body fat, which is discussed in greater detail later.

Working women : weight = 39.8 kg of which 22.3% is fatty
tissue;
therefore fat free mass (FFM) = 30.9 kg.

Middle income

women: : weight = 49.6 kg of which 30.1% is fatty
tissue;
therefore fat free mass (FFM) = 34.7 kg.

When the FFM is calculated it can be seen that there is only a 3.8 kg difference between the two groups of women. This is also reflected in the Body Mass Index (BMI) (Table 1) which takes into account any difference in height. Since there is still a large difference in BMI between the two groups, (17.9 and 21.7 for working women and middle income women respectively) it is apparent that the heavier weight of the middle income women is not merely due to a difference in height.

Although the middle income women tended to be slightly taller than the working women, 151 cm and 149 cm respectively, it was not a significant difference.

However, there were significant differences in three of the bone diameters. The mean biacromial, bi-iliac and bicondylar femur diameters were significantly higher in the middle income group ($P < 0.001$). The ulnar bone diameter was the same for both groups of women.

Therefore it can be said that in this village, the working women were lighter and in general of smaller skeletal frame than their middle income counterparts. This larger skeletal frame of the middle income women presumably results in their heavier weight, that which is not accounted for by their higher percentage body fat, ie around 4 kg.

TABLE 1

BONE DIAMETERS, WEIGHT AND HEIGHT OF WORKING AND MIDDLE INCOME WOMEN

	Working Women	Middle Income Women
Number in sample	102	30
Mean age	34	34
Mean weight (kg)*	39.8	49.6****
SD	5.3	6.8
Mean height (cm)	149	151
SD	5.9	5.0
BMI ----- ² height (m)	17.9	21.7
<u>Mean Diameters (cm)</u>		
Biacromial	31.5	32.9****
SD	1.6	1.1
Bi-iliac	25.6	27.9****
SD	1.7	1.2
Bicondylar femur	8.1	8.5****
SD	0.4	0.4
Ulnar	4.7	4.7
SD	0.2	0.3

* Taken at the beginning of the study (April 1985)

**** P 0.001

The weights and heights of the working women fall far below the range of desirable weights for heights for adults given in the joint report of FAO/WHO/UNU on Energy and Protein Requirements, (1985).

The average height in this study of 102 working women was approximately 1.5 metres which would correspond to a desirable average weight of 47 kg and a desirable weight range of 43 to 55 kg. However, the average weight of the working woman was 39.8 kg - about 3 kg below the low end of the desirable range.

The same is true for the BMI of these working women. The desirable average is given as 20.8 with a range of 18.7 to 23.8. However, the mean BMI for this group of working women was only 17.9.

The average weight and BMI of the middle income women did fall into the desirable range given in the report mentioned. Their mean weight of 49.6 was slightly above their desirable average but within the desirable range. Their BMI was also slightly above the desirable average - 21.7 but again, within the desirable range.

This is a good example of the difference between these two groups of subjects, where the middle income group have 'normal' BMI values and therefore are a suitable

control group with which to compare the working women. The middle income group obviously had no restrictions in energy intake and could maintain a reasonable weight, whereas the working women could not maintain a 'normal' BMI value.

SEASONAL CHANGES IN WEIGHT AND SKINFOLD THICKNESSES OF WORKING WOMEN

Since this study was carried out over two years, it is possible to look at any changes that occurred in the first year and to see if similar changes occur again in the second year.

In each year measurements were made during the harvest season from April to June, and during the lean season from July to September.

Paired sample and t-tests were carried out on all the anthropometric data between the two seasons. This test minimizes the effect of inter-individual variation and examines instead the intra-individual changes.

WEIGHT CHANGES

From Table 2 (and Fig. 2) it can be seen that from the harvest season to the lean season in 1985 there was a significant decrease in body weight of about 0.5 kg in the working women. ($P < 0.02$). There is a similar trend in 1986 over the same time period, ie a drop in body weight of 0.4 kg. However, this decrease just fails to reach significance.

Working Women: Weight

Fig. 2

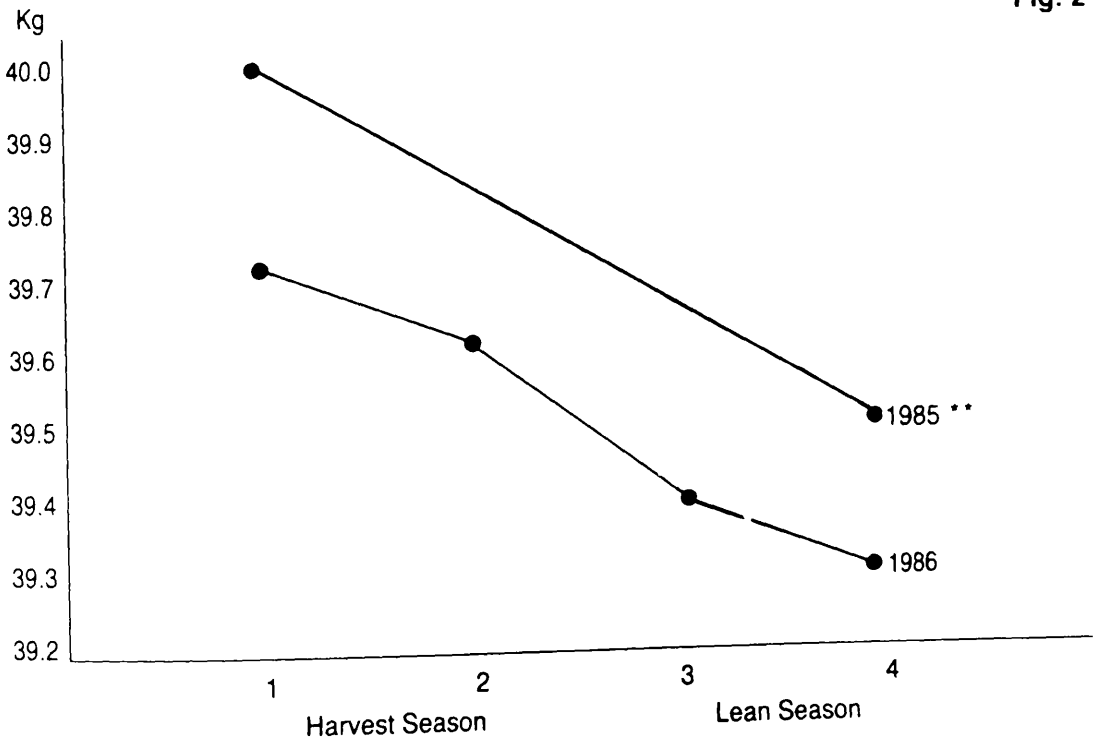

Working Women

Season:	May '85 (Harvest)	Aug. '85 (Lean)	Apr. '86 (Harvest)	May-June '86	July '86 (Lean)	Aug-Sept. '86
<u>Weight (KG)</u>						
Mean (n)	40 (66)	39.5 (66)**	39.7(87)	39.6(72)	39.4(78)	39.3(87)
SD	5.1	5.1	5.4	5.1	5.2	4.6
<u>Skin Folds (mm)</u>						
<u>Biceps:</u>						
Mean (n)	3.8(68)	3.9(68)	3.9(87)	3.8(72)	4.2(78)	3.4(87)****
SD	1.7	1.6	1.6	1.2	2.0	1.3
<u>Triceps:</u>						
Mean (n)	8.4(68)	9.3 (68)****	8.4(87)	8.6(72)	8.4(78)	8.2(87)
SD	3.0	3.3	3.5	3.6	3.4	3.0
<u>Subscapular:</u>						
Mean (n)	9.3(68)	8.5(68)****	8.4(87)	8.4(72)	7.8(78)	7.6(87)****
SD	3.3	3.0	2.8	2.5	2.2	2.3
<u>Supra-iliac:</u>						
Mean (n)	10.8(68)	10.4(68)	8.9(87)	8.1(72)	8.0(78)	7.8(87)*
SD	6.2	5.8	5.3	4.5	5.0	5.1
<u>Thigh:</u>						
Mean (n)	15.9(65)	14.9(65)***	13.6(85)	13.5(71)	13.0(76)	14.0(85)***
SD	5.8	5.6	5.8	5.6	5.3	5.9
<u>Total Mean:</u>						
(n)	48.1(65)	46.8(65)	43.4(85)	42.4(71)	41.2(76)	40.8(85)
SD	18.1	17.3	16.7	15.3	15.7	15.6
<u>% Fat:</u>						
Mean (n)	22.3(65)	22.3(65)	21.4(87)	21.1(72)	20.7(78)	20.1(87)****
SD	4.6	4.4	4.6	4.3	4.4	4.3

* P<0.05 ** P<0.02 *** P<0.01 **** P<0.001

seasonal changes in weight have been reported by authors in many developing countries, often being more severe than the weight losses seen here.

Hunter (1967) reported that in a part of the West African Savana between December and June, an active man lost around 3.5 kilos, which represented 6.2% of his body weight, and an active woman lost around 3.2 kg, 6.5% of her body weight. Overall, in Hunter's study 94% and 63% of all the male and female subjects respectively lost weight during the lean season.

Loutan and Lamotte (1984) studied the Nomadic pastoralists in Niger and saw that after a steady gain in weight after the rainy season to a maximum weight in February, there was a significant drop in the hot dry season.

In the rainy season the subjects weight for height was 82% of the standard, which fell to 78% in the lean season. This includes the females, who lost 4.6% of their body weight. During this season their energy expenditure was increased markedly, due to the distance necessary to walk for water, and the digging and

maintenance of wells. Also the food prices increased, when the food availability decreased - all resulting in the loss of body weight of the pastoralists.

Also in Africa, Fox (1953) saw a decrease in weight just before the harvest season, when agricultural activities increased and food supplies decreased. He reported a seasonal fluctuation in energy intake of 103% - 107% of the recommended daily allowance during November to January and only 90% during June and July.

In a study by the Ghana Nutrition Survey (1961) both in North and South Ghana, marked seasonal changes in weight were recorded, with adults losing as much as 4.5 kg during the hungry season, which is a very large amount, but this was put back on after the harvest season.

Huffman et al (1985) looked at the seasonal changes in weight and nutritional status of non-pregnant women in Bangladesh. She carried out a longitudinal study on over two thousand married women. These women had an average weight of 40.4 kg and an average height of 147.9 cm. These women were therefore of very similar weight and height to the working women of Hyderabad in this study (39.5 - 40 kg and 149 cm respectively).

Huffman found that their weight fluctuated throughout the two and a half year study period corresponding to seasonal food shortages. She recorded a gradual increase in weight from January, reaching peak weights between June and July which coincided with the second harvest season. However, these women lost what they had gained (about 1 kg in the first year and about 1.5 kg in the second year) between the months of July to October.

The low measures of nutritional status in October coincides with the period just before the main harvest in November - "the hungry season" - when food prices are highest. These trends in weight fluctuations were seen in each year of the study from 1976 to 1978. Huffman et al conclude that the nutritional status of these women is correlated with food availability, food pricing and purchasing power, also to different patterns of energy expenditure associated with agricultural crop planting, weeding and harvesting and also to morbidity patterns that correspond to changes in temperature and rainfall.

Many other studies report larger fluctuations in body weight where the populations are dependant on only one crop per year, such as in many regions in Africa. Obviously in regions where there are two harvests a year

there are not so many marked changes in body weight, as the seasonal variations in food availability tend to be smoothed out.

sloof (1978) found no differences between wet and dry seasons in the proportion of children under five years old with a weight for age relationship below eighty percent of the recommended value. He explains this lack of seasonal effect on nutritional status on there being two harvests per year in this district in Kenya. Also, many people in this district generate income from other non-agricultural activities during the periods of the year when there is less field work to be carried out, making these populations less dependant on the seasonal income. In Hyderabad however, the women were very dependant on the seasonal fieldwork and the increase in the amount of money coming into the household as a consequence.

INDIAN BODY WEIGHTS COMPARED TO WESTERN STANDARDS

In general it can be seen that these Indian working women are very much lighter than the average women in the west. In western Europe the "standard" woman has a body weight of 55 kg, therefore these women are on average 28% lighter, with a body weight of 40 kg. The same is true for men (although not measured here). The 'standard' man

in developed countries weighs 70 kg, whereas in developing countries they are 28% lighter, often weighing around 50 kg.

This lower body mass could be a genotypic adaptation, acquired over the generations, or a phenotypic adaptation to the low planes of nutrition these populations are subjected to, especially in their early years.

However, it consequently results in lower energy needs, which therefore makes these populations better equipped to deal with situations of reduced energy intake, which occur as a result of the seasonal variation in food availability.

SKINFOLD THICKNESSES OF WORKING WOMEN

Table 2 shows that the biceps and supra-iliac skinfold thicknesses did not change significantly from the harvest to the lean season in 1985. (Figs 3 and 6). However, there was a significant decrease in subscapular and thigh skinfold (Fig 5 and Fig 7) ($P < 0.001$ and $P < 0.01$ respectively). This decrease in subcutaneous fat may be expected when considering the loss in weight over the same time period. However, there was one surprising increase - the triceps skinfold thickness increased over the same time period ($P < 0.001$) (Fig 4). When the raw data was studied carefully it was seen that the majority of triceps skinfold thicknesses actually decreased and only a few had increased, but by a considerable amount. It was these few extreme values that had a big effect on the overall mean value.

One method of minimising the effect of a few extreme results is to calculate the median value for the group. Here, the median for the triceps skinfold thickness during the lean season was 8.5 mm, which is quite a lot lower than the actual mean value, and closer to the harvest season mean value of 8.4 mm (Fig 9).

When a graph was drawn, using the median values for all the triceps skinfold thicknesses, it can be seen that there is still a slight, although small, increase (0.3 mm) and not statistically significant from the harvest season 1985 to the lean season 1985.

Both sets of measurements were carried out by the author, therefore the difference between the means cannot be explained by the inter-observer variation. The calipers were regularly calibrated and no other effect of methodology is apparent to explain this unexpected result.

Working Women: Biceps Skinfold Thickness

Fig. 3

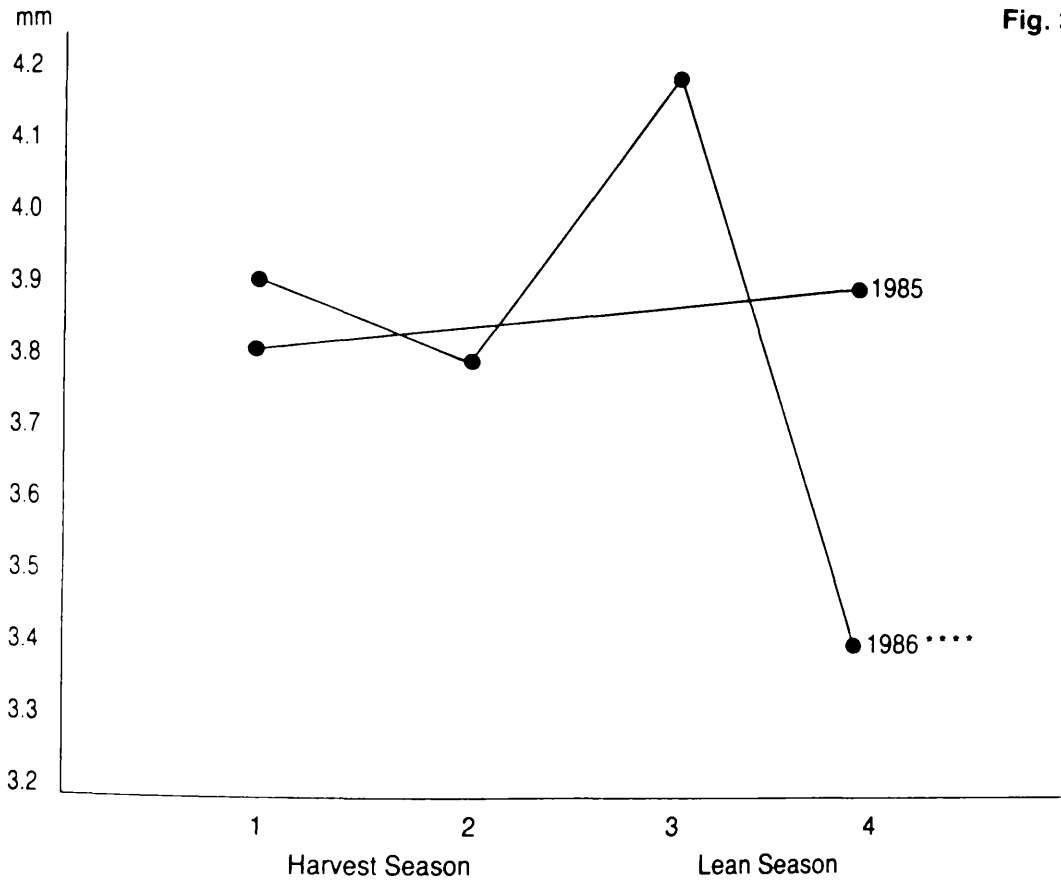

Working Women: Triceps Skinfold Thickness

Fig. 4

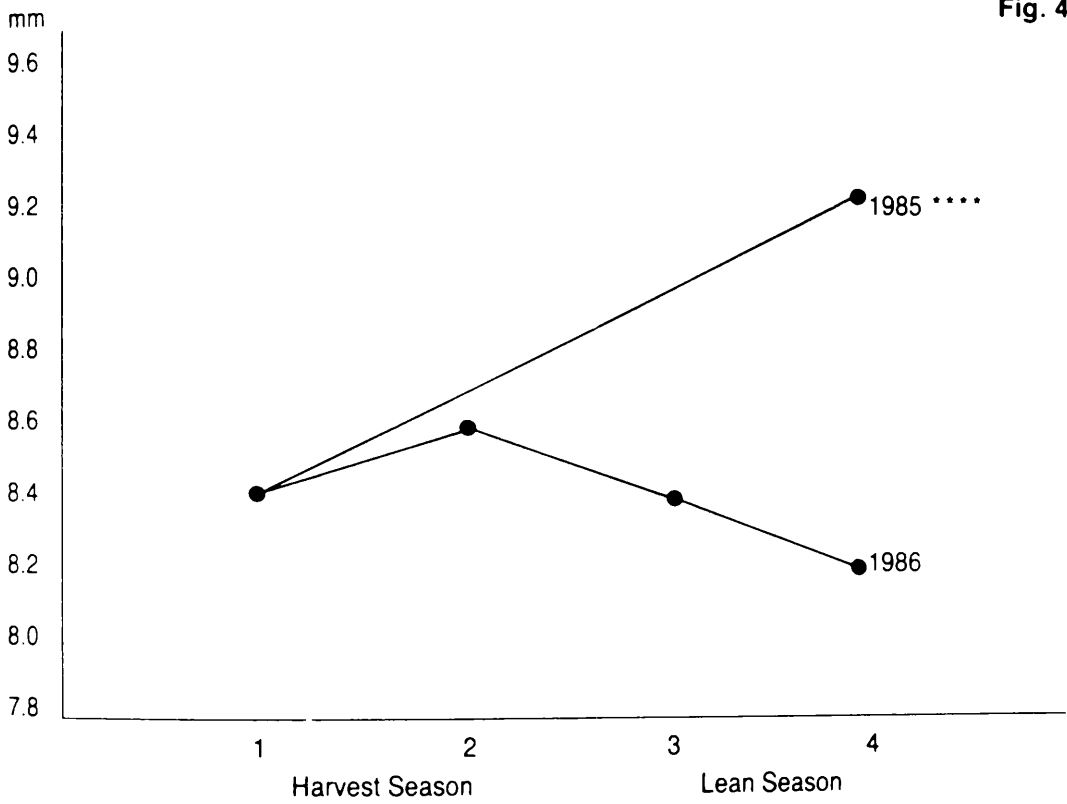

Working Women: Subscapular Skinfold Thickness

Fig. 5

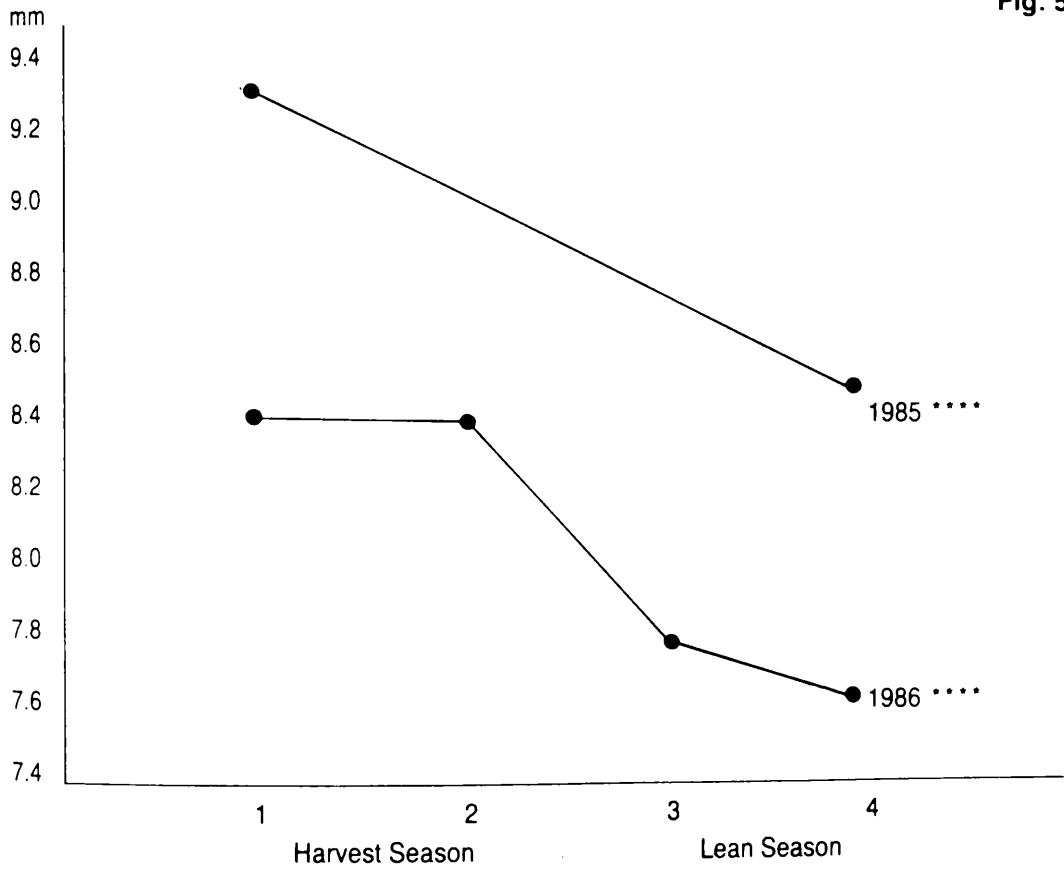

Working Women: Supra-iliac Skinfold Thickness

Fig. 6

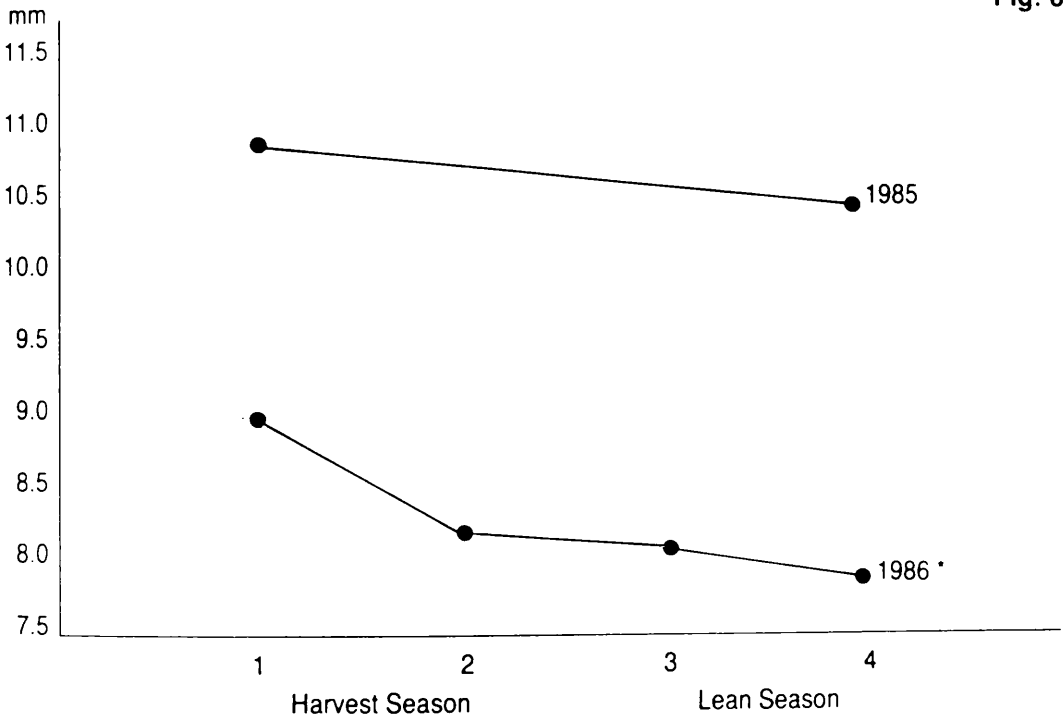

Working Women: Thigh Skinfold Thickness

Fig. 7

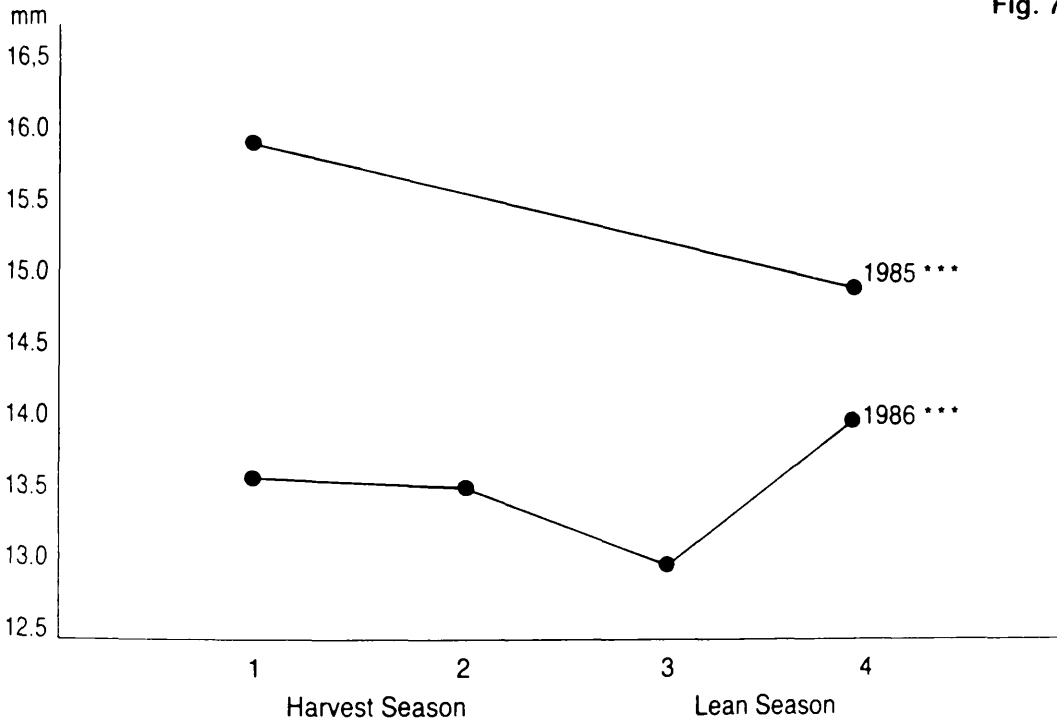

Working Women: Biceps Skinfold Thickness (Median)

Fig. 8

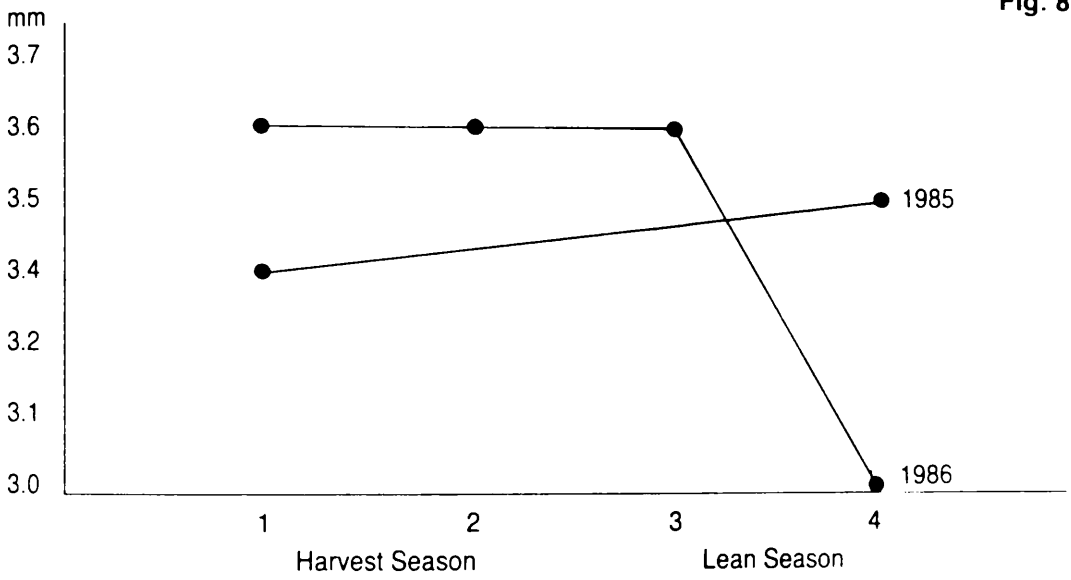

Working Women: Triceps Skinfold Thickness (Median)

Fig. 9

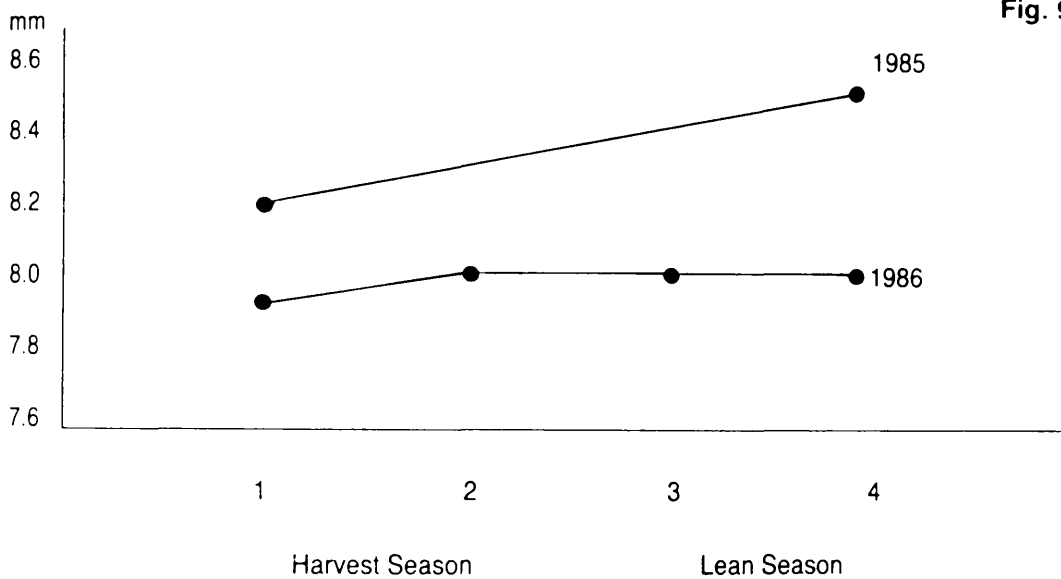

The graph of the median values for the triceps skinfold thicknesses in 1986 is almost a straight line, indicating very little change at all.

From the graph of the biceps medians in 1985 (Fig 8) a similar small increase was seen to occur but at lower values than the mean values, indicating again there were a few high values in the set of data which elevated the overall mean.

A few extreme values seem to be the reason for the high mean bicep thickness in the third measurement of 1986, as it is not reflected in the graph of the median bicep thicknesses. This graph shows no increase at all from the first to third measurement but shows a decrease in the fourth measurement similar to that seen in the 'mean' graph. Again the median values are lower than the mean values, indicating, as for the triceps, a few high values present which increases the overall mean.

In 1985 there was a slight decrease overall in the sum of the five skinfold thicknesses (Fig 10), but when the percentage fat was calculated from the sum of four skinfold thicknesses (Biceps, triceps, subscapular and

supra-iliac), not taking the thigh skinfold thickness into account, there was no change from the harvest season to the lean season (Fig 11).

However, since there was a decrease in body weight over this period of time, this infers there was a decrease in lean body mass (LBM), ie

weight during Harvest season 1985 = 40 kg, 22.3% fat
therefore LBM = 31.1 kg.

weight during Lean season 1985 = 39.5 kg, 22.3% fat
therefore LBM = 30.7 kg.

This is also reflected in a decrease in several circumferences, which will be discussed later.

During 1986 there were also significant changes in body composition. From the harvest season to the lean season there was a significant decrease in bicep skinfold thickness, (Fig 3), as mentioned earlier, ($P < 0.001$), the subscapular (also observed in 1985) (Fig 5) ($P < 0.001$) and also the supra-iliac skinfold thickness ($P < 0.05$) (Fig 6). This resulted in a significant drop in the overall percentage fat from 21.4% to 20.1% (Fig 11).

Working Women: Total Fat (mm)

Fig. 10

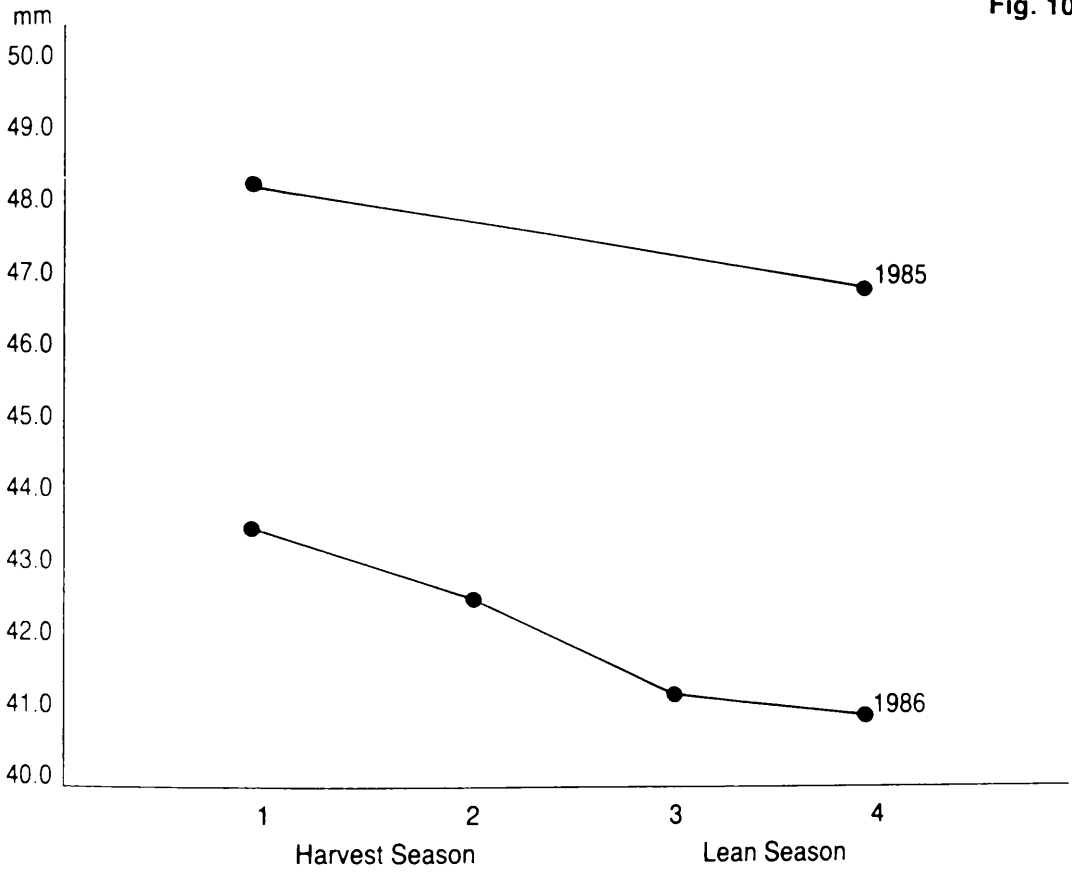

Working Women: Percentage Fat

Fig. 11

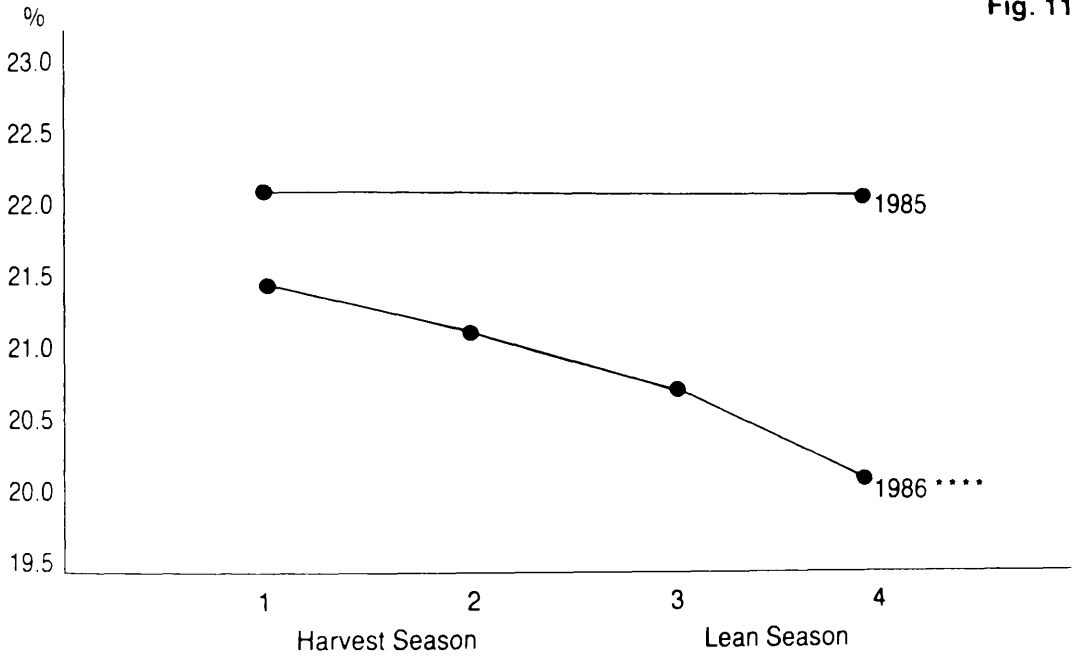

From this the lean body mass can be calculated.

1986 Harvest season weight = 39.7 kg, 21.4% fat
therefore LBM = 31.2 kg.

1986 Lean season weight = 39.3 kg, 20.1% fat
therefore LBM = 31.4 kg.

It can be seen that in 1986 the mean LBM actually tends to increase very slightly over the two seasons, and so the small decrease in weight may be accounted for by a decrease in body fat.

One surprising result was that the thigh skinfold thickness (Fig 7) actually increased, but only by a very small amount - from 13.6 mm to 14.0 mm. However, when the method of measuring the skinfold and its level of accuracy is taken into account, a difference of 0.4 mm cannot be considered physiologically significant. The thigh skinfold is also one of the more difficult skinfold measurements to take especially if the thigh skin is fairly taut.

When the median value for the thigh is calculated there is still an increase from the harvest season to the lean season:

	Lean			Harvest	
Season 1986	1	2		3	4
-----				-----	
Skinfold					
Thickness	12	12		12.4	13
(mm)					

However it is still a very small increase - 1.0 mm - and is probably of little importance.

An interesting area to examine is the fat distribution, and where exactly fat was lost during the lean season. The most marked areas of fat loss in both 1985 and 1986 was the subscapular region and the thigh in 1985 only. The supra-iliac skinfold only tended to decrease in 1985, but did significantly drop in 1986. This may indicate the certain areas of fat deposits which are most readily available for metabolism, when energy stores are required during periods of reduced intake, ie perhaps fat deposits are first utilised from the back and thighs in times of negative energy balance.

LIMB CIRCUMFERENCES OF WORKING WOMEN

In 1985 a decrease in all limb circumferences was observed. (Table 3). The decrease in the upper arm circumference (Fig 12) just failed to reach significance at the $P < 0.05$ level, but the buttocks ($P < 0.01$), thigh ($P < 0.05$) and calf ($P < 0.001$) circumferences all decreased significantly. (Figs 13, 14 and 15). Since there was no significant decrease in percentage fat over this period of time, but there was a decrease in body weight, the decrease in limb circumference indicates a reduction in muscle mass.

In 1986, again all limb circumferences tended to decrease from the harvest to the lean season, (as might be expected when considering the decrease in weight and percentage body fat over the same period of time) but they were small changes and failed to reach significance (Figures 12 - 15).

TABLE 3

Working Women Circumferences

Season:	May '85 (Harvest)	Aug. '85 (Lean)	Apr. '86 (Harvest)	May-June '86	July '86 (Lean)	Aug-Sept. '86
<u>Upper Arm</u>						
Mean (n)	23.2 (68)	22.2 (68)	22.3 (87)	21.8 (72)	22.6 (78)	22.2 (87)
SD	2.1	2.0	2.1	2.0	2.1	1.8
<u>Buttocks</u>						
Mean (n)	80.2 (68)	79.4 (68) ***	79.5 (87)	79.7 (72)	79.6 (78)	78.6 (87)
SD	4.5	4.6	5.2	5.0	4.7	7.6
<u>Thigh</u>						
Mean (n)	44.3 (68)	43.8 (68) *	43.8 (86)	43.6 (72)	43.7 (78)	43.5 (87)
SD	4.2	3.9	4.3	4.3	4.1	3.9
<u>Calf</u>						
Mean (n)	27.7 (68)	27.3 (68) ****	27.2 (87)	27.0 (72)	26.9 (78)	26.9 (87)
SD	2.0	2.0	2.2	2.1	2.0	2.0

Number of subjects in parenthesis.

* P<0.05

** P<0.02

*** P<0.01

**** P<0.001

Working Women: Upper Arm Circumference

Fig. 12

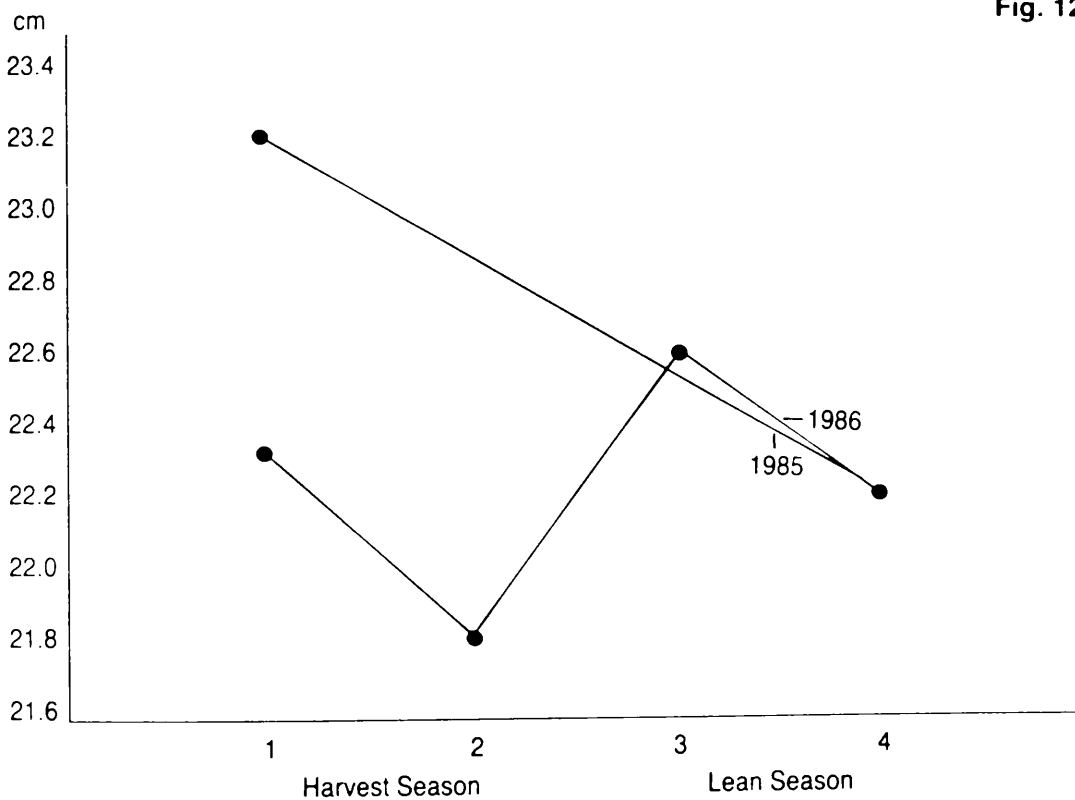

Working Women: Buttocks Circumference

Fig. 13

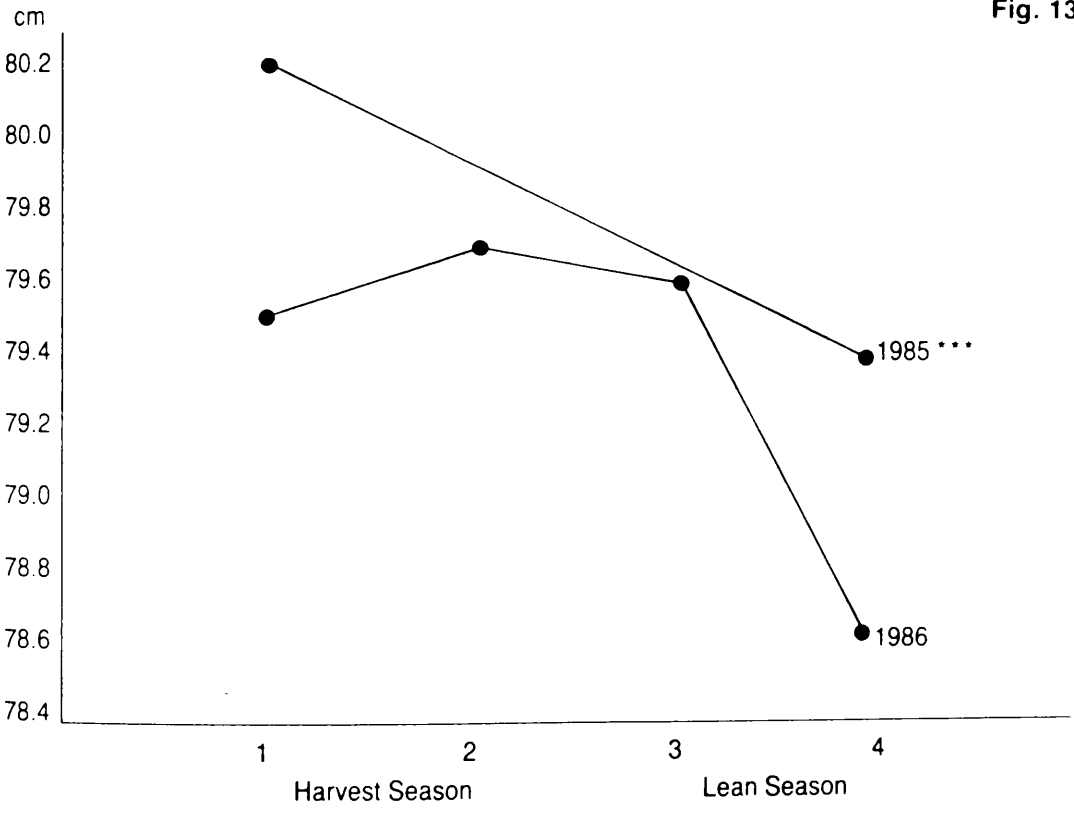

Working Women: Thigh Circumference

Fig. 14

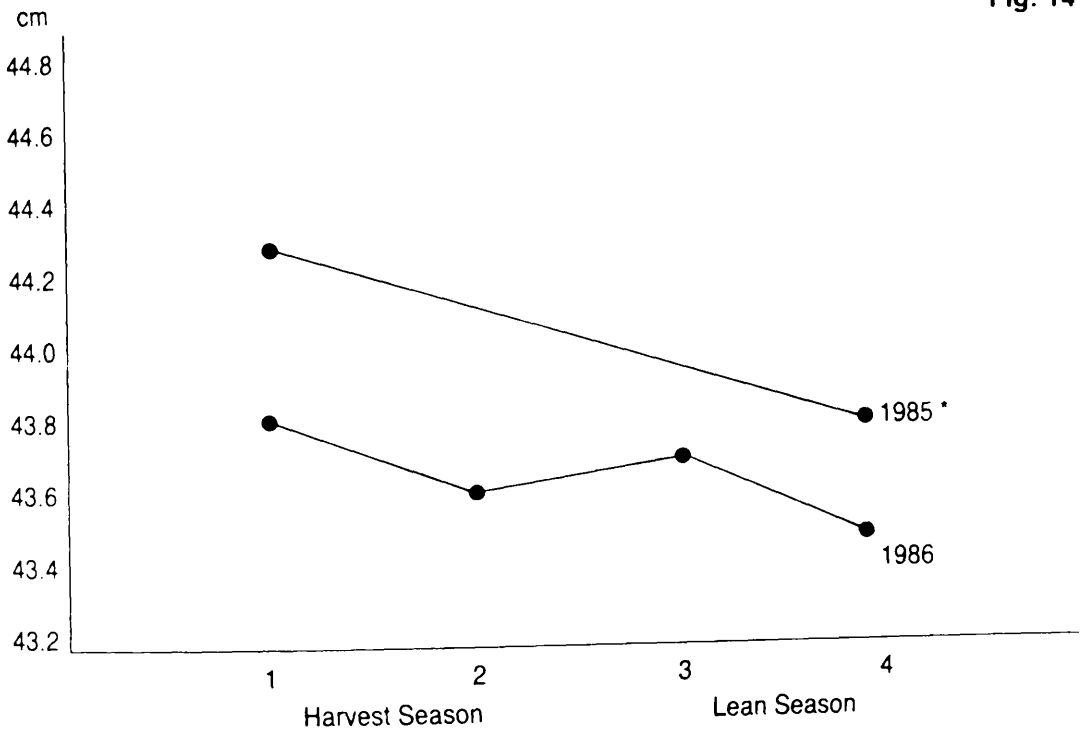

Working Women: Calf Circumference

Fig. 15

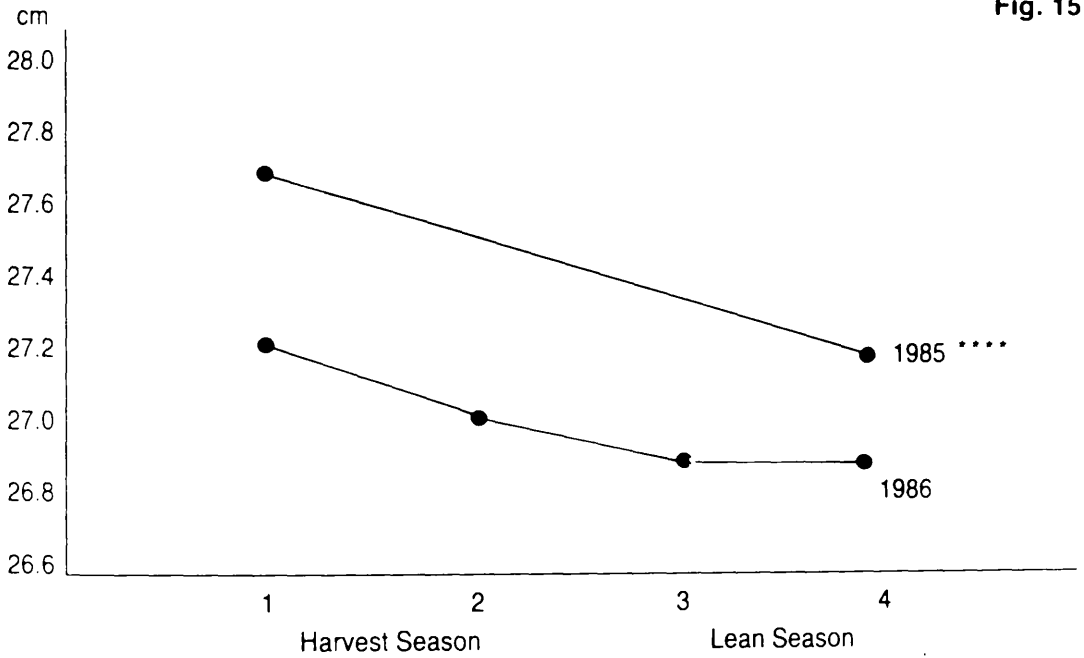

AN ALTERNATIVE STATISTICAL TEST

It is possible to use a slightly different statistical test of significance which is perhaps more sensitive. It looks at the difference between the two sets of results from the harvest season to the lean season and compares this average value to zero. If the average value was in fact zero this would mean, of course, that the averages of the two sets of data were the same. The further away from zero the difference is, the more likely it is that there is a real difference between the two sets of data ie a seasonal difference.

The test was carried out for weight, five individual skinfold thicknesses, total skinfold thickness, percentage fat and the four limb circumferences (see Table 4).

It was also carried out on food intake, basal metabolic rate, BMR factor and the exercise capacity test (see later, table 12).

As can be seen in Table 4 the probability of there being a significant difference between seasons is greater in many of the parameters. In 1985 this test results in a more highly significant drop in weight in the lean season

Test of the Significance of the Difference in Anthropometric Data Between Seasons

Parameter	Year	n	Mean Difference Between Seasons	SD of the Difference	Significance Level	Previous Significances Level
<u>Weight (Kg)</u>	1985	66	0.46	1.37	0.01	0.02
<u>Thigh Skinfolds (mm)</u>	1985	65	1.14	2.7	0.001	0.01
<u>Total Skinfolds (mm)</u>	1985 1986	65 85	1.7 2.1	6.5 7.5	0.05 0.02	N.S. N.S.
<u>Buttocks Circumf. (cm)</u>	1985	68	0.84	2.0	0.001	0.01

- $P < 0.01$ as compared to $P < 0.02$ with the previous test, and the difference in thigh skinfold between seasons in this test is also more highly significant which means the probability of there being no difference between the seasons was reduced from $P < 0.01$ to $P < 0.001$.

This test also picked up some significant differences which was not apparent with the other t-test. In 1985 and 1986 this test picked up a significant difference in total skinfold thicknesses (five skinfolds) between the two seasons. The probability of the two sets of data of the total skinfold thicknesses being the same in the harvest and lean season is less than 0.05 in 1985 and 0.02 in 1986.

This significant difference was not detected using the other test. This may be due to the fact that the fairly large absolute values used in calculating the test may over shadow or mask any small but consistent differences in the data. This is not the case when only the differences between the two sets of data are used and compared to zero.

This test did not show up any new significant differences in any of the limb circumferences, but in 1985 there was a higher probability of there being a real drop in the

buttocks circumference and thigh circumference from the harvest season to the lean season, ie from $P < 0.01$ to $P < 0.001$ and from $P < 0.05$ to $P < 0.01$ respectively.

SEASONAL CHANGES IN WEIGHT AND SKINFOLD THICKNESSES OF
MIDDLE INCOME WOMEN

WEIGHT

The significant changes in body composition seen in the working women from the harvest season to the lean season were not observed in the middle income group (Table 5). Although, in 1985 there was a decrease in average weight, it was not a significant drop. In 1986 from the harvest to the lean season their average weight actually tended to increase, but again this was not significant (Fig 16).

On average, there was no significant change in total fat, or percentage body fat in this group of women, either in 1985 or in 1986 between seasons (Figures 22 and 23). In 1986 a local girl was trained to perform the skinfold measurements and although she was regularly given spot checks and was a very conscientious worker, variations in measurements between observers are unavoidable. Although there are strict procedures to carry out before taking the measurement - for example, measuring the exact mid-point between the acromian process and the point of the elbow to measure the tricep skinfold thickness -

different observers may pick up very slightly more tissue, leave the calipers compressing the skinfold for a slightly different time, or even taking the skinfold measurement from just a slightly different place. Since the measurements are taken to the nearest 0.2 mm these small differences may become apparent. Bearing this in mind, it is probably more relevant to take the measurements to the nearest 0.5 mm.

However, these small differences between observers are of no importance, if the same observer performs all measurements in a longitudinal study.

Unfortunately this could not be the case in this study. In 1985 the two sets of data were collected by the author, and in 1986 the four sets of data were collected by the local girl. It is still possible to look at each seasonal change in the two years, but probably not possible to compare the actual mean values between years, ie not possible to look for any trends over the two year period.

Weight and Skinfolds

Middle Income Women

Season:	May '85 (Harvest)	Aug. '85 (Lean)	Apr. '86 (Harvest)	May-June '86	July '86 (Lean)	Aug-Sept. '86
<u>Weight (KG)</u>						
Mean (n)	49.8 (20)	49.3 (20)	49.5 (24)	49.5 (19)	49.5 (21)	49.8 (24)
SD	7.3	7.2	6.6	6.2	5.9	6.1
<u>Skin Folds (mm)</u>						
<u>Biceps:</u>						
Mean (n)	6.4 (20)	6.9 (20)	6.7 (24)	6.9 (19)	5.4 (21)	6.5 (24)
SD	2.7	3.0	2.6	3.1	1.8	3.8
<u>Triceps:</u>						
Mean (n)	14.6 (20)	15.9 (20)*	14.9 (24)	15.5 (19)	14.3 (21)	15.6 (24)
SD	4.1	4.5	5.6	3.6	3.8	3.9
<u>Subscapular:</u>						
Mean (n)	16.4 (20)	15.0 (20)*	12.9 (24)	14.8 (19)	11.4 (19)	13.5 (24)
SD	5.7	4.7	4.4	5.0	3.5	4.5
<u>Supra-iliac:</u>						
Mean (n)	21.9 (20)	21.1 (20)	17.4 (24)	17.3 (19)	18.4 (21)	18.3 (24)
SD	7.3	6.5	6.2	6.9	8.1	6.8
<u>Thigh:</u>						
Mean (n)	22.6 (13)	22.8 (13)	20.9 (19)	20.3 (13)	20.3 (16)	23.4 (19)*
SD	5.2	5.1	6.9	7.1	5.6	6.4
<u>Total Mean:</u>						
(n)	74.2 (13)	75.2 (13)	68.9 (19)	70.3 (13)	68.0 (16)	74.0 (19)
SD	17.8	16.5	20.4	19.9	19.4	21.2
<u>% Fat:</u>						
Mean (n)	30.1 (20)	30.1 (20)	28.5 (24)	29.1 (19)	27.6 (21)	28.8 (24)
SD	4.6	4.1	5.3	5.2	5.0	5.0

* P<0.05

** P<0.02

Middle Income Women: Weight

Fig. 16

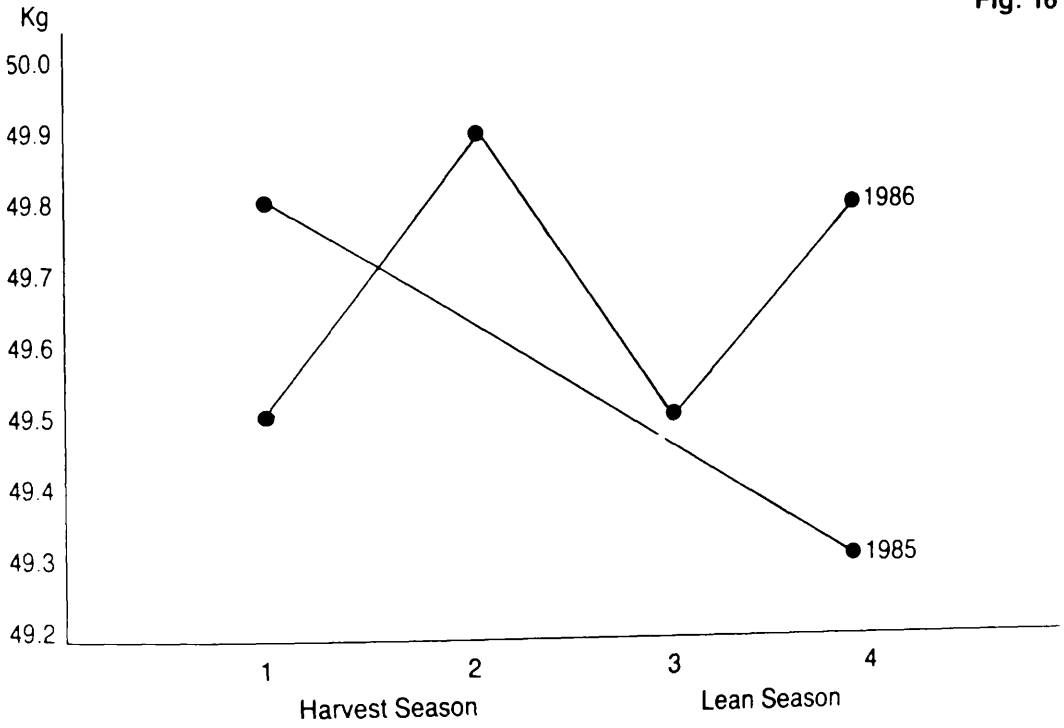

SKINFOLD THICKNESSES

In 1985 there were two significant changes in skinfold thicknesses. The triceps skinfold increased and the subscapular skinfold decreased ($P < 0.05$) (Figures 18 and 19).

However, the style of the middle income women's blouses made the triceps and subscapular measurements very difficult. They were worn very tight round their upper arm and tight across their chest and back.

Unfortunately, they would not agree to removing their blouses for these measurements therefore the difficulty in measuring these two skinfolds may account for these changes observed.

In 1986 there was only one skinfold thickness that changed significantly, ie the thigh skinfold increased from the harvest season to the lean season ($P < 0.05$) (Figure 21). The four other skinfolds also tended to increase but not significantly (Figures 17 to 20). This is in direct contrast to the trends seen in the working women.

Middle Income Women: Biceps Skinfold Thickness

Fig. 17

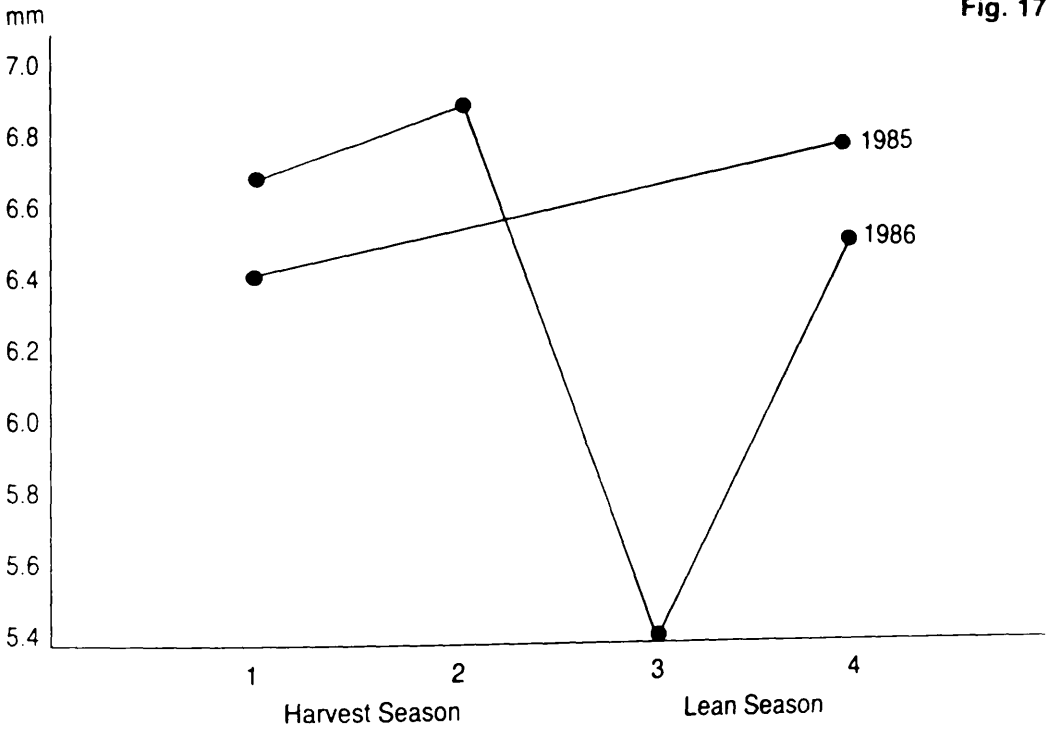

Middle Income Women: Biceps Skinfold Thickness

Fig. 17

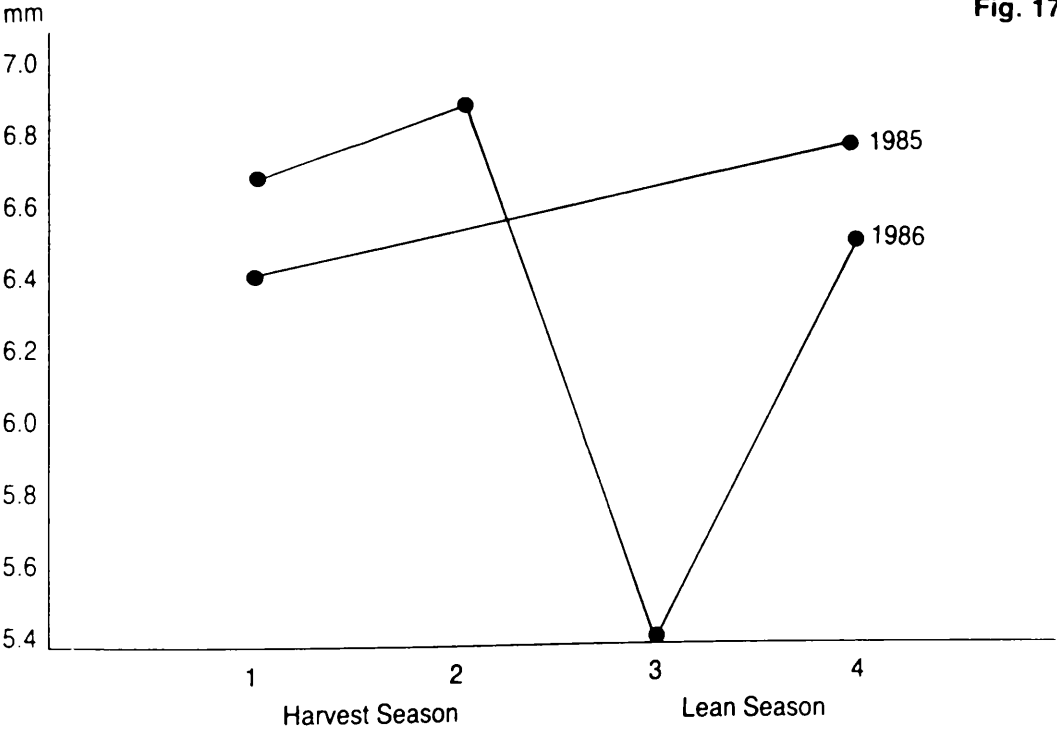

Middle Income Women: Triceps Skinfold Thickness

Fig. 18

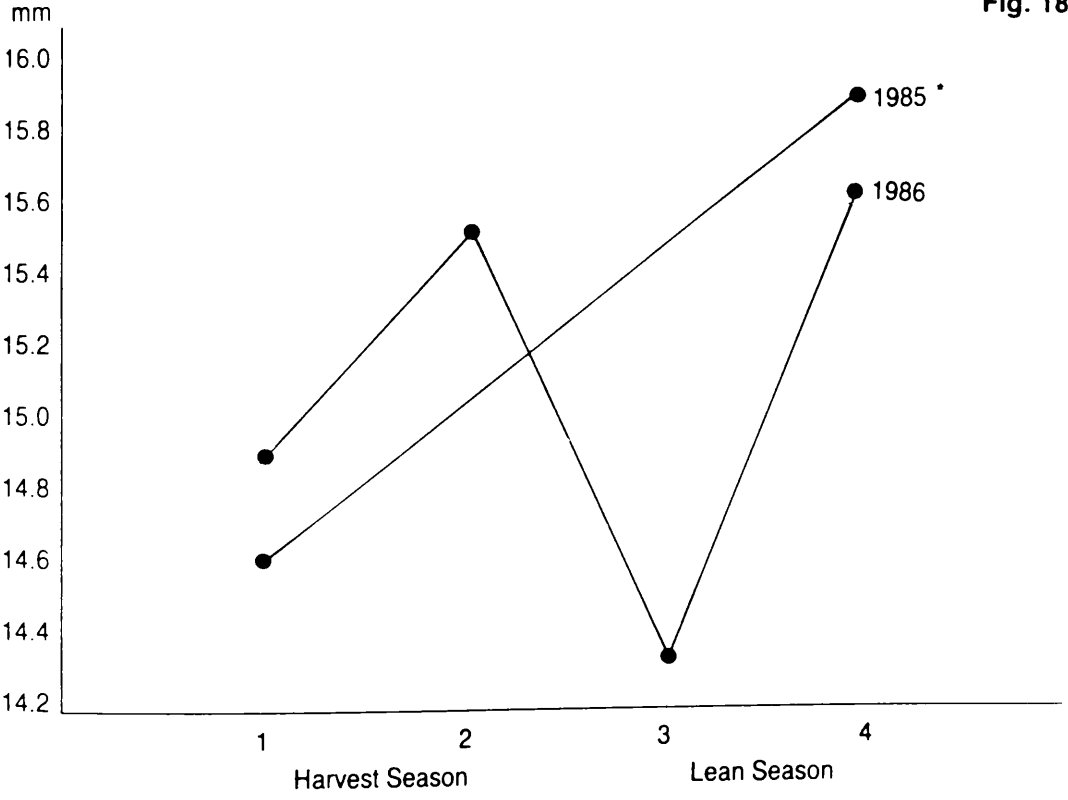

Middle Income Women: Subscapular Skinfold Thickness

Fig. 19

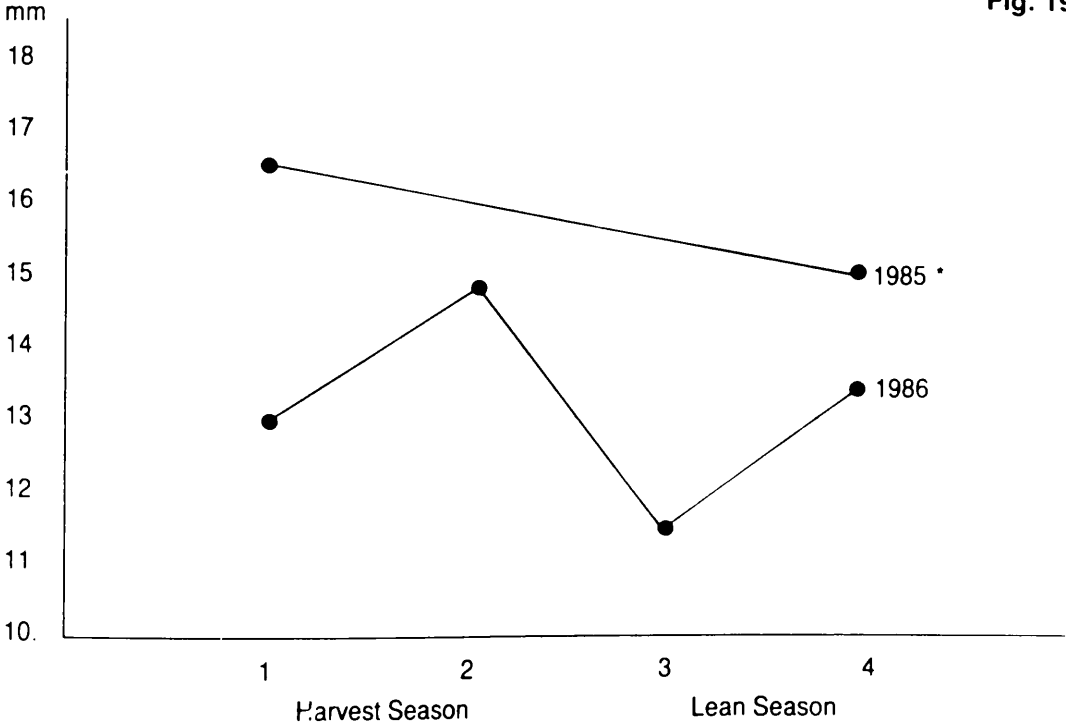

Middle Income Women: Supra-iliac Skinfold Thickness

Fig. 20

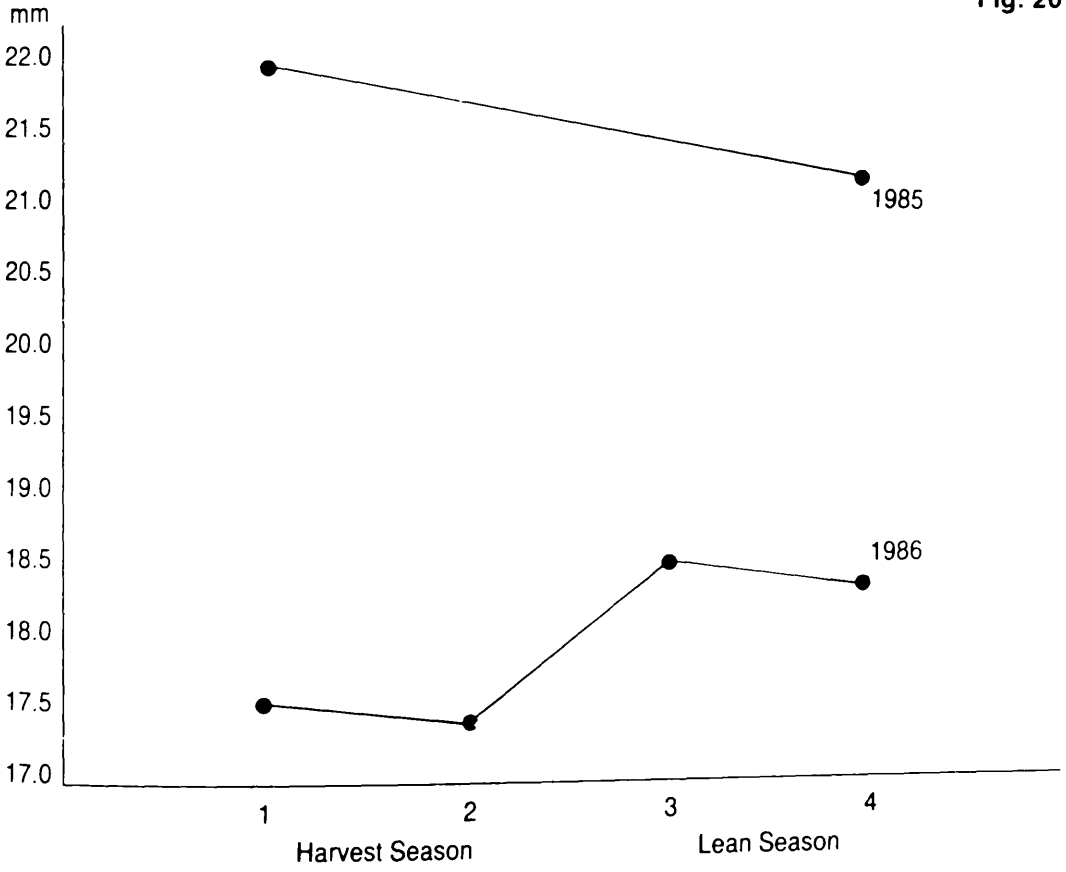

Middle Income Women: Thigh Skinfold Thickness

Fig. 21

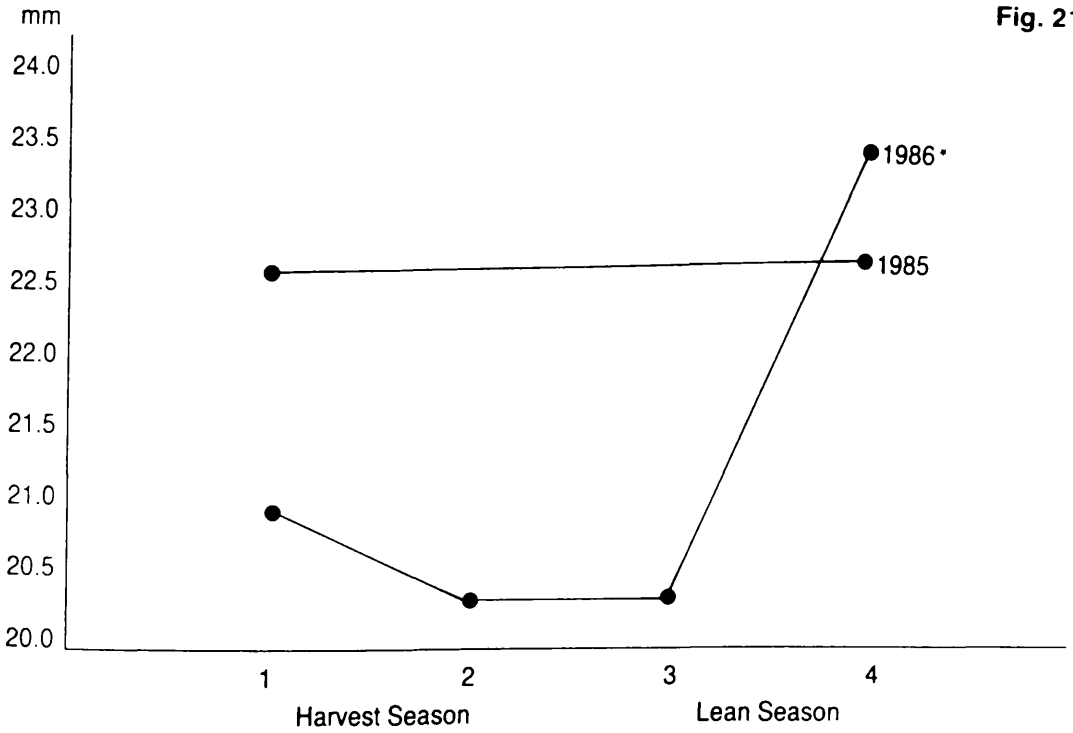

Middle Income Women: Total Fat (mm)

Fig. 22

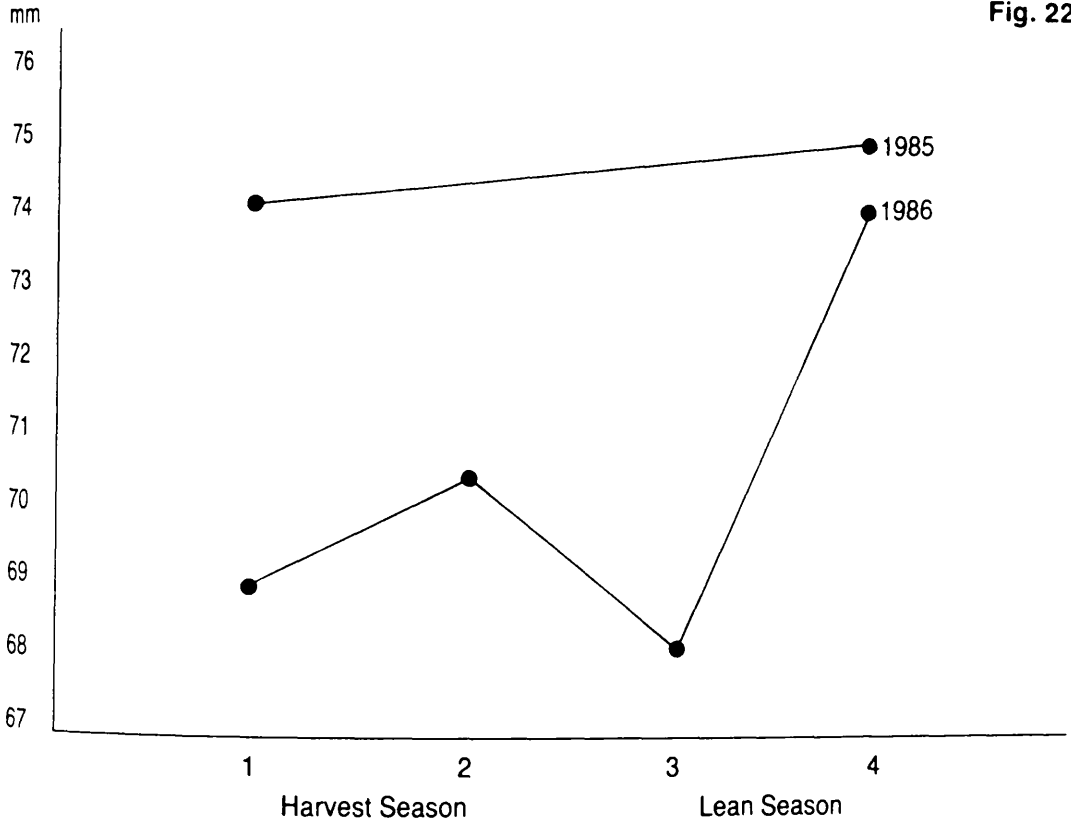

Middle Income Women: Percentage Body Fat

Fig. 23

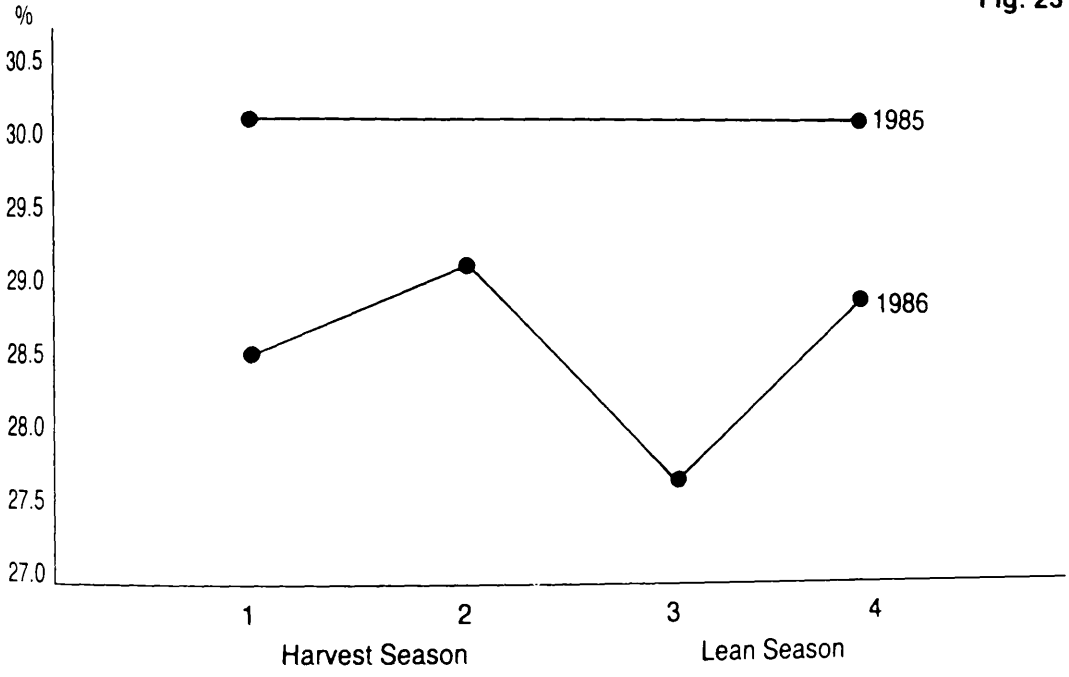

THE CONTROL GROUP

There has been very little work done on comparing two sets of women from the same area or village but of different socio-economic groups. It was thought necessary to look at the difference between these two groups of women in this study to determine if a shortage of money, in the case of the working women, and their increased energy output in the lean season, results in a loss of weight and body fat or whether this occurs normally for some other reason, as a climatic effect for example.

However, since the middle income group of women, ie the control group, showed no seasonal changes in weight, skinfold thicknesses or limb circumferences, it would appear that they maintained an energy balance throughout the year, something which was not possible for the working women due to their increased energy demands and decreased food availability during the lean season.

LIMB CIRCUMFERENCES OF MIDDLE INCOME WOMEN

It can be seen from Table 6 that there is very little change in the limb circumferences of the middle income women over the two seasons (Figures 24 - 27). In 1985 there was a significant increase in upper thigh circumference, ($P < 0.02$) which tended to occur in 1986 also but it was a small change and did not reach significance (Fig 26).

Overall therefore, it can be said that these middle income women were in energy balance throughout the period of study and were not influenced by the seasons and consequent variations in food availability, which the working women were subjected to.

TABLE 6

Middle Income Women Circumferences

Season:	May '85 (Harvest)	Aug. '85 (Lean)	Apr. '86 (Harvest)	May-June '86	July '86 (Lean)	Aug-Sept. '86
<u>Upper Arm</u>						
Mean (n)	25.1(20)	25.1(20)	25.2(24)	25.1(19)	25.7(21)	25.8(24)
SD	2.3	2.3	2.8	2.4	1.8	2.7
<u>Buttocks</u>						
Mean (n)	89.2(20)	89.7(20)	89.4(23)	89.2(18)	88.7(21)	89.2(23)
SD	5.6	5.4	5.4	6.2	5.0	5.1
<u>Thigh</u>						
Mean (n)	50.4(20)	51.6(20)**	49.0(23)	49.6(18)	50.5(21)	49.9(23)
SD	4.3	4.4	3.2	3.7	2.9	3.5
<u>Calf</u>						
Mean (n)	30.6(20)	30.4(20)	30.3(23)	30.0(19)	30.3(21)	30.2(23)
SD	2.4	2.4	2.3	2.4	2.2	2.2

** P<0.02

Middle Income Women: Upper Arm Circumference

Fig. 24

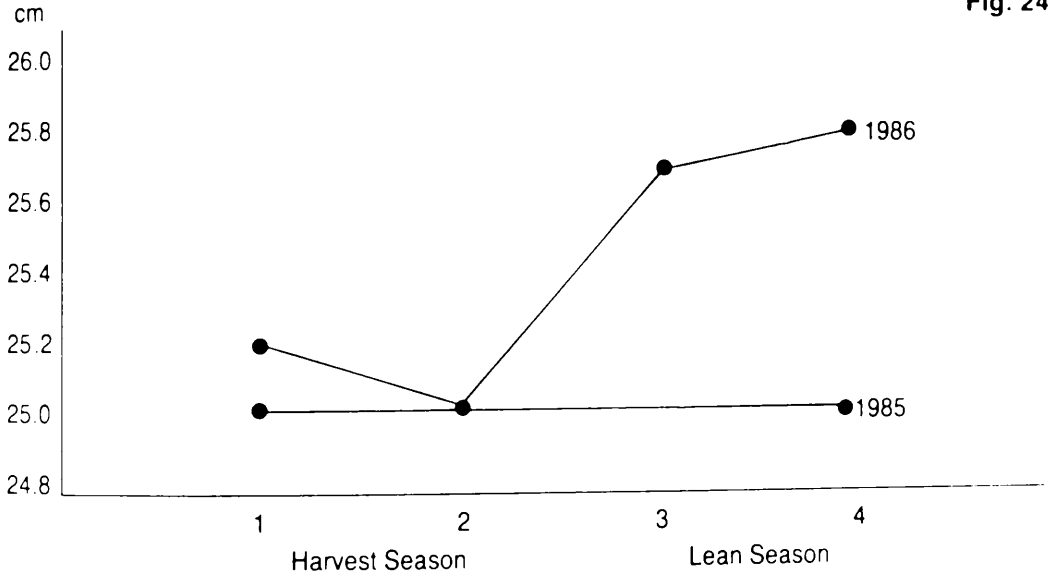

Middle Income Women: Buttocks Circumference

Fig. 25

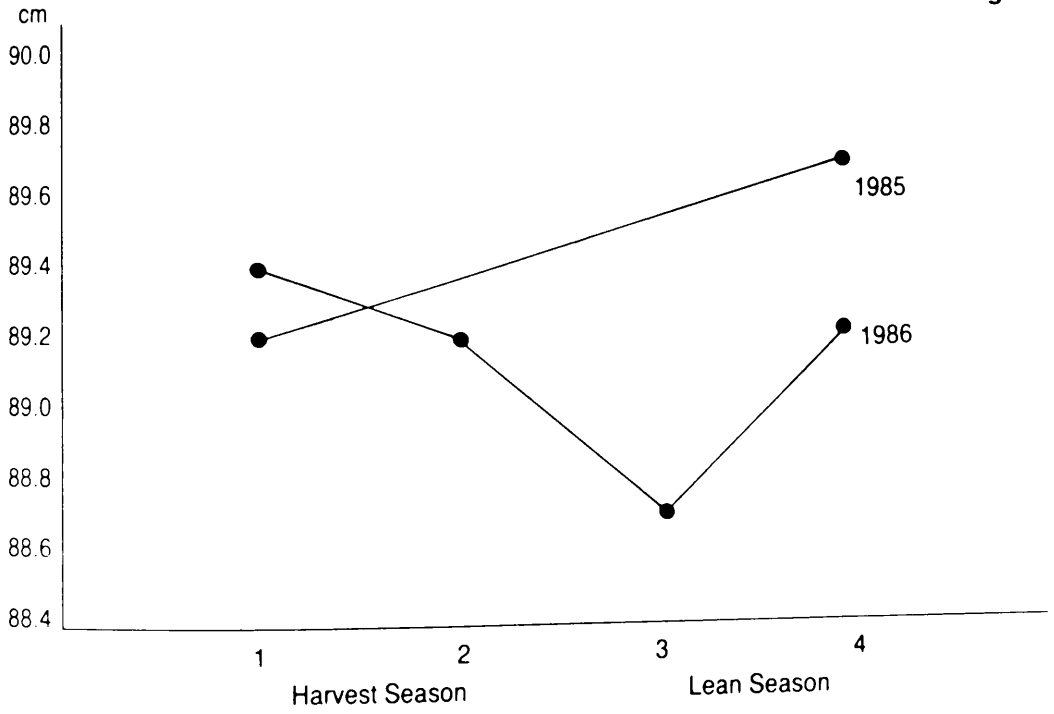

Middle Income Women: Thigh Circumference

Fig. 26

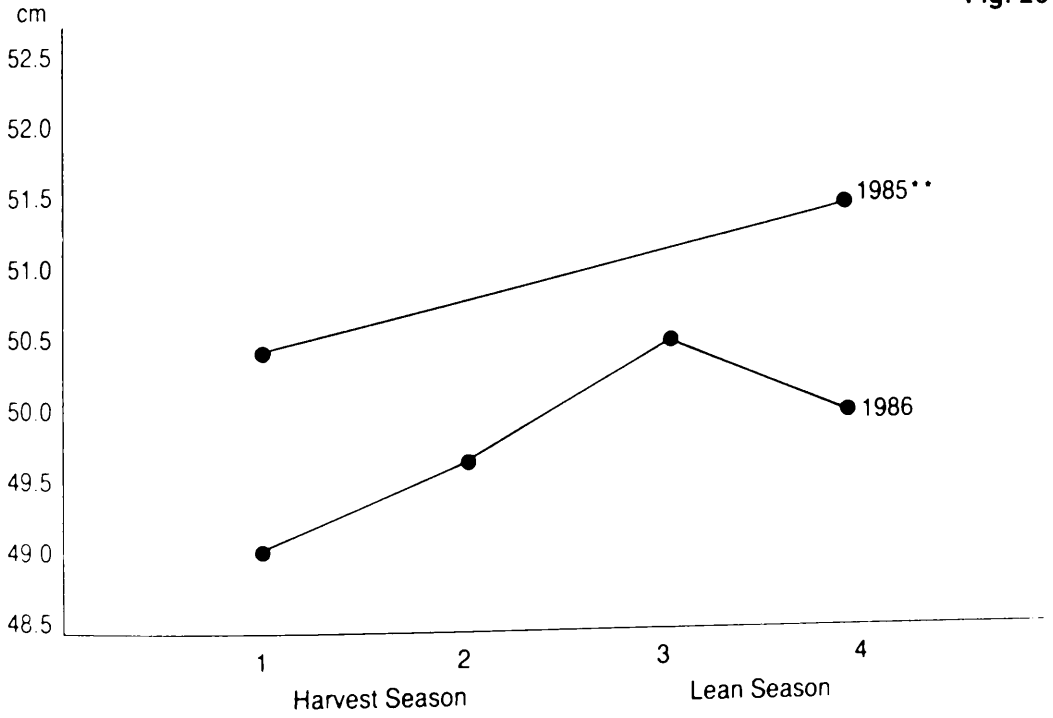

Middle Income Women: Calf Circumference

Fig. 27

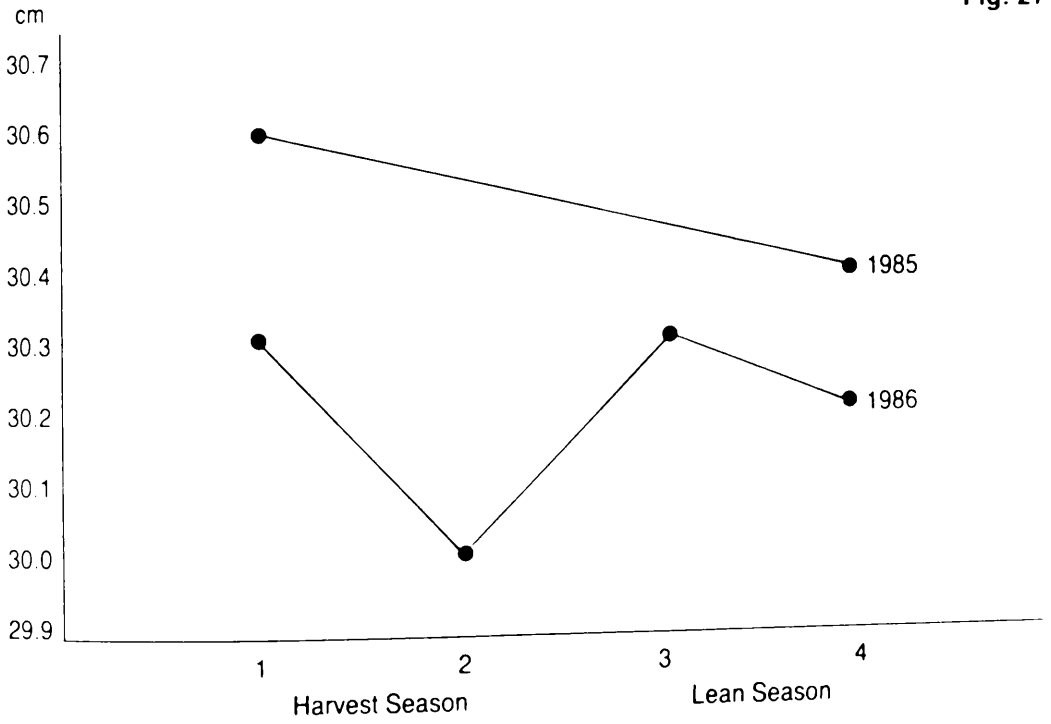

SUMMARY OF ANTHROPOMETRIC MEASUREMENTS

From Tables 1 - 5 it can be seen that there are obvious differences between the middle income and working women. The middle income women are, on average, around 10 kg heavier and have around 9% more body fat. Their slightly larger skeletal frame accounts for only 3.4 kg of the difference between the two groups. The remaining 6.6 kg is approximately due to the larger amount of body fat, ie

30% of 50 kg (middle income women)	=	15.0 kg body fat
22% of 40 kg (working women)	=	8.8 kg body fat

		6.2 kg difference

This is also reflected in the higher limb circumference values of the middle income women, with the middle income women having all four limb circumferences at least 10% larger than the working women:

Upper arm	14%
Buttocks	12%
Thigh	13%
Calf	11%

In general it can be seen that the working women tend to lose weight in the lean season, ie 3 - 4 months after the harvest season. In 1985 their mean percentage fat stayed constant, but a reduction in limb circumferences was noted, indicating a loss of lean body tissue. During this year the annual rains failed and their normal field work, which involved planting the new paddy plants, during the lean season, was very much reduced.

Therefore during the period of lower energy intake and less physical activity, a loss of lean body tissue occurred, ie wasting of the active muscular tissue.

During 1986 a smaller but steady decrease in weight occurred with a concomitant decrease in percentage body fat. During the lean season in this year there was more field work, due to the return of the annual rains just after the harvest season, therefore these working women maintained their lean body mass but decreased their percentage body fat during this season of reduced energy intake, ie their body fat was used as a source of energy during the lean season.

These patterns of change in the working women were not observed in the middle income woman, as would be expected, as they were not involved in field work nor subjected to reduced food intakes during the lean season.

When compared with the desirable weights for height, and BMI quoted in a recent report of a joint FAO/WHO/UNU expert consultation, only the group of middle income women fell into the 'desirable' ranges. The working women fell below the desirable range for both weight, for height and for BMI.

There have been very few reports on changes in body composition as a result of seasonal fluctuations of energy intake and output.

Many reports stop only at changes in body weight. However, one study in the Sahel looked at changes in mid-arm circumference, tricep skinfold thickness, mid-arm muscle circumference and weight for height in both males and females. (Benefice et al 1984).

In this region it has been reported that the pastoral populations are subjected to large differences in energy intake between the wet and dry seasons. The authors make an allowance for an "activity factor" and report that

these populations are in energy deficit of 260 Kcal/day during the wet season and about 500 Kcal/day during the dry season. Although they did not report any increase in the frequency of malnutrition among children or by the appearance of clinical signs of deficiency there was, nevertheless, a decrease in subcutaneous fat and a loss of body weight very well defined in adults. They also measured significant changes in mid-arm circumference, triceps skinfold thickness and mid-arm muscle circumference.

Benefice et al stated that there was a nutritional decline in the wet season, a phase of recuperation in the cool dry season, and a phase of deterioration in the hot dry season. They conclude that the subjects in the Sahel managed to cope with these changes by "mobilizing subcutaneous fat".

These results tend to agree with the findings here, so although the changes seen in the working women in Hyderabad are smaller, they are still consistent with other findings in similar populations.

FOOD INTAKES

DETAILS OF THE WORKING WOMEN INVOLVED IN THE FOOD INTAKE
AND BASAL METABOLIC RATE MEASUREMENTS

From the original group of 44 women chosen for the intensive study, 3 became pregnant, and one moved away from the village. (In the large anthropometry group 11 subjects became pregnant).

Table 7 below gives details of the group of 40 working women involved in the food intake and BMR Measurements.

TABLE 7

n = 40

	AGE (Yrs)	NO. OF CHILDREN	<u>LAND OWNED</u>		<u>LIVESTOCK OWNED</u>		
			WET LAND	DRY LAND	BUFFALO	GOATS	POULTRY
RANGE	22-45	0-5	0-2	0-6	0-8	0-4	0-5
MEAN	35	2.6	0.6	0.25	2.0	0.5	0.7
STANDARD DEVIATION	7.1	1.5	0.8	1.0	2.0	1.0	1.2

Although the range in each of these parameters is large, it can be seen from the low mean values that only a few women had a large number of children, livestock and owned a large amount of land. In fact, four women had no children living with her, sixteen women had no wet land, thirty two women did not own any dry land, thirteen women did not own any buffalo, thirty one women did not own any goats and twenty six women owned no poultry.

Therefore, on average these women owned very little land, but many of the subjects owned livestock of some kind - the most common was buffalo - on average two buffalo were owned, two subjects owned as many as eight. The large number of women owning buffalo is largely due to the fact that the government of Andhra Pradesh have a policy of giving low interest loans to these poor people for the purpose of buying buffalo, which they can pay off slowly over the next few years. fewer women owned poultry and even fewer owned goats.

On the other hand the middle income women owned in excess of five acres of wet land, this being one of the criteria for the selection of this middle income group, and often owned either a herd of buffalo, cattle or goats.

Table 8 gives details of the average age, weight, height and BMI of the group of women involved in the diet and BMR survey. These mean values are very similar to the values for the large group of women involved in the anthropometric measurements and are therefore taken to be a representative sub-group of the working women in this village. This is also true for the middle income comparison group, or 'control' group - their mean values fit in with the values for the larger anthropometry group.

TABLE 8

DIET SURVEY SUBJECTS

	Working Women			Middle Income Women	
	n = 40			n = 10	
	Harvest	Lean		Harvest	Lean
	Season	Season		Season	Season
----- -----					
<u>Age</u>					
(mean)	35	35		35	35
<u>Weight</u>					
(mean)	39.3	39.2		48.1	48.3
SD	4.8	4.8		5.7	5.6
<u>Height</u>					
(mean)	1.49	1.49		1.52	1.52
SD	0.06	0.06		0.05	0.05
<u>BMI</u>					
(mean)	17.7	17.7		20.8	20.9
SD	1.88	1.88		1.9	1.9

SEASONAL CHANGES IN ENERGY INTAKE IN WORKING WOMEN

The average of a three day food intake measurement was calculated for forty working women. The three day period was measured once during the harvest season in 1986 and once during the lean season in the same year, and the results are presented in Table 9. A significant difference of around 140 Kcal/day was observed between these two seasons ($P < 0.01$) ie the mean energy intake of forty women in the harvest season was 2030 Kcal/day, whereas in the lean season it was 1890 Kcal/day. Therefore over a period of three months (the duration of the 'lean' season) this represents a total decrease in energy intake of 12,600 Kcal.

However whether this represents an energy deficit of 12,600 Kcal or not, is difficult to say - perhaps during the harvest season these women were taking in an excess of energy. However, with the variation in energy output over the seasons, ie harvesting for a few months, planting for a few months, and relatively little work at other times of the year, it is difficult to obtain the 'habitual' level of energy intake if there is one at all,

when the women are sure to be in energy balance, therefore a comparison of seasons is the only realistic course of study.

In fact Prentice (1984), states that his subjects in the Gambia are probably in negative energy balance during the hungry/farming season, and in positive energy balance during the dry season, but they maintain their body weight from year to year, ie they were in long term energy balance.

TABLE 9

FOOD INTAKE RESULTS

	Working Women			Middle Income Women
	Harvest '86 (Apr-June)	Lean '86 (Aug-Sept)		July 1986
	-----			-----
Mean				
Kcal/day	2030	1890 ***		1760
n	40	40		10
SD	351	378		264
Kcal/kg				
Body Wgt	52	48		37

*** P<0.01 paired sample t - test.

This significant change in energy intake, to a large extent would be expected, considering the variation in food supply throughout the year, and variation in food prices which is a result of food availability. These variations in food intake have been found by many investigators studying the effects of seasonality.

Loutan et al (1984) saw this variation in food intake result in a decrease in weight at the end of the dry season, and an increase in weight at the end of the rainy season when the food was more plentiful, therefore the swing in body weight tend to cancel out over the year as a whole. They also noted swings in the body weights of the children over the seasons but their average weight for the year was normal.

Also Huffman et al (1985) recorded decreases in body weight with increased food prices, followed by increases in body weight corresponding to the drop in food prices after the harvest season. This enabled her subjects to maintain long term energy balance.

Therefore, small changes in food intake over the seasons with the corresponding changes in body weight may not be as unacceptable as often thought. This is provided, however, the drop in body weight at times of food

scarcity is not so large as to prevent the subject from working or to curtail the subjects social activities to any large extent and that there is a consequent increase in body weight after the food shortage is over.

A COMPARISON WITH MIDDLE INCOME WOMEN

As a comparison a group of ten middle income women were each studied for a period of three days during July 1986. These women are relatively wealthy, and therefore would not be subjected to any limitation in food availability. It was observed that they had a lower daily energy intake of 1760 Kcal. This would be expected, since they were not involved in any manual field work, therefore their energy expenditure would be less than that of the working women. Table 8 shows the differences between this group of middle income women and the working women, in terms of height, weight and BMI - the middle income women being heavier, and although they are slightly taller, have a higher BMI value, as was observed in the large anthropometry groups.

In a report by the Indian Council of Medical Research (ICMR) they recommend energy intakes for a reference woman of 45 kg involved in various degrees of activity. However, the working women in this study had an average body weight of around 40 kg which suggests that these

rural working women were considerably lighter than the average or "reference woman" given by the ICMR. The report also gives recommended energy intakes for lighter women involved in various degrees of activity - Table 10.

TABLE 10

	LEVEL OF ACTIVITY		
	Light (Kcal/day)	Moderate (Kcal/day)	Heavy (Kcal/day)
Recommended Energy Intake for a 40 kg Woman	1690	1955	2666

ie, the ICMR report recommend that a lightly active woman of 40 kg have an energy intake of 1690 Kcal/day, a moderately active woman have an energy intake of 1955 Kcal/day and a woman weighing 40 kg and involved in heavy activity have an energy intake of 2666 Kcal/day.

Referring to this, the working women in this study with an average body weight around 39.3 kg and an energy intake ranging from 1890 Kcal/day to 2030 Kcal/day fall into the moderately active group, both in the harvest season and the lean season.

This classification is perhaps to be expected in the lean season when the women are involved in field work for several hours each day. However, the measurements of food intake in the harvest season were carried out after the actual harvesting field work was completed and therefore the women did not work in the fields during these measurements. During this period it may have been thought that these women were only lightly active. However they were involved in many activities other than fieldwork during this time; such as fire wood collection, making cow dung cakes for fuel and spending more time tending to their livestock than during the lean season. These activities are obviously responsible for their relatively high energy requirements during the post harvest season, and result in their classification of "moderately active".

The middle income women with an average body weight of around 48.2 kg and an energy intake of 1760 Kcal/day

fall into the lightly active category as expected since they are not involved in field work and very little housework.

In 1973 FAO/WHO laid down recommendations for energy intake in terms of body weight. For a moderately active woman they suggest an intake of 40 Kcal/KG/day.

(Edmundson, 1980). When applying this to the working women in this study this would represent:

$$40 \times 39.3 = 1572 \text{ Kcal/day}$$

It is therefore apparent that either this recommendation is set too low or these working women are more than moderately active. In fact, their energy intake per kilogram body weight is:

2030 Kcal

----- = 51.6 Kcal/Kg/day in the harvest season

39.3

and

1890 Kcal

----- = 48.2 Kcal/Kg/day in the lean season

39.2

ie, roughly 20% higher than that recommended by FAO/WHO for a moderately active woman.

The middle income women however, have a much lower energy intake per Kilogram, ie:

$$\begin{array}{r} 1769 \text{ Kcal} \\ \text{-----} = 36.5 \text{ Kcal/KG/day} \\ 48.2 \end{array}$$

suggesting that these women are less than moderately active, which would be as expected.

However, in the FAO/WHO/UNU 1985 report, they do not mention this recommendation of 40 Kcal/Kg/day for a moderately active woman. Instead they base their energy requirement recommendations on multiples of the BMR. For a moderately active woman they suggest an energy intake of 1.64 x BMR. Therefore for this group of women:

$$\begin{array}{r} \text{Energy Requirement} = 1.64 \times 0.60 \times 1440 \\ = 1417 \text{ Kcal/day} \end{array}$$

(The mean BMR of these women was measured to be 0.60 Kcal/min. This will be discussed fully later).

This also underestimates the energy requirements for this group of women. There also appears to be large differences in the classification of level of activity these women are involved in between the 1973 FAO/WHO report and the 1985 FAO/WHO/UNU report.

An energy intake of 2030 Kcal/day by these 40 kg women corresponds to the "very heavy" or "exceptionally heavy" classification in the 1973 report. However in the 1985 report, the 2030 Kcal/day energy intake falls between the 1.6 x BMR and 1.8 x BMR, which is fairly low down in their activity scale - the scale increasing as high as 2.2 x BMR. This infers that according to the 1985 report the women would not be classed as involved in heavy activity, but maybe only "fairly active".

It appears that the BMR factor may be causing misleading levels of energy requirements for this group of rural Indian women. Also, the 1973 report appears to have underestimated the requirements of moderately active women and hence classified these women as involved in 'very heavy' activity.

As an observer of the lifestyle and activity patterns of these women over several months in each season it would seem improbable that these women were actually involved in very heavy to exceptionally heavy activity as suggested by the 1973 report.

OTHER STUDIES IN DEVELOPING COUNTRIES

Many studies where energy intake is measured involve pregnant women, and still, in many third world countries, it is found that their intakes are very low even although their energy requirements presumably would be higher than normal. In Tanzania, Maletnlema and Bavu (1974) reported values of 1850 Kcal/day in pregnant women.

Gebre-Medhin and Gobezie (1975) reported intakes of 1840 Kcal/day in low income Ethiopian women during pregnancy. These intakes are very low for pregnant women in developing countries, where they would undoubtedly be involved in manual work.

Paul et al (1979) measured intake levels of 1325 - 1652 Kcal/day for pregnant women and 1184 - 2107 Kcal/day for lactating women. In Guatemala, Shutz et al (1980) carried out a similar study on pregnant and lactating women and saw a range in intakes of 1280 - 2840 Kcal/day and 1500 - 2600 Kcal/day respectively.

Again, these values are exceptionally low, especially the energy intakes of around 1100 - 1500 Kcal/day for pregnant or lactating women. Perhaps these values were not the habitual or "normal" values for energy intake,

and the women in the study for some reason decreased their intake at the time of measurement - perhaps for some social or cultural reason.

Norgan et al (1974) studied the energy intake and energy expenditure of New Guinean adults and found that there was a discrepancy of around 400 Kcal/day between them, ie the energy intake was measured to be 400 Kcal/day less than the energy expenditure.

Over the period of 9 - 10 months of the study this would represent a discrepancy of around 114,000 Kcal. If this was a real 'deficit' it would result in a loss of around 16 kg body weight. Obviously there are some methodological errors either in the measurement of expenditure or intake.

Shetty (1984) recorded very low energy intakes of low income Indian labourers - 1530 Kcal/day. These intakes are much lower than the recommended standards given by FAO/WHO, as well as the Indian standards, given by the Indian Council of Medical Research. These men were physically active, and had satisfactory cardiovascular function. However, the method of assessment of food intake Shetty used was based on recall which can be unreliable, although Shetty states it was backed up by a one day weighed intake.

It is difficult to assess the extent to which the subject changes his/her food habits at the time of measurement, or eats secretly if for some social or cultural reason the subject wants to minimise the amount of food he/she is seen to eat.

Ashworth, in 1968, decided to test the measured intakes of 10 Jamaican farmers. Their 'usual' diet had been measured the week before in their own homes, and appeared to be very low - around 1700 Kcal/day. She admitted the 10 farmers to hospital and fed them this measured 1700 Kcal/day. Only two farmers could sustain their weight; the other eight lost weight. Ashworth rightly concluded that surveys reporting very low intakes must be suspected of underestimation. Perhaps the subjects had not been monitored throughout the full day, and had opportunities to eat extra food. In this study the women in Hyderabad were monitored from 6 am - 9 pm; therefore, they had little opportunity to eat extra food without it being monitored. However, the energy intakes measured appear to be relatively high, so there is no real indication of any underestimation.

Over and above these low intakes recorded in developing countries is the effect of the season on food intake, ie the varying food availability at different times of the year depending on the harvests.

In this study a significant decrease in energy intake was observed in the lean season during the months of July to September. Other studies have reflected this too. The National Nutrition Survey in the rice growing areas in Bangladesh (1962 - 1963 and 1975 - 1976) indicated a higher energy intake following the rice harvest, as would be expected, and measurements of lower intakes were obtained in the lean season, just before the monsoon harvest.

Rao et al (1961) recorded that in the North Arcot District in Southern India, the families' consumption of different foods was related to the seasonal availability as a result of the harvest periods, with the highest energy intakes of 1856 Kcal/day during the harvest season and 1516 Kcal/day during the months of the lean season.

Sundaraj et al (1969) looked at the seasonal variations in the dietary intake of children between the ages of 1 - 5 years in southern India. These were children of agricultural workers, either working in their own fields

or as tenant farmers or hiring themselves out by the day, to more wealthy land owners. Sundaraj and his colleagues measured the individual weighed intake of each child over three consecutive days. They recorded the highest intakes during the months April to June, which is the harvest season in Southern India, and a similar finding to that found in this study in Edulabad, Hyderabad. The lowest intakes were measured in September - the rainy season, also similar to the findings in the working women in this study. Sundaraj et al pointed out that children's diets were subject to seasonal availability of foods, but differences in energy intake, corrected by kilogram of body weight were not significant.

Andhra Pradesh is prone to drought and in a study by Swaminathan et al (1967) just after the 1965 - 1966 droughts they recorded intakes of less than 500 Kcal/day, where these people had resorted to eating wild leaves and berries to supplement their intake. If these were real intakes it is obvious that they could not survive very long under these conditions, as the energy required to maintain their basal needs would be at least twice this intake.

This study was conducted using the questionnaire method and recalling the foods eaten the previous day. This is not the best method to use, especially in times of drought and food scarcity, when families may want to minimize the amount seen to be eaten by them. Therefore 500 Kcal/day is very likely to be an underestimation. However, this is an extreme case of how the seasons can affect the food intake.

Obviously the seasonal fluctuations in food intake are more intense in climates with only one rainfall per year. In this region of Andhra Pradesh there were two harvests per year, so their second crop probably helps to smooth out any variations in food availability.

In one area of Africa where only one crop per year is possible Schofield (1974) saw a significant difference between food intake in the wet season in 25 villages when it was only 88% of the recommended daily allowance, (FAO/WHO(1973) recommendations) and the dry season, when it was 100% of the recommended daily allowance.

However, in areas where two crops per year were possible, no variation in food intake was seen by Schofield. In a review by Longhurst and Payne (1979) they comment on data by Jones from Swaziland, where there were large

variations in food consumption between regions and seasons. In the areas where there was a constant rainfall throughout the year, there was little difference in food intakes, whereas in areas where there were definite wet and dry seasons there were large differences in energy intake. However larger intakes were observed during the wet season than the dry season, which is in contrast to this study in Edulabad, where it was during the dry season that the largest intakes were observed.

In Swaziland therefore it is probable that the higher intakes were a result of the higher energy expenditure during the rainy season.

There are other reports of seasonal fluctuations where energy intakes are lower during the hungry pre-harvest season and recently Benefice et al (1984) reported large deficits between energy intake and expenditure in both the wet and dry seasons. Benefice noted that in Senegal the deficit was 260 Kcal during the wet season and around 500 Kcal during the dry season. Accompanying these differences in intake and expenditure was a decrease in subcutaneous fat and a loss of weight among the adults.

In fact most of the evidence on seasonal variation and nutritional status in developing countries is derived from studies in Africa. Sai (1969) in West Africa, saw the annual 90% - 95% of total energy requirements can drop to 80% in the preharvest period and as low as 50% if the previous year provided a poor harvest.

Seasonal intake data from Ghana also show a decline in energy intake during the hungry season and a comparatively higher intake during the post harvest season when local foods are abundantly available. Annegers (1973) reviewed the seasonal food availability in West Africa and concluded that the highest intakes occur during the November-December post harvest period, declining through the following months to minimal intakes during July - August.

BASAL METABOLIC RATES

ENERGY REQUIREMENTS AND BASAL METABOLIC RATE

The largest component of energy expenditure and therefore energy requirement is the basal metabolic rate.

Fortunately the BMR can be measured with accuracy under standardised conditions and from these measurements recommended energy requirements can be made. The FAO/WHO/UNU committee (1985) adopted the principle of calculating all components of total energy expenditure as multiples of the basal metabolic rate.

The BMR itself can be estimated principally by body size, body composition and age, the most important index is body weight. In the FAO/WHO/UNU report, in each age-sex group the BMR has been estimated from the body weight by simple linear equations. To obtain the total energy requirements, the estimate of the BMR is multiplied by a factor that covers the energy cost of increased muscle tone, physical activity, the thermic effect of food, and, where relevant, the energy requirement for growth and lactation. This estimate of energy requirement for the individual is therefore the level of energy intake from food that will balance energy expenditure when the individual has a certain body size, body composition and level of physical activity, is consistent with long term good health and allows for both economically and socially desirable activities.

DETERMINANTS OF ENERGY REQUIREMENTS

Since energy needs are determined, obviously, by energy requirements, the WHO/FAO/WHO (1973) committee recognised that the estimates of requirements should be based on measurements of energy expenditure. However, this kind of information is very difficult to obtain and often the only way to obtain a measure of energy requirement is from measurements of energy intake, assuming that the people under study are in energy balance at the time of measurement. However in populations where they are not always in steady state, or the effects of disease complicate the situation, it is not possible to obtain a 'habitual' intake which would provide these populations with the necessary energy requirements. In cases like these it is necessary to estimate energy requirements from other parameters.

In many populations (especially sedentary populations) the basal metabolic rate is one of the prime factors in determining the individuals energy requirements. Of course any amount of physical activity over and above this will increase the person's requirements. However, the basal metabolic rate still constitutes a very large proportion of the energy expended, as the examples below illustrate.

A 25 year old man weighing 65 kg has a predicted BMR of 1680 Kcal/day (FAO/WHO/UNU, 1985). The FAO/WHO/UNU committee (1985) recommended various intakes for this man depending on the type of work he is involved in.

OCCUPATION	RECOMMENDED INTAKE	PERCENTAGE BMR CONSTITUTES OF TOTAL INTAKE
------------	--------------------	--

Bank Clerk (Light activity work)	1.54 x BMR = 2580 Kcal/day	65%
Subsistence Farmer (Moderate activity work)	1.78 x BMR = 2780 Kcal/day	60%
Engaged in heavy work	2.14 x BMR = 3490 Kcal/day	48%

From this table it can be seen that as the level of activity the man is involved in increases, the BMR represents a smaller and smaller proportion of the

overall energy required. However even a man engaged in moderate activity the BMR represents more than half his overall expenditure, and if involved in heavy work it just falls below half (48%).

The BMR is therefore perhaps the most likely place adaptation would occur in times of reduced energy intake, since a small change in BMR could quite markedly affect the overall energy requirements.

Therefore in this study it was very important to measure the basal metabolic rate of the working women in both the harvest season and the lean season to detect any metabolic adaptation to the reduction in energy intake over the same period of time. Fortunately, as mentioned before, the BMR can be measured very accurately under standardized conditions to obtain repeatable results.

The basal metabolic rate of 29 working women was measured twice during the harvest season and twice during the lean season of 1986.

The average of the two-day measurements in each season for each woman, was taken to represent her BMR at that period of time. It can be seen from Table 11, from the

harvest season to the lean season, the average BMR of the 29 women tended to decrease. However, it was a small decrease and failed to reach significance, ie

Harvest Season: Average BMR = 0.61 Kcal/min = 878 Kcal/day

Lean Season : Average BMR = 0.58 Kcal/min = 835 Kcal/day

However, if this small decrease is real it could represent a saving of 43 Kcal/day and over a period of three months (the duration of the lean season) this could represent a total saving of around 4,000 Kcal.

Often estimated BMRs are quoted for the "reference" or "standard" women of 50 kg. This simplifies comparisons between populations, where it might not be immediately obvious to the reader the large effect weight has on the BMR. Therefore in Table 11 the BMR results have been "standardized" to a 50 kg 'standard' woman.

TABLE 11

BASAL METABOLIC RATE RESULTS

Working Women

	Harvest 1986 Season	Lean 1986 Season
<u>Kcal/min</u>		
mean	0.61	0.58
		Not Significant
n	29	29
SD	0.07	0.09
<u>Kcal/min/50KG</u>		
mean	0.79	0.75
n	29	29
SD	0.10	0.10
<u>Kcal/24 hr/50KG</u>		
mean	1130	1080
SD	168	137

(FAO/WHO/UNU predicted BMR for a 50 kg woman = 0.85

Kcal/min; RSD +/- 0.007)

This decrease in basal metabolic rate could be thought to be the result of the slight decrease in weight over the same period of time, ie as a result of the reduction in metabolically active body tissue. However, this is obviously not the case, as it can be seen that when the BMR is corrected for body weight, and expressed in the form of Kcal/min/50 kg, there is still a reduction in BMR from the harvest season to the lean season (0.79 Kcal/min/50 kg to 0.75 Kcal/min/kg respectively); see Table 11.

By western standards 0.61 Kcal/min is considered a very low BMR, but it may just be the result of the very low body weights of the subjects. However when the BMRs were corrected for body weight - to the "standard" 50 kg woman, it was still very low ie 0.79 Kcal/min/50 kg compared with western standards. Using the FAO/WHO/UNU (1985) equations, the reference woman of 50 kg is predicted to have a BMR of 0.85 Kcal/min.

In the report by the FAO/WHO/UNU committee (1985) their suggested equations for the prediction of BMR are based on either weight, or weight and height. Therefore for a woman between the ages of 30 - 60 years with a weight of 39.7 kg:

$$\begin{aligned}
 \text{BMR} &= 8.7 \times \text{weight} + 829 & \text{RSD} &= 108 \\
 &= 1174 \text{ Kcal/day} \\
 &= 0.816 \text{ Kcal/min}
 \end{aligned}$$

or

$$\begin{aligned}
 \text{BMR} &= 8.7 \times \text{weight} - 25 + \text{height} + 865 & \text{RSD} &= 108 \\
 &= 1173.1 \text{ Kcal/day} \\
 &= 0.815 \text{ Kcal/min}
 \end{aligned}$$

(Weight = 39.7 kg; Height = 1.49 m)

It can be seen here that when height is included into the equation it has very little, or no effect on the predicted value of BMR. However, these predicted values are far in excess of the measured BMR of the working women in this study.

Even if the lower end of the normal range is calculated, ie

$$\begin{aligned}
 &\text{predicted BMR} - 2 \text{ SD} \\
 &= 1174.4 - (108 \times 2) \\
 &= 958.4 \text{ Kcal/day} \\
 &= 0.666 \text{ Kcal/min}
 \end{aligned}$$

this is still higher than the average BMR value for the group of 29 working women in this study, which was 0.61 Kcal/min in the harvest season and 0.58 Kcal/min in the lean season.

However, the authors of the joint FAO/WHO/UNU report mention that investigators may find that the BMRs of the subjects in their particular country do not agree with the general equations they have stated. They mention the fact that many investigators have found Indian subjects to have BMRs approximately 10% below the average BMR of other populations of equivalent age, height and weight for height. This 10% reduction can be calculated in terms of the 24 hour BMR. For example, the 24 hour BMR can be calculated for the women in this study:

$$0.60 \text{ Kcal} \times 1440 \text{ minutes} = 864 \text{ Kcal/day}$$

A 10% increase in this would result in an increased expenditure of around 90 Kcal/day. In terms of total daily energy expenditure - for these women it was around 2000 Kcal, 90 kCal this does not seem very significant. However it could be a small but important energy saving adaptation over months or years of decreased food availability.

However, the FAO/WHO/UNU (1985) committee state that these observations are not in themselves evidence for ethnic difference in BMR and therefore still adopt these general equations for all ethnic groups. The committee state that there is no reason to suggest that these differences were a result of anything other than differences in nutritional state or possibly to climatic differences.

AN ALTERNATIVE STATISTICAL TEST

It was thought that the small differences in food intake, basal metabolic rate, the BMR factor and the predicted VO_2 max between seasons may be shown to be significant if the average difference between each set of data was tested, instead of comparing the absolute mean of each set of data, and testing whether this difference was significantly different from zero. If it was not significantly different from zero this would indicate there was no seasonal difference between the two measurements. This was also performed for the anthropometric data, as mentioned earlier.

However it can be seen from Table 12 that there were no new significant differences between the seasons in any of these parameters that was picked up using this, perhaps more sensitive, test. This could largely be due to the standard deviation of the differences being large in comparison to the mean difference between the seasons, or put simply, although there did seem to be a difference in all the sets of data between seasons, it was too small to show up to be significant.

TABLE 12

A More Sensitive Significance Test For Basal Metabolic Rate (BMR),
BMR Factor, Food Intake and The Step Test

Parameter	Year	n	Mean Difference Between Seasons	SD of the Difference	Significance Level	Previous Significances Level
Food Intake (Kcal/day)	1986	40	168.3	331.7	0.01	0.01
BMR x 24 hrs (Kcal/day)	1986	29	40.5	127.3	N.S.	N.S.
BMR Factor	1986	29	0.115	0.5	N.S.	N.S.
Step Test VO ₂ Max (ml/kg.min)	1986	17	2.69	7.95	N.S.	N.S.

$$\text{BMR Factor} = \frac{\text{Food Intake (Kcal/day)}}{\text{BMR x 24 hours (Kcal/day)}}$$

N.S. = Not Significant

NB: The large standard deviation of the difference indicates a large range in the magnitude of the difference between seasons.

Seasonal variations in BMR have not been well documented, and only a few studies are available on this topic. However, in one study in the Gambia, Lawrence et al (1984) saw a seasonal effect on the BMR, with the lowest BMR measured between August and November, which coincides with the hungry season. They found a significant reduction in BMR of 50 Kcal/day. During this period the lowest energy intakes and body weights were recorded, although there was no loss of lean tissue (no change in total body water). This indicates these individuals were in negative energy balance, using their fat reserves as an energy source.

This reduction of 50 Kcal/day in their resting metabolic rate agrees with the findings in Edulabad of the 29 working women. On average the reduction in their BMR represented a daily saving of 43 Kcal.

Ghali and Durnin in 1977 showed the metabolic adaptation to an experimental period of 20 months of over and under-eating in the UK. There was a progressive decrease in BMR during the periodic reductions in food intake.

At the end of 20 months when the body weight was back to normal, the BMR was still 15% lower than it was at the beginning of the study, ie the long term physiological

adaptation to the low food intake had resulted in the requirements for energy balance at the original body weight being very much less than the requirements at the beginning of the study. This might be similar to the situation in many developing countries where a succession of periods of reduced energy intakes results in an overall lowering of the BMR.

Jayo Rao and Khan (1974) measured the BMRs of clinically undernourished and normal Indian children. They observed highly significant differences in their BMRs, of the order of 2:1 ($P < 0.001$). Even after 30 days of dietary treatment the BMRs of the undernourished groups were still significantly lower than the normal children. It is difficult to say whether this is phenotypic adaptation, where the lower BMR has developed over the years as a result of low food intakes, or that only those children with a low BMR survived the periods of low intakes - genotypic adaptation, ie in developing countries where food deprivation favours the survival of those more metabolically efficient are therefore 'selected' to survive, and in turn pass on their inherited low BMR to their offspring.

However, from the Ghali and Durnin's study it does seem feasible for the BMR to decrease significantly and stay low even after the period of energy restriction is over, which favours the phenotypic adaptation.

Of course it could be a combination of both, geno and phenotypic adaptation.

A COMPARISON STUDY OF BASAL METABOLIC RATES OF INDIAN
WOMEN IN GLASGOW

To test the theory that the very low BMRs of the rural Indian women was not due to real ethnic differences but due to climatic or nutritional differences, a small study was carried out on 15 Indian women living in Glasgow. These women had recently moved to Glasgow from India, often due to their husbands studying or working in Glasgow, and intended to return to India after a few years.

The basal metabolic rate of these 15 women was measured in exactly the same way as the working women in India, ie by the open circuit method, using Douglas Bags. On average these women were slightly younger than the group in India. From Table 13 it can be seen that their average BMR was higher than that measured in India - ie 0.900 Kcal/min. However, this was largely due to their higher body weight, which was, on average, 55.7 kg, compared to 39.3 kg for the Indian women in Hyderabad ($P < 0.001$).

TABLE 13

BMR OF 15 INDIAN WOMEN LIVING IN GLASGOW

Subject	Age	Weight (kg)	BMR Kcal/min	BMR Kcal/min/50Kg
1	24	48.5	0.912	0.940
2	27	51.5	0.878	0.852
3	43	54.5	0.840	0.770
4	25	41.0	0.880	1.073
5	23	49.5	1.021	1.031
6	19	75.9	1.060	0.698
7	18	56.4	0.940	0.833
8	22	62.2	0.890	0.715
9	33	54.0	0.824	0.763
10	30	53.5	0.911	0.851
11	17	57.1	0.800	0.700
12	28	53.5	0.920	0.860
13	35	76.0	1.160	0.763
14	29	52.5	0.706	0.672
15	29	49.5	0.760	0.768
Mean	26.8	55.7	0.900	0.820
SD	6.9	9.4	0.12	0.12

The BMRs were therefore corrected for weight in order to be able to compare the BMR for both groups of women.

Indian Women in Glasgow : BMR = 0.82 Kcal/min/50 Kg

Indian women in Hyderabad: BMR = 0.79 Kcal/min/50 Kg
(Harvest Season)

Indian women in Hyderabad: BMR = 0.75 Kcal/min/50 Kg
(Lean Season)

Using a t-test for these two groups of results it was shown that the Indian women living in Glasgow had a significantly higher BMR than the working women in the lean season in India ($P < 0.05$) but it just failed to be significantly different than the working women during the harvest season.

Of course the Glasgow Indian women's absolute BMR (Kcal/min) was very significantly higher than the Hyderabad Indian women's BMR ($P < 0.001$) but this was, as mentioned before, due to the large significant difference in the average weight of the two groups.

The average BMR value for the Indian women in Glasgow is still slightly lower than the FAO/WHO/UNU equations predict, ie 0.855 Kcal/50 kg/min, but within the 'normal' range.

From their report, for a woman between the ages of 18 - 30 years they predict her BMR to be:

$$\begin{aligned}
 \text{BMR} &= 14.7 \times \text{weight} = 496 & \text{RSD} &= 121 \\
 &= 14.7 \times 50 + 496 \\
 &= 1231 \text{ Kcal/50 kg/day} \\
 &= 0.855
 \end{aligned}$$

The range for a 50 kg woman would be 1231 +/- 2 RSD/Day

$$\begin{aligned}
 &= 1231 \text{ +/- } 242 \\
 &= 989 - 1473 \text{ Kcal/50 kg/day} \\
 &= 0.687 - 1.023 \text{ Kcal/50 kg/min.}
 \end{aligned}$$

The fact that these Glasgow Indian women do tend to have a higher BMR per Kg body weight than the working women in India may be due to the cooler climate or better nutrition in Glasgow. It must be noted that the Indian women in Glasgow would be of a much higher socio-economic group than the working, low income, women in Hyderabad, and therefore it would be expected that their nutrition

would be very much better. However this small study tends to oppose the theory that Indians genetically have a lower basal metabolic rate than western populations.

Unfortunately, it was not possible to measure the BMRs of the middle income women in Hyderabad - the middle income women being very much less co-operative than the working women. It would have been interesting to investigate whether their BMRs were similar to the BMRs of the Indian women living in Glasgow, or whether it would be closer to the working women's BMR from the same village.

Schofield et al (1985) in his extensive review of BMR measurements in developing countries concluded that the BMR of Indians was 9% lower than the expected rate based on weight for height of Europeans. However, he notes that they may not be ethnic differences in themselves, but may be due to other variables confounded with ethnicity, for example, nutritional status. From Schofield's equations to predict BMR, he claims that in the case of Indian women, they overestimate the BMR by 14.4%

Therefore when the average weight of the 29 rural Indian women in this study is used in Schofield's equation and 14.4% subtracted, the predicted BMR is very close to the BMR actually measured ie,

average weight = 39.25 kg

$$\begin{aligned}
 24 \text{ hr BMR (MJ)} &= 3.4702 (\log \text{ weight}) + 0.2566 (\log \\
 &\quad \text{weight})^2 - 1.2366 \\
 &= (3.4702 \times 1.5938) + (0.2566 \times 1.5938) \\
 &\quad - 1.2366 \\
 &= 4.460 \text{ MJ/24 hours} \\
 &= 0.737 \text{ Kcal/min}
 \end{aligned}$$

Subtract 14.4% = 0.631 Kcal/min.

This compares well with the mean BMR measured during the harvest season which was 0.610 Kcal/min for the group of working women. Perhaps, therefore, Schofield's equation, minus the 14.4% correction factor should be employed when calculating the energy requirements of rural working Indian women.

However, when the same equation is applied to the well fed Indian women in Glasgow, the predicted BMR, even without the 14.4% correction factor, is lower than the average measured BMR:

Measured BMR = 0.900 Kcal/min. Average weight = 55.7 Kg.

Predicted 24 hour BMR :

$$\begin{aligned}(\text{MJ}) &= (3.4702 \times 1.746) + (0.2566 \times 1.746)^2 - 1.2366 \\ &= 5.0226 \text{ MJ/day} \\ &= 0.830 \text{ Kcal/min}\end{aligned}$$

If the 14.4% correction factor is subtracted BMR would equal 0.710Kcal/min which would be an even bigger under-estimation of the BMR of these well fed Indian women in Glasgow.

In conclusion it appears that Schofield's equations are best suited for rural Indian women living in Indian only if the Schofield's correction factor is taken into account.

Shetty (1984) measured the BMR of very low income Indian manual workers who had low energy intakes. He found that their BMR was lower than the well fed Indian controls and 17% lower than expected for Caucasians of the same body weight ie 83% of the expected BMR.

The working women in this study in Edulabad had a BMR 10% lower than the predicted BMR, based on weight and height (FAO/WHO/UNU 1985) which would agree with Schofield et al (1985) findings. They also had a BMR which was around 30% lower than the Indian women living in Glasgow, but when corrected for body weight was only 4% lower in the harvest season and 8.5% lower in the lean season.

It is possible that there is some sort of adaptation present in these Indian populations. This is apparent when they are compared to the effects of reduced intake on normally well fed individuals. Keys et al (1950) noted a reduction in BMR of more than 30% in his subjects after 24 weeks of semi-starvation, ie there was a much greater reduction in the BMR of the Americans exposed to a relatively short period of energy restriction compared to Indians who are exposed to energy restrictions throughout their lifetime.

This represents a successful adaptation, especially, bearing in mind that the Indians are active and fit whereas Key's subjects were not.

Many studies have compared the BMRs of European populations with the Indian population, and in a study in 1981 Schofield and colleagues measured the BMRs of well fed Indian medical students, and found that for the same

body weight the Indians have a lower BMR than Europeans. Mason (1934, 1964, 1972) has also reported lower BMR values for the Indian population than would be expected taking body weight into consideration. This would tend to support the theory of there being ethnic differences in BMR. However, the comparison study carried out here, in Glasgow, does not support this view, and more work would be necessary to verify the ethnic differences, if any exist, in BMR.

BMR FACTOR

In the 1985 report by the FAO/WHO/UNU joint committee, a table was presented of the average daily energy requirements of adults whose occupational work is classified as light, moderate or heavy, expressed as a multiple of BMR:

Table 15 from FAO/WHO/UNU (1985)

	<u>Light</u>	<u>Moderate</u>	<u>Heavy</u>
Men	1.55	1.78	2.10
Women	1.56	1.64	1.82

eg, for women involved in moderate physical activity the report recommends her energy intake to be 1.64 x BMR (Kcal/24 hours). However, when the energy intake of the working women in this study is calculated in terms of a multiples of the BMR it is a great deal higher than the recommended intake even for a woman involved in heavy physical activity.

TABLE 14

WORKING WOMEN

		<u>Harvest Season</u>	<u>Lean Season</u>
<u>Kcal/day</u>	mean	2.29	2.16
BMR x 24 hrs	n	29	29
	SD	0.41	0.41

ie, in the harvest season the mean intake of the 40 working women is 2.29 times her BMR, and in the lean season it drops very slightly to 2.16 times her 24 hour BMR. This would infer that these women had an exceptionally high energy expenditure when expressed in terms of multiple of their BMR, with respect to the recommendations given in the joint report mentioned above.

It was apparent, however, that although these working women were involved in field work for several hours during the lean season, and additional housework and animal care during the harvest season, it was unlikely

that this constituted exceptionally heavy activity. This sheds some doubt on the validity of the recommended energy requirement classifications of the FAO/WHO/UNU. Perhaps some revision is necessary especially for populations such as this who have very low basal metabolic rates.

However, the committee emphasize that these values given for the BMR factor are intended to be general guidelines for estimating the total energy requirements and it may vary with varying characteristics of each population. This would appear to be the case for this population, where their BMR is lower than many Western populations. Therefore if these women were classified as moderately active agricultural labourers, and their energy requirements calculated as a multiple of their BMR this would result in a large underestimation of their energy needs, ie

$$1.64 \times \text{BMR} = 1.64 \times 0.60 \times 1440$$

$$= 1417 \text{ Kcal/day}$$

(their measured daily energy intake was around 2000 Kcal/day).

Even if their agricultural work was classified as "heavy", their energy requirements would still be underestimated, ie

$$1.82 \times \text{BMR} = 1.82 \times 0.60 \times 1440$$

$$= 1572 \text{ Kcal/day}$$

Therefore it appears these BMR factor values are set too low for this female group of agricultural labourers in India, and perhaps some correction should be made for Indian populations. In populations therefore with low basal metabolic rates, and who are employed in moderately active work, the BMR may not be the best guideline in calculating the energy requirements for that population.

However, this group of working women did have a very high ratio of total energy expenditure to BMR. (taking the total energy intake per day to be approximately equal to their daily energy expenditure)

Since the type of work they were involved in did not appear to be very heavy or requiring a very high energy output, it may have been the length of time the women were involved in these activities that resulted in a high total energy expenditure.

For a start, their day-length was long. They woke around 5 am and in the evening often went to bed after 10 pm. Obviously they have no automated or electrical household equipment to perform the housework or cooking, so they had to perform fairly long and tedious tasks such as pounding rice, or separating the rice grains from small stones with a sieve, or collecting small peices of wood and twigs to make the fire just to make a meal. Also their only mode of transport was by walking. Although many of their husbands owned bicyles, the women did not cycle, so if they were working in a field several kilometers from the village their only option was to walk. All these activities add up to a fairly high expenditure. A following section - "Activity Patterns Results", looks at the women's day in detail and breaks it down into 10 various types of activity.

EXERCISE CAPACITY TEST : THE STEP TEST

Another important aspect in energy saving adaptations is an increased metabolic efficiency in performing certain work tasks. This could take several forms, from actual changes in activity patterns or the way in which the activity is performed, to changes in the energy cost of the activity.

Prentice (1984) supports the idea that people in certain communities are more metabolically efficient than others, and that mechanisms exist which could theoretically spare sufficient energy to account for the observed differences in energy intake.

During the periods of reduced energy intake, the corresponding reduction in body weight in itself results in energy savings when tasks involving movement of the body are involved. Therefore it may be that the energy expended performing a certain work task is greater during the harvest season than during the lean season when the average body weight was less.

It is also interesting to measure the work capacity of a population. Often it is thought that very lean populations, subsisting on low energy intakes also have low work capacities. Often this is not the case.

In this study, the step test was chosen as a simple test to measure the aerobic work capacity of a subgroup of the working women.

THE STEP TEST

Respiratory Quotient and 'True Oxygen'

Unfortunately there was no carbon dioxide analyser available to measure the subject's carbon dioxide output in her expired air during the test. Therefore, to calculate the oxygen consumption it is necessary to assume that the respiratory quotient (RQ) is equal to some value. Since the diet of the subjects consisted very largely of rice, ie carbohydrates, and very little fats, it was assumed that their RQ would be very close to 1.00. If their RQ was in fact less than 1.00, as is often the case in conditions of rest or moderate exercise, then the oxygen removed from the inspired air is only partly replaced by carbon dioxide and hence their 'True Oxygen' uptake will be underestimated, and hence will result in an underestimation of their VO_2 max.

However, since the principal purpose of these exercise tests was to compare this group of women with themselves in two different seasons, if any error was present in the first set of measurements hopefully the same error will be present in the second set of measurements and therefore will not have an effect when comparing the two sets of data, or result in any bias towards one particular set.

Step Test Subjects

Seventeen of only the most co-operative subjects took part in the exercise test, because it was necessary for them to complete the whole test, in each season, for a direct comparison to be made. Table 15 gives a summary of their physical characteristics. It can be seen that these women are fairly representative of the larger group, with a similar mean weight of around 39.5 kg, and a similar low BMI of around 18.4. There was only a small non-significant drop in weight from the harvest season to the lean season.

TABLE 15

SUBJECTS INVOLVED IN THE STEP TEST (WORKING WOMEN)

	<u>Harvest Season</u>	<u>Lean Season</u>
Number of Subjects	17	17
Mean <u>Age</u>	33	33
SD	6.0	6.0
Mean <u>Height</u>	146.8	146.8
SD	6.23	6.23
Mean <u>Weight</u>	39.6	39.4
SD	4.8	4.8
Mean <u>BMI</u>	18.4	18.3
SD	2.1	2.1

The raw data of the step test can be seen in Table 16. From Figure 28 it can be seen that there was very little change in the aerobic capacity of the working women from the harvest season to the lean season in 1986.

TABLE 16

Step Test N = 17 Working Women

Subject	Age	Harvest Season			Lean Season			VO ₂ (Level 2)	HR	VO ₂ (Level 3)	HR	VO ₂ (Level 3)	HR
		VO ₂ (level 1)	HR (level 1)	VO ₂ (level 2)	HR (level 2)	VO ₂ (level 1)	HR (level 1)						
1	27	8.9	107	15.1	114	19.7	127	10.8	105	14.0	113	17.7	120
2	40	8.3	95	14.9	108	18.9	115	10.6	91	14.6	103	16.7	107
3	28	11.3	86	15.8	103	18.8	119	10.4	87	10.0	95	11.4	106
4	38	12.5	85	17.6	105	20.7	109	13.6	72	17.0	94	18.3	102
5	31	8.0	97	12.3	114	16.0	136	9.8	97	15.3	118	17.1	129
6	30	6.3	88	8.11	107	12.3	124	9.1	87	12.1	100	-	-
7	38	12.0	74	17.5	95	19.7	-	10.1	92	13.9	101	-	-
8	35	11.4	97	15.7	115	19.7	137	8.2	90	13.8	105	16.7	121
9	22	10.2	96	17.0	117	21.6	133	12.3	103	14.9	117	19.1	131
10	30	8.9	95	16.7	109	24.0	127	10.8	98	15.7	105	19.9	130
11	30	6.9	97	14.5	117	16.7	130	11.3	100	14.8	116	21.9	128
12	25	12.1	88	15.6	107	18.7	115	10.6	86	11.4	90	14.9	100
13	33	11.3	92	13.6	107	-	-	8.6	85	13.5	99	16.1	113
14	40	9.0	104	12.1	119	-	-	10.1	106	12.6	121	15.5	133
15	35	12.2	89	14.1	94	17.8	106	8.2	85	15.1	94	17.3	107
16	36	10.3	86	12.1	92	14.9	102	11.5	80	15.6	91	18.6	103
17	45	7.5	103	10.4	120	-	-	8.3	101	16.2	123	20.7	144
n:	17	17	17	17	17	14	13	17	17	17	17	15	15
mean:	33	9.8	93.0	14.3	108.4	18.5	121.5	10.3	92.0	14.1	105	17.5	117.6
Standard Dev.	6	2.0	8.2	2.6	8.7	2.9	11.5	1.5	9.4	1.8	11.0	2.6	13.4

Mean Weight = 39.6 SD = 4.8
 Mean Height = 146.8 SD = 6.23
 Mean BMI = 18.4
 Mean Weight = 39.4 SD = 4.8
 Mean Height = 146.8 SD = 6.23
 Mean BMI = 18.3

STEPTEST:

Predicted Maximum Aerobic Capacity of 17 Rural Working Women

Fig. 28

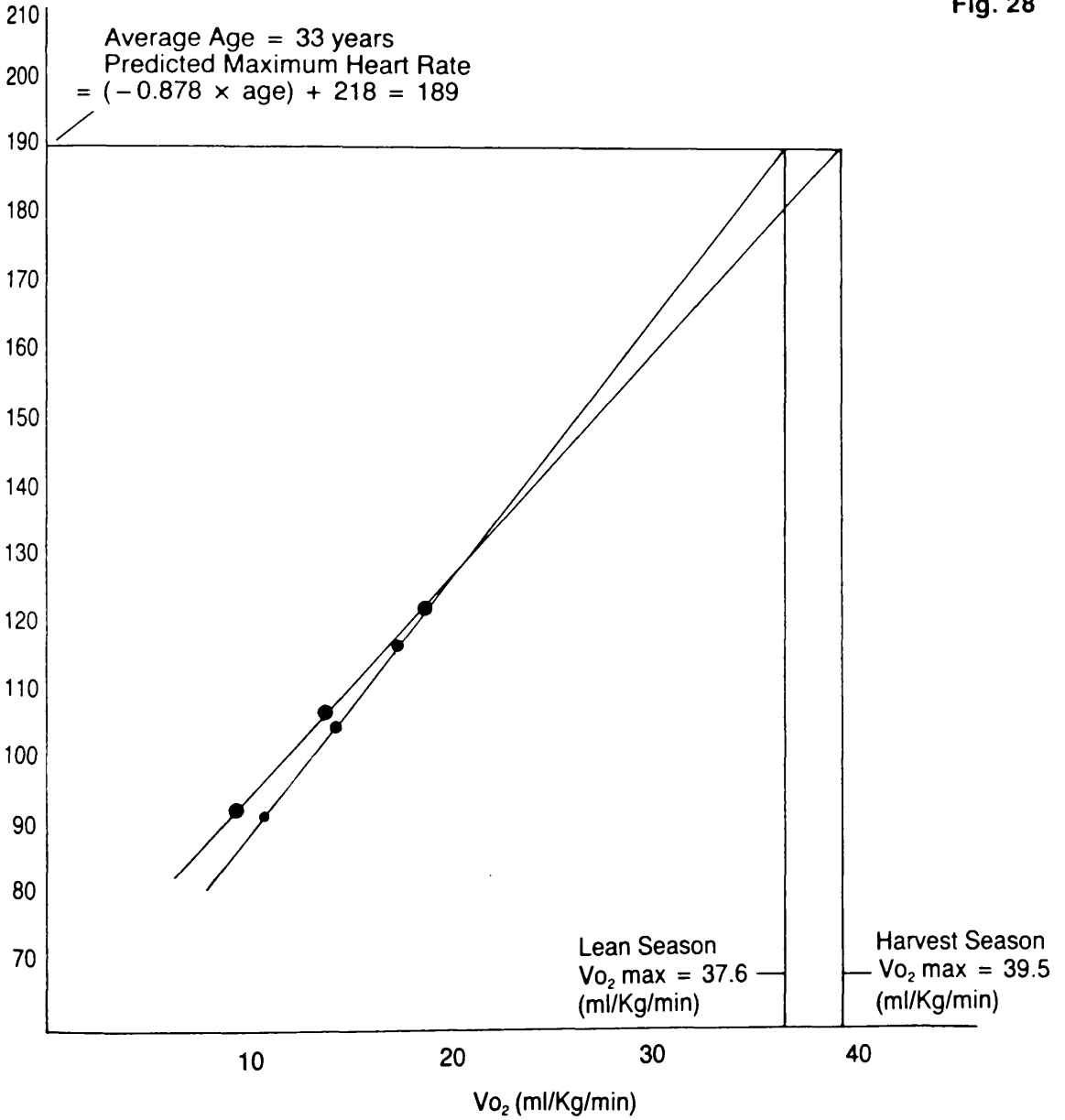

When the measurements were made at the end of the harvest season, this group of 17 women had an average predicted VO_2 max. of 39.5 ml/kg/min. Three months later during the lean season it had decreased very slightly to 37.6 ml/kg/min. This difference was not statistically significant.

The predicted maximum heart rate was calculated using a linear regression equation derived by Astrand (1970):

$$\begin{aligned} \text{Predicted max. heart rate for women} &= (-0.878 \times \text{age}) \\ &+ 218 \end{aligned}$$

$$r = 0.994$$

Therefore for this group of women, whose mean age is 33 years:

$$\begin{aligned} \text{Predicted max. heart rate} &= (-0.878 \times 33) + 218 \\ &= 189 \text{ beats/minute} \end{aligned}$$

The resulting VO_2 max. values for these women is quite high, when comparing them to the Cardio-respiratory Fitness Classification given by the Preventive Medicine

Centre, Palo Alto, California. For a woman between the age of 30 - 39 years, their classifications are as follows:

VO ₂ Max	Low	Fair	Average	Good	High
ml/kg/min	<20	20-27	28-33	34-44	45+

Therefore this group of working women falls into the 'Good' category.

However, Astrand (1960), categorizes aerobic work capacity slightly differently ie. for a woman between the ages of 30 - 39 years:

VO ₂ Max	Low	Fair	Average	Good	High
ml/kg/min	<27	28-33	34-41	42-47	48+

Using Astrands Classification, these women with an average VO₂ max of 39 ml/kg/min would fall into the 'Average' group.

However, these fitness categories are usually based on fitness assessments using either the treadmill or the bicycle ergometer. So if a direct comparison is to be made between these working women and the standard classifications, their VO_2 max. values should be increased by 8.6% due to the fact their fitness was assessed using the Step Test. This was discussed in the methods section and the experimental data to validate adding this 8.6% to be able to equate the Step Test and the treadmill test is presented in Appendix 1.

Hence the average VO_2 max. of around 39 ml/Kg/min. for this group of 17 working women represents a VO_2 max. of 42.4 ml/KG/min if it had been measured using the treadmill.

These women therefore are really quite fit - they now fall into the 'high end' of the "Good" category of the classification given by the Preventive Medicine Centre in California, and even move into the "high" category of Astrand's fitness classification.

During the lean season it can be seen in Figure 28 that the average heart rate values were slightly lower at each exercise level than these during the harvest season.

TABLE 17

	<u>Harvest</u>	<u>Lean</u>
	Heart Rate	Heart Rate (beats/min)
First Level	93	92
Second Level	108.4	105
Third Level	121.5	117.6

The difference becomes more pronounced as the exercise intensity increases.

This could suggest an increase in efficiency at the higher submaximal levels of exercise. But it is obvious that these differences are very small and they are not significantly different so it cannot be stated that there is any real difference in the aerobic capacity of these working women in the harvest season compared to the lean season.

At the third level of exercise, ie the faster rate of stepping using the higher step, these women expended, on average, 3.7 Kcal/min during the harvest season, and 3.4 Kcal/min during the lean season (see Table 18 below).

This however is not a significant difference, and any decrease in energy expended while performing the work task is probably due to the slightly lighter average body weights of the women in the lean season. Body weight is very important in determining the energy expended while performing the step test since it involves literally carrying the body weight up and down the step. However, there appears not to be any significant increase in metabolic efficiency or significant decrease in the energy cost of the activity in the lean season.

TABLE 18

ENERGY EXPENDED AT THE THIRD LEVEL OF THE STEP TEST

	<u>Harvest Season</u>	<u>Lean Season</u>
Kcal/min	3.7	3.4
SD	0.6	0.5
Average Weight (kg)	39.6	39.4

OTHER STUDIES OF WORK CAPACITY IN DEVELOPING COUNTRIES

Many studies made on the VO_2 max of adults and children in developing countries often found the poorer so called undernourished subjects have a lower absolute VO_2 max than the better fed groups. However Spurr et al (1983) noted that when these absolute values were corrected for body weight the differences disappear. This appears to be the case in this study, where the average weight of the women was very low - 39.5 kg, therefore their oxygen uptake per kilogram is relatively higher than would be for the "standard" women of 55 kg. However, other studies suggest that workers with optimal nutrition are more efficient and productive than those marginally nourished. Keys (1950) provided evidence on the detrimental effect of body weight loss on the subjects capacity for prolonged physical work and actual performance. However this was a fairly short term reduction in food intake, with a rapid weight loss. Perhaps over several years the subjects in this present study could have adapted to the low food intakes, and lower body weights. Popkin (1976) looked at one area of poor nutrition - anaemia - among construction workers in Indonesia and found a significant negative correlation between anaemia and work productivity. This is relevant to this study in Edulabad, where more than 75 per cent of the female population were classified as anaemic, ie their

haemoglobin levels were less than 12 grams per 100 grams blood. It is therefore impossible to exclude anaemic women from this study as they represent the norm in this village.

At present there is an ongoing project, which was initiated in 1984 to provide iron fortified salt to these women, which has in fact produced beneficial effects in terms of reducing the anaemia. Perhaps also, therefore, there will be improvements in their work capacity.

De Guzman (1983) studied the effect of deficient energy intake and subsequent supplementations on the total energy expenditure levels and activity pattern of some undernourished members of the rural household in the Philippines. He also looked at the effects the supplementation had on their capacity to perform a standard work task.

He did this by determining the level of daily energy intake, then measured the metabolic costs of various activities performed by the same individual prior to and immediately after supplementation. The subjects were supplemented for 60 days, the diet consisting of 100% of the recommended levels for energy and protein, - 2580 Kcal/day for the male farmers and 1920 Kcal/day for the female farmers.

This resulted in significant increases in weight in both the male and female farmers, 2.6 kg and 1.7 kg respectively.

Although De Guzman found no significant increase in the energy expended for certain activities after the supplementation there were significant differences in the mean duration time of exercise possible, their VO_2 max, and the level of exercise reached in a treadmill test, therefore their work capacity was significantly increased after supplementation. However, four weeks after cessation of supplementation the male and female farmers body weight had returned to their pre-supplementation level.

There have also been studies on the work capacity of Indians - comparing them with Western populations. Research has indicated that indigenous populations may differ in their ability to undertake endurance work (Verma et al 1979) seen by the wide range in VO_2 max of different populations. Endurance fitness of a population may be influenced by a number of factors, including nutrition, as commented on earlier, climate, incidence of diseases, medical services etc, and over the generations these influences may produce real differences in fitness

levels which are inherited. This will affect their aerobic capacity greatly, since natural endowment is the most important factor in determining the individual's VO_2 max.

Verma and colleagues (1979) noted wide differences in VO_2 max scores between Indians, Israelis, Americans and Swedes. In particular he noted that sedentary Indian populations living in India had the lowest VO_2 max. In a similar study Hardy et al (1985) compared the aerobic fitness of 32 Anglo-saxon students and 32 first generation Indian students. The findings showed that the absolute and relative predicted maximal oxygen uptake of the Indian group was significantly lower than the Anglo-Saxon group. Although the relative values of both groups may be classed as average according to Astrand's fitness classification (1970), the Indian group was still significantly lower - 43.2 ml/kg/min compared to 49.1 ml/kg/min for the Anglo-saxon group.

However from this study in Hyderabad, India it seems that these poor, working women, with an average weight of 39.5 kg and an average BMI of 18.3 are in fact very capable of performing work tasks, with a predicted VO_2 max in the "good" to "high" category. This tends to agree with Spurr (1983) who did not record any difference in VO_2 max values for populations in developing countries, as long

as it was corrected for weight; ie their oxygen uptake per kilogram was comparable to any other healthy population in developed countries.

SUMMARY OF METABOLIC AND FOOD INTAKE STUDY

The metabolic and energy intake study can be best summarised in graph form - see Figure 29. Here it can be seen that there is a general trend in every parameter, to decrease in the lean season, ie a decrease in body weight, a decrease in body mass index, a decrease in basal metabolic rate, in absolute terms and when the drop in body weight is taken into account, a drop in food intake per day, and hence a drop in the BMR factor, and finally a fall in the predicted $VO_{2\max}$ of these working women.

This appears to be a conclusive graph with every parameter decreasing in the lean season, but they are of course linked. Probably the fall in energy intake is the starting point, which resulted in a fall in body weight and concomittant fall in body mass index. The fall in basal metabolic rate however is not completely due to the fall in body mass, as mentioned in previous sections and represents a real metabolic adaptation to the reduced energy intake. However, since the BMR factor

Energy Intake Kcal/day

BMR Kcal/day

decreases this indicates that there is a bigger drop in energy intake in relation to basal metabolic rate. The decrease in VO_2 max of these working women during the lean season may result from the inadequate energy intake.

These are all fairly small decreases in every parameter but it is important not to overlook them for this reason. Taken collectively they may contribute significantly to energy savings as a result of the reduced energy intake in the lean season. In other words there may not be one large adaptation apparent in this population, but perhaps present is a collection of smaller, more physiologically realistic adaptations to the situation of reduced energy intake.

Summary of Metabolic and Food Intake Study. Working Women

Fig. 29

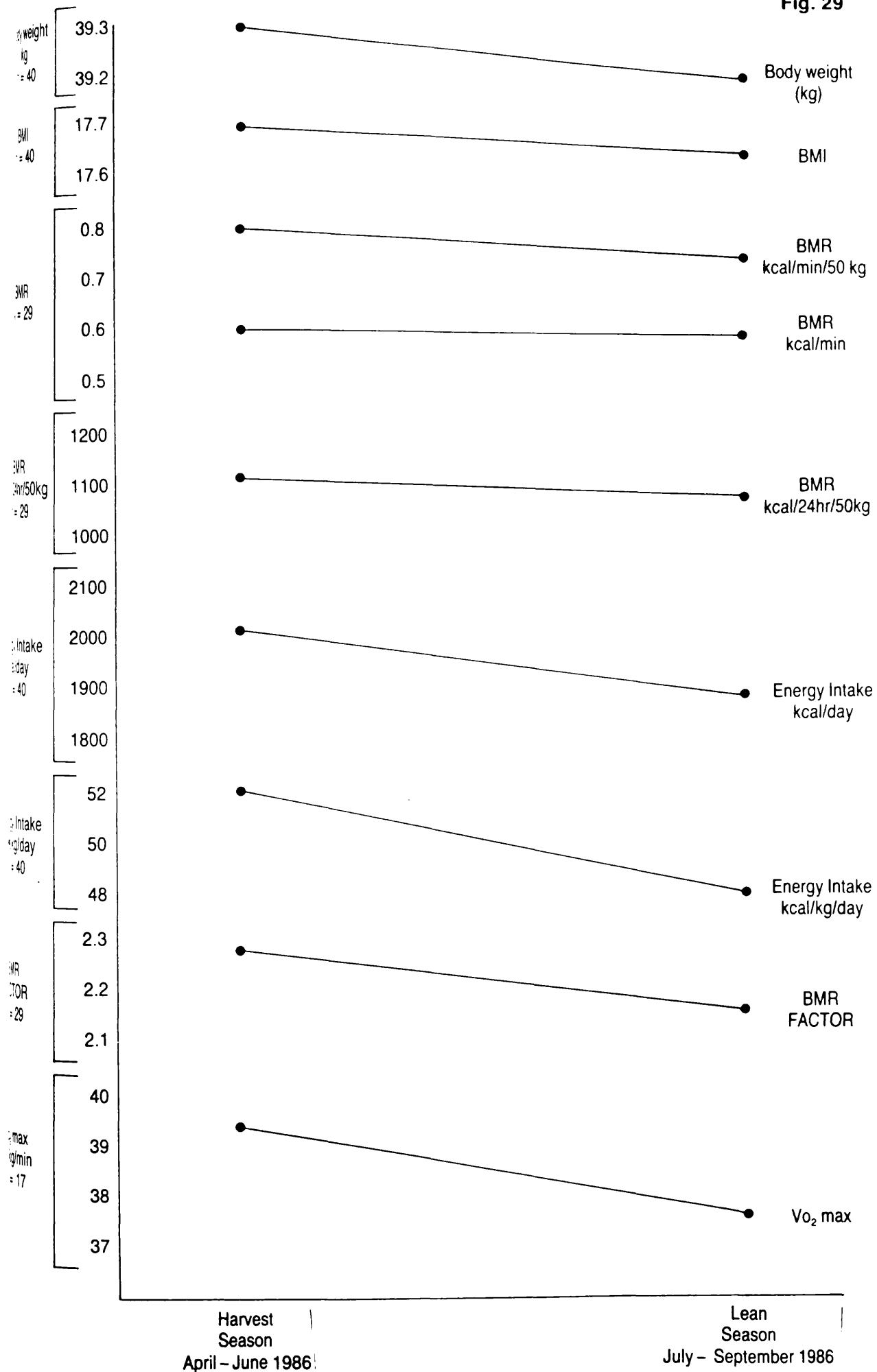

ACTIVITY PATTERN

SEASONAL ACTIVITY PATTERNS

From the harvest season to the lean season, there were several significant changes in the activity patterns of the 25 working women (Figure 30, and Table 19 later).

The two most significant changes ($P < 0.01$) was the amount of time spent involved in 'sitting activities', and the amount of time spent lying in bed. Both these activities decreased during the lean season, sitting activities by almost 100 minutes (a drop of 34%) and lying in bed by 23 minutes (a drop of 47%).

Since the study of the activity patterns were carried out only from 6 am until 9 pm, the amount of time lying in bed during the night, ie from 9 pm to 6 am was not recorded. Therefore any time spent lying in bed was over and above their night time sleep. Usually these women took a rest in the early afternoon.

However, the amount of time just sitting, not involved in any activity increased during the lean season ($P < 0.02$), from 33 minutes to 62 minutes; it almost doubled - an increase of 89%. The amount of time standing also increased during the lean season, by 30 minutes, (56%

rise, $P < 0.05$) and as expected the time spent involved in field work increased during the lean season by 75 minutes - it more than doubled (rise of 104%, $P < 0.05$).

There was no significant change in the amount of time spent walking, involved in standing activities, housework, manual work or personal needs. (Examples of the various activities in each category are given below.)

Activity Pattern Histogram for 25 Working Women

(from 6am to 9pm)

Fig. 30

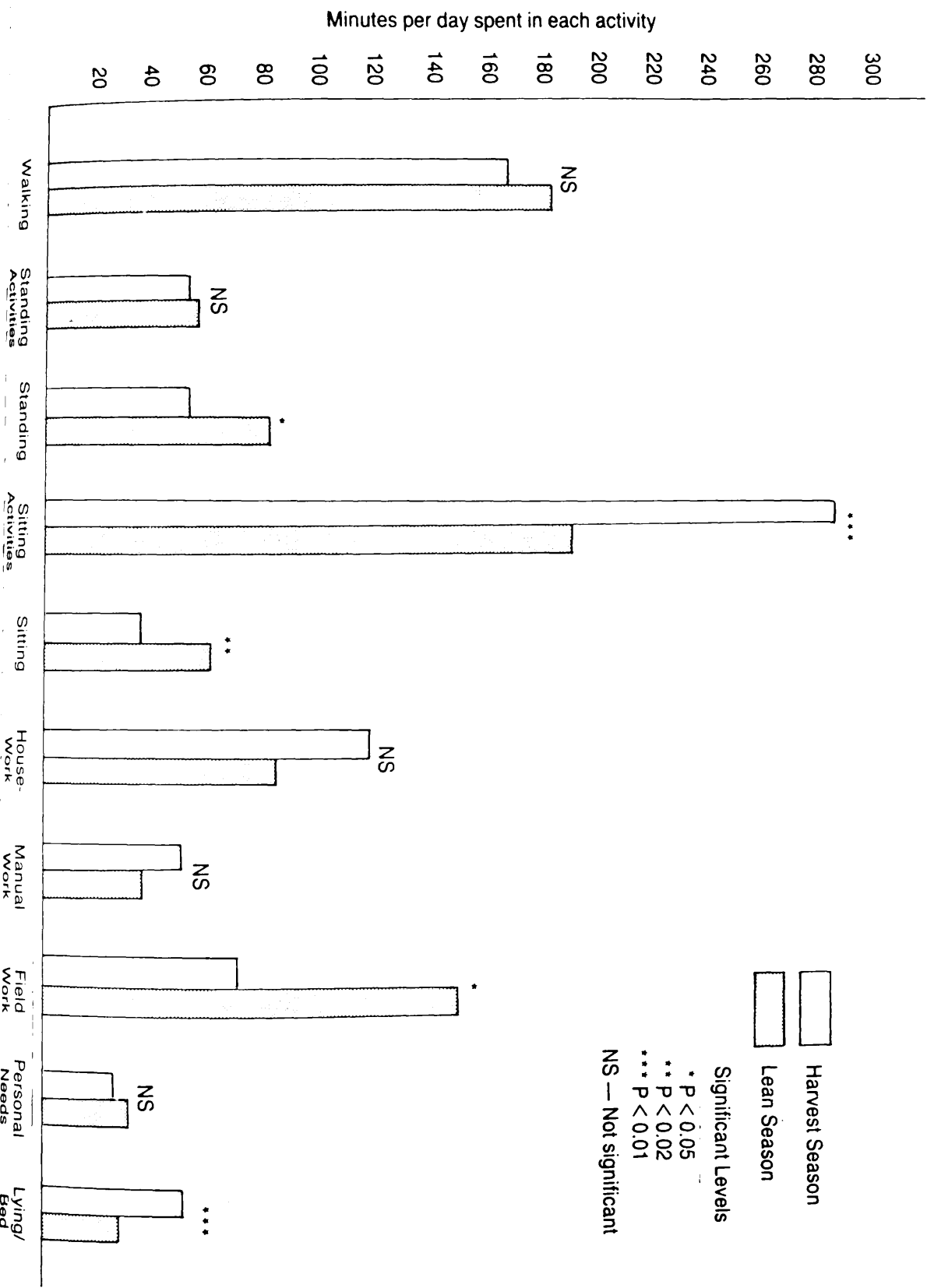

ACTIVITY CATEGORIES

1. Lying/Bed: resting in bed, sleeping, relaxing.
2. Sitting: sitting quietly, reading, talking but not involved in any activity.
3. Standing: standing in a queue, talking, standing without any activity.
4. Sitting Activities: eating, serving meals whilst seated, cooking meals whilst seated, brushing hair, attending to children, making handicrafts.
5. Standing Activities: hanging up washing, child care, tending to livestock.
6. Personal Needs: bathing, toileting, dressing, brushing teeth.
7. Housework: sweeping the floor, making the beds, brushing the walls, general tidying up.

8. Walking: walking around the village, to the market to the fields, at normal pace, not carrying any load.

9. Manual Work: collecting firewood and carrying it home, collecting water and carrying it to the home, any repairs to the home, or occasional constructional work.

10. Field Work: weeding, planting, cutting paddy plants in the fields.

These changes in activity pattern are to be expected during the lean season. Firstly, the increase in field work is common at this time of year, as the women are involved in clearing and preparing the land for the next crop. After the land is cleared and weeded, they plant the paddy plants. This is a very time consuming process, and the women spend several hours a day in the field. The length of time categorised as field work represents the only time spent active in the field. The women often took rests in between each bout of activity - either standing still for a couple of minutes every 10 or 15 minutes, or sitting quietly for a few minutes.

Therefore this accounts for the significant increases in the amount of time 'standing' and 'sitting' during the lean season. During the Harvest season when there was less field work, the women were involved in other activities such as making straw mats or making paper-like plates by sewing large flat dried leaves together. This activity was performed sitting down, and results in a large amount of time spent involved in "sitting activities" during this dry hot season. Perhaps also, they have more time during this season (when there is less field work) to spend preparing and cooking food, which is also classified as a 'sitting activity'. During the hot, harvest season the women also spend significantly more time lying asleep in bed or resting. It was common for these women to take a siesta after their lunch, at the hottest time of the day, when temperatures reached 44 degrees Centigrade (114°F).

In the lean season when the weather was slightly cooler, due to the arrival of the rains, only about 25 minutes a day was spent resting. Also, when the women were at the field there was not the same opportunity as at home, to take a rest.

During the lean season there was a tendency for the women to spend less time involved in housework and manual work, such as collecting water and gathering firewood.

Gathering firewood (manual work) was an activity that was more common in the harvest season, when they collected a large store of dry wood, and this would be adequate for the rainy season, when they were involved in more field work and had less time to collect it. However these differences failed to reach significance even although they spent on average about half an hour longer involved in housework and about a quarter of an hour longer involved in manual work in the harvest season.

Surprisingly there was no significant increase in the amount of time spent walking during the lean season. Often the women had to walk a few kilometres to and from the field every day, but it only resulted in an increase of, on average, 18 minutes extra walking a day during the lean season. Therefore it seems that even during the harvest season these women spend quite a considerable time walking, probably around the village and to the market, etc.

These differences in activity pattern in different seasons have been seen in other developing countries, where the population is dependant on seasonal

agricultural labour for their income. Bleiberg et al (1980) recorded that during the dry season female farmers in Upper Volta devoted two hours to cotton handicraft activities and half an hour to other handicraft activities. However during the rainy season these activities were non-existent, when the women spent three and a half hours hoeing or thinning out and replanting cereal plants in the field, with one hour travelling to and from the fields, ie there was a very different pattern of activity in the two seasons. Bleiberg also noted that in the dry season the women spend twice as much time gathering wood. They also recorded that in the rainy season the food preparation was limited to one hot meal per day, with the women being in the field at midday. The women also slept half an hour longer in the dry season. This agrees almost exactly with the results of the working woman in the village of Edulabad, where the women were only involved in making 'paper' plates or making straw mats during the hot harvest season, this being replaced by the field work in the rainy season - a changing of money earning activities with the different seasons. The women of Edulabad also collected the main bulk of the firewood during the hot dry season.

Loutan and Lamotte (1984) also reported a marked change in the activity pattern of a group of nomadic pastoralists in Niger. However their results indicated

an increased energy expenditure during the hot dry season when there were considerable water shortages. As a result the pastoralists were involved in digging and maintaining wells or walking 10 - 15 kilometres to collect water and carry it back to their homes. This was obviously an area with severe lack of water which was not the situation in Edulabad. However it illustrates the effect the season can have on a population's energy expenditure, activity pattern and lifestyle.

In Edulabad the season even dictated how many meals the women cooked per day, apart from the effect of the increased prices and reduced availability of the foods, which was also noted by Bleiberg as mentioned above.

Therefore it is very important for committees determining the energy requirements of third world populations or governments involved in the supplementation of food to these populations, to take into consideration the effect of season. This may avoid situations where for approximately half the year the amount of supplementation may be inaccurate - either food would be wasted in the not so labour intensive seasons, or not enough food supplementation in the seasons with a lot of field work required.

MEASUREMENT OF ENERGY EXPENDITURE

Unfortunately measurements of the energy expended in certain activities were not carried out, therefore a precise measurement of daily energy expenditure is not possible. However it is very difficult to obtain a true representative of the habitual energy expenditure, especially if the technique involves measuring the energy expended in only a few minutes of each activity, as there is a tendency to over estimate the total energy expenditure. Spurr et al (1975) stated that subjects tend to increase, rather than reduce the intensity of their activities when being observed; perhaps in order to "please" the observer, or to appear to be very hard working.

However, if the activities in this study are divided into approximate categories of moderately active, lightly active and sedentary, it is easier to look for general changes in the pattern of activity, between the two seasons. Therefore walking, housework, manual work and field work are grouped together as activities involving the most energy, standing activities, sitting activities, and personal needs are grouped as light activities; and sitting, standing and lying are grouped as sedentary activities.

TABLE 19

	<u>Harvest</u>	<u>Lean</u>
	<u>Season</u>	<u>Season</u>
MODERATELY ACTIVE		
Walking	166	183
Housework	112	86
Manual Work	49	35
Field Work	72	147
	---	---
	399	451
	Difference = + 52	
LIGHTLY ACTIVE		
Standing Activities	53	57
Sitting Activities	287	189
Personal Needs	25	30
	---	---
	365	276
	Difference = - 89	
SEDENTARY ACTIVITIES		
Standing	54	85
Sitting	33	62
Lying/Bed	49	26
	---	---
	136	173
	Difference = + 37	

From Table 19 it can be seen that in general, almost an hour extra per day is spent moderately active during the lean season, (as a result of increased field work). This is compensated for by quite a large reduction in light activities - on average an hour and a half less each day during the lean season, and an increase of more than half an hour per day when the women were sedentary.

Therefore this redistribution of activities may help to compensate for the increased work load in the field at this time of year, combined with a reduction in energy intake.

Estimations of energy expenditure of the free living individual are prone to large errors due to the fact it is very difficult to assess or measure the normal situation.

Durnin (1984) states that a precise measurement of energy expenditure is not necessary in the context of energy balance and a general indication of physical activity and the breakdown of the duration of varying activities on an average day is adequate for many rural populations.

Therefore Durnin suggests that the measurement of energy intake (which is more easily measured than energy output) coupled with data on changes in body weight and body

composition will provide satisfactory data on energy expenditure and energy balance, and this was what was attempted in this study.

Ferro-Luzzi (1984) claims that the major issue in free living conditions is not whether energy equilibrium is achieved or not at a given level of intake, but to determine whether any activities are curtailed, and if so, which ones, in order to obtain energy balance.

Ferro-Luzzi suggests that this can be determined by the assessment of food intake, and the energy spent on various activities, bearing in mind the social and economical relevance of these activities.

Gorsky and Calloway (1983) hypothesised that obligatory activities have priority to discretionary activities in times of reduced energy intake, and thereby maintain the economically important activities. However in a follow up experiment when energy was reduced both obligatory and discretionary activities were curtailed - contrary to the investigators first hypothesis. In this study in Edulabad it is possible that discretionary activities were curtailed - ie a reduction in the amount of time involved in housework and sitting activities. However a large proportion of the sitting activities during the harvest season involved making mats or 'paper' plates which were then sold for money. This is obviously an

economically important activity and cannot be classed as discretionary. Therefore it can be concluded that during the lean season there may be a reduction in obligatory activities and discretionary activities, at the very least the discretionary activities are different in each season.

One interesting point noted was that throughout the recording of the women's activities there was not one social event, or social gathering recorded. In fact these women very rarely met as a community or socially. Any weddings tend to be restricted to the months of March and April, and apart from these, the rural working women did not take part in any other group event. However it is difficult to assess whether these types of events are just not present in this society or whether the women are curtailing these discretionary activities consciously, for reasons of lack of money, time or energy.

It is obvious however that the quality of life of these women was not very high, and their lifestyle consisted mainly of sleeping, eating, cooking, tending to their children and working in the fields. Therefore if the energy requirements of this population were to be estimated, it is obvious that an additional amount should

be included to allow these women more freedom in choosing their activities, especially to include various social or discretionary activities.

CONCLUSIONS

The average body weight of 40 low income working women tended to decrease during the lean season at a time when there is significantly more fieldwork performed and a significantly lower energy intake. There was also a tendency for their basal metabolic rate to decrease during this time, by more than can be accounted for by the drop in their body weight, which suggests this may be a possible adaptation to the lower food intake. Also noted was a change in their activity pattern in the two seasons. As expected more time was spent working in the field, but energy savings in other activities were evident, which may help to reduce the increased daily energy expenditure by spending significantly more time just sitting, or just standing and less time involved in sitting activities.

The working women more or less maintained their aerobic capacity during the lean season, and although it was reduced, it was not a significant reduction.

One surprising result was their very low basal metabolic rate in comparison to other western populations, and also their high food intake in comparison to their basal needs. When these two are combined in the BMR factor a very high value is obtained. It is, in fact, higher than the highest value given in the FAO/WHO/UNU 1985 report.

Therefore it is possible that the BMR ratios related to energy intake as suggested in this report are not appropriate for women of low body mass and low basal needs living in rural areas of developing countries.

Also the equations for predicting basal metabolic rate given by the FAO/WHO/UNU committee, based on body weight, overestimate these Indian women's BMR by quite a considerable amount. The equations given by Schofield are more accurate, only if a reduction of 14% is made - a figure that Schofield suggests when dealing with the Indian population.

Whether this low measurement of BMR for these Indian populations is genetically determined is under a great deal of debate, and from the small study carried out on Indian women living in Glasgow it would appear that it is more likely to be an effect of the climate, or their poor diet, or a combination of both.

However, the reduction in body weight during the lean season is probably the most important adaptation to low energy intakes and allows savings in many ways, from a reduction in their energy requirements, to a decrease in the energy cost of physical activity.

However, the seasonal decrease in body weight was less than anticipated for these rural Indian women, (it was completely absent in the control group of middle income women) which may be the result of there being two harvests each year in this region which smoothes out any large fluctuations in food availability.

Alternatively, the lack of large systematic changes in body weight may be interpreted as evidence of adaptation to the variations in energy intake.

No attempt has been made to estimate total daily energy expenditure. As mentioned in the previous section it is very difficult to obtain a true measure of the 'normal' daily expenditure. With the limited time and funds available for this project a detailed and accurate study of energy expenditure was not possible. Instead, a general study of the activity patterns of these agricultural female labourers was made, and it verified the large increase in agricultural work carried out by these women during the lean season, and the overall changes in activity pattern. It is difficult, however, to assess to what extent the changes in activity to save energy are undesirable. It is also possible that energy savings are too subtle to be noticed by an observer, for example, a slightly slower pace of work, of walking, or in more economical actions in performing work tasks.

It could be decided that for this marginally nourished population a supplementation programme would be beneficial. However a problem in programmes of this type is ensuring that the supplementation significantly increases the food intake and not just replaces it. This would require intensive study and supervision to ensure the correct people received the supplement and that it was not just a substitute. If it was a real supplement then perhaps the seasonal weight loss could be avoided and possibly other beneficial effects would occur such as an increased work output, work capacity or just an increase in social interactions or in leisure pursuits - something which did not occur in this population of rural working women.

Although there were not large seasonal changes in this group of women and therefore does not support the commonly believed notion that very large swings in body weight occur over the seasons as a result of fluctuating food availability, there were several significant but small changes occurring. The very fact that the changes were small could indicate successful adaptation to the reduced energy intake during a season when an increased level of activity was required.

If, in the future, supplementation was deemed necessary for this population, the benefits could be considerable. This is assuming their energy requirements would not be calculated on the basis of multiples of their BMR as recommended by the FAO/WHO/UNU 1985 report, as this would result in vast underestimations and could be potentially disastrous. But, if calculated correctly it may significantly improve the quality of life of this very hard working group of rural women.

REFERENCES

1. Activity Changes with Reduced Food Intake in Man.
Nutrition Reviews. 1984 May 42(5): 186 - 188
2. Annegers J F, 1973. Seasonal Food Shortages in
West Africa. Ecology, Food and Nutrition 2: 251 -
257.
3. Apfelbaum M, 1978. Adaptations To Changes in Caloric
Intake. Progress Food, Nutritional Science. 2: 543 -
559.
4. Apfelbaum M, Bostsarron J, Brigant L, 1969.
La diminution de la Consommation 'Basale' D'oxygen
Sous L'effet D'une Restriction Calorique Chez Des
Sujets en Bilan D'azote Equilibre.
Rev. Franc Etud. Clin. Biol. 14: 361 - 372.
From: Waterlow J C, 1986. Metabolic Adaptation to
Low Intakes of Energy and Protein (see full reference
later).

5. Apfelbaum M, Bostsarron J, Lacates D, 1971.
Effect of Calorie Restriction and Excessive Caloric Intake on Energy Expenditure.
American Journal of Clinical Nutrition. 24: 1405 - 1409.
6. Ashworth A, 1978. An Investigation of Very Low Calorie Intakes Reported in Jamaica.
British Journal of Nutrition. 22: 341 - 355.
7. Astrand P O, 1960. Ergometry - Test of 'Physical Fitness' Varbarg, Sweden, Monark Crescent. As adapted from Astrand I, 1960. Aerobic Work Capacity in Men and Women with Special Reference to Age. Acta Physiologica Scandinavica. 49 (Suppl. 169): 83.
8. Astrand P O, 1970. Work Tests with the Bicycle Ergometer.
Monark Crescent, Varbarg, Sweden.
9. Astrand P O, Rodhal K, 1977. Text Book of Work Physiology. McGraw-Hill, London.

10. Beaton G H, 1983. Energy in Human Nutrition: Perspectives and Problems.
Nutritional Reviews. November 41 (11): 325.
11. Benedict F G, 1907. The Influence of Inanition on Metabolism.
Carnegie Institution of Washington. Publication 77
Washington DC.
12. Benedict F G, 1915. A Study of Prolonged Fasting.
Carnegie Institution of Washington. Publication 203
Washington DC.
13. Benedict F G. Miles W R, Roth P, Smith M,
1919. Human Vitality and Efficiency Under Prolonged
Restricted Diet.
Carnegie Institution of Washington. Publication 280
Washington DC.
14. Benefice E, Chevassus-Agnes S, Barral H, 1984.
Nutritional Situation and Seasonal Variations for
Pastoralist Populations of the Sahel. (Senegalese
Ferlo).
Ecology, Food and Nutrition. 14: 229 - 247.

15. Berio A J, 1981. Womens Food Related Activities and Time Allocation.
Ford Foundation/Institute of Environment of Studies.
16. Bleiberg F M, Brun T A, Gohmam S, 1980.
Duration of Activities and Energy Expenditure of Female Farmers in Dry and Rainy Seasons in Upper-Volta.
British Journal of Nutrition. 43: 71 - 82.
17. Bleiberg F, Brun T A, Gohmam S, Lippman D, 1981.
Food Intake and Energy Expenditure of Male and Female Farmers from Upper-Volta.
British Journal of Nutrition 45: 505 - 515.
18. Brooke O G, Cocks T, 1974. Resting Metabolic Rate in Malnourished Babies in Relation to Total Body Potassium.
Acta Paediatrica Scandinavica. 63: 817 - 25.
19. Brun T, 1984. Physiological Measurement of Activity Among Adults Under Free Living Conditions.
In: Current Topics in Nutrition and Disease, Vol. II. Energy Intake and Activity.
Editors: E Pollit and P Amante.
New York: Liss. 131 - 156.

20. Burke, 1947. The Dietary History as a Tool in Research. Journal of American Dietetics Association, 23: 1041 - 1046.
21. Cathcart E P, 1906 - 1907. On Metabolism During Starvation. Journal of Physiology, 35: 500 - 10.
22. Chavez A, Martinez C, 1979. Nutricion Y Desarrollo Infantil. Mexico, Nuerva Editorial Interamericana: 126 - 128.
23. Consolazio C F, Johnson R E, Pecora L V, 1963. Physiological Measurements of Metabolic Functions in Men. New York, McGraw.
24. Dallosso H, James W P T, 1982. Dietary Thermogenesis and Exercise. Proceedings of the Nutrition Society 41:35A.
25. Davey P L H, 1962. A Summary of Conclusions and Recommendations of the Ghana Nutrition Survey 1961 - 1962. Accra Ghana National Food and Nutrition Board.

26. De Guzman P E, 1983. Energy Allowances for the Philippine Population.
In: Substrate and Energy Metabolism in Man.
Editors: J S Garrow, D Halliday. 23 - 38.

27. Durnin J V G A, 1979. Energy Balance in Man with Particular Reference to Low Intakes.
Bibliotheca Nutritio et Dieta. 27: 1 - 10.

28. Durnin J V G A, 1984. Some Problems in Assessing the Role of Physical Activity in the Maintaining of Energy Balance.
In: Current Topics in Nutrition and Disease, Vol. II.
Editors: E Pollitt and P Amante. 103 - 113.

29. Durnin J V G A, Womersley J, 1974. Body Fat Assessed From Total Body Density and its Estimation from Skinfold Thickness: Measurements on 481 Men and Women Aged from 16 to 72 Years.
British Journal of Nutrition 32: 77 - 97.

30. Edmundson W, 1980. Adaptation to Under-nutrition: How Much Food Does Man Need?
Social Science and Medicine. 14: 119.

31. Eveleth P B, Tanner J M, 1976. World Wide Variation in Human Growth.
Cambridge: Cambridge University Press.
32. FAO/WHO, 1973. Energy and Protein Requirements. Report of a Joint FAO/WHO Expert Committee.
Technical Report Series No. 522. Rome, Geneva.
33. FAO/WHO, 1974. Energy and Protein Requirements.
Rome: FAO.
34. FAO/WHO/UNU, 1985. Energy and Protein Requirements Report of a Joint FAO/WHO/UNU Meeting.
Technical Report Series No. 000. Geneva: WHO.
35. Ferroluzzi A, 1984. Energy Intakes as Predictors of Energy Balance in Free Living Populations.
In: Current Topics in Nutrition and Disease. Vol II.
Editors: E Pollitt and P Amante. 79 - 99.
36. Fidanza F, Findanza-Alberti A, Ferroluzzi A, Proja M, 1964. Dietary Surveys in Connection with the Epidemiology of Heart Disease. Results in Italy.
Voeding, 25: 502 - 509.

37. Fidanza F, Fidanza-Alberti A, 1967. Diet Surveys in Connection with the Epidemiology of Heart Disease; Reliability Sources of Variation and Other Data from 9 Surveys in Italy.
Voeding, 28: 244 - 253.
38. Flores M, 1962. Dietary Studies for Assessment of the Nutritional Status of Populations in 'Non-modernized' Societies.
American Journal of Clinical Nutrition. 11:34.
39. Fox R H, 1953. A Study of Energy Expenditure of Africans in Various Rural Activities. PhD Thesis University of London.
From: Hussain M A, 1985. Seasonal Variation and Nutrition in Developing Countries. Food and Nutrition Vol. II: No 2, 23 - 27.
40. Garby L, Lammert O, 1977. Effect of Preceding Days Energy Intake on Total Energy Cost of Light Exercise.
Acta Physiologica Scandinavica 101: 411 - 417.
41. Gebre - Medhin M, Gobezie A, 1975.
American Journal of Clinical Nutrition 28: 1322.

42. Ghali N N, Durnin J V G A, 1977. A Study of Energy Balance of a Woman on Varying Energy Intakes During 14 Months.
Proceedings of the Nutritional Society. 36: 91A, 89.

43. Ghana National Food and Nutrition Board, 1961. National Nutrition Survey IV. The Nutrition of Adults in the North Accra.

44. Gorsky R D, Calloway D H, 1983. Activity Pattern Changes With Decrease in Food Energy Intake. Human Biology. 55: 577 - 586.

45. Grand F, 1964. Man Under Calorie Deficiency. In: Handbook of Physiology, Section 4. Adaptation to the Environment. Editors: D B Dill, E F Adolph, C G Wilber. Washington DC. American Physiological Society.

46. Grande F, Anderson J T, Keys A, 1958. Changes of Basal Metabolic Rate in Semi-starvation and Refeeding. Journal of Applied Physiology 12: 230 - 238.

47. Hardy C P, Eston R G, 1985. Aerobic Fitness of Anglo-Saxon and Indian Students.
British Journal of Sports Medicine Vol. 19.
4: 217 - 218.

48. Heady J A, 1961. Diets of Bank Clerks, Development of a Method of Classifying the Diets of Individuals for Use in Epidemiological Studies.
Journal Royal Statistical Society Series A. 124:
336 - 371; part 3.

49. Henschel A, Taylor H L, Keys A, 1954. Performance Capacity in Acute Starvation With Hard Work.
Journal of Applied Physiology 6: 623 - 633.

50. Hueneman R C, French F E, Bierman J M, 1961. Diets of Pregnant Women in Kawai, Hawaii.
Journal of the America Dietetics Association 39:
569 - 577.

51. Huffman S L, Wolff M, Lowell S, 1985. Nutrition and Fertility in Bangladesh: Nutritional Status of Non-Pregnant Women.
American Journal of Clinical Nutrition. 42:725 -
738.

52. Hunter J M, 1967. Seasonal Hunger in a Part of The West African Savana. A Survey of Body Weights in Nangodi, North East Ghana. Transactions of the Institute of British Geographers. 41: 167 - 185.
53. From: Hussain MA, 1985. Seasonal Variation and Nutrition in Developing Countries. Food and Nutrition Volume II No. 2: 23 - 27.
54. Indian Council of Medical Research, 1984. Recommended Dietary Intakes for Indians. Ansari Nagar, New Delhi.
55. Institute of Nutrition and Food Science 1977. Nutrition Survey of Rural Bangladesh 1975 - 1976. Dacca Institute of Nutrition and Food Science.
56. Jain D, 1985. 'In Poor Families Women's Income is the Lifeline'. Expert Consultation on the Role of Women in Food Production. Editor: Armelle Branon, Rome, FAO 85, 46297: 35 - 38.

57. James W P T, 1981. Adaptation to Different Energy Intakes: The Mechanism, Extent and Social Consequences.
FAO/WHO/UNU Expert Consultation on Energy and Protein Requirements. Rome: FAO.

58. James W P T, Shetty P S, 1982. Metabolic Adaptations and Energy Requirements in Developing Countries.
Human Nutrition: Clinical Nutrition. 36C: 331 - 336.

59. Jayo Rao K S, Khan L, 1974, Basal Energy Metabolism in Protein Calorie Malnutrition and Vitamin A Deficiency.
American Journal of Clinical Nutrition. 27: 892.

60. Kasch F W, Phillips W H, Ross W D, Carter J E L, Boyer J L, 1966. A Comparison of Maximal Oxygen Uptake by Treadmill and Step Test Procedures.
Journal of Applied Physiology. 21: 1387.

61. Keys A, Brozek J, Henschel A, Mickelson O, Taylor H L, 1950. The Biology of Human Starvation
Minneapolis : University of Minneapolis Press.

62. Lawrence M, Singh J, Lawrence F, Whitehead R G, 1984. Energy Requirements of Pregnancy and Lactation: The Energy Cost of Common Daily Activities in the Gambia.
Nestle Foundation Annual Report 43 - 52 Lausanne:
Nestle.
63. Longhurst R, Payne P R, 1978. Seasonal Aspects of Nutrition.
In: Seasonal Dimensions to Rural Poverty. A Conference Organised by the Institute of Development Studies and the Ross Institute of Tropical Hygiene. July 3 - 6.
From Valverde V et al, 1982. Seasonality and Nutritional Status. (see full reference later).
64. Longhurst R, Payne P, 1979. Seasonal aspects of Nutrition. Review of Evidence and Policy Implications.
Discussion Paper 145. Institute of Development Studies, Sussex University, Brighton.
65. Lopes J, Russell D M, Whitewell J, Jee Jee Bhoy K N, 1982. Skeletal Muscle Function in Malnutrition. American Journal of Clinical Nutrition. 36: 602 - 610.

66. Loutan L, Lamotte J M, 1984.
Seasonal Variations in Nutrition Among a Group
of Nomadic Pastoralists in Niger.
Lancet, April 25, 1. (8383) 945 - 947.
67. Lusk G, 1917. The Elements of the Science of
Nutrition. 3rd Edition. Philadelphia and London:
Saunders.
68. Maletnlema T N, Bavu J L, 1974.
East African Medical Journal 51: 515.
69. Maritz J S, Morrison J R, Peter J, Strydom N B,
Wyndham C H, 1961.
Ergonomics 4: 97 - 122.
70. Marr J, 1966. Seasonal Differences in the Diets
of Male Bank Staff.
R D C 7th International Congress of Nutrition.
Hamburg.
71. Marr J, 1971. Individual Dietary Surveys: Purpose
and Methods.
World Review of Nutrition and Dietetics. Vol 13:
105 - 164.

72. Mason, 1934. Effect of Sleep on BMR in Indian Women.
American Journal of Physiology. 108: 377.
73. Mason, 1964. Racial Differences in Basal Metabolic
Rate. Human Biology 36: 374.
74. Mason, 1972. Basal Metabolic Rate and Climatic
Change.
Human Biology. 44: 141 - 172.
75. Miller D S, 1975.
In: 'Regulation of Energy Balance in Man'.
198 - 208.
Editor: E Jequier. Geneve: Editions.
Medicine et Hygienes.
76. Miller D S, Wise A, 1975.
Exercise and Dietary Induced Thermogenesis.
Lancet 1. : 1290.
77. Montgomery R D, 1962. Changes in the Basal Metabolic
Rate of the Malnourished Infant and Their Relation
to Body Composition.
Journal of Clinical Investigation. 41: 1953 - 1663.

78. Morgan J B, York D A, Wasilewska A, Portman J, 1982.
A Study of the Thermic Responses to a Meal and to
a Sympathomimetic Drug (Ephedrine) in Relation to
Energy Balance in Man.
British Journal of Nutrition. 47: 21 - 32.
79. Myntti, 1978. Women in Rural Yemen
USAID 1978.
80. Nagle F J, Balke B, Naughton J P, 1965.
Graduational Step Tests for Assessing Work Capacity.
Journal of Applied Physiology. 20: 745.
81. Norgan N G, Ferroluzzi A, Durnin J V G A, 1974.
The Energy and Nutrient Intake and Energy Expenditure
of 204 New Guinean Adults.
Philosophical Transactions Royal Society, London.
Series B.
82. Nutrition Expert Group, 1968. Daily Allowances for
Indians. New Delhi. Indian Council of Medical
Research.
83. Pasricha S, Thimmayamma B V, Radhaiah G, 1983.
Seasonal Changes in the Cost of Balanced Diets.
Indian Journal of Medical Research. 77: 359 - 365.

84. Parizkova J, 1983. Energy Expenditure Under Field Conditions, Prague, Charles University. Page 130.
85. Passmore R, Durnin J V G A, 1955. Human Energy Expenditure.
Physiological Reviews 35: 801 - 840.
86. Paul A A, Muller E M, Whitehead R G, 1979. The Quantitative Effects of Maternal Dietary Energy Intake on Pregnancy and Lactation in Rural Gambian Women.
Transactions Royal Society Tropical Medicine Hygiene. 73: 686 - 692.
87. Popkin B M, 1976. Human Resource, Development and Productivity: The Role of Nutrition.
Ekonomi Dan Kenangan, Indonesia, XX1V3: 175 - 289.
88. Prentice A M, 1984. Adaptations to Long Term Low Energy Intake.
In: Current Topics in Nutrition and Disease Vol.II. Energy Intake and Activity.
Editors: E Pollitt and P Amante.

89. Rao B R H, Klontz C E, Rao F S S, Begum A, Dumm M E, 1961.
Nutritional Status Survey of the Rural Population in Sholavaram.
Seasonal Dietary Survey.
Indian Journal of Medical Research 49: 316 - 329.
90. Rose and Blackburn, 1968. Cardiovascular Survey Methods. WHO, Geneva, 1968.
91. Rothwell N J, Stock M J, 1981. Regulation of Energy Balance. Annual Review of Nutrition 1: 253 - 56.
92. Sai F T, 1969. The Problems of Food and Nutrition of West Africa. World Review of Nutrition and Dietetics. 10: 77 - 99.
93. Schofield S, 1974. Seasonal Factors Affecting Different Age Groups, Especially Pre-school Children. Journal of Developmental Studies. 11. (1): 22 - 40.
94. Schofield W N, Schofield C, James W P T, 1981.
FAO/WHO Report, Rome: FAO.

95. Schofield W N, Schofield C, James W P T, 1985.
Basal Metabolic Rate - Review and Prediction,
Together with an Annotated Bibliography of Source
Material.
Human Nutrition: Clinical Nutrition. 39C (Supplement
1): 5 - 41.
96. Seckler D, 1982. "Small But Healthy": A Basic
Hypothesis in the Theory, Measurement and Policy
of Malnutrition.
In: Newer Concepts in Nutrition and Their
Implications for Policy.
Editor: P V Sukhatme. 127 - 137. Pune, India.
Maharashtra Association of Cultivation Science.
97. Shetty P S, 1984. Adaptive Changes in Metabolic
Rate and Lean Body Mass in Chronic Undernutrition.
Human Nutrition: Clinical Nutrition. 38 C: 443 -
52.
98. Shutz Y, Lechtig A, Bradford B, 1980.
American Journal of Clinical Nutrition. 33: 892.

99. Sloof R, 1978. Health and Disease of Under Fives in Machakos District, Kenya.
In: Seasonal Dimensions to Rural Poverty. A conference organised by the Institute of Development Studies and The Ross Institute of Tropical Hygiene. Jul 3 - 6.
100. Spurr G B, Barac-Nieto M, Maksud M A, 1975.
Energy Expenditure Cutting Sugar Cane.
Journal of Applied Physiology. 39: 990 - 996.
101. Spurr G B, Barac-Nieto M, Reina J C, Ramirez R, 1984.
Marginal Malnutrition in School Aged Colombian Boys: Efficiency of Treadmill Walking in Submaximal Exercise.
American Journal of Clinical Nutrition. 39: 452 - 59.
102. Spurr G B, Reina J C, Dahners H W, Barac-Nieto M, 1983.
Marginal Malnutrition in School Aged Colombian Boys: functional consequences in maximum exercise.
American Journal of Clinical Nutrition. 37: 34 - 37.

103. Stravrakis O, Marshall M L, 1978. Women, Agriculture and Development in the Maya Highlands. Profit of Progress. University of Arizona Conference, January 8 - 11.
104. Stock M J, 1980. Effects of Fasting and Refeeding on the Metabolic Response to a Standard Meal in Man. European Journal of Applied Physiology 43: 35 - 40.
105. Sukhatme P V, Margen S, 1982. Autoregulatory Homeostatic Nature of Energy Balance. American Journal of Clinical Nutrition. 35: 355 - 65.
106. Sundaraj R, Regum A, Jesuchan G, Pereira S, 1969. Seasonal Variation in the Diets of Pre school Children in a Village (North Arcot District) Part I. Intake of Calories, Protein and Fat. Indian Journal of Medical Research. 57: 249 - 259.
107. Swaminthan M C, Rao K V, Rao D H, 1967. Food Nutrition in the Drought Affected Areas of Andhra Pradesh. Indian Journal of Medical Research. 55: 768.

107. Taskar AD, Swaminathan M C, Shanta Madhavan, 1967.
Diet Surveys by Weighment Method - A Comparison
of Random Day, Three Day and Seven Day Periods.
Indian Journal of Medical Research. 55: (1) 90 -
96.
108. Taylor H L, Bushkirk E R, Henschel A, 1955.
Oxygen Uptake An Objective Measure of Cardio-
respiratory Performance.
Journal of Applied Physiology. 8: 73.
109. Taylor H L, Bushkirk E R, Brozek J, Anderson J T,
Grande F, 1957. Performance Capacity and Effects
of Caloric Restriction with Hard Physical Work on
Young Men.
Journal of Applied Physiology. 10: 421 - 428.
110. Thomson A M, Billewicz W Z, Thomson B, McGregor
I A, 1966.
Journal of Obstetrics and Gynaecology, British
Commonwealth. 73: 724.

111. Valverde V, Delgado H, Martorell R, Belizan J M, Mejia-Pivaral V, Klein R E, 1982.
Seasonality and Nutritional Status: A Review
of Findings From Developed and Developing Countries.
Archivos Latinoamericanos de Nutricion. 32: 521 -
540.
112. Venkatchalam, 1960
Indian Journal of Medical Research: 511 - 517.
113. Verma S K, Sidhu L S, Kansal D K, 1979.
Aerobic Work Capacity in Young Sedentary Men and
Active Athletes in India.
British Journal of Sports Medicine. 13: 98 - 102.
114. Viteri F E, Tourin B, 1975.
Bol. of Sanit. Panam: 78: 58 - 74.
115. Viteri F E, Tourin B, Galicia J C, Herrera E, 1971.
American Journal of Clinical Nutrition. 24:418.
116. Viteri F E, Touin B, 1981: Nutrition, Physical
Activity and Growth.
In: Ritzen M, Editor. Biology of Normal Human
Growth.
New York, Raven Press. 253-264.

117. Waterlow J C, 1986. Metabolic Adaptation to Low Intakes of Energy and Protein. Annual Review of Nutrition. 6:495-526.
118. Widdowson E, 1947. A Study of Individual Children's Diets. Special Report Series No. 287. Report on Medical Research Congress: 1 - 196.
119. Widdowson E, 1962. Nutritional Individuality. Proceedings of the Nutrition Society. 21: 121 - 128.
120. Whitehead R G, Rowland M G M, Hutton M, Prentice A M, Muller E, Paul A, 1978. The Lancet ii, 1978: 178.

APPENDIX ONE

A COMPARISON OF THE STEPTEST AND TREADMILL TEST IN THE
ASSESSMENT OF WORK CAPACITY IN A GROUP OF FORTY WOMEN

INTRODUCTION

It is generally accepted that an accurate measure of a person's work capacity and cardiovascular fitness is to measure their maximum oxygen uptake (VO_2 max.) since oxygen uptake has been shown to increase with cardiac output and work performance. The VO_2 maximum can be measured directly, or indirectly by measuring submaximal oxygen uptakes and obtaining a maximal value by extrapolating to an age-related predicted maximum heart rate.

The latter method is often more convenient and acceptable, as an actual measurement of maximum oxygen uptake requires a high degree of motivation on the part of the subject.

The most common type of exercise used for these measurements involves either running or walking on the treadmill, but because a step has many advantages - it is inexpensive, versatile, portable and ideally suited for the field situation, it is important that values obtained by this test should be compared to the more commonly documented treadmill procedure.

This paper shows there is a significant difference between values obtained using the step test and the treadmill and although it is still a very viable test for assessing work capacity in the field situation, a correction factor may be needed to enable a direct comparison between these two tests.

Methods

Forty female subjects between the ages of 17 and 34 years took part in this study. They differed in physical fitness - ranging from sedentary, to involved in some sort of training scheme at least twice weekly.

All subjects were free from illness at the time of the tests which took place at least two hours after any physical activity or meal.

Initially each subject was given a practice run, to accustom them to walking on the treadmill and also to stepping in time to a metronome which emitted a bleep for every step. This trial run lasted 3 - 4 minutes after which the subject rested until her heart rate returned to its normal resting value. Not until this was achieved did the submaximal tests start.

Two tests were performed, one using the treadmill and one using the steptest procedure. Each test had three levels of increasing work load, each level lasting four minutes, ie three minutes to reach steady state and in the fourth minute the expired air was collected by the Douglas Bag method for analysis of oxygen and hence calculation of oxygen consumption, as described by Consolazio et al (1963). (The Taylor Servomix Type OA 72 oxygen analyser was used which has an accuracy of 0.15% and the Morgan CO₂ analyser which has an accuracy of 0.01%).

The heart rates were monitored throughout each test using a three lead ECG (LMS). This positioning of the electrodes has been shown to be advantageous in exercise testing as it results in minimal noise from respiratory muscles.

Exercise Protocol

The treadmill test followed the protocol:-

1st level: speed = 2.5 mph; gradient = 0%

2nd level: speed = 3.0 mph; gradient = 5%

3rd level: speed = 3.0 mph; gradient = 10%

The steptest followed the protocol:-

1st level: 15 steps/minute 25 cm step

2nd level: 20 steps/minute 25 cm step

3rd level: 20 steps/minute 33 cm step

The dimensions of the steps are given in Figure 1 of the Methodology section. However these speeds and stepping rates were varied to suit either a very fit or unfit subject in order to obtain a large range in heart rates over three levels of exercise.

The order of the tests were varied for different subjects and no apparent effect of order was seen. After the first test each subject was given a rest period of 15 - 20 minutes or until her heart rate returned to its resting value before the second test was initiated.

Both tests elicited heart rates from between 95 - 125 beats/minute at the first level, to around 175 beats/minute at the final level of exercise.

Maximal oxygen uptake was calculated by extrapolation from the three submaximal values to an age related predicted maximum heart rate (Astrand, 1960) and expressed in millimetres per kilogram of body weight per minute at STPD (ml/kg/min).

Geraldine — Age: 20

GRAPH A

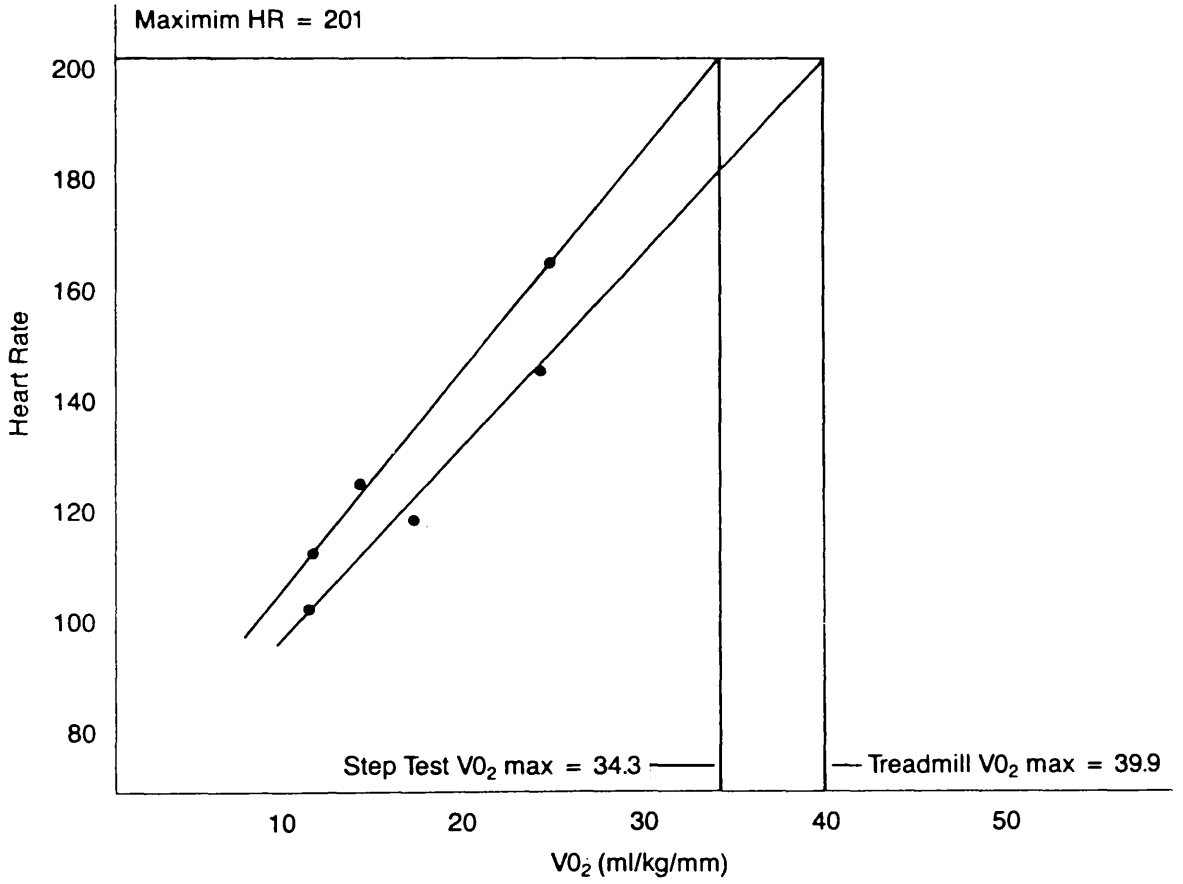

Christine — Age: 23

GRAPH B

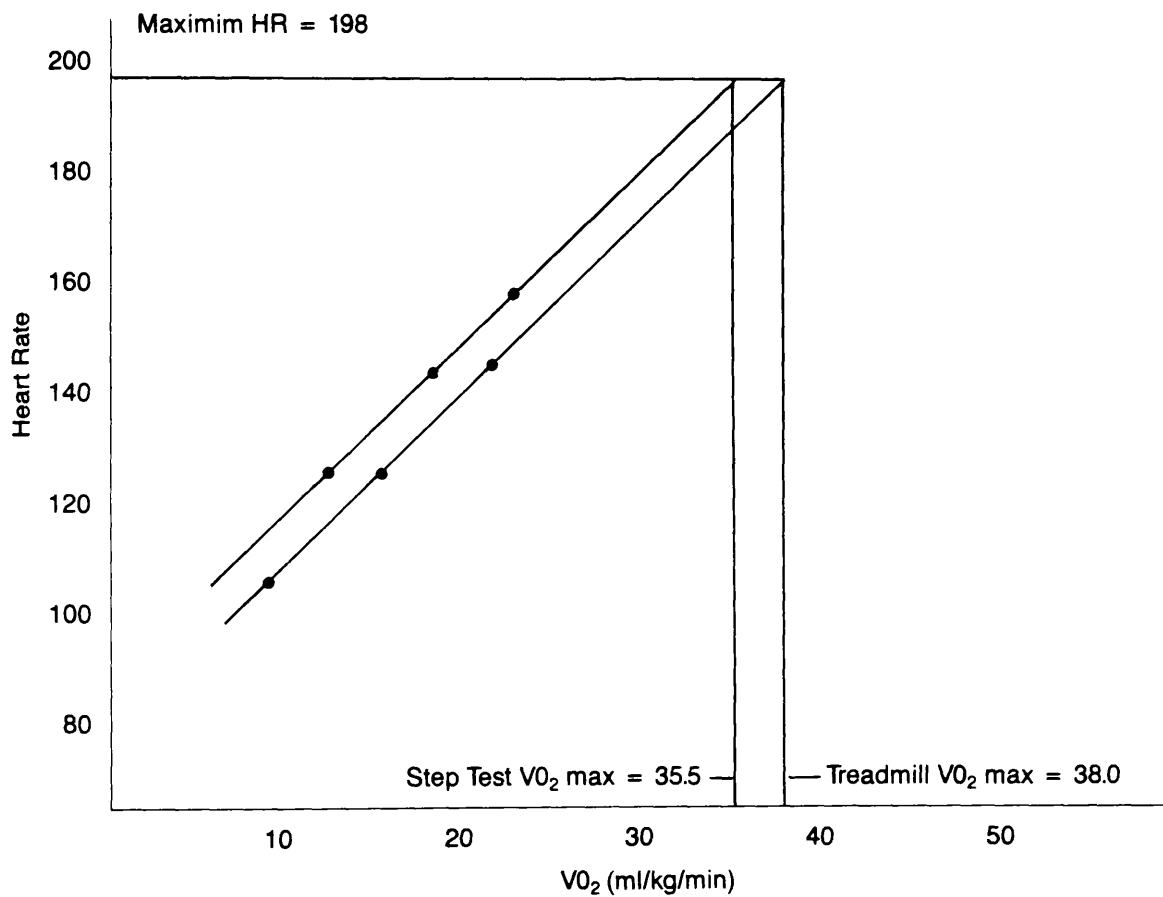

Karen — Age: 23

GRAPH C

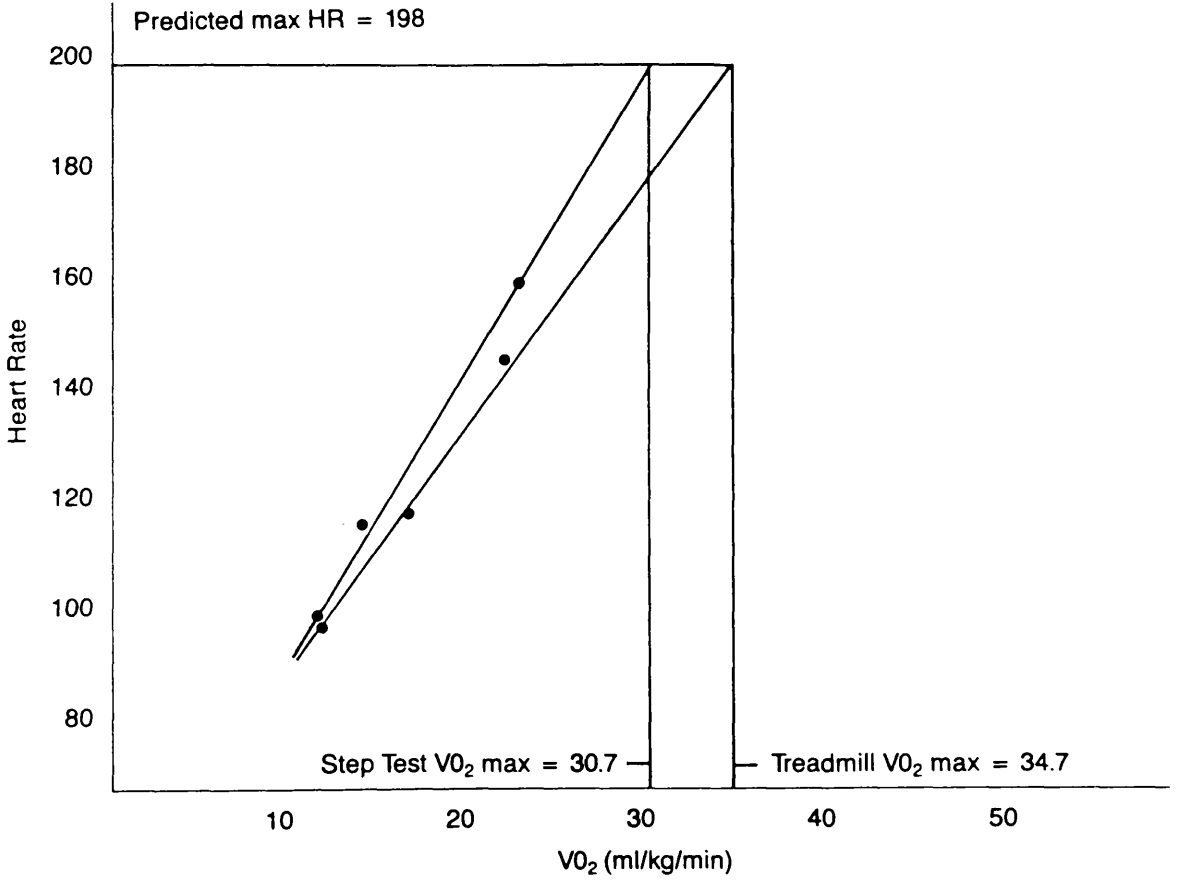

Jennett — Age: 23

GRAPH D

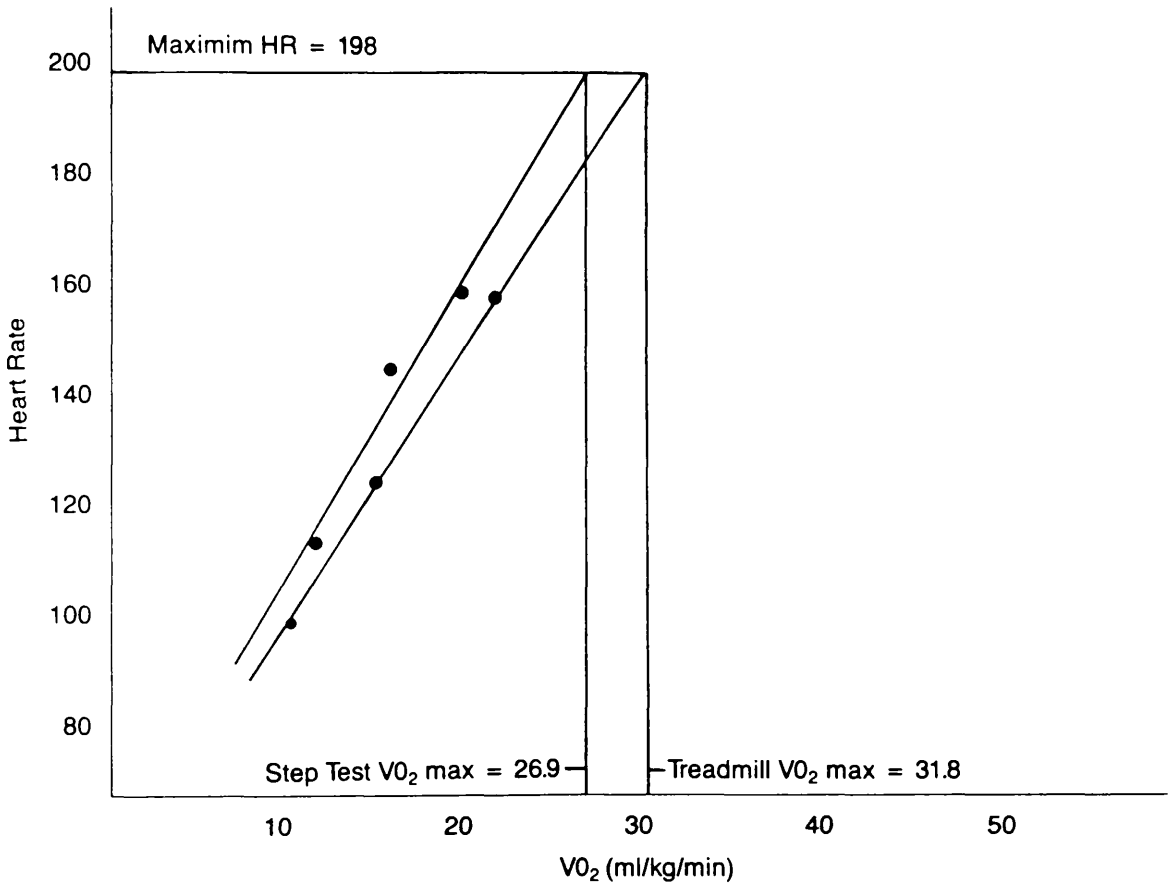

Christine L. — Age: 21

GRAPH E

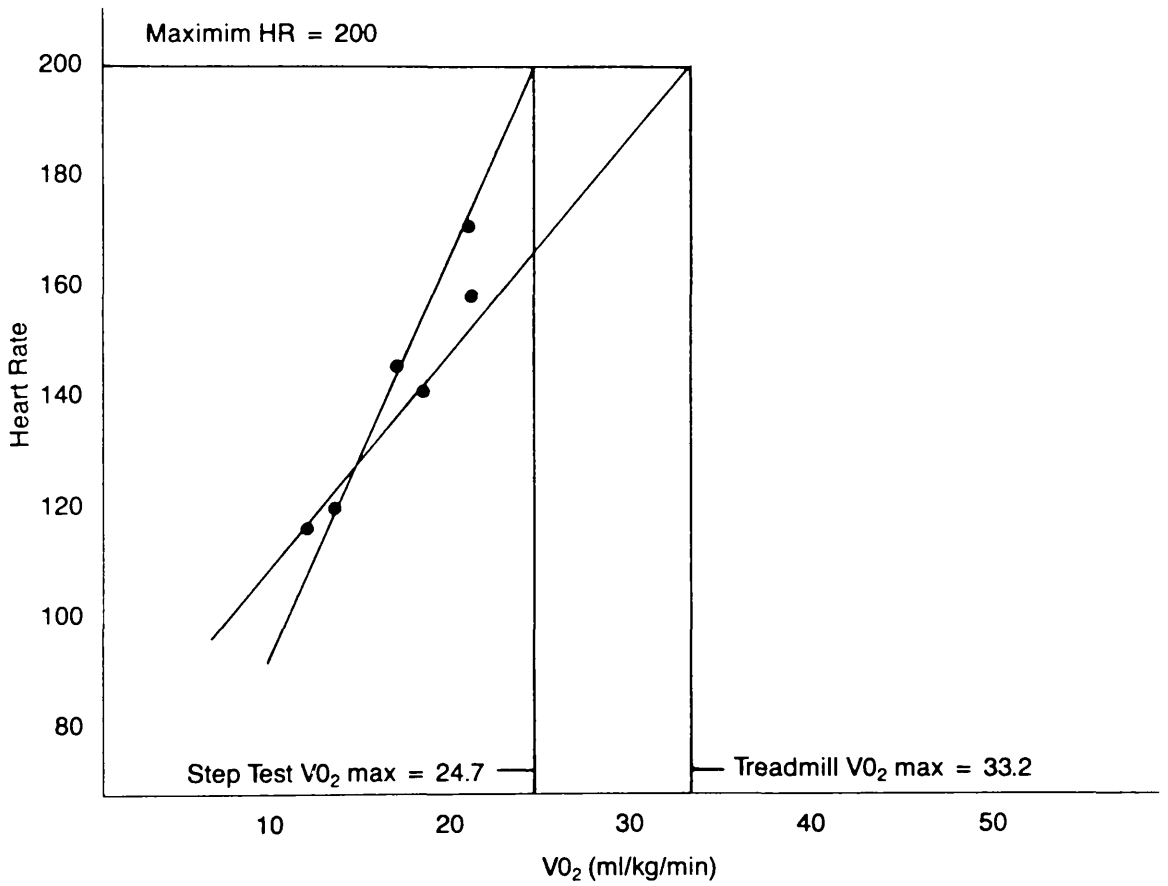

Lesley — Age: 24

GRAPH F

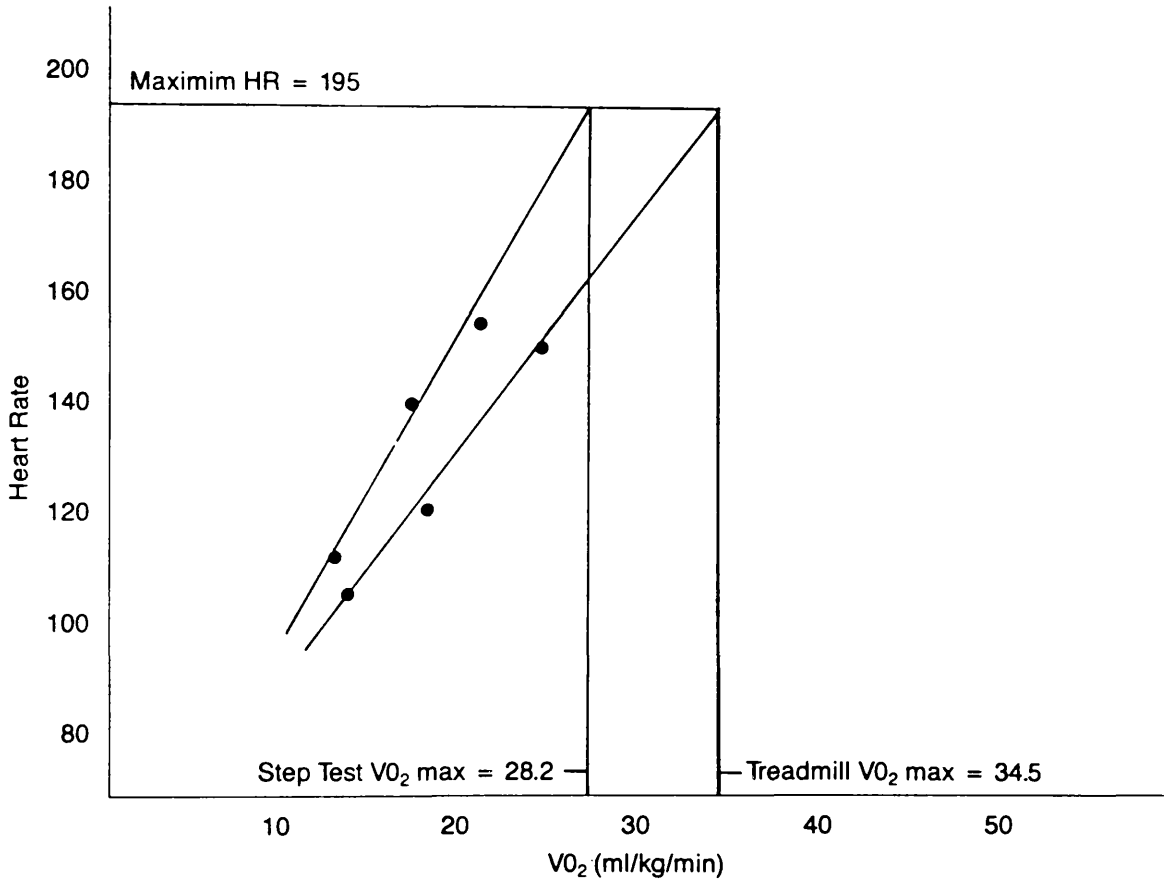

GRAPH G

Graph of 40 Step Test. Predicted VO_2 max, against 40 Treadmill. Predicted VO_2 max.

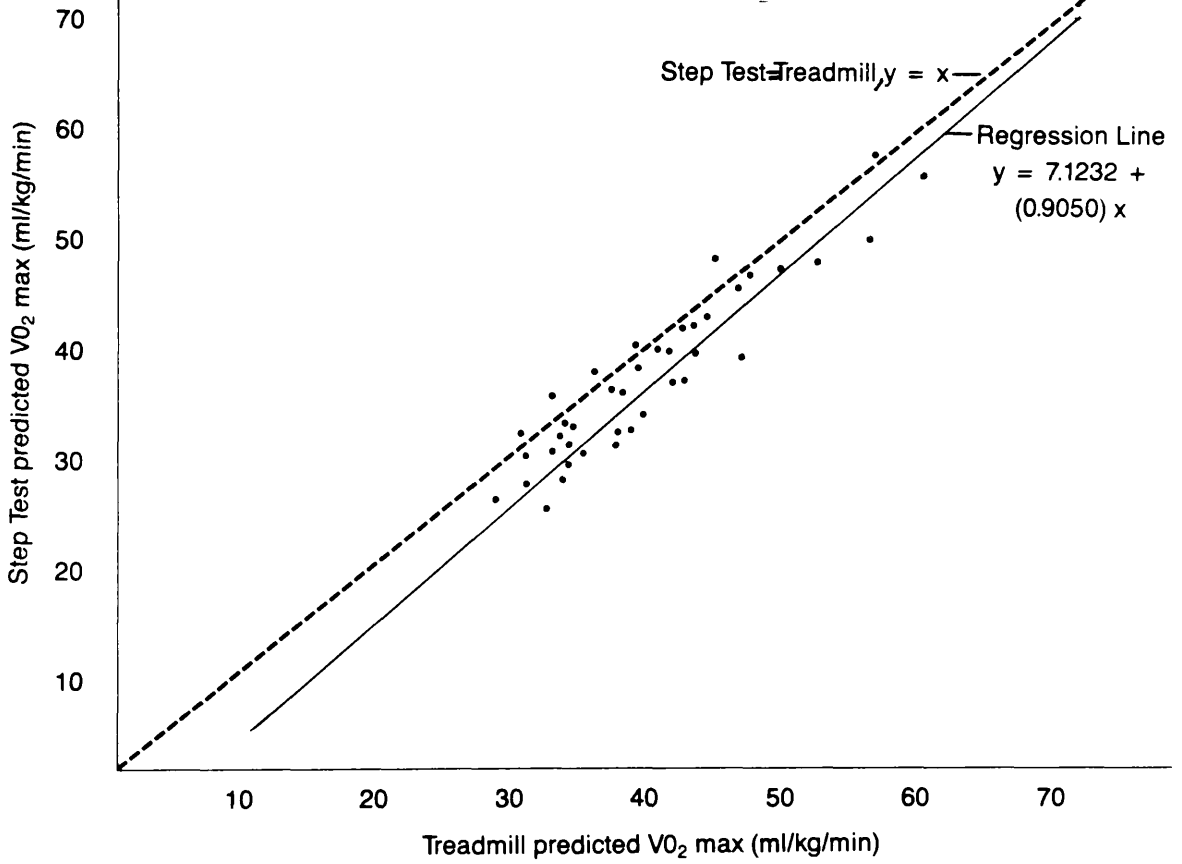

RESULTS AND DISCUSSION

Graphs A to F show the results of individual subjects when performing the steptest and the treadmill test. In all cases a higher predicted maximum oxygen uptake is obtained when performing the treadmill test.

Graphs A and B show that at every level of exercise the steptest elicits a higher heart rate for the same oxygen consumption than the treadmill. However, Graphs C,D,E and F show that it is only at the second and third levels of exercise that a difference is seen between the tests. This may suggest that these subjects were less efficient at high rates of stepping compared to a high rate of walking.

However an alternative explanation may be that the subjects were more anxious to keep up with the metronome while stepping. This may explain an initial increase of heart rate, but it is unlikely that this would persist throughout the whole test and it is therefore probably a result of the difference in the type of exercise performed in these two tests, which becomes more apparent at the higher rates of exercise.

Table 1 shows the results from the forty female subjects, and shows that the steptest produced lower predicted VO_2 max. values than the treadmill test. The average VO_2 max. obtained for these forty subjects from the steptest was 37.3 ml/kg/min and the average VO_2 max. from the treadmill test was 40.8 ml/kg/min. There were four exceptions however - subjects 12, 20, 21 and 31 had a higher predicted VO_2 max. while stepping.

Using a paired sample T-test it was shown that there was a highly significant difference between these two tests:-

$$T = - 5.337, \quad P < 0.0001$$

Therefore, on average there is an 8.6% underestimation of the VO_2 max. when the step test is used.

Graph G demonstrates the difference between the two sets of data graphically. Each dot represents a subject, the dotted line represents the situation where the steptest values equal the treadmill values. As can be seen, most of the individual results lie below this steptest = treadmill test line, indicating a higher VO_2 max. was obtained performing the treadmill test. The actual regression line for the data was calculated to be

$$y = 7.1232 + (0.9050)x$$

and is represented on the graph by the solid black line.

TABLE 1

<u>Subject</u>	<u>VO₂ max. (ml/KG.min)</u>		
	Treadmill	Steptest	Steptest + 8.6%
1	44.3	42.6	46.6
2	63.0	56.8	62.1
3	42.0	41.8	45.7
4	38.1	32.0	35.0
5	46.5	45.5	49.8
6	50.0	46.0	50.3
7	34.7	30.7	33.6
8	42.9	37.0	40.5
9	41.4	40.0	43.8
10	46.8	44.6	48.8
11	39.6	38.2	41.8
12	43.7	48.1	52.6
13	34.5	28.2	30.9
14	59.1	50.1	54.8
15	53.6	47.5	52.0
16	42.2	36.6	40.0
17	39.9	34.3	37.5
18	31.6	31.4	34.4
19	36.2	29.7	32.5
20	35.9	38.0	41.6

<u>Subject</u>	<u>VO₂ max. (ml/KG.min)</u>		
	Treadmill	Steptest	Steptest + 8.6%
21	33.0	35.6	38.9
22	33.7	30.7	33.6
23	33.2	24.7	27.0
24	51.0	38.0	41.6
25	58.8	58.4	63.9
26	38.2	31.9	34.9
27	34.3	31.6	34.6
28	43.5	39.7	43.4
29	38.0	35.5	38.8
30	31.8	26.9	29.4
31	39.4	39.8	43.5
32	37.7	35.8	39.2
33	38.4	32.1	35.1
34	44.5	40.0	43.8
35	43.4	41.8	45.7
36	34.7	32.5	35.6
37	35.0	27.1	29.6
38	29.4	26.5	29.0
39	32.3	31.1	34.0
40	34.2	33.3	39.6
mean (x)	40.8	37.3	40.9
SD	7.98	7.95	8.67
ESE (x)	1.26	1.26	

The correlation co-efficient between the treadmill and steptest values is very high, $R = 0.91$, as would be expected. Therefore, on average there is an 8.6 % underestimation of the VO_2 max. when the steptest is used. It may therefore be useful to apply a correction factor of 8.6% to each steptest value. When the steptest data is corrected in this way there is no significant difference between them and the treadmill values:-

$$t = - 0.668, \text{ not significant, } P > 0.05$$

This correction value would enable comparison of values obtained by the two different methods. This may be useful when the steptest is the only test available in, for example, the field situation where comparison to other documented populations is required. Since the extent of the under-estimation of the steptest is known, after applying the 8.6% correction factor, comparison with treadmill tested populations is possible.

Graph H is a graph of the corrected steptest values (steptest + 8.6%) against the treadmill values, with the solid black line representing steptest values = treadmill

GRAPH H

Comparison of predicted max $\dot{V}O_2$ for Treadmill and Step Test + 8.6%

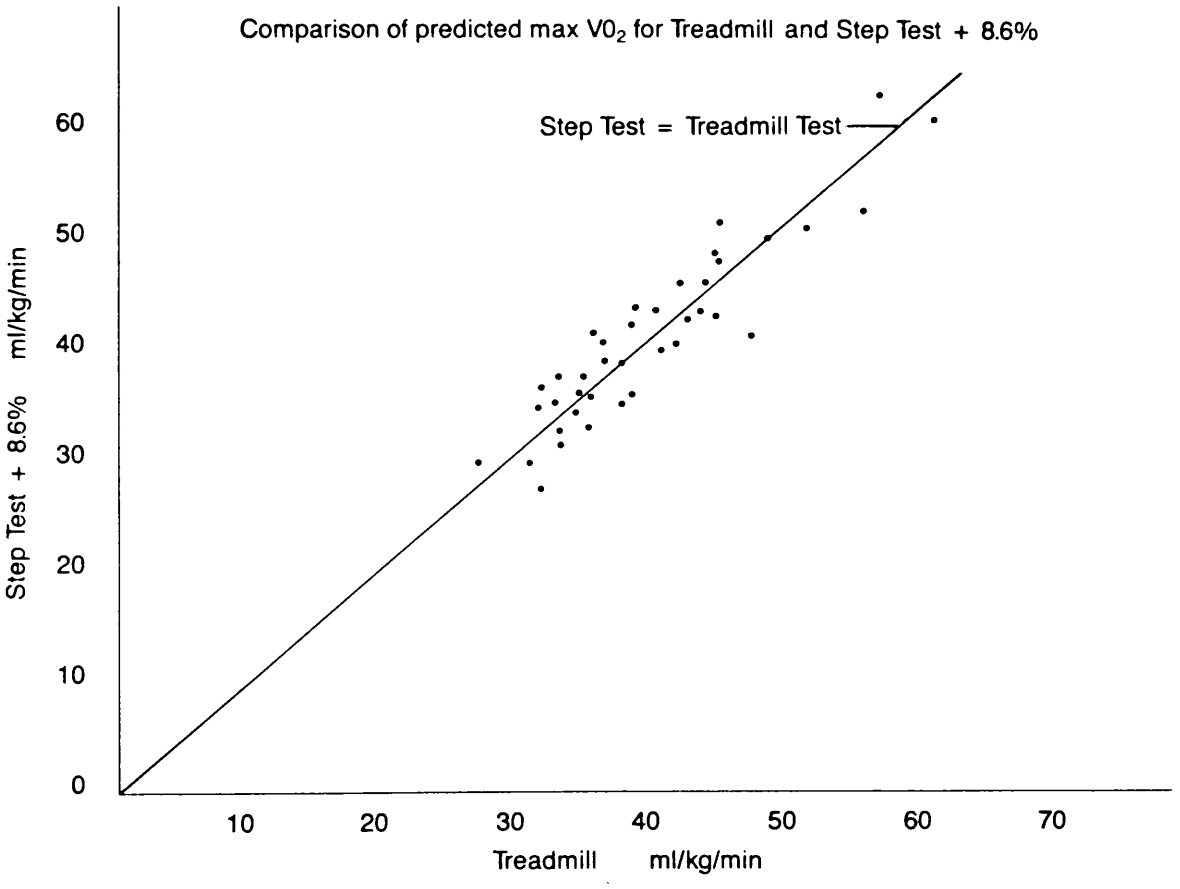

values. It can be seen here that the data is now clustered around this line, and not as in Graph G, lying below the line.

These results however conflict with a study by Kasch et al (1966) who report no significant difference in VO_2 max. values obtained whether walking or stepping (although the steepest did produce on average very slightly lower values).

Another study (Nagle et al, 1965) did report consistently lower oxygen consumptions obtained when stepping than walking at identical heart rates and the actual VO_2 max. obtained when stepping were, on average between 5% - 10% lower than when walking, which would agree with the results from this study.

The reasons for these differences may be explained by the variations in the amount of muscle mass used in the two tests. It is possible that uphill walking involves a larger muscle mass than stepping.

It is important in stepping to avoid local fatigue in the quadriceps muscle, as a local increase in lactic acid would tend to increase the heart rate more than a central

fatigue effect. It is therefore not advantageous to use a step which is too high for the subject, but to increase the work load by increasing the stepping rate.

Nagle et al (1965) explained the lower VO_2 max. values obtained when stepping by the actual stepping action. At high stepping rates they suggest the venous return may be impeded by the jerky action of stepping. This decreased venous return would result in a reduced stroke volume with an increased heart rate which would result in a decrease in the predicted VO_2 max.

However, whether this steptest is used in order to compare with data of populations using other tests, or whether examining "within-subject" changes in work capacity, it is a very simple, versatile and economical test to use. It is therefore ideal for the field situation where finances, transport or a steady electricity supply may rule out the other more commonly used tests.

REFERENCES

Astrand P O, 1960. Ergometry - Test of 'Physical Fitness' Varbarg Sweden, Monark Crescent. As adapted from Astrand I, 1960 Aerobic Work Capacity in Men and Women with special reference to age.

Acta Physiologica Scandinavica 49 (Suppl 169). 83.

Consolazio C F, Johnson R E, Pecora L V, 1963
Physiological Measurements of Metabolic Functions in Men
New York: McGraw.

Kasch F W, Phillips W H, Ross W D, Carter J E L,
Boyer J L, 1966. A Comparison of Maximal Oxygen Uptake
by Treadmill and Step Test Procedures.
Journal of Applied Physiology, 21: 1387.

Nangle F J, Balke B, Naughton J P, 1965.
Graduational Step Tests for Assessing Work Capacity.
Journal of Applied Physiology. 20:745.