



<https://theses.gla.ac.uk/>

Theses Digitisation:

<https://www.gla.ac.uk/myglasgow/research/enlighten/theses/digitisation/>

This is a digitised version of the original print thesis.

Copyright and moral rights for this work are retained by the author

A copy can be downloaded for personal non-commercial research or study,  
without prior permission or charge

This work cannot be reproduced or quoted extensively from without first  
obtaining permission in writing from the author

The content must not be changed in any way or sold commercially in any  
format or medium without the formal permission of the author

When referring to this work, full bibliographic details including the author,  
title, awarding institution and date of the thesis must be given

Enlighten: Theses

<https://theses.gla.ac.uk/>  
[research-enlighten@glasgow.ac.uk](mailto:research-enlighten@glasgow.ac.uk)

THE CONTROL OF HERPES SIMPLEX VIRUS

LATE GENE TRANSCRIPTION

by

PAUL ANDREW JOHNSON

A thesis presented for the  
Degree of Doctor of Philosophy

in

The Faculty of Science  
at the University of Glasgow

Institute of Virology,  
Church Street,  
Glasgow G11 5JR.

February 1987

ProQuest Number: 10991903

All rights reserved

INFORMATION TO ALL USERS

The quality of this reproduction is dependent upon the quality of the copy submitted.

In the unlikely event that the author did not send a complete manuscript and there are missing pages, these will be noted. Also, if material had to be removed, a note will indicate the deletion.



ProQuest 10991903

Published by ProQuest LLC (2018). Copyright of the Dissertation is held by the Author.

All rights reserved.

This work is protected against unauthorized copying under Title 17, United States Code  
Microform Edition © ProQuest LLC.

ProQuest LLC.  
789 East Eisenhower Parkway  
P.O. Box 1346  
Ann Arbor, MI 48106 – 1346

## CONTENTS

Acknowledgements  
Summary  
Abbreviations

### INTRODUCTION

#### SECTION A: THE HERPESVIRUSES

1	a	Classification of herpesviruses	1
	b	Pathogenicity of human herpesviruses	2
2		Herpesvirus - Host Interactions	4
	a	HSV and latency	4
	b	HSV and cervical cancer	6
	c	Effects of HSV infection on host-cell metabolism	8

#### SECTION B: HERPESVIRUS DNA

1		Structure	11
2		DNA Replication	12
	a	Template signals	12
	b	Virus-encoded replication functions	13
3		Inversion	15
4		Cleavage and Packaging	17
5		HSV-1 as a Vector	20
6		Sequence Utilization	21

#### SECTION C: RNA POLYMERASES AND MRNA PROCESSING

1		Eukaryotic RNA Polymerases	24
	a	RNA pol I transcription	24
	b	RNA pol III transcription	26
		Eukaryotic mRNA Processing:	
2		Initiation	26
3		Termination -	
	a	Gene regulation through termination of transcription and differential polyadenylation	27
	b	Mechanism of transcription termination and polyadenylation	28
4		Splicing	30

#### SECTION D: CONTROL OF RNA POL II TRANSCRIPTION INITIATION

1		Cis-acting Sequences	34
	a	Promoter sequences	34
	b	Enhancers	38
	c	Regulator elements	40
2		Transcription Factors	42
	(i)	Spl	43
	(ii)	CTF/CBP	44
	(iii)	TFIIB-D and TATA box factor	45
	(iv)	Enhancer factors	46
	(v)	Glucocorticoid receptor	46
3		Mechanisms of Action of Transcription Factors	47
4		Regulation of Transcription by Trans-acting Proteins	49

a	Adenovirus Ela	50
(i)	Sequences required for transactivation	50
(ii)	Factors involved in Ela-mediated transactivation	51
(iii)	Repression	53
b	SV40 T antigen	54
(i)	Late promoter activation	54
(ii)	Early promoter activation	55
(iii)	Activation of heterologous promoters	56

#### SECTION E: HSV-1 TRANSCRIPTIONAL PROGRAMME

1	Temporal Expression of the HSV-1 Genome	57
2	IE gene Regulation	59
a	Viral IE Gene Expression	59
b	IE gene regulatory sequences	60
c	Characterization of the virion factor which stimulates IE gene expression	62
3	Herpes-virus IE Gene Products	64
a	HSV-1 IE gene products	65
(i)	Vmw110	65
(ii)	Vmw63	66
(iii)	Vmw175	66
(iv)	Vmw68	69
(v)	Vmw12	69
b	PRV IE protein	69
4	Early Gene Expression	70
a	Early promoter sequences	70
b	Specificity of promoter activation	72
c	Trans-activation of E genes in co-transfection experiments	73
d	A role for the TATA box?	74
e	Trans-activation in vitro	76
f	The paradox of Vmw175 mutants and transdominance	76
5	Non-IE Gene Functions Involved In Transcriptional Regulation	78
6	Late Gene Expression	79
a	Gene expression and DNA replication	79
b	What are late genes?	80
c	Gene US11	81

#### MATERIALS AND METHODS

##### SECTION F: MATERIALS

1	Viruses	83
2	Cells	83
3	Bacteria	83
4	Cloning Vectors	84
5	Plasmids	84
6	Reagents	84
7	Radiochemicals	85
8	Enzymes	85
9	Tissue Culture Media	85
10	Bacterial Culture Media	86
11	Solutions	86

SECTION G:       METHODS

1	Tissue Cell Culture	88
2	Virus Preparation	88
3	Large Scale Plasmid Preparation	88
4	Small Scale Plasmid DNA Preparation	89
5	Preparation of Single-Stranded M13 Phage-Vector DNA	90
6	Preparation of Cytoplasmic RNA	90
7	Preparation of Nuclear DNA	91
8	Restriction Enzyme Digests	91
9	Separation and Preparation of Purified DNA Restriction Fragments	91
	(i) Non-denaturing agarose gels	91
	(ii) Non-denaturing polyacrylamide gels	92
	(iii) Strand-separation polyacrylamide gels	92
	(iv) Denaturing polyacrylamide gels	93
	(v) Sucrose gradients	93
10	Radioactive Labelling of DNA	93
	(i) 5'-end labelling	93
	(ii) nick-translation	94
11	Quantitation of Autoradiographs	94
12	Ligations	94
13	Bal 31 Exonuclease Digestion	95
14	Preparation of Competent Bacteria	95
15	Transformation and Transfection of <u>E.coli</u>	96
	(i) Transformation by plasmid DNA	96
	(ii) Transformation by M13 phage vector	96
16	DNA Sequencing	97
	(i) Chemical method	97
	(ii) Dideoxynucleotide method	97
17	S1 Mapping	98
18	Transfection of DNA into Tissue Culture Cells	98
19	Southern Transfer	99
20	DNA-DNA hybridization	99
21	CAT assays	100
22	Nuclear Run-On Assays	101

RESULTS

SECTION H:    VIRAL US11 GENE EXPRESSION

1	Location of the US11 RNA Cap Sites	103
2	Appearance of US11 and gD Transcripts During Viral Infection	104
3	Appearance of 21K Polypeptide and Glycoprotein D During Viral infection	105
4	Accumulation of Viral DNA in the Presence and Absence of PAA	106
5	HSV-1 Infection of HeLa Cells	107
6	The Effect of Delayed Inhibition of DNA Replication on US11 RNA Accumulation	107
7	Conclusions	108

SECTION I:    PLASMID-BORNE US11 GENE EXPRESSION

1	Construction of pPJ2	110
2	Internal Control Plasmid: pRED5	112

3	Time-course of Appearance and Accumulation of Hybrid Transcripts from the Plasmid-borne US11 Promoter	113
4	Replication of pPJ2	114
5	Quantitation of US11 Hybrid Transcripts and Plasmid DNA Replication	115
6	Role of Replication and IE Gene 5 Transcription Through the US11 Promoter	116
7	Conclusions	118

SECTION J: SEQUENCE REQUIREMENTS FOR REGULATED  
ACTIVITY OF A LATE PROMOTER

1	Construction of US11 Promoter Deletion Mutants	120
2	Transcriptional Activation of the pPJO Series	121
3	Effects of Replication and Transcription Through the -31 US11 Promoter	123
4	Does a TATA Box Constitute a Functional Late Promoter?	123
5	Construction of a "Late" gD Promoter	124
6	Transcriptional Activation of a "Late" gD Promoter	125
7	Conclusions	127

SECTION K: TRANS-ACTIVATION OF US11

1	Replicative Conditions: Incorporation of the SV40 Origin of Replication into pPJ2	129
2	Non-replicative Conditions: Construction of a US11 Promoter/CAT Fusion Gene - p31C	130
3	CAT-assay Protocol	130
4	Interpretation of Data	132
5	Trans-activation of the US11 Promoter	132
6	Methyldeoxyadenosine Residues do not Affect Activation of the US11 Promoter	134

SECTION L: TRANSCRIPTION OF US11 IN ISOLATED NUCLEI

1	Production of single stranded DNAs	136
2	US11 Transcription	137
3	Conclusions	138

DISCUSSION

1	Late Promoter Sequence Requirements	139
2	Trans-activation	
	a Trans-activation of late genes	143
	b Trans-activation in general	145
3	The Role of DNA replication in Late Gene Expression	147
4	Comparison of HSV-1 and Bacteriophage T4 Regulation of Late Gene Transcription	151
5	Future Prospects	154

REFERENCES

## ACKNOWLEDGEMENTS

I thank Professor John H. Subak-Sharpe for the provision of facilities in the Institute of Virology, and his overall supervision.

I thank Dr. Roger D. Everett for his friendship and his excellent and keen supervision.

I must have interacted with nearly all of the members of this Institute during my time here, and I am grateful for their friendship and help.

Particularly I must thank my companions in real ale, Mark Harris and Trevor Paterson (who has also done some of the proof-reading); Rhona Donaldson, with whom I kept sane by going to the Scottish hills; and Moyra Campbell, who has generally put up with me.

My parents have been an invaluable help by being there when needed, particularly when one of my other benefactors, Glasgow City Housing Benefits, was somewhat delayed.

The author was the recipient of a Science and Engineering Research Council studentship. Except where specified, all the results described herein were obtained by the author's own efforts.



## SUMMARY

The coordinate temporal control of the HSV-1 transcriptional programme involves three main phases of gene expression; immediate-early (IE), early (E), and late (L). The features which distinguish IE genes are well defined. IE genes are transcribed in the absence of de novo protein synthesis. Their transcription is stimulated by a component of the virus particle, Vmw65, and this requires the presence of a "far-upstream region" which includes one or more copies of the consensus sequence, 5'-TAATGARATTC-3'. IE gene products are required for the activation of the later classes of viral genes, whose expression in the absence of DNA replication is either maximal (E genes), sub-maximal (EL genes) or very poor (L genes). The organization of the promoter sequences of IE and E genes resembles that of many other eukaryotic (non-"housekeeping") genes, characterized by (i) a proximal element bearing a TATA box homology, and (ii) distal elements which are recognized by cellular transcription factors such as Spl and CTF. E genes do not possess far-upstream regulatory elements. Until recently, very little was known about late gene expression: What distinguishes a late promoter from an early promoter; why is efficient late gene expression dependent on DNA replication?

The work in this thesis has been directed at the control of expression of an HSV-1 late gene, US11. It was shown that the US11 gene was regulated in the virus with "true-late" kinetics, in terms of the time-course of appearance of US11 RNA and the sensitivity of US11 gene expression to inhibition of DNA replication. Under conditions of DNA replication inhibition, the accumulation of US11 RNA was reduced by 50 to 100-fold. In contrast, the accumulation of RNA from an EL gene, glycoprotein D (gD), was reduced by only 5 to 10-fold. Thus there is a clear difference between the regulation of transcription of gD, an EL gene, and US11, a "true-late" gene.

A plasmid system was developed in order to study the regulation of the US11 promoter. Plasmid DNA was introduced into tissue culture cells by a short-term transfection procedure, followed by infection with virus to provide the necessary factors for activation of US11. The US11 promoter was therefore linked to the coding portion of the rabbit  $\beta$ -globin gene, in order to distinguish between transcripts derived from the plasmid and those from the virus. The activity of the plasmid-borne US11 promoter in constructs containing or lacking a functional HSV-1 origin of DNA replication (ORI<sub>S</sub>) was analysed by quantitative S1 mapping of correctly initiated hybrid transcripts. Following HSV-1 infection of transfected HeLa cells, the US11 promoter in ORI<sup>+</sup> plasmids was expressed with similar kinetics to its viral counterpart. US11 promoter activity was first detected at the same time as the onset of DNA template replication. Expression of US11 RNA was detectable from non-replicating ORI<sup>-</sup> plasmids, although transcript accumulation was reduced by greater than 90%. Sequences containing the IE gene 5 promoter (a 3' co-terminal gene whose transcription starts 5' of US11) also played a positive role in achieving normal US11 gene expression, which suggested that both replication and through-transcription may act by inducing structural changes to the late promoter DNA.

The DNA sequence requirements for US11 gene expression were investigated using plasmids which contain ORI<sub>S</sub>. The sequences necessary for fully efficient regulated expression of US11 lie within the region -31 to +39 relative to the RNA start sites. It appeared that a late promoter might consist only of a proximal TATA box-cap site region. This hypothesis was tested by removing the distal upstream region of the gD promoter (which is required for its normal regulation as an EL promoter) and linking this truncated promoter to ORI<sub>S</sub>. The result was the conversion of gD promoter regulation to late gene kinetics during virus superinfection. It therefore seems unlikely that late promoters are distinguished by late promoter-specific

sequences.

Co-transfection of the US11 promoter with plasmids bearing HSV-1 IE genes showed that US11 could be activated by Vmw175 and Vmw110 and most efficiently, by the two in combination. This suggests that the target sequence for trans-activation by HSV IE gene products may be in the TATA box region. These results are discussed in terms of the possible mechanisms of regulation of late genes, and of transactivation of transcription in general, and also in comparison with late gene regulation in other viral systems.

## ABBREVIATIONS

A	adenine
Ac	acetate
Ad	adenovirus
Ap	ampicillin
ATP	adenosine-5'-triphosphate
BAP	bacterial alkaline phosphatase
bp	base pairs
BHK	baby hamster kidney cells
BSA	bovine serum albumin
C	cytosine
<sup>14</sup> C	radiolabelled carbon
CAT	chloramphenicol acetyltransferase
CBP/CTF	CAAT binding protein/ CAAT transcription factor
Ci	Curie(s)
CMV	cytomegalovirus
cpm	counts per minute
CTP	cytidine-5'-triphosphate
dATP	2'-deoxyadenosine-5'-triphosphate
dCTP	2'-deoxycytidine-5'-triphosphate
dGTP	2'-deoxyguanosine-5'-triphosphate
dTTP	2'-deoxythymidine-5'-triphosphate
dNTP	2'-deoxyribonucleoside-5'-triphosphate
ddNTP	2',3'-dideoxyribonucleoside-5'-triphosphate
DMSO	dimethyl sulphoxide
DNA	deoxyribonucleic acid
DNAase	deoxyribonuclease
ds	double stranded
DTT	di-thiothreitol
E (EL)	early (early-late) (class of HSV gene)
EBV	Epstein-Barr virus
<u>E.coli.</u>	<u>Escherichia coli</u>
EDTA	sodium ethylenediamine tetra-acetic acid
EtBr	ethidium bromide
G	guanine
g	grams
GRE	glucocorticoid response element

GTP	guanosine-5'-triphosphate
h	hour(s)
HSV	herpes simplex virus
IE	immediate early (class of HSV gene)
IR	internal repeat
K	kilo
kb	kilobase
kd	kilodalton
kg	kilogram
L	Late (class of HSV gene)
l	litre
LTR	long terminal repeat
M	molar
mcs	multiple cloning site
MDBP	major DNA binding protein
MEL	mouse erythroleukaemia cells
min	minute
ml	millilitre
ML	major late (adenovirus transcription unit)
mm	millimetre
mM	millimolar
MMTV	mouse mammary tumour virus
moi	multiplicity of infection
mol	moles
MoMSV	Moloney murine sarcoma virus
MRE	metal regulatory response element
mRNA	messenger ribonucleic acid
M.Wt.	molecular weight
N	unspecified nucleotide (A, G, C or T)
ng	nanogram
NPT	non-permissive temperature
NP40	Nonidet p40
nt	nucleotide
OD	optical density
ORI	origin of DNA replication
32p	radiolabelled phosphate
pmol	picamole
p.a.	post-adsorption
PAA	phosphonoacetic acid

PAGE	polyacrylamide gel electrophoresis
PBS	phosphate buffered saline
PEG	polyethylene glycol
pfu	plaque forming units
PIPES	piperazine-N,N'-bis(2-ethane sulphonic acid)
poly(A) <sup>+</sup>	polyadenylic acid
PRV	pseudorabies virus
R	purine moiety
rRNA	ribosomal nucleic acid
RNA	ribonucleic acid
RNAase	ribonuclease
rpm	revolutions per minute
RR	ribonucleotide reductase
RT	room temperature
SDS	sodium dodecyl sulphate
sec	seconds
snRNP	small nuclear ribonucleoprotein
SV40	simian virus 40
T	thymine
Tc	tetracycline
TEMED	n,n,n',n'-tetramethylethylene diamine
<u>tk</u>	thymidine kinase
TLC	thin layer chromatograph
tRNA	transfer ribonucleic acid
<u>ts</u>	temperature sensitive
UTP	uridine-5'-triphosphate
uv	ultra-violet
V	volt
v/v	volume/volume
Vmw	molecular weight (kd) of virus-induced protein
vol	volume
VP5	virion protein 5 (major capsid protein)
VZV	varicella zoster virus
w/v	weight/volume
<u>wt</u>	wild-type
Y	pyrimidine moiety
μCi	microcurie
μg	microgram
μl	microlitre

## INTRODUCTION

The subject of this thesis is the control of HSV-1 late gene transcription. The aims of the Introduction are to - (i) provide a brief background to the biology of herpes simplex virus (HSV) (Section A); (ii) highlight the important developments that have occurred in recent years in our understanding of HSV processes at a molecular biological level (Section B); (iii) review selectively eukaryotic transcription (Sections C and D), with the aim of putting into context - (iv) a detailed account of HSV-1 transcription (Section E).

### SECTION A: THE HERPESVIRUSES

#### 1a. Classification of herpesviruses

The family Herpetoviridae comprises of at least eighty different members, isolated from hosts as diverse as fish and man. Membership of this family is based on four morphological features:

(i) an electron-dense core, containing the double-stranded viral DNA genome (Epstein, 1962).

(ii) an icosahedral capsid, 100nm in diameter comprising 162 capsomeres (Wildy et al., 1960).

(iii) a tegument, consisting of a largely undefined layer of proteinaceous material between the capsid and envelope (Roizman and Furlong, 1974).

(iv) an envelope, which surrounds the capsid and tegument, and is derived by budding through the inner nuclear membrane. The envelope contains numerous virally encoded glycoprotein spikes (Wildy et al., 1960; Spear and Roizman, 1972).

The herpesviruses have undergone considerable diversification with respect to virion antigenic and biological properties. One property common to many herpesviruses is the ability to persist in a latent state.

Herpesvirus genomes show considerable variation in base composition, size and arrangement of their DNA. Subdivision according to biological properties has been proposed by Roizman et al. (1981): The three sub-families alpha-, beta- and gammaherpesvirinae are based on criteria of host-range, duration of the reproductive cycle, cytopathology and location of the viral genome during latent infection (see below). The herpesviruses have also been grouped on the basis of their genome structure, depending on the arrangement of reiterated sequences (Roizman et al., 1981; Roizman and Batterson, 1985).

#### 1b. Pathogenicity of human herpesviruses

There are at least five members of the Herpetoviridae family which infect man, including representatives from each of the three subfamilies. These pathogens are listed here, along with a brief mention of the diseases they cause or are associated with, and features of the subfamily to which they belong:

(i) Alphaherpesvirinae; Members of this subfamily may have a wide or narrow host range. The reproductive cycle is short (less than 24h), and in cell culture causes mass destruction of susceptible cells. Latent infection usually occurs in ganglia.

Herpes simplex virus types 1 and 2 (HSV-1, HSV-2):  
Varicella-zoster virus (VZV): Vesicular lesions of the lips and mouth, known as 'cold sores' are often caused by HSV-1. The primary agent of genital herpes is HSV-2. These two viruses are closely related and there is some overlap in their clinical manifestations (reviewed by Whitley, 1985). Following primary infection the virus often establishes latency, during which it lies dormant in nerve ganglia (reviewed by Hill, 1985). Recurrent lesions may then periodically occur at the same or other peripheral sites upon virus reactivation. HSV-1 is widespread in the human population, and although infection is usually mild or asymptomatic, it can give rise to systemic illness and encephalitis, particularly in immunosuppressed individuals.



The diseases caused by VZV are chickenpox (varicella) and shingles (herpes zoster). Varicella represents a primary infection and is seen predominantly in childhood. Herpes zoster appears to be a consequence of reactivation of VZV that has remained dormant since an earlier attack of varicella (reviewed by Gelb, 1985).

(ii) *Betaherpesvirinae*; Members of this subfamily have a narrow host range, frequently restricted to the species or genus to which the host belongs. The reproductive cycle is relatively long (greater than 24h), and results in slowly progressing lytic foci in cell culture; infected cells become enlarged both in vivo and in vitro. Latent infection may occur in secretory glands, lympho-reticular cells, kidneys and other tissues.

Human cytomegalovirus (HCMV): HCMV infects the majority of the human population. Infection is most serious in neonates, but usually HCMV infections are subclinical. CMV characteristically produces cell enlargement with intranuclear inclusions similar to those produced by HSV. One of the main problems caused by CMV is infection in immunosuppressed patients, particularly in transplant therapy, and more recently, in patients with acquired immunodeficiency syndrome (AIDS). HCMV DNA has been found in a small proportion of biopsies taken from patients with cervical intraepithelial neoplasia (pre-malignant cancer), suggesting that like HSV-2 (see below), HCMV may sometimes play a role in the development of cervical cancer (Fletcher et al., 1986; reviewed by Alford and Britt, 1985).

(iii) *Gammaherpesvirinae*; Host range is usually restricted to the same family or order as the natural host, although in vitro all members of this subfamily can replicate in lymphoblastoid cells. Lytic infection may occur to a lesser extent in epithelioid cells and fibroblasts, but the cytopathology is variable. Latent infection frequently occurs in lymphoid tissue.

Epstein Barr Virus (EBV): EBV is a lymphotropic virus that infects human B-cells. It is the causative agent of

infectious mononucleosis and is strongly associated with Burkitt's lymphoma and nasopharyngeal carcinoma. EBV is also capable of immortalizing lymphocytes (reviewed by Miller, 1985).

## 2. Herpes Virus - Host Interactions

### a. HSV and latency

The ability to establish a latent infection following primary infection of the host is an important property of HSV. The latent state is characterized by the prolonged association of the viral genome with its host, during which no infectious virus can be isolated (Hill, 1985). It is believed that the virus is transported intra-axonally from infected skin sensory nerve cells to the neurons of the sensory ganglia, where it is found in a latent state in both mouse model systems (Stevens and Cook, 1971; Cook et al., 1974; McLennan and Darby, 1980) and in man (Baringer and Swoveland, 1973). Reactivation of latent virus may occur in response to diverse stimuli, and in particular trauma and nerve damage (Hill, 1985).

Examination of DNA extracted from latently infected mouse brainstem and human trigeminal tissue has shown HSV DNA (which is linear in virions) to be present in an 'endless' form (Rock and Fraser, 1983, 1985; Efsthathiou et al., 1986). It is not clear whether this is due to integration of the HSV genome into cellular DNA, or if the viral genome is maintained extrachromosomally in circular or concatemeric form. Whether the HSV genome is silent in its latent state, or is capable of expressing some functions is also unknown.

In vitro latency systems have been developed in order to improve understanding of the molecular processes involved in the establishment and maintenance of HSV latent infections. A non-productive infection can be established in the absence of drugs that inhibit virus multiplication at a low moi (0.003 pfu/cell) by incubating infected cells at 42°C, a supraoptimal temperature (Russell and Preston,

1986). Virus replication can be repressed and latency established at a high moi (0.1-1.0 pfu/cell) by incubating infected cells in the presence of BVdR and interferon before transfer to an elevated temperature of 40.5°C (Wigdahl et al., 1982, 1984; Vonka et al., 1986). Virus reactivation can be induced by a variety of agents in one or both systems. These agents include superinfection with heterotypic virus, HSV ts mutants, HCMV or SV40 (but not adenovirus of types 2 and 5), and incubation in increased serum concentrations. Since Wigdahl et al. (1984) noted that the predominant form of HSV DNA in their latency system was nonintegrated and linear, which is at variance with the in vivo situation (Efsthliou et al., 1986), caution should be observed in extrapolating results obtained in vitro.

The in vitro latency system of Russell and Preston (1986) has demonstrated that HSV-1 tsK, but not uv-inactivated virus, is effective in reactivating latent HSV-2 at the non-permissive temperature (NPT). The tsK virus has a temperature sensitive lesion in Vmw175, an immediate-early polypeptide (the product of IE gene 3) which is essential for activation of early and late HSV transcription (Marsden et al., 1976; Preston, 1979). The virion component that stimulates IE transcription (see Section E(2b)) is probably not directly involved in reactivation, since it can be supplied efficiently by uv-irradiated tsK (Preston, C et al., 1984). These results raise the possibility that one or more of the four remaining HSV IE gene products is involved in reactivation of latent virus. A role for Vmw110 (IE gene 1 product) has recently been implicated since d11403, a mutant virus containing a large deletion in IE gene 1, is unable to reactivate latent HSV-2 in vitro (Russell, Stow and Preston, personal communication). Both tsK and d11403 are able to establish latency suggesting that little or no viral gene expression is required for this step in the in vitro latency system used (Russell, Stow and Preston, personal communication).

b. HSV and cervical cancer

An association between HSV and cervical cancer has long been recognised (Naib et al., 1966; Rawls et al., 1969; Nahmias et al., 1970). However, difficulties have been experienced in establishing whether or not there is a causal relationship, since the risk factors associated with developing cervical cancer are similar to those for becoming infected with HSV-2. It is also very likely that more than one factor is involved in the development of cervical cancer. Human papillomavirus DNA has been frequently detected in cervical disease (Durst et al., 1983; Boshart et al., 1984) and it has been suggested that HSV-2 may act as a co-carcinogen along with such other agents (zur Hausen, 1982). Evidence supporting the suggestion that HSV-2 may be involved in cervical neoplastic disease came from finding HSV gene products and DNA in some tumours (reviewed by Galloway and McDougall, 1983). The mechanism(s) by which HSV-2 may act as a carcinogen has been a field of intense investigation. It is generally accepted that HSV-2 does not carry a viral oncogene analogous to the oncogenes of retroviruses or the small DNA tumour viruses. It also seems clear that the retention of HSV DNA is not required to maintain the transformed phenotype, suggesting that the detection of HSV gene expression in cervical neoplasia may be fortuitous (Galloway and McDougall, 1983; Cameron et al., 1985).

Galloway and McDougall (1983) favour a 'hit-and-run' hypothesis for the oncogenic potential of HSV. This could occur through a transient or lasting disruption of normal cellular gene regulation or function as a result of HSV infection, which, in cooperation with other steps in the 'oncogenic process', might occasionally produce a malignant cell. There is much apparently conflicting evidence on the oncogenic nature of HSV. It may be relevant that all the experiments briefly reviewed below used various cell-types in culture, and therefore the significance of the conclusions in relation to the situation in vivo remains to be established. Two types of mechanism whereby HSV may affect cellular processes, which are not necessarily

mutually exclusive, are as follows:

(i) Gene regulation; Infection by HSV-1 or HSV-2 causes an increased level of some cellular polypeptides (Macnab et al., 1985; Kennedy et al., 1985; Patel, R. et al., 1986). Some of these polypeptides also accumulate to higher levels in transformed cells than in controls (Macnab et al., 1985). This might result from transcriptional activation by HSV gene products, which have the potential to trans-activate cellular promoters (Everett, 1985). Disruption of the normal regulation of cellular genes may also occur by rather more indirect means, such as HSV-induced mutagenesis or chromosomal rearrangements (see below).

(ii) Mutagenesis; HSV-2 has been shown to act as a mutagen, increasing the natural mutation rate of a cellular hypoxanthine phosphoribosyl transferase (HPRT) gene by up to ten-fold (Pilon et al., 1986). It is conceivable that the mutagenic activity may be caused by HSV-encoded enzymes involved in DNA biosynthesis. For instance, the disruption of normal nucleotide pool regulation by these enzymes could lead to an increased error rate during cellular DNA replication (Huszar and Bacchetti, 1983). Fragments of HSV-2 DNA containing transcribed regions encoding the large (BgIIc) and small (BgIIIn) subunits of the ribonucleotide reductase (RR) gene have been shown to have transforming activity in independent assay systems (Jariwalla et al., 1983; Galloway and MacDougall, 1983; Cameron et al., 1985), initially lending support to this hypothesis.

Jariwalla et al. (1986) have subsequently suggested that the BgIIc fragment of HSV-2 contains two independent transforming and immortalising functions. They mapped a transforming function to a 480bp fragment (PstIc/SalIb) which lies within the coding sequences of the large RR subunit, and yet lacks the promoter/regulatory sequences of this gene. Expression of at least some of the large RR subunit has been detected only in a minority of cell lines transformed with the 480bp fragment (Jariwalla et al., 1986), and it is now considered that the potential of sequences within the 480bp fragment to adopt stem/loop

structures may be involved in the activation and rearrangement of cellular genes (reviewed by Macnab, 1987).

It has been reported by Galloway et al. (1984) that a 737bp region of BglII $\lambda$  (termed the 'morphological transforming region' (MTR)II) is responsible for transformation, and this subfragment lies completely outside the coding sequences of both large and small RR genes. The transforming ability of the MTRII sequence has also been attributed to its apparent potential to adopt a stem/loop structure bounded by direct repeats, which bears a resemblance to the structure of insertion-like sequences (Galloway et al., 1984). It has been postulated that insertion of the MTRII into the cellular genome may cause activation of cellular genes through enhancer-like activity (Galloway et al., 1984). However, since such stem/loop structures frequently occur in DNA, the MTR must harbour some other definitive feature. Transformation by the MTR or other HSV fragments occurs at very low frequencies and certainly not by a one step mechanism (Macnab, 1987), which can create difficulties in the valid interpretation of transformation assay results. The mechanisms of HSV-induced mutagenesis and alteration of normal cellular gene regulation are evidently not straightforward; a detailed review of these and other possible mechanisms for the oncogenic potential of HSV is given in Macnab (1987).

#### c. Effects of HSV infection on host-cell metabolism

The infection of permissive cells with HSV-1 or HSV-2 is characterized by alterations in host functions and macromolecular synthesis. Mitosis ceases (Wildy et al., 1961), DNA synthesis is inhibited (Roizman and Roane, 1964), and there is a rapid shut-off of most host polypeptide synthesis (Sydiskis and Roizman, 1966, 1967), accompanied by a degradation of cellular mRNAs (Nishioka and Silverstein, 1977, 1978; Schek and Bachenheimer, 1985). Host polyribosomes are disaggregated following infection (Sydiskis and Roizman, 1966, 1967), and the polyribosomes which reform contain predominantly virus-encoded mRNAs (Stringer et al., 1977). In contrast to the general

reduction in levels of host RNA and protein synthesis, the expression of some cellular genes (notably heat-shock) is stimulated early in infection (Notarianni and Preston, 1982; LaThangue et al., 1984; Patel, R. et al., 1986). HSV infection can activate cellular promoters integrated into the genome of biochemically transformed cells (Everett, 1985), and increase the expression of certain cellular proteins which are also found at higher levels in HSV-transformed cells (Macnab et al., 1985). Alterations in host macromolecular synthesis early in viral infection could play a role in determining the ultimate outcome of infection (for example, lysis, latency or transformation). Host shut-off of polypeptide synthesis is considered in more detail below.

Infection with HSV-2 typically results in a more rapid inhibition of host protein synthesis compared to HSV-1 (Powell and Courtney, 1975; Pereira et al., 1977; Fenwick et al., 1979; Schek and Bachenheimer, 1985). The control of host shut-off is poorly understood and it is not clear how many mechanisms mediate this process. In most cell-types infected with uv-irradiated virus (Fenwick and Walker, 1979), or infected in the presence of actinomycin D (Sydikis and Roizman, 1967; Fenwick et al., 1979; Schek and Bachenheimer, 1985), there is a rapid shut-off of host polypeptide synthesis and a concomitant degradation of cellular mRNAs. This process is probably mediated by a virion function. Mutants have been isolated from HSV-1 which are defective in virion-associated host shut-off (vhs mutants) (Read and Frenkel, 1983). The vhs mutants which have been described are not conditionally lethal indicating that this mechanism of host shut-off is not essential for lytic growth. Interestingly, at least one of these mutants, vhs-1, overproduces virus IE polypeptides due to a failure in the post-transcriptional shut-off of IE viral gene expression (Read and Frenkel, 1983).

Full shut-off of host polypeptide synthesis may require viral gene expression in addition to the virion function, at least in HSV-1. Nishioka and Silverstein (1978) reported that infection of Friend Erythroleukaemia cells (which can

be induced to express large amounts of globin gene products) with uv-irradiated HSV-1 resulted in an inhibition of globin synthesis. However, further shut-off, characterized by the (non-specific) degradation of globin mRNA, required viral gene expression, suggesting that there is a secondary shut-off event distinct from the virion associated event (Nishioka and Silverstein, 1978). Other investigators have suggested that expression of an early or late viral protein is needed to fully inhibit host polypeptide synthesis (Hones and Roizman, 1974; Marsden *et al.*, 1976; Stenberg and Pizer, 1982), but the existence of a protein species involved in shut-off in addition to the virion-associated function(s) has not been demonstrated. Since the vhs mutants of Read and Frenkel (1983) are not defective in secondary shut-off of host polypeptide synthesis, the virion-associated and secondary shut-off events might be mediated by distinct viral gene products.

Schek and Bachenheimer (1985) have shown that the degradation of four common cellular mRNAs (encoding actin,  $\alpha$ -tubulin, and histones H3 and H4) in HSV-1 and HSV-2 infected Vero cells was not dependent on viral gene expression. Furthermore, the vhs-1 mutant defective in virion-associated shut-off of host polypeptide synthesis was also apparently defective in cellular mRNA degradation. Their results imply that the virion function is responsible for both host polyribosome disaggregation and cellular mRNA degradation, and seem inconsistent with a secondary shut-off event. However, it is possible that the rate of shut-off is dependent on variable factors such as the abundance and species of the mRNA in question, and that the speed of cellular mRNA degradation reported by Schek and Bachenheimer (1985), may not be fast enough to account for early shut-off of host protein synthesis.



## SECTION B:    HERPES VIRUS DNA

The structure and functions of HSV DNA are discussed in this section with particular reference to HSV-1, which is the best characterized of the alphaherpesviruses and the most relevant to the work described in this thesis. Viral gene products are mentioned only insofar as their interaction with the genome is concerned, while the regulation of viral gene transcription is discussed extensively in Section E.

### 1. Structure

The HSV-1 genome is a linear duplex DNA molecule of about 155,000 base-pairs with a base composition of 67% G+C (Becker et al., 1967; Kieff et al., 1971). HSV DNA can be fragmented by treatment with alkali or formamide, suggesting that it contains single-stranded nicks (Kieff et al., 1971; Wilkie, 1973; Gorden et al., 1973). Early electron microscopy studies showed that the termini of intact single strands of HSV DNA self anneal to internal inverted sequences, and that double-stranded HSV DNA which has been treated with processive 5'- or 3'-exonuclease is able to circularise, indicating the presence of terminal redundancy (Sheldrick and Berthelot, 1974; Grafstrom et al., 1974). These observations led Sheldrick and Berthelot (1974) to propose a model for the structure of HSV DNA which has since proved substantially correct (Wadsworth et al., 1975; Wilkie, 1976). The genome is divided into two unique segments, U<sub>L</sub> (long) and U<sub>S</sub> (short), each of which is bracketed by inverted repeats, R<sub>L</sub> and R<sub>S</sub> respectively (Figure 1). Flanking each end of the genome is a direct repeat, the a sequence, which varies in size from 280 to 550 bp among HSV strains (Davison and Wilkie, 1981). Multiple copies of the a sequence are often present at the L terminus and at least one inverted copy of the a sequence separates the L and S components, while a single copy is present at the S terminus (Wagner and Summers, 1978). The organization of the HSV genome can thus be represented as

$a_{nb}-U_L-b'a'_m c'-U_S-ca$ , as shown in Figure 1. The HSV-1 and

Map Units

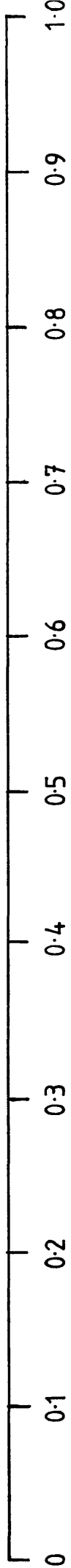

$\alpha_0$  b

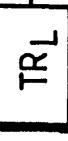

UL

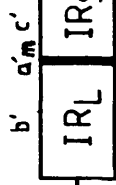

US

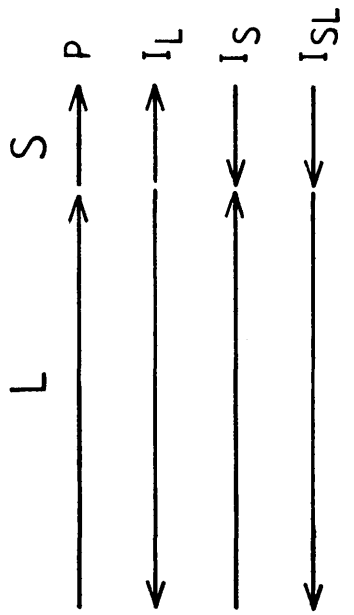
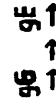

## Figure 1. Organization of the HSV-1 genome

The HSV-1 genome is shown to scale in prototype (P) orientation. The long unique ( $U_L$ ) and short unique ( $U_S$ ) regions (single lines) are flanked by terminal (TR) and internal (IR) repeats (double lines). The a sequences (a) at the termini of the L and S components are represented by heavy vertical lines, and may be duplicated "n" or "m" times (a' = inverse orientation). The remainder of the long and short repeats are referred to as "b" and "c" respectively, or in their inverted forms as "b'" and "c'". Below the genome are mapped (i) the IE mRNAs (spliced regions are raised); (ii) E and L transcripts which specify the best known virus-encoded proteins; and (iii) the three HSV-1 origins of DNA replication (ORI). The four possible isomers of the HSV-1 genome are depicted below, where the L and S components may be inverted (I) relative to the P orientation as indicated.

Abbreviations and key references (mainly for HSV-1 strain 17<sup>+</sup>), are as follows:

IE	immediated-early - (IE 1, Perry <u>et al.</u> , 1986; IE 2, Whitton <u>et al.</u> , 1983; IE 3, Rixon <u>et al.</u> , 1982; IEs 4 and 5, Rixon and Clements, 1982).	IE
AE	alkaline exonuclease (Costa <u>et al.</u> , 1983).	
VP5	major capsid protein (Costa <u>et al.</u> , 1984).	
tk	thymidine kinase (McKnight, 1980).	
gB	glycoprotein B (Bzik <u>et al.</u> , 1984).	
MDBP	major DNA binding protein (Quinn and McGeoch, 1985).	
Pol	DNA polymerase (Quinn and McGeoch, 1985).	
RR	ribonucleotide reductase (Frink <u>et al.</u> , 1981; McLauchlan and Clements, 1983).	
gC	glycoprotein C (Frink <u>et al.</u> , 1983).	
Vmw65	IE stimulatory protein (Hall <u>et al.</u> , 1982; Dalrymple <u>et al.</u> , 1985).	
dUTPase	(Hall <u>et al.</u> , 1982; Preston and Fisher, 1984).	
gG, gD, gE;	glycoproteins G, D and E (Rixon and McGeoch, 1985; McGeoch <u>et al.</u> , 1985, 1987).	
21K	US11 gene product (Rixon and McGeoch, 1984; Johnson <u>et al.</u> , 1986).	
ORI <sub>S</sub>	(Stow and McMonagle, 1983).	
ORI <sub>L</sub>	(Quinn and McGeoch, 1985).	

HSV-2 genomes are essentially colinear, with viral genes mapping at equivalent positions (Timbury and Subak-Sharpe, 1973; Esparza et al., 1976; Marsden et al., 1978; Schaffer et al., 1978; Davison and Wilkie, 1983a), and show 40-50% sequence homology as judged by solution hybridization (Kieff et al., 1972).

## 2. DNA Replication

### a) Template signals

Linear DNA molecules circularize soon after infection (Jacob and Roizman, 1977), probably by direct ligation of the termini (Davison and Wilkie, 1983a). Newly replicated DNA molecules consist of large head-to-tail concatemers, which probably arise by rolling-circle replication (Ben-Porat and Tokazewski, 1977; Jacob and Roizman, 1977; Jacob et al., 1979). The large concatemers are subsequently cleaved within a sequences, situated at the junctions between adjacent viral genomes (Davison and Wilkie, 1981).

The initiation of replication of HSV DNA can occur at multiple widely separated loci, as deduced by electron microscopy (Friedmann et al., 1977). The approximate locations of three HSV origins of DNA replication were found by characterization of two classes of defective genomes which accumulate in virus stocks passaged at high multiplicities of infection. Class I defective genomes contain an origin of replication from TR<sub>S</sub> or IR<sub>S</sub>, termed ORI<sub>S</sub>; Class II defectives possess an origin of replication from U<sub>L</sub>, ORI<sub>L</sub> (Vlazny and Frenkel, 1981; Spaete and Frenkel, 1982). A functional copy of ORI<sub>S</sub> is located in each of the short repeats, TR<sub>S</sub> and IR<sub>S</sub>, in the non-transcribed region between IE mRNAs 3 and 4/5 (Stow, 1982; see Figure 1). Stow and McMonagle (1983) subsequently identified a 90bp fragment which sufficed for origin function, and consists of a 45bp palindromic sequence featuring 18 centrally located A or T residues flanked by G+C-rich sequences. ORI<sub>L</sub> is located between the 5' termini of mRNAs encoding the DNA polymerase and major DNA binding protein (Figure 1). It has proved difficult to produce a

stable clone of this region in bacteria. However, cloning in yeast and direct sequencing of viral DNA showed that ORI<sub>L</sub> contained a 72bp palindrome and revealed a high degree of homology (85% identical residues) to the ORI<sub>S</sub> palindrome (Weller *et al.*, 1985; Quinn and McGeoch, 1985). The HSV-2 ORI<sub>L</sub> sequence (determined by cloning in *E.coli* recBC sbcB, under minimal growth conditions) is highly homologous to its HSV-1 counterpart, and is active in the presence of HSV-1 replication functions (Lockshon and Galloway, 1986).

The presence of an A+T-rich region in a eukaryotic origin of DNA replication may be significant in influencing origin configuration or facilitating the access of proteins required for replication (Stow, 1985). The A+T-rich region is sensitive to nuclease S1 digestion when ORI<sub>S</sub> is located in supercoiled plasmid DNA; this allowed substitution of the central 23bp by an 8bp synthetic oligonucleotide linker molecule, a manipulation which abolished replicative ability (Stow, 1985). The observation that both ORI<sub>L</sub> and ORI<sub>S</sub> are flanked by divergently transcribed mRNAs is of unknown significance, as is the importance of having three origins on the standard genome.

#### b) Virus-encoded replication functions

Since helper virus is needed to replicate defective genomes or plasmids which contain an HSV origin of replication (Vlazny and Frenkel, 1981; Stow, 1982), the induction of virus-specific replicative functions by HSV can be inferred. The HSV DNA polymerase (Keir and Gold, 1963; Keir *et al.*, 1966; Purifoy *et al.*, 1977; Chartrand *et al.*, 1980), the major DNA binding protein (Bayliss *et al.*, 1975; Powell *et al.*, 1981; Quinlan and Knipe, 1985a), and the alkaline exonuclease (Keir and Gold, 1963; Preston and Cordingley, 1982; Banks *et al.*, 1983; Moss, 1986), are all essential functions for DNA replication. The HSV DNA polymerase differs from most cellular eukaryotic polymerases by virtue of its 3' to 5' (proof-reading) exonuclease activity (Knopf, 1979). In addition, the HSV enzyme is sensitive to phosphonoacetic acid (PAA), a pyrophosphate analogue (Leinbach *et al.*, 1976). Properties of the major

DNA binding protein (MDBP) include its preferential binding to single-stranded DNA (Bayliss et al., 1975; Knipe et al., 1982) and ability to lower the melting temperature of poly A/T helices in vitro (Powell et al., 1981). Prior to viral DNA replication in infected cells, MDBP is localized to specific sites in the nucleus. When viral DNA replication occurs, MDBP is then found localised in large globular 'replication compartments' (Quinlan et al., 1984), where it is bound to progeny or replicating DNA (Leinbach and Castro, 1983; Lee and Knipe, 1983). It is postulated that MDBP acts in a replication complex with polymerase and alkaline exonuclease, since ts lesions in purified MDBP impair the function of these two enzymes at NPT in vitro (Littler et al., 1983). The role of MDBP in viral gene regulation is discussed in Section E. Recently, an unidentified virus-induced protein has been shown to specifically bind ORIs, and can<sup>be</sup> isolated from ORIs DNA in association with polymerase and MDBP (Elias et al., 1986).

The HSV-encoded ribonucleotide reductase (RR) is essential for virus growth and is also involved in DNA metabolism; the activity of DNA polymerase correlates with the functioning of RR (Cohen, 1972; Ponce de Leon et al., 1977, Dutia, 1983). This enzyme catalyses the reduction of all four ribonucleotides to their corresponding deoxyribonucleotides, and has different properties to the host enzyme including insensitivity to dTTP and dATP inhibition. Characterization of the HSV-RR has been of topical interest. Studies with ts1207, a ts mutant which has a single amino-acid change in the large RR subunit (RR<sub>1</sub> - Vmw136 (Preston, V. et al., 1984)), combined with experiments using a monoclonal antibody specific for Vmw136 and an oligopeptide-induced antiserum directed against the small RR subunit (RR<sub>2</sub> - Vmw38), showed that these two subunits form a complex in infected cells (Frame et al., 1985). An exciting finding was that a synthetic nonapeptide corresponding to the carboxy 9 amino-acids of the small subunit specifically inhibited the viral but not the cellular enzyme (Dutia et al., 1986; Cohen et al., 1986). Dutia et al. (1986) proposed that the inhibitory

oligopeptide prevents association of the two subunits by competing for the small subunit binding site on the large subunit, thus displacing Vmw38. This finding suggests a novel approach to the development of antiviral agents.

HSV enzymes involved in DNA metabolism, which are not essential for virus growth in tissue culture, include thymidine kinase (Kit and Dubbs, 1963; Klemperer et al., 1967; Jamieson and Subak-Sharpe, 1974; McKnight, 1980) and dUTPase (Wohlrab and Francke, 1980; Preston and Fisher, 1984). In addition, a type 1 DNA topoisomerase activity (topo 1) has been described in HSV virions (Muller et al., 1985). Although topo 1 activity tends to co-purify with an HSV-encoded 65K DNA binding protein (65K<sub>DBP</sub>), there is currently some doubt whether this function is virally encoded (M. Gallo, M.T. Muller, H.S. Marsden and D.S. Parris, personal communication).

Attempts to define all the HSV functions essential for DNA replication are being approached by determining the minimum fragments of the HSV genome required to support replication of an ORI<sup>+</sup> plasmid in a short-term replication assay (Challberg, 1986). The locations of the genes known to be involved in DNA replication are shown in Figure 1.

### 3. Inversion

A remarkable property of the HSV genome, predicted by Sheldrick and Berthelot (1974), is the ability of the L and S segments to invert with respect to one another, resulting in a viral population of all four possible isomers (Hayward et al., 1975; Delius and Clements, 1976; Clements et al., 1976). The isomers, shown diagrammatically in Figure 1, are either termed 'P' (prototype); or I<sub>L</sub>, I<sub>S</sub> and I<sub>LS</sub> for inverted L, S or both L and S segments relative to the P arrangement (Roizman et al., 1979). Studies with intertypic HSV-1/HSV-2 recombinants have occasionally identified mutants which fail to invert either one or both genome segments at normal frequencies (Preston et al., 1978; Davison and Wilkie, 1983b). Fine structure mapping indicated that homologous sequences within the flanking repeats, R<sub>S</sub> or R<sub>L</sub>, were required for segment inversion

(Davison and Wilkie, 1983b).

Flanking the major repeated sequences is the a sequence, which is composed of a number of direct repeats (DR) interspersed by unique sequences (Ub and Uc), such that the 501bp a sequence of HSV-1 strain F may be represented by;

$$DR1-Ub-(DR2)_{19}-(DR4)_3-Uc-DR1$$

(Mocarski and Roizman, 1982). Note that the exact number of direct repeats, DR2 and DR4, are variable among different virus isolates. The HSV-2 a sequence lacks reiterations, and its homology with the a sequence of HSV-1 is limited to one region of 27bp (Davison and Wilkie, 1981).

It was concluded by Mocarski et al. (1980) and Mocarski and Roizman (1982) that a site-specific recombination system operating on the a sequence was responsible for HSV genome segment inversion. This conclusion was based on evidence showing that duplications of fragments bearing the a sequence generated additional genome inversions, but duplications of several other HSV fragments from  $U_L$  and  $U_S$  as inverted repeats did not (Mocarski and Roizman, 1982). It has subsequently been shown by Chou and Roizman (1985) that the region of the a sequence inserted into  $U_L$  responsible for inversion contains the direct repeats, DR2 and DR4, but not the unique sequences, Ub and Uc.

Although the possibility of a site-specific recombination system in HSV cannot be ruled out, an alternative explanation is that HSV genome segment inversion results from both the summed recombinational activity of sequences dispersed throughout  $R_L$  and  $R_S$ , and from the use of alternative packaging phases on the precursor concatemer (Varmuza and Smiley, 1985). In both the repeated and unique regions of the HSV genome, there are a number of short tandemly reiterated sequences which vary in length between 5bp to 54bp (Whitton and Clements, 1984; Rixon et al., 1984; Perry et al., 1986). It has been suggested that these repeats may be highly recombinogenic, since homologous recombination can occur between any members of the same family (Rixon et al., 1984). In addition, out-of-register



crossover between imperfectly aligned families would generate progeny molecules with differing copy numbers of reiterations. The copy number of reiterated sequences does vary between different virus isolates, and this variation also occurs in the number of direct repeats within the a sequence (DR2, DR4 etc) (Davison and Wilkie, 1981; Mocarski and Roizman, 1981; Murchie and McGeoch, 1982; McGeoch et al., 1985). Thus, homologous recombination, particularly in the reiterated sequences of R<sub>S</sub> and R<sub>L</sub> (including the direct repeats of the a sequence), would appear to be a satisfactory explanation for the mechanism of genome segment inversion. Further evidence that inversion is not site-specific has come from the isolation of partially frozen genome arrangements, caused by deletions in the internal repeated region IR<sub>L</sub>/IR<sub>S</sub> (Longnecker and Roizman, 1986; Jenkins and Roizman, 1986). One isolate was deleted for IR<sub>S</sub>, the internal a sequence, and most of IR<sub>L</sub>. Its S segment was frozen in I<sub>S</sub> orientation, whilst its L segment continued to invert, albeit at a lower frequency than wild type virus (Longnecker and Roizman, 1986; Jenkins and Roizman, 1986). This result suggests that inversion of L in the absence of an internal a sequence was due to homology between the remaining sequences which flanked U<sub>L</sub>, but U<sub>S</sub> was unable to invert as it had no flanking homology. The isolation of frozen genome arrangements has also demonstrated that at least 3 of the 4 possible isomers are viable for virus replication.

#### 4. Cleavage and Packaging

Compelling evidence suggests that the a sequence contains the necessary signals for both cleavage and encapsidation of DNA, since plasmid molecules which contain an HSV origin of replication are replicated and packaged in the presence of helper virus, provided an a sequence is also located on the same plasmid molecule (Stow et al., 1983). In the viral genome, a single a sequence is flanked by the 20bp DR1 element, whereas adjacent reiterated copies of the a sequence are separated by only a single copy of DR1 (Davison and Wilkie, 1981; Mocarski and Roizman, 1982).

Since both viral termini bear an a sequence which ends in partial copies of DR1, it was initially supposed that the cleavage event may have occurred by a single ds breakage within the DR1 located between two adjacent a sequences (Davison and Wilkie, 1981). However, both defective viral genomes and plasmid molecules which contain an origin of replication and a non-reiterated a sequence may be replicated and packaged (Locker and Frenkel, 1979; Stow et al., 1983), which suggests that a single a sequence is sufficient to be a packaging substrate. Furthermore, packaged concatemeric plasmid molecules have been shown to contain an a sequence at both termini but do not generate internal a sequence duplications (Stow et al., 1986). Models which adequately describe the cleavage/packaging process must therefore be able to account how single copies of the a sequence may be used as substrates and yet result in the presence of at least one a sequence at both ends of the mature packaged DNA.

The essential features of the two models proposed by Varmuza and Smiley (1985) and outlined in Figure 2, which are consistent with the available data, are as follows; (i) The "staggered nick-repair mechanism", involves duplication of the a sequence between adjacent viral genomes by repair strand synthesis of the 5' overhanging single-stranded a sequences adjoining the L and S termini; (ii) The "theft mechanism", proposes that packaging commences at an a sequence and once a full genome length has been packaged, cleavage occurs at the next a sequence, which is 'stolen' from the adjoining DNA. A consequence of this second model is that lengths of DNA without an a sequence will be generated, and since these have not been detected experimentally it must be assumed that if this mechanism is used, they are rapidly degraded. Deiss et al. (1986) have elaborated upon the 'theft' model in an attempt to explain how multiple a sequences may accumulate at the L terminus but not at the S terminus, by proposing polarity in the packaging process. They have also described an additional model which requires recombinational repair to duplicate single a sequences. Whilst no model has been proved

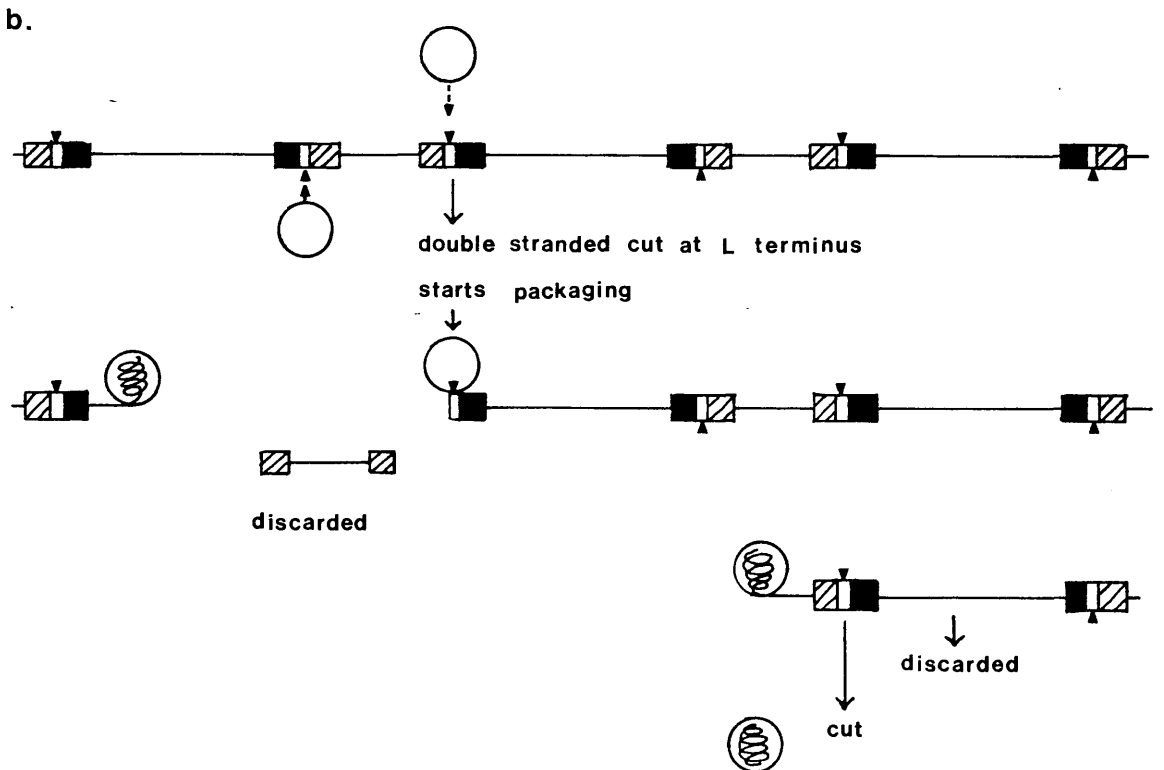
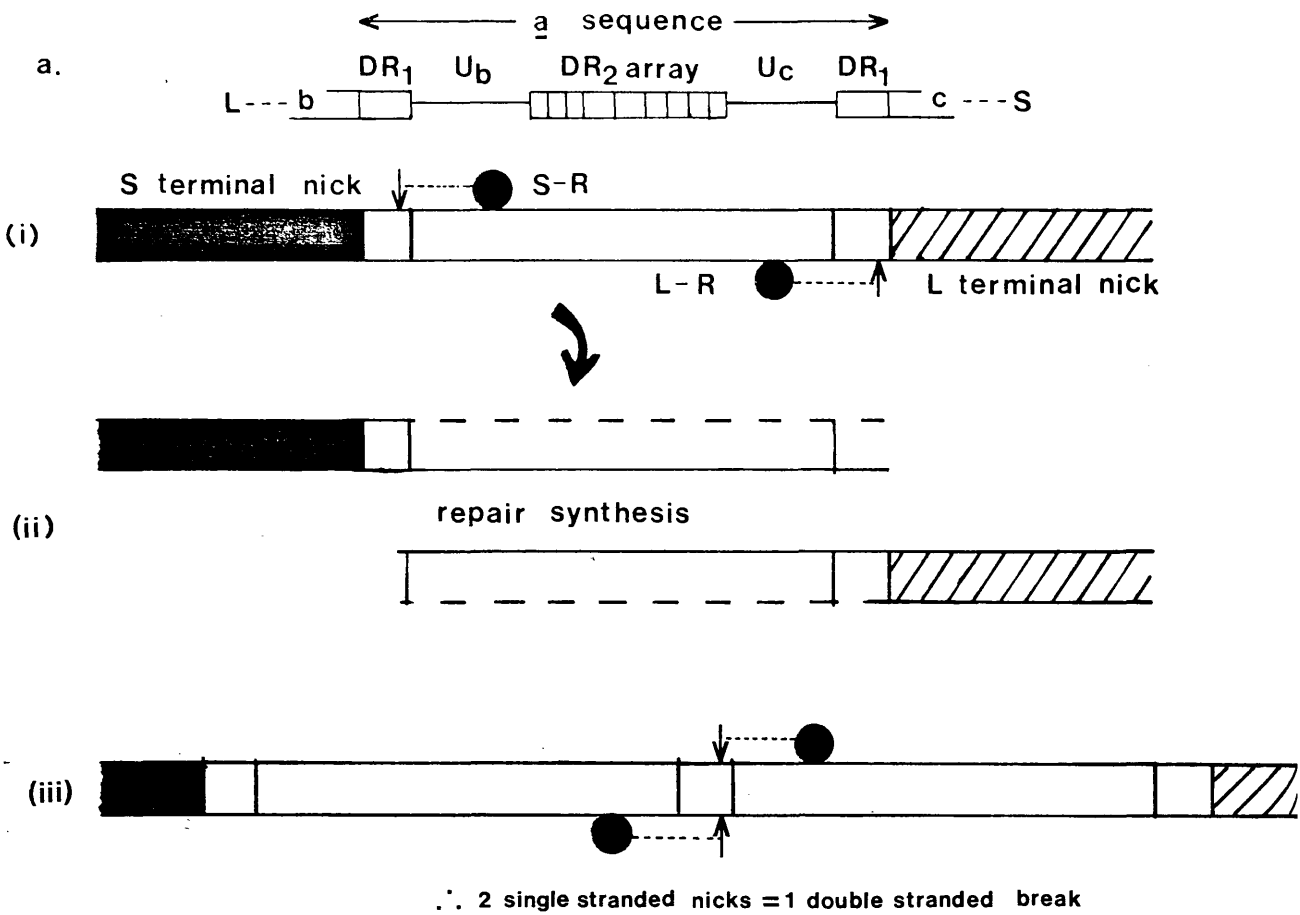

Figure 2.      Two cleavage/packaging models  
(from Varmuza and Smiley, 1985).

- a. Staggered nick repair mechanism. (i) The solid circles represent L and S recognition complexes (L-R and S-R), which are bound to signals in the U<sub>c</sub> and U<sub>b</sub> regions of the a sequence (see above), respectively. (ii) The L and S termini arise by single-stranded nicks, made by the bound complexes, followed by repair DNA synthesis. (iii) In cases where there are two or more tandemly repeated a sequences, cooperation between the two complexes may produce a double stranded break.
  
- b. "Theft" mechanism. Filled-in triangles represent packaging signals s situated on the a sequences; the open circles represent cleavage/packaging complexes (perhaps empty capsids). Double-stranded cleavage occurs at an L terminus cleavage signal, such that the L terminus carries the a sequence ("stolen" from the S terminus). Packaging proceeds until the next appropriately orientated L-S junction and a double-stranded cut is made at the S terminal. A consequence of this model is that some DNA fragments lack a sequences, and it is proposed that these must be rapidly degraded.

correct, it is clear that the cleavage events for the formation of L and S termini are distinct, and that the signals for cleavage are located within Ub and Uc (Varmuza and Smiley, 1985; Deiss et al., 1986). Cleavage does not require DR1, the sequence which is usually cut, and indeed may occur outside the a sequence if DR1 is deleted (Varmuza and Smiley, 1985).

Replicated DNA is not packaged by a simple 'headful' mechanism since short encapsidated DNA molecules may accumulate in the nucleus, although only those capsids containing an approximate genome equivalent of DNA can be enveloped and transported to the cytoplasm as mature virions (Vlazny et al., 1982; Stow et al., 1986). Cleavage of concatemeric DNA into unit length genomes is either prerequisite to, or occurs concomitantly with the packaging of DNA into capsids (Vlazny et al., 1982). A detailed characterization of tsl201, a ts mutant with a defect in encapsidation at NPT, showed that packaging was linked to the processing of Vmw40, a major structural (tegument) protein (Preston, V et al., 1983). Unprocessed forms of Vmw40 in tsl201 at NPT become associated with empty capsids, indicating that the failure in cleavage and packaging was not due to a gross aberration in capsid structure (Preston, V et al., 1983). Another mutant, tsl203, belonging to a different complementation group to tsl201, also has defects in both encapsidation and cleavage at NPT, indicating that these processes are tightly linked, and may not occur by a simple one step mechanism (Addison, 1986).

## 5. HSV-1 as a Vector

The large genome size and wide host range of HSV-1 makes it an attractive candidate for transducing manipulated or foreign DNA sequences into different types of mammalian cells. Features required for the replication, cleavage and packaging of the genome are now sufficiently well understood to allow rational design of HSV-based vectors.

Non-defective HSV-1 has been used as a vector for the expression of the hepatitis B surface antigen in cultured cells (Shih et al., 1984), and uv-irradiated recombinant HSV-1 containing the Chinese ham-ster ovary (CHO) aprt gene has been shown to stably transform Aprt<sup>-</sup> cells to the wild-type (Aprt<sup>+</sup>) phenotype (Tackney et al., 1984). Both types of recombinant virus were produced by flanking the foreign genes in plasmid vectors with HSV-1 tk sequences, and selecting for insertion into the non-essential tk locus of the virus by homologous recombination, following transfection of plasmid and viral DNA into animal cells. Stow et al. (1986) have described a helper-dependent viral vector system. In the presence of helper virus, plasmids which contain an a sequence and ORI<sub>S</sub> can be propagated as tandemly reiterated genomes in virus stocks. Regulated expression of a foreign vector gene through the use of different viral promoters and helper viruses has been demonstrated (Stow et al., 1986).

However, the presence of helper virus or the use of a replication competent vector in current systems limits their potential applications, thus failing to fully exploit HSV-1 as a gene-transducing vehicle. The existence of cell lines which express HSV-1 gene products required in trans for virus replication (Davidson and Stow, 1985; DeLuca et al., 1985) should allow the development of helper-free, defective HSV-1 vector systems. This would provide a useful complement to the amphotropic retroviral systems whose development is now quite well advanced (Miller et al., 1985; Hock and Miller, 1986; Yu et al., 1986).

## 6. Sequence Utilization

By the criteria of animal virology, the HSV genome is a large and complex genetic system. Many of its estimated 70-plus genes are uncharacterized in structure and function, while others are recognised only through the existence of ts mutants or by the mapping of protein species originating from particular regions of genome. Large scale DNA sequence analysis has greatly increased our knowledge of HSV-1. An almost complete transcript map of the genome now exists (Wagner, 1985; McGeoch et al., 1985, 1986; Rixon and McGeoch, 1984, 1985; Perry et al., 1986). The ability to raise antisera against synthetic oligopeptides, predicted to occur in HSV-encoded proteins from sequence data, has provided a powerful method of allowing the correlation of gene and product (Palfreyman et al., 1984; Frame et al., 1985, 1986; Johnson et al., 1986). One method of identifying potential gene functions is to compare by computer analysis the predicted protein sequence of an unknown gene with the protein sequences available in data banks. This approach has led to the tentative identification of a protein kinase encoded by US3 of HSV-1 (Figure 3; McGeoch and Davison, 1986). It is obviously necessary to identify and characterize all HSV genes for a full understanding of the virus.

The economic utilization of the HSV genome in terms of the density of protein coding sequences (gene compression), is intermediate between that found in smaller DNA viruses and in the eukaryotic genome, as judged in particular from the RNA mapping and DNA sequence data corresponding to U<sub>S</sub> (McGeoch et al., 1985; Rixon and McGeoch, 1985). There are twelve genes in U<sub>S</sub> (US1-12), expressed as thirteen mRNAs (Rixon and McGeoch, 1985; see Figure 3). In common with other studied areas of the genome, many of the mRNAs in the U<sub>S</sub> sequence are overlapping (Hall et al., 1982; Costa et al., 1983). Nested families with unique 5' ends and common 3' ends are the most frequent arrangement of overlap (Figure 3), although US10 and US11 are the only HSV genes in U<sub>S</sub> whose products are actually encoded by overlapping reading frames (Rixon and McGeoch, 1984).

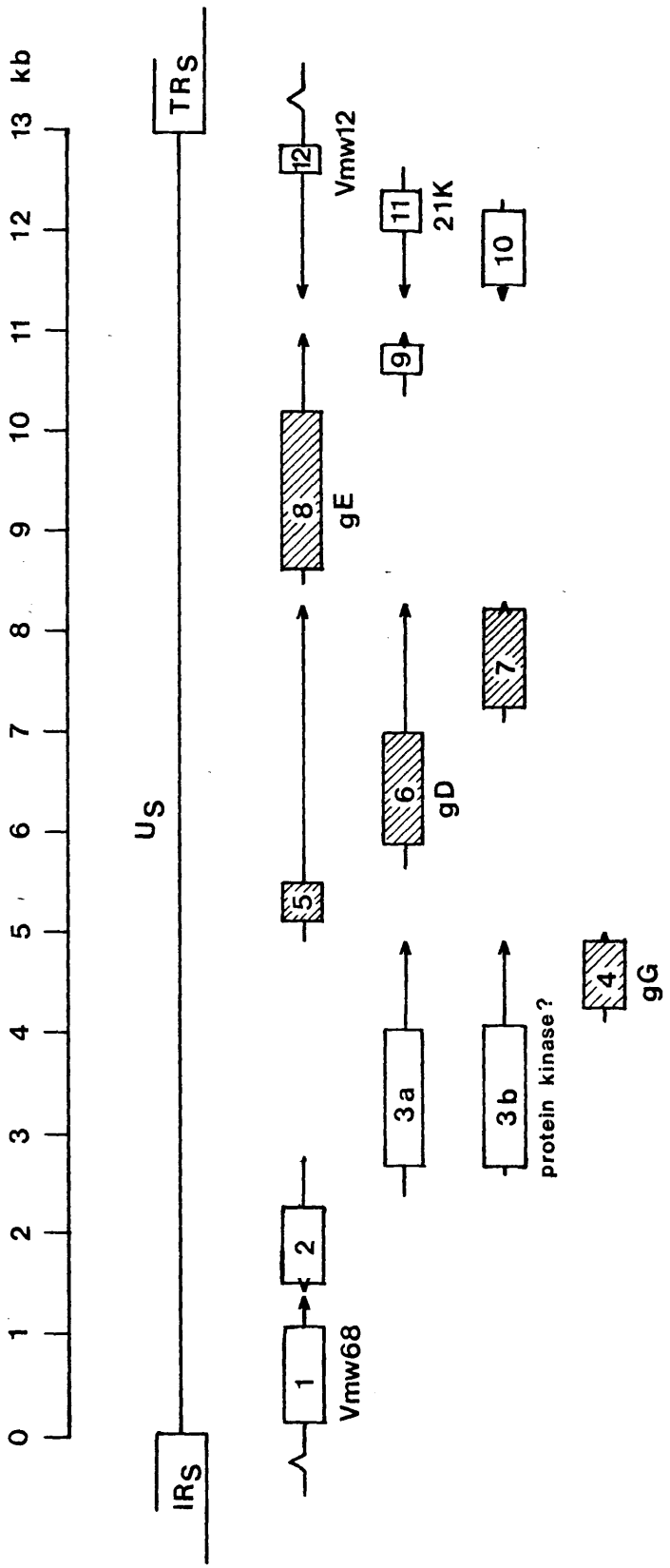



Figure 3. Transcript map of the short unique region of the HSV-1 genome

The U<sub>S</sub> region contains 12 genes (numbered 1 to 12 from left to right) which are expressed as 13 mRNAs (McGeoch et al., 1985; Rixon and McGeoch, 1985). The probable polypeptide coding (boxes) and non-coding (single lines) portions of mRNAs are indicated, and transcription is in the direction of the arrows. Hatched boxes indicate membrane associated glycoproteins which have been predicted from the sequence data, and confirmed where designated. The coding region of US3 shows homology to the protein kinase family of eukaryotes and retroviruses (McGeoch and Davison, 1986). Identified proteins have been referred to in the legend to Figure 1. Note that US11 is the internal member of a family of three, 3' co-terminal genes. US11 transcription begins in the coding region of IE gene 5 (US12), and the promoter for US10 (an early gene) lies in the coding portion of US11.

If the standard  $U_S$  sequence is taken as 12979bp (the exact size is variable due to the varying copy number of short, tandemly reiterated elements - Rixon et al., 1984; McGeoch et al., 1985), then 79% of  $U_S$  is occupied by open reading frames specifying polypeptides, and a further 16% appears as untranslated 3' and 5' mRNA (Rixon and McGeoch, 1985). After allowing for transcription initiation and termination signals 5' and 3' of transcription units, only a few hundred bp of  $U_S$  is without an obvious function, illustrating the compact sequence utilization of the HSV genome.

Splicing of HSV mRNAs is rare, in contrast to adenoviruses, papovaviruses, and some other herpes viruses including CMV and EBV. For these other viruses splicing allows the generation of individual mRNAs from overlapping gene families which have common 5' and 3' termini, thereby providing economic use of template DNA. Three of the five HSV-1 immediate-early (IE) mRNAs are spliced. However the purpose of this splicing does not seem to be related to gene compression since the IE gene introns do not lie within overlapping genes. HSV-1 IE mRNAs 4 and 5 have a single splice within their common 5' untranslated regions located within  $TR_S/IR_S$  (Watson et al., 1981; Rixon and Clements, 1982). IE gene 1 contains two introns and three protein coding exons (Perry et al., 1986). Interestingly, the 5' proximal intron of IE gene 1 contains three copies of a tandemly reiterated 54bp repeat sequence (Perry et al., 1986), and the IE gene 4/5 intron is composed of tandemly reiterated copies of a short 22bp repeat sequence (Murchie and McGeoch, 1982), but any significance or connection between reiterated sequences and splicing is unknown. Splicing has also been reported in two late HSV genes (Frink et al., 1983; Costa et al., 1985a).

The base composition of some areas of the HSV-1 genome is of exceedingly high G+C content. Although the estimated G+C content of the genome is 67% overall (Kieff et al., 1971), the protein coding sequences of IE genes 3 and 1 are 81.5% and 75.4% respectively (McGeoch et al., 1986; Perry et al., 1986). This extreme base composition is achieved

partly by encoding high levels of amino acids with G+C rich codons, and partly by a heavy bias towards G+C in the third codon position. The codon set available at this base composition is therefore sufficiently biased that restrictions on the possible amino acid composition must exist, and this has probably come about despite, rather than through demands of protein functionality (McGeoch et al., 1986; Perry et al., 1986). By comparison, the VZV homologue of IE gene 3 has a G+C content of 64% (Davison and Scott, 1985). McGeoch et al. (1986) suggest that the sequence of IE gene 3 must be near the attainable limit for extreme G+C content in protein coding DNA, although the nature of the evolutionary forces responsible for this effect are totally unknown.

SECTION C: RNA POLYMERASES AND mRNA PROCESSING1. Eukaryotic RNA Polymerases

In contrast to the DNA of bacteria, mitochondria and chloroplasts, which is transcribed by a single cognate DNA-dependent RNA polymerase, different classes of eukaryotic genes are transcribed by one of three RNA polymerase complexes. Each of these enzymes, distinguishable by their differing sensitivity to  $\alpha$ -amanitin toxin, consists of 10-15 subunits, some of which may be common to two or more complexes (Paule, 1981). RNA polymerase (pol) I transcribes ribosomal RNA (rRNA) genes, and is insensitive to  $\alpha$ -amanitin. RNA pol II transcribes polypeptide coding genes into mRNA, and is sensitive to low levels of  $\alpha$ -amanitin (less than  $1\mu\text{g/ml}$ ). RNA pol III transcribes 5S rRNA and tRNA genes, and requires higher levels of toxin ( $10\text{-}100\mu\text{g/ml}$ ) than pol II for inhibition of activity. The control of RNA pol I and pol III transcription is briefly described in this section, followed by a discussion of RNA pol II transcript processing. The control of RNA pol II transcription initiation is discussed in Section D.

a. RNA pol I transcription

The rRNA genes, repeated 100-5000 times per haploid genome, are very actively transcribed in growing cells in order to provide new ribosomes to support protein synthesis in daughter cells. Precursor rRNA (processed to yield 18S, 28S and 5.8S rRNA) is the sole product of synthesis by RNA pol I. The rRNA genes are organised in the form of tandem repeats, separated by non-transcribed spacer (NTS) sequences (Long and Dawid, 1980). Synthesis and processing of pre-rRNA occurs in the nucleolus during interphase (Roeder and Rutter, 1970).

Studies of cloned rDNA sequences required to direct transcription in vitro (Grummt, 1982; Learned et al., 1985) and in vivo (Moss, 1982; Smale and Tjian, 1985) have identified a bipartite promoter lying mainly 5' to the rDNA transcribed region. A detailed analysis of this region by

'linker scanning' mutagenesis (which produces a series of clustered point mutations) localised a 'core' element at -45 to +18, with respect to the transcription initiation site at +1, and an 'upstream' region between -157 to -106 (Haltiner et al., 1986). Mutations within the core element reduced transcription by up to 100-fold, compared to a 3 to 5-fold effect in the upstream region (Haltiner et al., 1986). It has recently been recognised that sequences further upstream from the bipartite pol I promoter, in the NTS region of Xenopus (Moss, 1983; Labhart and Roeder, 1985), rat (Cassidy et al., 1986) and probably of human rRNA genes (Haltiner et al., 1986), are responsible for a stimulatory transcriptional effect, independent of orientation and distance. This effect appears to be due to pol I specific enhancer elements contained in the repeats of the NTS (Labhart and Roeder, 1984). The pol I enhancer function cannot be recreated using a pol II enhancer (Smale and Tjian, 1985; Lopa-ta et al., 1986). In short-term transfection experiments using a rRNA promoter linked to either the HSV tk gene (Smale and Tjian, 1985) or the bacterial CAT gene (Lopa-ta et al., 1986), pol I initiated transcripts were not capped, polyadenylated or translated, (although some transcripts initiated at heterogenous start sites, presumably by pol II, were processed as mRNA). These results suggest that mRNA production by processing is specific to pol II initiated transcripts.

Two fractions ('C' and 'D') from cell extracts contain pol I transcription factors which are essential in in vitro assays (Mishimi et al., 1982; Miesfeld and Arnheim, 1984). Fraction C contains mainly polymerase I, while fraction D contains a species-specific transcription factor(s) that probably recognises the (poorly conserved) core element (Sollner-Webb and Tower, 1986). The highly purified 'SL1' fraction of Learned et al. (1985), which is functionally equivalent to fraction D, appears not to bind directly to DNA. Sollner-Webb and Tower (1986) suggest that the species specificity of the pol I transcription apparatus may be because recognition of only a single promoter has put fewer constraints on divergent evolution than for pol II or III.

### b. RNA pol III transcription

Class III genes are transcribed by pol III, and include, 5S RNA, tRNA, and adenovirus VA-RNA genes (Heintz and Roeder, 1982). A hallmark of class III genes is that their promoters are intragenic. Sakonju et al. (1980) localised the Xenopus laevis 5S promoter to the region +50 to +83, relative the 5' transcription start site. The bipartite tRNA promoter lies between +8 to +19, and +52 to +62 (Hofstetter et al., 1981; Sharp et al., 1981). The adenovirus VA1 gene promoter lies between +9 and +72, and is possibly modulated by 5' flanking sequences (Fowlkes and Shenk, 1980).

Accurate pol III transcription of 5S gene template in vitro requires either the template to be isolated as chromatin (Parker and Roeder, 1977), or the presence of a 38,600 mol.wt. 5S gene-specific transcription factor, TFIIIA (Engelke et al., 1980). Purified TFIIIA binds the intragenic 5S promoter region (Sakonju and Brown, 1982), and is able to locally unwind DNA (Hanas et al., 1984). Since TFIIIA also binds 5S RNA (Pelham and Brown, 1980), it has the ability to autoregulate 5S gene transcription. TFIIIB and TFIIIC are two further fractions which contain general factors required for the transcription of all class III genes. In 5S gene transcription, TFIIIB and C form a stable complex with TFIIIA-bound 5S DNA, allowing multiple rounds of polIII transcription in vitro (Bieker et al., 1985).

## 2. Eukaryotic mRNA Processing: Initiation

Heterogeneous starts are characteristic of the 5' termini of many pol II catalysed transcripts, both viral and cellular. Examples of microheterogeneity include the early transcripts of SV40 (Gidoni et al., 1981), early and late transcripts of HSV-1 (Everett, 1983; Johnson et al., 1986), and chicken ovalbumin transcripts (Malek et al., 1981). Extended 5' heterogeneity of starts, associated with the absence of a TATA-box signal (Breathnach and Chambon, 1981), has been reported for the SV40 late gene (Gidoni et al., 1981), chicken lysozyme gene (Grez et al., 1981) and the

human hypoxanthine phosphoribosyltransferase (HPRT) gene (Patel, P. et al., 1986), amongst others. Transcripts which have been initiated by RNA pol II are 'capped' at the initiator nucleotide (Gidoni et al., 1981; Malek et al., 1981), rather than at endonucleolytic cleavage points of transcripts initiated further upstream. The addition of a cap structure, m<sup>7</sup>G(5')ppp(5')N, protects mRNA at its 5' terminus against attack by phosphatases and nucleases, and promotes initiation of translation (Shatkin, 1976). It has recently been shown in some in vitro systems that capped pre-mRNA is a better substrate than non-capped for RNA splicing (Konarska et al., 1984; Krainer et al., 1984) and 3'-end processing reactions (Moore and Sharp, 1985; Hart et al., 1985). The addition of an exogenous cap analogue in vitro inhibits these reactions. The mRNAs of HSV have also been shown to be capped (Bartkoski and Roizman, 1976; Moss et al., 1977). The control of pol II transcription initiation is discussed in Section D.

### 3. Termination

#### a. Gene regulation through termination of transcription and differential polyadenylation

Although one of the main control points regulating eukaryotic gene expression is at the level of initiation of transcription, choice of termination site, 3' cleavage site (and/or splice sites) and correct 3' end processing offer additional levels of control. Inefficient termination leads to reduced translation efficiency, independent of the frequency of RNA initiation (McLauchlan et al., 1985). A secondary consequence of inefficient termination may be transcriptional interference. Proudfoot (1986) showed that the presence of a mouse  $\beta$ -globin gene 'terminator' located between two tandemly duplicated  $\alpha$ -globin genes increased transcription of the downstream promoter by 3-fold in a transient assay, and by 5 to 20-fold in biochemically transformed cells.

Tissue-specific regulation by differential selection of

two polyadenylation sites, and alternative splicing, enables expression of unique C-terminal portions of calcitonin and calcitonin gene-related peptide (CGRP). The calcitonin and CGRP mRNAs share a common 5' terminus and are expressed in thyroid and brain tissue respectively (Rosenfeld et al., 1983; Edbrooke et al., 1985). The adenovirus major late transcription unit (L1 through L5) offers a classic example of developmental regulation by differential selection of polyadenylation sites (Jones, 1986). Transcription termination early in infection precludes expression of L4 and L5. Later in infection transcription terminates distal to L5, enabling expression of L4 and L5 polypeptides, although the mechanism for this control is not understood (Imperiale and Nevins, 1986).

HSV encodes a number of transcripts with shared 5' termini and different 3' ends (Anderson et al., 1981; Wagner, 1985). However, since these 5' colinear RNA species encode the same polypeptides, the purpose of this apparent redundancy remains obscure, although the longer transcripts may arise simply through inefficient termination (Wagner, 1985).

#### b. Mechanism of transcription termination and polyadenylation

The 3' termini of the majority of eukaryotic mRNAs are formed by endonucleolytic cleavage of an mRNA precursor and the addition of 100 to 250 adenylate residues [poly(A)] to the newly formed 3' end (Nevins and Darnell, 1978). The exact sequences in the precursor molecule required for these processes have not been completely defined, but they include the poly(A) signal, AAUAAA, located 10 to 30 nucleotides 5' to the poly(A) site (Proudfoot and Brownlee, 1976), and a downstream element (GT-box) (McLauchlan et al., 1985). The non-polyadenylated histone mRNAs have a different conserved sequence, which is essential for processing, near their 3' ends (Birchmeier et al., 1983).

Deletions or single base changes in the AAUAAA signal can prevent RNA cleavage in vivo (Montell et al., 1983) and in vitro (using nuclear, rather than whole-cellular



extracts) (Moore and Sharp, 1985; Zarkower et al., 1986). Moreover, polyadenylation is dependent on an intact AAUAAA sequence, even when pre-mRNA with 3' termini at the normal polyadenylation site is used as a substrate, suggesting that polyadenylation might require recognition of AAUAAA by the cleavage complex (Zarkower et al., 1986).

Sequences greater than 10 nucleotides downstream from the poly(A) site are required for efficient 3' termini production in vivo (Gil and Proudfoot, 1984; Cole and Stacy, 1985; McLauchlan et al., 1985), and in vitro (Moore and Sharp, 1985; Hart et al., 1985). The consensus 'GT-box' sequence YGTGTTY (Y = pyrimidine) is located approximately 30 nucleotides downstream from the poly(A) signal of many, but not all, viral and cellular genes (McLauchlan et al., 1985). Deletions which eliminate the HSV-2 IE gene 3 GT-box reduce gene expression to 1-4% of wild-type in a transient assay (McLauchlan et al., 1985). However, since the GT-box is required for optimal processing of synthetic pre-mRNA in vitro (Hart et al., 1985), it would seem that this sequence is functional in the RNA (for cleavage/polyadenylation) rather than the DNA (for termination). The structural features of DNA involved in termination of pol II transcription, and the nature of this event, remain to be established. Also, the sequences adjacent to AAUAAA, and downstream or in place of YGTGTTY which play a role in 3' processing events require further investigation.

Recent evidence has indicated that (i) small ribonucleoproteins (snRNPs) are involved in the 3' processing reaction, and (ii) this reaction takes place after a time lag in vitro. This suggests an analogy to the splicing reaction which also shares these two parameters (Moore and Sharp, 1984; see following section). Anti-Sm antibodies from patients with autoimmune diseases recognise snRNPs (Lerner and Steitz, 1979), and inhibit polyadenylation in vitro (Moore and Sharp, 1984). Fragments containing AAUAAA from the 3' terminal portions of pre-mRNAs can be protected from RNase T1 digestion and immunoprecipitated by Sm antibodies (Hashimoto and Steitz,

1986), suggesting that snRNPs may be components of a 'polyadenylation complex'. However, purified Sm snRNPs (but this does not include all snRNA species) and RNA substrate were not found to associate by themselves; the nuclear extract capable of polyadenylation needed to<sup>be</sup> present for complex formation (Hashimoto and Steitz, 1986). The individual U RNAs (present in the snRNPs) which are required for 3' processing have yet to be determined. Berget (1984) proposed that U4 RNA which has a sequence complementary to five nucleotides of the AAUAAA signal would be a likely candidate, although any specific binding has yet to<sup>be</sup> shown. In the case of sea urchin histone H3 mRNA, a specific involvement of U7 RNA for 3' end formation is required, and the U7 RNA has sequence complementarity to essential conserved sequences near the 3' end of histone pre-mRNA (Strub et al., 1984).

#### 4. Splicing

Most RNA pol II transcribed genes of higher eukaryotes contain introns, which, in the primary transcript, separate the sequences found in the mature mRNA (exons). Whatever the origin or possible function of introns, their removal from primary transcripts by RNA splicing is an essential step in pre-mRNA maturation (reviewed by Breathnach and Chambon, 1981; Sharp, 1985; Gilbert et al., 1986). The human HPRT gene, for example, is 42kb in length and split into nine exons; the cDNA corresponding to the mature transcript is 1.6kb (Kim et al., 1986; Patel, P et al., 1986). As mentioned previously, splicing is not a common event in HSV (Watson et al., 1981; Wagner, 1985; Perry et al., 1986). However, it can play an important part in gene regulation, for example, by producing selective expression of late genes in the adenovirus major late transcription unit (Jones, 1986).

The consensus sequences deduced from a study of many splice junctions (Mount, 1982), are shown as follows. The most important and highly conserved dinucleotides (underlined) flank the intron boundaries (colons):

5'-A/CAG:GTA/GAGT

Splice donor  
site

Y<sub>6</sub>NCAG:G<sup>G</sup>/T-3'

Splice acceptor  
site

The recent development of in vitro cell-free systems which faithfully splice mRNA precursors has greatly improved our understanding of the splicing reaction (for review, see Padgett et al., 1985). For use as a substrate in these reactions, unspliced pre-mRNA is often produced from an appropriate plasmid DNA template using either (i) a HeLa whole-cell extract (Manley et al., 1980) under conditions which inhibit splicing, or (ii) the bacteriophage SP6 RNA polymerase transcription system (Melton, 1984). The fate of pre-mRNA during the splicing reaction may be determined directly, if it is radiolabeled during synthesis, or indirectly by S1 mapping and primer extension analysis.

From in vitro studies, it has been established that splicing occurs by a two step process (see Figure 4). Firstly, accompanying cleavage at the (5') splice donor site, the terminal G residue of the intron is linked to an internal A residue (at the intron 'branch site') through a 2'-5' phosphodiester bond (Ruskin et al., 1984). Secondly, cleavage at the splice acceptor site removes the intron RNA as a lariat, and the flanking exons are ligated (Ruskin et al., 1984). Mutations in the mammalian branch site (consensus sequence - YNYTRAY) are usually not critical since they allow activation of cryptic branch sites (Ruskin et al., 1984; Frendeway and Keller, 1985).

Precursor RNA is organized into a specific 50-60S complex (spliceosome) during the splicing process in vitro (Frendeway and Keller, 1985; Grabowski et al., 1985). Formation of the spliceosome requires ATP and takes place during the 15-30min lag period of the splicing reaction (Kramer et al., 1984; Frendeway and Keller, 1985; Grabowski et al., 1985). The reaction requires snRNPs, of

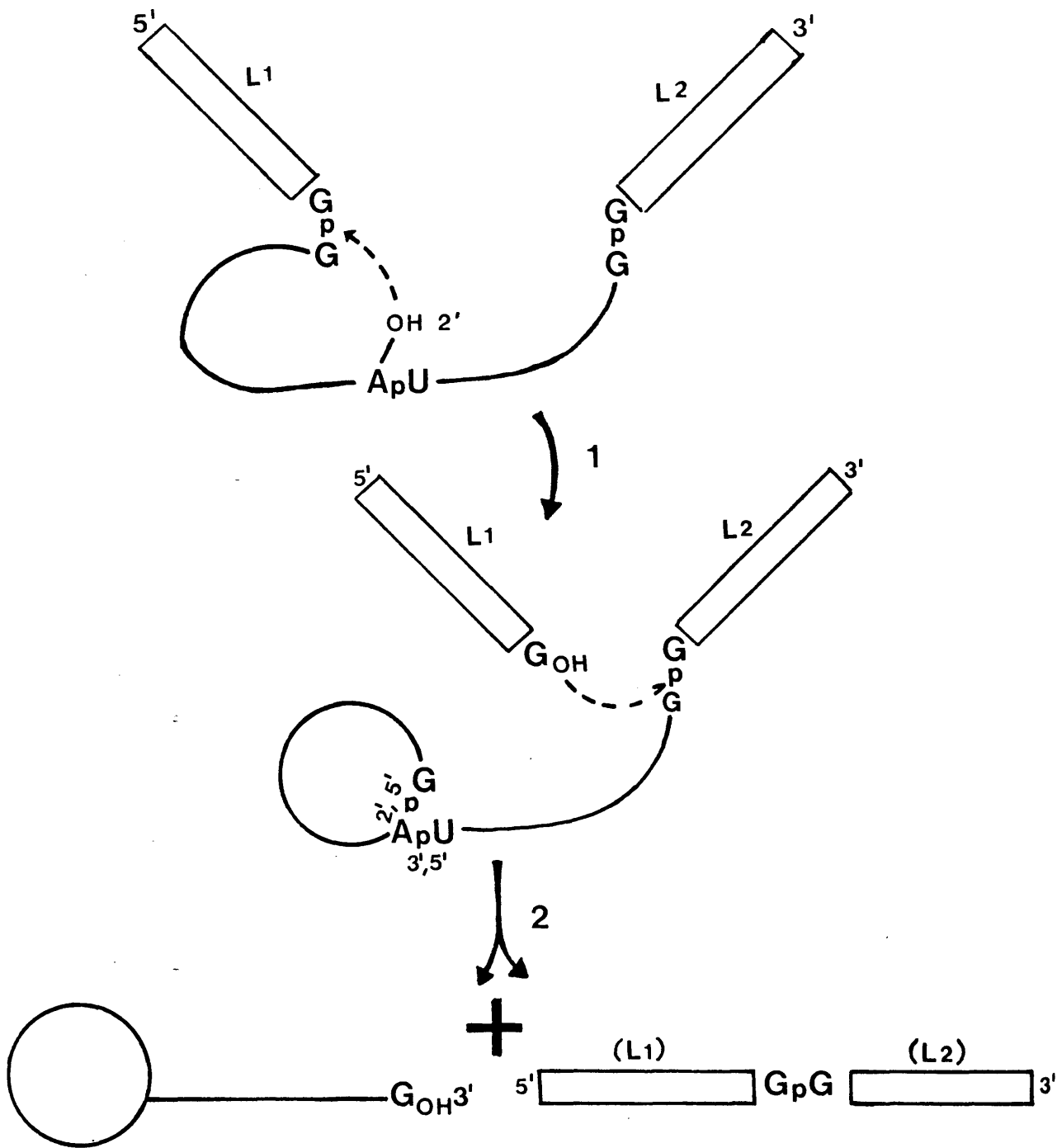

The reaction occurs in the 'SPLICEOSOME', which requires ATP for formation, and includes U1,U2,U5 and U4/6 snRNPs.

Figure 4.      Pathway of the pre-mRNA splicing reaction

The precursor RNA consists of 5' and 3' exons (L1 and L2, double lines), intervened by an intron (single line). The dinucleotides which represent part of the 5' and 3' consensus splice sites are cleaved at the indicated phosphodiester bonds. The central sequence of the branch site is A-U. The first covalent modification of the RNA is the formation of a phosphodiester bond between a 2' position in the ribose moiety of adenosine and the 5' phosphate at the 5' splice site. This first step gives rise to two products, a lariat RNA, which consists of the branched intron and L2, and a free L1 exon. In the second step, the intron is released in lariat form, and the two exons are spliced together.

which U1 and U2 snRNP were shown by Grabowski *et al.* (1985) to be associated with the 50-60S spliceosome. Site-directed hydrolysis of U1 or U2 snRNA with RNaseH and synthetic complementary deoxyoligonucleotides abolishes splicing (Kramer *et al.*, 1984; Black *et al.*, 1985). On the basis of sequence complementarity and from specific immunoprecipitation of RNase T1 protected fragments, it seems likely that U1 and U2 snRNPs associate with the 5' splice site and the intron branch site of pre-mRNA respectively (Black *et al.*, 1985). The 3' splice site is possibly recognised by U5 snRNP (Chabot *et al.*, 1985). Grabowski and Sharp (1986) have recently isolated components of the spliceosome by affinity chromatography of biotin-labeled pre-mRNA to streptavidin-agarose. With the presence of heparin in the glycerol gradient to displace contaminants, a 35S spliceosome was isolated. The RNA species in the 35S spliceosome were labeled with [<sup>32</sup>P]pCp and T4 RNA ligase, and identified by partial RNase T1 digestion and comparison with known snRNAs. The results of this approach indicated that U2, U5 and U4/U6 (which are present together in a single RNP particle) snRNAs were present at approximately one copy per 35S complex, in addition to an unknown species, 'X', and surprisingly, U1 snRNA was absent. The absence of U1 snRNP in the 35S spliceosome may be due to either unstable binding or a transient role in the splicing reaction. Grabowski and Sharp (1986) suggest that the involvement of multiple snRNPs in the splicing event may allow control and specificity, in addition to the potential catalytic role of the U snRNAs in the cleavage and ligation reactions.

SECTION D: CONTROL OF RNA POL II TRANSCRIPTION  
INITIATION

The accumulation of data on the control of eukaryotic gene expression has been rapidly increasing in recent years. A general picture of the nature of transcriptional controls has emerged although the actual mechanisms involved remain poorly understood.

Two interdependent factors govern the initiation of eukaryotic RNA polymerase II mediated transcription at a primary level. The first is the presence, repetition, and positioning of a variety of cis-acting DNA sequence signals generally located 5' to the transcription initiation point. The second involves the transcription factors which can recognise the cis-acting signals, and thereby have the potential to modulate transcription initiation. The activity of DNA sequence-specific transcription factors may be modulated in cis by other sequence-specific factors, or in trans by regulatory proteins that might not bind directly to the promoter DNA that they regulate.

At a secondary level, the ability of transcription factors to interact with cis-acting signals, and of genes to respond to this interaction, may be dependent on the physical status of the template DNA. Although less well understood, this may be affected by DNA methylation, chromatin organization, and particularly for some viral genes, DNA replication. It is unclear how the physical status of cellular DNA in particular is regulated, although this is probably a very important mechanism in controlling developmental and cell-type specific gene expression.

Some of the better characterized examples of cis-acting DNA sequences and transcription factors are described in this section. How these sequences and factors might interact to promote transcription is also discussed. An important aspect of gene expression, particularly relevant to viral systems, is trans-activation. Trans-activation is discussed in this section using adenovirus Ela and SV40 T antigen as examples. Although the study of HSV gene

expression has made important contributions towards our overall understanding of eukaryotic transcriptional regulation and is mentioned in this section, it is considered in more detail in Section E.

### 1. Cis-acting Sequences

The individual DNA sequence elements which constitute promoter, enhancer and regulator regions may overlap. However, in general terms, a promoter usually occupies a region of about 100 nucleotides 5'-flanking the transcription start site (+1) of a gene. It consists of a number of individual sequence elements and may exhibit 'basal' or 'constitutive' activity, and respond to activation or repression in trans or in cis. Cis-activation mediated by an enhancer region, which may lie far-upstream (often -100 to -300) or even downstream from the RNA start site, is generally thought of as constitutive. In contrast, cis-activation mediated by regulator elements, which have been found to lie within promoter and enhancer regions, is inducible. However, since enhancers exhibit cell specificity, they must also be inducible to some extent. Trans-activation by regulatory proteins (see part 4) requires essentially the same promoter sequences needed for basal- or cis-activated expression. The constitutive and inducible transcription factors which interact with the examples of regulatory DNA sequence elements described below are considered in part 2.

#### a. Promoter sequences

##### (i) HSV-1 tk promoter

The identity and function of promoter and regulatory regions of eukaryotic genes have been studied by introducing mutations into cloned DNA in vitro, and then analysing the effects of the mutations on the expression of a cis-linked gene. The effects of deletion, 'linker-scanning' (clustered point), and specific base mutations in the HSV-1 tk promoter have been examined in detail in a number of assays. These include measuring RNA accumulation from a plasmid-borne tk



promoter in microinjected frog oocytes (McKnight and Kingsbury, 1982; McKnight et al., 1984), transfected tissue-culture cells infected with HSV (Eisenberg et al., 1985; El Karez et al., 1985), and in vitro using infected or uninfected cell extracts (Jones et al., 1985). Oocytes provide a 'constitutive' transcription system for the tk gene since in these cells its promoter is active in the absence of virus-encoded trans-acting regulatory proteins which are normally required for efficient viral tk gene expression during lytic infection (Preston, 1979a; McKnight and Kingsbury, 1982), and for expression of a plasmid-borne tk gene in transfected cells (Eisenberg et al., 1985) (see Section E(3)). The linker-scanning tk promoter mutants have also been introduced into the HSV genome and their activity assessed at the level of transcription, RNA accumulation, and by an indirect assay for tk activity (Coen et al., 1986).

In all these assays, the same mutation-sensitive domains upstream of the RNA start site were revealed (although sequences between +4 to +16 were required for normal tk promoter activity in the viral genome, but not in other assay systems), and have established the map of the tk promoter domains shown in Figure 5. There are at least four components, (i) a TATA box located proximal to the tk RNA start sites (at about -25); and in the "upstream" region - (ii) an inverted GC hexanucleotide (5'-CCGCCC-3') (-103 and -98), (iii) an inverted CCAAT homology (-86 to -82), and (iv) a second GC hexanucleotide (5'-GGGCGG-3') (-55 and -50).

#### (ii) $\beta$ -globin promoter

The functional importance of highly conserved regions in the DNA 5'-flanking the transcription start site of a number of different mammalian  $\beta$ -globin genes has been shown by in vitro mutagenesis studies (Grosveld et al., 1982; Dierks et al., 1983; Charnay et al., 1985). Myres et al. (1986) studied the effects of over a 100 single point-mutations within the mouse  $\beta$ -globin promoter using a transient assay procedure. The  $\beta$ -globin promoter

T antigen binding sites

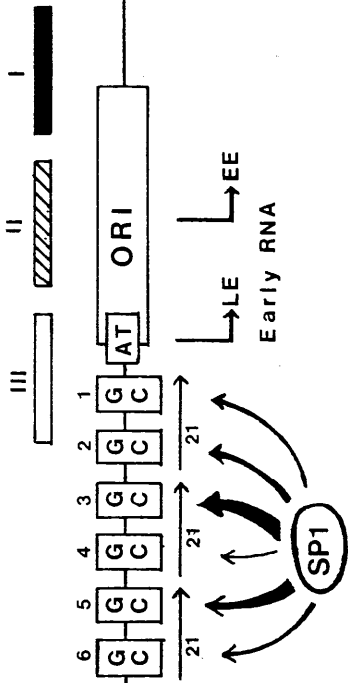

a. SV40

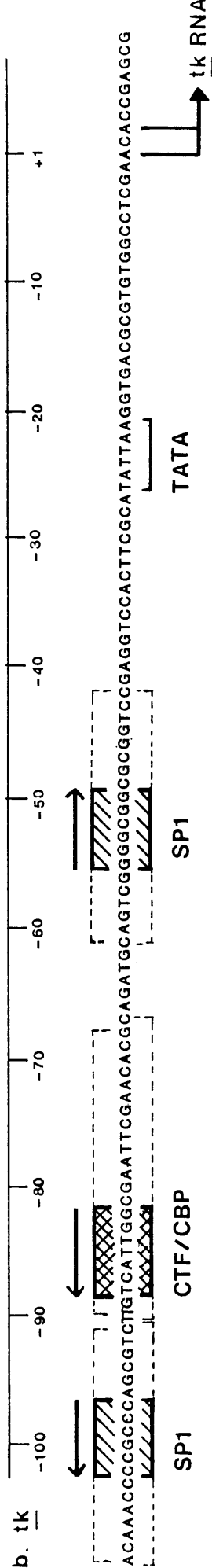

b. tk

c.  $\beta$ -globin

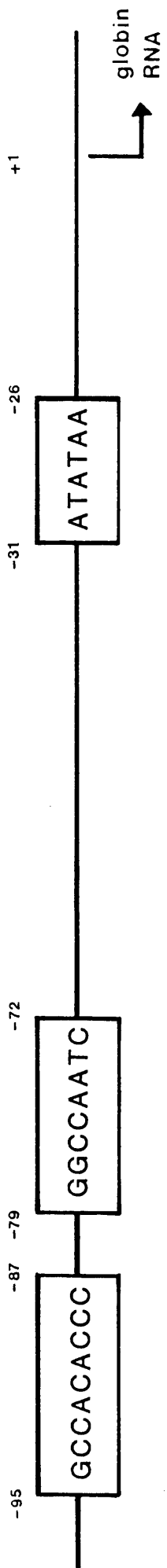

Figure 5.      Structures of the SV40 control region, and the  
HSV-1 tk and mouse  $\beta$ -globin promoters

- a. SV40: The important features of the the SV40 control region are as follows (from right to left): The large box marked 'ORI' represents the SV40 origin of DNA replication. An AT-rich TATA-like element is represented by small box. The 21bp repeats of the SV40 early promoter are underlined by arrows and contain six GC-hexanucleotide motifs (boxes numbered 1 to 6). The two extended boxes represent the 72bp repeats which contain regulatory elements for enhancer activity and late promoter activity. The positions of the early-early (EE) and late-early (LE) RNA starts are indicated, as are the two major late RNA start sites. Higher affinities for the GC-hexanucleotides by the represented Spl protomer are indicated by thicker arrows. T antigen binds to the designated recognition sites in sequential order (I, II, III).
- b. tk: The nucleotide sequence of the tk promoter is given from -110 to beyond the first tk RNA cap site at +1 (McKnight, 1980). Hatched boxes represent Spl binding sites; the cross-hatched box represents a CTF/CBP binding site (arrows indicate the orientation of the consensus sequences). The dotted lines indicate the extent of DNAase I footprint protection (Graves et al., 1986; Jones et al., 1985). A TATA box binding factor is thought to bind to the indicated TATA box and overlap the mutation-sensitive cap site region (Coen et al., 1986).
- c.  $\beta$ -globin: Three mutation sensitive regions in the mouse  $\beta$ -globin promoter were identified by saturation mutagenesis (Myers et al., 1986), which involved the isolation and analysis of individual point-mutations in nearly every nucleotide of the  $\beta$ globin promoter. The numbers refer to the positions from the  $\beta$ globin RNA cap site (+1).

substitutions were contained on plasmids with the SV40 enhancer, in order to achieve expression in transfected HeLa cells. The identity of three mutation sensitive regions was confirmed, and their locations accurately delineated; (i) a CACCC box, located between -95 and -87, (ii) a CCAAT box, located between -77 and -72, and (iii) a TATA box located between -30 and -26 relative to the start site of transcription (Myers et al., 1986; see Figure 5). It could be argued, however, that the results from a HeLa cell transient assay may not reflect the normal in vivo situation since expression of the globin gene is being studied in the absence of tissue specificity.

Although it is difficult to study the effect of in vitro manipulations of cellular genes reintroduced into their natural environment, such studies have enabled problems of developmental and tissue-specific gene regulation to be addressed (Palmiter and Brinster, 1985). Transgenic mice and proerythroblast mouse erythroleukaemia (MEL) cells (which can be induced to differentiate), provide systems in which an introduced globin gene may be specifically expressed in differentiated erythroid cells. In studies using MEL cells stably transformed with cloned  $\beta$ -globin DNA (Wright et al., 1984; Charnay et al., 1985) and germ-line transmitted human  $\beta$ -globin genes in transgenic mice (Townes et al., 1985), 5' deletions of the  $\beta$ -globin promoter to -48 still enabled relatively efficient gene expression. This contrasts the findings from transient assay experiments where sequences to -95 were important for efficient expression (Myres et al., 1986). However, the validity of the transient assay is supported by the existence of a naturally occurring  $\beta$ -thalassaemia mutation in the conserved element of the  $\beta$ -globin promoter lying at -90 (Treisman et al., 1983a).

The apparently less stringent sequence requirements in erythroid cells probably arise for a number of reasons. Firstly, quantitative comparisons of gene expression between transgenic animals are difficult due to the limited sample size. Secondly, in both transgenic animals and biochemically transformed cells, it is not possible to

control the copy number and integration sites of the introduced DNA. Thirdly, sequences which lie outside the globin promoter may be required for the induction of erythroid-specific expression, and these may be able to compensate for some promoter mutations in erythroid but not HeLa cells. Indeed, the chicken adult  $\beta$ -globin gene is reported to have a tissue-specific enhancer lying 350-650bp 3' to its polyadenylation site (Choi et al., 1986; Hesse et al., 1986). This 300bp enhancer region is required for the specific temporal induction of an exogenous chicken  $\beta$ -globin gene transfected into a differentiation-inducible avian erythroid cell line (Choi et al., 1986).

(iii) SV40 E promoter

The SV40 early (E) promoter is usually activated in cis by its 72bp repeat enhancer region (Banerji et al., 1981; Moreau et al., 1981; see below). Important features of the E promoter (see Figure 5) are a proximal TATA box, involved in designating the locations of the E mRNA start sites (Benoist and Chambon, 1981), and three direct 21bp repeats which abut the TATA box. Each 21bp repeat contains two copies of the GC hexanucleotide (5'-GGGCGG-3') which bind transcription factor Spl (Dyran and Tjian, 1983a,b). Not all six GC hexanucleotides are essential for overall E promoter activity, but have different roles in driving 'early-early' (EE) and 'late-early' (LE) transcription (Fromm and Berg, 1982; Everett et al., 1983; Baty et al., 1984; Vigneron et al., 1984). Early-mRNA initiation switches from EE to the upstream LE start sites at the onset of DNA replication (Ghosh and Lebowitz, 1981), or as a result of repression of the overlapping EE promoter (Wasylyk et al., 1983). The SV40 T antigen plays multiple roles in this switch, by repressing EE- and stimulating LE-transcription, in addition to its requirement for SV40 DNA replication (Buchman et al., 1984). Like the HSV tk (McKnight et al., 1984) and gD (Everett, 1984b) promoters, inversion of the distal (21bp repeat) region upstream of the TATA box does not render the SV40 E promoter non-functional (Everett, et al., 1983).

A requirement for an interaction between DNA-bound proteins at the SV40 TATA box, upstream early promoter region and enhancer, is suggested by the experiments of Takahashi et al. (1986). By altering the spacing between the various regulatory regions it was shown that the exact distances between the TATA box, the 21bp repeats, and the enhancer region influence early promoter activity. Moreover, by inserting either odd or even multiples of a half turn of the DNA helix, a requirement for stereospecific alignments between proteins which recognise different regulatory elements was indicated (Takahashi et al., 1986).

#### b. Enhancers

Enhancers, which were first discovered in SV40 (Banerji et al., 1981; Moreau et al., 1981), are viral or cellular transcriptional activation sequences whose operation is not critically dependent on orientation or distance (5' or 3') from a cis-linked promoter. They are composed of a variable number of individual DNA sequence modules, and may exhibit cell-specificity of action (for reviews, see Serfling et al., 1985; Voss et al., 1986).

The prototype SV40 enhancer shows less apparent cell-specificity than many other viral and cellular enhancers (Laimins et al., 1982; Herbomel et al., 1984; Voss et al., 1986). A systematic mutagenesis (Zenke et al., 1986) and study of mutant revertants (Herr and Clarke, 1986) of the SV40 enhancer has revealed that it extends beyond the 72bp repeat element and is composed of three domains, A, B, and C, which by themselves exhibit a very low transcriptional activity. The synergistic activity of domains A and B is not critically dependent on their relative orientation to each other, or the exact distance between them (Zenke et al., 1986). Enhancer activity can be recreated by the duplication of either domain A or B alone (Zenke et al., 1986) or by partial duplications of the whole enhancer region containing mutations in all three domains (Herr and Clarke, 1986). Each domain is composed of several sequence motifs whose integrity is required for full enhancer activity in HeLa cells (Zenke et al., 1986). No

individual point mutation decreases enhancer activity >8-fold, which still represents about a 50-fold enhancement relative to an enhancerless promoter (Zenke et al., 1986). The enhancer 'core' sequence, 5'-GTGG<sup>A</sup>/T<sup>A</sup>/T<sup>A</sup>/TG-3' (Weiher et al., 1983), is repeated twice in domain B, but nucleotides adjoining this sequence are also important for full activity (Zenke et al., 1986). The key feature of domain A are the directly repeated 'Sph-motifs', 5'-AAG<sup>T</sup>/CATGCA-3', the juxtaposition of which in the SV40 enhancer generates the 'octameric' sequence (5'-ATGCAAAG-3') of the immunoglobulin heavy chain (IgH) enhancer (Banerji et al., 1983; Neuberger, 1983; Zenke et al., 1986). Domain A also contains the 'P-motif', 5'-TCAATTAGCA-3', which is found in the opposite strand of the polyoma virus enhancer domain A (Herbomel et al., 1984). In fact, the individual motifs of the SV40 enhancer all occur in various assortments in other viral and cellular enhancers, and have been shown to bind cellular proteins (Wildeman et al., 1986; Davidson et al., 1986). That the IgH octameric motif of the SV40 enhancer is recognised in lymphoid cell extracts, whereas the Sph motifs which it overlaps are bound by protein in HeLa cell extracts, indicates how the remarkably wide cell-range of SV40 enhancer activity might be achieved (Davidson et al., 1986).

The polyoma virus enhancer contains two distinct cell-specific activities, which correspond to two non-overlapping domains within the enhancer region (Herbomel et al., 1984). Domain A is preferentially active in murine fibroblasts, whereas domain B is equally active in fibroblasts and mouse embryonal carcinoma cells (Herbomel et al., 1984).

The first cellular enhancer to be discovered was in an intron of the IgH gene (Banerji et al., 1983). This demonstrated the potential of enhancers to operate downstream of the RNA start site in a natural situation. The IgH enhancer, like many other more recently identified cellular enhancers, exhibits strict tissue specificity (reviewed by Voss et al. 1986).

It now seems unlikely that enhancers function at the

sequence level by providing a bidirectional entry site for RNA polymerase (Moreau et al., 1981), or inducing superhelical strain, e.g. by flipping to Z DNA (Nordheim and Rich, 1983). In an experiment designed to separate topologically the SV40 enhancer from a linked  $\beta$ -globin gene, it was shown that expression of the linked gene was still enhancer dependent, and that 'twisting' of the DNA at the enhancer could not be solely responsible for gene activation (Plon and Wang, 1986). It seems that the action of enhancers is dependent on their recognition by cellular transcription factors [see part 2(iv)], which may function by interacting with promoter-bound transcription factors (see part 3), and at least in the case of cellular enhancers, be involved in organizing the formation of 'active chromatin' (Voss et al., 1986). However, enhancers are sometimes associated with a nucleosome-free chromatin structure, which is also hypersensitive to nucleases (Jongstra et al., 1984).

### c. Regulator elements

Regulator elements are considered here as specific DNA sequence motifs that confer inducibility to a given gene, which is mediated by DNA-binding regulatory proteins in response to certain stimuli. Examples of regulator elements include the glucocorticoid response element (GRE) (Geisse et al., 1982; Chandler et al., 1983; Payvar et al., 1983), the metal regulatory element (MRE) (Brinster et al., 1982; Karin et al., 1984b), and the heat shock element (HSE) (Bienz and Pelham, 1982). The TAATGARAT motif of HSV IE genes, which is the target sequence for induction by the HSV virion component, also bears the hallmarks of a regulator element (see Section E(1)).

Transcription of glucocorticoid hormone-responsive genes is stimulated by the sequence-specific binding of the glucocorticoid receptor protein to its cognate GRE. It was first shown that receptor binding to a GRE within the long terminal repeat (LTR) of the mouse mammary tumour virus (MMTV) was involved in the stimulation of transcription in response to dexamethasone (Geisse et al., 1982; Chandler et



al., 1983). Unlike MMTV, the Moloney murine sarcoma virus (MoMSV) LTR contains an enhancer that is constitutively active in murine L and NIH3T3 cells (Laimins et al., 1982), in addition to a physiologically distinct transcription-stimulatory activity which is hormone inducible. This second activity, which corresponds to a GRE presence within the MoMSV LTR enhancer region, can be separated at the sequence level from the originally identified enhancer activity (DeFranco and Yamamoto, 1986; Miksicek et al., 1986). This suggests a similarity in function between a GRE and 'constitutive' enhancer motifs.

Metallothionein genes (Karin, 1985) are induced by metal ions and glucocorticoid hormones. The response to metal ions is mediated by the well conserved MRE sequence, consensus 5'-CCTTTGCGCCCG-3', and an as yet unidentified "metal regulatory protein" (Searle et al., 1984; Karin et al., 1984b). The human metallothionein (hMT-II) gene contains one GRE copy (-237 to -268), and two MRE copies (-38 to -50, and -138 to -150) which can act singly or together (Karin et al., 1984b). Constitutive elements of most MT promoters appear to include a TATA box and two GC hexanucleotides (Serfling et al., 1985).

Karin et al. (1984a) showed that hMT-II 5'-flanking DNA may confer heavy metal and hormone responsiveness when linked to the heterologous HSV-1 tk gene, even when placed 600 nucleotides upstream from the tk RNA start site. Enhancer-like activity has also been shown for mouse MT 5'-flanking DNA (-63 to -188), which has been integrated into the SV40 "enhancer trap" where it conferred metal regulation on the resulting virus (Weber et al., 1983; Serfling et al., 1985). Searle et al. (1985) studied the metal-induction response of the tk linker-scanning mutants, after the insertion of one or more synthetic MREs at a variety of positions in the tk promoter. They found that two or more MREs were required to enable significant metal inducibility of the tk gene. In contrast to the results of Karin et al. (1984a), the synthetic MREs did not function efficiently at a distance from the tk gene (Searle et al., 1985). However, it is possible that sequences flanking a

regulator element are important for an effect at a distance, or from a single copy. This is the situation in HSV where sequences flanking the TAATGARAT motif of IE genes, or the duplication of a synthetic oligonucleotide containing the TAATGARAT element, are important for response to the virion component (Gaffney et al., 1985; Bzik and Preston, 1986; see Section E(1)).

## 2. Transcription Factors

Given a map of the regulatory DNA sequences of a particular gene, it is possible to investigate how these sequences are recognised in the host cell. The identification of proteins which associate with known regulatory sequences is an important step towards understanding transcriptional control. Two main approaches have been used for this type of study. The first is based on the fractionation of cell extracts to purify (at least partially) transcription factors that can be detected by assay in vitro. The second is the detection of proteins bound to sequences of known functional importance by DNaseI footprinting, methylation protection experiments, or by gel mobility-shift assays (based on the retarded mobility of protein-bound DNA compared to unbound DNA migrating on non-denaturing polyacrylamide gel electrophoresis (Garner and Revzin, 1981)). One of the difficulties in detecting a protein that has specificity for a given DNA sequence in crude extracts is its affinity for other DNA sequences and the presence of other DNA binding proteins. The use of more rigorous fractionation procedures has helped to overcome this problem for some cellular transcription factors.

Significant progress in the investigation of promoter function has been made by the development of in vitro extracts that allowed accurate initiation of RNA pol II transcription from cloned DNA template (Weil et al., 1979; Manley et al., 1980). The reproduction of in vivo promoter specificity was initially a problem, as only a TATA-box was required for maximum (albeit poor) in vitro expression (Manley et al., 1980; Wasylyk et al., 1980). Crude fractionation of cell extracts improved transcription

efficiency, and resolved several factors which appeared to be required for the (in vitro) transcription of all class II promoters (Matsui et al., 1980; Samuels et al., 1982).

The characterization of some transcription factors, such as the glucocorticoid receptor, is now quite advanced and has allowed the identification of functional domains. In contrast, proteins that bind enhancer motifs have only recently been detected. An account of the characterizations of factors that recognise some of the previously identified important regulatory sequence motifs is given below.

(i) Spl

Dynan and Tjian (1983a) demonstrated that a partially purified factor isolated from HeLa cells (Spl) stimulated in vitro transcription of the SV40 early promoter but not the adenovirus (Ad) major late (ML) promoter. DNaseI footprinting (Galas and Schmitz, 1978), and dimethyl sulphate methylation protection studies on native and mutant versions of the SV40 early promoter have shown that Spl binds to one strand of the DNA duplex in the GC hexanucleotide sequence, 5'-GGGCGG-3' (Dynan and Tjian, 1983b). It is believed that single Spl protomers bind the closely spaced GC hexanucleotides of the SV40 21bp repeat region, which exhibits no discernible dyad symmetry (Dynan and Tjian, 1983b, 1985).

Many other regulatory regions besides the SV40 E promoter contain GC hexanucleotides which have been shown to bind Spl. These include the HSV-1 tk promoter (Jones et al., 1985), the promoters and far-upstream regions of HSV-1 IE genes 3 and 4/5 (Jones and Tjian, 1985), the HIV LTR (Jones et al., 1986), the human MT promoter and the mouse dihydrofolate reductase promoter (reviewed by Kadonaga et al., 1986). Nucleotides adjacent to the 5'-GGGCGG-3' motif appear to affect the affinity for Spl binding, and the sequence 5'-GGGAGG-3' functions as an Spl binding site in the HIV LTR (Kadonaga et al., 1986; Jones et al., 1986).

Since distal promoter elements can function in either orientation (Everett et al., 1983; McKnight et al., 1984; Everett, 1984b; Graves et al., 1986), how can the factors

that recognise these elements stimulate transcription when their binding sites occur in opposing directions on different DNA strands? Spl binding sites appear to be asymmetric, so it is possible that the orientation of DNA-bound Spl does not affect its function. However, Takahashi et al. (1986) favour a two-domain hypothesis to explain the non-polarity of bound Spl. They suggest that the DNA-binding domain, which specifically recognises GC hexanucleotides, and a protein-interacting domain, are linked by a flexible stem.

Using sequence-specific DNA affinity chromatography, Spl has now been purified to greater than 95% homogeneity, and this fraction has been shown to consist of two polypeptides of 105 and 95 kilodaltons (Briggs et al., 1986). The purification of sequence-specific transcription factors such as Spl has important applications. Firstly it enables antibodies to be raised against this factor, and secondly amino-acid sequencing will ultimately enable the preparation of DNA probes which can be used to isolate the gene encoding Spl. Many questions concerning the regulation and biochemical functions of Spl can then be addressed.

#### (ii) CTF/CBP

The pentanucleotide 5'-CCAAT-3' or "CCAAT box" binds the CAAT binding protein (CBP, Jones et al., 1985) or CAAT transcription factor (CTF, Graves et al., 1986). These two proteins may be equivalent or, since they were isolated from different cell types and have differences in heat stability and exact DNA footprinting (Jones et al., 1985; Graves et al., 1986), might represent different members of a family of cellular transcription factors that have different functions but recognise the same consensus sequence (McKnight and Tjian, 1986). Mutations in the CCAAT sequence that adversely affect the function of the MSV and HSV-1 tk promoters, correlate with reduced binding of CTF/CBP transcription factors (Jones et al., 1985; Graves et al., 1986). The observation that the CCAAT pentanucleotide occurs in opposite orientations in the MSV and tk promoters is in accordance with the ability<sup>of</sup> an inverted tk distal

promoter region to function (McKnight et al., 1984).

In mapping the binding domains of CBP on the MSV and tk promoters, Graves et al. (1986) found that the nuclease protection extends asymmetrically upstream from the MSV CCAAT box (on the coding strand), and asymmetrically downstream from the tk CCAAT box (on the non-coding strand; see Figure 5). Also, a G to C transversion in the sequence abutting the tk inverted CCAAT box which established perfect dyad symmetry, resulted in both elevated tk promoter function and CBP binding (Graves et al., 1986).

Rotational symmetry is a hallmark of prokaryotic DNA regulatory sequences that bind proteins in the form of dimers of two identical subunits (reviewed by Takeda et al., 1983). It is possible that the interaction of CBP and its cognate DNA sequence differs substantially from that of Sp1 (see above), but has more similarity to the prokaryotic situation, if the binding of one CBP protomer to a CCAAT box facilitates dimerization at a nearby less perfect dyad-symmetrical sequence (Graves et al., 1986).

### (iii) TFIIB-D and TATA box factor

In addition to Sp1, another fraction (Sp2) was required for transcription of both the SV40 early and Ad ML promoters (Dyanan and Tjian, 1983a). The Sp2 fraction probably contains the multiple transcription factors TFIIB, TFIID and TFIIE (also fractionated from HeLa cell nuclear extracts), shown to be required for Ad ML transcription in vitro (Sawadogo and Roeder, 1985a). Reconstitution of fractionated components indicated that the basal level of Ad ML transcription in vitro is stimulated 10 to 20-fold with the addition of another transcription factor, USF, present in uninfected HeLa cell nuclear extracts (Sawadogo and Roeder, 1985a). TFIID and USF are sequence-specific transcription factors which were shown by footprinting DNA to interact respectively with the TATA box and the -52 to -63 (5'-GGCCACGTGACC-3') upstream element of the ML promoter (Sawadogo and Roeder, 1985a,b).

(iv) Enhancer factors

Results of in vitro (Sassone-Corsi et al., 1985; Wildeman et al., 1984) and in vivo (Scholer and Gruss, 1984; Mercola et al., 1985) competition studies have indicated that specific trans-acting factors are involved in enhancer function. More recently, DNaseI footprinting experiments have confirmed that the individual SV40 enhancer motifs identified by systematic mutational analyses (Zenke et al., 1986; see above) are recognised by proteins present in Hela (Wildeman et al., 1986) and lymphoid cell (Davidson et al., 1986) nuclear extracts. Moreover, mutations which were detrimental to the function of a particular enhancer motif correlated with impaired DNaseI protection of that motif. Sen and Baltimore (1986), using a gel mobility-shift assay, found that both ubiquitous and lymphoid B cell-specific nuclear factors interacted with immunoglobulin enhancer sequences. These studies indicate that various enhancer motifs bind specific proteins, a process which is presumably involved in the generation of enhancer activity. The purification and characterization of these proteins will surely be an important advance.

(v) Glucocorticoid receptor

Glucocorticoid receptor proteins activate transcription in response to steroid hormones by binding the glucocorticoid response elements (GREs) of certain hormone-inducible genes (Geisse et al., 1982; Chandler et al., 1983; Payvar et al., 1983). Both human (Hollenberg et al., 1985) and mouse (Danielson et al., 1986) cDNAs encoding glucocorticoid receptors (h/mGRs) have been isolated, which has enabled the mapping of their functional domains.

Giguere et al. (1986) transfected GR-negative monkey kidney (CV-1) cells with an expression vector containing wild-type or mutant copies of the hGR cDNA. In the presence of the synthetic steroid hormone, dexamethasone, hGR produced from the expression vector induced transcription of a cotransfected MMTV-CAT fusion gene. Since the MMTV LTR appears only to have GRE-associated enhancer activity (Chandler et al., 1983), measurement of its induction

provided a suitable assay for functional hGR. A number of insertional mutants of the cloned hGR cDNA were then made, and their characterization has allowed at least four functional domains to be located; a DNA- and a steroid-binding domain; and two other domains required for transcriptional activation (Giguere et al., 1986).

### 3. Mechanisms of Action of Transcription Factors

How do transcription factors such as Sp1 and CBP/CTF activate transcription? Prokaryotic proteins that selectively activate gene expression by binding regulatory sites facilitate either the initial binding of RNA polymerase to a promoter (e.g. catabolite activator protein-activation of lacP), or the subsequent isomerization of the RNA polymerase/promoter complex to an "open" configuration (e.g. lambda cI repressor activation of  $P_{RM}$ ) (reviewed by McClure, 1985). Eukaryotic transcription factors may perform analogous functions during the initiation reaction, or have additional or different functions that cannot be predicted from prokaryotic mechanisms. McKnight and Tjian (1986) offer a number of speculative mechanisms for the action of Sp1 and CBP/CTF: (i) Derepression, resulting from the displacement of proteins, e.g. histones (but note that Sp1 and CBP/CTF are capable of activating transcription in vitro in the absence of histones); (ii) enzymatic modification of a substrate at the promoter, such as an RNA pol II subunit; (iii) enabling the binding of nuclear proteins that otherwise lack sequence-specificity (a mechanism for trans-activation?); (iv) guidance of cognate promoters into transcriptionally active areas of the nucleus (this is difficult to reconcile with in vitro transcription data, but the level of transcription in vitro may be orders of magnitude down on the effect in vivo); and (v) stabilization of a promoter-DNA complex, by interaction with neighbouring DNA-bound transcription factors.

Ptashne (1986) has cited a number of experiments that support the case for (v); that DNA-bound transcription factors operate by protein-protein interactions. Such an

interaction is favoured by Echols (1986), and described as a 'specialised nucleoprotein structure' (snups), which would apparently "provide the necessary regulated reactivity and site localization to direct DNA transactions", such as initiation of transcription and DNA replication, and site-specific recombination. This model predicts the looping out of intervening DNA between proteins bound at widely separated sites, and that transcription factors recognise specific sequences in DNA using structures that are complementary to the ordinary (B-form) helix (Ptashne, 1986). The requirement for a stereospecific alignment of the proteins which interact with the SV40 enhancer, 21bp repeat region, and TATA box (Takahashi et al., 1986) is cited in support for this model; these proteins could only interact by a simple looping if located on the same side of the helix. However, there is currently insufficient information on the nature of transcription factors to explain how the orientation independence of enhancers and upstream promoter elements fits in such a with model. It is likely that other mechanisms of transcription activation take place; for instance, some protein-DNA interactions must presumably influence chromatin structure; and some transcription factors (the TATA box recognition factor?) may well have catalytic activity.

Enhancers and regulator sequences may have important functions in addition to their ability to form a transcription complex. In contrast to the situation of viral genes, many cellular genes in differentiated cells are not expressed. It is likely that chromatin organization and DNA methylation are involved in the general repression of cellular genes (see reviews by Razin et al., 1984; Weintraub, 1985; Jackson, 1986). A primary step in activating tissue-specific genes may involve local inactivation of this general repression system. The observation that globin-specific trans-acting factors can stimulate the endogenous  $\beta$ -globin gene of non-erythroid cells indicates that this gene is not irreversibly repressed in at least some differentiated non-erythroid cell types



(Baron and Maniatis, 1986). It has been suggested that <sup>the</sup> role for enhancers besides a direct cis-activating function may be to influence the potential of genes to be activated (Voss et al., 1986).

#### 4. Regulation of Transcription by Trans-acting Proteins

Gene expression can be modulated in response to trans-acting regulatory proteins. The immediate-early or early proteins of several DNA viruses form a group of such trans-acting regulators, which have in common the function of activating viral genes expressed during the later stages of the lytic cycle. The best characterised of these, excluding those of the herpesviruses (see Section E) are the adenovirus (Ad) Ela proteins (Berk et al., 1979; Jones and Shenk, 1979), and the simian virus 40 (SV40) large T antigen (Keller and Alwine, 1984; Brady et al., 1984; Hartzell et al., 1984). A number of other viral proteins associated with transcriptional activation, which do not fall into the "immediate-early" category, include the Ad E4 protein (Goding et al., 1985), and the HSV virion component, Vmw65 (Batterson and Roizman, 1983; Campbell et al., 1984; see Section E). The tat gene products of human lymphotropic viruses HTLV-I and HTLV-II, and HIV (or HTLV-III), are also associated with trans-activation (Chen et al., 1986). While it is clear that tat is required for a high level of HIV gene expression, its precise mode of action (at a transcriptional or post-transcriptional level) is currently unresolved.

Some viral trans-acting proteins are also associated with transformation. Transformation of cells in tissue culture can be mediated by Ela and T antigen (Kingston et al., 1985), and possibly by IE proteins (Macnab et al., 1985). This has led to the speculation that the ability of viral trans-acting regulatory proteins to stimulate transcription of some cellular genes may be related to the function of a subset of cellular oncogenes such as c-myc and p53, which have some shared properties (Kingston et al., 1985).

a. Adenovirus Ela(i) Sequences required for trans-activation

The Ela region encodes two closely related polypeptides of 289 and 243 amino acids (from 13S and 12S mRNAs), which are processed from the same primary transcript and differ only in the size of the intron removed. No studies have been able to find specific sequences required for Ela-induced expression in adenovirus early promoters that are not also required for uninduced expression (Jones, 1986). Nor does it appear that Ela activates transcription by binding DNA (Jones, 1986). Consistent with these observations, it has been shown that Ela can activate cellular promoters or those of other viruses (Green et al., 1983; Triesman et al., 1983b; Everett and Dunlop, 1984; Svensson and Akusjarvi, 1984). However, the observation that not all heterologous promoters are activated by Ela (Alwine, 1985; Weeks and Jones, 1985), provides an approach towards delineating which sequences within an inducible promoter may be especially important in trans-activation.

All Ela inducible Ad early promoters contain an AG-rich sequence upstream from the TATA box (Jones, 1986). Mutations in this sequence appear to have the greatest quantitative effect on induced compared to basal expression (Imperiale et al., 1985). The HSV-1 tk gene does not have a homologue of this sequence. Weeks and Jones (1985) have shown that the expression of a transfected HSV tk promoter/CAT fusion gene (in a pBR322-based vector) was not appreciably induced by Ela. The introduction of the AG-rich sequence from the Ad E3 gene, to -79 of tk, rendered a hybrid promoter sensitive to Ela action. Since the hybrid promoter was not as strongly induced as the E3 promoter, it would suggest that either the positioning or combination of multiple promoter elements is important in determining the overall level of Ela induction.

Leff and Chambon (1986) have reported that the Ad ML promoter is poorly induced by Ela, but can be made responsive in a similar way to the HSV tk gene, by fusing the E3 upstream promoter region to the TATA box/cap site

region of the ML promoter. In this study, the Ela-uninducible ML promoter starting construct had sequences from -667 to +33 with respect to the ML transcription start-site (Leff and Chambon, 1986). It therefore lacked the 'downstream' region (+33 to +190) shown by Mansour et al. (1986), to influence ML promoter activity in response to an adenovirus-induced trans-acting factor. A fragment of the ML promoter, spanning -260 to +30, fails to compete for the transcription factor that binds the upstream region of the E2 promoter (SivaRamen et al., 1986). This raises the possibility that a cellular transcription factor which recognises Ad E promoters, but not an Ela-uniducible fragment of the ML promoter, is involved in Ela-mediated trans-activation.

(ii) Factors involved in Ela-mediated trans-activation

Cellular transcription factors have recently been identified that may be involved in Ela-mediated trans-activation. It is appropriate to ask how Ela exerts its effect through such factors. For instance, does Ela cause an increase in the concentration of transcription factors, or does it cause an increase in the activity of transcription factors (assuming that general transcription factors can be 'activated')?

Kovesdi et al. (1986) used a gel mobility shift assay to investigate the effect of Ela on the binding of cellular transcription factors to the Ad E2a promoter. A protein, just detectable in nuclear extracts of uninfected HeLa cells, was shown to bind upstream sequences (-74 to -33) that overlap those important for Ad E2a promoter activity (see below). Binding of this factor was greatly increased in nuclear extracts of adenovirus-infected cells which suggests that Ela increased the concentration of this factor (Kovesdi et al., 1986).

In apparent contradiction, SivaRamen et al. (1986), using a similar approach, identified a protein present at comparable levels in Ad-infected and uninfected HeLa cells, which also bound to DNA in the the Ad E2a promoter upstream region (-82 to -66). It is not clear if the cellular

factors identified by Kovesdi et al. (1986) and SivaRamen et al. (1986) are the same or different proteins due to the apparent difference in their sequence-binding specificity. However, the E2a promoter has only been shown to have two distinct sequence elements important for basal and induced activity (Jones, 1986). These are the -82 to -66 upstream region which includes the AG-rich sequence 5'-AGATGACGTA-3' between -79 and -70 (of which there are similar counterparts important for the activity of other Ad early promoters), and the -35 to -21 region which houses a functional 'TATA box-like' element. Differences in nuclear extract preparation might influence the abundance of the protein(s) detected by Kovesdi et al. (1986) and SivaRamen et al. (1986) in uninfected cells; or there could be two closely associated or overlapping sequence elements within the E2 promoter upstream region which are recognised by different proteins.

Leong and Berk (1986) have shown that nuclear extracts from various mutant adenovirus-infected cells only require prior expression of the 13S Ela in order to stimulate transcription from a number of adenovirus promoters in vitro. By limiting in vitro transcription to one initiation per template, it was found that the higher activity of the infected-cell extracts was due to an increase in the number of templates transcribed (Leong and Berk, 1986). This suggests that Ela has increased the availability of active transcription factors, but does not distinguish between an increase in the overall number of factors or the conversion of inactive to active factors. To distinguish between the two possibilities it will be important to test whether purified Ela can stimulate transcription when added to uninfected cell extracts.

Another mode of Ela action may be to relieve the effect of a cellular factor that represses Ad early transcription (Nevins, 1981; Borelli et al., 1986). That early transcription is increased at high multiplicities of infection of an Ela-negative virus (dl312), and by inhibition of cellular protein synthesis, supports this idea, assuming that such a cellular repressor can be

titrated out and has a short half-life (Nevins, 1981).

(iii) Repression

In addition to the ability of Ela to activate transcription of both viral and cellular genes (Green et al., 1983; Kingston et al., 1985), it can also repress the transcription of transfected genes linked to the SV40, polyoma, Ad2 Ela, or IgH enhancers (Borrelli et al., 1984, 1986; Velcich and Ziff, 1985; Lillie et al., 1986). The wild-type polyoma virus (Py) enhancer is repressed in undifferentiated embryonal carcinoma (EC) cells, as well as by Ela (Hen et al., 1986). A point-mutant of the Py enhancer that allows Py activity in EC cells is not repressed by Ela (Hen et al., 1986). These results, together with the fact that adenovirus mutants defective in Ela can replicate in EC cells, suggest that EC cells contain an Ela-like activity that can repress some promoters and trans-activate others.

The transcriptional activity of stable integrations of the mouse immunoglobulin gene is repressed by Ela in lymphoid cells (Hen et al., 1985), but stimulated in mouse fibroblast cell lines in the presence of Ela (Borrelli et al., 1986). Enhancer competition experiments suggest that Ela may be preventing the action of a cellular repressor, thus the 'activation' is indirect (Borrelli et al., 1986). It is intriguing to speculate that the transcription-repression activity of Ela might operate on the putative gene(s) encoding a short-lived cellular repressor, thus resulting in indirect 'activation' of transcription of formerly repressed genes in some cell types.

An analysis of Ela mutants with lesions in the unique portion of the 13S mRNA product has revealed that the transcription-stimulatory activity of Ela can be separated from its repression function, and also that some repression-negative mutants (with lesions in the shared portion of both 12S and 13S products) are defective in transformation (Lillie et al., 1986).

### b. SV40 T antigen

Simian virus 40 (SV40) is a small oncogenic virus of the papovavirus group, and has a double stranded DNA genome of length 5243bp (for review, see Tooze, 1980). During lytic cycle in 'permissive' monkey kidney cells, SV40 is expressed in two temporally regulated phases. Early gene expression begins shortly after infection, and gives rise to two tumour antigens, large T (94,000 m.wt.) and small t (17,000). These proteins continue to be synthesized in a regulated fashion throughout the cycle. High levels of late gene expression (for production of viral capsid proteins, VP1, VP2, and VP3) is generally delayed until after the onset of viral DNA replication.

Large T antigen binds specifically to several sites in the control region of the viral genome (see Figure 5), and plays a regulatory role in the developmental cycle of SV40, including autoregulation of early transcription, initiation of DNA replication, and stimulation of late transcription. Recent evidence demonstrating the ability of T antigen to trans-activate transcription is outlined below.

#### (i) Late promoter activation

Efficient utilization of the SV40 late promoter requires activation in trans by T antigen, in addition to DNA replication for maximal expression (Brady *et al.*, 1984; Hartzell *et al.*, 1984; Keller and Alwine, 1984). The requirement for T antigen (and DNA replication) is circumvented in germ cells, where late gene products exceed early gene products (Chalifour *et al.*, 1986). This is reminiscent of the bypass of HSV trans-activating proteins for HSV-1 *tk* gene expression in oocytes (McKnight and Kingsbury, 1982). Competition experiments *in vivo* suggest there may be negative factors involved in regulating the SV40 late promoter (Brady and Khoury, 1985).

Activation of the SV40 late promoter can occur by at least two independent mechanisms which have different sequence requirements within the SV40 control region (Keller and Alwine, 1985; Brady and Khoury, 1985). One mechanism requires T antigen binding to an intact origin region, in

addition to the presence of the 21bp repeats and late promoter-proximal sequences within 72bp enhancer (Keller and Alwine, 1985; Brady et al., 1985). The second mechanism, involving trans-activation by T antigen, requires sequences at the junction of the 72bp repeat, and is independent of an intact ORI region. The ORI-dependent activation is responsible for about a 10-fold stimulation of late promoter activity, but it is not clear if DNA replication is actually required (Keller and Alwine, 1985) or not (Brady and Khoury, 1985). ORI-dependent activation accounts for 25-35% of total late promoter activity; the remaining 65-75% activity is mediated in trans by T antigen in the absence of binding to DNA (Keller and Alwine, 1985).

A detailed deletional analysis of the late promoter region revealed a 33bp element located at the internal junction of the 72bp repeats which is involved in trans-activation by T antigen (Keller and Alwine, 1985). Interestingly, this element contains the SV40 enhancer 'core' sequence (Weiher et al., 1983), and a limited homology to the HSV TAATGARATTC consensus sequence (Whitton et al., 1983; Preston et al., 1984; see Section E(2)). A reasonable supposition would be that trans-activation by T antigen is mediated through cellular transcription factors that bind control DNA sequence elements. SV40 chromosomes from lytically infected CV-1 cells are tightly bound by SV40-induced cellular factors, which are required for efficient late gene transcription in vitro (Tack and Beard, 1985).

#### (ii) Early promoter activation

A potential involvement of T antigen in trans-activating the expression of the SV40 early promoter [LE rather than EE (Wasylyk et al., 1983)] is complicated by its binding to three adjacent sites that overlap the early promoter and origin of DNA replication, and its requirement for DNA replication which also affects early gene expression. The proximity of the three T antigen binding sites to the 21bp repeats, or their direct overlap with the early mRNA cap sites, is likely to interfere with the

interactions of transcription factors critical for (particularly EE) early gene expression (Myers et al., 1981). After the onset of viral DNA replication, LE RNAs become predominant over EE RNAs.

Buchman et al. (1984) have investigated the effect of DNA replication and the role of T antigen on LE promoter activity using a plasmid vector, in which manipulations of the SV40 origin of replication (ORI) and T antigen binding sites could be made. Their experiments have shown that DNA replication is important for abundant expression of the LE promoter, in the absence of the T antigen binding sites and the SV40 enhancer. The coupling of LE promoter activity to DNA replication bears similarity to HSV-1 late gene expression (see later), although a direct requirement for trans-activation of the LE promoter by SV40 T antigen has not been proven.

### (iii) Activation of heterologous promoters

The SV40 T antigen stimulates a number of heterologous promoters including the adenovirus E2 and E3, and the  $\alpha 2$  collagen and RSV LTR promoters (Alwine, 1985; Loeken et al., 1986). Activation is better in CV-1 cells than in HeLa cells (Alwine, 1985). Loeken et al. (1986) have shown that T antigen stimulation of an Ad E2 promoter/CAT fusion gene in CV-1 cells is as efficient as that mediated by Ela. However, at saturating levels, the effects of T antigen and Ela are additive, which suggests that stimulation by these two proteins occurs by different mechanisms (Loeken et al., 1986).



SECTION E: HSV-1 TRANSCRIPTIONAL PROGRAMME1. Temporal Expression of the HSV-1 Genome

Lytic infection by HSV-1 is characterized by the coordinate, temporal control of the viral transcriptional programme. The classification of three groups of HSV genes, immediate-early (IE), early (E), and late (L) (Clements et al., 1977), or  $\alpha$ ,  $\beta$ ,  $\gamma$  (Hones and Roizman, 1974; Jones and Roizman, 1979), is based on the kinetics of appearance of gene products, and their detection in the presence and absence of metabolic inhibitors of protein and DNA synthesis. IE genes are the only class to be expressed in the absence of de novo protein synthesis (Kozak and Roizman, 1974; Clements et al., 1977; Jones and Roizman, 1979). E and L gene expression requires prior synthesis of IE gene products (Hones and Roizman, 1974, 1975), and late genes are most abundantly expressed following the onset of DNA replication (Swanstrom and Wagner, 1974; Powell et al., 1975; Holland et al., 1980).

A similar pattern of gene expression has been described for other herpesviruses, including PRV (reviewed by Ben-Porat and Kaplan, 1985) and CMV (reviewed by Stinski, 1983). The main control of HSV-1 gene expression appears to be at the level of transcription initiation, but with two exceptions. (i) At early times during HSV-1 infection, an HSV virion component is associated with post-transcriptional shut-off of IE- and host-polypeptide synthesis (Read and Frenkel, 1983; see Section A(2c)). (ii) At late times, nuclear RNA hybridizes to a greater proportion of the viral genome than cytoplasmic RNA, indicating a retention of some RNA coding potential in the nucleus (Jaquemont and Roizman, 1975; Clements et al., 1977). Post-transcriptional events appear to play a role in the temporal regulation of CMV gene expression, notably in the delayed translation of at least two RNAs transcribed at early times which encode late proteins (Geballe et al., 1986).

Early investigations of HSV-1 gene expression were based principally on two techniques; (i) identification by size of radio-labelled viral polypeptides fractionated by polyacrylamide gel electrophoresis (Hones and Roizman, 1974, 1975; Powell et al., 1975); and (ii) solution and filter hybridization of infected-cell RNA to either HSV genomic DNA (Swanstrom and Wagner, 1974; Swanstrom et al., 1975), or to isolated restriction endonuclease fragments of HSV DNA (Jones and Roizman, 1979). The development of blot hybridization techniques (Southern, 1975) enabled the crude mapping of different transcript classes to physical restriction maps of the HSV-1 genome (Wilkie, 1976; Morse et al., 1977; Clements et al., 1977; Anderson et al., 1979; Holland et al., 1980). These studies showed that viral genes were not grouped on the genome according to temporal class with the possible exception of the IE genes.

More detailed studies of HSV transcriptional control required the identification of individual genes and the sensitive and specific detection of their products. The locations of many individual transcripts have been determined on physical maps of the HSV genome (see Wagner, 1985), by such techniques as S1 mapping and Northern blotting (e.g. as employed by Rixon and McGeoch, 1985). Individual proteins have been mapped by intertypic recombinant analysis (e.g. Marsden et al., 1978; Preston, V. et al., 1978; Morse et al., 1978), and marker rescue (e.g. Stow et al., 1978; Parris et al., 1980). In vitro translation of infected-cell RNA (Preston, 1977) made in the presence of cycloheximide ('immediate-early conditions'), provided an approach to identify which IE proteins were specified by size-fractionated RNAs (Watson et al., 1979). The availability of cloned HSV genomic fragments then enabled infected-cell RNA to be enriched (hybrid-selected) or depleted (hybrid-arrested) for specific sequences, thereby allowing individual mRNAs to be correlated with in vitro translated gene products (Anderson et al., 1980; Preston and McGeoch, 1981; Rixon and McGeoch, 1984).

## 2. IE Gene Regulation

### a. Viral IE gene expression

During a normal infection, IE RNAs can usually be detected by 1h, and later classes by 2-3h post-adsorption (p.a.). The synthesis and accumulation of IE RNAs peaks at around 2h and 3h p.a. respectively, but IE RNAs still persist in the cytoplasm at late times (Harris-Hamilton and Bachenheimer, 1985; Godowski and Knipe, 1986). Under immediate-early conditions, only a limited portion of the viral genome is transcribed. The mapping and orientation of IE transcripts on the HSV-1 genome revealed five IE mRNA species (Clements *et al.*, 1979). The IE mRNAs 1 and 3 mapped entirely within the TR<sub>L</sub>/IR<sub>L</sub> and TR<sub>S</sub>/IR<sub>S</sub> segments respectively, and are therefore encoded by diploid genes. The 5' termini of IE mRNAs 4 and 5 are located within TR<sub>S</sub>/IR<sub>S</sub>, and share common promoter and 5' untranslated leader sequences (Figure 3). IE 2 mRNA maps to a fragment within U<sub>L</sub> (Figure 1).

The level of IE 3 RNA declines particularly sharply after its peak which reflects an effective shut-off of transcription of this gene by 4h (Godowski and Knipe, 1986; Yager and Bachenheimer, 1987). On the basis of experiments using metabolic inhibitors it was first suggested that E gene products negatively regulate IE gene expression (Hones and Roizman, 1974, 1975). Indeed, a *ts* mutant in the major DNA binding protein (MDBP) fails to shut off IE gene 3 transcription at NPT, but it also overexpresses E and L genes (Godowski and Knipe, 1986). Evidence that the product of IE gene 3, Vmw175, represses transcription of its own gene is discussed in part 3a(iii).

Transcription of IE genes can be achieved without modification of the existing host-cell transcription machinery, since (i) deproteinised HSV-1 DNA is infectious (Graham *et al.*, 1973), (ii) IE transcription can take place in the absence of *de novo* protein synthesis (Kozak and Roizman, 1974; Clements *et al.*, 1977), and (iii) HSV transcription is sensitive to  $\alpha$ -amanitin, except in cell lines which possess an  $\alpha$ -amanitin-resistant RNA pol II

(Costanzo et al., 1977). However, IE gene transcription is also stimulated 5 to 10-fold in response to a component of the virus particle (Post et al., 1981; Mackem and Roizman, 1982a; Batterson and Roizman, 1983; Cordingley et al., 1983; Preston et al., 1984; Campbell et al., 1984).

#### b. IE gene regulatory sequences

The sequences regulating IE gene expression have been investigated in detail. Post et al. (1981) were the first to demonstrate that sequences within the 5'-flanking region of an IE gene differentiated the regulation of IE and E promoters. This was achieved by fusing the 5'-flanking sequences of IE gene 3 to the coding region of the HSV-1 tk gene. The resulting IE-tk fusion gene responded to IE control when inserted into recombinant virus or biochemically transformed cells (Post et al., 1981). Subsequent deletion mutant and gene fusion studies delineated two distinct regions controlling IE gene transcription; (i) a regulatory region located far-upstream (-174 to -331) of the IE 3 RNA start site; and (ii) a promoter region (contained within +26 to -108) required for basal and fully induced gene expression (Mackem and Roizman, 1982a; Cordingley et al., 1983).

All five HSV-1 IE promoter/regulatory regions respond to the virion component (Mackem and Roizman, 1982a,b; Cordingley et al., 1983; Preston et al., 1984). The basal level of transcription of IE genes 4/5, for instance, is efficiently mediated by 69bp of promoter DNA. With the addition of the IE 4/5 far-upstream region to an IE 4/5-tk fusion gene, a further 8-fold stimulation of tk activity is achieved in the presence of the virion component (Preston et al., 1984). The target sequence for induction mediated by the virion component was identified by deletion mutant studies (Cordingley et al., 1983; Preston et al., 1984; Bzik and Preston, 1986), and DNA sequence comparisons of the regions upstream from IE RNA start sites (Mackem and Roizman, 1982b; Whitton et al., 1983; Whitton and Clements, 1984). It is an AT-rich sequence, consensus 5'-TAATGARAT-3', present in one or more copies in either

orientation upstream from all HSV-1 and HSV-2 IE genes. A synthetic 20-mer oligonucleotide containing the target sequence confers IE regulation when linked in either orientation to a plasmid-borne IE promoter in the absence of other IE far-upstream sequences (Gaffney et al., 1985). In this system, the level of stimulation conferred by one TAATGARAT motif was quite small, but was increased by joining together two or three of the 20-mers (Gaffney et al., 1985). Additional sequence elements flanking the TAATGARAT motif appear to be important for full induction (Kristie and Roizman, 1984; Preston et al., 1984; Bzik and Preston, 1986).

The far-upstream regulatory region of IE gene 3 has uninduced enhancer activity. It can stimulate expression of linked promoter sequences in an orientation-independent manner and at a considerable distance from a heterologous promoter (Lang et al., 1984; Preston and Tannahill, 1984), and thus resembles a classical enhancer element. However, the IE gene 3 enhancer differs from that of SV40 (Banerji et al., 1981; Moreau et al., 1981), in that its activity is further stimulated by the virion component, and it is apparently inoperative when located downstream of a gene (Preston and Tannahill, 1984).

Bzik and Preston (1986) have investigated the DNA sequences within the IE gene 3 far-upstream region which specifically mediate enhancer activity and/or response to the virion component. The enhancer-like activity was assigned to three separate elements which each impart a cumulative 2 to 3-fold effect. Two of these regions contain the GC hexanucleotide, 5'-GGCGG-3', and bind the cellular transcription factor Sp1 (Jones and Tjian, 1985). Deletion of two other Sp1 binding sites in the IE gene 3 far-upstream region did not affect promoter function (Bzik and Preston, 1986). The third element involved in enhancer activity is GA-rich and contains sequences which resemble the SV40 enhancer 'core' sequence (Weiher et al., 1983), and important motifs in the adenovirus Ela and polyoma virus enhancers (Hearing and Shenk, 1983; Herbomel et al., 1984). The DNA sequences involved in response to the virion

component were separable from those required for enhancer activity. The most important sequence was the previously defined TAATGARAT element. In addition, a sequence largely overlapping the GA-rich element of the IE gene 3 enhancer was also required for full response to the virion component (Bzik and Preston, 1986). The far-upstream region of IE gene 3 thus has a complex, modular structure, which resembles the organization of other enhancers and regulatory regions.

c. Characterization of the virion factor which stimulates IE gene expression

Since the initial observation that a component of the virus particle could stimulate IE gene expression (Post et al., 1981), the identification and characterization of this factor has been an important focus of study. The factor is present in an active form in uv-irradiated HSV-1 and is also provided by an uncoating mutant of HSV-1, which suggested that it is a tegument protein (Batterson and Roizman, 1983). While the stimulation was greater with increased m.o.i. of HSV-1, it was not induced by the related herpesviruses PRV, BMV, or HCMV. Campbell et al. (1984) investigated the identity of the virion component by co-transfection of cloned restriction fragments of the HSV genome together with an IE-tk fusion gene. A region of the genome which stimulated tk activity with IE specificity was located. By further sub-cloning, insertional mutagenesis, and immunoprecipitation studies, the virion component was identified as the major tegument protein, Vmw65.

The DNA and predicted amino-acid sequences of the HSV-1 Vmw65 gene have been determined (Dalrymple et al., 1985; Pellet et al., 1985). A gene homologous to the HSV-1 Vmw65 has been found in VZV, but the corresponding protein, VZV 45K, lacks the carboxy-terminal 80 amino-acids of Vmw65 (Dalrymple et al., 1986; Davison and Scott, 1986), and it is not known if the 45K protein has any transcription stimulatory activity in VZV.

Preliminary studies of the HSV-1 virion component suggest that it does not bind to DNA (Marsden et al.,

submitted), although specific binding to HSV DNA has not been investigated. This observation contrasts with other regulatory-proteins, such as the glucocorticoid receptor (Giguere et al., 1986), and the heat-shock transcription factor (Parker and Topol, 1984), which bind their cognate "response" elements in order to induce transcription (Chandler et al., 1983; Payvar et al., 1983; Bienz and Pelham, 1982). It is possible that the mechanism of 'trans-induction' by Vmw65 has more in common with that of other viral trans-acting regulatory proteins, such as Ad Ela, SV40 T antigen (see Section D), PRV IE180, and HSV Vmw175 (see below), which 'trans-activate' transcription apparently without directly binding to target promoter sequences. An important difference, however, is the essential and specific target sequence for Vmw65-mediated induction, which is located upstream of the IE basal promoter sequences.

The HSV-1 virion component also stimulates expression of the single IE gene of PRV, although PRV does not harbour a corresponding trans-inducing activity (Batterson and Roizman, 1983; Campbell and Preston, 1987). Sequence analysis of the PRV IE gene upstream region revealed the presence of two TAATGARAT-like motifs, which are presumed to mediate response to Vmw65; and a six-times repeated 15bp element (see below) which contains a CCAAT box homology (Campbell and Preston, 1987). The organization of the PRV IE gene upstream region shows more similarity to the strong enhancer of HCMV (Boshart et al., 1985), than to the HSV-1 IE gene 3 far-upstream region (Bzik and Preston, 1986). It is interesting to speculate that the PRV 15bp motif may be recognised by a cellular transcription factor (possibly related to the CAAT-binding protein?) that stimulates PRV IE gene transcription, thus dispensing with the requirement for a trans-inducing factor. Whereas in HSV, trans-induction may be important for the co-ordinate regulation of the five IE genes, without recourse to multiple enhancers in addition to that of IE gene 3.

The detection of a cellular protein that recognises the HSV TAATGARAT motif (Kristie and Roizman, 1987; R.Thompson,

personal communication) is a compelling area for further study. The degree of relatedness between conserved motifs in the far-upstream regions of herpes virus IE genes (HSV, 5'-TAATGARATTC-3'; PRV, 5'-GGCCAATGGGATTTY-3'; HCMV, 5'-<sup>C</sup>/<sub>A</sub>CTAACGGGACTTCCAA -3'), suggests their recognition by related transcription factors. Whether Vmw65 substitutes for a cellular transcription factor, or alters the activity or availability of endogenous factors, is not known.

A similarity between the HSV TAATGARAT motif and part of the progesterone receptor binding sequence (5'-TACAAA/<sub>C</sub>CAGAA/<sub>T</sub>AATA/<sub>G</sub><sup>A</sup>/<sub>G</sub>GAT -3') of hormone-responsive genes of the chicken oviduct (Heilig et al., 1982), has been noted (Whitton, 1984). However, studies to date have failed to demonstrate any significant hormonal induction of HSV IE genes, although the converse possibility of a Vmw65-mediated induction of steroid hormone-responsive genes has not yet been investigated (E.Offord and J.Macnab, personal communication).

### 3. Herpes Virus IE Gene Products

The five IE polypeptides of HSV-1 are named according to their mobility on SDS-PAGE gels in terms of apparent molecular weight (Vmw) (Preston, V. et al., 1978; Watson et al., 1979), or 'infected cell polypeptide' (ICP) number (Hones and Roizman, 1974; Morse et al., 1978):

Gene Number	Apparent M.Wt.	ICP Number
IE 1	Vmw110	ICP0
IE 2	Vmw63	ICP27
IE 3	Vmw175	ICP4
IE 4	Vmw68	ICP22
IE 5	Vmw12	ICP47

Apart from Vmw12, all the IE proteins become phosphorylated (Pereira et al., 1977; Marsden et al., 1978; Fenwick and Walker, 1979; Ackermann et al., 1984), and migrate to the nucleus where they become tightly associated with chromatin (Hay and Hay, 1980, 1981). The functions of the IE proteins are outlined below and have been studied principally by two approaches; (i) characterization of



mutants carrying lesions in IE genes, and (ii) use of plasmids encoding IE gene products in short term transfection assays. The role of IE gene products in the activation of E gene transcription is discussed mainly in part 4.

a. HSV-1 IE gene products

(i) Vmw110: Conditional-lethal mutants have not been isolated in IE gene 1. Stow and Stow (1986) constructed a recombinant virus, d11403, which contains a deletion in both copies of IE gene 1. The same deletion has been shown to inactivate the E gene transcription-stimulatory activity of Vmw110 in a transient assay (see below; Perry *et al.*, 1986). Although initially isolated on a cell-line containing IE gene 1, d11403 grew on a number of other cell-lines, at 20 to 100-fold reduced efficiency compared to wt HSV-1. Functional Vmw110 is therefore not crucial for virus growth in tissue culture. However, stocks of d11403 have an exceptionally high particle/pfu ratio. This is not thought to result from a defect in the virus particle but rather from a reduced ability of the mutant virus to initiate a productive infection at low m.o.i. (Stow and Stow, 1986).

Sandri-Goldin *et al.* (1987) have investigated the effect of reducing Vmw110 expression during infection by use of cell lines which carry a plasmid engineered to express the antisense Vmw110 message. During HSV-1 infection of antisense cell lines the level of Vmw110 was reduced to less than 10%; but this had little effect on the expression of HSV-1 early or late genes, or on virus yield.

Sequence analysis of IE gene 1 revealed the presence in Vmw110 of a cysteine-rich region (Perry *et al.*, 1986), which is similar to that present in many DNA binding proteins (Berg, 1986), and may form a "metal-finger" binding domain. This may correlate with the binding of Vmw110 to chromatin in infected-cell nuclei (Hay and Hay, 1980), but it has yet to be shown that purified Vmw110 binds directly to DNA.

(ii) Vmw63: A number of ts mutants have been isolated in IE gene 2 which demonstrate that Vmw63 is essential for lytic growth (Sacks et al., 1985). At NPT, these mutants overproduce at least two IE proteins, Vmw175 and Vmw63 (but not Vmw110), exhibit normal levels of E proteins, have a spectrum of effects on EL proteins, and severely underproduce L proteins, although there is no block in viral DNA synthesis. Thus Vmw63 does not appear to be required until after the onset of E gene expression and viral DNA synthesis, and its effect appears to be limited to a subset of HSV promoters (Sacks et al., 1985; see part 4(c)).

(iii) Vmw175:

Genetic Studies:

The product of IE gene 3 has a critical role in the HSV transcriptional programme. Many ts-Vmw175 mutants at NPT overproduce IE gene products and fail to express E and L genes (Marsden et al., 1976; Preston, 1979a; Dixon and Schaffer, 1980; Watson and Clements, 1978; 1980). In temperature shift-up experiments, these mutants resume IE gene expression and discontinue E expression, suggesting that functional Vmw175 is continuously required for E gene expression, and is also involved in the negative regulation of IE genes (Watson and Clements, 1980; Dixon and Schaffer, 1980). The phenotypes of ts-Vmw175 mutants may vary from being non-permissive to being partially or completely permissive for E gene expression (DeLuca et al., 1984). Mutants permissive for E gene expression may exhibit reasonably high levels of DNA synthesis, but late gene products are consistently underproduced. This suggests that a distinct function of Vmw175 may be required for late gene expression. A similar variation in the permissiveness of E gene expression is seen during infection in experiments using the arginine analogue, canavanine, depending on the stringency of the conditions used (Hones and Roizman, 1975; Harris-Hamilton and Bachenheimer, 1985).

DeLuca et al. (1985) isolated two deletion mutants of IE gene 3, d120 and d202, on cell lines that express Vmw175. These mutants expressed truncated forms of Vmw175. When

grown on non-permissive cells, dl20 and d202 failed to express E genes but differed from most ts mutants of Vmw175 in that IE polypeptides were not overexpressed. A possible explanation is that the truncated forms of Vmw175 retained autoregulatory activity but were defective in trans-activation. However, since the mutant dl20 retains very little of the coding sequences of Vmw175 (less than one-fifth), it would be surprising to find that it also retains some functional activity.

Autoregulation of IE gene 3 expression by Vmw175 has been demonstrated by three groups using cloned IE genes in transient assays (O'Hare and Hayward, 1985b; DeLuca and Schaffer, 1985; Gelman and Silverstein, 1986). In these studies, it was apparent that the level of Vmw175 was critical for determining whether IE gene expression was stimulated or inhibited (O'Hare and Hayward, 1985b; Gelman and Silverstein, 1986) which indicates how such factors as multiplicity of infection could influence the outcome of an infection. A cloned ts-Vmw175 gene has been used to provide further evidence that functional Vmw175 is directly required for autoregulation (DeLuca and Schaffer, 1985). When co-transfected with an IE 3-CAT fusion gene it was found that increased levels of CAT were produced at NPT; consistent with the corresponding ts mutant virus phenotype of overexpression of IE gene products at NPT.

#### Physical Properties:

There are three phosphorylated forms of Vmw175 (a,b and c), which exhibit different electrophoretic mobilities on SDS-PAGE gels (Pereira et al., 1977). The HSV-1 mutant, tsK, has a single base-change in the coding region of Vmw175 (Davison, M-J. et al., 1984). Transcriptionally inactive tsK-Vmw175 (Preston, 1979a) correlates with the absence of the 'c' form of Vmw175 (Preston, 1979b), and the failure of this protein to be modified by poly(ADP-ribosylation) at NPT (Preston and Notarianni, 1983).

Vmw175 has been isolated as a homodimeric complex (Metzler and Wilcox, 1985). Hay and Hay (1980) reported that Vmw175 binds to DNA. However, Freeman and Powell,

1982) have shown that the ability of Vmw175 to bind to DNA was lost after extensive purification, but could be restored by the addition of uninfected cell extracts. This suggested that Vmw175 does not directly bind to DNA. A number of "Vmw175/protein"-DNA binding sites have recently been identified (see below) and their possible relevance in the regulation of transcription is considered further in part 4(e).

Faber and Wilcox (1986), by use of a DNA binding immunoassay, found that their partially purified preparation of Vmw175 could bind to DNA and that it bound preferentially to one site in the gD promoter region, and two more in pBR322 DNA. Comparison of the sequences bound yielded a surprisingly good consensus sequence (5'-ATCGTCN<sub>4</sub>YCGRC-3'). However, the binding site in gD DNA lies outside the essential gD promoter sequences (Everett, 1983; Faber and Wilcox, 1986) and its significance in gD transcription is not yet known. In addition, it is not known if the binding of Vmw175 in these studies is occurring through an intermediate.

Kristie and Roizman (1986a,b) used a gel retardation assay in the presence and absence of anti-Vmw175 monoclonal antibodies, in order to identify HSV-1 DNA fragments which bind Vmw175/protein. Binding was detected to the regulatory sequences of IE genes 1, 2 and 3, and a late promoter, but the tk promoter did not significantly bind Vmw175/protein. The binding site in the far-upstream region of IE gene 3 was investigated in further detail. Binding did not require the retention of nearby Sp1 binding sites (Kristie and Roizman, 1986b), nor did the bound DNA contain the consensus sequence of Faber and Wilcox (1986). The meaning of these results is unclear. It is possible that Vmw175 binds its own promoter DNA (which does have a consensus binding site - Murchie and McGeoch, 1984; McGeoch et al., 1986) in order to autoregulate IE gene 3 transcription, and that the detection of other binding sites is either fortuitous or an artifact of the DNA binding assays. Further purification of Vmw175 should help solve these current problems, and aid a better understanding of this multifunctional protein.

(iv) Vmw68: A recombinant HSV-1 virus, R325- $\beta$ TK<sup>+</sup>, which contains a 550bp deletion within the coding sequences of IE gene 4, grew as well as wt HSV-1 in some, but not all cell-types, in tissue culture (Post and Roizman, 1981; Sears et al., 1985). It has been speculated that a cellular function substitutes for Vmw68 in cells permissive for normal growth of R325- $\beta$ TK<sup>+</sup>, and that this function is involved in late gene expression (Sears et al., 1985).

(v) Vmw12: Very little is known about the the product of IE gene 5. It is evidently not essential for HSV-1 growth in tissue-culture, since viruses deleted for this gene (along with several others) are still able to grow reasonably well in tissue culture (Longnecker and Roizman, 1986; Umene, 1986; Brown and Harland, 1987).

#### b. PRV IE protein

PRV appears to specify only one IE protein, of M.Wt. 180K - IE180 (Ihara et al., 1983), whose coding sequences share homology with the HSV-1 IE gene 3 (Ben-Porat et al., 1983; Davison and Wilkie, 1983a). Infection of cells with a temperature-sensitive mutant defective in the 180K protein (tsG) results in the failure to transcribe early genes (Ihara et al., 1983). Both IE180 and HSV Vmw175 can substitute for Ela function in the adenovirus Ela-deficient mutant, dl312 (Feldman et al., 1982; Tremblay et al., 1985). IE180 can also mediate strong transcriptional activation of a variety of heterologous promoters in transient tranfection assays (Green et al., 1983; Imperiale et al., 1983; Everett, 1984a; Alwine, 1985).

Abmayr et al. (1985) have shown that IE180 can stimulate transcription in vitro from the Ad ML and E3 promoters, and the mouse  $\beta$ -globin promoter. This was the first report of the action of a trans-acting regulatory protein in vitro. However, the stimulation (about 10-fold) was not high and it was necessary to make extracts from a cell line apparently deficient in transcription factors for the stimulatory effect to be observed (Abmayr et al., 1985). Despite these reservations, this approach to study the

mechanism of trans-activation induced by PRV is very promising.

#### 4. Early Gene Expression

Early gene transcription begins after the appearance of functional IE products in the cell and usually reaches a maximum level at 4-6h p.a.. The criteria which define E genes are not as clear as those which define IE genes, and there is some variation in their kinetics of expression. For instance, the large subunit of the ribonuclease reductase (RR<sub>1</sub>) has been classed as an E gene product (ICP6 - Honess and Roizman, 1974), although it may be expressed under IE conditions and by some mutants of Vmwl75 that do not otherwise express E gene products (DeLuca et al. 1985). Hence RR<sub>1</sub> has also been described as a  $\beta_1$  gene product (Roizman and Batterson, 1985). Some genes such as gD are detected early in infection but require viral DNA synthesis for maximum expression, although they are expressed at moderately high levels in its absence (Gibson and Spear, 1983; Johnson et al., 1986). VP5 is often described as a late gene, but it too is expressed moderately well in the absence of DNA replication, although its response to activation by IE gene products is poorer than gD (Costa et al., 1985b; DeLuca and Schaffer, 1985; Harris-Hamilton and Bachenheimer, 1985; Everett, 1986). Descriptions of genes whose expression is moderately sensitive to inhibition of DNA replication include early-late (EL), leaky-late,  $\beta\delta$ , and  $\chi_1$  genes (Roizman and Batterson, 1985; Wagner, 1985; Harris-Hamilton and Bachenheimer, 1985).

##### a. Early gene promoter DNA sequences

The sequences required for expression of the HSV-1 tk promoter have been studied in considerable detail (McKnight et al., 1982; Eisenberg et al., 1985; El Karez et al., 1985; Coen et al., 1986), as discussed in Section D(1a). These studies have identified three upstream promoter elements (the CAAT box and two GC hexanucleotides) which are required for efficient transcription of the tk gene, and are

recognised by the cellular transcription factors CBP/CTF and Sp1, respectively (Jones et al., 1985; Graves et al., 1986). In addition, the tk TATA box was shown to be especially important for transcription of the tk gene when situated on the viral genome, and a mutation-sensitive region 3'-flanking the tk RNA start site has been noted (Coen et al., 1986).

A short term transfection procedure was employed by Everett (1983, 1984b) to investigate the sequence requirements of the gD promoter. Deletion analysis showed that sequences within -83 and +17 of the gD RNA start site (+1) were sufficient for fully regulated expression of a plasmid-borne gD promoter in HSV-1 infected cells (Everett, 1983). Four regions important for full gD promoter activity were subsequently identified: (i) A G-rich region between -73 and -63; (ii) A G-rich region between -53 and -41; (iii) A TATA box between -25 and -18; (iv) The cap site region between -4 and +11 (Everett, 1984b; see Figure 21 for the gD promoter sequence). How do the gD and tk promoters compare? The gD promoter appears to have a less complex upstream region than tk in that it lacks a CAAT box, although point-mutation analysis would be required to confirm the absence or otherwise of functional elements in addition to the G-rich motifs. A reasonable conjecture is that both promoters have two Sp1 binding sites, since the G-rich regions of the gD promoter (5'-GG<sup>G</sup>/<sub>A</sub>GAGGGGC-3') are highly similar to an Sp1 binding site in the HIV LTR (5'-GGGGAGTGGC-3') (Jones et al., 1986). In the proximal promoter region, the TATA boxes of both tk and gD are very important for full activation, and both promoters have mutation-sensitive cap site regions (Coen et al., 1986; Everett, 1984b). It is interesting to note that the upstream regions of the gD (Everett, 1984b) and tk (McKnight et al., 1984) promoters are able to function in the inverse orientation relative to the TATA box, as can the SV40 upstream region (Everett et al., 1983).

The VP5 promoter is regulated with essentially EL kinetics during HSV-1 infection (Harris-Hamilton and Bachenheimer, 1985). The DNA sequence requirements of the

VP5 promoter extend 5' between -75 to -125 from the VP5 RNA start site (Costa et al., 1985b). It is therefore likely that the VP5 promoter has a functional 'upstream region', although the nature of the important sequences within this region await investigation.

#### b. Specificity of promoter activation

The activity of deletion mutants of the gD promoter were examined in response to (i) trans-acting viral products provided by HSV-1 infection, and (ii) cis-activation by a linked SV40 enhancer (Everett, 1984b). A striking observation was that the same mutation-sensitive sequences were revealed in both situations, and no specific sequences for viral trans-activation were detected. Likewise, no virus-specific sequences have been detected for activation of the tk promoter (Eisenberg et al., 1985; Coen et al., 1986). These observations suggest that the same basic transcriptional machinery is used in the activation of viral promoters, whether mediated in the presence or absence of viral transcription factors.

A second important observation made by Everett (1983, 1984b), was that the activity of a co-transfected rabbit  $\beta$ -globin promoter (which was included to provide a reference to standardize transfection efficiencies) was also stimulated by HSV-1 infection. Subsequently, a large variety of herpes viruses were shown to trans-activate both the HSV-1 gD and the rabbit  $\beta$ -globin promoters (Everett and Dunlop, 1984). This activation was mediated by their IE gene products (Everett, 1984a). Similar results have been obtained for other viral trans-acting regulatory proteins, demonstrating that activation by viral gene products is not specific for viral promoters (Green et al., 1983; Imperiale et al., 1983; Alwine, 1985; see Section D). However, activation of heterologous promoters by viral trans-acting regulatory proteins is not universal. For instance, the SV40 early promoter (without the enhancer) responds poorly to activation during HSV-1 infection (O'Hare and Hayward, 1984; Everett, 1987).

Is the state of the promoter DNA important for



trans-activation? HSV-1 infection can stimulate viral (Smiley et al., 1983; Sandri-Goldin et al., 1983; Dennis and Smiley, 1984; Mosca et al., 1985) and cellular promoters (Everett, 1985) stably integrated into the genome of biochemically transformed cell-lines. Thus promoter activation by trans-acting regulatory proteins is not dependent on the extrachromosomal nature of infected viral or transfected plasmid DNA. Stimulation of an integrated rabbit  $\beta$ -globin promoter was shown to be mediated by HSV IE gene products, although the resident  $\beta$ -globin promoter in rabbit kidney cells did not respond to HSV-1 infection (Everett, 1985). This suggests that chromatin structure is likely to play an important role in determining whether or not a particular promoter may respond to trans-activation. It has recently been shown that the rabbit  $\beta$ -globin gene is regulated with E gene kinetics when inserted into the HSV-1 genome (J.R.Smiley, C.Smibert, R.D.Everett, submitted for publication). Thus promoter selectivity is not dependent upon exclusive viral or cellular sequences, nor genome location, although it then becomes difficult to postulate mechanisms for the general shut-off of host cell macromolecular synthesis (Section A).

### c. Trans-activation of E genes in co-transfection experiments

Studies with ts mutant viruses have demonstrated the requirement for Vmw175 in E gene transcription, and indicated that Vmw63 has a role in the expression of a subset of viral genes (part 3(a)). The development of short-term transfection procedures, using cloned IE genes, has enabled the individual or combinational functions of the various IE gene products of HSV-1 to be examined in greater detail.

Everett (1984a) investigated the ability of cloned IE gene products to activate a plasmid-borne gD promoter in co-transfected HeLa cells. The level of activation by Vmw175 was very low, but was significantly increased when in combination with Vmw110. Other HSV-1 IE gene products had no effect on gD promoter activity, either alone or in

combination with Vmw175 and Vmw110. Similarly, Quinlan and Knipe (1985) showed that although Vmw175 or Vmw110 could activate the E MBDP promoter, their effect in combination was synergistic. This was in apparent contrast to the findings of O'Hare and Hayward (1985a), who reported that co-transfection of Vmw175 or Vmw110 with a tk-CAT fusion gene produced significant levels of CAT activity, and those of Gelman and Silverstein (1985), who found that Vmw110 was a better activator of the tk promoter than Vmw175. However, differences in the test promoters, activator plasmid constructs, assay systems, and cell types, may account for the varied levels of activation in each system. Subsequent studies by Gelman and Silverstein (1986), and Everett (1986), have shown that the synergistic effect of Vmw110 and Vmw175 also applies to the tk promoter.

Using a similar approach, it has been found that Vmw63 has a transcription stimulatory activity on the VP5 promoter, but only in the presence of both Vmw175 and Vmw110 (Everett, 1986). Vmw63 had no effect on the activity of the tk or gD promoters, either alone or in combination with other IE gene products. In this study, tk was activated better than gD in a single co-transfection with either Vmw175 or Vmw110, and both gD and tk were activated better than VP5 with all combinations of activators (Everett, 1986). DeLuca and Schaffer (1985) have shown that a plasmid-borne ts-Vmw175 mutant, capable of activating a tk-CAT fusion gene, did not stimulate a VP5-CAT construct (unlike wt-Vmw175), except in the presence of additional IE gene products including Vmw63. These studies suggest that the multiple activators of HSV-1 may be required to regulate differentially subsets of HSV promoters, and that Vmw175 may have more than one function in this process.

#### d. A Role for the TATA box?

An alternative approach towards investigating trans-activation mediated by HSV-1 IE gene products has been to identify which elements within a responsive promoter can confer inducibility to a poorly responsive promoter. This approach has been used successfully to identify an upstream

element present in adenovirus early promoters which has the ability to confer Ela inducibility to the normally unresponsive HSV-1 tk gene (Weeks and Jones, 1985).

Everett (1987) constructed hybrid promoters consisting of the upstream or TATA box region of the HSV-1 gD promoter (which responds well to HSV-1 trans-activation) with the complementary region from the SV40 early promoter (which is poorly responsive - O'Hare and Hayward, 1984). Alteration of the SV40 TATA box region to that of gD resulted in a promoter that could be efficiently activated by HSV-1 infection. The upstream regions of the SV40 and gD promoters were functionally interchangeable (Everett, 1987). These results imply that the DNA sequence of the TATA box is of crucial importance to the mechanism of activation by HSV-1 IE gene products, and yet are consistent with the absence of virus-specific regulatory signals within the gD and tk promoters.

Cellular transcription factors have been identified which interact with upstream promoter sequences (see Section D) and the TATA box (Sawadogo and Roeder, 1985b). Given the variation in functional TATA box sequences (Breathnach and Chambon, 1981), it is possible that there is more than one TATA box factor, and that these factors have different sequence-recognition specificities. The results of Everett (1987) could be explained if HSV-1 IE gene products interact poorly with the SV40 TATA box factor, but efficiently with the gD TATA box factor. Since HSV TATA box sequences are not strictly conserved (Wagner, 1985; McGeoch et al., 1985), it would be useful to investigate the identity and specificity of TATA box binding factors, and determine whether or not they interact with IE gene products, or if HSV gene products can substitute for a TATA box factor.

That HSV-1 IE gene products may interact with the TATA box or TATA box factors is consistent with two observations. Firstly, Tackney et al. (1984) found that a recombinant HSV-1 virus, containing the Chinese hamster aprt gene and regulatory sequences, did not express aprt during lytic infection. In common with other housekeeping genes (Kim et al., 1986), the aprt gene does not appear to contain a TATA

box (or a CCAAT box), although it does possess potential Sp1 binding sites (Dush *et al.*, 1985). Secondly, Coen *et al.* (1986) showed that linker scanning mutations within the viral-borne HSV-1 tk TATA box region had the most severe effect compared to other sites during infection. The results of experiments investigating trans-activation of an HSV-1 L promoter are also consistent with the proposed importance of the TATA box (this thesis).

#### e. Trans-activation in vitro

The observation that purified Vmw175 fails to bind DNA (Freeman and Powell, 1982), suggests that Vmw175-mediated trans-activation occurs through direct or indirect interaction(s) with cellular transcription factors which themselves recognise general promoter sequences. Beard *et al.* (1986) have analysed the effect of partially purified (5%) Vmw175 on gD transcription in vitro. The addition of Vmw175 to HeLa cell nuclear extracts stimulated transcription of the gD gene. Pre-incubation of the Vmw175 preparation with anti-Vmw175 antibody impaired its ability to stimulate transcription (Beard *et al.*, 1986). If the binding of Vmw175/protein to the gD promoter is significant (Faber and Wilcox, 1986; Beard *et al.*, 1986), then Vmw175-mediated transcriptional activation would seem to involve its direct presence in the transcription complex on promoter DNA.

#### f. The paradox of Vmw175 mutants and transdominance

The fact that both Vmw110 and Vmw175 can separately trans-activate E genes (O'Hare and Hayward, 1985a,b; Quinlan and Knipe, 1985; Gelman and Silverstein, 1985, 1986; Everett, 1986) raises a paradox, namely, why can ts mutants be isolated in IE gene 3, if not in IE gene 1? It is also surprising that no tk activity is observed in cells infected with tsK at NPT (Preston, 1979a), given the ability of Vmw110 to activate tk expression on its own or with Vmw175 in transient assays.

DeLuca *et al.* (1985) observed that Vmw175-producing cell-lines poorly complemented an HSV-1 ts mutant of Vmw175,

whereas the deletion mutants, dl20 and d202, grew reasonably well in these cells. Interestingly, these deletion mutants exhibit IE profiles in non-producer cells, indicating that Vmw110 by itself was not able to stimulate E gene expression. The detectable levels of truncated Vmw175 expressed by dl20 and d202 (DeLuca *et al.*, 1985), could conceivably act to inhibit Vmw110-mediated trans-activation, but allow complementation by wt Vmw175. However, as stated above (part 3(iii)), it would be very surprising if the mostly deleted gene product of mutant dl20 retained any function, thus casting doubt on the possibility that mutant forms of Vmw175 are transdominant over Vmw110.

Gelman and Silverstein (1986) have investigated the transdominance of tsK over wt HSV-1 in co-infection studies. Increasing the ratio of tsK to wt virus, or prior infection with tsK, caused a reduction in the accumulation of tk RNA. A tsK to wt ratio of 1:1 had a barely noticeable effect on tk RNA levels, but increasing the ratio to 100:1 caused a significant reduction. These results indicate that the tsK form of Vmw175 is transdominant over the wild-type product. Interestingly, transdominance has also been reported for another mutant viral trans-acting regulatory protein, the tat (or x) protein of HTLV-II (Wachsman *et al.*, 1987).

The absolute requirement for functional Vmw175 in the viral situation (compared to the dispensibility of Vmw110), and the transdominance of some mutant forms of Vmw175 over the wild-type product may be due to a number of possibilities: (i) Some mutant forms of Vmw175 may retain the ability to negatively regulate IE gene expression, thus masking the potential effects of Vmw110 or wt-Vmw175 on E gene transcription. (ii) Mutant forms of Vmw175 may interfere stochastically with functional Vmw175, particularly if Vmw175 acts in a dimer as suggested by Metzler and Wilcox (1985). The trans-acting function of Vmw110 may be blocked similarly, if Vmw175 and Vmw110 normally act as a complex. (iii) There may be competition between mutant and wild-type forms of Vmw175 for cellular transcription factors or promoter DNA binding sites; this too could interfere with the ability of Vmw110 to activate transcription. (iv)

Vmw175 has been shown to affect the nuclear distribution of Vmw110 (Gelman and Silverstein, 1986; Knipe and Smith, 1986). However, it is also possible that Vmw175 has an essential function(s), possibly in the activation of EL and L gene expression, that Vmw110 does not possess, or that in the complete absence of Vmw175, the trans-activating function of Vmw110 might simply not be strong enough to initiate infection, particularly in the presence of negative regulatory functions such as MDBP (Godowski and Knipe, 1986). Obviously, the paradox of Vmw175 mutants is not solved.

##### 5. Non-IE Gene Functions Involved in Transcriptional Regulation

The products of two HSV-1 non-IE genes are known to affect viral transcription. These are Vmw65, as discussed in part 2(c), and the product of an E gene which encodes the major DNA binding protein (MDBP, or ICP8), which is briefly discussed here.

The role of MDBP in the control of HSV transcription, as distinct from its requirement for DNA replication (see Section B(2b)), has been studied mainly by D.Knipe and colleagues. Defects in MDBP result in the increased accumulation of RNAs from all temporal classes of HSV-1 genes (Godowski and Knipe, 1983, 1986). The conditional-lethal mutant, ts18, has a temperature-sensitive lesion in MDBP, and is defective for DNA replication at NPT (Lee and Knipe, 1983). Infection with ts18 had an unexpected effect on the expression of an L gene (gC) at NPT: In the presence of PAA, ts18 accumulated significantly more gC RNA than wt virus, in the absence of detectable DNA replication (Godowski and Knipe, 1985). By use of nuclear run-on assays, Godowski and Knipe (1986) showed that functional MDBP was required for the shut-off of IE gene 3 transcription, and a decrease in the levels of E (- MDBP), EL (- VP5), and L (- gC) transcription in the absence of DNA replication.

The simplest interpretation of these results is that MDBP causes a general repression of HSV gene transcription

in the absence of DNA replication, which may well be mediated through its ability to coat ds DNA in a non-specific manner (Powell et al., 1975). The experiments of Godowski and Knipe (1986) have shown that MDBP directly effects RNA synthesis, but if MDBP is also able to bind RNA it may also have a role in post-transcriptional regulation (Godowski and Knipe, 1985). Another possibility is that since MDBP appears to be required for the negative regulation of IE gene 3, ts18 may overexpress Vmw175 which as a consequence, increases the level<sup>of</sup> trans-activation of other HSV genes. It seems unlikely that MDBP plays a part in the activation of specific genes, but it could be important at the early stages of infection in regulating the level of IE transcription, in addition to its role in DNA replication.

## 6. Late Gene Expression

### a. Gene expression and DNA replication

Late gene products can be first detected by 2-3h p.a. and reach maximum levels of accumulation by 10-16h. HSV-1 DNA synthesis is initiated by about 2h p.a., and peaks around 8h (Munk and Sauer, 1964; Roizman, 1969; Wilkie, 1973). A reduction in both the 'genetic-complexity' of viral RNA, and the number of virus-induced polypeptides, is seen under conditions of DNA synthesis inhibition using chemical inhibitors or ts (DNA<sup>-</sup>) mutant virus stocks (Swanstrom and Wagner, 1974; Honess and Roizman, 1974; Powell et al., 1975; Marsden et al., 1976; Jones and Roizman, 1979; Holland et al., 1980; Conley et al., 1981; Pederson et al., 1981). The limited sensitivity of the RNA and protein detection techniques available at the time of these studies did not allow a firm conclusion to be reached regarding the absolute role of DNA replication in late gene expression. Also, it was not possible to conclude that absolutely no DNA replication had taken place under conditions of DNA synthesis inhibition or with ts-DNA<sup>-</sup> mutants at NPT. However, it did emerge that there are two classes of HSV genes whose expression is curtailed when DNA

synthesis is inhibited: (i) Early-late genes (EL - see part 4), whose expression is reduced but still readily detectable, and (ii) Late (L) genes (or 'true-late',  $\gamma$ ,  $\gamma_2$ ), whose expression either does not take place or is hard to detect (Wagner, 1985; Roizman and Batterson, 1985).

In the presence of phosphonoacetic acid (PAA), which inhibits the HSV-1 DNA polymerase (Hay *et al.*, 1977), the synthesis and accumulation of IE and E RNAs is unaffected at early times. At late times, the presence of PAA prevents a large increase in the amount of transcription of both coding and non-coding DNA strands of HSV-1 genes belonging to all temporal classes (Godowski and Knipe, 1986; Yager and Bachenheimer, 1987), a phenomenon known as 'symmetric transcription' (Jaquemont and Roizman, 1975; Kozak and Roizman, 1974; Stringer *et al.*, 1977). The accumulation of heterogeneously sized transcripts in the nucleus which are not transported into the cytoplasm (Clements *et al.*, 1977), may be a consequence of symmetric transcription.

#### b. What are late genes?

The ability of IE genes to be transcribed in the absence of de novo protein synthesis, the stimulation of their transcription by a component of the virus particle, and the presence of a far-upstream region including the consensus sequence TAATGARAT, are criteria which clearly and unambiguously define an IE gene. Fully efficient regulated activity of E and EL genes (which have not been distinguished at a molecular level) requires a proximal TATA box homology and a distal upstream region. Cellular transcription factors have been shown to specifically bind to the functional elements of an E promoter (McKnight and Tjian, 1986), but additionally require IE proteins (or other means) to effect promoter activation.

At the outset of the work conducted for this thesis, very little was known about the control of L gene expression. The requirement of DNA replication for efficient late gene expression has been discussed above, and the involvement of MDBP has been considered in part 5. However, it is not known why some HSV genes require DNA replication



for their efficient expression, or if DNA replication is absolutely essential for L gene activation. If it is simply the case of increasing the copy number of a weak promoter, why is the expression from E promoters not increased similarly? It could be that replication causes a structural change to the DNA template, either lasting or transient, which provides a switch for L gene expression. Or perhaps part of the replication machinery is needed in situ to initiate L gene transcription. In order to improve our understanding of late gene regulation, an investigation into the control of expression of a particular L gene of HSV-1 was undertaken.

### c. Gene US11

The gene chosen for study was US11 (McGeoch et al., 1985), which lies in the U<sub>S</sub> sequence of the HSV-1 genome and encodes a protein of 161 amino acids with a predicted M.Wt. 17756 (McGeoch et al., 1985), and has an apparent M.Wt. on SDS-polyacrylamide gels of 21000 (21K) (Rixon and McGeoch, 1984). This late gene was an attractive candidate for an investigation of late promoter regulation since (i) the sequence of US11 and its upstream region had been determined (Murchie and McGeoch, 1982), (ii) the position the 5' end of its RNA had been approximately mapped (Rixon and McGeoch, 1984) and (iii) a protein of this apparent M.Wt. has been preliminarily classified as one of the latest viral proteins to appear during lytic infection and subsequently to accumulate in large amounts (Marsden et al., 1976)

A 21K polypeptide has been shown to bind DNA, and appears to interact specifically with the a sequence of HSV-1 (Dalziel and Marsden, 1984). It is possible that this 21K polypeptide is the product of US11, which is also a DNA binding protein (MacLean et al., 1987). The predicted product of US11 has a very unusual amino acid composition. The carboxy-terminal portion of the protein contains 24 tandem repeats of the sequence 'X-Pro-Arg', where 'X' may be any one of nine amino acids (Rixon and McGeoch, 1984). The high arginine content renders this a highly basic protein, consistent with it being a DNA-binding protein. However, it

is unlikely that the product of US11 plays an important role in the lytic cycle of HSV-1, or more specifically, in DNA maturation, since (i) this protein localizes to the cytoplasm and nucleolus, neither of which during HSV-1 infection contain unpackaged viral DNA (MacLean et al., 1987), and (ii) HSV mutants have been isolated which lack gene US11, which shows that this gene is dispensable, at least in tissue culture (Longnecker and Roizman, 1986; Umene, 1986; Brown and Harland, 1987). This does not mean to say that the product of gene US11 is not useful to HSV in some situations, and it would be of interest to discover its role.

The aims of the work described in this thesis were (i) to carry out a thorough analysis of the time-course of appearance and dependence on DNA replication of the RNA and protein products of US11 during a normal viral infection, (ii) to develop a plasmid based system to study the regulation of the US11 promoter, and (iii) to determine the characteristics of a late promoter that distinguish it from those of IE and E classes.

MATERIALS AND METHODSSECTION F: MATERIALS1. Viruses

HSV-1 Glasgow strain 17 syn<sup>+</sup> (Brown et al., 1973) was used in most studies. PAA<sup>r</sup>-1, a PAA-resistant mutant of HSV-1 17 syn<sup>+</sup> (Hay and Subak-Sharpe, 1976), was used for a control in one experiment.

2. Cells

- (i) BHK21 clone 13 (MacPherson and Stoker, 1962), a fibroblastic cell line derived from baby hamster kidney cells, was used for growth of virus and study of viral gene expression.
- (ii) HeLa cells (obtained from Dr.W.Schaffner, Zurich) were mainly used for transient assays.
- (iii) COS-1 cells (obtained from Dr.R.M.Elliot), which express SV40 T antigen, were used in one transfection experiment.

3. Bacteria

The following strains of E.coli K12 were used:

- (i) C600 (F<sup>-</sup>, thi-1, thr-1, leu-6, tonA21, supE44, λ<sup>-</sup>; Appleyard, 1954), and HB101 (ramC1, F<sup>-</sup>, proA2, galK2, strA, recA; Boyer and Roulland-Dussoix, 1969), were used as hosts for pBR322-based vectors and pUC-CAT gene constructs.
- (ii) JM83 (ara, lac-pro<sup>del</sup>, strA, thi, ø80dlacM15<sup>del</sup>), was used as a host for cloning in a pUC9 vector.
- (iii) JM101 (lac-pro<sup>del</sup>, supE, thi, F'traD36, proAB, lacI<sup>q</sup>, ZM15<sup>del</sup>; Messing et al., 1981), was the host strain used for M13 bacteriophage vectors; it harbours an F factor essential for the transmittance of the male specific phage.
- (iv) GM48 (dam-6, dam-3, galT22, dral4, lacY1, thr-1, leu-6, tonA31, tsxA78, supE44; Marinus, 1973), was used as a host to prepare unmethylated plasmid DNA.

#### 4. Cloning Vectors

- (i) Most of the constructs made during this work used pRE3 (Moreau et al., 1981) as the vector. This plasmid was derived from pBR322 (Bolivar, 1977), and has a mutation in the BamHI site but retains resistance to tetracycline.
- (ii) pUC9 (Vieira and Messing, 1982) was used for sub-cloning fragments for nuclear run-on experiments.
- (iii) M13 bacteriophage vectors (Messing and Vieira, 1982) were used for the production of single-stranded DNA to assay for strand-specific RNA in nuclear run-on experiments. Cloned HSV-1 fragments were sub-cloned into the double-stranded replicative forms (RFs) of M13mpl8 and M13mpl9 (obtained from J.Scott).

#### 5. Plasmids

The following plasmids (generously provided by the person indicated) were either used directly, or for the generation of further constructs:

- (i) pGX57, pGX48, pGX156 (Dr.F.Rixon).
- (ii) pDG8 (Dr.D.Gaffney).
- (iii) pRED4, pRED5, pRED122, pERD130/33, pERD130/83, pOR33, pOR83, pDER8, pDER10, pgDCAT, pSCAT, p63, p63dell, pSV63, pl11, pl75, p $\beta$ (244+) $\beta$  (Dr.R.D.Everett).

The structures of these plasmids are given in the relevant places in the text.

#### 6. Reagents

Most chemicals were purchased from BDH Chemicals UK or Sigma Chemical Co., and were of analytical grade. Otherwise, Bio-Rad Laboratories supplied ammonium persulphate and TEMED, Koch-Light Laboratories supplied caesium chloride, sodium hydroxide and boric acid; Camlab (Cambridge) supplied TLC plates (0.25mm silica gel); Schleicher and Schuell supplied nitrocellulose paper; P-L Biochemicals Inc. supplied unlabelled nucleotides; and New England Biolabs

supplied synthetic oligonucleotide linkers and M13 dideoxy sequencing primer.

## 7. Radiochemicals

Radioisotopes were obtained from Amersham International plc, at the following specific activities:

5' [ $\alpha$ - $^{32}\text{P}$ ]dNTPs; 3000 Ci (110 TBq)/mmol

5' [ $\gamma$ - $^{32}\text{P}$ ] ATP; 5000 Ci (185 TBq)/mmol

5' [ $\alpha$ - $^{32}\text{P}$ ] UTP; 410 Ci (15.2 TBq)/mmol

$^{14}\text{C}$  Chloramphenicol (Sp. activity 45.5 Ci (1.7 TBq)/mmol) was obtained from NEN Research Products, Boston (Mass.).

## 8. Enzymes

Restriction enzymes were obtained from Bethesda Research Laboratories (BRL), New England Biolabs, or Nbl Enzymes Ltd. S1 nuclease, proteinase K, Klenow polymerase and T4 DNA ligase were from Boehringer Mannheim Corporation. BRL also supplied S1 nuclease, and Bal 31 exonuclease. Bovine alkaline phosphatase (BAP) was obtained from Worthington and purified by M. Dunlop. Lysozyme was obtained from Sigma.

## 9. Tissue Culture Media

- (i) BHK cells were grown in Glasgow Modified Eagle's Medium (Busby *et al.*, 1964) supplemented with 100 units/ml penicillin, 100ug/ml streptomycin, 0.2ug/ml amphotericin, 0.002% phenol red, 10% tryptose phosphate, and 10% calf serum (= ETC10).
- (ii) HeLa cells were grown in Dulbecco's medium (Flow) supplemented with 20mM glutamine, 100 units/ml penicillin, 100ug/ml streptomycin, 0.2ug/ml amphotericin, 2.5% foetal calf serum and 2.5% calf serum.
- (iii) COS-1 cells were grown in ECT10 medium, additionally supplemented with 0.01% non-essential amino acids (Gibco) and 0.01% sodium pyruvate (Gibco), and 10% foetal calf serum in place of calf serum.

Versene (0.6mM EDTA in PBS, 0.002% (w/v) phenol red) and trypsin (0.25% (w/v) (Difco) in tris-saline) were used for the washing and removal of cell monolayers during passaging or setting up sub-confluent monolayers for infections or transfections.

- PBS: 170mM NaCl, 3.4 mM KCl, 10mM Na<sub>2</sub>HPO<sub>4</sub>, 2mM KH<sub>2</sub>PO<sub>4</sub> (pH7.2).
- Tris-saline: 140mM NaCl, 30mM KCl, 280mM Na<sub>2</sub>HPO<sub>4</sub>, 1mg/ml glucose, 0.0015% (w/v) phenol red, 25mM Tris.HCl (pH7.4), 100 units/ml penicillin, 100ug/ml streptomycin.

## 10. Bacterial Culture Media

All strains of bacteria were grown in L-broth, except for JM101 which was grown in 2YT broth. Agar plates contained 1.5% (w/v) agar in L-broth. Where appropriate, media was supplemented with ampicillin (100ug/ml), tetracycline (15ug/ml), or chloramphenicol (100ug/ml). JM101 was plated on L-broth agar which had been surface-treated prior to use with 25ul of 5-bromo-4-chloro-3-indoxyl- $\beta$ -D-galactoside (BCIG) (25mg/ml in dimethylformamide) and 25ul of isopropyl-D-thiogalactoside (IPTG) (25mg/ml in H<sub>2</sub>O), in order to colour-test for the insertion of DNA into the multiple cloning site (mcs) of M13mp phage vectors.

- L-broth: 177mM NaCl, 10g/l Difco Bactotrytone, 5g/l yeast extract (pH7.5 pre-sterilization).
- 2YT broth: 85mM NaCl, 16g/l Difco Bactopectone, 10g/l yeast extract (pH7.5 pre-sterilization).

## 11. Solutions

- TE: 10mM Tris.HCl (pH8.0), 1mM EDTA.
- TBE: 90mM Tris, 90mM boric acid, 1mM EDTA (pH8.3).
- SSC: 0.15M NaCl, 0.015M tri-sodium citrate (pH7.5).
- STE: 150mM NaCl, 10mM Tris.HCl (pH7.5), 1mM EDTA.
- STET: 50mM Tris.HCl (pH8.0), 50mM EDTA, 8% (w/v) sucrose, 5% (v/v) Triton X-100.
- TEN: 100mM NaCl, 50mM Tris.HCl (pH7.5), 10mM EDTA.

RNA Lysis Buffer: 10mM NaCl, 10mM Tris.HCl (pH7.8), 2mM MgCl<sub>2</sub>

Sucrose Gradient Solution: 25mM Tris.HCl (pH7.4), 200mM NaCl, 5mM EDTA, 0.1% (v/v) sarkosyl, 5ug/ml EtBr (plus 5 or 20% (w/v) sucrose).

Elution Buffer: 500 mM NH<sub>4</sub>Ac., 10mM MgAc., 0.1% (w/v) SDS, 1mM EDTA.

TE(P) 1mM Tris.HCl (pH7.5), 0.05mM EDTA.

2X HBS 280mM NaCl, 50mM HEPES, 1.5mM Na<sub>2</sub>HPO<sub>4</sub> (NaOH to pH7.12).

Gel Soak I: 200mM NaOH, 600mM NaCl.

Gel Soak II: 1M Tris.HCl (pH8.0), 0.6M NaCl.

50X PAF 1% (w/v) polyvinylpyrrolidone, 1% (w/v) Ficoll, 1% (w/v) BSA.

Loading Buffer: 49% (v/v) 1X TBE, 1% (v/v) 10% SDS, 50% glycerol, 0.1g/100ml bromophenol blue.

Formamide Dyes: 98% (v/v) de-ionised formamide, 2% (v/v) 0.5M EDTA, plus 0.1g/100ml xylene cyanol, 0.1g/100ml bromophenol blue.

10X BRL CORE Buffer: 500mM Tris.HCl (pH8.0), 100mM MgCl<sub>2</sub>, 500mM NaCl.

5X Pst: 30mM Tris.HCl (pH7.8), 30mM MgCl<sub>2</sub>, 250mM NaCl, 30mM B-mercaptoethanol.

10X DpnI: 60mM Tris.HCl (pH8.3), 1.5M NaCl, 6mM MgCl<sub>2</sub>, 7mM B-mercaptoethanol.

5X Bal31: 20mM Tris.HCl (pH8.0), 200mM NaCl, 12mM MgCl<sub>2</sub>, 12mM CaCl<sub>2</sub>, 1mM EDTA.

5X Ligase Buffer: 250mM Tris.HCl (pH7.5), 50mM MgCl<sub>2</sub>, 50ug/ml BSA, 100mM DTT.

10X NT: 0.5M Tris.HCL (pH7.5), 100mM MgCl<sub>2</sub>, 100mM DTT, 500ug/ml BSA.

5X Kinase Buffer: 350mM Tris.HCl (pH7.5), 50mM MgCl<sub>2</sub>, 25mM DTT.

5X S1: 150mM NaAc. (pH4.5), 15mM ZnSO<sub>4</sub>, 2M NaCl.

10X PIPES: 400mM PIPES (pH6.5), 10mM EDTA.

S1 Stop: 0.5M Tris.HCl (pH8.0), 100mM EDTA.

PK Buffer: 15mM Tris.HCl (pH8.0), 1mM CaCl (plus proteinase K @ 10mg/ml).

SECTION G: METHODS1. Tissue Cell Culture

Cells were usually passaged in 175cm<sup>2</sup> (Nunclon) flasks, and kept in an atmosphere of 95% air, 5% CO<sub>2</sub> at 37°C. For storage, cells were harvested, pelleted (at 1500 rpm), and resuspended at approximately 10<sup>7</sup> cells/ml in storage medium (15% foetal calf serum, 10% DMSO, 75% growth medium). Aliquoted cells were frozen slowly to -140°C. For recovery, cells were thawed quickly and resuspended in growth medium.

2. Virus Preparation

BHK cells in 80oz roller bottles were infected with HSV-1 at an moi of 0.003 pfu/cell (10<sup>6</sup> virus per bottle) in 40ml ETC10. Virus-infected cells were incubated at 31°C for 3-4 days until extensive cytopathic effect (CPE) had developed. Cells were removed by shaking into the medium, and pelleted (MSE Coolspin, 1500 rpm/ 10min/ 4°C). Supernatant medium was further centrifuged (Sorvall SS34 rotor, 12K rpm/ 2h/ 4°C) to concentrate cell-released virus (CRV), which was sonicated and stored at -70°C. The pelleted material from the low-speed centrifugation was sonicated in a small volume of ETC10 for recovery of cell-associated virus (CAV). Cell debris was removed by further low-speed centrifugation, and sonicated and centrifuged again if necessary. Supernatant containing CAV was stored at -70°C.

The CRV and CAV fractions were checked for sterility (on blood agar plates) and titrated on BHK cell monolayers in the presence of human serum, as described by Brown et al. (1973).

3. Large Scale Plasmid Preparation

An "overnight" incubation of a bacterial colony (containing the desired plasmid) in 3ml L-broth was transferred to 800ml L-broth in a 2l shaking flask. Bacteria were grown shaking at 37°C until an OD<sub>650</sub> of about 0.8 had been reached. Chloramphenicol was then added (final concentration 100ug/ml), and the culture was shaken



overnight to amplify plasmid DNA.

Plasmid DNA was prepared by the "maxi-boiling" method (Holmes and Quigley, 1981). Bacteria were pelleted (Sorvall GS3 rotor, 10K rpm/ 6min/ RT) and resuspended in 34ml STET, followed by the addition of 4ml of freshly prepared lysozyme (10mg/ml). The suspension was brought to 100°C for 45sec and the lysate cleared by high speed centrifugation (Sorvall SS34 rotor, 20K rpm/ 45min/ 15°C). DNA in the supernatant was precipitated with 0.9vol isopropanol and pelleted (MSE coolspin 3K rpm/ 4min/ RT). The pellet was resuspended in TE followed by the addition of CsCl to a final density of 1.6g/ml and EtBr to 0.5mg/ml. DNA was banded by ultracentrifugation either in a Ti50 angle rotor (45K rpm/ 2-3 days/ 15°C) or in a TV865 vertical rotor (40K rpm/ 16-20h/ 15°C). The DNA was visualized in daylight or long wave uv light, and collected by side-puncture with a syringe. First, the upper band (chromosomal DNA) was removed and discarded; the lower band (supercoiled plasmid DNA) was then collected, extracted twice with butan-1-ol (saturated with TE) to remove EtBr, and dialysed for 3h against TE. The dialysed DNA was then treated with 50ug/ml RNAase A (1h/ 65°C), and then with 50ug/ml proteinase K plus 0.1% (w/v) SDS (1h/ 37°C). Enzymes were removed by extraction with phenol and then chloroform and the DNA was precipitated twice with ethanol. Lyophilized DNA was resuspended in TE, the volume being adjusted to reach a final concentration of 1ug/ul estimated by spectrophotometry (Abs<sub>260</sub> 1.0 = 50ug DNA/ml).

#### 4. Small Scale Plasmid DNA Preparation ("Miniprep")

Tubes containing 3ml of L-broth were inoculated with single plasmid-transformed bacterial colonies and incubated shaking at 37°C overnight. Up to 24 samples were then processed simultaneously. Half the bacterial suspension was poured into a 1.5ml reaction vial and centrifuged for 15sec in a benchtop microfuge (<12K rpm). The remaining culture was kept at RT until its future requirement had been determined. The bacterial pellet was resuspended in 200ul STET and 5ul lysozyme (10mg/ml), placed in a boiling water bath for 45sec, and centrifuged (12K rpm) for 10min. The

glutinous pellet was discarded, and 0.9vol isopropanol added to the supernatant. The precipitated nucleic acids were pelleted (12K rpm/ 5min), washed in 70% ethanol and lyophilized. Finally, the pellet was resuspended in 20ul 3mM EGTA and stored at 4°C. The addition of 0.2ul RNAase (1mg/ml) to each restriction digest of miniprep DNA helped to visualize bands following gel electrophoresis.

#### 5. Preparation of Single-Stranded M13 Phage-Vector DNA

1.5ml of a 1:100 dilution of "overnight" JM101 bacteria in 2YT broth was inoculated with M13 phage from a plaque. Phage and bacteria were grown shaking at 37°C for 5-6h. The bacteria were then pelleted and the supernatant containing the phage was carefully transferred to a new 1.5ml vial. Phage were precipitated by the addition of 150ul 20% (w/v) polyethylene-glycol 6000 (BDH), 2.5mMNaCl, and pelleted. The pellet was resuspended in 100ul TE buffer, then extracted with phenol, and precipitated with ethanol. The DNA was then lyophilized, and resuspended in 30ul TE buffer. Its concentration was determined by spectrophotometry. For large scale preparations of M13 DNA, this method was scaled up by 10-fold, and yielded approximately 0.5mg DNA.

#### 6. Preparation of Cytoplasmic RNA

Cytoplasmic RNA was prepared from tissue culture cells grown on 90mm Petri dishes. All solutions and vessels up until the phenol/chloroform extraction steps were cooled on ice. Cells were washed and harvested in STE, then pelleted (MSE Coolspin, 2K rpm/ 30sec/ 4°C), washed in STE again, and re-pelleted. Following resuspension in lysis buffer plus 1% (v/v) NP40, and a 2min incubation on ice, nuclei and cytoplasmic fractions were separated by centrifugation (MSE Coolspin, 3K rpm/ 3min/ 4°C). The supernatant was added to an equal volume of STE containing 2.5% (w/v) SDS, and extracted three times with phenol/chloroform, and once with chloroform. RNA was twice precipitated with ethanol, washed (70% ethanol), lyophilized, and resuspended in 20ul H<sub>2</sub>O. The concentration of RNA was determined by spectrophotometry (Abs<sub>260</sub> 1.0 = 40ug RNA/ml).

## 7. Preparation of Nuclear DNA

The cell-nuclei pellet from NP40-lysed cells (as above) was resuspended in SSC containing 0.6% (w/v) SDS, and treated with proteinase K (at 100ug/ml) for 3h at 37°C. Nucleic acid was extracted with phenol and chloroform, precipitated with ethanol, and resuspended in SSC prior to treatment with RNAase (at 50ug/ml) for 2h at 37°C. DNA was again phenol and chloroform extracted, and precipitated in ethanol. Lyophilized DNA was resuspended in 50ul TE, and its concentration determined by spectrophotometry.

## 8. Restriction Enzyme Digests

Restriction digests for diagnostic purposes were usually carried out in 15ul volumes of 1X Pst buffer using 0.5ug plasmid DNA and 1 unit of enzyme for 1h at 37°C, unless the reaction conditions specified by the enzyme supplier differed radically. Notably, SmaI digests were carried out in 20mM KCl in place of NaCl; SalI digests required high salt (150mM NaCl) conditions; and TaqI and BstNI worked best at high temperature (65°C). For cloning and preparation of probe DNA, the incubation time and enzyme units were increased according to the amount of DNA to be cleaved, and the importance of achieving complete digestion. DNA fragments greater than 200bp were analysed on agarose gels with concentrations varying from 0.7 - 2.5% (w/v). DNA fragments of less than 500bp were analysed on non-denaturing 5 - 8% (w/v) polyacrylamide gels, using 2ug of DNA per digest. Larger quantities of DNA (5-50ug) were sometimes fractionated by sucrose density gradient centrifugation.

## 9. Separation and Preparation of Purified DNA

### Restriction Fragments

(i) Non-denaturing agarose gels:

Slab gels of 0.7 - 2.5% (w/v) agarose in 1X TBE were run submerged in 1X TBE at up to 12V/cm. Samples were loaded in 0.1vol loading buffer. Following gel electrophoresis, DNA was visualized by staining in EtBr (1ug/ml) prior to examination under in short-wave or long-wave uv light.

Short-wave uv light is more sensitive but damages the DNA. Long-wave uv light was used if DNA was to be recovered. To obtain a purified restriction fragment from a gel, a strip of DE-81 paper (previously treated with 2.5M NaCl, washed, and stored at 4°C in 1mM EDTA) was inserted below the required band and electrophoresis continued until the fragment had been adsorbed to the paper. The DNA was eluted from the DE-81 paper by pulverization and agitation (2h at 37°C) in 1.5M NaCl, 10mM Tris.HCl (pH8.0), 1mM EDTA, and then strained through siliconized glass wool prior to ethanol precipitation.

(ii) Non-denaturing polyacrylamide gels

Polyacrylamide gels were prepared in a vertical gel sandwich (0.35mm or 1mm thickness) using 5 or 8% (w/v) acrylamide: bis-acrylamide (19:1), diluted from a 20% stock solution, in 1X TBE. For 0.35mm gel sandwiches, the acrylamide solution was filtered (0.45µm millipore filter) and de-gassed before the addition of catalysts. Polymerization was catalysed by mixing in 0.1vol 10% (w/v) ammonium persulphate and 0.01vol TEMED, before pouring the solution between the cleaned glass plates and inserting a gel comb. Samples were loaded as above, electrophoresed at a maximum voltage of 16V/cm, and the DNA visualized by EtBr staining or autoradiography. On occasion, DNA was recovered from a polyacrylamide gel slice by extrusion through a pierced 0.7ml reaction vial by centrifugation (12K rpm/20sec) into a 1.5ml reaction vial. The DNA was eluted by shaking overnight in 1ml elution buffer at 37°C, filtering the slurry through glass wool and then precipitation (twice) with ethanol in the presence, if necessary, of carrier tRNA (Sigma).

(iii) Strand-separation polyacrylamide gels

A 30% (w/v) stock solution of acrylamide/bis-acrylamide (59:1) was diluted to 8% in 1X TBE, polymerized as above, and poured into a sequencing gel sandwich (230mm x 450mm x 0.35mm). The gel was pre-run at 400V in the cold for 30min. Ethanol-precipitated end-labelled DNA fragments were

resuspended in 2vols 1X TBE plus 1vol DMSO, heated at 90°C for 2min and rapidly cooled prior to loading, then electrophoresed in the cold at 400V overnight. Single stranded DNA bands, visualized by autoradiography, were cut out and eluted directly into elution buffer, as above (ii).

(iv) Denaturing polyacrylamide gels

This type of gel was used to analyse the products of S1 mapping and DNA sequencing reactions (Maxam and Gilbert, 1980). Gels were prepared to a final concentration of 8% acylamide/bis-acrylamide (19:1), 1X TBE, and 7M urea. This solution was filtered, de-gassed and polymerized as described above (ii), and pre-run for 30min at 40W. Lyophilized samples were resuspended in 5 to 10ul formamide dyes mix, denatured at 90°C for 2min, and run at 40W for an appropriate length of time (usually 2-5h). Radiolabelled DNA was detected by autoradiography.

(v) Sucrose gradients

5-20% (w/v) sucrose gradients were poured into polyallomer tubes using a peristaltic pump linked to a mixing chamber. Between 10 to 50ug of DNA in 100ul TE was carefully applied to the top of the gradient. The samples were placed in a swing-out rotor (Sorvall AH650), and centrifuged according to the sizes of the fragments being separated (30-40K rpm/ 3-20h/ 15°C). Bands, visualized by long-wave uv light, were removed by side puncture, and purified by phenol/chloroform extraction and ethanol precipitation. Lyophilized DNA was taken up in 20ul H<sub>2</sub>O.

## 10. Radioactive Labelling of DNA

(i) 5'-end labelling

To prepare a 5'-end labelled probe for S1 nuclease mapping, plasmid DNA was restricted with appropriate enzymes and treated with bacterial alkaline phosphatase (BAP) to remove 5'-terminal phosphate groups. The BAP was removed by phenol/chloroform extraction (3 times) and DNA was then ethanol precipitated. Lyophilized DNA was then taken up in

H<sub>2</sub>O at a concentration of about 1pmol/ul, and stored at -20°C. 1pmol of DNA (sufficient for about 50 S1 nuclease reactions) was added to 100uCi of 5' [ $\gamma$ -<sup>32</sup>P] ATP in 15ul final volume of 1X kinase buffer, and treated with 5 units of T4 polynucleotide kinase for 45min at 37°C.

Unincorporated radio-nucleotides were removed by ethanol precipitation in the presence of carrier tRNA, and a 70% (v/v) ethanol wash. The pellet was lyophilized, and the labelled DNA strands fractionated and strand separated as described above (part 9(ii)).

#### (ii) Nick translation

100ug of DNA was radiolabelled (Rigby et al., 1977) by the addition of 5uCi each of all four 5' [ $\alpha$ -<sup>32</sup>P]dNTPs, 1 unit of E.coli DNA pol I, and 0.1ug/ml DNAaseI, in a final volume of 12.5ul 1X NT buffer. The reaction was incubated at RT for 2h, and stopped by mixing with an excess of 1% (w/v) SDS in TE (with bromophenol-blue). Unincorporated radioactivity was removed by fractionation on a G50 Sephadex column, equilibrated with 0.1% SDS in TE. The fastest running peak of radioactivity (ahead of the dye) contained the <sup>32</sup>P-DNA.

### 11. Quantitation of Autoradiographs

Where appropriate, the amount of radioactive product was quantified by densitometry of autoradiographs using a Joyce-Loebl scanning densitometer. The areas under the peaks of the densitometer tracing were measured using a programme, DENS, written by Dr. P.Taylor for a DEC PDP 11/44 computer linked to a digitizing tablet. The response to Kodak XSl film was found to be linear over the optical density range of the peaks analysed.

### 12. Ligations

DNA-DNA ligations were performed in 10-20ul 1X ligase buffer, containing 0.5mM ATP, 1-2 units of T4 DNA ligase, and 50-500ug DNA. The amount of DNA and ligase used depended on the expected difficulty of the ligation reaction (e.g. blunt-ended vs sticky-ended), and the competence of the bacteria to be transformed with the ligation mix.

For blunt-end ligations, restricted or exonuclease treated DNA was incubated with Klenow DNA polymerase and all four dNTPs (0.05mM each), in order to fill-in an underhanging 5' end or trim back an overhanging 3'-end, where necessary.

A 10-fold molar excess of a DNA fragment, or a 20 to 50-fold molar excess of a linker, was used to improve the efficiency of simple insertions into a linearized vector. Prior treatment of the vector with BAP also helped to increase the proportion of colonies with vectors containing insertions.

### 13. Bal 31 Exonuclease Digestion

20ug of linearized plasmid DNA was treated with 1 unit of the processive double-stranded exonuclease, Bal 31, in 1X Bal 31 buffer at 31°C for various lengths of time (0.5-10min). Exonuclease activity was stopped by quenching with an excess of 20mM EGTA/phenol (1:1). The extent of nuclease activity was determined by running samples from each time point on an agarose gel after cutting with a suitable restriction enzyme.

### 14. Preparation of Competent Bacteria

#### (i) For plasmid transformations

An overnight culture of bacteria was diluted into 100ml L-broth, and aerated vigorously until an OD<sub>650</sub> of 0.3 had been reached. The bacteria were then chilled on ice for 10min, and pelleted (Sorvall GSA rotor 6K rpm/ 10min/ 4°C). The pellet was resuspended and left in 40ml ice-cold 0.1M CaCl<sub>2</sub> for 20 min. The bacteria were then re-pelleted, resuspended in 2ml 0.1M CaCl<sub>2</sub>, and left on ice overnight. 0.2vol sterile glycerol was mixed in with the competent bacteria, which were then rapidly frozen in 100-200ul aliquots and stored at -70°C.

#### (ii) For M13 transfections

For transfection by M13 vector DNA (replicative form - RF), 0.2ml of a JM101 "overnight" culture was diluted into

20ml 2YT broth and grown shaking for 2h (or until  $OD_{650}=0.3$ ). The cells were pelleted at 4°C and resuspended in 10ml ice-cold CT (50mM  $CaCl_2$ , 10mM Tris.HCl (pH7.5)). After leaving on ice for 20min, the cells were pelleted again, then taken up in 2ml ice-cold CT, and used within 48h.

## 15. Transformation and Transfection of E.coli

### (i) Transformation by plasmid DNA

1-10ul plasmid DNA solution was added to 100-200ul competent bacteria, and left on ice for about 20min. The bacteria were heat-shocked in a water-bath at 37°C for 1min, and then incubated for 30min after the addition of 500ul of pre-warmed L-broth. The bacteria were then spread onto L-broth agar plates containing appropriate antibiotics, and incubated overnight at 37°C.

### (ii) Transfection by M13 phage vector

A colour test can help predict the successful insertion of DNA into the multiple cloning site (mcs) of M13 RF DNA. The mcs lies in a truncated  $\beta$ -galactosidase ( $\beta$ -gal) gene, whose encoded peptide complements the enzymatically inactive product of the lacZ M15<sup>del</sup> mutation in JM101. Thus, in the presence of the lacZ transcriptional inducer, IPTG, and the hydrolyzable substrate BCIG (or Xgal), activity of the M13 encoded peptide can be assessed by the appearance of blue plaques when plated on a lawn of JM101; the blue colour being due to the product of BCIG cleavage by  $\beta$ -gal. A "white" plaque potentially contains a phage with a fragment inserted into the mcs, which has disrupted the coding sequences of the M13 portion of the  $\beta$ -gal gene.

20ng of RF vector/ligation mix was added to 100ul of competent JM101 and left on ice for 40min. The cells were then heat-shocked at 42°C for 5min, and added to 3ml molten top-agar containing 25ul BCIG (25mg/ml in dimethylformamide), 25ul IPTG (25mg/ml in H<sub>2</sub>O), and 20ul of an "overnight" JM101 culture. The mixture was poured onto L-broth plates which were then incubated overnight at 37°C.



## 16. DNA Sequencing

DNA sequencing by the chemical degradation method was employed to confirm the identity of plasmid constructions and determine deletion end-points. Dideoxynucleotide sequencing was used to analyse M13 DNAs used for the strand specific detection of RNA in nuclear run-on experiments. These methods are outlined below; the detailed procedures are described in the cited papers.

### (i) Chemical method

The nucleotide sequences of 5'-end labelled DNA restriction fragments were determined by the methods of Maxam and Gilbert (1977, 1980). These methods are based on the specific modification of DNA bases followed by their removal and cleavage of the DNA backbone. In outline, the methods are as follows. The purine reaction was conducted by incubating about 0.1 $\mu$ M of DNA in 15 $\mu$ l of depurination (DPU) mix (66% (v/v) formic acid, 1mM EDTA, 2% (w/v) diphenylamine) for 2min at 25°C. The reaction was stopped by ether extraction and lyophilization. Guanine residues alone are modified by dimethylsulphate (DMS). The modification of cytosine residues reaction used hydrazine in the presence of 1.5M NaCl for 2min at 25°C (both C and T are modified in the absence of NaCl). This reaction was stopped by the addition of 0.3M NaCl and 0.1mM EDTA and ethanol precipitation. In order to cleave the DNA at the modified bases, the lyophilized DNAs from the first reaction were resuspended in 100 $\mu$ l of freshly diluted 1M piperidine, and incubated for 30min at 90°C. The cleaved DNAs were then ethanol precipitated and run on denaturing 8% polyacrylamide gels.

### (ii) Dideoxynucleotide method

The M13 dideoxy sequencing method of Sanger et al. (1977, 1980) is based on the "random" termination at specific nucleotides of an elongating radiolabelled nucleotide chain. This is caused by the inclusion of a particular dideoxynucleotide (ddNTP) in a reaction to synthesize, using Klenow polymerase, the complementary DNA

to a single-stranded M13 template from a primer complementary to sequences adjacent to the mcs.

The sequencing primer was annealed to template DNA in 10mM Tris.HCl (pH 8.0), 10mM MgCl<sub>2</sub>. Four reaction tubes were set up for each template; these contained all four dNTPs plus one ddNTP. Annealed template, <sup>32</sup>P-dATP and Klenow enzyme were then added to each reaction tube and incubated for 15min at RT. The reactions were completed by the addition of further dNTPs (0.25mM each) and either stored at -20°C or run immediately on a denaturing polyacrylamide gel.

### 17. S1 Mapping

5-20ug RNA was first denatured with 0.02pmol <sup>32</sup>P end labelled probe DNA in 30ul of 40mM PIPES (pH6.5), 1mM EDTA, 400mM NaCl and 50% (v/v) formamide at 85°C for 5min, then allowed to hybridize at 42°C for 12-16h. Following hybridization, 60ul of 5X S1 nuclease buffer, 210ul H<sub>2</sub>O and 5000 units of S1 nuclease (Boehringer) (or 166 units, BRL) were added and the mixture incubated at 30°C for 3h. Nuclease activity was stopped by the addition of 100ul 0.5M Tris.HCl (pH8.0), 100mM EDTA. Nuclease protected hybrids were extracted with phenol/chloroform, and then ethanol precipitated. Protected hybrids were fractionated on an 8% denaturing polyacrylamide gel, and quantitated by densitometry.

### 18. Transfection of DNA into Tissue Culture Cells

Rapidly dividing cells were seeded at 30 to 40% confluence on 90mm petri dishes 12-24h prior to transfection. TE(P) buffer was added to 10-20ug plasmid DNA to reach a final volume of 420ul. Then, 60ul of 2M CaCl<sub>2</sub> was added dropwise to the DNA-TE(P) whilst vortexing. The DNA-CaCl<sub>2</sub> solution was then added dropwise to tubes containing 480ul 2X HBS, also whilst vortexing. The DNA-CaPO<sub>4</sub> precipitate was allowed to form for 30min at RT, and was then applied dropwise to subconfluent cell monolayers, and swirled into the medium (15ml per 90mm dish). After 24h the cells were washed twice with 3ml

prewarmed medium, and were then usually incubated for another 24h, or infected with virus, prior to harvesting. Note that 50mm plates were used for CAT assays, so the quantity of DNA and volumes of solutions used for transfections were reduced by 3-fold.

#### 19. Southern Transfer

Size fractionated DNA was blotted and immobilized on nitrocellulose membranes essentially by the procedure of Southern (1975). Following electrophoresis, an agarose gel was shaken for 45min in Gel Soak I (to denature the DNA), and then Gel Soak II (to neutralise the NaOH). The gel was placed on a large piece of Whatman 3mm paper (on a glass plate), which served as a wick to allow 10X SSC from a reservoir access to the gel. The gel was then overlaid with a similarly sized sheet of nitrocellulose (pre-treated with H<sub>2</sub>O and 10X SSC), Whatman 3mm paper, and stack of paper towels, all under a 1kg weight. The transfer was left overnight. The following day, the nitrocellulose sheet was washed in 10X SSC, air-dried, and baked in a vacuum oven at 80°C for 2h. Efficient transfer of DNA fragments from the gel was monitored by visualising blotted gels under uv-light.

#### 20. DNA-DNA hybridization

Nitrocellose blots were pre-hybridized in 6X SSC, 5X PAF, 0.1% (w/v) SDS, 20ug/ml denatured calf-thymus DNA, at 65°C. Approximately  $5 \times 10^7$  cpm of probe DNA was hybridized to the blotted DNA in 20mM Tris.HCl (pH7.5), 6X SSC, 10X PAF, 1mM EDTA, 0.5% (w/v) SDS, 50ug/ml denatured calf-thymus DNA, shaking at 65°C overnight. After hybridization, the blot was washed twice in 2X SSC plus 0.25% SDS, at 65°C for 1h, then rinsed in water at RT. The blot was then air-dried and autoradiographed.

## 21. CAT Assays

Chloramphenicol acetyl transferase activity was determined essentially as described (Gorman et al., 1982). Cells from 50mm transfection plates were washed in PBS, scraped into TEN, and resuspended in 75ul 0.25M Tris.HCl (pH7.8). The cells were lysed by sonication, and centrifuged (bench-top centrifuge, 12K rpm/ 2min) to remove debris. The cell extract supernatants were stored at -20°C.

Assay mixtures contained 25ul of supernatant, 1ul 50mM acetyl co-enzyme A, 14ul H<sub>2</sub>O and 0.5ul <sup>14</sup>C chloramphenicol (45uCi/mM), and were incubated at 37°C for 1h. The reaction was stopped by the extracting the chloramphenicol and acetylated products into 200ul ethyl acetate. The ethyl acetate was evaporated under vacuum, and the pellets were then dissolved in a smaller volume (20ul) of ethyl acetate before spotting onto thin layer chromatography (TLC) plates. After running in 95% (v/v) chloroform, 5% (v/v) methanol, plates were air-dried and autoradiographed. The amount of radioactivity in the chloromphenicol and its 3'-monoacetylated product (visualized by autoradiography) was determined by scintillation counting, enabling the percentage conversion of substrate to product to be calculated. The protein concentration of each extract was also determined, by the method of Lowry et al. (1951) as outlined below, in order to calculate the percentage conversion of chloramphenicol per mg of protein in the extract.

Briefly, 20ul of extract in 0.25M Tris.HCl (pH7.8) was diluted with 80ul H<sub>2</sub>O and mixed with 500ul of alkaline copper solution (2% (w/v) Na<sub>2</sub>CO<sub>3</sub> in 0.1M NaOH; 1% (w/v) CuSO<sub>4</sub>.5H<sub>2</sub>O; 2% sodium potassium tartrate; in a 100:1:1 ratio), and left for 10min at RT. Then, 50ul of H<sub>2</sub>O:Folin (3:1, freshly mixed) was added, and after 30min at RT the absorbance of the solution at 750nm was measured. The absorbance values were converted to milligrams of protein by comparison to a standard curve produced by using known quantities of BSA made up in 0.25M Tris.HCl (pH7.8).

## 22. Nuclear Run-On Assays

Run-on transcription in isolated nuclei was used as an assay to estimate the relative number of active RNA polymerase II molecules on a given gene, and thus give a direct indication of the rate of transcription. The method given below was adapted from Greenberg and Ziff (1984), Godowski and Knipe (1986), and Yager and Bachenheimer (1987).

### (i) Labelling RNA

Cells on 90mm plates were washed twice in ice-cold PBS and scraped into STE. The harvested cells were lysed in RNA lysis buffer during a 5min incubation on ice. Nuclei were pelleted (MSE Coolspin, 2K rpm/ 3min/ 4°C), washed in lysis buffer, then resuspended in 50ul 50mM Tris.HCl (pH8.3), 5mM MgCl<sub>2</sub>, 0.1mM EDTA and 40% glycerol. Run-on transcripts were labelled by incubating the nuclei for 30min at 30°C in an equal volume (50ul) of reaction buffer (10mM Tris.HCl (pH8.0), 5mM MgCl<sub>2</sub>, 300mM KCl, 0.5mM ATP, 0.5mM CTP, 0.5mM GTP) plus 60uCi 5'[( $\alpha$ -<sup>32</sup>P]UTP and 50 units of human placental RNAase inhibitor (Amersham). The labelling reaction was stopped by the addition of 25ug RNAase-free DNAaseI (Sigma) in 150ul DNAase buffer (50mM Tris.HCl (pH7.5), 500mM NaCl, 5mM MgCl<sub>2</sub>, 1mM CaCl<sub>2</sub>). Following DNAase treatment at 30°C for 5min, 100ul of 2X extraction buffer (200mM Tris.HCl (pH7.5), 300mM NaCl, 25mM EDTA, 2% (w/v) SDS) containing 200ug/ml proteinase K was added, and the samples were further incubated at 37°C, for 15min. Samples were then extracted against phenol/chloroform (3 times), then chloroform, and precipitated with ethanol. The RNA was pelleted, then treated with DNAaseI and proteinase K as above, and extracted against phenol and chloroform, and finally precipitated with ethanol. Following lyophilization, RNA pellets were resuspended in 100ul H<sub>2</sub>O and stored at -20°C prior to hybridization.

### (ii) RNA-DNA hybridization

Single-stranded DNA was immobilized on nitrocellulose membranes using a Schleicher and Schuell slot-blot

apparatus. 10ug of DNA was applied per slot, in 150ul 6X SSC. The filters were rinsed in 2X SSC, air-dried, and then baked in vacuo at 80°C for 2h. The filters were then pre-treated with hybridization solution (50% (v/v) formamide, 5X SSC, 5X PAF, 0.2% (w/v) SDS, 50ug/ml yeast tRNA) for 4-12h at 42°C. Hybridization was in the same solution, plus 25ug/ml polyadenylic acid (Sigma), and the labelled RNA sample (pre-treated with 0.1M NaCl on ice for 30min). The hybridization was at 42°C for 36-48h. Filters were then washed twice in 2X SSC, 0.1% (w/v) SDS, and twice in 2X SSC, at RT. They were then treated with 50ug/ml RNAaseA, before twice washing again in 2X SSC, 0.1% SDS, as above. The final two washes were in 0.1X SSC, 0.1% SDS, for 15min at 56°C. Filters were air-dried and autoradiographed.

RESULTSSECTION H: Viral US11 Gene Expression

The aim of the work presented in this thesis was to determine the basis of the regulation of a true late gene. To this end, the initial part of the study involved the detailed characterization of a true late gene, US11, and comparison of its temporal regulation with that of a gene of an earlier temporal class. The time-course of appearance and accumulation of US11 RNA was compared with that of US6, which encodes glycoprotein D (gD). The gD promoter is activated by IE gene products early in infection (Watson *et al.*, 1983, Everett, 1984a,b), but since it requires DNA replication for maximal expression (Johnson and Spear, 1984) it has also been described as an EL gene. The positions of the US11 and gD genes in the viral genome are shown in Figure 6a.

1. Location of the US11 RNA cap sites

US11 RNA was first identified and its approximate 5' terminus mapped against size standards by Rixon and McGeoch (1984). The positions of the 5' ends of US11 RNA have been analysed here in more detail by S1 nuclease mapping. The probe used for mapping was the appropriate <sup>32</sup>P end-labelled single strand from a BamHI-TaqI fragment of pDG8 (Figure 6b), isolated on a strand-separating 8% polyacrylamide gel. The correct strand was identified by DNA sequencing (not shown). The probe was hybridized to total cytoplasmic RNA made at 8h after HSV-1 adsorption (p.a.) to BHK cells, using 0.02pmol of probe and 5ug of RNA as described in Materials and Methods. After treatment with S1 nuclease, S1-resistant bands were identified on an 8% polyacrylamide sequencing gel, and their sizes were determined by comparison to an A+G DNA sequence ladder made from the same probe DNA, run in the adjacent lane (Figure 7). The 5' ends of US11 RNA map at positions 121, 123, 124 and 127 nucleotides inside U<sub>G</sub> (coordinates 12859, 12857, 12856 and 12853 respectively of the published U<sub>G</sub> sequence - McGeoch *et al.*, 1985). These

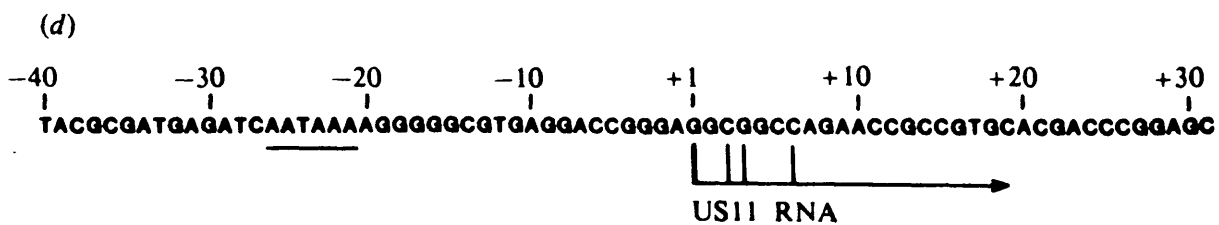
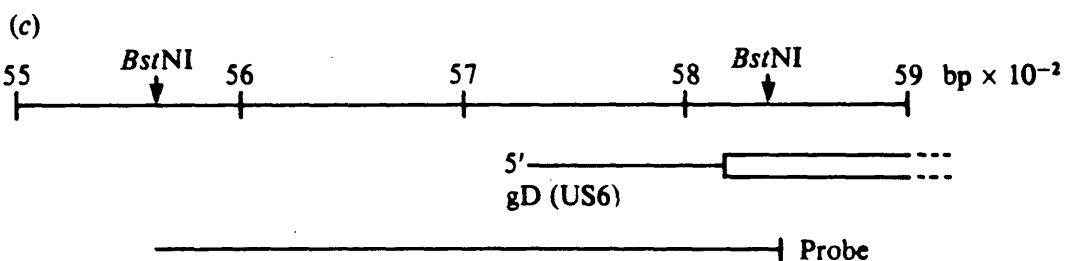
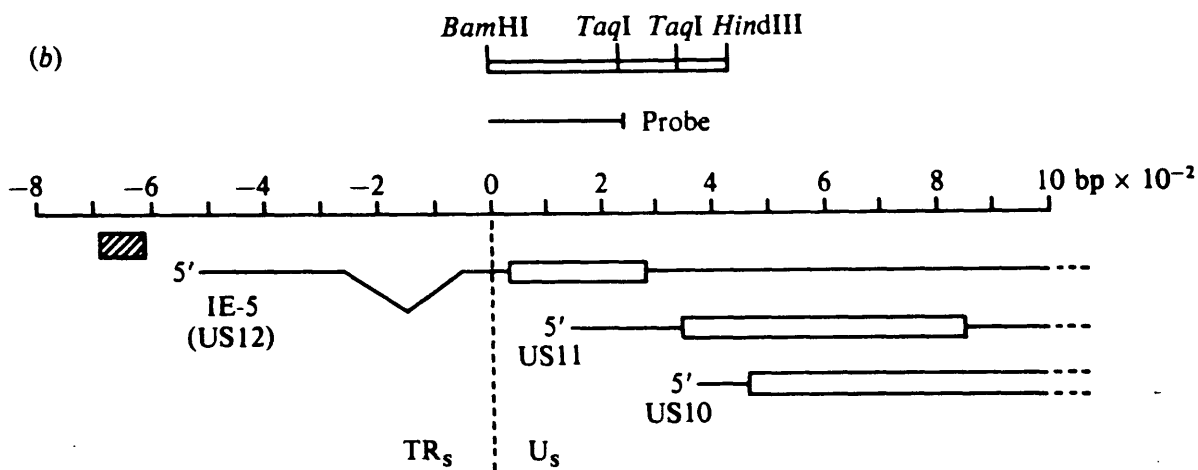
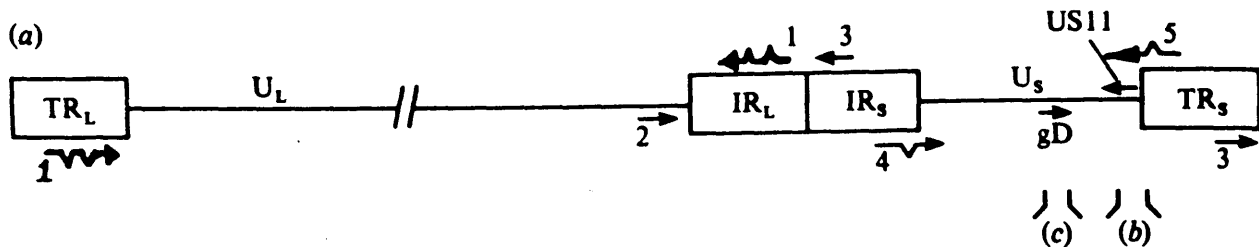

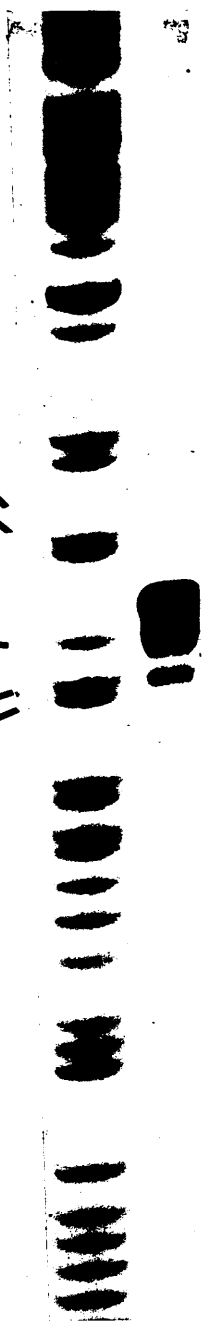

Figure 6.      The genome structure of HSV-1 and the location of the US11 and gD genes

- a. Prototype viral genome indicating the short and long unique regions ( $U_S$  and  $U_L$ ), and the terminal and internal repeated regions (TR and IR). The locations and orientations of the five IE RNAs are shown, as are the positions of the US11 and gD transcripts.
  
- b. The 5' termini and coding sequences (open boxes) for the family of three 3' co-terminal genes located about the TR<sub>S</sub>/ $U_S$  junction. Numbering refers to bp from the TR<sub>S</sub>/ $U_S$  junction (coordinate 12979 of  $U_S$ ; McGeoch et al., 1985). Also indicated are the TR<sub>S</sub> origin of DNA replication (hatched box; Stow and McMonagle, 1983), and the probe used for S1 mapping of US11 RNA. The probe was single-stranded, and  $^{32}P$  labelled at the indicated TaqI site of pDG8 [pDG8 is a pBR322 based plasmid containing an HSV-1 insert (BamHI-HindIII) as shown in the figure].
  
- c. Detail of the gD terminus and coding region (open box), and the single stranded probe used for S1 mapping gD RNA ( $^{32}P$  labelled at the indicated BstNI site of pGX48). Numbering is as described by McGeoch et al. (1985), where 1 is the first base of  $U_S$  at the  $U_S$ /IR<sub>S</sub> junction.
  
- d. DNA sequence around the US11 5' mRNA termini (Rixon and McGeoch, 1984), indicating cap site usage of the US11 gene, as described in the text. A potential TATA box at -26 relative to the US11 transcription start at +1 (121bp inside  $U_S$ , or coordinate 12859, McGeoch et al., 1985), is underlined.

1 2

C  
C  
G  
G  
A  
G  
G  
C  
G  
G  
C  
C  
A  
G  
A



US 11

Figure 7.      US11 RNA cap sites

Lane 1, A+G sequence reaction of the 5'-end labelled probe shown in Figure 7b; lane 2, protected hybrids from S1 nuclease mapping of RNA produced 8h after infection of BHK cells with HSV-1. The nucleotide sequence of the 'sense' strand (complementary to the probe) around the cap sites is given. Interpretation of the data takes into account that the sequence track is displaced down the gel by one base compared to the S1 hybrids, due to the chemistry of the sequencing reaction.

results are in close agreement with previous data (Rixon and McGeoch, 1984), although "nibbling" by S1 nuclease may be responsible for one or two of the apparent starts, or cause the exact positions of the 5' ends to be underestimated by about a single nucleotide. The major cap site employed by US11 is taken to be at position 121 (as numbered in Figure 6b), and is indicated on the nucleotide sequence in Figure 6d as +1. The potential TATA box identified by McGeoch et al. (1985) is located between 21 and 26 nucleotides upstream from the major cap site, and is shown underlined in Figure 6d.

## 2. Appearance of US11 and gD transcripts during viral infection

The time of appearance and subsequent accumulation of gD and US11 transcripts during a lytic viral infection of BHK cells was determined by quantitative S1 mapping of total cytoplasmic RNA using the specific, 5' end-labelled probes described above and shown in Figures 6b and 6c. The gD promoter and cap sites have been described by Watson et al. (1983) and Everett (1983, 1984b). A series of 90mm petri dishes containing BHK cell monolayers, at 75% confluence, were infected with HSV-1 at a multiplicity of 20 pfu per cell for a 1h adsorption period, in a volume of 1.5ml of growth medium. Infected monolayers were then incubated further in 15ml of growth medium, and at various times post-adsorption the cells were harvested for the preparation of RNA for analysis.

US11 transcripts could be consistently detected at very low levels by 2h p.a., then rose dramatically until between 6 and 10h, and were maintained at a high level until 24h p.a. (Figures 8 and 9), despite considerable and increasing cytopathic effect from 16h p.a. onwards. In comparison, gD transcripts were first detected at 1h p.a., accumulated to a maximum level at 4-5h, and then gradually diminished (Figures 8 and 9). This result confirmed previous findings regarding transcription of the gD gene (Dr. R.D.Everett, personal communication). Thus, by the criteria of simple

**A****B****C****D**

Figure 8.

Time course of appearance (h post adsorption) and accumulation of US11 (a,b) and gD (c,d) transcripts in the presence and absence of PAA. The S1 resistant hybrids corresponding to the 5' starts of the US11 and gD RNA are indicated. a,c; Without PAA. b,d; PAA included before, during and after the infection at 300 ug/ml. MI, mock-infected.

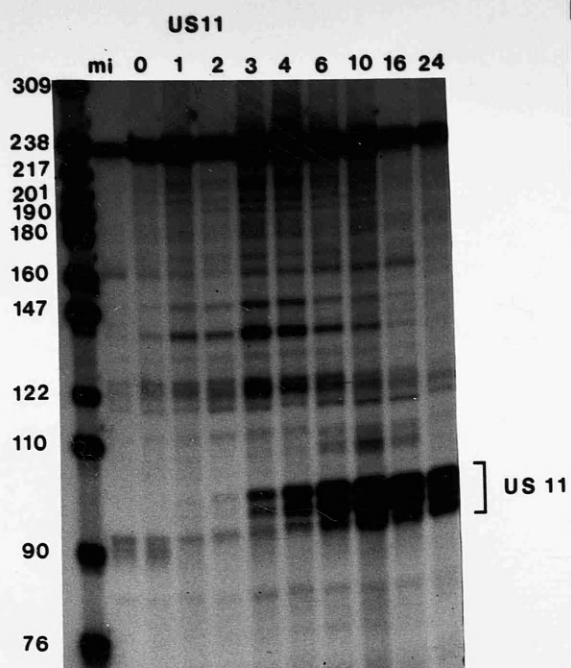
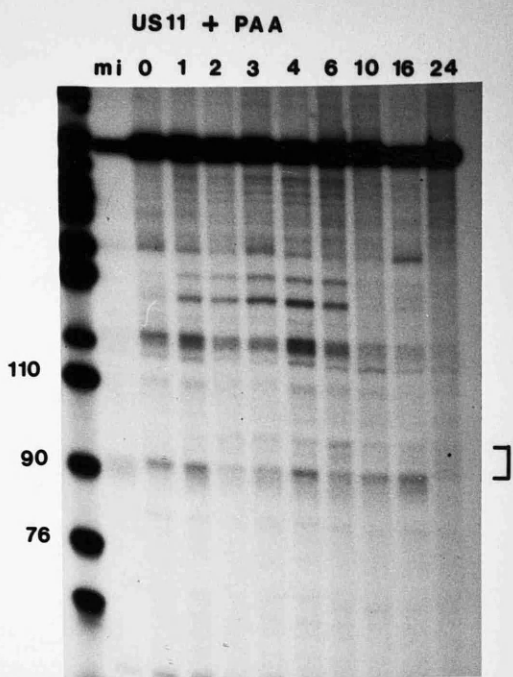
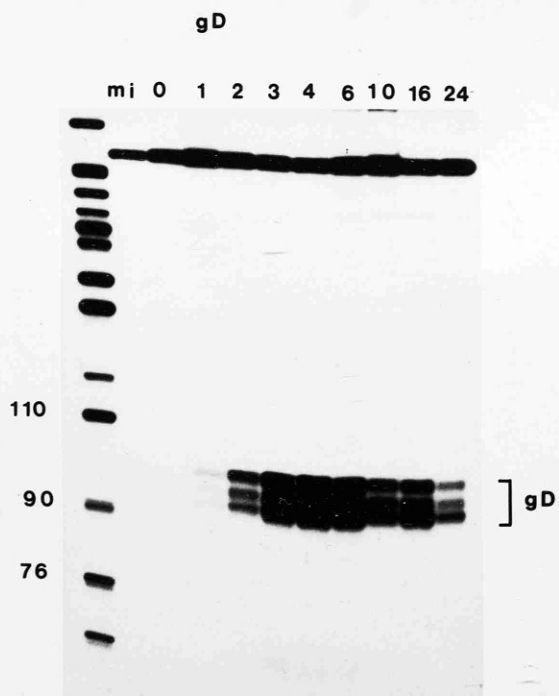
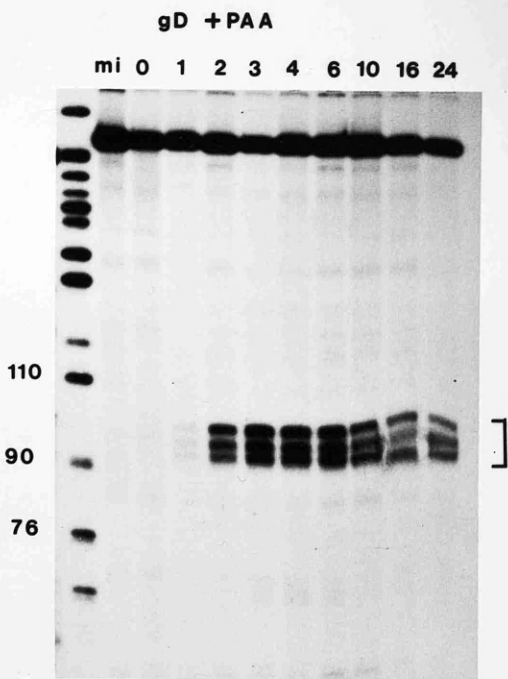
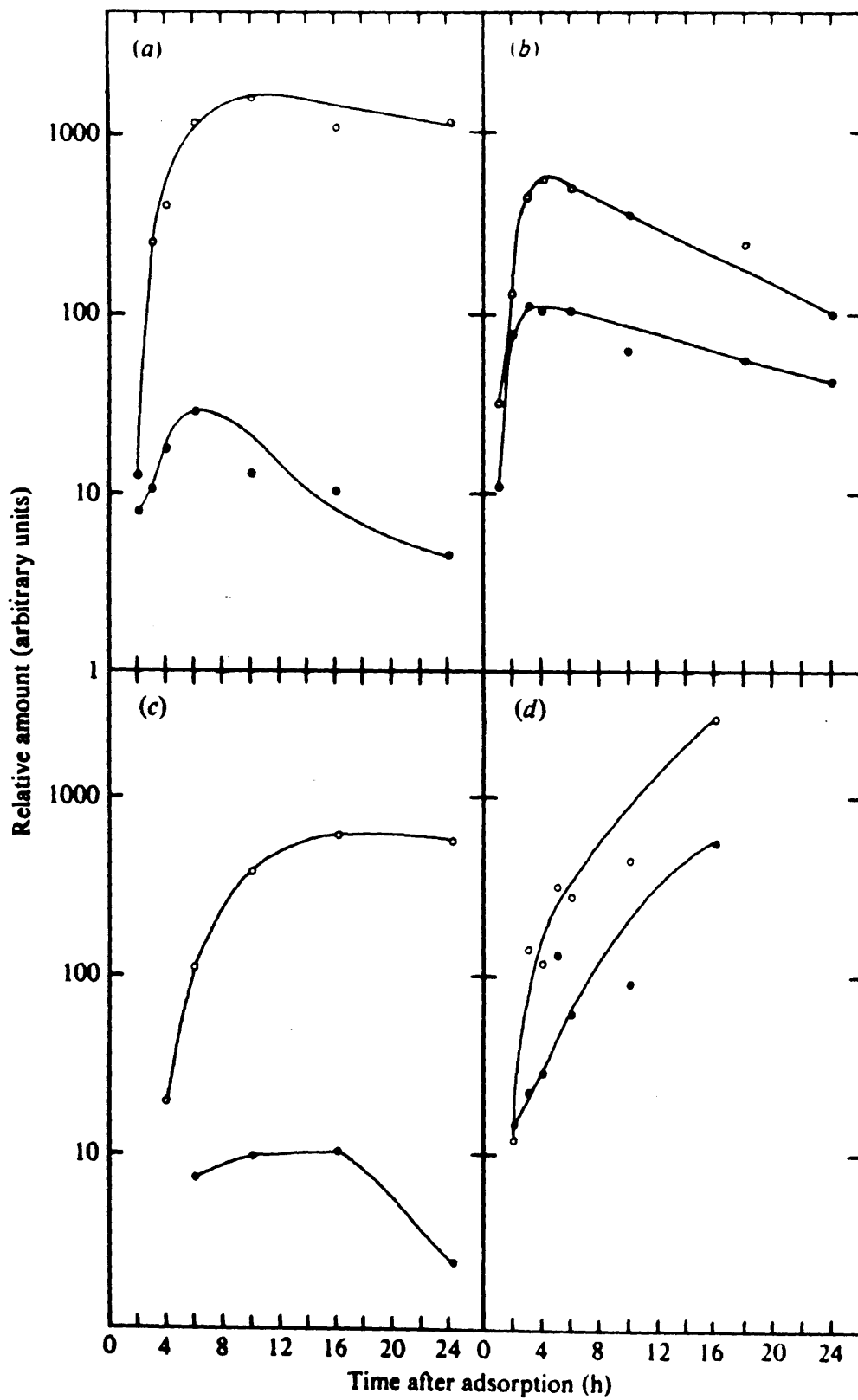

Figure 9.

Time course of appearance, accumulation, and sensitivity to PAA of US11 and gD transcripts (a and b respectively) and protein products (c and d respectively). PAA absent, open circles; PAA present, closed circles. Autoradiographs of the S1 gels shown in Figure 8 and the protein gels shown in Johnson et al. (1986), were scanned by densitometry (see Materials and Methods) in order to quantitate the relative amounts of US11 and gD gene products. Note that the vertical scale is logarithmic.



kinetics of appearance, US11 is of a later class than the gD gene. However, the definitive characteristic of a true late gene has been described as its dependence on DNA replication for expression (Wagner, 1985; Roizman and Batterson, 1985). Therefore, the effect of inhibition of DNA replication on US11 transcription during viral infection was investigated.

Viral DNA synthesis was inhibited by maintaining cells in medium containing 300ug PAA per ml 1h before adsorption and throughout infection. In the presence of PAA, US11 transcripts were again first detected at 2h p.a., but did not rise substantially above this level at later times (Figures 8B and 9). Accumulation of US11 transcripts was inhibited by PAA between 50 to 100-fold (Figure 9). The level of US11 transcripts made from mutant PAA<sup>r</sup>-1-infected cells at 16h was similar to unrestricted wild-type levels, and was unaffected by the presence of PAA (data not shown). This indicated that PAA at a concentration of 300ug/ml did not have any indirect effect on US11 transcription other than by inhibiting the DNA replication of PAA-sensitive virus. In contrast, the time course of gD expression in the presence of PAA was unchanged, but the total level of gD transcripts was reduced by 5 to 10-fold (Figures 8D and 9). Thus there is a clear difference between the regulation of transcription of gD, an EL gene, and US11, a "true late" gene.

In one time-course experiment (not shown), RNA was isolated from the nucleus and cytoplasm of BHK cells which had been infected with HSV-1 in the presence and absence of PAA. The level of correctly initiated US11 RNA in the nucleus corresponded with cytoplasmic levels at all times, both in the presence and absence of PAA. This experiment indicated that inhibition of DNA replication does not affect the transport of US11 RNA to the cytoplasm. Regulation at the level of RNA transport to the cytoplasm appears to be involved in CMV late gene expression (Geballe et al., 1986).

### 3. Appearance of 21K polypeptide and glycoprotein D during viral infection

To confirm the difference in behaviour seen between gD

and US11 RNAs, the appearance and accumulation of their protein products were simultaneously investigated under the above conditions by Christine MacLean (see Johnson et al., 1986). The product of US11, a 21kd protein (21K - see Section E(6c)), was detected by Western blotting using an oligopeptide-induced antiserum directed against the carboxy-terminal seven amino acids of 21K, as predicted from the DNA sequence (McGeoch et al., 1985). Detection of gD was by immunoprecipitation of radiolabelled infected cell proteins using a gD-specific monoclonal antibody, kindly supplied by Ann Cross. The results are illustrated in Figure 9. Both 21K and gD proteins were first detected at slightly later times than their respective RNAs. Continued accumulation of gD protein at late times during infection was observed, which contrasted with a decline in gD RNA accumulation during the corresponding period. This may reflect differences in the stability between gD RNA and protein products. The sensitivities of 21K and gD protein synthesis to PAA were similar to those of their RNA synthesis. Therefore, the differences in regulation of the US11 and gD genes observed by analysis of RNA are also observed by analysis of their protein products. Note that 21K appears to be less stable than gD protein.

#### 4. Accumulation of viral DNA in the presence and absence of PAA

For the purposes of this experiment, it was important to establish that the use of PAA had indeed inhibited viral DNA replication. Total DNA was extracted from the nuclei of the same cells used for the preparation of cytoplasmic RNA in the above experiment, and analysed for the presence of viral DNA sequences using a nick-translated probe, pGX156 (Rixon and McGeoch, 1985), which contains the entire U<sub>S</sub> sequence. Figure 10 shows that the amount of viral DNA detected began to increase between 2-3h p.a.. In the presence of PAA, there was no obvious increase in the level of virus DNA. The histogram in Figure 10 shows that the level of background hybridization of pGX156 to DNA from mock-infected cells was similar to that with DNA from PAA-treated cells. The histogram also confirms that PAA did

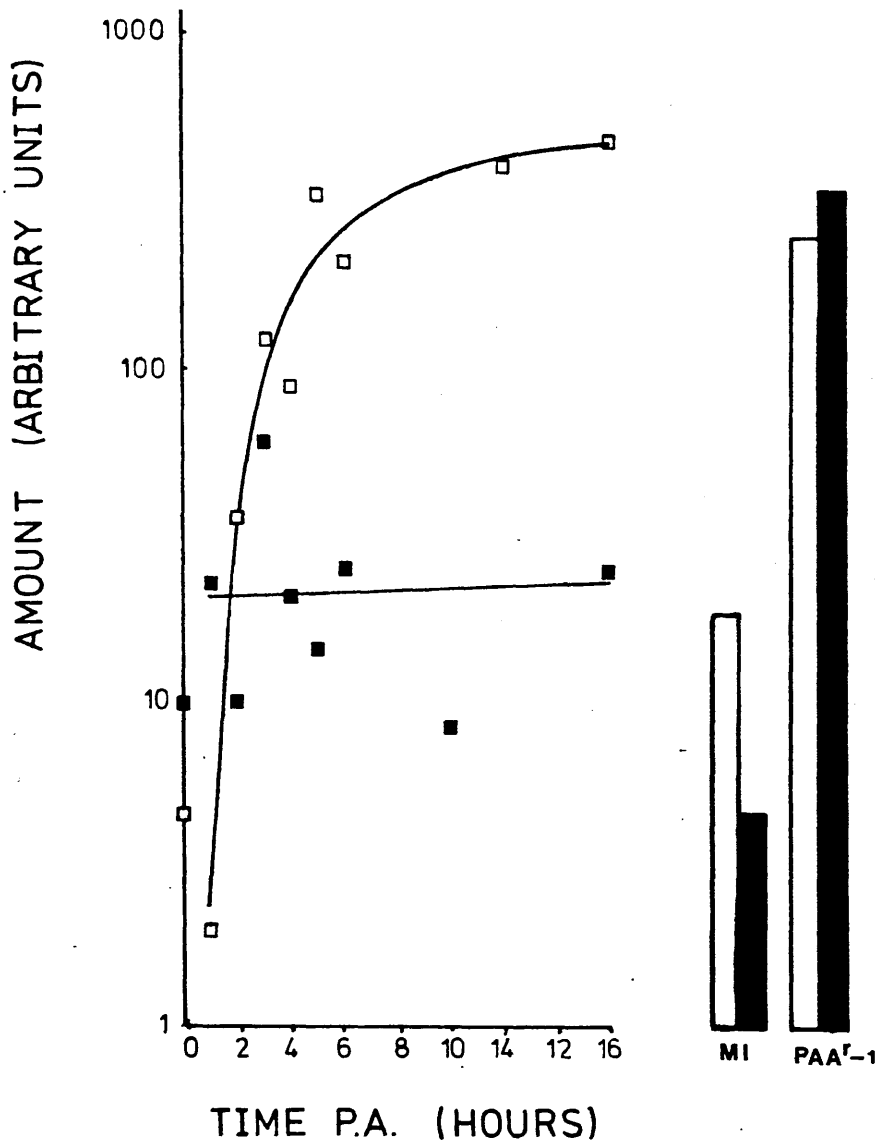

**Figure 10.** Effect of PAA on viral DNA synthesis

Dot blots of infected cell DNA hybridized to nick translated pGX156 (which contains the entire U<sub>g</sub> sequence) were autoradiographed and quantified by densitometry. Results from cells either mock infected (MI) or infected with PAA<sup>T</sup>-1 at 16h post-adsorption are shown in the histogram. PAA absent, open symbols; PAA present, closed symbols.

not inhibit DNA replication of the PAA resistant mutant, PAA<sup>r</sup>-1. Thus it can be concluded that under the conditions in which the addition of PAA led to an absence of detectable viral DNA synthesis, the expression of US11 was decreased by 50 to 100-fold

##### 5. HSV-1 infection of HeLa cells

HSV-1 strain 17 syn<sup>+</sup> is routinely grown on BHK cells. However, for studying the expression of a plasmid-borne US11 promoter in subsequent experiments, HeLa cells were likely to be more useful than BHK cells due to their better transfection efficiency. Accordingly, the time course of US11 and gD transcript accumulation was also examined during infection of HeLa cells. The graphs in Figures 11a and 11b are of a typical time course, and show that the appearance and accumulation of US11 and gD transcripts in infected HeLa cells is delayed compared to infected BHK cells (Figure 9). The conditions of infection, RNA extraction and S1 nuclease analysis were identical to those described above for experiments using BHK cells.

##### 6. The effect of delayed inhibition of DNA replication on US11 RNA accumulation

The experiments described above indicate that DNA replication is required for maximum US11 expression. However, it is not clear if it is ongoing DNA replication that is required, or merely the presence of replicated template molecules. Accordingly, <sup>an</sup> in attempt to distinguish between these possibilities PAA was added to HeLa cell monolayers at 0, 9 and 16n p.a. in order to investigate the effects of inhibiting DNA replication after its onset on the accumulation of US11 and gD RNAs. Samples for RNA analysis were taken at various times up to 30h p.a. (Figure 11a). The rationale for this experiment was that (i) a decline in RNA levels following the addition of PAA would indicate a requirement for continuous DNA synthesis, assuming that the RNA species is relatively unstable, or (ii) a rise in RNA levels would indicate that transcription is independent of the process of ongoing DNA replication, assuming in this

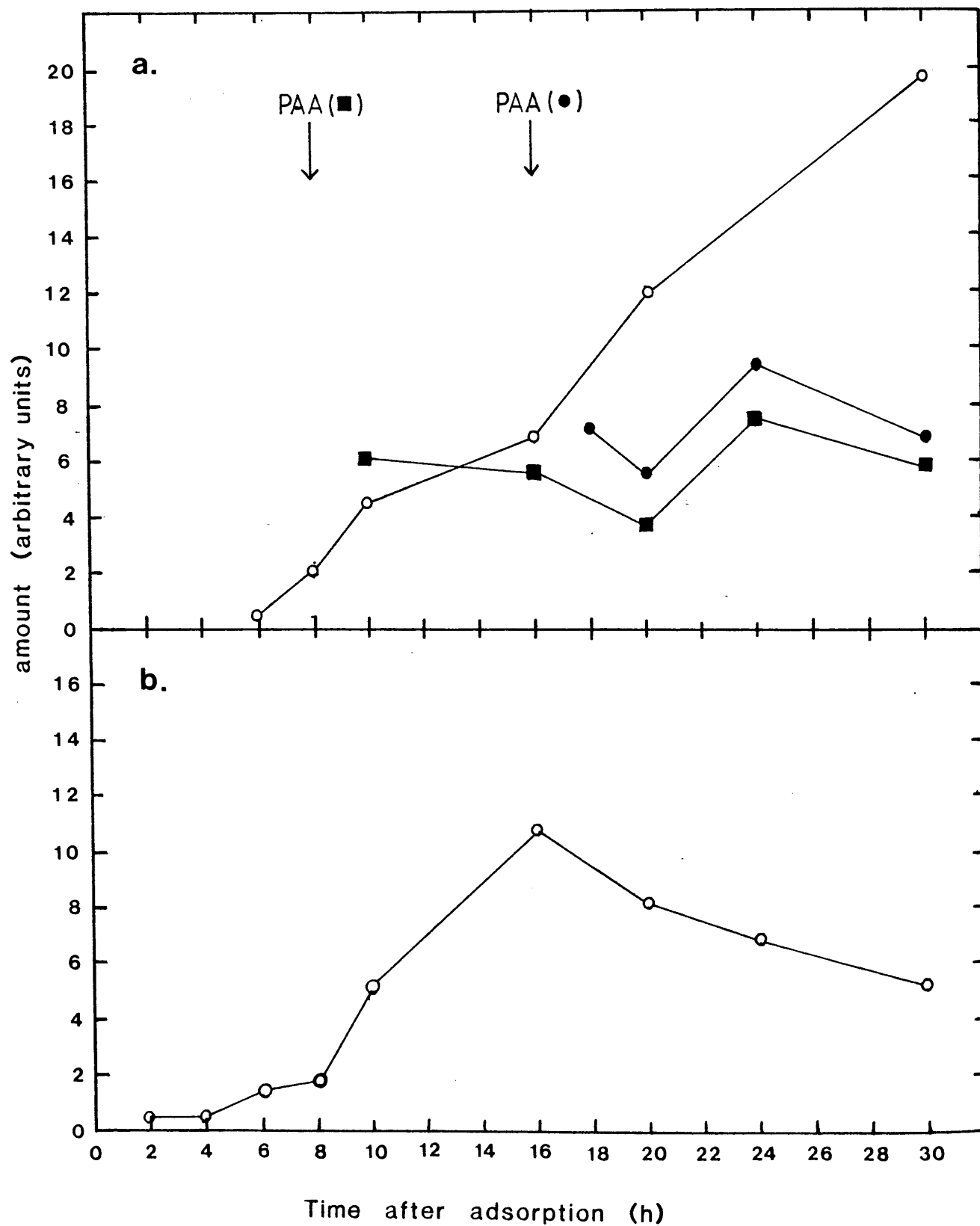

Figure 11.

Time course of appearance and accumulation of US11 (a) and gD (b) transcripts in HeLa cells. The effect on US11 RNA accumulation of adding PAA at 8h (closed squares) and 16h p.a. (closed circles), is also shown in a. Open circles indicated the absence of PAA.

case that the RNA species is relatively stable. However, if the level of RNA remains unchanged, only limited information can be deduced from this experiment.

The results showed that the levels of US11 transcripts detected after the inhibition of DNA synthesis remained at approximately the level found in the uninhibited control at the time of the addition of PAA (Figure 11a). Similar results were obtained for gD RNA, and also in infected BHK cells on a shorter time scale (data not shown). Since the stability of US11 mRNA is unknown, it is not possible to distinguish from this experiment between (i) steady transcription from previously replicated templates matched by a steady turnover of transcripts, or (ii) persistence of stable mRNA in the cytoplasm in the absence of US11 transcription.

## 7. Conclusions

The above experiments describe the temporal regulation and sensitivity to inhibition of DNA replication of US11 gene expression. The differences in the pattern of US11 and gD gene expression during both a productive infection and in the presence of a DNA replication inhibitor indicate that US11 is regulated as a later class of viral gene than gD.

Late genes have been occasionally defined as those which have a stringent dependence on viral DNA synthesis for their expression, unlike the earlier EL class whose expression is reduced, but not abolished, in the absence of DNA synthesis (Silver and Roizman, 1985; Roizman and Batterson, 1985). Having found that the appearance of US11 gene expression is extremely sensitive to inhibition of DNA synthesis, it appears in this respect to be comparable to previously defined late genes. However, modern techniques have brought problems to the use of definitions based on older methodologies; at this point it is pertinent to re-examine the established definition of a true-late gene.

Using specific and sensitive probes to monitor the expression of US11 RNA it has been shown here that as little as 1% of the observed maximum amount of gene product may be detected. The use of sensitive techniques, which have

enabled the detection of US11 gene products under conditions of DNA synthesis inhibition, brings into question the absolute requirement of DNA replication for late gene expression. However, it is not possible to conclude that absolutely no DNA replication has taken place in experiments using chemical inhibitors. Similarly, given the sensitivity of the techniques that have sometimes been used to detect late gene products, it is not possible to state that no product was present under the conditions used for DNA replication inhibition. Thus the available evidence does not allow any conclusion to be reached regarding the mechanistic relationship between DNA replication and late gene expression. An operational definition of late genes which is consistent with this study and others (Powell et al., 1975; Honess and Watson, 1977; Pederson et al., 1981; Godowski and Knipe, 1985, 1986; Yager and Bachenheimer, 1987) may be put as follows:

"Late genes are those whose expression is most severely reduced, compared to all other groups of genes, under conditions of severely inhibited DNA replication" (Johnson et al., 1986).

In the absence of a clear understanding of the mechanism of control of late gene expression, the classification of late genes remains subjective and cannot be defined using absolute statements. However, as a practical guide, on the term "most severely reduced", a figure of 95% inhibition could be used.



## SECTION I: Plasmid-borne US11 Gene Expression

The experiments described in this section were designed to determine whether DNA replication is obligatory for late gene expression, by studying transcription from a plasmid-borne US11 promoter in the presence and absence of a functional HSV-1 origin of DNA replication. Prior to this, it was first necessary to establish whether a plasmid-borne US11 promoter could mimic the regulated expression of its viral counterpart. The crucial method used in these experiments is the introduction of plasmid DNA into cultured HeLa cells by transfection, as described in Materials and Methods (Section G(18)). The transfected cells could then be infected with HSV-1 to provide all the viral factors required for DNA replication and trans-activation of transcription.

### 1. Construction and structure of pPJ2

The initial cloning objective was to construct a plasmid which directs properly regulated synthesis of correctly initiated transcripts from the US11 promoter. On the assumption that superinfection with HSV would be necessary to activate the plasmid-borne promoter (and origin of DNA replication) in short-term transfection assays, it was necessary to be able to distinguish transcripts derived from the plasmid and the viral US11 promoters. This was achieved by linking the US11 promoter to the rabbit  $\beta$ -globin coding region.

Plasmid pGX57 (Rixon and McGeoch, 1985) contains HSV-1 DNA which extends from within the coding region of US11 to over 1kb 5' to the US11 transcription start site (see Figure 12). This plasmid also contains in the region upstream of the US11 RNA start sites an origin of DNA replication and the regulatory sequences and transcription start sites of IE gene 5. Sequences which constitute the HSV-1 TR<sub>G</sub>/IR<sub>G</sub> origin of DNA replication (ORI<sub>G</sub>) are contained in the region -785 to -825 relative to the US11 transcription start site at +1 (Stow and McMonagle, 1983). The IE gene 5 promoter is contained within a region extending 69bp upstream from its

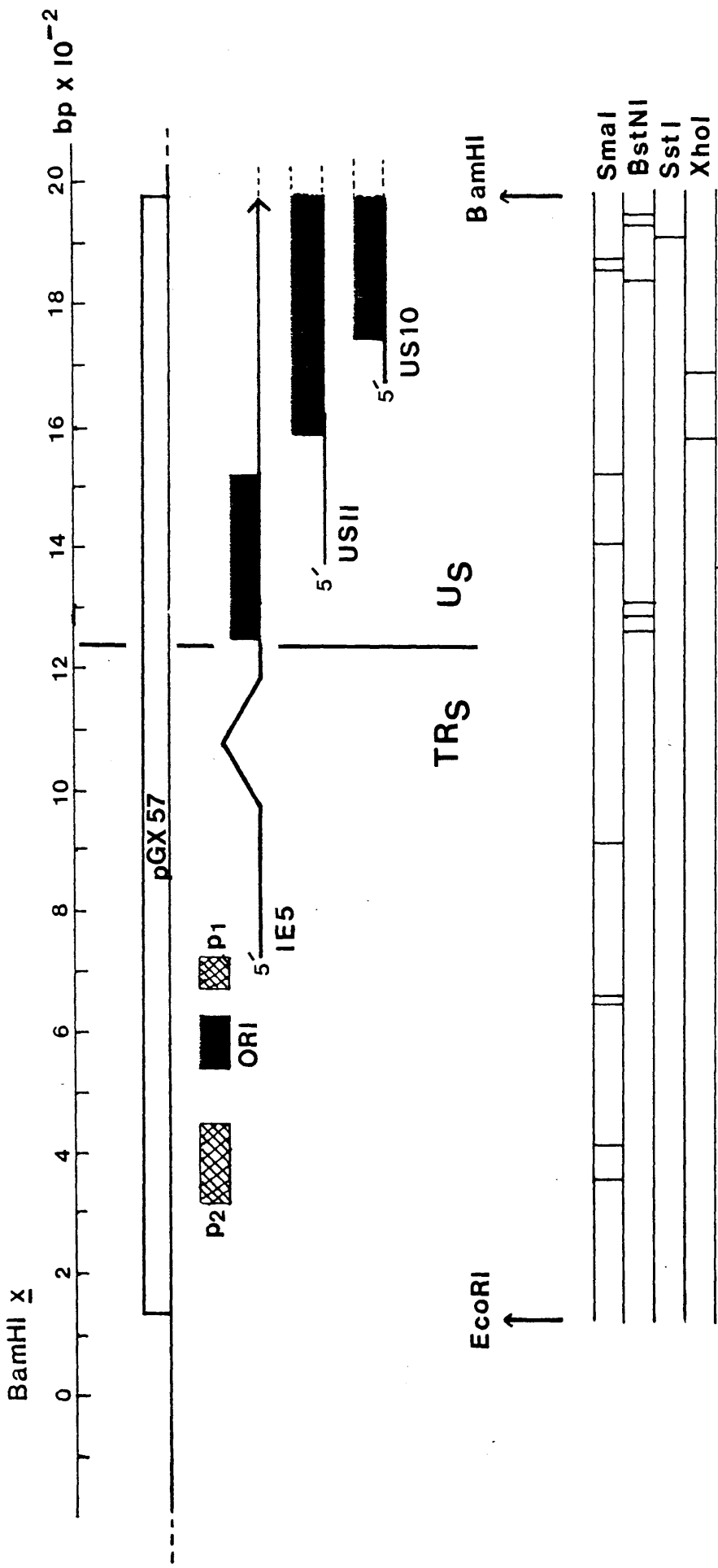

Figure 12.      Map of pGX57

Plasmid pGX57 contains the larger EcoRI-BamHI subfragment from the BamHI x fragment of HSV-1 (double lines), in a pAT153 vector background (single lines). The HSV-1 DNA is shown to scale, and numbering is in bp  $\times 10^{-2}$  where "0" corresponds to the TR<sub>G</sub> end of BamHI x. Located below pGX57 are (i) the IE gene 5 promoter (P1) and far upstream regulatory element (P2); the TR<sub>G</sub> origin of DNA replication (ORI); (iii) the 5' starts of IE 5, US11 and US10 RNAs (single lines) and their coding regions (solid boxes); and (iv) relevant restriction sites.

For cloning purposes, a new restriction site, SstI, was introduced into pGX57 such that it was downstream from the US11 RNA start sites, but 5' to the SmaI site at 1417. This was achieved by cutting pGX57 with XhoI, treating with exonuclease as shown, and religating in the presence of SstI linker oligonucleotides.

Recombinants were screened for the loss of the SmaI site at 1417, and judged by the size of SstI-BstNI fragments to have retained the US11 transcription start site.

transcription start site (-640 relative to +1 of US11). The far-upstream regulatory region of IE gene 5, which is required for an ~8 fold stimulation of the IE 5 promoter in response to the virion component (see Section E), is located on the far side of ORI<sub>g</sub> relative to the IE 5 promoter; that is 944 to 1007bp upstream from +1 of US11 (Preston et al., 1984; see Figure 12).

In order to isolate the DNA 5'-flanking the US11 transcription start sites, pGX57 was cut at its two XhoI sites (which lie over 200bp 3' to +1 of US11), treated with exonuclease, and religated in the presence of synthetic oligonucleotide SstI linkers. Recombinants were analysed for the presence of an SstI linker inserted 3' proximally to the US11 transcription start sites. The location of the SstI linker was judged initially by restriction analysis, and a recombinant clone was chosen which had lost the SmaI site lying 50bp downstream from +1 of US11 in pGX57 (see Figure 12). The absence of this SmaI site was desirable in order to facilitate the removal of ORI<sub>g</sub> and the IE gene 5 regulatory sequences in later derivatives by usage of the five remaining SmaI sites located in the far upstream region (see Figure 12).

The EcoRI site (at position -1233) in the pGX57-deletion construct was converted to a XhoI site using XhoI linker oligonucleotides, to give plasmid pdel57/X.S (Figure 13). This contains a XhoI-SstI HSV DNA fragment which includes the US11 and IE 5 promoters and ORI<sub>g</sub> (Figure 13). The HindIII site at the gD/globin junction of pRED122 (Everett, 1983; see Figure 13) was converted to an SstI site using SstI linker oligonucleotides, and the SstI-PstI fragment of the resulting plasmid, pl22/S (Figure 13), was used to provide the rabbit  $\beta$ -globin portion of pPJ2. Lastly, pBR322 vector sequences were completed by insertion of the appropriate XhoI-PstI fragment from pRED4 (Everett, 1983; see Figure 13), during the 3-way ligation shown in Figure 13. The US11/globin junction of pPJ2 was sequenced (from the probe shown in Figure 14b and its complementary strand, which were prepared as described below) to verify the final structure and ensure retention of the US11 cap

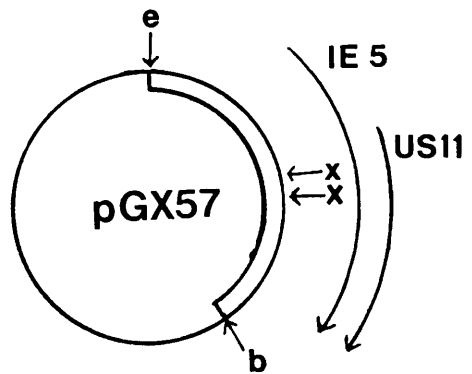
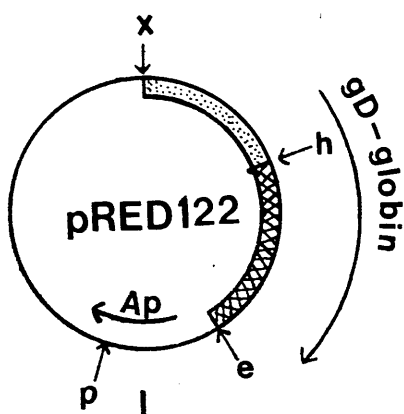

HindIII → SstI

1. XhoI
2. exonuclease
3. ligate + SstI linker
4. EcoRI → XhoI

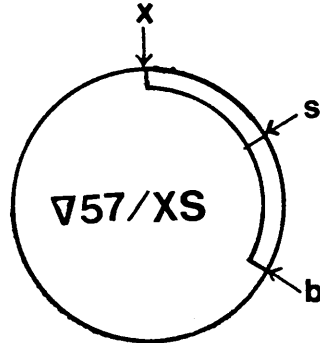
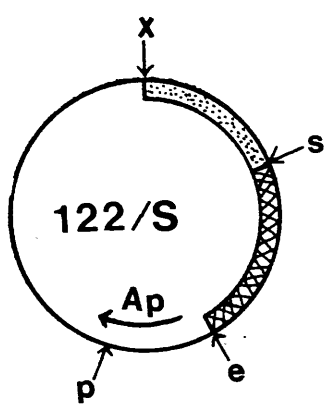

PstI-SstI

SstI-XhoI

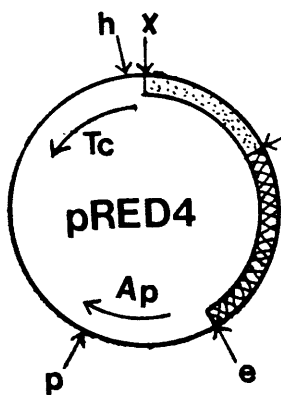

XhoI-PstI

3-way ligation

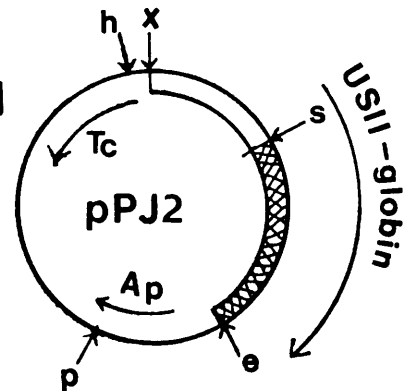

Figure 13.      The construction of pPJ2

HSV-1 DNA (-1233 to +37 of US11, open box) containing ORIs, IE gene 5 regulatory sequences and the US11 RNA start sites was derived from pGX57 by the indicated manipulations, via plasmid 57/XS; rabbit  $\beta$ -globin DNA (from -7 to 400bp beyond the globin gene polyadenylation site, hatched box) was derived from pRED122 via plasmid 122/S; the remaining pBR322 vector sequences (single lines) including the Tc gene were derived from pRED4. pRED122 and pRED4 contain gD promoter DNA (stippled box) from -33 and -396 respectively, to +11. Cloning steps were as indicated. Tc, tetracycline resistance gene; Ap, ampicillin resistance gene. Relevant restriction sites: e, EcoRI; x, XhoI; b, BamHI; h, HindIII; s, SstI; p, PstI.

sites. The important features of pPJ2 are shown in Figure 14b. The region 3' of +1 comprises 39bp of untranslated US11 leader sequence, joined by an SstI linker to the entire rabbit  $\beta$ -globin gene, from -7 to 400bp beyond the polyadenylation site. Therefore, activation of the US11 promoter in pPJ2 will result in hybrid US11/ $\beta$ -globin RNAs which can be detected by S1 mapping using a single stranded end-labelled DNA probe, as shown in Figure 14b.

The probe for mapping US11 hybrid transcripts was prepared as follows: 100ug of pPJ2 DNA (total size; 7320bp) was digested with BamHI and HindIII, which cut the plasmid at the single sites shown in Figure 14b. The 1778bp BamHI-HindIII fragment containing US11 DNA was isolated by sucrose gradient centrifugation (see Materials and Methods), and the efficiency of recovery was estimated by running aliquots of the isolated fragment against a known quantity of BamHI/HindIII-cut pPJ2 DNA. The fragment was then digested with BstNI (which cuts at the sites shown in Figure 14b), treated with bacterial alkaline phosphatase (BAP), and 1pmol aliquots were 5'-end labelled with  $^{32}\text{P}$ , as described in Materials and Methods (Section G(10)). Labelled fragments were strand-separated on a non-denaturing polyacrylamide gel and the complementary strand to US11-initiated RNA was identified by DNA sequencing (not shown). The length of the probe was calculated to be 259 nucleotides, and it is 5'-end labelled at the BstNI site, position +136 of the globin gene (see Everett, 1983), as shown in Figure 14b.

## 2. Internal control plasmid: pRED5

Quantitation and comparison of results obtained from independent transfection experiments using different plasmid constructions requires the ability to standardize transfection efficiencies. For this purpose pRED5 was used as an internal control. This plasmid produces  $\beta$ -globin transcripts from the gD promoter under control of the SV40 enhancer (Everett, 1984b; see Figure 14a). The single stranded DNA probe prepared from the BstNI fragment of pPJ2 (Figure 14b) also detects RNAs derived from pRED5 which span

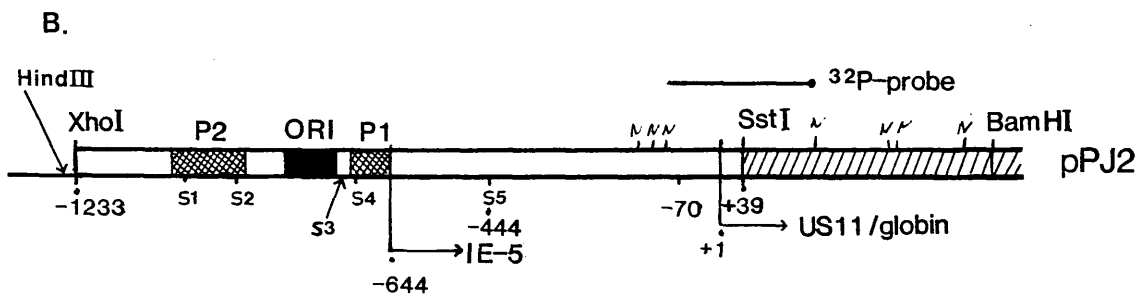
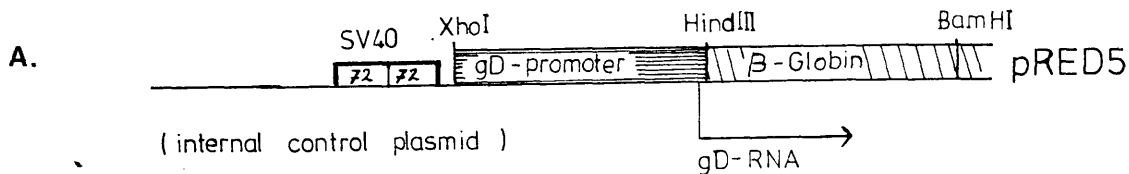

**C.**

			% PJ2	SEM
—————	—————	PJ4	40 ±	8.0
—————	—————	PJ5	10	2.0
—————	—————	PJ6	38	5.9
—————	—————	PJ7	69	12.8
—————	—————	PJ8	6	1.3
—————	—————	PJ9	192	39
—————	—————	PJX4	3.4	1.1
—————	—————	PJX5	6.5	1.2
—————	—————	PJX2	102	1.5



Figure 14.      Detailed structures of pRED5, pPJ2 and  
pPJ-mutant plasmids

- A. Internal control plasmid, pRED5. gD promoter DNA (-396 to +11) is joined to the rabbit  $\beta$ -globin gene (from -7 to 400bp beyond the polyadenylation site, hatched) by a HindIII linker. SV40 DNA containing the 72 bp repeat enhancer region is located directly upstream from the HSV-1 gD DNA.
- B. Structure of pPJ2. HSV-1 US11 DNA (-1233 to +39) is joined to the rabbit  $\beta$ -globin gene (hatched), shown aligned with pRED5, via an SstI linker. Indicated upstream from the US11 transcription start site: IE gene 5 transcription start site and promoter (P1); TR<sub>G</sub> origin of DNA replication (ORI); IE gene 5 far-upstream regulatory sequence (P2). The positions of relevant restriction sites are shown, including BstNI sites (N) used for probe isolation, and 5 SmaI sites (1-5) employed for pPJ-mutant construction. Coordinates refer to bp from the US11 RNA start site at +1. Positioned above pPJ2 is the single stranded DNA probe used to detect US11 initiated and pRED5 RNA, which was <sup>32</sup>P 5'-end labelled at the BstNI site at +136 of the  $\beta$ -globin gene.
- C. Mutant test plasmids. Gaps represent deleted sequences, whose end-points align to the numbered SmaI sites or the XhoI site of pPJ2. The identities of the constructs are on the right. HeLa cells were transfected with test plasmids and pRED5. After 24h, the transfected cells were infected with HSV-1 for 16h, harvested, and RNA was made for S1 analysis. The ratio of US11- and pRED5-derived RNAs was calculated for the individual transfections, and compared to the ratio from pPJ2 (taken to be 100%). The mean relative transcriptional activities of the various constructs (derived from at least four independent experiments and for more than one plasmid preparation), are given on the right, and the standard error of the mean (SEM).

the break in homology between pPJ2 and pRED5. These RNAs, which include correctly initiated gD/globin RNA, varied in quantity during infection (Figure 15a), presumably in response to trans-acting viral factors which at early times increase gD expression from pRED5 above its cis-activated level mediated by the SV40 enhancer (Everett, 1984b). At late times, pRED5 RNAs were readily detectable (Figure 15a) and gave a reliable standardization of the transfections in combination with all the test plasmids used (Figure 17).

Suitably exposed autoradiographs of S1 gels were analysed by densitometry (see Materials and Methods). The ratio of correctly initiated RNA at the US11 cap sites compared with bands from pRED5 corresponding to the homology break was calculated. The value of this ratio obtained with pPJ2 was taken to be 100, and the ratios obtained with the mutant plasmids were expressed as percentages of pPJ2. The activities given in Figure 14c were calculated from at least four independent experiments using two different plasmid preparations.

### 3. Time-course of appearance and accumulation of hybrid transcripts from the plasmid-borne US11 promoter

The ability of the plasmid-borne US11 promoter in pPJ2 to mimic its viral counterpart during transfection and infection experiments was investigated. Sub-confluent monolayers of HeLa cells in 90mm petri dishes were transfected with 10ug of pPJ2 and 10ug of pRED5 (except in the indicated controls - Figure 15), using the calcium-phosphate transfection procedure described in Materials and Methods. After 24h, transfected monolayers were infected with HSV-1 at a multiplicity of 20 pfu per cell. Cells were then harvested for the preparation of cytoplasmic RNA and nuclear DNA at various times p.a., as indicated in Figure 15. Isolated RNA was analysed for US11 hybrid transcripts by S1 mapping (see Materials and Methods) using the single-stranded 5'-end labelled probe described above. The analysis of DNA isolated from the same cells is described below (part 4).

As shown in Figure 15a, the US11 promoter in pPJ2 was

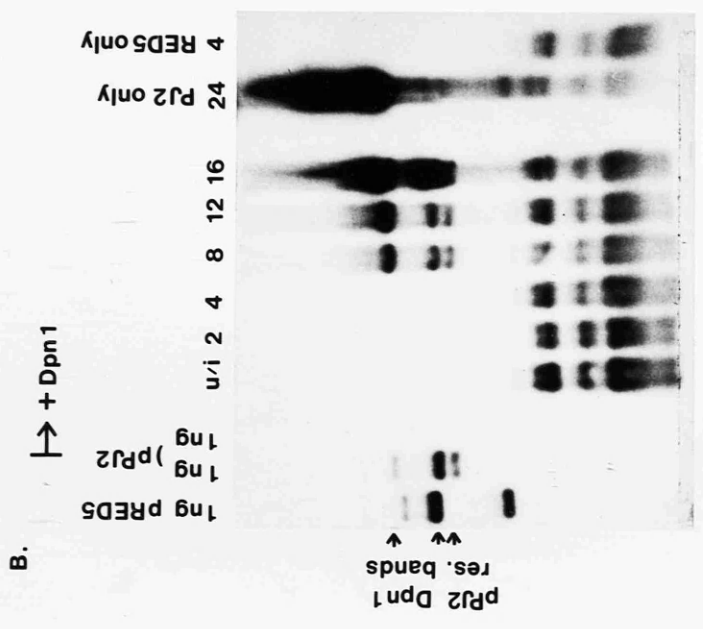
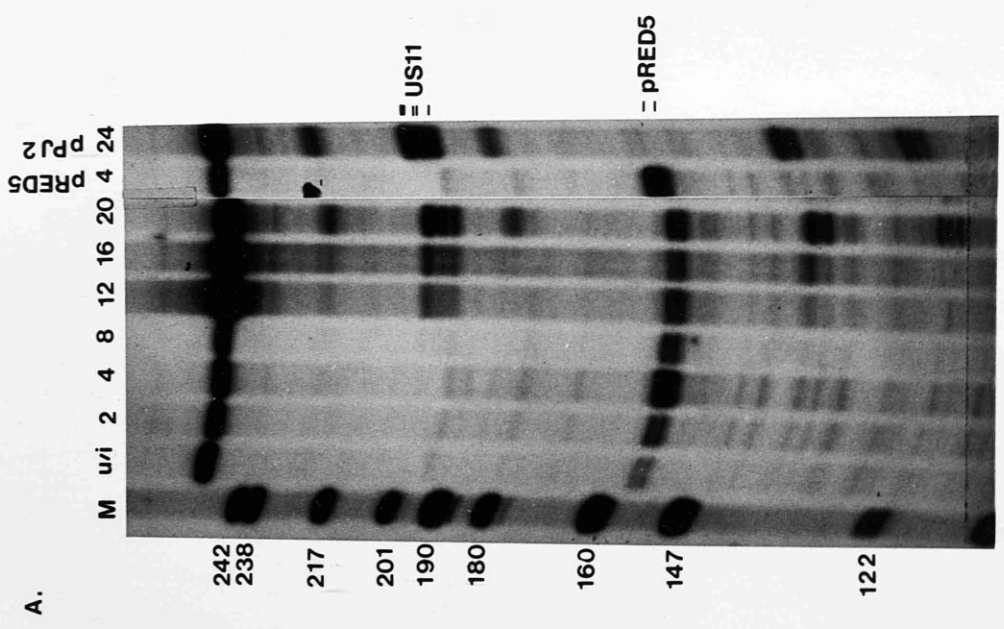

Figure 15.      Time course of plasmid-borne US11 promoter expression and replication of pPJ2

- A. Nuclease S1 analysis of RNA isolated from HeLa cells transfected with pPJ2 and pRED5, and probed for US11/globin hybrid RNA, using the probe indicated in Figure 14b. Transfected cells were either uninfected (u/i), or infected with HSV-1 for the length of time indicated (hours p.a.), prior to harvesting. The indicated bands correspond to US11 initiated hybrids and pRED5 RNAs which map to the pRED5/probe homology break.
- B. Replication assay of pPJ2 plasmid DNA. Unlabelled DNA was prepared from the same cells as in A., digested with DpnI (which does not cut plasmid DNA which has replicated in eukaryotic cells and become unmethylated), and SstI and PvuII (to distinguish between pPJ2 and pRED5). The DNA was run on an 0.8% agarose gel following digestion, blotted onto nitrocellulose, and probed with <sup>32</sup>P-labelled pBR322 DNA. The first two tracks correspond to 1ng of (E.coli-grown) pRED5 or pPJ2 DNA with DpnI omitted from the digest to provide quantitative and positional references. The final two tracks of A. and B. are from single transfections of pPJ2 or pRED5.

inactive in the absence of viral infection, which demonstrated that the plasmid-borne promoter was dependent on virus induced trans-acting factors involved in transcription and replication for its activity. After activation, the pattern and location of the 5' transcriptional starts from the plasmid-borne US11 promoter (Figure 15a) were identical to the transcriptional starts from the viral US11 promoter (Figures 7 and 8). This was confirmed by running S1-protected hybrids of pPJ2 RNAs alongside a sequence ladder derived from the same probe DNA (data not shown). The initial detection of hybrid gene transcripts in transfected HeLa cells occurred after 8h of superinfection (Figure 15a). This is similar to the initial time of detection of viral US11 transcripts in infected HeLa cells (Figure 11a). Thus in the same cell-type, the plasmid-borne and viral US11 promoters are regulated with essentially the same kinetics of induction. The final two tracks in Figure 15a demonstrate the plasmid origin of the indicated US11 or pRED5 bands; the bands at around 200nt are clearly derived from pPJ2 while those at around 155nt are produced from pRED5, the internal control.

#### 4. Replication of pPJ2

Analysis of the regulation of US11 in viral studies demonstrated the importance of viral DNA replication in achieving abundant gene expression (Section H). To test whether the origin of replication in pPJ2 was functional in transfected cells, DNA was extracted from the same cells used in the time-course experiment described above, and the samples were analysed as follows: One-fifth of the total DNA isolated for each time point was digested with SstI, PvuII and DpnI. The SstI/PvuII digestion allowed discrimination between bands arising from pRED5 and pPJ2. DpnI cleaves the sequence GATC provided the A residue is methylated (by propagation of plasmids in dam<sup>+</sup> strains of E.coli), but will not cleave the unmethylated DNA resulting from replication in a eukaryotic cell. Hence the DpnI digestion provides the basis for a sensitive plasmid replication assay in eukaryotic cells (Stow, 1985). The

digested DNA was analysed by Southern blot hybridization, with pBR322 DNA  $^{32}\text{P}$ -labelled in vitro. lng each of pRED5 and pPJ2 DNA were treated as the cellular extracts, but with the omission of DpnI, to allow identification of bands corresponding to replicated pPJ2.

Figure 15b shows the time-course of pPJ2 replication following superinfection with HSV-1. The appearance of DpnI resistant bands corresponding to pPJ2 clearly shows that the plasmid is efficiently replicated after HSV-1 infection of transfected cells. At later times, concatemeric forms of pPJ2 become increasingly resistant to cleavage with SstI and PvuII which is probably due to partial digestion. There are no DpnI resistant bands which correspond to pRED5, indicating that, as expected, this plasmid is not replicated during the course of the transient assay, and that the DpnI digestion was complete in these samples.

#### 5. Quantitation of US11 hybrid transcripts and plasmid replication

The accumulation of US11 hybrid transcripts correlates well with the replication of pPJ2 (Figure 15a,b), and is thus characteristic of normal late gene expression. Using the Southern blot shown in Figure 15b it was possible to estimate the number of plasmid molecules per cell during the time-course. The level of replicated plasmid molecules, which have necessarily spent some time in "active" areas of the nucleus, should give a guide to template availability for transcription. By comparing the relative rise in accumulated hybrid transcripts to replicated plasmid copy number, it was reasoned that information regarding the relationship between copy number and late gene expression could be derived. This is an important question, since as described above (Section H(6)), one theory to account for the mechanism of true late gene expression proposes that the amount of transcription is simply proportional to the copy number of template DNA molecules.

Autoradiographs of the S1 gel shown in Figure 15a and a shorter exposure of the blot shown in Figure 15b (to ensure comparability between lighter and darker tracks) were

Estimated copy number of replicated pPJ2 / cell ( $\times 10^3$ )

Time P.A. (h)	Est. pPJ2 ng/plate	DNA copy no.	US11-hyb. RNA
0	1.7	114.0	-
4	-	-	-
8	0.8	553	1
12	1.8	1170	19
16	11.0	7150	25
20	ND	ND	58
24	21.5	13650	120

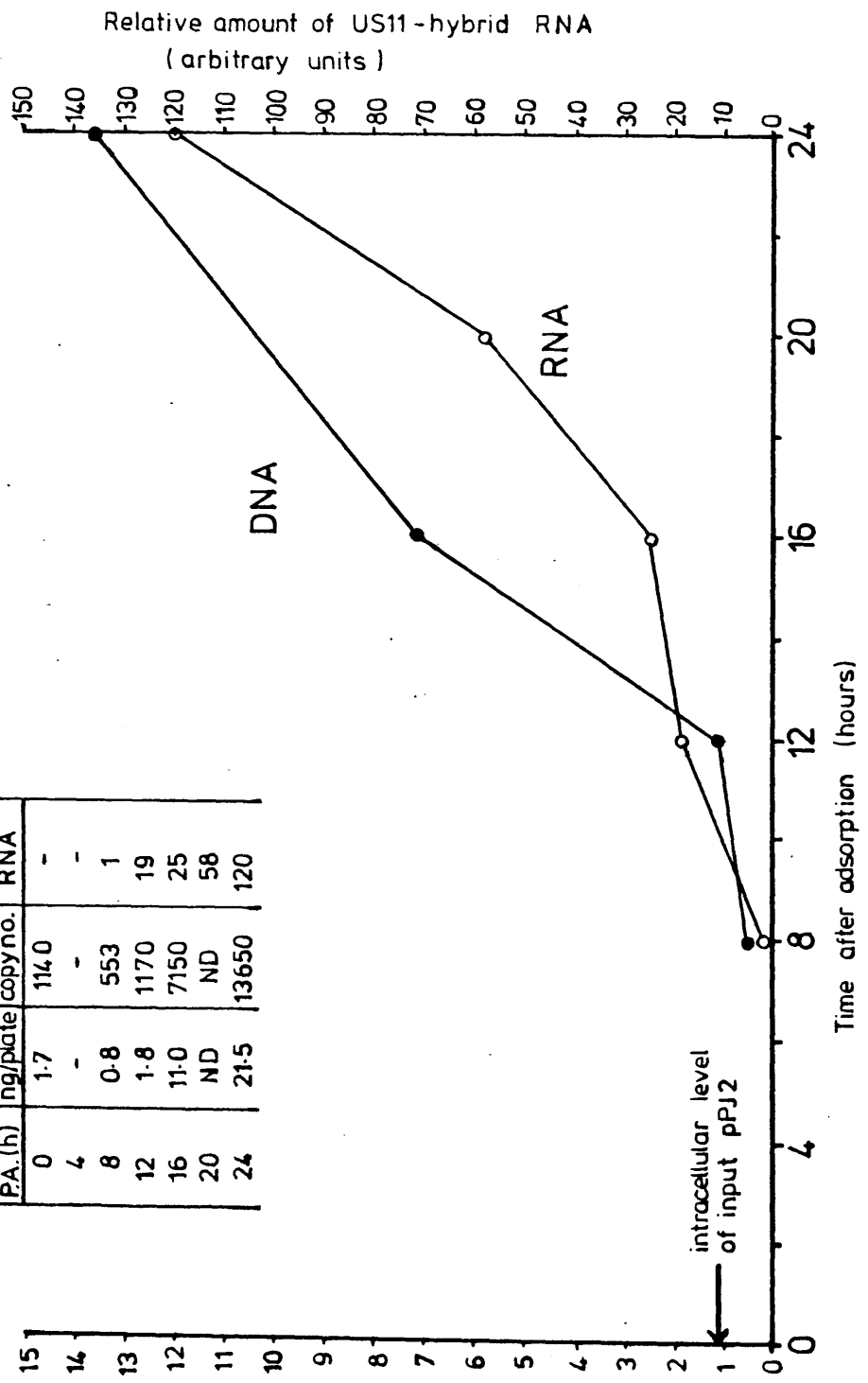

Figure 16. Accumulation of replicated pPJ2 DNA and US11 hybrid transcripts

The graphs of US11 RNA and pPJ2 DNA accumulation correspond to the S1 gel and blot in Figures 15A and 15B respectively. The copy number of pPJ2 was estimated by calculating the ng equivalents of replicated pPJ2 present at each time point (see insert). Since 1/5th of the total DNA from  $2 \times 10^6$  cells was used for each analysis, and on the assumption that 50% of transfected HeLa cells take up calcium phosphate-precipitated DNA (based on immunofluorescence studies with the same cell line; Dr. R. Everett, personal communication),  $1 \text{ ng pPJ2}$  ( $1.3 \times 10^8$  copies) = 650 copies per cell. The level of intracellular input pPJ2 was estimated from the DpnI digested plasmid DNA from uninfected cells, taking into account the proportion of pRED5 DNA. The relative amount of US11-hybrid transcript accumulation takes the first detected level at 8h to be 1.



scanned and quantitated. The estimated level of plasmid copies per cell and the relative accumulation of US11 hybrid transcripts are shown in Figure 16 and the method of calculation is described in the legend.

At 4h p.a. no replicated plasmid DNA was detectable, even on long exposures of the blot (the limit of sensitivity was estimated at approximately 4 copies/cell). Replicated pPJ2 DNA was first detected at 8h p.a., at a level of 530 copies per cell, and doubled between 8 and 12h p.a., and then increased 6-fold during the following 4h (Figure 16). The input (unreplicated) level of plasmid DNA was estimated to be at 1100 copies of pPJ2 per cell (Figure 16), which is consistent with the data of Alwine (1985). Since DNA was extracted from the nuclei of transfected cells, it would seem reasonable to propose that most of the 1100 plasmid copies prior to infection were intranuclear and were available for transcription and replication.

It was notable that US11 hybrid transcript accumulation increased dramatically (at least 10-fold) between 8 and 12h p.a., a period in which replicated plasmid DNA had barely doubled (Figure 16). Thereafter, transcript levels increased 1.3-fold between 12 and 16h, and in 2-fold steps up to 20 and 24h. Hybrid transcript accumulation from 12h onwards increased rapidly, and thus resembled the increase in replicated template from 8h onwards. This experiment suggests that the accumulation of transcripts had increased proportionally with the copy number of replicated template molecules, rather than the total copy number of plasmid molecules in the cell. The implication is that true late gene expression is not regulated simply by total copy number, but that the act of DNA replication of the template in some way allows the onset of efficient late gene expression.

#### 6. Role of DNA replication and IE gene 5 transcription through the US11 promoter on US11 promoter activity

In order to investigate the absolute role of DNA replication and possible effects caused by transcription from the IE 5 promoter on US11 gene expression, a series of

derivatives of pPJ2 were constructed which contained deletions in the region far upstream of the US11 RNA start sites.

The construction of the pPJ2 derivatives, shown in Figure 14c, was as follows. As indicated in Figure 14b, there are five SmaI sites in pPJ2 located in the region far upstream from +1 of US11. By utilizing these SmaI sites, two series of deletions were made, by either (i) XhoI-partial SmaI digestion, followed by filling-in and religation (which reproduces a XhoI site), to create the pPJXn series; or (ii) SstI-partial SmaI digestion followed by, flushing of the overhanging 3' end of the cleaved SstI site with Klenow DNA polymerase, and ligation in the presence of SalI linker oligonucleotides, to create the pPJSn series (where n is the numbered SmaI site shown in Figure 14b). Insertion of the appropriate XhoI-SalI fragments from pPJS3, pPJS2 and pPJS1 into the XhoI site of pPJX5 gave rise to pPJ4, pPJ5 and pPJ8, respectively. pPJ9 was made simply by a partial SmaI digestion of pPJ2 and religation. pPJ6 and pPJ7 were made by SmaI or SmaI-XhoI digestions respectively, of pPJ4, followed by religation. The structures of all the plasmids shown in Figure 14c were checked extensively by restriction analysis.

The activity of the US11 promoter in each of the constructs shown in Figure 14c was determined in short-term transfection assays by quantitative S1 mapping of RNA prepared 16h after HSV-1 superinfection. Typical results obtained by S1 mapping are shown in Figure 17, and the averaged data from at least four independent experiments using more than one preparation of each plasmid was determined (see Figure 14c), using the method of calculation described above (part 2). The pPJ2 derivatives can be split into three groups, on the basis of a broad correlation between inducible promoter activity and far upstream structure:

(i) The activities of pPJ5, pPJ8, pPJX4 and pPJX5 were consistently less than 10% of wild type pPJ2 activity, and their structures have in common the absence of ORI<sub>S</sub>. The

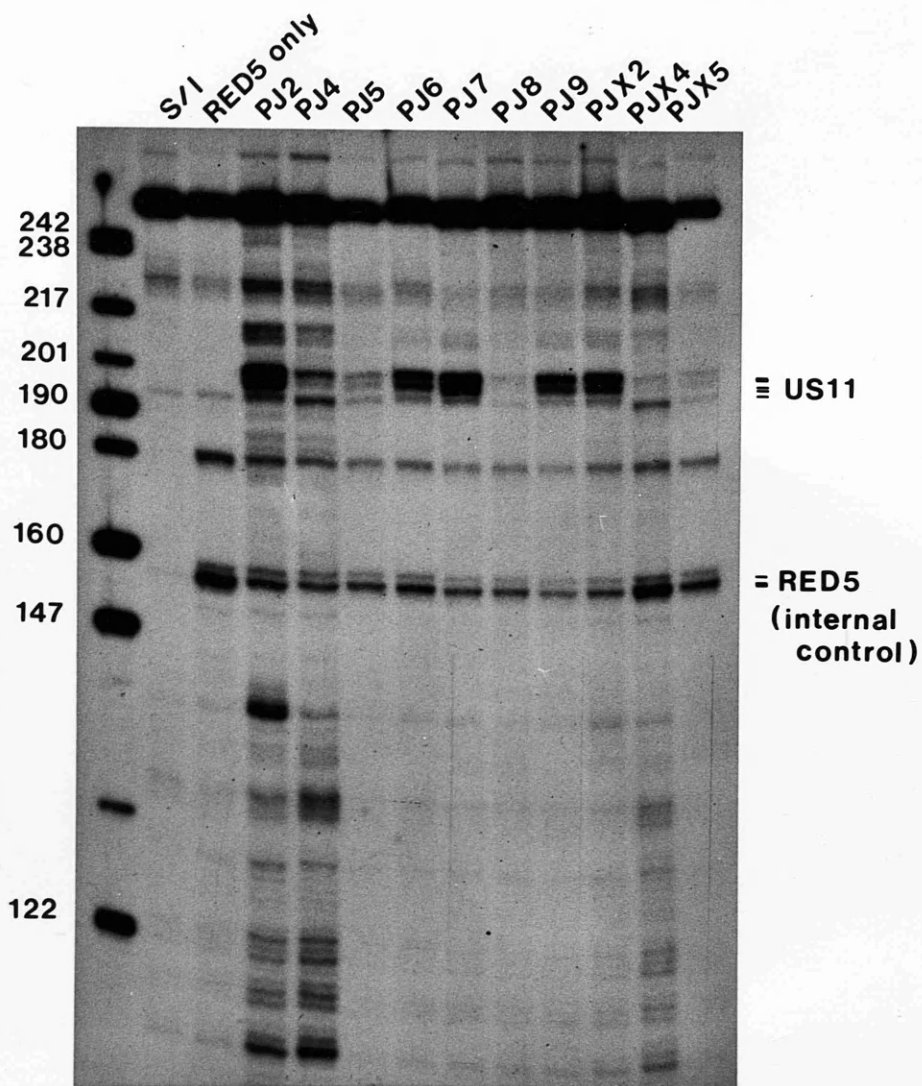

**Figure 17.**     Activation of pPJ-mutant plasmids

The transcriptional activation of pPJ2 and mutant test plasmids (shown in Figure 14) was compared after transfected cells had been superinfected with HSV-1 for 16h. RNAs produced from the US11 hybrid gene and pRED5 are marked. Transfections included 10ug of indicated test plasmid and 10ug of pRED5, except where indicated: S/I = RNA from only superinfected cells; RED5 only = no pPJ-test plasmid (shows that the background level of hybridization at the US11 position is negligible). Size standards are HpaII cut pBR322 DNA.

structure of pPJX4 differs from pPJX2 only by the absence of the origin containing sequence, yet the activity of the pPJX4-US11 promoter was reduced to 3-4% of pPJX2. These results clearly show that deletion of ORI<sub>S</sub> results in a drastic decrease in US11 promoter activity. Analysis of DNA from transfected cells using the DpnI assay described earlier showed a consistent correlation between ORI<sup>+</sup> plasmids and the appearance of replicated plasmid DNA, whilst no DpnI resistant bands were observed in DNA samples where ORI<sup>-</sup> plasmids had been tested (data not shown).

(ii) Plasmids which contain ORI<sub>S</sub> but lack the IE 5 promoter (pPJ4, pPJ6 and pPJ7) have reduced US11 promoter activity compared to pPJ2, but substantially higher levels of expression compared to constructs lacking ORI<sub>S</sub>. Since the IE 5 promoter is absent in pPJ4, pPJ6 and pPJ7, correctly initiated IE 5 RNA cannot be transcribed through the US11 promoter in these constructions. These data indicate that such through-transcription may play a positive role in US11 transcription.

(iii) Plasmids which retain ORI<sub>S</sub> and the IE 5 promoter have similar levels of expression compared to pPJ2, as seen with pPJX2, or substantially higher, in the case of pPJ9. The result with pPJ9 suggested that the presence of the IE 5 far-upstream regulatory sequence may be acting negatively on US11 promoter activity, but this hypothesis was inconsistent with the results obtained for pPJX2. Similar comparison between the activities and structures of pPJ4, pPJ6 and pPJ7 yielded no obvious role for the far-upstream element of IE gene 5 in modulating US11 promoter activity.

## 7. Conclusions

These experiments demonstrated that the regulation of a plasmid-borne US11 promoter closely mimicked that of its viral counterpart during productive infection. In response to activation during HSV-1 infection, correctly initiated transcripts were produced from the plasmid copy of the US11 promoter with the same kinetics as viral transcripts, and

their appearance coincided with the onset of DNA replication. Hybrid transcripts were not detected in mock-infected cells, indicating that induction of the plasmid-borne promoter, like its viral counterpart, requires viral gene products.

An important question is the validity of extrapolating findings from the transient assay to the viral situation. Several lines of evidence suggest that promoter regulation in a transient assay is representative of viral gene regulation. The intact plasmid-borne US11 (this study) and gD (Everett, 1983) promoters behaved in transient assays like their viral counterparts, and a series of mutations in the tk promoter upstream of the mRNA cap site exerted qualitatively similar effects in both transient assays and reconstructed viral genomes (Eisenberg et al., 1985; Coen et al., 1986). In addition, both plasmid and viral DNA molecules are in open chromatin structure in the nucleus (Leinbach and Summers, 1980; Cereghini and Yaniv, 1984), suggesting that their physical state may be similar.

The greater than 90% reduction in US11 initiated transcript accumulation from replication-inhibited viral genomes (Figure 9 - Section H), and ORI<sup>-</sup> plasmids (Figure 14c - with the exception of pPJ5), is strikingly similar. Allowing for a particle/pfu ratio of 20-50 in the HSV-1 stock (determined by Mr. J.Aitkin), the number of viral genomes entering a cell at an moi of 20 pfu is unlikely to exceed the 500-1000 intracellular transfected plasmid copies estimated in these experiments. This comparison suggests that plasmid and viral templates are transcribed with similar poor efficiency in the absence of replication.

In contrast to the experiments using inhibitors of DNA replication (see Section H), it is possible to state with more confidence on the evidence of this transient assay system (using plasmids which lack a eukaryotic origin of replication), that US11 can be expressed from unreplicated template DNA. However, it is important to stress that in both the transient assay system and the viral situation, DNA replication played a major role in achieving abundant expression. An obvious role for replication would be to

increase the copy number of an intrinsically weak promoter, but it is also possible that template replication per se plays a role in increasing late promoter activity; this latter possibility is more consistent with the data described above than the former. The possible mechanisms involved in achieving abundant late gene expression through DNA replication are considered in more detail in the final Discussion.

## SECTION J: Sequence Requirements For Regulated Activity of a Late Promoter

As discussed in Section E of the Introduction, the criteria which define an IE gene have been unambiguously defined. At the sequence level, IE genes are characterized by the presence of a far-upstream region which includes the consensus sequence, TAATGARATTC, in addition to a promoter region 5' flanking the IE RNA start sites (Mackem and Roizman, 1982a,b; Whitton et al., 1984; Preston et al., 1984). The promoters of E and EL genes which have been characterized include a proximal TATA box (in the -25 region) and an "upstream" region (usually between -35 to -100) (Everett, 1984b; Costa et al., 1985b; Eisenberg et al., 1985; Coen et al., 1986). The basis for the difference in the expression kinetics of early and late genes had not been discovered due to the lack of detailed molecular studies on late promoters. In this section, an investigation of the sequences which characterize a late promoter and which distinguish it from early promoters is described.

### 1. Construction of US11 promoter deletion mutants

Efficient expression of a plasmid-borne US11 promoter following HSV-1 infection of transfected cells requires the presence of ORI<sub>S</sub> (Section I). It was therefore decided to study the activity of US11 promoter deletion mutants in

plasmids which contain ORIS. The fragment containing ORIS used in most of these deletion constructs also contains the regulatory sequences of IE gene 5. This was intentional since transcription through the US11 promoter from the IE 5 promoter played a positive role in achieving high levels of US11 promoter activity in the previous experiments (Section I).

Deletions extending towards the US11 promoter were made by Bal31 exonuclease digestion of XhoI- cut pPJX5; this plasmid contains a single XhoI site at -444 relative to +1 of US11 (Figure 14c). The result of increasing exposure to exonuclease on the length of the XhoI-BamHI fragment of pPJX5 is shown in Figure 18a. Following termination of the exonuclease reaction, plasmid DNA was recircularised by ligation in the presence of Sall linker oligonucleotides. The Sall linker therefore defines the limit of the deletion. Plasmid pPJS5 is a derivative of pPJ2, and contains a Sall linker at position -444 (Figure 18b). Thus fusion of the Sall site of a deletion plasmid to the Sall site of pPJS5, as outlined in Figure 18b, created the pPJO.n series of plasmids - where 'n' refers to the number of nucleotides 5' to the US11 start site. The various deletion constructs used in this study are shown diagrammatically in Figure 19c.

## 2. Transcriptional activation of the pPJO series

Plasmids were transfected into HeLa cells with the internal control plasmid pRED5 (see Section I(2)), to allow standardization of the transfection procedure. The cells were washed 24h after transfection, infected with HSV-1, and RNA isolated 16h after infection. Correctly initiated US11 hybrid transcripts were detected by S1 mapping, using the <sup>32</sup>p end-labelled single-stranded DNA probe shown in Figure 19b. This probe is identical to that described in Section I. The level of correctly initiated US11 RNA from the promoter deletion series of plasmids was compared to the level from pPJ2, after normalization of the individual transfections efficiencies (determined by comparison to the level of detected RNA corresponding to pRED5).

Preliminary experiments indicated that US11 expression

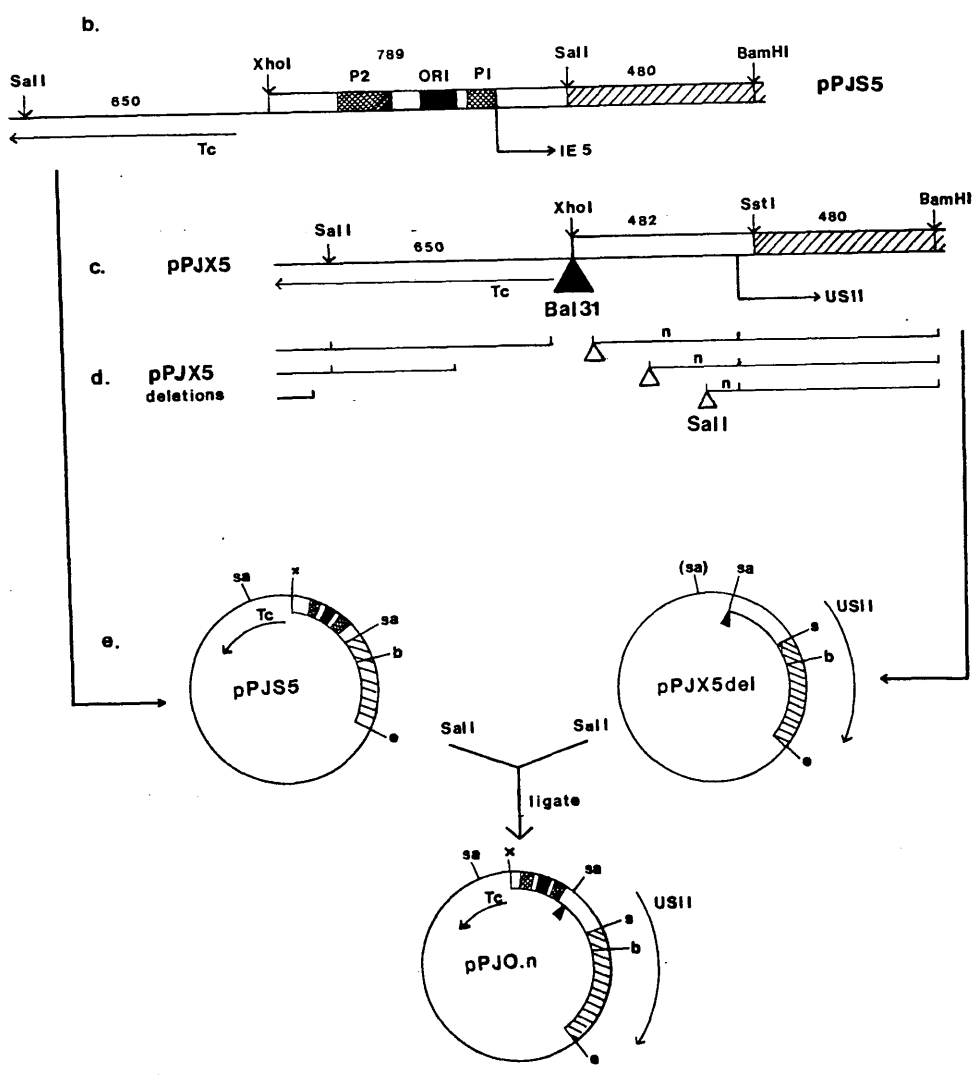
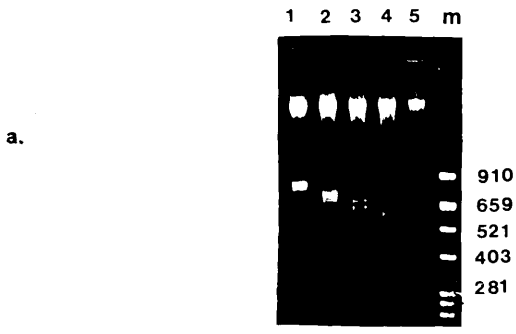



Figure 18. Construction of the pPJO.n series

pPJX5 DNA was cut with XhoI and treated with Bal31 exonuclease for various lengths of time (c). Samples from each time point were digested with BamHI and run on a 1.5% agarose gel to determine the approximate extent of the deletions. pPJX5-deleted DNA was then recircularized in the presence of SalI linker oligonucleotides (pPJX5del; d). In order to obtain finer control over the extent of the deletions, a pPJX5del plasmid which had lost about 200bp of HSV DNA was cut with SalI and treated as above; the ethidium bromide-stained agarose gel in (a) shows the effect of Bal31 treatment for 0, 1, 2, 5 and 10 minutes (tracks 1-5), size standards were provided by AluI cut pBR322 DNA. Appropriately deleted DNA was again recircularized by ligation in the presence of SalI linker oligonucleotides. The 1439bp SalI fragment of pPJS5, which contains the ORIs and the IE 5 regulatory elements (b), was isolated from an agarose gel (Materials and Methods). SalI-cut pPJX5del DNA (e) was ligated in the presence of the 1439bp pPJS5 SalI fragment, and recombinants were selected in the presence of tetracycline; the exonuclease treatment of pPJX5 causes inactivation of the bacterial tetracycline resistance gene (Tc). The precise extent of the deletions were determined by DNA sequencing, and 'n' refers to the number of nucleotides upstream from the US11 RNA start sites (d,e). Abbreviations and representations are as in Figures 13 and 14 [sa = SalI, and may be lost (sa), in some pPJX5del plasmids].

from pPJO plasmids with deletions extending to -70 was not impaired. Analysis was therefore concentrated on constructs with deletion end-points downstream from -70. The results of a typical transfection experiment are shown in Figure 20. A summary of the data derived from multiple transfections using pPJO.61,41,31 and 21 is given in Figure 19c.

Deletion of sequences upstream from the US11 cap sites had no effect on inducible promoter activity until the deletion end-point had passed -31. The observation that sequences 3' of -32 are sufficient for abundant US11 transcription was striking. Most of the TATA box (see Figure 19a) is lost in pPJO.21, so the corresponding decrease in the level of correctly initiated transcripts from this construct was not surprising. Higher levels of expression were reproducibly observed from the pPJO series of plasmids (deletion end points -31 or upstream) compared to pPJ2 (Figure 19c). If DNA replication and through-transcription from the IE 5 promoter potentiate the US11 promoter by opening up the template structure (Johnson and Everett, 1986a), then the increased transcription from pPJO.61, 41 and 31 may be because the initiation of both replication and IE gene 5 transcription is closer to the US11 promoter in these constructs than in pPJ2. However, the possibility of sequences required for a negative effect on US11 transcription, contained within the region -444 to -61, cannot be ruled out.

Further constructs were made to investigate the possibility that the IE 5 promoter, or other sequences upstream of -444, might be providing surrogate promoter functions for the -31 US11 promoter construct. The deletion of sequences 5' to the SalI linker, up to and including the IE gene 5 promoter (in plasmid pPO.31, Figure 19c), resulted in a promoter only slightly less efficient than pPJ2. Inversion of the SalI fragment in pPO.31 (see Figure 18b) puts prokaryotic sequences (encoding part of the tetracycline resistance gene) adjacent to the -31 deletion point. This plasmid, pPO'31 (not shown) gave similar levels of US11 promoter activity compared to pPO.31 and pPJ2. The sequences adjacent to the US11 TATA box in pPJO.31, pPO.31,

A.

```

-70      -60      -50      -40      -30      -20
CTGGACACCA TCGGGGTTGG GCCCAGGACG TAGCGGATGA GATCAATAAA AGGGGGCGTG
-10      +1      +10      +20      +30
AGGACCGGGA GCGGGCCAGA ACCGCCGTGC ACGACCCGGA GCGTCCCCTG/SstI/β-gI.

```

US11 RNA

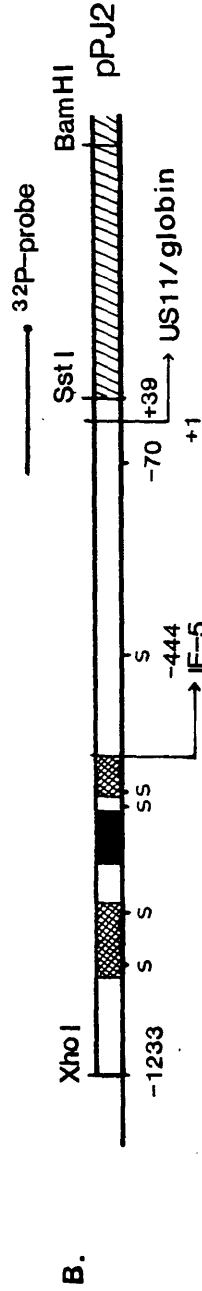

C.

Construct	Start	End	% pPJ2	± SEM
pPJO.61	-61	-	365	114
pPJO.41	-41	-	222	78
pPJO.31	-31	-	328	117
pPJO.21	-21	-	4	2
pPO.31	-31	-	83	22
pP.31	pP.31	-	4	-

Figure 19. Structure of the US11/ $\beta$ -globin hybrid gene promoter region and activities of US11 promoter-deletion mutants

- A. DNA sequence of the US11 promoter region, -70 to +39, in pPJ2. The positions of the RNA starts and the consensus TATA box are indicated.
- B. Structure of pPJ2. HSV-1 DNA (-1233 to +39) is joined to rabbit  $\beta$ -globin DNA at an SstI linker oligonucleotide. The key for pPJ2 is contained in the legend to Figure 14.
- C. Structures and activities of mutant test plasmids. Gaps represent deleted sequences, whose 3' end-points align to the indicated SmaI sites, and are joined by a SallI linker to 5' deletions (-21 to -61) of the US11 promoter. The 3' end-point of pP31 is the SallI site of pBR322 (see Figure 18). The mean transcriptional activities (+/- standard error of the mean; SEM) of the transfected mutant constructs after 16h viral infection, are shown on the right.

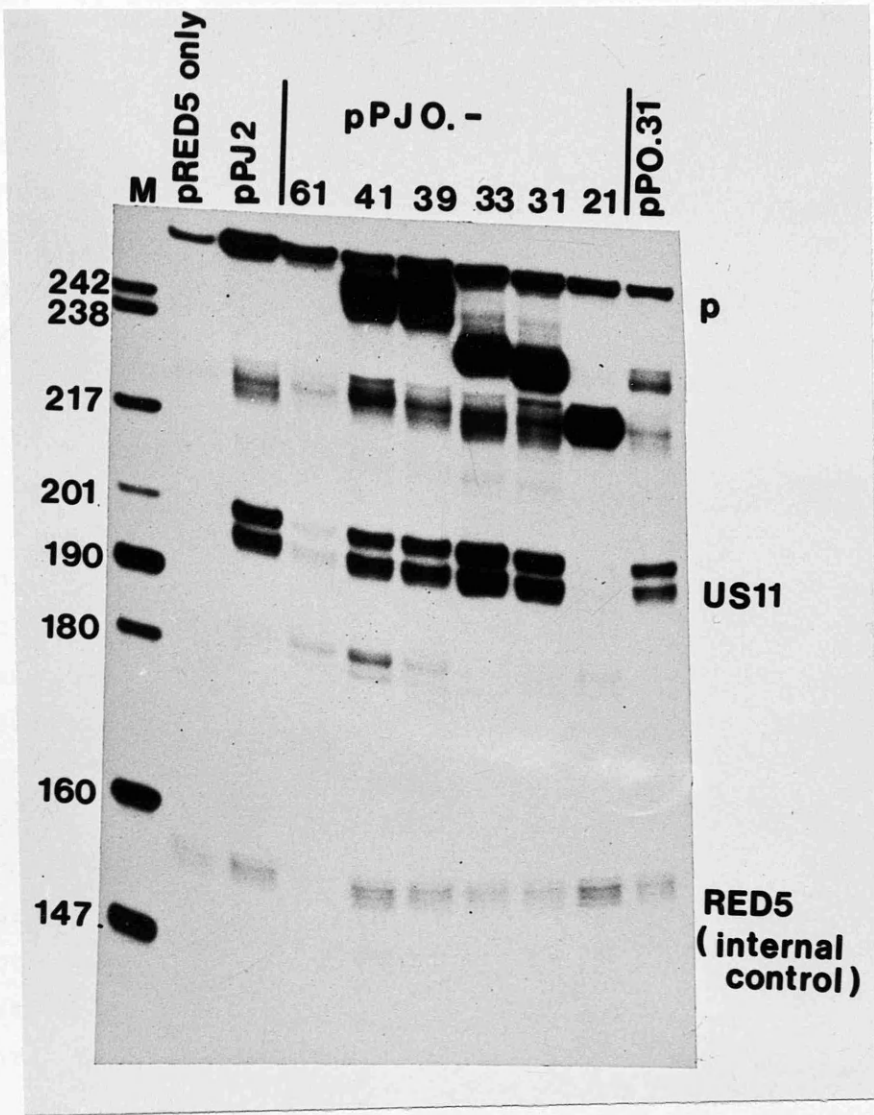

**Figure 20.** S1 analysis of transcriptional activation of the mutant US11 promoter constructs after 16h superinfection of transfected cells with HSV-1. RNAs produced from the US11 hybrid gene and pRED5 are marked. Transfections included 10ug of test plasmid and/or 10ug pRED5, as indicated. The band marked 'p' corresponds to full length probe. Size standards are HpaII-cut pBR322 DNA. The ratio of US11 initiated RNA compared to pRED5 RNA was determined by densitometry, and the averaged results from multiple experiments are given in Figure 19C. The poor detection of both US11 and pRED5 in the pPJO.61 track demonstrates the importance of the internal control.

pPO'.31 and pPJ2 are entirely different, which implies that they are not providing a distal upstream promoter region.

These results suggest that the US11 promoter does not have an essential "upstream" promoter region analogous to those of the HSV-1 tk and gD promoters (Eisenberg et al., 1985; Everett, 1984b): the TATA box and cap site region are necessary and sufficient to allow fully efficient regulated expression.

### 3. Effects of replication and transcription through the -31 US11 promoter

Previous studies have indicated that transcription through the US11 promoter has a positive effect on its activity (Section I(6)). The effects of an absence of IE gene 5 transcription on the activity of the minimal (-31) US11 promoter are illustrated by plasmid pPO.31. US11 transcription from pPO.31 was only slightly reduced compared to pPJ2, but around 4-fold less compared to pPJO.31 (Figures 19c and 20). Inducibility of the US11 promoter in the absence of the IE 5 promoter indicates that the latter does not provide an essential function for US11 promoter activity, but does support the conclusion that transcription through the US11 promoter increases its expression.

In the absence of ORI<sub>S</sub> or other HSV sequences upstream from -31, the US11 promoter was poorly expressed (see pP.31, Figure 19c). The level of expression from pP.31 was similar to an undeleted US11 promoter in an ORI<sup>-</sup> environment (for example, see plasmids pPJX4 and pPJX5 in Figure 14c, Section I(6)).

### 4. Does a TATA box constitute a functional late promoter ?

The experiments described above show that HSV-1 sequences between -31 and +39 are sufficient for efficient expression of US11. This region includes a consensus TATA box homology beginning at position -26, as indicated in Figure 19a. If a TATA box alone is sufficient for late gene expression it should be possible to induce "late" expression from the TATA box of other promoters, which do not otherwise share homology with US11. This ....

hypothesis was tested using a deletion mutant of the HSV-1 gD promoter. During viral infection the gD gene is regulated with EL kinetics and is only moderately sensitive to inhibition of DNA replication (Section H). The necessary proximal and distal promoter elements for normal gD expression lie within 83bp of the gD mRNA cap sites (Everett, 1983). A TATA box is located at position -25 to -20 (Figure 21a), and has been shown to be essential for accurate initiation of gD transcription (Everett, 1984b). Deletion of the distal promoter sequences upstream of the TATA box leads to a greater than 25-fold decrease in gD promoter activity in the absence of DNA replication (Everett, 1983).

#### 5. Construction of a "late" gD promoter

It was decided to examine the transcriptional activity of a -33 deletion mutant of the gD promoter (which retains a TATA box), in an ORI<sup>+</sup> environment. The IE gene 5 regulatory sequences and ORI<sub>S</sub> from the SallI fragment of pPJS5 (as described in part 1) were placed upstream from a -33 deletion mutant of gD (pRED122 - see Everett, 1983; 1984b), to give pOR33 (Figure 21c). Induction of pOR33 was compared with pERD130/33, which has gD sequences -2045 to -130 incorporated upstream from the -33 deletion end-point (Figure 21c). pERD130/33 thus provides a negative control for the induction of the -33 deleted gD promoter in an ORI<sup>-</sup> environment. To eliminate possible surrogate promoter effects by IE gene 5 in pOR33, an ORI<sub>S</sub>-containing fragment from pPJS3 (Section I(1)), which lacks the IE 5 promoter, was placed upstream from the -33 deletion to create pRO33 (Figure 21c). For comparison with the -33 gD promoter, analogous constructs were made using a -83 promoter deletion (pERD130/83, pOR83 and pRO83), which retains all the cis-acting DNA sequence elements for properly regulated expression of the gD promoter (Everett, 1983).

## 6. Transcriptional activation of a "late" gD promoter

Transcriptional activation of the gD promoter constructs shown in Figure 21c was examined at early (4h) and late (16h) times after HSV-1 infection of transfected cells. The relative promoter activities were determined by quantitative S1 mapping using the  $^{32}\text{P}$  5' end-labelled probe indicated in Figure 21b. Standardization of the transfection procedure was by reference to the level of globin transcripts from a co-transfected internal control plasmid,  $\text{p}\beta(244+)\beta$ , (Everett, 1983); bands corresponding to RNA from this plasmid are indicated in Figure 22. The activities of the various gD promoter constructs were compared to and expressed as percentages of the level of gD hybrid RNA from pERD130/83. Since both the level of accumulated globin (Figure 22, and data not shown) and gD transcripts decrease at late times (Section H - Figures 8 and 9), the activities determined at the two time-points in Figure 21c are not directly comparable.

In an  $\text{ORI}^-$  environment, induction of the -33 gD promoter in pERD130/33 is poor at both early and late times (Figures 21c and 22). This is consistent with previous findings (Everett, 1984b). The addition of  $\text{ORI}_S$  to the -33 gD promoter in pOR33 and pRO33 produced a dramatic increase in gD initiated transcripts at late times (Figures 21c and 22). This result demonstrated that the gD TATA box region alone can function as a late promoter in an  $\text{ORI}^+$  environment. Deletion of the IE 5 promoter in pRO33 reduced gD promoter activity at late times compared to pOR33 - transcription through the gD 'TATA box promoter' thus has a similar effect as seen with the US11 promoter (Figures 16c and 21c).

Some unexpected effects were observed with the introduction of  $\text{ORI}_S$  to plasmids containing a complete or deleted gD promoter. At early times, pOR33 and pRO33 were usually (but not always) moderately active (Figure 21c). This early activity probably occurred in assays where DNA replication had commenced before cells were harvested. It was also noticed that at early times the presence of  $\text{ORI}_S$  reduced expression from the -83 promoter (pRO83) and this



A. -90 -80 -70 -60 -50 -40  
 CACCGACGAA TCCCCCAAGG GGGAGGGGCC ATTTTACGAG GAGGAGGGGT ATAACAAAGT  
 -30 -20 -10 +1  
 CTGTCCTTAA AAAGCAGGGG TTAGGGAGTT GTTCGGTCATAAGCTT /  $\beta$ -globin  
 gD RNA

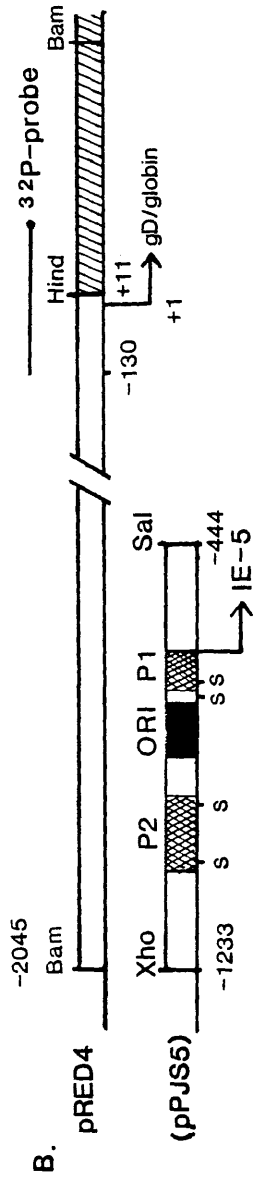

C.

Construct	4hrs	16hrs
pRED 130/83	100	100
pOR83	28 (11)	352 (128)
pRO83	64 (25)	306 (102)
pRED 130/33	7 (2)	5 (0.5)
pOR33	20 (15)	197 (45)
pRO33	19 (13)	72 (14)

% pRED130/83  
 ( $\pm$  SEM)

Figure 21. Structure of the gD/ $\beta$ -globin hybrid promoter region and activities of mutant gD promoter constructs

- A. DNA sequence of the gD/ $\beta$ -globin promoter, from -90 to +11, in pRED4. The positions of the RNA starts and the consensus TATA box are shown.
- B. HSV-1 DNA (-2045 to +11) is joined to rabbit  $\beta$ -globin DNA at the HindIII site beginning at +11. The probe derived from pRED4 for detecting gD- and globin-initiated RNA (labelled at +136) is shown above (kindly supplied as an unlabelled fragment by Dr.R.D.Everett). The structure of the HSV-1 ORI<sub>S</sub>-containing fragment from pPJS5 is shown below pRED4.
- C. Structures and activities of the mutant test plasmids. Deletions into the gD promoter, 5' delineated by a XhoI linker oligonucleotide, are joined to: (i) -2045 to -130 gD upstream DNA (3' XhoI) - pRED130/n; (ii) -1233 to -444 US11 upstream DNA (3' SalI) - pORn; or (iii) -1233 to -714 US11 upstream DNA (3'SalI) - pRON, where 'n' is the -83 or -33 gD promoter deletion end-point. The mean relative transcriptional activities (+/- SEM) after 4 or 16h viral superinfection are shown on the right (pRED130/83 = 100%). Note that the results at the two time points are not directly comparable since between 4 and 16h superinfection, the accumulation of plasmid-derived gD transcripts in HeLa cells is reduced by around 20%.

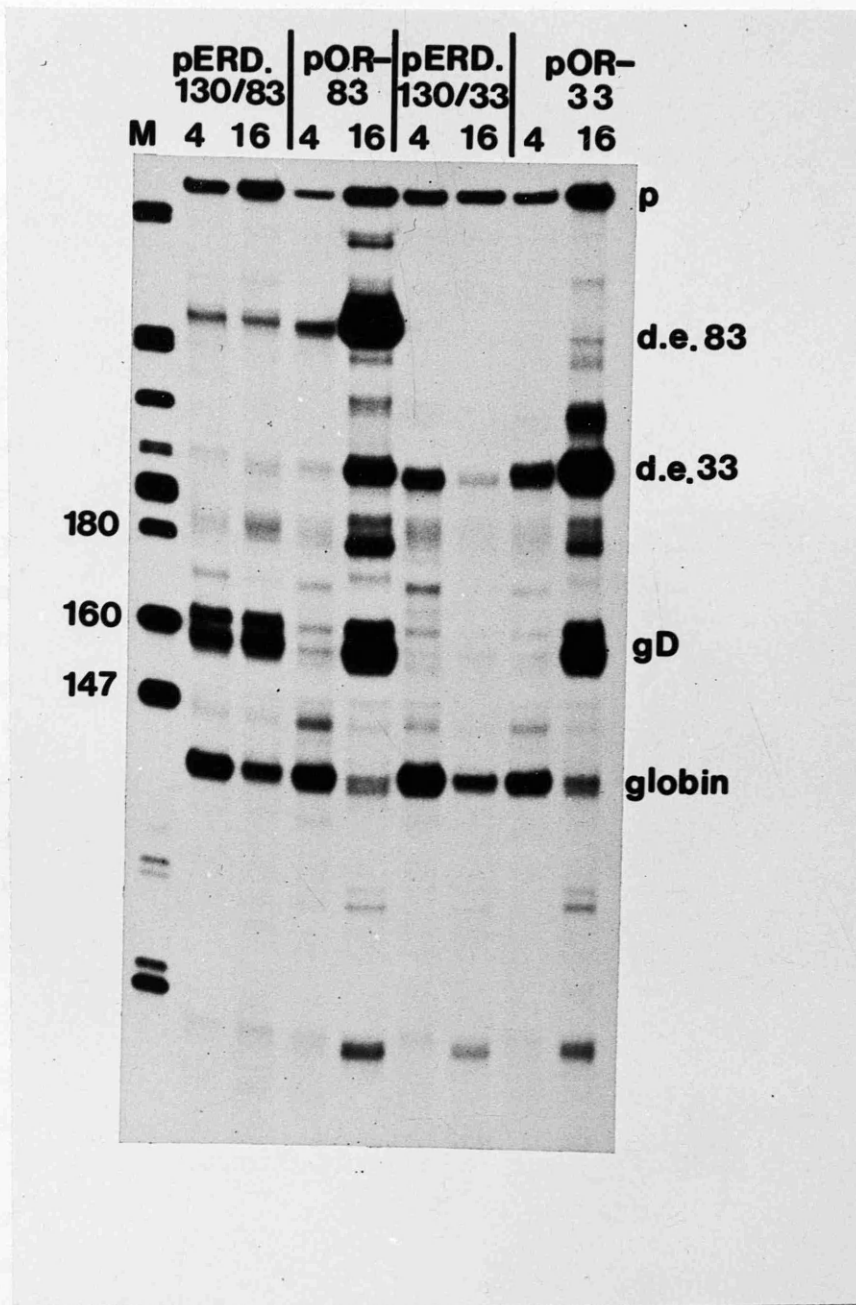

**Figure 22.** S1 analysis of transcriptional activation of mutant gD promoter test plasmids after 4 or 16h viral activation. Transcripts initiated from the gD test plasmids and the  $\beta$ -globin internal control plasmid, p $\beta$ (244+) $\beta$ , are marked. Full length probe (p) and bands corresponding to the break in homology at the -83 and -33 deletion end-points (d.e.), are indicated.

reduction was more marked in the presence of the IE 5 promoter (pOR83 - Figures 21c and 22). It is interesting that through-transcription and replication appear to have the converse effect on the fully functional gD promoter compared to that on US11 and the -33 deleted gD promoters - they down regulate a functional EL promoter at early times. It could be argued that the effect of replication and the presence of the upstream IE 5 promoter is to increase competition for cellular factors, and thus cause a reduction in gD promoter activity. However, at late times ORI<sub>g</sub> is responsible for increased activity of the -83 gD promoter (Figure 21c), which suggests that cellular factors are not in short supply, unless gD is then activated by a different mechanism. It was shown in previous experiments that the presence ORI<sup>+</sup> or ORI<sup>-</sup> plasmids did not appear to influence the level of RNA derived from the co-transfected internal control plasmid, pRED5 (Figure 17 - Section H), which suggests that the negative effect of ORI<sub>g</sub> on gD promoter activity at early times is due to a cis-linked mechanism, i.e. replication.

Negative effects on transcription caused by replication and through-transcription have been documented in recent reports. Replication of SV40-based plasmids in 293 cells (which express the adenovirus Ela region and are proficient for SV40 DNA replication in the presence of T antigen) caused repression of transcription from the SV40 early promoter; expression was increased in the presence of inhibitors of DNA replication or with DNA<sup>-</sup> mutants of SV40 T antigen (Lewis and Manly, 1985; Lebkowski et al., 1985). Proudfoot (1986) studied the transcription of two tandemly duplicated  $\alpha$ -globin genes located either on a plasmid or integrated into the genome of biochemically transformed cells. Transcription of the downstream  $\alpha$ -globin gene was repressed by transcription of the upstream  $\alpha$  gene, unless separated by transcription termination signals. It is possible that DNA replication and through-transcription interfere with the activity of susceptible promoters in a similar way; they might reduce the ability of cellular transcription factors to bind to promoter DNA due to its

altered, open structure.

## 7. Conclusions

Gene US11 is regulated with "true-late" kinetics (Section H). A plasmid-borne promoter containing a functional HSV origin of DNA replication can mimic these kinetics in a transient assay (Section I). Here, the function of US11 promoter deletions has been investigated in a transient assay system using plasmids which contain ORIs. It is shown that, in clear contrast to the requirements of early promoters, the DNA sequence elements required for fully efficient regulated expression of US11 lie within 31bp of the RNA cap sites.

Visual comparison of the DNA sequences upstream from the US11 cap sites with the well characterized tk and gD promoters yielded no obvious homology, with the exception of a proximal TATA box region (Eisenberg et al., 1985; Everett, 1984b). Thus it seemed possible that an HSV late promoter might be characterized by the presence of a TATA box in the absence of distal regulatory sequences upstream. It was predicted that the EL regulation of the gD promoter might be converted to typical late gene kinetics, following (i) removal of sequences upstream from its TATA box, and (ii) linkage to the ORI<sub>S</sub> origin of DNA replication. This prediction was confirmed with constructs pOR33 and pRO33, both of which contain an upstream to -33 deletion of the gD promoter in an ORI<sup>+</sup> environment, and are inducible at late times after infection with HSV-1 (Figure 21c). These results demonstrate that there is a clear difference in the sequence requirements for proper regulation of a model EL and a model L promoter.

Previous studies have shown that transcription through the US11 promoter from the upstream IE gene 5 promoter plays a positive role in achieving abundant US11 transcription (Section I). The results shown in this section suggest that transcription through either the minimal US11, or the 'converted late' gD promoters, increases standard late promoter activity. In the pPJO series of constructs and pOR33 (Figures 19c and 21c) the IE gene 5 promoter (in the

ORIG-containing fragment) was placed immediately upstream from the US11 and gD deletion end-points. Conceivably this might have enabled the IE gene 5 regulatory region to provide surrogate promoter functions on US11 and gD. This possibility was dismissed by constructs pPO.31 and pRO33, in which the IE gene 5 promoter had been deleted. Despite the complete change of sequences upstream of their TATA box regions, both promoter constructs exhibited substantial activities at late times (Figures 19c and 21c).

Furthermore, inversion of the ORIG-vector fragment in pPO.31 and pRO33 (which places pBR322 vector sequences immediately upstream of the US11 and gD TATA box regions) did not alter the level of induced expression (data not shown). This indicated that the position or nature of the DNA sequences upstream of the deleted promoters made no essential contribution to their inducible expression at late times after infection.

Thus, features that distinguish an HSV late promoter and account for its characteristic late induction kinetics have been identified. If US11 is typical of HSV true late promoters [the HSV-1 late gene, gC, has been shown to have similar sequence requirements (Homa *et al.*, 1986)], then the relationship between the three temporal classes of HSV promoters may be summarised as shown in Figure 23. This illustrates that as infection proceeds and after DNA replication occurs, fewer regulatory signals are required for efficient transcription from promoters of different temporal classes.

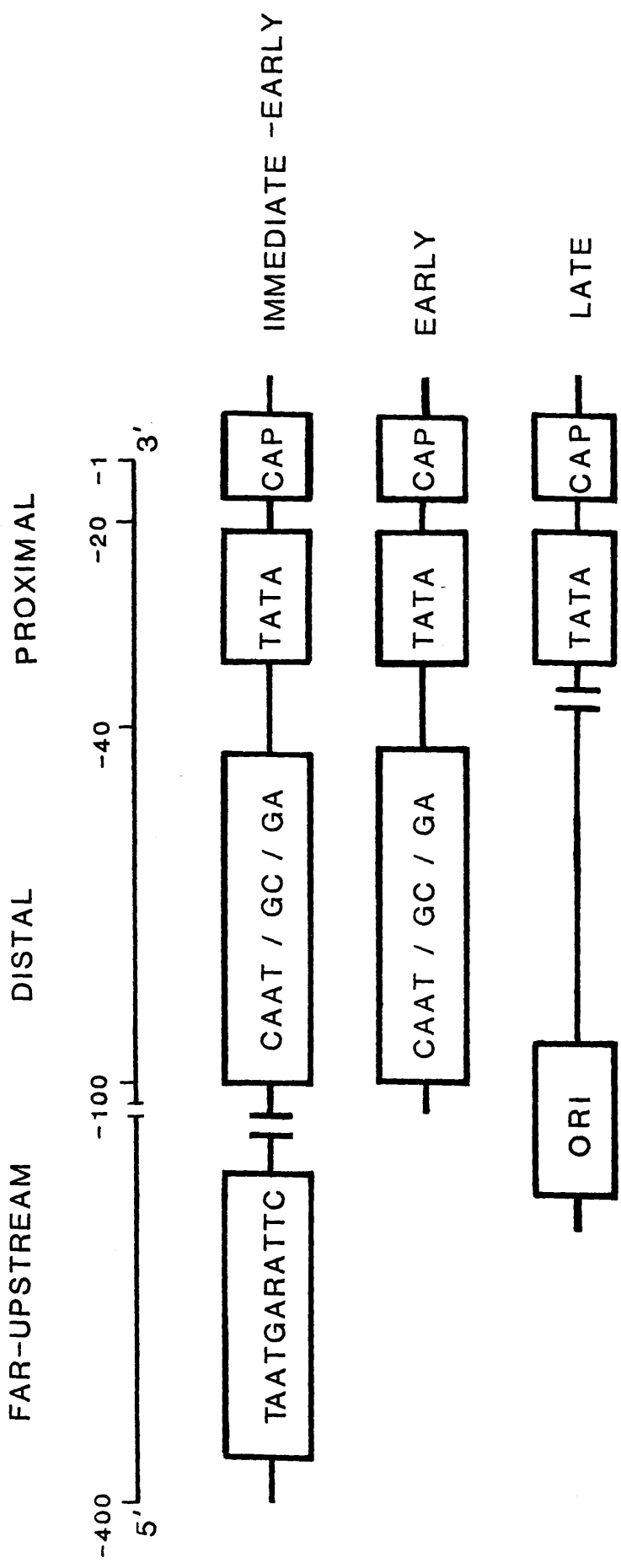

Figure 23. Regulatory signals required in cis for the efficient expression of HSV-1 genes  
(from Johnson and Everett, 1986b)

The far-upstream element of IE genes, required for activation by the virion component, Vmw65, includes the consensus sequence TAATGARATTC, in addition to flanking modulatory sequences. The distal promoter elements of IE and E genes contain one or more copies of at least one of the following: (i) GC-rich motifs, (ii), GA-rich motifs, (iii) a CAAT box. Late promoters, which contain only a TATA box-cap site region (CAP), require an active origin of DNA replication (ORI) in cis for their efficient expression.



SECTION K: Trans-activation of US11

The aim of the experiments described in this section was to identify viral gene products involved in trans-activation of the US11 promoter. This was first attempted in an ORI<sup>+</sup> environment by use of a replication system that does not require HSV gene products (part 1). However, this approach did not meet with success, for the reasons mentioned below. The second approach (parts 2-6) was to use the sensitive chloramphenicol acetyltransferase assay (CAT) to facilitate the detection of US11 promoter activation in the absence of template replication. This led to the identification of at least two IE gene products involved in US11 promoter activation.

1. Replicative Conditions: Incorporation of the SV40 origin of replication into pPJ2

Plasmids containing the SV40 origin of replication (ORI<sub>SV</sub>) are replicated in COS cells due to the presence of SV40 T antigen. It was reasoned that the addition of ORI<sub>SV</sub> to plasmid pPJ2 would enable US11 promoter activation to be studied on replicated template without a requirement for HSV replication functions. The effect of individual HSV gene products on US11 promoter activity might then be determined by co-transfection of COS cells with plasmids bearing isolated HSV genes.

The construction of pPJSV2 is outlined in Figure 24. This plasmid contains a 200bp SphI-HindIII fragment from the control region of SV40 (including ORI<sub>SV</sub>, but not the SV40 enhancer), inserted into the HindIII site of pPJ2.

Unfortunately, US11 hybrid RNA was not detectable in pPJSV2 or pPJ2 transfected COS cells which had been mock- or super-infected with HSV-1. Only very low levels of replicated pPJSV2 could be detected in DNA isolated from transfected COS cells, suggesting that the failure to observe US11 expression was due to an inadequate transfection efficiency (data not shown). It might have been possible to improve the transfection efficiency by either (i) using different COS cell lines, or (ii) trying

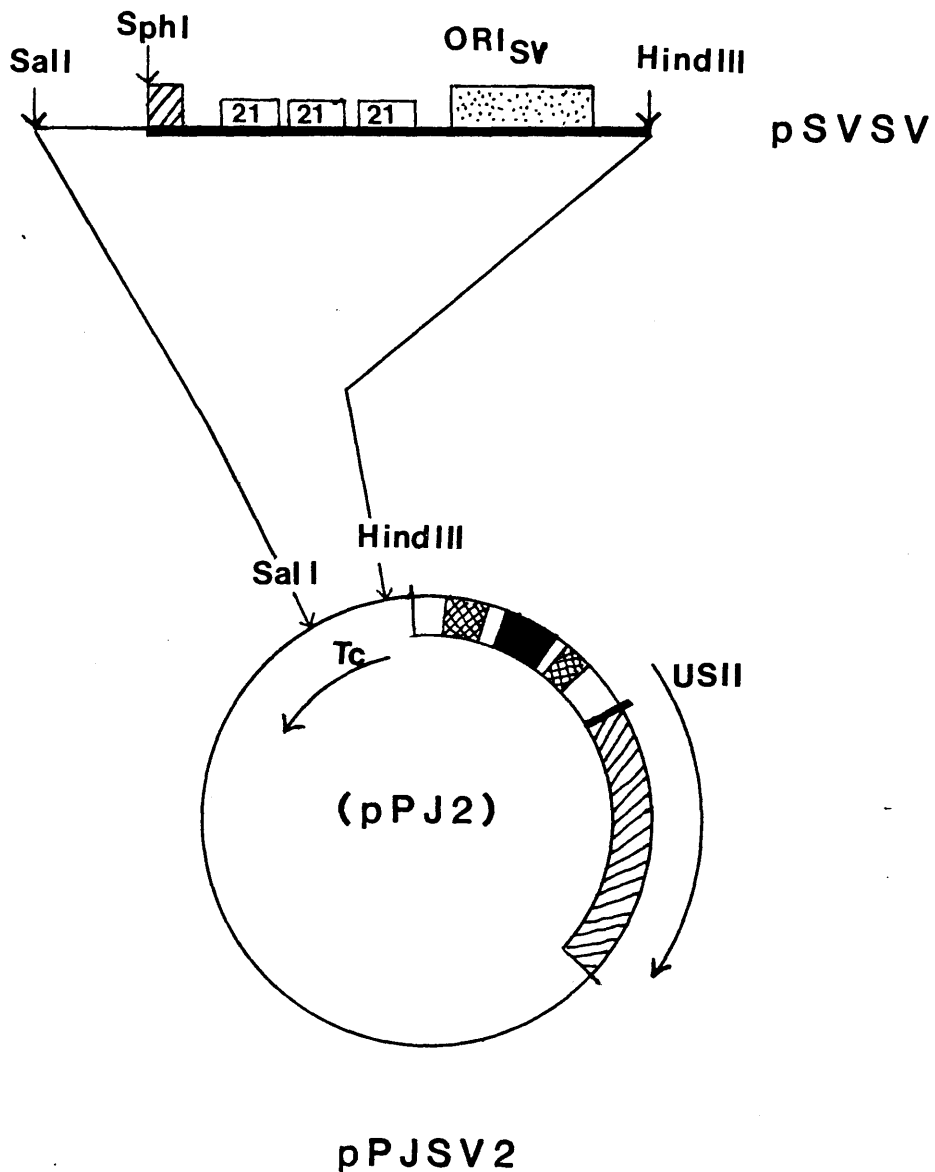

**Figure 24.** Construction of pPJSV2

pSVSV contains the indicated 200bp SphI-HindIII fragment from the SV40 control region (coordinates 128-5171, BBB numbering system; Tooze, 1980) cloned between the SphI and HindIII sites of pRED4 (Everett, 1987). The SV40 DNA contains the extreme 3' end of the 72bp repeat region (hatched box), the 21bp repeats (open boxes), and the origin of DNA replication (ORI<sub>sv</sub>, stippled box). This region also contains the EE and LE RNA start sites (see Figure 5). The thick line represents SV40 DNA, the thin line represents vector DNA.

The SalI-HindIII fragment of pSVSV was cloned between the SalI and HindIII sites of pPJ2 (see Figure 14 for key to pPJ2), to create pPJSV2, as shown.

other transfection procedures. However, due to pressure of time it was felt more worthwhile to pursue the experiments described below. Also, the presence of T antigen in COS cells may have created difficulties in the interpretation of results using this approach.

## 2. Non-replicative conditions: Construction of a US11 promoter/CAT fusion gene - pP31C

Since US11 promoter activity in an ORI<sup>-</sup> environment is rather poor (Section I), it was decided to link the US11 promoter to the bacterial CAT gene. The advantages of making such a construct are that CAT assays are very sensitive (more so than S1 mapping), and the background of CAT activity in untransfected cells is zero.

The US11 promoter DNA used in the construction of the CAT fusion gene was the Sall-SstI fragment from pP.31, which contains the defined minimal US11 promoter region (Section J - Figure 19c). This fragment was inserted into the Sall/SstI sites of the multiple cloning site region of the CAT vector plasmid, pSCAT (derived from pLW2 - Gaffney et al., 1985), as shown in Figure 25. pSCAT contains the CAT gene with an HSV-2 polyadenylation signal at its 3' end, and several convenient restriction sites at its 5' end, cloned into pUC8.

## 3. CAT-assay protocol

CAT assays (Gorman et al., 1982) are now routinely used to obtain an indirect measure of the amount of transcription produced from a promoter. Increased levels of CAT activity have correlated well with increased levels of cytoplasmic RNA in studies using the HSV-2 IE 4/5 promoter (McLaughlan et al., 1985; Gaffney et al., 1985) and the HSV-1 gD promoter (Everett, 1984a, 1986). Everett (1986) has shown that stimulation of transfected tk and gD promoter/CAT fusion genes can be mediated by the HSV-1 IE gene products, Vmw175 and Vmw110, in agreement with the results of O'Hare and Hayward (1985a); and in combination these two IE gene products produced very high levels of activation. In contrast, activation of the VP5 promoter brought about by

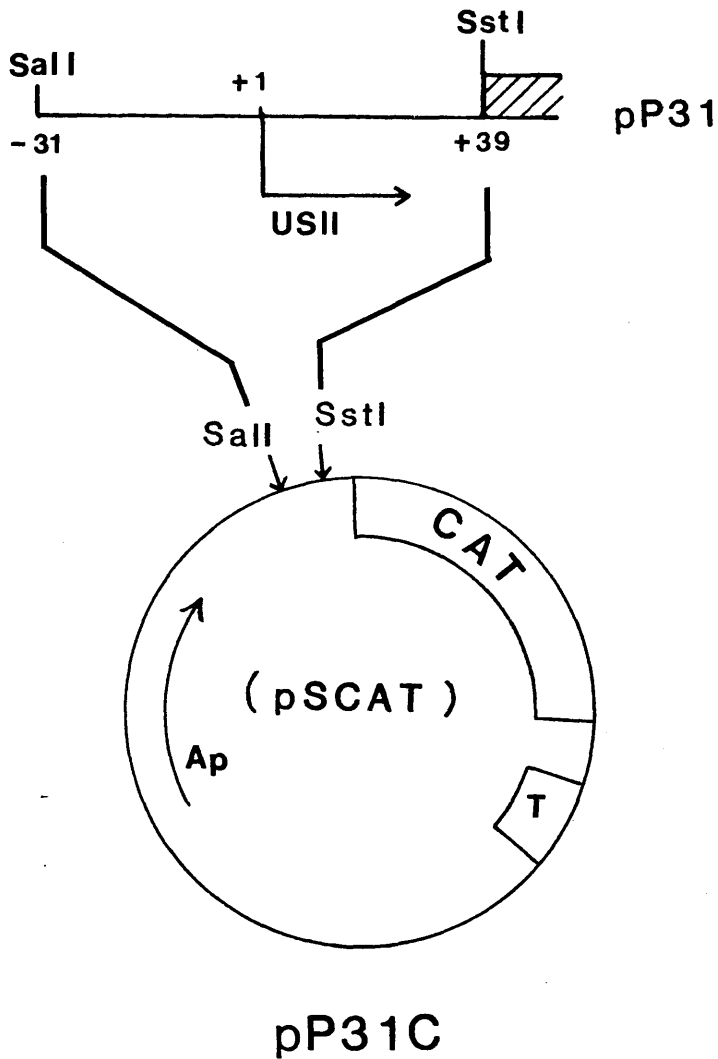

**Figure 25. Construction of pP31C**

The SalI-SstI fragment of pP31, containing USII promoter DNA from -31 to +39, was cloned between the SalI and SstI sites of pSCAT to create pP31C. The USII promoter in pP31 is linked to globin DNA (hatched box; see Figure 19). The pSCAT vector plasmid contains the bacterial chloramphenicol acetyltransferase gene (CAT) inserted into pUC8. Transcription termination signals (T) are provided by a 100bp SmaI-XbaI fragment from the 3' terminus of HSV-2 IE gene 5. pSCAT was derived from pLW2 (Gaffney *et al.*, 1985), by removal of a BamHI fragment (containing the HSV-2 IE 4/5 promoter) lying 5' to the CAT gene, and conversion of the resulting BamHI site to an SstI site (R. Everett, personal communication).

the combination of Vmw175 and Vmw110 was relatively slight, but was increased further (by about 4 to 5-fold) when plasmids encoding Vmw63 were included in the transfection (Everett, 1986). Using a similar approach, the ability of cloned IE genes to activate the US11 promoter in pP31C-transfected HeLa cells has been examined.

IE gene products were provided by the following plasmids; (i) p111, which encodes Vmw110 (Perry et al., 1986); (ii) p175, which contains the coding sequences of Vmw175 under control of the SV40 early promoter and enhancer (Perry et al., 1986); (iii) p63 contains the BamHI-SstI subfragment of HSV-1 fragment EcoRI b, which encodes Vmw63. (iv) pSV63, which contains the Vmw63 coding sequences from p63, with the SV40 enhancer region inserted upstream of IE gene 2; and (v) p63dell, which differs from p63 by the presence of a frameshift mutation at the SalI site located in the Vmw63 coding sequences (L.Perry and D.McGeoch, personal communication).

Combinations of 'activator' plasmids which express IE gene products were transfected into HeLa cells with either (i) pP31C; (ii) pSCAT - for a negative control; or (iii) pgDCAT (Everett, 1986), which contains the HSV-1 gD promoter linked to CAT, for a positive control. The cells were grown in 50mm petri dishes and were transfected with 4ug of each plasmid DNA. After 24h, transfected monolayers were washed and then incubated in fresh medium for a further 24h. The cells were then harvested for the extraction of proteins which were assayed for (i) CAT activity (Gorman et al., 1982), and (ii) protein concentration (Lowry et al., 1951), as described in Materials and Methods. The level of CAT activity present in individual extracts was calculated by the percentage conversion of substrate to 3' monoacetylated product (see Figure 26), determined by scintillation counting. If the conversion was greater than 50% the extract was diluted and assayed again. The percentage conversion was then standardized to the amount of protein in the assayed extract, and expressed relative to the value (adjusted to 1), obtained with pP31C in the absence of activator plasmids.

#### 4. Interpretation of data

Interpretation of the CAT expression data presented in Table 1 requires consideration of the following. The CAT activities have been normalized to the level of activity obtained with pP31C in the absence of co-transfected activator plasmids. This basal level of activity is very low (essentially the same as that for the CAT vector plasmid, pSCAT), and could lead to relatively high levels of variation in the standardization of more active extracts. Also, since there is no internal control in the CAT transfections, the individual transfection efficiencies cannot be standardized (unlike in S1 RNA assays). As a result, the calculated level of CAT expression for a particular experimental condition may vary widely, although falling within a normal distribution for that condition. Quantitative comparisons should therefore only be made with caution.

This limitation may be partially overcome by repeating the individual experiments many times. However, the data in Table 1 shows individual and averaged activities from a limited number of repeated experiments, and a significant difference in the level of activation should only be considered where the averaged CAT activities differ by at least 5-fold.

#### 5. Trans-activation of the US11 promoter

The results of a typical CAT assay are shown in Figure 26; the individual and averaged data from six transfection experiments are given in Table 1.

It is clear that Vmw175 and Vmw110 in combination can activate the US11 promoter. In the positive control, activation of pgDCAT by Vmw175 and Vmw110 is about an order of magnitude higher than pP31C. However, it is not clear from these results whether Vmw63 has any effect on the US11 promoter in combination with Vmw175 and Vmw110. Certainly its effect is not as obvious as on the VP5 promoter (about 4 to 5-fold; Everett, 1986), and nor does it have any effect on its own. However, as reported by Sacks et al. (1985), Vmw63 is important for the production of normal levels of

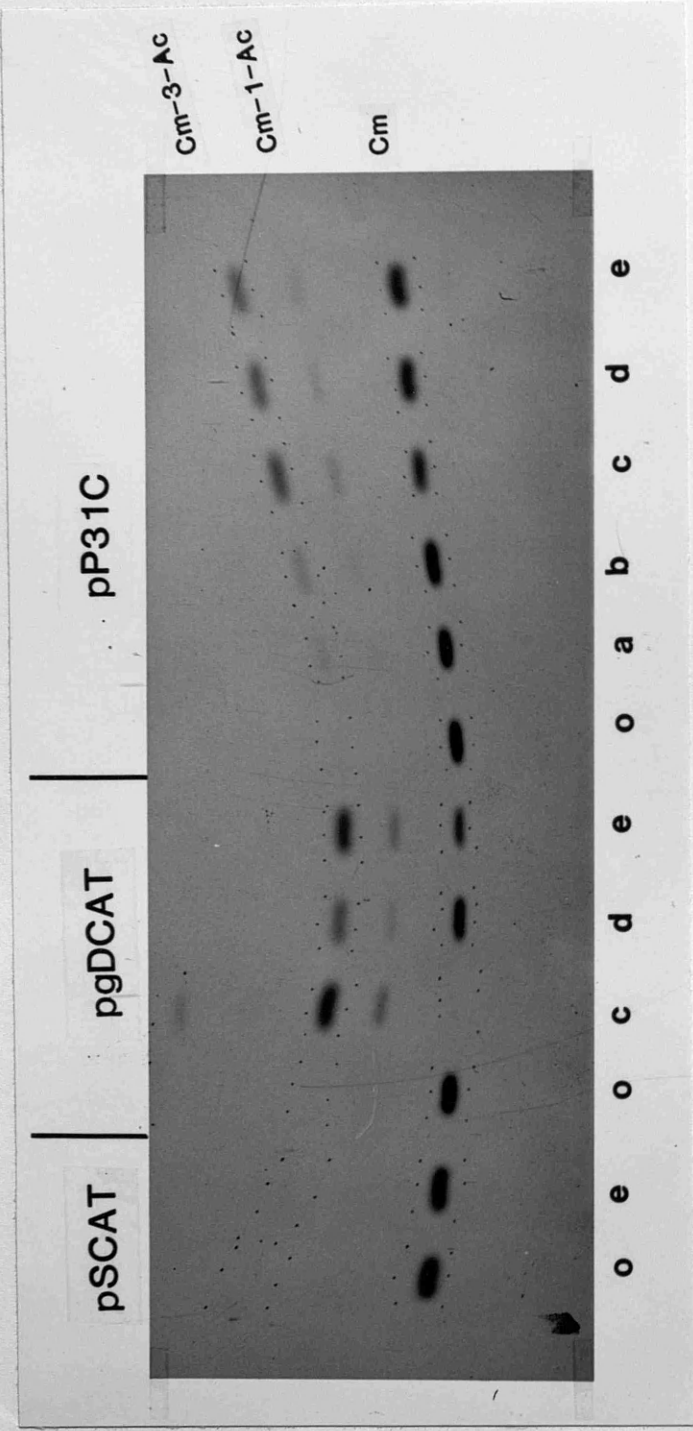

Figure 26.      Activation of the US11 promoter-CAT  
fusion gene

Plasmids containing the CAT gene with either no promoter (pSCAT), or linked to the gD promoter (pgDCAT) or US11 promoter (pP31C), were transfected into HeLa cells with the following combinations of activator plasmids bearing IE genes:

o	no activator plasmids
a	p175
b	p111
c	p175 + p111
d	p175 + p111 + p63
e	p175 + p111 + pSV63

Cells were harvested after 48h, and cell extracts were assayed for CAT activity. The products of the CAT reaction were separated by thin-layer chromatography and identified by autoradiography of the resulting chromatogram.

Cm	chloramphenicol (substrate)
Cm-1-Ac	chloramphenicol-1-acetate
Cm-3-Ac	chloramphenicol-3-acetate

In track "c" of pgDCAT, a third, diacetylated product of chloramphenicol (Cm-1,3-Ac) can be seen above the Cm-3-Ac form. Spots corresponding to Cm and Cm-3-Ac were removed from the TLC plate for liquid scintillation counting (see Table 1).



TABLE 1.

## Activation of US11-CAT by IE gene products

CAT plasmid	Experiments: 1 2 3 4 5 6						Mean	SEM	N
PSCAT	oKey	2.0	1.0	1.0	0.3		1.1	0.3	4
	S/I	3.0					3.0	-	1
	c		3.0	1.0			1.3	0.5	4
	e		10.0	1.0	0.3	0.7	3.8	2.6	3
PGDCAT	o	1.0	25.0	0.5	0.7		6.8	5.2	4
	S/I	56					56	-	1
	c	488	93	873	1078		633	188	4
	d			49	24		37	8	2
	e		261	94	72		142	48	3
	f		233				233	-	1
PP31C	o	1.0	1.0	1.0	1.0	1.0	1.0	-	6
	S/I	131					98	23	2
	a	1.0	1.0	7.5	5.3		3.7	1.4	4
	b	4.0	5.0	6.5	7.5		5.7	0.6	4
	c	8.0	4.0	138	35	5.3	34	20	6
	d	4.0		54	31		29	10	3
	e	25	85	28	31	4.0	44	11	6
	f	9.0	26	5.0	20		15	4.2	4
	g	1.0					1.0	-	4
PP31C (dam <sup>-</sup> )	o	1.0	1.0	1.5	0.1		0.9	.25	4
	S/I	83					83	-	1
	a		1.0	2.0	8.0		3.7	1.8	3
	b		6.0	22	6.7		11	4.3	3
	c	19	155	27	228	9.6	83	41	5
Key:	d		1.0	27	57		28	12	3
	e		122	28	0.1		50	30	3
	f		8.0	5.7			6.9	0.8	2

Key:

o = no activator plasmids  
b = p111  
e = p175 + p111 + pSV63S/I = superinfection (16h)  
c = p175 + p111  
f = p175 + p111 + p63del1a = p175  
d = p175 + p111 + p63  
g = p63

Table 2.            Activation of the US11 promoter by IE gene products or superinfection with HSV-1.

Test Plasmid	Mode of Activation	Amount of US11 5' RNA
pBR322	p175 + p111	undetectable
pPJ2	HSV-1	1733
pPJ2	p175 + p111	25
pPJX2	p175 + p111	14
pPJ4	p175 + p111	22
pPJX5	p175 + p111	163
pP31	p175 + p111	4
pPJO.31	p175 + p111	212
pPO.31	p175 + p111	55

The structures of the test plasmids are outlined in Figures 14 and 19. HeLa cells were either transfected with the indicated test plasmid and either p175 and p111 for 48h, or infected with HSV-1 for 16h, as indicated. The level of correctly initiated US11 hybrid RNA (arbitrary units) was determined by quantitative S1 mapping, using the same probe as described in Sections I and J.

the US11 gene product, 21K, during virus infection.

It is important that trans-activation of pP31C can be attributed directly to the presence of the US11 promoter as this result may have significant implications for the mechanism of trans-activation by HSV IE gene products (see Discussion). Since the level of US11 trans-activation was low, it may have resulted from spuriously initiated RNAs. For instance, Langer et al. (1986) have shown that in 293 or HeLa cells, Ad Ela causes trans-activation of a CAT vector plasmid which lacks a eukaryotic promoter (pSV0-CAT; Gorman et al., 1982). By mapping pSV0-CAT-specific RNAs, it was shown that pSV0-CAT activity was mediated by prokaryotic promoter-like sequences in the pBR322 section of this construct (Langer et al., 1986).

However, it is unlikely that prokaryotic sequences mediate the HSV IE trans-activation response in pP31C, since the control vector plasmid pSCAT, which only differs from pP31C by the lack of the minimal US11 promoter, is not activated. To check whether the trans-activated US11 promoter produced correctly initiated RNA, in one co-transfection experiment plasmids containing the US11/ $\beta$ -globin gene were used for the analysis of RNA by S1 mapping (Table 2). This also enabled a comparison between the level of US11-initiated transcripts from a replicating template in response to HSV-1 infection, and from a non-replicating template in response to HSV-1 IE gene products. Low levels of correctly initiated RNA were detected from the US11 promoter in pP.31 and related constructs in response to co-transfections with Vmw175 and Vmw110. Therefore, sequences within the minimal US11 promoter appear to respond to trans-activation by IE gene products. It is possible these sequences correspond to the TATA box.

The data in Table 2 also shows that, as expected, the level of US11 promoter activation in an ORI<sup>+</sup> environment (pPJ2) in response to infection with HSV-1 is very substantially higher to that produced in an ORI<sup>-</sup> environment, by co-transfection with Vmw175 and Vmw110. Therefore, the transient assay system using co-transfected

IE genes with a late promoter appears to be a valid system to investigate late promoter activation in the absence of DNA replication, in contrast to the conclusions of Mavromara-Nazos et al. (1986) (see Discussion).

#### 6. Methyldeoxyadenosine residues do not affect activation of the US11 promoter

Methylation of CpG dinucleotides in the DNA 5'-flanking eukaryotic promoters has been associated with promoter inactivation (Bird, 1986). Although methylation is unlikely to play a normal role in the regulation of animal virus gene expression during a productive infection, there have been reports where methylation in vitro has caused inhibition of gene expression. In vitro methylation of the HSV-1 tk gene at CpG sites results in the maintenance of this methylation pattern in biochemically transformed cells, and the subsequent inhibition of tk gene expression (Keshet et al., 1985). Methylation of the adenosine residue at -78 of the tk gene, using EcoRI methylase, also inhibited tk expression in microinjected tk<sup>-</sup> cells (Waechter and Baerga, 1982). Knebel and Doerfler (1985) have reported that deoxyadenosine methylation at certain specific sites in the vicinity of the Ad12 Ela promoter caused reduced expression of a linked CAT gene in transfected cells. Although there is no evidence that N<sup>6</sup>-methyldeoxyadenosine normally occurs at detectable levels in eukaryotic DNA, this "unnatural" modification can evidently inactivate a eukaryotic promoter.

The US11 promoter contains the dam methylase target sequence, 5'-GATC-3', at -30 to -27 (McGeoch et al., 1985; see Figure 19c). The adenosine residue of this sequence is methylated by propagation in the routinely used dam<sup>+</sup> strains of E.coli (strains C600 and HB101, see Materials and Methods). It was conceivable that methylation at this site reduced the activation of US11 by HSV gene products, and that plasmid replication in eukaryotic cells increased US11 expression due to de-methylation. Unreplicated viral DNA might have reduced late gene expression compared to replicated template for entirely different reasons, such as the presence of nicks in parental DNA.

Therefore, pP31C was grown up in a dam<sup>-</sup> strain of E.coli (strain GM48, see Materials and Methods; kindly provided by Dr.R.Thompson) to examine the effect of methylation at residue -29. Restriction with DpnI confirmed that stocks of pP31C (dam<sup>-</sup>) DNA were not methylated, whereas other stocks of pP31C were dam-methylated (not shown). The activation of pP31C (dam<sup>-</sup>) is shown in Table 1. There was no clear difference in the activation of methylated (pP31C) and non-methylated plasmids [pP31C (dam<sup>-</sup>)], indicating that the methylated adenosine residue at -29 of the US11 promoter did not inhibit US11 gene expression. In addition, the behaviour of pPJ2 grown in dam<sup>-</sup> E.coli was similar to methylated pPJ2 DNA in terms of US11 gene expression in response to viral superinfection (data not shown).

#### SECTION L: Transcription of US11 in Isolated Nuclei

The aim of experiments described in this section was to investigate how DNA replication increases late gene expression. It is likely that either copy number, replicated template, or ongoing replication are important for abundant late gene expression. These three mechanisms might be distinguished by measuring the actual rate of US11 transcription after DNA replication has been inhibited at various times during infection. Rates of RNA synthesis were therefore determined in isolated nuclei (nuclear run-on assays), which measure primarily elongation of nascent transcripts (Hoffer and Darnell, 1981; Greenberg and Ziff, 1984).

Measurement of US11 transcription by run-on assays is complicated by two factors. Firstly, following the onset of DNA replication, transcription of both strands of HSV genes may occur (Jaquemont and Roizman, 1975; Godowski and Knipe, 1986; Yager and Bachenheimer, 1987). This necessitates the measurement of strand-specific RNAs. Secondly, US11 is the

internal member of a family of three, 3' co-terminal overlapping genes. Therefore, it is necessary to take account of the synthesis IE gene 5 transcripts, which completely overlap US11 transcripts. The results described here should be considered as preliminary.

### 1. Production of single-stranded DNAs

HSV-1 DNA sequences (Figure 27) were cloned into the double-stranded replicative form (RF) of the M13 phage vectors, mpl8 or mpl9, either directly or via pUC9, as described below. The multiple cloning sites (mcs) in mpl8 and mpl9 are identical but present in opposite orientations, and contain all the restriction sites present in the mcs of pUC9. Fragments were inserted into M13 vectors in both relative orientations, such that complementary and anti-complementary DNAs could be produced. Dideoxy sequencing was employed to confirm the identity and orientation of inserts (see Materials and Methods).

(i) US11; A 348bp BstNI-HindIII fragment from pDG8 (Figure 6b) was isolated and its overhanging ends were filled in. This fragment was inserted into SmaI-cleaved pUC9. The HSV DNA insert was then re-isolated by a BamHI/EcoRI double restriction digest, and inserted by a sticky-end ligation into the BamHI/EcoRI sites of mpl8 and mpl9.

(ii) IE-5 (US12); A 534bp XhoI-TaqI fragment from pPJX4 (Figure 14c) was isolated from an agarose gel, filled-in, and blunt-end ligated into SmaI-cleaved pUC9. The fragment was then re-isolated by BamHI/EcoRI digestion and inserted into the BamHI/EcoRI sites of mpl8 and mpl9.

(iii) tk; An 840bp PstI fragment from pTK1 (Wilkie et al., 1979) was inserted directly into the PstI site of mpl9. Recombinant phage were obtained with the insert in both orientations.

Single-stranded phage containing both complementary (cUS11, cUS12, ctk) and anti-complementary (aUS11, aUS12, atk) DNA inserts were propagated for the isolation of recombinant phage DNA, as described in Material and Methods (Section G(5)). Single-stranded DNA was applied in 10ug

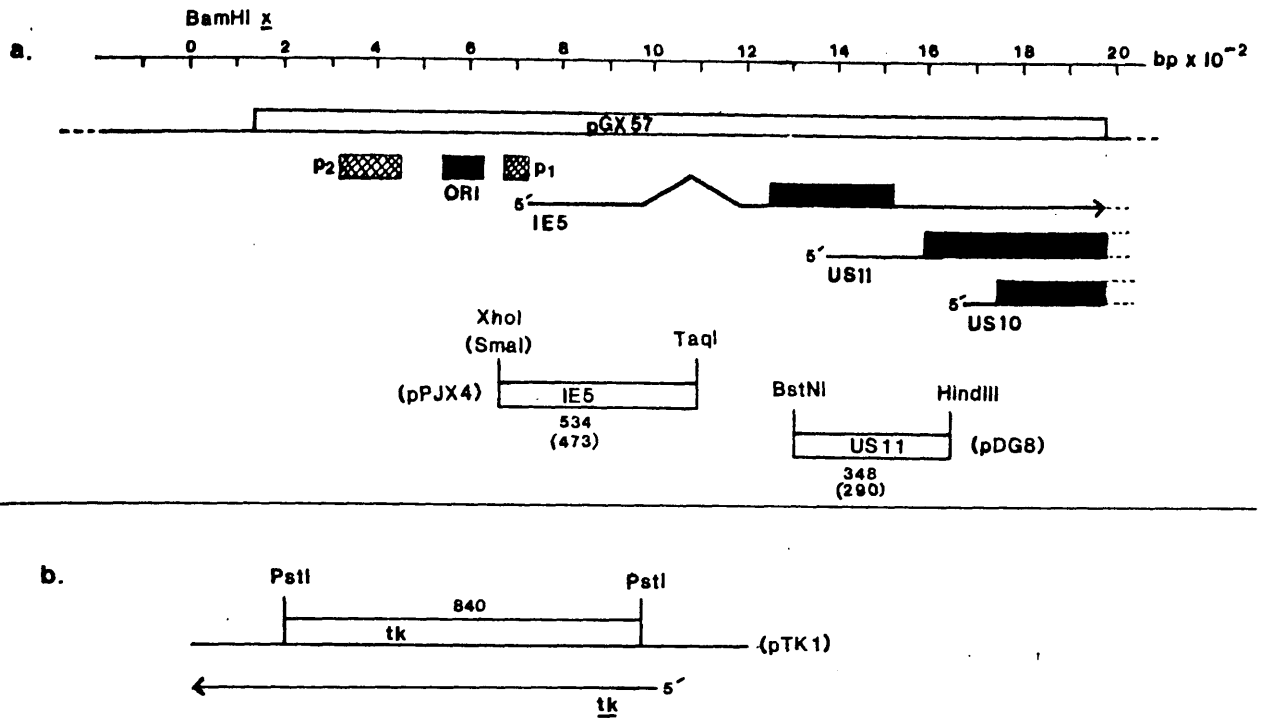

**Figure 27.** DNA sequences used for the detection of US11, IE 5 and tk RNA synthesis

a. The coding potential of HSV-1 BamHI x fragment (see Figure 12 legend for key). In the lower part of the figure, the subfragments from pPJX4 and pDG8 which were used for the detection of IE 5 and US11 RNA by hybridization, are indicated. The size of the subfragments and length of hybrids (in brackets) are given (bp).

b. The 840bp PstI subfragment from pTK1 used for hybridization to tk RNA. The tk RNA start site lies approximately 10bp 5' to the right-most indicated PstI site.

aliquots to nitrocellulose strips using a Schleicher and Schuell slot-blot apparatus.

## 2. US11 transcription

Nuclei were isolated from BHK cells on 90mm plates, 0-8h after adsorption with HSV-1. PAA was added to two additional plates, at 0h or 7h p.a., and at 8h p.a. nuclei were isolated from these plates. The nuclei were incubated with exogenous nucleotide triphosphates and [  $-^{32}p$ ] UTP. RNA was then isolated and hybridized to filters which had been blotted with single-stranded DNAs (using a "slot-blot" apparatus) as described in Section G(22). This experiment was repeated twice (Exp.1 and Exp.2). An autoradiograph corresponding to the slot-blot from the Exp.2 is shown in Figure 28. It can be seen that there is a high level of background hybridization from uninfected cellular RNA to the cUS11 and cUS12 ssDNAs, although this is over-represented in the autoradiograph as the incorporation of radioactivity was highest in the uninfected cells in Exp.2. The relative levels of hybridization were measured by densitometry, and normalized for input cpm and length of hybrids. Standardized results for the two experiments are given in Table 3 (note that tk DNA was not available for Exp.1).

The calculated level of US11-initiated transcription at various times during infection is given in Table 3 (see cUS11-cUS12 column). These values have been determined from the level of hybridization to corresponding to US12 (cUS12) subtracted from that to US11 plus US12 (cUS11). In both experiments, the rate of US11 transcription increased during infection. Interestingly, the rate of IE 5 transcription was high at late times in Exp.2, although in both experiments it was less than the amount of US11 transcription at 4 and 8h. The level of anti-complementary transcripts remained low in all cases, in contrast to previous reports (Godowski and Knipe, 1986; Yager and Bachenheimer, 1987). In Exp.2, the detected level of tk transcription was poor; the reason for this was unknown, but might simply be due to a poor infection.



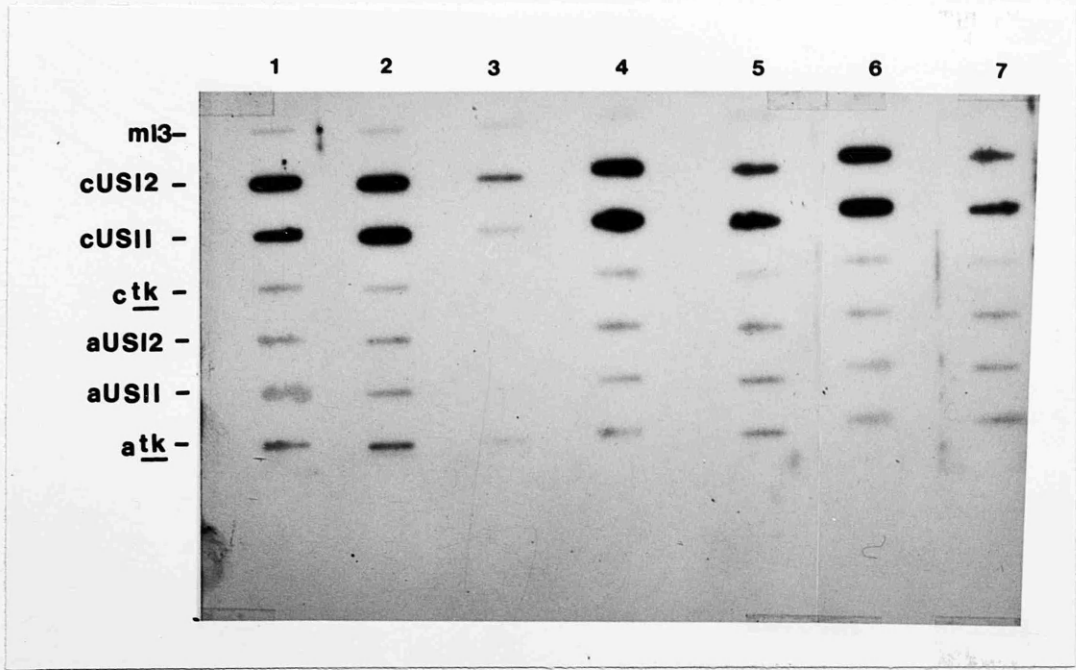

Figure 28.      Transcription of US11, IE 5, and tk  
in isolated nuclei

Nuclei were isolated from BHK cells which were uninfected (track 1), or had been infected with HSV-1 for 1h (track 2), 2h (track 3), 4h (track 4) or 8h (tracks 5,6,7). In two cases, PAA had been added to cells, at 0h (track 6) and 7h p.a. (Track 7). Radioactively labelled run-on transcripts synthesized in isolated nuclei were hybridized to ss M13 DNAs that had been blotted onto nitrocellulose filters. The ss DNAs contained either no insert (M13) or HSV-1 sequences complementary (c) or anti-complementary (a) to RNAs for US12 (IE 5), US11, and tk (see Figure 27). The relative levels of hybridization from the autoradiograph were quantified by densitometry, and standardized for the lengths of hybrids and the total CPM used in each hybridization (Table 3).

Table 3. Transcription in isolated nuclei

Experiment 1:

Time	cUS12	cUS11	aUS12	aUS11	cUS11-cUS12
U/Ia	0.07 <sup>b</sup>	u <sup>c</sup>	u	u	-
2h	2.15	1.97	0.05	0.06	(-0.18)
4h	4.08	4.87	0.17	0.28	0.8
8h	1.39	4.60	0.54	0.84	3.2
PAA @ 0h <sup>d</sup>	0.39	0.11	0.01	0.14	(-0.28)
PAA @ 7h <sup>d</sup>	1.26	3.56	0.43	0.35	2.3

Experiment 2:

Time	cUS12	cUS11	ctk	aUS12	aUS11	atk	cUS11-cUS12
U/I	1.92	1.82	0.09	0.16	0.27	0.17	(-0.1)
1h	1.94	3.13	0.07	0.18	0.21	0.22	1.22
2h	0.55	0.18	0.01	0.14	0.01	0.06	(-0.37)
4h	6.00	14.74	0.25	0.79	0.61	0.26	8.74
8h	7.53	24.08	0.53	3.00	3.23	1.70	16.55
PAA @ 0h	10.00	19.48	0.72	1.12	0.93	0.68	9.48
PAA @ 7h	7.26	10.58	0.20	0.90	1.24	0.52	3.32

- Key:
- a. Nuclei were isolated from uninfected (U/I) BHK cells or from cells infected with HSV-1 at the indicated times (h) p.a..
  - b. Numbers refer to the relative amount of radioactive RNA (arbitrary units) hybridized to the complementary (c) or anti-complementary (a) ssDNAs shown in Figure 27, and have been standardized for the length of hybrids and the CPM used in each hybridization.
  - c. u = undetectable
  - d. Nuclei isolated at 8h p.a..

The results of the experiments with PAA are also shown in Table 3. In Exp.1, PAA at 0h severely diminished US11 and IE 5 transcription, but not in Exp.2. In both experiments, the addition of PAA at 7h appeared to reduce, although not abolish, US11 transcription one hour later. Due to the variability of these results, the uncertain contribution of transcription from IE gene 5, and the lack of a control for the effect of PAA, it is unwise to draw any conclusions from these experiments concerning the role of DNA replication on US11 promoter activity.

### 3. Conclusions

The results shown here indicate that the nuclear run-on assay would be useful in investigating the role of DNA replication on late promoter activity. At the moment, it is unclear whether copy number, past-replication, or ongoing replication is the dominant controlling factor for abundant late gene expression. To distinguish between these possibilities it will be essential to measure actual rates of RNA synthesis under varying conditions of DNA synthesis inhibition. However, the choice of US11 as a late gene promoter appeared unfortunate in these experiments due to the substantial level of overlapping transcripts which arose from the IE 5 promoter at late times in infection. A late gene such as gC, which is not overlapped by other transcription units, would be more suitable for this type of investigation. In future experiments, the effect of PAA on DNA replication should be controlled for (perhaps by measuring the incorporation of  $^3\text{H}$  into HSV DNA), and the effects of PAA on both late and early (or EL) transcription should be compared. Note that gD was not used in this study as it too is overlapped by another transcription unit (see Figure 3; Rixon and McGeoch, 1985).

A nuclear run-on assay would also enable the effect of specific gene products on late gene transcription to be investigated. For example, temperature shift-up experiments could be used to see if Vmw175 (from the temperature-sensitive tsK virus) is essential later in infection for late gene transcription.

DISCUSSION

The experiments described in this thesis were designed to investigate the molecular basis for the temporal regulation of HSV-1 late genes. The gene chosen for study was US11 (McGeoch et al., 1985), which was shown to be regulated with "true-late" kinetics during viral infection (Section H). A plasmid-borne US11 promoter can mimic these kinetics in a transient assay system, where it was shown that DNA replication is not an absolute requirement for promoter activation, but is important for abundant expression (Section I). The activities of deletion mutants of the US11 promoter were studied in plasmids containing the HSV-1 TR<sub>S</sub>/IR<sub>S</sub> origin of replication (ORI<sub>S</sub>). The sequences required for fully efficient regulated expression of US11 are contained within the region -31 to +39 relative to the RNA cap sites (Section J). Thus, by the absence of an upstream region, the structure of the US11 promoter appears to differ significantly from that of characterized HSV IE, E and EL promoters (see Section E). Co-transfection experiments indicated that the US11 promoter may be activated by the HSV IE gene products, Vmw175 and Vmw110, at least in the absence of DNA replication (Section K). The mechanism of late promoter activation may therefore share some similarity to the activation of E promoters, but differs by its requirement of DNA replication for abundant expression.

1. Late Promoter Sequence Requirements

Deletion analysis indicated that the sequences required for US11 promoter activity lie within -31 to +39 of the US11 RNA start sites. In the region upstream from +1 of US11 there is no sequence homology to either of the well characterized tk and gD promoters, except for the presence in all three promoters of a consensus TATA box sequence in the -25 region (see Figure 29). Since a deletion mutant of the gD promoter, with sequences -33 to +17 linked to the ORI<sub>S</sub> origin of DNA replication, is regulated with late

kinetics (Section J), it is possible that an HSV late gene might be characterized simply by the presence of a TATA box, in the absence of distal regulatory signals upstream.

How typical is US11 of other HSV true late promoters? The HSV-1 glycoprotein C (gC) gene is also regulated with true late kinetics during viral infection, and is dependent on DNA replication for efficient expression (Hall et al., 1982; Yager and Bachenheimer, 1987). Homa et al. (1986) have studied the expression of deletion mutants of the gC gene reinserted into the gC locus of recombinant viruses. The sequences required for proper regulation of gC transcription during viral infection were found to lie within -34 to +124 of the gC cap sites. Moreover, the -34 to +124 region of gC functioned as a late promoter when placed 5' to the tk structural gene. The gC promoter contains a TATA box at -30 and therefore resembles US11 with regard to its minimum sequence requirements, and lack of a functional "upstream" region.

Homa et al. (1986) suggested that sequences downstream of -35 of gC, although containing signals responsive to trans-activation, also contain signals which prevent the expression of gC prior to the onset of viral DNA replication. They argue that when linked to the tk structural gene, these sequences prevented tk expression prior to DNA replication. However, it seems unlikely that late promoters contain specific signals for their negative regulation in the absence of DNA replication, since a -33 deletion mutant of the gD promoter is poorly active in a transient assay (Everett, 1983), but can be converted to a late promoter capable of efficient expression, simply by linkage to ORI<sub>S</sub> (Section J).

The role of sequences within the TATA box-cap site regions of US11 (Section J) and gC (Homa et al., 1986), have not been specifically investigated. The TATA box itself is likely to be critical for promoter function, since its deletion (by removal of sequences between -31 to -21) reduced US11 promoter activity by nearly 100-fold (see Figure 19). But it is possible that sequences other than the TATA box are involved in the activation of the US11 and

gC promoters. Although there is no obvious conservation at the sequence level in the tract of DNA between the TATA box and cap site regions of US11 and gC (Figure 29), both regions are notably purine-rich (80% and 70% respectively). The degree of purine richness in the same region of other HSV promoters is variable; e.g. gD- 73%; tk- 55%; VP5- 50% (see Figure 29); and the significance (if any) of a purine-rich tract in the region -20 to -1, is not known. The TATA box sequences of the five promoters shown in Figure 29 all match reasonably well the consensus sequence of Breathnach and Chambon (1981), although this is not universally true for all HSV promoters (Wagner, 1985). It would be of interest to determine the effect of individual base mutations in the TATA box-cap site region of, say US11. Since the deletion or mutation of sequences in the cap site regions of gD (Everett, 1984b) and tk (Coen et al., 1986) affected their expression, it is possible that similar mutations might also affect US11 promoter activity.

The relationship between the three temporal classes of HSV promoters may be summarised as shown in Figure 23. This illustrates that as infection proceeds, and after DNA replication occurs, fewer regulatory signals are required for efficient transcription from a promoter. In the case of US11, an active origin of DNA replication appears to substitute for a distal ("upstream") promoter region during the later stages of the lytic cycle. Thus late promoters may not require certain cellular transcription factors such as Sp1, that IE and E genes have been shown to require (Jones et al., 1985; Jones and Tjian, 1985); these cellular factors may become scarce or diluted out at the later stages of the lytic cycle, due to HSV mediated shut-off of host mRNA and polypeptide synthesis (Fenwick and Morse, 1979; Read and Frenkel, 1983). It is interesting to speculate that a relaxation in the requirements for cis-acting DNA sequences for transcription initiation may lead to an increase in apparently randomly initiated RNA molecules, which may account for at least <sup>a</sup> proportion of the "symmetric" transcription observed at late times and which is associated with DNA replication (Jaquemont and Roizman, 1975; Godowski

Figure 29.

Nucleotide Sequences around the TATA boxes of HSV-1 Promoters

	-31	-21	-11	-1	
<u>tk</u>	AGGTC <u>CACTT</u>	CGCA <u>TATTTAA</u>	GGTGACGGCT	GTTGGCCTCGA	(McKnight, 1980)
gd	ATAACAAGT	CTGTC <u>TTTAA</u>	AAAGCAGGGG	TTAGGAGTTT	(Watson <u>et al.</u> , 1983)
VP5	GGTGGGGCGG	GGGGG <u>TATA</u>	TAAGCCTGG	GATCCACGT	(Costa <u>et al.</u> , 1984)
gc	ATGGGGCCCG	GGTAT <u>TAAATT</u>	CCGGAAGGGG	ACACGGGCTA	(Frink <u>et al.</u> , 1985)
US11	TACGGGATGA	GATCA <u>ATTA</u>	AGGGGGCGTG	AGGACCGGGA	(Rixon and McGeoch, 1984)

-34 to -26

\*  
TATA<sup>A</sup>/TAA<sup>A</sup>/T

(consensus - Breathnach  
and Chambon, 1981)

The TATA box homologies are underlined.



and Knipe, 1986; Yager and Bachenheimer, 1987).

Although the expression of some early genes (the EL class) is increased by DNA replication (perhaps simply due to an increase in copy number), at late times their expression is decreased (Hones and Roizman, 1974; Johnson et al., 1986). The difference between the late and early promoters at the sequence level suggests a mechanism to turn down early transcription without affecting late gene expression: Factors that bind to distal upstream elements may be inhibited, or their function altered causing inhibition of early promoter activity. Thus the mechanisms for both activation (in conjunction with IE gene products) and repression of early gene expression may be mediated by cellular transcription factors without recourse to virus-specific sequences.

Two very different viruses share a similar brevity in DNA sequence requirement for replication-associated late gene expression. Bacteriophage T4, which has a large double stranded DNA genome of about 166kb, replicates in the bacterium, E.coli. A comparison of nucleotide sequences around the 5' starts of five T4 late genes revealed the presence of a conserved "-10" region (consensus 5'-TATAAATA-3'), but no common sequences in the "-35" consensus region of T4 early and E.coli promoters (Christensen and Young, 1983). The minimal DNA sequence requirements for the function of a T4 late promoter, P<sub>23</sub>, are contained within a 35bp segment of T4 DNA (from -18 to +17 of P<sub>23</sub>), which includes the "-10" homology (Elliott and Geiduschek, 1984). Vaccinia virus, which also has a large double-stranded DNA genome (about 190kb), replicates in the cytoplasm of mammalian cells, and is thought to use exclusively virus-encoded enzymes for the expression of its genes (Moss, 1985). Although there is currently little information on the structure of vaccinia virus early genes, two groups have recently published similar results regarding the sequences required for late promoter activity, using recombinant viruses (Bertholet et al., 1986; Hanggi et al., 1986). Only 15bp of 5' flanking DNA is required for

properly regulated expression of a vaccinia virus late gene.

The respective biologies of HSV, T4 and vaccinia virus could hardly seem more disparate, yet these large DNA viruses which undergo rapid lytic cycles may have come to a similar solution regarding the control of expression of their late genes; namely linkage (in some way) to DNA replication, and a minimalization of promoter DNA sequences. Whereas the functions involved in HSV DNA replication and late promoter activation are only just beginning to be defined, the wealth of knowledge concerning bacteriophage T4 genetics means that the understanding of T4 late promoter activation is well advanced by comparison (Geiduschek et al., 1983). Thus, T4 might provide useful insights into the possible mechanisms of HSV late promoter function, and is discussed further below (part 4).

## 2. Trans-activation

### a. Trans-activation of late genes

The activity of a plasmid-borne US11 promoter was studied in response to activation by HSV-1 IE gene products by linking the minimally defined US11 promoter DNA to the bacterial CAT gene, and assaying for CAT activity in co-transfected HeLa cells (Section K). Co-transfection of US11-CAT with either Vmw175 or Vmw110 gave low but detectable levels of CAT activity. An approximate 10-fold increase in CAT activity was produced by Vmw175 and Vmw110 in combination, thus their synergistic effect appears to apply to a late promoter as well as to early promoters (Everett, 1984a; Quinlan and Knipe, 1985; Gelman and Silverstein, 1986). Vmw63 did not cause a detectable increase in CAT activity from US11-CAT, either alone or in combination with Vmw175 and Vmw110 (Section K). This contrasts with the observation that late gene products are underproduced during infection with a virus bearing a ts lesion in Vmw63, at NPT (Sacks et al., 1985). Since the US11-CAT construct was not replicated in the co-transfection experiments, it is not possible to rule out that Vmw63 might only be required following the onset of replication.

Two groups have investigated trans-activation of the L42 late promoter (Hall *et al.*, 1982), also in co-transfection experiments. DeLuca and Schaffer (1985) found that CAT activity was induced from an L42-CAT fusion gene by co-transfection with a plasmid bearing IE genes 1,2,3 and 5, but not by IE gene 3 alone. In contrast, Mavromara-Nazos *et al.* (1986) reported that similar levels of tk activity were induced by Vmw175 from an L42-tk construct, as from a plasmid bearing the natural tk gene. Co-transfection of L42-tk with Vmw110 also stimulated tk activity, whereas Vmw63, Vmw68, and Vmw12 did not, but no combinations of IE genes were tested.

It is clear that late promoters can be activated by HSV-1 IE gene products in co-transfection experiments, but between different groups there appear to be differences in the level of stimulation and the requirement for one or more IE gene products. This is reminiscent of the differences found in the activation of E promoters, as discussed in Section E. Essentially the results in Section K are compatible with those of DeLuca and Schaffer (1985), which indicate Vmw175 does not activate L promoters very well on its own. The major apparent discrepancy is that Mavromara-Nazos *et al.* (1986) found that a similar level of tk activity was induced by Vmw175 from the L42 promoter as from the tk promoter. Mavromara-Nazos *et al.* (1986) argue this result shows that late promoters are regulated as early promoters in transient assays. This need not be the case:

Firstly, the level of stimulation of tk activity was quite low, only 5-fold above background. Trans-activation of the US11 promoter by Vmw175 or Vmw110 also increased CAT activity by about 5-fold, and in combination Vmw175 and Vmw110 further increased CAT activity by 5 to 10-fold (Table 2). It was possible to detect US11-initiated RNA from pPJ2 in response to co-transfection with plasmids encoding Vmw175 and Vmw110 (Table 3). However, the level of US11-initiated RNA from plasmid pPJ2 was increased much more efficiently (over 25-fold) by superinfection with HSV-1 (Table 3). Although it is not strictly valid to make a direct comparison, this result indicates that the level of

stimulation by Vmw175 and Vmw110 is of the order of magnitude that might be expected, since superinfection of pPJ2 induces replication of pPJ2 DNA whereas a co-transfection does not. Therefore, the level of late promoter activation in co-transfection experiments is not sufficiently high to suggest that it involves a novel mechanism.

Secondly, Mavromara-Nazos et al. (1986) did not show that the stimulation of tk activity from L42-tk correlated at the RNA level with the stimulation of the natural tk gene. The probe used for S1 mapping L42-tk hybrid transcripts was labelled at +138 of the tk gene, and would not have detected any RNA initiated at +200 from a downstream pseudo-promoter, which is also capable of producing enzymatically active tk (Dennis and Smiley, 1984; Halpern and Smiley, 1984). Thus the overall level of tk activity induced from L42-tk, although not especially high, might not have arisen solely from L42-initiated transcripts.

#### b. Trans-activation in general

Since a late promoter can be activated by cloned HSV-1 IE gene products, the sequences required for trans-activation probably lie within the TATA box-cap site region rather than, for instance, the upstream promoter region. Everett (1987) constructed a hybrid promoter consisting of the SV40 early promoter upstream region and the HSV gD TATA box region. This hybrid promoter was activated well in response to HSV-1 infection, whereas the natural SV40 early promoter is poorly responsive (O'Hare and Hayward, 1984). The TATA box itself may therefore be a critical promoter element for the mechanism of action of HSV-1 IE gene products. In support of this conclusion, Tackney et al. (1984) observed that the Chinese hamster aprt gene, which in common with many other housekeeping genes lacks a TATA box (Dush et al., 1985; Kim et al., 1986), was not activated during infection with an HSV-1 recombinant virus that contained the aprt gene and promoter. In contrast, the rabbit  $\beta$ -globin gene, which does possess a TATA box, is activated during infection with an

HSV-1/ $\beta$ -globin recombinant virus (J.R.Smiley, C.Smibert, R.D.Everett, submitted).

Trans-activation mediated by the adenovirus Ela proteins requires the presence of an AG-rich element in the upstream region of responsive promoters (see Section D). There is evidence that at least one mechanism of action of Ela occurs through a direct or indirect interaction with a cellular factor that recognises this sequence (Kovesdi et al., 1986; SivaRamen et al., 1986). Experiments by Loeken et al. (1986) indicate that Ela and SV40 T antigen stimulate the adenovirus E2 promoter by different mechanisms, and it is clearly possible that HSV IE gene products may also have different mechanisms for trans-activation, especially since different sequences are implicated in trans-activation mediated by Ela and HSV IE products. A complexity in proposing how HSV IE proteins might operate is the observed synergism between Vmwl75 and Vmwl10. It is possible that both IE products might operate through the TATA box, if for example, Vmwl10 were to increase the availability of a TATA box binding factor and Vmwl75 were to increase the activity of this factor. Possible mechanisms of action of Vmwl75 are considered below, however, there is currently insufficient data on the properties of Vmwl10 to enable a reasoned proposal of how it might operate.

Some of the reported properties of Vmwl75 include: (i) Partially purified Vmwl75 failed to bind to DNA except in the presence of uninfected cell extracts (Freeman and Powell, 1982); (ii) In a DNA binding immunoassay, antibodies to Vmwl75 immunoprecipitated DNA fragments, including gD promoter DNA (Faber and Wilcox, 1986; Beard et al., 1986); (iii) Vmwl75 stimulated gD transcription in vitro (Beard et al., 1986). With the assumption that the TATA box is critical for the action of Vmwl75, a mechanism of action that is consistent with the above observations would involve a direct interaction of Vmwl75 with a TATA box binding factor, and for this interaction to occur in a nucleoprotein complex (see Echols, 1986). Three alternative mechanisms which seem less likely are (i) Vmwl75 transiently interacts with unbound TATA box factor, and alters its

activity, (ii) Vmw175 increases the availability of TATA boxbinding factors, or (iii) Vmw175 binds directly to the TATA box. The first two alternatives are inconsistent with the observation that the related herpes virus IE protein, PRV IE180, is required in functional form to stimulate transcription in vitro (Abmayr et al., 1985). However, the third possibility, that Vmw175 might bind directly to DNA, cannot be ruled out completely on currently available evidence.

A general mechanism of promoter activation for RNA polymerase II-mediated transcription may involve the formation of a stable complex of DNA-bound transcription factors (see Section D). It is attractive to postulate that trans-activating proteins are able to take part in the formation of such a complex. This may explain how in some cases trans-activating proteins are able to substitute for enhancer function: If one of the functions of enhancer DNA-bound transcription factors is to interact with promoter DNA-bound transcription factors in the formation of a stable complex, then the enhancer factors might be replaced by trans-activating proteins if these are able to interact directly with promoter DNA-bound transcription factors.

### 3. The Role of DNA Replication in Late Gene Expression

It is well established in the literature that HSV-1 late gene expression is hard to detect under conditions of DNA replication inhibition or using ts DNA<sup>-</sup> mutants at NPT (see Section E). How dependent is late gene expression on DNA replication? During HSV-1 infection in the presence of 300ug/ml of PAA, US11 gene expression was reduced 50 to 100-fold, whilst the expression of an EL gene, gD, was reduced 5 to 10-fold (Section H). This result indicated that late gene expression was more dependent on DNA replication than EL expression, by about an order of magnitude. Although low levels of US11 gene products were detected in the presence of PAA, it cannot be assumed using chemical inhibitors that absolutely no DNA replication had taken place. To investigate the absolute requirement for

DNA replication, the activity of plasmid-borne US11 promoter was studied using plasmids which contained or lacked a functional HSV-1 origin of DNA replication (ORI<sub>S</sub>). In response to HSV-1 infection, the US11 promoter was activated on ORI<sup>-</sup> plasmids, but expression was reduced by about 25-fold compared to an ORI<sup>+</sup> plasmid (Section I). This indicates that DNA replication is not an absolute requirement for late gene expression. Late gene expression under non-replicating conditions has also been reported for gC, using wild-type virus and a ts MDBP (DNA<sup>-</sup>) mutant at NPT, both in the presence of PAA (Godowski and Knipe, 1985). Transcription of gC in isolated nuclei is strongly inhibited but not completely abolished by the presence of PAA (Godowski and Knipe, 1986; Yager and Bachenheimer, 1987). Activation of the L42 promoter in transient assays has also been shown to take place in the absence of DNA replication functions (DeLuca and Schaffer, 1985; Mavromara-Nazos, 1986). Although DNA replication is not an absolute requirement for late gene expression, it clearly is important for achieving abundant expression.

How does DNA replication increase late gene expression? An obvious role for replication would be to increase the copy number of an intrinsically weak promoter, i.e. the "amplification model". The absence of an upstream region would suggest why a late promoter might have poor activity. The ability to trans-activate late promoter function in the absence of DNA replication is consistent<sup>with</sup> the amplification model, in that replication is only needed to increase copy number, not late promoter activity. However, evidence described below suggests that the role of replication in late gene transcription may be more complex than merely to increase copy number.

A frequent observation is the coincidence of the detection of late gene expression with the onset of DNA replication (Swanstrom et al., 1975; Powell et al., 1975; Pedersen et al., 1981; Johnson et al., 1986). In the time-course experiment described in Section I, transcription from the plasmid-borne US11 promoter was not detectable prior to the onset of DNA replication, yet up to 1000 copies

per cell of plasmid DNA were isolated from transfected cell nuclei (Figure 16). US11 transcripts became detectable when there were 500 copies per cell of replicated plasmid DNA. The similarity in the times of appearance of US11 hybrid transcripts and pPJ2 plasmid DNA replication is striking. It was notable too that US11 hybrid transcript accumulation dramatically increased (at least 10-fold) between 8 and 10h p.a., a period in which the copy number of replicated plasmid DNA had barely doubled (Figure 16). These observations suggest that replication may provide a switch which increases late promoter activity, independent of the changes in template copy number.

If DNA replication per se is important, does a lasting change in template structure or the transient act of replication itself affect late promoter activity? The experiments in Sections I and J indicated that transcription through a late promoter (from the upstream IE gene 5 promoter) increased its expression. Replication of and transcription through a late promoter may indicate a common mechanism by which both processes operate positively on late gene expression; both would lead to an opening up of the template structure to improve access to the transcription machinery. However, the presence of the IE 5 promoter upstream from the US11 promoter had no effect on US11 promoter activity in the absence of ORI<sub>5</sub> (Figure 14). It would seem that replication is required to potentiate the effect of 'through-transcription', therefore their mechanisms of action on late gene expression are likely to be different. For instance, if replication prepares a 'competent' template for late transcription, the effect of the IE 5 promoter might be to increase the concentration of RNA polymerase molecules in the vicinity of the US11 promoter.

Two experiments were designed to test whether the effect of DNA replication on late gene transcription was transient or lasting. The effect of inhibiting DNA replication late during infection was measured in terms of US11 RNA accumulation (Section H) and US11 transcription in isolated nuclei (Section L). Although the addition of PAA



checked the normal rise in US11 RNA accumulation (Figure 11), it is uncertain whether the measured decrease in US11 transcription in isolated nuclei was significant (Table 3). Ideally this experiment should be repeated using a late gene (such as gC) which is not overlapped by other transcription units, as is the case for US11. However, if DNA replication has multiple roles in increasing late promoter activity (see discussion below, on T4), then the overall effect of inhibiting replication late in infection might be difficult to interpret, and the method of inhibition may also be important.

A view held by some is that late genes are regulated with early kinetics, and bypass a requirement for DNA replication, when they are integrated into the cellular genome (Silver and Roizman, 1985), or resident on a plasmid in transient assays (Mavromara-Nazos et al., 1986). As such, the regulation of late genes as early genes in the "environment of the host" (Mavromara-Nazos et al., 1986), has been taken into account to construct two further models for the role of DNA replication. As discussed in part 2 above, there is no reason to assume that the ability to trans-activate a late promoter in a transient assay is proof that it is being regulated by a different mechanism to its counterpart in the viral genome under non-replicative conditions. Silver and Roizman (1985) have shown that an L42-tk fusion gene was active in the absence of both a cis-linked HSV DNA replication origin, and HSV gene products, when integrated into the cellular genome of biochemically transformed cells. Infection of L42-tk transformed cells with HSV-1 increased tk activity by 16-fold. However, it is not known whether the early gene-like activity of the L42 promoter was due to an effect of the host genome, or the nature of cellular sequences surrounding the multiple, randomly integrated fusion genes. Aspects of the two models described below are influenced by whether or not viral genes are regulated differently outside the viral genome because of differences in DNA structure.

In simple terms, the "repressor model" supposes that viral or cellular factors prevent the activation of late

genes by IE gene products until these factors are displaced by viral DNA replication. Mavromara-Nazos et al. (1986) suggest that the putative "late-repressor" binds to viral late promoter DNA which is not part of a replication complex, but that the repressor cannot bind to cellular or plasmid DNA. Homa et al. (1986) suggest that there are specific sequences within a late promoter which are a target for a repressor; but this is difficult to reconcile with the ability to convert an EL promoter to a late promoter (Section J). There is evidence that prior to DNA replication MDBP represses transcription of HSV-1 genes belonging to all temporal classes (Godowski and Knipe, 1985, 1986), and therefore the repressor model is at least partly valid. However, a defect in MDBP permits only low levels of late gene transcription, so it is unlikely that MDBP plays a major role in the regulation of late gene expression. The repressor model is also unattractive for the following reason; it predicts that in the absence of repression late promoters can be activated by IE gene products as well as early promoters. However, the absence of an upstream region would suggest that late promoters need a positive mechanism to increase their expression, rather than the relief of repression.

The second model is the "sequestered factor" hypothesis, put forward by Mavromara-Nazos et al. (1986). This model predicts that host factors necessary for the induction of late genes are contained within host chromatin, and are released by an effect of the viral DNA polymerase. The main support for this model is that the expression of a late gene integrated into the cellular genome appeared to be unlinked from DNA replication (Silver and Roizman, 1985). However, it is difficult to imagine how the viral DNA polymerase could cause a release of factors from cellular chromatin.

#### 4. Comparison of HSV-1 and Bacteriophage T4 Regulation of Late Gene Transcription

Although HSV-1 replicates in eukaryotic cells and bacteriophage T4 replicates in prokaryotic cells, these

viruses appear to share a similarity regarding late promoter structure and the association of late transcription with DNA replication (see part 1 above). Unlike HSV-1, the majority of the ~150 gene functions of T4 have been characterized, facilitated by the ease with which phage containing mutations in individual genes can be isolated (for review, see Mathews et al., 1983). It is known that three T4-coded proteins, gp33, gp55, and gp45, are normally required for late gene expression. Two of these, gp33 and gp55, are subunits of the modified E.coli RNA polymerase, and are required for selective transcription from late promoters. The third gene product, gp45, is a component of the T4 DNA replication complex (the 'replisome'), but is also directly required for late transcription and is thought to interact with gp55 and RNA polymerase (Geiduschek et al., 1983). The components of T4 late gene transcription are therefore better defined than those of HSV. From this knowledge it would seem important that the intrinsic effects of DNA replication on HSV late gene transcription are able to be distinguished from the effects of individual HSV DNA replication proteins.

T4 late transcription is not dependent on a lasting covalent modification of replicated DNA, nor does it have an absolute requirement for DNA replication, as with HSV (Riva et al., 1970a). Blocking ongoing replication causes an approximate 10-fold decrease in the rate of T4 late RNA synthesis (Riva et al., 1970a), although metabolic inhibitors generate a less extreme effect on late transcription than inactivation of the T4 DNA polymerase (Rabussay and Geiduschek, 1979). This is reminiscent of the moderate reduction in the rate of HSV-1 US11 RNA synthesis in isolated nuclei following inhibition of DNA replication with PAA (Section L). Geiduschek et al. (1983) suggest that the 10-fold effect of ongoing DNA replication in T4 is divided between the effects of individual replication proteins (such as gp45), and the effects of DNA structure. An insight into the DNA structure that is important for late transcription has been gained by studying ts mutants in temperature shift-up experiments (Riva et al., 1970b). It

is possible to uncouple late transcription from DNA replication in a T4 multiple mutant bearing ts lesions in DNA polymerase, DNA ligase, and gene 46 exonuclease function. At NPT, the ts lesion in ligase prevents the repair of single-stranded nicks and gaps, many of which are likely to be generated at the replication fork. The mutation in DNA polymerase blocks DNA replication, and the mutation in gene 46 inhibits degradation of phage DNA. A role for DNA replication may therefore be the transient generation of a nicked template. Uncoupled late transcription has been shown to be correctly initiated, and absolutely dependent on gp55 and gp45 (Christensen and Young, 1982). Since it was attractive to propose that gp45 might link RNA polymerase to the replisome, and thus aid the initiation of late transcription in newly made DNA (Geiduschek et al., 1983), it was surprising to find that uncoupled late transcription was still dependent on gp45 function. The ability to express cloned T4 genes in plasmid DNA, following infection with T4 helper phage, has also presented problems in the interpretation of T4 late gene regulation (Geiduschek et al., 1983). However, the genetic background of the helper phage is critical for the induction of correctly initiated late RNA. The infecting phage must contain a mutation that allows transcription of cytosine-containing DNA (since T4 DNA normally contains hydroxymethylcytosine), and from the literature it seems controversial whether or not a recombination/nuclease function is involved in creating an independence from DNA replication for plasmid-borne late promoters (Christensen and Young, 1983; Geiduschek et al., 1983; Elliott and Geiduschek, 1984).

A major difference between HSV and T4 late transcription is that a T4-modified RNA polymerase appears to select T4 late promoters. There is no evidence that different factors are required in HSV infected cells for the recognition early and late promoters, with the possible exception of Vmw63 (Sacks et al., 1985). Promoter selectivity in T4 might be based on (i) a slight difference in the highly conserved "-10" region of T4 late promoters

(5'-TATAAATA-3') compared to the E.coli "-10" homology (5'-TATAAT-3') present in T4 early promoters, and (ii) a less conserved 3-4bp sequence located 3' to the late "-10" region (Christensen and Young, 1983). In HSV, selection of specific sequences within the TATA box-cap site regions of E and L genes is unlikely, since it has been shown that the TATA box of the EL gD promoter can function as a late promoter (Section J), and in general, the TATA box sequences of HSV early and late promoters do not appear to be very highly conserved (Wagner, 1985).

### 5. Future Prospects

Future work directed at improving the understanding of the control of HSV late gene transcription falls into three main areas; (i) precise definition of the late promoter sequence requirements; (ii) complete identification of the proteins involved in late transcription; and (iii) determining the exact role of DNA replication. Since the sequences required for late transcription are relatively short, the use of synthetic oligonucleotides to introduce specific mutations into the TATA box-cap site region would be quite easy. It would be possible to ask if the TATA box alone constitutes a late promoter, and determine the importance of individual nucleotides within the TATA box sequence.

The experiments which have shown that Vmw175 and Vmw110 can activate late promoters have been done in the absence of DNA replication, and the level of activation was quite low. It would be interesting to see if the DNA structure conferred by replication is sufficient to increase the level of activation mediated by Vmw175 and Vmw110, or if different IE or E gene products (such as Vmw63 replication functions) are involved. Plasmids bearing the US11 promoter could be replicated in the absence or presence of HSV replication functions, by (i) transfection into COS cells (which provide SV40 T antigen), using a US11 promoter linked to the SV40 origin of DNA replication (as in Section K(1)), or by (ii) reconstitution of isolated HSV-1 replication functions in a multiple co-transfection (using the approach of Challberg,

1986). The effect of isolated HSV genes, such as Vmw175, Vmw110 and Vmw63, could then be tested, on the expression of the US11 promoter contained on a replicating template.

To investigate the role of DNA replication in late gene expression, a sensitive assay is needed to measure the effects of various perturbations on late RNA synthesis. The nuclear run-on assay described in Section L appeared promising, although US11 was not a particularly suitable gene to study using this technique, as it was difficult to distinguish US11 RNA synthesis from that of IE gene 5, and due to the high level of background hybridization of cellular RNA to the US11 region. A more suitable late gene would be gC. It would be possible to determine the effect on gC transcription of, e.g. inhibition of DNA replication late in infection, temperature shift-up of ts DNA<sup>-</sup> mutants, and of ts mutants in other genes, such as Vmw175, which might be involved in late transcription.

Finally, does the control of HSV-1 late gene transcription have any relevance to the regulation of cellular genes? It seems reasonable to suggest that coupling transcription to DNA replication would be an appropriate way to achieve cell-cycle specific gene expression. However, the needs of a virus at the later stages of the lytic cycle are vastly different to those of a dividing cell. HSV-1 employs a method of achieving abundant late gene expression that appears to require less control than viral early genes or cellular genes; the absence of upstream promoter elements is likely to correlate with a reduced requirement for cellular transcription factors. Following the onset of HSV DNA replication, there appears to be an increase in the transcription of non-coding RNA molecules, which accumulate in the infected-cell nucleus; this may be a consequence of the relaxation of cis-acting control. If DNA replication is used as a trigger for cell-cycle specific gene expression, it is likely that the cellular mechanisms of control would differ from that of HSV-1 late gene expression, especially because the dividing cell replicates its DNA only once.

## REFERENCES

- Abmayr, S.M., Feldman, L.D. & Roeder, R.G. (1985). In vitro stimulation of specific RNA polymerase II-mediated transcription by the pseudorabies virus immediate early protein. *Cell* 43, 821-829.
- Ackermann, M., Braun, D.K., Pereira, L. & Roizman, B. (1984). Characterization of herpes simplex virus 1 proteins 0, 4, and 27 with monoclonal antibodies. *J. Virol.* 52, 108-118.
- Addison, C.A. (1986). Characterisation of herpes simplex virus type 1 ts mutants which have structural defects. Ph.D Thesis, University of Glasgow.
- Alford, C.A. & Britt, W.J. (1984). Cytomegalovirus. In "Virology" (ed. B.N.Fields), Raven Press, NY. pp629-660.
- Alwine, J.C. (1985). Transient gene expression control: Effects of transfected DNA stability and trans-activation by viral early proteins. *Mol. Cell. Biol.* 5, 1034-1042.
- Anderson, K.P., Stringer, J.R., Holland, L.E. & Wagner, E.K. (1979). Isolation and localization of herpes simplex type 1 mRNA. *J. Virol.* 30, 805-820.
- Anderson, K.P., Holland, L.E., Gaylord, B.H. & Wagner, E.K. (1980). Isolation and translation of mRNA encoded by a specific region of the herpes simplex virus type 1 genome. *J. Virol.* 33, 749-759.
- Anderson, K.P., Frink, R.J., Devi, G.B., Gaylord, B.H., Costa, R.H. & Wagner, E.K. (1981). Detailed characterisation of the mRNA mapping in the HindIII fragment k region of the herpes simplex virus type 1 genome. *J. Virol.* 37, 1011-1027.
- Appleyard, R.K. (1954). Segregation of new lysogenic types during growth of a doubly lysogenic strain from E.coli K12. *Genetics* 39, 440.
- Banerji, J., Olson, L. & Schaffner, W. (1983). A lymphocyte-specific cellular enhancer is located downstream of the joining region in immunoglobulin heavy chain genes. *Cell* 33, 729-740.
- Banerji, J., Rusconi, S. & Schaffner, W. (1981). Expression of a  $\beta$ -globin gene is enhanced by remote SV40 DNA sequences. *Cell* 27, 299-308.
- Banks, L., Purifoy, D.J.M., Hurst, P-F., Killington, R.A. & Powell, K.L. (1983). Herpes simplex virus non-structural proteins. IV. Purification of the virus-induced deoxyribonuclease and characterisation of the enzyme using monoclonal antibodies. *J. Gen. Virol.* 64, 2249-2260.

- Baringer, J.R. & Swoveland, P. (1973). Recovery of herpes simplex virus from human trigeminal ganglions. *New England J. of Med.* 288, 648-650.
- Baron, M.H. & Maniatis, T. (1986). Rapid reprogramming of globin gene expression in transient heterokaryons. *Cell* 46, 591-602.
- Bartoski, M. & Roizman, B. (1976). RNA synthesis in cells infected with herpes simplex virus. XIII. Differences in the methylation patterns of viral RNA during the reproductive cycle. *J. Virol.* 20, 583-588.
- Batterson, W & Roizman, B. (1983). Characterization of the herpes simplex virion-associated factor responsible for the induction of  $\alpha$  genes. *J. Virol.* 46, 371-377.
- Baty, D., Barrera-Saldana, H.A., Everett, R.D., Vigneron, M. & Chambon, P. (1984). Mutational dissection of the 21 bp repeat region of the SV40 early promoter reveals that it contains overlapping elements of the early-early and late-early promoters. *Nucleic Acids Res.* 12, 915-932.
- Bayliss, G.J., Marsden, H.S. & Hay, J. (1975). Herpes simplex virus proteins: DNA binding proteins in infected cells and in the virus structure. *Virology*, 68, 124-134.
- Beard, P., Faber, S., Wilcox, K.W. & Pizer, L.I. (1986). Herpes simplex virus mediated early infected-cell polypeptide 4 binds to DNA and promotes transcription. *Proc. Natl. Acad. Sci., U.S.A.* 83, 4016-4020.
- Becker, Y., Dym, H. & Sarov, I. (1968). Herpes simplex virus DNA. *Virology* 36, 184-192.
- Benoist, C. & Chambon, P. (1981). In vivo sequence requirements of the SV40 early promoter region. *Nature* 290, 304-310.
- Ben-Porat, T. & Kaplan, A.S. (1985). Molecular biology of pseudorabies virus. In "The Herpesviruses" Vol. 3 (ed. B. Roizman). Plenum Press, NY. pp105-173.
- Ben-Porat, T. & Tokazewski, S.A. (1977). Replication of herpesvirus DNA. II. Sedimentation characteristics of newly synthesized DNA. *Virology* 79, 292-301.
- Ben-Porat, T., Veach, R.A. & Ihara, S. (1983). Localization of the regions of homology between the genomes of herpes simplex virus, type 1, and pseudorabies virus. *Virology* 127, 194-204.
- Berg, J.M. (1986). Potential metal-binding domains in nucleic acid binding proteins. *Science* 232, 485-487.
- Berget, S.M. (1984). Are U4 small nuclear ribonucleoproteins involved in polyadenylation? *Nature* 309, 179-182.



- Berk, A.J., Lee, F., Harrison, T., Williams, J. & Sharp, P.A. (1979). Pre-early adenovirus 5 gene product regulates synthesis of early viral messenger RNAs. *Cell* 17, 935-944.
- Bertholet, C., Stocco, P., van Meir, E. & Wittek, R. (1986). Functional analysis of the 5' flanking sequence of a vaccinia virus late promoter. *EMBO J.* 5, 1951-1957.
- Bieker, J.J., Martin, P.L. & Roeder, R.G. (1985). Formation of a rate-limiting intermediate in 5S RNA gene transcription. *Cell* 40, 119-127.
- Bienz, M. & Pelham, H.R.B. (1982). Expression of a *Drosophila* heat shock protein in *Xenopus* oocytes: conserved and divergent regulatory signals. *EMBO J.* 1, 1583-1588.
- Birchmeier, C., Folk, W. & Birnstiel, M.L. (1983). The terminal RNA stem-loop structure and 80bp of spacer DNA are required for the formation of 3' termini of sea urchin H2A mRNA. *Cell* 35, 423-440.
- Bird, A.P. (1986). CpG-rich islands and the function of DNA methylation. *Nature* 321, 209-213.
- Black, D.L., Chabot, B. & Steitz, J.A. (1985). U2 as well as U1 small nuclear ribonucleoproteins are involved in premessenger RNA splicing. *Cell* 42, 737-750.
- Bolivar, F., Rodriguez, R.L., Greene, P.J., Betlach, M.C., Heynecker, H.L., Boyer, H.W., Crosa, J.H. & Falkow, S. (1977). Construction and characterisation of new cloning vehicles. II. A multi-purpose cloning system. *Gene* 2, 95-113.
- Borelli, E., Hen, R. & Chambon, P. (1984). Adenovirus-2 E1A products repress enhancer-induced stimulation of transcription. *Nature* 312, 608-612.
- Borelli, E., Hen, R., Wasylyk, C., Wasylyk, B. & Chambon, P. (1986). The immunoglobulin heavy chain enhancer is stimulated by the adenovirus type 2 E1A products in mouse fibroblasts. *Proc. Natl. Acad. Sci., U.S.A.* 83, 2846-2849.
- Boshart, M., Gissman, L., Ikenberg, H., Kleinenz, A., Scheurlen, W. & zur Hausen, H. (1984). A new type of papillomavirus DNA, its presence in genital cancer biopsies and cell lines derived from cervical cancer. *EMBO J.* 3, 1151-1157.
- Boshart, M., Weber, F., Jahn, G., Dorsch-Hasler, K., Fleckenstein, B. and Schaffner, W. (1985). A very strong enhancer is located upstream of an immediate early gene of human cytomegalovirus. *Cell* 41, 521-530.

- Boyer, H.W. & Roulland Dussoix, D. (1969). A complementation analysis of the restriction modification of DNA in Escherichia coli. *J. Mol. Biol.* 41, 459-472.
- Brady, J. & Khoury, G. (1985). trans Activation of the simian virus 40 late transcription unit by T-antigen. *Mol. Cell. Biol.* 5, 1391-1399.
- Brady, J., Bolen, J.B., Radonovich, M., Salzman, N. & Khoury, G. (1984). Stimulation of simian virus 40 late gene expression by simian virus 40 tumor antigen. *Proc. Natl. Acad. Sci., U.S.A.* 81, 2040-2044.
- Breathnach, R. & Chambon, P. (1981). Organisation and expression of eukaryotic split genes coding for proteins. *Ann. Rev. Biochem.* 50, 349-384.
- Briggs, M.R., Kadonaga, J.T., Bell, S.P. & Tjian, R. (1986). Purification and biochemical characterization of the promoter-specific transcription factor Spl. *Science* 234, 47-52.
- Brinster, R.L., Chen, H.Y., Warren, R., Sarthy, A. & Palmiter, R.D. (1982). Regulation of metallothionein-thymidine kinase fusion plasmids injected into mouse eggs. *Nature* 296, 39-42.
- Brown, S.M. & Harland, J. (1987). Three mutants of herpes simplex virus type 2: One lacking the genes US10, US11 and US12 and two in which R<sub>S</sub> has been extended by 6kb to 0.091 map units with loss of U<sub>S</sub> sequences between 0.94 and the U<sub>S</sub>/TR<sub>S</sub> junction. *J. Gen. Virol.* 68, 1-18.
- Brown, S.M., Ritchie, D.A. & Subak-Sharpe, J.H. (1973). Genetic studies with herpes simplex virus type 1. The isolation of temperature sensitive mutants, their arrangement into complementation groups and recombination analysis leading to a linkage map. *J. Gen. Virol.* 18, 329-346.
- Buchman, A.R. & Berg, P. (1984). Unusual regulation of simian virus 40 early-region transcription in genomes containing two origins of DNA replication. *Mol. Cell. Biol.* 4, 1915-1928.
- Buchman, A.R., Fromm, M. & Berg, P. (1984). Complex regulation of simian virus 40 early-region transcription from different overlapping promoters. *Mol. Cell. Biol.* 4, 1900-1914.
- Busby, D.W.G., House, W. and McDonald, J.R. (1964), in "Virological techniques", Churchill, London.
- Bzik, D.J. and Preston, C.M. (1986). Analysis of DNA sequences which regulate the transcription of herpes simplex virus immediate early gene 3: DNA sequences required for enhancer-like activity and response to trans-activation by a virion polypeptide. *Nucleic Acids*

- Bzik, D.J., Fox, B.A., DeLuca, N.A. & Person, S. (1984). Nucleotide sequence specifying the glycoprotein gene, gB, of herpes simplex virus type 1. *Virology* 133, 301-314.
- Cameron, I.R., Park, M., Dutia, B.M., Orr, A. & Macnab, J.C.M. (1985). Herpes simplex virus sequences involved in the initiation of oncogenic morphological transformation of rat cells are not required for maintenance of the transformed state. *J. Gen. Virol.* 66, 517-527.
- Campbell, M.E.M. & Preston, C.M. (1987). DNA sequences which regulate the expression of pseudorabies virus major immediate early gene. *Virology* (in press).
- Campbell, M.E., Palfreyman, J.W. & Preston, C.M. (1984). Identification of herpes simplex virus DNA sequences which encode a transacting polypeptide responsible for stimulation of immediate-early transcription. *J. Mol. Biol.* 180, 1-21.
- Cassidy, B.G., Yang-Yen, H. & Rothblum, I.L. (1986). Transcriptional role for the nontranscribed spacer of rat ribosomal DNA. *Mol. Cell. Biol.* 6, 2766-2773.
- Cereghini, S. & Yaniv, M. (1984). Assembly of transfected DNA into chromatin: Structural changes in the origin-promoter-enhancer region upon replication. *EMBO J.* 3, 1243-1253.
- Chabot, B., Black, D.L., LeMaster, D.M. & Steitz, J.A. (1985). The 3' splice site of pre-messenger RNA is recognized by a small nuclear ribonucleoprotein. *Science* 230, 1344-1349.
- Chalifour, L.E., Wirak, D.O., Wassarman, P.M. & DePamphilis, M.L. (1986). Expression of simian virus 40 early and late genes in mouse oocytes and embryos. *J. Virol.* 59, 619-627.
- Challberg, M.D. (1986). A method for identifying the viral genes required for herpesvirus DNA replication. *Proc. Natl. Acad. Sci. U.S.A.* 83, 9094-9098.
- Chandler, V.L., Maler, B.A. & Yamamoto, K.R. (1983). DNA sequences bound specifically by glucocorticoid receptor in vitro render a heterologous promoter hormone responsive in vivo. *Cell* 33, 489-499.
- Charnay, P., Mellon, P. & Maniatis, T. (1985). Linker scanning mutagenesis of the 5'-flanking region of the mouse  $\beta$ -major-globin gene: Sequence requirements for transcription in erythroid and nonerythroid cells. *Mol. Cell. Biol.* 5, 1498-1511.

- Chartrand, P., Crumpacker, C.S., Schaffer, P.A. & Wilkie, N.M. (1980). Physical and genetic analysis of the herpes simplex virus DNA polymerase locus. *Virology* 103, 311-326.
- Chen, I.S.Y. (1986). Regulation of AIDS virus expression. *Cell* 47, 1-2.
- Choi, O-R., & Engel, J.D. (1986). A 3' enhancer is required for temporal and tissue-specific transcriptional activation of the chicken adult  $\beta$ -globin gene. *Nature* 323, 731-734.
- Chou, J. & Roizman, B. (1985) Isomerization of herpes simplex virus 1 genome: Identification of the cis-acting and recombination sites within the domain of the a sequence. *Cell* 41, 803-811.
- Christensen, A.C. & Young, E.T. (1982). T4 late transcripts are initiated near a conserved DNA sequence. *Nature* 299, 369-371.
- Christensen, A.C. & Young, E.T. (1983). Characterization of T4 transcripts. In "Bacteriophage T4" (ed. C.Mathews et al.). American Society for Microbiology, Washington.
- Clements, J.B., Cortini, R. & Wilkie, N.M. (1976). Analysis of herpesvirus substructure by means of restriction endonucleases. *J. Gen. Virol.* 30, 243-256.
- Clements, J.B., McLauchlan, J. & McGeoch, D.J. (1979). Orientation of herpes simplex virus type 1 immediate-early mRNAs. *Nucleic Acids Res.* 7, 77-91.
- Clements, J.B., Watson, R.J. and Wilkie, N.M. (1977). Temporal regulation of herpes simplex virus type 1 transcription: location of transcripts on the viral genome. *Cell* 12, 275-285.
- Coen, D.M., Weinheimer, S.P. & McKnight, S.L. (1986). A genetic approach to promoter recognition during trans induction of viral gene expression. *Science* 234, 53-59.
- Cohen, E.A. Gaudreau, P., Brazeau, P. & Langelier, Y. (1986). Specific inhibition of herpesvirus ribonucleotide reductase by a nonapeptide derived from the carboxy terminus of subunit 2. *Nature* 321, 441-443.
- Cohen, G.H. (1972). Ribonucleotide reductase activity of synchronised KB cells infected with herpes simplex virus. *J. Virol.* 9, 408-418.
- Cole, C.N. & Stacy, T.P. (1985). Identification of sequences in the herpes simplex virus thymidine kinase gene required for efficient processing and polyadenylation. *Mol. Cell. Biol.* 5, 2104-2113.

- Conley, A.J., Knipe, D.M., Jones, P.C. & Roizman, B. (1981). Molecular genetics of herpes simplex virus. VII. Characterization of a temperature-sensitive mutant produced by in vitro mutagenesis and defective in DNA synthesis and accumulation of  $\gamma$  polypeptides. *J. Virol.* 37, 191-206.
- Cook, M.L., Bastone, V.B. & Stevens, J.G. (1974). Evidence that neurons harbour latent herpes simplex virus. *Infection and Immunity*, 9, 946-951.
- Cordingley, M.G., Campbell, M.E. & Preston, C.M. (1983). Functional analysis of a herpes simplex type 1 promoter: identification of far-upstream regulatory sequences. *Nucleic Acids Res.* 11, 2347-2365
- Costa, R.H., Cohen, G., Eisenberg, R., Long, D. & Wagner, E.K. (1984). Direct demonstration that the abundant 6 kilobase herpes simplex virus type 1 mRNA mapping between 0.23 and 0.27 map units encodes the major capsid protein VP5. *J. Virol.* 49, 287-292.
- Costa, R.H., Draper, K.G., Banks, L., Powell, K.L., Cohen, G., Eisenberg, R. & Wagner, E.K. (1983). High-resolution characterization of herpes simplex virus type 1 transcripts encoding alkaline exonuclease and a 50,000-dalton protein tentatively identified as a capsid protein. *J. Virol.* 48, 591-603.
- Costa, R.H., Draper, K.G., Kelly, T.J. & Wagner, E.K. (1985a). An unusual spliced herpes simplex virus type 1 transcript with sequence homology to Epstein-Barr virus DNA. *J. Virol.* 54, 317-328.
- Costa, R.H., Draper, K.G., Devi-Rao, G., Thompson, R.L. & Wagner, E.K. (1985b). Virus-encoded modification of the host cell is required for expression of the bacterial chloramphenicol acetyltransferase gene controlled by a late herpes simplex virus promoter (VP5). *J. Virol.* 56, 19-30.
- Costanzo, F., Campadelli-Fiume, G., Foa-Tomasi, L. & Cassai, E. (1977). Evidence that herpes simplex virus DNA is transcribed by cellular RNA polymerase B. *J. Virol.* 21, 996-1001.
- Dalrymple, M.A., McGeoch, D.J., Davison, A.J. & Preston, C.M. (1985). DNA sequence of the herpes simplex virus type 1 gene whose product is responsible for transcriptional activation of immediate early promoters. *Nucleic Acids Res.* 13, 7865-7879.
- Dalziel, R.G. & Marsden, H.S. (1984). Identification of two herpes simplex virus type 1-induced proteins (21K and 22K) which interact specifically with the a sequence of herpes simplex virus DNA. *J. Gen Virol.* 65, 1467-1475.

- Danielson, M., Northrop, J.P. & Ringold, G.M. (1986). The mouse glucocorticoid receptor: Mapping of functional domains by cloning, sequencing and expression of wild-type and mutant receptor proteins. *EMBO J.* 5, 2513-2522.
- Davidson, I. & Stow, N.D. (1985). Expression of an immediate early polypeptide and activation of a viral origin of DNA replication in cells containing a fragment of herpes simplex virus DNA. *Virology* 141, 77-88.
- Davidson, I., Fromental, C., Augereau, P., Wildeman, A., Zenke, M. & Chambon, P. (1986). Cell-type specific protein binding to the enhancer of simian virus 40 in nuclear extracts. *Nature*, 323, 544-548.
- Davison, A.J. & Scott, J.E. (1985). DNA sequence of the major inverted repeat in the varicella-zoster virus genome. *J. Gen. Virol.* 66, 207-220.
- Davison, A.J. & Scott, J.E. (1986). The complete DNA sequence of varicella-zoster virus. *J. Gen. Virol.* 67, 1759-1816.
- Davison, A.J. & Wilkie, N.M. (1981). Nucleotide sequences of the joint between the L and S segments of herpes simplex virus types 1 and 2. *J. Gen. Virol.* 55, 315-331.
- Davison, A.J. & Wilkie, N.M. (1983a). Location and orientation of homologous sequences in the genomes of five herpesviruses. *J. Gen. Virol.* 64, 1927-1942.
- Davison, A.J. & Wilkie, N.M. (1983b). Inversion of the two segments of the herpes simplex virus genome in intertypic recombinants. *J. Gen. Virol.* 64, 1-18.
- Davison, M.-J., Preston, V.G. & McGeoch, D.J. (1984). Determination of the sequence alteration in the DNA of the herpes simplex virus type 1 temperature-sensitive mutant tsK. *J. Gen. Virol.* 65, 859-863.
- DeFranco, D. & Yamamoto, K.R. (1986). Two different factors act separately or together to specify functionally distinct activities at a single transcriptional enhancer. *Mol. Cell. Biol.* 6, 993-1001.
- Deiss, L.P., Chou, J. & Frenkel, N. (1986). Functional domains within the a sequence involved in the cleavage-packaging of herpes simplex virus DNA. *J. Virol.* 59, 605-618.
- Delius, H. & Clements, J.B. (1976). A partial denaturation map of herpes simplex virus type 1 DNA: Evidence for inversions of the unique DNA regions. *J. Gen. Virol.* 33, 125-133.

- DeLuca, N.A. & Schaffer, P.A. (1985). Activation of immediate-early, early, and late promoters by temperature-sensitive and wild-type forms of herpes simplex virus type 1 protein ICP4. *Mol. Cell. Biol.* 5, 1997-2008.
- DeLuca, N.A., Courtney, M.A. & Schaffer, P.A. (1984). Temperature-sensitive mutants in herpes simplex virus type 1 ICP4 permissive for early gene expression. *J. Virol.* 52, 767-776.
- DeLuca, N.A., McCarthy, A.M. and Schaffer, P.A. (1985). Isolation and characterization of deletion mutants of herpes simplex virus type 1 in the gene encoding immediate-early regulatory protein ICP4. *J. Virol.* 56, 556-570.
- Dennis, D. & Smiley, J.R. (1984). Transactivation of a late herpes simplex virus promoter. *Mol. Cell. Biol.* 4, 544-551.
- Dierks, P., van Ooyen, A., Cochran, M.D., Dobkin, C., Reiser, J. & Weissmann, C. (1983). Three regions upstream from the cap site are required for efficient and accurate transcription of the rabbit  $\beta$ -globin gene in mouse 3T6 cells. *Cell* 32, 695-706.
- Dixon, R.A.F. & Schaffer, P.A. (1980). Fine-structure mapping and functional analysis of temperature-sensitive mutants in the gene encoding the herpes simplex virus type 1 immediate early protein VP175. *J. Virol.* 36, 189-203.
- Durst, M., Gissman, L., Ikenberg, H. & zur Hausen, H. (1983). A papillomavirus DNA from a cervical carcinoma and its prevalence in cancer biopsy samples from different geographic regions. *Proc. Natl. Acad. Sci. U.S.A.* 80, 3812-3815.
- Dush, M.K., Sikela, J.M., Khan, S.A., Tischfield, J.A. & Stambrook, P.A. (1985). Nucleotide sequence and organization of the mouse adenine phosphoribosyltransferase gene: Presence of a coding region common to animal and bacterial phosphoribosyltransferases that has a variable intron/exon arrangement. *Proc. Natl. Acad. Sci. U.S.A.* 82, 2731-2735.
- Dutia, B.M. (1983). Ribonucleotide reductase induced by herpes simplex virus has a virus-specified constituent. *J. Gen. Virol.* 64, 513-521.
- Dutia, B.M., Frame, M.C., Subak-Sharpe, J.H., Clark, W.N. & Marsden, H.S. (1986). Specific inhibition of herpesvirus ribonucleotide reductase by synthetic peptides. *Nature* 321, 439-441.

- Dynan, W.S. & Tjian, R. (1983a). Isolation of transcription factors that discriminate between different promoters recognised by RNA polymerase II. *Cell* 32, 669-680.
- Dynan, W.S. & Tjian, R. (1983b). The promoter specific transcription factor Spl binds to upstream sequences in the SV40 early promoter. *Cell* 35, 79-87.
- Dynan, W.S. & Tjian, R. (1985). Control of eukaryotic messenger RNA synthesis by sequence-specific DNA-binding proteins. *Nature* 316, 774-778.
- Echols, H. (1986). Multiple DNA-protein interactions governing high-precision DNA transactions. *Science* 233, 1050-1056.
- Edbrooke, M.R., Parker, D., McVey, J.H., Riley, J.H., Sorenson, G.D., Pettengill, O.S. & Craig, R.K. (1985). Expression of human calcitonin/CGRP gene in lung and thyroid carcinoma. *EMBO J.* 4, 715-724.
- Efstathiou, S., Minson, A.C., Field, H.J., Anderson, J.R. & Wildy, P. (1986). Detection of herpes simplex virus-specific DNA sequences in latently infected mice and humans. *J. Virol.* 57, 446-455.
- Eisenberg, S.P., Coen, D.M. & McKnight, S.L. (1985). Promoter domains required for expression of plasmid-borne copies of the herpes simplex virus thymidine kinase gene in virus infected mouse fibroblasts and microinjected frog oocytes. *Mol. Cell. Biol.* 5, 1940-1947.
- Elias, P., O'Donnell, M.E., Mocarski, E.D. & Lehman, I.R. (1986). A DNA binding protein specific for an origin of replication of herpes simplex virus type 1. *Proc. Natl. Acad. Sci., U.S.A.* 83, 6322-6326.
- El Karez, A., Murphy, A.J.M., Fichter, T., Efstratiadis, A. & Silverstein, S. (1985). "Transactivation" control signals in the promoter of the herpesvirus thymidine kinase gene. *Proc. Natl. Acad. Sci., U.S.A.* 82, 1002-1006.
- Elliott, T. & Geiduschek, E.P. (1984). Defining a bacteriophage T4 late promoter: Absence of a "-35" region. *Cell* 36, 211-219.
- Engelke, D.R., Ng, S-Y., Shastry, B.S. & Roeder, R.G. (1980). Specific interaction of a purified transcription factor with an internal control region of 5S RNA genes. *Cell* 19, 717-728.
- Ephrussi, A., Church, G.M., Tonegawa, S. & Gilbert, W. (1985). B lineage-specific interactions of an immunoglobulin enhancer with cellular factors in vivo. *Science* 227, 134-140.



- Epstein, M.A. (1962). Observations on the fine structure of mature herpes simplex virus and on the composition of its nucleoid. *J. Exp. Med.* 115, 1-9.
- Esparaza, J., Benyesh-Melnick, M. & Schaffer, P.A. (1976). Intertypic complementation and recombination between temperature sensitive mutants of herpes simplex virus types 1 and 2. *Virology* 70, 372-384.
- Everett, R.D. (1983). DNA sequence elements required for regulated expression of the HSV-1 glycoprotein D gene lie within 83 bp of the RNA capsites. *Nucleic Acids Res.* 11, 6647-6666.
- Everett, R.D. (1984a). Trans activation of transcription by herpes virus products: requirement for two HSV-1 immediate-early polypeptides for maximum activity. *EMBO J.* 3, 3135-3141.
- Everett, R.D. (1984b). A detailed analysis of an HSV-1 early promoter: sequences involved in trans-activation by viral immediate-early gene products are not early-gene specific. *Nucleic Acids Res.* 12, 3037-3056.
- Everett, R.D. (1985). Activation of cellular promoters during herpes virus infection of biochemically transformed cells. *EMBO J.* 4, 1973-1980.
- Everett, R.D. (1986). The products of herpes simplex virus type 1 (HSV-1) immediate early genes 1, 2 and 3 can activate HSV-1 gene expression in trans. *J. Gen. Virol.* 67, 2507-2153.
- Everett, R.D. (1987). Differential promoter activation during infection by herpes simplex virus type 1: A role for the TATA box region. *J. Mol. Biol.* (in press).
- Everett, R.D. & Dunlop, M. (1984). Trans-activation of plasmid-borne promoters by adenovirus and several herpes group viruses. *Nucleic Acids Res.* 12, 5969-5978.
- Everett, R.D., Baty, D. & Chambon, P. (1983). The repeated GC-rich motifs upstream from the TATA box are important elements of the SV40 early promoter. *Nucleic Acids Res.* 11, 2447-2464.
- Faber, S.W. & Wilcox, K.W. (1986). Association of the herpes simplex virus regulatory protein ICP4 with specific nucleotide sequences in DNA. *Nucleic Acids Res.* 14, 6067-6083.
- Feldman, L.T., Imperiale, M.J. & Nevins, J.R. (1982). Activation of early adenovirus transcription by the herpes virus immediate-early gene: evidence for a common cellular control factor. *Proc. Natl. Acad. Sci. U.S.A.* 79, 4952-4956.

- Fenwick, M.L. & Walker, M.J. (1979). Phosphorylation of a ribosomal protein and of virus-specific proteins in cells infected with herpes simplex virus. *J. Gen. Virol.* 45, 397-405.
- Fenwick, M.L., Morse, L.S. & Roizman, B. (1979). Anatomy of herpes simplex virus DNA. XI. Apparent clustering of functions effecting rapid inhibition of host DNA and protein synthesis. *J. Virol.* 29, 825-827.
- Fletcher, K., Cordiner, J.W. & Macnab, J.C.M. (1986). Detection of sequences that hybridize to human cytomegalovirus DNA in cervical neoplastic tissue. *Disease Markers* 3 (in press).
- Fowlkes, D.M. & Shenk, T. (1980). Transcription control regions of the adenovirus VAI RNA gene. *Cell* 22, 405-413.
- Frame, M.C., Marsden, H.S. & Dutia, B.M. (1985). The ribonucleotide reductase induced by herpes simplex virus type 1 involves minimally a complex of two polypeptides (136K and 38K). *J. Gen. Virol.* 66, 1581-1587.
- Frame, M.C., Marsden, H.S. & McGeoch, D.J. (1986). Novel herpes simplex virus type 1 glycoprotein identified by antiserum against a synthetic oligopeptide from the predicted product of US4. *J. Gen. Virol.* 67, 745-751.
- Freeman, M.J. & Powell, K.L. (1982). DNA-binding properties of a herpes simplex virus immediate early protein. *J. Virol.* 44, 1084-1087.
- Friendewey, D. & Keller, W. (1985). Stepwise assembly of a pre-mRNA splicing complex requires U-snrRNPs and specific intron sequences. *Cell* 42, 355-367.
- Friedmann, A., Shlomai, J. & Becker, Y. (1977). Electron microscopy of herpes simplex virus DNA molecules isolated from infected cells by centrifugation in CsCl density gradients. *J. Gen. Virol.* 34, 507-522.
- Frink, R.J., Anderson, K.P. & Wagner, E.K. (1981). Herpes simplex virus type 1 HindIII fragment L encodes spliced and complementary mRNA species. *J. Virol.* 39, 559-572.
- Frink, R.J., Eisenberg, R., Cohen, G. & Wagner, E.K. (1983). Detailed analysis of the portion of the herpes simplex virus type 1 genome encoding glycoprotein C. *J. Virol.* 45, 634-647.
- Fromm, M & Berg, P. (1982). Deletion mapping of DNA regions required for SV40 early promoter function in vivo. *J. Mol. Appl. Genet.* 1, 457-481
- Gaffney, D., McLauchlan, J., Whitton, J.L. & Clements, J.B. (1985). A modular system for the assay of transcription regulatory signals: The sequence TAATGARAT is required

for herpes simplex virus immediated early gene activation. *Nucleic Acids Res.* 13, 7847-7863.

- Gannon, F., O'Hare, K., Perrin, F., Le Pennec, J.P., Benoist, C., Cochet, M., Breathnach, R., Royal, A., Garapin, A., Cami, B. and Chambon, P. (1979). Organisation and sequences at the 5' end of a cloned complete ovalbumin gene. *Nature* 278, 428-434.
- Galas, D. & Schmitz, A. (1978). DNAase footprinting: a simple method for the detection of protein-DNA binding specificity. *Nucleic Acids Res.* 5, 3157-3170.
- Galloway, D.A. & McDougall, J.K. (1983). The oncogenic potential of herpes simplex viruses: evidence for a 'hit-and-run' mechanism. *Nature* 302, 21-24.
- Galloway, D.A., Nelsen, J.A. & McDougall, J.K. (1984). Small fragments of herpesvirus DNA with transforming activity contain insertion sequence-like structures. *Proc. Natl. Acad. Sci., U.S.A.* 81, 4736-4740.
- Garner, N.M. & Revzin, A. (1981). A gel electrophoresis method for quantifying the binding of proteins to specific DNA regions. Applications to components of the *E.coli* lactose operon regulatory system. *Nucleic Acids Res.* 9, 3047-3060.
- Geballe, A.P. Leach, F.S. & Mocarski, E.S. (1986). Regulation of cytomegalovirus late gene expression:  $\gamma$  genes are controlled by posttranscriptional events. *J. Virol.* 57, 864-874.
- Geiduschek, E.P., Elliott, T. & Kassavetis, G.A. (1983). Regulation of late gene expression. In "Bacteriophage T4" (ed. C.K.Mathews et al.), pp189-192. American Society for Microbiology, Washington.
- Geisse, S., Scheidereit, C., Westphal, H.M., Hynes, N.E., Groner, B. & Beato, M. (1982). Glucocorticoid receptors recognise DNA sequences in and around murine mammary tumour virus DNA. *EMBO J.* 1, 1613-1619.
- Gelb, L.D. (1985). Varicella-zoster virus. In "Virology" (ed. B.Fields et al.). Raven Press, NY. pp 591-627.
- Gelman, I.H. & Silverstein, S. (1985). Identification of immediate early genes from herpes simplex virus that transactivate the virus thymidine kinase. *Proc. Natl. Acad. Sci., U.S.A.* 82, 5265-5269.
- Gelman, I.H. & Silverstein, S. (1986). Co-ordinate regulation of herpes simplex virus gene expression is mediated by the functional interaction of two immediate early gene products. *J. Mol. Biol.* 191, 395-409.
- Ghosh, P. & Lebowitz, P. (1981). Simian virus 40 mRNAs contain multiple 5' termini upstream and downstream from

a Hogness-Goldberg sequence: a shift in 5' termini during the lytic cycle is mediated by large T antigen. *J. Virol.* 40, 224-240.

- Gibson, M.G. & Spear, P.G. (1983). Insertion mutants of herpes simplex virus have a duplication of the glycoprotein D gene and express two different forms of glycoprotein D. *J. Virol.* 48, 396-404.
- Gidoni, D., Kahana, C., Canaani, D, & Groner, Y. (1981). Specific in vitro stimulation of transcription of simian virus 40 early and late genes occurs at various cap nucleotides including cytidine. *Proc. Natl. Acad. Sci., U.S.A.* 78, 2174-2178.
- Giguere, V., Hollenberg, S.M., Rosenfeld, M.G. & Evans R.M. (1986). Functional domains of the human glucocorticoid receptor. *Cell* 46, 645-652.
- Gil, A. & Proudfoot, N.J. (1984). A sequence downstream of the AAUAAA is required for rabbit  $\beta$ -globin mRNA 3'-end formation. *Nature* 312, 473-474.
- Gilbert, W. Marchionni, M. & McKnight, G. (1986). On the antiquity of introns. *Cell* 46, 151-154.
- Goding, C., Jalinot, P., Zajchowski, D., Boeuf, H. & Kedinger, C. (1985). Sequence-specific trans-activation of the adenovirus EIIa early promoter by the viral EIV transcription unit. *EMBO J.* 4, 1523-1528.
- Godowski, P.J. & Knipe, D.M. (1983). Mutations in the major DNA-binding protein gene of herpes simplex virus type 1 result in increased levels of viral gene expression. *J. Virol.* 47, 478-486.
- Godowski, P.J. & Knipe, D.M. (1985). Identification of a herpes simplex virus function that represses late gene expression from parental viral genomes. *J. Virol.* 55, 357-365.
- Godowski, P.J. & Knipe, D.M. (1986). Transcriptional control of herpesvirus gene expression: Gene functions required for positive and negative regulation. *Proc. Natl. Acad. Sci., U.S.A.* 83, 256-260.
- Gordin, H., Olshevsky, U., Rosenkrantz, H.S. & Becker, Y. (1973). Studies on herpes simplex virus DNA: denaturation properties. *Virology* 55, 280-284.
- Gorman, C.M., Moffat, F.L. & Howard, B.H. (1982). Recombinant genomes which express chloramphenicol acetyl transferase in mammalian cells. *Mol. Cell. Biol.* 2, 1044-1051.
- Grabowski, P.J. & Sharp, P.A. (1986). Affinity chromatography of splicing complexes: U2, U5, and U4+U6 small nuclear ribonucleoprotein particles in the

spliceosome. *Science* 233, 1294-1299.

- Grabowski, P.J., Seiler, S.R. & Sharp, P.A. (1985). A multicomponent complex is involved in the splicing of messenger RNA precursors. *Cell* 42, 345-353.
- Grafstrom, R.H., Alwine, J.C., Steihart, W. L. & Hill, C.W. (1974). Terminal repetitions of herpes simplex virus type 1 DNA. *Cold Spring Harbour Symp. Quant. Biol.* 39, 679-683.
- Graham, F.L., Veldheisen, G. & Wilkie, N.M. (1973). Infectious herpesvirus DNA. *Nature New Biology* 245, 265-266.
- Graves, B.J., Johnson, P.F. & McKnight, S.L. (1986). Homologous recognition of promoter domains common to the MSV LTR and the HSV *tk* gene. *Cell* 44, 565-576.
- Green, M.R., Treisman, R. & Maniatis, T. (1983). Transcriptional activation of cloned human  $\beta$ -globin genes by viral immediate-early gene products. *Cell* 35, 137-148.
- Greenberg, M.E. & Ziff, E.B. (1984). Stimulation of 3T3 cells induces transcription of the c-fos proto-oncogene. *Nature*, 311, 433-437.
- Grez, M., Land, H., Giesecke, K, Schutz, G., Jung, A. & Sippel, A.E. (1981). Multiple mRNAs are generated from the chicken lysozyme gene. *Cell* 25, 743-752.
- Grosveld, G.C., de Boer, E., Shewmaker, C.K. & Flavell, R.A. (1982). DNA sequences necessary for transcription of the rabbit  $\beta$ -globin gene in vivo. *Nature* 295, 120-126.
- Grummt, I. (1982). Nucleotide sequence requirements for specific initiation of transcription by RNA polymerase I. *Proc. Natl. Acad. Sci. U.S.A.* 79, 6908-6911.
- Grummt, I., Roth, E. & Paule M.R. (1982). Ribosomal RNA transcription in vitro is species specific. *Nature* 296, 173-174.
- Hall, L.M., Draper, K.G., Frink, R.J., Costa, R.H. & Wagner, E.K. (1982). Herpes simplex virus mRNA species mapping in EcoRI fragment I. *J. Virol.* 43, 594-607.
- Halpern, M.E. & Smiley, J.R. (1984). Effects of deletions on expression of herpes simplex virus thymidine kinase gene from the intact viral genome: The amino terminus of the enzyme is dispensable for catalytic activity. *J. Virol.* 50, 733-738.
- Haltiner, M.M., Smale, S.T. & Tjian, R. (1986). Two distinct promoter elements in the human rRNA gene identified by linker scanning mutagenesis. *Mol. Cell. Biol.* 6, 227-235.

- Hanas, J.S., Bogenhagen, D.F. & Wu, C-W. (1984). DNA unwinding ability of Xenopus transcription factor A. *Nucleic Acids Res.* 12, 1265-1276.
- Hänggi, M., Bannwarth, W, & Stunnenberg, H.G. (1986). Conserved TAAAT motif in vaccinia virus late promoters: overlapping TATA box and site of transcription initiation. *EMBO J.* 5, 1071-1076.
- Harris-Hamilton, E. & Bachenheimer, S.L. (1985). Accumulation of herpes simplex virus type 1 RNAs of different kinetic classes in the cytoplasm of infected cells. *J. Virol.* 53, 144-151.
- Hart, R.P., McDevitt, M.A. & Nevins, J.R. (1985). Poly(A) site cleavage in a HeLa nuclear extract is dependent on downstream sequences. *Cell* 43, 677-683.
- Hartzell, S.W., Byrne, B.J. & Subramanian, K.N. (1984). Mapping of the late promoter of simian virus 40. *Proc. Natl. Acad. Sci., U.S.A.* 81, 23-27.
- Hashimoto, C. & Steitz, J.A. (1986). A small nuclear ribonucleoprotein associates with the AAUAAA polyadenylation signal in vitro. *Cell* 45, 581-591.
- Hay, R.T. & Hay, J. (1980). Properties of herpesvirus-induced "immediate-early" polypeptides. *Virology* 104, 230-234.
- Hay, R.T. & Hay, J. (1981). Characteristics of chromatin preparations from herpes simplex virus infected cells. *Biochem. Biophys. Acta* 655, 71-81.
- Hay, R.T. & Subak-Sharpe, J.H. (1976). Mutants of herpes simplex virus types 1 and 2 that are resistant to phosphonoacetic acid induce altered DNA polymerase activities in infected cells. *J. Gen. Virol.* 31, 145-148.
- Hay, J., Brown, S.M., Jamieson, A.T., Rixon, F.J., Moss, H., Dargan, D.A. & Subak-Sharpe, J.H. (1977). The effect of phosphonoacetic acid on herpes viruses. *J. Antimicrobial Chemotherapy (Suppl.A)*, 3, 63-77.
- Hayward, G.S., Jacob, R.J., Wadsworth, S.C. & Roizman, B. (1975). Anatomy of herpes simplex virus DNA: evidence for four populations of molecules that differ in the relative orientations of their long and short components. *Proc. Natl. Acad. Sci.* 72, 4243-4247.
- Hearing, P. & Shenk, T. (1983). The adenovirus type 5 E1A transcriptional control region contains a duplicated enhancer element. *Cell* 33, 695-703.
- Helig, R., Muraskowsky, R. & Mandel, J-L. (1982). The ovalbumin gene family. The 5' end region of the X and Y genes. *J. Mol. Biol.* 156, 1-19.

- Heintz, N. & Roeder, R.G. (1982). Transcription of eukaryotic genes in soluble cell-free systems. In "Genetic Engineering" Vol. 4, pp57-89. Plenum Press, NY.
- Hen, R.H., Borrelli, E. & Chambon, P. (1985). Repression of the immunoglobulin heavy chain enhancer by the adenovirus-2 E1A products. *Science* 230, 1391-1394.
- Hen, R.H., Borrelli, E., Fromental, C., Sassone-Corsi, P. & Chambon, P. (1986). A mutated polyoma virus enhancer which is active in undifferentiated embryonal carcinoma cells is not repressed by adenovirus-2 E1A products. *Nature* 321, 249-251.
- Herbommel, P., Bourachot, B. & Yaniv, M. (1984). Two distinct enhancers with different cell specificities co-exist in the regulatory region of polyoma. *Cell* 39, 653-662.
- Herr, W. & Clarke, J. (1986). The SV40 enhancer is composed of multiple functional elements that can compensate for one another. *Cell* 45, 461-470.
- Hesse, J.E., Nickol, J.M. Lieber, M.R. & Felsenfeld, G. (1986). Regulated gene expression in transfected primary chicken erythrocytes. *Proc. Natl. Acad. Sci., U.S.A.* 83, 4312-4316.
- Hill, T.J. (1985). Herpes simplex virus latency. In "The Herpesviruses", Vol.3 (ed. B.Roizman), Plenum Press. pp175-240.
- Hock, R.A. & Miller, A.D. (1986). Retrovirus-mediated transfer and expression of drug resistance genes in human haematopoietic progenitor cells. *Nature* 230, 275-277.
- Hofer, E. & Darnell, J.E. (1981). The primary transcription unit of the mouse  $\beta$ -major globin gene. *Cell* 23, 585-593.
- Hofstetter, H., Kressmann, A. & Birnstiel, M.L. (1981). A split promoter for a eukaryotic tRNA gene. *Cell* 24, 573-585.
- Holland, L.E., Anderson, K.P., Shipman, C. & Wagner, E.K. (1980). Viral DNA synthesis is required for the efficient expression of specific herpes simplex virus type 1 mRNA species. *Virology* 101, 10-24.
- Hollenberg, S.M., Weinberger, C., Ong, E.S., Cerelli, G., Oro, A., Lebo, R., Thompson, E.B., Rosenfeld, M.G. & Evans, R.M. (1985). Primary structure and expression of a functional human glucocorticoid receptor cDNA. *Nature* 318, 635-641.
- Holmes, D.S. & Quigley, M. (1981). A rapid boiling method for the preparation of bacterial plasmids. *Anal. Biochem.* 114, 193-197.

- Homa, F.L., Otal, T.M., Glorioso, J.C. & Levine, M. (1986). Transcriptional control signals of a herpes simplex virus type 1 late ( $\gamma_2$ ) gene lie within bases -34 to +124 relative to the 5' terminus of the mRNA. *Mol. Cell. Biol.* (in press).
- Honess, R.W. & Roizman, B. (1974). Regulation of herpesvirus macromolecular synthesis. I. Cascade regulation of the synthesis of three groups of viral proteins. *J. Virol.* 14, 8-19.
- Honess, R.W. & Roizman, B. (1975). Regulation of herpesvirus macromolecular synthesis: sequential transition of polypeptide synthesis requires functional viral polypeptides. *Proc. Natl. Acad. Sci. U.S.A.* 72, 1276-1280.
- Honess, R.W. & Watson, D.H. (1977). Herpes simplex virus resistance and sensitivity to phosphonoacetic acid. *J. Virol.* 21, 584-600.
- Huszar, D. & Bacchetti, S. (1983). Is ribonucleotide reductase the transforming function of herpes simplex virus type 1? *Nature* 302, 76-79.
- Ihara, S., Feldman, L., Watanabe, S. & Ben-Porat, T. (1983). Characterization of the immediate early functions of pseudorabies virus. *Virology* 131, 437-454.
- Imperiale, M.J. & Nevins, J.R. (1986). Transcriptional and post-transcriptional regulation of adenovirus gene expression. In "Adenovirus DNA" (ed. W.Doerfler), pp129-160. Martinus Nijhoff Publishing, Boston.
- Imperiale, M.J., Feldman, L.T. & Nevins, J.R. (1983). Activation of gene expression by adenovirus and herpesvirus regulatory genes acting in trans and by a *cis*-acting adenovirus enhancer element. *Cell* 35, 127-136.
- Imperiale, M.J., Hart, R.P. & Nevins, J.R. (1985). An enhancer-like element in the adenovirus E2 promoter contains sequences essential for uninduced and E1A-induced expression. *Proc. Natl. Acad. Sci., U.S.A.* 82, 381-385.
- Jacob, R.J. & Roizman, B. (1977). Anatomy of herpes simplex virus DNA. VIII. Properties of replicating DNA. *J. Virol.* 23, 394-411.
- Jacob, R.J., Morse, L.S. & Roizman, B. (1979). Anatomy of herpes simplex virus DNA. XII. Accumulation of head-to-tail concatamers in nuclei of infected cells and their role in the generation of the four isomeric arrangements of viral DNA. *J. Virol.* 29, 448-457.
- Jackson, D.A. (1986). Organization beyond the gene. *Trends in Biochem. Sci.* 11, 249-252.



- Jamieson, A.T. & Subak-Sharpe, J.H. (1974). Biochemical studies on the herpes simplex virus specific deoxyypyrimidine kinase activity. *J. Gen. Virol.* 24, 481-492.
- Jaquemount, B. & Roizman, B. (1975). RNA synthesis in cells infected with herpes simplex virus. X. Properties of viral symmetric transcripts and of double-stranded RNA prepared from them. *J. Virol.* 15, 707-713.
- Jariwalla, R.J., Aurelian, L. & Ts'O, P.O.P. (1983). immortalization and neoplastic transformation of normal diploid cells by defined cloned DNA fragments of herpes simplex virus type 2. *Proc. Natl. Acad. Sci., U.S.A.* 80, 5902-5906.
- Jariwalla, R.J., Tanczos, B., Jones, C., Ortiz, J. & Salimi-Lopez, Z. (1986). DNA amplification and neoplastic transformation mediated by a herpes simplex DNA fragment containing cell related sequences. *Proc. Natl. Acad. Sci., U.S.A.* 83, 1738-1742.
- Jenkins, F.J. & Roizman, B. (1986). Herpes simplex virus 1 recombinants with non-inverting genomes frozen in different isomeric arrangements are capable of independent replication. *J. Virol.* 59, 494-499.
- Johnson, D.C. & Spear, P.G. (1984). Evidence for translational regulation of herpes simplex virus type 1 gD expression. *J. Virol.* 51, 389-394.
- Johnson, P.A. & Everett, R.D. (1986a). DNA replication is required for abundant expression of a plasmid-borne late US11 gene of herpes simplex virus type 1. *Nucleic Acids Res.* 14, 3609-3625.
- Johnson, P.A. & Everett, R.D. (1986b). The control of herpes simplex virus type-1 late gene transcription: a 'TATA-box'/cap site region is sufficient for fully efficient regulated activity. *Nucleic Acids Res.* 14, 8247-8264.
- Johnson, P.A., MacLean, C., Marsden, H.S., Dalziel, R.G. & Everett, R.D. (1986). The product of gene US11 of herpes simplex virus type 1 is expressed as a true late gene. *J. Gen. Virol.* 67, 871-883.
- Jones, K.A. & Tjian, R. (1985). Spl binds to promoter sequences and activates herpes simplex virus "immediate-early" gene transcription in vitro. *Nature* 317, 179-182.
- Jones, K.A., Kadonaga, J.T., Luciw, P.A. & Tjian, R. (1986). Activation of the AIDS retrovirus promoter by the cellular transcription factor, Spl. *Science* 232, 755-759.

- Jones, K.A., Yamamoto, K.R. and Tjian, R. (1985). Two distinct transcription factors bind to the HSV thymidine kinase promoter in vitro. *Cell* 42, 559-572.
- Jones, N.C. (1986). Genetic elements governing adenoviral gene expression. In "Adenovirus DNA" (ed. W.Doerfler). Martinus Nijhoff Publishing, Boston. ppl61-191.
- Jones, N. & Shenk, T. (1979). An adenovirus type 5 early gene function regulates expression of other early viral genes. *Proc. Natl. Acad. Sci. U.S.A.* 76, 3665-3669.
- Jones, P.C. & Roizman, B. (1979). Regulation of herpesvirus macromolecular synthesis. VIII. The transcription program consists of three phases during which both the extent of transcription and accumulation of RNA in the cytoplasm are regulated. *J. Virol.* 31, 299-314.
- Jongstra, J., Reudelhuber, T.L., Oudet, P., Benoist, C., Chae, C-B., Jeltsch, J-M., Mathis, D.J. & Chambon, P. (1984). Induction of altered chromatin structures by simian virus 40 enhancer and promoter elements. *Nature* 306, 708-714.
- Kadonaga, J.T., Jones, K.A. & Tjian, R. (1986). Promoter-specific activation of RNA polymerase II transcription by Spl. *Trends in Biochem. Sci.* 11, 20-23.
- Karin, M. (1985). Metallothioneins: proteins in search of function. *Cell* 41, 9-10.
- Karin, M., Haslinger, A., Holtgreve, H., Cathala, G., Slater, E. & Baxter, J.D. (1984a). Activation of a heterologous promoter in response to dexamethasone and cadmium by metallothionein gene 5' flanking DNA. *Cell* 36, 371-379.
- Karin, M., Haslinger, A., Holtgreve, H., Richards, R.I., Krauter, P., Westphal, H.M. & Beato, M. (1984b). Characterization of DNA sequences through which cadmium and glucocorticoid hormones induce human metallothionein-II<sub>A</sub> gene. *Nature* 308, 513-519.
- Keir, H.M. & Gold, E. (1963). Deoxyribonucleic acid nucleotidyltransferase and deoxyribonuclease from cultured cells infected with herpes simplex virus. *Biochim. Biophys. Acta* 72, 263-276.
- Keir, H.M., Subak-Sharpe, H., Shedden, W.I.H., Watson, D.H. & Wildy, P. (1966). Immunological evidence for a specific DNA polymerase produced after infection by herpes simplex virus. *Virology* 30, 154-157.
- Keller, J.M. & Alwine, J.C. (1984). Activation of the SV40 late promoter: Direct effects of T antigen in the absence of viral DNA replication. *Cell* 36, 381-389.

- Keller, J.M. & Alwine, J.C. (1985). Analysis of an activatable promoter: sequences in the simian virus 40 late promoter required for T-antigen-mediated trans-activation. *Mol. Cell. Biol.* 5, 1859-1869.
- Kennedy, P.G.E., LaThangue, N.B., Chan, W.L. & Clements, G.B. (1985). Cultured human neural cells accumulate a heat-shock protein during acute herpes simplex virus infection. *Neuroscience Letters* 61, 321-326.
- Keshet, I., Yisraeli, J. & Cedar, H. (1985). Effect of regional DNA methylation on gene expression. *Proc. Natl. Acad. Sci. U.S.A.* 82, 2560-2564.
- Kieff, E.D., Bachenheimer, S.L. & Roizman, B. (1971). Size, composition and structure of the deoxyribonucleic acid of herpes simplex virus subtypes 1 and 2. *J. Virol.* 8, 125-132.
- Kieff, E.D., Hoyer, B., Bachenheimer, S.L. & Roizman, B. (1972). Genetic relatedness of type 1 and type 2 herpes simplex virus. *J. Virol.* 9, 738-745.
- Kim, S.H., Moores, J.C., David, D., Respass, J.G., Jolly, D.G. & Friedmann, T. (1986). The organization of the human HPRT gene. *Nucleic Acids Res.* 14, 3103-3118.
- Kingston, R.E., Baldwin, A.S. & Sharp, P.A. (1985). Transcriptional control by oncogenes. *Cell* 41, 3-5.
- Kit, S. & Dubbs, D.R. (1963). Acquisition of thymidine kinase activity by herpes simplex virus infected mouse fibroblast cells. *Biochem. Biophys. Acta* 11, 55-59.
- Klemperer, H.G., Haynes, G.R., Shedden, W.I.H. & Watson, D.H. (1967). A virus-specific thymidine kinase in BHK 21 cells infected with herpes simplex virus. *Virology* 31, 120-128.
- Knebel, D. & Doerfler, W. (1986). N<sup>6</sup>-methyldeoxyadenosine residues at specific sites decrease the activity of the E1A promoter of adenovirus type 12 DNA. *J. Mol. Biol.* 189, 371-375.
- Knipe, D.M., Quinlan, M.P. & Spang, A.E. (1982). Characterization of two conformational forms of the major DNA-binding protein encoded by herpes simplex virus type 1. *J. Virol.* 44, 736-741.
- Knipe, D.M. & Smith, J.L. (1986). A mutant herpesvirus protein leads to a block in nuclear localization of other viral proteins. *Mol. Cell. Biol.* 6, 2371-2381.
- Knopf, K.W. (1979). Properties of herpes simplex virus DNA polymerase and characterisation of its associated exonuclease activity. *Eur. J. Biochem.* 98, 231-244.

- Konarska, M.M., Padgett, R.A. & Sharp, P.A. (1984). Recognition of cap structure in splicing in vitro of mRNA precursors. *Cell* 38, 731-736.
- Kovesdi, I., Reichel, R. & Nevins, J.R. (1986). Identification of a cellular transcription factor involved in E1A trans-activation. *Cell* 45, 219-228.
- Kozak, M. & Roizman, B. (1974). Regulation of herpesvirus macromolecular synthesis: nuclear retention of nontranslated viral RNA sequences. *Proc. Natl. Acad. Sci. U.S.A.* 71, 4322-4326.
- Krainer, A.R., Maniatis, T., Ruskin, B. & Green, M.R. (1984). Normal and mutant human  $\beta$ -globin pre-mRNAs are faithfully and efficiently spliced in vitro. *Cell* 36, 993-1005.
- Kramer, A., Keller, W., Appel, B. & Luhrmann, R. (1984). The 5' terminus of the RNA moiety of U1 small nuclear ribonucleoprotein particles is required for the splicing of messenger RNA precursors. *Cell* 38, 299-307.
- Kristie, T. & Roizman, B. (1984). Separation of sequences defining basal expression from those conferring  $\alpha$  gene recognition within the regulatory domains of herpes simplex virus 1  $\alpha$  genes. *Proc. Natl. Acad. Sci. U.S.A.* 81, 4065-4069.
- Kristie, T.M. & Roizman, B. (1986a).  $\alpha$ 4, the major regulatory protein of herpes simplex virus type 1, is stably and specifically associated with promoter-regulatory domains of  $\alpha$  genes and of selected other viral genes. *Proc. Natl. Acad. Sci. U.S.A.* 83, 3218-3222.
- Kristie, T.M. & Roizman, B. (1986b). DNA-binding site of major regulatory protein  $\alpha$ 4 specifically associated with promoter-regulatory domains of  $\alpha$  genes of herpes simplex virus type 1. *Proc. Natl. Acad. Sci. U.S.A.* 83, 4700-4704.
- Kristie, T.M. & Roizman, B. (1987). Host cell proteins bind to the cis-acting site required for virion-mediated induction of herpes simplex virus 1  $\alpha$  genes. *Proc. Natl. Acad. Sci. U.S.A.* 84, 71-75.
- Labhart, P. & Reeder, R.H. (1984). Enhancer-like properties of the 60/81 bp elements in the ribosomal gene spacer of *Xenopus laevis*. *Cell* 37, 285-289.
- Laimins, L.A., Khoury, G., Gorman, C., Howard, B. & Gruss, P. (1982). Host-specific activation of transcription by tandem repeats from simian virus 40 and Moloney murine sarcoma virus. *Proc. Natl. Acad. Sci., U.S.A.* 79, 6453-6457.

- Lang, J.C., Spandidos, D.A. & Wilkie, N.M. (1984). Transcriptional regulation of a herpes virus immediate-early gene is mediated through an enhancer-type sequence. *EMBO J.* 3, 389-395.
- Langer, K.D., Weyer, U. & Doerfler, W. (1986). Trans effect of the E1 region of adenoviruses on the expression of a prokaryotic gene in mammalian cells: Resistance to 5'-CCGG-3' methylation. *Proc. Natl. Acad. Sci., U.S.A.* 83, 1598-1602.
- LaThangue, N.B., Shriver, K., Dawson, C. & Chan, W.C. (1984). Herpes simplex virus infection causes the accumulation of heat-shock proteins. *EMBO J.* 3, 267-277.
- Learned, R.M., Cordes, S. & Tjian, R. (1985). Purification and characterization of a transcription factor that confers promoter specificity to human RNA polymerase I. *Mol. Cell. Biol.* 5, 1358-1369.
- Lebkowski, J.S., Clancy, S. & Calos, M.P. (1985). Simian virus 40 replication in adenovirus-transformed human cells antagonizes gene expression. *Nature* 317, 169-171.
- Lee, C.K. & Knipe, D.M. (1983). Thermolabile in vivo DNA-binding activity associated with a protein encoded by a mutant of herpes simplex virus type 1. *J. Virol.* 46, 909-919.
- Leff, T. & Chambon, P. (1986). Sequence-specific activation of transcription by adenovirus E1a products is observed in HeLa cells but not in 293 cells. *Mol. Cell. Biol.* 6, 201-208.
- Leinbach, S.S. & Summers, W.C. (1980). The structure of herpes simplex virus type 1 DNA as probed by micrococcal nuclease digestion. *J. Gen. Virol.* 51, 45-59.
- Leinbach, S.S. & Casto, J. F. (1983). Identification and characterization of deoxyribonucleoprotein complexes containing the major DNA-binding protein of herpes simplex virus type 1. *Virology* 131, 274-286.
- Leinbach, S.S., Reno, J.M., Lee, L.F., Isbell, A.F. & Boezi, J.A. (1976). Mechanism of phosphonoacetate inhibition of herpesvirus-induced DNA polymerase. *Biochemistry* 15, 426-430.
- Leong, K. & Berk, A.J. (1986). Adenovirus early region 1A protein increases the number of template molecules transcribed in cell-free extracts. *Proc. Natl. Acad. Sci., U.S.A.* 83, 5844-5848.
- Learner, M.R. & Steitz, J.A. (1979). Antibodies to small nuclear RNAs complexed with proteins are produced by patients with systemic lupus erythematosus. *Proc. Natl. Acad. Sci., U.S.A.* 76, 5495-5499.

- Lewis, E.D. & Manley, J.L. (1985). Repression of simian virus 40 early transcription by viral DNA replication in human 293 cells. *Nature* 317, 172-175.
- Lillie, J.M., Green, M. & Green, M.R. (1986). An adenovirus Ela protein region required for transformation and transcriptional repression. *Cell* 46, 1043-1051.
- Littler, E., Purifoy, D.J.M., Minson, A. & Powell, K.L. (1983). Herpes simplex virus non-structural proteins. III. Function of the major DNA binding protein. *J. Gen. Virol.* 64, 983-995.
- Locker, H. & Frenkel, N. (1979). Structure and origin of defective genomes contained in serially passaged HSV type 1 (Justin). *J. Virol.* 29, 1065-1077.
- Lockshon, D. & Galloway, D.A. (1986). Cloning and characterization of ori<sub>L2</sub>, a large palindromic DNA replication origin of herpes simplex virus type 2. *J. Virol.* 58, 513-521.
- Loeken, M.R., Khoury, G. & Brady, J. (1986). Stimulation of the adenovirus E2 promoter by simian virus 40 T antigen or E1A occurs by different mechanisms. *Mol. Cell. Biol.* 6, 2020-2026.
- Long, E.O. & Dawid, I.B. (1980). Repeated genes in eukaryotes. *Ann. Rev. Biochem.* 49, 727-764.
- Longnecker, R. & Roizman, B. (1986). Generation of an inverting herpes simplex virus 1 mutant lacking the L-S junction a sequences, an origin of DNA synthesis, and several genes including those specifying glycoprotein E and the  $\alpha$ 47 gene. *J. Virol.* 58, 583-591.
- Lopata, M.A., Cleveland, D.W. & Sollner-Webb, B. (1986). RNA polymerase specificity of mRNA production and enhancer action. *Proc. Natl. Acad. Sci., U.S.A.* 83, 6677-6681.
- Lowry, O.H., Rosebrough, N.J., Farr, A.L. & Randall, R.J. (1951). Protein measurement with the Folin phenol reagent. *J. Biol. Chem.* 193, 265-275.
- McClure, W.R. (1985). Mechanisms and control of transcription initiation in prokaryotes. *Ann. Rev. Biochem.* 54, 171-204.
- McGeoch, D.J. & Davison, A.J. (1986). Alphaherpesviruses possess a gene homologous to the protein kinase gene family of eukaryotes and retroviruses. *Nucleic Acids Res.* 14, 1765-1777.
- McGeoch, D.J., Dolan, A., Donald, S. & Rixon, F.J. (1985). Sequence determination and genetic content of the short unique region in the genome of herpes simplex virus type 1. *J. Mol. Biol.* 181, 1-13.

- McGeoch, D.J., Dolan, A., Donald, S. & Brauer, D.H.K. (1986). Complete DNA sequence of the short repeat region in the genome of herpes simplex virus type 1. *Nucleic Acids Res.* 14, 1727-1745.
- McGeoch, D.J., Moss, H.W.M., McNab, D. & Frame, M.C. (1987). DNA sequence and genetic content of the HindIII 1 region in the short unique component of the herpes simplex virus type 2 genome: Identification of the gene encoding glycoprotein G, and evolutionary comparisons. *J. Gen. Virol.* 68, 19-38.
- Mackem, S. & Roizman, B. (1982a). Differentiation between  $\alpha$ -promoter and regulator regions of herpes simplex virus 1: the functional domains and sequence of a movable regulator. *Proc. Natl. Acad. Sci. U.S.A.* 79, 4917-4921.
- Mackem, S. & Roizman, B. (1982b). Structural features of the herpes simplex virus  $\alpha$  gene 4, 0, and 27 promoter-regulatory sequences which confer regulation on chimeric thymidine kinase genes. *J. Virol.* 44, 939-949.
- McKnight, S.L. (1980). The nucleotide sequence and transcript map of the herpes simplex virus thymidine kinase gene. *Nucleic Acids Res.* 8, 5949-5964.
- McKnight, S.L. & Kingsbury, R. (1982). Transcription control signals of a eukaryotic protein coding gene. *Science* 217, 316-324.
- McKnight, S.L. & Tjian, R. (1986). Transcriptional selectivity of viral genes in mammalian cells. *Cell* 46, 795-805.
- McKnight, S.L., Kingsbury, R.C., Spence, A. & Smith, M. (1984). The distal transcription signals of the herpesvirus TK gene share a common hexanucleotide control sequence. *Cell* 37, 253-262.
- McLauchlan, J. & Clements, J.B. (1983). Organisation of the herpes simplex virus type 1 transcription unit encoding two early proteins with molecular weights of 140000 and 40000. *J. Gen. Virol.* 64, 997-1006.
- McLauchlan, J., Gaffney, D., Whitton, J.L. & Clements, J.B. (1985). The consensus sequence YGTGTTY located downstream from the AATAAA signal is required for efficient formation of mRNA 3' termini. *Nucleic Acids Res.* 13, 1347-1368.
- MacLean, C.A., Rixon, F.J., & Marsden, H.S. (1987). The products of gene U<sub>g11</sub> of herpes simplex virus type 1 are DNA-binding and localise to the nucleoli of infected cells. *J. Gen. Virol.* (in press).

- McLennan, J.L. & Darby, G. (1980). Herpes simplex virus latency: the cellular location of virus in dorsal root ganglia and the fate of the infected cell following virus activation. *J. Gen. Virol.* 51, 233-243.
- Macnab, J.C.M. (1987). Herpes simplex virus and human cytomegalovirus: their role in morphological transformation and genital cancers. *J. Gen. Virol.* (in press).
- Macnab, J.C.M., Orr, A. & LaThangue, N.B. (1985). Cellular proteins expressed in herpes simplex virus transformed cells also accumulate on herpes simplex virus infection. *EMBO J.* 4, 3223-3228.
- MacPherson, I & Stoker, M. (1962). Polyoma transformation of hamster cell clones - an investigation of genetic factors affecting cell competence. *Virology* 16, 147-151.
- Malek, L.T., Eschenfeldt, W.T., Munn, T.W. & Rhoads, R. (1981). Heterogeneity of the 5' terminus of hen ovalbumin messenger ribonucleic acid. *Nucleic Acids Res.* 9, 1657-1673
- Manley, J.L., Fire, A., Cano, A., Sharp, P.A. & Geyer, M.L. (1980). DNA-dependent transcription of adenovirus genes in a soluble whole-cell extract. *Proc. Natl. Acad. Sci., U.S.A.* 77, 3855-3859.
- Mansour, S.L., Grodzicker, T. & Tjian, R. (1986). Downstream sequences affect transcription initiation from the adenovirus major late promoter. *Mol. Cell. Biol.* 6, 2684-2694.
- Marinus, M.G. (1973). Location of DNA methylation genes on the *E.coli* K12 genetic map. *Mol. Gen. Genet.* 127, 47-55.
- Marsden, H.S., Crombie, I.K. & Subak-Sharpe, J.H. (1976). Control of protein synthesis in herpes virus-infected cells: Analysis of the polypeptides induced by wild type and sixteen temperature-sensitive mutants. *J. Gen. Virol.* 31, 347-372.
- Marsden, H.S., Stow, N.D., Preston, V.G., Timbury, M.C. & Wilkie, N.M. (1978). Physical mapping of herpes simplex virus-induced polypeptides. *J. Virol.* 28, 624-642.
- Mathews, C.K., Kutter, E.M., Mosig, G. & Berget, P.B. (eds.) (1983). "Bacteriophage T4". American Society for Microbiology, Washington.
- Matsui, T., Segall, J., Weil, P.A. & Roeder, R.G. (1980). Multiple factors required for accurate initiation of transcription by purified RNA polymerase II. *J. Biol. Chem.* 255, 11992-11996.



- Mavromara-Nazos, P., Silver, S., Hubenthal-Voss, J., McKnight, J.L.C. & Roizman, B. (1986). Regulation of herpes simplex virus 1 genes:  $\alpha$  gene sequence requirements for transient induction of indicator genes regulated by  $\beta$  or late ( $\gamma_2$ ) promoters. *Virology* 149, 152-164.
- Maxam, A.M. & Gilbert, W. (1977). A new method for sequencing DNA. *Proc. Natl. Acad. Sci., U.S.A.* 74, 560-564.
- Maxam, A.M. & Gilbert, W. (1980). Sequencing end-labelled DNA with base-specific chemical cleavages. *Methods Enzymol.* 65, 499-560.
- Melton, D.W., Konecki, D.S., Brennan, J. and Caskey, C.T. (1984). Structure, expression and mutation of the hypoxanthine phosphoribosyltransferase gene. *Proc. Natl. Acad. Sci., U.S.A.* 81, 2147-2151.
- Mercola, M., Goverman, J., Mirell, C. and Calame, K. (1985). Immunoglobulin heavy chain enhancer requires one or more tissue-specific factors. *Science* 227, 266-270.
- Messing, J. and Vieira, J. (1982). A new pair of M13 vectors for selecting either DNA strand of a double digest restriction fragment. *Gene* 19, 269-276.
- Messing, J., Crea, R. and Seeburg, P.H. (1981). A system for shotgun DNA sequencing. *Nucleic Acids Res.* 9, 309-321.
- Metzler, D.W. & Wilcox, K.W. (1985). Isolation of herpes simplex virus regulatory protein ICP4 as a homodimeric complex. *J. Virol.* 55, 329-337.
- Miesfeld, R. & Arnheim, N. (1984). Species-specific rDNA transcription is due to promoter-specific binding factors. *Mol. Cell. Biol.* 4, 221-227.
- Miksicek, R., Heber, A., Schmid, W., Panesch, U., Posseckert, G., Beato, M. & Schutz, G. (1986). Glucocorticoid responsiveness of the transcriptional enhancer of moloney murine sarcoma virus. *Cell* 46, 283-290.
- Miller, A.D., Law, M-F. & Verma, I.M. (1985). Generation of helper-free amphotropic retroviruses that transduce a dominant-acting, methotrexate-resistant dihydrofolate reductase gene. *Mol. Cell. Biol.* 5, 431-437.
- Miller, G. (1985). Epstein-Barr Virus. In "Virology" (ed. B.N.Fields et al.), Raven Press, NY. pp563-589.
- Mishima, Y., Financsek, I., Kominami, R. & Muramatsu, M. (1982). Fractionation and reconstitution of factors required for accurate transcription initiation of mammalian ribosomal RNA genes: identification of a species-dependent initiation factor. *Nucleic Acids Res.* 10, 6659-6670.

- Mocarski, E.S. & Roizman, B. (1981). Site specific inversion of the herpes simplex virus genome: domain and structural features. *Proc. Natl. Acad. Sci. U.S.A.* 78, 7047-7051.
- Mocarski, E.S. & Roizman, B. (1982). Structure and role of the herpes simplex virus DNA termini in inversion, circularization and generation of virion DNA. *Cell* 31, 89-97.
- Mocarski, E.S., Post, L.E. & Roizman, B. (1980). Molecular engineering of the herpes simplex virus genome: insertion of a second L-S junction into the genome causes additional genome inversions. *Cell* 22, 243-255.
- Montell, C., Fisher, E.F., Caruthers, M.H. & Berk, A.J. (1983). Inhibition of RNA cleavage but not polyadenylation by a point mutation in the 3' consensus sequence AAUAAA. *Nature* 305, 600-605.
- Moore, C.L. & Sharp, P.A. (1984). Site-specific polyadenylation in a cell-free reaction. *Cell* 36, 581-591.
- Moore, C.L. & Sharp, P.A. (1985). Accurate cleavage and polyadenylation of exogenous RNA substrate. *Cell* 41, 845-855.
- Moreau, P., Hen, R., Wasylyk, B., Everett, R., Gaub, M.P. & Chambon, P. (1981). The SV40 72 base pair repeat has a striking effect on gene expression both in SV40 and other chimeric recombinants. *Nucleic Acids Res.* 9, 6047-6068.
- Morse, B.L., Buchman, T.G., Roizman, B. & Schaffer, P.A. (1977). Anatomy of herpes simplex virus DNA IX. Apparent exclusion of some parental DNA arrangements in the generation of intertypic (HSV-1 x HSV-2) recombinants. *J. Virol.* 24, 231-248.
- Morse, L.S., Pereira, L., Roizman, B. & Schaffer, P.A. (1978). Anatomy of herpes simplex virus (HSV) DNA X. Mapping of viral genes by analysis of polypeptides and functions specified by HSV-1 x HSV-2 recombinants. *J. Virol.* 26, 389-410.
- Mosca, J.D., Reyes, G.R., Pitha, P.M. & Hayward, G.S. (1985). Differential activation of hybrid genes containing herpes simplex virus immediate-early or delayed-early promoters after superinfection of stable DNA-transfected cell-lines. *J. Virol.* 56, 867-878.
- Moss, B. (1985). Replication of poxviruses. In "Virology" (ed. B.N. Fields et al.), Raven Press, NY. pp685-703.
- Moss, B., Gershowitz, A., Stringer, J.R., Holland, L.E. & Wagner, E.K. (1977). 5' terminal and internal methylated nucleosides in herpes simplex virus type 1 mRNA. *J.*

Viol. 23, 234-239.

- MOSS, H.W.M. (1986). The herpes simplex virus type 2 alkaline exonuclease activity is essential for replication and growth. J. Gen. Virol. 67, 1173-1178.
- Moss, T. (1982). Transcription of cloned Xenopus laevis ribosomal DNA microinjected into Xenopus oocytes, and the identification of an RNA polymerase I promoter. Cell 30, 835-842.
- Moss, T. (1983). A transcriptional function for the repetitive ribosomal spacer in Xenopus laevis. Nature 302, 223-228.
- Mount, S.M. (1982) A catalogue of splice junction sequences. Nucleic Acids Res. 10, 459-472.
- Muller, M.T., Bolles, L.S. & Parris, D.S. (1985). Association of type 1 DNA topoisomerase with herpes simplex virus. J. Gen. Virol. 66, 1565-1574.
- Munk, K. & Sauer, G. (1964). Relationship between cell DNA metabolism and nucleoplasmic alterations in herpesvirus infected cells. Virology 22, 153-154.
- Murchie, M.J. & McGeoch, D.J. (1982). DNA sequence of an immediate-early gene region of the herpes simplex virus type 1 genome (map coordinates 0.950 to 0.978). J. Gen. Virol. 62, 1-15.
- Myers, R.M., Rio, D.C., Robbins, A.K. & Tjian, R. (1981). SV40 gene expression is modulated by the cooperative binding of T antigen to DNA. Cell 25, 373-384.
- Myers, R.M., Tilly, K. & Maniatis, T. (1986). Fine structure genetic analysis of a  $\beta$ -globin promoter. Science 232, 613-618.
- Nahmias, A.J., Josey, W.E., Naib, Z.M., Luce, C.F. & Guest, B. (1970). Antibodies to herpesvirus hominis types 1 and 2 in humans. II. Women with cervical cancer. Amer. J. Epidem. 91, 547-552.
- Naib, Z.M., Nahmias, A.J. & Josey, W.E. (1966). Cytology and histopathology of cervical herpes simplex infection. Cancer 19, 1026-1031.
- Neuberger, M.S. (1983). Expression and regulation of immunoglobulin heavy chain gene transfected into lymphoid cells. EMBO J. 2, 1373-1378.
- Nevins, J.R. (1981). Mechanism of activation of early viral transcription by the adenovirus E1A gene product. Cell 26, 213-220.

- Nevins, J.R. & Darnell, J.E. Steps in the processing of Ad2 mRNA: poly(A)<sup>+</sup> nuclear sequences are conserved and poly(A) addition precedes splicing. *Cell* 15, 1477-1493.
- Nishioka, Y. & Silverstein, S. (1977). Degradation of cellular mRNA during infection by herpes simplex virus. *Proc. Natl. Acad. Sci., U.S.A.* 74, 2370-2374.
- Nishioka, Y. & Silverstein, S. (1978). Requirement of protein synthesis for the degradation of host mRNA in Friend Erythroleukemia cells infected with herpes simplex virus type 1. *J. Virol.* 27, 619-627.
- Nordheim, A. & Rich, A. (1983) Negatively supercoiled simian virus 40 DNA contains Z-DNA segments within transcriptional enhancer sequences. *Nature* 303, 674-679.
- Notorianni, E.L. & Preston, C.M. (1982). Activation of cellular stress protein genes by herpes simplex virus temperature-sensitive mutants which overproduce immediate early polypeptides. *Virology* 123, 113-122.
- O'Hare, P. & Hayward, G.S. (1984). Expression of recombinant genes containing herpes simplex virus delayed-early and immediate-early regulatory regions and trans activation by herpesvirus infection *J. Virol.* 52, 522-531.
- O'Hare, P. & Hayward, G.S. (1985a). Evidence for a direct role for both the 175,000- and 110,000-molecular weight immediate-early proteins of herpes simplex virus in the trans activation of delayed-early promoters. *J. Virol.* 53, 751-760.
- O'Hare, P. & Hayward, G.S. (1985b). Three trans-acting regulatory proteins of herpes simplex virus modulate immediate-early gene expression in a pathway involving positive and negative feedback regulation. *J. Virol.* 56, 723-733.
- Padgett, R.A., Grabowski, P.J., Konarska, M.M. & Sharp, P.A. (1985). Splicing messenger RNA precursors: branch sites and lariat RNAs. *Trends in Biochem. Sci.* 10, 154-157.
- Palfreyman, J.W., MacLean, J.B., Messeder, E. & Sheppard, R.C. (1984). Successful use of oligopeptides as immunogens in the preparation of antisera to immediate-early gene products of herpes simplex virus type 1. *J. Gen. Virol.* 65, 865-874.
- Palmiter, R.D. & Brinster, R.L. (1985). Transgenic mice. *Cell* 41, 343-345.
- Parker, C.S. & Roeder, R.G. (1977). Selective and accurate transcription of the Xenopus laevis 5S RNA genes in isolated chromatin by purified RNA polymerase III. *Proc. Natl. Acad. Sci., U.S.A.* 74, 44-48.

- Parker, C.S. & Topol, J. (1984). A Drosophila RNA polymerase II transcription factor binds to the regulatory site of an hsp70 gene. Cell 37, 273-283.
- Parris, D.S., Dixon, R.A.F. & Schaffer, P.A. (1980). Physical mapping of herpes simplex virus type 1 ts mutants by marker rescue: Correlation of the physical and genetic maps. Virology 100, 275-287.
- Patel, P.I., Frameson, P.E., Caskey, C.T. & Chinault, A.C. (1986). Fine structure of the human hypoxanthine phosphoribosyltransferase gene. Mol. Cell. Biol. 6, 393-403.
- Patel, R., Chan, W.L., Kemp, L.M., LaThangue, N.B. & Latchman, D.S. (1986). Isolation of cDNA clones derived from a cellular gene transcriptionally induced by herpes simplex virus. Nucleic Acids Res. 14, 5629-5640.
- Paule, M.R. (1981). Comparative subunit composition of the eukaryotic nuclear RNA polymerases. Trends in Biochem. Sci. 6, 128-131.
- Payvar, F., DeFranco, D., Firestone, G.L., Edgar, B., Wrangle, O., Okret, S., Gustafsson, J-A. & Yamamoto, K.R. (1983). Sequence-specific binding of glucocorticoid receptor to MTV DNA at sites within and upstream of the transcribed region. Cell 35, 381-392.
- Pedersen, M. Talley-Brown, S. & Millet, R.L. (1981). Gene expression of herpes simplex virus III. Effect of arabinosyladenine on viral polypeptide synthesis. J. Virol. 38, 712-719.
- Pelham, H.R.B. & Brown, D.D. (1980). A specific transcription factor that can bind either the 5S RNA gene or 5S RNA. Proc. Natl. Acad. Sci., U.S.A. 77, 4170-4174.
- Pellet, P.E., McKnight, J.L.C., Jenkins, F.J. & Roizman, B. (1985). Nucleotide sequence and predicted amino acid sequence of a protein encoded in a small herpes simplex virus DNA fragment capable of trans-inducing  $\alpha$  genes. Proc. Natl. Acad. Sci., U.S.A. 82, 5870-5874.
- Pereira, L., Wolff, M.H., Fenwick, M. & Roizman, B. (1977). Regulation of herpesvirus macromolecular synthesis V. Properties of  $\alpha$  polypeptides made in HSV-1 and HSV-2 infected cells. Virology 77, 733-749.
- Perry, L.J., Rixon, F.J., Everett, R.D., Frame, M.C. & McGeoch, D.J. (1986). Characterization of the IE110 gene of herpes simplex virus type 1. J. Gen. Virol. 67, 2365-2380.
- Persson, R.H., Bacchetti, S. & Smiley, J.R (1985). Cells that constitutively express the herpes simplex virus immediate-early protein ICP4 allow efficient activation

- of viral delayed-early genes in trans. J. Virol. 54, 414-421.
- Pilon, L., Langelier, Y. & Royal, A. (1986). Herpes simplex virus type 2 mutagenesis: Characterization of mutants induced at the hprt locus of nonpermissive XC cells. Mol cell. Biol. 6, 2977-2983.
- Plon, S.E. & Wang, J.C. (1986). Transcription of the human  $\beta$ -globin gene is stimulated by an SV40 enhancer to which it is physically linked but topologically uncoupled. Cell 45, 575-580.
- Poffenberger, K.L. & Roizman, B. (1985). A noninverting genome of a viable herpes simplex virus 1: Presence of head-to-tail linkages in packaged genomes and requirements for circularisation after infection. J. Virol. 53, 587-595.
- Ponce de Leon, M., Eisenberg, R.J. & Cohen, G.H. (1977). Ribonucleotide reductase from herpes simplex virus (type 1 and 2) infected and uninfected KB cells: Properties of the partially purified enzymes. J. Gen. Virol. 36, 163-173.
- Post, L.E., Mackem, S. & Roizman, B. (1981). Regulation of genes of herpes simplex virus: expression of chimeric genes produced by fusion of thymidine kinase with  $\alpha$  gene promoters. Cell 24, 555-565
- Powell, K.L. & Courtney, R.J. (1975). Polypeptides synthesized in herpes simplex virus type 2-infected Hep-2 cells. Virology 66, 217-228.
- Powell, K.L. Purifoy, D.J.M. & Courtney, R.J. (1975). The synthesis of herpes simplex virus proteins in the absence of DNA synthesis. Biochem. Biophys. Res. Com. 66, 262-271.
- Powell, K.L., Littler, E. & Purifoy, D.J.M. (1981). Non-structural proteins of herpes simplex virus. II. Major virus specified DNA binding protein. J. Virol. 39, 894-902.
- Preston, C.M. (1979a). Control of herpes simplex type 1 mRNA synthesis in cells infected with wild-type virus or the temperature-sensitive mutant tsK. J. Virol. 29, 275-284.
- Preston, C.M. (1979b). Abnormal properties of an immediate-early polypeptide in cells infected with the herpes simplex virus type 1 mutant tsK. J. Virol. 32, 357-359.
- Preston, C.M. & Cordingley, M.G. (1982). mRNA- and DNA-directed synthesis of herpes simplex virus-coded exonuclease in Xenopus laevis oocytes. J. Virol. 43, 386-394.

- Preston, C.M. & McGeoch, D.J. (1981). Identification and mapping of two polypeptides encoded within the herpes simplex virus type 1 thymidine kinase gene sequences. *J. Virol.* 38, 593-605.
- Preston, C.M. & Notarianni, E. (1983). Poly(ADP-ribosylation) of a herpes simplex virus immediate early polypeptide. *Virology* 131, 492-501.
- Preston, C.M. & Tannahill, D. (1984). Effects of orientation and position on the activity of a herpes simplex virus immediate early gene far-upstream region. *Virology* 137, 439-444.
- Preston, C.M., Cordingley, M.G. & Stow, N.D. (1984). Analysis of DNA sequences which regulate the transcription of a herpes simplex virus immediate early gene. *Virology* 50, 708-716.
- Preston V.G. & Fisher, F.B. (1984). Identification of the herpes simplex virus type 1 gene encoding the dUTPase. *Virology* 138, 58-68.
- Preston, V.G., Coates, J.A.V. & Rixon, F.J. (1983). Identification and characterisation of a herpes simplex virus gene product required for encapsidation of virus DNA. *J. Virol.* 45, 1056-1064.
- Preston, V.G., Davison, A.J., Marsden, H.S., Timbury, M.C., Subak-Sharpe, J.H. & Wilkie, N.M. (1978). Recombinants between herpes simplex virus types 1 and 2: analyses of genome structures and expression of immediate-early polypeptides. *J. Virol.* 28, 499-517.
- Preston, V.G., Palfreyman, J.W. & Dutia, B.M. (1984). Identification of a herpes simplex type 1 polypeptide which is a component of the virus-induced ribonucleotide reductase. *J. Virol.* 65, 1457-1466.
- Proudfoot, N.J. (1976). 3'non-coding region sequences in eukaryotic mRNA. *Nature* 263, 211-214.
- Proudfoot, N.J. (1986). Transcriptional interference and termination between duplicated  $\beta$ -globin gene constructs suggests a novel mechanism for gene regulation. *Nature* 322, 562-565.
- Ptashne, M. (1986). Gene regulation by proteins acting nearby and at a distance. *Nature* 322, 697-701.
- Purifoy, D.J.M., Lewis, R.B. & Powell, K.L. (1977) Identification of the herpes simplex virus DNA polymerase gene. *Nature* 269, 621-623.
- Quinlan, M.P. & Knipe, D.M. (1985). Stimulation of expression of a herpes simplex virus DNA-binding protein by two viral functions. *Mol. Cell. Biol.* 5, 957-963.

- Quinn, J.P. & McGeoch, D.J. (1985). DNA sequence of the region in the genome of herpes simplex virus type 1 containing the genes for DNA polymerase and the major DNA binding protein. *Nucleic Acids Res.* 13, 8143-8163.
- Rabussay, D. & Geiduschek, E.P. (1979). Relation between bacteriophage T4 DNA replication and late transcription in vitro and in vivo. *Virology* 99, 286-301.
- Rawls, W.E., Tompkins, W.A.F. & Melnick, J.L. (1969). The association of herpes virus type 2 and carcinoma of the uterine cervix. *Amer. J. Epidem.* 89, 547-554.
- Razin, A. Cedar, H. & Riggs, A.D. (1984). (eds.) DNA methylation. Springer-Verlag, NY.
- Read, G.S. & Frenkel, N. (1983). Herpes simplex virus mutants defective in the virion-associated shutoff of host polypeptide synthesis and exhibiting abnormal synthesis of  $\alpha$  (immediate-early) viral polypeptides. *J. Virol.* 46, 498-512.
- Rigby, P.W.J., Dieckman, M., Rhodes, C. & Berg, P. (1977). Labelling deoxyribonucleic acid to high specific activity in vitro by nick translation with DNA polymerase I. *J. Mol. Biol.* 113, 237-251.
- Riva, S., Cascino, A. & Geiduschek, E.P. (1970a). Coupling of late transcription to viral replication in bacteriophage T4 development. *J. Mol. Biol.* 54, 85-102.
- Riva, S., Cascino, A. & Geiduschek, E.P. (1970b). Uncoupling of late transcription from DNA replication in bacteriophage T4 development. *J. Mol. Biol.* 54, 103-119.
- Rixon, F.J. & Clements, J.B. (1982). Detailed structural analysis of two spliced HSV-1 immediate-early mRNAs. *Nucleic Acids Res.* 10, 2241-2256.
- Rixon, F.J. & McGeoch, D.J. (1984). A 3' co-terminal family of mRNAs from the herpes simplex virus type 1 short region: Two overlapping reading frames encode unrelated polypeptides one of which has a highly reiterated amino acid sequence. *Nucleic Acids Res.* 12, 2473-2487.
- Rixon, F.J. & McGeoch, D.J. (1985). Detailed analysis of the mRNAs mapping in the short unique region of herpes simplex virus type 1. *Nucleic Acids Res.* 13, 953-973.
- Rixon, F.J., Campbell, M.E. & Clements, J.B. (1982). The immediate-early mRNA that encodes the regulatory polypeptide Vmwl75 of herpes simplex virus type 1 is unspliced. *EMBO J.* 1 1273-1277.



- Rixon, F.J., Campbell, M.E. & Clements, J.B. (1984). A tandemly reiterated DNA sequence in the long repeat region of herpes simplex virus type 1 found in close proximity to immediate-early mRNA 1. *J. Virol.* 52, 715-718.
- Rock, D.L. & Fraser, N.W. (1983). Detection of HSV-1 genome in central nervous system of latently infected mice. *Nature* 302, 523-525.
- Roeder, R.G. & Rutter, W.J. (1970). Specific nucleolar and nucleoplasmic RNA polymerases. *Proc. Natl. Acad. Sci., U.S.A.* 65, 675-682.
- Roizman, B. (1969). The herpesviruses- a biochemical definition of the group. *Current Topics in Micro. and Immun.* 49, 3-79.
- Roizman, B. & Batterson, W. (1985). Herpesviruses and their replication. In "Virology" (ed. B.N.Fields et al.), Raven Press, NY. pp497-526.
- Roizman, B. & Furlong, D. (1974). The replication of herpesviruses. In "Comprehensive Virology" vol. 3 (eds. H.Fraenkel-Conrat & R.R.Wagner). Plenum Press, NY. pp229-403.
- Roizman, B. & Roane, P.R Jr. (1964). The multiplication of herpes simplex virus. II. The relationship between protein synthesis and the duplication of viral DNA in infected HEP-2 cells. *Virology* 22, 262-269.
- Roizman, B., Carmichael, L.E., Deinhardt, F., De The, G., Nahmias, A.J., Plowright, F., Sheldrick, P., Takahashi, M. & Wolf, K. (1981). Herpesviridae: Definition, provisional nomenclature and taxonomy. *Intervirology* 16, 201-217.
- Roizman, B., Jacob, R.J., Knipe, D.M., Morse, L.S. & Ruyechan, W.T. (1979). On the structure, functional equivalence and replication of the four rearrangements of herpes simplex virus DNA. *Cold Spring Harbour Symposia on Quant. Biol.* 43, 809-826.
- Rosenfeld, M.G., Mermod, J-J., Amara, S.G., Swanson, L.W. Sawchenko, P.E., Rivier, J., Vale, W.W. & Evans, R.M. (1983). Production of a novel neuropeptide encoded by the calcitonin gene via tissue-specific RNA processing. *Nature* 304, 129-135.
- Ruskin, B., Krainer, A.R., Maniatis, T. & Green, M.R. (1984). Excision of an intact intron as a novel lariat structure during pre-mRNA splicing in vitro. *Cell* 38, 317-331.
- Russell, J. & Preston, C.M. (1986). An in vitro latency system for herpes simplex virus type 2. *J. Gen. Virol.* 67, 397-403.

- Sacks, W.R., Greene, C.C., Aschman, D.P. & Schaffer, P.A. (1985). Herpes simplex virus type 1 ICP27 is an essential regulatory protein. *J. Virol.* 55, 796-805.
- Sakonju, S. & Brown, D.D. (1982). Contact points between a positive transcription factor and the Xenopus 5S RNA gene. *Cell* 31, 395-405.
- Sakonju, S., Bogenhagen, D.F. & Brown, D.D. (1980). A control region in the center of the 5S RNA gene directs specific initiation of transcription: I. The 5' border of the region. *Cell* 19, 13-25.
- Samuels, M., Fire, A. & Sharp, P.A. (1982). Separation and characterization of factors mediating accurate transcription by RNA polymerase II. *J. Biol. Chem.* 257, 14419-14427.
- Sandri-Goldin, R.M., Goldin, A.L., Holland, L.E., Glorioso, J.C. & Levine, M. (1985). Expression of herpes simplex virus  $\beta$  and  $\gamma$  genes integrated in mammalian cells and their induction by an  $\alpha$  gene product. *Mol. Cell. Biol.* 3, 2028-2044.
- Sandri-Goldin, R.M., Sekulovich, R.E. & Leary, K. (1987). The  $\alpha$  protein ICP0 does not appear to play a major role in the regulation of herpes simplex virus gene expression during infection in tissue culture. *Nucleic Acids Res.* 15, 905-919.
- Sanger, F., Coulson, A.R., Barrell, B.G., Smith, A.J.H. & Roe, B.A. (1980). Cloning in single stranded bacteriophage as an aid to rapid DNA sequencing. *J. Mol. Biol.* 143, 161-178.
- Sanger, F., Nicklen, S. & Coulson, A.R. (1977). DNA sequencing with chain terminating inhibitors. *Proc. Natl. Acad. Sci., U.S.A.* 74, 5463-5467.
- Sassone-Corsi, P., Dougherty, J.P., Wasylyk, B. & Chambon, P. (1984). Stimulation of in vitro transcription from heterologous promoters by the simian virus 40 enhancer. *Proc. Natl. Acad. Sci., U.S.A.* 81, 308-312.
- Sassone-Corsi, P., Wildeman, A. & Chambon, P. (1985). A trans-acting factor is responsible for the simian virus 40 enhancer activity in vitro. *Nature* 313, 458-463.
- Sawadago, M. & Roeder, R.G. (1985a). Factors involved in specific transcription by human RNA polymerase II: Analysis by a rapid and quantitative in vitro assay. *Proc. Natl. Acad. Sci., U.S.A.* 82, 4394-4398.
- Sawadago, M. & Roeder, R.G. (1985b). Interaction of a gene-specific transcription factor with the adenovirus major late promoter upstream of the TATA box region. *Cell* 43, 165-175.

- Schaffer, P.A., Carter, V.C. & Timbury, M.C. (1978). Collaborative complementation study of temperature-sensitive mutants of herpes simplex virus types 1 and 2. *J. Virol.* 27, 490-504.
- Schek, N. & Bachenheimer, S.L. (1985). Degradation of cellular mRNAs induced by a virion-associated factor during herpes virus infection of Vero cells. *J. Virol.* 55, 601-610.
- Scholer, H.R. & Gruss, P. (1984). Specific interaction between enhancer-containing molecules and cellular components. *Cell* 36, 403-411.
- Searle, P.F., Davison, B.L., Stuart, G.W., Wilkie, T.M., Norstedt, G. & Palmiter, R.D. (1984). Regulation, linkage and sequence of mouse metallothionein I and II genes. *Mol. Cell. Biol.* 4, 1221-1230.
- Searle, P.F., Stuart, G.W., & Palmiter, R.D. (1985). Building a metal-responsive promoter with synthetic regulatory elements. *Mol. Cell. Biol.* 5, 1480-1489.
- Sears, A.E., Halliburton, I.W., Meignier, B., Silver, S. & Roizman, B. (1985). Herpes simplex virus 1 mutant deleted in the  $\alpha$ 22 gene: Growth and gene expression in permissive and restrictive cells and establishment of latency in mice. *J. Virol.* 55, 338-346.
- Sen, R. & Baltimore, D. (1986). Multiple nuclear factors interact with the immunoglobulin enhancer sequences. *Cell* 46, 705-716.
- Serfling, E., Jasin, M. & Schaffner, W. (1985). Enhancers and eukaryotic gene transcription. *Trends in Genet.* 1, 224-230.
- Sharp, P.A. (1985). On the origin of RNA splicing and introns. *Cell* 42, 397-400.
- Sharp, S., DeFranco, D., Dingermann, T., Farrell, P. & Soll, D. (1981). Internal control regions for transcription of eukaryotic tRNA genes. *Proc. Natl. Acad. Sci., U.S.A.* 78, 6657-6661.
- Shatkin, A.J. (1976). Capping of eukaryotic mRNAs. *Cell* 9, 645-653.
- Sheldrick, P. & Berthelot, N. (1974). Inverted repetitions in the chromosome of herpes simplex virus. *Cold Spring Harbor Symp. Quant. Biol. U.S.A.* 39, 667-678.
- Shih, M-F., Arsenakis, M., Tiollais, P. & Roizman, B. (1984). Expression of hepatitis B virus S gene by herpes simplex type 1 vectors carrying  $\alpha$ - and  $\beta$ -regulated gene chimeras. *Proc. Natl. Acad. Sci., U.S.A.* 81, 5867-5870.

- Silver, S. & Roizman, B. (1985).  $\gamma_2$ -thymidine kinase chimeras are identically transcribed but regulated as  $\gamma_2$  genes in herpes simplex virus genomes and as  $\beta$  genes in cell genomes. *Mol. Cell. Biol.* 5, 518-528.
- SivaRaman, L., Subramanian, S. & Thimmappay, B. (1986). Identification of a factor in HeLa cells specific for an upstream control sequence of an E1A-inducible adenovirus promoter and its relative abundance in infected and uninfected cells. *Proc. Natl. Acad. Sci., U.S.A.* 83, 5914-5918.
- Smale, S.T. & Tjian, R. (1985). Transcription of herpes simplex virus tk sequences under the control of wild-type and mutant human RNA polymerase I promoters. *Mol. Cell. Biol.* 5, 352-362.
- Smiley, J.R., Swan, H., Pater, M.M., Pater, A. & Halpern, M.E. (1983). Positive control of the herpes simplex virus thymidine kinase gene requires upstream DNA sequences. *J. Virol.* 47, 301-310.
- Smiley, J.R., Smibert, C. & Everett, R.D. Expression of a cellular gene cloned in herpes simplex virus: rabbit beta globin is regulated as an early viral gene in infected fibroblasts. *J. Virol.* (submitted).
- Sollner-Webb, B. & Towers, J. (1986). Transcription of cloned eukaryotic ribosomal RNA genes. *Ann. Rev. Biochem.* 55, 801-830.
- Southern, E.M. (1975). Detection of specific sequences among DNA fragments separated by gel electrophoresis. *J. Mol. Biol.* 98, 503-517.
- Spaete, R.R., & Frenkel, N. (1982). The herpes simplex virus amplicon: a new eukaryotic defective-virus cloning-amplifying vector. *Cell* 30, 295-304.
- Spear, P.G. & Roizman, B. (1972). Proteins specified by herpes simplex virus. V. purification and structural proteins of the herpes virion. *J. Virol.* 9, 143-159.
- Stenberg, R.M. & Pizer, L. (1982). Herpes simplex virus-induced changes in cellular and adenovirus metabolism in an adenovirus type 5-transformed cell line. *J. Virol.* 42, 474-487.
- Stevens, J.G. & Cook, M.L. (1971). Latent herpes simplex virus in spinal ganglia of mice. *Science* 173, 843-845.
- Stinksy, M.F. (1983). The molecular biology of cytomegalovirus. In "The herpesviruses" vol. 2 (ed. B.Roizman). Plenum Press, NY. pp67-113.
- Stow, N.D. (1982). Localization of an origin of DNA replication within the TR<sub>S</sub>/IR<sub>S</sub> repeated region of the herpes simplex virus type 1 genome. *EMBO J.* 1, 863-867.

- Stow, N.D. (1985). Mutagenesis of a herpes simplex virus origin of DNA replication and its effect on viral interference. *J. Gen. Virol.* 66, 31-42.
- Stow, N.D. & McMonagle, E.C. (1983). Characterization of the TR<sub>S</sub>/IR<sub>S</sub> origin of DNA replication of herpes simplex virus type 1. *Virology* 130, 427-438.
- Stow, N.D. & Stow, E.C. (1986). Isolation and characterization of a herpes simplex virus type 1 mutant containing a deletion within the gene encoding the immediate-early polypeptide Vm<sub>w</sub>110. *J. Gen. Virol.* 67, 2571-2585.
- Stow, N.D., McMonagle, E.C. and Davison, A.J. (1983). Fragments from both termini of the herpes simplex virus type 1 genome contain signals required for the encapsidation of viral DNA. *Nucleic Acids Res.* 11, 8205-8220.
- Stow, N.D., Murray, M.D. & Stow, E.C. (1986). Cis-acting signals involved in the replication and packaging of herpes simplex virus type 1 DNA. In "Cancer Cells" vol. 4 (eds. M.Botchan, T.Grodzicker, P.A.Sharp), "DNA tumor viruses: control of gene expression and replication". Cold Spring Harbor Laboratory. pp497-507.
- Stow, N.D., Subak-Sharpe, J.H. & Wilkie, N.M. (1978). Physical mapping of HSV-1 mutations by marker rescue. *J. Virol.* 28, 182-192.
- Stringer, J.R., Holland, L.E., Swanstrom, R.I., Pivo, K. & Wagner, E.K. (1977). Quantitation of herpes simplex virus type 1 RNA in infected cells. *J. Virol.* 21, 889-901.
- Strub, K., Galli, G., Busslinger, M. & Birnstiel, M.L. (1984). The cDNA sequences of the sea urchin U7 small nuclear RNA suggest specific contacts between histone mRNA precursors and U7 RNA during RNA processing. *EMBO J.* 3, 2801-2807.
- Svensson, C. & Akusjarvi, G. (1984). Adenovirus 2 early region 1A stimulates expression of both viral and cellular genes. *EMBO J.* 3, 789-794.
- Swanstrom, R.L. & Wagner, E.K. (1974). Regulation of synthesis of herpes simplex type 1 virus mRNA during productive infection, *Virology* 60, 522-533.
- Swanstrom, R.I., Pivo, K. & Wagner, E.K. (1975). Restricted transcription of the herpes simplex virus genome occurring early after infection and in the presence of metabolic inhibitors. *Virology* 66, 140-150.
- Sydiskis, R.J. & Roizman, B. (1966). Polysomes and protein synthesis in cells infected with a DNA virus. *Science* 153, 76-78.

- Sydiskis, R.J. & Roizman, B. (1967). The disaggregation of host polyribosomes in productive and abortive infection with herpes simplex virus. *Virology* 32, 678-686.
- Tack, L.C. & Beard, P. (1985). Both trans-acting factors and chromatin structure are involved in the regulation of transcription from the early and late promoters in simian virus 40 chromatin. *J. Virol.* 54, 207-218.
- Tackney, C., Cachianes, G. & Silverstein, S. (1984). Transduction of the chinese hamster ovary aprt gene by herpes simplex virus. *J. Virol.* 52, 606-614.
- Takahashi, K., Vigneron, M., Matthes, H., Wildeman, A., Zenke, M. & Chambon, P. (1986). Requirement of stereospecific alignment for initiation from the simian Virus 40 early promoter. *Nature* 319, 121-126.
- Takeda, Y., Ohlendorf, D.H., Anderson, W.F. & Matthews, B.W. (1983). DNA binding proteins. *Science* 221, 1020-1026.
- Timbury, M.C. & Subak-Sharpe, J.H. (1973). Genetic interactions between temperature-sensitive mutants of types 1 and 2 herpes simplex virus. *J. Gen. Virol.* 18, 347-357.
- Tooze, J. (1980). *Molecular Biology of Tumor Viruses: DNA Tumor Viruses* (2<sup>nd</sup> Ed.). Cold Spring Harbor Laboratory, NY.
- Townes, T.M., Lingrel, J.B., Chen, H.Y., Brinster, R.L. & Palmiter, R.D. (1985). Erythroid-specific expression of human  $\beta$ -globin genes in transgenic mice. *EMBO J.* 4, 1715-1723.
- Treisman, R., Orkin, S.H. & Maniatis, T. (1983a). Specific transcription and RNA splicing defects in five cloned  $\beta$ -thalassemia genes. *Nature* 302, 591-596.
- Treisman, R., Green, M. & Maniatis, T. (1983b). Cis and trans-activation of globin gene transcription in transient assays. *Proc. Natl. Acad. Sci. U.S.A.* 80, 7428-7432.
- Tremblay, M.L., Yee, S-P., Persson, R.H., Bacchetti, S., Smiley, J.R. & Branton, P.E. (1985). Activation and inhibition of expression of the 72,000-Da early protein of adenovirus type 5 in mouse cells constitutively expressing an immediate early protein of herpes simplex virus type 1. *Virology* 144, 35-45.
- Umene, K. (1986). Conversion of a fraction of the unique sequence to part of the inverted repeats in the S component of the herpes simplex virus type 1 genome. *J. Gen. Virol.* 67, 1035-1048.

- Varmuza, S.L. & Smiley, J.R. (1985). Signals for site-specific cleavage of HSV DNA: Maturation involves two separate cleavage events at sites distal to the recognition sequences. *Cell* 41, 793-802.
- Velcich, A. & Ziff, E. (1985). Adenovirus Ela proteins repress transcription from the SV40 early promoter. *Cell* 40, 705-716.
- Vieire, J. & Messing, J. (1982). The pUC plasmids, an M13mp7-derived system for insertion mutagenesis and sequencing with synthetic universal primers. *Gene* 19, 259-268.
- Vigneron, M., Barrera-Saldana, H.A., Baty, D., Everett, R.E. & Chambon, P. (1984). Effect of the 21-bp repeat upstream element on *in vitro* transcription from the early and late SV40 promoters. *EMBO J.* 3, 2373-2382.
- Vlazny, D.A. & Frenkel, N. (1981). Replication of herpes simplex virus DNA: Localisation of replicative recognition signals within defective viral genomes. *Proc. Natl. Acad. Sci., U.S.A.* 78, 742-746.
- Vlazny, D.A., Kwong, A. & Frenkel, N. (1982). Site-specific cleavage/packaging of herpes simplex virus DNA and the selective maturation of nucleocapsids containing full-length viral DNA. *Proc. Natl. Acad. Sci., U.S.A.* 79, 1423-1427.
- Vonka, V. Shiraki, K. Wrzos, J. & Rapp, F. (1986). Cellular DNA synthesis associated with activation of latent herpes simplex virus in cell culture. *Intervirology* 25, 144-150.
- Voss, S.D., Schlokot, U. & Gruss, P. (1986). The role of enhancers in the regulation of cell-type specific transcriptional control. *Trends in Biochem. Sci.* 11, 287-289.
- Wachsman, W., Cann, A.J., Williams, J.L., Slamon, D.J., Souza, L., Shah, N.P. & Chen, I.S.Y. (1987). HTLV x gene mutants exhibit novel transcriptional regulatory phenotypes. *Science* 235, 674-677.
- Wadsworth, S., Jacob, R.J. & Roizman, B. (1975). Anatomy of herpes simplex virus DNA II. Size composition and arrangement of inverted terminal repeats. *J. Virol.* 15, 1487-1497.
- Waechter, D.E. & Baerga, R. (1982). Effect of methylation on expression of microinjected genes. *Proc. Natl. Acad. Sci., U.S.A.* 79, 1106-1110.
- Wagner, E.K. (1985). Individual HSV transcripts. In "The Herpesviruses" vol.3 (ed. B. Roizman). Plenum Press, NY. pp45-104.

- Wagner, E.K. & Summers, W.C. (1978). Structure of the joint region and the termini of the DNA of herpes simplex virus type 1. *J. Virol.* 27, 374-387.
- Wasylyk, B., Derbyshire, R., Guy, A., Molko, D., Roget, A., Teolue, R. & Chambon, P. (1980). Specific *in vitro* transcription of conalbumin gene is drastically decreased by a single-point mutation in TATA box homology sequence. *Proc. Natl. Acad. Sci., U.S.A.* 77, 7024-7028.
- Wasylyk, B., Wasylyk, C., Matthes, H., Wintzerith, M. & Chambon, P. (1983). Transcription from the SV40 early-early and late-early overlapping promoters in the absence of DNA replication. *EMBO J.* 2, 1605-1611.
- Watson, R.J. & Clements, J.B. (1980). Identification of a herpes simplex virus type 1 function continuously required for synthesis of early and late virus RNAs. *Nature* 285, 329-330.
- Watson, R.J., Preston, C.M. & Clements, J.B. (1979). Separation and characterization of herpes simplex virus type 1 immediate-early mRNAs. *J. Virol.* 31, 42-52.
- Watson, R.J., Sullivan, M. & Vande-Woude, G.F. (1981). Structure of two spliced herpes simplex virus type 1 immediate-early mRNAs which map at the junctions of the unique and reiterated regions of the virus DNA S component. *J. Virol.* 37, 431-444.
- Watson, R.J., Weis, J.H., Salstrom, J.S. & Enquist, L.W. (1982). Herpes simplex virus type-1 glycoprotein D gene: Nucleotide sequence and expression in *Escherichia coli*. *Science* 218, 381-384.
- Watson, R.J., Colberg-Poley, A.M., Marcus-Sekura, C.J., Carter, B.J. & Enquist, L.W. (1983). Characterization of the herpes simplex virus type 1 glycoprotein D mRNA and expression of this protein in *Xenopus* oocytes. *Nucleic Acids Res.* 11, 1507-1522.
- Weber, F., De Villiers, J. & Schaffner, W. (1983). An SV40 "enhancer trap" incorporates exogenous enhancers or generates enhancers from its own sequences. *Cell* 36, 983-992.
- Weeks, D.L. & Jones, N.C. (1985). Adenovirus E3-early promoter: sequences required for activation by E1A. *Nucleic Acids Res.* 13, 5389-5402.
- Weiher, H., Konig, M. & Grus, P. (1983). Multiple point mutations affecting the simian virus 40 enhancer. *Science* 219, 626-631.
- Weil, P.A., Luse, D.S., Segall, J. & Roeder, R.G. (1979). Selective and accurate initiation of transcription at the Ad2 major late promoter in a soluble system



- dependent on purified RNA polymerase II and DNA. Cell 18, 469-484.
- Weintraub, H. (1985). Assembly and propagation of repressed and derepressed chromosomal states. Cell 42, 705-711.
- Weller, S.K., Spadaro, A., Schaffer, J.E., Murray, A.W., Maxam, A.M. & Schaffer, P.A. (1985). Cloning, sequencing, and functional analysis of ori<sub>L</sub>, a herpes simplex virus type 1 origin of DNA synthesis. Mol. Cell. Biol. 5, 930-942.
- Whitley, R.J. (1985). Epidemiology of herpes simplex viruses. In "The herpesviruses" vol.3 (ed. B.Roizman). Plenum Press. ppl-44.
- Whitton, J.L. (1984). Structural elements involved in herpes simplex virus immediate-early transcription. Ph.D. Thesis, University of Glasgow.
- Whitton, J.L. & Clements, J.B. (1984). The junctions between the repetitive and the short unique sequences of the herpes simplex virus genomes are determined by the polypeptide-coding regions of two spliced immediate-early mRNAs. J. Gen. Virol. 65, 451-466.
- Whitton, J.L., Rixon, F.J., Easton, A.J. & Clements, J.B. (1983). Immediate-early mRNA-2 of herpes simplex viruses types 1 and 2 is unspliced: conserved sequences around the 5' and 3' termini correspond to transcription regulatory signals. Nucleic Acids Res. 11, 6271-6287.
- Wigdahl, B.L., Scheck, A.C., De Clerq, E. & Rapp, F. (1982). High efficiency latency and activation of herpes simplex virus in human cells. Science 217, 1145-1146.
- Wigdahl, B.L., Scheck, A.C., Ziegler, R.J. De Clerq, E. & Rapp, F. (1984). Analysis of the herpes simplex virus genome during in vitro latency in human diploid fibroblasts and rat sensory neurons. J. Virol. 49, 205-213.
- Wildeman, A.G., Sassone-Corsi, P., Grundstrom, T., Zenke, M. & Chambon, P. (1984). Stimulation of in vitro transcription from the SV40 early promoter by enhancer involves a specific trans-acting factor. EMBO J. 3, 3129-3133.
- Wildeman, A.G., Zenke, M., Schatz, C., Wintzerith, M., Grundstrom, T., Matthes, H., Takahashi, K. & Chambon, P. (1986). Specific protein binding to the simian virus 40 enhancer in vitro. Mol. Cell. Biol. 6, 2098-2105.
- Wildy, P., Russell, W.C. & Horne, R.W. (1960). The morphology of herpesvirus. Virology 12, 204-222.
- Wildy, P., Smith, C., Newton, A.A. & Dendy, P. (1961). Quantitative cytological studies on HeLa cells infected with herpes virus. Virology 15, 486-500.

- Wilkie, N.M. (1973). The synthesis and substructure of herpesvirus DNA: The distribution of alkali-labile single strand interruptions in HSV-1 DNA. *J. Gen. Virol.* 21, 453-467.
- Wilkie, N.M. (1976). Physical maps for herpes simplex virus type 1 DNA for restriction endonucleases HindIII, HpaII and XbaI. *J. Virol.* 20, 222-233.
- Wilkie, N.M., Clements, J.B., Boll, W., Mantei, N., Lonsdale, D. & Weissman, C. (1979). Hybrid plasmids containing an active thymidine kinase gene of herpes simplex virus 1. *Nucleic Acids Res.* 7, 859-877.
- Wohlrab, F. & Francke, B. (1980). Deoxyribopyrimidine triphosphatase activity specific for cells infected with herpes simplex virus type 1. *Proc. Natl. Acad. Sci. U.S.A.* 77, 1872-1876.
- Wright, S., Rosenthal, A. Flavell, R. & Grosveld, F. (1984). DNA sequences required for regulated expression of  $\beta$ -globin genes in murine erythroleukemia cells. *Cell* 38, 265-273.
- Yager, D.R. & Bachenheimer, S.L. (1987). Regulation of the expression of herpes simplex virus type 1: Control at the level of transcription. (in press).
- Yu, S.F., von Ruden, T., Kantoff, P.W., Garber, C., Seiberg, M., Ruther, U., Anderson, W.F., Wagner, E.F. & Gilboa, E. (1986). Self-inactivating retroviral vectors designed for transfer of whole genes into mammalian cells. *Proc. Natl. Acad. Sci., U.S.A.* 83, 3194-3198.
- Zarkower, D., Stephenson, P., Sheets, M. & Wickens, M. (1986). The AAUAAA sequence is required both for cleavage and for polyadenylation of simian virus 40 pre-mRNA in vitro. *Mol. Cell. Biol.* 6, 2317-2323.
- Zenke, M., Grundstrom, T., Matthes, H., Wintzerith, M., Schatz, C., Wildeman, A. & Chambon, P. (1986). Multiple sequence motifs are involved in SV40 enhancer function. *EMBO J.* 5, 387-397.
- zur Hausen, H. (1982). Human genital cancer: Synergism between two virus infections or synergism between a virus infection and initiating events. *Lancet* 2, 1370-1372.