



<https://theses.gla.ac.uk/>

Theses Digitisation:

<https://www.gla.ac.uk/myglasgow/research/enlighten/theses/digitisation/>

This is a digitised version of the original print thesis.

Copyright and moral rights for this work are retained by the author

A copy can be downloaded for personal non-commercial research or study,
without prior permission or charge

This work cannot be reproduced or quoted extensively from without first
obtaining permission in writing from the author

The content must not be changed in any way or sold commercially in any
format or medium without the formal permission of the author

When referring to this work, full bibliographic details including the author,
title, awarding institution and date of the thesis must be given

Enlighten: Theses

<https://theses.gla.ac.uk/>
research-enlighten@glasgow.ac.uk

CLINICAL AND EXPERIMENTAL STUDIES
OF THE
FETAL AND UTEROPLACENTAL CIRCULATIONS
USING DOPPLER ULTRASOUND

a thesis submitted by

Alan Dougal Cameron

M.B. Ch. B. M.R.C.O.G.

in fulfilment of the requirements for the degree

of

DOCTOR OF MEDICINE OF THE UNIVERSITY OF GLASGOW

based on research conducted between October 1985 and September 1989 in
the Department of Obstetrics and Gynaecology, University of Calgary,
Canada and at the Glasgow Royal Maternity Hospital

© Dr Alan Cameron 1990

ProQuest Number: 10983762

All rights reserved

INFORMATION TO ALL USERS

The quality of this reproduction is dependent upon the quality of the copy submitted.

In the unlikely event that the author did not send a complete manuscript and there are missing pages, these will be noted. Also, if material had to be removed, a note will indicate the deletion.



ProQuest 10983762

Published by ProQuest LLC (2018). Copyright of the Dissertation is held by the Author.

All rights reserved.

This work is protected against unauthorized copying under Title 17, United States Code
Microform Edition © ProQuest LLC.

ProQuest LLC.
789 East Eisenhower Parkway
P.O. Box 1346
Ann Arbor, MI 48106 – 1346

TABLE OF CONTENTS	Page
Table of contents	2
Index of tables	8
Index of figures	10
Acknowledgements	15
Publications and presentations	16
Summary	17
Abbreviations	20
CHAPTER 1	
INTRODUCTION	2 1
1.1 Circumstances of the research work	2 2
1.2 Philosophy behind the thesis	2 2
1.3 Objectives of the thesis	2 4
CHAPTER 2	
THE INVESTIGATION OF FETAL AND UTEROPLACENTAL BLOOD FLOW - A LITERATURE SURVEY	2 6
2.1 Historical aspects of the fetal and uteroplacental circulation	2 7
2.2 Uteroplacental anatomy and physiology	2 8
2.3 Historical aspects of blood flow measurements	2 9
2.4 The history of obstetric ultrasound	3 2
CHAPTER 3	
PHYSICS AND SAFETY ASPECTS OF OBSTETRIC ULTRASOUND	3 5
3.1 The Doppler principle	3 6
3.2 The Doppler spectrum	3 7
3.3 Continuous wave Doppler ultrasound	3 8
3.4 Pulsed wave Doppler ultrasound	3 9
3.5 Doppler signal processing	4 0
3.6 Duplex scanner configurations	4 1

3.7	Doppler flow velocity waveforms	4 2
3.7.1	The fetal descending thoracic aortic waveform	4 2
3.7.2	The fetal inferior vena cava waveform	4 3
3.7.3	The umbilical artery waveform	4 3
3.7.4	The maternal "arcuate" artery waveform	4 3
3.8	Qualitative Doppler waveform analysis	4 3
3.9	Quantitative Doppler waveform analysis	4 4
3.10	Technical factors influencing the Doppler flow velocity waveform	4 5
3.10.1	Measurement of the angle of insonation	4 5
3.10.2	The vessel wall "thump" filter	4 5
3.10.3	The sample volume	4 6
3.10.3	The vessel diameter and elasticity	4 7
3.11	Safety aspects of obstetric ultrasound	4 7
3.12	Definition of acoustic output	4 8
3.12.1	Spatial intensity	4 8
3.12.2	Temporal intensity	4 8
3.12.3	Measurement of acoustic output	5 0
3.12.4	Data for pulse-echo ultrasound equipment	5 0
3.12.5	Data for duplex and pulsed Doppler equipment	5 1
3.12.6	Data for continuous wave Doppler ultrasound equipment	5 1
3.12.7	Discussion	5 1
3.13	Potential risks of obstetric ultrasound to the fetus	5 2
3.13.1	Thermal effects	5 2
3.13.2	Non-thermal effects	5 2
3.13.3	Biologic effects	5 3
3.14	Recommendations for the use of ultrasound in clinical obstetrics	5 5
CHAPTER 4		
FETAL AND UTERO PLACENTAL BLOOD FLOW		
: ULTRASONIC STUDIES		5 7
4.1	The application of Doppler ultrasound to study fetal and placental blood flow velocity	5 8
4.2	Doppler measurement of umbilical venous flow	5 8

4.3	Umbilical artery blood flow velocity waveform analysis	6 0
4.3.1	Introductory remarks	6 0
4.3.2	Normal pregnancy and labour	6 0
4.3.3	Placental resistance	6 4
4.3.4	Pathological pregnancy	6 6
4.3.5	Twin pregnancy	7 0
4.4	Doppler measurement of fetal aortic blood flow	7 1
4.4.1	Introductory remarks	7 2
4.4.2	Normal pregnancy and labour	7 2
4.4.3	Pathological pregnancy	7 4
4.5	Doppler measurement of maternal placental blood flow	7 9
4.5.1	Introductory remarks	7 9
4.5.2	Normal pregnancy and labour	8 0
4.5.3	Pathological pregnancy	8 1
4.6	Doppler measurement of fetal cerebral blood flow	8 3
4.7	Doppler measurement of fetal renal blood flow	8 6
CHAPTER 5		
METHODOLOGY AND CALIBRATION OF DOPPLER EQUIPMENT		8 8
5.1	Doppler equipment	8 9
5.2	Calibration of Doppler equipment	8 9
5.2.1	Introduction	8 9
5.2.2	Materials and methods	9 0
5.2.3	Results	9 1
5.3	Recording of Doppler signals	9 3
5.3.1	Recording technique	9 3
5.4	Signal analysis	9 4
5.5	Animal preparations	9 5
5.5.1	Surgical techniques in animal models	9 6
5.6	Recruitment of patients	9 8
CHAPTER 6		
DUPLEX ULTRASONOGRAPHY OF THE FETAL AORTA, UMBILICAL ARTERY AND PLACENTAL ARTERY THROUGHOUT NORMAL HUMAN PREGNANCY		9 9

6.1	A study of the variability of Doppler recordings at different sites of the umbilical artery and fetal aorta	100
6.2	Introduction	100
6.3	Patients and methods	100
6.4	Results	101
6.5	Discussion	101
6.6	A cross-sectional study of Doppler flow velocity waveforms in normal human gestation	102
6.7	Introduction	102
6.8	Materials and methods	103
6.9	Results	103
6.9.1	The maternal "arcuate" artery	103
6.9.2	The fetal descending aorta	104
6.9.3	The fetal inferior vena cava	104
6.9.4	The umbilical artery	104
6.10	Discussion	105
CHAPTER 7		
THE INFLUENCE OF HEART RATE AND GESTATIONAL AGE ON DOPPLER FLOW PATTERNS IN THE FETAL LAMB		108
7.1	Introduction	109
7.2	Materials and methods	109
7.3	Results	110
7.3.1	Time-to-time variation of the aortic SD ratio	110
7.3.2	The effect of gestational age on the aortic SD ratio	110
7.3.3	The effect of gestational age on the aortic pulsatility index	110
7.3.4	The effect of gestational age on the aortic peak systolic velocity	110
7.3.5	The effect of gestational age on the aortic volume flow	110
7.3.6	The effect of heart rate on the aortic SD ratio	111
7.3.7	The effect of heart rate on the aortic mean velocity	111
7.3.8	The effect of heart rate on the aortic volume flow	111
7.3.9	The effect of heart rate on the inferior vena cava waveform	111
7.4	Discussion	111
CHAPTER 8		
DOPPLER WAVEFORM STUDIES IN PREGNANCY INDUCED HYPERTENSION		115

8.1	Introduction	1 1 6
8.2	The consequences of fetal asphyxia	1 1 6
8.2.1	Death and neurodevelopmental handicap	1 1 7
8.2.2	Apgar score, fetal umbilical cord pH	1 1 8
8.3	Techniques of assessing fetal well-being in the human fetus	1 1 9
8.3.1	The cardiotocograph	1 2 0
8.3.2	The biophysical profile score	1 2 1
8.4	Doppler waveform studies in pregnancies complicated by pregnancy induced hypertension	1 2 2
8.5	Introduction	1 2 2
8.6	Patients and methods	1 2 3
8.7	Results	1 2 4
8.7.1	Group 1 - chronic hypertension	1 2 5
8.7.2	Group 2 - moderate pregnancy induced hypertension	1 2 5
8.7.3	Group 3 - severe pregnancy induced hypertension	1 2 5
8.8	Discussion	1 2 6
8.9	The effect of acute and chronic antihypertensive therapy on the Doppler waveform of the uteroplacental and umbilical circulations	1 2 8
8.10	Introduction	1 2 8
8.11	Patients and methods	1 2 9
8.11.1	Acute study	1 2 9
8.11.2	Chronic study	1 2 9
8.11.3	Control group	1 3 0
8.11.4	Doppler waveform analysis	1 3 0
8.12	Results	1 3 0
8.12.1	Acute study	1 3 0
8.12.2	Chronic study	1 3 1
8.13	Discussion	1 3 1
CHAPTER 9		
THE ULTRASONIC ASSESSMENT OF HUMAN FETAL CARDIAC DYSRHYTHMIAS		1 3 5
9.1	Introduction	1 3 6
9.2	Patients and methods	1 3 6

9.3	Results	137
9.3.1	Irregular fetal heart rate	137
9.3.2	Fetal tachycardia	138
9.3.3	Fetal bradycardia	138
9.4	Discussion	139

CHAPTER 10		
THE INFLUENCE OF ATRIAL PACING ON THE DOPPLER WAVEFORM IN ORDER TO CREATE FETAL HYDROPS IN A CHRONICALLY INSTRUMENTED SHEEP MODEL		147

10.1	Introduction	148
10.2	Materials and methods	148
10.3	Results	149
10.3.1	Biochemical changes	150
10.3.2	Fetal arterial pressure	150
10.3.3	The fetal descending aorta FVW	150
10.3.4	The umbilical artery FVW	151
10.3.5	The fetal inferior vena cava FVW	151
10.4	Discussion	151

CONCLUSIONS AND SUGGESTIONS FOR FURTHER RESEARCH		155
---	--	------------

REFERENCES		158
-------------------	--	------------

TABLES

CHAPTER 4

Table I

Normal values of umbilical venous blood flow in human pregnancy as reported in the literature

Table II

Normal values of umbilical artery FVW indices in human pregnancy as reported in the literature

Table III

Normal values of uteroplacental artery FVW indices in human pregnancy as reported in the literature

CHAPTER 6

Table IV

Fetal Aortic Doppler Parameters at 4-weekly intervals in normal human pregnancy

CHAPTER 8

Table V

The Biophysical Profile Score

Table VI

Maternal characteristics and perinatal outcome of 3 study groups of pregnancies complicated by hypertension

Table VII

Detailed outcome in patients with severe pregnancy induced hypertension

Table VIII

Doppler score and perinatal course in severe pregnancy induced hypertension

Table IX

Maternal blood pressure and uteroplacental and umbilical S/D ratios pre and post nicardipine therapy

Table X

Maternal blood pressure and uteroplacental and umbilical S/D ratios pre and post pindolol therapy

Table XI

The changes in maternal blood pressure and uteroplacental and umbilical S/D ratios in pre-eclamptic patients on no therapy

CHAPTER 9**Table XII**

Overall perinatal outcome in 43 patients with fetal dysrhythmia

Table XIII

Perinatal outcome in 6 patients with fetal tachycardia

Table XIV

Perinatal outcome in 11 patients with fetal bradycardia

CHAPTER 10**Table XV**

Gestational age data, time taken to develop hydrops and time taken to clear hydrops in 6 fetal lambs

Table XVI

Biochemical parameters in six fetal lambs

Table XVII

Mean fetal blood pressure in six fetal lambs at development of fetal hydrops and at its resolution

FIGURES**CHAPTER 2****Figure 2.2**

Blood supply to the intervillous space

CHAPTER 3**Figure 3.1**

The Doppler principle

Figure 3.2a

Parabolic (laminar) flow across a vessel

Figure 3.2b

Flat (highly accelerated) flow across a vessel

Figure 3.3a

Continuous wave Doppler

Figure 3.3b

Continuous wave Doppler sample volume

Figure 3.4a

Principle of pulsed Doppler

Figure 3.4b

Pulsed Doppler

Figure 3.6a-d

Duplex scanner configurations

Figure 3.7.1

Fetal descending thoracic Aortic flow velocity waveform

Figure 3.7.2

Fetal Inferior vena cava flow velocity waveform

Figure 3.7.3

Umbilical artery flow velocity waveform

Figure 3.7.4

Utero-placental (arcuate) artery flow velocity waveform

Figure 3.8

Three indices of qualitative blood flow measurements

Figure 3.10.3

The effect of sample volume geometry on the Doppler spectrum

CHAPTER 5

Figure 5.2.3a

Calibration of a 3.5MHz pulsed Doppler unit using continuous flow

Figure 5.2.3b

Calibration of a 3.5MHz pulsed Doppler unit using a water Sephadex mixture

Figure 5.2.3c

Calibration of a 3.5MHz pulsed Doppler unit using pulsed flow

Figure 5.3.1

Examination set up for sheep ultrasound studies

CHAPTER 6

Figure 6.9.1

Maternal arcuate artery S/D ratio in normal pregnancy

Figure 6.9.2a

Peak systolic velocity in fetal aorta in normal pregnancy

Figure 6.9.2b

End-diastolic velocity in fetal aorta in normal pregnancy

Figure 6.9.2c

Mean velocity in fetal aorta in normal pregnancy

Figure 6.9.2d

Fetal aortic volume flow in normal pregnancy

Figure 6.9.2e

Fetal aortic S/D ratio in normal pregnancy

Figure 6.9.3

Fetal inferior vena cava S/D ratio in normal pregnancy

Figure 6.9.4

Umbilical artery S/D ratio in normal pregnancy

CHAPTER 7**Figure 7.3.1**

Variability of aortic S/D ratio

Figure 7.3.2

Scattergram of the relationship between gestational age and aortic S/D ratio

Figure 7.3.3

Scattergram of the relationship between gestational age and aortic pulsatility index

Figure 7.3.4

Scattergram of the relationship between gestational age and aortic peak systolic velocity

Figure 7.3.5

Scattergram of the relationship between gestational age and aortic volume flow

Figure 7.3.6

Slope of aortic S/D ratio versus increases in heart rate for nine fetal lambs

Figure 7.3.7

Changes in the mean velocity of the descending aorta of seven fetal lambs with increasing heart rate

Figure 7.3.8

Changes in the volume flow of the descending aorta of seven fetal lambs with increasing heart rate

Figure 7.3.9

Fetal inferior vena cava waveform in association with rapid increases in heart

rate

CHAPTER 8

Figure 8.7a

Results of fetal aortic peak systolic velocity for groups 1-3

Figure 8.7b

Results of fetal aortic mean velocity for groups 1-3

Figure 8.7c

Results of fetal aortic end-diastolic velocity for groups 1-3

Figure 8.7d

Results of fetal aortic S/D ratio for groups 1-3

Figure 8.7e

Results of umbilical artery S/D ratio for groups 1-3

CHAPTER 9

Figure 9.4a

An algorithm for the management of fetal cardiac dysrhythmias

Figure 9.4b

Fetal aortic and inferior vena cava waveforms in complete heart block

CHAPTER 10

Figure 10.3.3a

Changes in aortic and umbilical S/D ratios of fetal lambs during atrial pacing study

Figure 10.3.3b

Changes in the mean aortic velocity and volume flow in individual animals during atrial pacing study

Figure 10.3.5

The inferior vena cava waveform under different experimental conditions

ACKNOWLEDGMENTS

Since much of the work concerned in this thesis was carried out in the Department of Obstetrics and Gynaecology, University of Calgary, Alberta, Canada, I wish to express my thanks to members of the department who were involved in the studies. In this respect, I would particularly like to thank Dr Carl Nimrod, Dr Stu Nicholson, Dr Joyce Harder and Dawn Davies. They provided me with constant inspiration and taught me a tremendous amount about general obstetrical ultrasound but more specifically the techniques of Doppler ultrasound.

I also wish to thank Dr Jeff Lipshitz who was acting Chairman of the Department during my Fellowship. He provided much useful advice concerning the preparation of the thesis and also helped me obtain financial support from the Alberta Heritage Medical Federation.

In the animal laboratory, I especially wish to thank Dr John Maloney who, as Director of the Perinatal Research Programme, helped to outline the work of this thesis and allowed me constant access to the animal laboratory. I am also indebted to the technical staff of the animal laboratory who taught me the animal surgery and helped me prepare the animals for the studies involved in the thesis.

I would like to express my gratitude to Dr James Neilson, Senior Lecturer in the Department of Obstetrics and Gynaecology, University of Edinburgh, who provided continual encouragement and supervision in the preparation of this thesis.

Since returning to Glasgow, I wish to express my thanks to Dr James Walker, a good friend and colleague, who has given me much needed advice concerning the presentation of the thesis.

I also wish to acknowledge the constant support that I have obtained from Professor Sir Malcolm Macnaughton since my return from Canada.

Last, but by no means least, it would have been impossible to carry out the work of this thesis and its presentation without the much needed support and encouragement that I received from my wife Phil, who, despite advancing gestation, continued to type the chapters of this thesis. It is to Phil that I dedicate this thesis.

PUBLICATIONS AND PRESENTATIONS CONTAINED IN THIS THESIS

Harder, J., Nimrod, C., Davies, D., Cameron, A.D., Maloney, J. and Nicholson, S. (1987) Pulsed Doppler assessment of fetal blood flow in the inferior vena cava in normal and altered physiological states. In; Perinatal development of the heart and lung (eds. Lipshitz J. Maloney J. Nimrod C. and Carson G.). New York : Perinatology Press, 161-174.

Cameron, A.D., Nicholson, S.F., Nimrod, C.A., Harder, J.R. and Davies, D.M. (1988) Doppler waveforms in the fetal aorta and umbilical artery in patients with hypertension in pregnancy. *American Journal of Obstetrics and Gynecology* 58, 339-345.

Cameron, A.D., Nicholson, S.F., Nimrod, C.A., Harder, J.R. and Davies, D.M. (1988) The role of 2D, M-mode and pulsed Doppler ultrasound in the evaluation of fetal cardiac dysrhythmias. *American Journal of Obstetrics and Gynecology* 58,286-290.

Cameron, A.D., Walker, J.J. and Nimrod, C.A.(1989) Diagnosis and management of fetal cardiac dysrhythmias. *Contemporary Reviews in Obstetrics and Gynaecology* 161,195-199.

Cameron, A.D., Nimrod, C.A., Harder, J.R., and Davies, D.M. and Nicholson, S.F. The influence of heart rate and gestation on the fetal aortic Doppler waveforms. Presented to the Munro Kerr Society , March 1988.

Cameron, A.D., Mathers, A.M., Bjornsson, S. and Walker, J.J. The effect of antihypertensive therapy on the Doppler waveform of the umbilical and uteroplacental circulations. Presented to the Society of Perinatal Obstetricians , Tenth Annual Meeting, January 23-27, 1990, Houston, Texas.

SUMMARY

Doppler ultrasound is finding an increasing use in perinatal medicine. Unfortunately, its value in clinical practice has yet to be fully established. A more thorough understanding of the Doppler flow velocity waveform in various fetal and placental vessels is required before adapting this technology into clinical decision making processes. The studies involved in this thesis were designed with the following aims:

1. To perform calibration studies on the equipment used to investigate the fetal and uteroplacental circulations.
2. To establish normal values throughout normal human gestation for the fetal aorta, inferior vena cava, umbilical artery and the maternal uteroplacental artery.
3. To study the variability of Doppler recordings at different sites of the umbilical artery and fetal aorta.
4. To examine the possibility of investigating ovine pregnancy using Doppler ultrasound and to compare the gestational age influences on the flow velocity waveform with those seen in the human pregnancy.
5. To investigate pregnancies complicated by hypertension with Doppler ultrasound in order to determine the value of this technique in detecting signs of fetal compromise before the standard tests of assessing fetal well being.
6. To investigate derangements of the fetal heart seen in human pregnancy with Doppler ultrasound and to prepare a guide for clinicians managing such problems.
7. To create an animal model of fetal hydrops using atrial pacing and to investigate the development of the condition using Doppler ultrasound.

A pulsed wave duplex Doppler system was used to record the flow velocity waveforms in all the studies apart from the one study which investigated the influence of antihypertensive therapy on the Doppler waveform in patients with pregnancy induced hypertension.

In the calibration studies, the performance of the pulsed duplex Doppler system

which was used in the clinical studies was calibrated against direct measurements of pulsatile flow. A satisfactory agreement between time averaged Doppler mean flow and the directly measured mean flow was found. The technique used proved to be easy to set up and could quite easily be adapted for other Doppler equipment. In normal pregnancy, the coefficient of variation for the aortic S/D ratio was 11.1% and that of the umbilical S/D ratio 9.0% with no significant difference being found.

In the cross-sectional study of Doppler flow velocity waveforms in normal pregnancy, the S/D ratios for the umbilical artery and fetal aorta were found to decrease with advancing gestational age. This was felt to reflect decreasing placental resistance towards term. The S/D ratios in the arcuate artery and the inferior vena cava remained stable throughout pregnancy. Quantitative Doppler measurements were performed in the fetal aorta and it was found that there was a slight decrease in aortic blood flow towards term.

The changes seen throughout the third trimester of ovine pregnancy were similar to those found in human gestation. The coefficient of variation of the aortic S/D ratio ranged from 4-14%. As gestation advances in the sheep pregnancy, a fall in aortic volume flow was also seen. The influence of heart rate on the aortic S/D ratio, aortic mean velocity and aortic volume flow was also studied using this model. The aortic S/D ratio was seen to decrease progressively as the heart rate was increased. As regards the aortic mean velocity, this increased until the heart rate reached approximately 220-240 beats per minute (bpm) and this was followed by a decline in mean velocity. Very similar results were seen when studying the aortic volume flow.

The changes seen in the Doppler flow velocity waveforms in the fetal aorta, umbilical artery and maternal arcuate artery were studied in a group of patients with different hypertensive complications in pregnancy. In both chronic hypertension and mild to moderate pregnancy induced hypertension showed little change in the waveform patterns from those of normal pregnancy except when the infant was small for gestational age. However, in severe pregnancy induced hypertension, numerous abnormalities of both the aortic and umbilical artery flow velocity waveform were seen. A higher number of abnormalities were seen

in the aortic waveform compared to the umbilical artery. In some patients, these changes pre-dated any changes seen in the standard tests of fetal wellbeing such as cardiotocography or biophysical profile scoring. The influence of antihypertensive therapy on the Doppler flow velocity waveform in the umbilical and uteroplacental arteries was studied using continuous wave Doppler. Two new drugs were studied. Acute reduction of blood pressure by nicardipine in severe pregnancy induced hypertension produced no change in the Doppler flow velocity waveform. Likewise, no change was seen in patients on more chronic therapy with pindolol.

The value of Doppler ultrasound in assessing fetal cardiac dysrhythmias was next considered. Forty three patients with fetal heart rate rhythm disturbances were evaluated over a 3 year period. Doppler ultrasound proved to be of particular value in the five fetuses with complete heart block and also in assessing the response of fetuses with supraventricular tachycardias to antiarrhythmic treatment.

The final study in the thesis exploited a fetal sheep model of hydrops by atrial pacing. The fetal heart rate responses to atrial pacing were assessed using Doppler ultrasound. Dramatic responses were seen in the Doppler flow velocity waveforms in the thoracic aorta and the umbilical artery. The S/D ratios in both these vessels decreased as fetal hydrops developed. These changes were reversed with the discontinuation of pacing and the resolution of fetal hydrops. A marked alteration in the venous flow pattern was seen when the flow velocity waveform of the inferior vena cava was examined.

The introduction of Doppler ultrasound into perinatal medicine provides us with an exciting new technique. The studies performed in this thesis prove that it does have a role in defining fetal and maternal vascular physiology and also for studying the effects of vasoactive drugs. It can also be of value in trying to establish the pathophysiology of fetal conditions which are poorly understood such as non-immune hydrops. Whether or not Doppler ultrasound will prove to be the definitive method of fetal monitoring in either low or high risk pregnancies, requires further assessment with large multicentre studies, using well defined end points of fetal condition at delivery.

LIST OF ABBREVIATIONS

A/B	A/B ratio
AGA	Appropriate for gestational age
bpm	beats per minute
CS	Caesarean section
CTG	Cardiotocograph
CW	Continuous wave
F_{\min}	minimum frequency
F_{\max}	maximum frequency
F_{mean}	mean frequency
fD	Doppler shift
FHR	Fetal heart rate
FIP	Frequency Index Profile
FWV	flow velocity waveform
g	gram
IUGR	intrauterine growth retardation
kHz	kilo Hertz
kPa	kilo Pascals
mHz	mega Hertz
mPa	mega Pascals
mW	milli Watts
kg	kilogram
mls	millilitres
NST	non stress test
PI	Pulsatility Index
PIH	Pregnancy Induced Hypertension
PW	pulsed wave
Q	volume blood flow
RI	Resistance Index
SEM	standard error of the mean
S/D	systolic/diastolic ratio
SD	standard deviation
SGA	small for gestational age

CHAPTER 1
INTRODUCTION

1.1 Circumstances of the research work

The research work presented in this thesis was carried out between October 1985 and September 1989 in the Department of Obstetrics and Gynaecology, University of Calgary, Alberta, Canada, and at the Glasgow Royal Maternity Hospital. With the exception of the study on the effect of antihypertensive therapy on the Doppler waveform of the umbilical artery and uteroplacental circulations presented in Chapter 8, all studies were carried out when the author was a Fellow in Maternal Fetal Medicine in the Department of Obstetrics and Gynaecology, Division of Maternal Fetal Medicine, University of Calgary, Alberta, Canada. The study in Chapter 8 was performed in Glasgow Royal Maternity Hospital, when the author held the post of Lecturer in the Department of Obstetrics and Gynaecology at the University of Glasgow. The studies were made possible by a clinical fellowship grant from the Alberta Heritage Foundation for medical research. The supervisors of this grant were Dr Carl Nimrod and Dr John Maloney. The project carried out in Glasgow Royal Maternity Hospital was supervised by Dr James Walker, Senior Lecturer in Obstetrics and Gynaecology at the University of Glasgow.

The purpose of the project was to evaluate pulsed Doppler ultrasound as a method of studying changes in the fetal placental and uteroplacental circulations during normal and pathological pregnancies and to evaluate this technique in the study of ovine pregnancy.

1.2 Philosophy behind the thesis

The assessment of maternal and fetal placental circulation has been of special interest to the obstetrician for a long time. Normal fetal growth and oxygenation is dependent on adequate perfusion of the placental bed. A better understanding of this circulation is essential in the management of the pregnant woman and her unborn child. In the past, studies on placental circulation were carried out using highly invasive techniques in acute and chronic animal experiments. These invasive methods were not suitable for application in the human. After the introduction of the Doppler ultrasound principle in the investigation of blood

flow velocities in peripheral vessels in adults (Satomuro, 1959), the human maternal and fetal placental circulation became accessible for this new, non-invasive evaluation. FitzGerald and Drumm (1977) and McCallum et al (1978) first reported on human fetal blood flow measurements by recording the blood flow velocity waveforms (FVW) of the umbilical artery. Campbell et al (1983) first reported on the non-invasive evaluation of the maternal placental circulation by analysis of the arcuate artery FVWs. Since then, Doppler ultrasound has been used to investigate the vascular physiology of normal and complicated pregnancies from the first trimester to delivery.

The most fundamental process of human placentation takes place in the first trimester. The maternal spiral arteries supplying the placenta undergo extensive morphological changes (i.e. trophoblastic invasion) in the course of normal pregnancy (Robertson et al, 1975). The result of this physiological process, is well established in early pregnancy (Pijnenborg et al, 1980). A secondary invasion of the myometrial segments occurs in mid pregnancy and this, together with the progressive distension of the decidual segments of the spiral arteries causes a low resistance to blood flow into the intervillous space. Cohen-Overbeek et al (1985) found a significant change in the arcuate FVW between 14 and 20 gestational weeks with an increase in end diastolic flow velocities, suggesting a decrease in peripheral resistance. Several studies have subsequently been published concerning the Doppler FVW in the uteroplacental circulation. These are referred to in greater detail in Chapter 4. These studies support the possible relationship between the maternal placental FVWs and the morphological changes in the decidual spiral arteries.

Haemodynamic studies in humans with invasive methods have shown that in cases of pre-eclampsia and pregnancies complicated by small for gestational age (SGA), the blood supply to the placental unit is impaired (McClure-Brown and Veale, 1953; Dixon et al, 1963; Kaar et al, 1980; Lunell et al, 1979, 1982; Nyland et al, 1983). A plausible morphological explanation for the reduced placental blood supply in these pregnancy disorders was based on the observation that in complicated pregnancies like these, the physiological changes as described

above, were less marked with narrowing vascular lesions (Shepard and Bonner, 1981). Thus, disturbances of the physiological process of trophoblastic invasion might be associated with pathology later on in pregnancy. It was then hypothesised that FVW analysis of the maternal placental vessels could possibly be an early screening test for the detection of pathological pregnancies.

Results of antepartum studies have suggested an association between Doppler blood FVW measurements and fetal wellbeing. Abnormal umbilical artery FVWs with loss of end diastolic frequencies have been reported in pregnancies complicated by SGA fetuses (Erskine and Ritchie, 1985; Reuwer et al, 1984; Giles et al, 1985). Reduced umbilical venous volume flow, abnormal aortic FVWs and abnormal umbilical artery FVWs have been observed to predate fetal heart rate changes (Joupilla and Kirkinen, 1984; Lingman et al, 1986; Trudinger et al, 1986). These observations raise the possibility that Doppler ultrasound could identify the fetus at risk of hypoxia.

In theory, as well as potentially being of value in assessing fetal wellbeing of complicated pregnancies, Doppler ultrasound may be a useful technique for the evaluation of abnormal fetal cardiovascular dynamics. (Wladimiroff et al, 1983; Tonge et al, 1986).

It is because of a fundamental interest in fetal physiology, and in particular the physiology of the fetal cardiovascular system, that the studies presented in this thesis were performed. An understanding of the fetal circulation is important and essential in the care of the unborn child.

1.3 Objectives of the thesis

The objectives of the thesis were fourfold:

The first objective was to use pulsed Doppler ultrasound to study the changes in the FVWs of the fetal and uteroplacental circulation (umbilical artery, fetal aorta and inferior vena cava and the arcuate artery) throughout normal human gestation. In order to carry out such studies, the equipment used was validated. The results of these studies are presented in chapters 5 and 6.

The second objective of the thesis was to apply the validated technique to

investigate the gestational age changes on the FVW of the fetal aorta throughout the third trimester of normal ovine pregnancy. In addition, the influence of heart rate on the flow velocity waveform of the fetal aorta and inferior vena cava of the fetal lamb was also studied. The results of these studies are presented in chapter 7.

The third objective of the thesis was to study the effects of pregnancies complicated by hypertension on the Doppler FVW of the fetal aorta, umbilical artery and uteroplacental circulations, and to compare the results obtained with the standard tests of fetal wellbeing such as cardiotocography and biophysical profile scoring. Also, the influence of antihypertensive therapy on the umbilical and uteroplacental FVW's was examined in patients with pregnancy induced hypertension (PIH). The results of these studies are presented in chapter 8.

The final objective of this thesis was to examine the role of pulsed Doppler ultrasound in the evaluation of disturbances of fetal cardiac function such as dysrhythmias, and to construct a simple approach to that problem for the clinician. In order to attempt to better understand the role of disturbances of fetal cardiac function in the pathophysiology of non-immune fetal hydrops, pulsed Doppler ultrasound was used to examine a sheep model of fetal hydrops, created by persistent atrial pacing. The results of these studies are presented in chapters 9 and 10.

CHAPTER 2
THE INVESTIGATION OF
FETAL AND UTERO PLACENTAL BLOOD FLOW
A LITERATURE SURVEY

2.1 Historical aspects of the fetal and utero-placental circulations

One of the earliest known references to fetal and maternal vascular physiology is from the Greek philosopher Aristotle (384-322 BC). Aristotle did not accept that intrauterine nourishment was achieved from the oral route and recognised that the umbilical cord functioned as a supply line to the fetus providing food from the mother (Kurjak and Rajhvajn, 1982).

"The vessels join on to the uterus as the roots of plants, and through them the embryo receives nourishment." (Aristotle, 384-322 BC).

In the second century AD, Galen of Pergamon described the connection of the umbilical cord with the fetus (Dobson, 1925). Leonardo da Vinci (1452-1519) also recognised the fetoplacental unit when he stated: "the veins of the child do not ramify in the substance of the uterus of the mother but in the placenta, which takes the place of a shirt in the interior of the uterus, which it coats and to which is connected but not united" (da Vinci, 15th century).

Several centuries passed before further progress was made on the understanding of cardio-vascular anatomy and physiology. In 1542, Jean Fernelle observed that cardiac systole and diastole coincided respectively with expansion and contraction of the arteries (Cournand, 1964). Andreas Caesalpinus (1519-1603) recognised the significance of the pumping action of the heart and the important role of valves. He may have been the first person to use the term "circulation".

The 17th century has been called the "age of physiology" because of the documentation and "discovery" of the circulation of blood by William Harvey in 1628. In his writings, Harvey accurately described the right to left vascular shunts, namely the foramen ovale and ductus arteriosus, that are present in the fetus, and their closure after birth (Harvey, 1628). Harvey appreciated that there was no mixing of fetal and maternal blood in the placenta.

In 1776, as a result of anatomical studies on the cat and guinea pig, Wolff and Becker suggested that two thirds of the oxygenated blood in the fetal inferior vena cava was directed to the left side of the heart (Wolff and Becker, 1776). This view was challenged by Sabatier in 1778 who proposed that there was preferential distribution of well oxygenated blood to the ascending aorta to supply

the brain and heart, and that there was no mixing of well oxygenated blood returning from the placenta with poorly oxygenated blood returning from the fetal tissues (Sabatier, 1778). The exact situation was not clarified until the 1920s and 1930s, when animal studies began to reveal the degree of mixing and oxygenation of blood in the major fetal vessels. Hugget in 1927, using fetal goats, demonstrated that the oxygen content in the carotid artery was greater than that in the descending aorta and umbilical artery (Hugget, 1927). Using cine angiographic methods, Barclay and co-workers illustrated the normal course of blood flow in the fetal lamb (Barclay et al, 1939), and Sir Joseph Barcroft demonstrated the mixing of fetal venous blood streams in the heart and great vessels. The degree of mixing is indeed incomplete but more than Sabatier supposed (Dawes, 1968). The results showed that poorly oxygenated blood returning from the fetal tissues mixed with well oxygenated blood from the placenta (Born et al, 1954). Using cine angiographic techniques also, Lind and Wegelius (1954), showed that the course of the human fetal circulation was essentially the same as that in the fetal lamb.

2.2 Uteroplacental anatomy and physiology

The placenta is supplied with maternal blood by the way of the endometrial "spiral" or "curling" arteries. These vessels arise from the radial and arcuate arteries coming out of the main uterine artery branch (Figure 2.2). William Hunter (1774) provided the first detailed description of the "curling" arteries. The uterine arteries penetrate the lateral margins of the uterine musculature between the layers of the broad ligament. They extend inwards for about one third of the myometrial thickness. Here they divide and, as a ring of arcuate arteries, pass circumferentially but still tortuous to the anterior and posterior uterine walls. From these vascular rings arise branches supplying the inner two thirds of the myometrium and the endometrium, called radial arteries.

Arts (1961a, 1961b) has described the large calibre of the uterine artery and its branches over the placental implantation region. This "hypertrophy" and "dilatation" of spiral arteries were further described by Brosens et al (1975), demonstrating the trophoblast invasion into the spiral arteries as a physiological phenomenon in normal pregnancy. The number of spiral arteries opening into

PERITONEUM

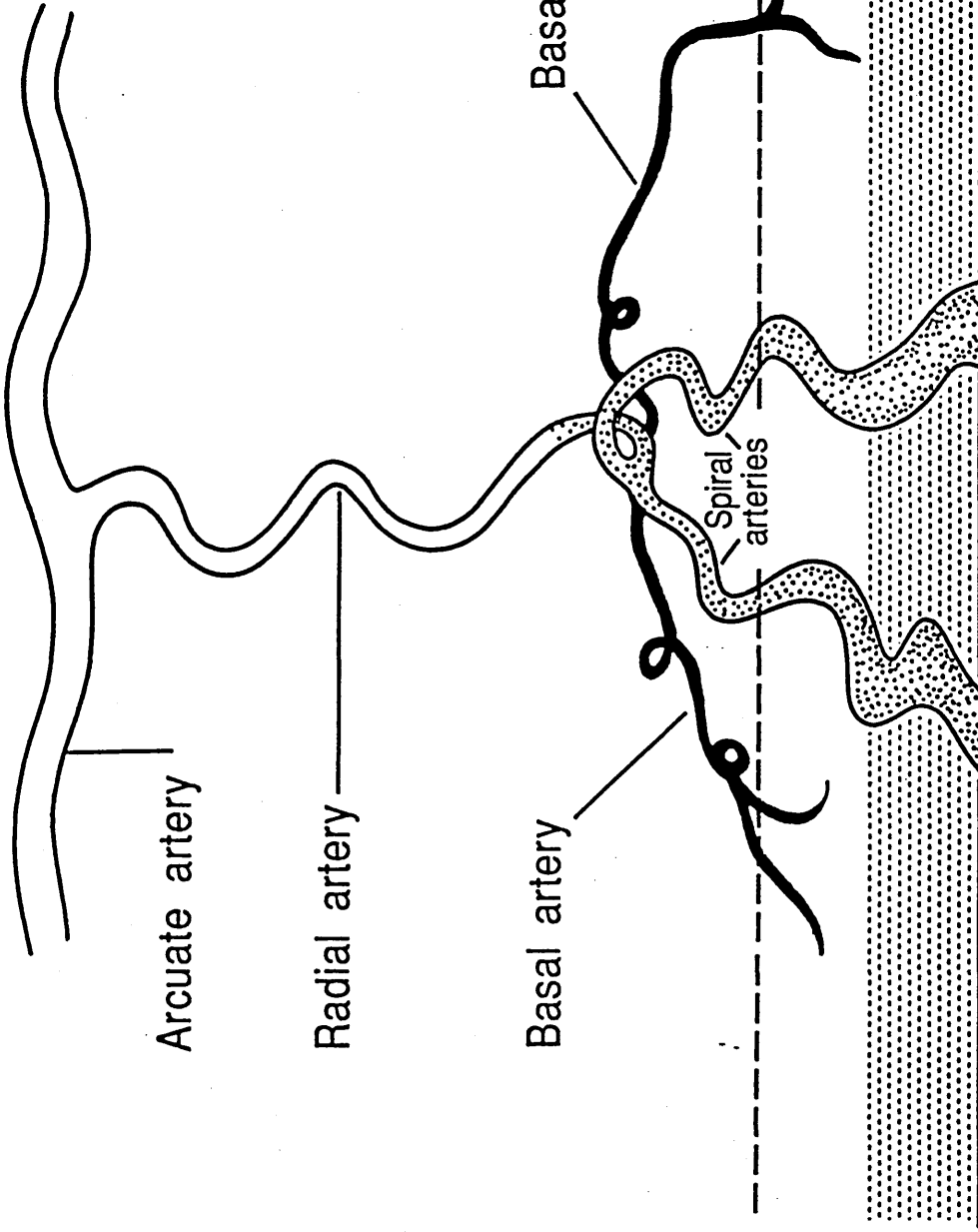

MYOMETRIUM

DECIDUA

BASAL PLATE

INTERVILLOUS SPACE OF THE PLACENTA

Figure 2.2 Blood supply to the intervillous space

the intervillous space is still a matter of debate. Ramsay et al (1963) from cine-radio-angiographic studies in the macaque monkey found no more than 17 arteries opening into the definitive primary and secondary placentae. Eskes et al (1965) found no more than six "spurts" into the intervillous space in a 26 week pregnant human uterus. These in-vivo studies are in sharp contrast with the numerous arterial openings into the intervillous space in anatomic counts. The diameter of the spiral arteries is reported up to 2 mm in calibre and they can indeed be regarded as arteries and not arterioles.

2.3 Historical aspects of blood flow measurements

Much of present knowledge of the fetal and placental circulation comes from animal studies which have employed invasive techniques to quantify blood flow and observe the direction of flow.

The earliest direct study of umbilical blood flow was published by Cohnstein and Zuntz in 1884. They connected a flow meter to the sheep umbilical cord and observed flow in the order of 0.03 mls per gramme of fetal weight per minute (Barcroft et al 1934). This technique proved unreliable because application of the flow meter traumatised the cord and produced vessel spasm. In 1927, Hugget demonstrated the experimental method of acute exteriorisation. A hysterotomy was performed in a goat to expose the fetus, umbilical cord and placenta intact. Hugget wished to study the mechanism of placental gas transfusion. He measured oxygen saturation and carbon dioxide content in the umbilical artery, the fetal aorta and carotid artery. He concluded that there was gas exchange over all of the placenta and he found evidence to support Wolff's theory (Wolff and Becker, 1776) concerning the directions of the blood flow (Hugget, 1927).

The technique of acute exteriorisation was also used by Barcroft et al (1934) to measure cardiac output in the fetal goat. During late gestation, blood flow through the heart was found to be relatively constant in the range of 0.12-0.18 mls per gramme of fetal weight per minute. It was estimated that one third of this output was directed through the placenta - a much greater volume than that calculated by Zuntz and Cohnstein (1884).

In 1939, Barcroft et al employed a method of dye dilution described by Kennedy and Millikan (1938) to obtain serial determinations of fetal and placental blood

flow throughout pregnancy in sheep. He recognised that this technique was less invasive than his acute exteriorisation studies of 1934. Barcroft estimated that umbilical cord blood flow varied with fetal size and age ranging from 111 mls per minute at 111 days gestation to 600 mls per minute at 129 days gestation. Uterine blood flow also increased with advancing gestation, the lowest value being 106 mls per minute and the highest being 475 mls per minute.

Ketty and Schmidt (1948) described the method of estimating tissue blood flow in humans with a diffusible inert gas, such as nitrous oxide. The method utilised the Fick principle. It was applied to study uterine blood flow in humans by Assali et al (1953) but major hazards including cardiac arrhythmias, pulmonary embolism and prolonged exposure to radiation prevented it from being widely adopted. Cooper and Greenfield (1949) used a plethysmograph to measure umbilical blood flow in a fetal lamb immersed in a bath of saline, but still connected to its mother by the umbilical cord. When the umbilical veins were occluded, the rate of decrease of fetal volume was taken to represent the umbilical blood flow. They have reported flow in near term lambs of 500 mls per minute. This was similar to the results obtained by Barcroft (1939).

The first reported attempt to quantify human fetal umbilical blood flow (Greenfield et al, 1951) was on an exteriorised 15 week fetus, its cord intact, placed in a modified venous occlusion plethysmograph. The value of 45 mls per minute per kg obtained from 12 occlusions over a period of 8 minutes was appreciably lower than values obtained later. The authors recognised that their experiment probably did not reproduce the physiological condition of the healthy fetus *in utero*.

Improvements in experimental methods, such as better anaesthesia and the introduction of "chronic fetal preparations", provided more physiological and subsequently more reliable measurements of cardiac output and its distribution. Meschia et al (1965a) developed in New Haven (USA) the methodology of indwelling fetal catheters, allowing studies without the influence of operative procedures and anaesthesia in intact sheep and goat pregnancies. During the 1960s, a detailed account of fetal cardiac output and its distribution, fetal arterial blood pressure and cardiovascular control, together with other aspects of the fetal cardiovascular system became available. Using the Fick principle with urea or antipyrine, Meschia found mean umbilical blood flow values of 183 mls per minute per kg for young fetuses (< 100 days) and for older fetuses (> 100 days) values of 164 mls per minute per kg (Meschia et al, 1965b), of 223

mls per minute per kg (Meschia et al, 1967) and of 238-302 mls per minute per kg (Crenshaw et al, 1968). Makowski et al (1968) showed agreement between the steady state diffusion method using antipyrine and the isotope labelled microsphere method both applied in acute experiments *in utero* in fetal lambs, but their figures were lower (mean value of 135 mls per minute per kg) than those reported previously. Rudolph and Heymann (1967) found agreement between the antipyrine test and the electromagnetic flow meter with mean umbilical flow values of 192-244 mls per minute per kg in fetal lambs. Dawes and Mott (1964) measured umbilical blood flow in near term lambs with an electromagnetic flow meter. They reported a value of 179 mls per minute per kg. Kirschbaum et al (1967) in a similar experiment, observed a mean umbilical flow of 138 mls per minute per kg. Assali et al (1960) used an electromagnetic flow meter to study umbilical venous flow between 10 and 28 post menstrual weeks prior to termination of pregnancy in human pregnancy. A mean value of 110 mls per minute per kg was recorded with minimal gestational variation. A major problem with these methods is that considerable skill is required to insert the transducers into small vessels which supply individual organs without interfering with the circulation. Exteriorisation of the fetus is often necessary to apply these transducers and the probe itself may alter blood flow due to compression of the vessel being studied. In the case of uterine blood flow measurements, the flow meters cannot differentiate between the flow to the uterus and that to the placenta.

In view of these difficulties, several workers have attempted to study utero-placental blood flow with radioactive isotopes. The rate of clearance of radioactive tracers injected either into the myometrium or inter-villous space (Browne and Veal, 1953, Dickson et al, 1963, Clavero et al, 1973) or directly into the maternal circulation (Rekonen et al, 1976, Lunell et al, 1982) has been used as an index of human myometrial or placental flow. These are invasive techniques and thus not readily applicable to a clinical situation, and it is also difficult to interpret results in terms of quantitative blood flow.

The microsphere technique to study the proportionate distribution of cardiac

output was explored in detail by Rudolph and Heymann (1967). Using this technique, actual organ blood flow and total cardiac output using radioactive microspheres can be accomplished. If the microspheres are well mixed with blood, and if they are too large to pass through the pre-capillary arterioles, then they will be distributed according to arterial blood flow. Microspheres with different radioactive labels can be used and several observations made in one animal. The technique has the advantage of being able to measure the total uterine blood flow and its distribution but requires cannulation of limb vessels and is certainly not suitable for quantifying blood flow in humans. A major disadvantage of the microsphere technique is that chronic animal preparations cannot be used since experiments involve sacrificing the animals after the microspheres have been injected.

A major advance in the study of fetal circulation occurred in the late 1970s with the application of Doppler ultrasound (Fitzgerald and Drumm, 1977). The advantage of this technique is that it is non-invasive and current evidence suggests that ultrasound has no detrimental effects on human tissue. Recordings can be readily repeated and also provide a direct assessment of blood flow velocity. Doppler ultrasound is well established as a valuable method of assessing peripheral and cerebrovascular disease in adults. In contrast, the use of Doppler to study the fetal and uteroplacental circulations is still in its early stages. The potential role of this technique to study both the physiology and pathology of pregnancy has yet to be realised.

2.4 The history of obstetric ultrasound

The Curie brothers (Curie and Curie, 1880) discovered the phenomenon known as the piezo-electric effect. They discovered that certain crystals when pressed or deformed emitted electrical energy and conversely, if electrical energy was applied to these crystals, they changed shape. One of their pupils was the physicist Paul Langevin. Following the sinking of the Titanic in 1912, he wished to develop a technique which would detect underwater obstructions. He constructed a Quartz crystal transducer which generated mechanical energy from electrical energy by the piezo-electric effect (Biquard, 1972). The mechanical energy was emitted as a beam of ultrasound, ie soundwaves of frequencies greater

than 20,000 Hz. Unlike ordinary sound, ultrasound is emitted in a beam of predictable velocity with little tendency for diversions. These characteristics make the task of plotting echo producing surfaces relatively simple.

There are two main types of ultrasound. Continuous wave ultrasound, as the name implies, means that ultrasound is admitted continuously from the transducer. Pulsed wave ultrasound, however, involves the intermittent production of a series of identical ultrasound pulses. With continuous wave systems, two piezo-electric crystals are required, one which emits ultrasound and the other which receives the returning echos. A pulsed ultrasound wave system, however, only has one crystal which serves to both emit the ultrasound pulse and in between pulses, receives the echo. The main advantage of imposing a time delay between emission and reception of pulses, is that depth selection along the ultrasound beam is achieved (Robinson, 1978). This has important implications in clinical studies since accurate localisation of structures to be studied can be achieved.

From the use of ultrasound in navigational and industrial sonar equipment (White, 1976), medical ultrasound was developed. There are three chief applications of medical ultrasound:

1. To promote healing - ultrasound appears to encourage muscle relaxation, reduce pain and speed the healing processes of damaged tissues. It thus has a useful application, especially in the post-operative period.
2. Surgical therapy - ultrasound has been employed to destroy tumours, particularly in the brain (Fry et al, 1958). More recently, gallstones and renal calculi can be treated in this way.
3. As a diagnostic tool - The simplest form of ultrasound is A-mode. This is uni-dimensional and only provides information about objects encountered along the sound path, nothing being received from surrounding structures. Two dimensional ultrasound images (B-mode) were first produced by Howry and Bliss (1952). They performed postmortem work using a hand-held instrument immersed in an elliptical water chamber (Wild and Reid, 1952). Such cumbersome equipment was unsuitable for clinical use, but the development of an ultrasound machine which did not require a water tank by Donald et al (1958) meant that diagnostic

ultrasound could become a practical proposition. This so-called contact B scanner was used by Professor Ian Donald in Glasgow to establish the ultrasonic features of normal pregnancy as well as to delineate some abnormalities of fetal and placental structure.

A major advance in ultrasound technology occurred during the late 1970s. This came with the development of real-time scanners which were capable of producing moving images. Real-time equipment has many advantages over the static B-scanner since it is smaller, lighter and technically easier to manipulate and thus easier to use. Since the image is seen continuously, other structures such as blood vessels can also be visualised and a three-dimensional character reconstructed (Goddard et al, 1980). Further improvements in real-time ultrasound technology have allowed the diagnostic applications to expand. In the field of perinatal medicine, biophysical assessment of the fetus can be performed. This allows observation of fetal activity, measurements of fetal growth throughout the pregnancy, and the assessment of fetal structural normality and abnormality. As well as being able to study fetal behavioural states, real-time ultrasound has permitted invasive ultrasound techniques such as amniocentesis, chorionic villous sampling and intrauterine fetal blood transfusion and other methods of fetal therapy to be performed.

The most recent development has seen the combination of real-time and Doppler ultrasound in order to measure fetal and utero-placental blood flow velocity (Griffin et al, 1983).

CHAPTER 3
THE PHYSICS AND SAFETY OF DOPPLER
ULTRASOUND
AND BLOOD FLOW

3.1 The Doppler principle

The Doppler effect is the term given to the shifts in red light from binary stars. It was described by Christian Johanne Doppler (an Austrian professor of mathematics and geometry) in 1842. He postulated that the observed frequency of light or soundwaves depends on the relative motion of the wave source and the observer. He indicated how the observed frequency could be derived mathematically. The Dutchman BuysBallot called this phenomenon the "Doppler theory". BuysBallot was responsible for the first experimental test of the theory. This took place in Utrecht in 1845. A locomotive was used to carry a group of trumpeters in an open carriage to and fro past some musicians able to detect the pitch of the notes being played. The variation of the pitch produced by the motion verified Doppler's equations (BuysBallot, 1845, Jonkman, 1980).

Figure 3.1 illustrates the Doppler principle. The perceived frequency of sound depends on the number of wavefronts which reach the ear per second. The difference between the emitted frequency and the perceived frequency is called the Doppler shift.

Movement of the reflecting object towards the sound source results in apparent increase in the frequency of reflected sound. Movement away from the source results in an apparent decrease. Echoes reflected from stationary boundaries are received at the emitted frequency, but ultrasonic waves reflected from moving particles, such as red blood cells, undergo Doppler shift that is proportional to the velocity at which the particles are moving. The Doppler shift (f_d) is given by the formula:

$$f_d = \frac{2 \times F_o \times V \times \cos \theta}{C}$$

- F_o = the frequency of the emitted ultrasound
- V = the velocity of the moving target
- θ = the angle between the ultrasound beam and the direction of movement
- C = the velocity of sound in tissue, which is approximately 1540 metres/second.

If the Doppler beam is at right angles to the vessel being investigated, no Doppler shift will be recorded, as the cosine of 90° is 0. The size of the Doppler shift increases as the angle of insonation approaches 0 degrees (maximum positive

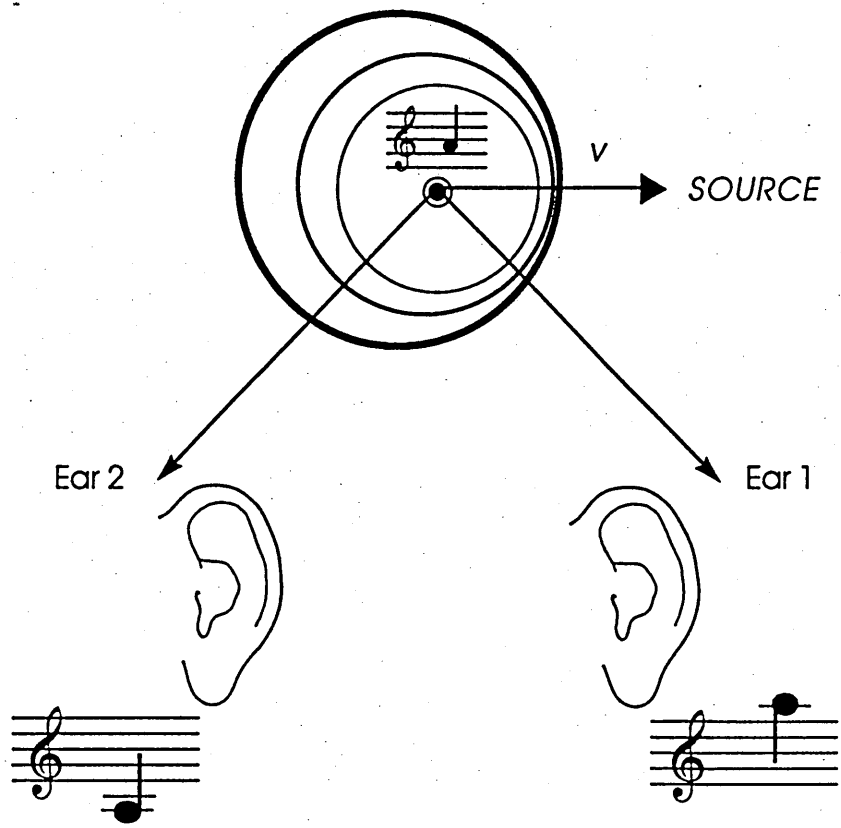

Figure 3.1 The Doppler Principle

Doppler shift) or 180° (maximum negative Doppler shift). By pure chance, Doppler shifts obtained from flowing blood are in the order of 0-5 kHz, which is within the audible range and can therefore be recorded and stored on audio cassettes.

3.2 The Doppler spectrum

When ultrasound strikes blood it is scattered by the erythrocytes. This scattering is very weak in comparison with that from tissue, as inspection of any ultrasonic image of a vessel will indicate.

The "sample volume" of a Doppler system is the region from which the instrument can receive Doppler shifted echoes. Depending on the design of the machine, it may be as small as 3-4 mm in depth and width, or it may be considerably larger.

Since the red cells are in general independent and randomly distributed within the sample volume, their Doppler shifted signals add together randomly to produce the final signal which is detected by the Doppler machine. This process gives the Doppler signal its characteristic "noise-like" quality.

A further consideration in understanding the nature of a Doppler signal is the fact that the red cells within the sample volume do not, in general, all travel at the same velocity. This gives rise to a "spectrum" of Doppler shifts, reflecting the range of velocities present in the sample volume.

The dynamics of blood flow have been analysed extensively, both theoretically and experimentally, and it has been shown that the distribution of blood velocity across the diameter of a vessel is complex and highly variable (McDonald, 1974; O'Rourke, 1982). Among other factors, this distribution often called the "velocity profile" depends on the viscosity of the blood, the time variation of the flow, the presence or absence of turbulence, and any branching or curvature of the vessel.

In a straight non-elastic pipe with an ideal fluid flowing at a constant rate without turbulence, the velocity profile is parabolic, with the maximum velocity being in the centre and with the blood at the vessel walls scarcely moving (figure 3.2a). This distribution, referred to as "laminar flow", may be a reasonable approximation for steady (venous) flow in a relatively straight section of a

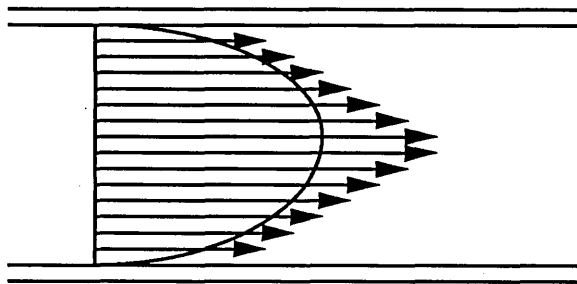

Figure 3.2a Parabolic (laminar) flow across a vessel

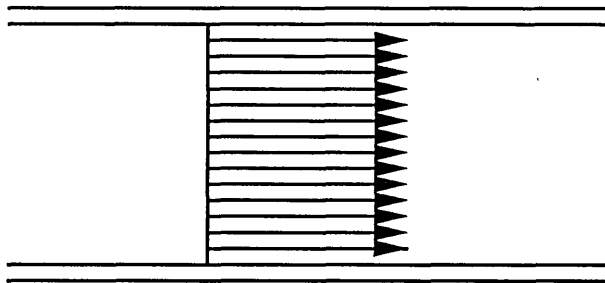

Figure 3.2b Flat (highly accelerated) flow across a vessel

vessel. At the other extreme, however, highly accelerated blood (eg in the aortic outflow tract during systole) tends to behave as a solid, with all the red cells moving at the same velocity (figure 3.2b). This is referred to as "plug flow". In most vessels the velocity distribution is unlikely to follow either of these ideals. Indeed, with time varying flow, the shape of the velocity distribution across the vessel is not even constant throughout the cardiac cycle.

The variation of blood velocity over the vessel cross-section means that the sample volume of a Doppler machine will contain a range of red cell velocities. As a result, a spectrum of Doppler shifts will be detected, rather than a single Doppler shift frequency. The precise nature of a spectrum will depend not only on the velocity profile in the vessel but also on the ultrasound beam pattern and the geometry of the sample volume relative to the vessel. The influence of sample volume size on the Doppler flow velocity waveform is discussed later. In addition, turbulence (which is virtually never found in the absence of pathology) may cause an irregular motion of the red cells to be superimposed on their normal movement along the vessel. This is manifested as a broadening of a Doppler spectrum relative to that which would otherwise have been expected.

The information obtained from the Doppler spectrum depends on what assumptions can be made about the size and orientation of the sample volume (relative to the vessel, the symmetry of the velocity profile, etc). However, it may be possible to deduce some or all of the following:

1. the maximum velocity in the vessel and its time variation
2. the velocity profile
3. the flow regime, ie laminar-turbulent flow
4. the average velocity (within the sample volume, which may encompass the entire vessel lumen)
5. rate of blood flow in the vessel (in mls/minute).

The volume flow rate can only be estimated if the vessel cross-sectional area is known, and the influence of this measurement is discussed later.

3.3 Continuous wave Doppler ultrasound

The simplest type of Doppler machine is a continuous wave (CW) Doppler, shown in the block diagram form in figure 3.3a. Here two separate transducers are

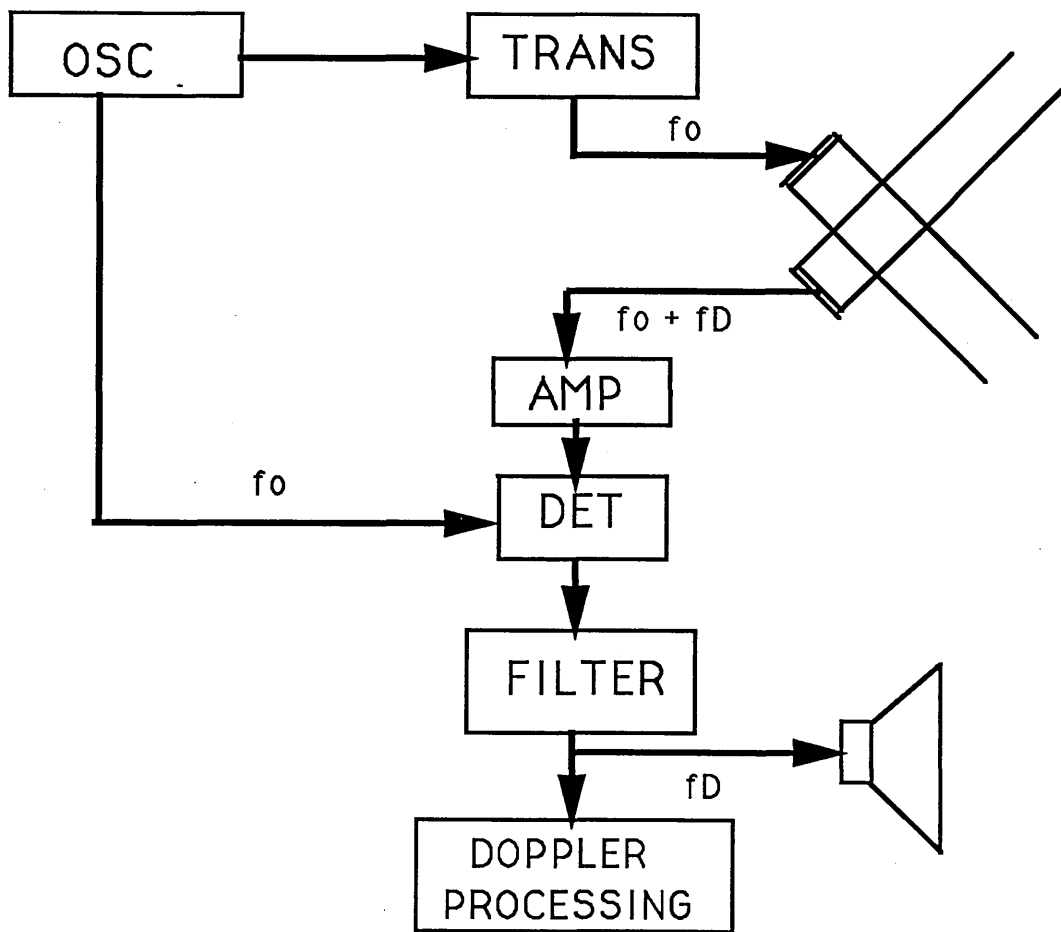

f_0 =frequency
 f_D =Doppler shift

Figure 3.3a
 Continuous- wave Doppler

used, one to transmit continuously at a fixed frequency, the other to act as a receiver for the back scattered signals. The sample volume of this device, as figure 3.3b shows, is simply the area of overlap of the transmitted beam and the beam pattern of the receiving transducer. In general this sample volume is large. As a consequence, CW Dopplers have relatively poor spatial selectivity, particularly in depth. While this may appear to a severe disadvantage for many applications, it does mean that they can be used "blind" without imaging guidance, since the positioning of the probe is not as critical as in the systems with better spatial selectivity.

3.4 Pulsed wave Doppler ultrasound

A more complex form of Doppler instrument is pulsed Doppler, shown in figures 3.4a and b. This uses the relationship between the depth of a scatterer and the time taken for its echo to arrive at the transducer. The transmitted signal consists of a short burst of ultrasound, containing 3-20 cycles at a fixed frequency. Generally the same transducer then acts as the receiver, picking up the back scattered echoes that arise as the transmitted energy travels through the body.

After the weak echo signals have been amplified, a "range gate" circuit selectively lets through the Doppler shift detector only those echoes which arrive at a given time delay after the transmit burst. This ensures that the signals originate from scatterers, such as erythrocytes, at a fixed depth, with that depth being determined by the time delay between the transmit time and the opening of the range gate. In fact, the sample volume has a finite extent in depth; this is determined by the number of cycles in the transmit burst and the length of time for which the range gate is open. The width of a sample volume is simply the width of the ultrasound beam at that depth.

In view of the limitations of continuous wave ultrasound, especially because of the poor spatial selectivity at depth, vessels such as the fetal aorta, inferior vena cava or cerebral vessels have to be examined using pulsed Doppler systems. As the ultrasound has to travel to the vessel and back, a depth limitation is imposed, since all information from one pulse must be received prior to the next pulse being emitted. The maximum pulsed repetition frequency (PRF) is given by the

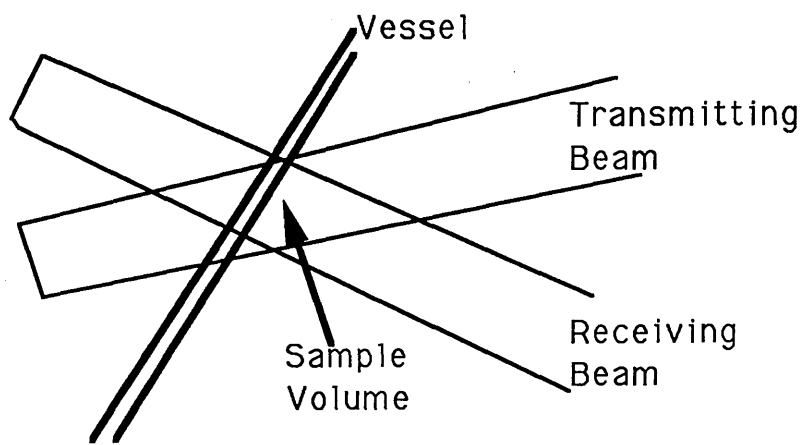

Figure 3.3b
Continuous wave Doppler sample volume

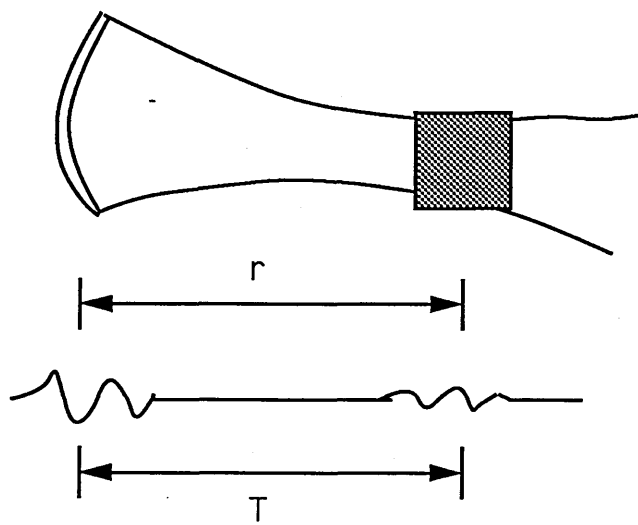
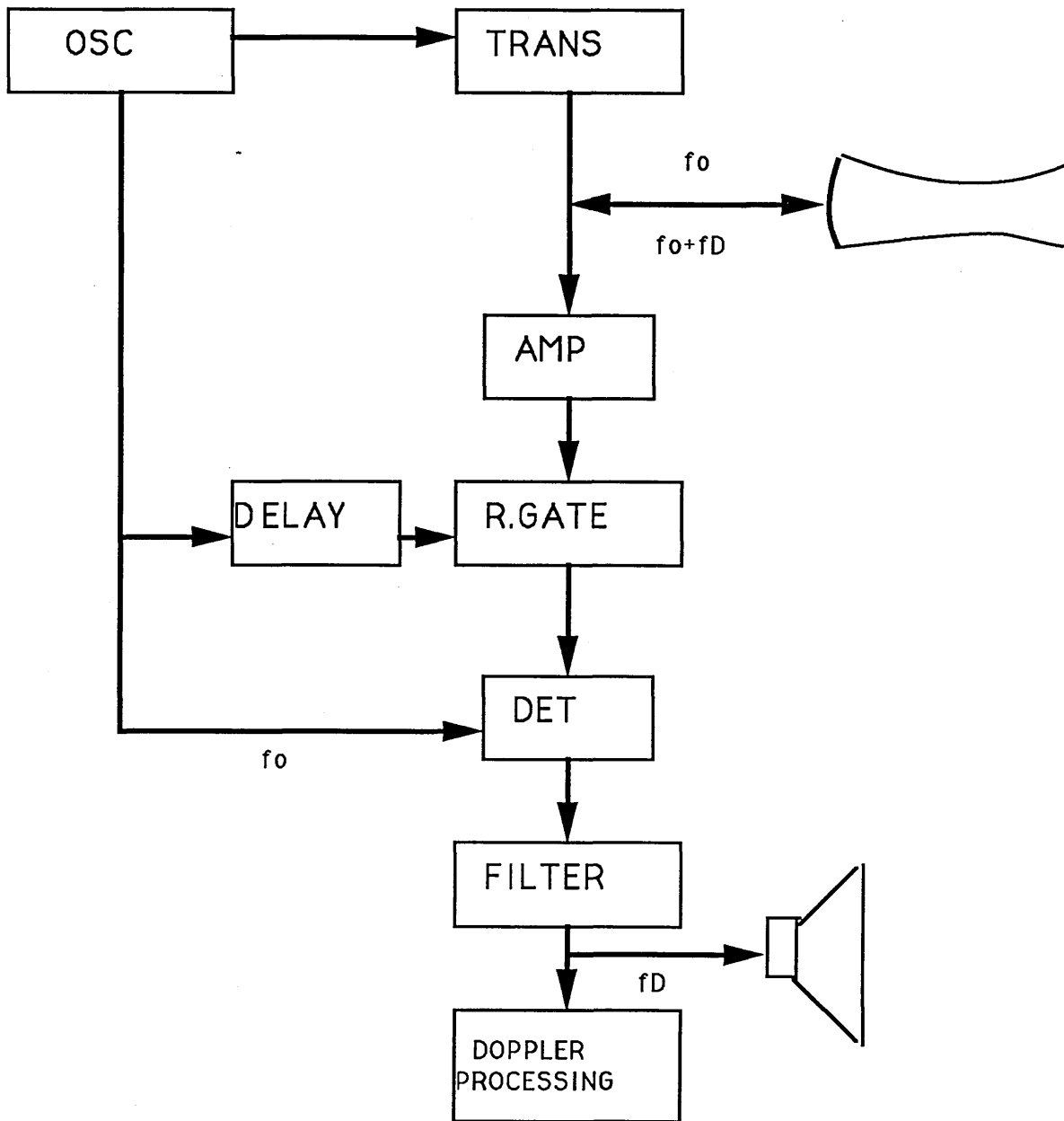

Figure 3.4a
Principle of pulsed Doppler



f_0 =frequency
 f_D =Doppler shift

Figure 3.4b
 Pulsed Doppler

formula:

$$\text{PRF (Hz)} = (\text{CxD}) / 2,$$

where C is the velocity of sound in tissue (generally assumed to be 1540 metres/second) and D is the depth of the structure being investigated.

In addition, if the PRF is less than half the Doppler shifted frequency, an artefact known as aliasing occurs. This phenomenon is readily recognised as the peaks of the Doppler shifted waveform fold round and appear in the lower channel. The best known example of aliasing is that of wagon wheels in Western films appearing to rotate backwards because of sampling effects caused by filming. Aliasing may result in substantial underestimation of systolic velocities (Teague et al, 1985).

As major fetal vessels can be up to 15 cms from the surface of the maternal abdomen, and as peak systolic velocity is recorded from the descending aorta approaches 1.5 m/second, then, with angles of insonation from 45-55⁰, the optimum PRF is 5-7.5 kHz, with ultrasound frequencies of 2-3 MHz (Griffin et al, 1983). Although techniques have been developed to reduce frequency aliasing, it is still a significant problem in some applications. A number of machines provide the possibility of switching to continuous wave Doppler when aliasing cannot be eliminated, since CW Doppler does not suffer from this limitation.

3.5 Doppler signal processing

Aural monitoring of the signal is a vital part of the examination, providing the operator with feedback regarding the quality and nature of the signal. In the fetus this is particularly important, since fetal movements (including fetal breathing movements) must be recognised if they occur during the Doppler portion of an examination.

Spectral analysis has become established as the method of choice for analysing and displaying the signals, and virtually all equipment now provides this option. The spectral display shows the signal in considerable detail indicating the frequency components of the Doppler spectrum, the relative intensity of these components and their time variation. Various derived values may also be available, including the peak and instantaneous mean frequencies, and time

average values. These allow the calculation of waveform indices, or of the volume flow rate, which is discussed later in this chapter. Since the process of spectral analysis involves sampling the Doppler signal, the considerations mentioned above regarding the pulse repetition frequency apply to the sampling rate; frequency aliasing can still occur in the spectrum analyser, even if the signals originated from a continuous wave Doppler.

3.6 Duplex scanner configurations

Since the purpose of pulsed Doppler is to achieve high spatial selectivity, it becomes essential to combine it with some form of imaging to guide the placement of the sample volume. The natural choice is ultrasonic imaging, and this has led to the widespread proliferation of "duplex ultrasound machines", which combine imaging with pulsed Doppler. In general, duplex scanners can be viewed as conventional B-mode scanners with added Doppler facilities. The scanner may be a linear array (which produces a rectangular field of view, a phased array (producing a sector scan), or a mechanically activated sector scanner. Sector scanners are favoured for early pregnancy ultrasonography and for gynaecology because they require only a small "acoustic window" into the body, while linear arrays are preferred for later pregnancies because they provide a more complete image of near structures.

A major factor in determining the suitability of a duplex machine for a given application is the question of whether the same transducer is used for imaging and for the Doppler examination. Unfortunately the requirements for imaging a vessel and for obtaining good Doppler signals from it are not compatible. To image a vessel well, the interrogating ultrasound beam must strike it at approximately right angles; to obtain good Doppler signals, the beam should strike the vessel at an angle well away from 90° , preferably in the range $30-60^{\circ}$. A scanner which uses the same transducer for imaging and for Doppler (the most common duplex configuration) obviously cannot simultaneously satisfy both these requirements (figure 3.6a).

For this reason alternative configurations have been developed. The method described by Eik-nes et al, (1980a) uses a linear array, with a separate transducer attached to one end at a fixed angle for the Doppler measurement

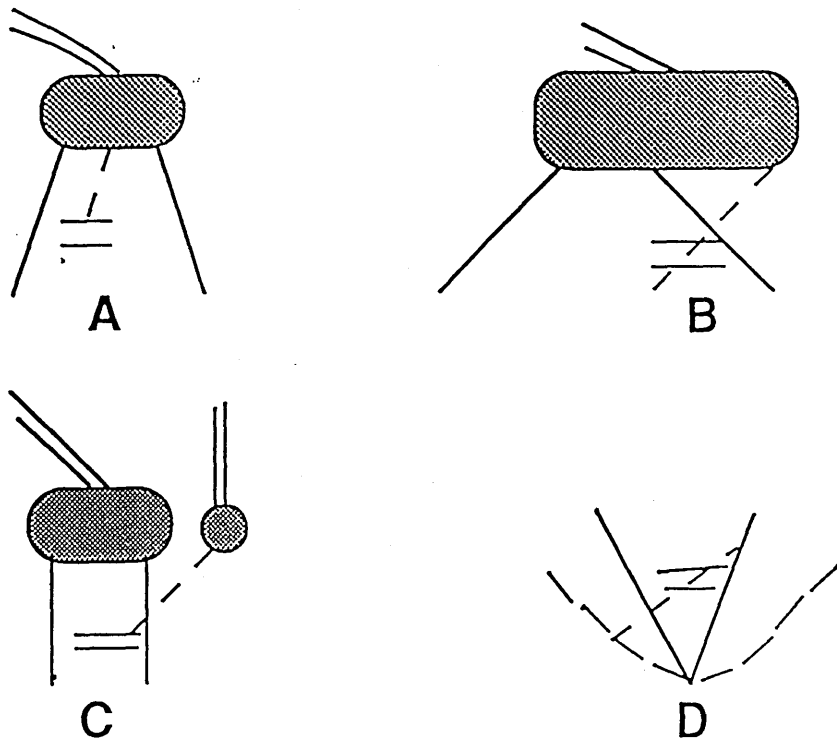

Figure 3.6

Duplex scanner configurations

A) Sector scanner using the same transducer for imaging and

Doppler

B) Sector scanner with separate

Doppler transducer

C) Linear array with separate

Doppler transducer

D) UI Octoson, where 8

transducers scan patient through

a water bath; any of the 8 can be

used for imaging or Doppler

(figure 3.6c). A similar arrangement has been developed using a sector scanner in place of the linear array, and with the Doppler transducer being steerable (figure 3.6b). The UI octoson (Gill, 1984) offers an unusual situation with any of its eight transducers being available for either imaging or Doppler measurement (figure 3.6d). Additional advantages of the multi-transducer approach is the ability to separately optimise the imaging and Doppler transducers (in terms of frequency of operation, beam width, etc), and the possibility of achieving simultaneous imaging and Doppler measurement. A disadvantage is the need to maintain registration of the Doppler beam with the imaging scan plane.

3.7 Doppler flow velocity waveforms

The blood velocity in an artery, and its time variation, results from many factors (Macdonald, 1974, O'Rourke, 1982). These include:

1. the "driving force", which is the pressure pulse in the artery resulting from each cardiac contraction.
2. the resistance to blood flow of the circulation supplied by the artery.
3. the elasticity of the vascular system.
4. the heart rate.

The different waveforms in the fetal and utero-placental circulations which are to be studied in this thesis are described below.

3.7.1 The fetal descending thoracic aortic waveform

The descending thoracic aortic waveform is biphasic and shows continuing forward flow during diastole with no reverse component (figure 3.7.1). This wave shape is similar to those encountered in the adult internal carotid and renal arteries and is typical of arterial supply to a low resistance peripheral vasculature.

3.7.2 The fetal inferior vena cava waveform

The fetal inferior vena cava waveform shows two distinct peaks, one during ventricular systole and the second during ventricular diastole (figure 3.7.2).

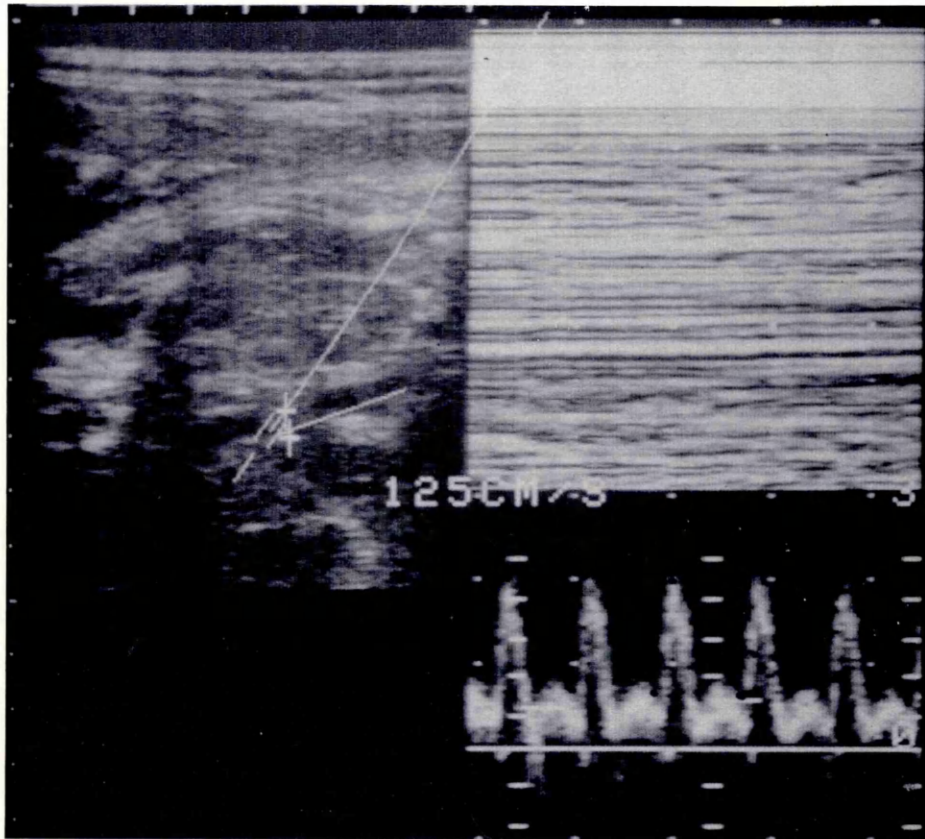

Figure 3.7.1
Fetal descending thoracic Aortic flow
velocity waveform (bottom right)
Real time display with cursor and sample
volume illustrated on left

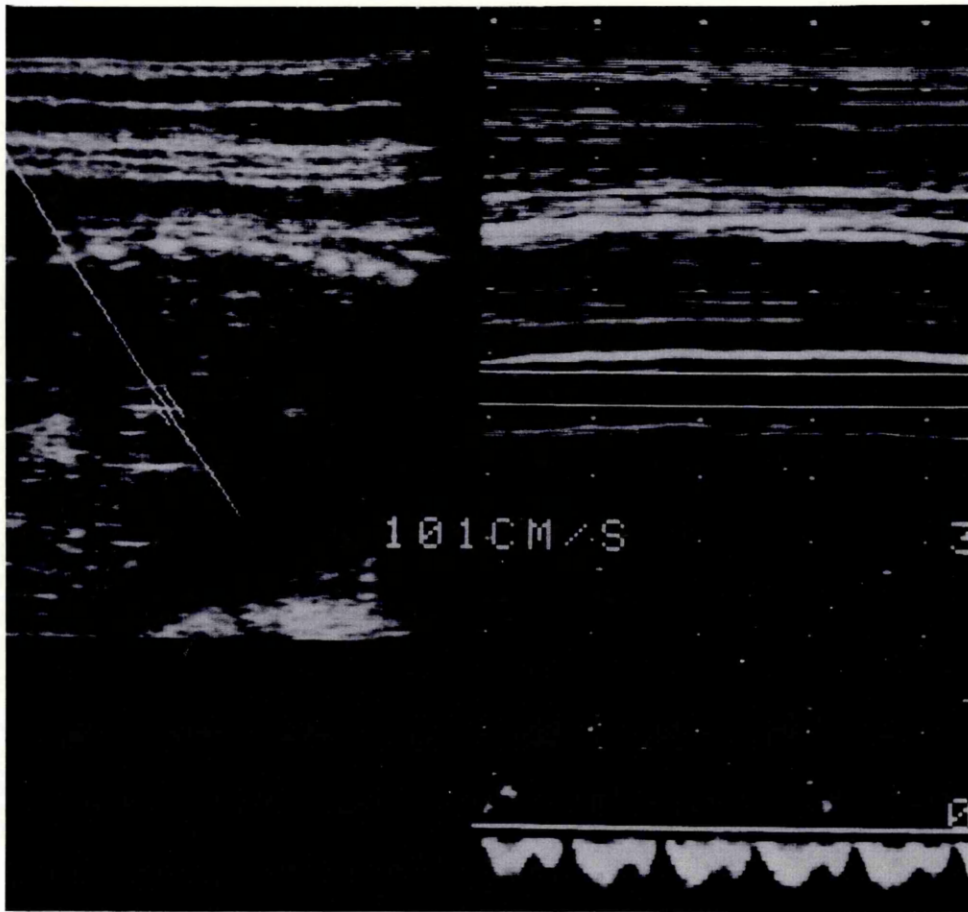

Figure 3.7.2
Fetal Inferior vena cava flow velocity
waveform (bottom right)
Real time display with cursor and sample
volume illustrated on left

The systolic wave begins immediately after an atrial contraction and peaks during ventricular systole. There is a decrease in flow into the right atrium towards the end of ventricular systole, just before the opening of the atrial ventricular valve. This decrease in flow results in a small dip in the Doppler sonogram. A second surge of blood flow occurs during ventricular diastole. It peaks slowly and then falls off again. (Reuss, 1983). The return to the baseline may be gradual or sharp and its variability depends on the length of diastole. Under normal physiological conditions, no reversal of flow is noted in the inferior vena cava.

3.7.3 The umbilical artery waveform

The waveform from this vessel is typically less pulsatile than waveforms obtained from the fetal aorta (figure 3.7.3).

3.7.4 The maternal "arcuate" artery waveform

The waveform from this vessel demonstrates low pulsatility and high diastolic velocity (figure 3.7.4).

3.8 Qualitative analysis of the Doppler waveform

As discussed in Chapter 5.4, most investigators perform frequency analysis (or spectrum analysis) of the required signals using a spectrum analyser. The result of this spectrum analysis is a display of all frequencies and hence of all velocities in the vessel under study as a function of time. The amplitude of the frequencies is represented by the intensity of the grey scale in the display of the spectrum. From this spectrum, the characteristics of its maximum envelope (maximum frequency (MAX) curve) can be generated: the maximum frequency (F max) or peak systolic flow velocity (A) or (S in this thesis), the mean frequency (F mean) and the lowest frequency (F low) or end diastolic flow velocity (B) or (D in this thesis). In this way, information of the fastest moving blood cells in the vessel (producing the highest Doppler frequency shifts) is obtained. Several indices, originally introduced to evaluate the pulsatility of the arterial waveforms of different vascular beds in adults (Gosling and King, 1974, Gosling, 1976), are used for the description of the flow velocity waveform (FVW): figure 3.8 illustrates the various indices that are derived from the

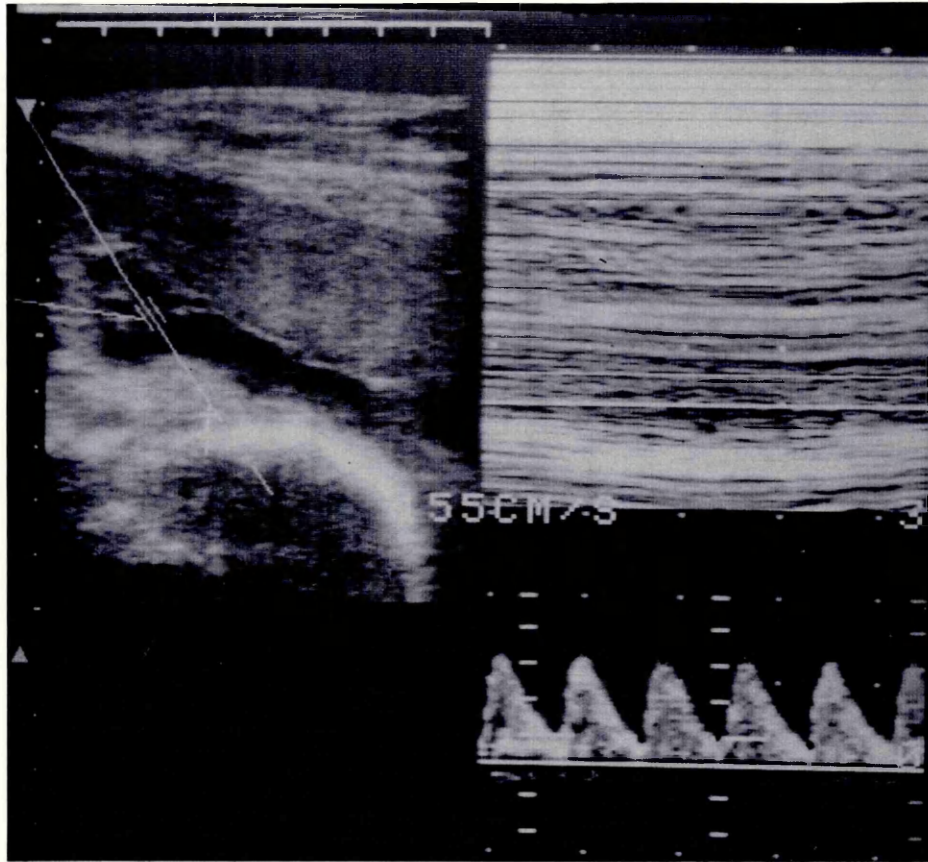

Figure 3.7.3
Umbilical artery flow velocity waveform
(bottom right)
Real time display with cursor and sample
volume illustrated on left

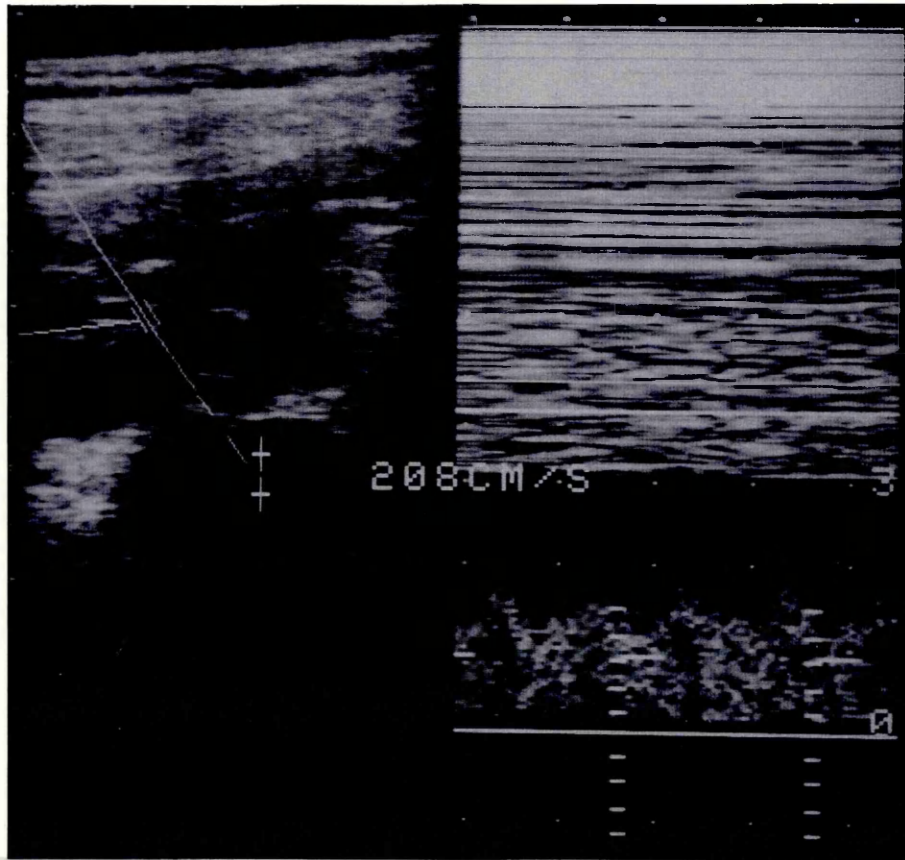
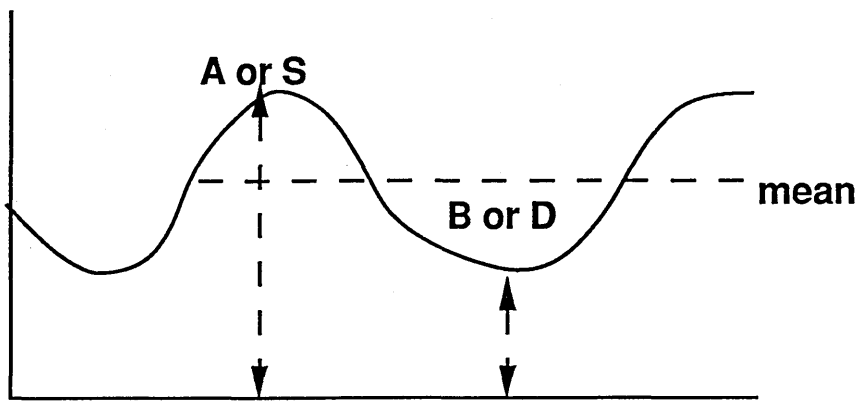

Figure 3.7.4
Utero-placental (arcuate) artery flow
velocity waveform (bottom right)
Real time display with cursor and sample
volume illustrated on left



$$A/B \text{ or } S/D \text{ ratio} = A/B \text{ or } S/D$$

$$\text{Resistance Index} = A-B / A$$

or

$$S-D / S$$

$$\text{Pulsatility Index} = A-B / \text{mean}$$

or

$$S-D / \text{mean}$$

Figure 3.8 Three indices of qualitative blood flow measurements

FVW; the A/B or S/D ratio (A/B or S/D) the Resistance Index ($RI = (S - D)/S$) and the Pulsatility Index ($PI = (S - D)/\text{mean}$). In addition to this, Campbell et al, (1983) have described the frequency index profile (FIP) as a way of constructing an angle independent nomogram for the waveforms. The FIP was initially constructed by measuring the height of the maximum frequency outline at 0.04 second intervals throughout the cardiac cycle. Each value was then divided by the mean of all the measured frequencies as a percentage of that mean. Since each of these indices is a ratio of two values taken from the same waveform, then they have the great advantage of being independent of the angle theta.

To calculate one or more of these indices for a given vessel, it is necessary only to obtain a Doppler signal from the vessel (using either CW or pulsed Doppler) and to display this signal as a waveform, generally using spectral analysis. The quantities needed for calculation of the index can then be measured from the display.

3.9 Quantitative analysis of Doppler waveforms

At present, duplex ultrasound offers the only non invasive method to measure the rate of blood flow (in mls per minute). The purpose of the circulation is to perfuse the various organs with blood at flow rate sufficient for their proper function. The basic problem in measuring flow is the variation of blood velocity across the vessel cross-section. Since the overall flow rate is the sum of contributions made by blood at every point on the vessel cross-section, it is necessary to average the velocity profile. Various approaches to the Doppler measurement of volume flow have been described (Gill, 1985). These can be broken into three groups, depending on whether the velocity profile is:

- (a) measured (using multigated pulsed Doppler) and then averaged
- (b) assumed to have a particular form (as in laminar or plugged flow) or
- (c) averaged by making the Doppler sample volume sufficiently large so that it encompasses the entire vessel cross-section.

Only this latter approach, termed "uniform insonation", is applicable to the relatively small and deep-lying vessels which are generally of interest (Gill, 1979). It therefore forms the basis of most Doppler systems used for fetal blood

flow measurement. The uniform insonation approach requires:

1. a large sample volume
2. accurate measurement of the mean Doppler shift
3. accurate estimation of the angle theta and the vessel cross-sectional area.

The influence of these factors is discussed in the next section. However, these criteria are not satisfied by conventional duplex scanners, which generally have narrow beams in order to achieve high spatial resolution. In addition, they do not generally take account of factors (such as thump filtering) which can significantly affect the estimation of the mean Doppler shift (Gill, 1979). In summary, waveform indices and volume flow measurements should not be seen simply as competing techniques for obtaining the same information. While volume flow measurement indicates the functional consequence, ie altered flow, of a change in the circulation, it cannot generally indicate what has caused the flow to change. On the other hand, waveform analysis can provide (albeit by inference) information about the mechanisms involved, but it cannot give a measure of the resulting alteration of the flow rate. The two techniques are thus complimentary, not competitive.

3.10 Technical factors influencing the Doppler flow velocity waveform

3.10.1 Measurement of the angle of insonation (theta)

As the Doppler shift is directly proportional to the cosine of the angle of insonation, this angle must be known with accuracy in order to determine the velocity. Errors in the estimation of the angle of insonation can be expected to be less than +/- 5 degrees. The smaller the angle of insonation, the smaller the error in estimating velocity. Angles greater than 85° will cause significant errors (more than 20%) in velocity calculation (Griffin et al, 1983).

3.10.2 The vessel wall "thump" filter

The recorded Doppler spectrum comprises not only the moving blood but also the pulsating vessel wall. Vessel wall motion is low in frequency, but is high in

intensity (Reneman, 1981), and, in order to remove the low frequency signals from the vessel wall, a high pass filter is generally used. Initial studies tended to use a filter of approximately 600 Hz, but this also removed low frequency Doppler shifted signal from red blood cells, resulting in serious miscalculation of the average Doppler shift, and filters of 150-200 Hz are now generally used (Griffin et al, 1983).

3.10.3 The sample volume

A satisfactory flow velocity waveform requires that the full range and distribution of the velocities within the lumen of the blood vessel are represented in the Doppler spectrum. It is essential, therefore, that the sample volume adequately covers the vessel, and that the beam width at operating depth should be of the same order (or greater) than the vessel diameter. In addition, flow should only be recorded from vessels (such as the descending thoracic aorta) in which there is no turbulence due to major vessel branches. The influence of the sample volume size can be seen in figure 3.10.3. When a small sample volume interrogates a region in the centre of the vessel, a relatively narrow Doppler spectrum results. When the sample volume covers the entire vessel, a much wider spectrum results.

If, for example, the velocity profile is parabolic, Doppler frequencies ranging from zero up to the maximum frequency are present with equal intensity. The advantage gained by using a large sample volume may be offset by the danger of including other moving structures. In particular, signals from the inferior vena cava may contaminate those from the fetal aorta. As the direction of flow in the inferior vena cava is opposite to that in the fetal aorta, the automatic analyser displays the signals from each vessel in opposite channels on the screen of the spectrum analyser. Recognition of this fact is important as it is possible to mistake the signal from the inferior vena cava for reverse flow in the aorta. The ability to demonstrate the signals from a vessel with flow in opposite directions is also useful in recording the signal from the umbilical artery. The waveform from the umbilical vein is displayed in the opposite channel to the umbilical artery and allows fetal breathing movements to be recognised by the distortions they cause in the umbilical vein .

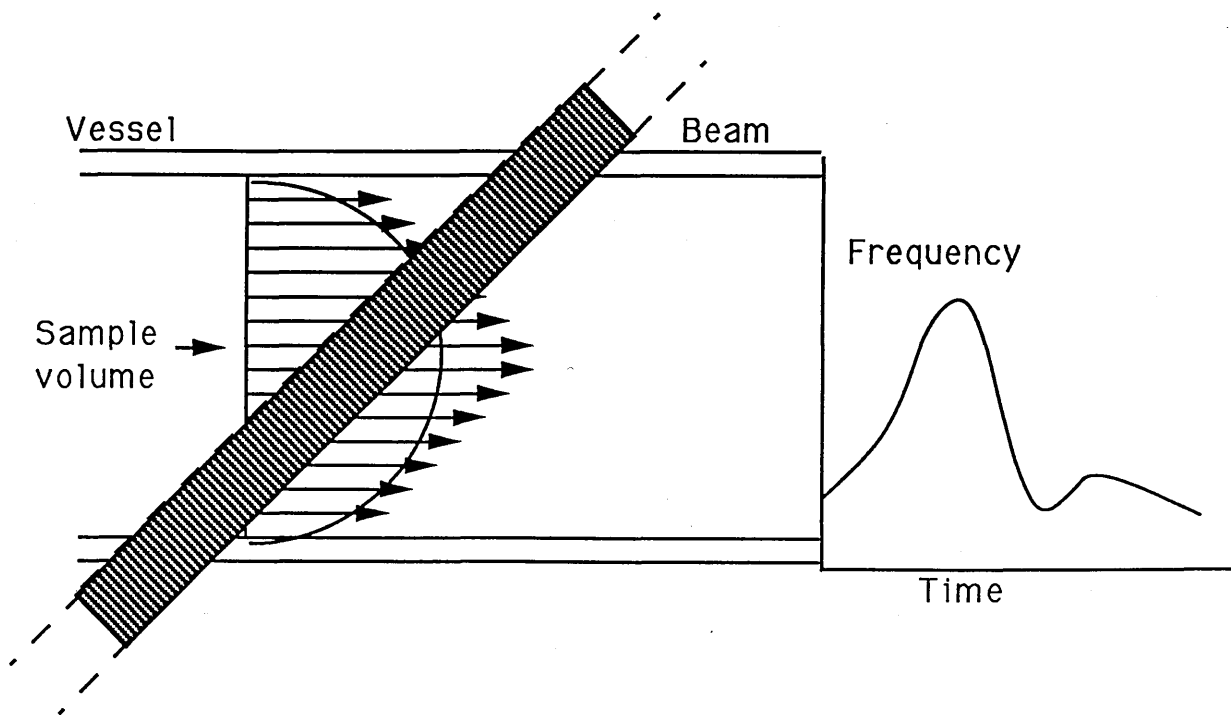
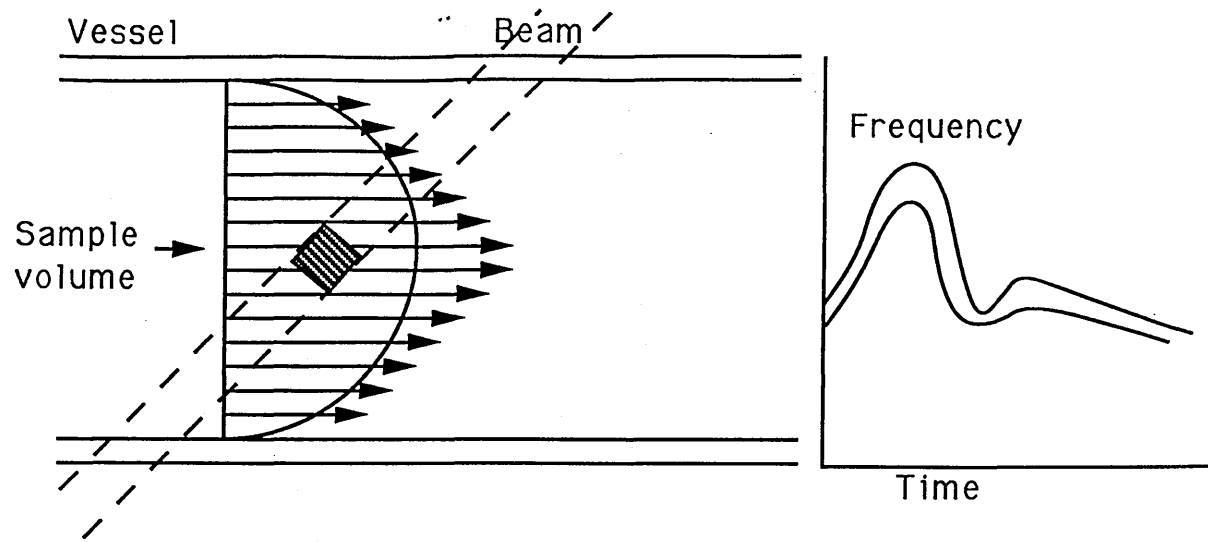

Figure 3.10.3
The effect of sample volume geometry on the Doppler spectrum

The influence of fetal breathing on the Doppler waveform is discussed below.

3.10.4 The vessel diameter and elasticity

The problems of measurement of the vessel wall diameter are largely due to the small size of the vessels relative to the resolution of the ultrasound calipers, which is approximately 0.5 mm. In addition, the arterial wall pulsates due to its elasticity and produces a change in diameter of about 15% through the cardiac cycle. Eik-Nes et al (1984) attempted to overcome this by taking the mean of 10 on-screen measurements of randomly frozen images. Alternatively, aortic diameter may be measured by use of M-mode (Griffin et al, 1983) or a time-distance recorder (Linstrom et al, 1977) connected to a real-time scanner. The time distance recorder has two markers which are positioned in front of the vessel wall echoes and then the recorder locks on to the outer wall and inner outlines and measures the pulsatile movements of the vessel wall. The aortic diameter is registered on a polygraph, and is usually averaged from 10 diastolic and systolic calculations (Eik-Nes et al, 1984).

Griffin et al (1983) and Eik-Nes et al (1984) calculated that errors in vessel diameter measurement will result in an approximate 10% error for blood flow measurements made in the third trimester (ie for a fetal aortic diameter of 6-9 mm) and a 25% error for recordings made in the first half of pregnancy (ie for a fetal aortic diameter of approximately 4 mm).

3.11 Safety aspects of obstetric ultrasound

Ultrasound has become an indispensable tool in diagnostic medicine. The question of possible adverse effects associated with the use of diagnostic ultrasound is as old as the technique itself. It is used extensively in obstetrics and the majority of infants in Europe are exposed in-utero to ultrasound. After more than a decade of follow-up, no epidemiological study showing any direct bio-effects have been reported. No-one can state with complete confidence, however, that it is innocuous. The study of the effects of ultrasound has been severely limited by the fact that it is rarely possible to know the amount of sound energy which was imparted to the biological system. Inconsistent methods have been used to characterise the beam and, surprisingly, it has not even been clear which

parameters should be measured.

3.12 Definition of acoustic output

Many parameters are used to describe acoustic output. There are two features of the ultrasonic field: firstly, the spatial intensity distribution and secondly, the temporal intensity variation.

3.12.1 Spatial intensity

The spatial average (SA) intensity is the average intensity across the area of the ultrasound beam. Since the area and spatial distribution vary with position and distance from the transducer, the SA measurement does not provide valid measurements of very high localised intensity. To overcome this, the spatial peak (SP) intensity may also be reported. The SP intensity is the maximum intensity either in the plane of the measurement or throughout the entire ultrasonic field depending on the measurement procedure.

3.12.2 Temporal intensity

Coupled with the spatial distribution, it is also important to have information about the relative amount of time that the ultrasound beam is turned on. Obviously in continuous wave (CW) equipment, the beam is always on. However, in pulsed equipment (both imaging and Doppler) the beam is on for only a small part of the pulsing cycle. Typically a pulsing rate of 1 kHz is used with a pulse length of 1 microsecond. Thus, the beam is only on for 1000th of the total time. The amount of time the beam is on is termed the duty factor (DF). Therefore, initial measurements that characterise the intensity in terms of temporal average (TA) were quite satisfactory for CW equipment but do not represent the whole picture for pulsed systems. It is possible to construct different pulsed systems that will have the same TA intensity output yet quite different SA or SP values. Thus, although the TA intensity represents the average intensity during the entire pulse cycle, it is necessary to have information about the temporal peak (TP) as well. The TP intensity is defined as the peak intensity occurring throughout pulse repetition cycle.

As can be readily appreciated, TP is generally 100 to 1000 times greater than

the TA value because of the limited beam-on time. Occasionally it is also of interest to know the pulse average (PA) intensity as well. The PA intensity is the average intensity during the time the beam is on. In principle, the PA and TP values should be the same or similar. Since pulse shaping circuits are used in modern ultrasound scanners, the PA intensity is usually less than the TP value. In practice, since both the spatial and temporal characteristics are important descriptions of ultrasonic fields, they are frequently combined together.

The following gives common groupings in ascending order of reported intensity.

- SATA - Spatial average temporal average
- SATP - Spatial average temporal peak
- SPTA - Spatial peak temporal average
- SPPA - Spatial peak pulse average
- SPTP - Spatial peak temporal peak

However, it should be noted that the definitions of some of these quantities differ in detail (Livett and Preston, 1985).

These parameters are useful in characterising the properties of an ultrasonic beam. However, the mechanism of propagation and absorption are still not well understood, particularly in cells and tissue. The concept of "ultrasound dose" while recognised as valuable, is still not well developed since many of the mechanisms are poorly understood or not known at all. Recent work is beginning to elucidate the mechanisms of interaction and more importantly the effects of those interactions, both macroscopic and microscopic. Therefore, for the assessment of the risk of thermal damage due to ultrasonic exposure, the relevant measures of exposure are power, intensity, time and duty cycle. Since ultrasound may interact with tissues by other mechanisms besides heat, however, it may in some circumstances be relevant to state the exposure conditions in terms of wave particle pressure, velocity or acceleration. Moreover, the radiation force of the wave may affect structure or function of the tissue (Dyson et al, 1974). The recognition of the importance of wave values other than power and intensity has recently focused attention on the physics of the propagation of sound waves through tissues and other media and in particular on the non-linear properties of some tissues (Bacon, 1984; Law et al, 1985).

3.12.3 Measurement of acoustic output

From a practical stand point, there are basically two types of measuring instruments:

- (a) those that measure total intensity (watts) and
- (b) those that measure quantities at a point such as the various intensities (watts cm^{-2}).

Total intensity for an imaging beam can be measured more accurately than point quantities and is frequently measured by means of a radiation force balance. Detectors which are small compared to the size of the beam, are needed to characterise the variations of intensity within the field, and to characterise the change in intensity with time as the pulse passes the measurement point. Miniature hydrophones are often used but require considerable care to calibrate. Standards of calibration and measurement are emerging but are not in widespread use. As a result, the beam characteristics are not always known or reproducible in many biological effect studies.

3.12.4 Data for Pulse-Echo ultrasound equipment

The results of four major surveys of the acoustic beam parameters characterising the pulsed ultrasonic fields from medical imaging equipment have been published (Hill, 1971; Carson et al, 1978; DHSS, 1979; Duck et al, 1985). These papers review the methods of measurement and, in particular, discuss the difficulties of defining conditions which adequately describe the outputs of systems with scanned beams (eg from realtime mechanical sector scanners, linear and phased arrays).

In the survey by Duck et al (1985), measurements were made on 12 single element transducers, 5 arrays and 6 sector scanners. There was a very wide range of maximum powers, pressures and intensities. Powers from 0.5-80 mW were measured; SATP positive pressures at the transducer lay between 30 kPa and 1.15 MPa and SPPA intensities were in the range 3.6×10^3 to 1.1×10^7 mW^{-2} .

3.12.5 Data for Duplex and Pulsed Doppler Equipment

In a report on the safety of diagnostic ultrasound edited by Wells (1987), a survey of the outputs of a total of 28 transducers operating in the pulsed Doppler mode and associated with three mechanical sector and two phased array Duplex scanners, the range of output values was not dramatically different from that of pulse echo imaging equipment.

3.12.6 Data for Continuous Wave Doppler Ultrasound Equipment

The report from Wells (1987) gives typical values for the ultrasonic fields of continuous wave systems. Doppler fetal heart detectors generally operate at lower levels than instruments designed for peripheral vascular applications. The ultrasonic frequency for obstetrics is typically 2-3 MHz, while that for the peripheral vasculature is 4.5-10 MHz.

3.12.7 Discussion

Some of the exposure conditions used in ultrasonic diagnosis range over several orders of magnitude, varying markedly according to the types and manufacturers of the different machines. However, the mean value of time averaged power is a little less than 10 mW for pulsed-echo systems and somewhat higher for Doppler applications, whether duplex, pulsed or continuous wave. It is the value of power which seems predominantly to determine the operating frequency which, in any given application, is usually chosen to be the maximum which allows the required penetration.

The description of the exposure conditions used in ultrasonic diagnosis is not simple. The concepts are complex and there is no general agreement as to what aspects of the ultrasonic field are critical in respect of the safety of diagnostic procedures and it seems likely that any agreements about this would have to be limited to particular hazards in specified examination conditions, if indeed it can be shown that such hazards ever exist in clinical practice.

3.13 Potential risks of obstetric ultrasound to the fetus

Ultrasound is a form of radiation in which pressure waves are propagated through tissue. This oscillating pressure causes displacement of the particles of the medium in which energy is transferred. Pressure, compression, stress (elastic and viscous), expansion, acceleration, velocity, tension and shearing are all associated with the passage of sound through tissue. Biological changes may be produced by one or a combination of these parameters. Usually, effects on biological systems are classified in two categories: thermal and non-thermal (Williams, 1983).

3.13.1 Thermal effects

Thermal effects are those changes in a biological system induced by a rise in temperature. Temperature changes extensive enough to be measured in tissue (a few degrees celsius) have been detected in experimental animals exposed to diathermy and continuous wave ultrasound. Several biological effects are, thus far, best explained by such a thermal mechanism. Diathermy, the purposeful deep heating of tissue, is a clear example of a bulk thermal process. Several models predict that very large temperature changes over very short distances are produced by pulsed sound in which the change in pressure (rise in time of the pulse) is rapid. These local phenomena could reach temperatures as high as 10,000 degrees centigrade. By and large, diagnostic ultrasound is applied at low intensity levels (Duck et al, 1985) and is far too low to cause measurable temperature elevation in tissues. A recent publication by Soothill et al (1987) failed to demonstrate any temperature rise in either amniotic fluid or fetal tissues during sector, linear array or Doppler ultrasound exposure.

3.13.2 Non-thermal effects

When an ultrasonic field impinges on an object with a different acoustic impedance than its surroundings, a force or torque will be exerted on the object causing it to translate or rotate. This principle is used to measure acoustic output or intensity by a radiation force balance. Cytoplasmic flow and spinning

of inter and intra-cellular objects have been reported. Acoustic microstreaming has been credited with membrane disruption at high intensity levels. Cavitation is the production of bubbles or cavities during the compression and rarefaction phases of the wave. This can result in transient (collapse) or stable (non-collapse) cavitation, neither of which are well understood. Cavitation is a complex phenomenon which has potential for creating considerable damage in complex media-like tissue. The collapse of a cavity concentrates all of the kinetic energy into an extremely small volume resulting in very high localised pressure and temperatures. Bubbles which may already be present in the medium can undergo violent expansion and compression, particularly when struck by a pulsed beam. Cavitation induced free radicals have been demonstrated in tissue and have been associated with cell damage *in vitro*. Although, in principle, transient cavitation can occur with microsecond length pulses of ultrasound (Flynn, 1982; Apfel, 1982, 1986), it is not clear at this time whether the appropriate conditions exist in the human body.

Neither stable nor transient cavitation can be ruled out as mechanisms for biological effects under the conditions of diagnostic ultrasound. On the one hand, with the short, isolated pulses used in imaging where temporal average intensity is low but temporal maximum intensities may exceed $1,000 \text{ Watts cm}^{-2}$, a transient cavitation may occur in principle. However, under those circumstances, stable cavitation and its characteristic associated phenomena have little meaning. For information of direct relevance to imaging conditions and for information about biological effects of transient cavitation, we must look to experiments conducted with low temporal average intensity pulsed ultrasound. On the other hand, there are a few pulsed Doppler devices with high pulse repetition frequencies and with large pressure amplitudes which, in principle could produce both stable and transient cavitation. In any case, this phenomenon has not yet been observed under the exposure conditions used in pulsed ultrasound at diagnostic levels (Hill and Ter Haar, 1982).

3.13.3 Biological effects

The most direct evidence of risk would be that obtained from human experience. A few epidemiological studies have been conducted, principally for *in utero*

exposure, but the results are inconclusive. (Stewart et al, 1985; Scheidt et al 1978; Williams, 1983). Some of the shortcomings of these studies include inadequate ultrasound dosimetry measurements, non-clinically relevant exposure conditions and few independently verified findings.

Direct effects on biomolecules such as proteins and nucleic acids have been shown at very high intensities and are usually attributed to cavitation. These effects are very difficult to study but likely underlie the more general effects seen in cells. Mammalian cells on culture have been shown to be affected by ultrasound; including cell lysis, inactivation, altered growth and physiology, altered ultra-structure and chromosomal changes. (Harvie et al, 1975; Hrazdira, 1980; Webster et al, 1978). Hrazdira (1980) states, however, that these alterations are non-specific and may also result from exposure to other physical or chemical agents.

The possibility of teratogenic effects from ultrasound has been studied for more than 30 years. (Hollander, 1972; Sunden, 1964). Therapeutic ultrasound was the first modality to be investigated, with experimental animals exposed to intensities of 0.5-5.0 Watts cm⁻² at frequencies of 0.8-1 MHz. On the whole, these experiments did not provide evidence of teratogenicity. While there were a few reports of increased rates of abortion and fetal resorption, these could be satisfactorily explained on the basis of local hyperthermia.

With the advent of diagnostic ultrasound, investigations were done using pulsed Doppler ultrasound of higher frequency, but no adverse effects of any kind were demonstrated (Hollander, 1972; Sunden, 1964). However, when continuous ultrasound was applied in the same frequency range, increased rates of malformations, fetal resorption and low birth weight were recorded at intensities exceeding 1 Watts cm⁻². The observed dependence of these effects on the length of exposure (Mannor et al, 1972) points to hyperthermia as the most probable teratogenic mechanism. This is further supported by the findings of Hara (1980), who measured the rectal temperature of gravid mice exposed to ultrasound. When the body temperature rose above 41°C, there was a rise in the incidence of facial clefts, skeletal anomalies, and neural tube defects. The same malformations have been observed in hyperthermia experiments without ultrasound (Hellmann, 1980).

Besides animal experiments, several studies have been done in which the physical and mental development of children exposed to ultrasound *in utero* was followed for up to 3 years postpartum (Bernstine, 1969; Hellman et al, 1970; Koranyi et al, 1972). In the study of Hellman et al (1970), the data from diagnostic ultrasonic imaging studies of 1114 apparently normal pregnancies in Glasgow, Lund and New York were pooled. The incidence of fetal abnormalities in the irradiated group was 2.7%; in a separate and unmatched survey of women who had not had ultrasound diagnosis, the corresponding figure was 4.8%.

Two recent publications (Bakketeig et al, 1984; Neilson et al, 1984) have described trials aimed primarily at determining the benefit, from the point of view of clinical outcome, of ultrasonic screening in pregnancy. Neither trial revealed any evidence of deleterious effects due to ultrasonic exposure.

Kinnier-Wilson and Waterhouse (1984) investigated the possible contribution of obstetric ultrasound exposure to the risk of subsequent occurrence of childhood malignancies. Exposure to ultrasound *in utero* did not appear to increase the risk of cancer and leukaemia between birth and the sixth year of life.

In the report by the British Institute of Radiology Working Group (Wells, 1987), the conclusions were that the available evidence of ultrasound bioeffects is a picture of confusion. The main criticisms were that the experimental end points were markedly different and that not enough account has been taken to search for and eliminate possible sources of artefact. The report also concluded that the database is woefully inadequate especially with regard to the effects which could be produced by short pulses of intense ultrasound. The report suggested that, from a clinical diagnosis point of view, it is imperative that experiments should be carried out urgently to collect the necessary relevant data, especially from human subjects.

3.14 Recommendations for the use of ultrasound in clinical obstetrics

The state of knowledge concerning ultrasound bio-effects is analogous to that of early radiology. The beneficial results from its use demand that it be applied before toxicity data are complete. Sufficient research has not been done to draw conclusions, and the results, especially recent ones, deserve further

investigation.

The American Institute of Ultrasound in Medicine (1981) has endorsed the following statements on mammalian biological effects:

"in the low mHz frequency range there have been no independently confirmed significant biological effects in mammalian tissues exposed to intensities (SPTA) below 100 mW cm^{-2} . Furthermore, for ultrasonic exposure times (total time less than 500 seconds and greater than 1 second), such effects have not been demonstrated even at higher intensities, when the product of intensity (SPTA) and exposure times is less than $50 \text{ joules cm}^{-2}$."

This statement was reaffirmed in 1982.

The question of ultrasound safety, especially with respect to the fetus, will be with us for a long time. Given its known benefits and recognised efficacy for medical diagnosis, including use during human pregnancy, the American Institute of Ultrasound in Medicine (1983) has published the following statement on clinical safety:

"no confirmed biological effects on patients or instrument operators caused by exposure at intensities typical of present diagnostic ultrasound instruments have ever been reported. Although the possibility exists that such biological effects may be identified in the future, current data indicates that the benefits to patients of the prudent use of diagnostic ultrasound outweighs the risks, if any, that may be present."

The Royal College of Obstetricians and Gynaecologists issued a report of a Working Party in 1984. The report concluded that the present evidence for the safety of ultrasound is sufficiently convincing not to recommend a change in the current common United Kingdom practice of routine ultrasound examination between 16 and 18 weeks of pregnancy.

CHAPTER 4
FETAL AND UTERO PLACENTAL
BLOOD FLOW:
ULTRASONIC STUDIES

4.1 The application of Doppler ultrasound to study fetal and placental blood flow velocity

The Doppler principle was found to hold true for ultrasound waves and Paul Langevin's work formed the basis of the sonar (Sound, Navigation and Ranging) systems that played a crucial part in detecting submerged submarines during the Second World War (White, 1976). The earliest recorded medical application of Doppler ultrasound was by Satomura in 1956. He first realised that red blood cells can reflect ultrasound waves that are subject to a change in frequency in accordance with the Doppler effect (Satomura, 1956). His work and that of the earlier investigators who used Doppler equipment, applied the Doppler effect to adult cardiology initially to detect adult cardiac activity (Satomura, 1956) and then to investigate blood flow in peripheral vessels (Satomura, 1959).

Doppler scanners detect changes in ultrasound frequency. In obstetrics and gynaecology, Doppler ultrasound has been used to confirm fetal viability by detecting fetal heart movements since 1964 (Callaghan et al, 1964) and as a method of monitoring fetal heart rate changes antepartum and in labour for almost 3 decades (Hon, 1958). The technique has also been used to study fetal breathing movements (Boyce et al, 1976; McDicken et al 1979).

4.2 Doppler ultrasound measurement of umbilical venous flow

Umbilical vein blood flow was first measured using pulsed Doppler ultrasound by Gill in 1979. Since then, a large number of reports have been published in normal (Table I) as well as in complicated pregnancies. These measurements were performed in the intra-abdominal part of the umbilical vein and flow data was expressed in mls per minute per kg fetal body weight.

From Table I, it can be seen that the data of the different centres are in reasonable agreement; in normal human pregnancy, umbilical venous blood flow is fairly constant (± 100 mls per minute per kg), with a slight decrease in blood flow at the end of pregnancy. Thus, despite the use of different equipment

Author	number of patients	weeks of gestation	blood flow (mls per min per kg)
Gill (1979)	12	25-40 wks	range: 80-129
Gill and Kossoff (1979)	12	25-40 wks	103
Gill et al. (1980)	50	28-38 wks	100
Gill et al. (1981, 1984)	47,118	38-40 wks	gradual decrease till 90
		26-35 wks	120 (average)
		36-40 wks	90 (average)
Eik-Nes et al. (1980a, 1980b)	20	32-41 wks	110 +/- 5.8 (SEM)
Eik-Nes et al. (1981)	27	28 wks	115 ± 6.9 (SEM)
Jouppilla et al. (1981)	?	28 wks	108-113
Rajhvajn and Kurjak (1981)	56	28 wks	109
Kurjak and Rajhvajn (1982)	63	28 wks	107
Griffin et al. (1983, 1985)	45	28 wks	122 +/- 42
v. Lierde et al. (1984)	20	28 wks	117 +/- 16
Rasmussen et al. (1984)	5	?	138 +/- 32
Erskine and Fitchie (1985a)	15	28 wks	125 +/- 62
Lingman and Marsal (1986b)	21	27-36 wks	114.8 +/- 42.6
		37-38 wks	76.3 +/- 24.6
		39-40 wks	65.2 +/- 14.2
Gerson et al. (1987)	209	20 wks	153
		30 wks	131
		40 wks	108

Table 1 Normal values of umbilical venous blood flow in human pregnancy as reported in the literature

with different thump filter settings, the results obtained for umbilical venous flow in normal pregnancy are in close agreement with the classic work of Assali et al (1960) who used a magnetic cuff to detect umbilical blood flow of 100 mls per minute per kg in early human pregnancy.

Chiba et al (1985) studied the umbilical venous flow in relation to fetal breathing movements, and found an increase of flow during inspiration. Marsal et al (1984) however, demonstrated the opposite phenomenon. Hence, it is important to perform blood flow measurements during fetal apnoea. This is the method which was adopted in the studies of this thesis.

With regard to the measurements in complicated pregnancies, a diminished blood flow in the umbilical vein was reported in cases of intrauterine growth retardation (IUGR) (Gill et al, 1980, 1984; Kurjak and Rajhvajn, 1982; Kirkinen and Jouppila, 1983a; Rasmussen et al, 1984; Giles et al, 1986a; Laurin et al, 1987a). The problem with any study looking at detection of IUGR is that the definition of IUGR varies from study to study. Also, the Doppler criteria classified as abnormal varies between studies. Benson and Doubilet (1988) reviewed two studies (Gill, 1984; Giles, 1986a) which fitted specific criteria using the umbilical vein Doppler flow waveform to detect IUGR. It was found that umbilical vein Doppler had slightly higher positive predictive values of IUGR (28-42%) than the uterine arcuate waveform but less than that of the umbilical arterial waveform.

In pregnancies complicated by severe Rhesus iso-immunisation, maternal anaemia and uterine bleeding (especially before the 34th week) an increase in blood flow in the umbilical vein was found (Kirkinen et al, 1983; Jouppila and Kirkinen, 1984b). Umbilical venous blood flow was also measured in pregnancies with chronic fetal hypoxia; all recordings during the last 12 hours before delivery showed pathologically low flow values (mainly due to narrowing of the umbilical vein (Jouppila and Kirkinen, 1984a). This narrowing was so extreme in four patients that exact measurement of the diameter was impossible. Methodological errors could have been responsible for failure to achieve a measurement of the vein, although a similar result has been demonstrated in a

sheep fetus (Parer, 1980).

Jouppila et al (1983) studied also the immediate effect of maternal smoking of one cigarette on blood flow in the umbilical vein; the measured changes after maternal smoking were insignificant. The effect of maternal smoking on the fetal aortic Doppler waveform is discussed later in this chapter and also in chapter 9. In cases of fetal heart arrhythmias, the umbilical venous blood flow remained in the normal range (Lingman et al, 1984). The influence of fetal cardiac arrhythmias on the aortic waveform is discussed later in this chapter.

4.3 Umbilical artery blood flow velocity waveform analysis

4.3.1 Introductory remarks

In view of the problems experienced in the use of quantitative analysis of Doppler blood flow, different methods which are less dependent on the above mentioned factors and would also provide accurate information on fetal haemodynamics have been studied. This has led to the analysis of the blood flow velocity waveform (FVW) of the umbilical artery (and other fetal vessels) with the use of angle independent parameters. Since the first publications on FVW analysis of the umbilical artery (Fitzgerald and Drumm, 1977; McCallum et al, 1978), numerous reports on the evaluation of this new technique have been published.

4.3.2 Normal pregnancy and labour

The normal umbilical artery waveform is described in Chapter 3.7.3. In normal pregnancy, the umbilical artery FVW is characterised by high end diastolic flow velocity relative to peak systolic flow velocity throughout gestation. In all studies, a relative increase of the end diastolic velocity and therefore a decline of the calculated indices is found, suggesting decrease in resistance in the placental bed with advancing gestational age. The results in normal pregnancy as reported in the literature are summarised in Table II. The umbilical circulatory system has been the most widely investigated component of the fetal circulation. Its application to the study of pathological pregnancy has also been widespread and preliminary experience indicates that the indices measured from the umbilical

Author	number of patients	weeks of gestation	FVW index	normal mean values
McCallum et al. (1978)	34	20-40	PI	1.5-0.6
Stuart et al. (1980)	18	16-40	A/B	6.4-2.1
Arbeille et al. (1983)	50	10-40	RI	0.9-0.6
FitzGerald et al. (1984)	128	16-40	PI	0.8-0.55
Reuwer et al. (1984b)	23	16-40	PI	2.8-0.65
Reuwer (1986)	75	24-40	PI	1.34-0.7
Schulman et al. (1984)	89	25-41	S/D	2.8-2.2
Trudinger et al. (1985a)	15	28-40	A/B	3.2-2.1
Fleischer et al.(1985)	?	24-42	S/D	3.2-2.1
Thompson et al. (1985,1986a)	12	29-40	A/B	3.5-2.2
			RI	0.68-0.53
			PI	1.1-0.75
Erskine and Ritchie(1985b)	15	16-40	A/B	0.5-0.25
			RI	0.8-0.55
			PI	1.4-0.8
Wladimiroff et al. (1987)	156	26-39	PI	1.19-0.8
Van Vugt et al.(1987)	27	18-40	A/B	3.4-2.3
			RI	0.7-0.55
			PI	1.24-0.83
Al-Ghazali et al.(1988)	271	16-42	A/B	4.5-2.5
Thompson et al.(1988)	35	20-40	A/B	3.9-2.2
			RI	0.75-0.52
Mulders (thesis,1988)	41	18-38	A/B	3.59-2.22
			PI	1.27-0.83

Table II Normal values of umbilical artery FVW indices in human pregnancy as reported in the literature

artery FVW may reliably predict perinatal compromise in certain high risk pregnancies (Trudinger, 1987b). However, caution should be exercised in interpreting any changes in the Doppler index values because they not only reflect variations in the haemodynamic state in the fetal placental circulation, but also contain information related to the measurement technique. The latter represents the error component of the variance of the Doppler data. This was first described by Thompson et al (1986a and b) who introduced other parameters to describe the Doppler waveforms. They described waveform parameters which take fetal cardiac performance into account (eg the relative flow rate index, R, which measures the ratio of the average flow before the systolic peak to the average flow during the remainder of the cardiac cycle), possibly provide additional information about fetal well being. The same group also studied the umbilical artery FVW indices as derived from the mean velocity and the first moment waveforms (Thompson et al, 1986b). Their results showed that it is preferable to use the maximum velocity waveform, as was done in this thesis.

Reuwer et al (1984a) first demonstrated that the umbilical artery pulsatility index (PI) was reproducible within and between observers. The same group (Reuwer et al, 1986) studied in a mathematical model the haemodynamic factors determining the PI; biological PI variations on a minute by minute basis are caused by short term variations in blood pressure pulsatility. More recently, Maulik et al (1989) examined the components of variability of the umbilical artery Doppler FVW in a prospective study of 308 normal pregnancies. They found that gestational age and fetal heart rate contributed to 33-46% and 15-18% of the variance respectively. The location of the Doppler measurement contributed to 29-46% of the error variance. A study of the variability of Doppler recordings at different sites of the umbilical artery is presented in Chapter 6. The study by Maulik et al (1989) also showed the inter observer and intra observer variance amounted to 10-14% and 5-9% respectively. The proportion of variance accounted for by gestational age is not surprising but gives important information. It is interesting to note that the intra and inter

observer variance was lowest for the umbilical artery S/D ratio compared to the other indices. Their study can be criticised in terms of the equipment used. Two types of Doppler systems and three different transducers were used in the study. Since the equipment used to obtain the waveforms was different between the two systems used and since the type of instrumentation itself may account for variance, a study design that has precise instrument control would seem desirable. In this thesis, all studies, except that concerning the effect of antihypertensive therapy were carried out using the same pulsed Doppler equipment which had previously been calibrated in the laboratory.

When assessing the results of a Doppler flow velocity waveform, the variation and reproducibility of the Doppler indices is crucial before applying the results of the test into clinical practice. In one such study examining the influence of daily variability of the Doppler flow velocity waveforms from the umbilical artery and utero-placental circulation (Hastie et al, 1988), no significant changes in the S/D ratio or the pulsatility index in either vessel was seen over a 7 day study period. Schulman et al (1984) reported an average error of 6% in 80 randomly selected umbilical artery S/D ratio readings in 20 women at different gestational ages. Fitzgerald et al (1984), examining the same artery but analysing the PI and another waveform index, the angle of acceleration, found no significant differences in recordings taken from 17 subjects within 30-60 minutes. Pearce et al (1988) studied the variation in indices from the utero-placental arteries, the fetal aorta and umbilical arteries, over a 24-hour period, before and after meals and performed by different observers; they found no significant differences in values. Further reports (Murrills et al, 1987) have reported up to 12.1% interobserver variation and up to 10.9% interobserver variation for a single subject in the umbilical artery.

The umbilical artery FVW has also been studied in relation to fetal behavioural states in normal pregnancy as well as in the growth retarded fetus (Van Eyck et al, 1987, 1988) at 37-38 weeks of gestation; in both studies a behavioural state independency of umbilical artery PI was found. This group have so far been the only investigators to examine fetal behavioural states, which are technically

complex to perform and thus of limited clinical value.

The relation between fetal umbilical artery flow velocimetry and postterm pregnancy was studied by Guidetti et al (1987); comparisons of the FVWs for the neonates with and without complications associated with postmaturity showed no significant differences. They concluded that the method was unlikely to be useful for the routine antenatal assessment of the condition of the postterm fetus. Stuart et al (1981) demonstrated that the fetal placental vascular dynamics (as studied by umbilical artery FVWs) were not altered in any significant way by the events of normal labour (uterine contractions, artificial rupture of membranes, oxytocin infusion or epidural anaesthesia) in healthy patients nursed in the lateral position. In a more recent study, Fairlie et al (1989) also examined umbilical artery FVWs in labour. They agreed with the findings of Stuart et al (1981) but did find elevations of umbilical artery PI in patients who developed abnormal labour but failed to show a correlation between umbilical artery PI and umbilical cord gases. Feinkind et al (1989) performed a screening study of both uterine artery and umbilical artery in 273 random labouring patients and compared the results to traditional electronic fetal heart rate monitoring. Despite showing significant associations between umbilical artery S/D ratios and fetal distress, 5-minute Apgar scores, the need for intubation and umbilical arterial cord PH and base excess, this study did not control for labour abnormalities, types of sedation in labour, which are known to have an effect on the umbilical artery FVW (Fairlie et al, 1989).

Marx et al (1986) demonstrated that the umbilical artery S/D ratios in the fetuses of healthy parturients were significantly higher with the mother in the supine than in either lateral position, thus indicating that umbilical artery vascular resistance is increased when the mother lies supine. This stresses the need to nurse patients in the left lateral position when in labour and that when performing any Doppler studies, the patient's position should remain the same during each examination. This was adhered to during the work performed in both the human and animal studies of this thesis.

4.3.3 Placental resistance

As described in Chapter 2.2, in normal pregnancy, trophoblast invasion converts the small muscular spiral arteries into wide flaccid lower resistance "utero placental arteries" by replacing the muscular elastic tissue of the latter by fibrinoid material (Brosens et al, 1967). These "physiological" changes occur in two stages and normally involve every spiral artery. During the first trimester, conversion of the decidual segments of the spiral artery takes place and, in the second trimester a second wave of trophoblastic invasion occurs with conversion of the myometrial segments (Robertson et al, 1975; Pijnenborg et al, 1983). These resulting utero placental arteries offer little resistance to the flow of blood from the radial vessels to the intervillous space (Figure 2.2). Pregnancies complicated by fetal growth retardation and/or pregnancy induced hypertension are associated with impaired blood supply to the fetal placental unit (Browne and Veale, 1953; Wanell et al, 1979, 1982). A plausible morphological explanation for the reduced blood supply was the observation by Brosens et al (1972) that, in pregnancy induced hypertension and in a proportion of patients with a growth retarded fetus, physiological changes were restricted to the decidual segments of the utero placental arteries. More recently, Khong et al (1986) found complete absence of physiological changes throughout the entire length of some spiral arteries in some pregnancies complicated by hypertension and fetal growth retardation. It has also been suggested that these pregnancies may be associated with the formation of significantly fewer than the normal number of utero placental arteries (Robertson et al, 1985).

As regards Doppler blood flow studies and placental resistance, in most studies the flow pattern of the umbilical artery is said to reflect particularly the low resistance downstream to the studied artery, ie the fetal placental bed. Giles et al (1985a) studied human placental microvascular anatomy in relation to the antenatal assessment of the umbilical circulation; the small muscular arterial vessel count in the tertiary stem villi was shown to be significantly less in the group with the high fetal risk and high A/B ratio as compared with the normal

group, demonstrating that umbilical artery FVW analysis identifies a specific microvascular lesion in the placenta. Also, McCowan et al (1987b) studied the relationship between the umbilical artery FVW and histological examination of the placenta; a highly significant negative relationship was found between PI and mean small arterial vessel count in the tertiary stem villi, suggesting that obliteration of the small placental arteries may be the explanation for elevated umbilical artery PIs. These results are somewhat surprising since Fox in 1976 did not find consistent pathological changes on the fetal side of the placental circulation in pregnancies complicated by hypertension or fetal growth retardation.

The suggestion that Doppler FVWs can be directly correlated with placental vascular abnormalities must be viewed with caution. Histological appearances in a placental biopsy may not be representative of the remainder of the utero placental circulation. Also, it is unlikely that an area examined microscopically includes the vessels studied by Doppler ultrasound. Pearce (1987) postulated that impaired utero placental perfusion might lead to thrombosis of tertiary stem arterioles resulting in increased placental resistance and shunting of blood towards the fetal brain, heart and adrenals. However, he concluded that, as yet, there was no evidence to support this sequence of events.

As it is known that pregnancies complicated by pre-eclampsia or IUGR or both can be associated with increased blood viscosity (Matthews, 1974; Kaibara et al, 1981; Buchan, 1982; Hobbs et al, 1982; Thorburn et al, 1982), several workers have attempted to look at the influence of blood viscosity on the Doppler FVW. Giles et al (1986b) tried to find an association between whole blood viscosity determined in the umbilical cord and umbilical FVWs; an abnormal pattern of the FVW (elevated A/B ratio) was associated with an increase in whole blood viscosity at high shear; while no correlation with viscosity at low shear was found. It is difficult to be certain of the significance of these results since the control group also included six patients who delivered preterm and the cord bloods were collected post delivery without any account being taken of the type of labour the patient experienced. In a more recent study, Steel et al (1989)

perform a similar study and found a significant correlation between plasma viscosity and gestational age and the resistance index used to characterise the umbilical FVW. However, they failed to show any correlation between whole blood viscosity and resistance index. They speculated that, although the correlation between resistance index and plasma viscosity was demonstrated, they felt it was unlikely to be of any clinical significance.

In order to get more insight to the relationship between the umbilical artery FVW and the fetal placental resistance, Trudinger et al (1987a) and Morrow (1988) studied the effect of placental embolisation (from the fetal side) on umbilical FVWs in the fetal lamb using microspheres; a good correlation was found between progressive embolisation and an increase of the umbilical artery S/D ratio. These studies had similar results to an earlier study by Clapp et al (1980) who embolised the uterine circulation of pregnant sheep with microspheres and managed to produce a rapid increase in umbilical artery resistance if fetal growth retardation were to result later.

4.3.4 Pathological pregnancy

The clinical areas in which Doppler may be most likely to show benefit are in identifying or predicting fetal growth retardation, determining pathophysiology when a fetus has already been identified as small for dates, assessing fetal well being and to investigate the effects of vasoactive drugs.

Characteristic changes in the FVW, ie a diminished end diastolic flow velocity, have been described in combination with IUGR (Fitzgerald et al, 1984; Reuwer et al, 1984b; Schulman et al, 1984; Erskine and Ritchie, 1985b; Fleischer et al, 1985; Trudinger et al, 1985b; Arduini et al, 1987b; Rochelson et al, 1987; Van Vugt et al, 1987; Wladimiroff et al, 1987). Comparison between these reports is difficult because of varying diagnostic criteria, and selection of patients, but reviews of the available data (Neilson and Whittle, 1987; Benson and Doubilet, 1988) suggest that fetal measurements with diagnostic ultrasound give better prediction of perinatal outcome. This is supported by a further study which compared a single measurement of the fetal abdominal circumference and

Doppler studies of the umbilical and arcuate arteries (Chambers et al, 1989). These authors found that abdominal circumference measurement gave the best prediction of the small for gestational age infant with a sensitivity of 73% compared to a sensitivity for the umbilical artery of 47%. The umbilical artery resistance index, however, did give the best prediction of antenatal fetal compromise. In a large antenatal screening study to assess the usefulness of continuous wave Doppler of the umbilical artery for the detection of IUGR and fetal compromise, no abnormal features or indices of neonatal outcome were adequately predicted (Beattie and Dornan, 1989). The most sensitive index for delivering a small for dates infant was an elevated A/B ratio at 34 weeks (sensitivity 40%, specificity 84%). However, the three unexplained stillbirths in the series all had elevated umbilical artery A/B ratios at some stage, but the time of elevation of the ratio did not appear to be useful for predicting the time of subsequent death. In two subsequent smaller studies (Dempster et al, 1989; Sijmons et al, 1989) similar results were obtained. The conclusions from these screening studies are not at all surprising in view of the heterogenous nature of the small for dates fetus, but they emphasise the importance for researchers to investigate alternative and better indices of fetal growth retardation (Neilson, 1987).

The prediction of adverse perinatal outcome is where Doppler ultrasound may show the main benefit. However, a total of nine intrauterine deaths reported in pregnancies with abnormal umbilical waveforms have been reviewed (Neilson and Whittle, 1987) and in some cases, major fetal compromise was already evident, and the knowledge of the Doppler results would have made little or no difference to management or outcome. Also on the debit side, Erskine et al (1986a) reported an unexplained intrauterine death occurring within 12 hours of normal umbilical Doppler studies and cardiotocography.

Trudinger et al (1987) performed the first randomised controlled trial on the value of umbilical artery velocimetry in 300 hospitalised high risk pregnancies. There was a lower incidence of caesarean section during labour in the reported group, although overall caesarean section rates and other indices of outcome were

not significantly different between the groups. The question of whether Doppler ultrasound actually improves management or outcome remains open.

As regards comparison of umbilical artery FVWs to standard tests of fetal well being, Trudinger et al (1986) found umbilical artery FVW analysis to be more sensitive in the prediction of fetal compromise than antenatal fetal heart rate monitoring. Also, Reuwer et al (1987) found that umbilical artery Doppler velocimetry allowed accurate and early recognition of those fetuses who will become distressed perinatally. Berkowitz et al (1988) found umbilical artery FVW studies to be valuable in identifying those IUGR fetuses at increased risk for an adverse perinatal outcome. While it has been suggested by these studies that the velocity waveform changes precede abnormal cardiotocography, the optimal time at which intervention is advisable is still uncertain and further research is required in this area. A study comparing Doppler velocimetry in three vessels, in a group of patients with pregnancies complicated by hypertension is presented in Chapter 8 of this thesis.

Recently, Johnstone et al (1988) evaluated the outcome of 24 pregnancies with absent diastolic flow in the umbilical artery; this phenomenon was found only in abnormal pregnancy, and was felt to be a very serious sign of likely fetal compromise. They also felt that absent end diastolic flow was an indication for extremely careful surveillance but that it did not necessarily aid in the timing of delivery. A more recent study (Hanretty et al, 1989) looked at 10 pregnancies in a screening study with absent end diastolic flow. They found that all infants but one were born in good condition. However, no information was given concerning pregnancy abnormalities in these cases and the thump filter setting on the equipment used was higher (400 Hz) than that used in most other studies. High thump filtering, as mentioned previously, could give a false impression of absent end diastolic velocities.

The group of workers from King's College Hospital have examined the relationship of absent end diastolic velocities in the umbilical artery to cord blood gas analysis as obtained by cordocentesis in a group of fetuses suspected to be growth retarded. They found that the absence of end diastolic velocities

appear to be a good marker for fetal asphyxia (Nicolaidis et al, 1988). However, this technique is invasive and obviously not practical to perform in most clinical centres. A more recent case report (Warren et al, 1989) demonstrated normal blood gases in a fetus with absent end diastolic flow in the umbilical artery. There is obviously much more research required before such an invasive technique can be adopted to study pregnancies complicated by IUGR.

Bracero et al (1986) reported on umbilical artery FVW analysis in diabetic pregnancies; a significant positive correlation between S/D ratios and serum glucose level was found. Elevated S/D ratios were associated with an increased number of stillbirths and neonatal morbidity. However, this was a small study and one of the two antepartum fetal deaths was in a pregnancy complicated by chronic hypertension and the fetus had multiple congenital anomalies.

Other Doppler studies have been performed in fetuses with congenital anomalies. Hsieh et al (1988) found evidence for a relationship between absent or reversed diastolic flow velocity in the umbilical artery of fetuses dying with major congenital anomalies and the state of hypoxia and acidosis. Al-Ghazali (1987) studied umbilical artery FVWs in relation to fetal cardiac abnormality; no correlation was found between the type of congenital heart disease and the characteristics of the FVWs, although absent end diastolic flow indicated a poor short term prognosis, particularly after 20 weeks. Reed et al (1987) reported on intracardiac Doppler flow velocities in fetuses with absent end diastolic flow in the umbilical artery; the latter was associated with increased tricuspid and pulmonary valve volume flow and changes in mitral valve velocity patterns, which suggested alterations in left ventricular function.

Rightmire et al (1986) reported an inverse correlation between the umbilical artery RI and fetal haematocrit levels in pregnancies complicated by Rhesus isoimmunisation. Also, Copel et al (1988) studied the umbilical artery FVW in isoimmunised pregnancies; They also concluded that the method may be helpful in the evaluation of these pregnancies; however, it did not appear to be useful in determining the timing of later transfusions. The same authors have recently reported a prospective trial of the ability of Doppler information from the

umbilical artery and fetal aortic waveform to predict haematocrit (Copel et al, 1989). They used two formulae for the prediction of haematocrit value. Although one of the two formulae predicted haematocrit values significantly better, the only component of this formula which made a significant contribution was the presence of fetal hydrops. They concluded that the Doppler measurements used were unable to be applied in the prospective prediction of haematocrit values.

The effect of vasoactive drugs on the umbilical artery Doppler FVW has also been investigated. Rizzo et al (1987) studied the effect of nifedipine on umbilical artery FVWs in healthy human fetuses. Their data suggested a possible use of nifedipine to normalise the umbilical artery FVW in pregnancies complicated by hypertension and IUGR. This suggestion was purely speculative because it is likely that the effects they saw on healthy fetuses would be quite different in the compromised fetus. Hanretty et al (1989) have reported on the effect of nifedipine on the umbilical artery FVWs in severe pre-eclampsia. They found that, despite a rapid and sustained effect on maternal blood pressure, no effect was seen on the Doppler parameters studied. This is similar to the experience of Montan et al (1987) who investigated short term treatment of hypertension with atenolol and found that no effect was seen on the umbilical artery FVW. However, they did show a significant increase in the PI of the arcuate artery FVW and also in the fetal aorta. A study of the effects of two anti-hypertensive agents on the Doppler FVWs of the fetal vascular systems is presented in Chapter 8.

4.4.5 Twin pregnancy

Doppler ultrasound may also be of value in the assessment of multiple pregnancies, both in identifying IUGR, which is common, and also the twin to twin transfusion syndrome which is not. In their study on umbilical artery FVWs in twin pregnancies, Farmakides et al (1985) found that S/D differences between the two fetuses that averaged 0.4 or more were predictive of a weight difference of more than 349 g. They also found that in the normal twin appropriate for gestational age (AGA) fetus, there was an elevated umbilical

vascular resistance as compared to that in the singleton fetus. Also, Giles et al (1985b) found that an abnormal (elevated) A/B ratio in one of the two umbilical cords was associated with discordancy in birth weight. Saldana et al (1987) tried to further elucidate the relationship of umbilical artery FVWs to fetal growth and well being in the twin couple; Their results indicated that umbilical artery velocimetry is a useful adjunct in the management of twin pregnancies. The problem with all of these studies is that they were performed using continuous wave Doppler ultrasound, and the umbilical cord was identified using real time ultrasound prior to the Doppler examination. This methodology is prone to errors since it is not always easy to be certain which fetus is associated with the umbilical artery being examined; therefore, the results of any investigation of twin pregnancy which uses continuous wave Doppler equipment to examine the umbilical artery FVW must be questioned.

Interesting results have also been reported concerning Doppler studies in the twin to twin transfusion syndrome; Farmakides et al (1985) stated, (based on two cases of twin to twin transfusion syndrome) that this entity was recognised by the simultaneous presence of high and low resistance flow values. Also, Erskine et al (1986) found normal umbilical artery FVWs in the surviving larger twin fetus (recipient) and persistently high umbilical artery impedance (with reversal of flow) in the smaller twin fetus (donor), which died *in utero*. Giles et al (1985b) however, found in five pairs with twin to twin transfusion syndrome that the umbilical artery A/B ratio was similar in the two fetuses. They suggested that the twin to twin transfusion syndrome must be strongly suspected if a discrepancy in ultrasound size is seen in the presence of no umbilical artery A/B ratio difference. Unfortunately, no clear, consistent picture appears to emerge in any of these studies. Finally, umbilical artery FVW analysis may also be of value in the diagnosis of conjoined twins, in which a characteristic "double layer" waveform can be seen (Woo et al, 1987).

4.4 Doppler measurement of fetal aortic blood flow

4.4.1 Introductory remarks

A description of the fetal aortic FVW has already been provided in Chapter 3.7.1. The waveform shows substantial forward diastolic flow, a pattern consistent with a low impedance circulation. The aortic FVW can be analysed by both quantitative and qualitative methods and the problems and potential errors in analysis have already been discussed in Chapter 3. The previous studies performed on the fetal aorta will be discussed in the next two sections, since further studies of the fetal aortic Doppler FVW both in normal and pathological pregnancies occurs in subsequent chapters of this thesis.

4.4.2 Normal pregnancy and labour

Quantitative analysis of fetal arterial blood flow has been carried out predominantly in the lower part of the descending aorta. The Doppler system which was used for this part of the study was first introduced by Eik-Nes et al (1980a). The fetal descending aorta was located by means of a two dimensional dynamically focusing linear array transducer with a carrier frequency of 3.5 MHz. A 2 MHz pulsed Doppler transducer with a diameter of 12 mm was used for measurements of the blood flow velocity. The Doppler probe was attached to the linear array real time transducer so that the Doppler beam intersected the fetal descending aorta at a fixed angle of 45° . The reflected Doppler signals were fed into estimators of maximum and mean Doppler shifts, which produced analogue voltages. Since then, several workers using improved pulsed Doppler equipment have reported normal values for fetal aortic blood flow at various gestational ages. In general, considering the methodological problems with quantitative estimation of aortic volume flow, the results obtained have been similar between groups. Some researchers have found the results to be independent of gestational age (Erskine and Ritchie, 1985a), whereas others (Gill et al, 1981), found a slight fall after 35 weeks gestation. A more detailed discussion of the results obtained in a study of normal pregnancy is performed in Chapter 6.

Two studies have examined the impact of maternal smoking on Doppler derived FVWs in the fetal aorta. Eriksen and Marsal (1987) studied the acute effects of

smoking a cigarette, whereas, Eldridge (1981) examined serially fetal aortic FVWs in smoking and non-smoking mothers. In each series, high flow velocity, calculated flow and stroke volume/kg were found in the fetuses of smoking mothers. Suggestions that the findings related to flow distribution, fetal hypertension or fetal inotropic stimulation by catecholamines have not been examined in animal studies as yet. However, prior to the examination of fetal blood flow, maternal smoking should be avoided, since it may affect the results. Another factor which should be taken into account when performing the Doppler examination is the influence of fetal breathing. Both the mean velocity and the waveform of the maximum velocity of the fetal aorta are affected by breathing movements and the results obtained will not be reproducible (Marsal et al, 1984) it is therefore recommended that recordings should only be performed during periods of fetal apnoea.

Lingman, Marsal and co-workers have studied most extensively the impact of cardiac rhythm disturbances on fetal aortic flow patterns (Lingman et al, 1980, 1985; Lingman and Marsal, 1985; Marsal et al, 1984). Most cases studied have shown either supraventricular tachycardia (SVT) or third degree atrioventricular block (complete heart block). Calculated flows as well as waveform analysis for acceleration time, pulsatility index and rising slope confirm the adverse haemodynamic impact of SVT, the usual maintenance of circulatory integrity with complete heart block and interval related variation in performance suggesting the existence of the Starling relationship antenatally (Anderson et al, 1980; Klopfenstein and Rudolph, 1978). These data confirm the morphologic and echo M-mode analysis studies of Kleinman and colleagues (1983), who suggested ventricular filling and output deteriorate at fetal heart rates over 280 bpm. Some information reporting follow-up of subjects with SVT *in utero* is available. Sporadic reports of intrauterine therapy and clinical experience suggest good outcome in most cases of uncomplicated SVT (Wiggins et al, 1986). The outlook with fetal hydrops or associated structural deformities of the heart is less good (Kleinman et al, 1982). The contribution of episodic or unrecognised arrhythmias to the syndrome of non-immune hydrops is still

evolving. At this time, the combination of high quality two dimensional/ M-mode imaging with pulsed Doppler, great vessel and A-V valve flow velocity data appears to be the most productive way of approaching rhythm analysis in the human fetus (Eldridge et al, 1983; Silverman et al, 1985). The application of this technology in the clinical situation of fetal cardiac dysrhythmias is discussed in Chapter 9 of this thesis.

The influence of labour and obstetric analgesia on aortic volume flow has also been studied (Linblad et al, 1987). They found that fetal aortic blood flow increased significantly during labour from 200 to 245 mls per minute per kg in the group without analgesia and significantly from 211 to 236 mls per minute per kg in the group with epidural analgesia but decreased insignificantly from 216 to 204 mls per minute per kg after pethidine. After paracervical block the aortic blood flow fell in two out of three fetuses. They concluded that, not only is epidural anaesthesia the most effective means of pain relief during labour but that it was also the type of analgesia that interferes least with the physiological response to labour in terms of its effect on fetal blood flow. The previously mentioned methodological problems in the assessment of aortic volume flow apply to this study. Also, no account was taken of the amount of fluid load given to the patient receiving epidural analgesia and the influence that this could have on the maternal and fetal circulations. True comparisons can only be made in a randomised controlled trial, and so far this has not been reported.

4.4.3 Pathological pregnancy

Parallel with examinations of normal fetuses, data has been collected on pregnancies with complications, and characteristic features of fetal blood flow have been described for certain groups.

In the descending aorta of growth retarded fetuses, a reduction occurs in diastolic velocities, and a corresponding increase in the pulsatility index (Griffin et al, 1983; Laurin et al, 1986; Jouppila and Kirkinen, 1984; Tonge et al, 1986a; Van Vugt et al, 1987). In these studies, the reduction of the diastolic blood flow is suggestive of an increase in peripheral resistance in the placental vascular bed

as discussed previously in Chapter 4.3.3. When the volume flow in the descending aorta of growth retarded fetuses was measured, low mean velocity values were found (Griffin et al, 1983; Laurin et al, 1986), although the volume flow values were not significantly different from these of controls (Laurin et al, 1986). This is in contrast to the results of umbilical venous flow in severely growth retarded fetuses discussed in Chapter 4.2, which were found to be very low by Gill in 1979. Since the pulsatility index is believed to mirror the impedance of the arterial vascular bed distal to the site of measurement (McCallum, 1981; Gosling and King, 1974), it not only reflects vascular dynamics in the placenta, but also in the total vascular system distal to the point of measurement. Thus, in addition to the placental vascular bed, the vascular beds of the viscera and of the lower extremities are included. This is supported by experimental studies in fetal lambs which have demonstrated a redistribution of blood flow in the growth retarded fetuses (Block et al, 1984). In the study of Laurin et al (1986), a definite conclusion regarding redistribution based on the volume flow data presented, cannot be drawn since there was a large variance in the obtained values of volume blood flow measurements and the possible methodological errors (Eik-Nes et al, 1984) are of magnitude. Nevertheless, an antenatal diagnosis of IUGR is supported when a low volume flow, either in the fetal aorta or the umbilical vein is found in a fetus suspected of being growth retarded.

The IUGR fetus, suffering from chronic oxygen deficiency is particularly vulnerable to the superimposed hypoxia likely to appear during labour and delivery (Lin et al, 1980). In order to reduce the neonatal morbidity and mortality, it is important to avoid intrapartum fetal hypoxia and to detect fetal distress as soon as possible. In a study by Lingman (1986), it was found that the fetal aortic blood velocity changes preceded the cardiotocographic signs of fetal distress. In a more recent study (Laurin, 1987), the median interval between the two findings was three days. This is also in agreement with a report by Jouppila and Kirkinen (1984) who found that, in nine cases with "chronic fetal hypoxia", (ie growth retarded fetuses in patients with hypertensive

complications of pregnancy), the cardiotocography recordings at the time of the blood flow examinations were normal, and, that shortly after the occurrence of "end diastolic block" (ie no detectable forward flow during the last part of diastole), fetuses developed an abnormal cardiotocographic pattern. This study demonstrated some interesting results but failed to sub-divide the hypertensive groups into true pre-eclampsia and chronic hypertension. Also, many patients were taking a variety of antihypertensive agents which could interfere with fetal haemodynamics. A study of various Doppler indices in pregnancies complicated by hypertension and the effect of antihypertensive agents is presented in Chapter 8.

Further studies have suggested differential alterations in regional blood flow may result in tissue ischaemia and produce neonatal complications such as necrotising enterocolitis (Hackett et al, 1987). They studied 82 consecutive cases of IUGR and identified 26 IUGR fetuses which had absent end diastolic aortic blood flow and seven of these went on to develop necrotising enterocolitis after delivery. However, six of these neonates not only weighed less than 1 kg at birth but also had coexisting respiratory problems and it is likely that the Doppler investigations were of less prognostic value than their desperate circumstances. This study also tried to assess whether the duration of absent end diastolic frequencies might predict an even poorer neonatal outcome. They identified 13 neonates who had had absent end diastolic flow in the fetal aorta for more than 14 days as fetuses, and found a neonatal death rate of 54%. This study suffers from being a retrospective analysis and still gives no guide as to the optimum timing of delivery in such cases.

In an attempt to aid the problem of timing of delivery, Soothill et al (1986) attempted to correlate measurements of the mean velocity of blood in the fetal aorta with fetal blood gas and acid-base measurements by performing ultrasound directed needling of the umbilical vein. They described a strong negative correlation of fetal hypoxia, hypercapnoea, and hyperlactaemia with mean velocity of blood in the fetal aorta. They also found a significant positive correlation between the mean velocity of the fetal aorta and the pH of the cord

blood. This study was performed in 29 cases of IUGR and the indication for cord blood sampling was rapid karyotyping. No details are given of the karyotypes obtained and it is possible that some of these fetuses may have had structural defects which could interfere with the Doppler FVW (Meizner et al, 1987; Hsieh et al, 1988; Trudinger and Cook, 1985). It is to be hoped that these interesting results will be investigated further in a prospective study. The King's College Hospital group have more recently reported prolonged maternal oxygen therapy in five pregnancies complicated by fetal growth retardation during the second trimester (Nicolaidis et al, 1987). In each case, the mean blood velocity in the fetal aorta appeared to increase in response to this therapy, but regrettably the study was uncontrolled and therefore is of limited interest. In addition, as regards timing of delivery, it appears that to wait for reverse flow to be present in the aortic FVW is too late. A recent report (Illyes and Gati, 1988) describes five fetuses with reverse flow in the fetal aortic FVW and all died within 24 hours of the recording.

Other pathological situations in pregnancy have been studied using Doppler assessment of the fetal aortic FVW. Hackett et al (1987) investigated 41 pregnancies complicated by oligohydramnios in the second trimester of pregnancy. The cause of oligohydramnios was variable and the highest incidence of abnormal Doppler indices was seen in the groups with fetal renal defects or with premature rupture of the membranes. The extremely poor survival rate in these fetuses (12%) reflects the extremely poor prognosis of 18% in early recognised oligohydramnios previously reported (Mercer and Brown, 1986). That, as suggested, Doppler studies should be an integral part of the antenatal investigation of pregnancies with severe second trimester oligohydramnios, is not justified by the results presented in this retrospective review.

Aortic velocities have also been studied in Rhesus isoimmunisation by the group from King's College Hospital (Bilardo et al, 1986). In Rhesus affected pregnancies at less than 24 weeks gestation, a significant negative correlation was obtained between the mean aortic velocity and the haemoglobin value obtained by fetoscopic blood sampling within 24 hours of the Doppler study ($R = -0.46$, p

< 0.05). Further analysis of the 26 fetuses revealed that this correlation held for non-hydrops fetuses ($R = -0.43$, $p < 0.01$), but, with hydrops, a wide range of aortic velocities, across the normal range, was obtained, suggesting various degrees of decompensation. The authors suggested that the anaemic fetus can maintain tissue oxygenation by means of a hyperdynamic circulation until the fetal haemoglobin is less than 4 g/dl. At this point, decompensation occurs with a rapid onset of hydrops fetalis. However, a more recent study (Copel et al, 1989) as mentioned in Chapter 4.4.2 has failed to confirm the true value of Doppler ultrasound in the prediction of fetal haematocrit.

Various pharmacological studies have employed Doppler ultrasound assessment of the fetal aortic waveform. As discussed in Chapter 4.3.4, Montan et al (1987) examined the effect of atenolol on the fetal aorta and arcuate artery FVW. They showed no change in the aortic volume blood flow before and after therapy but found an increase in the PI of the fetal aorta and arcuate artery. They concluded that these results revealed that the peripheral vascular resistance, both on the maternal and fetal side of the placenta increased during short term antihypertensive treatment with atenolol. Another study (Rasmussen, 1987) compared fetal aortic FVWs in untreated maternal hypertension to normal pregnancies and found that the aortic blood flow velocities were reduced significantly in the untreated hypertensive patients. They found a significant positive correlation between maternal diastolic blood pressure and the PI from the fetal descending aorta. There was also a significant negative correlation between maternal diastolic blood pressure and the mean velocity of blood in the fetal aorta. After administration of therapy for one to two weeks to the nine patients who continued their pregnancies, maternal diastolic pressure, aortic PI and the least diastolic velocity were shifted significantly towards normal values. The blood flow in the fetal descending aorta and in the umbilical vein, and the velocity in the fetal aorta, showed no significant changes. The results reported in this study are quite tentative and are not sufficiently convincing to suggest that antihypertensive therapy can improve fetal and placental circulation. In some fetuses, peripheral resistance seemed to improve, while in others it did not. The

methodological problems concerning the accurate assessment of blood velocity again applied to this study.

4.5 Doppler measurement of maternal placental blood flow

4.5.1 Introductory remarks

The ultrasonic study of uteroplacental blood flow comprises the study of the arterial blood flow, the intervillous blood flow and the venous outflow. For the latter, so far, no ultrasound studies have been published in the literature. Concerning ultrasonic studies of the intervillous blood flow, Bleker et al (1975) reported that during uterine contractions, the intervillous space is distended, resulting in the availability of more maternal blood for exchange with the fetal compartment. Recently, Hoogland (1988) reported on ultrasonic areas in the placenta, which might possibly represent a dilated intervillous space. It was possible to see turbulence of maternal blood within those areas as well as the blood flow coming out from the spiral arteries. He concluded that with this new non-invasive technique, it would be possible to study changes in the intervillous space circulation.

The introduction of the Doppler ultrasound principle made also possible the non-invasive study of the arterial inflow of the human uteroplacental circulation. Campbell et al (1983) first described this new method to study the arterial inflow. They used a pulsed Doppler system and performed their measurements in the arcuate arteries of the side nearest to the placenta. In 30 normal pregnancies, a low resistance blood flow was found in the second and third trimester, demonstrated by a high diastolic velocity (relative to peak systolic velocity) and low pulsatility. The characteristic waveform obtained from these arteries has been described in Chapter 3.7.4.

In the study by Campbell et al (1983), the Frequency Index Profile (FIP), $(F_d/\text{mean } F_d \times 100)$ was designed as an angle independent index and was used to provide a valid basis for comparison between patients. Among 31 pregnancies with complications, 14 showed waveform changes (dicrotic notch and reduced end diastolic velocity) suggesting raised vascular resistance. They concluded that

this new non-invasive technique could give early warning of impaired uteroplacental blood flow. Their conclusions must be regarded as speculative since direct comparisons of the two groups studied are difficult due to differing mean gestational ages. Pearce et al (1988) reported on the variation in the FVW indices of the arcuate (placental as well as non-placental) artery between three observers, over a 24 hour period, and before and after a meal; no significant differences were found. Recently, no significant changes in the A/B ratio and PI of the uterine artery were found between observations on three different days within a seven day period (Hastie et al, 1988).

4.5.2 Normal pregnancy and labour

After the first report of Campbell et al (1983), a growing amount of studies on FVW analysis of the maternal placental circulation have been published, in normal as well as complicated pregnancy, using continuous wave or pulsed wave Doppler with different sites of measurement of the uteroplacental circulation. Table III summarizes the results in normal pregnancy as reported in the literature to date. Despite the noted differences in methodology, it can be seen that all studies report low resistance FVWs throughout normal pregnancy. Schulman et al (1986) found marked differences between the vaginally and abdominally recorded FVWs of the uterine artery between 14 and 24 weeks of gestation, while after 24 weeks no difference in S/D ratio between both methods was seen. They stated that the abdominal measurements were primarily those of arcuate branches of the uterine artery whereas the vaginal studies were more likely to come from the proximal part of the vessel and that a decrease in resistance as reflected in the FVW was first seen in the arcuate vessels. These conclusions must be regarded as speculative and it is likely that only with improvements in the ultrasound technology such as colour Doppler and vaginal ultrasound will the true anatomical site of the vessels being studied be clarified. The studies to date suffer from serious methodological problems. Different modes of Doppler have been used and different parts of the uteroplacental circulation have been insonated. The studies listed in Table III are therefore not comparable

Author	CW/PW	Uterine /arcuate artery	number of patients	weeks gestation	FVW index	normal values
Campbell et al.(1983)	PW	arcuate	30	28	FIP	constant
Campbell et al.(1986)	PW	arcuate	30	28	RI	constant (mean+2SD=0.58)
Cohen-Overbeek et al.(1985)	PW	arcuate	10	14-20	FIP	increase in end-diastolic velocity 0.6-0.68
Trudinger et al.(1985b)	OW	arcuate (subplacental)	12	20-40	B/A	
Schulman et al.(1986)	OW	uterine (vaginal /abdominal)	79	-16 16-26 26-40	S/D	9.5-3.0 3.0-2.0
Arduini et al.(1987a)	PW	uterine/ ascending arcuate	50	18-20	RI	constant(2.0+/-0.3) mean+2SD=0.57
Pearce et al.(1988)	PW	arcuate (placental)	34	16-24 24-40	RI	0.46-0.4 constant(0.4)
		arcuate (non-placental)	34	16-40	RI	0.55-0.3
Deutinger et al.(1988)	PW	uterine (vaginal)	80	1-3 trim.	A/B	5.44-2.2
McCowan et al.(1988)	OW	uterine (abdominal)	16	16-20 20-42	PI	2.59-1.32
				16-20	PI	0.59-0.46
				20-42	A/B	constant(0.4) 1.86-1.51
Al-Ghazali et al.(1988)	PW	arcuate (subplacental)	271	20-42 16-42	B/A	constant(1.46) 0.58-0.62
Mulders (Thesis, 1988)	OW	uterine (abdominal)	41	18-32 32-38	PI	constant(0.73) constant(0.67)
				18-32	A/B	constant(1.98)
				32-38		constant(1.85)

Table III Normal values of uteroplacental artery FVW indices in human pregnancy as reported in the literature

Chambers et al.(1988)	OW	arcuate (placental) arcuate (non placental)	29	RI	constant(0.37)
Bewley et al.(1989)	OW	placental	619	RI	0.56-0.51
		arcuate (placental)	617	RI	0.51-0.42
		arcuate (non placental)	614	RI	0.55-0.47
		uterine (non placental)	618	RI	0.60-0.52

Table III (continued)
Normal values of uteroplacental artery FVW indices in human pregnancy as reported in the literature

and this has added to the confusion about the usefulness of such measurements. The most recent and the largest detailed study (Bewley et al, 1989) revealed a significant fall in the RI with increasing gestation. The RI was found to be lower from the placental than non-placental sites and also from distal arcuate than proximal uterine sites. The authors concluded that there is a need to define fixed standardised sites for sampling and for normal ranges to account for variables such as placental site.

Cohen-Overbeck et al (1985, arcuate artery) as well as Fleischer et al (1986, uterine artery) described a notch in the FVW as a normal finding in the first half of pregnancy. The notch disappeared around 20-26 weeks of gestation, possibly related to the process of trophoblastic invasion of the spiral arteries. Thereafter, no changes in the FVWs were observed in normal pregnancy.

Janbu and Nesheim (1987) studied the FVWs of branches of the uterine arteries (along the lateral wall of the uterus) in relation to contractions during pregnancy and labour; blood velocities fell and PI increased during contractions. Fleischer et al (1987) studied the waveforms on both sides of the placental bed during labour in 12 normal parturients; the S/D ratio of the umbilical artery was not affected by the process of labour, while the uterine artery end diastolic velocity fell progressively during the contraction, reaching zero when the intrauterine pressure exceeded 35 mmHg. Similar results were obtained by Fairlie et al (1988) as discussed in Chapter 4.3.2, studying only the umbilical artery. Brar et al (1988a) also found a progressive fall in uterine artery end diastolic velocity during a uterine contraction. These results suggest that during uterine contractions, fetal placental blood flow continues uninterrupted, whereas the reduction in uteroplacental blood flow is dependent on the intensity of the uterine contraction.

4.5.3 Pathological pregnancy

Cohen-Overbeek et al (1985) found that those patients with abnormal arcuate FVWs had a greater incidence of proteinuric hypertension and were delivered earlier of smaller babies than those of normal FVWs. Trudinger et al (1985b)

found abnormal sub-placental arcuate FVWs in relation to IUGR and hypertensive disease of pregnancy. Fleischer et al (1986) studied the uterine artery FVWs in pregnant women with hypertension; the pregnancies of the patients with an elevated S/D ratio (> 2.6) were complicated by stillbirth, premature birth, IUGR and pre-eclampsia. McCowan et al (1988) studied the uterine artery FVWs also in relation to IUGR. In those IUGR pregnancies with pre-eclampsia, uterine artery resistance was increased in almost all patients, whereas in the pregnancies complicated by IUGR of non pre-eclamptic origin, a wide range of results was obtained.

Uterine fundal as well as lower segment arcuate artery velocimetry was studied by Leiberman et al (1988); in severe pre-eclamptic patients, the abnormality of the FVWs was more severe in the fundal than in the lower segment arcuate measurements. Brar et al (1988b) studied the uterine artery FVWs before and after delivery; in the normotensive patients, no significant change in uterine velocimetry occurred in the peripartum period, while in severe pregnancy induced hypertension, a very high uteroplacental resistance reversed to normal within a day after delivery in the majority of cases. They concluded that the increased uteroplacental resistance in severe pregnancy induced hypertension might be secondary to reversible vasospasm in the uteroplacental bed.

Unfortunately, despite interesting results, all of these studies were uncontrolled, used different definitions of IUGR and of hypertension in pregnancy. Also, the studies of Doppler FVWs in pregnancy induced hypertension were done in patients receiving different hypotensive agents with unknown effects on blood velocimetry. In an attempt to control for some of these problems, Hanretty et al (1988) performed a study of uteroplacental FVWs in 32 untreated patients with pregnancy induced hypertension as compared to those in 32 carefully matched women; there was no overall difference in PI between both groups. The normal values in this study, however, were elevated compared to other studies (Pearce et al, 1988) and it has been suggested that Hanretty et al (1988) were studying internal iliac vessels in some patients (Pearce and McParland, 1988). Since the PI from the internal iliac artery is higher than that obtained from a healthy

uteroplacental vessel, then this could account for the falsely elevated normal values. Some other workers (Campbell et al, 1988) have suggested that vessel identification using colour flow mapping Doppler techniques would help to identify the branches of the uterine artery to be studied and therefore fixed standardised sites as recommended by Bewley et al (1989) could be achieved.

Campbell et al (1986) studied the FVWs of the arcuate artery in early pregnancy (16-18 weeks of gestation) and found a sensitivity of 68% with a specificity of 69% for the early prediction of complications during pregnancy associated with an assumed impaired trophoblastic invasion of the placental bed. However, closer examination of the results in this study reveals that 40% of the "screened" population had a waveform from the uteroplacental circulation greater than two standard deviations above the mean and 58% of these patients went on to have a normal outcome. Thus, it would seem that this technique used as a screening test either holds little promise or requires further study (Neilson, 1987). The most recent screening study (Hanretty et al, 1989) found no significant difference in pregnancy outcomes between patients with abnormal uteroplacental FVWs screened at either 26-30 weeks gestation or 34-36 weeks gestation.

Two studies have been published concerning the effect of antihypertensive therapy on uteroplacental FVWs. Lindow et al (1988) showed that Nifedipine did not reduce uteroplacental blood flow as measured with a radioisotope technique. Similar results were obtained by Hanretty et al (1989) who found no change in either umbilical or uteroplacental PI following Nifedipine therapy when given to nine patients with pre-eclampsia. This study was carried out only in patients who had normal Doppler FVWs and it remains to be seen whether lowering blood pressure in patients in whom the Doppler indices are abnormal demonstrates the same results.

4.6 Doppler measurement of fetal cerebral blood flow

Doppler assessment of the cerebral arteries was first reported by Bada et al (1979). They evaluated the neonatal cerebrovascular haemodynamic alterations

produced by asphyxia and intracerebral interventricular haemorrhage in infants from studies of the pulsatile flow changes in the anterior cerebral arteries. Before haemorrhage, PI measurements were significantly lower in these infants than in infants who did not eventually develop this complication. Since then, the technique has been found to be a useful method for the investigation of neonatal asphyxia (Evans et al, 1985; Archer et al, 1986).

These studies of the neonatal circulation have prompted researchers to evaluate Doppler ultrasound in the assessment of the fetal cerebral circulation. Wladimiroff et al (1986) reported a pulsed Doppler study of the FVW in the internal carotid artery, descending aorta and the umbilical artery in the human fetus. 42 fetuses in normal pregnancy and nine growth retarded fetuses between 26 and 41 weeks gestation were studied. In normal pregnancy, the mean PI in the internal carotid artery varied between 1.5 and 1.6. In the growth retarded fetuses, the PI was reduced in the internal carotid artery. In a larger study from the same group (Wladimiroff et al, 1987), 156 normal and 42 cases of IUGR were studied. The reproducibility of the technique was satisfactory but acceptable FVWs from the internal carotid artery were obtained in only 74% of the normal population. The PI in this artery had a downward trend with advancing gestation but this was not statistically significant. A large standard deviation of the results at term was obtained and it has been suggested that this was due to the effect of the fetal behavioural state of the FVW (Van Eyck et al, 1987). In the 42 growth retarded fetuses studied, a marked decrease in the PI in the internal carotid artery was seen. These changes were accompanied by a marked increase in the PI of the umbilical artery. The changes in PI were predominantly due to changes in end diastolic flow velocity and were felt to confirm their earlier data (Wladimiroff et al, 1986), suggesting a "brain sparing" effect in the presence of IUGR. The authors also found that the IUGR fetuses with structural or chromosomal defects had normal PI values in the internal carotid artery. When these fetuses were excluded, the sensitivities of the PI values in the internal carotid artery, the umbilical artery and for the umbilical artery/internal carotid artery ratio were 65, 83 and 88% at the one

standard deviation (SD) cut off level; and 48, 60 and 70% at the 2 SD cut off level.

Woo et al (1987) in a longitudinal study of 14 fetuses, assessed the velocity waveforms of the middle cerebral arteries both at their origin from the internal carotid arteries and at the "incisura". They observed no appreciable difference in the shape of the waveforms in the middle cerebral arteries at their origin or at the "incisura". The A/B ratio showed a progressive and significant decline from 6.89 +/- 1.48 at 25 weeks to 4.23 +/- 0.67 at term. Elevation of diastolic velocities and diminished A/B ratio in the middle cerebral arteries were noted in four fetuses in whom severe antepartum compromise was diagnosed. None of these infants survived.

Kirkinen et al (1987) performed a Doppler study of the fetal intracranial arteries in 83 normal and 84 high risk pregnancies. They reported that it was not possible to determine with absolute certainty whether the Doppler signals were derived from the main trunk of the internal carotid artery or from the very proximal parts of the middle cerebral artery. This group also found a decreasing RI in the intracranial vessel FVW with advancing gestation. They also found that a low RI predicted the birth of a small for dates newborn and/or the appearance of subsequent cardiotocographic abnormality, with 57% sensitivity and 94% specificity.

The findings in the above studies are generally in agreement and seem to be compatible with the well recognised, compensatory "brain sparing" effect found when hypoxia was induced in experimental animals (Kjellmer et al, 1974). Whether studies of the fetal intracranial arteries will allow better identification of the fetus in jeopardy compared to other Doppler studies of the fetal and uteroplacental circulations, remains to be seen.

What is apparent, is that there is some doubt in the minds of the various investigators concerning which vessel is being examined. In the latest and most comprehensive study (Mari et al, 1989), all cerebral vessels in 30 fetuses at 23-37 weeks gestation were studied. They found that the PI of the middle cerebral artery was higher than the PI for either the internal carotid artery or

the proximal anterior cerebral artery. The authors did not present gestational age data but emphasised the importance of knowing exactly which FVW is being studied. This is because a normal value of the PI for the internal carotid artery or proximal anterior cerebral artery would be abnormal for the middle cerebral artery. If, therefore, one insonates the middle cerebral artery in a normal fetus and, in a subsequent examination, the proximal anterior cerebral artery or the internal carotid artery is studied, one may conclude that there is an increase in cerebral flow even though no change in flow has occurred. How practical this technique will prove to be is difficult to ascertain but the increasing application of colour flow mapping may make its feasibility more likely.

4.7 Doppler measurement of fetal renal blood flow

The latest aspect of the fetal cardiovascular system to be evaluated is the renal artery FVW. To date, only one group have studied this vessel (Vyas et al, 1989). A cross sectional study of 114 normal pregnancies between 17 and 43 weeks was performed. The fetal renal artery was identified using colour flow mapping and the appropriate FVW analysed. Since end diastolic frequencies were absent in the fetal renal artery FVW in 54% of the fetuses studied, the PI was chosen for evaluation. The PI was found to decrease linearly with gestation, presumably indicating an increase in renal perfusion. The renal artery FVW was obtained in 87% of cases. The intraobserver variation of this method was found to be 5.4%. No significant differences were found between the left and right renal artery PIs in the 12 fetuses in which this comparison was made.

A group of 18 growth retarded fetuses also had Doppler studies performed 30 minutes before umbilical vein sampling was carried out for rapid fetal karyotyping and blood gas analysis. The renal artery PI was significantly higher and the blood pO_2 was significantly lower in the SGA fetus. Also, a direct relationship was found between hypoxia and the renal artery PI in the SGA fetuses.

This study demonstrates interesting results, but how feasible it is in terms of practical clinical application remains unclear. It is hoped that groups who can

perform such studies will accept the advice of Neilson (1987) and "establish the optimal vessel or vessels for study and the optimal form of waveform analysis, to establish suitable end points for clinical studies in broadly based groups and, finally, to assess the impact on fetal outcome and pregnancy management by randomised controlled trials".

CHAPTER 5
METHODOLOGY AND CALIBRATION
OF DOPPLER EQUIPMENT

5.1 Doppler equipment

With the exception of the study described in chapter 8.9, in which continuous wave equipment was used, fetal and placental vessels were assessed using a duplex Doppler system with a 2.42 MHz pulsed Doppler transducer attached to a 3.5 MHz linear array transducer at a fixed angle of 55 degrees (Toshiba SAL50A, Toshiba America, Tustin, California). A 100 Hz thump filter was used to eliminate Doppler shift frequencies caused by vessel wall movements. Diastolic frequencies may be seriously underestimated if the filter level is high and thus thump filters of the order 100-200 Hz are generally used in most clinical studies (Pearce, 1987). The calibration of this equipment is described in the following section.

5.2 Calibration of Doppler equipment

5.2.1 Introduction

Ultrasound is now a fully established diagnostic tool, yet few users have a set protocol for velocity calibration. An awareness of instrumental characteristics and their limitations allows an operator to fully exploit the potential of this technique. A knowledge of the accuracy of the blood velocity measurements and their various conditions is of a particular importance to clinical practice.

Ultrasonic Doppler units operate with pulsed or continuous wave ultrasound of frequencies in the range of 1-10 MHz. Doppler units may be used as stand alone devices or, as in the equipment used in this thesis, can be linked with imaging equipment in a duplex system. Using a duplex Doppler system, the diameter of the blood vessel and its angle to the Doppler beam can be measured, allowing a calculation of volume flow to be made. A number of commercial Doppler and imaging duplex systems such as the machine used in this thesis, will perform the calculation of flow, mean velocity and maximum velocity, and present the results on a display screen. Since there are numerous sources of error in the measurement of blood flow, it is particularly important to check the performance of these systems. It is particularly difficult to exactly imitate the clinical situation in an artificial environment. However, a calibration

performed with a simplified *in vitro* test object is of value to reassure the user that the Doppler units can produce accurate values of quantitative flow at least in an idealised situation. Such a test can also provide reassurance as to the size of the sample volume and to the detectability of turbulence.

Several test objects have previously been reported in the literature. Generally they have been simple moving structures which oscillate, rotate or move in a linear fashion, e.g. a piston phantom (Reid, 1983) or a rotating tissue equivalent cylinder (McDicken et al, 1983). These test objects are useful for simple routine checks, but cannot be used for confirmation of flow measurement. Another group of flow test objects consist of methods to pass a liquid through a tube which simulates a blood vessel. The red cells of the blood are mimicked by small particles suspended in the liquid (Newhouse et al, 1982). Commercial versions of this type of test object are now becoming available.

The aim of this experiment was to design a versatile test object which could be used in the laboratory to test Doppler equipment commonly used for clinical application in the study of fetal blood flow. There were various features which required to be incorporated into the design of this experiment. These included:

- (a) Either pulsed or continuous flow of a liquid suspension of particles.
- (b) Thin-walled tubes which can have their internal diameter adjusted.
- (c) Thin-walled tubes whose shapes can be altered by moulding.
- (d) Thin-walled tubes of small internal diameter (e.g. 0.5 mm) to study sample volume size and shape.
- (e) Thin-walled tubes placed next to each other in order to check the direction of flow.
- (f) A tissue equivalent material of variable thickness between the ultrasonic transducer and the simulated blood vessel.
- (g) A tissue equivalent material through which artificial blood can be passed slowly.

5.2.2 Materials and methods

To assess the accuracy of velocity measurements, a test fluid whose acoustic

properties were similar to those of blood was manufactured. This artificial blood was made using a mixture of glycerol and water (4 parts glycerol to 5 parts water). Such a mixture has a similar viscosity to that of blood, i.e. 5 cP at 25°C. Fine Sephadex particles (insoluble Dextran spheres of diameters 20-80 microns) were suspended in the above mixture to act as scatterers and thus mimic red cells (Reid, 1983). A strong Doppler acoustic signal was obtained using 100 g of Sephadex particles in 2 litres of the water-glycerol mixture.

Transparent heat shrink sleeving (RS Components, Corby, UK) was used to mimic the blood vessel. This type of tubing could be shrunk to various internal diameters in the range 10-0.5 mm. The tube used for calibration had a wall thickness of 0.25 mm and an internal diameter of 10 mm. The tube was placed on the high pressure side of the pump in order to maintain its shape during flow studies. A 70 cm length of tubing enabled Doppler measurements to be carried out at a distance of more than 50 diameters from the input, thus minimising the risk of turbulence at the measurement site.

Lerski et al (1982) describes a reticulated foam (Bulpren S20)(Foam Engineers, High Wycombe, UK) as a convenient tissue mimicking material. This material was placed in layers above and below the blood vessel tube. The total thickness of the top layers was varied to suit the ultrasonic frequency employed.

A gear pump (Micropump Corp., Concord, California, USA) which could deliver 5 litres/minute at 50 psi was used in order to produce adequate flow through the range of tubes of interest. This pump was linked to the motordrive via a magnetic coupling which removed the possibility of air bubbles being sucked into the system. This pump enabled continuous or pulsed flow, over a range of rates.

Flow measurement was made using a simple technique incorporating a graduated cylinder and a stop-watch.

5.2.3 Results

The sample volume was arranged to straddle the tube. By assuming parabolic flow, a good correlation was obtained between direct and Doppler measurements

by noting the maximum velocity from the ultrasound recording (figure 5.2.3a). As can be seen from this graph, there were deviations of the measurements at high flow rates. This was due to turbulence, observed in the ultrasound, which arose in the 10 mm tube at velocities greater than 100 cms per second. Measurement of the maximum frequency was difficult at velocities above 100 cms per second so flow values above 40 mls per second have large errors and the leveling off of the Doppler flow values shown in figure 5.2.3a may be due to artefact. Figure 5.2.3b illustrates the measurements obtained using a Sephadex and water mixture which did not have a viscosity close to that of blood and thus turbulence set in at a lower velocity. The upper velocity limit of 100 cms per second for the 10 mm tube corresponds to the typical highest values of velocity encountered in the fetal aorta (Eik-Nes et al, 1980a). Since the equipment under test was purely applied for obstetric studies, no further steps were taken to obtain laminar flow at high velocities.

The performance of the pulsed Doppler system used in clinical studies was calibrated against direct measurements for pulsatile flow (figure 5.2.3c). The agreement between time-averaged Doppler mean flow and the directly measured mean flow was found to be satisfactory.

The ability of the Doppler unit to assess the direction of flow can be carried out by examining the spectrum where it is known that the flow is all in one direction to see if any reverse flow is presented on the display due to errors in the phase-shifting circuitry or aliasing. The flow towards and away from the transducer can easily be checked by altering the direction of the ultrasound beam relative to that of the flow. As an alternative to this method, two thin-walled tubes placed next to each other with the flow in each identical but in opposite directions can be used. Total forward or total reverse flow can be studied by directing the ultrasound beam at the appropriate vessel. Simultaneous forward and reverse flow is recorded when the Doppler sample volume is located so as to intercept both vessels. This has clinical relevance when it is desirable to simultaneously record arterial and venous flow from the umbilical vessels and can also be used to assess fetal aorta and inferior vena cava simultaneously.

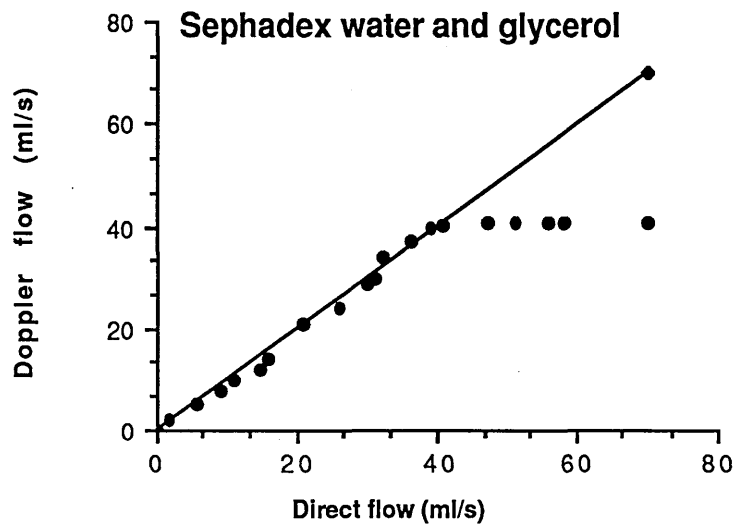

Figure 5.2.3a
Calibration of a 3.5MHz pulsed Doppler unit using
continuous flow

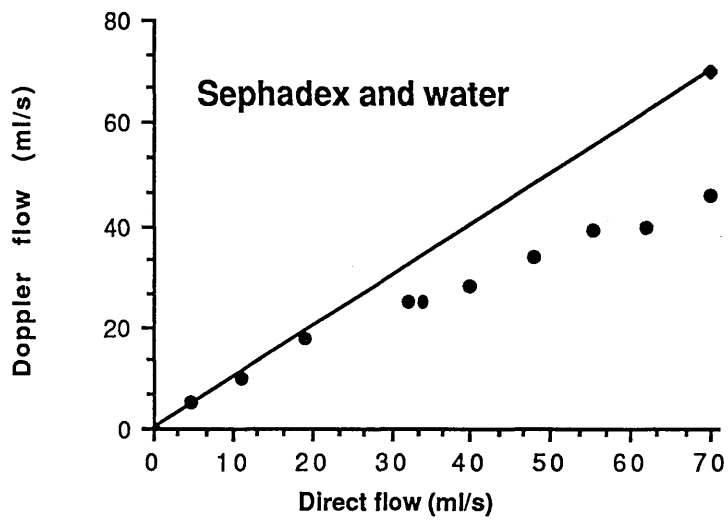

Figure 5.2.3b
Calibration of a 3.5MHz pulsed Doppler unit using a
water -Sephadex mixture

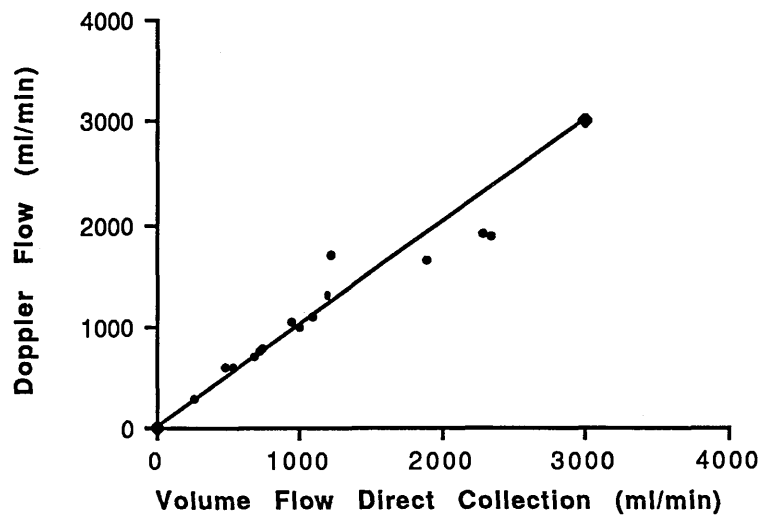

Figure 5.2.3c
Calibration of a 3.5MHz pulsed Doppler unit using pulsed flow. Time averaged mean Doppler flow is plotted against mean flow measured directly with a measuring jar and stop watch

In conclusion, this method of assessing the accuracy of blood velocity measurements using an artificial blood and tissue medium is well-suited for the calibration of Doppler instruments in current clinical use. Although the model of tissue equivalent layers and a non-elastic vessel represent an idealised and simplified situation, tests with it can establish confidence in ultrasonic equipment.

5.3 Recording of Doppler signals

5.3.1 Recording technique

In the human studies, all the Doppler waveform recordings were performed during the ante partum period. During recording, the patient rested in the semi-recumbant position tilted 15 degrees to the left to avoid caval compression. Aorto-caval compression is a well-recognised complication of the supine position in pregnancy. Both aortic and caval compression are likely to reduce uterine artery blood flow and placental perfusion, carrying a risk of fetal hypoxia and metabolic acidosis (Corke et al, 1982).

The fetal descending thoracic aorta was examined in the absence of fetal breathing movements at a point just above the level of the diaphragm with the transducer orientated parallel to the aorta. A sufficiently large sample volume was chosen to completely cross the aorta but not provide interference from other vessels. The aortic diameter and Doppler angle were then measured and entered into the ultrasound machine to allow on-line calculation of mean velocity (cms per second) and volume flow (mls per minute).

The aortic volume flow was calculated according to the formula:

$$Q = \frac{V \times A}{\cos 55^\circ}$$

Q = blood volume flow

V = mean blood flow velocity

A = cross-sectional vessel area.

The umbilical artery was then examined with the position of the sample volume

adjusted to provide the best signal.

The placental bed was then examined until a typical arcuate waveform, as described in Section 3.7.4, was obtained.

When carrying out Doppler ultrasound examination in the animal studies, the sheep was placed on a specially constructed wooden bench (figure 5.3.1). The equipment used was the same as that used for the human studies. The vessels studied in the chronic sheep preparations were the fetal aorta, inferior vena cava and the umbilical artery.

5.4 Signal analysis

To measure blood flow velocities, it is necessary to display and quantify the Doppler shift frequencies. The equipment used to perform these studies displayed the Doppler spectrum visually in real-time and thus allowed the quality of the signal to be optimised. Flow towards the transducer is represented as frequencies above the baseline and flow away from the transducer as frequencies below the baseline. This ability to separate forward and reverse flow is vital for accurate signal analysis. As stated previously, this system allowed on-line calculation of velocity and volume flow once the vessel diameter and Doppler angle were entered into the machine. The characteristic waveforms have been described already in Section 3.7. Once the waveforms were obtained, freeze-frame images of the waveform for each of the vessels studied were hard copied on to x-ray film and these images were then used for off-line analysis using a microcomputer with a digitizing pad (Microsonics, Indianapolis, Indiana). Peak systolic and end diastolic velocities were marked by hand for measurement since these points were clearly visible. Three consecutive waveforms were measured and a simple average calculated.

The indices calculated from the velocity waveforms were those of Resistance Index (RI), the Systolic to Diastolic ratio (S/D ratio), and the Pulsatility Index (PI). A greater explanation of these three indices has already been described in Chapter 3.8.

There is a close correlation between these three waveform indices (Thompson,

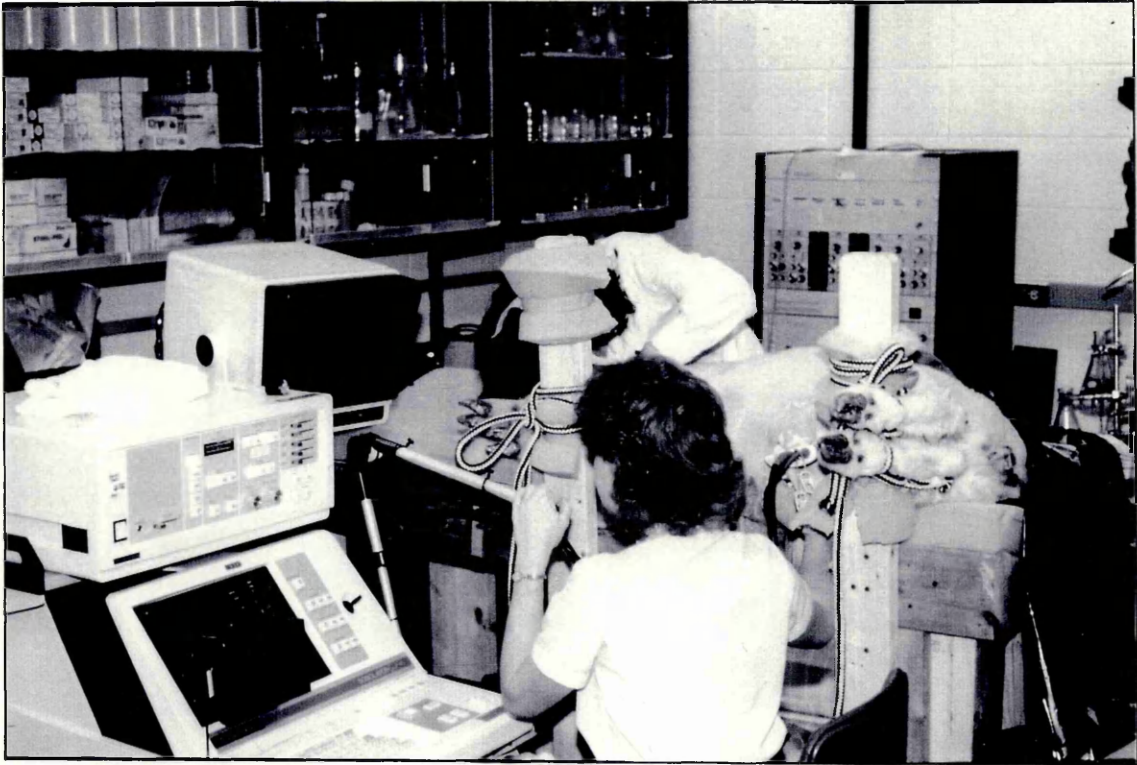

Figure 5.3.1 Experimental set up for sheep studies

1987). Pulsatility index includes the shape of the waveform in its calculation and unlike S/D and RI, a value for the PI can be derived in the absence of end diastolic frequencies. In some of the studies in this thesis, flow velocity waveforms with absence of end diastolic flow were recorded.

5.5 Animal preparations

Part of the work of this thesis involved the study of Doppler ultrasound in chronic animal preparations. The chronically catheterised sheep preparation has served as a model for human pregnancy for many years (Dawes, 1968). The sheep has the advantage of tolerating surgery well so that the fetus may return to a relatively normal physiological state before experimentation.

The anatomy of the sheep fetal and placental circulations differs from the human in that there is a shorter common umbilical artery which arises as a terminal branch of the aorta and divides after a short distance (usually less than 1 cm) into two umbilical vessels. The common trunk of the umbilical artery is somewhat shorter than the human (approximately 30 cms) before it divides into a variable number of branches to supply individual cotyledons. Despite these differences, the overall structure of the placental vasculature is similar and is likely to be influenced by the same physiological influences as the human, and using the fetal sheep as a model may give valuable insight into the human fetal placental circulation (Nathanielsz, 1980).

There were two aspects to the animal studies performed in this thesis. The sheep used were of mixed breed and in the study concerning the influence of gestational age on the Doppler waveform of the sheep fetal aorta, the animals had studies undertaken prior to surgery. The second aspect of the animal studies involved surgical preparation of these animals. The general techniques employed in preparing the sheep for experimentation are described below and also in subsequent chapters of the thesis.

5.5.1 Surgical techniques in animal models

Surgery was performed on time-dated ewes of mixed-breed at 110-140 days

gestation. The animals were transported from the farm and housed in pens or metabolic cages for several days before surgery. They were fed with "Purina" milk generative chow (Purina, Canada), compressed alfalfa pellets (Purina, Canada) and water *ad libitum*. The ewes were fasted for 24 hours prior to surgery.

An intravenous infusion of balanced electrolyte solution was commenced via one of the fore limbs of the ewe. Anaesthesia was induced with 20-30 mls of 2.5% thiopental sodium (IMS, California). The animal was then intubated and ventilated with N₂O (40%) and O₂ (60%) at a rate of approximately 17 breaths/minute and tidal volume 0.5 litres. Anaesthesia was maintained with Halothane ("Somnothane", Hoescht, Canada) at a rate of 0.5-1.5 litres/minute to maintain the correct level of surgical anaesthesia. This was monitored by pupillary reflexes.

The abdomen was sheared and washed with soap and water followed by Povidone iodine solution (Betadine Purdue, Canada). The animal was then transferred to the operating table.

A midline sub-umbilical incision was made and the uterus was exposed. The number and position of fetuses was ascertained. If more than one fetus was present, only one was instrumented. The fetal head and chest was exposed. An incision was made in the 4th intercostal space from the right side to expose the heart and the pericardial sac was opened. The great vessels were identified and bi-polar pacemaker electrodes were implanted in the right atrial appendage close to the insertion of the superior vena cava. The pericardium was left open at the time of chest closure. Electrocardiograph electrodes were implanted under the skin of the fetus, one lead being placed in the neck and the other in the chest wall at the 6th rib.

The fetus was then partially returned to the uterus so that only the hind limbs were exposed. An incision was made in the fetal inguinal area on one side and the femoral artery exposed. The distal ends of the femoral artery were ligated. A fine polyvinyl catheter was introduced into the artery (internal diameter 0.72 mm and external diameter 1.22 mm, Bolab, Arizona). The catheter was advanced

8 cms to the lower aorta just proximal to its bifurcation. This catheter allowed measurement of blood pressure and withdrawal of samples. The catheter was sutured in position and the fetal groin closed with 2/0 silk sutures.

An incision was made in the fetal neck and the jugular vein was exposed. A similar catheterisation as performed on the femoral artery, was carried out. The neck incision was closed with 2/0 silk sutures. The fetus was carefully replaced in the uterus, the lost amniotic fluid was replaced by sterile saline and the uterus was closed with 2/0 silk in two layers, ensuring that a tight seal was made round the catheters to avoid leakage of amniotic fluid. The catheter and leads were exteriorised through the ewe's flank prior to closure of the midline skin incision. This incision was closed by placing a purse string suture (0 Vicryl) in the peritoneum and a second in the skin. The maternal abdominal wall was closed in two layers with 0 Vicryl and the skin was closed with a continuous 0 Vicryl suture.

Immediately following surgery, each animal was given prophylactic analgesia of Levonorfonal Tartrate, 2 mgs s.c. (Levo-Dromoran, Roche, Canada). Prophylactic penicillin, 200,000 IU was given to the fetus and into the amniotic fluid per-operatively and daily for four days. The ewes received prophylactic penicillin Procaine (0.8 mega units), dihydrostreptomycin (1g) (Pen-di-strep, Rogar, Canada) prior to surgery and for three days after surgery.

On regaining consciousness, the ewes were returned to metabolic cages and allowed free access to food and water. The vascular catheters were flushed daily with heparinised normal saline. The catheters were closed with sterile stop-cocks and stored in a clean plastic bag tied to the wool on the sheep's back. Experiments occurred after a minimum recovery period of five days.

The maternal and fetal vascular catheters were connected to pressure transducers (Gould, California) and attached to amplifiers in the chart recorder. The pressure transducers were calibrated with a sphygmomanometer before use. Throughout experiments, the blood pressures were continuously monitored. A signal line crossing detector (tachograph) was used to derive fetal and maternal

heart rate from auscultations in arterial blood pressures.

The fetal and maternal blood gases were measured from samples taken via the fetal femoral and maternal jugular catheters. Approximately 0.5 mls of blood was withdrawn into a heparinised plastic syringe and blood gases were measured immediately using the blood gas analyser (model 170, Corning, Canada).

The signals obtained from the vascular catheters were continuously recorded during the experiments using a 16 channel chart recorder (Grass, Massachusetts).

5.6 Recruitment of patients

Patients enrolled into the Doppler studies were recruited mainly from the Ultrasound Department and Fetal Assessment Centre of the Hospital. They all provided informed consent prior to any Doppler examination being carried out.

CHAPTER 6
DUPLEX ULTRASONOGRAPHY OF THE FETAL AORTA,
UMBILICAL ARTERY AND PLACENTAL ARTERY
THROUGHOUT NORMAL HUMAN GESTATION

6.1 A study of the variability of Doppler recordings at different sites of the umbilical artery and fetal aorta

6.2 Introduction

As discussed in Chapter 4, flow velocity waveform analysis of the umbilical arteries provides a measure of placental vascular resistance, whereas the descending fetal aorta waveform reflects cardiac contractility, fetal peripheral vascular resistance and placental vascular resistance.

There are characteristics of the umbilical arteries and of the fetal aorta which could result in varying results from repeated Doppler analysis of the waveform of the same vessel eg. difference in calibre of the umbilical arteries. The relative ease of assessment of the umbilical arteries versus the fetal aorta may also alter the relative reliability of analysis of the waveform. This study was designed to assess the variability of Doppler analysis of the fetal aorta and umbilical arteries, and to determine whether reliability of repeat waveform analysis favours one vessel over the other.

6.3 Patients and Methods

30 subjects with near-term pregnancies were selected from patients attending for obstetrical ultrasound examination. Patients had been referred for a variety of clinical problems: normal pregnancies (16), diabetes (7), maternal systemic illness (3), suspected small for gestational age fetus(4). Normal obstetrical ultrasound examinations and normal fetal Doppler studies (as plotted on the population nomogram) were obtained in all patients. A single Doppler assessment was performed for each patient. All pregnancies resulted in the birth of a normal, healthy infant with birthweights in the 10th-90th centile range.

The equipment used was identical to that described in Chapter 5.1. Flow velocity waveform analysis was recorded during periods of fetal apnoea. The umbilical arteries were sampled at whatever area of the cord provided the optimum Doppler signal. Descending aortic measurements were obtained below the level of the arch and above the level of the renal arteries. Flow velocity waveform

analysis was performed three times at 2 minute intervals on each area for each patient. A 100 MHz thump filter was applied to remove low frequency signals from the pulsatile vessel walls. The S/D ratio was calculated from the average of 3 complexes of the waveforms of each examination using the methods previously described in Chapter 3.8. For each patient, a coefficient of variation was calculated from the three umbilical or aortic S/D ratio measurements obtained at 2 minute intervals (Coefficient of variation = (standard deviation/mean x 100). The mean coefficient of variation was then calculated for all of the subjects' umbilical artery values and fetal aortic values. A student's t-test was applied to assess statistical significance with significant difference accepted at $p < 0.05$.

6.4 Results

In 24 of the 30 patients, satisfactory Doppler waveform analysis of the fetal aorta was performed. In six patients, only the signal from the umbilical artery was recorded. In all 30 patients, satisfactory waveform analysis was obtained for the umbilical arteries.

Comparison of the variability of the umbilical S/D ratio versus the aortic S/D ratio was performed by examining the 24 patients in whom the aortic S/D ratio was obtained and the 30 patients in whom the umbilical S/D ratio was obtained. The aortic S/D ratio coefficient of variation was 11.1% with a standard deviation of 5.2%. The umbilical S/D ratio coefficient of variation was 9.0% with a standard deviation of 5.8%. These results were not significantly different ($p = 0.18$).

6.5 Discussion

In Doppler flow velocity waveform analysis of the umbilical arteries and fetal aorta, the possibility arises that there may be significant differences found in repeated studies of the same vessel. This would have particular relevance to clinical application. Study of the umbilical artery waveform is made more complex by the presence of two arteries and the uncertainty of which artery is studied on repeat assessment. There could also be a significant difference in size

between the two arteries and this may also affect the waveform results. The umbilical arteries supply different areas of the placenta which may be unequally affected by placental pathology and result in different levels of placental vascular resistance. The effect of alterations in placental resistance on the umbilical artery waveform has already been discussed in Chapter 4.3.3.

Variation of the fetal aortic waveform may be caused by changes in fetal peripheral vascular resistance and by cardiac contractility which may not alter the umbilical artery waveform to the same degree. Differences in fetal activity between examinations may also alter variability in the fetal aorta. Fetal position and movement can also hinder satisfactory Doppler waveform recordings of the fetal aorta and this could also contribute to an increased variability in the assessments successfully obtained.

It is concluded that in normal pregnancies the variation in indices of waveform analysis of the vessels studied is acceptably low and that from this point of view, there is no advantage to studying one vessel over the other. Whether these results can be extrapolated to abnormal pregnancies is uncertain and requires further study.

6.6 A cross sectional study of Doppler flow velocity waveforms in normal human gestation

6.7 Introduction

An intimate relationship exists between fetal well-being and placental and fetal blood flow. Until recently, inaccessibility of the fetus has prevented examination of the fetal and placental circulations. Most of the present knowledge concerning fetal circulatory physiology has been gained from observations on animal fetuses using invasive methods (Dawes, 1968), but Doppler ultrasound now allows a non-invasive assessment. For the correct interpretation of clinical results, it is necessary to collect data on the normal fetal and placental circulations. This study was performed in order to obtain Doppler values for the fetal aorta, inferior vena cava, umbilical artery and placental artery during normal human gestation in order to better understand fetal and placental cardiovascular

responses to pregnancy and also to be able to interpret the changes seen in pathological pregnancies.

6.8 Materials and methods

The study was a cross-sectional one carried out between the 20th and 42nd week of gestation in patients with uncomplicated singleton pregnancies attending the Ultrasound Department for a variety of indications. All women participating in the study gave birth at term to healthy babies whose weights were appropriate for gestational age. There were no infants with 5 minute Apgar scores less than or equal to 7 and no umbilical cord blood gases with pH of less than 7.25. Any patient who developed a pregnancy complication such as pregnancy induced hypertension or intra-uterine growth retardation, was excluded retrospectively. The investigation was approved by the Ethical Committee of the hospital. Each patient had had a previous ultrasound examination for dating purposes and was examined using the Doppler technique, as described below, on only one occasion. Routine biometric parameters, including biparietal diameter and abdominal circumference, were measured according to the methods reported by Hadlock (1982a, 1982b). Estimated fetal weight was calculated from the formula of Warsof (1977).

The equipment used, its calibration and the signal recording technique has already been described in Chapters 5.1, 5.2 and 5.3.

The data was analysed using both linear and curvilinear regression. Once the study was completed, the patients were divided on the basis of gestational age into two-weekly intervals from 20-42 weeks. The results were not revealed to the clinicians managing the patients.

6.9 Results

The study group comprised the singleton fetuses of 111 healthy patients.

6.9.1 The maternal "arcuate" artery

The arcuate artery proved to be the most difficult to assess but was obtained in

92 of 111 patients. The S/D ratio for this vessel remained constant throughout the pregnancy (figure 6.9.1).

6.9.2 The fetal descending aorta

Measurements of the velocity parameters were possible in all patients, but volume estimations were not obtained in three patients. Peak systolic, end diastolic and mean velocities increased until late gestation when a plateau occurred (figures 6.9.2a,b and c). The correlation coefficients for curvilinear regression analysis was significantly better than those for linear regression for all the aortic parameters ($p < 0.0001$). The best fit curvilinear regression equation for all the velocity data was of the form:

$$Y = \text{Exp} [1/X \times (B+C)]$$

A curvilinear increase in volume flow in the fetal aorta was seen with advancing gestational age (figure 6.9.2d) with a wide scatter of data points as gestational age increased. When corrected for estimated fetal weight, aortic blood flow showed little change throughout the pregnancy but a fall in this value at term was seen. (Table IV). The S/D ratio for the fetal aorta decreased with advancing gestational age (figure 6.9.2e).

6.9.3 The fetal inferior vena cava

There was a constant relationship in the amplitude of the systolic and diastolic peaks of the inferior vena cava waveform as gestational age advanced (figure 6.9.3).

6.9.4 The umbilical artery

The S/D ratio for the umbilical artery was achieved in all patients and was found to decrease with advancing gestational age (figure 6.9.4).

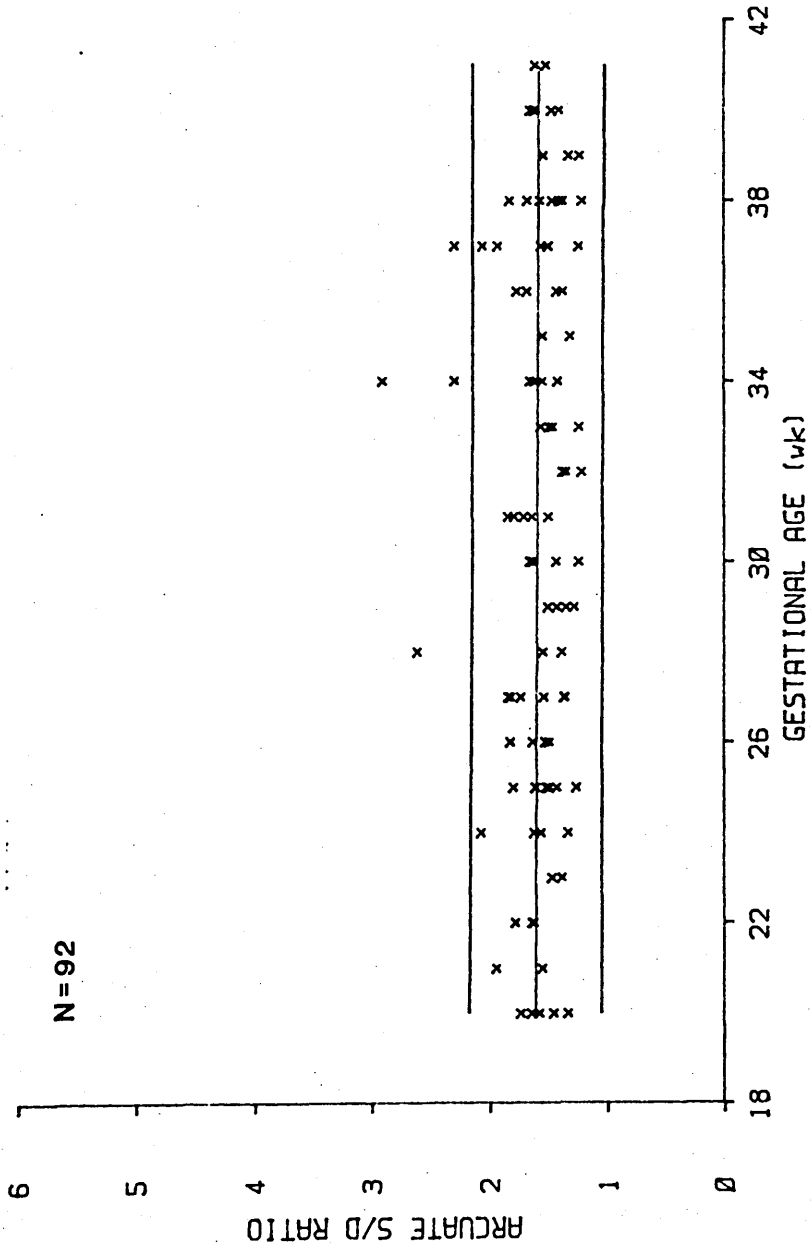

Figure 6.9.1 Maternal arcuate artery S/D ratio in normal pregnancy
 Lines are mean and 95% confidence limits of the data
 derived by linear regression

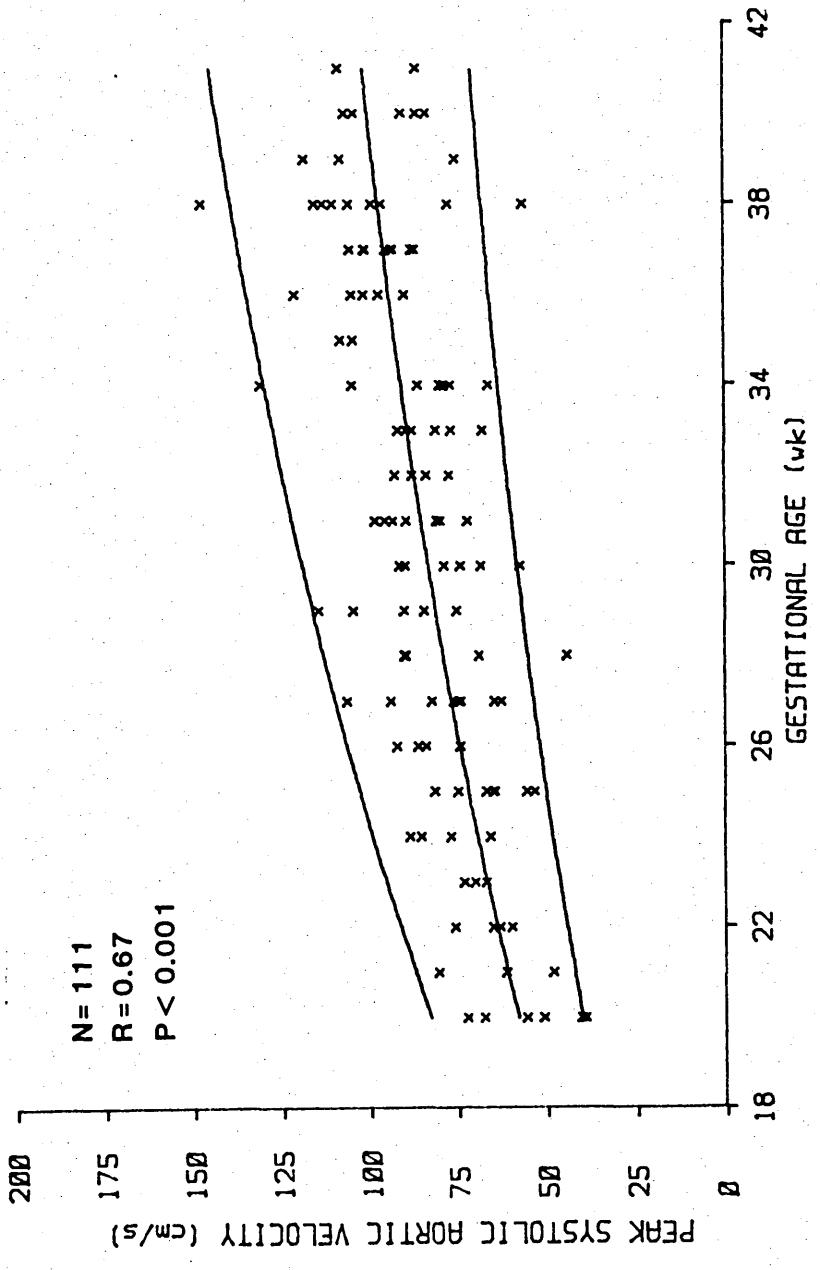

Figure 6.9.2a Peak systolic velocity in normal fetal aorta
 Lines are mean and 95% confidence limits of the data
 derived by curvilinear regression

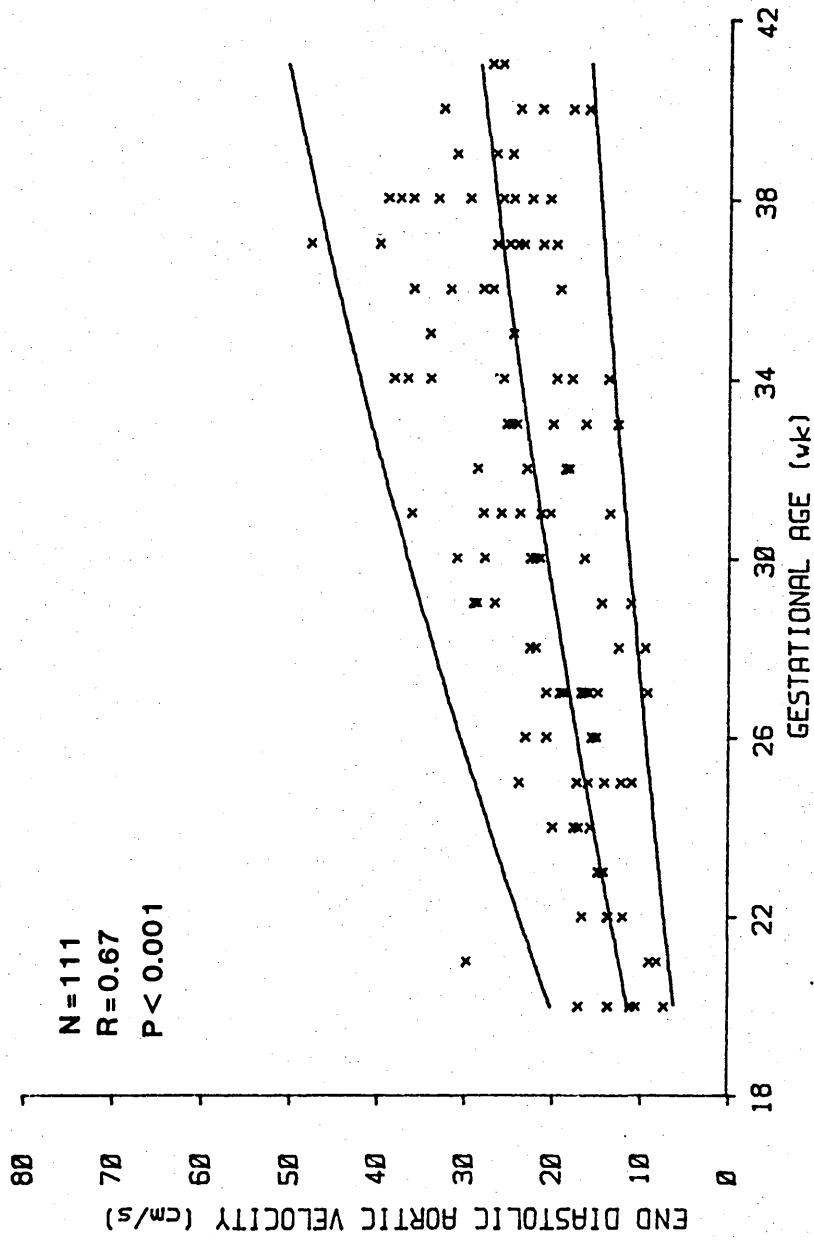

Figure 6.9.2b End-diastolic velocity in normal fetal aorta
 Lines are mean and 95% confidence limits of the data
 derived by curvilinear regression

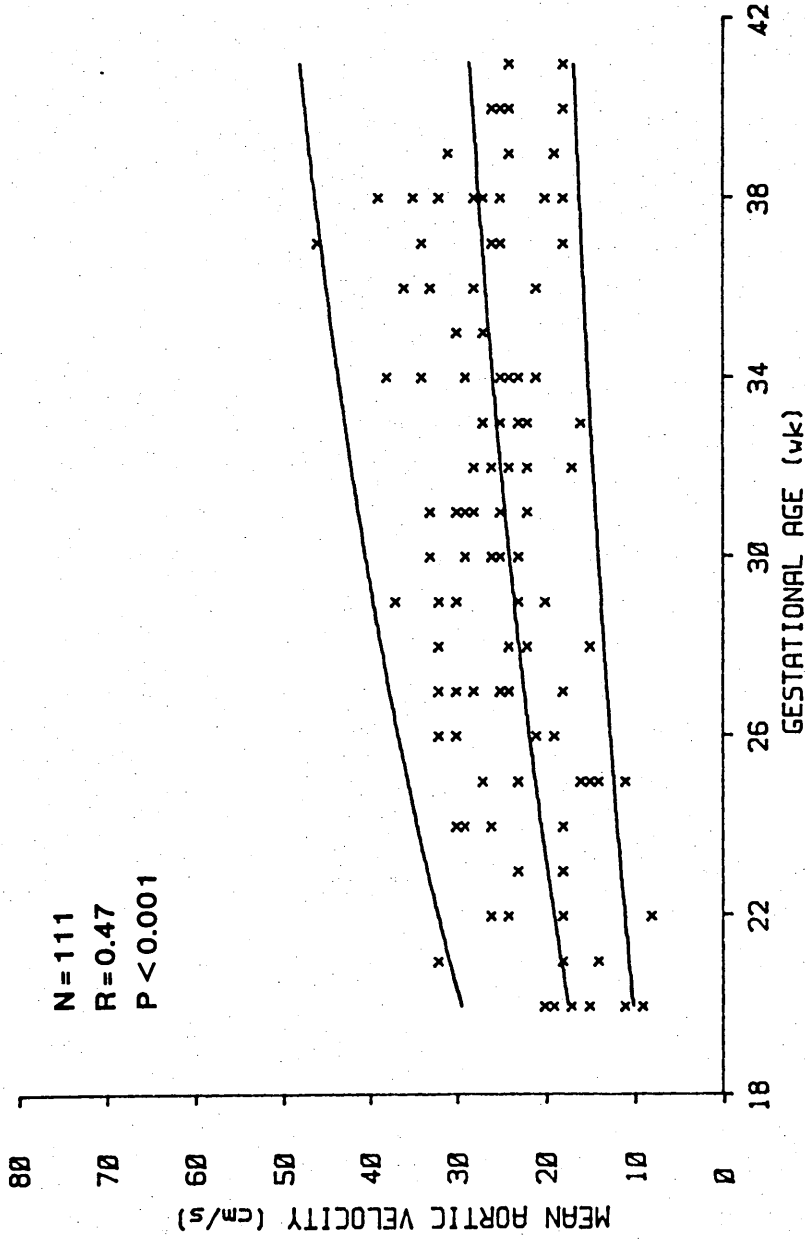

Figure 6.9.2c Mean velocity in normal fetal aorta
Lines are mean and 95% confidence limits of the data
derived by curvilinear regression

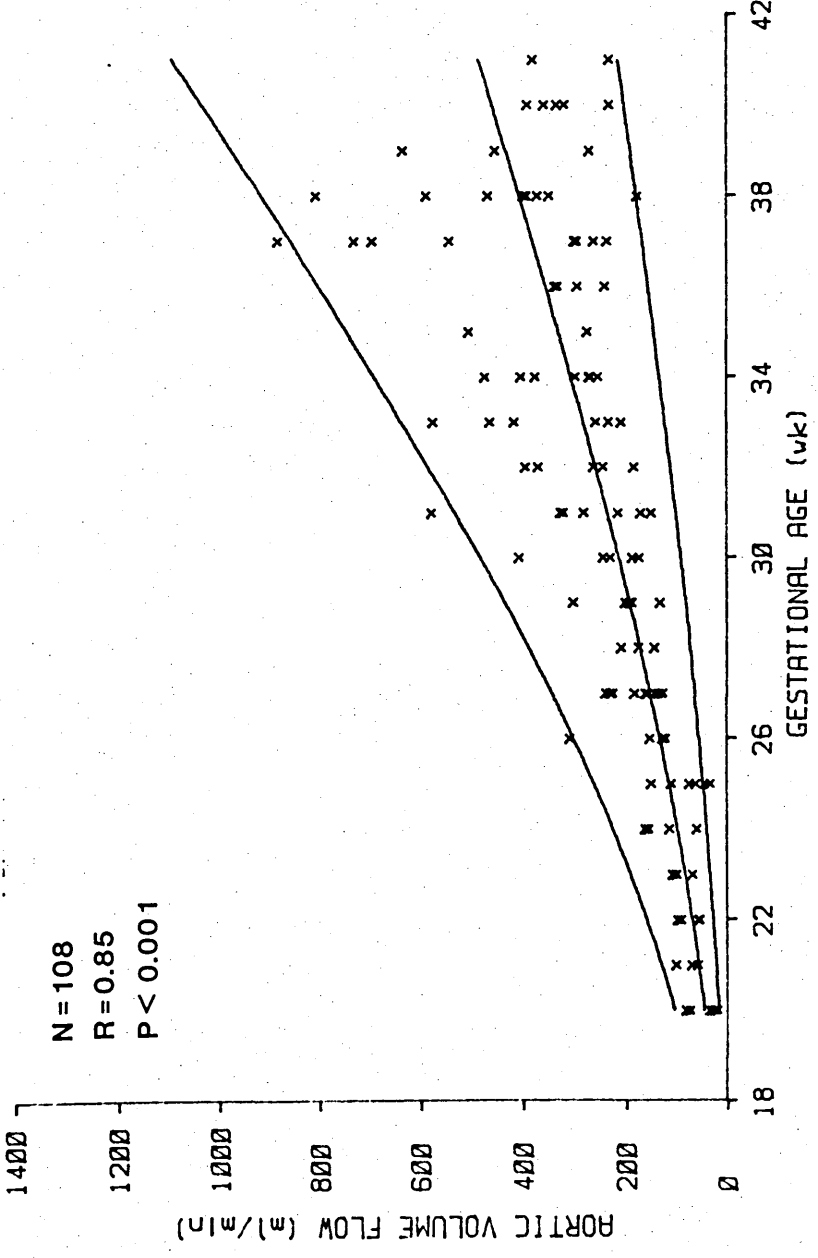

Figure 6.9.2d Fetal aortic volume flow in normal pregnancy
Lines are mean and 95% confidence limits of the data
derived by curvilinear regression

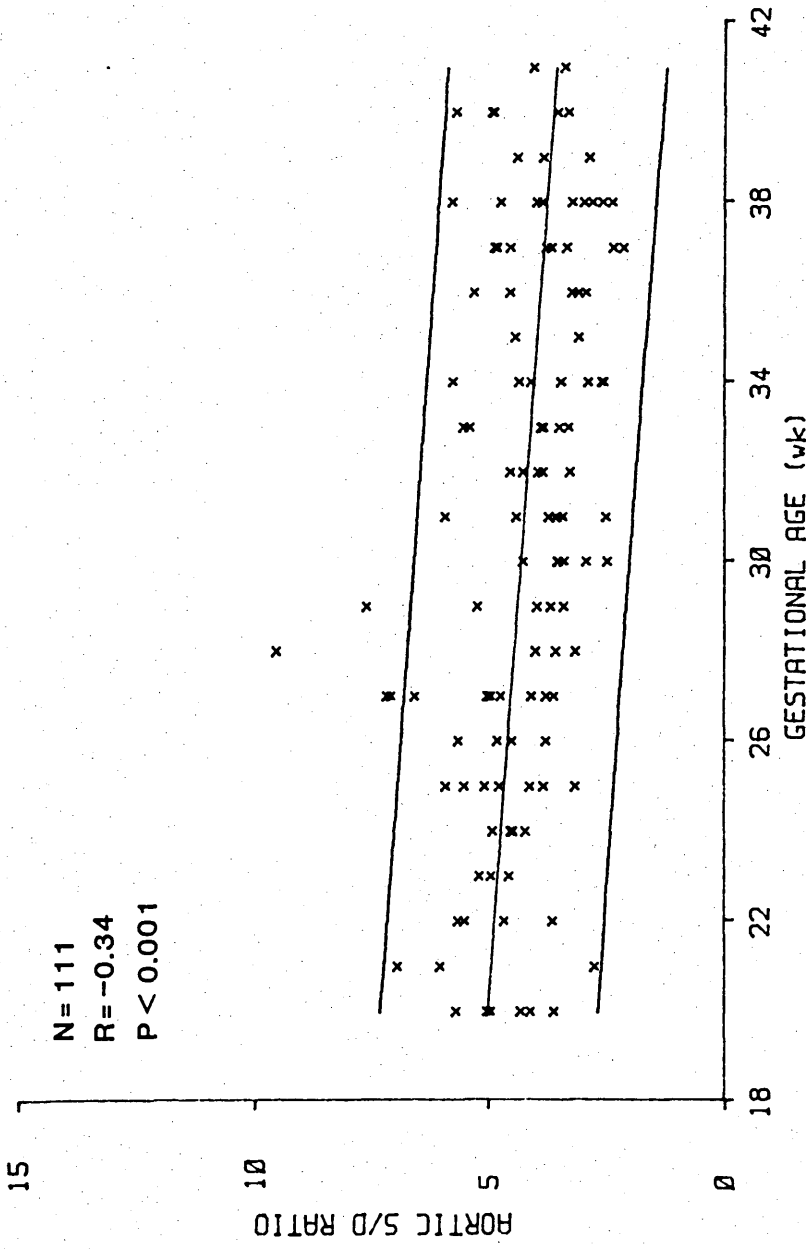

Figure 6.9.2e Fetal aortic S/D ratio in normal pregnancy
Lines are mean and 95% confidence limits of the data
derived by linear regression

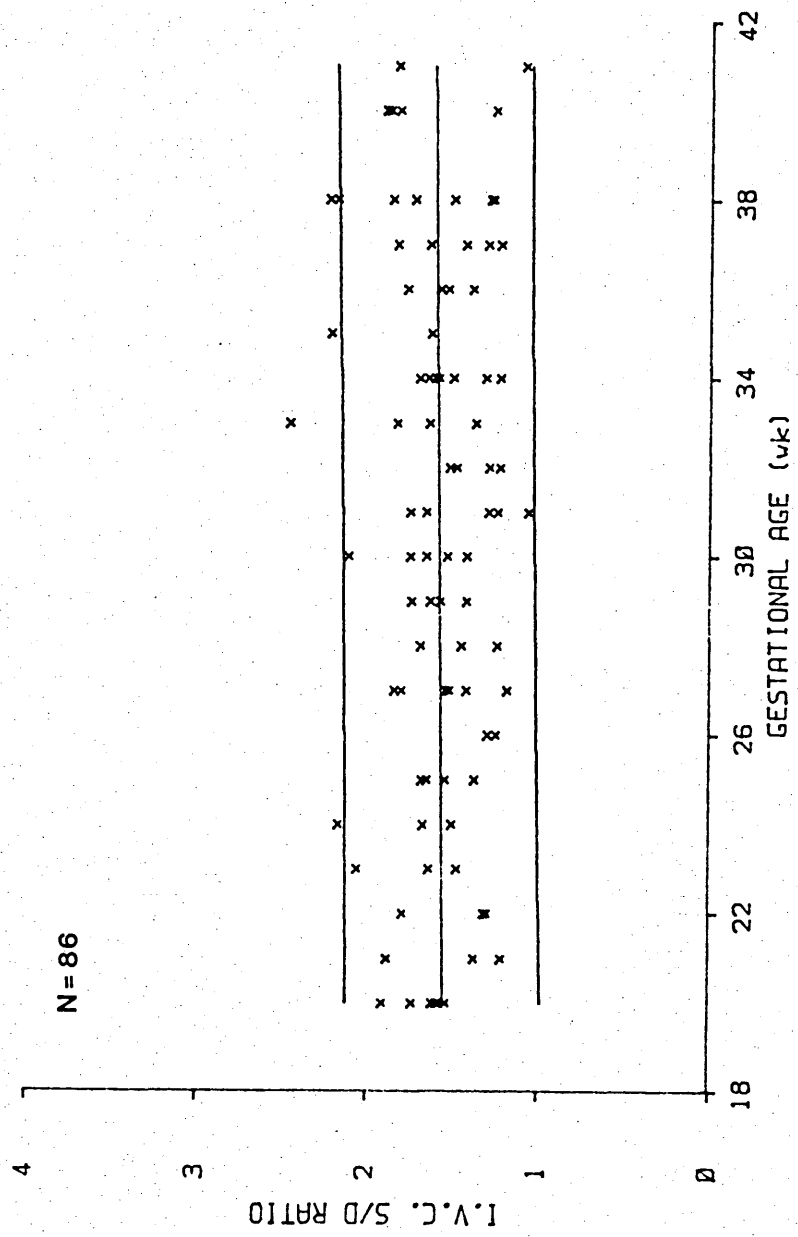

Figure 6.9.3 Fetal inferior vena cava S/D ratio in normal pregnancy

Lines are mean and 95% confidence limits of the data derived by linear regression

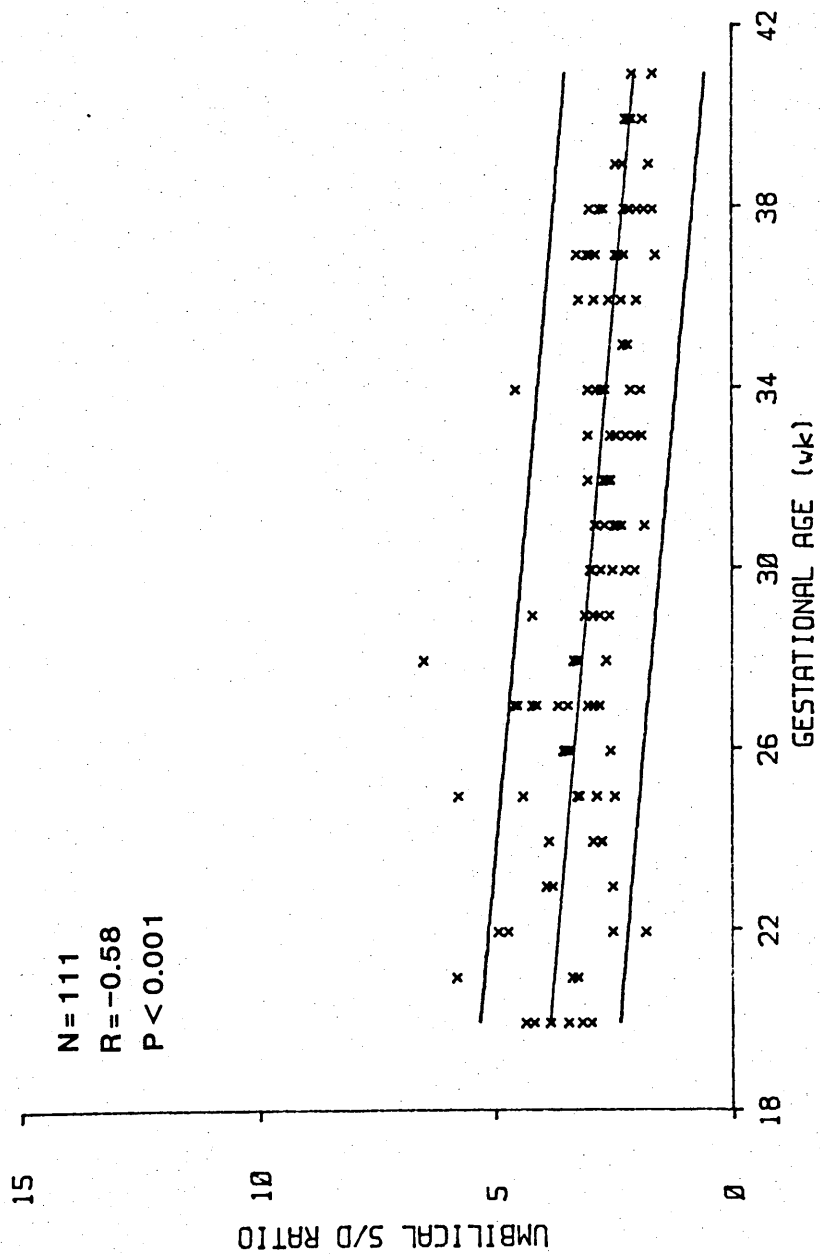

Figure 6.9.4 Umbilical artery S/D ratio in normal pregnancy
 Lines are mean and 95% confidence limits of the data
 derived by linear regression

6.10 Discussion

This study demonstrated that measurements of fetal aortic and placental blood flow can be performed in almost all patients during the second half of normal pregnancy. The curvilinear increase in aortic velocities is at variance with other recently published data (Marsal et al, 1984; Lingman et al, 1986a, 1986b; Tonge et al, 1986a). In these reports, no significant changes were seen in the aortic velocity parameters measured in the third trimester of normal human pregnancy. Some of the differences between these studies and the results from this study could be accounted for by differences in analysis, since the previous studies compared velocities averaged over several weeks in the third trimester. Such analysis may obscure a rise in the velocities which would be clearly apparent with curvilinear analysis. If the velocity and flow data from this study is analysed by calculating the mean at 4-weekly intervals of gestational age, the increase in late gestation is not as striking (Table IV). The fall in values at 40 weeks however, is still apparent.

Why do the aortic velocities increase? Systolic velocity is related to stroke volume and the force of cardiac contraction acting against peripheral impedance. Diastolic velocities appear to depend mainly on peripheral impedance. Some investigators (Anderson et al, 1984) have found that the myocardial contractile force in fetal lambs is enhanced over the last 4-6 weeks of gestation. Peripheral impedance, at least in the placenta, has been shown to decrease as gestation advances (Dawes, 1968, Trudinger et al, 1985a). Therefore, as in this study, it would be expected that the aortic velocities would increase with increasing gestational age. The cause of the plateau at term is not apparent but is consistent with the slowing of other fetal growth parameters at term (Williams et al, 1982).

The absolute levels of blood flow in this study were slightly less than those reported in other series (Eldridge et al, 1983 ,1985) where measurements were performed at comparable altitudes. A high altitude (Calgary is at 1100 metres above sea level) is reported to lead to relative fetal hypoxia and thus reduced blood flow (Eldridge et al, 1985). Smoking is also known to increase

Gestation (weeks)	20	24	28	32	36	40
Number of patients	9	11	9	9	13	4
Mean velocity (cms per sec)	17+/-6	21+/-6	26+/-7	28+/-5	29+/-7	23+/-3
Peak velocity (cms per sec)	57+/-13	68+/-11	85+/-19	93+/-19	102+/-23	95+/-10
End-diastolic velocity (cms per sec)	13+/-6	16+/-4	20+/-7	27+/-8	29+/-6	23+/-5
Volume flow (mls per min)	55+/-27	97+/-45	191+/-48	346+/-90	446+/-168	320+/-60
Volume flow/kg (mls per min per kg)	144+/-56	126+/-59	143+/-34	151+/-50	149+/-45	92+/-21

All measurements are tabulated as means together with their standard deviations

Table IV Fetal aortic Doppler parameters at 4-weekly intervals in normal human pregnancy

fetal aortic blood flow (Eldridge et al, 1983). The few smoking mothers (19 of 111) in our population may also have contributed to the lower values that were seen. Higher estimates of fetal weight are another possible source of discrepancy in the measurement of flow/kg. However, in this study, the fetal weight was calculated using the same method (Warsof et al, 1977) as in the series reported above where the aortic volume flows were higher. Quantitative assessment of volume flow is fraught with danger and this has been discussed in detail in Chapter 3.9. Such factors could account for the larger scatter of values seen in figure 6.9.2d. Despite these limitations, it is felt that volume flow may give important information about fetal cardiovascular status that is not available in semi-quantitative measures such as the S/D ratio, although serial measurements are probably required if it is to be used to assess fetal well-being. The other major fetal vessel, the inferior vena cava, was also sampled during this study. No significant change in the S/D ratio of this vessel was seen during gestation. However, this vessel does demonstrate marked changes in conditions of altered physiological states (Harder et al, 1986) and these are discussed in greater detail in Chapter 11.

Clinical interest in studies of fetal blood flow centre on the assessment of resistance to flow in the placental villous vascular bed. The S/D ratios for the fetal aorta and umbilical artery show a decline with advancing gestational age. This is due to the relatively larger increase seen in end diastolic velocity with advancing gestation. This downward trend has previously been reported (Stuart and Drumm, 1980; Griffin et al, 1983, Trudinger et al, 1985a) and is believed to be due to decreasing placental resistance on the fetal side of the circulation.

The "arcuate" artery proved to be the most difficult to assess, but it was obtained in 92 of 111 patients. The flow velocity waveform of the maternal arcuate artery demonstrated low pulsatility with high diastolic velocities indicating low flow resistance in the arterial supply to the intervillous space. The S/D ratio for this vessel remains constant throughout the pregnancy. Lack of change in the arcuate S/D ratio suggests that increasing gestation affects the fetal and maternal side of the placental circulations differently, but the reasons and importance are

unclear. Following this study, Pearce et al (1988) reported Doppler indices in normal pregnancy from the arcuate artery on the placental and non-placental side of the uterus. He demonstrated a fall with increasing gestation until approximately 24 weeks. Thereafter there was little or no change with gestational age. He speculated that the cause of this fall may be due to the trophoblastic invasion of the spiral arteries. This hypothesis is supported by their data which does not show this fall in the resistance index from the arcuate arteries on the non-placental side of the uterus. Trudinger et al (1985b) produced their range from 12 normal patients and used an index of least diastolic to maximum systolic frequency (the inverse of the S/D ratio). They demonstrated a continuing fall in this index and suggested that this was due to progressive increase in the cross-sectional area of the uterine vascular bed as observed in ovine pregnancy. However, this study used continuous wave Doppler ultrasound and although the placental bed was located initially by real-time ultrasound, it is impossible to be certain about the source of the signal in the absence of a range-gate. More recently, Bewley et al (1989) discussed the methodological problems in the assessment of the uteroplacental circulation and this has already been discussed in Chapter 4.5.

In conclusion, using pulsed Doppler ultrasound, fetal and placental blood flow can be measured in almost all patients. A curvilinear increase in aortic velocities and volume flow, and a linear decrease in S/D ratios in the fetal aorta and umbilical artery are seen with advancing gestation. The changes in these waveforms in pregnancy disease states such as pregnancy induced hypertension are discussed in Chapter 8.

CHAPTER 7
THE INFLUENCE OF HEART RATE
AND GESTATIONAL AGE
ON DOPPLER FLOW PARAMETERS
IN THE FETAL LAMB

7.1 Introduction

Knowledge of the variation in fetal Doppler waveforms in the short term or as gestational age increases is lacking in the fetal lamb. In addition, controversy exists as to the effect of an increase in heart rate on the Doppler flow pattern of the fetal aorta and the inferior vena cava. Following the study described in Sections 6.6-6.10 in human pregnancies, this study was undertaken to evaluate the variation in fetal aortic blood flow with time, with increasing gestational age and with heart rate in an animal model.

7.2 Materials and methods

All studies were performed in singleton fetal lambs. Each animal was restrained, unsedated on a cushioned table, as previously described. Doppler studies were performed using the Toshiba 2.42 MHz fixed angle, pulsed Doppler system as described in Chapter 5.1. All studies were recorded on to hard copy x-ray film and also on video tape for later analysis. The signal analysis used was that described in Section 5.3.

Once the animal was positioned and the skin prepared, the fetal lamb was visualised from the best available site. The descending aorta was aligned parallel to the transducer and the Doppler sample volume was large enough to cover the entire vessel diameter.

The initial part of the study was performed by a measurement of the S/D ratio and pulsatility index (PI) of the fetal aorta every 15 minutes for a period of 60-90 minutes in four animals. The variability coefficients were formulated for each fetus by dividing the standard deviation by the mean.

The second part of the study was performed by a single measurement of the S/D ratio, averaged over three cardiac cycles in the descending aorta of 20 fetal lambs ranging in gestation from 115-142 days.

The methodology in the third part of the study involved nine pregnant ewes of approximately 115 days gestation. Under general anaesthesia the fetus was instrumented to introduce bipolar electrodes in the fetal right atrium, ECG electrodes and femoral arterial and jugular venous catheters by the methods

described in Section 5.5. A recovery period of 5 days was allowed prior to any experimentation. With each study, initial baseline Doppler information was obtained from the fetal aorta and IVC. Pacing of the right atrium was then begun at a rate of 180 beats/minute with stepwise increments of 20-40 beats/minute to a maximum rate of 300 beats/minute. Atrial pacing was achieved using a General Electric Standby Pacemaker 7118 (General Electric, Fairfield, Connecticut, USA). Measurements of the S/D ratio, volume flow and velocity from the fetal aorta were taken with each incremental increase in heart rate.

7.3 Results

7.3.1 Time to time variation of the aortic S/D ratio

Figure 7.3.1 illustrates the variation in S/D ratio in the fetal thoracic descending aorta with time in each of the four animals. The coefficients of variation were low, ranging from 4-14%.

7.3.2 The effect of gestational age on the aortic S/D ratio

The effect of advancing gestational age on the aortic SD ratio is shown in figure 7.3.2, and demonstrated no significant change.

7.3.3 The effect of gestational age on the aortic pulsatility index (PI)

Figure 7.3.3 illustrates the influence of gestational age on the aortic PI. The PI remained stable over the study period.

7.3.4 The effect of gestational age on the aortic systolic velocity

The aortic systolic velocity increased until near term and was followed by a decline as illustrated in figure 7.3.4.

7.3.5 The effect of gestational age on aortic volume flow

Figure 7.3.5 illustrates a curvilinear increase in aortic volume flow to term followed by a drop in values.

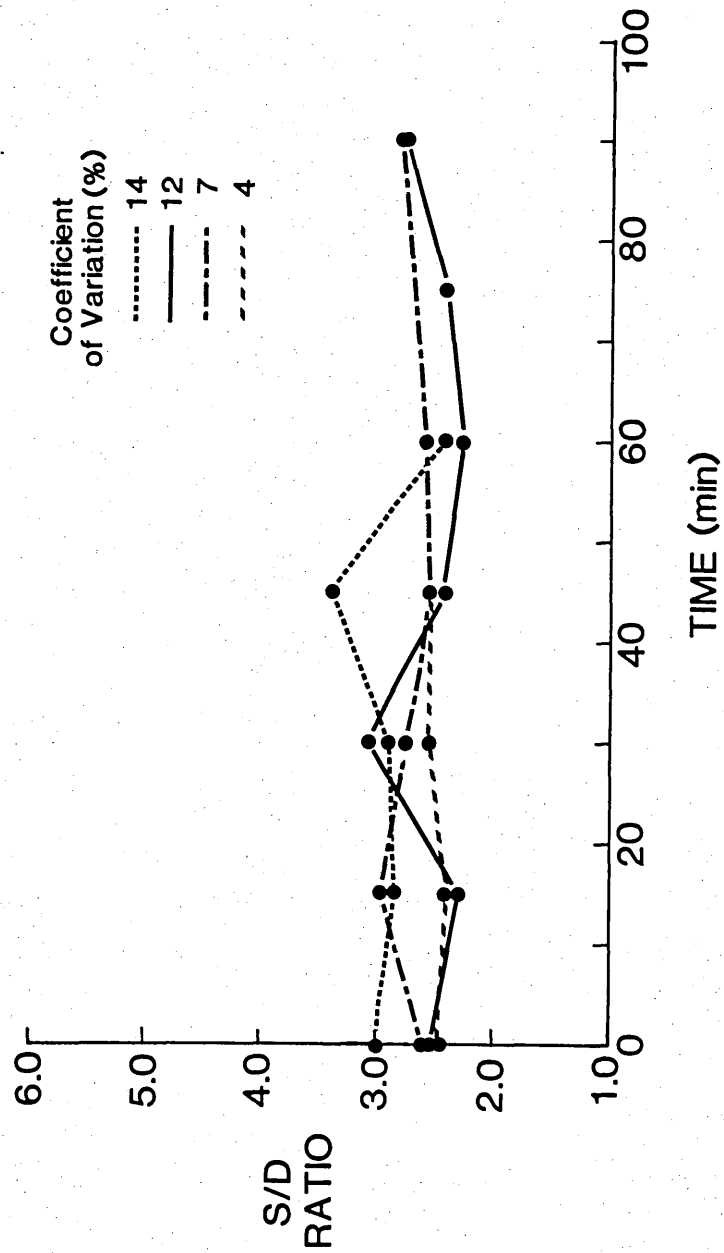

Figure 7.3.1 Variability of aortic S/D ratio

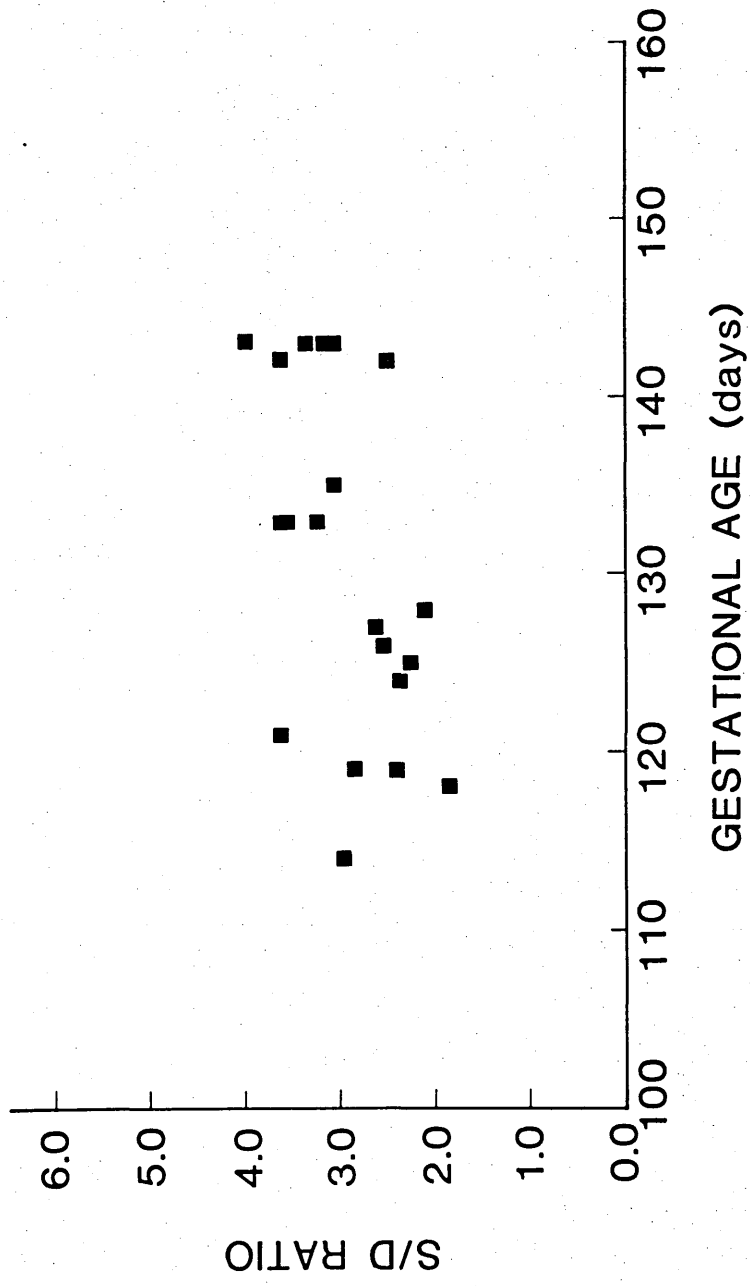

Figure 7.3.2 Scattergram of the relationship between gestational age and aortic S/D ratio

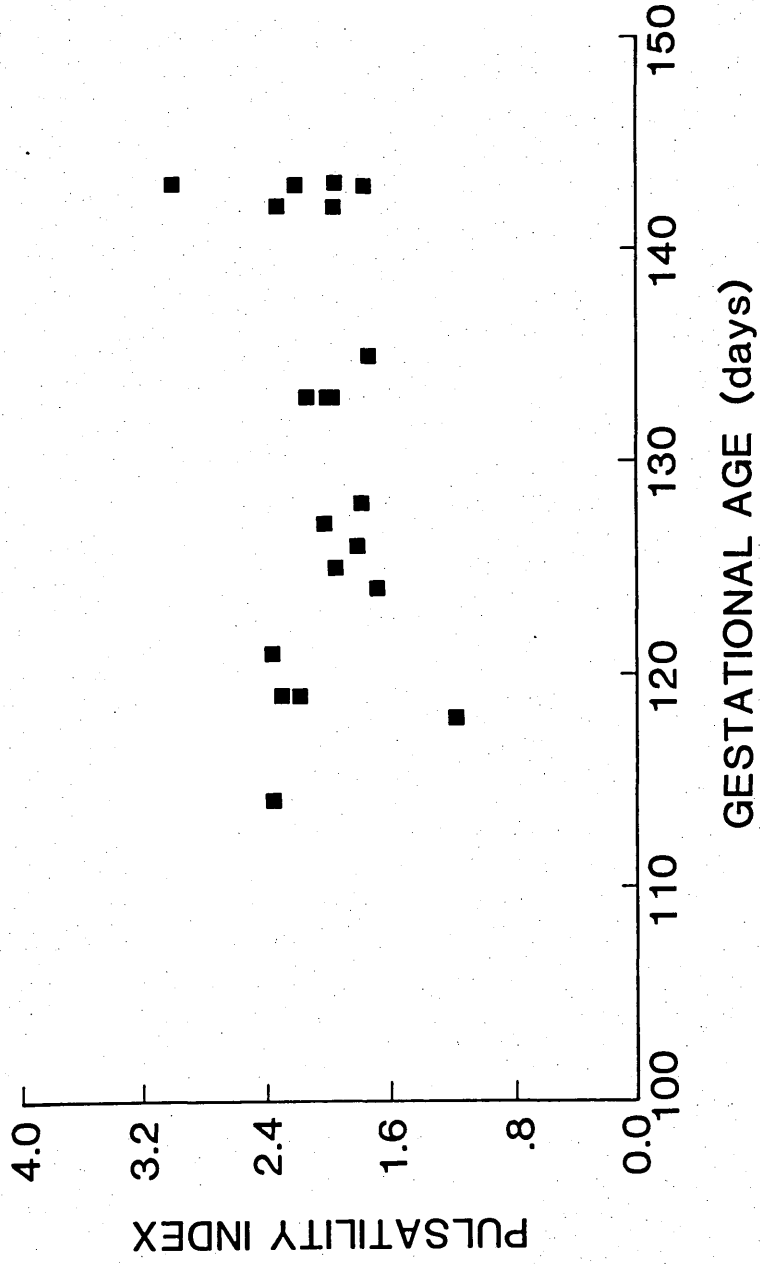

Figure 7.3.3 Scattergram of the relationship between gestational age and aortic pulsatility index

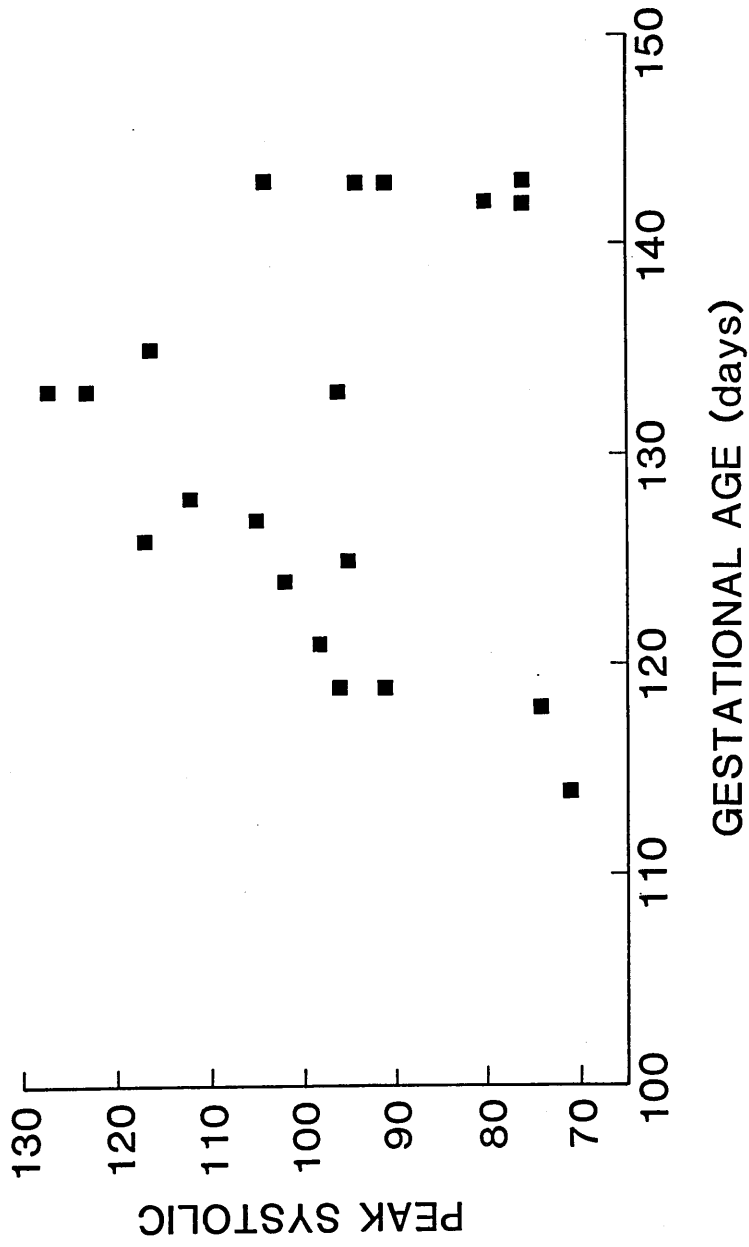

Figure 7.3.4 Scattergram of the relationship between gestational age and aortic peak systolic velocity

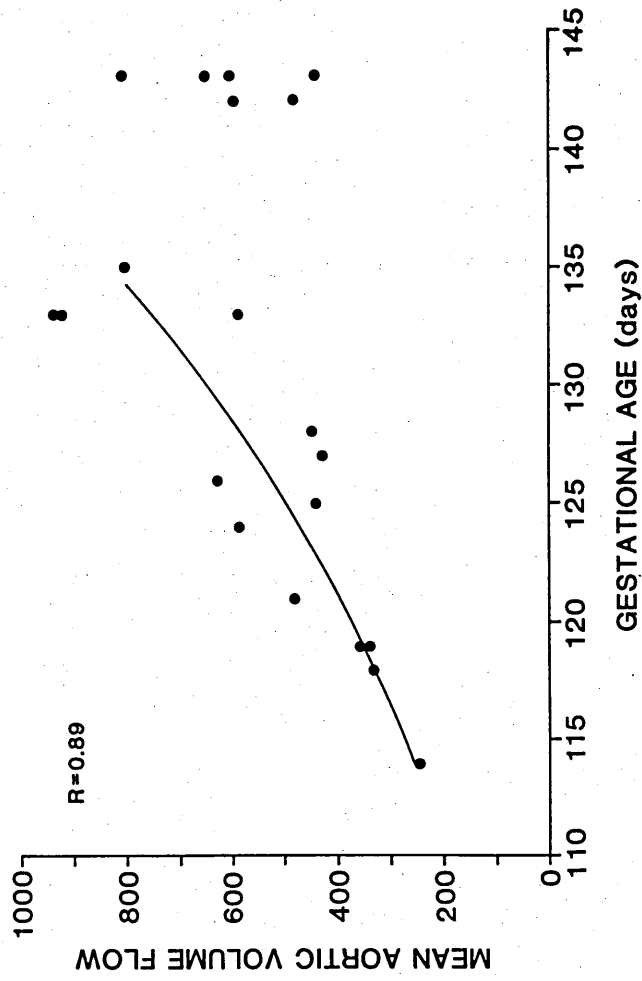

Figure 7.3.5 Scattergram of the relationship between gestational age and aortic volume flow

7.3.6 The effect of heart rate on the aortic S/D ratio

The aortic S/D ratio decreased progressively as the heart rate was increased by atrial pacing as seen in figure 7.3.6.

7.3.7 The effect of heart rate on the aortic mean velocity

Figure 7.3.7 shows the initial increase in aortic mean velocity until the heart rate reached approximately 220-240 beats/minute. This occurred in all but 2 animals with one other fetus demonstrating only a slight initial rise. As pacing was continued 6 of the fetuses demonstrated a decline in mean velocities with the end point value being generally lower than the baseline measurement.

7.3.8 The effect of heart rate on the aortic volume flow

The results of atrial pacing on aortic volume flow were similar to those seen with aortic mean velocity. Figure 7.3.8 illustrates the initial rise in volume flow seen in 3 fetuses and the fall in volume flow in 4 animals. As pacing was continued 6 fetuses showed a decrease in values. The end point value was lower than the baseline measurement in all but one fetus.

7.3.9 The effect of heart rate on the IVC waveform

The IVC waveform was evaluated qualitatively and is illustrated in figure 7.3.9. As previously described in Section 3.7.2, under baseline conditions there is a dominant systolic wave followed by a smaller diastolic wave. This pattern was drastically altered during pacing with dominant diastolic flow and systolic flow which is reversed in its direction. Immediately after discontinuation of the pacing, the reverse flow disappeared with re-establishment of the biphasic pattern. The systolic and diastolic flow peaks were however, equal in amplitude instead of the usual relationship.

7.4 Discussion

Many Doppler studies done *in utero* are lengthy, particularly when the fetus is situated in an unusual position. Animal studies with both acutely or chronically instrumented preparations can also extend over several hours. This study served to answer questions concerning the stability of the Doppler waveform indices in

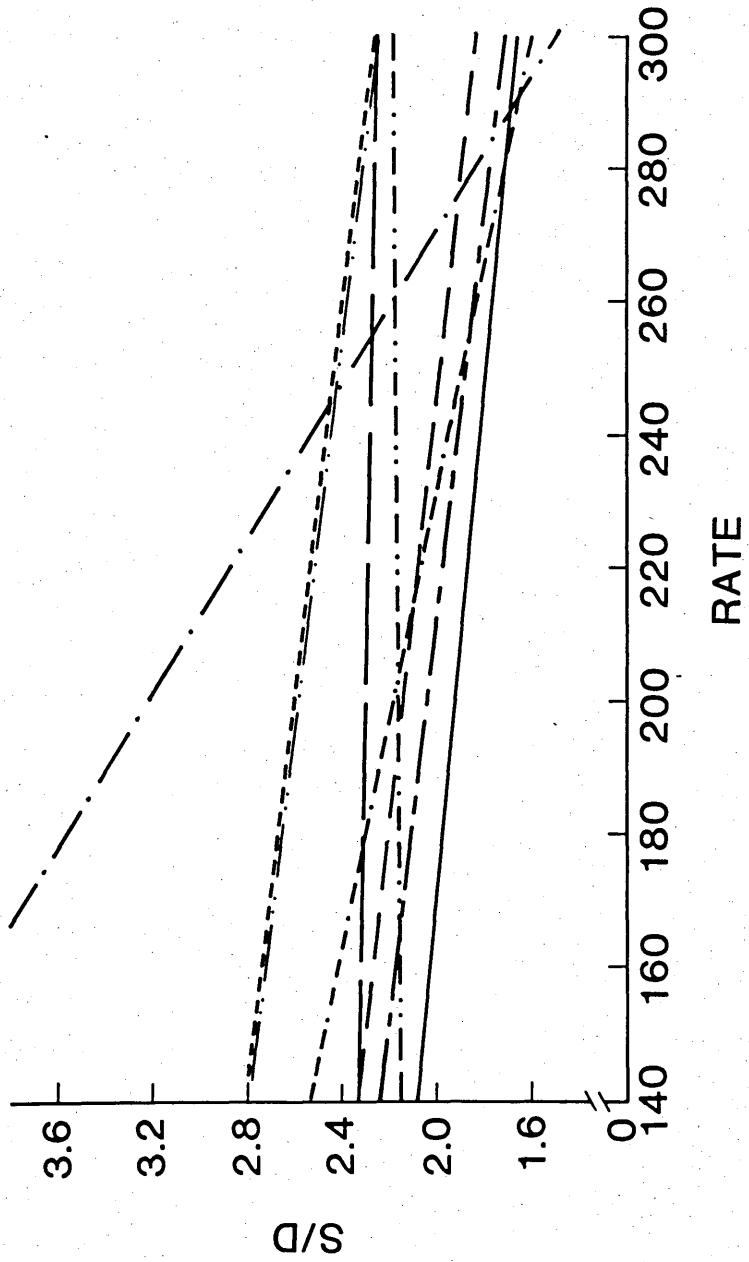

Figure 7.3.6 Slope of aortic S/D ratio versus increases in heart rate for nine fetal lambs . The slope for each fetal lamb was generated from an average of six data points

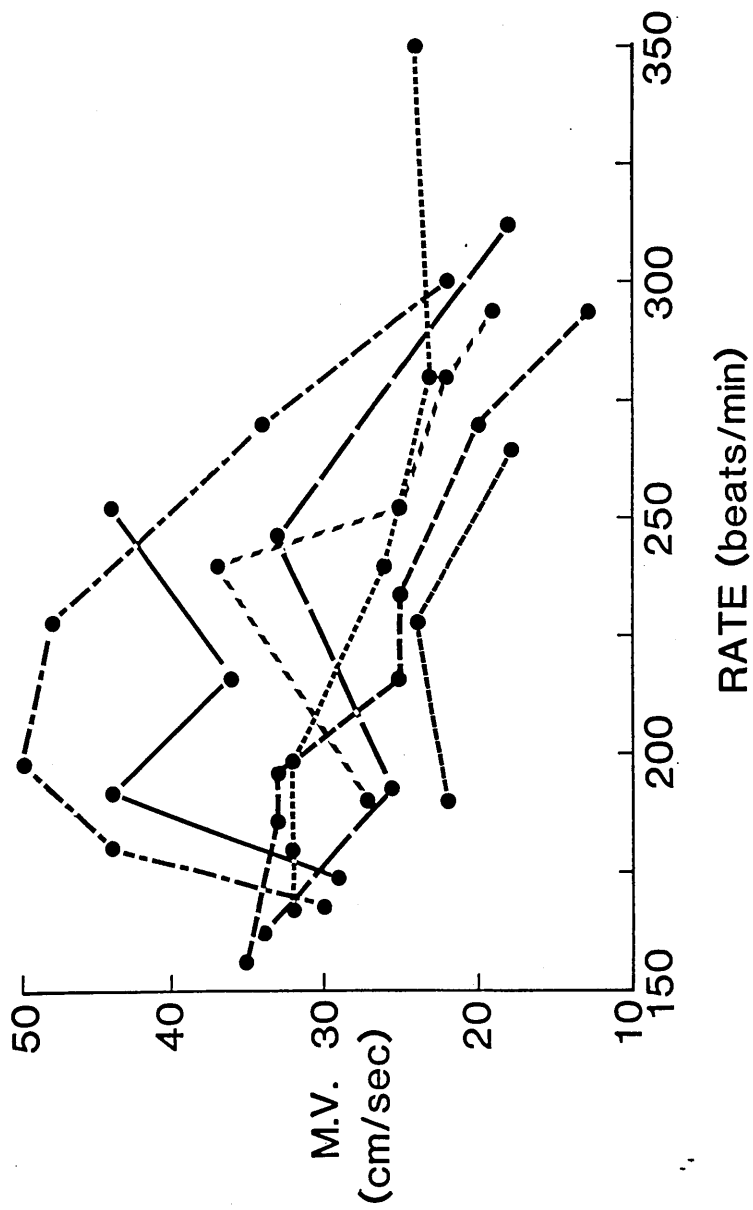

Figure 7.3.7 Changes in the mean velocity of the descending aorta of seven fetal lambs with increasing heart rate

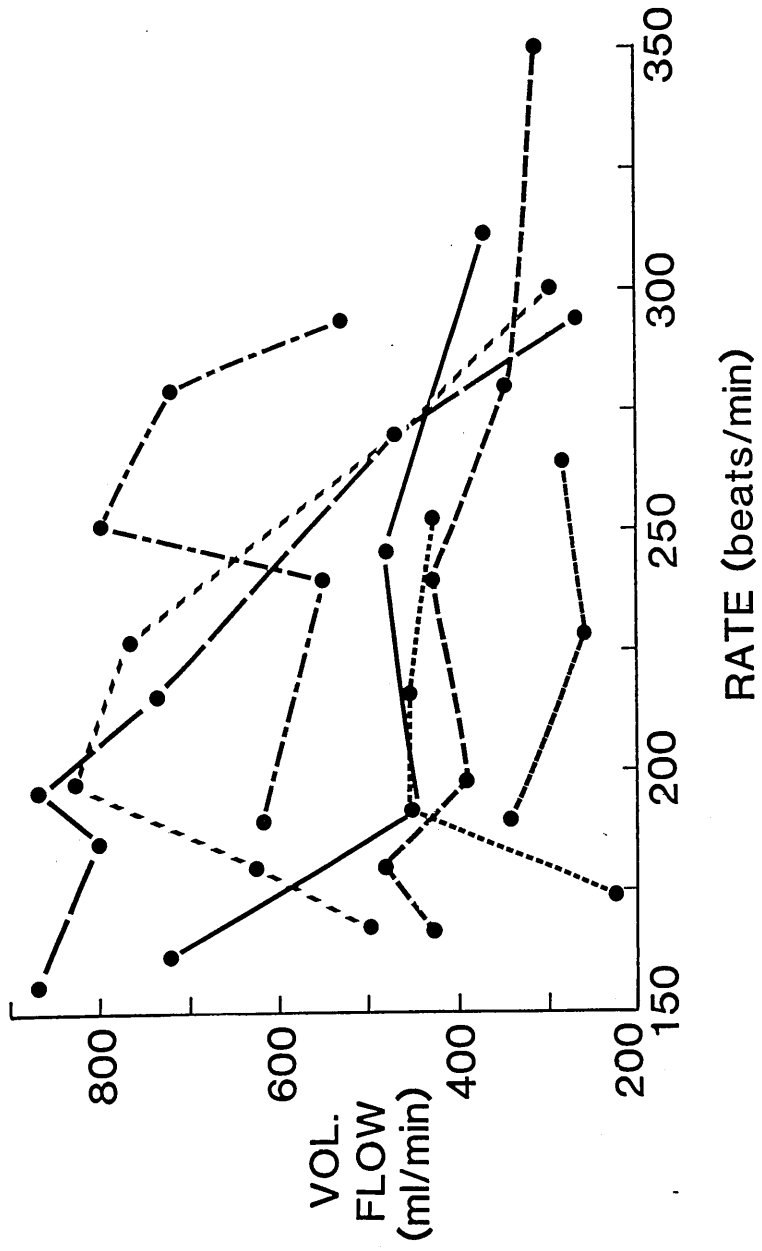

Figure 7.3.8 Changes in the volume flow of the descending aorta of seven fetal lambs with increasing heart rate

IVC Waveform

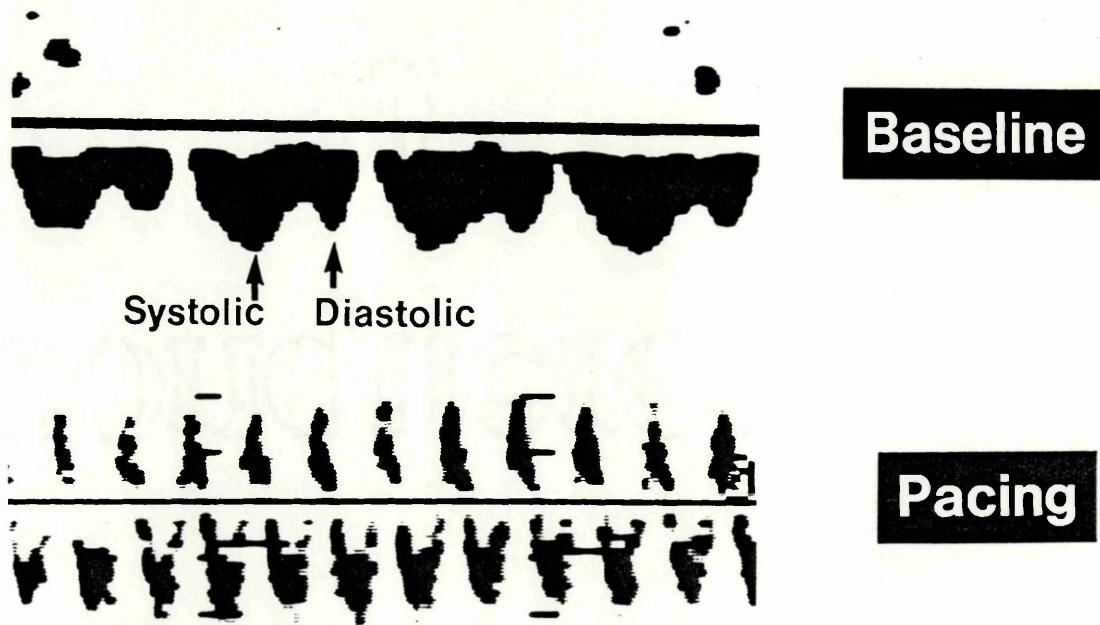

Figure 7.3.9

Fetal inferior vena cava waveform in association with rapid increases in heart rate

the fetal aorta over short periods of time. The low values of coefficients of variation which were found provided reassurance and allowed the identification of any abnormal changes in further experiments.

The results concerning the influence of gestational age on the aortic Doppler waveform of the fetal lamb are very similar to those reported in Chapter 6 on the human fetal aorta. However, there was a more pronounced fall in aortic velocities and volume flow at term in the fetal lamb than was seen in the human fetal aorta. It must be emphasised that caution must be exercised in the interpretation of quantitative blood flow measurements. The angle of insonation is very important in the measurement of peak systolic velocity; with a fixed angle duplex system, the angle may not always be at an ideal angle of less than 30 degrees. Likewise, volume flow introduces a much greater source of error in the measurement of vessel diameter since this error is squared in the volume flow calculation. The problems of quantitative Doppler waveform analysis have already been addressed in Chapter 3.9.

The longitudinal assessment of the aortic S/D ratio included fetal lambs of 115-140 days gestation. Newnham et al (1987) used continuous wave Doppler to evaluate umbilical flow in the normal sheep pregnancy from 66-140 days gestation. They observed a considerable decline in the peak systolic to diastolic flow in the umbilical artery from 66-115 days, with no significant variation thereafter. They concluded that this finding was consistent with that of Dawes (1962) indicating the lack of further decrease in umbilical artery impedance in late gestation. In this study, the aortic S/D ratio in the fetal lamb did not show this downward trend. Due to technical difficulties in visualising the descending aorta in fetal lambs under 100 days gestation, this study did not include any animals of such low gestational age and therefore only reflects the portion of gestation when the placental and fetal vasculature have a stable resistance and hence the stable S/D ratio.

As with the human results discussed in Chapter 6, an increase in peak and mean aortic velocity with growth was seen, followed by a drop towards term. These values were not compared to an estimated fetal weight. Uteroplacental flow

increases progressively in the pregnant ewe (Rosenfeld, 1974), because of increasing placental mass and decreasing vascular resistance (Clapp et al, 1980). However, Huchebee (1972) has reported an actual fall in flow per unit weight in late pregnancy which may explain the fall that this study has demonstrated in both peak and mean aortic velocity at term.

In a report of volume flow in the human fetal descending aorta, Eldridge et al (1985) reported an increase in aortic volume flow but not in the aortic velocities with increasing post-menstrual weeks. When the flow was normalised to estimated fetal weight, the value showed little change. Similar findings have been reported by Griffin et al (1983), but they also observed a slight drop in both total flow and flow per kg towards term in both the descending aorta and umbilical vein.

Observation of the Doppler waveform with induced elevations in heart rate showed a progressive decline in aortic S/D ratio, which was due to a fall in peak systolic velocity with preservation of the diastolic component. The systolic portion of the waveform is felt to reflect the compression wave with the peak velocity being an indicator of cardiac contractility. Pacing at lower levels (less than 220 beats per minute (bpm)) did produce an increase in volume flow despite the decrease in the systolic peak. However, above this level, the diastolic filling time of the ventricle is compromised and there was a concomitant fall in total volume flow. The progressive fall in the systolic wave presumably reflects a decline in the cardiac contractility. The results in this study are supported by the findings of Tonge et al (1986) who found that during fetal cardiac arrhythmia volume blood flow per kg fetal weight in the human fetus was maintained within the normal range, until heart rates reached around 50 bpm and 230 bpm when volume blood flow diminished. Following these observations, they have suggested that the Frank-Starling mechanism is functional in the fetal myocardium and that the results demonstrate the stability of the fetal circulation.

The Doppler waveform in the fetal IVC also revealed impressive changes. The marked flow above and below the baseline, with merging of the systolic and diastolic peaks and "a" wave reversal has been observed in a hydriopic 30-week

fetus with supra-ventricular tachycardia (Griffin et al, 1983). Reuss (1983) has reported similar changes in direct pressure measurements of the IVC with spontaneous and atropine produced increases in heart rate.

The "a" wave reversal likely occurs because of high-rate induced atrial pressure but could also be produced by tricuspid regurgitation. Further characterisation of the tricuspid valve flow pattern with pacing is necessary to explain this observation.

In conclusion, this study illustrates the variability in Doppler waveform indices in the lamb fetal aorta both in the short-term and with advancing gestational age. In addition, the impact of induced changes in heart rate on the Doppler waveform has also been described. The effect of these changes is of importance at the extremes of heart rate.

In view of the corroboration achieved comparing the Doppler waveform analysis in the human and animal situation, it became apparent that the fetal lamb was a useful animal in which to assess the fetal circulation and draw comparisons to the human situation. Further studies concerning both the clinical and experimental value of Doppler ultrasound at the extremes of fetal heart rate are discussed in Chapters 9 and 10.

CHAPTER 8
DOPPLER WAVEFORM STUDIES
IN PREGNANCY INDUCED HYPERTENSION

8.1 Introduction

Changes in the fetal and/or placental blood flow velocity may reflect fetal well-being and one of the objectives of this thesis was to evaluate Doppler ultrasound as a method of predicting ante-partum fetal asphyxia in pregnancies complicated by hypertension. The first part of this study concerns Doppler waveform examinations in patients with untreated hypertension in pregnancy. The second aspect of this study was to examine the influence of certain forms of anti hypertensive therapy on the Doppler waveform.

8.2 The consequences of fetal asphyxia

Hypoxia is defined as a decrease in the partial pressure of oxygen in arterial blood. Asphyxia means pulseless or suffocated but is commonly used to imply a combination of hypoxia, hypercarbia and incipient or actual acidosis. Fetal asphyxia may result in stillbirth or neonatal death or may cause neurological damage with permanent physical and/or mental handicap (Brann and Dykes, 1977). The disabilities attributed to fetal asphyxia may seriously impair the quality of life for the damaged child and enforce major adjustments and restrictions on the child's family. It is, however, possible for a fetus to withstand a period of acute asphyxia with no apparent residual disability or deficit.

The aims of antepartum fetal monitoring are two-fold. Firstly, to detect as early as possible the fetus at risk of hypoxic damage, and secondly to use this information in order to plan the optimum time to deliver a fetus in good condition at birth. The effectiveness of a fetal monitoring test should be judged not simply by its sensitivity and specificity in predicting adverse outcome, but also by its impact on clinical practice. A test may be highly predictive but is of little clinical use if it does not benefit pregnancy outcome (Whittle, 1987).

8.2.1 Death and neurodevelopmental handicap

The spectrum of perinatal compromise ranges from the extremes of death and debilitating major handicap to minor, nearly imperceptible, functional and/or structural defects. Adverse perinatal outcome, while rare, still remains a major life tragedy for the expectant couple. The goal of any antenatal fetal surveillance method is to detect the disease state and to initiate therapeutic intervention when possible at an early enough stage to avoid major sequelae. Balancing of fetal versus neonatal risk remains an integral part of these perinatal management decisions. By knowing with some considerable assurance the rate at which a perinatal disease process is progressing in the fetus, then this allows a rational decision to be taken regarding the need for, and the timing of, perinatal intervention.

When considering how to evaluate a test of fetal well-being, the definition of reliable and reproducible end points presents a major stumbling block. By convention, the perinatal death rate has been used as the end point to measure efficacy of antepartum fetal surveillance schemes since this end point is clearly defined and not subject to observer bias or error. Mortality is unequivocal and in this respect is an ideal end point. However, in developed countries, perinatal mortality is a relatively rare event, and a study seeking to evaluate the role of a fetal monitoring test by reduction in mortality would require thousands of participants.

Apart from death, intrapartum asphyxia may express itself as neurological damage. Accurate detection of neurological injury requires expert and detailed follow-up. The development of seizures in the neonatal period is associated with an increased risk of subsequent handicap, particularly if the seizures are multiple and recur over a prolonged period (Holden, 1982, Denis and Chalmers, 1982). However, a significant percentage of infants with convulsions at birth or neurological abnormalities in the first year of life, do not suffer severe deficits in the longterm (De Souza and Richards, 1978, Nelson and Ellenberg, 1982). Conversely, damage may occur which is not clinically evident for several months or years after birth. There is now

accumulating evidence to suggest that childhood neurological dysfunction may result from factors present long before the onset of labour (Illingworth, 1985; Holm, 1982; Symonds, 1987; Nelson and Ellenberg, 1986; Taylor et al, 1985) and that the events of parturition are incidental.

If both fetal and uteroplacental Doppler waveforms are to be assessed as a method of monitoring fetal well-being during the antepartum period, it is important to compare this method to other gold standard methods of antepartum fetal surveillance. Condition at birth as assessed by Apgar score and cord blood gases are discussed in the next section and the other gold standards of fetal monitoring such as the cardiotocograph and biophysical profile score are discussed in Section 8.3.

8.2.2 Apgar score, fetal umbilical cord pH

The parameter most likely used to define fetal condition at birth is the Apgar score (Apgar, 1953; Apgar et al, 1962). Although providing a rapid physical assessment of the newborn infant, the five elements of the score may be influenced by many factors and a low value does not necessarily indicate fetal asphyxia (Sykes et al, 1982). A low score may be associated with prematurity (Goldenberg, 1984), respiratory depression secondary to maternal analgesia, trauma, intrauterine infection or congenital abnormalities affecting the fetal cardiovascular or muscular systems. There is little correlation between Apgar score at either one or five minutes and longterm physical and neurological development (Fields et al, 1983, Nelson and Ellenberg, 1981).

It has been suggested that a combination of acidosis with hypercarbia and hypoxia in cord arterial blood and a low five minute Apgar score provides conclusive evidence of birth asphyxia (Boylan, 1987). Neonatal acidaemia has traditionally been defined as an umbilical artery pH of less than 7.2 (Wible et al, 1982). However, a low umbilical artery and/or vein pH at delivery may simply reflect a terminal event such as a difficult operative delivery or a prolonged period between crowning of the head and delivery

(Wood et al, 1973) or transient maternal hypotension. Furthermore, cord blood pH may be influenced by the sampling and analysis technique (Sykes and Molloy, 1984). Cord blood pH does not appear to be an accurate predictor of neurological complications neonatally (Dijxhoorn et al, 1986, Low et al, 1985) or later in childhood (Aarnoudse et al, 1985). Johnson et al (1988) studied the relationship of acidosis in cord arterial blood and neurological development at four and a half years. The highest proportion of children with no impairment was found amongst those who were most severely acidotic at birth. The authors of this study concluded that cord blood pH at delivery "should be used with caution when assessing causes of longterm handicap".

A major problem in assessing the infants condition at birth and comparing this to antepartum evaluation of fetal well-being is that condition at birth can be profoundly affected by events leading up to or during labour. With the advent of new techniques such as fetal blood sampling (Daffos, 1983) *in utero* acid base status can now be determined (Soothill et al, 1986). However, until such techniques become established, a new technique such as Doppler ultrasound to evaluate the fetus antenatally should be compared to established non-invasive techniques such as cardiotocography and biophysical profile scoring. One of the objectives of this thesis was to address the question of the value of Doppler ultrasound in assessing fetal well being *in utero* compared to other non-invasive methods of fetal monitoring. A study comparing the value of antenatal Doppler studies with cardiotocography and biophysical profile scoring in patients with pregnancies complicated by hypertension is presented later in this chapter.

8.3 Techniques of assessing fetal well being in the human fetus

Before addressing the question of a relationship between the fetal and uteroplacental Doppler waveform and fetal condition in complicated pregnancies, it is relevant to consider the efficacy of current antepartum fetal monitoring tests.

8.3.1 The cardiotocograph

Fetal heart rate responses to intrinsic stimuli such as fetal movement have been studied as predictive tests of fetal function. This test was designed to detect fetal asphyxia, real or potential, and was not designed to recognise other serious conditions such as developmental anomaly or acquired fetal disease. Through empiric observation, the combination of fetal heart rate accelerations with fetal body movements has been associated with a high probability of a favourable perinatal outcome (Rochard et al, 1985).

Since this test of fetal condition requires only passive observation and does not require perturbation of the fetal environment by extrinsic stimuli, the term "non stress test" (NST) has been most commonly applied. The relationship of the NST results to perinatal outcome has been studied extensively in high risk pregnancies. The interpretation of test results may vary from study to study in accordance with the number of required accelerations (range 2-5) and the duration of testing (range 10-20 minutes). In general, a test result is recorded as normal (reactive) if at least two accelerations of at least 15 beats/minute are observed within 20 minutes of continuous observation and is termed abnormal (non reactive) if these criteria are not met in 40 minutes. Two major clinical problems exist with this single variable method of fetal risk assessment. First, the frequency of abnormal tests is relatively high, in the order of 9-10% and the true positive predictive accuracy of the abnormal test is low, in the order of 12-30% (Lavery, 1982). The positive predictive accuracy may be improved by extending the duration of observation (Brown, 1981) or by combining other testing modalities such as fetal breathing monitoring (Manning, 1979) or contraction stress testing (Braly, 1982). In view of the problems experienced with antenatal fetal heart rate monitoring and due to the vast improvements in dynamic ultrasound imaging of the fetus, newer techniques have been developed to assess the fetus in-utero.

8.3.2 The biophysical profile score

The impact of high resolution dynamic ultrasound image on the development of the science of fetology is difficult to overstate. The ability to "see" the fetus and its environment and to monitor fetal activity and the responses to intrinsic and extrinsic stimuli, shifts the factual and psychological basis of the practice of fetal medicine profoundly. The ability to visualise the fetus and its activities allows for application of the time honoured principle of physical examination, albeit indirect, creating the emerging concept of "the fetus as a patient". The growing ability to accurately catalogue fetal responses to the potentially detrimental effect of maternal disease states (such as pregnancy induced hypertension) expands our understanding of the mechanisms by which maternal condition may influence fetal health. Based upon this knowledge, it becomes possible to identify specifically and differentiate accurately fetal risk from maternal risk. This then allows for abandonment of a universal management approach to some obstetric problems (eg routine delivery of all fetuses after 42 weeks) to a selective approach based upon fetal risk (eg delivery of all post mature fetuses when signs of compromise such as oligohydramnios are observed) (Phelan et al, 1985, Chamberlain, 1984). Fetal biophysical profile scoring is a method of fetal assessment based on dynamic ultrasound monitoring of five fetal variables and interpretation of these variables as normal or abnormal according to fixed criteria (Table V). The variables may be considered as two groups: those that reflect immediate fetal condition (fetal movement, tone, breathing, heart rate activity) and those that reflect fetal condition in the longer term (amniotic fluid volume). Each variable is subject to complex influence in both the normal and pathologic state. Observation is continued until either all variables are normal or 30 minutes of observation have elapsed. At the end of the observation period, the variables are judged as normal or abnormal and then are assigned an arbitrary score of 2 if normal and 0 if abnormal (Table V). Thus, a range of scores of 10 (all variables normal) to 0 (all variables abnormal) may be reported. The results of a prospective study of 1184 high risk pregnancies suggested that management based on this profile may result

Biophysical Variable	Normal (score=2)	Abnormal (score=0)
Fetal breathing movements	At least 1 episode of at least 30 secs in 30 min	Absent or no episode of >30 secs in 30 min
Gross body movement	At least 3 discrete body/limb movements in 30 min	<2 episodes of body limb movements in 30 sec
Fetal tone	At least 1 episode of active extension with return to flexion of fetal limbs or trunk; opening or closing of hand	Slow extension with return to partial flexion or movement of limb in full extension or absent fetal movement
Reactive fetal heart rate	At least 2 episodes of acceleration of >15 bpm and at least 15 sec duration associated with fetal movement in 30 min	<2 accelerations or accelerations <15 bpm in 30min
Qualitative amniotic fluid volume	At least 1 pocket of amniotic fluid that measures at least 1cm in 2 perpendicular planes	Either no amniotic fluid pockets or a pocket < 1cm in 2 perpendicular planes

Table V

The Biophysical Profile Score

in a significant decrease in perinatal mortality (Manning, 1981). In a study of 652 patients, Platt et al (1985) suggested that the biophysical profile is more predictive in diagnosing fetal condition than the non-stress test. Manning et al (1985) in a series of 12,620 referred high-risk pregnancies concluded that fetal biophysical profile scoring is an accurate method for identification of the fetus at risk for perinatal death. Both Manning and Platt agree, however, that the optimal method for the ante partum detection of the fetus at risk for death or damage has not yet been identified. The aim of the study presented next in this thesis was to use Doppler ultrasound to examine both the fetal and maternal circulations in a group of patients with pregnancies complicated by hypertension and to compare the results of the Doppler examination with those of the non stress test and biophysical profile.

8.4 Doppler waveform studies in pregnancies complicated by hypertension in pregnancy

Having established nomograms for our pregnancy population, as presented in Chapter 6, this study was performed to investigate the effect of hypertension in pregnancy on blood flow in the fetal placental unit.

8.5 Introduction

Pregnancy induced hypertension (PIH) is a common complication of pregnancy occurring in approximately 7% of primigravidae (MacGillivray, 1958). Clinical manifestations of this disorder include blood pressure elevation, proteinuria, and oedema. The disease varies in time of onset and severity. In the more severe cases, there are frequently disturbances of biochemical and haematological indices. Placental function can also deteriorate, resulting in blood flow disturbances in the fetus, impaired fetal growth, and fetal hypoxia. With severe pregnancy induced hypertension and fetal compromise, delivery is essential, even though this may result in high fetal mortality and morbidity because of prematurity. Previous methods

used to study uteroplacental blood flow have involved the use of radioactive isotopes, which may not be without danger to the mother and fetus (Lunell, 1982). Abnormalities of Doppler waveforms from either the fetal aorta or umbilical artery have been reported in pregnancies complicated by hypertension and intra-uterine growth retardation (Trudinger et al, 1985b; Fleischer et al, 1985; Erskine and Ritchie, 1985; Jouppila and Kirkinen, 1986; Griffin et al, 1983), but no author has investigated more than one vessel simultaneously.

The aim of this study was to explore the role of Doppler ultrasound of the of the fetal aorta and umbilical artery in the assessment and management of patients with varying degrees of hypertension.

8.6 Patients and methods

Patients who presented to the obstetric service of the hospital with hypertension in pregnancy were recruited into the study, which was approved by the hospital Ethical Committee. After reviewing the clinical information, patients were divided into three groups depending on the severity and the nature of the hypertension. Group 1 was made up of patients with chronic hypertension, Group 2 had mild pregnancy induced hypertension, and Group 3 patients had severe pregnancy induced hypertension. The criteria used was that of the American College of Obstetricians and Gynaecologists (Pritchard and MacDonald, 1985).

Even though the medical management of all patients was the responsibility of the attending obstetrician, all patients were investigated using a similar protocol. The maternal observations were those commonly applied to patients with pregnancy induced hypertension. This included 4-hourly blood pressure recordings, daily urinalysis, twice-weekly full blood count including platelet count, twice-weekly urea and electrolytes including uric acid, and twice-weekly liver function tests. Weekly 24-hour urine collections for quantitative proteinuria and creatinine clearance were also performed. Fetal surveillance consisted of non stress tests (NST),

biophysical profiles, and fetal Doppler examination. In all patients the Doppler examination result analysed was the one performed at the time closest to delivery. The Doppler information was not made available to the clinician who was managing the patient.

The Doppler ultrasound examination was performed with the equipment described in Chapter 5. The decisions regarding the time and mode of delivery were made by the attending physician based on signs of deterioration of either maternal health or fetal well-being. Maternal indications for delivery included uncontrollable hypertension, deteriorating renal function, or laboratory signs of coagulation problems. The fetal indications for delivery were evidence of fetal distress either on a NST or biophysical profile. Fetal outcome data were analysed within the previously stratified hypertensive groups and was correlated with the tests used to determine fetal well-being.

8.7 Results

Forty one patients were recruited to the study during a 12-month period. The patients were categorised based on the nature of the hypertension, maternal characteristics, and perinatal outcome (Table VI). The mean gestational age at delivery in Group 2 was significantly higher than in Group 1 ($p < 0.05$) and Group 3 ($p < 0.001$). In addition, a higher proportion of fetuses in Group 3 (60%) were growth retarded at birth and required longer hospital stays than other groups. Five patients in Group 1 had superimposed pre eclampsia, three of whom had moderate pre eclampsia and two had severe pre eclampsia. These latter two patients required early delivery of low birth weight infants, and this skewed the mean gestational age of delivery and the birth weights of the group as a whole. The results of the final Doppler examination before delivery including aortic peak systolic, mean and end diastolic aortic velocities, and S/D ratios in the fetal aorta and umbilical artery were plotted on the nomograms for the patient population .

8.7.1 Group 1 - Chronic hypertension

	Mean Maternal Age	Primi gravidae	Multi gravidae	Mean G.A. (\pm 1S.D) at last exam.	Mean G.A. (+ 1S.D) at delivery	Mean Birth wt (Kg) (+1S.D) (+ range)	No. of Infants < 10 centile	Mean Length of Infant hospitalization (+ range) (days)
Group 1 N=14	29	8	6	33.6 \pm 4.9	34.9 \pm 5.5	2.9 \pm 1.0 (0.5-4.0)	3	15 (2-120)
Group 2 N=17	28	11	6	36.6 \pm 2.1	37.9 \pm 1.2	3.1 \pm 0.7 (2.3-4.4)	3	5 (2-7)
Group 3 N=10	25	10	0	31.2 \pm 3.8	31.4 \pm 3.9	1.4 \pm 0.6 (0.4-2.5)	6	42 (2-212)

G.A. - Gestational Age

Table VI Maternal Characteristics and Perinatal Outcome of Study Groups

Of this group of patients with chronic hypertension, two patients had abnormal aortic Doppler results (figures 8.7a-d). One patient developed a non reactive NST three days later and was delivered. The second patient had labour induced two days after abnormal Doppler results because of deterioration of maternal health. Both of these patients were delivered of infants who were small for gestational age (SGA). The other patient in Group 1 who delivered a SGA infant had a Doppler examination performed two days before delivery. This patient who had severe hypertension and lupus nephropathy was delivered because of massive abruptio placentae. None of the patients in Group 1 with normal Doppler results delivered infants with low (< 7) 5 minute Apgar scores or low (< 7.25) umbilical cord gas values.

8.7.2 Group 2 - Mild to moderate pregnancy induced hypertension

When the Doppler examination was performed in the 17 patients with mild to moderate pregnancy induced hypertension, only one patient had any abnormal Doppler parameters (figure 8.7b), and the infant was SGA at delivery. Two other infants in this group were SGA. None had evidence of fetal compromise during antepartum or intrapartum monitoring. No infants in this group had low 5 minute Apgar scores or low umbilical cord gas values.

8.7.3 Group 3 - Severe pregnancy induced hypertension

The majority of abnormal Doppler waveforms were seen in this group. The detailed maternal and fetal outcomes of the 10 primigravidae with severe PIH are presented in Tables VII and VIII. The Doppler studies, biophysical profiles, and NSTs were done within one hour of each other in this group. The interval between the timing of the initial Doppler examination and the change in NST or biophysical profile or maternal health, which necessitated intervention, is also shown. Case numbers 2, 4 and 6 provide good examples of abnormal Doppler examination changes preceding NST and biophysical profile abnormalities. The results of the umbilical cord gas values in two of these infants are evidence that fetal compromise had occurred. Three

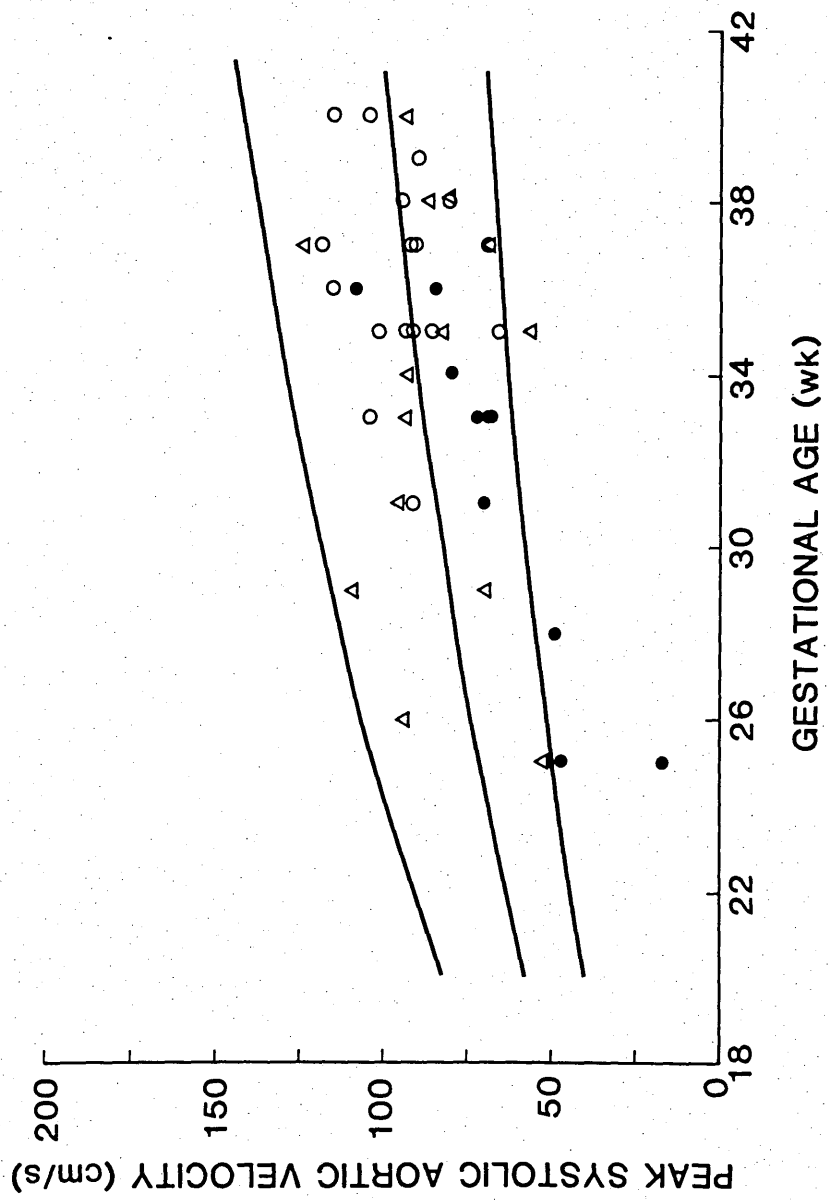

Figure 8.7a Results of fetal aortic peak systolic velocity for groups 1-3

△, Group 1

○, Group 2

●, Group 3

Lines are mean and 95% confidence limits of the normal pregnancy data

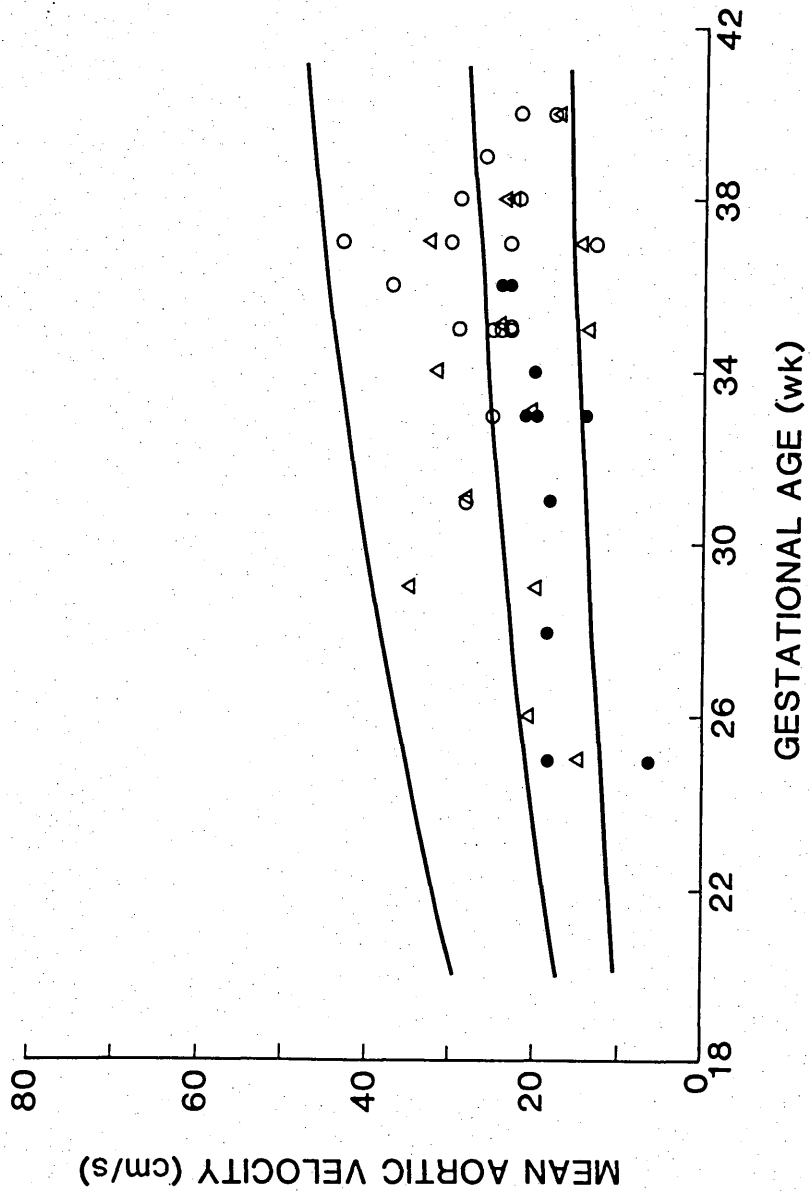

Figure 8.7b Results of fetal aortic mean velocity for groups 1-3

△, Group 1

○, Group 2

●, Group 3

Lines are mean and 95% confidence limits of the normal pregnancy data

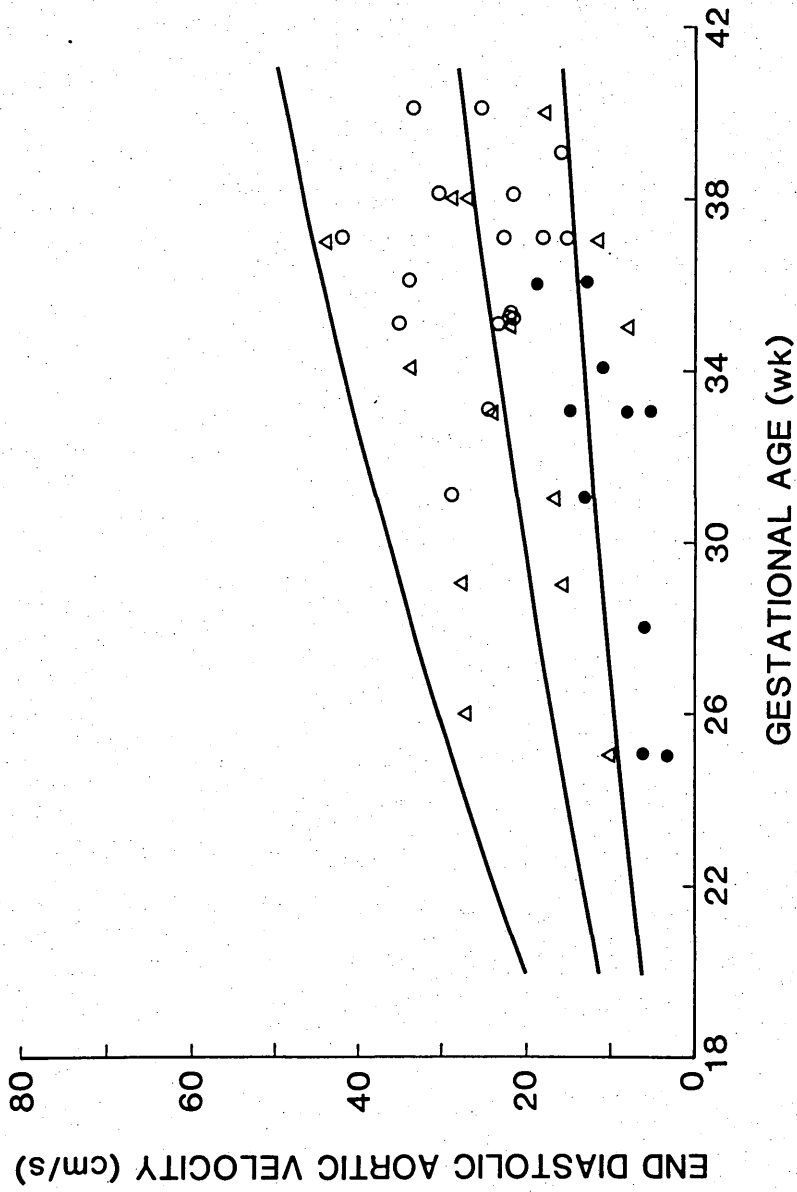

Figure 8.7c Results of fetal aortic end-diastolic velocity for groups 1-3

△, Group 1

○, Group 2

●, Group 3

Lines are mean and 95% confidence limits of the normal pregnancy data

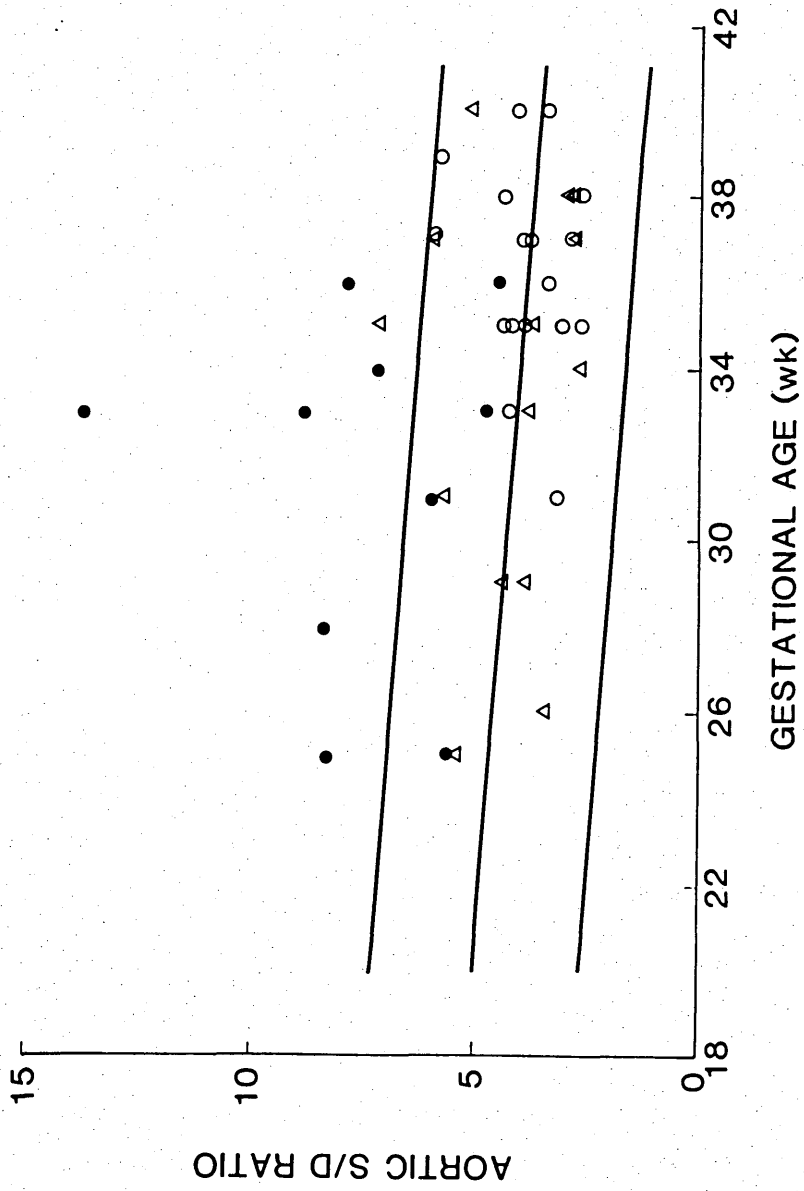

Figure 8.7d Results of fetal aortic S/D ratio for groups 1-3

- △, Group 1
- , Group 2
- , Group 3

Lines are mean and 95% confidence limits of the normal pregnancy data

Case Number	G.A.at delivery	Doppler Exam	B.P.P.	N.S.T.	Interval From Doppler To *Clinical Change	Indications for Delivery	Cord pH
1	25	Abnormal	6/8	R	3 hrs.	HELLP Syndrome, IUGR	7.29
2	25	Abnormal	6/8	R	36 hrs.	Decelerations on NST	7.23
3	31	Abnormal	2/8	R	4 hrs.	HELLP Syndrome, IUGR	7.26
4	28	Abnormal	4/8	R	24 hrs.	B.P.P. 0/8 NST non reactive	7.31
5	32	Abnormal	6/8	R	24 hrs.	HELLP Syndrome, IUGR	7.35
6	37	Abnormal	6/8	R	6 hrs.	Uncontrollable Hypertension Non Reactive NST	7.22
7	34	Abnormal	8/8	R	36 hrs.	HELLP Syndrome. IUGR	7.29
8	31	Normal	8/8	R	3 hrs.	Uncontrollable Hypertension	7.30
9	37	Normal	8/8	R	24 hrs.	Uncontrollable Hypertension	7.32
10	34	Normal	8/8	R	36 hrs.	Uncontrollable Hypertension	7.30

R - Reactive BPP - Biophysical Profile Score NST - Non Stress Test

* Clinical change = Abnormal BPP or NST or maternal indications for delivery

Table VII Detailed Outcome of Group 3 Patients

Gestation Delivery	Birthweight		Fetal Aorta			Umbilical Artery S/D	Total Abnormal Parameters	Ventilation(Days) Hospital (Days)	Follow-Up
	D	S	M	S/D	S/D				
25	SGA	1	1	0	1	1	4	17/17	DIED
25	SGA	1	1	1	0	0	3	77/212	BPD
31	SGA	1	0	0	1	1	3	14/42	BPD
28	AGA	1	1	0	1	0	3	9/30	FAIR
32	SGA	1	0	1	1	1	4	0/40	FAIR
37	SGA	1	0	0	1	0	2	0/30	GOOD
34	SGA	1	0	0	1	0	2	13/30	GOOD
31	AGA	0	0	0	0	0	0	2/7	EXCELLENT
37	AGA	0	0	0	0	0	0	0/5	EXCELLENT
34	AGA	0	0	0	0	0	0	5/13	EXCELLENT

D - End Diastolic Aortic Velocity S - Peak Systolic Aortic Velocity

M - Mean Aortic Velocity S/D - Systolic Diastolic Ratio

BPD - Bronchopulmonary dysplasia

Table VIII Doppler score and perinatal course in severe Pregnancy Induced Hypertension.

patients demonstrated abnormal elevations of the umbilical S/D ratio (figure 8.7e). The aortic Doppler examination also identified these three patients as abnormal but identified an additional three patients with abnormal aortic S/D ratios (figure 8.7d and Table VIII). Seven patients had low levels of aortic end diastolic velocities (figure 8.7c). Five of these infants had a sub-optimal outcome and the remaining two were growth retarded. Three of these infants also had low systolic aortic velocities (figure 8.7a). There was one case of a falsely normal S/D ratio in the fetal aorta. In this patient both peak systolic and end diastolic velocities were reduced proportionately. However, the mean velocity in the fetal aorta was also reduced. Table VIII correlates the number of abnormal Doppler parameters, length of time spent in the hospital, the number of days requiring ventilatory support, and longterm neonatal complications. The three infants delivered because of maternal indications only (cases 8-10) had no abnormal Doppler findings, and all had a short hospitalisation with excellent perinatal outcome.

8.8 Discussion

Pregnancy induced hypertension and intra uterine growth retardation are associated with impaired perfusion of the inter-villous space (Fleischer et al, 1985). Both of these conditions are associated with antenatal asphyxia, resulting in high perinatal mortality and morbidity. Previously published reports have focused either on umbilical artery (Trudinger et al, 1985b; Fleischer et al, 1985; Erskine and Ritchie, 1985) or aortic (Jouppila and Kirkinen, 1986; Griffin et al, 1983) blood flow in hypertensive patients but not both in the same fetus. In this study, it has been demonstrated that the aortic flow velocity waveform was more frequently abnormal than the umbilical artery waveform in patients with severe pregnancy induced hypertension. Moreover, no abnormalities of umbilical waveform were detected in patients with chronic hypertension or mild pregnancy induced hypertension. It has been suggested that in patients with severe pre-eclampsia, the fetus can tolerate the consequences

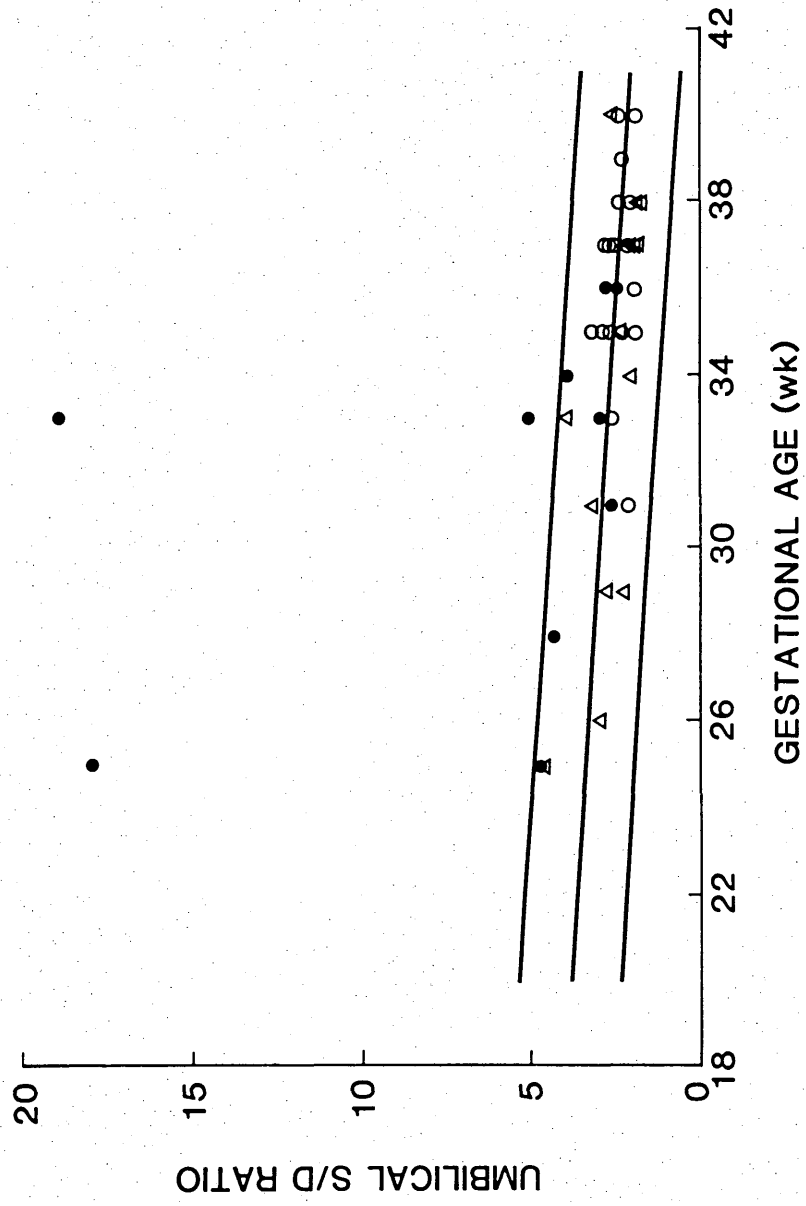

Figure 8.7e Results of umbilical artery S/D ratio for groups 1-3

△, Group 1

○, Group 2

●, Group 3

Lines are mean and 95% confidence limits of the normal pregnancy data

of maternal hypertension for a long time without any signs of haemodynamic alteration (Jouppila and Kirkinen, 1986). In cases 8-10 the fetuses showed no Doppler abnormalities but were delivered because of uncontrollable maternal hypertension, thus indicating that the fetus can tolerate high maternal blood pressures for some time. If, however, there is compromise of fetal growth or asphyxia, then haemodynamic redistribution by selective vasoconstriction and vasodilatation occurs. Such findings have been verified in animal models of fetal hypoxia (Block et al, 1984, Petershill, 1979). Changes in the fetal blood flow velocity waveform in the descending aorta and the umbilical artery could therefore be a reflection of such haemodynamic alterations. The waveform in the descending aorta reflects placental resistance upstream and also fetal peripheral vascular resistance. Therefore, diastolic flow in the descending fetal aorta may become abnormal earlier than the same measurement in the umbilical artery. This perhaps accounts for the higher number of abnormalities seen in the aortic waveform compared with the umbilical artery. Jouppila and Kirkinen (1986) have previously demonstrated significant reduction in all aortic velocity parameters in hypertensive patients with fetal distress. This present study demonstrates a decrease in individual end diastolic aortic velocities, and in some patients, there is a concomitant decrease in systolic velocity. As the pathologic changes increase, the increase in fetal hypoxia may produce myocardial ischaemia and a secondary decrease in aortic systolic velocity. This study demonstrates a much higher frequency of aortic diastolic flow abnormalities; systolic flow reduction may reflect a progression in the pathological process. Therefore, the systolic and end diastolic aortic velocities must be considered individually. The infants who demonstrated a higher number of Doppler abnormalities often had a more complicated perinatal outcome, and this suggests that Doppler study reflects the extent of the disease. Also, the lower the gestational age, the more complicated the perinatal outcome. It is of interest that the abnormal Doppler study preceded changes in the standard methods of fetal surveillance in

several patients. Other patients were delivered because of maternal reasons and a repeat biophysical profile or NST was not performed. It is postulated that the Doppler examination may be an earlier indicator of fetal compromise, but further research in this area will be important.

In conclusion, the data presented indicate that Doppler assessment offers no significant value as an adjunct to fetal monitoring in mild PIH. However, in patients with severe disease, Doppler changes may precede those of the biophysical profile or NST. Both systolic and diastolic flow velocities in the fetal aorta must be considered, and abnormalities of these may precede those seen in the umbilical artery.

8.9 The Effect of Acute and Chronic Antihypertensive Therapy on the Doppler Waveforms of the umbilical and uteroplacental circulations

8.10 Introduction

A major contribution to perinatal complications in pregnancy induced hypertension (PIH) is the premature delivery of the baby because of severe maternal hypertension (Walker, 1988). However, if antihypertensive therapy is used to lower the blood pressure and reduce the maternal risks, pregnancies can be prolonged allowing the fetus to reach greater maturity. The reduction of blood pressure does not treat the underlying disease and continuing monitoring of the mother and fetus is necessary. The main concern about antihypertensive therapy is the potential effects on the fetus, either directly or by causing a reduction in uteroplacental blood flow.

The risks of antihypertensive therapy appear to be related to the acute administration of antihypertensive drugs by the intravenous route. Intravenous hydralazine and diazoxide have been reported as causing acute fetal distress (Vink et al, 1980). However, a number of authors have reported no change in the uterine blood flow after antihypertensive therapy using nifedipine (Hanretty et al, 1989; Lindow et al, 1988), labetalol (Lunell et al, 1982), or pindolol (Lunell et al, 1984), as discussed in

chapter 4.4.3 and 4.5.3.

The aim of this study was to monitor the effects of acute and chronic blood pressure reduction on the umbilical artery and uteroplacental circulations using Doppler ultrasound.

8.11 Patients and Methods

8.11.1 Acute Study

Eight primigravid patients with acute hypertension in the third trimester of pregnancy were recruited. All had a diastolic blood above 105 mmHg for 30 minutes on bed rest in the semirecumbent position. The patients remained in this position and were given 10mg oral nicardipine, a calcium channel blocker. The blood pressure, pulse rate, cardiotocograph and Doppler waveform analysis of the utero-placental, and umbilical arteries were carried out before and during the 60 minutes following the administration of the drug.

8.11.2 Chronic Study

Fifteen primigravid patients with mild pre-eclampsia as defined by the American College of Obstetricians (Pritchard and MacDonald, 1985) were recruited. All had an average daily diastolic blood pressure of greater than 100 mmHg and a gestation between 30 and 36 weeks. They were treated with the beta-blocker Pindolol, with a starting dose of 5mg twice daily increasing to a maximum of 10 mg three times a day or until the average daily diastolic blood pressure was less than 100 mmHg. The same investigations as in the acute study were carried out before, the day following and on alternate days of pindolol therapy.

Both groups of patients were monitored using standard investigations for pregnancies complicated by pregnancy induced hypertension (Walker, 1987).

8.11.3 Control Group

There was no control group of patients for the acute study. For the chronic study, 15 primigravid patients with untreated mild pre-eclampsia were used as controls. All had an average daily diastolic blood pressure of between 90 mmHg and 99 mmHg and a gestation between 30 and 36 weeks. They were monitored using the identical methods as described above.

8.11.4 Doppler Waveform Analysis

Doppler ultrasound examination was performed using a continuous wave system (Doptek, Chichester, UK). A 150 Hz high pass filter was used to eliminate low frequency signals caused by vessel wall movement. During all Doppler studies, patients adopted a semirecumbent position with a 15 degree left lateral tilt to avoid caval compression. Umbilical artery and uteroplacental Doppler waveforms were recorded using the methods of Schulman et al (1984, 1986). The systolic/diastolic ratio (S/D ratio) was calculated when three representative consecutive wave forms had been obtained from each vessel studied.

This study was approved by the local ethical committee and all patients gave informed consent prior to enrolment.

The Wilcoxon rank test for matched pairs was used for statistical analysis.

8.12 Results

8.12.1 Acute Study

Administration of nicardipine was associated with a significant fall in the diastolic blood pressure by 30 minutes (Table IX). Diastolic blood pressures at 45 minutes and 60 minutes were also significantly lower compared with pretreatment values. As regards the Doppler readings, the only significant

Time (min)	Pre	15	30	45	60
Systolic Bp	155.5 ± 8.7	156.6 ± 14.6	144.9 ± 13.2	145.4 ± 15.2	146.6 ± 10.6
Diastolic Bp	108.0 ± 4.3	96.6 ± 5.6	94.9 ± 7.8**	93.9 ± 5.8**	93.7 ± 4.5**
Uteroplacental SD	1.6 ± 0.5		1.8 ± 0.8*		1.8 ± 0.3
Umbilical SD	2.5 ± 0.9		2.4 ± 0.7		2.4 ± 0.8

SD = systolic/diastolic ratio Bp = blood pressure Significance by Wilcoxon rank test for matched pairs * p<0.05 ** p<0.001

Table IX

Maternal blood pressure and uteroplacental and umbilical artery systolic/diastolic ratios pre and post nicardipine therapy (results are mean ± 1 standard deviation).

finding was a rise in the uteroplacental S/D ratio at 30 minutes. This change was not evident at 60 minutes.

8.12.2 Chronic Study

Following the administration of pindolol (Table X), there was a significant fall in blood pressure seen within 24 hours but this control was not as good by 72 hrs. Control varied after this depending on whether the patients could tolerate higher doses of pindolol. The main reason for withdrawal of patients was marked beta-agonist side effects such as tremor. By 8 days, the number of patients remaining in the study make the results more difficult to interpret. The only significant change in Doppler measurements was a rise in the uteroplacental S/D ratio at 3 days. This change was no longer evident by 5 days.

When the control group were studied (Table XI), it can be seen that conservative management made little difference to the blood pressure, which rose steadily over the study period. With respect to Doppler indices, there was a significant rise in the uteroplacental S/D ratio at 5 days and the umbilical S/D ratio at 7 days.

8.13 Discussion

Few would argue that severe hypertension in pregnancy is hazardous to the mother and that it should be treated. More controversial is the use of antihypertensive agents in the management of mild or moderate hypertension (Walker, 1987). Reluctance to administer antihypertensive drugs in pregnancy has arisen from reports of possible detrimental effects on the fetus and neonate. Vink et al (1980) described 14 women with severe hypertension who showed fetal heart rate abnormalities after intravenous bolus of 6.25mg dihydralazine. Leiberman et al (1978) reported 9 pregnancies treated with propranolol, 7 of which resulted in a fetal or neonatal death. Parisi et al (1989a) observed that following the administration of intravenous nicardipine to pregnant ewes, angiotensin

Time	Pre	1st Day	3rd Day	5th Day	7thDay	9th Day
Systolic Bp	151.7 ± 8.4	145.9 ± 10.4	152.8 ± 16.1	148.7 ± 15.1	145.6 ± 5.3	144.7 ± 4.1
Diastolic Bp	105.4 ± 4.1	95.6 ± 7.5*	102.1 ± 11.8	97.9 ± 12	99.4 ± 10.3	93.2 ± 5.3
Utero-placental						
SD	1.8 ± 0.4	1.9 ± 0.3	2.0 ± 0.4*	1.9 ± 0.4	1.5 ± 0.5	1.5 ± 0.6
Umbilical						
SD	2.6 ± 0.9	2.7 ± 0.7	2.7 ± 0.8	2.8 ± 0.8	2.4 ± 0.4	2.7 ± 1.0

SD = systolic/diastolic ratio Bp = blood pressure Significance by Wilcoxon Rank test for matched pairs *p<0.05

Table X

Maternal blood pressure and uteroplacental and umbilical artery systolic/diastolic ratios pre and post pindolol therapy (results are mean ± 1 standard deviation).

Time	Pre	1st Day	3rd Day	5th Day	7thDay	9th Day
Systolic Bp	138.5 ± 8.5	135 ± 9.2	136.3 ± 8.6	138.1 ± 8.3	140.8 ± 8.4	145.8 ± 10.2
Diastolic Bp	92.9 ± 3.9	93.2 ± 5.8	91.5 ± 6.6	95.2 ± 5.8	96.4 ± 6.4	99.5 ± 6.2
Utero-placental SD	1.9 ± 0.4	2.0 ± 0.5	2.1 ± 0.4	2.3 ± 0.3*	2.2 ± 0.7	2.3 ± 0.4
Umbilical SD	2.4 ± 0.3	2.4 ± 0.2	2.4 ± 0.3	2.4 ± 0.4	2.7 ± 0.6*	2.5 ± 0.5

SD = systolic/diastolic ratio Bp = blood pressure Significance by Wilcoxon Rank test for matched pairs *p<0.05

Table XI

The changes in maternal blood pressure and uteroplacental and umbilical artery systolic/diastolic ratios in pre-eclamptic patients on no therapy (results are mean ± 1 standard deviation).

II-induced vasoconstriction was reversed systemically but placental vasoconstriction appeared to increase. Furthermore, nicardipine infusion was associated with fetal bradycardia, acidemia and hypercapnia and the death of 5 of 15 fetuses by 65 minutes (Parisi et al, 1989b).

In contrast to this adverse data, a number of studies have suggested that antihypertensive therapy may not be detrimental to the fetus or to uteroplacental blood flow (Hanretty et al, 1989; Lindow et al, 1988; Lunell et al, 1982,1984; Ahokas et al, 1988). This conflicting information prompted this study to investigate the effects of two vasodilating drugs on the fetoplacental, uteroplacental and maternal peripheral circulations in pregnancy induced hypertension.

It would be surprising if therapy to lower blood pressure was not associated with maternal and fetal circulatory changes. The magnitude of such changes and their effect on fetal wellbeing must be influenced by the pharmacological properties of the drugs used, the rate of onset of antihypertensive action and the inherent ability of the mother and fetus to compensate for drug induced circulatory changes.

Most of the reported adverse fetal effects of antihypertensive therapy have been associated with acute lowering of maternal blood pressure. In the acute study, a rise in uteroplacental S/D ratio was seen 30 minutes after administration of nicardipine and this was sustained but this was not reflected in changes seen in the umbilical blood flow parameters or fetal heart rate monitoring. It may be that the maternal and fetal circulations studied were able to rapidly compensate for the effect of acute blood pressure lowering. These findings do not exclude the possibility that some patients with hypertension in pregnancy (particularly those with a reduced circulating blood volume) may not be able to compensate for the circulatory changes induced by acute antihypertensive therapy. Consequently, they may show a sustained change in uteroplacental and/or fetoplacental Doppler indices and fetal heart rate abnormalities. Nylund et al (1989) observed that patients who did not exhibit a fall in maternal blood pressure after intravenous

hydralazine showed a greater reduction in uteroplacental blood flow compared with those whose blood pressure did respond to therapy. These authors suggested that "non-responders" may be more susceptible to developing fetal heart rate abnormalities after antihypertensive therapy because they are maintaining blood pressure at the expense of the uteroplacental circulation. Montan et al (1987) reported a significant rise in the pulsatility index of uteroplacental and fetal aortic waveforms during atenolol therapy in hypertensive pregnancies. This change was observed 3 days after commencing therapy. Doppler studies were not continued after 3 days and there was no untreated control group for comparison. In this chronic study, a rise in uteroplacental S/D ratio occurred by the third day of treatment. This might be interpreted as harmful to the fetus. However, it was no longer evident by 5 days. The untreated control group showed a significant rise in uteroplacental and umbilical artery S/D indices within 7 days. The possibility that this rise reflects the natural progression of the hypertensive disease process makes it difficult to interpret Doppler ratios in association with antihypertensive therapy.

Adverse fetal and neonatal effects of antihypertensive therapy appears to be most often reported if there is evidence of pre-existing fetal compromise (Lieberman et al, 1978; Woods and Malan, 1983). All patients in the present study showed normal baseline uteroplacental and umbilical artery Doppler indices throughout the study period. It may be argued that such patients have a relatively stable cardiovascular system and lowering maternal blood pressure is unlikely to produce changes in fetoplacental or uteroplacental blood flow velocities. In addition, even if no Doppler changes are detected, this does not mean that there has been no change in maternal or fetal cardiovascular function. Further studies are indicated to assess the effect of antihypertensive therapy on patients with abnormal fetoplacental and uteroplacental waveform patterns, particularly when the umbilical artery shows absent end-diastolic frequencies.

In conclusion, this study supports that the use of antihypertensive therapy in

pregnancy has no detrimental effect on uteroplacental or fetoplacental vascular waveform if the fetus is in good condition before treatment. Although acute administration of nicardipine and chronic administration of pindolol was associated with a change in the uteroplacental S/D ratio, there was no change in umbilical artery S/D ratio. The rise in uteroplacental S/D ratio is likely to be clinically insignificant and it was not associated with evidence of either maternal or fetal compromise.

CHAPTER 9
THE ULTRASONIC ASSESSMENT
OF HUMAN FETAL CARDIAC DYSRHYTHMIAS

9.1 Introduction

Cardiac dysrhythmias and disturbances of heart rate and conduction may occur in utero in much the same way as they occur after birth (Shenker, 1979). Fetal cardiac dysrhythmias occur in approximately 2% of all pregnancies (Elkayham and Gleicher, 1982), and therefore are a significant clinical problem. The increasing use of obstetric ultrasonography and electronic fetal heart rate monitoring, coupled with greater awareness of the problem among clinicians, has led to the referral of more patients for further evaluation. The possible harmful effects of misdiagnosis and the difficulty in obtaining a fetal electrocardiogram and accurately assessing fetal cardiac structure, make diagnosis and management of the dysrhythmia a challenge, which usually requires special expertise. Such expertise should encompass a team approach to the problem so that an accurate diagnosis and plan of management can be made.

The prognosis in each case depends on the type of dysrhythmia, the association of anatomical cardiac disease or the presence of intrauterine cardiac failure (Shenker, 1979). The clinical implications of an accurate diagnosis are evident when one considers the associated fetal risks and subsequent clinical management decisions of the dysrhythmia. The aim of this study was to review the diagnosis and management of all fetuses referred because of cardiac dysrhythmia and to construct an algorithm to assist the clinician in the assessment and appropriate referral to an experienced centre.

9.2 Patients and methods

A multidisciplinary team incorporating perinatology, radiology and paediatric cardiology was established for the assessment of fetal cardiac problems. A review of all patients referred with a diagnosis of fetal cardiac dysrhythmia to this team until January 1987 was conducted. Patients were referred because an abnormal fetal heart rate had been detected in the physician's office or in another ultrasound department.

Dysrhythmias were categorised as follows:

1. Irregular fetal heart rate: atrial or ventricular ectopic beats of frequency greater than one in 10.
2. Fetal tachycardias: a recurrent tachycardia, of more than 180 bpm and greater than 10 seconds duration, on more than two occasions at least one day apart.
3. Fetal bradycardias: a recurrent bradycardia of less than 100 bpm of greater than 10 seconds duration.

A Toshiba SAL 50A ultrasound machine incorporating two dimensional, m-mode, and pulsed Doppler ultrasonography was used to examine the fetal heart as described in Chapter 5.1. All patients had thyroid function testing, in addition to anti-nuclear antibody, anti-RO (SSA), and viral screens. All patients had two dimensional echocardiography to confirm or exclude a structural cardiac anomaly. The fetus was examined for signs of cardiac failure, and an attempt was made to characterise the arrhythmia by noting the rate and contraction sequence of the atria and ventricles according to the methods of Allan et al (1983) using m-mode and Harder et al (1987) with pulsed Doppler ultrasonography. Outcome data were obtained from a review of newborn records.

9.3 Results

Forty five patients were referred to the institution for evaluation of a fetal cardiac arrhythmia. Two patients were subsequently excluded from the study because no heart rate abnormality was detected during the complete cardiac ultrasound examination.

The number of patients and overall perinatal outcome of the three types of dysrhythmia are illustrated in Table XII.

9.3.1 Irregular fetal heart rate

The group of fetuses with an irregular fetal heart rate had the most favourable outcome. Twenty six patients were seen with this diagnosis. All the fetuses had frequent atrial or ventricular extrasystoles, with at least one extrasystole

	n	Gestational age at referral	Gestational age at delivery	Mean birth weight(Kg)	vaginal delivery	Caesarean section	Mortality
Irregular	26	33.1 +/- 7.8	38.2 +/- 3.7	3.3 +/- 0.9	21	5	0
Tachycardias	6	33.1 +/- 3.4	37.6 +/- 2.8	3.4 +/- 0.7	4	2	1
Bradycardias	11	28.1 +/- 5.1	32.1 +/- 5.9	2.0 +/- 0.1	4	7	4
Total	43				29	14	5

Table XII Overall perinatal outcome in 43 patients with fetal dysrhythmia

occurring every 10 beats. At no time did any fetus develop a tachycardia, bradycardia, or intrauterine cardiac failure in association with premature beats. No Caesarean sections were performed because of concerns about the fetal heart rate. All the dysrhythmias disappeared before or within a few days of delivery and there were no further complications.

9.3.2 Fetal tachycardia

The clinical course and time and mode of delivery of the six patients with fetal tachycardia are summarised in Table XIII. With the exception of Case No. 2, all fetuses were delivered at term and had a good outcome. In Case No. 2, the tachycardia was of viral origin, and the infant was delivered at 33 weeks gestation because of a poor biophysical profile but died of herpes simplex virus encephalitis several weeks later. Of the other five patients with tachycardia, four (Case Nos. 1, 3, 4 and 6) were due to supraventricular tachycardia and one was due to atrial flutter. Two fetuses (Case Nos. 5 and 6) required maternal anti-arrhythmic therapy to control the fetal tachycardia and both responded well. The fetus in Case No. 6 was diagnosed *in utero* as having a cardiac tumour, which was confirmed postnatally by echocardiography and medically managed. Delivery was carried out in Case No. 1 because of ultrasonic evidence of cardiac failure associated with fetal maturity. This infant, along with the infants in cases numbers 3 and 4, required digoxin for a short period after birth. The infants in cases numbers 3 and 4 were not treated with anti-arrhythmic therapy *in utero* because they showed no compromise and the episodes of tachycardia were not continuous. They were followed up with regular biophysical profiles and fetal movements counting.

9.3.3 Fetal bradycardia

The 11 patients with fetal bradycardia had the worst perinatal outcome (Table XIV). Four (Case Nos. 3, 7, 8 and 9) of the five (Case Nos. 3, 7-10) patients with complete heartblock had anti-RO (SSA) antibodies in maternal serum, and three of these mothers (Case Nos. 3, 7 and 9) had clinical evidence of connective tissue disease. Two of these infants (Case Nos. 3 and 9) required pacemakers, with one infant (Case 3) being severely handicapped because of complications due to prematurity. None of the infants born to mothers with the anti-RO antibody had structural cardiac anomalies.

Case No.	G.A. at Referral	G.A. at Delivery	Diagnosis	Therapy	Evidence of		Perinatal outcome
					Failure	Mode of Delivery	
1	37	37	SVT	Delivery	Hydrops	C/S	Well, Digoxin
2	33	33	SVT(viral)	Delivery	Pericardial effusion	C/S	Died, HSV encephalitis
3	36	41	SVT		No	Vaginal	Well, Digoxin
4	33	38	SVT		No	Vaginal	Well, Digoxin
5	27	40	AF	Digoxin Verapamil	Hydrops	Vaginal	Well
6	33	37	SVT	Digoxin Verapamil	No, cardiac tumour	Vaginal	Well, tumour of right ventricle Mexilitine/propranolol

G.A.=Gestational age; SVT=supraventricular tachycardia; AF=atrial flutter; C/S=caesarean section; HSV=herpes simplex virus

Table XIII Perinatal outcome in six patients with fetal tachycardia

Case No	GA at Referral	GA at Delivery	Diagnosis	Antibodies	Evidence of failure	Mode of delivery	Perinatal outcome
1	30	38	Bradycardia	No	No	C/S	Single arterial trunk; truncus arteriosus; digoxin;died before surgery
2	20	24	Bradycardia	No	Hydrops	Vaginal	Stillborn; Turner's syndrome
3	23	29	CHB	Anti RO, SLE	No	C/S	Pacemaker; cerebral palsy
4	35	37	Bradycardia Diabetes	No	No	C/S	Situs inversus; double outlet right ventricle
5	25	26	Bradycardia	No	Hydrops	Vaginal	Stillborn
6	21	22	Bradycardia	No	Pericardial effusion	Vaginal	Neonatal death
7	34	35	CHB	Anti RO, SLE	No	C/S	Good; no further problems
8	31	37	CHB	Anti RO, ANA	Pericardial effusion	Vaginal	Bradycardia; no therapy
9	31	33	CHB	Anti RO, ANA Sjogren's syndrome	No	C/S	Pacemaker; well
10	28	38	CHB	No	No	C/S	L-transposition; remains well
11	31	34	Bradycardia	No	No	C/S	Duodenal atresia; bradycardia resolved

GA=Gestational age; CHB=Complete heart block; SLE=Systemic lupus erythematosus; ANA=Antinuclear antibodies; C/S=Caesarean section

Table XIV Perinatal outcome in 11 patients with fetal bradycardia

In the group of fetuses with bradycardias, three had cardiac anomalies (Case Nos. 1, 4 and 10). The first case was an infant with a single arterial trunk who was delivered at term but died before corrective surgery. The infant with situs inversus, double outlet right ventricle, and pulmonary stenosis (Case 4) had shunt surgery performed. The third case (Case 10) was an infant with complete heartblock who was diagnosed as having L-transposition. This infant has not required surgery and is progressing well.

There were four fetuses (Case Nos. 2, 5, 6 and 8) in whom evidence of cardiac failure was seen in association with a bradycardia. Two fetuses demonstrated generalised fetal hydrops at early gestational ages (Case Nos. 2 and 5) and both infants were stillborn. One of the infants had Turner's syndrome (Case 2). Two infants had ultrasonic evidence of pericardial effusion (Case Nos 6 and 8). One of these infants was delivered after premature rupture of the membranes and died.

9.4 Discussion

Fetal dysrhythmias are common and occur in more than 2% of all pregnancies (Shenker, 1979), but it was 1969 before the first case of supraventricular tachycardia causing fetal hydrops was diagnosed in utero (Silber and Durnin, 1969). Another decade passed before *in utero* treatment of cardiac failure caused by a dysrhythmia was reported (Kerenyi et al, 1980). Subsequently, several investigators (Kleinman et al, 1985; Wladimiroff and Stuart, 1985; Bergmans et al, 1985) have reported their experience of the treatment of such conditions.

One of the problems in the detection of fetal dysrhythmias is the wide variation in normal heart rate. The normal fetal heart rate gradually decreases from 140 bpm at 20 weeks to 130 bpm at term, with a range of +/- 20 bpm. However, short episodes of slowing or acceleration are common, and occasional extrasystoles are considered a normal variation (Komaromy, 1977) and a function of immaturity. It is not clear how long a dysrhythmia must last to be abnormal, but Allan et al (1983) have suggested several minutes is pathological whereas normal variation lasts only a few seconds. Since the aim of this study was to screen all cardiac dysrhythmias, episodes lasting longer than 10 seconds

were chosen as abnormal.

A variety of techniques are available to assess fetal dysrhythmias but only an electrocardiogram can properly characterise the abnormality. However, the use of a fetal electrocardiogram is severely limited with current techniques, since it is very difficult to obtain between 28 and 34 weeks because of the insulating effects of the vernix (Marks, 1961). In view of these limitations, several investigators (Allan, 1983; Silverman et al, 1985; Kleinman et al, 1980) have reported the use of two dimensional and m-mode echocardiography to aid in the diagnosis and evaluation of fetal dysrhythmias. The differentiation between atrial and ventricular premature beats is possible by the simultaneous visualisation of the left atrial wall and the left ventricle or aortic valve with m-mode echocardiography (Allan, 1983; Silverman et al, 1985; Kleinman et al, 1980). This is not always technically possible with a linear array machine; in the group of patients with an irregular heart beat, the cause of the extrasystole did not have an effect on the prognosis.

An irregular fetal heart rhythm is the commonest and most benign form of rhythm disturbance. Atrial extrasystoles occur more frequently than ventricular ectopic beats (De Vore et al, 1983; Allan et al, 1983). Premature atrial beats arise from an abnormal focus, which may lie anywhere within the atrium. Such atrial ectopic beats have been described in the fetus before 20 weeks gestation (Nielsen and Moestrup, 1968). In the series of cases with atrial or ventricular ectopic beats reported (De Vore, 1983; Allan, 1983; Silverman, 1985), progression to persistent tachycardia, bradycardia or intrauterine cardiac failure occurred in only one case. In this present study, no Caesarean section was performed because of concern about the fetal heart rate. The consensus is that isolated irregular fetal heart rhythms represent a benign arrhythmia which will usually disappear during the first week of life. It is also considered that there is no increased incidence of congenital heart disease unless such beats occur in association with other arrhythmias or unless fetal heart murmurs are detectable (Redman, 1958). Since extrasystoles are not associated with fetal hypoxia, distress, or an adverse perinatal outcome (Hon and Huang, 1962), such cases could be managed in the physician's office with auscultation or

non-stress testing after an initial fetal cardiac structural ultrasound examination (Figure 9.4a).

If detected, fetal tachycardias generally have a good prognosis and can be treated in utero (Kerenyi et al, 1980; Kleinman et al, 1985; Wladimiroff and Stuart, 1985; Bergmans et al, 1985). A sinus tachycardia is defined as a pulse rate greater than 180 bpm, normal conduction and a variability of 5-15 bpm. Among the known causes of sinus tachycardia in the fetus, the following have been reported: cytomegalo virus disease; administration of drugs such as isoxuprine, atropine and scopolamine; maternal fever; amnionitis; early fetal hypoxia; and maternal anxiety states (Shenker, 1979; Ferrer, 1977; Odendaal and Crawford, 1975).

Atrial flutter is defined as an atrial rate of 300-460 bpm with a variable degree of atrial ventricular (AV) block, resulting in a ventricular rate of 60-200 bpm; this is usually irregular, but regular in a case of fixed AV block. Atrial fibrillation is probably underdiagnosed in utero (Shenker, 1979). The reported clinical experience with the intrapartum diagnosis of atrial fibrillation is too small to allow any significant conclusions. It remains to be determined whether an association with congenital heart disease will become apparent. Since atrial fibrillation is associated with thyrotoxicosis in the adult, such a cause should be sought in any mother of a fetus with atrial fibrillation. Unlike the adult, atrial flutter appears to be more common in the fetus than atrial fibrillation. The mechanism of this dysrhythmia is still poorly understood and controversial. It is most likely to be due to a reciprocating rhythm or circus current movement. In contrast to atrial fibrillation, the atria contract at a rate of 250-350 bpm in most cases. Accompanying AV block is almost always present; its ratio is commonly an even number. Therefore, the ventricular rate is usually in the range of approximately 150 bpm or 75 bpm depending on whether a 2:1 or 4:1 block is present. However, this is not always the case. Regularity of the fetal heart rate may be detectable using auscultation alone. When a fixed block is present, the fetal heart rate may be regular and also in the normal range, and thus the abnormality may be overlooked. Atrial flutter can have severe fetal effects and intrauterine congestive heart failure and fetal hydrops have been

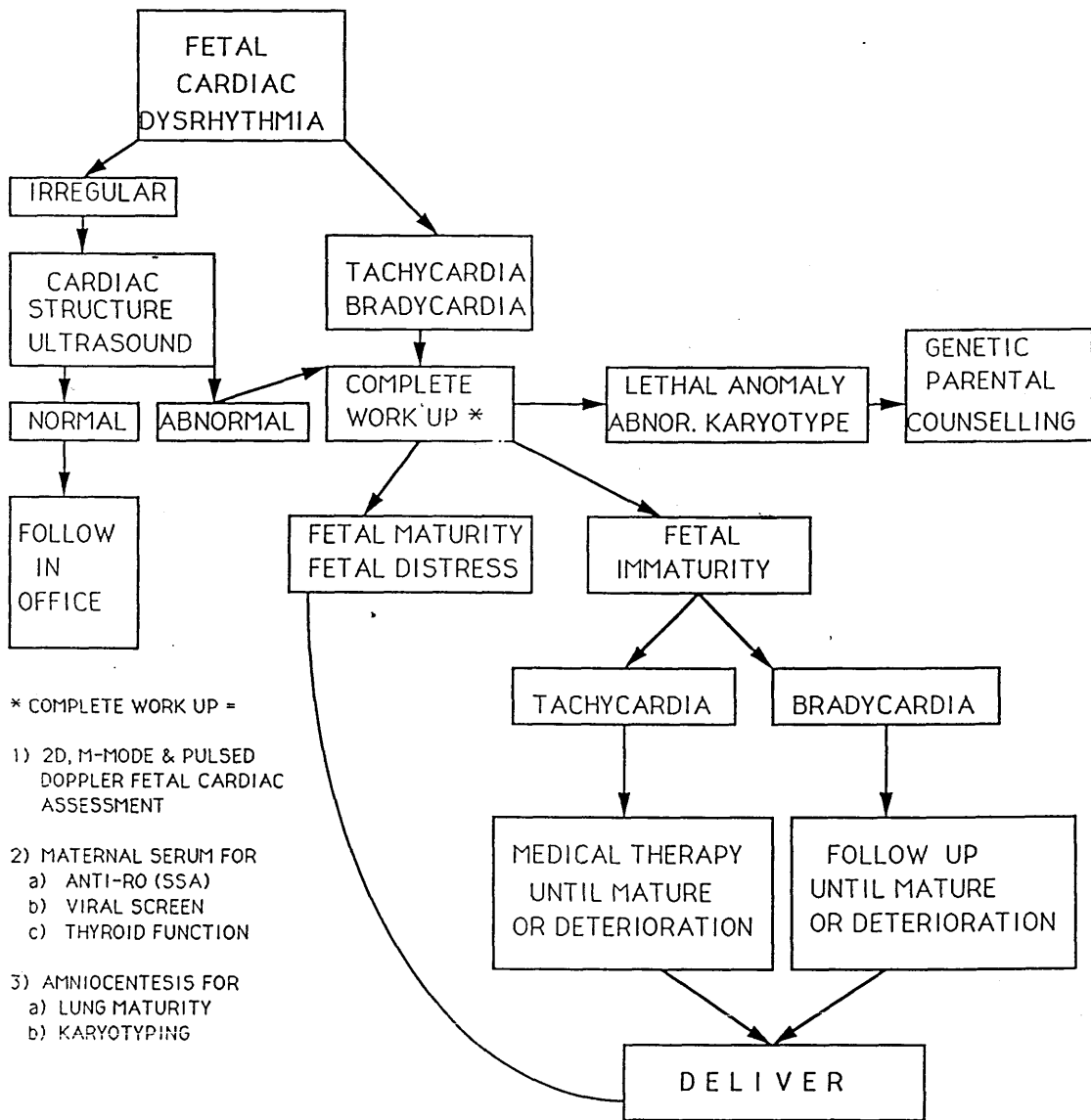

Figure 9.4a
An algorithm for the management of fetal cardiac dysrhythmia

reported (Maxwell et al, 1988).

Supraventricular tachycardia is defined as a heart rate often exceeding 200 bpm with normal conduction and almost no variability. It is the most frequent form of fetal tachycardia, and is classically called paroxysmal atrial tachycardia. The clinical significance of this type of dysrhythmia depends on the duration of disturbance. Generally, short bursts of supraventricular tachycardia are benign and probably of no clinical significance. However, persisting fetal supraventricular tachycardia can lead to high output failure of the fetal heart, a serious and sometimes fatal complication. This type of rhythm disturbance is potentially the most amenable to fetal therapy. Reviews of the literature concerning fetal cardiac dysrhythmias have previously been published (Bergmans et al, 1985; Kleinman et al, 1985; Wladimiroff and Stuart, 1985). The first case of a supraventricular tachycardia causing fetal hydrops *in utero* was reported in 1969 by Silber and Durnin. The most recent series (Maxwell et al, 1988) reported 23 cases of fetal tachycardia. Anti-arrhythmic treatment was given to the mother in 22 of these cases. Digoxin alone or in combination with verapamil was used in all these cases. The mothers were treated with 0.75 mg digoxin daily and the dose was adjusted to maintain the maternal serum concentration at 2.6 nmol/l. Verapamil was added in increasing doses to a maximum of 480 mg daily until control was achieved or delivery supervened. The rationale for treating all cases of atrial tachycardia was to prevent or reverse cardiac failure. In this series, conversion to sinus rhythm was achieved in 14 of 22 patients and a further three achieved partial control. These results were comparable with the results of other series (Kleinman et al, 1985; Wladimiroff and Stuart, 1985). In this present study, two fetuses required maternal anti-arrhythmic therapy and both responded well. One of these fetuses with hydrops and atrial flutter responded to a combination of digoxin and verapamil, but the ascites persisted until the later addition of maternal frusemide treatment. Other medications which have been used in an attempt to convert fetal tachycardia to sinus rhythm have included quinidine, propranolol, practolol and procainamide. Flecainide, an analogue of lignocaine, has been described in one previous case report as a method of *in utero* therapy (MacPhail

and Walkinshaw, 1987)

The incidence of structural heart disease in infants with fetal tachycardia is uncertain but it has been reported to occur in 5-10% of cases (Shenker, 1979). In the present series, one of the fetuses with supraventricular tachycardia had a cardiac tumour diagnosed prenatally. It is therefore crucial that all patients have a complete fetal cardiac examination (Figure 9.4a) in order to plan further management. Also, as mentioned previously, intrauterine infection is a potential cause of fetal tachycardia. In this series, one fetus with supraventricular tachycardia died in the postnatal period of herpes simplex virus encephalitis. This emphasises the need to perform a viral screen on the mother's serum.

The place of aggressive medical management remains controversial, with some authors preferring a conservative approach (Elkayham and Gleischer, 1982) and others preferring to treat almost all cases (Maxwell et al, 1988; Kleinman et al, 1985; Wladimiroff and Stuart, 1985). From the results of this study it is felt that all fetuses with either SVT, atrial flutter or fibrillation should receive indirect (maternal) digitalisation as a first line therapy. Maternal flecainide treatment would seem to be a promising second line therapy.

Unfortunately, accurate information on the natural course of these types of arrhythmias *in utero* is lacking. However, an attempt to construct an animal model of fetal hydrops using atrial pacing has been achieved and this is discussed in the next chapter. The traditional approach is to deliver the fetus immediately in the presence of lung maturity and use *in utero* drug therapy for the treatment of an immature fetus. From the results of this series, it is proposed that *in utero* treatment is the preferred initial approach, since the mature fetus could be delivered vaginally if in sinus rhythm, thus reducing fetal and maternal morbidity. If the fetal tachycardia fails to respond to drug therapy, delivery is indicated when the lungs are mature or when there is fetal deterioration.

It has been suggested that when there is ultrasonic evidence of severe cardiac failure, anti-arrhythmic treatment may be less effective (Allan et al, 1983), and hence prompt medical intervention is necessary. The response to medical therapy is often gradual, and therefore in the absence of fetal deterioration, with fetal immaturity, urgent delivery should be avoided, but careful fetal

surveillance is important. Methods used for fetal monitoring in the follow-up of these patients are discussed later.

Of all the fetal dysrhythmias, fetal bradycardias have been reported to have the worse prognosis (Allan et al, 1983; Crawford et al, 1985). The commonest congenital heart block seen in the fetal period is a third degree (complete) AV block. The reported incidence of complete block is 1 in 20,000 live births. The first antenatal diagnosis of this condition (Plant and Stevens) was published in 1945, and the first review of this subject was published in 1968 (Teteris et al, 1968). In this report, 15 of 29 infants died with congenital heart disease. A more recent series (Shenker, 1979) reported 13 cases with five having congenital heart disease and six dying, either from congenital heart disease or with a pacemaker in situ. The very high incidence of major congenital cardiovascular abnormalities in association with congenital heart block has been confirmed by more recent studies (Allen et al, 1983; Crawford et al, 1985). In this present series, the 11 fetuses with bradycardia had the worst perinatal outcome (Table XIV). There were three fetuses with cardiac anomalies and one of these fetuses died before corrective surgery.

In recent times, attention has focused on the association with congenital AV block and maternal collagen vascular disease, especially systemic lupus erythematosus (SLE). After an initial report (Hull et al, 1966) of an association between congenital heart block and widespread fibrosis due to maternal SLE, it was some years before additional supportive evidence for this association was provided (McCue et al, 1977; Chameides et al, 1977). This association allows the search for congenital fetal heart block in the offspring of mothers with known connective tissue disease and also the search for dormant connective tissue disease in mothers of infants with congenital AV block. In the series reported in this thesis, four of the five patients with complete heart block had anti-RO (SSA) antibodies in maternal serum, and three of these mothers had clinical evidence of connective tissue disease. Two of these infants required pacemakers. Interestingly, none of the infants born to mothers with the anti-RO (SSA) antibody had structural cardiac anomalies. These results were similar to those reported by Crawford et al (1985) on 12 patients.

Accurate diagnosis is essential in fetal bradycardias, since this arrhythmia may be misinterpreted as fetal distress and a Caesarean section may be performed unnecessarily. Such implications have been extensively discussed by Reid et al (1979).

Fetal surveillance in cases of irregular heart rate has already been discussed. A stepwise approach to the problem of fetal tachycardia and bradycardias is strongly advised (Figure 9.4a). It is thus essential that a complete work-up of both types of dysrhythmia is performed. This includes a two dimensional, m-mode and pulsed Doppler fetal cardiac assessment to look at fetal cardiac structure and function. Pulsed Doppler ultrasonography plays an important role in the management of fetal tachycardias and bradycardias. The degree of heart block can be determined by the simultaneous examination of the fetal aortic and inferior vena cava waveforms (Harder et al, 1987) (Figure 9.4b). This technique is also useful in the follow-up of fetal bradycardias, since any progression in the degree of block can be detected. The other important role of pulsed Doppler ultrasonography is in the estimation of aortic volume flow in both tachycardias and bradycardias. It has been suggested that the aortic volume blood flow is maintained within the normal range only until the heart rate drops to approximately 50 bpm or exceeds 230 bpm. Outside this range the volume of blood flow diminishes (Tonge et al, 1986). However, volume blood flow measurements must be regarded with great caution and this has been discussed already in this thesis.

An additional part of a complete work-up of fetal tachycardias and bradycardias includes sampling maternal serum for anti-RO (SSA) antibodies, a viral screen and thyroid function tests. Fetal karyotyping either by amniocentesis or by fetal blood sampling (Daffos et al, 1983) is also required, since a lethal chromosome complement would alter the management of the case.

Apart from patients with irregular fetal heart rates, it is important that in the follow-up of any patients with fetal tachycardia or bradycardia, strict fetal surveillance is performed. Thus, the mother should be instructed about daily fetal movement counting and attend for weekly fetal biophysical testing and cardiac ultrasound evaluation. If maternal anti-arrhythmic drug therapy is

given, drug levels should be checked regularly.

In conclusion, fetal cardiac dysrhythmias pose a significant problem in terms of incidence, diagnosis and management. Tachycardias and bradycardias require prompt referral to an institution in which a multi-disciplinary team approach involving obstetricians, radiologists and paediatric cardiologists can evaluate the condition and assist in further fetal management.

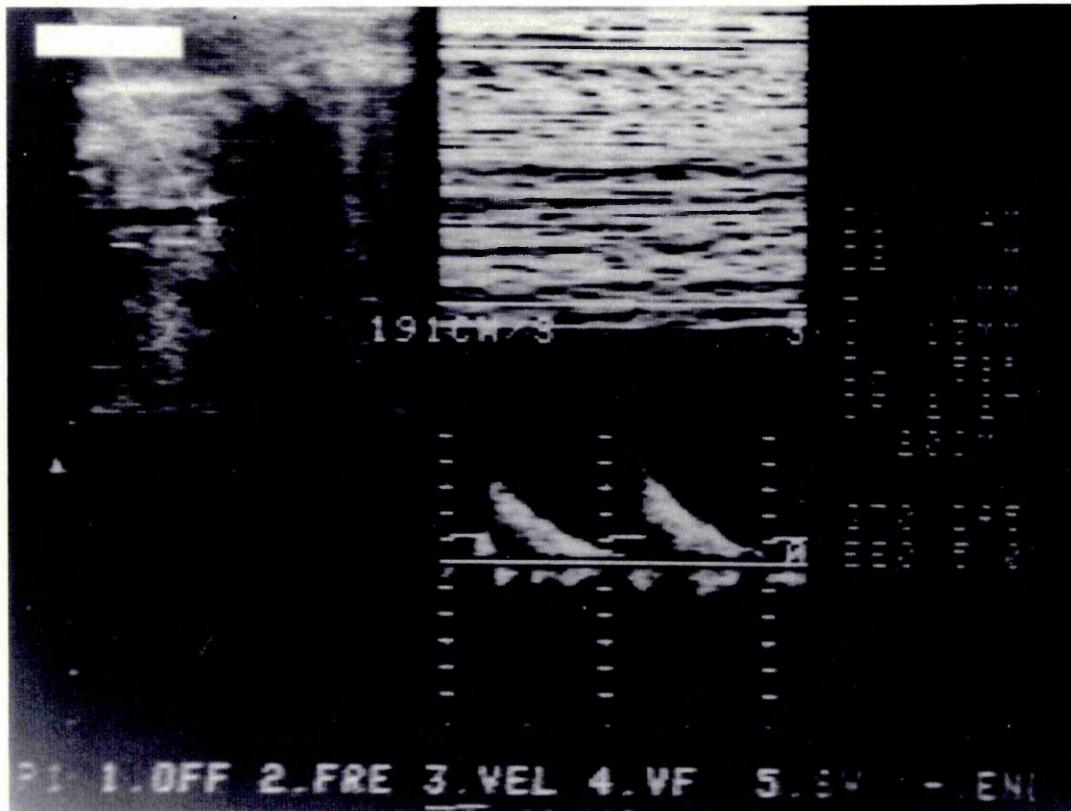

Figure 9.4b Aortic and Inferior vena cava waveform in complete heart block (centre). Aortic waveform above and IVC waveform below axis. Real time display with cursor and sample volume illustrated on left

CHAPTER 10
THE INFLUENCE OF ATRIAL PACING ON THE DOPPLER
WAVEFORM IN ORDER TO CREATE FETAL HYDROPS IN A
CHRONICALLY INSTRUMENTED
SHEEP MODEL

10.1 Introduction

Cardiovascular disease has been implicated as a significant cause of non-immune fetal hydrops (Kleinman et al, 1982). As discussed in the previous chapter, supraventricular tachycardia has come into greater focus as a potential cause of the condition because it is amenable to maternal antiarrhythmic drug administration (Wiggins et al, 1986; Silverman et al, 1985; Wladimiroff and Stuart, 1985). In view of this potential for treatment of the condition, there is a definite need for a clearer understanding of the natural history and the changes which occur during the evolution of non-immune fetal hydrops. In the human fetus, prenatal diagnosis of hydrops by ultrasound has been well established (Watson and Campbell, 1986). However, investigators working with the fetal lamb hydrops model have only been able to assess this condition at post mortem (Stevens et al, 1982).

The aim of this study was to assess both the real-time and Doppler waveform changes as assessed by ultrasound which occur during the production and resolution of fetal hydrops secondary to right atrial pacing.

10.2 Materials and Methods

Six pregnant ewes and their fetuses at approximately 115 days gestation were surgically instrumented and studied as previously described in Chapter 5.5.1. Experiments occurred after a minimum recovery period of five days. All control and experimental studies were conducted while the ewe was awake and lying restrained on a specially constructed, cushioned table as previously illustrated (figure 5.2.3c). Between study times, the animals were allowed up and were given normal food and water *ad libitum*. Baseline biochemical and cardiovascular data were obtained during a control period when measurements were allowed to stabilise for at least 30 minutes. The fetal pacemaker leads were attached to a General Electric Standby Pacemaker 7118 (General Electric, Fairfield, Connecticut, USA) and pacing occurred at 300 bpm from a mean baseline of 178 bpm. Pulsed Doppler studies were carried out during periods of absent fetal breathing using the equipment described in Chapter 5.1. The vessels studied

were those of the fetal descending thoracic aorta, umbilical artery and inferior vena cava. As previously described, the ultrasound equipment provided on-line calculations of flow velocity and volume flow from the descending aorta. The peak systolic (S) and end diastolic (D) velocities and S/D ratios of the fetal aorta and umbilical artery were calculated by off-line averaging of the measurements from three consecutive waveforms.

Following the measurement of baseline biochemical and ultrasound parameters, pacing was commenced. After the first 12 hours of pacing, real time ultrasound assessments and blood sampling for biochemical analysis were repeated at approximately four hourly intervals until ultrasound confirmation of fetal hydrops was made. Hydrops was considered to be present when marked fetal ascites was present with a rim of fluid greater than 10 mm all around the fetal abdomen. Since this was much easier to recognise and quantitate than either pleural effusion or skin oedema, it was the only diagnostic criteria adhered to.

For the purpose of analysis, data is presented at the the following time intervals:

- (1) prior to the commencement of pacing, ie baseline
- (2) at the ultrasound diagnosis of fetal hydrops
- (3) immediately following discontinuation of atrial pacing
- (4) during recovery at 12-16 hours after discontinuation of
 pacing
- (5) at resolution of fetal hydrops (no ascites visible on
 ultrasound).

The ewe was removed from the cushioned table and transfered to a metabolic cage after each evaluation. Statistical analysis of data was done using paired t-tests for grouped results.

10.3 Results

With right atrial pacing at 300 bpm, it was possible to achieve fetal hydrops in this model between 18 and 41 hours after the commencement of atrial pacing (Table XV). Spontaneous resolution of hydrops occurred in each lamb after the discontinuation of pacing.

Animal No.	Gestational age at surgery (days)	Gestational age at pacing (days)	Time to Hydrops(Hrs)	Time to clearance(Hrs)
1	107	114	41	31
2	116	123	18	18
3	113	118	23	50
4	120	124	40	24.5
5	114	126	27	29.5
6	115	119	22.5	36
mean	114.2+/-4.3	120.7+/-4.5	28.6+/-9.6	31.5+/-10.9

Table XV Gestational age data, time taken to develop hydrops and time taken to clear hydrops in six fetal lambs

10.3.1 Biochemical changes

Each of the six animals was considered to be normal on the basis of the baseline blood gases and electrolytes at the commencement of each study. Table XVI highlights the baseline values and the biochemical changes seen with the development and clearance of fetal hydrops. There was no statistically significant change in sodium or potassium concentration during fetal hydrops development. Also, no significant changes were seen in the blood gas results (Table XVI). Normal pO_2 in this laboratory (at 1500 metres above sea level) was 23.3 +/- 2.6 mmHg. A statistically significant change was seen in serum protein and albumin levels (Table XVI).

10.3.2 Fetal arterial pressure

Table XVII summarizes the changes observed in fetal blood pressure during the study. There was a statistically significant decrease in systolic blood pressure and an increase in venous pressure with the development of hydrops. Both systolic and venous pressures returned to the pre-pacing levels during the recovery phase (Table XVII).

10.3.3 The fetal descending thoracic aortic FVW

The mean S/D ratio changes from baseline in the descending thoracic aorta FVW for the six lambs are shown in Figure 10.3.3a . There was a significant decrease in S/D ratio from baseline at the time of hydrops development. Following withdrawal of pacing, despite hydrops still being present, a significant increase in the aortic S/D ratio was seen. Even although the data presented represents mean values, these Doppler changes described were seen in each individual fetal lamb studied.

Figure 10.3.3b illustrates the individual changes which occurred in mean aortic velocity and volume flow throughout the experiments. The trends were similar to those described above for the S/D ratio. All animals studied demonstrated a fall in both parameters during the development of hydrops and an immediate rise

	Baseline	At Hydrops	At Resolution
Potassium	4.6+/-0.7	4.7+/-0.7	4.3+/-0.3
Sodium	149.8+/-4.0	144.1+/-2.6	147.8+/-1.3
Protein	34.3+/-3.8	29.0+/-2.6*	32.6+/-1.9
Albumin	23.0+/-2.6	19.5+/-1.3*	22.5+/-1.6
pH	7.33+/-0.02	7.33+/-0.02	7.34+/-0.02
pO ₂	18.2+/-4.2	18.6+/-3.6	20.7+/-4.2
pCO ₂	42.2+/-5.1	46.7+/-2.1	43.4+/-3.9

*p<0.05

Table XVI Biochemical parameters in six fetal lambs

Blood pressure	Baseline	Hydrops	Resolution
Systolic	75.8+/-6.0	67.1+/-7.9*	73.0+/-4.6
Diastolic	53.8+/-4.8	51.6+/-3.6	52.8+/-2.0
Jugular	24.6+/-5.3	31.3+/-7.4**	24.6+/-4.3

*p=0.01

**p=0.06

Table XVII Mean fetal blood pressure (mmHg) in six fetal lambs at development of fetal hydrops and at its resolution

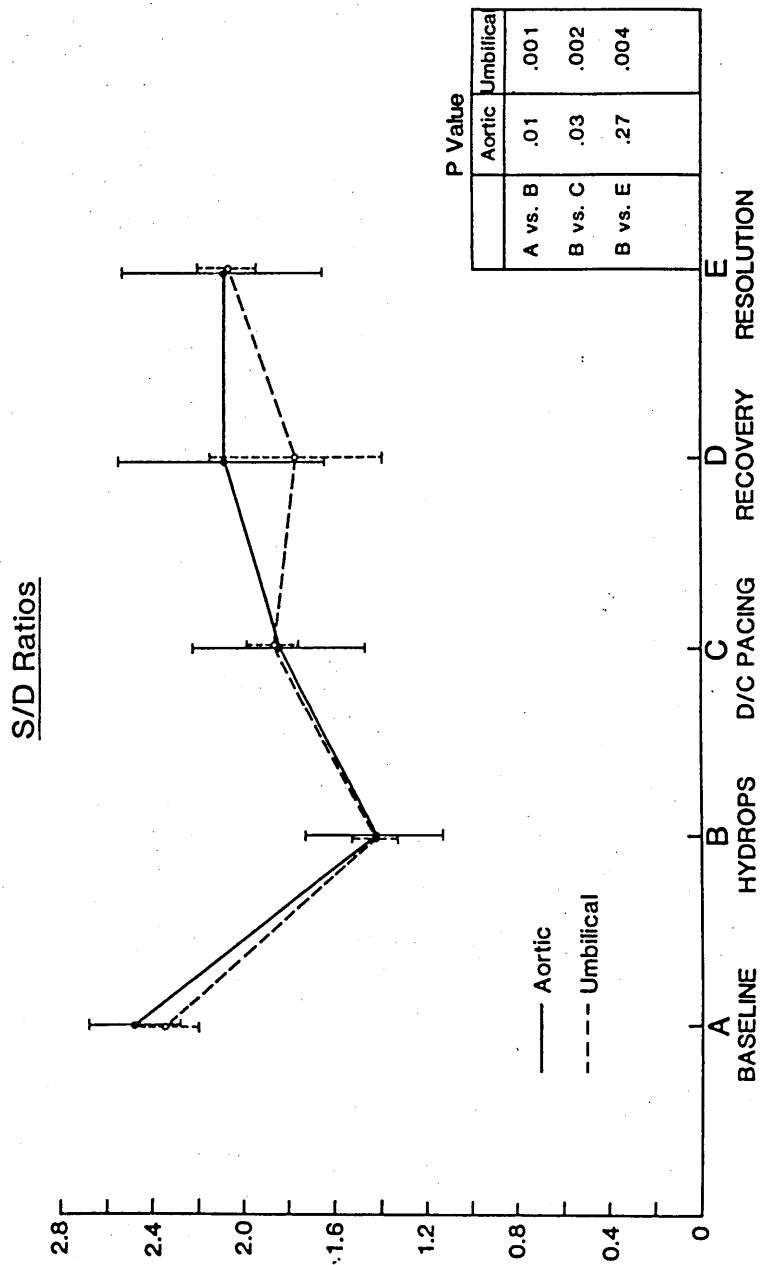

Figure 10.3.3a Changes in aortic and umbilical S/D ratios of fetal lambs during atrial pacing with levels of statistically significant changes included

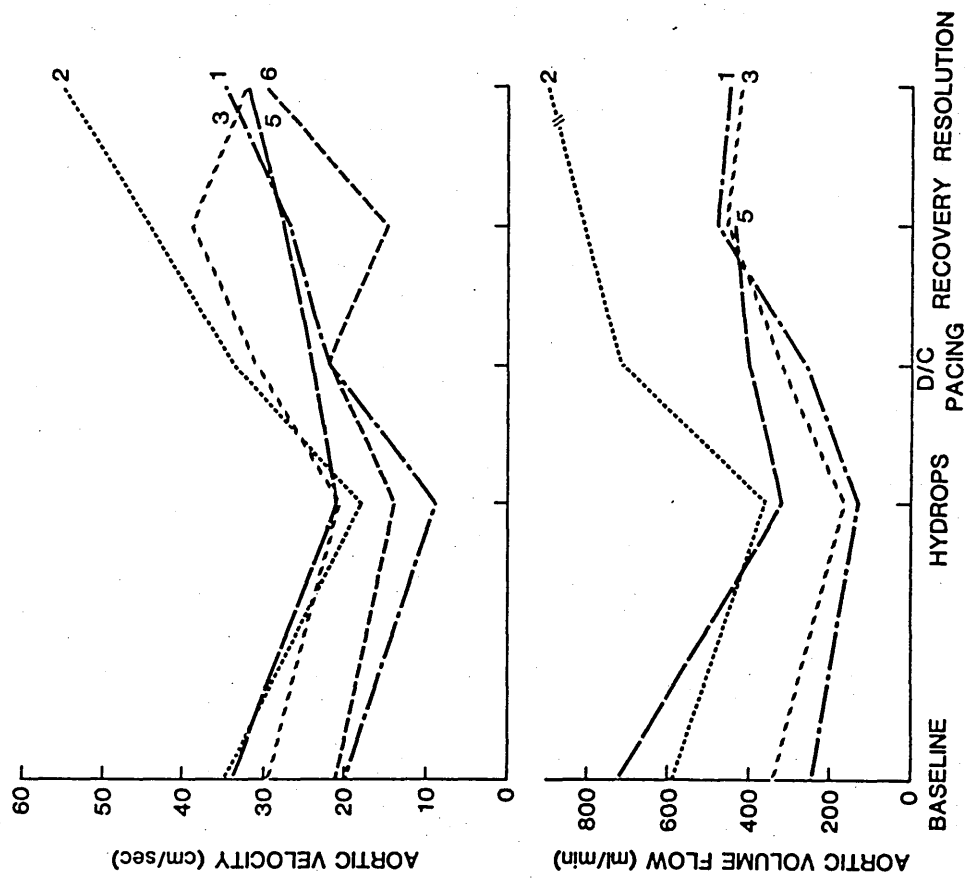

Figure 10.3.3b Changes in the mean aortic velocity and volume flow in individual animals during atrial pacing study

when the effect of pacing was removed. In ewe number 4, the fetal position precluded obtaining any quantitative information from the aorta, and in ewe number 6, volume flow information is not presented because it was unobtainable at several of the time intervals studied.

10.3.4 The umbilical artery FVW

The mean S/D ratio changes from baseline in the umbilical artery FVW for the six lambs is shown also in Figure 10.3.3a . As with the aortic S/D ratio, there was a significant decrease in this ratio from baseline to the time of hydrops development. This was followed by a significant increase in the S/D ratio immediately following withdrawal of pacing, despite hydrops still being present. These Doppler changes were seen in each individual lamb that was studied.

10.3.5 The fetal inferior vena cava FVW

The normal FVW of the inferior vena cava has been described in Chapter 3.7.2. It is a biphasic waveform with the larger peak indicative of the systolic to diastolic surge (Harder, 1987). This relationship is disturbed during atrial pacing and causes a disappearance of the biphasic pattern and evidence of reverse flow. Following discontinuation of atrial pacing, the systolic and diastolic surges reappear, reverse flow is no longer apparent and by six hours the normal relationship of the systolic to diastolic surge is restored (Figure 10.3.5).

10.4 Discussion

The atrial tachycardia model for the investigation of fetal hydrops was first described by Stevens et al (1982). The disadvantage of this atrial tachycardia model was that ultrasound imaging was not utilised in the experiments and the diagnosis of fetal hydrops had to be relied upon from post mortem changes. The advantages of this present study were that the tachycardia was directly visualised using ultrasound and this ensured that it was a continuous tachycardia that was being studied. In view of the study design, the time taken for the production and clearance of hydrops was more precisely defined in this study. The need for

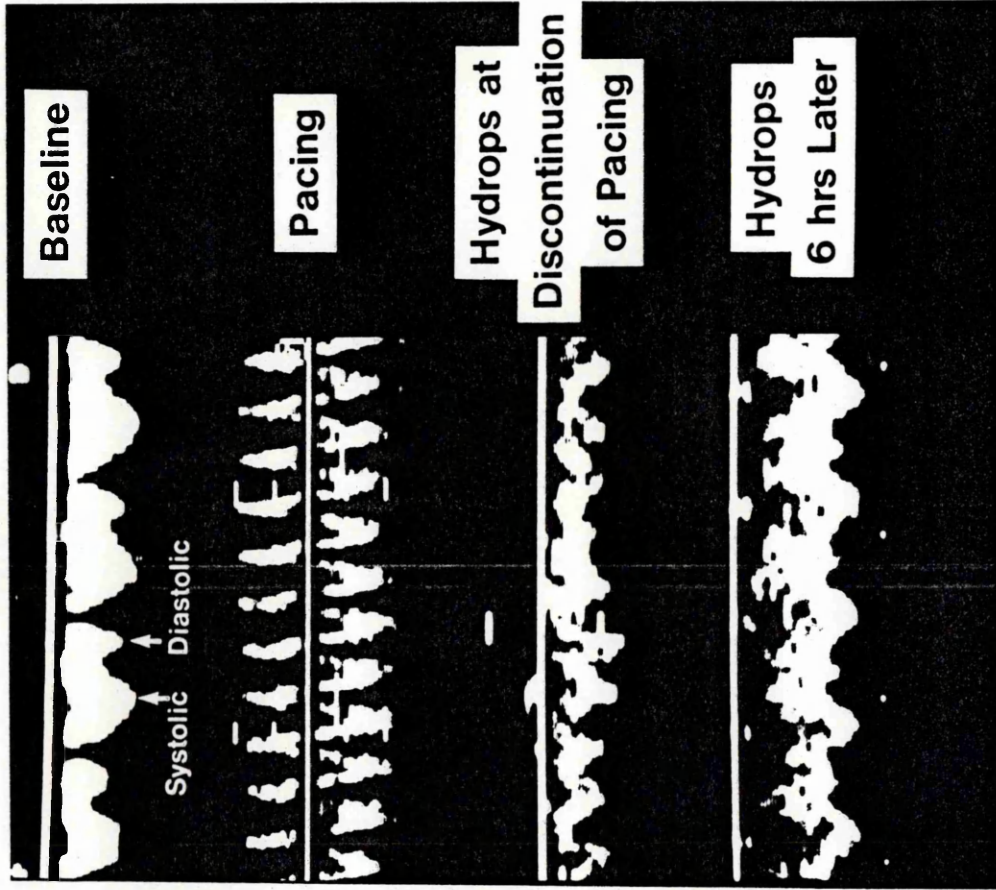

Figure 10.3.5 The inferior vena cava waveform under different experimental conditions

prolonged pacing which could lead to death of the fetal lamb was also eliminated in this present study. The experimental design allowed for Doppler blood flow evaluation of the model, which was the main aim of the study.

The pathogenesis of non-immune fetal hydrops is not known. However, one hypothesis that has been suggested, is that venous hypertension leads to loss of albumin into the extravascular space with resultant decreased osmotic and increased venous pressure combining to produce hydrops (Silverman et al, 1985). The results achieved using this present model and by using the techniques described appeared to support this hypothesis. In view of the obvious difficulty of continuous monitoring of the sheep, this present study does not however answer the question of the natural progression of changes seen during the production of fetal hydrops. However, ascites was seen first and then became more severe leading to the development of pleural effusions and abdominal wall oedema.

This study was performed using right atrial pacing only; it has previously been noted in animal studies that pacing of an atrium results in a decrease in the ipsilateral ventricular output. Therefore, with right atrial pacing, a decrease in flow in the descending thoracic aorta would be anticipated; this in fact was the observation noted (Figure 10.3.3b). Once pacing was stopped, a prompt and significant increase in velocity and volume flow occurred. This immediate improvement following atrial pacing would support the fact that the fetal myocardium was not dysfunctional, although this study did not specifically evaluate myocardial ischaemia and function. Other investigators working with an isoproterenol induced tachycardia have shown the preservation of intramyocardial blood flow during pacing but a decrease in myocardial glycogen (Tweed et al, 1987). The changes in Doppler indices seen at the time of fetal hydrops are a summation of changes due to tachycardia and those secondary to hydrops. In four animals, the umbilical S/D ratio was recorded at 16 hours following the initiation of pacing but prior to the development of hydrops. In each of these, the umbilical S/D ratio was significantly lower than baseline values. In all animals the S/D ratio immediately on discontinuation of pacing

with hydrops still present was also significantly different from baseline values. These Doppler studies provide new information concerning changes in the venous and arterial flow patterns in this hydropic animal model. The changes noted in the pressure and flow in the inferior vena cava concur with the observations of Reuss and Rudolph (1983). The data presented in this experiment suggests that there is a trend towards an inverse correlation between the baseline venous pressure and the time to the development to hydrops. However, statistical significance was not achieved. During the recovery phase following atrial pacing, the normal biphasic pattern of flow in the inferior vena cava FVW, with a predominant systolic peak was rapidly established.

The Doppler waveform in the descending aorta and umbilical artery showed a significant decrease in S/D ratio in all animals during the development of fetal hydrops. This was complimented by a decrease in both volume flow and velocity in the aorta. A prompt increase in all of these measurements following termination of pacing were the observed features of the recovery phase of fetal hydrops.

The design of this study differed from that of Stevens et al (1982) in that their period of pacing was much longer (72 versus 216 hours) and several of their animals (six) died during pacing. It is not surprising therefore, that even although the baseline levels of pO_2 were low but similar in both studies, a greater decrease was seen after pacing by Stevens. Although the baseline pO_2 levels were lower than expected in this study, none of the animals died during the experimental or recovery period or were otherwise compromised.

This study also demonstrated decreases in serum protein and albumin at the time of development of hydrops and a return to baseline levels during the recovery period. Such changes were not seen by Stevens et al (1982) and it can only be speculated that this was probably due to the more chronic nature of their preparation.

In summary, in this study of an animal model of fetal hydrops produced by rapid atrial pacing, the changes that were seen were those of venous hypertension, a fall in serum protein, and an alteration in the venous flow pattern but no

significant change in the fetal blood gases. The aortic velocity levels and volume flow measurements during tachycardia induced hydrops were decreased but showed a prompt increase following termination of pacing and this rise continued during the recovery phase. The S/D ratio was consistently decreased during pacing and at hydrops, and also was observed to rise again during recovery. The Doppler analysis of blood flow in the fetal vessels provided new and important information on the fetal changes during tachycardia induced hydrops and fetal recovery.

CONCLUSIONS AND SUGGESTIONS FOR FURTHER RESEARCH

With the introduction of the Doppler ultrasound principle, the non-invasive evaluation of human placental and fetal blood flow became possible. A continuously growing amount of reports (especially during recent years) on this subject reflects the worldwide interest in this research line. According to most authors, the technique appears to be very promising. It is suggested that the method will definitely play a role in the future management of the obstetrical patient. However, as has been stated in Chapter 4, a critical evaluation of this new diagnostic method is mandatory before the transition from research to clinical practice is justified.

The results presented in this thesis in Chapters 5, 6 and 7, concerning normal pregnancy, as well as the recent literature reference to in Chapter 4, do suggest that Doppler ultrasound can be applied to investigate both fetal and uteroplacental cardiovascular adaptation in normal pregnancies. One of the objectives of this thesis was to investigate the possibility of using Doppler ultrasound to investigate an animal model of pregnancy and to study the influence of physiological changes such as changes of fetal heart rate and gestation on the Doppler flow velocity waveform. This technique proved to be relatively easy to apply to an ovine pregnancy model and aided in the understanding of the physiological influences on the Doppler flow velocity waveform.

Another objective of this thesis was to examine the application of Doppler ultrasound in complicated pregnancies. The studies presented in Chapter 8 of the common pregnancy complication of hypertension, revealed that Doppler ultrasound indeed can detect warnings of fetal compromise before the standard tests of fetal wellbeing. This chapter also dealt with the influence of antihypertensive drugs on the Doppler flow velocity waveform. Using two

different antihypertensive agents, no effect was seen on the Doppler flow velocity waveform. From the results of these studies, it is tempting to start using the Doppler FVW's in these clinical situations, and to inform the clinician in charge whenever abnormal flow velocities are observed. The finding of abnormal flow velocities could then be an indication for intensive fetal monitoring. In such a protocol, Doppler velocimetry should be regarded as an adjunct to conventional obstetrical surveillance methods. However, in view of the fact that abnormal Doppler findings are reported to precede signs of fetal compromise by several weeks, Doppler velocimetry does not appear to be of help in the precise timing of delivery; thus, the latter has still to be based on established fetal monitoring techniques as well as worsening maternal condition.

Another useful role for Doppler ultrasound is in the evaluation of fetal cardiovascular function. The results presented in Chapters 9 and 10 of the thesis show that this technique can be used to correctly diagnose and provide surveillance in cases of fetal cardiac dysrhythmias. Although relatively rare conditions, cardiac dysrhythmias do pose a significant problem in terms of perinatal morbidity and mortality. The results presented in Chapter 9 and the animal study of fetal hydrops presented in Chapter 10, show that Doppler ultrasound can be used to provide a greater understanding of the pathophysiology of fetal hydrops and further studies in this area may help to improve the perinatal outcome of these conditions.

There are several reasons not to introduce Doppler velocimetry into clinical practice at this time. One serious problem in the evaluation of the method used for the prediction of fetal distress during pregnancy up until now, is the lack of an adequate gold standard as reference for the fetal condition. The best one can do, is to refer to indirect antenatal condition parameters such as cardiotocography and biophysical profile scoring, which might reflect the antenatal condition. Afterwards one may refer to the neonatal condition, but this in turn is influenced by the obstetrical intervention which has been taken.

It has furthermore to be emphasised, that no proper randomised evaluation of this technique has been published. Also, any proposed randomised evaluation will

be hampered on ethical and practical grounds now that the method has been introduced in routine clinical practice in many centres. So far, no convincing evidence has been given that Doppler FVW analysis of vessels of the maternal and fetal placental circulation is indeed a valuable tool in clinical decision making. One of the most important goals of perinatal care, is a reduction of perinatal mortality and morbidity. There has only been one randomised controlled trial published (Trudinger et al, 1987). This study tried to evaluate the real advantage of the availability of Doppler technology. The study concluded that the availability of Doppler umbilical artery studies led to better decision making. It was, however, not possible to investigate the influence of the availability of the test on perinatal mortality and morbidity, due to the low number of patients involved in the study.

Prospective, randomised, controlled trials in a large population are necessary to evaluate the real advantage of Doppler flow velocity waveform analysis with regard to a reduction of perinatal mortality and morbidity.

REFERENCES

- Aarnoudse, J.G., Yspeert-Gerards, J., Huisjes, H.J. and Touwen, B.C.L. (1985) Neurological follow-up of infants with severe acidemia (Abstract 297) Phoenix, Arizona : Society for Gynaecological Investigation, 32nd meeting, March 20-23rd.
- Ahokas, R.A., Sibai, B.M., Mabie, W.C., and Anderson, G.D. (1988) Nifedipine does not adversely affect uteroplacental blood flow in the hypertensive term-pregnant rat. *American Journal of Obstetrics and Gynecology* 159, 1440-1445.
- AIUM/NEMA (1981) Safety standard for diagnostic ultrasound equipment. National Electrical Manufacturers Association, Washington, Publication UL 1-1981. *Journal of Ultrasound in Medicine* 2,(April 1983 supplement)
- AIUM (1983) American Institute of Ultrasound in Medicine Bio-effects Committee. Safety considerations for diagnostic ultrasound.
- Allan, L.D., Anderson, R.H., Sullivan, I.D., Campbell, S., Hott, D.W. and Tynam, M. (1983) Evaluation of fetal arrhythmias by echocardiography. *British Heart Journal* 50, 240-245.
- Al-Ghazali, W., Chapman, M.G., Chita, S.K., Crawford, D.C. and Allan, L.D. (1987) Doppler assessment of umbilical artery blood flow for the prediction of outcome in fetal cardiac abnormality. *British Journal of Obstetrics and Gynaecology* 94, 742-745.
- Al-Ghazali, W., Chapman, M.G. and Allan, L.D. (1988) Doppler assessment of the cardiac and uteroplacental circulations in normal and complicated pregnancies. *British Journal of Obstetrics and Gynaecology* 95, 575-580.

- Anderson, P.A., Manning, A. and Crenshaw, C. Jr. (1980) Biophysics of the developing heart II. The interaction of the force-interval relationship with inotropic state and muscle length (preload). *American Journal of Obstetrics and Gynecology* **138**, 44.
- Anderson, P.A., Glick, K.L., Manning, A. and Crenshaw, C. Jnr. (1984) Developmental changes in cardiac contractility in fetal and postnatal sheep: In vitro and in vivo. *American Journal of Physiology* **247**, H371-379.
- Apfel, R.E. (1982) Acoustic cavitation: A possible consequence of biomedical uses of ultrasound. *British Journal of Cancer* **45**, (Supp V) 140-146.
- Apfel, R.E. (1986) Possibility of microcavitation from diagnostic ultrasound. *IEEE Transactions of Ultrasound Ferroelectrics and Frequency Control*. **UFFC 33**, 139-142.
- Apgar, V. (1953) Proposal for a new method for evaluation of newborn infants. *Anaesthesia analogues* **32**, 260-267.
- Apgar, V. and James, L.S. (1962) Further observations on the newborn scoring system. *American Journal of Diseases of Children* **104**, 419-427.
- Arbeille, Ph., Asquier, E., Moxhon, E., Magnin, M., Pourcelot, L., Berger, Ch. and Lansac, J. (1983) L'etude de la circulation foetale et placentaire par ultrasons. *European Journal of Obstetrics and Gynaecology and Reproductive Biology* **12**, 851-859.
- Archer, L., Levine, M. and Evans, D. (1986) Cerebral artery Doppler ultrasonography for prediction of outcome after perinatal asphyxia. *Lancet* **II**, 1116.

- Arduini, D., Rizzo, G., Romanini, C. and Mancuso, S. (1987a) Uteroplacental blood flow velocity waveforms as predictors of pregnancy-induced hypertension. *European Journal of Obstetrics and Gynaecology and Reproductive Biology* 26, 335-341.
- Arts, N.F.Th. (1961a) Investigations on the vascular system of the placenta, Part I. General introduction and the fetal vascular system. *American Journal of Obstetrics and Gynecology* 82, 147-158.
- Arts, N.F.Th. (1961b) Investigations on the vascular system of the placenta, Part II. The maternal vascular system. *American Journal of Obstetrics and Gynecology* 82, 159-166.
- Assali, N.S., Roy, A.D., Baird, W., Nicholson, D.B. and Suyemoto, R. (1953) Measurement of uterine blood flow and uterine metabolism. *American Journal of Obstetrics and Gynaecology* 66, 3-17.
- Assali, N.S., Rauramo, L. and Peltonen, T. (1960) Measurement of uterine blood flow and uterine metabolism. VIII. Uterine and fetal blood flow and oxygen consumption in early human pregnancy. *American Journal of Obstetrics and Gynaecology* 79, 86-98.
- Bacon, D.R. (1984) Finite amplitude distortion of the pulsed field used in diagnostic ultrasound. *Ultrasound in Medicine and Biology* 10, 189-195.
- Bada, H.S., Hajjar, W., Chua, S. and Summner, D.S. (1979) Non invasive diagnosis of neonatal asphyxia and intraventricular haemorrhage by Doppler ultrasound. *Journal of Pediatrics* 95, 775-779.
- Bakketeig, L.S., Eik-Nes, S.H., Jacobsen, G., Ulstein, M.K., Brodtkorb, C.J., Balstad, P., Eriksen, B.C. and Jorgensen, N.P. (1984) Randomised controlled

- trial of ultrasonograph screening in pregnancy. *Lancet* II, 207-210.
- Barclay, A.E., Barcroft, J., Barron, D.H. Franklin, K.J. (1939) A radiographic demonstration of the circulation through the heart in the adult and in the fetus, and the identification of ductus arteriosus. *British Journal of Radiology* 12, 505-517.
- Barcroft, J. Flexner, L.B. and McClurkin, T. (1934) The output of the fetal heart in the goat. *Journal of Physiology* 82, 498-508.
- Barcroft, J. Kennedy, J.A. and Mason M.F. (1939) The direct determination of the oxygen consumption of the foetal sheep. *Journal of Physiology* 95, 269-275.
- Barcroft, J. (1946) *Researches on prenatal life*. Oxford:Blackwell Scientific Publication.
- Beattie, R.B. and Dornan, J.C. (1989) Antenatal screening for intrauterine growth retardation with umbilical artery Doppler ultrasonography. *British Medical Journal* 298, 631-635.
- Benson, C.B. and Doubilet, P.M. (1988) Doppler criteria for intrauterine growth retardation: Predictive values. *Journal of Ultrasound in Medicine* 7, 655.
- Berkowitz, G.S., Mehalek, K.E., Chitkara, U., Rosenberg, J., Cogswell, C. and Berkowitz, R.L. (1988) Doppler ultrasound velocimetry in the predictor of adverse outcome in pregnancies at risk for intrauterine growth retardation. *Obstetrics and Gynecology* 71, 742-746.
- Bernstine, R.L. (1969) Safety studies with ultrasonic Doppler technique. *Obstetrics and Gynaecology* 34, 704-709.

- Bergmans, M.G.M., Jonker, G.J. and Kock, H.C.L.V. (1985) Fetal supraventricular tachycardia: review of the literature. *Obstetrics and Gynecology Survey* **40**, 61-68.
- Bewley, S., Campbell, S. and Cooper, D. (1989) Uteroplacental Doppler flow velocity waveforms in the second trimester. A complex circulation. *British Journal of Obstetrics and Gynaecology* **96**, 1040-1046.
- Bilardo, C.M., Soothill, P.W., Nicolaides, K.H., Rodeck, C.H. and Campbell, S. (1986) Fetal blood flow velocities in Rhesus isoimmunisation (Abstract). *Obstetrics and Neonatal Blood Flow*, King's College Hospital, London.
- Biquard, P. (1972) Paul Langevin. *Ultrasonics* **10**, 213-214.
- Bleker, O.P., Kloosterman, G.J., Mieras, D.J., Oosting, J. and Sall, H.J.A. (1975) Intervillous space during uterine contractions in human subjects: An ultrasonic study. *American Journal of Obstetrics and Gynecology* **123**, 697-699.
- Block, B.S.B., Llanos, A.J. and Creasy, R.K. (1984) Responses of the growth-retarded fetus to acute hypoxaemia. *American Journal of Obstetrics and Gynecology* **148**.
- Boyce, E.S., Dawes, G.S., Gough, J.D. and Poore, E.R. (1976) Doppler ultrasound method for detecting human fetal breathing in utero. *British Medical Journal* **2**, 17-18.
- Boylan, P. (1987) Intrapartum fetal monitoring. *Clinics in Obstetrics and Gynaecology* **1**, 73-96
- Born, G.V.R., Dawes, G.S., Mott, J.C. and Widdicombe, J.G. (1954) Changes in the

- heart and lungs at birth. *Cold Spring Harbour Symposia on Quantitative Biology* 19,102.
- Bracero, L., Schulman, H., Fleischer, A., Farmakides, G. and Chelson, B. (1986) Umbilical artery velocimetry in diabetes and pregnancy. *Obstetrics and Gynecology* 68, 654-658.
- Braly, P. and Freeman, R.K. (1982) The significance of fetal heart rate reactivity with a positive oxytocin challenge test. *Obstetrics and Gynecology* 25, 707.
- Brann, A.W. and Dykes, F.W. (1977) The effect of intrauterine asphyxia on the full term neonate. *Clinics in Perinatology* 4, 149.
- Brar, H.S., Platt, L.D., De Vore, G.R., Horenstein, J. and Meandearis, A.L. (1988a) Qualitative assessment of maternal uterine and fetal umbilical artery blood flow and resistance in laboring patients by Doppler velocimetry. *American Journal of Obstetrics and Gynecology* 158, 952-956.
- Brar, H.S. and Platt, L.D. (1988b) Peripartal changes in uterine velocimetry - evidence of reversible spasm in uteroplacental bed in pre-eclampsia (PIH). 35th Annual Meeting of the Society of Gynecologic Investigation, Baltimore, March 1988, abstract 303.
- Brosens, I.A., Dixon, G. and Robertson, W.B. (1975) Human placentation (proceedings of an international symposium 29-30 July 1974, Leuven, Belgium). *European Journal of Obstetrics and Gynaecology and Reproductive Biology* 5, 1-170.
- Brosens, I., Robertson, W.B. and Dixon, H.G. (1967) The physiological response of the vessels of the placental bed to normal pregnancy. *Journal of Pathology*

and Bacteriology 93, 569-579.

Brosens, I., Robertson, W.B. and Dixon, H.G. (1972) The role of the spiral arteries in the pathogenesis of pre-eclampsia. *Obstetrics and Gynaecology Annual* 1, 177-191.

Brown, R. and Patrick, J.E. (1981) The non-stress test: How long is enough? *American Journal of Obstetrics and Gynecology* 141, 645.

Browne J.C.M. and Veall, N. (1953) The maternal placental blood flow in normotensive and hypertensive women. *Journal of Obstetrics and Gynaecology of the British Commonwealth* 60, 141-147.

Buchan, P.C. (1982) Pre-eclampsia - a hyperviscosity syndrome. *American Journal of Obstetrics and Gynecology* 142, 111-112.

Buys Ballot C.H.D. (1845) Akustische Versuche auf der Niederlandischen Eisenbahn, nebst gelegentlichen Bemerkungen zur Theorie des Herrn. Prof. Doppler. *Pogg. Ann. Bd. 66, No. 11, 321-351.*

Callaghan, D.A., Rowland, T.C. and Goldman, D.E. (1964) Ultrasound Doppler observation of the fetal heart. *Obstetrics and Gynecology* 23, 637-641.

Campbell, S. Griffin, D.R., Pearce, J.M., Diaz-Recasens, J., Cohen-Overbeek, T.E., Willson, K. and Teague, M.J. (1983) New Doppler technique for assessing uteroplacental blood flow. *Lancet* I, 675-677.

Campbell, S., Pearce, J.M.F., Hackett, G., Cohen-Overbeek, T. and Hernandez, C. (1986) Qualitative assessment of uteroplacental blood flow : early screening test for high-risk pregnancies. *Obstetrics and Gynecology* 68, 649-653.

Campbell, S., Vyas, S. and Bewley, S. (1988) Doppler uteroplacental

- waveforms (Letter). *Lancet* **I**, 1288.
- Carson, P.L., Fischella, P.R. and Oughton, T.V. (1978) Ultrasonic power and intensities produced by diagnostic ultrasound equipment. *Ultrasound in Medicine and Biology* **3**, 341-350.
- Chamberlain, P.F., Manning, F.A., Morrison, I. et al (1984) Ultrasound evaluation of amniotic fluid volume I. The relationship of marginal and decreased amniotic fluid volume to perinatal outcome. *American Journal of Obstetrics and Gynecology* **150**, 245.
- Chambers, S.E., Johnstone, F.D., Muir, B.B., Hoskins, P.R., Haddad, N.G. and McDicken, W.N. (1988) The effects of placental site on the arcuate artery flow velocity waveform. *Journal of Ultrasound in Medicine* **7**, 671-673.
- Chambers, S.E., Hoskins, P.R., Haddad, N.G., Johnstone, F.D., McDicken, W.N. and Muir, B.B. (1989) A comparison of fetal abdominal circumference measurements and Doppler ultrasound in the prediction of small-for-dates babies and fetal compromise. *British Journal of Obstetrics and Gynaecology* **96**, 803-808.
- Chameides, L, Truex, R.C., Vetter, V., Raskind, W.J. Galido, Jr, F.M. and Noonan, J.A. (1977) Association of maternal systemic lupus erythematosus with congenital complete heart block. *New England Journal of Medicine* **297**, 1204-1207.
- Chiba, Y., Utsu, M., Kanzaki, T. and Hasegawa, T. (1985) Changes in venous flow and intra tracheal flow in fetal breathing movements. *Ultrasound in Medicine and Biology* **11**, 43-49.
- Clapp, J.F., Szeto, H.H., Larrow, R., Hewitt, J. and Mann, L.I. (1980) Umbilical blood flow response to embolization of the uterine circulation.

American Journal of Obstetrics and Gynaecology 138, 60-67.

Clavero, J., Negueruela, J., Ortiz, L., de Los Heros, J.A and Modrego, S.P. (1973) Blood flow in the intervillous space and fetal blood flow. *American Journal of Obstetrics and Gynaecology* 116, 340-346.

Cohnstein, J. and Zuntz, N. (1884) Untersuchungen uber das Blut, den Kreislauf und die Atmung beim Säugetier-Fötus. *Arch ges Physiol* 34, 173-233.

Cohen-Overbeek, T., Pearce, M.J. and Campbell, S. (1985) The antenatal assessment of utero-placental and fetoplacental blood flow using Doppler ultrasound. *Ultrasound in Medicine and Biology* 11, 329-339.

Cooper, K.E. and Greenfield, A.D.M. (1949) A method for measuring the blood flow in the umbilical vessels. *Journal of Physiology* 108, 167-169.

Copel, J.A., Grannum, P.A., Belanger, K., Green, J. and Hobbins, J.C. (1988) Pulsed Doppler flow velocity waveforms before and after intrauterine intravascular transfusion for severe erythroblastosis fetalis. *American Journal of Obstetrics and Gynecology* 158, 768-774.

Copel, J.A., Grannum, P.A., Green, J.J., Belanger, K., and Hobbins, J.C. (1989) Pulsed Doppler flow velocity waveforms in the prediction of fetal haematocrit of the severely isoimmunized pregnancy. *American Journal of Obstetrics and Gynecology* 161, 341-344.

Corke, B.C., Datta, S., Ostheimer, G. W., Weiss, J.B. and Alper, M. (1982) Spinal anaesthesia for caesarean section. The influence of hypotension on neonatal outcome. *Anaesthesia* 37, 658.

Cournand, A. (1964) In: Air and blood: Circulation of the blood, men and Ideas.

- Ed Fishman A.P. and Richards D.W. Oxford University Press, New York. p3-70.
- Crawford, D., Chapman, M. and Allan, L. (1985) The assessment of persistent bradycardia in prenatal life. *British Journal of Obstetrics and Gynaecology* **92**, 941-944.
- Crenshaw, C., Huchabee, W.E., Curet, L.B., Mann, L. and Barron, D.H. (1968) A method for the estimation of the umbilical blood flow in unstressed sheep and goats with some results of its application. *Quarterly Journal of Experimental Physiology* **53**, 65-75.
- Curie, J. and Curie, P. (1880) Sur l'electricite polaire dans cristaux hemiedres a face inclinees. *Compt Rend Seances Acad Sci.* **91** 383-389.
- Daffos, F., Capella-Pavlovsky, M. and Forestier, F. (1983) Fetal blood sampling via the umbilical cord using a needle guided by ultrasound: report of 66 cases. *Prenatal Diagnosis* **3**, 271-277.
- Dawes, G.S. (1962) The umbilical circulation. *American Journal of Obstetrics and Gynecology* **84**, 163.
- Dawes, G.S. and Mott, J.C. (1964) Changes in oxygen distribution and consumption in foetal lambs with variations in umbilical blood flow. *Journal of Physiology* **170**, 524-540.
- Dawes G.S. (1968) Fetal and Neonatal Physiology. Year book medical publishers Chicago 1968.
- Dempster, J., Mires, G.J., Patel, N. and Taylor, D.J. (1989) Umbilical artery velocity waveforms: poor association with small-for-gestational age babies. *British Journal of Obstetrics and Gynaecology* **96**, 692-696.

Dennis, J. and Chalmers, I. (1982) Very early neonatal seizure rate : a possible epidemiological indicator of the quality of perinatal care. *British Journal of Obstetrics and Gynaecology* **89**, 418-426.

Department of Health and Social Security (DHSS) (1979) Evaluation of real time ultrasonic scanners; first report. *Health Equipment Information*, **81**.

De Souza, S.W. and Richards, B. (1978) Neurological sequelae in newborn babies after perinatal asphyxia. *Archives of Diseases in Children* **53**, 564.

Deutinger, J., Rudelstorfer, R. and Bernaschek, G. (1988) Transvaginal pulsed Doppler velocimetry of the uterine artery in pregnant women. Abstract book XI European Congress of Perinatal Medicine, ed. CIC Edizioni Internazionali, **93**.

De Vore, G.R., Slassi, B. and Platt, L.D. (1983) Fetal echocardiography III. The diagnosis of cardiac arrhythmias using real time direct M-mode ultrasound. *American Journal of Obstetrics and Gynecology* **146**, 792-799.

Dijxhoorn, M.J., Visser, G.H.A., Fidler, V.J., Touwen, B.C.L. and Huisjes, H.J. (1986) Apgar score, meconium and acidaemia at birth in relation to neonatal neurological morbidity in term infants. *British Journal of Obstetrics and Gynaecology* **93**, 217-222.

Dixon, H.G., Browne, J.C.M. and Davey, D.A. (1963) Choriodecidual and myometrial blood-flow. *Lancet* **II**, 369-373.

Dobson, J.F. (1925) Herophilus of Alexandria. *Proceedings of the Royal Society of Medicine* **18** 19-32.

Donald, I., MacVicar, J. and Brown T.G. (1958) Investigation of abdominal

masses by pulsed ultrasound. *Lancet* **I**, 1188-1195

Doppler, J.C. (1842) Über das farbige Licht der Doppelsterne und einiger anderer Hestirne des Himmels. Abhandlungen d. Konigl. Bohmischen Gesellschaft der Wissenschafter zu Prag. V. 2, 467-482.

Duck, F.A., Starritt, H.C., Aindow, J.D., Perkins, M.A. and Hawkins, A.J. (1985) The output of pulse-echo ultrasound equipment: a survey of powers, pressures and intensities. *British Journal of Radiology* **58**, 989-1001.

Eik-Nes, S.H. Brubakk, A.O. and Ulstein M. (1980a) Measurement of human fetal blood flow. *British Medical Journal* **1**, 283-284.

Eik-Nes, S.H., Marsal, K., Brubakk, A.D. and Ulstein, M.K. (1980b) Ultrasonic measurements of human fetal blood flow in aorta and umbilical vein: influence of fetal breathing movements. In: Recent Advances in Ultrasound diagnosis. II, Ed. Kurjak, A., Excerpta Medica, Amsterdam, 233-240.

Eik-Nes, S.H., Marsal, K., Kristofferson, K. and Vernersson, E. (1981) Transcutaneous measurement of human fetal blood flow. Methodological studies. In: Recent Advances in Ultrasound diagnosis. III, Ed. Kurjak, A. and Kratochwii, A., Excerpta Medica, Amsterdam, 209-219.

Eik-Nes, S.H., Okland, O., Aure, J.C. and Ulstein, M. (1984) Ultrasound screening in pregnancy - a randomised controlled trial. *Lancet* **1**, 1347.

Eik-Nes, S.H., Marsal, K. and Kristoffersen, K. (1984) Methodology and basic problems related to blood flow studies in the human fetus. *Ultrasound in Medicine and Biology* **10**, 329-337.

Eldridge, M.W., Alverson, D.C., Howard, E.A. and Berman, W. Jr. (1983) Pulsed Doppler ultrasound - principles and instrumentation in pulsed

- Doppler ultrasound in clinical pediatrics. Ed: Berman, W. Jr. Futura Mt Kisco, N.Y. 5-40.
- Eldridge, M.W. and Berman, W. (1983) Serial measurement of human fetal aortic blood flow. Ed: Berman W. Pulsed Doppler Ultrasound in Clinical Pediatrics. New York: Futura, 211-223.
- Eldridge, M.W., Berman, W. and Greene, E.R. (1985) Serial echo-Doppler measurements of human fetal abdominal aortic blood flow. *Journal of Ultrasound Medicine* 4, 453-458.
- Elkayham, U. and Gleicher, N. (1982) Cardiac problems in pregnancy: Diagnosis and management of maternal and fetal disease. New York: Ed: Alan R Liss, 535-565.
- Eriksen, P.S. and Marsal, K. (1987) Circulatory changes in the fetal aorta after maternal smoking. *British Journal of Obstetrics and Gynaecology* 94, 301-305.
- Erskine, R.L.A. and Ritchie, J.W.K. (1985a) Quantitative measurement of fetal blood flow using Doppler ultrasound. *British Journal of Obstetrics and Gynaecology* 92, 600-604.
- Erskine, R.L.A. and Ritchie, J.W.K. (1985b) Umbilical artery blood flow characteristics in normal and growth retarded fetuses. *British Journal of Obstetrics and Gynaecology* 92, 605-610.
- Erskine, R.L.A., Ritchie, J.W.K., Zaltz, A. and Tice, T. (1986a) Failure of non stress test and Doppler assessed umbilical artery blood flow to detect imminent intrauterine death. *American Journal of Obstetrics and Gynecology* 154, 1109-1110.

- Erskine, R.L.A., Ritchie, J.W.K. and Murnaghan, G.A. (1986b) Antenatal diagnosis of placental anastomosis in a twin pregnancy using Doppler ultrasound. *British Journal of Obstetrics and Gynaecology* **93**, 955-959.
- Eskes, T., Stolte, L., Seelen, J. and Lamping, P. (1965) Radioangiographic studies of the maternal circulation in the human placenta. *Arch Gynak* **200**, 735-743.
- Evans, D., Archer, L. and Levine, M. (1985) The detection of abnormal neonatal cerebral haemodynamics using principal component analysis of the Doppler ultrasound waveforms. *Ultrasound in Medicine and Biology* **11**, 441.
- Eyck, J. van., Wladimiroff, J.W., Wijngaard, J.A.G.W., van de, Noordam, M.J. and Prechtl, H.F.R. (1987) The blood flow velocity waveform in the fetal internal carotid and umbilical artery; its relationship to fetal behavioural states in normal pregnancy at 37-38 weeks of gestation. *British Journal of Obstetrics and Gynaecology* **94**, 736-741.
- Eyck, J. van, Wladimiroff, J.W., Noordam, M.J., Wijngaard, J.A.G.W. van de and Prechtl, H.F.R. (1988) The blood flow velocity waveform in the fetal internal carotid and umbilical artery; its relation to fetal behavioural states in the growth retarded fetus at 37-38 weeks gestation. *British Journal of Obstetrics and Gynaecology* **95**, 473-477.
- Fairlie, F.M., Lang, G.D. and Sheldon, C.D. (1989) Umbilical artery flow velocity waveforms in labour. *British Journal of Obstetrics and Gynaecology* **96**, 151-157.
- Farmakides, G., Schulman, H., Saldana, L.R., Bracero, L.A., Fleischer, A. and Rochelson, B. (1985) Surveillance of twin pregnancy with umbilical arterial velocimetry. *American Journal of Obstetrics and Gynecology* **153**, 789-792.

- Feinkind, L., Abulafia, O., Delke, I., Feldman, J. and Minkoff, H. (1989) Screening with Doppler velocimetry in labor. *American Journal of Obstetrics and Gynecology* **161**, 765-70.
- Ferrer, P.L. (1977) Arrhythmias in the neonate. In: Cardiac arrhythmias in the neonate, infant and child. Ed: Robert N.K., Gelband, H. New York: Appleton Century Crofts, Chapter 17.
- Fields, L.M., Entman, S.S., Boehm, F.H. (1983) Correlation of the one-minute Apgar score and the pH value of the umbilical arterial blood. *Southern Medical Journal* **76**, 1477.
- Finer, N.W., Robertson, C.M., Richards, R.T., Pinnell, L.E. and Peters, K.L. (1981) Hypoxic-ischaemic encephalopathy in term neonates : Perinatal factors and outcome. *Journal of Paediatrics* **98**, 112.
- Fitzgerald, D.E. and Drumm, J.E. (1977) Non-invasive measurement of human fetal circulation using ultrasound : a new method. *British Medical Journal* **II**, 1450-1451.
- Fitzgerald, D.E., Stuart, B., Drumm, J.E. and Duignan, N.M. (1984) The assessment of the fetoplacental circulation with continuous wave Doppler ultrasound. *Ultrasound in Medicine and Biology* **10**, 371-376.
- Fleischer, A., Schulman, H., Farmakides, G., Bracero, L., Blattner P. and Randolph G. (1985) Umbilical artery velocity waveforms and intrauterine growth retardation. *American Journal of Obstetrics and Gynecology* **151**, 502-505.
- Fleischer, A., Schulman, H., Farmakides, G., Bracero, L., Grunfeld, L., Rochelson, B. and Koenigsberg, M. (1986) Uterine artery Doppler

velocimetry in pregnant women with hypertension. *American Journal of Obstetrics and Gynecology* **154**, 806-813.

Fleischer, A., Anyaegbunam, A.A., Schulman, H., Farmakides, G. and Randolph, G. (1987b) Uterine and umbilical artery velocimetry during labour. *Obstetrics and Gynecology* **157**, 40-43.

Flynn, H.G. (1982) Generation of transient cavities in liquids by microsecond pulses of ultrasound. *Journal of the Acoustic Society of America* **74**, 1062-1065.

Fox, H. (1976) The histopathology of placental insufficiency. *Journal of Clinical Pathology* **29** (10), 1-8

Fry, W.J., Meyers, R., Fry, F.J., Schultz, D.F., Dreyer, L.L. and Noyes, R.F. (1958) Topical differentia of pathogenetic mechanisms underlying Parkinsonian tremor and rigidity as indicated by ultrasonic irradiation of the human brain. *Transactions of the American Society of Neurologists* **83**, 16-24.

Gerson. A.G., Wallace, D.M., Stiller, R.J., Paul, D., Weiner, S., and Bolognese, R.J. (1987) Doppler evaluation of umbilical venous and arterial blood flow in the second and third trimesters of normal pregnancy. *Obstetrics and Gynecology* **70**, 622-626.

Giles, W.B., Trudinger, B.J. and Baird, P.J. (1985a) Fetal umbilical artery flow velocity waveforms and placental resistance : pathological correlation. *British Journal of Obstetrics and Gynaecology* **92**, 31-38.

Giles, W.B., Trudinger, B.J. and Cook, C.M. (1985b) Fetal umbilical artery flow velocity-time waveforms in twin pregnancies. *British Journal of Obstetrics and Gynaecology* **92**, 490-497.

- Giles, W.B., Lingman, G., Marsal, K. and Trudinger, B.J. (1986a) Fetal volume blood flow and umbilical artery flow velocity waveform analysis: a comparison. *British Journal of Obstetrics and Gynaecology* **93**, 461-465.
- Giles, W.B., Trudinger, B.J. and Palmer, A.A. (1986b) Umbilical cord whole blood viscosity and the umbilical artery flow velocity time waveforms : a correlation. *British Journal of Obstetrics and Gynaecology* **93**, 466-470.
- Gill, R.W. (1979) Pulsed Doppler with B-mode imaging for quantitative blood flow measurement. *Ultrasound in Medicine and Biology* **5**, 222-235.
- Gill, R.W. and Kossoff, G. (1979) Pulsed Doppler combined with B-mode imaging for blood flow measurement. *Controversies in Gynecology and Obstetrics* **6**, 139-141.
- Gill, R.W., Kossoff, G., Trudinger, B.J. and Warren, P.S. (1980) Flow velocity in the venous return from the placental. In: *Recent Advances in Ultrasound Diagnosis* Ed: Kurjak, A., Excerpta Medica, Amsterdam, pp 229-232.
- Gill, R.W., Trudinger, B.J., Garrett, W.J., Kossoff, G. and Warren, P.S. (1981) Fetal umbilical venous flow measured in utero by pulsed Doppler and B-mode ultrasound. *American Journal of Obstetrics and Gynecology* **139**, 720-725.
- Gill, R.W., Kossoff, G., Warren, P.S. and Garrett, W.J. (1984) Umbilical venous flow in normal and complicated pregnancy. *Ultrasound in Medicine and Biology* **10**, 349-363.
- Gill, R.W. (1985) Measurement of blood flow by ultrasound: accuracy and sources of error. *Ultrasound in Medicine and Biology* **11**, 625-641.
- Goddard, J., Everette James, A., Rao, G.U.V. and Powis, R. (1980) Practical

Aspects of Instrumental usage and Image recording. In: The principles and practice of ultrasonography in obstetrics and gynaecology. Ed. R.C. Saunders and A. Everette James. Appleton-Century Crofts. p25-49.

Gosling, R.C. and King, D.H. (1974) Continuous wave ultrasound as an alternative and complement to x-rays in vascular examination. In: Cardiovascular Applications of Ultrasound, Ed: Reneman, R.S., North Holland/American Elsevier, New York, pp 266-282.

Gosling, R.G. (1976) Extraction of physiological information from spectrum analysed Doppler shifted ultrasound signals obtained non-invasively from the arterial system. In: Institute of Electrical Engineers Medical Electronics Monograph 21. Peter Peregrinus, Stevenage, p73-125.

Greenfield, A.D.M., Shepherd, J.T. and Whelen, R.F. (1951) The rate of blood-flow in the umbilical cord. *Lancet* II, 422-424.

Griffin, D., Cohen-Overbeek, T. and Campbell, S. (1983) Fetal and utero-placental blood flow. *Clinics in Obstetrics and Gynaecology* 10, 565-602.

Griffin, D., Teague, M.J., Tallet, P., Willson, K., Bilardo, C., Massini, L. and Campbell, S. (1985) A combined ultrasonic linear array scanner and pulsed Doppler velocimeter for the estimation of blood flow in the foetus and adult abdomen- II: Clinical evaluation. *Ultrasound in Medicine and Biology*, 11, 37-41.

Guidetti, D.A., Divon, M.Y., Cavalieri, R.L., Langer, O. and Merkatz, I.R. (1987) Fetal umbilical artery flow velocimetry in postdate pregnancies. *American Journal of Obstetrics and Gynecology* 157, 1521-1523.

Hackett, G.A., Campbell, S., Gamsu, H., Cohen-Overbeek, T. and Pearce, J.M.F.

- (1987) Doppler studies in the growth retarded fetus and prediction of necrotising enterocolitis, haemorrhage, and neonatal morbidity. *British Medical Journal* **294**, 13-16.
- Hadlock, F.P., Deter, R.L., Harrist, R.B. and Park, S.K. (1982a) Fetal biparietal diameter: Rational choice of plane of section for sonographic measurement. *American Journal of Radiology* **138**, 871-874.
- Hadlock, F.P., Deter, R.L., Harrist, R.B. and Park, S.K. (1982b) Fetal abdominal circumference as a predictor of menstrual age. *American Journal of Radiology* **139**, 367-370.
- Hanretty, K.P., Whittle, M.J. and Rubin, P.C. (1988) Doppler uteroplacental waveforms in pregnancy-induced hypertension: a re-appraisal. *Lancet* **I**, 850-852.
- Hanretty, K.P., Primrose, M.H., Neilson, J.P. and Whittle, M.J. (1989) Pregnancy screening by Doppler uteroplacental and umbilical artery waveforms. *British Journal of Obstetrics and Gynaecology* **96**, 1163-1167.
- Hanretty, K.P., Whittle, M.J., Howie, C.A. and Rubin, P.C. (1989) Effect of nifedipine on Doppler flow velocity waveforms in severe pre-eclampsia. *British Medical Journal* **299**, 1205-1206.
- Harder, J.R., Nimrod, C.A., Davies, D.M., Cameron, A.D., Maloney, J. and Nicholson, S. (1987) Pulsed Doppler assessment of fetal blood flow in the inferior vena cava in normal and altered physiological states. In: *Perinatal Development of the Heart and Lung*. Eds: Lipshitz, J., Maloney, J., Nimrod, C., and Carson, G. Ithaca, New York: Perinatology Press.

Harvey, W. (1628) *Exeratio anatomica de morte cordis et sanguinis in animalibus*. Barclay, Franklin and Pritchard.

Hastie, S.J., Howie, C.A., Whittle, M.J. and Rubin, P.C. (1988) Daily variability of umbilical and lateral uterine wall artery blood velocity waveform measurements. *British Journal of Obstetrics and Gynaecology* **95**, 571-574.

Hellmann, L.M. Duffus, G.M., Donald, I. and Sunden, B. (1970) Safety of diagnostic ultrasound in obstetrics. *Lancet* **I**, 1133-1135.

Hill, C.R., (1971) Acoustic intensity measurements on ultrasonic diagnostic devices. *Ultrasonographic medica; 1st International Congress of Medical Ultrasonics*, 2, Ed: Brock, J. and Ossoinig, K. (Vienna Academy of Medicine, Vienna), 21-27.

Hobbs, J.B., Oats, J.N., Palmer, A.A. et al. (1982) Whole blood viscosity in pre-eclampsia. *American Journal of Obstetrics and Gynecology* **142**, 288-292

Holden, K.R., Mellits, E.D. and Freeman, J.M. (1982) Neonatal seizures. 1. Correlation of prenatal and perinatal events with outcomes. *Pediatrics* **70**, 165.

Holm, V. (1982) The causes of cerebral palsy : a contemporary perspective *Journal of the American Medical Association* **247**, 1473.

Hon, E.H. (1958) The electronic evaluation of the fetal heart rate : A preliminary report. *American Journal of Obstetrics and Gynecology* **75**, 1215-1230.

- Hon, E.H. and Huang, H.S. (1962) The electronic evaluation of fetal heart rate VII. Premature and missed beats. *Obstetrics and Gynecology* **20**, 81-83.
- Hoogland, H.J. (1988) Echoscopische aspecten van placenta circulatie. *Ned Tijdschr voor Obstet Gynaecol* **101**, 119-120.
- Howry, D.H. and Bliss, W.R. (1952) Ultrasonic visualisation on soft tissue structures of the body. *Journal of Clinical Laboratory Medicine*. **40**, 579-592.
- Hsieh, F.J., Chang, F.M., Ko, T.M., Chen, H.Y. and Chen, Y.P. (1988) Umbilical artery flow velocity waveforms in fetuses dying with congenital anomalies. *British Journal of Obstetrics and Gynaecology* **95**, 478-482.
- Huchebee, W.E., Crenshaw, M., Curet, L.B. et al (1972) Uterine blood flow and oxygen concentration in the unrestrained pregnancy ewe. *Quarterly Journal of Experimental Physiology* **57**, 12-23.
- Hull, D., Binns, B.A. and Joyce, D. (1966) Congenital heart block and widespread fibrosis due to maternal lupus erythematosus. *Archives of Diseases of Children* **4**, 688-690.
- Hunter, W. (1774) An anatomical description of the human gravid uterus. Baskerville, London.
- Huggett, A.St.G. (1927) Foetal blood-gas tensions and gas transfusion through the placenta of a goat. *Journal of Physiology* **62**, 373-384.
- Illingworth, R.S. (1985) A paediatrician asks - why is it called birth injury? *British Journal of Obstetrics and Gynaecology* **92**, 122-130.
- Illyes, M. and Gati, I. (1988) Reverse flow in the human fetal descending aorta

as a sign of severe fetal asphyxia preceding intrauterine death. *Journal of Clinical Ultrasound* **16**, 403-407.

Janbu, T. and Nesheim, B. (1987) Uterine artery blood velocities during contractions in pregnancy and labour related to intrauterine pressure. *British Journal of Obstetrics and Gynaecology* **94**, 1150-1155.

Johnson, A., Dennis, J., Mutch, L., Yudkin, P. and Johnson, P. (1988) Umbilical arterial acid-base status at birth in term infants and outcome at age four and a half years. (Abstract) Proceedings of the X1 European Congress of Perinatal Medicine, Rome. p82 published by CIC Edizioni Internazionali, Rome.

Johnstone, F.D., Haddad, N.G., Hoskins, P., McDicken, W., Chambers, S.E. and Muir, B. (1988) Umbilical artery Doppler flow velocity waveform: the outcome of pregnancies with absent end diastolic flow. *European Journal of Obstetrics and Gynaecology and Reproductive Biology* **28**, 171-178.

Jonkman, E.J. (1980) An historical note: Doppler research in the nineteenth century. *Ultrasound in Medicine and Biology* **6**, 1-5.

Jouppila, P., Kirkinen, P., Eik-Nes, S.H. and Koivula, A. (1981) Fetal and intervillous blood flow measurements in late pregnancy. In: Recent Advances in Ultrasound diagnosis. III, Ed. Kurjak, A. and Kratochwii, A., Excerpta Medica, Amsterdam, 226-233.

Jouppila, P., Kirkinen, P. and Eik-Nes, S.H. (1983) Acute effect of maternal smoking on the human fetal blood flow. *British Journal of Obstetrics and Gynaecology* **90**, 7-10.

Jouppila, P. and Kirkinen, P. (1984a) Umbilical vein blood flow as an indicator of fetal hypoxia. *British Journal of Obstetrics and Gynaecology* **91**, 107-110.

Jouppila, P. and Kirkinen, P. (1984b) Umbilical vein blood flow in the human fetus in cases of maternal and fetal anemia and uterine bleeding. *Ultrasound in Medicine and Biology* **10**, 365-370.

Kaibara, M., Marumoto, Y., Taniguchi, I. and Kobayashi, T. (1981) Blood viscosity at a low shear rate in normal and abnormal pregnancies. *Biorheology* **18**, 177.

Kamocsay, D. and Gy, D.O. (1958) Ultrasound in gynaecology. *American Journal of Physiology in Medicine* **37**, 196.

Kennedy, J.A. and Millikan G.A. (1938) A micro blood volume method using a blue dye and photocell. *Journal of Physiology* **93**, 276-284.

Kerenyi, T.D., Neller, J., Steinfeld, L., Gleicher, N., Brown, E. and Chitkara, U. (1980) Transplacental cardioversion of intrauterine supraventricular tachycardia with digitalis. *Lancet II*, 393-395.

Ketty, S.S. and Schmidt, C.F. (1948) The nitrous oxide method for the quantitative determination of cerebral blood flow in man: Theory, procedure, and normal values. *Journal of Clinical Investigation* **27**, 476-483.

Khong, T.Y., De Wolf, F., Robertson W.B. and Brosens, I. (1986) Inadequate maternal vascular response to placentation in pregnancies complicated by pre-eclampsia and by small-for-gestational age infants. *British Journal of Obstetrics and Gynaecology* **93**, 1049-1059.

Kinnier Wilson, L.M. and Waterhouse, J.A.H. (1984) Obstetric ultrasound and childhood malignancies. *Lancet I*, 997-998.

- Kirkinen, P. and Jouppila, P. (1983a) Ultrasonic measurement of human umbilical circulation in various pregnancy complications. *Ultrasound Annual 1983*. Ed: Sanders, R.C. and Hill, M. Raven Press, New York.
- Kirkinen, P., Jouppila, P. and Eik-Nes, S.H. (1983b) Umbilical vein blood flow in rhesus-isoimmunization. *British Journal of Obstetrics and Gynaecology* **90**, 640-643.
- Kirkinen, P., Muller, R., Huch, R. and Huch, A. (1987) Blood flow velocity waveforms in human fetal intracranial arteries. *Obstetrics and Gynecology* **70**, 617-621.
- Kirschbaum, T.H., Lucas, W.E., De Haven, J.C. and Assali, N.S. (1967) The dynamics of placental oxygen transfer. *American Journal of Obstetrics and Gynecology* **429-443**.
- Kjellmer, I., Karlsson, K., Olsson, T. et al (1974) Cerebral reactions during intrauterine asphyxia in the sheep circulation and oxygen consumption in the fetal brain. *Pediatric Research* **8**, 50.
- Kleinman, C.S., Hobbins, J.C., Jaffe, C. et al (1980) Echocardiographic studies of the human fetus: prenatal diagnosis of congenital heart disease and cardiac dysrhythmias. *Pediatrics* **65**, 1059-1066.
- Kleinman, C.S., Donnerstein, R.L., De Vore, G.R. et al (1982) Fetal echocardiography for evaluation of in utero congestive heart failure. *New England Journal of Medicine* **306**, 568.
- Kleinman, C.S., Donnerstein, R.L., Jaffe, C.C. et al (1983) Fetal echocardiography. A tool for evaluation of in utero cardiac arrhythmias and monitoring of in utero therapy: analysis of 71 patients. *American Journal of Cardiology* **51**, 237.

- Kleinman, C.S., Copel, J.A., Weinstein, E., Santulli, T.V. and Hobbins, J.C. (1985) Treatment of fetal supraventricular tachyarrhythmias. *Journal of Clinical Ultrasound* **13**, 265-273.
- Klopfenstein, H.S. and Rudolph, A.M. (1978) Postnatal changes in the circulation and responses to volume loading in sheep. *Circulation Research* **42**, 839.
- Komaromy, B., Gaal, J. and Lampe, L. (1977) Fetal arrhythmia during pregnancy and labour. *British Journal of Obstetrics and Gynaecology* **84**, 492-496.
- Kurjak, A and Rajhvajn, B. (1982) Ultrasonic measurements of umbilical blood flow in normal and complicated pregnancies. *Journal of Perinatal Medicine* **10**, 3-16.
- Larks, S.D. (1961) Fetal electrocardiography. Springfield, Illinois: Ed: Charles C Thomas, 49.
- Laurin, J. (1987) Intrauterine growth retardation. A clinical and ultrasonic investigation of diagnosis and fetal surveillance. Thesis, University of Lund, Malmo General Hospital, Sweden.
- Laurin, J., Lingman, G., Marsal, K. and Persson, P. (1987a) Fetal blood flow in pregnancies complicated by intrauterine growth retardation. *Obstetrics and Gynecology* **69**, 895-902.
- Laurin, J., Marsal, K., Persson, P-H. and Lingman, G. (1987b) Ultrasound measurement of fetal blood flow in predicting fetal outcome. *British Journal of Obstetrics and Gynaecology* **94**, 940-948.

- Lavery, J.P. (1982) Non stress fetal heart rate testing. *Clinics in Obstetrics and Gynaecology* **25**, 689.
- Law, W.K., Frizzell, L.A., and Dunn, F. (1985) Determination of non linearity parameter B/A of biological media . *Ultrasound in Medicine and Biology* **11**, 307-318.
- Lieberman, B.A., Stirrat ,G.M., Cohen, S.L., Beard,R.W., Pinker, G.D., and Belsey, E. (1978) The possible adverse effect of propranolol on the fetus in pregnancies complicated by severe hypertension. *British Journal of Obstetrics and Gynaecology* **85**, 678-683.
- Leiberman, J.R., Meizner, I., Mazor, M. and Insler, V. (1988) Blood supply to the uterus in pre-eclampsia. *European Journal of Obstetrics and Gynaecology and Reproductive Biology* **28**, 23-27.
- Lerski, R.A., Duggan, T.C. and Christie, J. (1982) A simple tissue like ultrasound phantom material. *British Journal of Radiology* **55**, 156-157.
- Lierde, M. van, Oberweiss, D and Thomas, K. (1984) Ultrasonic measurement of aortic and umbilical blood flow in the human fetus. *Obstetrics and Gynecology*, **63**, 801-805.
- Lin, C.C., Moawad, A.H., Rosenon, P.J. and River, P. (1980) Acid-base characteristics of fetuses with intrauterine growth retardation during labor and delivery. *American Journal of Obstetrics and Gynecology* **137**, 553-559.
- Lind, J. and Wegelius, C. (1954) Human fetal circulation in the mammalian fetus; physiological aspects of development. *Symp Quant Biol* **19**, 109.
- Lindblad, A. Bernow, J. and Marsal, K. (1987) Obstetric analgesia and fetal

aortic blood flow during labour. *British Journal of Obstetrics and Gynaecology* **94**, 306-311.

Lindow, S.W., Davies, N., Davey, D.A. and Smith, J.A. (1988) The effect of sublingual nifedipine on uteroplacental blood flow in hypertensive pregnancy. *British Journal of Obstetrics and Gynaecology* **95**, 1276-1281.

Lingman, G., Ohlin, P. and Ohrlander, S. (1980) Intrauterine digoxin treatment of fetal paroxysmal tachycardia. *British Journal of Obstetrics and Gynaecology* **87**, 340.

Lingman, G., Dahlstroem, J.A., Eik-Nes, S.H., Marsal, K., Ohlin, P. and Ohrlander, S. (1984) Haemodynamic assessment of fetal heart arrhythmias. *British Journal of Obstetrics and Gynaecology* **91**, 647-652.

Lingman, G., Lundstrom, N.R., Marsal, K. and Ohrlander, S. (1985) Fetal cardiac arrhythmia: clinical outcome of 113 cases in human fetal haemodynamics. Lingman, G. Malmö, Sweden. VII I-VII 13.

Lingman, G. and Marsal, K. (1985) Circulatory effect of fetal heart arrhythmia in human fetal haemodynamics. Lingman, G., ed. Malmö, Sweden. VI I-VI 20.

Lingman, G., Laurin, J. and Marsal, K. (1986) Circulatory changes in fetuses with imminent asphyxia. *Biology of the Neonate* **49**, 66-73.

Lingman, G. and Marsal, K. (1986a) Fetal central blood circulation in the third trimester of normal pregnancy - a longitudinal study. I. Aortic and umbilical blood flow. *Early Human Development* **13**, 137-150.

Lingman, G. and Marsal, K. (1986b) Fetal central blood circulation in the third trimester of normal pregnancy - A longitudinal study II - Aortic blood velocity waveform. *Early Human Development* **13**, 151-159.

- Livett, A.J., and Preston, R.C.(1985) A comparison of the AIUM/NEMA, IEC and FDA (1980) definitions of various acoustic output parameters for ultrasonic transducers. *Ultrasound in Medicine and Biology* **11**, 793-802.
- Low, J.A., Galbraith, R.S., Muir, D.W. et al (1985) The relationship between perinatal hypoxia and newborn encephalopathy. *American Journal of Obstetrics and Gynecology* **152**, 256-260.
- Lunell, N.O., Nylund, R., Lewander, R., and Sarby, B. (1982) Uteroplacental blood flow in pre-eclampsia. *Clinical Experimental Hypertension B1*,105-117.
- Lunell, N.O., Nylund, R., Lewander, R., and Sarby, B. (1982) Acute effects of an antihypertensive drug, labetalol, on uteroplacental blood flow. *British Journal of Obstetrics and Gynaecology* **89**, 640-644.
- Lunell, N.O., Nylund, R., Lewander, R., and Sarby, B., and Wager, J. (1984) Uteroplacental blood flow in pregnancy hypertension after the administration of a beta adrenergic blocker, pindolol. *Gynaecological and Obstetrical Investigation* **18**, 269-273.
- MacDonald, D.A. (1974) Blood Flow in Arteries. Ed. Edward Arnold Ltd, London, 118-146.
- MacGillivray, I. (1958) Some observations on the incidence of pre eclampsia. *Journal of Obstetrics and Gynaecology of the British Commonwealth* **65**, 536.
- MacPhail, S. and Walkinshaw, S.A. (1988) Fetal supraventricular tachycardia: detection by routine auscultation and successful in-utero management. *British Journal of Obstetrics and Gynaecology* **95**, 1073-6.

- McCallum, W.D., Williams, C.S., Napel, S. and Daigle R.E. (1978) Fetal blood velocity waveforms. *American Journal of Obstetrics and Gynecology* **132**, 425-429.
- McCallum, W.D. (1981) Fetal cardiac anatomy and vascular dynamics. *Clinics in Obstetrics and Gynaecology* **24**, 837-849.
- McCowan, L.M., Mullen, B.M. and Ritchie, K. (1987) Umbilical artery flow velocity waveforms and the placental vascular bed. *American Journal of Obstetrics and Gynecology* **157**, 900-902.
- McCowan, L.M., Ritchie, K., Mo, L.Y., Bascom, P.A. and Sherret, H. (1988) Uterine artery flow velocity waveforms in normal and growth-retarded pregnancies. *American Journal of Obstetrics and Gynecology* **158**, 499-504.
- McCue, C.M., Mantakas, M.E., Tinglestad, J.B. and Ruddy, S. (1977) Congenital heart block in newborns of mothers with connective tissue disease. *Circulation* **56**, 82-90.
- McDicken, W.N., Anderson, T., McHugh, R., Bow, C.R., Boddy, K. and Cole, R. (1979) An ultrasonic real-time scanner with pulsed Doppler and T-M facilities for fetal breathing and other obstetrical studies. *Ultrasound in Medicine and Biology* **5**, 333-339.
- McDicken, W.N., Morrison, D.C. and Smith, D.S.A. (1983) A moving tissue equivalent phantom for ultrasonic real time scanning and Doppler techniques. *Ultrasound in Medicine and Biology* **9**, L455-L459.
- Makowski, E.L., Meschia, G., Droegemueller, W. and Battaglia, F.C. (1968) Measurement of umbilical arterial blood flow to the sheep placenta and fetus

in utero. *Circulation Research* 23, 623-631.

Manning, F.A. and Platt, L.D. (1979) Fetal breathing movements: Antepartum monitoring of fetal condition. *Clinics in Obstetrics and Gynaecology* 6, 335.

Manning, F.A., Baskett, T.F., Morrison, I. et al (1981) Fetal biophysical profile scoring: A prospective study in 1184 high risk pregnancies. *American Journal of Obstetrics and Gynecology* 140, 289.

Manning, F.A., Morrison, I., Lange, I. R. et al (1985) Fetal assessment based on fetal biophysical scoring: Experience in 12,620 referred high risk pregnancies. *American Journal of Obstetrics and Gynecology* 151, 343.

Mari, G., Moise, K.J., Deter, R.L., Kirshon, B., Carpenter, R.J. and Huhta, J.C. (1989) Doppler assessment of the pulsatility index in the cerebral circulation of the human fetus. *American Journal of Obstetrics and Gynecology* 160, 698-703.

Marsal, K., Lindblad, A., Lingman, G. and Eik-Nes, S.H. (1984) Blood flow in the fetal descending Aorta ; intrinsic factors affecting fetal blood flow, i.e. fetal breathing movements and cardiac arrhythmia. *Ultrasound in Medicine and Biology* 10, 339-348.

Marx, G.F., Patel, S., Berman, J.A., Farmakides, G. and Schulman, H. (1986) Umbilical blood flow velocity waveforms in different maternal positions and with epidural analgesia. *Obstetrics and Gynaecology* 68, 61-64.

Mathews, J.D. and Mason, T.W. (1974) Plasma viscosity and pre-eclampsia. *Lancet* II, 409.

Maulik, D., Yarlagadda, A.P., Youngblood, J.P. and Willoughby, L. (1989) Components of variability of umbilical arterial Doppler velocimetry - A

prospective analysis. *American Journal of Obstetrics and Gynaecology* 160, 1406-12.

Maxwell, D.J., Crawford, D.C., Curry, P.V.M. et al (1988) Obstetric importance, diagnosis and management of fetal tachycardias. *British Medical Journal* 297, 107-110.

Meschia, G., Cotter, J.R., Breathnach, C.S. and Barron, D.H. (1965a) The hemoglobin, oxygen, carbon dioxide and hydrogen ion concentration in the umbilical bloods of sheep and goats as sampled via indwelling catheters. *Quarterly Journal of Experimental Physiology* 50, 185-195.

Meschia, G., Breathnach, C.S., Cotter, J.R., Hellegers, A. and Barron, D.H. (1965b) The diffusibility of urea across the sheep placenta in the last two months of gestation. *Quarterly Journal of Experimental Physiology* 50, 23-41.

Morrow, R.J., Adamson, S.L., Ritchie, J.W.K. and Bull, S. (1988) The effect of placental embolisation on umbilical artery waveforms. 35th Annual Meeting of the Society of Gynecologic Investigation, Baltimore, March, 1988, abstract 260.

Meizner, I., Katz, M., Lunenfeld, E. and Insler, V. (1987) Umbilical and uterine flow velocity waveforms in pregnancies complicated by major fetal anomalies. *Prenatal Diagnosis* 7, 491-496.

Mercer, L.J. and Brown, L.G. (1986) Fetal outcome with oligohydramnios in the second trimester. *Obstetrics and Gynecology* 67, 840-842.

Montan, S., Liedholm, H., Lingman, G. Marsal, K., Sjoberg, N-O and Solum, T. (1987) Fetal and uteroplacental haemodynamics during short-term atenolol

treatment of hypertension in pregnancy. *British Journal of Obstetrics and Gynaecology* **94**, 312-317.

Mulders, L.M., Jongsma, H.W., Wijn, P.F.F. and Hein, P.R. (1988) The uterine artery blood flow velocity waveform: reproducibility and results in normal pregnancy. *Early Human Development* **17**, 55-70.

Murrills, A.J., Gorman, F., Bamford, P.N., Gazzard, V.M. and Keen, A.C. (1987) Reproducibility in umbilical artery blood velocity waveforms. In: *Obstetric and Neonatal Blood Flow* - published by the Biological Engineering Society, London WC2A 3PN. p 41-46.

Nathanielsz, P.W. (1980) *Animal models in fetal medicine I (Monographs in Fetal Physiology 2)*. Elsevier/North Holland Biomedical Press.

Nelson, K.B. and Ellenberg, J.H. (1981) Apgar scores as predictors of chronic neurological disability. *Pediatrics* **68**, 36-44.

Nelson, K.B. and Ellenberg, J.H. (1982) Children who "outgrew" cerebral palsy. *Pediatrics* **69**, 529.

Nelson, K.B. and Ellenberg, J.H. (1986) Antecedents of cerebral palsy. *New England Journal of Medicine* **315**, 81-86.

Neilson, J.P., Munjana, S.P. and Whitfield, C.R. (1984) Screening for small for dates fetuses: a controlled trial. *British Medical Journal* **289**, 1179-1182.

Neilson, J.P. and Whittle, M.J. (1988) Doppler blood flow studies in fetal growth retardation. In: *Fetal and Neonatal Growth* Ed: Cockburn, F., John Wiley. Chichester. p 79-91.

- Neilson, J.P. (1987) Doppler ultrasound. *British Journal of Obstetrics and Gynaecology* **94**, 929-934.
- Newhouse, V.L., Nathan, R.S. and Herzler, L.W. (1982) A proposed standard target for ultrasound Doppler gain calibration. *Ultrasound in Medicine and Biology* **8**, 313-316.
- Newnham, J.P., Kelly, R.W., Roberts, R.V. et al (1987) Fetal and maternal Doppler flow velocity waveforms in normal sheep pregnancy. *Placenta* **8**, 467-476.
- Nicolaides, K.H., Bilardo, C.M., Soothill, P.W., Bradley, R.J., Gibb, D. and Campbell, S. (1987) Maternal oxygen therapy for intrauterine growth retardation. *Lancet* **i**, 942-945.
- Nicolaides, K.H., Bilardo, C.M., Soothill, P.W. and Campbell, S. (1988) Absence of end diastolic frequencies in umbilical artery: a sign of fetal hypoxia and acidosis. *British Medical Journal* **297**, 1026-1027.
- Nielsen, J.S. and Moestrup, J.K. (1968) Foetal electrocardiographic studies of cardiac arrhythmias and the heart rate. *Acta Obstet Gynecol Scand* **47**, 247-256.
- Nyland, L., Lunell, N.O., Lewande, R., Sarby, B., and Thornstrom, S. (1989) Does a blood pressure reduction after dihydralazine, labetalol or pindolol affect the human maternal placental circulation? *Clinical and Experimental Hypertension in Pregnancy* **B8(2)**, 271-275.
- Odendaal, H.J. and Crawford, J.W. (1975) Fetal tachycardia and maternal pyrexia during labour. *South African Medical Journal* **49**, 1873-1875.
- O'Rourke, M.F. (1982) Vascular impedance studies of arterial and cardiac

function. *Physiology Review* **62**, 571-623.

Parer, J.T. (1980) The effect of acute maternal hypoxia on fetal oxygenation and the umbilical circulation in the sheep. *European Journal of Obstetrics and Gynaecology and Reproductive Biology* **10**, 125-136.

Parisi, V.M., Salinas, J., and Stockmar, E.J. (1989a) Placental vascular responses to nicardipine in the hypertensive ewe. *American Journal of Obstetrics and Gynecology* **161**, 1039-1043.

Parisi, V.M., Salinas, J., and Stockmar, E.J. (1989b) Fetal vascular responses to maternal nicardipine administration in the hypertensive ewe. *American Journal of Obstetrics and Gynecology* **161**, 1035-1039.

Pearce, J.M.(1987) Uteroplacental and fetal blood flow. *Clinics in Obstetrics and Gynaecology* **1**, 157-184.

Pearce, J.M., Campbell, S., Cohen-Overbeek, T., Hackett, G., Hernandez, J. and Royston, J.P. (1988) Reference ranges and sources of variation for indices of pulsed Doppler flow velocity waveforms from the uteroplacental and fetal circulation. *British Journal of Obstetrics and Gynaecology* **95**, 248-256.

Pearce, J.M. and McParland, P. (1988) Doppler uteroplacental waveforms (Letter). *Lancet* **I**, 1287.

Peetershill, H., Sheldon, R.E., Jones, M.D. et al (1979) Blood flow to fetal organs as a function of arterial oxygen content. *American Journal of Obstetrics and Gynecology* **135**, 637.

Phelan, J.P., Platt, L.D., Sze-Ya, Y. et al (1985) The role of ultrasound assessment of amniotic fluid volume in the management of the post-dates pregnancy. *American Journal of Obstetrics and Gynecology* **151**, 304.

- Pijnenborg, R., Bland, J.M. Robertson, W.B. and Brosens, I. (1983) Uteroplacental arterial changes related to interstitial trophoblastic migration in early human pregnancy. *Placenta* 4, 387-414.
- Plant, R.K. and Stevens, R.A. (1945) Complete AV block in a fetus: case report. *American Heart Journal* 30, 615-618.
- Platt, L.D., Wall, C.D., Paul, R.H. et al (1985) A prospective trial of the fetal biophysical profile versus the non stress test in the management of high risk pregnancies. *American Journal of Obstetrics and Gynecology* 153, 624.
- Pritchard, J.A. and MacDonald, P.T.C. (1985) Hypertensive disorders in pregnancy. In: Williams Obstetrics. Ed: Pritchard, J.A., MacDonald, P.T.C. 17th ed, New York: Appleton-Century-Crofts, 525-561.
- Rajhvajn, B. and Kurjak, A. (1981) Ultrasound measurements of umbilical blood flow in normal and complicated pregnancies. In: Recent Advances in Ultrasound Diagnosis III. Eds Kurjak, A. and Kratochwil, A., Excerpta Medica, Amsterdam, 240-242.
- Ramsay, E.M., Corner, G.W. and Donner, M.W. (1963) Serial and cineradioangiographic visualisation of maternal circulation in the primate (hemochorial) placenta. *American Journal of Obstetrics and Gynaecology* 86, 213-225.
- Rasmussen, K., Thorup, E. and Sindberg Eriksen, P. (1984) Evaluation of the fetal circulation using Doppler ultrasound method in patients with pre-eclampsia and intrauterine growth retardation. *Journal of Perinatal Medicine* 12, 257-259.
- Rasmussen, K. (1987) Fetal haemodynamics before and after treatment of

maternal hypertension in pregnancy. *Danish Medical Bulletin* 34, 170.

Redman, T.F. (1958) The significance of some unusual fetal cardiac arrhythmias. *Journal of Obstetrics and Gynaecology of the British Commonwealth* 65, 304-309.

Reed, K.L., Anderson, C.F. and Shenker, L. (1987) Changes in intracardiac Doppler blood flow velocities in fetuses with absent umbilical artery diastolic flow. *American Journal of Obstetrics and Gynecology* 157, 774-779.

Reid, R.L., Pancham, S.R., Kean, W.F. and Ford, P.M. (1979) Maternal and neonatal implications of congenital complete heart block in the fetus. *Obstetrics and Gynecology* 54, 470-474.

Reid, J.M. (1983) Methods of measuring the performance of continuous wave ultrasonic Doppler diagnostic equipment. Draft IEC Standard, Sub-Committee 29.D. Working Group 10.

Rekonen, A., Luotola, H., Pitänen, M., Kuikka, J. and Pyörälä, T. (1976) Measurement of intervillous and myometrial blood flow by an intravenous ¹³³Xe method. *British Journal of Obstetrics and Gynaecology* 83, 723-828.

Reneman, R.S. (1928) What measurements are necessary for a comprehensive evaluation of the peripheral circulation. *Cardiovascular Disease. Bulletin of the Texas Heart Institute* 8(3),435-454.

Report of the Royal College of Obstetricians and Gynaecologists Working party on routine ultrasound examination in pregnancy (1984) published by the Royal College of Obstetricians and Gynaecologists p17-18.

- Reuss, M.L., Rudolph, A.M. and Dae, M.W. (1983) Phasic blood flow patterns in the superior and inferior vena cavae and umbilical vein of fetal sheep. *American Journal of Obstetrics and Gynecology* **145**, 70-78.
- Reuwer, P.J.H.M., Nuyen, W.C., Beijer, H.J.M., Heethaar, R.M., Bruinse, H.W., Stoutenbeek, P. and Haspels, A.A. (1984a) Characteristics of flow velocities in the umbilical arteries, assessed by Doppler ultrasound. *European Journal of Obstetrics and Gynaecology and Reproductive Biology* **17**, 397-408.
- Reuwer, P., Bruinse, H.W., Stoutenbeek, P. et al. (1984b) Doppler assessment of the fetoplacental circulation in normal and growth retarded fetuses. *European Journal of Obstetrics and Gynaecology and Reproductive Biology* **18**, 199-205.
- Reuwer, P.J.H.M., Nuyen, W.C., Beijer, H.J.M., Heethaar, R.M., Haspels, A.A. and Bruinse, H.W. (1986) Feto-placental circulatory competence. *European Journal of Obstetrics and Gynaecology and Reproductive Biology* **21**, 15-26.
- Reuwer, P.J.H.M., Rietman, G.W., Sijmons, E.A., Tiel, M.W.M. van and Bruinse, H.W. (1987) Intrauterine growth retardation: prediction of perinatal distress by Doppler ultrasound. *Lancet* **II**, 415-418.
- Rightmire, D., Nicolaidis, K.H., Rodeck, C.H. and Campbell, S. (1986) Fetal blood velocities in Rh isoimmunisation: relationship to gestational age and to fetal hematocrit. *Obstetrics and Gynecology* **68**, 233-236.
- Rizzo, G., Arduini, D., Mancuso, S. and Romanini, C. (1987) Effects of Nifedipine on umbilical artery velocity waveforms in healthy human fetuses. *Gynecological and Obstetrical Investigation* **24**, 151-154.
- Robertson, W.B., Brosens, I. and Dixon, G. (1975) Uteroplacental vascular pathology. *European Journal of Obstetrics and Gynaecology and Reproductive*

Biology 5, 47-65.

Robertson, W.B., Brosens, I. and Landells, W.N. (1985) Abnormal placentation. *Obstetrics and Gynecology Annual* 14, 4111-426.

Robinson, H.P (1978) The current status of sonar in obstetrics and gynaecology. In: Recent advances in obstetrics and Gynaecology. Ed. Stallworthy, J. and Bourne, G., Edinburgh, Churchill Livingstone. 239-290.

Rochard, F., Schifrin, B.S., Goupil, F. et al (1985) Non-stressed fetal heart rate monitoring in the antepartum period. *American Journal of Obstetrics and Gynecology* 151, 441.

Rochelson, B.L., Schulman, H., Fleischer, A., Farmakides, G., Bracero, L., Ducey, J., Winter, D. and Penny, B. (1987) The clinical significance of Doppler umbilical artery velocimetry in the small for gestational age fetus. *American Journal of Obstetrics and Gynecology* 156, 1223-1226.

Rosenfeld, C.R., Morriss, F. and Makowski, E. (1974) Circulatory changes in the reproductive tissues of ewes during pregnancy. *Gynecology and Obstetrics Investigation* 5, 252-268.

Rudolph, A.M. and Heymann, M.A. (1967) The circulation of the fetus in utero: Methods for studying distribution of blood flow, cardiac output and organ flow. *Circulation Research* 21, 163-184.

Sabatier, R.B. (1778) Memoire sur les organes de la circulation du sang du fetus. Memoires Academie Royal des Sciences, (Paris) p 198 quoted in Circulation of the blood, Men and Ideas. A.P. Fishman and D.W. Richards. (1964) Oxford University Press, New York. p746.

Saldana, L.R., Eads, M.C. and Schaefer, T.R. (1987) Umbilical blood waveforms

in fetal surveillance of twins. *American Journal of Obstetrics and Gynecology* **157**, 712-715.

Satomura, S. (1956) A study on examining the heart with ultrasonics.I. Principles II. Instrument. *Japanese Circulation Journal* **20**,227.

Satomura, S. (1959) Study of the flow pattern in peripheral arteries by ultrasonics. *Journal of the Acoustic Society of Japan* **15** 151-159.

Schulman, H., Fleischer, A., Stern, W., Farmakides, G., Jagani, N. and Blattner, P. (1984) Umbilical velocity wave ratios in human pregnancy. *American Journal of Obstetrics and Gynecology* **148**, 985-990.

Schulman, H., Fleischer, A., Farmakides, G., Bracero, L., Rochelson, B. and Grunfeld, L. (1986) Development of uterine artery compliance in pregnancy as detected by Doppler ultrasound. *American Journal of Obstetrics and Gynecology* **155**, 1031-1036.

Scheidt, P.C., Stanley, F. and Bryla, D.A. (1978) One year follow up of infants exposed to ultrasound in utero. *American Journal of Obstetrics and Gynecology* **131**, 743-748.

Shenker, L. (1979) Fetal cardiac arrhythmias. *Obstetric and Gynecology Survey* **34**, 561-572.

Sijmons, E.A., Reuwer, P.J.H.M., Van Beek, E. and Bruinse, H.W. (1989) The validity of screening for small-for-gestational age and low weight for length infants by Doppler ultrasound. *British Journal of Obstetrics and Gynaecology* **96**, 557-561.

Silber, D.L. and Durnin, R.E. (1969) Intrauterine atrial tachycardia. *American Journal of Diseases of Childhood* **117**, 722.

- Silverman, N.H., Kleinman, C.S., Rudolph, A.M., Copel, J.A., Weinstein, E.M., Enderlein, M.A. and Golbus, M. (1985) Fetal atrioventricular valve insufficiency associated with non immune hydrops: a 2-dimensional echocardiographic and pulsed Doppler ultrasound study. *Circulation* **72**, 825.
- Silverman, N.H., Enderlein, M.A. and Stanger, P. (1985) Recognition of fetal arrhythmias by echocardiography. *Journal of Clinical Ultrasound* **13**, 255-263.
- Soothill, P.W., Nicolaides, K.H., Bilardo, C.M. et al (1986) Relation of fetal hypoxia in growth retardation to mean blood velocity in the fetal aorta. *Lancet* **I**, 1118.
- Soothill, P.W., Nicolaides, K.H., Rodeck, C.H. and Campbell, S. (1987) Amniotic fluid and fetal tissues are not heated by obstetric ultrasound scanning. *British Journal of Obstetrics and Gynaecology* **94**, 675-677.
- Stark, C.R., Orleans, M., Haverkamp, A.D. and Murphy, J. (1984) Short and long term risks after exposure to diagnostic ultrasound in-utero. *Obstetrics and Gynecology* **63**, 194-200.
- Steel, S.A., Pearce, J.M.F., Nash, G., Christopher, B., Dormandy, J. and Bland, J.M. (1989) Correlation between Doppler flow velocity waveforms and cord blood viscosity. *British Journal of Obstetrics and Gynaecology* **96**, 1168-1172.
- Stevens, D., Hilliard, J., Schreiner, R. et al (1982) Supraventricular tachycardia with edema, ascites and hydrops in fetal sheep. *American Journal of Obstetrics and Gynecology* **142**, 316.

- Stuart, B., Drumm, J., Fitzgerald, D.E. and Duigan, N.M. (1980) Fetal blood flow velocity waveforms in normal pregnancy. *British Journal of Obstetrics and Gynaecology* **87**, 780-785.
- Stuart, B., Drumm, J., Fitzgerald, D.E. and Duigan, N.M. (1981) Fetal blood flow velocity waveforms in uncomplicated labour. *British Journal of Obstetrics and Gynaecology* **88**, 865-869.
- Sykes, G.S., Johnson, P., Ashworth, F., Molloy, P.M., Gu Wei., Stirrat, G.M. and Turnbull, A.C. (1982) Do Apgar scores indicate asphyxia? *Lancet* **I**, 494-496.
- Sykes, G.S. and Molloy P.M. (1984) Effect of delays in collection or analysis on the results of umbilical cord measurements. *British Journal of Obstetrics and Gynaecology* **91**, 989-992.
- Symonds, E.M. (1987) Antenatal, perinatal or postnatal brain damage? *British Medical Journal* **294**, 1046-1047
- Taylor, D.J., Davidson, J., Drillen, C.M., Howie, P.W. and Davidson, D. (1985) Do pregnancy complications contribute to neurodevelopmental disability? *Lancet* **I**, 713-716.
- Teague, M.J., Wilson, K., Battye, C.K., Taylor, M.G., Griffin, D.R., Campbell, S. and Roberts, V.C. (1985) A combined ultrasonic linear array scanner and pulsed Doppler velocimeter for the estimation of blood flow in the fetus and adult abdomen - 1 ; technical aspects. *Ultrasound in Medicine and Biology* **11**, 27-36.
- Terteris, N.J., Chisholm, J.W. and Ullery, J.C. (1968) Antenatal diagnosis of congenital heart block: report of a case. *Obstetrics and Gynecology* **32**, 851-853.

- Thompson, R.S., Trudinger, B.J. and Cook, C.M. (1985) Doppler ultrasound waveforms in the fetal umbilical artery: quantitative analysis technique. *Ultrasound in Medicine and Biology* **11**, 707-718.
- Thompson, R.S., Trudinger, B.J. and Cook, C.M. (1986a) A comparison of Doppler ultrasound waveform indices in the umbilical artery - I. Indices derived from the maximum velocity waveform. *Ultrasound in Medicine and Biology* **12**, 835-844.
- Thompson, R.S., Trudinger, B.J. and Cook, C.M. (1986b) A comparison of Doppler ultrasound waveform indices in the umbilical artery - II. Indices derived from the mean velocity and first moment waveforms. *Ultrasound in Medicine and Biology* **12**, 845-854.
- Thompson, R.S., Trudinger, B.J., Cook, C.M. and Giles, W.B. (1988) Umbilical artery velocity waveforms: normal reference values for A/B ratios and Pourcelot ratio. *British Journal of Obstetrics and Gynaecology* **95**, 23-30.
- Thorburn, J., Drummond, M.M., Whigham, K.A., Lowe, G.D.O., Forbes, C.D., Prentice, C.R.M. and Whitfield, C.R. (1982) Blood viscosity and haemostatic factors in late pregnancy, pre-eclampsia and fetal growth retardation. *British Journal of Obstetrics and Gynaecology* **89**, 117-122.
- Tonge, H.M., Wladimiroff, J.W., Noordam, M.J. and van Kooten, C. (1986a) Blood flow velocity waveforms in the descending fetal aorta: comparison between normal and growth-retarded pregnancies. *Obstetrics and Gynaecology* **67**, 851-855.
- Tonge, H.M., Wladimiroff, J.W., Noordam, M.J. et al. (1986b) Fetal cardiac arrhythmia and its effect on volume blood flow in the descending aorta of the human fetus. *Journal of Clinical Ultrasound* **14**, 607-612.

- Trudinger, B.J. and Cook, C.M. (1985) Umbilical and uterine artery flow velocity waveforms in pregnancy associated with major fetal abnormality. *British Journal of Obstetrics and Gynaecology* **92**, 666-670.
- Trudinger, B.J., Giles, W.B., Cook, C.M., Bombardieri, J. and Collins, L. (1985a) Fetal umbilical artery flow velocity waveforms and placental resistance : clinical significance. *British Journal of Obstetrics and Gynaecology* **92**, 23-30.
- Trudinger, B.J., Giles, W.B. and Cook, C.M. (1985b) Uteroplacental blood flow velocity-time waveforms in normal and complicated pregnancy. *British Journal of Obstetrics and Gynaecology* **92**, 39-45.
- Trudinger, B.J. Giles M.B. and Cook C.M. (1985c) Flow velocity waveforms in the maternal uteroplacental and fetal umbilical placental circulations. *American Journal of Obstetrics and Gynaecology* **152**, 155-63.
- Trudinger, B.J., Cook, C.M., Jones, L. and Giles, W.B. (1986) A comparison of fetal heart rate monitoring and umbilical artery waveforms in the recognition of fetal compromise. *British Journal of Obstetrics and Gynaecology* **93**, 461-465.
- Trudinger, B.J., Stevens, D., Connelly, A., Hales, J.R.S., Alexander, G., Bradley, L., Fawcett, A. and Thompson, R.S. (1987a) Umbilical artery flow velocity waveforms and placental resistance: The effects of embolisation of the umbilical circulation. *American Journal of Obstetrics and Gynaecology* **157**, 1443-1448.
- Trudinger, B.J., Cook, C.M., Giles, W.B., Connelly, A. and Thompson, R.S. (1987b) Umbilical artery flow velocity waveforms in high-risk pregnancy. Randomised controlled trial. *Lancet* **I**, 188-190.

- Tweed, W.A., Davies, J.M., Alexander, F., Csorba, T., and Weber, S. (1987) Effects of isoproterenol induced tachycardia on myocardial blood flow and glycogen in the fetal lamb. *Biology of the neonate* **52**, 104-114.
- Vink, G.L., Moodley, J., Philpott, R.H. (1980)Effect of dihydralazine on the fetus in the treatment of maternal hypertension. *Obstetrics and Gynecology* **55**, 519-522.
- Vugt, J.M.G. van, Ruissen, C.J., Hoogland, H.J. and Haan, J. de (1987) A prospective study of the umbilical artery waveform in appropriate-for-date and growth-retarded fetuses. *Gynaecological and Obstetrical Investigation* **23**, 217-225.
- Vugt, J.M.G. van (1988) Fetal artery Doppler velocimetry. A study in the human fetus and the fetal lamb. Thesis, Maastricht.
- Vyas, S., Nicolaides, K.H. and Campbell, S. (1989) Renal artery flow velocity waveforms in normal and hypoxaemic fetuses. *American Journal of Obstetrics and Gynecology* **161**, 168-172.
- Walker, J.J. (1987) The case for early recognition and intervention in pregnancy induced hypertension. In: Sharp F, Symonds EM, eds. *Hypertension in pregnancy* , Proceedings 16th study group, RCOG, 289-304.
- Walker, J.J. (1988) Management of the hypertensive crisis and chronic hypertension in pregnancy. In: Belfort P, Pinotti JA, Eskes TKAB, eds. *Advances in Gynecology and Obstetrics* - Proceedings of the XIIth World Congress of Gynecology and Obstetrics, Rio de Janeiro, October. p91-97.
- Warren, W., Ronkin, S., Chayen, B., Needleman, L. and Wapner, R.G. (1989) Absence of end diastolic umbilical artery blood flow predicts poor fetal

outcome despite normal blood gases. *American Journal of Obstetrics and Gynecology* 160, 197.

Warsof, S.L., Gohari, P., Berkowitz, R.L. and Hobbins, J.C. (1977) The estimation of fetal weight by computer assisted analysis. *American Journal of Obstetrics and Gynecology* 128, 881-892.

Watson, J. and Campbell, S. (1986) Antenatal evaluation and management in non-immune hydrops fetalis. *Obstetrics and Gynecology* 67, 589.

Wells, P.N.T.(ed) (1987) The safety of diagnostic ultrasound. Report of a British Institute of Radiologists working group. *British Journal of Radiology* (Suppl. 20) 1-43.

White, D.N. (1976) Ultrasound in medical diagnosis. Ed: D.N. White Ultramedison, Kingston, Ontario.

Whittle, M.J (1987) An overview of fetal monitoring *Clinics in Obstetrics and Gynaecology* 1, 203-218.

Wible J.L., Petrie, R.H., Koons, A. et al (1982) The clinical use of umbilical cord acid-base determinations in perinatal surveillance and management. *Clinics in Perinatology* 9, 387-397.

Wiggins, J.W. Jr., Bowes, W., Clewell, W. et al (1986) Echocardiographic diagnosis and intravenous digoxin management of fetal tachyarrhythmias and congestive cardiac failure. *American Journal of Diseases of Childhood* 140, 202.

Wild, J.J. and Reid, J.M. (1952) Application of echo-ranging techniques to the determination of structure of biological tissues. *Science*, 226-230.

- Williams, A.R. (1983) In:Ultrasound: Biological effects and potential hazards. Academic Press, London.
- Williams, R.C., Creasy, R.K., Cunningham, G.G., Hawes, W.E., Norries, F.D. and Tashiro, M. (1982) Fetal growth and perinatal viability in California. *Obstetrics and Gynecology* 59, 624-632.
- Wladimiroff, J.W. and Stewart, P.A. (1985) Treatment of fetal cardiac arrhythmias. *British Journal of Hospital Medicine* 34, 134-140.
- Wladimiroff, J.W., Tonge, H.M. and Stewart, P.A. (1986) Doppler ultrasound assessment of cerebral blood flow in the human fetus. *British Journal of Obstetrics and Gynaecology* 93, 471-475.
- Wladimiroff, J.W., v.d. Wijngaard, J.A.G.W., Degani, S., Noordam, J. v. Eyck. M.J. and Tonge H.M. (1987) Cerebral and umbilical blood flow velocity waveforms in normal and growth- retarded pregnancies. *Obstetrics and Gynecology* 69, 705-709.
- Wolff, C.F. and Becker, R.F. (1776) The course of blood through the fetal heart. An experimental study in the cat and the guinea pig. *Anat. Res.* 77. p 417 quoted in *Circulation of the blood, Men and Ideas*.Ed: A.P. Fishman and D.W. Richards. (1964) Oxford University Press, New York. p748.
- Woo, J.S.K., Liang, S.T., Lo, R.L.S. and Chan, F.Y. (1987) Middle cerebral artery Doppler flow velocity waveforms. *Obstetrics and Gynecology* 70, 613-616.
- Woo, J.S.K., Liang, S.T. and Lo, R. (1987) Characteristic pattern of Doppler umbilical arterial velocity waveform in conjoint twins. *Gynaecological and Obstetrical Investigation* 23, 70-72.

Wood, C., Ng. K.W., Hounslow, D. and Berming, H. (1973) The influences of difference of birth times upon fetal condition in normal deliveries. *Journal of Obstetrics and Gynaecology of the British Commonwealth* 80, 289-295.

Woods, D.L., and Malan, A.F. (1983) Side effects of labetalol in newborn infants. *British Journal of Obstetrics and Gynaecology* 90, 876.

