

Air Force Institute of Technology AFIT Scholar

Theses and Dissertations

Student Graduate Works

3-10-2010

Evaluation of Alternative Technologies to Supply Drinking Water to Marines in Forward Deployed Locations

Derek R. George

Follow this and additional works at: <https://scholar.afit.edu/etd>

 Part of the [Water Resource Management Commons](#)

Recommended Citation

George, Derek R., "Evaluation of Alternative Technologies to Supply Drinking Water to Marines in Forward Deployed Locations" (2010). *Theses and Dissertations*. 2126.
<https://scholar.afit.edu/etd/2126>

This Thesis is brought to you for free and open access by the Student Graduate Works at AFIT Scholar. It has been accepted for inclusion in Theses and Dissertations by an authorized administrator of AFIT Scholar. For more information, please contact richard.mansfield@afit.edu.



**EVALUATION OF ALTERNATIVE TECHNOLOGIES TO SUPPLY DRINKING
WATER TO MARINES IN FORWARD DEPLOYED LOCATIONS**

THESIS

Derek R. George, Captain, USMC
AFIT/GES/ENV/10-M02

**DEPARTMENT OF THE AIR FORCE
AIR UNIVERSITY**

AIR FORCE INSTITUTE OF TECHNOLOGY

Wright-Patterson Air Force Base, Ohio
APPROVED FOR PUBLIC RELEASE; DISTRIBUTION UNLIMITED

The views expressed in this thesis are those of the author and do not reflect the official policy or position of the United States Air Force, Department of Defense, or the United States government.

AFIT/GES/ENV/10-M02

EVALUATION OF ALTERNATIVE TECHNOLOGIES TO SUPPLY
DRINKING WATER TO MARINES IN FORWARD DEPLOYED LOCATIONS

THESIS

Presented to the Faculty

Department of Systems and Engineering Management

Graduate School of Engineering and Management

Air Force Institute of Technology

Air University

Air Education and Training Command

In Partial Fulfillment of the Requirements for the
Degree of Master of Science in Environmental Engineering and Science

Derek R. George, BS

Captain, USMC

March 2010

APPROVED FOR PUBLIC RELEASE; DISTRIBUTION UNLIMITED.

Abstract

With recent increases in US troop levels, there are now approximately 20,000 Marines deployed in the Helmand Province of Afghanistan. The cost of delivering bottled water to the troops is rapidly becoming unsustainable. In addition, the convoys needed to truck in the bottled water are very vulnerable to Improvised Explosive Devices (IEDs), posing great risks to convoy personnel. Raw water sources are available in the Helmand River Basin (e.g., the Helmand River and groundwater). However, these water sources have both chemical and microbiological contaminants and require treatment before use. Current policy is to treat raw water with reverse osmosis (RO), but only use the treated water for hygiene and washing, with bottled water used for drinking. Due to the economic costs and risks to life of providing bottled water, decision-makers need to evaluate technology alternatives that can be used to treat indigenous raw water in order to supply Marines in Afghanistan with adequate quantities of safe drinking water.

In this study, an innovative decision analysis tool, Choosing by Advantages (CBA), was used to evaluate and select the best alternative water treatment technology to support Marines deployed in Afghanistan. Using criteria developed by a panel of experts, the CBA method evaluated the attributes of various technology solutions. The panel of experts considered the advantages of the technology attributes, as well as the importance of each advantage. Application of the CBA method revealed that the best alternative is a treatment train consisting of ultrafiltration as a pretreatment, reverse osmosis treatment, and electrodeionization as a post treatment. This treatment train

would not only ensure production of high quality water, but it would also lower overall RO energy consumption and operation and maintenance costs, while extending the life and reducing the replacement frequency of the RO membranes.

*Dedicated to my family
and
all of the Marines
and
other service members
deployed in harm's way*

Acknowledgements

I would like to express my sincere appreciation to Dr. Mark N. Goltz for his patience, support and guidance throughout this process. His meticulousness and attention to detail made this process an invaluable experience and ensured my successful completion of this thesis. Additionally, I would like to thank my thesis committee; Dr. Alfred E. Thal, Jr and Maj Pete P. Feng for their continued support and guidance.

I would like to acknowledge the Staff Noncommissioned Officers and Company Commander of the Marine Corps Engineer School, Utilities Instruction Company for their time, information and support. Also, Crown Solutions in Ohio for the support during the early stages of this research.

Additionally, I would like to thank: Mr. Gilpin, Maj O'Brien, Capt Lang, MSgt Plattsmier, MSgt Williams, MSgt Morrow, GySgt Buckheit, and GySgt McClary.

Derek R. George

Table of Contents

	Page
Abstract	iv
Acknowledgements	vii
Table of Contents	viii
List of Figures	xii
List of Tables	xiii
1.0. Introduction	1
1.1. Problem Background	1
1.2. Problem Statement	1
1.2.1. Bottled Water	2
1.2.2. Indigenous Water Supplies	3
1.2.2.1. Groundwater	4
1.2.2.2. Surface Water	4
1.2.3. Current Water Supply Situation	5
1.3. Scope/Limitations of Research	6
1.4. Research Objective	8
1.5. Methodology Outline	9
2.0. Literature Review	10
2.1. Introduction	10
2.2. Water Sources in Afghanistan	11
2.3. Drinking Water Requirements	12
2.3.1. Federal Regulations	13
2.3.2. DoD Drinking Water Policy	14

	Page
2.3.3. USMC Drinking Water Policy	15
2.4. USMC Water Operations	15
2.4.1. Planning	16
2.4.2. Source Development	17
2.4.3. Purification	17
2.4.3.1. Reverse Osmosis Water Purification Unit (ROWPU)	18
2.4.3.2. Light, Medium, Tactical (3000 LMT)	20
2.4.4. Storage	23
2.4.5. Distribution	24
2.5. Current Operations in Afghanistan	25
2.6. Alternative Technologies	28
2.6.1. Membrane Configurations	30
2.6.1.1. Ultrafiltration (UF)	30
2.6.1.1.1 Spiral Wound UF	31
2.6.1.1.2 Hollow Fiber UF	32
2.6.1.2. Nanofiltration (NF)	34
2.6.1.2.1 Spiral Wound NF	34
2.6.1.2.2. Hollow Fiber NF	35
2.6.2. Electrodeionization	36
2.6.3. Ultraviolet Radiation (UV)	38
2.7. Decision Analysis	42
2.7.1. Value-Focused Thinking (VFT)	42
2.7.1.1. Advantages/ Less Desirable Attributes of VFT	43

	Page
2.7.1.2. VFT Application	44
2.7.2. Analytical Hierarchy Process (AHP)	46
2.7.2.1. Advantages/ Less Desirable Attributes of AHP	47
2.7.2.2. AHP Application	48
2.7.3. Choosing By Advantages (CBA)	50
2.7.3.1. Advantages/ Less Desirable Attributes of CBA	53
2.7.3.2. Sample Application	54
2.8. Conclusion of Literature Review	55
3.0. Methodology	56
3.1. Introduction	56
3.2. Phase I: The Stage-Setting Phase	57
3.2.1. ‘Must’ Criteria	57
3.2.2. ‘Want’ Criteria	58
3.3. Phase II: The Innovation Phase	59
3.3.1. Pretreatment Alternatives	60
3.3.2. Post Treatment Alternatives	60
3.4. Phase III: The Decision-making Phase	61
3.4.1. Step 1: Summarize the Attributes of Each Alternative	61
3.4.2. Step 2: Decide the Advantages of Each Alternative	64
3.4.3. Step 3: Decide the Importance of Each Advantage	66
3.4.4. Step 4: Choosing From Total Importance	69
4.0. Results and Discussion	73
4.1. Introduction	73

	Page
4.2. Phase I Reconsideration	73
4.3. Phase II Reconsideration	74
4.4. Phase III Reconsideration	76
4.4.1. Pretreatment Reconsideration	76
4.4.1.1. UF Hollow Fibers as a Pretreatment	78
4.4.1.2. RO Membrane Replacement and Cleaning	79
4.4.1.3. Other Fixed and Variable Costs	80
4.4.1.4. Total Cost of Ownership	81
4.4.2. Post Treatment Reconsideration	82
5.0. Conclusions and Recommendations	84
5.1. Summary	84
5.2. Conclusions	84
5.2.1. Research Questions	84
5.2.2. Recommendations for Future Study.....	86
Bibliography	88

List of Figures

	Page
Figure 1-1: Helmand Province (Institute for the Study of War, 2009)	3
Figure 1-2: The Hindu Kush. (Encyclopedia Britannica, Inc, 2009)	5
Figure 2-1: Water Processing Block Diagram (USMC, 1991)	18
Figure 2-2: LMT Components (USMC, 1999)	22
Figure 2-3: LMT Layout (USMC, 1999)	23
Figure 2-4: Slow Sand Filter (Learning Space, 2010)	29
Figure 2-5: Spiral Wound Membrane (Li and Tung, 2008)	31
Figure 2-6: Modes of Filtration (Mourato, 2010)	32
Figure 2-7: Modes of Hollow Fiber Filtration (Mourato, 2010)	33
Figure 2-8: Spiral Wound Membrane (Li and Tung, 2008)	35
Figure 2-9: EDI Module (DOW, 2009)	36
Figure 2-10: EDI Chambers (DOW, 2009)	37
Figure 2-11: UV Structure (Wagenet et al., 2004)	39
Figure 2-12: UV Light Spectrum (Excel Water, 2010)	40
Figure 2-13: Value-Focused Thinking Ten-Step Process (Shoviak, 2001)	44
Figure 2-14: AHP Standard Form (Thal, 2009)	47
Figure 4-1: Theoretical Relationship between SDI and R_t	76
Figure 4-2: RO Membrane Replacement Frequency	80
Figure 4-3: TCO of Conventional Pretreatment	82
Figure 4-4: TCO of UF Hollow Fiber Pretreatment	82

List of Tables

	Page
Table 1-1: Decision Analysis Tools	7
Table 1-2: Water Purification Technologies	8
Table 2-1: NDWR and SDWR (USEPA, 2009)	14
Table 2-2: MEGs (USACHPPM, 1996 and USACHPPM, 2004)	15
Table 2-3: CBA Simple Example 1	51
Table 2-4: CBA Simple Example 2	52
Table 2-5: CBA Methods (Suhr, 2008)	53
Table 3-1: Decision Analysis Method Comparison	56
Table 3-2: Pretreatment Attribute and Criteria	62
Table 3-3: Post Treatment Attribute and Criteria	62
Table 3-4: Attribute of Each Pretreatment Alternative	63
Table 3-5: Attribute of Each Post Treatment Alternative	64
Table 3-6: Identify Least-preferred Pretreatment Attribute	65
Table 3-7: Identify Least-preferred Post Treatment Attribute	66
Table 3-8: Importance of Each Pretreatment Advantage	68
Table 3-9: Importance of Each Post Treatment Advantage	69
Table 3-10: Pretreatment Total Importance	70
Table 3-11: Post Treatment Total Importance	71
Table 3-12: Including Cost	72

EVALUATION OF ALTERNATIVE TECHNOLOGIES TO SUPPLY DRINKING WATER TO MARINES IN FORWARD DEPLOYED LOCATIONS

1.0. Introduction

1.1. Problem Background

Currently there are about 68,000 United States (U.S.) troops in Afghanistan, with approximately 30,000 more troops to be deployed starting at the end of 2009. With 9,000 of these troops being from the United States Marine Corps (USMC), the total number of Marines in country will eventually reach approximately 20,000. USMC troop levels could possibly remain this high for another 10 years. A study by the U.S. Department of Defense (DoD) shows the cost of delivering bottled water to troops in Afghanistan to be \$4.69 per gallon (USACHPPM, 2003). With a daily water demand of 5.2 gallons per capita per day, just supplying water to the 20,000 Marines will cost nearly \$500,000 daily; this is a cost that may not be sustainable over the long-term.

1.2. Problem Statement

There are basically two ways of meeting the USMC requirement for over 100,000 gallons per day of drinking water: (1) trucking in bottled water and (2) purifying indigenous water sources. Each of these alternatives has pitfalls. As noted above, trucking in bottled water is expensive. It also poses many dangers to the troops who need to transport the water, requires an extensive logistics infrastructure, and uses precious fuel resources. On the other hand, available water supplies in-country are contaminated and therefore require treatment.

1.2.1. Bottled Water

Presently, there are continuing operations being conducted by U.S. Marines in both the mature theaters of Iraq and Afghanistan. With the shift of focus to the Afghan Area of Operations (AO), there will be a dramatic increase in USMC personnel deployed to that location. With mountain passes closed by snow, overturned trucks, and attacks by hostile tribes, delivering equipment and supplies to Marines in Afghanistan continues to be a challenge (Bowen, 2009). Improvised Explosive Devices (IEDs) have caused approximately 80 percent of U.S. military casualties in Afghanistan. Many of these IEDs are placed on convoy supply routes. Many of the supplies get pilfered as trucks are waiting to pass through Pakistan customs into Afghanistan (Bowen, 2009). One of the most critical supplies that must be delivered to troops on operating bases in Afghanistan is bottled water. Enormous quantities of bottled water are currently being shipped into Afghanistan in order to meet the greater than 100,000 gallon per day requirement. U.S. Marines have many established bases that sit along the Helmand River (Figure 1-1) and yet their water supply is trucked in weekly at great expense and danger. With the roads infested with IEDs, the transportation of enormous quantities of bottled water presents an unnecessarily high risk.

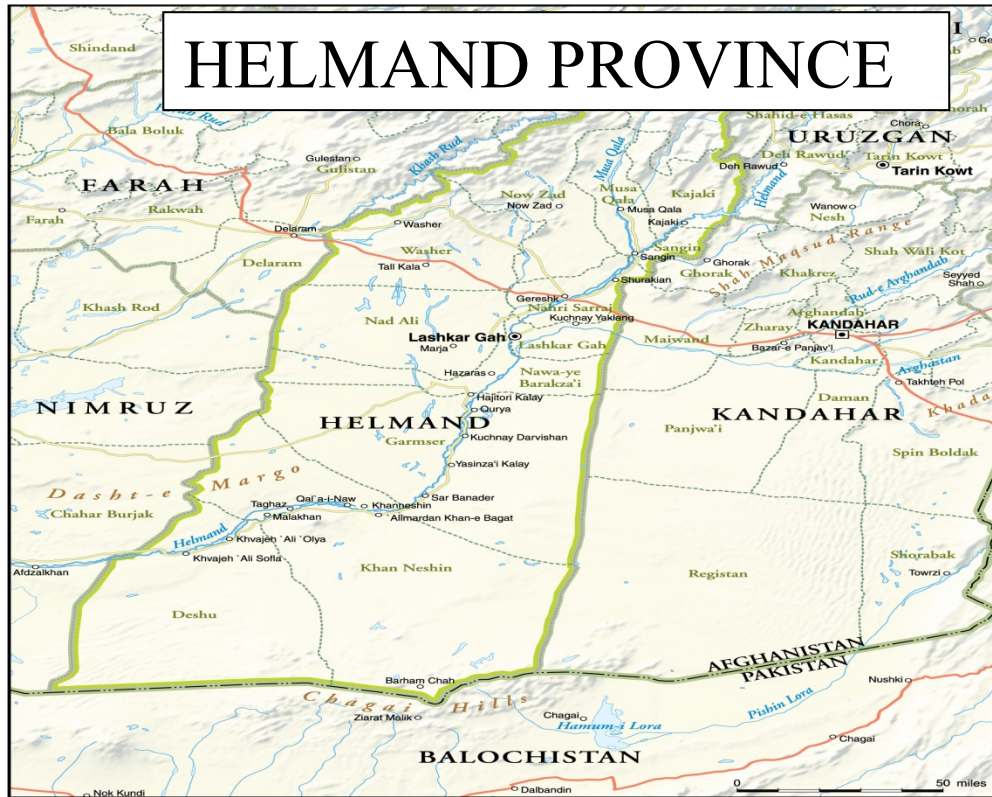

Figure 1-1 Helmand Province (Institute for the Study of War, 2009)

1.2.2. Indigenous Water Supplies

According to the U.S. Geological Survey (USGS), “An overwhelming majority of the Afghan population lacks an adequate, safe supply of water because of contamination by a wide variety of sources, lack of water-resources management, and lack of basic infrastructure, compounded by the recent 5-year drought and seasonal flooding” (USGS, 2005). Afghanistan is comprised of three distinct geological environments: the northern sedimentary basins, the central mountain ranges, and the southern basins. In the northern sedimentary basins, salinity and bacteria make the groundwater unfit for human consumption; the highly porous sandy soil allows the aquifers to be contaminated via bacterial transport (Cole-Palmer Technical Library, 2009). In the central mountain ranges, certain rock formations contain arsenic, which leaches into the groundwater,

making it unsuitable for use without treatment. In the southern basin, the Helmand River represents 40 percent of Afghanistan's surface water and is the main water source, but it is also inadequate because the river is contaminated with harmful bacteria (Scott, 2007).

1.2.2.1. Groundwater

Afghanistan relies on groundwater, which represents the most consistent water source in both rural and urban areas, more than most countries. Unfortunately, according to a geological study conducted in Afghanistan, "65 percent of protected, closed wells and 90 percent of open wells (the most common drinking water source in many areas) are contaminated with coliform bacteria" (DA, 2006). Additionally, an estimated 500,000 people are potentially at risk from arsenic, with concentrations ranging from 10 µg/L to 500 µg/L in the majority of wells (Mukherjee et al., 2006).

1.2.2.2. Surface Water

More than 80 percent of Afghanistan's water resources originate in the Hindu Kush Mountains (Figure 1-2). The snow accumulates in the winter and melts in the spring. Water pollution from raw sewage is the most significant environmental contamination problem and health threat to deployed personnel (DA, 2006). Nationwide, to include the Helmand River where many U.S. Marines are deployed, the water sources are contaminated with harmful bacteria such as E. Coli and Leptospira. Leptospira causes an infectious disease, Leptospirosis, that affects the kidneys and liver of humans and domestic animals (DA, 2006).



Figure 1-2 The Hindu Kush (Encyclopedia Britannica, Inc, 2009)

1.2.3. Current Water Supply Situation

Due to the contaminated indigenous water sources, the Marines in Afghanistan are currently relying on bottled water. While indigenous water supplies are treated by the Marines, the water is only used for hygiene and washing, not drinking. With an increased number of Marines being deployed to Afghanistan, the reliance on bottled water will become unsustainable. A shift from bottled water will require a significant increase in the use of indigenous sources, which will require appropriate treatment to be rendered potable.

1.3. Scope/Limitations of Research

Hughes (2006) evaluated alternatives for supplying drinking water at deployed locations. In his analysis, Hughes (2006) investigated Reverse Osmosis Water Purification Unit (ROWPU) treatment, advanced well drilling, and commercial bottled water as potential sources of potable water. He used the ten-step Value-Focused Thinking (VFT) model as a decision analysis tool to select a preferred alternative for drinking water supply (Hughes, 2006). The VFT method is meant to recognize and articulate fundamental values of decision-makers in order to identify decision opportunities and create better alternatives. The intent of VFT application is to proactively identify more attractive alternatives to ponder before selecting solutions (Keeney, 1992). Hughes (2006) presented the advantages, disadvantages, and cost effectiveness of the different water supply options using VFT, and concluded that “more of the decision-makers’ values are met if water is supplied through drilling of wells versus the continued reliance on commercial bottled water” (Hughes, 2006). The goal of this study is to follow-up on Hughes’ conclusion that bottled water cannot be sustained and to identify a water treatment technology that could be employed to cost-effectively support the water supply needs of USMC troops in the AO.

The proposed research will differ from and expand upon Hughes’ study in a number of ways. First, Hughes’ (2006) study was focused on Air Force requirements for drinking water in a generic deployed environment which are much different than USMC requirements in Afghanistan. Second, Hughes considered a range of technology and “management” solutions (e.g., bottled water) while this study will begin with Hughes’ (2006) conclusion that use of local water supplies is preferred over bottled water; it will

also consider a number of innovative technologies that have become available in recent years (for example, ultrafiltration, nanofiltration, ultraviolet radiation, and electro-dionization).

To choose a “best” technology solution, there are many decision analysis tools available (see Table 1-1). The current study will review Value-Focused Thinking (VFT), the Analytical Hierarchy Process (AHP), and Choosing by Advantages (CBA). The VFT and AHP approaches are decision analysis tools that have been used in a number of studies focused on DoD problems (e.g., Alghamdi, 2009; Duke, 2004; Pate, 2005; Porter, 2004; Pruitt, 2003). Because CBA is relatively new, and apparently has not been used in the past by USMC or DoD decision-makers, it will be applied in this study. The CBA uses three decision-making concepts: alternatives, attributes, and advantages (Suhr, 2008). The method is meant to be simpler than VFT and other decision-making tools in that the decision process is based on the importance of advantages and does not consider disadvantages like most other comparison tools (Suhr, 2008). Because the alternatives are listed and weighted based on advantages, listing disadvantages is considered double-counting which will take more time and skew the results; therefore, the CBA decision-making process is less time consuming and more focused on selecting the best option from a list of attributes and advantages.

Table 1-1 Decision Analysis Tools

DECISION ANALYSIS TOOLS	
Analytical Hierarchy Process (AHP)	Choosing By Advantages
Choice	Decision support
Decision analysis cycle	Influence diagram
Decision making software	Multi-criteria decision analysis (MCDA)
Decision model	Optimal decision
Decision theory	Management science
Decision tree	Value Focus Thinking

There are many technologies that have been developed to date that can be used to remove contaminants present in water (see Table 1-2). This research will focus on five alternative technologies (ultrafiltration, nanofiltration, electrodeionization, ultraviolet radiation, and reverse osmosis). These technologies were chosen for further study due to their novelty and a preliminary determination that they were likely to meet requirements for implementation in the AO. Focusing on five technologies simplifies the decision analysis process and assures the analyses can be accomplished within time constraints for this thesis. This research will not obtain any data from the conduct of laboratory experiments; technology performance and cost information will be obtained from the peer-reviewed literature and technical manuals.

Table 1-2 Water Purification Technologies

Water Purification Technologies	
Reverse Osmosis	Ultraviolet (UV) Radiation
Nanofiltration	Distillation
Ultrafiltration	Sand filtration
Microfiltration	Carbon Adsorption
Ceramic filtration	Ion exchange
Electrodeionization (EDI)	Boiling

1.4. Research Objective

The objective of this research is to evaluate technology alternatives in order to select a preferred technology that may be employed to provide drinking water to USMC troops deployed in the Afghanistan AO. A secondary objective is to determine the efficacy of applying CBA to facilitate the technology evaluation. To meet the goal of this research, the following investigative questions will be addressed.

1. What are the attributes of drinking water treatment technologies that may be employed to support troops in the Afghanistan AO?
2. What criteria should be used to evaluate the technologies?

3. What technology is the best available (based on using the CBA decision analysis method to evaluate the technologies against the criteria)?

1.5. Methodology Outline

The first step will be to conduct a literature review of (1) the five water treatment technologies that were selected for study for potential application in the Afghanistan AO and (2) the three decision analysis methodologies. The review will also include literature pertaining to water collection, purification, and storage in Afghanistan. The information from the literature review will be used to develop a list of technology attributes, as well as constraints, with regard to water sources in the AO.

Following the literature review, evaluation criteria will be developed by using a combination of the literature pertaining to water collection, purification, and storage in the AO and recommendations from an expert panel of decision-makers with more than 70 years of USMC water purification experience combined. These experts will be from the Utilities Instruction Company at the Marine Corps Engineer School in Camp Lejeune, North Carolina, as well as experienced personnel who have recently served in the AO.

The final step will be to apply the decision analysis model to weigh the advantages of the various alternatives and select a preferred technology.

2.0 LITERATURE REVIEW

2.1. Introduction

Troop levels in Afghanistan are projected to exceed 100,000 over the next few years. The Helmand Province in the southern basin of Afghanistan will be occupied with 20,000 Marines who will be conducting combat operations for many years to come. The dynamics of this troop increase will require extensive logistical planning in order to establish a sustainable environment for life support and operational support. The majority of the resources being consumed by Marines in the Helmand Province are being pushed to the bases on a weekly schedule via supply routes. Improvised Explosive Devices (IEDs) have caused approximately 80 percent of U.S. military casualties in Afghanistan. Many of these IEDs are placed on convoy supply routes. Many of the supplies get pilfered as trucks are waiting to pass through Pakistan customs into Afghanistan (Bowen, 2009). One of the most critical supplies that must be delivered to troops on operating bases in Afghanistan is bottled water. A study by the U.S. Department of Defense shows the cost of delivering bottled water to troops in Afghanistan to be \$4.69 per gallon (USACHPPM, 2003). With a daily water demand of 5.2 gallons per capita per day, just supplying water to the 20,000 Marines will cost nearly \$500,000 daily; this a cost that may not be sustainable over the long-term. Enormous quantities of bottled water are currently being shipped into Afghanistan in order to meet the greater than 100,000 gallon per day requirement. While the Marines have the capability to treat indigenous water supplies, current water operations conducted in Afghanistan use treated water only for hygiene and washing, not for drinking.

2.2. Water Sources in Afghanistan

The Helmand River Basin is the location where many U.S. Marines are deployed in Afghanistan. The Helmand River stretches for 1,150 km (715 miles). The river begins in the Hindu Kush Mountains, which is about 80 km (50 miles) west of Kabul, and passes north of the Unai Pass. The Helmand River represents 40 percent of Afghanistan's surface water and is the main water source, but it is also inadequate because the river is contaminated with harmful bacteria (Scott, 2007). The river remains relatively salt-free for much of its length, unlike most rivers with no outlet to the sea. This river is used extensively for irrigation, although a buildup of mineral salts has decreased its usefulness in watering crops. Its waters are essential for farmers in Afghanistan.

Water pollution from raw sewage is the most significant environmental contamination problem and health threat to deployed personnel (DA, 2006). The water sources, to include the Helmond River, are contaminated with harmful bacteria such as *Escherichia coli* (E. Coli) and *Leptospira*. Individuals infected with E. Coli experience acute symptoms which include nausea, fever, vomiting, abdominal pain, and diarrhea after a period of about 2 to 5 days (USACHPPM, 2004). The effects of this bacterium could have a temporary but significant impact on an entire unit and the overall mission. *Leptospira* cause an infectious disease, *Leptospirosis*, which affects the kidneys and liver of humans and domestic animals (DA, 2006). The bacterial disease can be contracted through skin contact with surface water contaminated with urine from infected animals. *Leptospira* penetrate the skin through abrasions or mucus membranes. The symptoms of this disease are fever, headache, chills, severe muscular pain in the calves and thighs, and

conjunctival suffusion (USACHPPM, 2004). Infected persons may excrete *Leptospira* in the urine for 1 to 11 months after the acute illness.

The groundwater in Afghanistan represents the most consistent water source and is heavily relied upon by the Afghan people. Unfortunately, according to a geological study conducted in Afghanistan, “65 percent of protected, closed wells and 90 percent of open wells (the most common drinking water source in many areas) are contaminated with coliform bacteria” (DA, 2006). Arsenic concentrations ranging from 10 µg/L to 500 µg/L were found in the majority of the wells that were sampled (Mukherjee et al., 2006). According to Harisha et al. (2009), “arsenic may be released from ores into soil, surface water, and ground water.” Yoshida et al. (2004) explains that the chronic effects of exposure to arsenic via drinking water include skin lesions, skin cancer, neurological effects, hypertension, peripheral vascular, cardiovascular, and respiratory disease.

2.3. Drinking Water Requirements

In 1974, Congress passed the Safe Drinking Water Act (SDWA) to protect public health by regulating the nation's public drinking water supply. Amendments to the law (1986 and 1996) required many actions to protect drinking water and its sources: rivers, lakes, reservoirs, springs, and water wells (USMC¹, 2008). This act also requires federal installations and activities to comply with all federal, state, or local requirements (USMC¹, 2008).

2.3.1. Federal Regulations

In accordance with the SDWA, the United States Environmental Protection Agency (USEPA) has established National Primary and Secondary Drinking Water Regulations that set maximum contaminant levels (MCLs) and maximum contaminant level goals (MCLGs). The MCLs, which are enforceable, are the highest permissible levels of a contaminant in water that will be consumed by humans. MCLGs are the levels of a contaminant in drinking water below which there is no known or expected risk to health (USEPA, 2009). MCLGs, which are non-enforceable public health goals, allow for a margin of safety (USEPA, 2009). MCLs take cost into consideration. MCLs are set as close to MCLGs as possible, based upon using the best available treatment technology. The USEPA also publishes non-enforceable Drinking Water Advisories that report concentrations of contaminants in water that are likely to be without adverse effects on health and aesthetics (USEPA, 2009). The Taste Threshold of the Drinking Water Advisory is the concentration at which the majority of consumers do not notice an adverse taste in drinking water, though it is recognized that some sensitive individuals may detect a chemical at levels below this threshold (USEPA, 2009). Table 2-1 shows the National Primary Drinking Water Regulations (MCLs, potential health effects to humans, sources, and MCLGs), Secondary Drinking Water Regulations, and Drinking Water Advisories for the contaminants that have been commonly found in both surface and subsurface drinking water sources in Afghanistan.

Table 2-1 NDWR and SDWR (USEPA, 2009)

National Primary Drinking Water Regulations For Contaminants Found in Afghan Water Sources				
Contaminant	MCL	Potential health effects	Source	MCLGs
Arsenic	0.010 mg/L	Skin damage/ cancer	Erosion of natural mineral deposits	0 mg/L
Total Coliforms	no more than 5.0% samples total coliform-positive per month	Used to indicate whether other potentially harmful bacteria (e.g. Leptospira, E. Coli) may be present	Fecal Waste	Zero
Nitrate	10 mg/L	Serious illness/ death for infants below age of six months who consume in excess of MCL (Shortness of breath and blue-baby syndrome)	Fertilizer runoff, erosion of natural deposits	10 mg/L
Secondary Drinking Water Regulations (SDWR) For Contaminants Found in Afghan Water Sources				
Contaminant	SDWR	Concern		
Total Dissolved Solids	500 mg/L	Taste		
Sulfate	250 mg/L	High levels can cause diarrhea		
Drinking Water Advisory Table				
Contaminant	Health-based Value	Taste Threshold		
Sodium	20 mg/L (for individuals on a 500 mg/day restricted sodium diet).	30–60 mg/L		
Sulfate	500 mg/L	250 mg/L		

2.3.2. DoD Drinking Water Policy

The Department of Defense (DoD), which is required to abide by the USEPA drinking water standards, has established military exposure guidelines (MEGs) which are meant to protect troops from the risk of exposure to chemical and biological contaminants in drinking water (USACHPPM, 2004). These protective guidelines were derived by modifying USEPA and other civilian drinking water standards to account for the unique military population, deployment durations, and doctrinal field water consumption rates both in Continental United States (CONUS) and overseas (DA, 2005). Some MEGs are higher and some are lower than the corresponding USEPA drinking water standards. The USACHPPM (2004) publishes the MEG concentrations for 5 and 15 L/d water consumption rates and exposure durations of less than 7 days, 7 to 14 days, and 1 year. The MEGs for total coliforms are the same as the MCL and MCLGs

established by the USEPA (USACHPPM, 1996). The U.S. Navy Manual of Naval Preventive Medicine (2008) states, “the presence of total coliforms is a water quality violation and requires the water supplier to take immediate corrective action” (DON, 2008). On the other hand, the MEGs for arsenic exposure are less stringent than MCLs, as they are based on the assumption that DoD personnel will only be exposed for a relatively short time, while MCLs are developed assuming lifetime exposures. Table 2-2 lists the MEGs for the contaminants commonly found in Afghanistan.

Table 2-2 MEGs (USACHPPM, 1996 and USACHPPM, 2004)

Contaminant	5 L/day 5 day MEG (mg/L)	15 L/day 5 day MEG (mg/L)	5 L/day 1 yr MEG (mg/L)	15 L/day 1yr MEG (mg/L)
Arsenic	0.3	0.1	0.004	0.001
Total Coliforms (e.g. Leptospira, E. Coli)	Positive	Positive	Positive	Positive
Nitrate	35	12	22	7.5
Boron	5.6	1.9	1.3	0.42
Total Dissolved Solids	1000	1000	1000	1000
Sulfate	300	100	300	100
Sodium	60	60	60	60

2.3.3. USMC Drinking Water Policy

In the U. S. Marine Corps, the policy regarding Water Quality Management (WQM) in either the U.S. or a foreign country is as follows:

Marine Corps installations in the United States will comply with all substantive and procedural WQM regulations established by the USEPA or those states that have been granted primary enforcement responsibility. Marine Corps installations within foreign countries will comply with the applicable Final Governing Standards (FGS)/Japan Environmental Governing Standards or the Overseas Environmental Baseline Guidance Document (OEBGD) if no FGS has been published. (USMC¹, 2008)

The OEBGD provides criteria, standards, and management practices for environmental compliance at DoD installations overseas (DoD, 2007). In Afghanistan, the OEBGD is applied to USMC installations and forward operating bases where small units are

conducting combat operations and no applicable FGS established for the area of operations.

2.4. USMC Water Operations

Determining the required amount of water for the mission is perhaps the most important part of planning when preparing to conduct any combat operation. An inadequate supply of water can drastically degrade the unit's ability to accomplish the mission. Water is needed to survive and stay in the fight. When the USMC deploys troops to a foreign country such as Afghanistan, one of the priorities is to locate a source of safe water and ensure that this water can be delivered to the troops for consumption in a timely manner. The USMC uses a five-phase approach to ensure troops have adequate water in order to accomplish the mission. The five phases are: planning, source development, purification, storage, and distribution.

2.4.1. Planning

The planning phase begins with reconnaissance in order to gather information about potential water sources. The only positive way to gather accurate information about a potential water source is by conducting ground reconnaissance. The following factors should be considered during ground reconnaissance: Is the source capable of providing the projected water quantity required? Does the source meet medical personnel standards for a raw water source and will the purification equipment produce water that meets drinking water standards? Does the site allow adequate accessibility for vehicles required for staging water purification equipment and conducting water purification operations? Does the site allow for appropriate security and adequate drainage for bivouac area?

These questions are listed in the order in which they should be considered (USMC², 2008).

2.4.2. Source Development

The next phase of USMC water operations is source development. This involves developing a water source to increase the quantity of water, improve its quality, and expedite treatment and distribution (USMC², 2008). Because of its accessibility, surface water sources provide the best opportunity for USMC Engineer Units to employ purification equipment. Intake points can be constructed to make the water collection easier. Pits can be dug to assist with shallow water sources. Dams can be used to raise the level of water in small streams. Floats can be used to keep the suction hoses off the bottom in large streams where the quantity of water varies across its width. Aquifers, springs, and wells are also commonly used as water sources by USMC Engineers. Once the sources are developed and prepared for water extraction, the purification process can commence.

2.4.3. Purification

The primary process used by the USMC to purify water is reverse osmosis (RO). Natural osmosis occurs when the concentration of minerals is greater on one side of a semi-permeable membrane than on the other side. Water will naturally pass through the membrane from the less concentrated solution into the more concentrated solution, thereby diluting the concentrated solution. The RO process consists of water flowing at high pressure, through a semi-permeable membrane from the high solute concentration side to the low solute concentration side, opposite the direction of osmotic diffusion. The RO process separates purified water from a seawater or brackish water source. Pressure

is applied on the salt water side of a semi-permeable membrane, and purified water diffuses through the membrane to the freshwater side (USMC, 1991).

2.4.3.1. Reverse Osmosis Water Purification Unit (ROWPU)

The Reverse Osmosis Water Purification Unit (ROWPU) is a skid mounted, mobile, or air transportable unit capable of purifying fresh, brackish, and salt water at a rate of 600 gallons per hour (USMC, 1991). The unit is configured in a frame that measures 5.6' H x 6.9' W x 9.5' L, weighs approximately 7300 lbs, and requires a 22-kilowatt power source. The unit is designed to operate for 20 continuous hours a day and requires two Marines for operations. The source water must be free of chlorine prior to beginning the purification process (USMC, 1991). Figure 2-1 illustrates the ROWPU purification process (USMC, 1991). When the ROWPU is setup for operation, the water passes through the strainer on the end of the suction hose to keep leaves, plants, stones, fish, and dirt out of the raw water pumps and filters of the ROWPU. The polymer feed pump adds polymer (polyelectrolyte) solution to the raw water to help coagulate suspended solids that can then be removed by the multimedia filters (USMC, 1991). The sodium hex feed pump feeds diluted sodium hexametaphosphate into the raw water to prevent scaling (USMC, 1991). After passing through the multimedia filters, the citric acid feed pump adds diluted citric acid (tricarboxylic) to the filtered water to maintain the desired pH for the RO process (USMC, 1991). The booster pump forces the filtered water from the multimedia filter through the cartridge filter. The second stage of filtration is the cartridge filter. The cartridge filter removes finer suspended solids that were not removed by the multimedia filter (USMC, 1991). After the first two stages of

filtration, nearly all suspended solids have been removed, but dissolved solids still remain in the water.

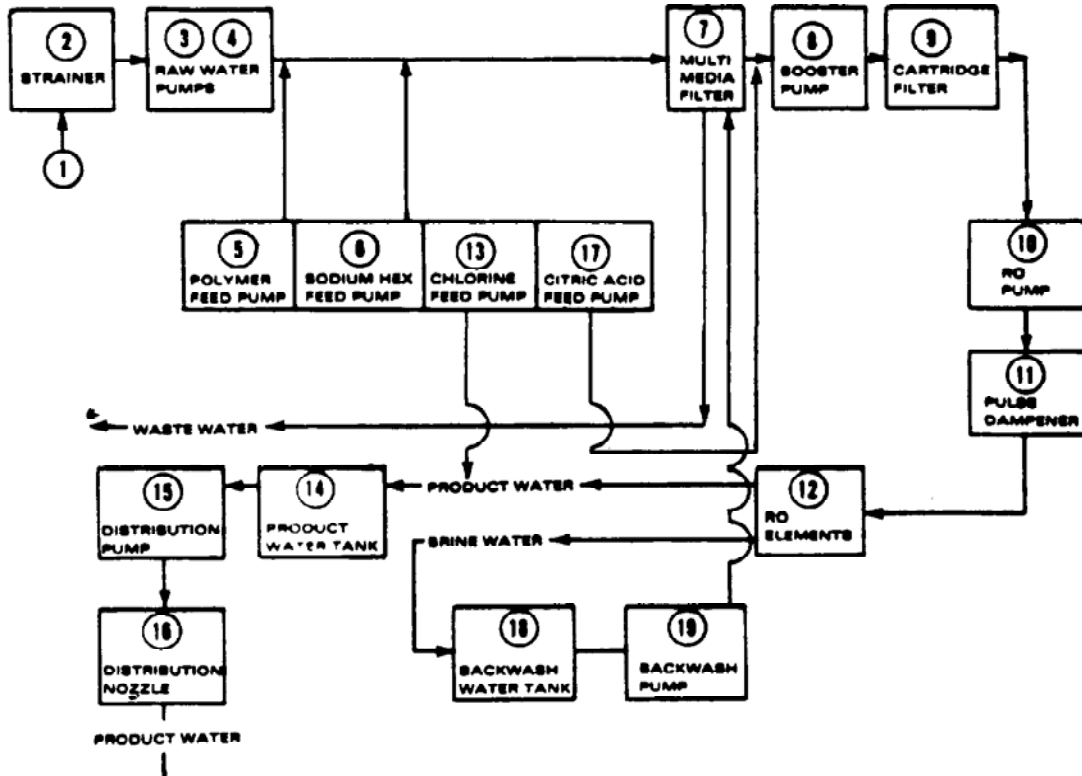

Figure 2-1 Water Processing Block Diagram (USMC, 1991)

Once the second filtration stage is complete, the RO pump forces the water under high pressure through the RO element (USMC, 1991). Dissolved minerals and any suspended solids that may have passed through the filters are removed by the rolls of thin film of the RO element. As the water leaves the ROWPU, chlorine is added to kill any bacteria present in the product water. At this point, the potable water is stored in the product water tank where it can be distributed directly or pumped to a larger storage container for distribution.

Note that during the RO process, a high solute concentration brine is produced on the “dirty side” of the RO elements. This brine is stored in the backwash water tank and

then used to backwash the multimedia filters. The purpose of backwashing is to flush out accumulated dirt in the multimedia filters and re-circulate citric acid solution through the RO elements in order to clean them.

The RO filter elements are critical to the operation of the ROWPU for desalinization and purification of water. These filters have a normal life of 1,000 to 2,000 operating hours and normally will not operate continuously on one set of filters (Pike, 2009). ROWPUs will cease operations upon mission completion, end of deployments or training exercises, or for winterization. During ROWPU operation, operators monitor system performance and clean or replace filters if functioning improperly. The RO filter elements are replaced anytime total dissolved solids (TDS) of product water exceeds 1500 parts per million and cannot be corrected by using specified cleaning procedures (USMC, 1991). Replacing the filters of a ROWPU is extremely expensive. The combined filter replacement cost of eight filters for the 600 gallons per hour ROWPU and twelve filters for the 3,000 gallons per hour ROWPU is approximately \$16,000 (Pike, 2009).

2.4.3.2. Light, Medium, Tactical (3000 LMT)

The ROWPU has been the primary water purification unit used by the USMC for many decades. With recent changes in how and where combat operations are taking place, the USMC has developed the 3,000 gallons per hour, Light, Medium, Tactical (LMT), Water Purification System (3000 LMT) in order to make water purification more expedient and flexible with the capability of purifying a fresh water source with less than 1,500 total dissolved solids (TDS) (USMC, 2009). The unit was designed to be transported by tactical vehicle or air lifted by helicopter to remote sites and can also

perform a number of other functions such as decontamination, fire fighting, and irrigation (USMC, 2009).

According to the student outline USMC (2009), “the 3000 LMT weighs 680 lbs, is a frame mounted, skid based, diesel operated, diatomite type unit, that requires two Marines to operate.” The three chemicals used by the 3000 LMT for the filtration and storage process are chlorine (bacterial disinfectant), polymer (coagulant to aid in the filtration process), and Diatomaceous Earth (D.E.) (white powdery substance caked on filter elements to perform filtration) (USMC, 2009).

The major components of the system are illustrated in Figure 2-2. The 3000 LMT is comprised of a diesel powered pump module which increases operating safety and extends the system life; a control module which houses the D.E. slurry tank and chlorine reservoir; a filter module; and a main frame which protects all components when they are mounted (USMC, 2009). When this system is mounted on a wheeled trailer, it can be set up and operated by one person, hence reducing the manpower, as compared to operating a ROWPU.

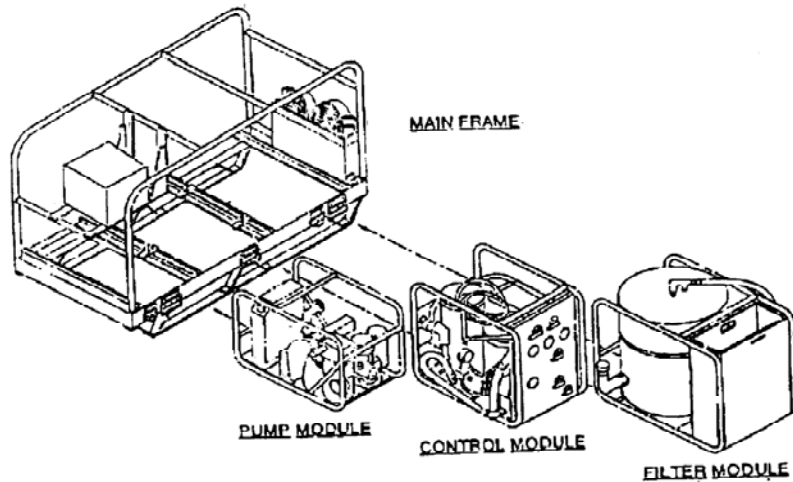

Figure 2-2 LMT Components (USMC, 1999)

As noted above, the 3000 LMT is unique in that the system modules can be operated independently. By eliminating the introduction of chlorine into the water flow, the unit may be used as a pretreatment for any RO system. The modules may also be disassembled and transported manually by two Marines and can be operated without assembly in the main frame. The hoses can extend up to 150 feet to assist in water extraction when it is not practical to set up the entire unit adjacent to the water source. The unit may also be used as a chlorination system, and the pump module may be used as a portable diesel pumper. Figure 2-3 illustrates the 3000 LMT assembly in normal operating mode.

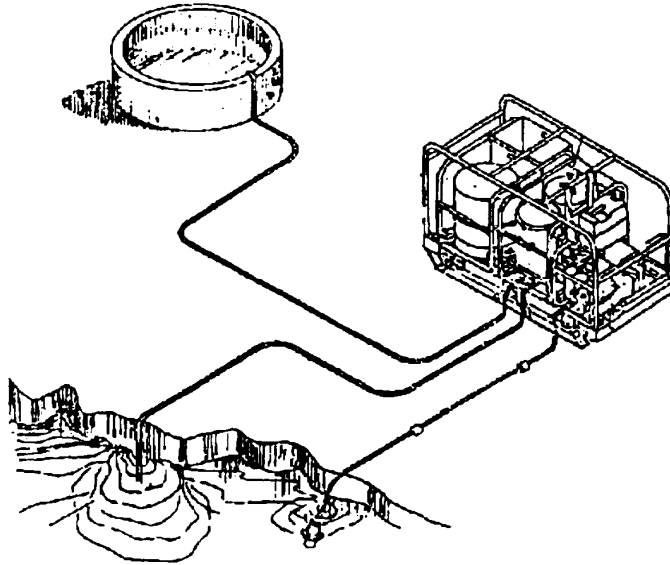

Figure 2-3 LMT Layout (USMC, 1999)

2.4.4. Storage

After the water is treated, it needs to be stored. Storage is ideally done in close proximity to the purification sites. The goal of water storage is to keep one day of supply (DOS) on hand at all times in order to prevent water shortages during periods of interrupted water operations (USMC³, 2008). Arid regions such as Afghanistan will require the storage of large quantities of potable water to support operations. This water can be stored using a combination of different tanks (USMC³, 2008).

USMC has several different tanks available to store DOS of water depending on the number of personnel being supported. One storage container is the durable 500-gallon collapsible potable water drum which is used to store and transport potable water (USMC³, 2008). When filled to its 500-gallon capacity, the drum can be towed and lifted using a military vehicle fork lift (USMC³, 2008). The 900 gallon SIXCON water storage system consists of five tank modules and one pump module which form an 8 by 8 by 20 foot module when attached to each other. The water tank is covered with at least one

inch of foam insulation to keep stored water from freezing or heating up (USMC³, 2008). The system can be used as a mobile water dispensing asset or as a stationary dispensing unit. Additionally, there are 3,000, 20,000, and 50,000 gallon collapsible fabric water tanks that are used for storage of potable and non-potable water and are designed for quick setup/teardown (USMC³, 2008). When large numbers of personnel must be supplied with water, multiple storage tanks can be filled to provide adequate quantities of water to support the mission.

2.4.5. Distribution

The last phase, and often the weakest link in water support operations, is water distribution (USMC³, 2008). Units responsible for providing potable water must be well organized in order to have sufficient organic water distribution equipment at the supply point to get water to the user. Water should be produced as close to the end user as possible, ideally within ten miles (USMC³, 2008).

The equipment and systems available to the USMC for water distribution allow for flexible and responsive water support. Each system is specifically designed and configured to support a unique mission (USMC³, 2008). The 400 gallon M149 water trailer is equipped with four dispensing faucets and one drain faucet. The M149 can be towed by a 2.5 ton truck or larger and is capable of transporting water at 50 MPH over highways and at 30 MPH cross-country (USMC³, 2008). The Forward Area Water Point Supply System (FAWPSS) is a portable, self-contained water dispensing system consisting of a 125 GPM pump, hoses, and ancillary components necessary to establish four distribution points with the 500 gallon collapsible drum (USMC³, 2008). The Tactical Water Distribution System (TWDS) consists of a ten mile segment with five 600

GPH pumps and a five mile segment with eight 500' hoses-reel systems (USMC³, 2008). On level terrain, the TWDS can transport 864,000 gallons of water in 24 hours at a rate of 600 GPM; however, in mountainous terrain (as in Afghanistan), the flow rate will be decreased and less water will be transported (USMC³, 2008). The hypo-chlorination unit is designed to mix hypochlorite solution (disinfecting agent) into water transported by the TWDS to produce water acceptable for consumption (USMC³, 2008).

Marine forces must make efficient use of all available resources and assets in conducting water distribution operations. Getting water from the storage site to the using units can involve utilizing all organic water distribution assets. During the early phases of deployments and in emergency situations, before the water distribution system can be established, bottled water will be the primary means of re-supply in forward areas.

2.5. Current Operations in Afghanistan

Although bottled water is normally planned for use only during the early phases of deployments and in emergency situations, the main source of potable water in the Afghanistan AO is bottled water. The alternative to continuing this unsustainable distribution of bottled water is to purify water with the use of available equipment (e.g. ROWPU and 3000 LMT). Because Afghanistan is a mountainous, arid country, in most locations, water of sufficient quantity is available only by drilling wells. As discussed above, lack of sustainable, potable water supplies can have a negative impact on both military forces and local populations. USMC Engineers are using heavy equipment to drill wells throughout the Helmand River Basin in southern Afghanistan. The water obtained from these wells is contaminated with total dissolved solids, nitrates, sulfates, sodium, boron, and coliform bacteria which have been found in quantities exceeding

MEGs in the wells (Gellasch, 2009). Once purified, the water is initially being used to provide potable water to the local population.

The expert panel shared the following obstacles that were encountered while conducting water purification operations in Afghanistan. The limited availability of raw water sources in certain locations made it difficult for the USMC to establish water supply and treatment facilities without affecting the daily lives of the local populace. As Marines expand their presence across the Helmand River Basin, the quantity and quality of water is highly dependent upon site location. For example, one site was located in an area where a 2 feet deep and 3 feet wide canal was the water source. The local populace was dependent upon this canal for farm irrigation and personal hygiene use. Extreme caution was taken with regards to the amount of water that was extracted from the canal by the Marines in order to not interrupt the availability of water for local use. In addition to the wells that were being drilled and the canals, the Helmand River itself was a more accessible source of raw water for treatment. Although the Helmand River provided the USMC with an abundant quantity of water, the River is contaminated with bacteria and a build-up of salts. Some locations where water was needed did not have a useable raw water source to draw from. At locations such as these, heavy equipment engineers attempted to dig and drill in order to find an acceptable source. If no acceptable source was found, it was concluded that there was not enough water for USMC use without interfering with the local populace water supply.

Water treatment using the ROWPU was not difficult. The Marines have been trained well and were technically proficient in the operation of the equipment. One member of the expert panel explained (during his tour from July to November 2009) that water operations were conducted during the hottest parts of the summer and during the early part of the winter. Although the method of treatment was the same during both seasons, some of the major pitfalls that were experienced were created by the environment. The sand and dust were the biggest challenges when it came to keeping purified product water clean and maintaining the equipment. The terrain presented different problems depending on location. For example, at one site in particular where the water source was not abundant, the water table was determined to be approximately 4 feet below the surface of the ground. Pits were excavated (20' X 10' X 10') inside of a secure area, and the raw water from the pit was treated for use. However, because of the low conductivity of the aquifer, after water was withdrawn from the pit, 24-36 hours were needed in order to allow the pit to naturally recharge. The geology also played a role in the disposal of the "reject" (brine) water from the purification units. At another site, soakage pits/evaporation beds were required in order to dispose of the brine. Some of the sites allowed for adequate seepage of the brine into the ground and others did not. Due to the amount of chemicals wasted at the site during backwash and disinfection cycles, when adequate seepage did occur, the chlorine contaminated the source to a level where it could no longer be used as feed water for the ROWPU. At the many sites where ROWPUs were used to treat water in the Helmand River Basin, there was no consistency to the hours that the units were in operation. Some of the factors that determined the hours of operation include the number of troops that were to be supported, space

available for water storage, and other factors. On average, it was estimated that the purification units were operational for approximately 6-8 hours a day.

2.6. Alternative Technologies

As seen in Table 1-2 of the previous chapter, there are many technologies that have been developed that can be used to remove contaminants from indigenous water sources. The USMC uses the RO process as the primary water purification tool. A potential solution to overcoming some of the deficiencies in the current method could be to implement one or more of these other technologies. Although some of these technologies are viable alternatives to RO, others are clearly not useful in the Afghan AO. For example, USEPA (1981) defines “the ion exchange (IE) process as a reversible chemical reaction wherein an ion (an atom or molecule that has lost or gained an electron and thus acquired an electrical charge) in solution is exchanged for a similarly charged ion attached to an immobile solid particle.” The drawback is that as a standalone process, it does not effectively remove most organics or microorganisms; however, IE can be used as a pretreatment for RO, filtration, and carbon adsorption (APEC, 2010).

Another technology is the slow sand filter (SSF). SSF is a physical filtration treatment process that removes pathogens and turbidity. SSFs are constructed using graded layers with the coarsest sand and gravel on the bottom and the finest sand at the top. As seen in Figure 2-4, the Schmutzdecke, which is German for film or deck of dirt, is the layer where fine filtration and some biodegradation takes place, removing organic matter which may be present in the water (Learning Space, 2010). Advantages of SSF are its efficiency as a physical, chemical and bacterial filter and the consistent quality of water produced (Learning Space, 2010). Some less desirable attributes of the SSFs are

their high cost to build and maintain, the large area required, and the need to carefully control temperature and low flow rate in order to manage microbial growth (Learning Space, 2010). Because the Afghan AO has open desert and sufficient land and space near water source locations, the environment in Afghanistan would be feasible to build a SSF. The problem is the time needed to construct and maintain the filters, and the security risks this would present. A demand operated SSF would only produce a quantity of 2 gal/m²/min (Manz, 2004).

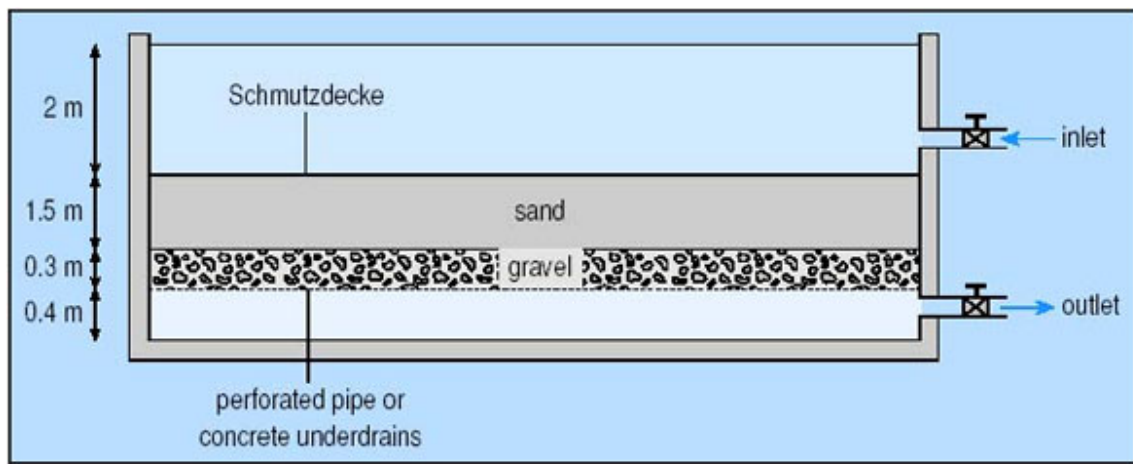

Figure 2-4 Slow Sand Filter (Learning Space, 2010)

Of the many available options, in addition to RO, this research will focus on four alternative technologies (ultrafiltration (UF), nanofiltration (NF), electrodeionization (EDI), and ultraviolet radiation (UV)). These technologies were chosen for further study due to their novelty, and a preliminary determination that they were likely to meet requirements for implementation in the AO.

2.6.1. Membrane Configurations

UF and NF are membrane technologies that are increasingly being used for water clarification, wastewater recycling, and pretreatment for RO. These are pressure-driven processes that separate impurities from water by forcing water through a membrane where pore size determines what constituents are separated from the filtrate. Nominal pore size or Molecular Weight Cut-off (MWCO) for the filters is specified (CROWN Solution, 2003). The expectation is that 90% of material larger than the specified pore size would be removed. The membrane type and manufacturing process determine the variation in pore size. UF and NF membranes are available in spiral wound, hollow fiber, flat sheet, tubular, and ceramic configurations. The spiral wound and hollow fiber technologies are generally more competitive for use in several applications (CROWN Solution, 2003). The expected membrane life of the hollow fiber and spiral wound membranes are 7-10 years and 8 years, respectively. For hollow fiber, the power consumption ranges from 0.2-0.3 kWh/kgal. The spiral wound power consumption ranges from 0.2-0.8 kWh/kgal. Hollow fiber and spiral wound technologies will be the focus for both UF and NF.

2.6.1.1. Ultrafiltration (UF)

UF membranes typically range from 1,000 MWCO to approximately 500,000 MWCO, corresponding to nominal pore sizes of 0.005 - 0.1 microns (CROWN Solution, 2003). Due to its ability to handle contaminated waters at a reasonable cost and with a small footprint, hollow fiber configuration for UF is the most common configuration used today for drinking water treatment of surface water and water reuse applications (CROWN Solution, 2003). For more than 15 years, UF spiral wound configuration has

been used as pre-treatment for RO systems to produce ultrapure water from surface water (CROWN Solution, 2003).

2.6.1.1.1. Spiral Wound UF

Spiral wound UF membranes are usually made from flat sheet polysulfone membranes rolled into a spiral around a permeate core tube (See Figure 2-5). The membrane modules are commonly 8” in diameter and look similar to spiral wound RO modules (CROWN Solution, 2003). Spiral wound configuration operating pressure is 20-100 psi, and feed water travels from one end across the feed spacers and is forced through the membrane (CROWN Solution, 2003). Particles that are larger than the membrane MWCO are separated from the feed water and filtered permeate is transported out via the filtrate core at the center of the module.

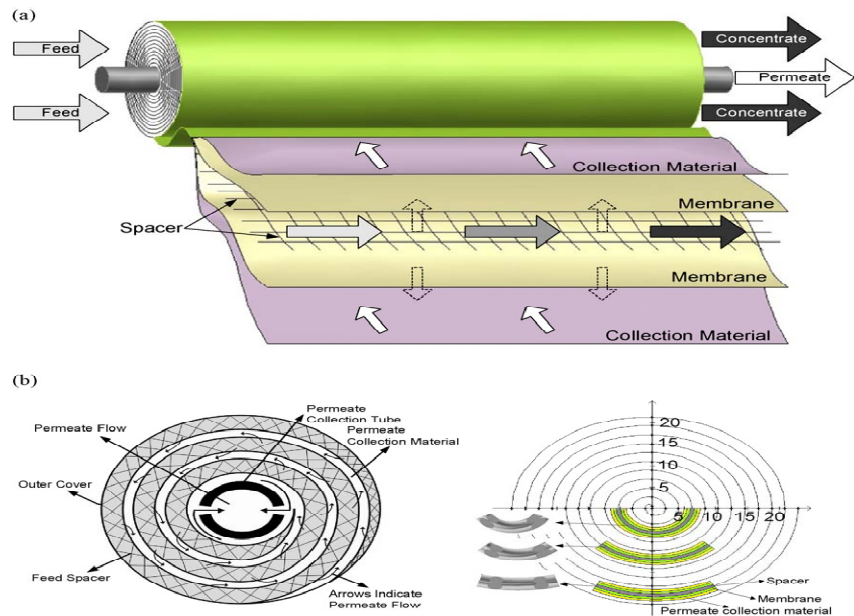

Figure 2-5 Spiral Wound Membrane (Li and Tung, 2008)

The filtered solids are removed from the membrane surface by continuously scouring with water in a crossflow direction (see Figure 2-6) (CROWN Solution, 2003). In order to maintain the recommended crossflow velocity, a portion of the feed water is processed through the membrane and leaves as concentrate. Because most spiral wound systems cannot be physically backwashed, the filtered solids will eventually foul the membrane and increase the operating pressure (CROWN Solution, 2003). As the operating pressure increases, chemical clean-in-place (CIP) will have to be performed (CROWN Solution, 2003). The CIP frequency will be dependent upon the quality of feed water being filtered.

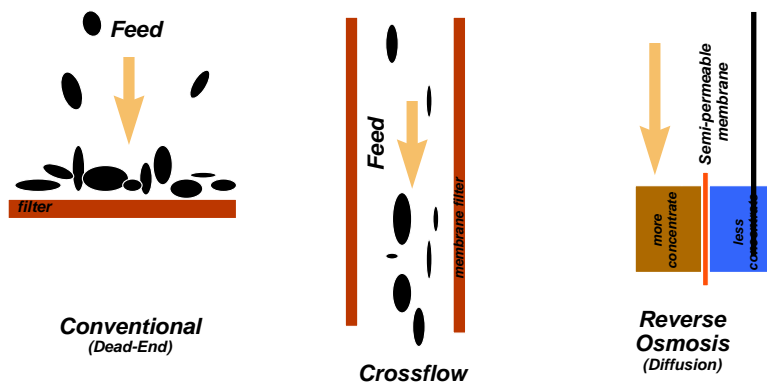

Figure 2-6 Modes of Filtration (Mourato, 2010)

2.6.1.1.2. Hollow Fiber UF

UF hollow fiber membranes are typically made from polysulfone, PVDF, polypropylene, polyacrylonitrile, polyethylene, and polyethersulfone (CROWN Solution, 2003). The sizes of the several thousand fibers bundled into a membrane element typically range from 0.5 – 1 mm in diameter. The hollow fiber vessels can be mounted vertically or horizontally (similar to RO vessels) (CROWN Solution, 2003). Figure 2-7 illustrates how the water can either be fed to the inside of the fibers, with filtrate leaving

from the outside of the fibers (inside-out), or fed from the outside of the fibers with filtrate leaving from the inside of the fibers (outside-in) (CROWN Solution, 2003). According to CROWN Solution (2003), “hollow fiber membrane systems for membrane filtration have gained wide acceptance for surface water treatment for potable water production.” Field tests have verified that hollow fiber membranes can remove bacteria such as Giardia Cysts and Cryptosporidium Oocysts (CROWN Solution, 2003). Because UF hollow fiber has been increasingly used for many potable water applications, this technology is cost competitive with conventional water treatment and RO pretreatment technologies (CROWN Solution, 2003).

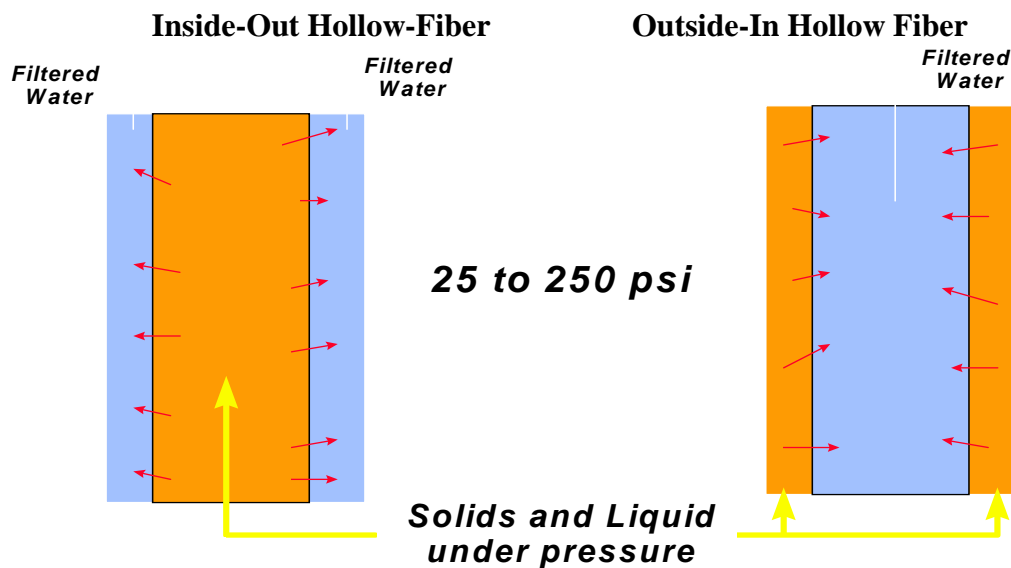

Figure 2-7 Modes of Hollow Fiber Filtration (Mourato, 2010)

Hollow fiber systems are typically operated in a dead-end mode (operating pressures around 10-50 psi), and in cases where the feed waters have a high concentration of solids, the membrane may be operated in a crossflow mode (See Figure 2-6). In dead-end mode, particles are captured and removed from the membrane surface by means of a physical backwash; in crossflow mode, water is recirculated, and the crossflow velocity is

increased to remove solids from the surface of the membranes (CROWN Solution, 2009). Although physical backwash and CIP are options for removing membrane fouling, a Chemically Enhanced Backwash (CEB) may also be required. The CEB process involves injecting chemicals (usually sodium hypochlorite, caustic, or acid) into the backwash water which cleans the membrane without having to go off-line for a CIP (CROWN Solution, 2009). The backwash frequency depends on the system mode and the feed water source.

2.6.1.2. Nanofiltration (NF)

NF membranes have pore sizes in the range of 200 to 10,000 MWCO, which is approximately 0.001 to 0.01 microns (CROWN Solution, 2009). Due to the small pore size and the charged nature of NF membranes, they can remove suspended solids, dissolved organics, and divalent ions such as calcium (CROWN Solution, 2009). Since NF membranes remove hardness, they are sometimes called softening membranes (CROWN Solution, 2009).

2.6.1.2.1 Spiral Wound NF

The most common configuration for NF membranes is spiral wound which is similar to RO membranes. The systems typical operating pressure range is 75-125 psi (CROWN Solution, 2009). Spiral wound NF system's often require scale control to prevent scaling in the membrane module, and may also require pretreatment (media filters or UF) to remove suspended solids in order to prevent plugging of the concentrate spacer (CROWN Solution, 2009). Figure 2-5 identifies the location of concentrate spacers within the spiral wound configuration. As seen in Figure 2-8, the curvature of each channel varies in the radial direction with Figure 2-8(d) showing curvature close to

the center axis and Figure 2-8(a) showing curvature at the outer layer (Li and Tung, 2008). This curvature affects the crossflow velocity, with the center velocity being slower than the outer velocity, thereby promoting plugging near the center axis (Li and Tung, 2008).

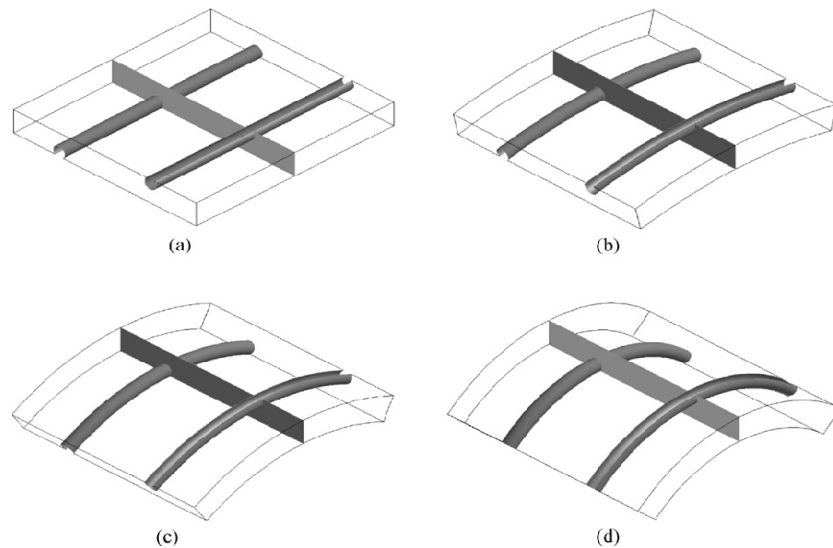

Figure 2-8 Spiral Wound Membrane (Li and Tung, 2008)

2.6.1.2.2. Hollow Fiber NF

According to CROWN Solutions (2003), “hollow fiber NF membranes combine the cleaning properties of hollow fiber UF membranes with the separation properties of NF membranes for removal of suspended solids, organics, and hardness. Since these have only recently been introduced to the marketplace, most operating data are still at the pilot scale.”

2.6.2. Electrodeionization

Electrodeionization (EDI) is a continuous and chemical-free process to remove ionized and ionizable species from feed water using direct current (DOW, 2009). EDI is typically used to polish RO permeate and to replace conventional ion exchange mixed beds, thereby eliminating the need to store and handle hazardous chemicals (DOW, 2009). As a disinfectant, EDI has a high pH gradient (pH 2 - 12) that greatly reduces the number of pyrogens and microorganisms (Christ GmbH, 2003). Figure 2-9 illustrates the EDI module which utilizes a unique, leak free, low maintenance spiral wound design containing membrane and ion exchange resins, sealed in a high-strength fiberglass reinforced plastic (FRP) pressure vessel (DOW, 2009).

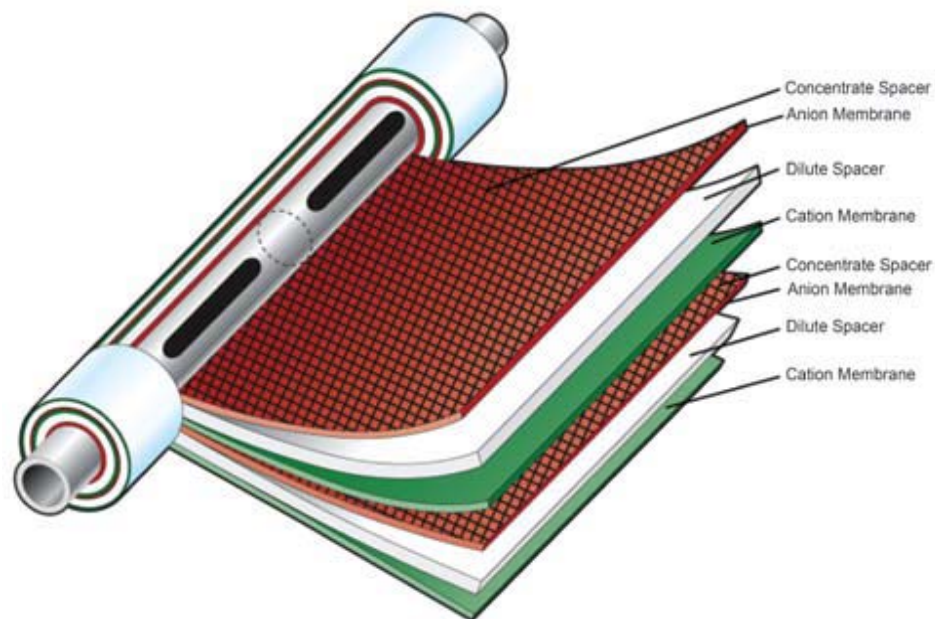

Figure 2-9 EDI Module (DOW, 2009)

A typical EDI system will use approximately 0.25 kWh of electricity to deionize 1m³ of water (DOW, 2009). EDI modules use electrical current to force contaminant ions out of the feed water and into the reject stream. As Figure 2-10 illustrates, the feed water (dilute stream) enters from the bottom of the EDI module and is diverted into the dilute chambers. The dilute stream flows vertically through ion-exchange resins located between two membranes where anions and cations are separated. The resin bed water is split into H⁺ (hydrogen) and OH⁻ (hydroxide) ions by direct current and is attracted by the cathode or anode, respectively (DOW, 2009). Concentrate enters the bottom of the module through the center pipe and is diverted into the concentrate chambers. Contaminant ions, dissolved in the feed water, attach to their respective ion exchange resin, displacing H⁺ and OH⁻ ions. The contaminant ions are trapped in the concentrate chamber and are recirculated and bled out of the system. The feed water continues to pass through the dilute chamber and is purified and collected on the outlet of the dilute chambers and exits the EDI module (See Figure 2-10).

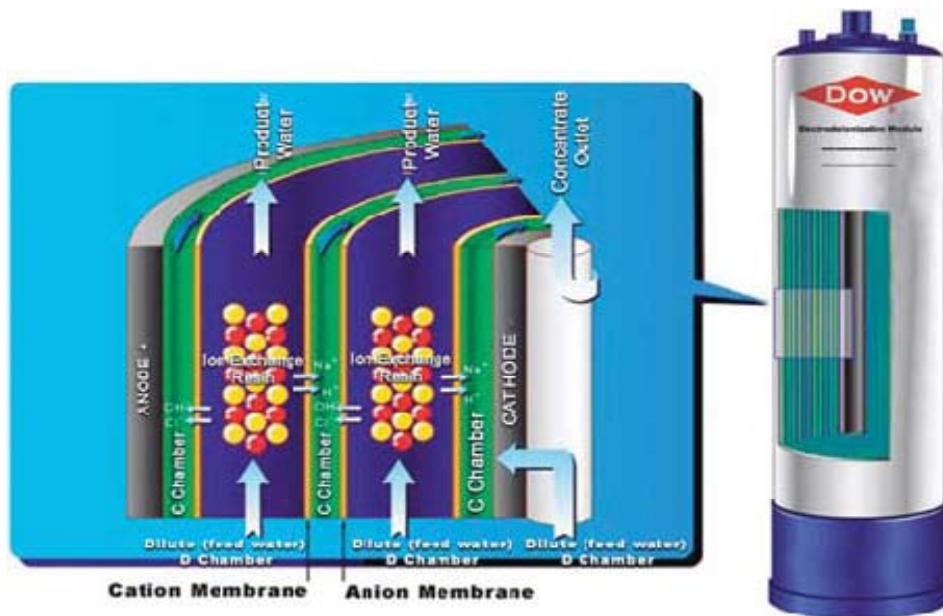

Figure 2-10 EDI Chambers (DOW, 2009)

Some of the advantages of the EDI as opposed to conventional ion exchange are its simple and continuous operation, cost-effective operation (initial cost of about \$6500 with \$100 membrane replacement cost) and maintenance, low power consumption, destruction of microorganisms, and elimination of a polluting waste stream (DOW, 2009). These systems are safe, reliable and require very few automatic valves or complex control systems requiring supervision by an operator (Lenntech, 2010). EDI also has a small footprint, produces high purity water at a constant flow, and provides complete removal of dissolved inorganics (Lenntech, 2010). The most undesirable attribute of EDI is that the process requires pretreatment; however, in combination with RO pre-treatment, EDI removes more than 99.9% of ions from the water (Lenntech, 2010).

2.6.3. Ultraviolet Radiation (UV)

Ultraviolet (UV) radiation is a disinfection process that uses an invisible light from the violet end of the spectrum, ranging from 100 to 400 nanometers (nm), to render microorganisms harmless. These microorganisms can range from bacteria and viruses to algae and protozoa. As seen in Figure 2-11, the UV light source is a low-pressure mercury lamp resembling a fluorescent lamp enclosed in a transparent protective sleeve that is mounted so that water can pass through a flow chamber, and UV rays are admitted and absorbed into the stream (Excel Water, 2010).

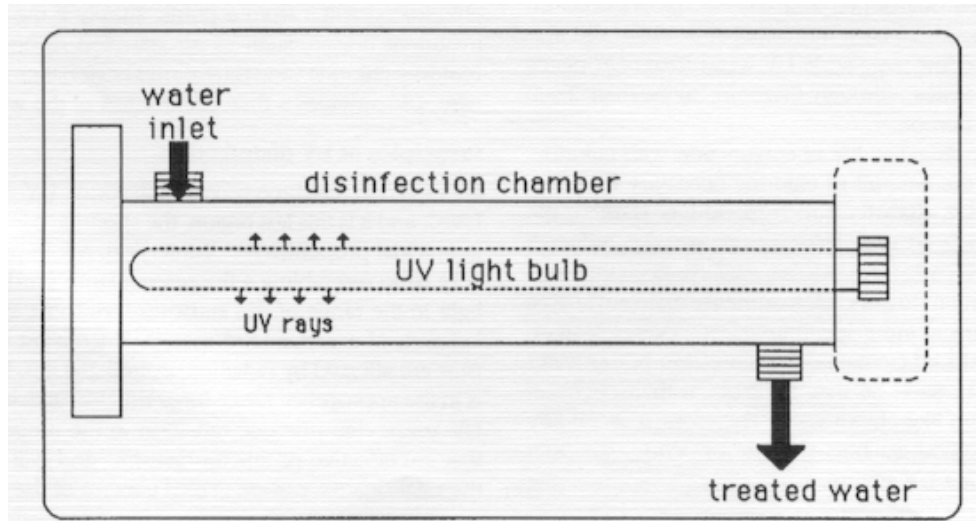

Figure 2-11 UV Structure (Wagenet et al., 2004)

According to Wagenet et al. (2004), “UV radiation has three wavelength zones: UV-A, UV-B, and UV-C, and it is this last region, the shortwave UV-C that has germicidal properties for disinfection.” Since most microorganisms are affected by radiation around 260 nm, the UV light produces UV-C rays in the range of 254 nm that penetrate the cells of harmful bacteria and viruses in drinking water, destroying their ability to reproduce causing these organisms to die and no longer pose a health threat and destroying 99.99% of harmful microorganisms (Wagenet et al., 2004) (See Figure 2-12 below).

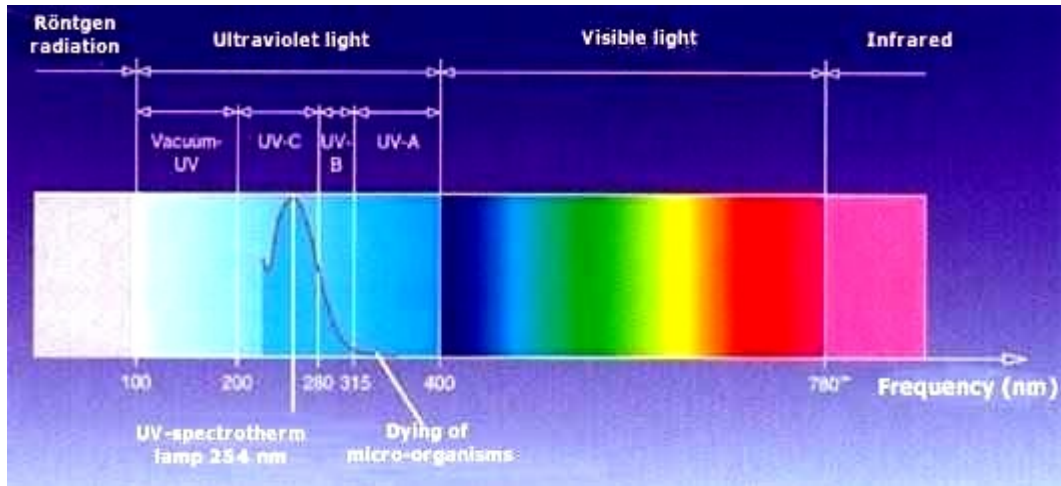

Figure 2-12 UV Light Spectrum (Excel Water, 2010)

Wagenet et al. (2004) explains that “the effectiveness of this process is related to exposure time and lamp intensity as well as general water quality parameters. The exposure time is reported as "milliJoules per square centimeter" (mJ/cm^2), and the U.S. Department of Health and Human Services has established a minimum exposure of $16 \text{ mJ}/\text{cm}^2$ for UV disinfection systems; most manufacturers provide a lamp intensity of $30\text{-}50 \text{ mJ}/\text{cm}^2$.” For example, Coliform bacteria such as *Escherichia coli* and *Leptospira* are destroyed at $7 \text{ mJ}/\text{cm}^2$ and $6 \text{ mJ}/\text{cm}^2$, respectively (Excel Water, 2010).

UV systems are designed for continuous operation and should be shut down only if treatment is not needed for several days. Since lamp intensity decreases over time with use, the lamp (bulb) should be cleaned on a regular basis and replaced at least once a year; a warning device should be incorporated to signal when lamp intensity falls below the germicidal range (Wagenet et al., 2004). The sleeve should be cleaned several times a year with a solution of 0.15% sodium hydrosulfite or citric acid and only needs to be replaced when broken (Wagenet et al., 2004).

A major advantage of UV treatment is that it is capable of disinfecting water faster than chlorination without needing cumbersome retention tanks and harmful chemicals (Triangular wave, 2010). Some other advantages of UV treatment are its environmental friendliness, the fact that there are no dangerous chemicals to handle or store, its low power consumption (about the same amount of energy as a 60 watt light bulb), and its low cost (Triangular wave, 2010). An 80gpm, light commercial UV system with UV lamp and cooling fan to reduce elevated water temperatures has an initial cost of \$6000 with replacement bulbs costing around \$200 a year (Excel Water, 2010).

The problem with this process is that UV systems require pre-filtration to maintain effectiveness as sediment and other contaminants in the water can create a "shadow" which prevents the UV rays from reaching and disinfecting the harmful microorganisms. Hence, as Wagenet et al. (2004) explains, "UV is often the last device in a treatment train (a series of treatment devices) following reverse osmosis, water softening, or filtration" and should be placed as close as possible to the distribution point to prevent bacterial contamination during transport. The presence of iron, manganese, TDS, turbidity, and suspended solids, all of which are found in Afghanistan water sources, inhibit UV from functioning properly (Triangular wave, 2010).

2.7. Decision Analysis

According to Suhr (2008), “human behavior is largely a cause-effect chain with four links: methods, decisions, actions, and outcomes.” There are three connections to these links: decision methods produce decisions, decisions guide actions, and actions produce outcomes (Suhr, 2008). As military leaders, there is an expectation that both sound and timely decisions are made in order to accomplish many different missions that our Armed Forces face each day. The decisions that are made have a lasting impact on the lives of both our military and civilian populations all over the world. As part of a military officer’s annual evaluation, leadership is often judged by an officer’s ability to make sound decisions. For the same reasons that it is important to make sound decisions, it is essential to use sound methods for making decisions (Suhr, 2008). Over the years, there have been many methods developed to facilitate sound decision-making. Table 1-1 lists some of the common decision analysis tools that have been used to date. Two decision analysis tools commonly applied in research at the Air Force Institute of Technology (AFIT) are the Analytical Hierarchy Process (AHP) and Value Focus Thinking (VFT) (e.g., Pate, 2005; Hughes, 2006). This research will be using an innovative decision analysis method known as Choosing By Advantages (CBA). Apparently, the CBA has not been used in the past by AFIT, USMC, or DoD decision makers. The following sections will discuss each of these methods.

2.7.1. Value-Focused Thinking (VFT)

Keeney (1992) presented a way of thinking about decisions by beginning with the values of the decision-maker. According to Keeney (1992), value-focused thinking describes and illustrates concepts and procedures for creating better alternatives for decision problems, identifying opportunities that are more appealing than the status quo, and articulating and using fundamental values to guide and integrate decision-making activities (Keeney, 1992). Because values are considered to be fundamentally important in any decision situation, Keeney explains that values should be the driving force for decision-making. This concept of focusing first on values and later on alternatives that might achieve these values is known as Value-Focused Thinking (VFT). VFT is a ten-step decision analysis tool meant to recognize and articulate fundamental values of decision-makers in order to identify decision opportunities and create better alternatives. The intent of VFT application is to proactively identify more attractive alternatives to ponder before selecting solutions (Keeney, 1992).

In framing a decision, it is necessary to develop a complete understanding of the decision context and the fundamental objectives (Keeney, 1992). The decision context defines the set of alternatives appropriate to consider for a specific decision situation (Keeney, 1992). The construction of a decision analysis framework, based on the VFT process, fits into the 10 steps compiled by Shoviak (2001) as shown in Figure 2-13.

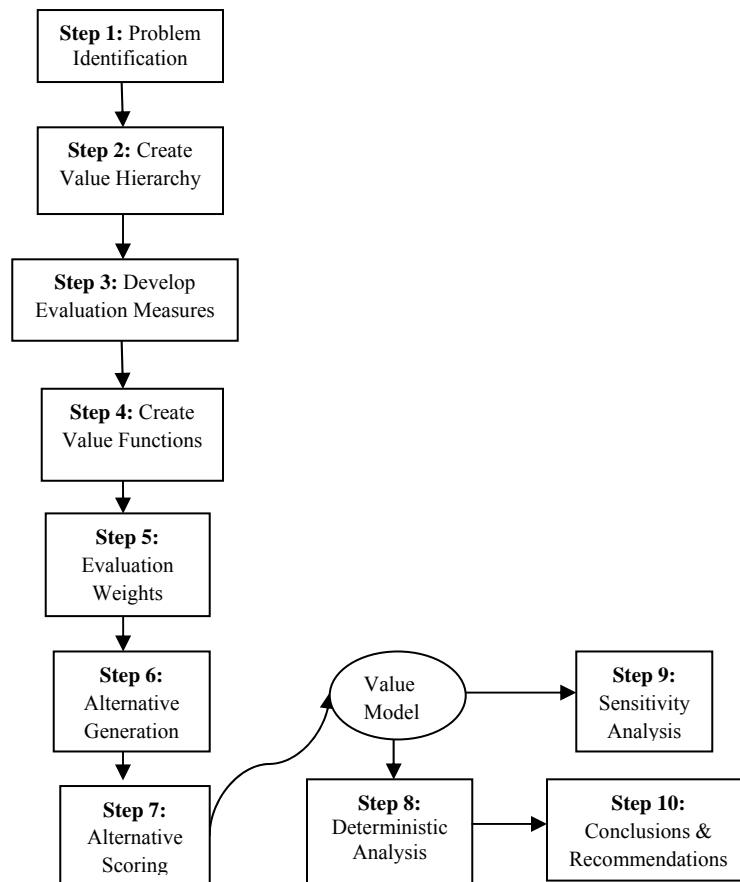

Figure 2-13 Value-Focused Thinking Ten-Step Process (Shoviak, 2001)

2.7.1.1. Advantages/ Less Desirable Attributes of VFT

Keeney (1992) identifies nine benefits of value-focused thinking: guiding strategic thinking, identifying decision opportunities, creating alternatives, uncovering hidden objectives, evaluating alternatives, improving communication; facilitating involvement; guiding information collection, and inter-connecting decisions. Although most of these benefits are self-explanatory, three are especially relevant to operational analysis (Parnell, 2003). The first is guiding strategic thinking: value-focused thinking can capture the decision-maker's intent for courses of action (Parnell, 2003). The second is evaluating alternatives: multiple objective decision analysis can evaluate alternative

courses of action (Parnell, 2003). The third is creating alternatives: once alternatives are evaluated, the difference between the ideal value and the best alternative can be assessed and efforts can then focus on developing better alternatives (Parnell, 2003). The less desirable attribute of VFT is the bias that is presented from the decision-makers' values as the driving force of the decision.

2.7.1.2. VFT Application

An example use of VFT was at the United States Military Academy, West Point. As lead analyst, Keeter (2005) highlighted ways in which commanders at all levels can use VFT to improve their results with Effects Based Operations (EBO). EBOs are operations conceived and planned in a systems framework that considers the full range of direct, indirect, and cascading effects which may be achieved by the application of military, diplomatic, psychological, and economic instruments (Keeter, 2005). The analysis showed how the nine benefits given in Keeney's "Value-Focused Thinking" aligned with commanders performing missions across the entire spectrum of military operations (Keeter, 2005). Keeter (2005) explains that "by executing all decisions based on end objectives that collectively represent the commander's honestly identified values, the commander would greatly increase the likelihood of a successful long-term outcome." These effects were considered to be the best way to measure progress in terms of the decision-maker's values (Keeter, 2005). A measure used in this research was a more holistic approach in terms of the attitudes of soldiers and local populace from military and non-military operations. This method is consistent with the current combat mentality in the war on terror of winning the hearts and minds of the people. Keeter (2005)

concluded that planners and leaders must think in terms of values and outcomes, and not in terms of task and completion of those tasks.

Another example of VFT application involved the evaluation of alternatives for supplying drinking water at deployed locations (Hughes, 2006). In his analysis, Hughes (2006) investigated ROWPU treatment, advanced well drilling, and commercial bottled water as potential sources of potable water. He used the ten-step VFT model as a decision analysis tool to select a preferred alternative for drinking water supply (Hughes, 2006). Hughes (2006) presented the advantages, disadvantages, and cost effectiveness for the different water supply options using VFT. He demonstrated that the use of VFT is an appropriate, effective, and powerful tool to evaluate alternative methods for the provision of water to Airmen in the field (Hughes, 2006). Hughes (2006) concluded that “more of the decision-makers’ values are met if water is supplied through drilling of wells versus the continued reliance on commercial bottled water” (Hughes, 2006).

2.7.2. Analytical Hierarchy Process (AHP)

The Analytic Hierarchy Process (AHP) is a structured technique for dealing with complex decisions developed by Saaty in the 1970s. AHP helps decision-makers find the alternative that best suits their needs and understanding of the problem rather than prescribing one correct decision. This method is based on mathematics and psychology; it provides a comprehensive and rational framework for structuring a decision problem. Vaidya et al. (2004) describes AHP as “a multiple criteria decision-making tool that has been used in almost all the applications related with decision-making.” According to Forman et al. (2001), the AHP uses the relative measurement of pair-wise comparisons which requires no scales because the process of forming ratios would produce the same

results with or without a scale. There are five basic stages used to structure complex problems in a hierarchical manner: decompose the decision problem into decision elements and decision alternatives (i.e., create hierarchy), determine the relative importance of hierarchical elements, determine the relative (i.e., local) weight of each alternative, determine indicators of consistency in making pair-wise comparisons, and determine the overall score of each alternative. Figure 2-14 illustrates a simple AHP Standard Form.

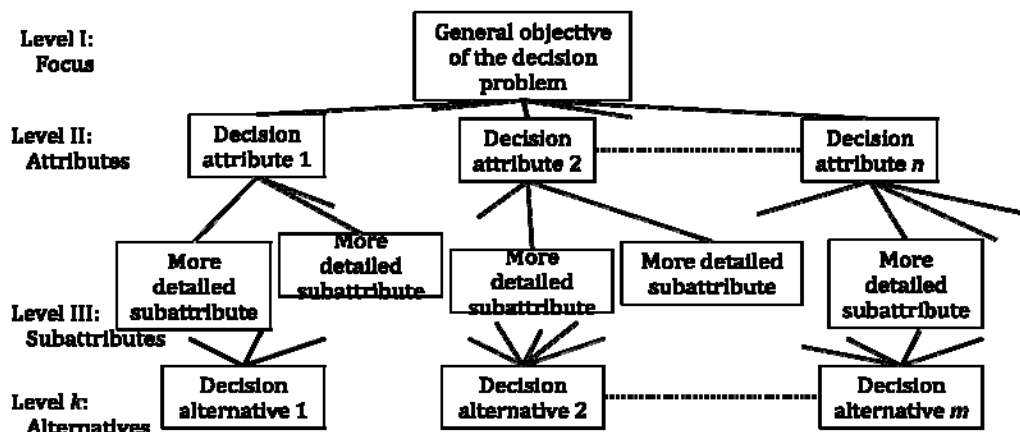

Figure 2-14 AHP Standard Form (Thal, 2009)

2.7.2.1. Advantages/ Less Desirable Attributes of AHP

An advantage of AHP is its flexibility to be integrated with different techniques. This enables the user to extract benefits from all the combined methods, and hence, achieve the desired goal in a better way (Vaidya et al., 2004). Consistency is another advantage. The AHP tracks the logical consistency of judgments used in determining priorities (Pate, 2006). The AHP also enables people to refine their definition of a problem and to improve their judgment and understanding through repetition (Pate, 2006). Some less desirable attributes of AHP are the vagueness of how attribute weights are elicited and assessed. Also, the decision maker must be aware of what is being

compared. Because attribute weights are assessed independently of alternatives, rank reversal can occur when a new alternative is introduced that results in changes to alternatives' previous rankings. Finally, arguably the most undesirable attribute is that the model must be reconstructed each time an alternative is added.

2.7.2.2. AHP Application

An example of AHP application was a study conducted by Hajeesh et al. (2004). The study was of a seawater desalination plant that supplied fresh water to the Gulf Cooperation Council (GCC) countries. The main objective of this study was to select the most suitable technology for adoption in the GCC countries given the various environmental, geographic, and oceanographic characteristics of the region (Hajeesh et al., 2004). Based on seven different criteria, the AHP was utilized to select the most appropriate technology. The selection process in the study was limited to seawater feed, seven evaluation criteria, and four commercially available desalination technologies, i.e., multi-stage flash (MSF), multi-effect desalination (MED), vapor compression (VC), and reverse osmosis (RO) (Hajeesh et al., 2004). The research used four steps in solving the problem. The first step involved structuring the decision into a hierarchical model. This included the decomposition of the problem into elements according to their common characteristics forming a hierarchical model at different levels (Hajeesh et al., 2004). The topmost level represented the main goal or focus of the problem; the intermediate levels corresponded to the criteria and sub-criteria, while the lowest level contained the decision alternatives (Hajeesh et al., 2004). In the second step, the elements of a particular level were compared pair-wise with respect to a specific element in the immediate upper level (Hajeesh et al., 2004). A judgmental matrix was formed and used for computing the

priorities of the corresponding elements (Hajeesh et al., 2004). Finally, the relative weights of the different criteria and the ratings of the various technologies were calculated (Hajeesh et al., 2004). The rankings of the different technologies were determined for each criterion with respect to the relative weights. The rankings revealed that RO desalination process was the most appropriate technology, followed by MED, then MSF, and finally VC. RO technology was the most preferred because cost was the most important criterion (Hajeesh et al., 2004).

Another example of AHP application was Pate (2005), who used the AHP in his research to select the most appropriate transportation alternative for the general purpose vehicle used in Pacific Air Force (PACAF) units. The study was completed in two phases. In the first phase, a qualitative analysis of the existing regulatory restrictions for purchasing transportation alternatives regarding the general purpose vehicle was conducted, as well as an examination of available transportation alternatives (Pate, 2005). In the second phase, this framework was applied to the AHP model. The research focused on those vehicle alternatives that would meet the sponsoring organization's requirements as they pertain to cost, functionality of use, capability, and accessibility for procurement (Pate, 2005). According to Pate (2005), commanders wanted a vehicle that was well suited for the particular mission of the unit. A combination of engine type, daily operating range and hours, and availability of a utility bed formed the job suitability factor, which was ranked most important by four of five squadron commanders (Pate, 2005). The AHP model was thoroughly illustrated with a simple example of how the model might be used in a vehicle purchase scenario. The ability of the model to allow the decision-maker to specify priorities in the form of criteria and the weight of those criteria

made the AHP a particularly useful decision-making tool (Pate, 2005). By weighting the criteria and performing pair-wise comparisons on both the criteria and the alternatives, the decision-maker would have the ability to specifically focus on those attributes of the alternatives that influence the decision processes the most (Pate, 2005). His conclusion indicated that commanders want a vehicle that can perform at a relatively low cost while minimizing out-of-service times due to maintenance problems. Pate (2005) declared that the ease of use and capability to handle large, complex problems in a systematic manner enhance the value of this decision-making tool.

2.7.3. Choosing By Advantages (CBA)

The Choosing By Advantages method was developed when the U.S. Forest Service wanted to improve the management of human resources and renewable and non-renewable natural resources (Suhr, 2008). As an employee of the U.S. Forest Service, Suhr (2008), along with many individuals in universities and other organizations, developed the basic CBA definitions, principles, models, and methods. The CBA uses three sound decision-making concepts: alternatives, attributes, and advantages (Suhr, 2008). The method is meant to be simpler than the VFT and other decision-making tools in that the decision process is based on the importance of advantages, and does not consider disadvantages like most other comparison tools (Suhr, 2008). Because the alternatives are listed and weighted based on advantages, listing disadvantages is considered double-counting which will take more time and skew the results; therefore, the CBA decision-making process is less time consuming and more focused on selecting the best option from a list of attributes and advantages.

According to Suhr (2008), “most people who don’t know how to make a sound decision don’t seem to know that they don’t know.” Sound decision-making is not a natural skill; it must be learned and practiced in order to consistently make sound decisions. In the CBA vocabulary, unsound decision analysis methods are those that cause critical mistakes, omit key relevant facts, distort facts, and perform double counting (Suhr, 2008). Sound decision analysis methods use correct objective data, correct subjective data, and use these data correctly. The fundamental rule of CBA is that decisions must be based on the importance of advantages.

The CBA defines alternatives as people, things, or plans from which one alternative must be chosen (Suhr, 2008). For example, a person has to choose one of two types of cars. An attribute is a characteristic, quality, or consequence of an alternative. For example, the fuel efficiency of the car measured in miles per gallon. An advantage is a difference between the attributes of the two alternatives, and this advantage is guided by either a must or a want that is determined by the customer. In this example, the customer wants a car that is more fuel efficient. The Table 2-3 shows the outcome of this simple example.

Table 2-3 CBA Simple Example 1

Two Alternatives, Two Attributes, and One Advantage		
Alternatives:	Car A	Car B
Attributes: Criteria: Higher MPG is better	23 miles per gallon	35 miles per gallon
Advantage:		12 miles per gallon better
Importance:		60

Although this example shows a very obvious advantage of Car B over Car A, it is still not clear which car would be chosen because there are other attributes that will need to be considered. At this point, it should be clear that attributes are not the same as advantages. In order to ensure that clarity is achieved when evaluating advantages, a difference word or phrase must be used when numerical differences are not obvious (Suhr, 2008). In Table 2-4, using the difference word ‘Easier’, makes it clear that there is a distinguishable advantage.

Table 2-4 CBA Simple Example 2

Two Alternatives, Two Attributes, and One Advantage		
Alternatives:	Car A	Car B
Attributes: Criteria: Easier is better	Manual Transmission	Automatic Transmission
Advantage:		Easier to operate
Importance:		60

In both Tables 2-3 and 2-4, the value 60 indicates how important this attribute is to the stakeholder (the car purchaser in this case). The scale in this case is from 1 to 100, and the range is dependent upon the stakeholder’s preference, anchored questions, and anchored judgment based on relevant facts related to the decision; the higher the value, the higher the level of importance given the attribute by the stakeholder. These values are then totaled in order to determine which alternative is the best.

The CBA is often applied in five-phases: Phase I: The Stage-Setting Phase; Phase II: The Innovation Phase; Phase III: The Decision-making Phase; Phase IV: The Reconsideration Phase; and Phase V: The Implementation Phase (Suhr, 2008). In Phase I, the purpose, scope, and circumstances of the decision are established (Suhr, 2008). The stakeholder's needs and preferences are also identified with the use of must-criteria and want-criteria (Suhr, 2008). In Phase II, the Innovation Phase, alternatives are formulated and attributes are displayed (Suhr, 2008). In Phase III, a tentative decision is made using one of eleven available CBA methods (See Table 2-5) (Suhr, 2008). In Phase IV, the decision is reconsidered for improvement options. Finally, in Phase V, the decision is implemented.

Table 2-5 CBA Methods (Suhr, 2008)

CBA Methods	
The Two-List Method	The Simplified Two-List Method
Instant CBA	Studying, Testing, and Making Improvements
One-Factor Decision-making	Responding to One-Option Situation
Using Good Intuition and Good Judgment	The Recognition-Response Process
The Tabular Method for Choosing from Two Options	Two Tabular Methods for Choosing from Several Options
Essential Sound Methods for Money Decisions	

2.7.3.1. Advantages/ Less Desirable Attributes of CBA

The CBA has advantages over other decision analysis tools. The CBA methods are simpler and much faster than many of the methods listed in Table 1-1. It is easy to see why the best alternative is the best alternative (Suhr, 2008). The CBA builds stronger personal relationships when teamwork is used in order to determine the best alternative. Because normally used decision-making methods must be unlearned and replaced with

the CBA methods, the CBA may be less desirable to many decision-makers. Learning how to use correct objective data, correct subjective data, and use these data correctly may not be easy for many decision-makers.

2.7.3.2. Sample Application

The CBA method has been used as a decision-making tool for vertical construction projects, prioritizing cleanup of hazardous material sites at national parks, and highway construction for the 2002 Winter Olympics. This method apparently has not been used in the past by USMC or DoD decision makers. One example application of the use of the CBA method was Parrish (2009), who selected a design for steel reinforcement (rebar in a beam column joint). The CBA was used in conjunction with set-based design to allow for an explicit consideration of multiple design alternatives that meet various ‘must’ and ‘want’ criteria (Parrish, 2009). The factors and criteria developed for evaluation reflected the values of the various project team members involved in rebar design and construction (Parrish, 2009). Parrish (2009) used the “Two Tabular Methods for Choosing from Several Options” (see Table 2-5) applying the five phases discussed above to select the desired rebar size for use in the steel reinforcement.

Another example of the use of the CBA method was by Nguyen et al. (2009), who investigated the possibility of performing a virtual first-run study (VFRS) for the design phase of a project. VFRS is a first-run study carried out in a virtual environment, where objects of study were created in a computer model in three dimensions, and those objects were linked to process and resource data to represent the process of construction (Nguyen et al., 2009). The case study described employing VFRS, process mapping, and CBA to choose a method for the installation of Viscous Damping Walls at the Cathedral Hill

Hospital Project in San Francisco (Nguyen et al., 2009). Given various factors that needed to be considered in selecting an installation option, the cross-functional team decided to use CBA to analyze advantages of the identified alternatives (Nguyen et al., 2009). The ‘must’ criteria included assuring safety, reliability, and ease of installation. The ‘want’ criteria were determined to be minimizing unnecessary transportation, movement, temporary storage, and waiting for material, equipment, and labor (Nguyen et al., 2009). The five phases of the CBA were used to propose an integrated framework for the efficient application of VFRS to support project teams on constructability review, construction planning, and operation design (Nguyen et al., 2009).

2.8. Conclusion of Literature Review

Overall, this literature review has given an overview of the contaminants, available water sources, and drinking water requirements for Marines conducting combat operations in Afghanistan. The Federal Regulations, DoD Drinking Water Policy, and USMC Drinking Water Policy require the USMC to conduct water purification operations in order to produce water that is fit for human consumption. Due to difficulties presented by terrain and weather, the ROWPU units are functioning for 6-8 hours a day, which is not adequate for producing the quantity of water necessary to move the USMC from reliance on bottled water. The next chapter will compare the decision analysis tools that were explained in detail (VFT, AHP, CBA) and use the appropriate method to select from the identified treatment alternatives (UF, NF, EDI, UV) to help the USMC extend the life of the RO elements and produce the quantity of water required for sustainment.

3.0. Methodology

3.1. Introduction

In the previous chapter, three decision analysis methods (VFT, AHP, CBA) that may be appropriate for application in the context of this study were explained in detail. Table 3-1 presents a direct comparison of the three methods and justifies why the CBA is the method of choice in this study. The simplicity of this method, and the fact that it is currently not being used by either the USMC or Department of Defense, makes this innovative decision analysis method of great interest for application in this study.

Table 3-1 Decision Analysis Method Comparison

VFT	AHP	CBA
Ten steps	Five basic stages	Five phases
Multiple criteria decision-making	Multiple criteria decision-making	Three decision making concepts
Values are the driving force	Based on mathematics and psychology	Based on the importance of advantages
Present results, advantages, disadvantages, and recommendations	Summarize and eliminate dominated and unsatisfactory alternatives	Does not consider disadvantages
Creates better alternatives for decision problems	Does not prescribe one correct decision	Selects best alternative
Technique for dealing with complex decisions	Technique for dealing with complex decisions	Technique for dealing with simple and complex decisions
Used for many DoD applications	Used for many DoD applications	Not used for DoD applications

Using CBA in this research will help determine the efficacy of applying CBA to facilitate the technology evaluation in general. In this chapter, the first three phases of the CBA will be used in order to meet the primary and secondary objectives of this study. These phases of the CBA include: Phase I: The Stage-Setting Phase; Phase II: The Innovation Phase; and Phase III: The Decision-making Phase. Phase IV: The Reconsideration Phase and Phase V: The Implementation Phase will be discussed in the later chapters.

3.2. Phase I: The Stage-Setting Phase

In this study, the purpose of using the CBA is to evaluate technology alternatives in order to select a preferred technology that may be employed to provide drinking water to USMC troops deployed in the Afghanistan AO. Two master sergeants and two gunnery sergeants were identified as the expert panel designated to learn the CBA method and participate in the evaluation process. The participants are sound decision-makers with more than 70 years of combined experience in the USMC engineer community. Because the expert panel had not used the CBA method to make decisions before, essential CBA training was conducted by providing a detailed description of the process. Each member had approximately two months to learn the process. Once the team members were comfortable with CBA, the criteria for evaluating alternative technologies for the conduct of water purification operations were established. There are two types of criteria that are required during this phase of the CBA process: the ‘must’ criteria, representing conditions that each alternative must satisfy, and the ‘want’ criteria, representing preferences of one or multiple decision-makers (Suhr, 2008).

3.2.1. ‘Must’ Criteria

One of the major ‘musts’ that was established was that each alternative must comply with USMC policy on Water Quality Management (WQM). The alternative technology ‘must’ produce an adequate quality of water that meets drinking water standards. The team also determined that the ability for the basic Marine students to pass a written, oral, and practical application exam for licensing on the technology was also a ‘must.’ This licensing requirement included providing a competent qualified examiner with thorough knowledge of the alternative technology’s operating procedures. Such an

examiner should be designated in writing by the Unit Commander as an additional duty. Licensing would require demonstrating knowledge and awareness of all major technology components, operating modes and procedures, preventive maintenance service, and safety procedures. In addition, due to the current operational tempo, this training and licensing could not add to the time currently required for USMC students to complete the basic engineer school; therefore, the alternative technology ‘must’ be relatively simple to operate (e.g., valves, controls, membrane cleaning, etc...). Another ‘must’ is that the equipment associated with the technology must provide flexible and responsive water support. This is important because of the logistics (e.g., trucks, heavy equipment, etc...) that will be required to employ any technology in an AO such as Afghanistan. To achieve this flexibility and responsiveness, the technology ‘must’ be a skid mounted, mobile, or air transportable unit capable of purifying fresh, brackish, and salt water at a rate of 3,000 gallons per hour for 20 continuous hours a day. After the ‘must’ criteria were determined, the ‘want’ criteria were specified.

3.2.2. ‘Want’ Criteria

There are several attributes that the participating expert panel considered preferable for implementation of one or more of the alternative technologies. It is preferred that the site preparation time and overall footprint of the alternative technology not present an increased security risk to implement. Other than one team member’s desire to have the licensing requirement satisfied during on-the-job training at a basic student’s first duty station, the rest of the ‘wants’ were based on a comparison of the alternative technologies with some of the attributes of the ROWPU. One ‘want’ is for the alternative technology to have a lower operating pressure than the ROWPU. Because the

RO elements of the ROWPU operate at a desired pressure of 85 psi, the preferred operating pressure of the alternative technology has to be less in order to prevent an increase in energy consumption. A longer membrane life and lower membrane replacement cost is also preferred due to the \$16,000 required to replace the RO elements. Finally, it is preferred that there is not an increase in chemicals needed for disinfection or storage. Once the 'must' and 'want' criteria were determined, Phase I was complete. Now, the alternative technologies that were described in Chapter 2 of this research are introduced.

3.3. Phase II: The Innovation Phase

In Phase II, the attributes of the alternatives are determined and incorporated into the methodology. The literature reviewed in the previous chapter discussed a full range of water treatment options and revealed some very important factors that need to be addressed before the alternatives are formulated. Some of the alternatives were eliminated due to inadequate water quality or quantity, or the security risk that the technology presented (e.g., IE, carbon adsorption, SSF). Also, it was determined by the expert panel that the technologies that were discussed should be placed in one of two categories: pretreatment or post-treatment. The team determined that the goal of using an alternative treatment technology should not be to replace RO, but should be to reduce the wear and tear on the current system through pretreatment. This decision was made because RO has been proven to provide the best quality of potable water while meeting requirements for deployment in the AO. However, because of the high replacement costs of RO elements, the limited availability of raw water sources, and excessive maintenance time due to sand and dust, RO is not currently being used to provide drinking water.

Also, because of the chlorine required for disinfection, one team member suggested that it may be better to incorporate a post treatment technology to avoid having to chlorinate the source water, which has an adverse effect on the ROWPU. The two pretreatment options to be evaluated are UF and NF while the two post-treatments are EDI and UV. The next section will discuss the pretreatment alternatives.

3.3.1. Pretreatment Alternatives

A recent trend in pretreatment has been towards using larger pore size membranes (UF, and NF) to pretreat RO feed water (Greenlee et al., 2009). UF modules have backwash and near dead-end modes of operation that give these membranes more operational flexibility than NF modules. Of the membrane types, UF membranes represent perhaps the best balance between removing contaminants and maximizing permeate production. NF has found various applications in the treatment of ground and surface water for water softening; however, one of the problems associated with the application of NF is plugging (fouling) of a membrane surface by the solids precipitated in the retentate (Orecki et al., 2004). Due to the high level of solids in the water sources in Afghanistan, the fouling problem was significant enough to eliminate NF from consideration as an alternative technology. This leaves UF to be evaluated; though there are two membrane configurations to select from (Spiral Wound and Hollow Fiber).

3.3.2. Post Treatment Alternatives

Disinfection is normally the last step in purifying drinking water. Water is disinfected to kill any pathogens which may pass through the membrane of the primary filtration technology. Under the U.S. Safe Drinking Water Act, the USEPA is developing regulations for improved disinfection against the types of chlorine-resistant pathogens

(e.g., Cryptosporidium, Giardia, etc.) as well as coliform bacteria such as Escherichia coli and Leptospira, which have been identified in the waters in Afghanistan, while at the same time reducing disinfection by-products (Leinberger, 2009). EDI and UV radiation are continuous and chemical-free processes that eliminate the need to store and handle hazardous chemicals. Using these methods, water disinfection is faster than chlorination, producing high quality water while keeping energy and operating costs low. The post treatment attributes are developed from the expert panel's criteria as to what makes a disinfectant effective.

3.4. Phase III: The Decision-making Phase

Because of the preliminary determination that the environment in Afghanistan will support a limited number of alternative technologies, Phase III will summarize the attributes of each alternative, decide the advantages of each alternative, decide the importance of each advantage, and then compare costs if necessary. In this phase, a tentative decision is made using one of eleven available CBA methods (See Table 2-5) (Suhr, 2008). This research will be using the “Tabular Method for Choosing from Two Options” to determine the best pretreatment and post treatment alternative.

3.4.1. Step 1: Summarize the Attributes of Each Alternative

In Step 1a, Tables 3-2 and 3-3, which list the technology attributes, were developed from the literature review and the ‘must’ and ‘want’ criteria that came from the expert panel. The expert panel determined what the criteria were and then those criteria were applied to attributes that were common to the technologies that were being compared. In Step 1b, these attributes are displayed in Table 3-4 and Table 3-5 to clearly reveal the difference among the alternatives.

Table 3-2 Pretreatment Attribute and Criteria

Pretreatment Attributes
Attribute: Physical Backwash Criteria: Having the ability to perform physical backwash is better
Attribute: Chemical Cleanings Criteria: The more chemical cleaning options the better
Attribute: Operating Pressures Criteria: Lower pressure range is more desirable
Attribute: Membrane Life Criteria: Less variation in membrane life increases predictability
Attribute: Pre-filter Requirements Criteria: The ability to remove a smaller size particle will extend the life of the filter
Attribute: Operating mode Criteria: More operating modes support more raw water sources
Attribute: Valves Criteria: The less complex the valves promotes simplicity in operation
Attribute: Control Criteria: The less complex the controls promotes simplicity in operation
Attribute: Break Tank Criteria: No break tank will reduce time and footprint
Attribute: Availability of Membrane Replacement Criteria: More available options for purchasing replacement filters can save money and time
Power Consumption Criteria: Lower energy consumption reduces cost

Table 3-3 Post Treatment Attribute and Criteria

Post treatment Attributes
Attribute: Bacteria removal Criteria: The more efficient the better
Attribute: Inorganics removal Criteria: The more efficient the better
Attribute: Organics removal Criteria: The more efficient the better
Attribute: Lamp/ Membrane Life Criteria: Longer life provide is more desirable
Power Consumption Criteria: Lower energy consumption reduces cost

Table 3-4 Attributes of Each Pretreatment Alternative

Attributes	Pretreatment Alternatives	
	UF Hollow Fiber	UF Spiral Wound
Attribute: Physical Backwash Criteria: Having the ability to perform physical backwash is better	Possible	Not generally
Advantage		
Importance		
Attribute: Chemical Cleanings Criteria: The more chemical cleaning options the better	CIP or CEB	CIP possible
Advantage		
Importance		
Attribute: Operating Pressures Criteria: Lower pressure range is more desirable	5-30 psi	20-100 psi
Advantage		
Importance		
Attribute: Membrane Life Criteria: Less variation in membrane life increases predictability	7-10 years	8years
Advantage		
Importance		
Attribute: Pre-filter Requirements Criteria: The ability to remove a smaller size particle will extend the life of the filter	100-500 micron strainer	5 micron cartridge filter
Advantage		
Importance		
Attribute: Operating mode Criteria: More operating modes support more raw water sources	Dead-end or crossflow	crossflow
Advantage		
Importance		
Attribute: Valves Criteria: The less complex the valves promotes simplicity in operation	Requires several pneumatically operated valves for backwash sequence	Can be operated with manual valves
Advantage		
Importance		
Attribute: Control Criteria: The less complex the controls promotes simplicity in operation	Requires PLC and transmitters for monitoring to maintain performance	May be simple on/off with indicators for manual adjustment
Advantage		
Importance		
Attribute: Break Tank Criteria: No break tank will reduce time and footprint	Requires break tank to supply backwash water and to continuously feed RO when off-line for backwash	Operates continuously so no break tank before RO system is required
Advantage		
Importance		
Attribute: Availability of Membrane Replacement Criteria: More available options for purchasing replacement filters can save money and time	Each system is proprietary, with spare membranes only available from manufacturer	Spirals are a standard size, with replacements available from several vendors
Advantage		
Importance		
Attribute: Power Consumption Criteria: Lower energy consumption reduces cost	0.2-0.3 kWh/kgal	0.2-0.8 kWh/kgal
Advantage		
Importance		
Total Importance		

Table 3-5 Attribute of Each Post Treatment Alternative

Attributes	Post treatment Alternatives	
	UV	EDI
Attribute: Bacteria removal Criteria: The more efficient the better	Complete Removal	Mostly Removed
Advantage		
Importance		
Attribute: Inorganics removal Criteria: The more efficient the better	Not very effective	Complete Removal
Advantage		
Importance		
Attribute: Lamp/ Membrane Life Criteria: Longer life provide is more desirable	1 years	2 year
Advantage		
Importance		
Power Consumption Criteria: Lower energy consumption reduces cost	1.44 kWh	0.25 kWh
Advantage		
Importance		
Total Importance		

3.4.2. Step 2: Decide the Advantages of Each Alternative

In this step, each attribute is compared among the alternatives. The alternative having the lowest value of an attribute is underlined (see Tables 3-6 and 3-7). Underlining the alternative that has the lowest-valued attribute allows the decision-maker to clearly see the advantage of the more preferred alternatives. One of the most significant discoveries from CBA development was that it is much better to compare differences with the attribute of the least-preferred alternative; and that these differences highlight the advantages of the other alternatives (Suhr, 2008).

Table 3-6 Identify Least-preferred Pretreatment Attribute

Attributes	Pretreatment Alternatives	
	UF Hollow Fiber	UF Spiral Wound
Attribute: Physical Backwash Criteria: Having the ability to perform physical backwash is better	Possible	<u>Not generally</u>
Advantage		
Importance		
Attribute: Chemical Cleanings Criteria: The more chemical cleaning options the better	CIP or CEB	<u>CIP possible</u>
Advantage		
Importance		
Attribute: Operating Pressures Criteria: Lower pressure range is more desirable	5-30 psi	<u>20-100 psi</u>
Advantage		
Importance		
Attribute: Membrane Life Criteria: Less variation in membrane life increases predictability	<u>7-10 years</u>	8years
Advantage		
Importance		
Attribute: Pre-filter Requirements Criteria: The ability to remove a smaller size particle will extend the life of the filter	100-500 micron strainer	<u>5 micron cartridge filter</u>
Advantage		
Importance		
Attribute: Operating mode Criteria: More operating modes support more raw water sources	Dead-end or crossflow	<u>crossflow</u>
Advantage		
Importance		
Attribute: Valves Criteria: The less complex the valves promotes simplicity in operation	<u>Requires several pneumatically operated valves for backwash sequence</u>	Can be operated with manual valves
Advantage		
Importance		
Attribute: Control Criteria: The less complex the controls promotes simplicity in operation	<u>Requires PLC and transmitters for monitoring to maintain performance</u>	May be simple on/off with indicators for manual adjustment
Advantage		
Importance		
Attribute: Break Tank Criteria: No break tank will reduce time and footprint	<u>Requires break tank to supply backwash water and to continuously feed RO when off-line for backwash</u>	Operates continuously so no break tank before RO system is required
Advantage		
Importance		
Attribute: Availability of Membrane Replacement Criteria: More available options for purchasing replacement filters can save money and time	<u>Each system is proprietary, with spare membranes only available from manufacturer</u>	Spirals are a standard size, with replacements available from several vendors
Advantage		
Importance		
Power Consumption Criteria: Lower energy consumption reduces cost	0.2-0.3 kWh/kgal	<u>0.2-0.8 kWh/kgal</u>
Advantage		
Importance		
Total Importance		

Table 3-7 Identify Least-preferred Post Treatment Attribute

Attributes	Post treatment Alternatives	
	UV	EDI
Attribute: Bacteria removal Criteria: The more efficient the better	Complete Removal	<u>Mostly Removed</u>
Advantage		
Importance		
Attribute: Inorganics removal Criteria: The more efficient the better	<u>Not very effective</u>	Complete Removal
Advantage		
Importance		
Attribute: Lamp/ Membrane Life Criteria: Longer life provide is more desirable	<u>1 years</u>	2 year
Advantage		
Importance		
Power Consumption Criteria: Lower energy consumption reduces cost	<u>1.44 kWh</u>	0.25 kWh
Advantage		
Importance		
Total Importance		

3.4.3. Step 3: Decide the Importance of Each Advantage

In the Tabular Methods application, a scale of importance is established in two steps: highlight the most important advantage of an alternative within each attribute and select the paramount advantage and assign it an importance score. When selecting the paramount advantage and when weighing the importance of each of the other advantages, relevant facts must be used to anchor the decision. The perception of each advantage must be clear and accurate and three principles and four considerations should be kept in mind. The three principles are: (1) there is no such thing as zero advantage, (2) all advantages of all alternatives in all factors must be weighed on the same scale of importance, and (3) decision-making is not a branch of mathematics; therefore, you must decide, not calculate the importance of each advantage (Suhr, 2008). The four considerations are: (1) the purpose and circumstances of the decision, (2) the needs and

preferences of the expert panel affected by the decision, (3) the magnitudes of the advantage, and (4) the magnitudes of the associated attributes (Suhr, 2008).

Following the three principles, four considerations, and their personal operational and water purification experience, a majority of the expert panel decided that a scale of 1 to 100 was appropriate for measuring the level of importance (100 indicating highest importance and 1 indicating no importance). Based on the fixed and variable cost of water treatment technologies used in the USMC, the expert panel also determined that if the cost of alternatives are not equal, (in accordance with the CBA method for money decisions) every 20 level of importance points would be represented by \$100. Table 3-8 and Table 3-9 illustrate the weight of all the advantages on the established scale.

Table 3-8 Importance of Each Pretreatment Advantage

Attributes	Pretreatment Alternatives	
	UF Hollow Fiber	UF Spiral Wound
Attribute: Physical Backwash Criteria: Having the ability to perform physical backwash is better	Possible	Not generally
Advantage	More Options	
Importance	70	
Attribute: Chemical Cleanings Criteria: The more chemical cleaning options the better	CIP or CEB	CIP possible
Advantage	More Options	
Importance	80	
Attribute: Operating Pressures Criteria: Lower pressure range is more desirable	5-30 psi	20-100 psi
Advantage	Less Pressure	
Importance	90	
Attribute: Membrane Life Criteria: Less variation in membrane life increases predictability	7-10 years	8years
Advantage		More Predictable
Importance		60
Attribute: Pre-filter Requirements Criteria: The ability to remove a smaller size particle will extend the life of the filter	100-500 micron strainer	5 micron cartridge filter
Advantage	Smaller is better	
Importance	50	
Attribute: Operating mode Criteria: More operating modes support more raw water sources	Dead-end or crossflow	crossflow
Advantage	More Options	
Importance	60	
Attribute: Valves Criteria: The less complex the valves promotes simplicity in operation	Requires several pneumatically operated valves for backwash sequence	Can be operated with manual valves
Advantage		More Simple
Importance		60
Attribute: Control Criteria: The less complex the controls promotes simplicity in operation	Requires PLC and transmitters for monitoring to maintain performance	May be simple on/off with indicators for manual adjustment
Advantage		More simple
Importance		60
Attribute: Break Tank Criteria: No break tank will reduce time and footprint	Requires break tank to supply backwash water and to continuously feed RO when off-line for backwash	Operates continuously so no break tank before RO system is required
Advantage		Less interruption is better
Importance		70
Attribute: Availability of Membrane Replacement Criteria: More available options for purchasing replacement filters can save money and time	Each system is proprietary, with spare membranes only available from manufacturer	Spirals are a standard size, with replacements available from several vendors
Advantage		More Options
Importance		90
Power Consumption Criteria: Lower energy consumption reduces cost	0.2-0.3 kWh/kgal	0.2-0.8 kWh/kgal
Advantage	Less Power is better	
Importance	90	
Total Importance		

Table 3-9 Importance of Each Post Treatment Advantage

Attributes	Post treatment Alternatives	
	UV	EDI
Attribute: Bacteria removal Criteria: The more efficient the better	Complete Removal	<u>Mostly Removed</u>
Advantage	More Efficient	
Importance	100	
Attribute: Inorganics removal Criteria: The more efficient the better	<u>Not very effective</u>	Complete Removal
Advantage		More Efficient
Importance		90
Attribute: Lamp/ Membrane Life Criteria: Longer life provide is more desirable	<u>1 years</u>	2 year
Advantage		Much better
Importance		70
Power Consumption Criteria: Lower energy consumption reduces cost	<u>1.44 kWh</u>	0.25 kWh
Advantage		Less Power is better
Importance		65
Total Importance		

3.4.4. Step 4: Choosing From Total Importance

The last step of the Tabular Method is choosing the alternative with the greatest total importance of advantages. Table 3-10 and Table 3-11 display which alternative has the greatest total importance. According to Koch Membrane Systems, both UF pretreatment configurations cost \$100. With costs being equal, the UF Hollow Fiber configuration is selected as the alternative with the greatest total importance. For the post treatment alternatives, the costs are unequal; therefore, an applicable money-decision-making method must be used.

Table 3-10 Pretreatment Total Importance

Attributes	Pretreatment Alternatives	
	UF Hollow Fiber	UF Spiral Wound
Attribute: Physical Backwash Criteria: Having the ability to perform physical backwash is better	Possible	Not generally
Advantage	More Options	
Importance	70	
Attribute: Chemical Cleanings Criteria: The more chemical cleaning options the better	CIP or CEB	CIP possible
Advantage	More Options	
Importance	80	
Attribute: Operating Pressures Criteria: Lower pressure range is more desirable	5-30 psi	20-100 psi
Advantage	Less Pressure	
Importance	90	
Attribute: Membrane Life Criteria: Less variation in membrane life increases predictability	7-10 years	8years
Advantage		More Predictable
Importance	60	
Attribute: Pre-filter Requirements Criteria: The ability to remove a smaller size particle will extend the life of the filter	100-500 micron strainer	5 micron cartridge filter
Advantage	Smaller is better	
Importance	50	
Attribute: Operating mode Criteria: More operating modes support more raw water sources	Dead-end or crossflow	crossflow
Advantage	More Options	
Importance	60	
Attribute: Valves Criteria: The less complex the valves promotes simplicity in operation	Requires several pneumatically operated valves for backwash sequence	Can be operated with manual valves
Advantage		More Simple
Importance	60	
Attribute: Control Criteria: The less complex the controls promotes simplicity in operation	Requires PLC and transmitters for monitoring to maintain performance	May be simple on/off with indicators for manual adjustment
Advantage		More simple
Importance	60	
Attribute: Break Tank Criteria: No break tank will reduce time and footprint	Requires break tank to supply backwash water and to continuously feed RO when off-line for backwash	Operates continuously so no break tank before RO system is required
Advantage		Less interruption is better
Importance	70	
Attribute: Availability of Membrane Replacement Criteria: More available options for purchasing replacement filters can save money and time	Each system is proprietary, with spare membranes only available from manufacturer	Spirals are a standard size, with replacements available from several vendors
Advantage		More Options
Importance	90	
Attribute: Power Consumption Criteria: Lower energy consumption reduces cost	0.2-0.3 kWh/kgal	0.2-0.8 kWh/kgal
Advantage	Less Power is better	
Importance	90	
Total Importance	440	340

Table 3-11 Post Treatment Total Importance

Attributes	Post treatment Alternatives	
	UV	EDI
Attribute: Bacteria removal Criteria: The more efficient the better	Complete Removal	Mostly Removed
Advantage	More Efficient	
Importance	100	
Attribute: Inorganics removal Criteria: The more efficient the better	Not very effective	Complete Removal
Advantage		More Efficient
Importance		90
Attribute: Lamp/ Membrane Life Criteria: Longer life provide is more desirable	1 years	2 year
Advantage		Much better
Importance		70
Power Consumption Criteria: Lower energy consumption reduces cost	1.44 kWh	0.25 kWh
Advantage		Less Power is better
Importance		65
Total Importance	100	225
Cost	\$6000	\$6500

When choosing from mutually-exclusive alternatives, the CBA uses Importance/Cost ratios. In this decision-making method, money is viewed as a message and not as a commodity. The decision is based on the interdependency principle that different proposals competing for the same money are interdependent decisions (Suhr, 2008). As Table 3-11 shows, the least-cost option is on the left. Most decision-makers would ask the question, why is the \$500 less cost not shown as an advantage for UV? The reason it is not shown as an advantage is because the message that money serves in the CBA is as a medium of exchange (Suhr, 2008). Therefore, a decision needs to be made about what would be exchanged for the \$500 and what would be the scale to determine the worth of the level of importance.

The expert panel determined on a 1 to 100 level of importance scale, every 20 level of importance points would be represented by \$100. Therefore, the expert panel decided to buy 100 importance points for the \$500 in order to determine the trade-off for

spending the additional money (See Table 3-12). Based on this trade-off, EDI is seen to be the preferred alternative. Now that Phase III is complete, Chapter 4 of this study will outline the next phase of the CBA, Phase IV: The Reconsideration Phase in order to analyze and discuss the results of the model.

Table 3-12 Including Cost

Post treatment Alternatives			
Advantages of UV		Advantages of EDI	
More Efficient Bacteria removal Complete Removal	100	More efficient inorganics removal	90
What we would buy with the \$500 savings	100	Lamp/ Membrane Life is much better	70
		Power Consumption is less	65
Total Importance	200	Total Importance	<u>225</u>
Total Cost	\$6500	Total Cost	\$6500

4.0. Results and Discussion

4.1. Introduction

In this chapter, Phase IV: The Reconsideration Phase will be used to analyze the three phases from the previous chapter. First, the purpose, scope, and circumstances of the decision will be examined in order to validate if the right criteria guided the decision in Phase I. Next, Phase II will be examined to ensure that the alternatives were evaluated and categorized properly. Finally, Phase III will be analyzed in order to determine if the decision needs to be changed.

4.2. Phase I Reconsideration

The CBA was used to evaluate technology alternatives for providing drinking water to Marines deployed to Afghanistan. Teaching the methodology to expert panel helped ensure that the CBA method would be correctly applied. Each member of the evaluation team had extensive experience in the water purification processes used by the USMC. Water quality and the requirement to license operators were very important ‘must’ criteria that came out during Phase I. The conduct of operations would be severely impacted if the right protocol is not followed when distributing potable water. Marines at the basic water operation school are normally young and inexperienced at the water purification process; therefore, it is imperative that they have a complete understanding of the equipment and the ability to operate this equipment with confidence and efficiency. Although membrane life was considered a ‘want’ by the expert panel, this attribute should probably be considered a ‘must’ due to the fact that membrane fouling would result in down time. The cost of RO element replacement had less significance to the expert panel because their focus is normally on planning and

conducting the operation rather than requisitioning the funds required for purchasing the equipment. This can be directly related to the mentality that bottled water is adequate for use as the primary source of drinking water at this time because the decision to move away from it would have to come from a higher echelon in the chain of command. At the operator level, the cost implications are not a strong consideration. With the understanding that the circumstances that influence the expert panel's criteria are consistent with the purpose and objective of this study, it is now time to re-evaluate Phase II.

4.3. Phase II Reconsideration

During the innovation phase, the attributes of each alternative were determined and incorporated into the model. By eliminating a number of technologies for the inability to produce adequate water quality; inability to learn, teach, or license within allocated school time; and lack of flexibility and responsive support; the remaining alternatives were evaluated with the goal of reducing the wear and tear on the current systems and reducing the frequency of the \$16,000 membrane replacement cost. Although it may have seemed premature to eliminate NF and select UF as the primary pretreatment alternative technology to be evaluated, the following discussion justifies why UF handles fouling effectively.

According to Greenlee et al. (2009), surface fouling and fouling in pores are two fouling mechanisms generally observed for membrane processes with surface fouling being the main fouling mechanism for RO membranes. "Surface fouling can occur from a variety of contaminants, including suspended particulate matter (inorganic or organic), dissolved organic matter, dissolved solids, and biogenic material" (Greenlee et al., 2009).

Fouling can also develop unevenly through a membrane and in spacers between the membrane sheets of a module (Greenlee et al., 2009). The silt density index (SDI) is often used to measure the capacity of water to foul RO membranes. SDI values of 4 and 5 produce far more fouling than SDI values between 1 and 4. “Therefore, ideally, a pretreatment scheme that can lower the SDI to below 2 will provide feed water with a lower fouling propensity than a pretreatment scheme that provides an SDI of 3-5” (Greenlee et al., 2009).

The total flow resistance (R_t) is the resistance of the filter (R_p) and the resistance of the foulant on the filter (R_F). The theoretical relationship between SDI and R_t , shown in Figure 4-1, displays an exponential relationship between increasing SDI and increasing foulant accumulation on the membrane with and without pretreatment. UF acts as a barrier that minimizes fouling of the RO by the contaminants discussed earlier. UF will remove all suspended solids and provide a substantial reduction in microbiological growth. UF pretreatment can lower the SDI of the RO feed water to less than 2 which is a level that can completely eliminate plugging of RO spacers and substantially reduce the cleaning frequency of RO membranes (Greenlee et al., 2009). In addition, UF pretreatment reduces the general aging and destruction of RO membranes by feed water components; RO membrane replacement decreases, as well as the frequency of chemical cleaning.

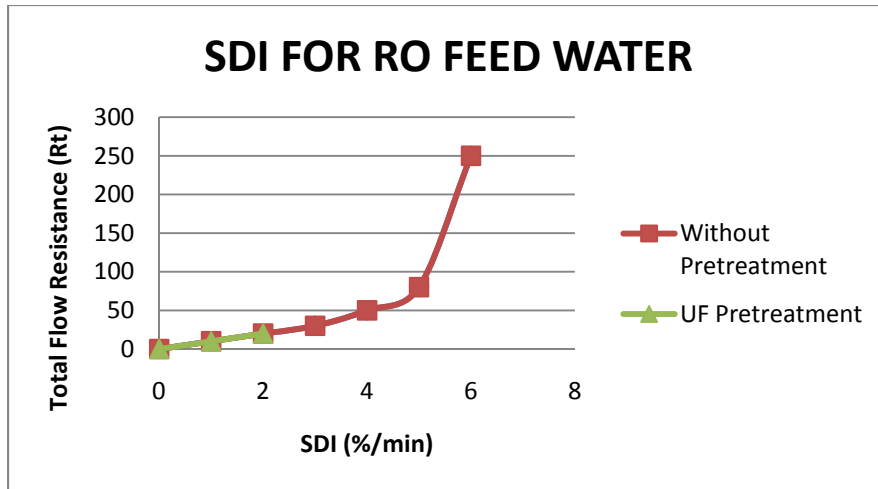

Figure 4-1 Theoretical Relationship between SDI and R_t (Greenlee et al., 2009)

4.4. Phase III Reconsideration

The decision-making phase in chapter 3 of this study used the “Tabular Method for Choosing from Two Options.” Phase III summarized the attributes of each alternative, decided the advantages of each alternative, quantified the importance of each advantage, and then compared costs when necessary.

4.4.1. Pretreatment Reconsideration

The results of the Tabular Method for the two pretreatment options are displayed in Table 3-9. The perception of each advantage was clear and accurate. The advantages of both alternatives in all factors were weighed on the same scale of importance. The purpose and circumstances of the decision and the needs and preferences of the expert panel affected by the decision had a significant influence in the alternative selection process. According to the manufacturer Koch, the costs of the pretreatment configurations are equal; therefore, a cost comparison was not necessary. However, it is important to reconsider and discuss how the selection of UF hollow fibers as a pretreatment will be the best alternative to improve the current RO system.

Hollow fiber membranes (pore size 0.005 μm) remove suspended solids, biomass, viruses, and microorganisms from the feed water. “The UF hollow fibers act as open channels allowing crossflow of feed water along the membrane surface” (Halpern et al., 2005). The physical backwash process helps maintain a stable permeate flow rate by physically removing the fouling layer from the membrane surface. Organic and colloidal foulants, which are detrimental to RO membrane performance, can be easily removed from the hollow fiber membranes utilizing clean in place (CIP) or chemically enhanced backwash (CEB) (Halpern et al., 2005). Having the ability to conduct physical backwash, CIP, and CEB, gives UF hollow fibers more options than the UF spiral wound configuration.

The primary energy used in an RO system is the power required to pump the feed water and is directly related to the feed pressure and flow rate. UF hollow fiber configuration allows for direct feed of the feed water into the RO high pressure pumps, thus eliminating the need for interstage tanks and reducing the energy required to pump the feed water (Knops et al., 2006). Because UF hollow fibers have a lower pressure range than UF spiral wound, UF hollow fibers lower the overall energy used by the RO system much more than UF spiral wound would.

When incorporating UF hollow fibers as a pretreatment, there is a total cost of ownership (TCO) that will be associated with this additional treatment process. According to Knops et al. (2006), “The total cost of ownership (TCO) is the cost calculated over the life cycle of a desalination plant.” Based on the TCO for a large-scale ROWPU desalination facility, the data were plotted and extrapolated for conventional pretreatment (strainer and chemicals) and compared to UF hollow fiber pretreatment.

The TCO takes into consideration the cost of implementing the pretreatment and the impact on other costs in the system. The following section will discuss the TCO that is split into four categories of expenses: Pretreatment, RO membrane cleaning and replacement, other fixed costs (amortization of other equipment etc.) and other variable costs (energy costs etc.) (Knops et al., 2006).

4.4.1.1. UF Hollow Fibers as a Pretreatment

With conventional pretreatment methods, the pretreatment portion of the TCO is approximately 17% (Knops et al., 2006). “The pretreatment costs can be split into amortization of investment and operating costs (mainly chemicals for coagulation and for disinfection)” (Knops et al., 2006). With the UF hollow fibers pretreatment option, the investment costs for the pretreatment will increase; therefore, the fixed costs associated with implementing this pretreatment technology will increase. On the other hand, implementing UF hollow fiber will decrease the costs required for chemicals (mainly coagulant) by at least 25-50% (Knops et al., 2006). The amortization of the pretreatment using UF hollow fibers will be increased by approximately 10-20% (Knops et al., 2006). With all factors considered for implementing UF hollow fibers as a pretreatment, the overall cost of pretreatment will remain unchanged at 17%. However, as will be shown below, implementing UF hollow fiber pretreatment will reduce other costs.

4.4.1.2. RO Membrane Replacement and Cleaning

The RO replacement and RO cleaning part of TCO using conventional pretreatment is approximately 6% (Knops et al., 2006). When UF hollow fibers are incorporated, the RO cleaning frequency will be greatly reduced. According to Knops et al. (2006), “pilot tests have shown that with UF [hollow fibers] as pretreatment RO cleaning frequency can be virtually eliminated.” Because of the reduced RO fouling and reduced cleaning with harsh chemicals, cleaning frequency can be reduced and the RO membrane lifetime will be increased (Knops et al., 2006). In an environment such as Afghanistan where fouling would be much greater than a conventional plant, the cleaning frequency might be increased; however, the addition of the UF hollow fibers pretreatment would still reduce RO cleaning by 50% and RO replacement by 15-30% (Knops et al., 2006). Figure 4-2 illustrates a notional difference in the RO membrane replacement frequency with and without UF hollow fiber pretreatment. The first curve represents the natural decay of the RO elements. At the six month mark (which is usually the point in time when operations are turned over to a new Marine unit), the RO elements have degraded to 30% serviceability without UF hollow fiber pretreatment. At this point, excessive fouling and RO membrane wear and tear begins to occur more rapidly. With the UF hollow fiber pretreatment, the 30% serviceability degradation point does not occur until approximately month eight; thereby, slowing the natural decay, reducing wear and tear, and ultimately extending the life of the RO elements. In this notional comparison, UF hollow fiber pretreatment would result in saving in RO membrane replacement and provide more continuous operation.

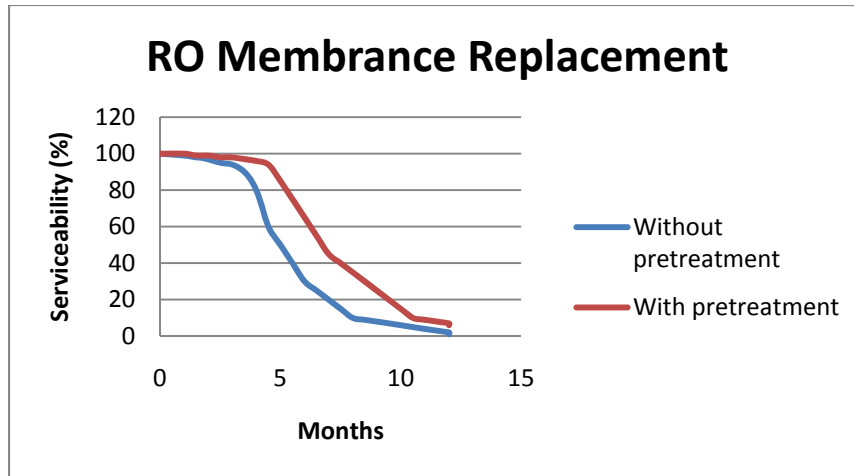

Figure 4-2 RO Membrane Replacement Frequency

4.4.1.3. Other Fixed and Variable Costs

Using Knops et al. (2006) TCO model, ROWPU with conventional pretreatment fixed costs of approximately 27%. “The fixed costs are a function of the online time: the shorter the online time the higher the fixed costs will be” (Knops et al., 2006). By incorporating UF hollow fibers pretreatment, the site preparation time required for protecting the source water from chemical disinfectants and the chemical coagulation time required by conventional pretreatment would be shorter allowing longer water producing time. Although the savings in fixed costs are important, the security benefits associated with reducing the time required to secure a water source site are even more important. Because of the decreased RO cleaning frequency, the RO system will operate more hours per day, and if the RO cleaning duration is decreased, the net increase of the RO output would be approximately 2% (Knops et al., 2006).

ROWPU with conventional pretreatment has variable costs of TCO of approximately 50% (Knops et al., 2006). According to Knops et al. (2006), “it can be argued that variable costs will be reduced when conventional pretreatment is replaced with UF hollow fiber membrane technology; less RO fouling will lead to lower RO operating pressures” (Knops et al., 2006). The Knops et al. (2006) comparison did not take into account the variable costs saving because of the difficulties associated with quantifying these costs; therefore, in this discussion, the variable costs of the overall TCO of UF hollow fiber pretreatment as compared to conventional pretreatment will remain at approximately 50%.

4.4.1.4. Total Cost of Ownership

With the incorporation of UF hollow fibers pretreatment based on extrapolated data from a large-scale desalination plant, the cost of ownership would be reduced by 3% (Knops et al., 2006). The additional replacement cost of UF hollow fiber membranes at the end of their life cycle is offset by the cost savings from the reduced use of chemical coagulants. The main cost savings in the system are achieved by a decrease in RO cleaning and replacement frequency, less use of chemicals, and longer operation time. Figure 4-3 and 4-4 illustrates the TCO saving of using UF hollow fibers as compared to conventional pretreatment.

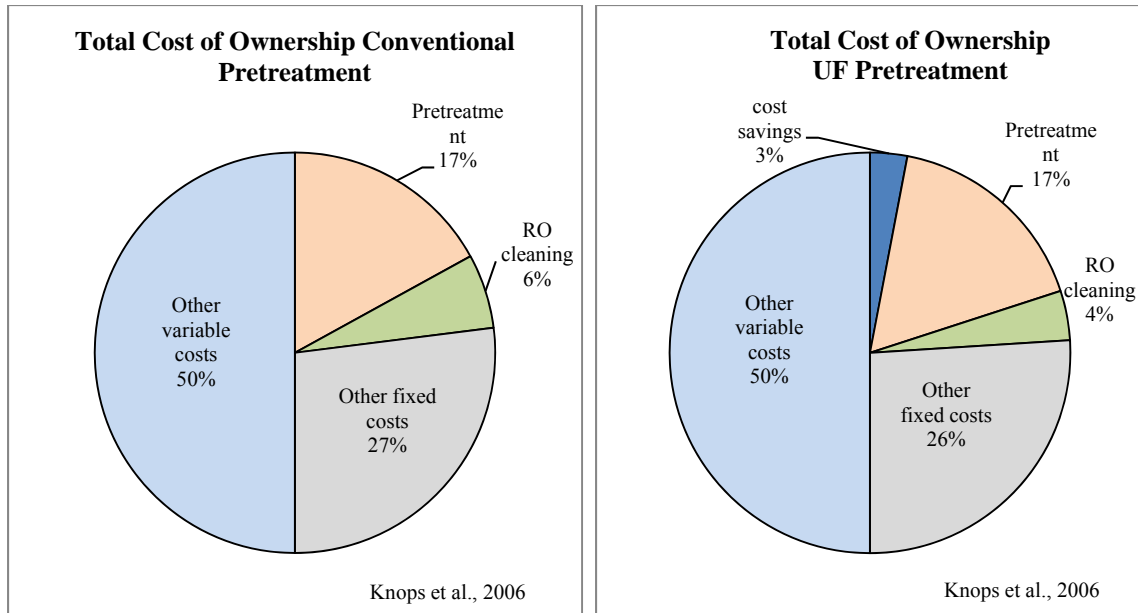

Figure 4-3 TCO Conventional Pretreatment **Figure 4-4 TCO UF Hollow Fiber Pretreatment**

4.4.2. Post Treatment Reconsideration

The results of the Tabular Method for the two post treatment alternatives are displayed in Table 3-11. For the post treatment alternatives, the perception of each advantage was also clear and accurate. All advantages of both alternatives in all factors were weighted on the same scale of importance. The purpose and circumstances of the decision and the needs and preferences of the expert panel affected by the decision had a significant influence in the alternative selection process. Because the cost of the post treatment alternatives were not equal, a cost comparison was necessary. The advantages presented in Table 3-11 obviously favored EDI over UV radiation. Table 3-12 displayed the money decision-making method of the CBA. As this table is reconsidered, the \$500 could not buy enough importance points to give the UV radiation an advantage over EDI as a post treatment.

Combined with RO pre-treatment, EDI removes more than 99.9% of ions from the water (Lenntech, 2010). EDI has low energy, operating, and maintenance costs. The few automatic valves and simple control systems make EDI ideal for the basic Marine water specialist to operate. EDI's small footprint makes it well-suited for use in Afghanistan. EDI produces a constant flow of high quality water with nearly complete removal of dissolved inorganics and microorganisms, making it compatible for use with the water storage tanks and the Tactical Water Distribution System (TWDS) that are used by the USMC.

5.0. Conclusions and Recommendations

5.1. Summary

This study examined four alternative treatment technologies (UF, NF, EDI, UV) and three decision analysis methodologies (VFT, AHP, CBA) in order to select a viable alternatives for potential application to provide drinking water to USMC troops deployed in the Afghanistan AO. Using four of the five phase of the Choosing By Advantages (CBA) decision-making model (Tabular Method for Choosing from Two Options in particular), this thesis showed that for the purpose of providing drinking water to Marines, and in consideration of expert panel's 'must' and 'want' criteria, total level of importance, and cost comparison, a treatment train (UF, RO, EDI) would be the best alternative. The addition of the pretreatment and post treatment technologies would extend the life and reduce the replacement frequency of the RO membrane; reduce operation and maintenance costs; and eliminate the need for chlorine disinfection during the USMC water purification process.

5.2. Conclusions

5.2.1. Research Questions

Three investigative questions formed the basis of this research effort. Listed below is each question with its respective answer.

1. What are the attributes of drinking water treatment technologies that may be employed to support troops in the Afghanistan AO?

Tables 3-2 and 3-3 display the attributes of drinking water treatment technologies that may be employed to support troops in the Afghanistan AO:

Table 3-2 Pretreatment Attribute and Criteria

Attribute: Physical Backwash Criteria: Having the ability to perform physical backwash is better
Attribute: Chemical Cleanings Criteria: The more chemical cleaning options the better
Attribute: Operating Pressures Criteria: Lower pressure range is more desirable
Attribute: Membrane Life Criteria: Less variation in membrane life increases predictability
Attribute: Pre-filter Requirements Criteria: The ability to remove a smaller size particle will extend the life of the filter
Attribute: Operating mode Criteria: More operating modes support more raw water sources
Attribute: Valves Criteria: The less complex the valves promotes simplicity in operation
Attribute: Control Criteria: The less complex the controls promotes simplicity in operation
Attribute: Break Tank Criteria: No break tank will reduce time and footprint
Attribute: Availability of Membrane Replacement Criteria: More available options for purchasing replacement filters can save money and time
Power Consumption Criteria: Lower energy consumption reduces cost

Table 3-3 Post Treatment Attribute and Criteria

Post treatment Attributes
Attribute: Bacteria removal Criteria: The more efficient the better
Attribute: Inorganics removal Criteria: The more efficient the better
Attribute: Organics removal Criteria: The more efficient the better
Attribute: Lamp/ Membrane Life Criteria: Longer life provide is more desirable
Power Consumption Criteria: Lower energy consumption reduces cost

2. What criteria should be used to evaluate the technologies?

The expert panel’s ‘must’ and ‘want’ criteria, equipment specifications, and limitations created by the environment in Afghanistan should be used to evaluate the technologies. As discussed, the ‘must’ criteria included adequate quality of water that meets drinking water standards; the basic Marine students licensing and competent qualified examiner; associated equipment providing flexible and responsive water support; and capable of

purifying fresh, brackish, and salt water at a rate of 3,000 gallons per hour for 20 continuous hours a day.

The ‘want’ criteria included that site preparation time and overall footprint was not to increase the security risk to implement; licensing via on-the-job training; low operating pressure and low energy consumption; longer membrane life and lower membrane replacement cost than the RO elements of the ROWPU; and no increase in chemicals needed for disinfection or storage.

3. What technology is the best available (based on using the CBA decision analysis method to evaluate the technologies against the criteria)?

Based on the CBA decision analysis, a treatment train is the best alternative with ultrafiltration hollow fiber configuration as the best available pretreatment, an extended membrane life and low membrane replacement RO technology, and electrodeionization as the best chlorine-free disinfectant as the best available post treatment.

5.2.2. Recommendations for Future Study

There are several areas of potential research that could be explored in order to test the results of the selected alternative technologies and to further validate the efficacy of using the CBA as a decision analysis tool. With the final phase of the CBA process being Phase V: The Implementation Phase, this research concluded that a treatment train (UF, RO, EDI) is the best alternative for providing drinking water to USMC troops in Afghanistan. A potential future study could be to actually perform an experimental pilot study to examine the effectiveness of employing this treatment train while subjected to the conditions presented by the terrain, weather, and constituents found in the raw water sources in Afghanistan.

Another recommendation involves efforts to improve the effectiveness of the CBA model developed in this research. Although the CBA method was learned by the expert panel, and they participated correctly in the entire process, the method is not fully accepted by USMC personnel. The majority of the expert panel did not and could not unlearn the current planning and decision analysis method that is used by the USMC. If the CBA method is practiced and implemented for simple USMC decision-making and eventually incorporated into more complex decisions, the CBA method could very well be the future of USMC decision-making.

Finally, a more detailed cost analysis would be appropriate for future research. This research evaluated alternative technologies, but it did not explore in detail how the implementation of these technologies would reduce the costs associated with the current reliance on bottled water.

Bibliography

- Alghamdi, Abdullah S. "Evaluating Defense Architecture Frameworks for C4I System Using Analytic Hierarchy Process," *Journal of Computer Science*, 5: 1078-1084 (2009)
- APEC. "Water Education." Excerpts from unpublished article. n. pag. <http://www.freedrinkingwater.com/water-education/quality-water-filtration-method.htm>. 15 January 2010.
- Bowen, Jennifer A. "U.S. mission in Afghanistan depends on supply chain," *McClatchy*, 4 November 2009
<http://www.mcclatchydc.com/2009/11/04/78367/us-mission-in-afghanistan-depends.html>.
- Cole-Palmer Technical Library. "A Search for Potable Water in War-Torn Afghanistan." 2009.
<http://www.coleparmer.com/techinfo/techinfo.asp?htmlfile=water-afghanistan.htm&ID=964>.
- Christ-wasser. "RO, EDI and optional UF stages guarantees high water purity," *Filtration & Separation*, 40: 16 (December 2003).
- Crown Solutions Incorporated. "Filtration UF, MF, NF." Excerpts from unpublished article. Vandalia OH, August 2003.
- Department of Defense. *Overseas Environmental Baseline Guidance Document*. DoD Instruction 4715.05-G. Washington: GPO, 1 May 2007.
- Department of the Army, Deputy Chief of Staff Army G-1, "Preventive medicine Health briefing-Afghanistan." Pre-deployment Assessment Brief. 2006.
www.armyg1.army.mil.
- Department of the Army. *Sanitary Control and Surveillance of Field Water Supplies*. TB MED 577. Washington: HQ USA, 15 December 2005.
- Department of the Navy. *Manual of Naval Preventive Medicine*. NAVMED P-5010-5. Washington: GPO, 2008.
- DOW Water & Process Solutions*. Product Form No. 795-00006-0608XBBI. USA: The Dow Chemical Company, June 2008.

- Duke, James S. *Decision Analysis Using Value-Focused Thinking to Select Renewable Energy Sources*. MS thesis, AFIT/GEM/ENV/04M-09. School of Engineering and Management, Air Force Institute of Technology (AU), Wright-Patterson AFB OH, March 2004.
- Encyclopedia Britannica, Inc., Hindu Kush Map, 2009.
- Excel Water Technologies Incorporated. Ultraviolet Disinfection. Excerpts from unpublished article. n. pag.
http://www.excelwater.com/eng/b2c/water_tech_3.php. 23 January 2010.
- Forman, Ernest H. and Saul I. Gass. "The Analytic Hierarchy Process- An Exposition," *Operations Research*, 49: 469-496 (Summer 2001).
- Gellasch, Christopher A. "Hydrogeologic Studies In Afghanistan In Support of Military Operations and Local Population," *2009 Portland GSA Annual Meeting, 18 October 2009-21 October 2009*. Paper no. 227-15. Oregon: Geological Society of America, 2009.
- Greenlee, Lauren F., Desmond F. Lawler, Benny D. Freeman, Benoit Marrot, and Philippe Moulin. "Reverse osmosis desalination: Water sources, technology, and today's challenges," *Water Research*, 43: 2317-2348 (March 2009).
- Hajeesh, M, and A. Al-Othman. "Application of the analytical hierarchy process in the selection of desalination plants," *Desalination*, 174: 97-108 (Winter 2005).
- Halpern, Dawn F., John McArdle, and Benjamin Antrim. "UF pretreatment for SWRO: pilot studies," *Desalination* 182: 323-332 (February 2005).
- Harisha, R.S, K.M. Hosamani, R.S. Keri, S.K. Nataraj, and T.M. Aminabhavi. "Arsenic removal from drinking water using thin film composite nanofiltration membrane," *Desalination*, 252: 75-80 (November 2009).
- Hughes, Brian S. *Evaluating Alternatives for Drinking Water at Deployed Locations*. MS thesis, AFIT/GEM/ENV/06M-03. School of Engineering and Management, Air Force Institute of Technology (AU), Wright-Patterson AFB OH, March 2006.
- Institute For the Study of War. "Helmand Province, Afghanistan," 9 October 2009
<http://www.understandingwar.org/map/helmand-province-afghanistan>.
- Keeney, Ralph L. *Value-focused Thinking: A Path to Creative Decision-making*. Massachusetts: Harvard University Press, 1992.

- Keeter, Robert R. *Applying Value-Focused Thinking to Effects Based Operations*. Technical Report DSE-BCR-0520. United States Military Academy West Point NY: Operations Research Center of Excellence, September 2005 (ADA438165).
- Knops, Frans, Stephan van Hoof, Harry Futselaar, and Lute Broens. "Economic evaluation of a new ultrafiltration membrane for pretreatment of seawater reverse osmosis," *Desalination*, 203: 300-306 (April 2007).
- Koch Membrane System Incorporated*. Flat Sheet Product Feasibility Testing. Wilmington: Koch Chemical Technology Group, LLC Company, no date [2010].
- Learning Space. "Potable water treatment." Excerpts from unpublished article. n. pag. <http://openlearn.open.ac.uk/mod/resource/view.php?id=185902>. 22 January 2010.
- Leinberger, Jackie. "Disinfection of Drinking water With Ultraviolet Light." Excerpts from unpublished article. n. pag. Trojan Technologies Incorporated. no date [2009].
- Lenntech Water Treatment Solutions*. Electrodeionization. The Netherlands: Lenntech Water treatment & purification Holding B.V. no date [2010] <http://www.lenntech.com/library/edi/edi.htm>.
- Li, Yu-Ling and Kuo-Lun Tung. "The Effect of Curvature of A Spacer-filled Channel on Fluid Flow in Spiral-wound Membrane Modules," *Journal of Membrane Science*, 319: 286-297 (April 2008).
- Manz, David H. "New Horizons for Slow Sand Filtration," *Proceedings of the Eleventh Canadian National Conference and Second Policy Forum on Drinking Water and the Biennial Conference of the Federal Provincial Territorial Committee on Drinking Water, Promoting Public Health Through Safe Drinking Water*. 682-692. Calgary, Alberta: 2004.
- Mourato, D. "Microfiltration and Nanofiltration," Excerpts from unpublished article. n. pag. ZENON Environmental Inc, Burlington, Ontario Canada. 25 January 2010.
- Mukherjee, Amitava, Mrinal Kumar Sengupta, M. Amir Hossain, Sad Ahamed, Bhaskar Das, Bishwajit Nayak, Dilip Lodh, Mohammad Mahmudur Rahman, and Dipankar Chakraborti. "Arsenic Contamination in Groundwater: A Global Perspective with Emphasis on the Asian Scenario," *J Health Popul Nutr*, 24:142-163 (June 2006).

- Nguyen, Hung V., Boris Lostuvali, and Iris D. Tommelein. "Decision Analysis Using Virtual First-run study Of A Viscous Damping Wall System," *Proceedings for the 17th Annual Conference of the International Group for Lean Construction*. 371-382. Taiwan: 2009.
- Orecki, A., M. Tomaszewska, K. Karakulski, and A.W. Morawski. "Surface Water Treatment By The Nanofiltration Method," *Desalination*. 162: 45-50 (Winter 2004).
- Parnell, Gregory S. "Chapter 19: Value-focused Thinking," United States Military Academy at West Point and Innovative Decisions Incorporated. 2003.
- Parrish, Kristen D. *Applying A Set-based Design Approach To Reinforcing Steel Design*. PhD dissertation. University of California, Berkeley, Berkeley CA, 2009.
- Pate, Andrew H. *Determining PACFAF Transportation Alternatives To The General Vehicle*. MS thesis, AFIT/GLM/ENS/05-20. School of Engineering and Management, Air Force Institute of Technology (AU), Wright-Patterson AFB OH, March 2005.
- Pike, John. "Reverse Osmosis Water Purification Unit (ROWPU)," GlobalSecurity.org. 23 December 2009.
<http://www.globalsecurity.org/military/systems/ground/rowpu.htm>.
- Porter, Timothy W. *Valued-Focused thinking In The Presence of Weight Ambiguity: A Solution Technique Using Monte Carlo*. MS thesis, AFIT/GOR/ENS/04-15. School of Engineering and Management, Air Force Institute of Technology (AU), Wright-Patterson AFB OH, June 2004.
- Pruitt, Kristopher A. *Modeling Homeland Security Valued Focused Thinking Approach*. MS thesis, AFIT/GOR/ENS/03-19. School of Engineering and Management, Air Force Institute of Technology (AU), Wright-Patterson AFB OH, March 2003.
- Scott, Richard B. "Opium Poppy Cultivation Central Helmand, Afghanistan: A Case Study in Bad Program Management," *The Society for Applied Anthropology 67th Annual Meeting*. 30 March 2007.
- Shoviak, Mark J. *Decision Analysis Methodology to Evaluate Integrated Solid Waste Management Alternatives for A Remote Alaskan Air Station*. MS thesis, AFIT/GEE/ENV/01M-20. School of Systems and Engineering Management, Air Force Institute of Technology (AU), Wright-Patterson AFB OH, March 2001.
- Suhr, Jim. *Choosing By Advantage: Making Choices Correctly*. Utah: Decision Innovations, 2008.

- Thal, Alfred. Class handout, EMGT 550, Engineering Economic Decision Analysis. School of Systems and Engineering Management, Air Force Institute of Technology, Wright-Patterson AFB OH, December 2009.
- Triangular Wave Technologies. "FAQs about Ultraviolet Water Disinfection." Excerpts from unpublished article. n. pag.
[http://www.triangularwave.com/f3.htm#What are the Advantages of UV Disinfection?](http://www.triangularwave.com/f3.htm#What%20are%20the%20Advantages%20of%20UV%20Disinfection?)
- United States Army Center for Health Promotion and Preventive Medicine (USACHPPM). *Bacteriological Surveillance Of Drinking Water*. TG 224. Maryland: GPO, 1996.
- United States Army Center for Health Promotion and Preventive Medicine (USACHPPM). *Chemical Exposure Guidelines for Deployed Military Personnel*. TG 230. Maryland: GPO, 2004.
- United States Army Center for Health Promotion and Preventive Medicine (USACHPPM). *Executive Summary Water Quality Information Paper NO. 31-034 Use of Bottled Water For Deployment Support*. MCHB-TS-EWS. Maryland: GPO, 2003.
- United States Environmental Protection Agency (USEPA). "Drinking Water Contaminants." 5 January 2009
<http://www.epa.gov/safewater/contaminants/index.html>.
- United States Environmental Protection Agency (USEPA). "Summary Report: Control and Treatment Technology for the Metal Finishing Industry Ion Exchange" USEPA 625/-81-007. Cincinnati OH: Industrial Environmental Research Laboratory, June 1981.
- United States Geological Survey (USGS). *Water-Resources Assessment, Monitoring, And Capacity Building in Afghanistan*. International Water Resource Branch. 2005.
- United States Marine Corps¹. Student Outline, U-22A04, Planning For Environmental Protection. Utilities Instruction Company, Marine Corps Engineer School, Camp Lejeune NC, October 2008.
- United States Marine Corps². Student Outline, U-05D02, Water Sources. Utilities Instruction Company, Marine Corps Engineer School, Camp Lejeune NC, November 2008.

- United States Marine Corps³. Student Outline, U-10B06, Planning Water Storage and Distribution. Utilities Instruction Company, Marine Corps Engineer School, Camp Lejeune NC, October 2008.
- United States Marine Corps. Student Outline, U-10E01, Operate Water Purification System (3000 LMT) Utilities Instruction Company, Marine Corps Engineer School, Camp Lejeune NC, February 2009.
- United States Marine Corps. *Operation and Maintenance Instructions for the Water Purification System Model 3000LMT*. TM 09777A-14/1. Washington: HQ USMC, 31 March 1999.
- United States Marine Corps. *Operator's Manual: Water Purification Unit, Reverse Osmosis, 600 GPH Trailer Mounted Flatbed Cargo, 5 ton 4 Wheel Tandem POWPU Model 600-1 and 600 GPH Sid Mounted ROWPU Model 600-3*. TM 08580A-10/1. Washington: HQ USMC, 5 March 1991.
- Vaidya, Omkarprasad S. and Sushil Kumar. "Analytic hierarchy process: An overview of applications," *European Journal of Operational Research*, 169: 1-29 (July 2004).
- Wagenet, Linda, Susan Darling, and Ann Lemley. Water Treatment Notes, "Fact sheet 10: Ultraviolet Radiation for Disinfecting household Drinking Water," Cornell Cooperative Extension, College of Human Ecology, Cornell University, NY August 2004.
- Yoshida, Takahiko, Hiroshi Yamauchi, and Gui Fan Sun. "Chronic health effects in people exposed to arsenic via the drinking water: dose-response relationships in review," *Toxicology and Applied Pharmacology*, 198: 243-252 (March 2004).

REPORT DOCUMENTATION PAGE			Form Approved OMB No. 074-0188	
<p>The public reporting burden for this collection of information is estimated to average 1 hour per response, including the time for reviewing instructions, searching existing data sources, gathering and maintaining the data needed, and completing and reviewing the collection of information. Send comments regarding this burden estimate or any other aspect of the collection of information, including suggestions for reducing this burden to Department of Defense, Washington Headquarters Services, Directorate for Information Operations and Reports (0704-0188), 1215 Jefferson Davis Highway, Suite 1204, Arlington, VA 22202-4302. Respondents should be aware that notwithstanding any other provision of law, no person shall be subject to a penalty for failing to comply with a collection of information if it does not display a currently valid OMB control number.</p> <p>PLEASE DO NOT RETURN YOUR FORM TO THE ABOVE ADDRESS.</p>				
1. REPORT DATE (DD-MM-YYYY) 26-03-2010		2. REPORT TYPE Master's Thesis		3. DATES COVERED (From – To) Mar 2009-Mar 2010
4. TITLE AND SUBTITLE Evaluation of Alternative Technologies to Supply Drinking Water to Marines in Forward Deployed Locations			5a. CONTRACT NUMBER	
			5b. GRANT NUMBER	
			5c. PROGRAM ELEMENT NUMBER	
6. AUTHOR(S) George, Derek R, Captain, USMC			5d. PROJECT NUMBER	
			5e. TASK NUMBER	
			5f. WORK UNIT NUMBER	
7. PERFORMING ORGANIZATION NAMES(S) AND ADDRESS(S) Air Force Institute of Technology Graduate School of Engineering and Management (AFIT/EN) 2950 Hobson Way WPAFB OH 45433-7765			8. PERFORMING ORGANIZATION REPORT NUMBER AFIT/GES/ENV/10-M02	
9. SPONSORING/MONITORING AGENCY NAME(S) AND ADDRESS(ES) Marine Corps Engineer School, Utilities Instruction Company Marine Corps Training Command Attn: Dave O'Brian, Major USMC PSC BOX 20069 Camp Lejeune, NC 28542-0069 (910) 440-7073			10. SPONSOR/MONITOR'S ACRONYM(S) MCES/ UIC	
			11. SPONSOR/MONITOR'S REPORT NUMBER(S)	
12. DISTRIBUTION/AVAILABILITY STATEMENT APPROVED FOR PUBLIC RELEASE; DISTRIBUTION UNLIMITED				
13. SUPPLEMENTARY NOTES				
14. ABSTRACT With recent increases, there are approximately 20,000 Marines deployed in the Helmand Province of Afghanistan. The cost of delivering bottled water to the troops is rapidly becoming unsustainable and convoys delivering bottled water are vulnerable to Improvised Explosive Devices (IEDs). Currently, raw water from indigenous sources, which has chemical and microbiological contaminants, is treated with reverse osmosis (RO), but only used for hygiene, with bottled water used for drinking. Due to the economic costs and risks to life of providing bottled water, decision-makers need to evaluate technology alternatives to treat raw water to supply safe drinking water. In this study, an innovative decision analysis tool, Choosing by Advantages (CBA), was used to evaluate and select the best alternative water treatment technology to support Marines in Afghanistan. Using criteria developed by a panel of experts, the CBA method was applied to determine that the best alternative technology is a treatment train: ultrafiltration pretreatment, RO treatment, and electrodeionization post treatment. This treatment train would produce high quality water and lower overall RO energy consumption, operation and maintenance costs, and reduce the replacement frequency of RO membranes.				
15. SUBJECT TERMS Water purification, Filtration technology, Afghanistan water sources, Electrodiionization, Reverse osmosis, Ultrafiltration, Nanofiltration, Choosing by advantages, Decision analysis				
16. SECURITY CLASSIFICATION OF:			17. LIMITATION OF ABSTRACT UU	18. NUMBER OF PAGES 108
a. REPORT U	b. ABSTRACT U	c. THIS PAGE U		
			19b. TELEPHONE NUMBER (Include area code) (937) 255-3636, ext 4638; e-mail: Mark.Goltz@afit.edu	
Standard Form 298 (Rev. 8-98) Prescribed by ANSI Std. Z39-18				
			Form Approved OMB No. 074-0188	