

3-11-2011

# A Systems Architecture and Advanced Sensors Application for Real-time Aircraft Structural Health Monitoring

Hyoungjin Shin

Edward C. Beckett

Follow this and additional works at: <https://scholar.afit.edu/etd>

Part of the [Other Engineering Commons](#)

---

## Recommended Citation

Shin, Hyoungjin and Beckett, Edward C., "A Systems Architecture and Advanced Sensors Application for Real-time Aircraft Structural Health Monitoring" (2011). *Theses and Dissertations*. 1302.  
<https://scholar.afit.edu/etd/1302>

This Thesis is brought to you for free and open access by the Student Graduate Works at AFIT Scholar. It has been accepted for inclusion in Theses and Dissertations by an authorized administrator of AFIT Scholar. For more information, please contact [richard.mansfield@afit.edu](mailto:richard.mansfield@afit.edu).



**A SYSTEMS ARCHITECTURE AND ADVANCED SENSORS APPLICATION  
FOR REAL-TIME AIRCRAFT STRUCTURAL HEALTH MONITORING**

THESIS

Hyoungjin Shin,

Major, R.O.KAF

Edward C. Beckett

Captain, USAF

AFIT/GSE/ENV/11-M04

**DEPARTMENT OF THE AIR FORCE**

**AIR UNIVERSITY**

**AIR FORCE INSTITUTE OF TECHNOLOGY**

**Wright-Patterson Air Force Base, Ohio**

APPROVED FOR PUBLIC RELEASE; DISTRIBUTION UNLIMITED

The views expressed in this thesis are those of the author and do not reflect the official policy or position of the United States Air Force, Department of Defense, or the United States Government.

This material is declared a work of the United States Government and is not subject to copyright protection in the United States.

AFIT/GSE/ENV/11-M04

A SYSTEMS ARCHITECTURE AND ADVANCED SENSORS APPLICATION FOR  
REAL-TIME AIRCRAFT STRUCTURAL HEALTH MONITORING

THESIS

Presented to the Faculty

Department of Systems and Engineering Management

Graduate School of Engineering and Management

Air Force Institute of Technology

Air University

Air Education and Training Command

In Partial Fulfillment of the Requirements for the

Degrees of Master of Science in Research and Development Management and Systems  
Engineering

Hyungjin Shin, Major, R.O.KAF

Edward Beckett, B.S.M.E.

Capt, USAF

March 2011

APPROVED FOR PUBLIC RELEASE; DISTRIBUTION UNLIMITED

AFIT/GSE/ENV/11-M04

A SYSTEMS ARCHITECTURE AND ADVANCED SENSORS APPLICATION FOR  
REAL-TIME AIRCRAFT STRUCTURAL HEALTH MONITORING

Hyungjin Shin, Major, R.O.KAF

Edward Beckett, Capt, USAF

Approved:

\_\_\_\_\_  
Dr. Som Soni (Chairman)      \_\_\_\_\_  
Date

\_\_\_\_\_  
Dr. David Jacques (Member)      \_\_\_\_\_  
Date

\_\_\_\_\_  
Dr. Joseph Carl (Member)      \_\_\_\_\_  
Date

\_\_\_\_\_  
Dr. Shankar Mall (Member)      \_\_\_\_\_  
Date

\_\_\_\_\_  
Dr. James Blackshire (Member)      \_\_\_\_\_  
Date

## Abstract

Aircraft are being pushed beyond their original service life, increasing the potential for structural failures. A catastrophic in flight failure of an F-15 bulkhead and severe cracking in the C-130 Wing rainbow fitting are two recent examples that have caused major problems for the Air Force. Previous Aircraft Structural Health Monitoring Systems research primarily explored using a system during the ground maintenance phase. This research will explore a Real-Time Aircraft Structural Health Monitoring System (RTASHMS) that includes a ground phase as well as an in-flight phase. The RTASHMS will continuously analyze structural hot spots, detect critical structural damage or cracks and will alert pilots and maintainers of potential trouble before a catastrophic structural failure. Current sensor technology has limited the construction and use of a reliable aircraft structural health monitoring system. This research will compare the capabilities of current sensor technology with the capabilities of a new cutting edge sensor. The new sensor shows promise in advancing a reliable RTASHMS from theory to reality. This technology was validated in Aluminum Dog Bone specimens and Composite Lap Joint with nano-adhesives.

## **Acknowledgements**

We would like to express sincere appreciation to our faculty advisor, Dr. Som Soni for his guidance and steadfast support throughout the course of this thesis effort. We would like to thank Dr. James Blackshire for all of his brilliant advice, keen insight and great help with sensor testing and data collection and analysis without which this thesis would not be possible. We would like to thank Dr. Shankar Mall for providing expert guidance and materials for testing. We would like to thank Dr. Carl for his Systems Engineering Architecture advice and guidance. We would like to thank the NDI and Failure Analysis Teams at AFRL/RXSA for all of their assistance with imaging and analysis throughout the course of our research. We would also like to thank our academic advisor, Dr. Jacques, for his support during master degree coursework. In addition, we would like to thank Mrs. Annette Robb, director of IMSO in AFIT, for sacrifices supporting international officers. We would like to thank the USAF and AFIT. We would like to thank our families for the encouragement and support throughout this process.

Hyounjin Shin and Edward Beckett

## Table of Contents

	Page
Abstract .....	iv
Acknowledgements .....	v
Table of Contents .....	vi
List of Figures .....	x
List of Tables .....	xiii
List of Abbreviations .....	xiv
I. Introduction .....	1
<i>1.1 Motivation</i> .....	1
<i>1.1.1 The Aging Fleet</i> .....	1
<i>1.1.2 Recent Structural Problems</i> .....	4
<i>1.1.3 Composites in Aircraft Structures</i> .....	7
<i>1.2 Research Proposal</i> .....	7
<i>1.3 Research Focus</i> .....	9
II. Background .....	12
<i>2.1 DoD Architecture Framework</i> .....	12
<i>2.1.1 Previous Systems Engineering and Structural Health Monitoring Research</i> ...	12
<i>2.1.2 The 6-step Architecture process</i> .....	14
<i>2.1.3 Architecture Viewpoints and DoDAF-described Models</i> .....	16
<i>2.2 Sensor technology and basic wave theory</i> .....	17
<i>2.2.1 PZT Sensors and Lamb waves</i> .....	17



	Page
2.2.2 IDT Sensors and Rayleigh waves .....	22
2.2.3 Pitch Catch and Pulse Echo Damage Detection Methods .....	26
2.2.4 Previous Research on Sensor Technology .....	26
III. System Architecture.....	31
3.1 System Architecture Proposal.....	31
3.1.1 Research Goals.....	31
3.1.2. Systems Requirements .....	33
3.1.3 Critical Questions.....	34
3.1.4 Scope .....	34
3.1.5 Purpose and Perspective .....	35
3.1.6 Assumptions.....	36
3.1.7 Findings.....	37
3.2 OV-1 (CONOPS /Operational-Views-1).....	39
3.3 Use Case Diagram.....	43
3.4 OV-5 (Operational Activity Diagram).....	44
3.4.1 Node Tree Diagram.....	44
3.4.2 External System Diagram (A-1 Page).....	46
3.4.3 Context Diagram (A-0 Page) .....	46
3.4.4 Implement Real Time ASHMS (A0 Page).....	47
3.4.5 Predict Structural Damage or Crack Occurrence & Part Replacement (A1 Page) .....	49
3.4.6 Monitor Aircraft Structural Condition (A2 Page).....	50
3.4.7 Assess Aircraft Structural Condition & Mission Environment (A3 Page).....	50
3.4.8 Decide & Take Appropriate Action (A4 Page).....	51
3.5 OV-2 (Operational Node Connectivity Diagram).....	52
3.6 OV-4 (Organization Chart Diagram) .....	53

	Page
3.7 SV-4 Node Tree (Functional Decomposition Diagram) .....	54
3.7.1 Provide Wave Generating Power .....	55
3.7.2 Detect Aircraft Structural Damage or Crack .....	56
3.7.3 Show Aircraft Structural Condition on Cockpit Instrument .....	56
3.7.4 Distribute Aircraft Structural Condition and Information .....	57
3.8 SV-4 IDEF0 Version (Systems Functionality Description) .....	58
3.8.1 Provide Aircraft Wave Generating Power (A1) .....	59
3.8.2 Detect Aircraft Structural Damage or Crack (A2) .....	60
3.8.3 Show Aircraft Structural Condition on Cockpit Instrument (A3) .....	61
3.8.4 Distribute Aircraft Structural Condition and Information (A5) .....	62
3.9 SV-1 (System Interface Diagram) .....	63
3.10 SV-5 (System Function to Operational Activity Chart) .....	64
IV. Testing Methodology and Results .....	67
4.1 Aluminum Dog Bone Experiment .....	67
4.1.1 Test Equipment .....	68
4.1.2 Aluminum Dog-Bone Experiment methodology: .....	69
4.1.3 Aluminum Dog Bone Test Results .....	70
4.1.3.1 Signal Collection .....	71
4.1.3.2 Clean versus Cracked PZT and IDT signal comparison .....	80
4.2 Composite Lap Joint Testing .....	90
4.2.1 Composite Lap Joint Test Equipment .....	91
4.2.2 Composite LAP Joint Experiment Methodology: .....	92
4.2.3 .....	93
Composite Lap Joint Test Results .....	93
V. Conclusion .....	104

	Page
<i>5.1 Summary</i> .....	104
<i>5.2 Future Research</i> .....	106
Appendix A. AV-1.....	107
Appendix B. OV-1.....	116
Bibliography.....	122

## List of Figures

	Page
Figure 1 : General Aviation Aircraft Manufactured [1].....	2
Figure 2 : Number of Aircraft versus Age [1] .....	2
Figure 3 : Average Fleet Age [1] .....	3
Figure 4 : IDT Sensor placement on complex aircraft geometry [11].....	5
Figure 5 : Fatigue Crack detected by IDT Sensors [12] .....	6
Figure 6 : Animation of F-15 Structural Failure [7] .....	6
Figure 7: Architecture Development 6-Step Process [6] .....	16
Figure 8: Architecture Viewpoints in DoDAF V2.0 [6].....	17
Figure 9: Top and bottom of PZT discs used in this study. ....	18
Figure 10: Examples of plate particle displacement during Lamb wave modes [3].....	18
Figure 11: Theoretical normalized amplitude of the S0 and A0 Lamb wave modes for excitation frequencies 50 to 500 kHz.[17].....	19
Figure 12: Phase velocity dispersion curves for aluminum [4] .....	21
Figure 13: Dispersion Curve for Aluminum using Disperse .....	21
Figure 14: IDT Sensors [13] .....	23
Figure 15 Propagation of Rayleigh Waves from IDT Sensor showing Directionality [12] .....	24
Figure 16 Actual signals from IDT Test .....	24
Figure 17: Typical IDT Signal Strength In Pitch Catch and Pulse Echo [12] .....	25
Figure 18: Healthy vs. damaged response at 150 kHz excitation [4] .....	27
Figure 19: Bond thesis Healthy and Damaged Plot on same axes [3].....	28
Figure 20: Underwood research TOA predictions [17] .....	29
Figure 21: CONOPS of Real Time ASHMS .....	39
Figure 22: Use Case Diagram .....	43
Figure 23: Node Tree Diagram .....	45
Figure 24: External System Diagram (A-1 Page).....	46
Figure 25: Context Diagram .....	47
Figure 26: Implement Real Time ASHMS (A0 Page).....	48
Figure 27: Predict Structural Damage or Crack Occurrence & Part Replacement.....	49
Figure 28: Monitor Aircraft Structural Condition .....	50
Figure 29: Assess Aircraft Structural Condition & Mission Environment.....	51
Figure 30: Decide & Take Appropriate Action .....	52
Figure 31: OV-2 (Operational Node Connectivity Diagram).....	53
Figure 32: OV-4 (Organization Chart Diagram) .....	54
Figure 33: SV-4 Implement Real Time ASHMS.....	54

	Page
Figure 34: Provide Wave Generating Power .....	55
Figure 35: Detect Aircraft Structural Damage or Crack .....	56
Figure 36: Show Aircraft Structural Condition on Cockpit Instrument .....	57
Figure 37: Distribute Aircraft Structural Condition and Information.....	58
Figure 38: SvcV-4 Implement Real Time ASHMS (A0) .....	59
Figure 39: Provide Aircraft Wave Generating Power (A1) .....	60
Figure 40: Detect Aircraft Structural Damage or Crack (A2) .....	61
Figure 41: Show Aircraft Structural Condition on Cockpit Instrument (A3).....	62
Figure 42: Distribute Aircraft Structural Condition and Information (A5) .....	63
Figure 43: SV-1 (System Interface Diagram).....	64
Figure 44: SV-5 (System Function to Operational Activity Chart).....	65
Figure 45 SV-4.....	66
Figure 46: PZT and IDT Test Equipment .....	68
Figure 47: Laser Vibrometry Equipment.....	69
Figure 48: Aluminum Dog Bone Test Article .....	70
Figure 49: PZT Test Setup of Clean Dog Bone.....	71
Figure 50: PZT Pitch Catch Readings of Clean Dog Bone .....	72
Figure 51: PZT Pitch Catch Readings of Clean Dog Bone .....	72
Figure 52: Pulse Echo Signals from Sensor 1 on Dog Bone .....	73
Figure 53: PZT Pulse Echo Signals from Sensor 2 on Dog Bone .....	74
Figure 54 : IDT Readings of Clean Dog Bone .....	75
Figure 55 : IDT Test Setup of Cracked Dog Bone .....	76
Figure 56: PZT Pitch Catch Readings of Cracked Dog Bone .....	76
Figure 57: PZT Pitch Catch Readings of Cracked Dog Bone .....	77
Figure 58: PZT Pulse Echo Readings of Cracked Dog Bone .....	77
Figure 59 : PZT Pulse Echo Readings of Cracked Dog Bone .....	78
Figure 60: IDT Readings of Cracked Dog Bone .....	79
Figure 61 : PZT versus IDT Comparison in Pitch Catch 1 to 2.....	81
Figure 62 : PZT versus IDT Comparison in Pitch Catch 2 to 1.....	82
Figure 63 : PZT versus IDT Comparison of Pulse Echo Signal from Sensor 1 .....	83
Figure 64 : PZT versus IDT Comparison of Pulse Echo Signals from Sensor 2.....	84
Figure 65 : PZT Vibrometry Images in Cracked and Uncracked Specimens.....	85
Figure 66 : Color Vibrometry Images of PZT wave propagation.....	86
Figure 67 : PZT signal comparison.....	87
Figure 68 : IDT versus PZT energy over test area.....	88
Figure 69 : IDT versus PZT over crack .....	89
Figure 70 : Pull Test Machine.....	91
Figure 71 : Stress Strain Plotter .....	91
Figure 72 : Composite Lap Joint Specimens .....	92

	Page
Figure 73 : Laser Vibrometry of Control 1 .....	96
Figure 74 : Laser Vibrometry results on Control 1 Lap joint Sample .....	96
Figure 75 : Composite Lap Joint 400 lb Pull Test Stress Strain Plots .....	97
Figure 76 : Stress Strain Plot of 800lb Test of Composite Lap Joints.....	97
Figure 77 : Stress Strain Plot at 1200lb Pull Test on Composite Lap Joints .....	98
Figure 78 : Ultrasound on Control samples 1 and 2 .....	99
Figure 79 : Ultrasound on XPN1 samples 1 and 2.....	99
Figure 80 : Ultrasound on XPN3 samples 1 and 2.....	100
Figure 81 : Ultrasound on XPC1 Samples 1 and 2 .....	100
Figure 82 : X-Ray comparison of Lap Joints.....	101
Figure 83 : Orientation of Lap Joint Sample for SEM.....	102
Figure 84 : SEM Images of Control Sample 1 Post 1200lb Test.....	102

## List of Tables

	Page
Table 1 : Goals of the RTASHMS .....	32
Table 2 : Real Time ASHMS [1] .....	35
Table 3 : Dog Bone Test Matrix .....	67
Table 4 : Composite Lap Joint Test Matrix .....	90
Table 5 : Lap Joint Name and Epoxy Material Additives .....	92

## **List of Abbreviations**

ISHMS	Integrated Structural Health Monitoring System
ASHMS	Aircraft Structural Health Monitoring System
RTASHMS	Real Time Aircraft Structural Health Monitoring System
PZT	Piezoelectric Transducer
IDT	Interdigital Transducer
KHz	Kilohertz
MHz	Megahertz
DoD	Department of Defense
CBO	Congressional Budget Office
JCAA	Joint Council on Aging Aircraft
O&M	Operations and Maintenance
METIS	Monitoring and Evaluation Technology integration System
CONOPS	Concept of Operations
USAF	United States Air Force
AOR	Area of Responsibility
GPS	Global Positioning System
OODA	Observe, Orient, Decide and Act
DoDAF	Department of Defense Architecture Framework



# A SYSTEMS ARCHITECTURE AND NEW TECHNOLOGY APPROACH FOR REAL-TIME AIRCRAFT STRUCTURAL HEALTH MONITORING SYSTEM

## ***I. Introduction***

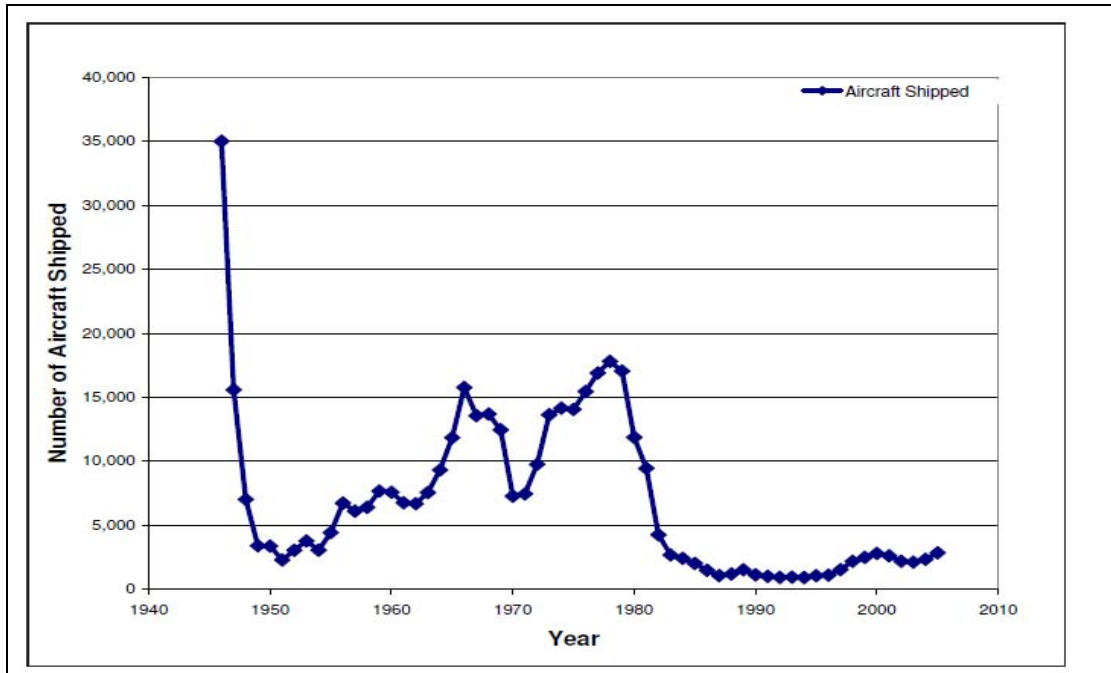
Aircraft in the military and civilian communities are aging. Due in part to cost constraints, companies and the military are pushing aircraft service beyond their initial predicted service life. Recent structural failures have highlighted the need for a Structural Health Monitoring System that can reliably analyze the condition of known structural hot spots in real time. This chapter will discuss the motivation for our work, previous graduate work and describe the proposed approach to developing a Real Time Aircraft Structural Health Monitoring System (RTASHMS).

### ***1.1 Motivation***

#### ***1.1.1 The Aging Fleet***

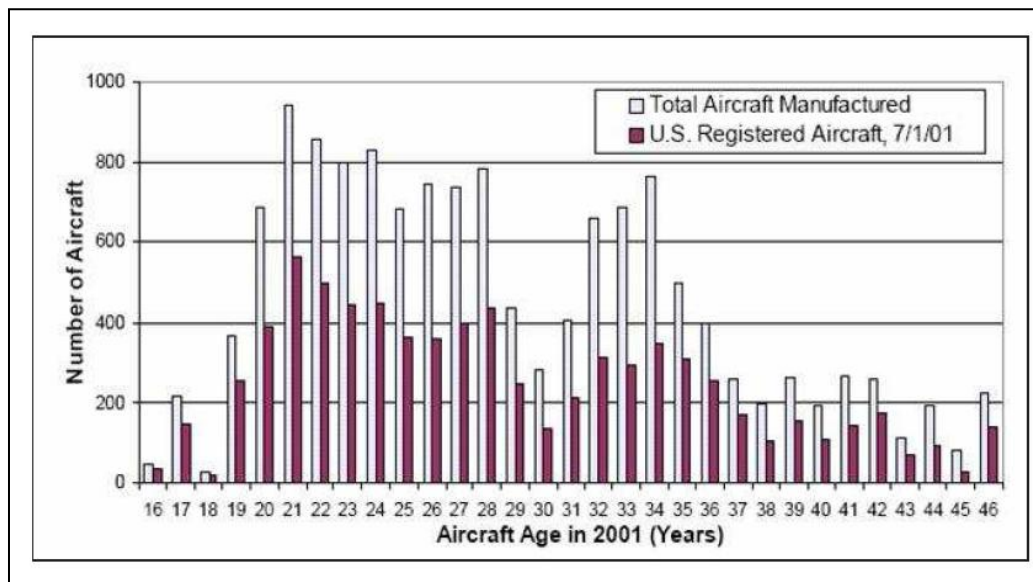
Previous research work highlighted the aging problem.

Structural health concerns are focused on aircraft with increasing age. Civilian and military aircraft inventories have both experienced a gradual and continual increase in the average aircraft age. In the civilian general aviation market, the high cost of new aircraft reduced new aircraft purchases resulting in legacy aircraft usage beyond the original design service life (Figure 1) [1].



**Figure 1 : General Aviation Aircraft Manufactured [1]**

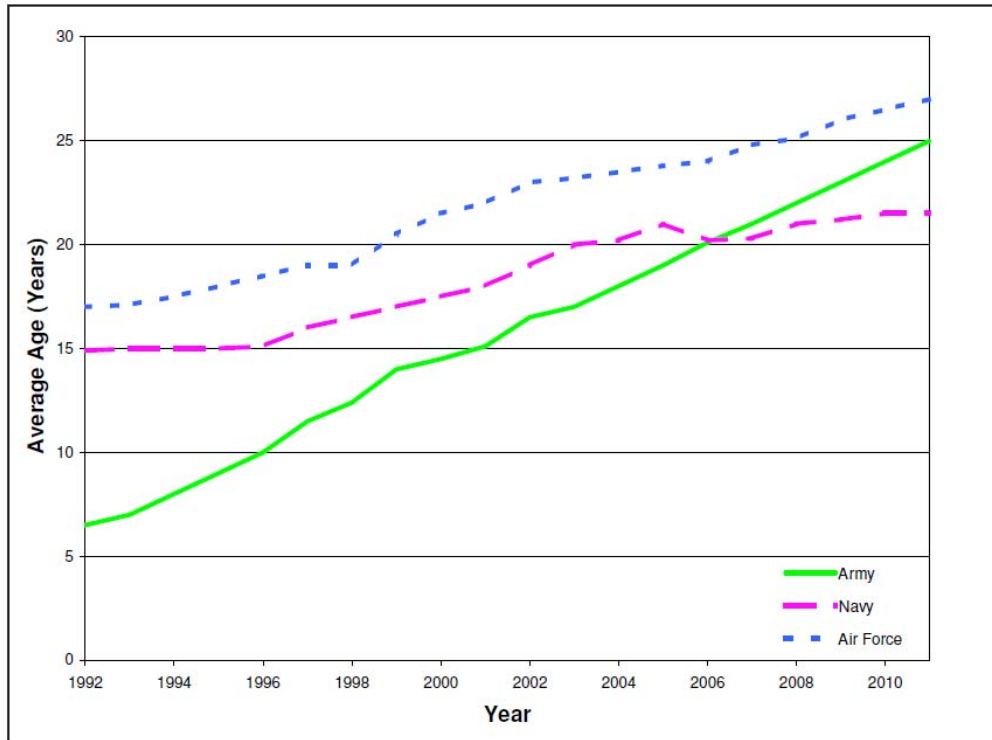
Civilian commercial and general aviation aircraft inventories have both increased in average aircraft age. The high cost of new aircraft forced the civilian general aviation market to purchase and maintain legacy aircraft beyond the original design service life (Figure 2) [1].



**Figure 2 : Number of Aircraft versus Age [1]**

Similarly, the high cost of Operations and Maintenance (O&M) of legacy military aircraft combined with the high cost of new aircraft purchase created an aging military aircraft fleet. This trend showed that the United

States was unable to purchase enough new aircraft each year to reduce average aircraft age. This inability to reduce the average age of the United States military aircraft has been coined a “death spiral” by the Joint Council on Aging Aircraft (JCAA). The “death spiral” started with deferring modernization and recapitalization due to constrained resources. This resulted in the further increasing the age of weapon systems with an associated increase in maintenance. This increased maintenance drove up O&M costs and reduced readiness, which then required the shifting of funds from procurement accounts to O&M to keep our existing systems mission capable. The Congressional Budget Office (CBO) estimated “spending on O&M for aircraft increases by 1 percent to 3 percent for every additional year of age, after adjusting for inflation”. These market forces created an increase in the average age of military aircraft (Figure 3). [1]



**Figure 3 : Average Fleet Age [1]**

Five years have passed and the average age of Air Force aircraft is now 27 yrs. The Air Force is flying planes past their original service life predictions. This creates a need for a cost effective way to autonomously monitor at risk structural components and

alert pilots and maintainers when damage occurs. Currently, the only way to inspect for damage or cracks is to ground the aircraft and conduct lengthy, time consuming inspections and costly maintenance. A RTASHMS provides the ability to analyze hard to access structural hot spots without time consuming inspections. Significant cost savings through reduced or eliminated maintenance and aircraft downtime are some achievable benefits. Sensors placed in the structural hot spot locations could inform engineers, maintainers and pilots if a crack has formed and whether or not it's growing according to structural models or past a safe limit.

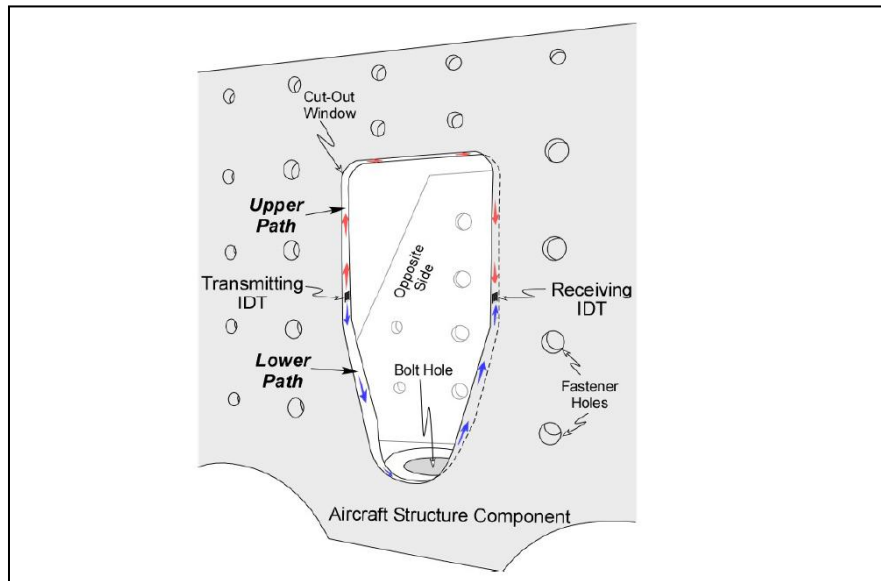
Newer production aircraft, such as the B-2, F-22 and F-35, are being produced with low observable radar absorbing coating materials. A large portion of maintenance costs in dollars and time are due to low observable coatings removal and application. This is costing the Air Force not only in dollars but aircraft availability. Due to the high cost of these aircraft, production numbers are limited. Aircraft availability numbers drop quickly when aircraft are down for maintenance. With threats to the country ever present and growing, the US Air Force needs its entire fleet of weapons at the ready. An operational Structural Health Monitoring system would be able to eliminate a large portion of this costly maintenance burden by enabling the maintainers to conduct structural inspections without the need to remove panels or skins.

### *1.1.2 Recent Structural Problems*

The Air Force has encountered structural problems with its aging fleet. From 2001 to 2004, C-130E/H aircraft Center Wing inspections revealed 123 planes with significant fatigue cracking [16]. The cracking was occurring earlier than projected based on model predictions. Some risk mitigation options were to ground aircraft until a

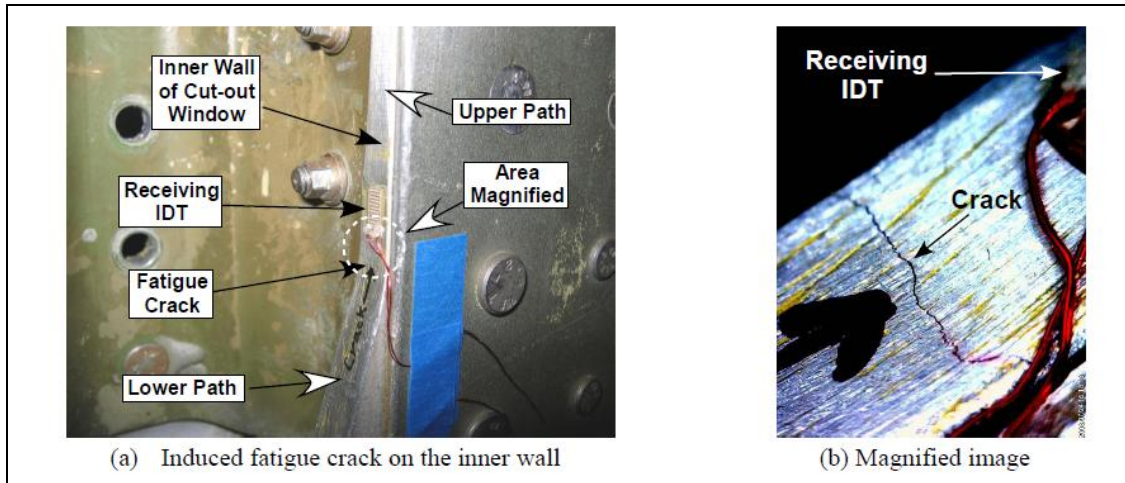
redesign could be found or place severe flight restrictions on flying. In order to keep flying, the cracks would have to be monitored. A RTASHM system would be the answer.

A study was ordered and C-130 structural components were provided for fatigue testing [11]. The Interdigital Transducer (IDT) Sensor and other emerging technology sensors were used in this analysis. Due to the location of the cracking, Piezoelectric Transducer (PZT) sensors using Lamb waves would not effectively work in the restricted geometry. The IDT sensors were placed in the predicted hot spot location, Figure 4.



**Figure 4 : IDT Sensor placement on complex aircraft geometry [11]**

The IDT was not only able to detect the presence of a crack (unobserved by the naked eye), but it was able to accurately estimate the location of the crack as well, Figure 5.



**Figure 5 : Fatigue Crack detected by IDT Sensors [12]**

In November 2007, an F-15C aircraft had a major in-flight structural failure, (Figure 6) which costs the Air Force an aircraft and grounded the F-15 fleet until inspections could be conducted [8].



**Figure 6 : Animation of F-15 Structural Failure [7]**

Cracks were found in 40% of the fleet. A critical structural component had been under designed and a redesign was ordered. The area was a known structural hot spot location. If a RTASHMS was installed and operational, the system may have alerted the maintainers that the crack had grown beyond the critical length and the aircraft could have been grounded and repaired. If the crack grew to a critical length during flight, the

RTASHM system could have warned the pilot of this impending failure and perhaps saved the aircraft.

### *1.1.3 Composites in Aircraft Structures*

Composite materials are increasingly being used in newer production aircraft to replace heavier metal structural components. The newer technology utilizes bonds to join components together. The joints are areas of higher stress and are susceptible to damage and failure. This thesis will explore the effectiveness of various sensors on composite lap joint materials to see damage can be detected in this type of geometry and material.

### *1.2 Research Proposal*

The research work accomplished in 2006 [1] concentrated on aging aircraft, in particular the CAF's A-37. Their analysis demonstrated that a structural health monitoring system for aging aircraft might have promising benefits with respect to both safety improvements and decreased maintenance costs. The effort of the 2007's research team [4] was to take what had been accomplished in 2006 [1] and to further expand upon that work so that an installed Integrated Structural Health Monitoring System (ISHMS) could be adapted and applied to any aircraft. The group sought to accomplish several tasks in order to achieve the previously stated goal. The first task was to continue the systems engineering process in the development of functional and physical architectures to complement the architectures in the previous thesis. Secondly, they executed the processes and architectures in the development of a prototype ISHMS in order to verify and validate the processes and architectures. The third task was to use what was learned from the previous development and iteratively refine those processes and architectures.

The 2009 research (Kuhn, 2009) found out that the sensors are significantly affected by cyclic strain, and that the effects could be estimated using a power equation model.

No current system exists that can detect damage during flight. Most research is focused on wide-area measurement capabilities, where non-deterministic damage (random or more widespread) and non-localized damage is occurring. Real-time damage sensing for the entire aircraft is an unrealistic goal. This research will focus on a real time system that monitors localized deterministic damage or structural hot-spots.

This research seeks to present a more detailed and realistic methodology to install a RTASHMS on an aircraft. Some benefits are a more cost effective, real time, more integrated and simpler System Engineering approach to Aircraft Structural Health Monitoring. This thesis will describe the new RTASHMS, what it is, and what should be developed. This research thesis consists of two primary tasks. The first one is to improve the architecture of the ISHMS which had been developed by 2006 and 2007 research and create a streamlined architecture for a RTASHMS. Secondly, to explore new technology that could be used in advancing and building a reliable RTASHMS. In order to advance the methodology to install a RTSHMS, this thesis will explore the use of cutting edge Interdigital Transducer (IDT) sensor technology that operates with surface waves called Rayleigh waves. The thesis will compare the IDT/Rayleigh wave technology to the Piezoelectric Transducer (PZT) disc sensors utilized in previous thesis work. The PZTs operate with plate waves called Lamb waves.

Two separate tests will be conducted. The first test includes comparing the sensors on an undamaged and a cracked flat Aluminum Dog Bone shaped specimen. The second tests will explore signals collected on composite lap joints with different epoxy



bonding materials. This thesis would compare the effectiveness of the PZT and IDT sensors in order to determine what type would be better in advancing a Real Time Structural Health Monitoring System.

This research will take a different approach to the concept of operations (CONOPS) than the previous research. The RTASHMS should be able to detect unexpected cracks during both flight and maintenance stages. The Aircraft structural condition will be shown real time during flight on the Aircraft's instrument panel. A warning signal will alert the pilot of potential structural problems and they can take necessary emergency action to prevent a potential mishap. At the same time, the maintenance team will be alerted to the location and extent of the damage or crack and plan for appropriate part or component replacement. These capabilities will help to improve flight safety and reduce life cycle maintenance cost. The RTASHMS must be small, light weight and operate on aircraft electrical power.

When used along with the March 2006, 2007, and 2009 research, the reader will have a well defined Systems Architecture products with updated CONOPS. Moreover, the reader can use to guide the development of an enhanced RTASHMS for their particular application.

### ***1.3 Research Focus***

Previous thesis groups designed a Systems Engineering process and architecture that was generic enough to be used to design an ISHMS for any particular problem. The research described herein will investigate a RTASHMS by improving on the previous ISHMS Operational Concept and testing of emerging technologies. The operational concept of ISHMS has changed with advancements in technology and development of

USAF and an allied nations' Air Force operational concept. The Systems Engineering process should be flexible in accordance with the CONOPS. Previous ISHMS work focused primarily on life cycle and cost effective maintenance, and did not address flight safety, real time monitoring, and simple and easy inspection aspects during the SE process and architecture development. Real time maintenance was addressed during the pre and post flight ground maintenance phase, but not during flight. One problem with ground maintenance is that a crack could initiate or grow beyond failure limits after takeoff. The pilot would be unaware of the aircraft condition and perform a higher g maneuver. The stress goes beyond load limits, and the aircraft suffers severe structural damage or catastrophic failure like the F-15 bulkhead failure. This research seeks to develop a real time monitoring concept that addresses the in flight phase. Pilots will be alerted to structural condition through cockpit instruments and can apply appropriate emergency procedures when problems are detected. In previous theses, the Aircraft Health Monitoring equipment required to conduct post flight maintenance inspections was large, heavy, complex and expensive and required an external power source creating problems during contingency operations. Inspectors would have to spend extra time setting up equipment to inspect and maintain the aircraft's structural components. Mobilizing with large inspection equipment would be costly as well. Therefore, this research will focus on a simple and easy installation of the RTASHMS. The system would operate on the aircraft's internal power and could provide real time structural information to the pilot and maintainers eliminating external equipment and reducing time needed to conduct inspections. Current advancements in sensor technology could help bring the users a step closer to making an on aircraft system possible.

This research seeks to develop and provide an updated System Architecture that is tailored to a Real Time Structural Health Monitoring System. Secondly, this research thesis work seeks to advance and promote the use of a RTASHMS by comparing current and emerging sensors on metal and composite materials.

This research is organized in an attempt to walk the reader through various steps. The next chapter, Chapter 2, discusses the background associated with the research and the problem. Chapter 3 discusses the Systems Engineering Architecture developed to address the problem. Chapter 4 discusses testing conducted in support of the architecture and to advance the technology that can address the problem. Chapter 5 discusses the conclusions drawn from this research and provides recommendations for further research in this problem area.

## ***II. Background***

This chapter describes background information and theory important to this research. The primary information included in this research is DoD Architectural Framework process. The second theory involved in this research is wave theory and piezoelectric theory. The third theory included in this research is a miniature Rayleigh surface wave sensor (A miniature interdigital transducer (IDT)) methodology theory.

### ***2.1 DoD Architecture Framework***

The Department of Defense Architecture Framework (DoDAF), Version 2.0 is the overarching, comprehensive framework and conceptual model enabling the development of architectures to facilitate the ability of Department of Defense (DoD) managers at all levels to make key decisions more effectively through organized information sharing across the Department, Joint Capability Areas (JCAs), Mission, Component, and Program boundaries. [6]

#### ***2.1.1 Previous Systems Engineering and Structural Health Monitoring Research***

Several previous theses have been written about a Systems Engineering Approach to Aircraft Structural Health Monitoring System. The first one, titled “A Systems Engineering Approach to Integrated Structural Health Monitoring for Aging Aircraft” was published in March 2006 by Captain Allan P. Albert, Captain Efstathios Antoniou, Captain Stephen D. Leggiro, Major Kimberly A. Tooman, and Captain Ramon L. Veglio [1]. The research explored a systems engineering approach to the implementation and development of a near real-time, cost-effective, and integrated structural health monitoring system on aircraft. The research conducted two primary tasks. The first task

was the development of an Integrated Structural Health Monitoring System (ISHMS) Systems Engineering (SE) design process. Operating functional architecture products were used to identify the top-level operational concept and stakeholder requirements of an ISHMS for a generic aging aircraft. The second task was a demonstration of the potential cost benefits of an ISHMS installation on an aging aircraft. The research utilized the Coalition Air Force's A-37 aircraft. The research team tried to accomplish the first task by utilizing the SE V Model to identify the system level design problem. They developed the operational functional system architecture according to the Department of Defense (DoD) Architecture Framework. To achieve the second task, the research team produced mathematical simulation models using data from the A-37 aircraft and described how installing an ISHMS could reduce maintenance inspections while maintaining safety.

The second thesis, titled, "A Systems Engineering Process for an Integrated Structural Health Monitoring System", was completed in March 2007 by Matthew S. Bond, Captain James A. Rodriguez, and 1st Lt Hieu T. Nguyen [4]. The research group used the March 2006 research as a starting point and built on the prior research. This research applied systems engineering to develop an ISHMS for a generic aircraft. This was achieved by further development of system architecture products, including physical architectures. To verify and validate the system architecture products, the research team looked to apply the processes in the development of a prototype ISHMS. Ultimately, the goal was that the reader would have well defined SE architectural products. The reader could use the information to guide the development of an ISHMS for particular applications.

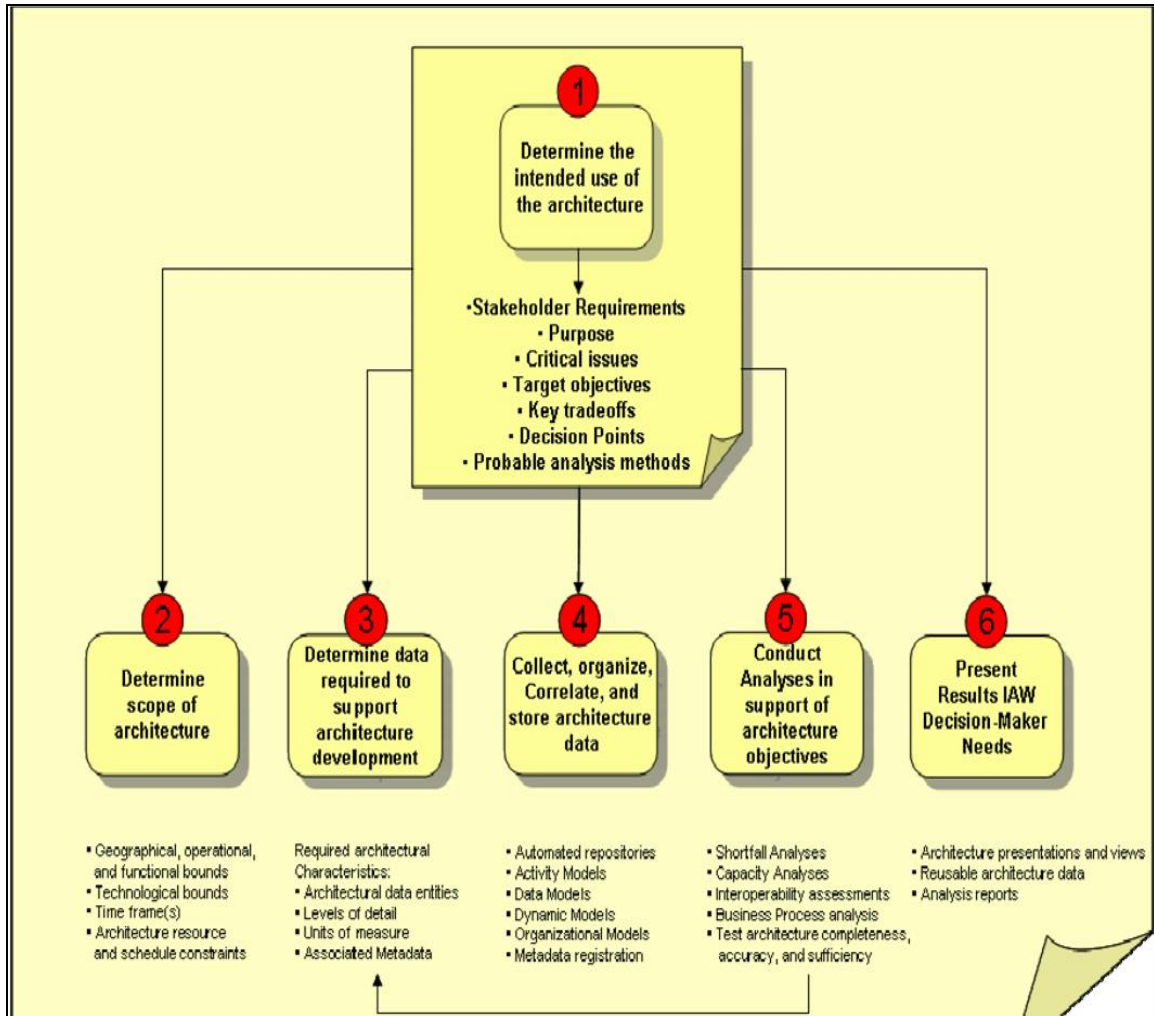
A doctoral dissertation titled “Changes in Structural Health Monitoring System Capability Due to Aircraft Environmental Factors” was accomplished in September 2009 by Major Jeffrey D. Kuhn [15]. This research analyzed the current USAF inspection paradigm and how aircraft are affected by environmental factors, tested a representative structural component, and investigated inspection locations from the F-15 and C-130 aircraft and as well as current Structural Health Monitoring technologies. A design of experiments approach was used to build and implement an experiment to find out the effect of one aircraft’s environmental factor (cycle strain) on a common SHM technology (PZT-based sensors). The experimental results proved the sensors are significantly affected by cyclic strain, and the effects could be estimated using a power-law equation model.

### ***2.1.2 The 6-step Architecture process***

The Real-time Aircraft Structural Health Monitoring System process begins with the requirements generation process and concludes with the operation of a system. This research group chose to develop system architecture products as a method to understand the overall RTASHMS. A six-step process presented in DoD Architecture Framework Version 2.0 was followed. This process is presented in Figure 7 and depicts the sub-steps that the decision maker needs to perform within the 6-step Architecture Development process.

The first step in the six-step architecture process was to determine the intended use of the architecture. The research group built the system architecture products to represent the RTASHMS. The second step was to determine the scope of the system architecture. The third step was to determine the characteristics to be captured. The fourth

step in the process was to determine the architecture products to be built. The fifth step was to build the required system architecture products. Finally, the sixth step was to use the architecture for its intended purpose. The group decided to build the following architecture products: AV-1, Use Case Diagram, OV-1 Concept of Operation, OV-5 Operational Node Tree Diagram, OV-5 Context Diagram, OV-5 Activity Model (A-0, A0, A1, A2, A3, and A4), OV-2 Operation Node Connectivity, OV-4 Organization Chart, SV-4 System Node Tree Diagram, SV-1 System Interface Diagram, and SV-5 System Function to Operational Activity. These architecture products will provide the diagrams that will define a Real Time ASHMS. The research group accomplished these by using the system architecture to represent an actual Real Time Aircraft Structural Health Monitoring System. These system architecture products will be described in Chapter III and justification for them will be presented later in the paper.



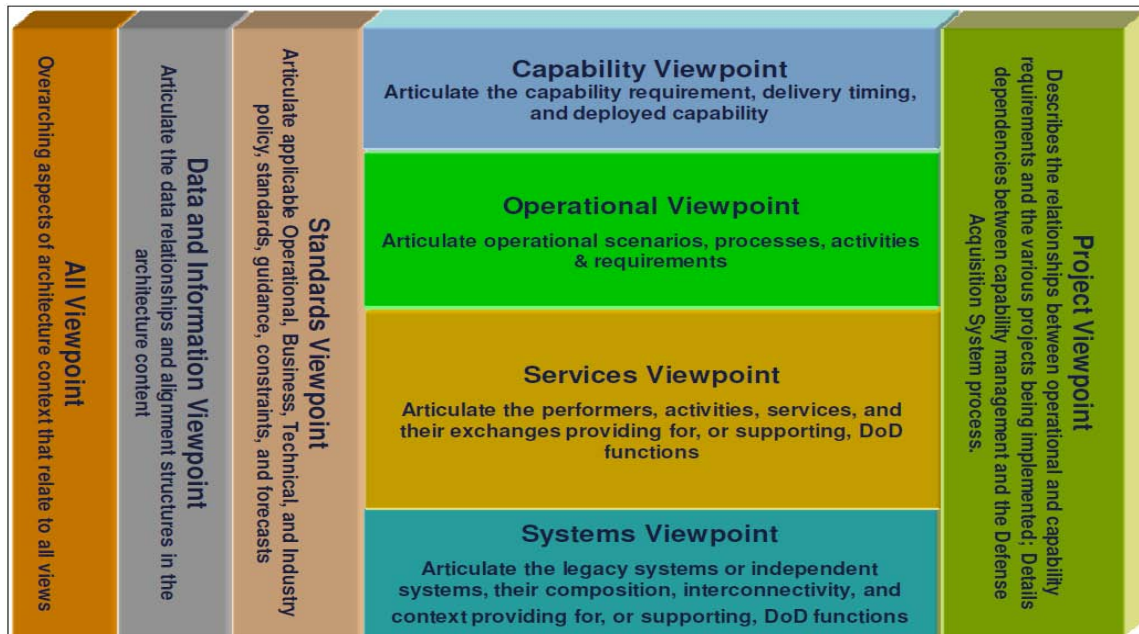
**Figure 7: Architecture Development 6-Step Process [6]**

### 2.1.3 Architecture Viewpoints and DoDAF-described Models

System Architecture was used to define a RTASHMS. The System Architecture products developed herein began with the operational views. Operational viewpoints represent operating scenarios and activities. System viewpoints describe the information on supporting automated systems, interconnectivity, and other functionality in support of operating activity. Service views illustrate system, service, and interconnection functionality providing for operational activities. During the System Architecture development phase, the research group tried to focus on describing the RTASHMS in



detail by utilizing system and service viewpoints. System and Service viewpoints are a better representation of the RTASHMS than the operational viewpoint. Figure 8 describes each viewpoint definition. Appendix A-DoD Architecture Framework 2.0 Volume 1 describes the detailed model, description and definition of System Architecture Viewpoint.

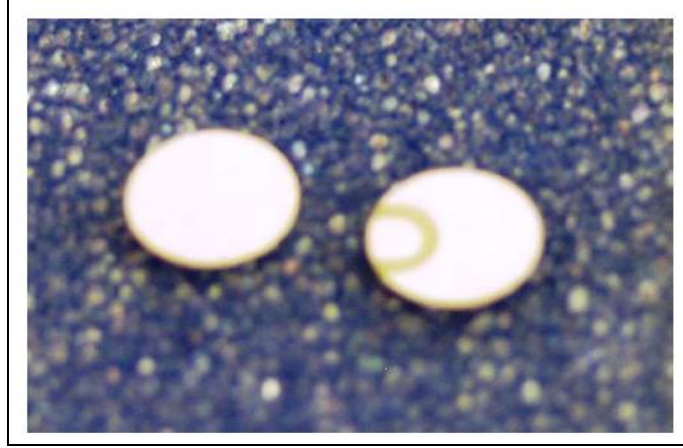


**Figure 8: Architecture Viewpoints in DoDAF V2.0 [6]**

## 2.2 Sensor technology and basic wave theory

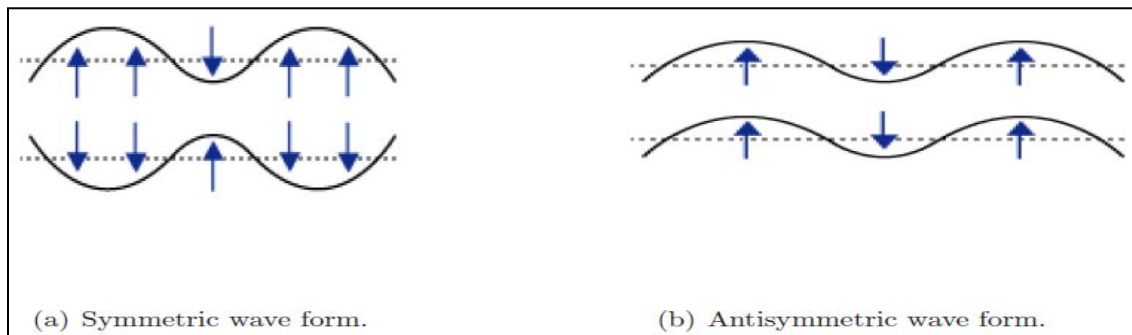
### 2.2.1 PZT Sensors and Lamb waves

Many materials have been found to possess piezoelectric properties, but today the most popular material is Lead Zirconate Titanate (PZT) sensor Figure 9. PZT is cost effective to produce, with higher operating temperatures and greater sensitivity than other piezoelectric materials. PZTs are considered a smart material in the field of SHM, meaning they are capable of both actuating and measuring signals.



**Figure 9: Top and bottom of PZT discs used in this study.**

PZT disks generate Lamb wave signals. The formulas are discussed in length in previous research (Underwood, 2008) and in literature[10]. For the purposes of this research, we are primarily interested in comparing the complexities of the signals produced and received by different sensors, and how signal analysis is conducted. This research will only present some basic theory to highlight those complexities. The two most common types of Lamb waves are symmetrical ( $S_0$ ), and anti-symmetrical ( $A_0$ ) Figure 10.



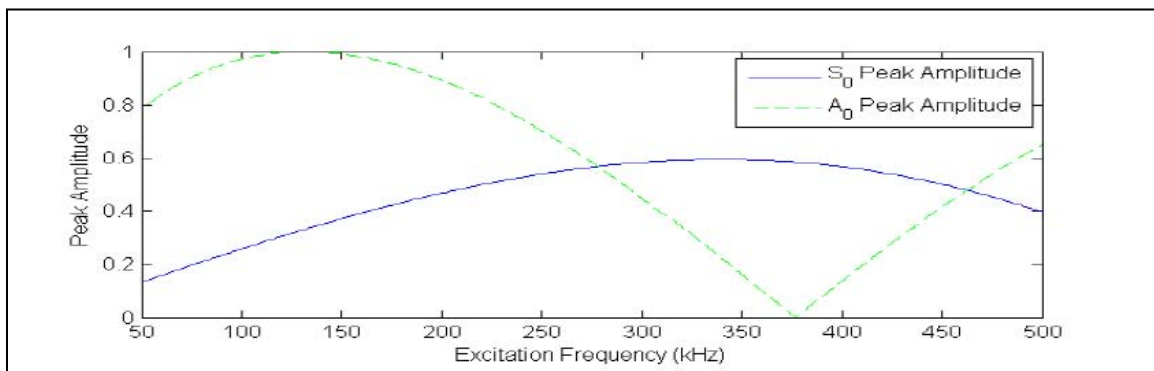
**Figure 10: Examples of plate particle displacement during Lamb wave modes [3].**

The Lamb wave mode defines the properties of the Lamb wave in the material. In an elastic plate, the symmetric modes of Lamb waves cause particles of the plate to move

in opposite directions of the thickness of the plate, Figure 10(a). The antisymmetric modes of lamb waves cause the particles of the plate to move in the same direction, relative to each other, through the thickness of the plate, Figure 10(b) [ (IgorViktorov, 1967)].

Lamb waves traveling through material, such as aluminum, have wave speeds that are dependent upon their frequency. The initial Symmetric and Antisymmetric wave arrival times are calculated to predict the Time of Arrival (TOA) of each wave mode at the primary excitation frequency. The velocities are not only dependent on the frequency of excitation but are also a function of the thickness of the plate.

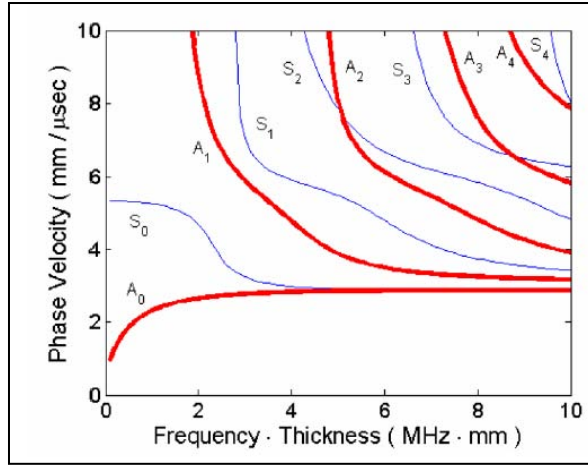
The response amplitude of the Symmetric and Antisymmetric waves varies with different material, material thicknesses and frequency, Figure 11. Only the mode expected to produce the best return will be used to collect data to detect damage. Using the appropriate Lamb wave mode window,  $S_0$  or  $A_0$ , to detect damage during a particular excitation frequency is known as tuning [ (Giurgiutiu, 2003)]. Tuning is a useful technique for measuring data because specific waveforms are targeted, and reflected wave amplitudes can be minimized.



**Figure 11: Theoretical normalized amplitude of the  $S_0$  and  $A_0$  Lamb wave modes for excitation frequencies 50 to 500 kHz. [17]**

Some limitations of the PZT disc sensor can be attributed to the way that they operate. PZTs produce Lamb waves in an omni-directional pattern meaning that the waves travel like ripples on water, in a circular pattern in all directions. The sensors operate at frequencies in the kilohertz range where the wavelengths are longer. Lamb waves produced at a certain frequency will produce different modes, typically a Symmetric wave and an Asymmetric wave, which increases the level of complexity of signal analysis and comparison. To properly analyze the Lamb wave signals a dispersion curves must be used to calculate estimated arrival times of the various wave modes depending on the material, frequency and thickness. Additional difficulty with Lamb waves is that they are influenced by material properties, geometry, and thickness. The thickness presents a significant problem for Lamb waves in structural health monitoring. Aircraft structures are complex with varying thickness, curvatures, and multi-layered joints, which are not easily monitored with Lamb waves.

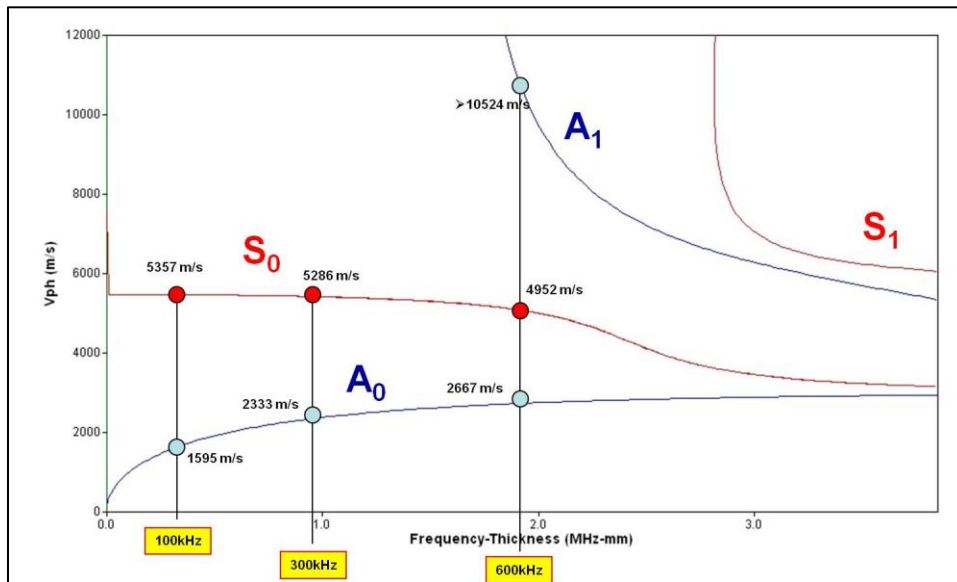
To predict Time of Arrival windows, dispersion curves have to be used to calculate estimated arrival times of Symmetric and Antisymmetric wave modes at various frequencies. These calculations work best in flat isotropic materials. Figure 12 is a dispersion curve for Aluminum [4].



**Figure 12: Phase velocity dispersion curves for aluminum [4]**

Figure 13 shows the dispersion curve for the Aluminum specimens used in this research.

The plot was created by researchers at AFRL/RXLP.



**Figure 13: Dispersion Curve for Aluminum using Disperse**

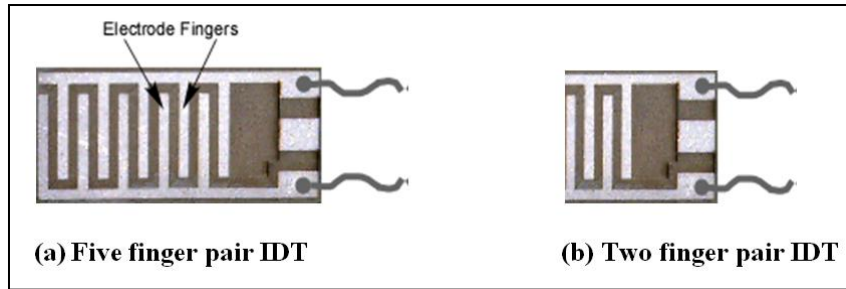
The vertical axis shows the speed of the wave and the horizontal axis shows the frequency-thickness. After choosing three operating frequencies, the wave speed for the different modes can be found by drawing a vertical line. The Symmetric, S<sub>0</sub> speeds for

the three frequencies were 5357 m/s, 5286 m/s, and 4952 m/s for the antisymmetric speeds were 1595 m/s, 2333 m/s and 2667 m/s for the 100, 300 and 600 kHz frequencies respectively. Given those speeds with a known distance, the Time of arrival can be estimated. The number of different speeds and different waves illustrates the challenges faced when calculations have to be made using PZT type sensors compared with an emerging sensor technology that operates on one frequency and speed. In a RTASHMS, easy analysis and calculations are desirable.

### ***2.2.2 IDT Sensors and Rayleigh waves***

The IDT's produce Rayleigh waves that can detect surface breaking cracks or damage. Furthermore, the sensor operates on a single high frequency that is not sensitive to material properties, thickness or geometry and the wave travels at one velocity.

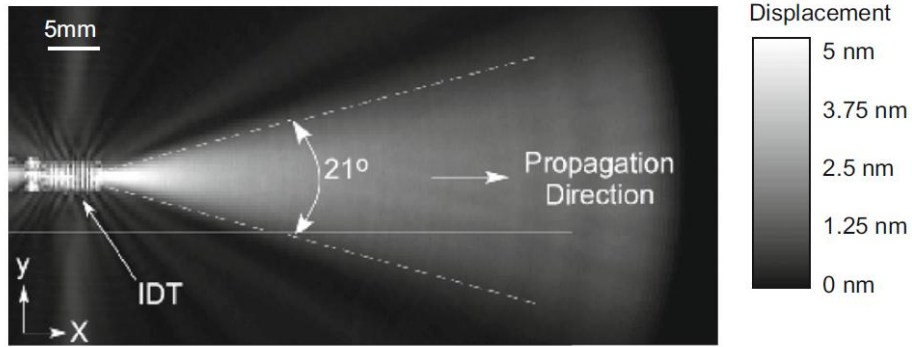
An interdigital transduction method generally used in telecommunication filtering devices was adapted to design and fabricate a narrow band of IDT sensor with a resonance frequency of 3 MHz [14]. The silver electrode on a shear mode piezoelectric PZT ceramic plate was replaced by laser machining to leave electrode fingers as shown as in Figure 14. The thickness of the PZT plate was 200 micrometers and the physical dimensions of the sensors were 3 mm x 7 mm, and 3 mm x 4.025 mm for the five finger pair sensor, Figure 14a and the two finger pair sensor, Figure 14b, correspondingly. All of the physical sizes are the same except for the length. This smaller two finger pair sensor can be used when the five finger IDT sensor is too big to apply.



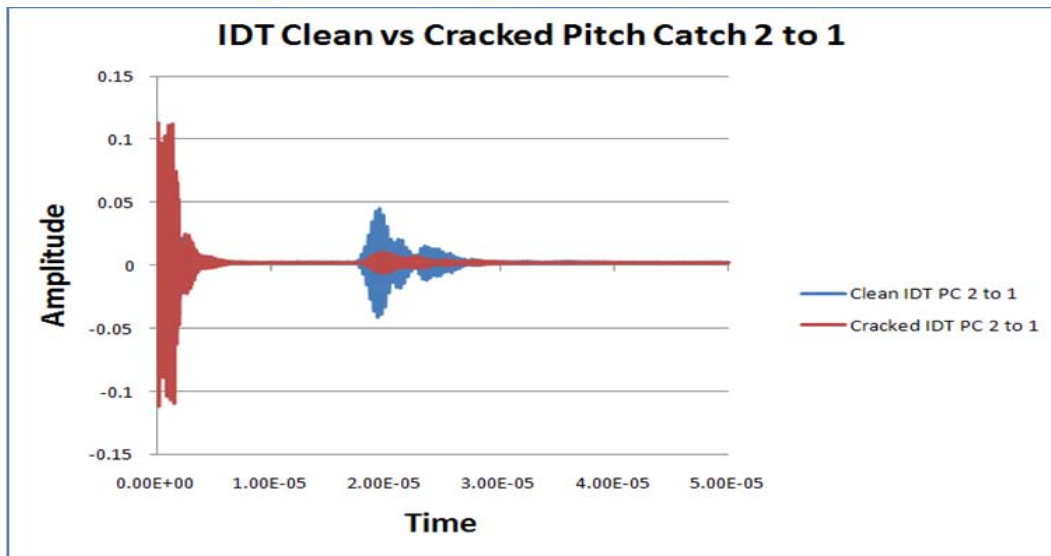
**Figure 14: IDT Sensors [13]**

Compared to bulk waves, Rayleigh waves can propagate much longer distances with lower signal attenuation levels, which are nominally proportional to  $1/r$  for a given frequency ( $r$ =distance). In addition to the small attenuation, Rayleigh waves are also non-dispersive and sensitive to surface-breaking defects. The surface penetration depth of Rayleigh waves is also approximately one wavelength, which can be beneficial for many Non Destructive Evaluation applications. Rayleigh waves are called surface waves because they propagate on the surface of a material and the depth of penetration is frequency dependent [13].

Because IDT sensors operate at a single frequency, there will only be one wave speed used to calculate the Time of Arrival for the signal. Secondly, the signals produced are directional, meaning that the signal is aimed towards the anticipated damage or crack location. The directionality virtually eliminates reflected wave interference and allows the user to place the sensors in a “hot spot” location where predicted damage or crack initiation can occur, Figure 15. Typically one very strong signal is typically produced that can easily be isolated and analyzed while reflected signals are minimal. The peak signal is clear and well defined See Figure 16.



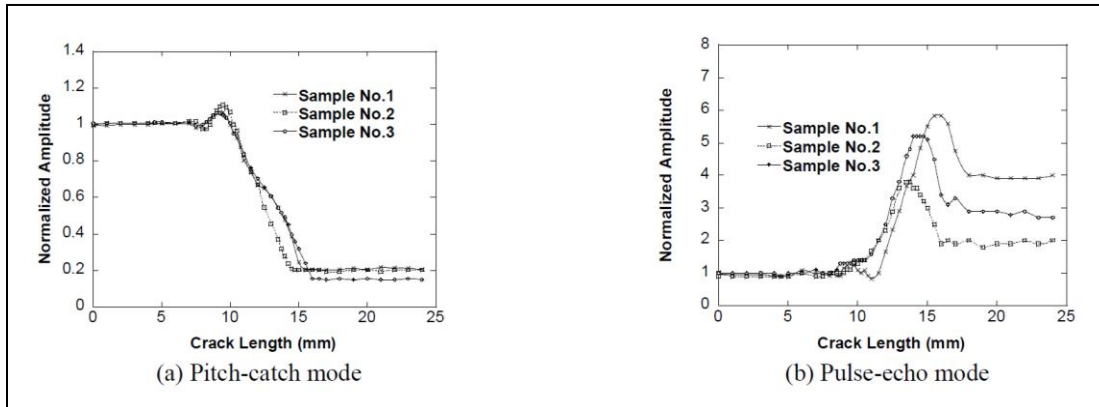
**Figure 15 Propagation of Rayleigh Waves from IDT Sensor showing Directionality [12]**



**Figure 16 Actual signals from IDT Test**

IDT sensors can operate in complex geometry situations as shown and discussed in the motivation section during the C-130 fatigue test. Another benefit of IDT sensors and Rayleigh waves is that the pitch-catch and pulse-echo signals change linearly with increasing crack length, which provided a new capability for accurately sizing the cracks based on signal strengths in a simple linear manner Figure 17. A recent paper summarizes it best:





**Figure 17: Typical IDT Signal Strength in Pitch Catch and Pulse Echo [12]**

Figure 17 shows a fatigue crack initiate and grow across the ultrasonic field on a compact tension specimen, both the length of crack and the signals of IDT sensors. In these graphs, the amplitudes are normalized to the initial amplitude levels. From the plots in Figure 17, one can notice that there is an indication of the initial interaction of crack tip with the ultrasonic field when the crack length reaches approximately 8 mm which was measured with a micrometer. This indication seems to be composed with two distinctive features of change in the amplitude of signal; a small dip followed by a relatively larger peak. These features are more pronounced with the signals detected in a pitch-catch mode as in Figure 21(a). On the contrary, for the signals detected by a pulse-echo mode as shown in Figure 21(b), the first dip and the following peak is not as clear as the pitch-catch mode. A systematic drop in pitch-catch signal amplitudes to ~20% of the initial levels was noticed, while an increase in pulse-echo signal amplitudes of between 200% - 400% was observed with the current IDT sensors [12].

The plots in Figure 17 show the linearity and predictability of the signal change in pitch catch and pulse echo modes. These aspects of the signals will greatly reduce the possibility of a false signal.

### ***2.2.3 Pitch Catch and Pulse Echo Damage Detection Methods***

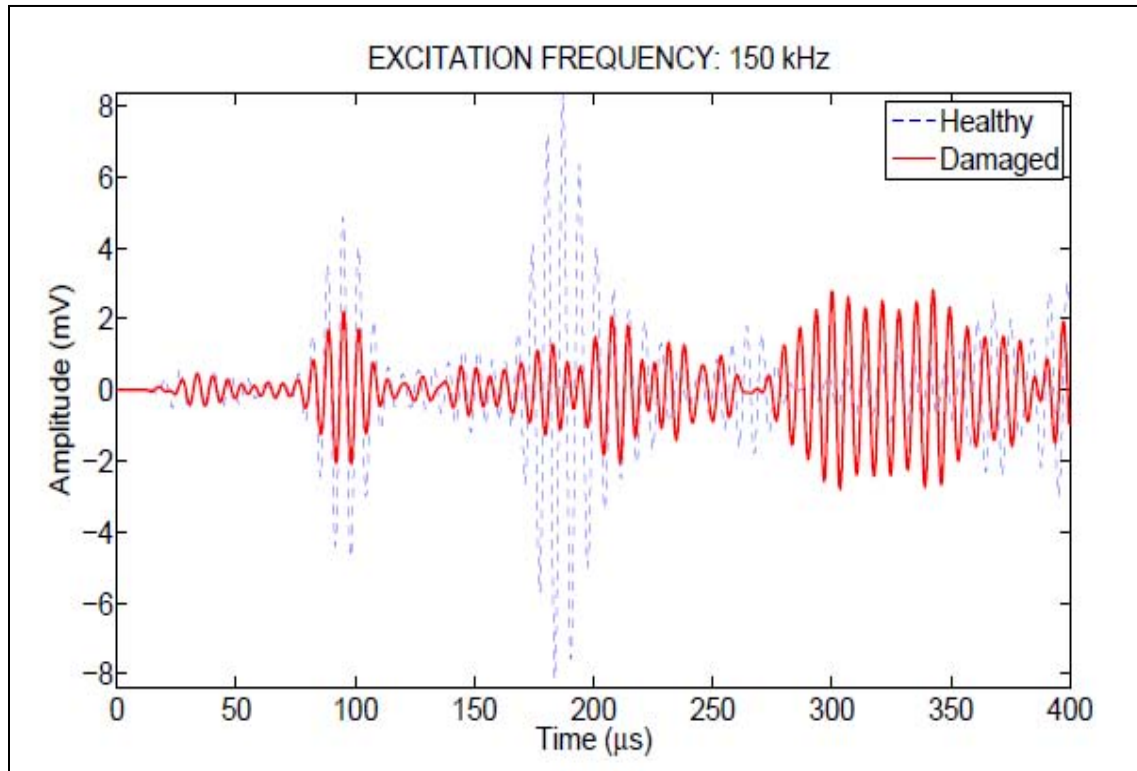
The two types of damage detection methods used in this research are the pitch-catch method and the pulse-echo method. The pitch-catch method excites (pitches) a signal at one sensor then measures (catches) the signal at another sensor. Damage is detected by comparing the amplitude change from a healthy response to an unhealthy response. If damage has occurred, the measured response will have decreased in amplitude for both the PZT and IDT sensors. The pulse-echo method uses one sensor to excite a signal and the same sensor measures the returning reflected signal (known as the "echo") [4]. Damage is detected by comparing the amplitude change from a healthy response to an unhealthy response. If damage has occurred, the measured response will have increased in amplitude for both the PZT and IDT sensors.

### ***2.2.4 Previous Research on Sensor Technology***

The ability to detect, locate and quantify a crack in real time is the ultimate goal of an operational aircraft structural health monitoring system. The system will need to be rugged, robust and limit false signals. Current sensor technology has been unable to reliably meet these needs, which has limited the advancement of a reliable Structural Health Monitoring System.

Problems with Lamb wave signal collection and analysis occur in small, tight geometries where the waves reflect quickly and begin to overlap one another. In a large flat plate material the signals don't reflect as quickly and the primary wave signals are more clearly defined. The previous research work (Bond, 2007) (Crider, 2005) tested on large flat plates for easier signal isolation and analysis.

In the 2005 research by Crider (Crider, 2005), Monitoring and Evaluation Technology integration System (METIS) sensors were tested on an aluminum plate 1220mm long by 610 mm wide by 1 mm thick. The sample result of a healthy versus damaged signal is shown in Figure 18.

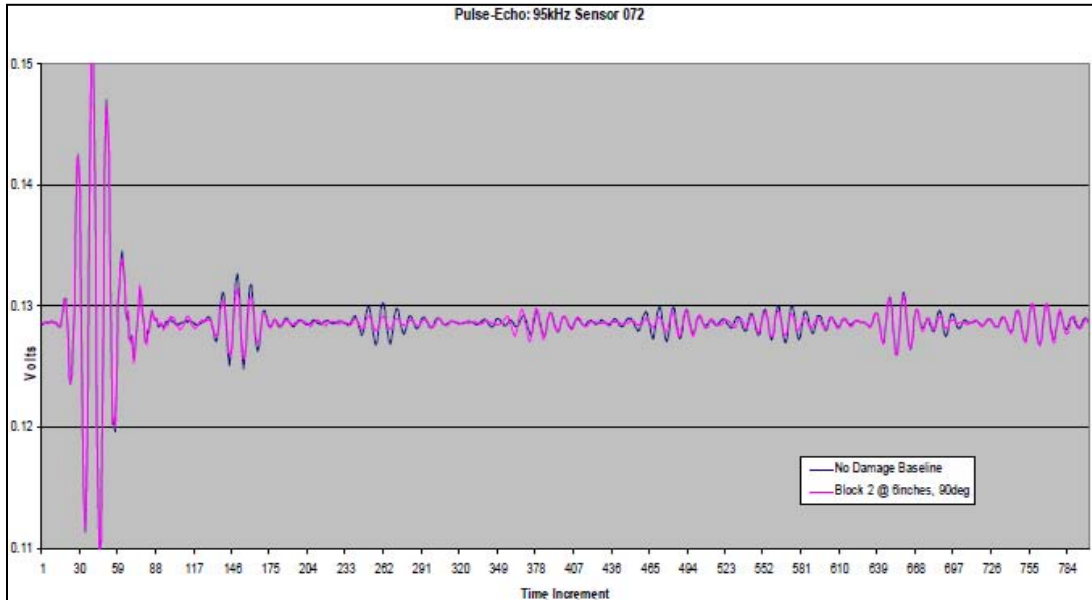


**Figure 18: Healthy vs. damaged response at 150 kHz excitation [4]**

The initial large signal received is the Symmetric wave followed by the Asymmetric wave as well as additional reflected signals. The distance between the sensors allows for a small gap between signals which would be helpful in predicting damage due to amplitude changes.

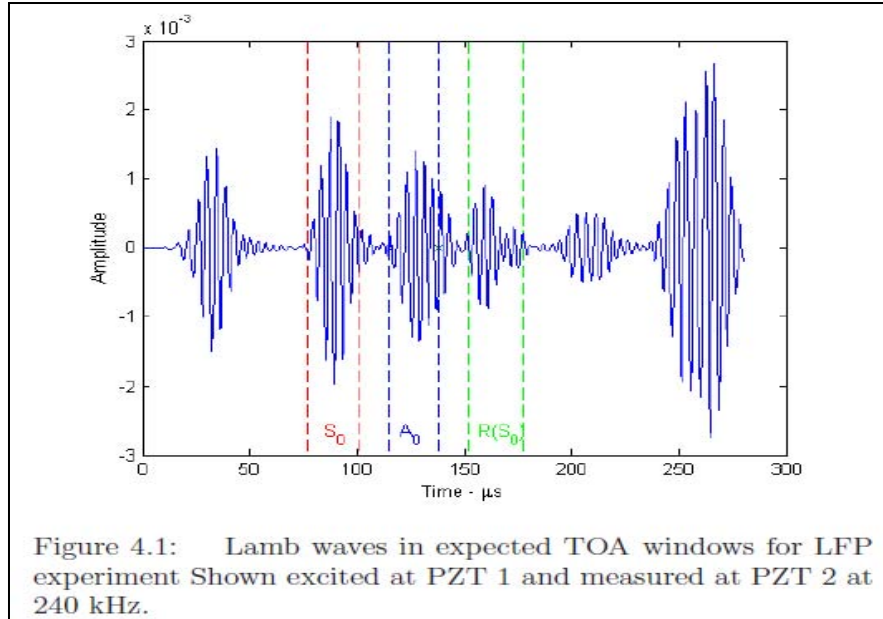
The 2007 research (Bond, 2007) conducted tests using the METIS sensor on a large flat aluminum 21”x42”x1/4” plate. A sample of their signal collection is shown in

Figure 19. Again the signals are separate and distinct, but once again they are under idyllic conditions of a large flat plate.



**Figure 19: Bond thesis Healthy and Damaged Plot on same axes [4]**

In the 2008 Underwood research (Underwood, 2008), the PZT discs were used on a large flat plate. The results of his large flat plate shown in Figure 20 show that there is distinct separation between the initial Symmetric ( $S_0$ ) and initial Antisymmetric ( $A_0$ ) signals, but the reflected signal symmetric  $R(S_0)$  is close to overlapping the antisymmetric  $A_0$ .



**Figure 20: Underwood research TOA predictions [19]**

In most real world aircraft applications, the sensors would not be placed on a large flat plate, but on smaller components with complex geometries. In a more restricted geometry, the signals will overlap and make signal analysis due to amplitude change nearly impossible. The inability to easily isolate and compare two Lamb wave signals makes accurate crack detection extremely difficult if not impossible. The probability of producing false signals is too high and would be unacceptable in a RTASHM system. In a RTASHMS, it would be vital to tell the pilot or maintainer that there is a problem only when there is an actual problem to avoid unnecessary mission aborts or maintenance actions.

Research is being done into various detection and monitoring technologies and their application in structural health monitoring. Current sensor technology has limited the development and use of an operational system. Emerging sensor technology shows

promise in advancing the use of a RTASHMS and highlights the need for updated systems architecture products.

### ***III. System Architecture***

Chapter III introduces the Real Time Aircraft Structural Health Monitoring System Architecture. This architecture defines a real time methodology, and flight safety concept of RTASHM for aging and next generation aircraft. Representative architecture products depict the operation of a RTASHMS. The products were created using IBM Telelogic (Popkin) System Architect (Version 11.2) software. This research group chose to build architecture as a means to describe the essential requirements needed to develop the overall system and followed the six-step process presented in DoD Architecture Framework Version 2.0. This framework was presented in chapter 2.

#### ***3.1 System Architecture Proposal***

This section will discuss the main purpose of the System Architecture this research will produce. This architecture differs from the previous Aircraft Structure Health Monitoring System Systems Architecture. The previous research groups considered the development phase and System Engineering process of RTASHMS. However, they did not clearly define “what the RTASHMS is”, “what we want to build”, and “what we should build”. In this chapter, we will describe the RTASHMS by using AV (All Views), OV (Operational Views), and SV (System Views which were explained in DoDAF 2.0).

##### ***3.1.1 Research Goals***

The goals are virtually unchanged from the 2006 research (Albert, March 2006). The goals are described in this section.

The implementation of an ISHMS will reduce the current aircraft inspection burden on the maintainers. The burden shall be reduced, by increasing the mean time between inspections, decreasing mean time to inspect, and/or decreasing number of inspection items, as well as reducing the risk of damage due to performing the inspections. Ideally, such a system will alert the user of current and/or impending aircraft structural health failures. The system shall be reliable and accurate such that it does not adversely impact aircraft safety or maintenance. The addition of the ISHMS should maintain the Safety of Flight within the allowable parameters. Ideally, the addition of the RTASHMS should not reduce the performance nor impose restrictions on the operational limits of the aircraft. The presence of the system on the aircraft should not limit the use of the aircraft in current and anticipated operational environments. The total life-cycle cost (development, acquisition, installation, operating/maintenance, and disposal) of the RTASHMS should not exceed the total aircraft maintenance costs (inspections and repairs) of the structural components being monitored by the RTASHMS for the extended service-life period. [1]

The goals of a Real Time Aircraft Structural Health Monitoring System are included in Table 1.

**Table 1 : Goals of the RTASHMS**

	<b>Goals</b>
1	Extend Service Life
2	Reduce Inspection Burden
3	Reduce Inspection Induced Damage
4	Maintain Safety of Flight
5	Reduce Cost
6	Collect Data in Real Time
7	Minimize Impact on Aircraft Operations
8	Easy to Maintain
9	Easy to Use Pilot and Maintenance Cuing
10	Minimize Development and Installation Time



	Goals
11	Streamline Acquisition

### 3.1.2. Systems Requirements

1. The RTASHMS must be a simple small device which can be installed on the aircraft structure and in the cockpit. It should utilize an aircraft internal electrical power. The equipment would include the RTASHMS instrument, data recording and processing software, sensors, wires, and a wave generating equipment.
2. The physical attachment and reliability of the RT ASHMS should be enduring in the conditions of high load factors approximately 9 to 12G.
3. The software should have the ability to record RTASHMS data for more than 300 hours. The hardware which recorded RTASHMS data can be dispatched and plugged in ground equipment for analyzing damage and crack occurrences.
4. The software of RTASHMS must have a function to reset the RTASHMS when the system causes uncertain types of errors.
5. The RTASHMS should have a function to be checked periodically and manually by the pilots and maintainers.
6. The RTASHMS should contain the function of wirelessly sending and receiving the data with the ground maintenance center. The RTASHMS and the ground maintenance center would communicate with each other and share the RTASHMS data in real time.

### ***3.1.3 Critical Questions***

The RTASHMS relates to all functional concepts that rely on manned and unmanned air vehicles.

The critical questions addressed by this architecture include the following:

1. What resources need to be devoted to RTASHMS (hardware, software, bandwidth, and personnel)?
2. What organizations are responsible for the different parts of the RTASHMS architecture and how do they coordinate with one another?
3. What potential end users are there for RTASHMS (DoD, allies, and commercial)?
4. What is the inherent system reliability and what redundancies are built in?
5. How long will this architecture be required before it is obsolete?
6. Are there security concerns with applying this RTASHMS?
7. How would a system integrate a RTASHMS?

Analysis of these questions will occur as the architectural products described previously are developed and refined.

### ***3.1.4 Scope***

Various manned and unmanned air platforms could benefit from a RTASHMS. The system may reduce life cycle maintenance cost and contribute to increased flight safety.

This architecture is meant to be utilized on and would be required for aging aircraft and next generation air platforms. This architecture is broad enough to enable these areas of responsibility to include users such as the US and allied military services as

well as commercial entities. The scope of the products currently in development to realize this architecture is summarized in the Table 2:

**Table 2 : RTASHMS [1]**

<b>Product</b>	<b>Short Name</b>	<b>Working Form</b>
Concept of Operations	OV-1	Word Document
Overview and Summary Information	AV-1	Word Document
Operational Node Connectivity Description	OV-2	System Architect Graphic
Organization Chart	OV-4	System Architect Graphic
Activity Model	OV-5	System Architect Graphic
Logical Data Model	OV-7	System Architect Graphic
Systems Interface Description	SV-1	System Architect Graphic
Systems Functionality Description	SV-4	Excel Spreadsheet
Operational Activity to System Function Traceability Matrix	SV-5	Excel Spreadsheet
System Measures Matrix	SV-7	Excel Spreadsheet
Capability to Operational Activity Traceability Matrix	CV-6	Excel Spreadsheet
Use Case	n/a	System Architect Graphic

### ***3.1.5 Purpose and Perspective***

The purpose of the RTASHMS is to provide a real time, life cycle cost effective and flight safety concept and methodology of Aircraft Health Monitoring System for

aging and next generation aircraft. The developing RTASHMS is too big and complicated, does not work in real time and is expensive.

Currently, various types of manned and unmanned air platforms would need to install the RTASHMS on the aircraft for saving life cycle maintenance costs and increasing flight safety. Ultimately, the RTASHMS would provide an increased operation and mission capability and air platform's availability during war time.

The RTASHMS relates to all functional concepts that rely on manned and unmanned air vehicles.

The more detailed AV-1 will be presented in Appendix A.

### ***3.1.6 Assumptions***

It is assumed that sensor technology and methodology for detecting cracks on aircraft structures will provide continuous and reliable monitoring capability.

It is assumed that the information and data about RTASHMS will remain unclassified. At the time of this concept, the data concerning an RTASHMS is unclassified and will remain unclassified for the foreseeable future. There are no significant concerns about data security at this time.

It is assumed that the current USAF, Allied Air Forces, and other services will continuously use various types of manned and unmanned air platforms. Furthermore, they will need to get a real time, life cycle cost effective, and safety enhancing concept and methodology for detecting an Aircraft's structural damage and crack during both flight and ground maintenance phases.

### ***3.1.7 Findings***

The development of this architecture has provided insight into only some of the prior questions. Pertinent comments on these questions are listed below utilizing the same numbering scheme as in section 3.2.3:

1. This question has not yet been fully addressed by this architecture. The basic design and test effort provided some insight into simple hardware, software, and personnel requirements for a RTASHMS. Further testing and architectural construction will provide more details on equipment and personnel requirements.
2. Primarily operational pilots and operational maintainers have a responsibility for checking an aircraft's structural condition during flight and maintenance phase by using RTASHMS. The flight control center and ground maintenance center have a responsibility for gathering and recording aircraft structural condition data. The flight squadron supervisor and maintenance squadron supervisor have a responsibility for identifying, analyzing, and advising an appropriate action to the pilots and maintainers. The Flight wing commander has a responsibility for managing the RTASHMS.
3. Primary end users identified in the current architecture, are DoD, allied nation and commercial aircraft operators and maintainers, but it is anticipated that there will be more users than can currently be conceived. Potentially a system could be used in ground vehicles, ships and even static structures such as buildings and bridges.
4. This system relies on available or new sensor technology, wave generating and crack detecting methodology, and hardware/software technology. This system

relies on the existing communications infrastructure which has redundant paths and systems already built in. One example cited is Data Link, AND UHF/VHF Radio. Numerical reliability analyses were not performed.

5. As fully explained in Section 3.2., the anticipated technological advances will ultimately render this current architecture obsolete.
6. Due to the security capabilities and needs of the wide variety of anticipated users, the presence of both classified and unclassified paths will be needed.
7. Most aircraft systems have the wiring and hardware capabilities to integrate the RTASHMS processing and detection systems as well as the communication bandwidth to relay emergency data to the ground maintenance center or air operations center. Air platform specific studies will have to be conducted for integration purposes.

### 3.2 OV-1 (CONOPS /Operational-Views-1)



**Figure 21: CONOPS of Real Time ASHMS**

An OV-1, Concept of Operation (Figure 21) was developed to represent the overall Real Time Aircraft Structural Health Monitoring System at a high level. The Real Time ASHMS is able to check and distribute an aircraft's structural condition in flight and on the ground in real time to the pilot, the maintainer, and the flight and maintenance supervisor. The pilot and maintainer can check aircraft structural condition on the aircraft cockpit by using the aircraft's internal electrical power, equipment, and instruments. The aircraft structural condition data would be transferred to the Ground Maintenance Center by the aircraft's communication equipment, and data link systems. These aircraft structural conditions will then be transferred to a Flight & Maintenance Supervisor by

network and communication systems. Therefore, all of the users who are related to flight missions and operation can share the aircraft structural conditions information in real time. The more detailed OV-1 will be presented in Appendix B.

## **1. Fully-Dressed Use Case – Real Time Aircraft Structural Health Monitoring**

### **System:**

**2. Description:** The RTASHMS on the aircraft checks the aircraft's structural condition and sends the RTASHMS data to the ground maintenance center periodically and automatically when the ASHMS turns on during both flight and maintenance phases. The RTASHMS equipment consists of an ASHM cockpit instrument, data recording and processing software, sensors, wires, and a wave generator. The pilots, operational maintainers, depot maintainers, and ground maintenance center use the RTASHMS data to make decisions concerning the health of the aircraft.

**3. Actors:** Pilot, Operational Maintainer, Depot Maintainer, Ground Maintenance Center, Aircraft

**4. Preconditions:** The RTASHMS would be turned on by using the internal aircraft power or alternatively ground electrical power equipment. The aircraft's RTASHMS software is linked to the ground maintenance center by using data link, or UHF/VHF communication system. The RTASHMS web server for the ground maintenance center is always turned on and communicates with the aircraft's RTASHMS software.



## **5. Main Success Scenario:**

5.1. The ASHMS on the aircraft checks the aircraft structural condition and sends the ASHMS data to the ground maintenance center periodically and automatically during flight and maintenance phases.

5.2. The operational maintainer checks an aircraft's structural condition before flight.

5.3. Pilot checks the aircraft structural condition before taking off.

5.4. The RTASHMS distributes data to ground maintenance center during both flight and maintenance phases.

5.5. The pilot applies an appropriate emergency procedure when a crack or structural damage is identified on the ASHMS cockpit instrument during flight.

5.6. The depot maintainer repairs or replaces the aircraft's structural part when damage is detected by the ASHMS during ground maintenance phase.

## **6. Alternate flows:**

1a. There is an unknown error in the ASHMS software or hardware on the aircraft.

- i. The ASHMS on the aircraft shows an error message on the ASHMS instrument in the cockpit and sends an error message to the ground communication center.
- ii. The pilot and depot maintainer recognize the ASHMS is not working.

1b. The link between the ASHMS on the aircraft and web server in the ground maintenance center was broken. The communication between the aircraft ASHMS and ground web server is out of order.

- i. The ASHMS instrument in the cockpit shows communication error message to pilot.
- ii. The ground maintenance center web server shows communication error message to depot maintainer.

2a. There is an unknown structural damage or crack on the aircraft structure.

- i. The ASHMS instrument shows the problem and location to the operational maintainer.
- ii. The operational maintainer reports the problem and aborts the aircraft's flight.

3a. There is an unknown structural damage or crack on the aircraft structure.

- i. The ASHMS instrument shows the problem and location to the pilot.
- ii. The pilot applies a mission abort procedure.

**7. Post Conditions:** Success end condition. Real Time Aircraft Structural Health Monitoring

**8. Potential use case list:**

8.1. Army Use of the RTASHMS

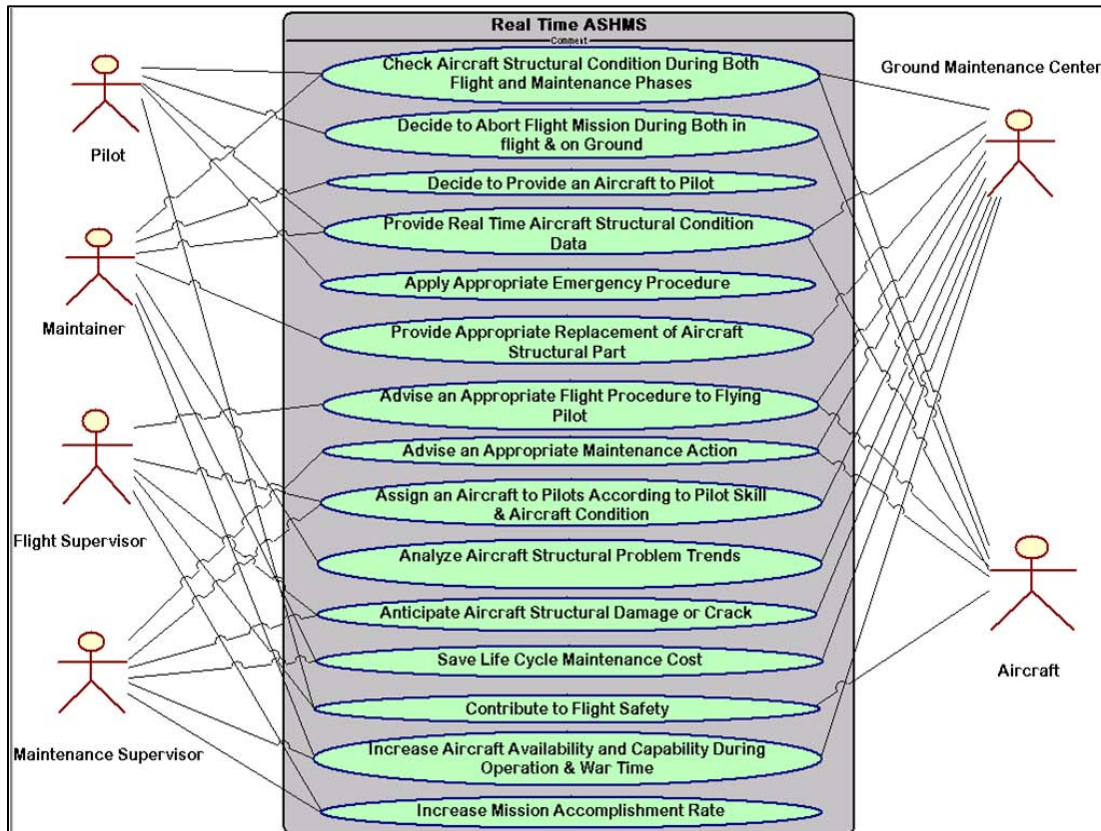
8.2. Navy Use of the RTASHMS

### 8.3. Allied Air Force's RTASHMS

### 8.4. Commercial Use of the RTASHMS

### 8.5. UAV Applications

### 3.3 Use Case Diagram.



**Figure 22: Use Case Diagram**

The Use Case Diagram (Figure 22) depicts the entire use case model of the RTASHMS. The primary actors of the RTASHMS are pilots, maintainers, and flight and maintenance supervisors. Moreover, all the people who are related to Air Force flight mission and operation could be potential primary actors. The supporting actors of the RTASHMS are the ground maintenance center and aircraft. These supporting/secondary

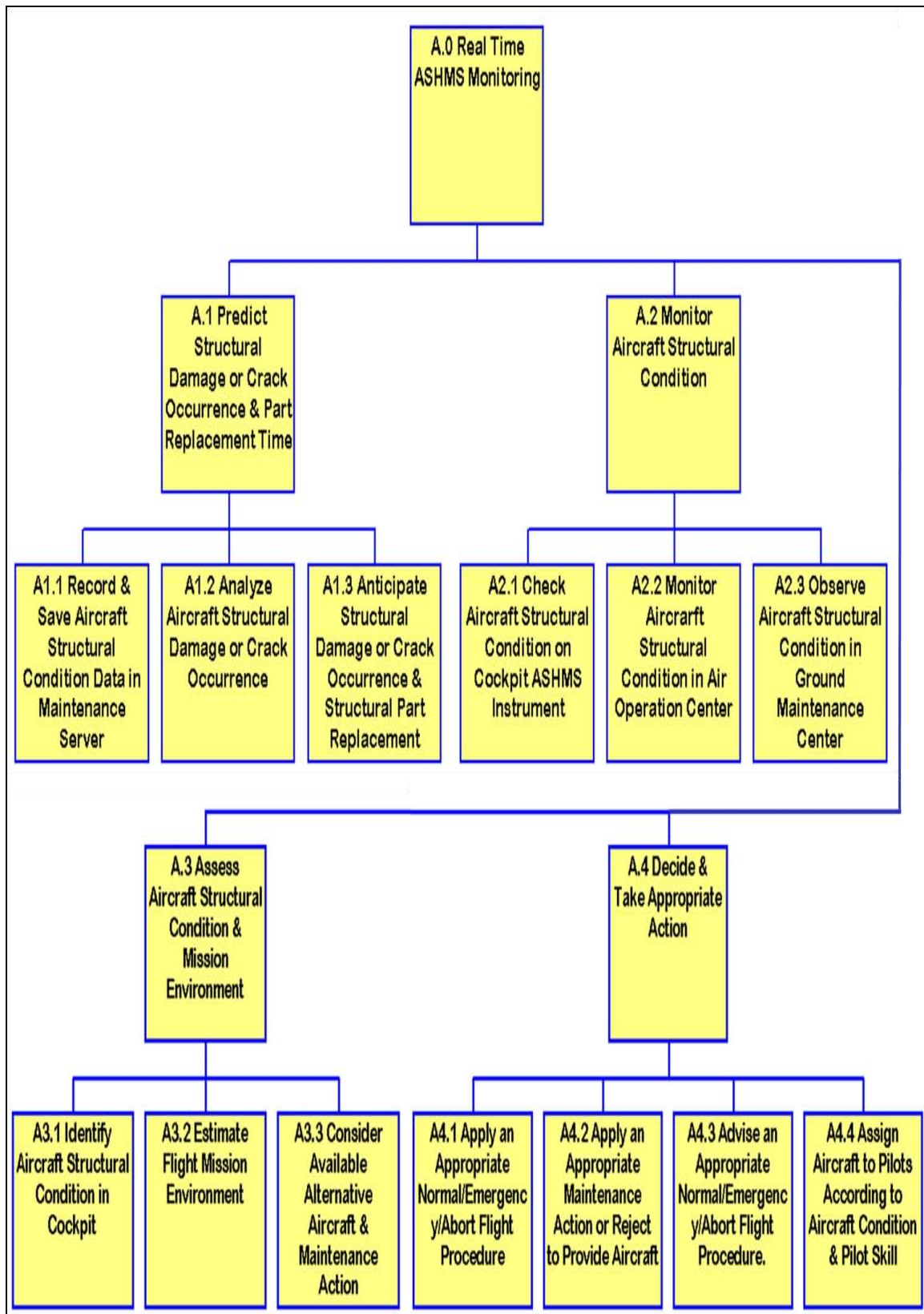
actors would provide a real time monitoring interface to primary actors. The purpose of this use case is to satisfy the primary actor's goal

### ***3.4 OV-5 (Operational Activity Diagram)***

The next architecture products are the OV-5s, the operational activity diagrams. The operational activity diagrams represent the functional decomposition of the overall system's operating scenarios and activities by using the inputs, controls, outputs, and mechanisms (ICOMs) for each function [6]. The research group focused on building the architecture by defining the main purpose of the activity model. The main purpose of the activity model is to provide a functional representation of the RTASHMS.

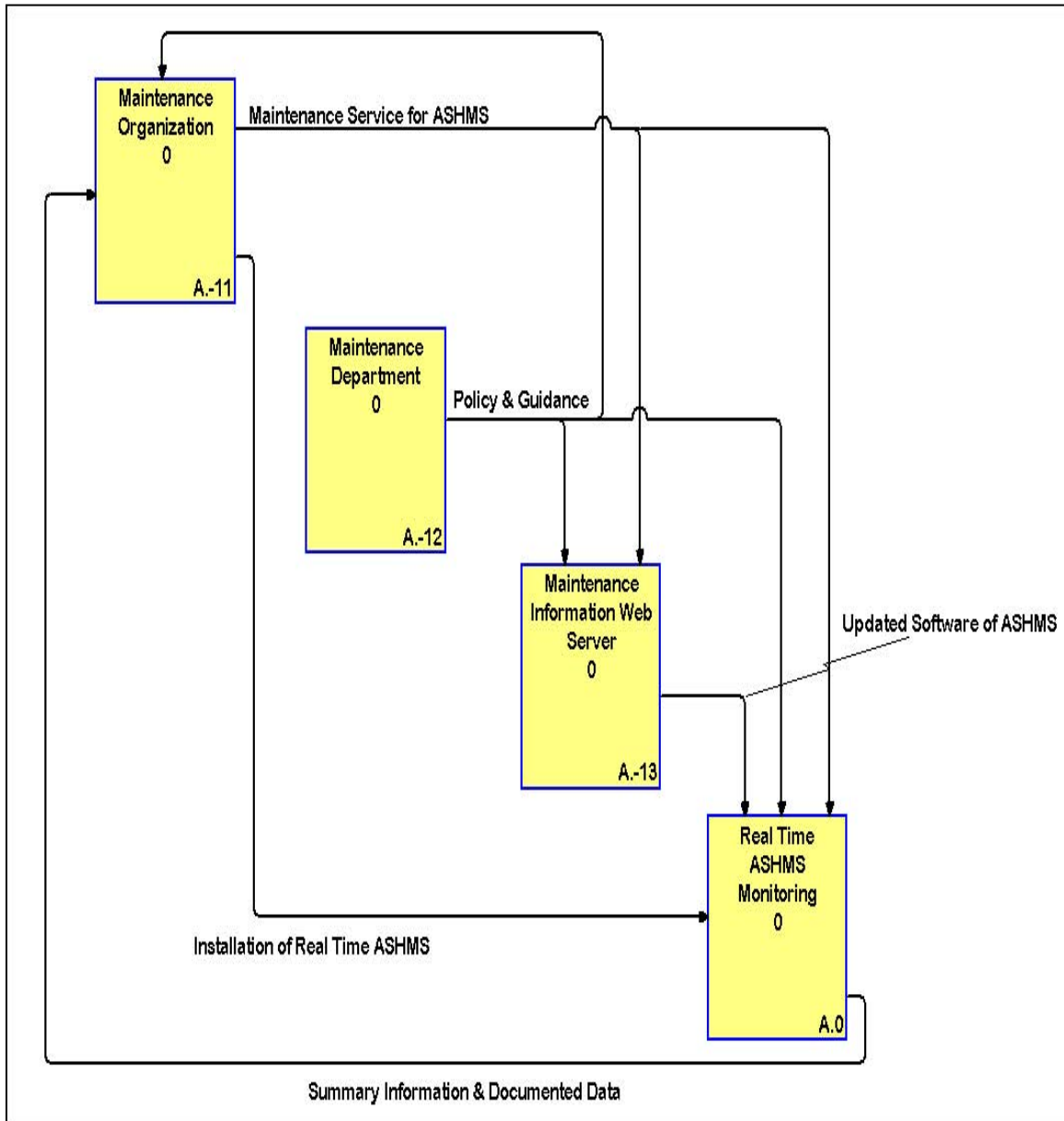
#### ***3.4.1 Node Tree Diagram***

The Node Tree Diagram (Figure 23) represents the functional decomposition of the RTASHMS. The highest level function (A.0 Implement RTASHMS) consists of four main functions – Predict Structural Damage or Crack Occurrence and Part Replacement, Monitor Aircraft Structural Condition, Assess Aircraft Structural Condition and Mission Environment, and Decide and Take Appropriate Action. Each main function was further decomposed into more detailed functions.



**Figure 23: Node Tree Diagram**

### 3.4.2 External System Diagram (A-1 Page)

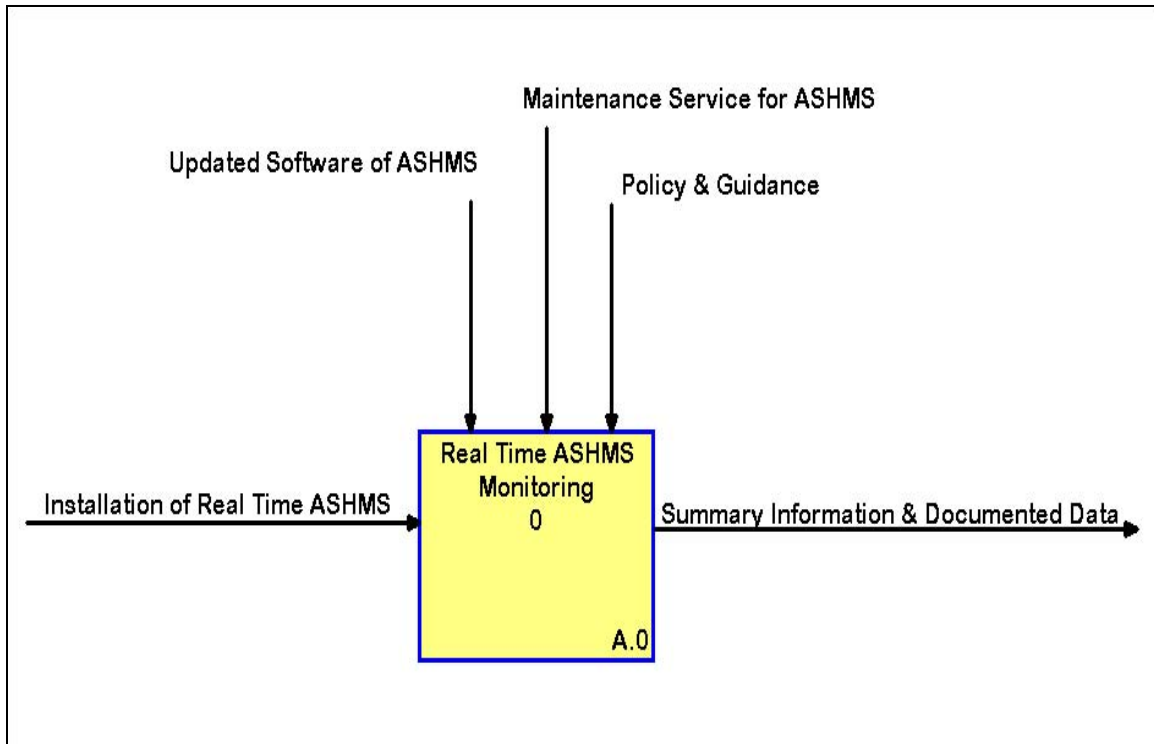


**Figure 24: External System Diagram (A-1 Page)**

The A-1 Page (Figure 24) describes the External system of the RTASHMS Monitoring. The relating External Systems are Maintenance Organization, Maintenance Department, and Maintenance Information Web Server. These External Systems would provide maintenance service, updated software, and policy and guidance as Controls.

### 3.4.3 Context Diagram (A-0 Page)

The following architecture product (Figure 25) is the Context Diagram. This Context Diagram has Inputs, Outputs, and Controls. The Input is only Installation of RTASHMS. Maintenance Service, Policy and Guidance, and Updated Software would be provided for this A.0, RTASHMS Monitoring. The outcome will be Summary Information & Documented Data.

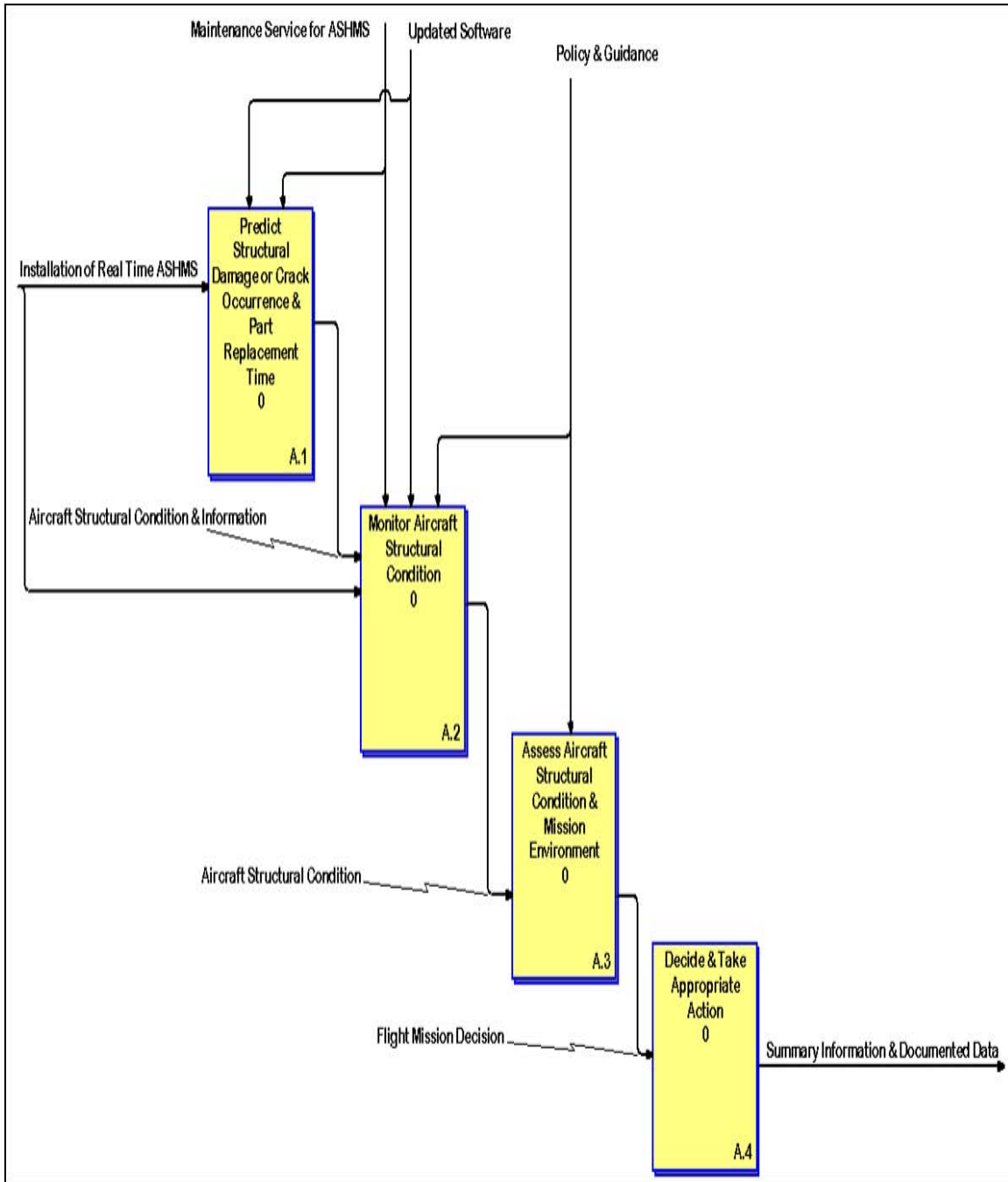


**Figure 25: Context Diagram**

#### ***3.4.4 Implement Real Time ASHMS (A0 Page)***

This A0 Page (Figure 26) represents the overall internal system’s operating activities & functions which are included in A.0 RTASHMS Monitoring. The A0 RTASHMS Monitoring has four sub functions – Predict Structural Damage or Crack Occurrence and Part Replacement Time, Monitor Aircraft Structural Condition, Assess Aircraft Structural Condition & Mission Environment, and Decide and Take Appropriate

Action. The group followed OODA Loop (Observe, Orient, Decide, and Act). The A0 diagram describes how the RTASHMS could interact with Air Force Flight.



**Figure 26: Implement Real Time ASHMS (A0 Page)**



### 3.4.5 Predict Structural Damage or Crack Occurrence & Part Replacement (A1 Page)

The A1 Page (Figure 27) describes sub functions of the A1 Predict Structural Damage or Crack Occurrence and Part Replacement. The RTASHMS can distinguish between a bad and a good structural condition aircraft by predicting structural damage or crack occurrence and part replacement time. Therefore, flight and maintenance supervisors can assign an appropriate aircraft to a pilot according to aircraft's condition and flying skill. It will contribute to increased flight safety and mission accomplishment rate.

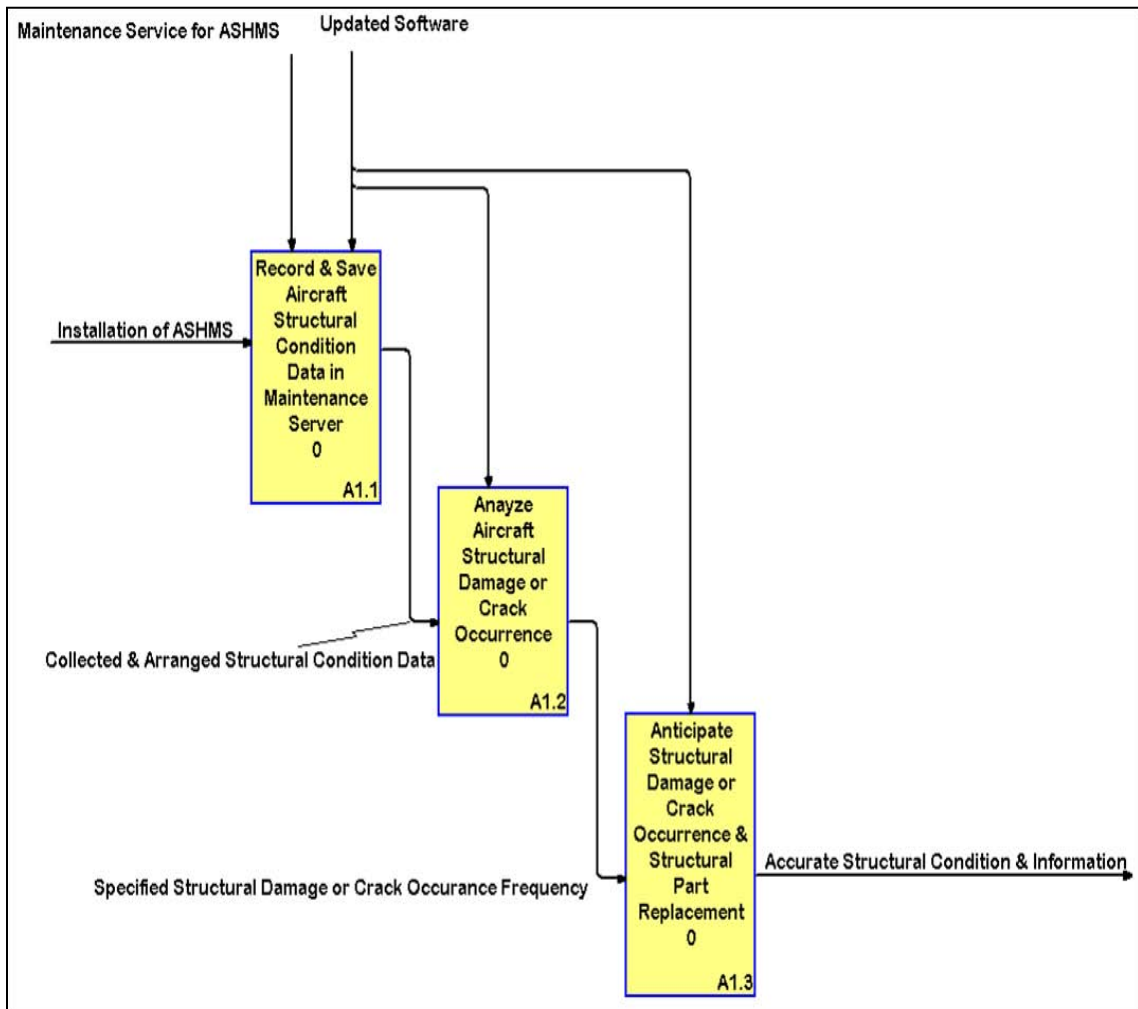


Figure 27: Predict Structural Damage or Crack Occurrence & Part Replacement

### 3.4.6 Monitor Aircraft Structural Condition (A2 Page)

The A2 Page (Figure 28) is the description of A2 Monitor Aircraft Structural Condition. Monitoring aircraft structural condition can be conducted in flight, on the ground, in Air Operation Center, and in Ground Maintenance Center. The A2 page represents the real time monitoring concept of the RTASHMS.

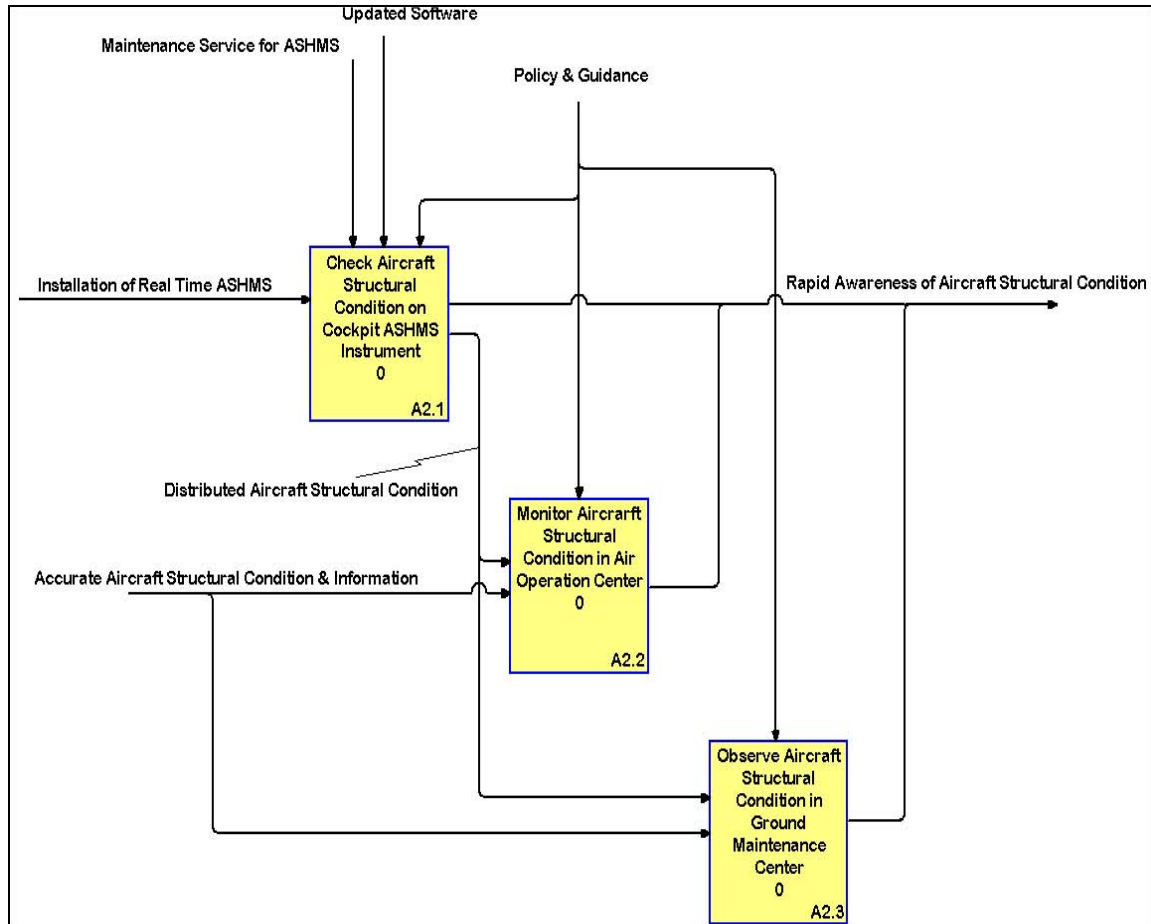
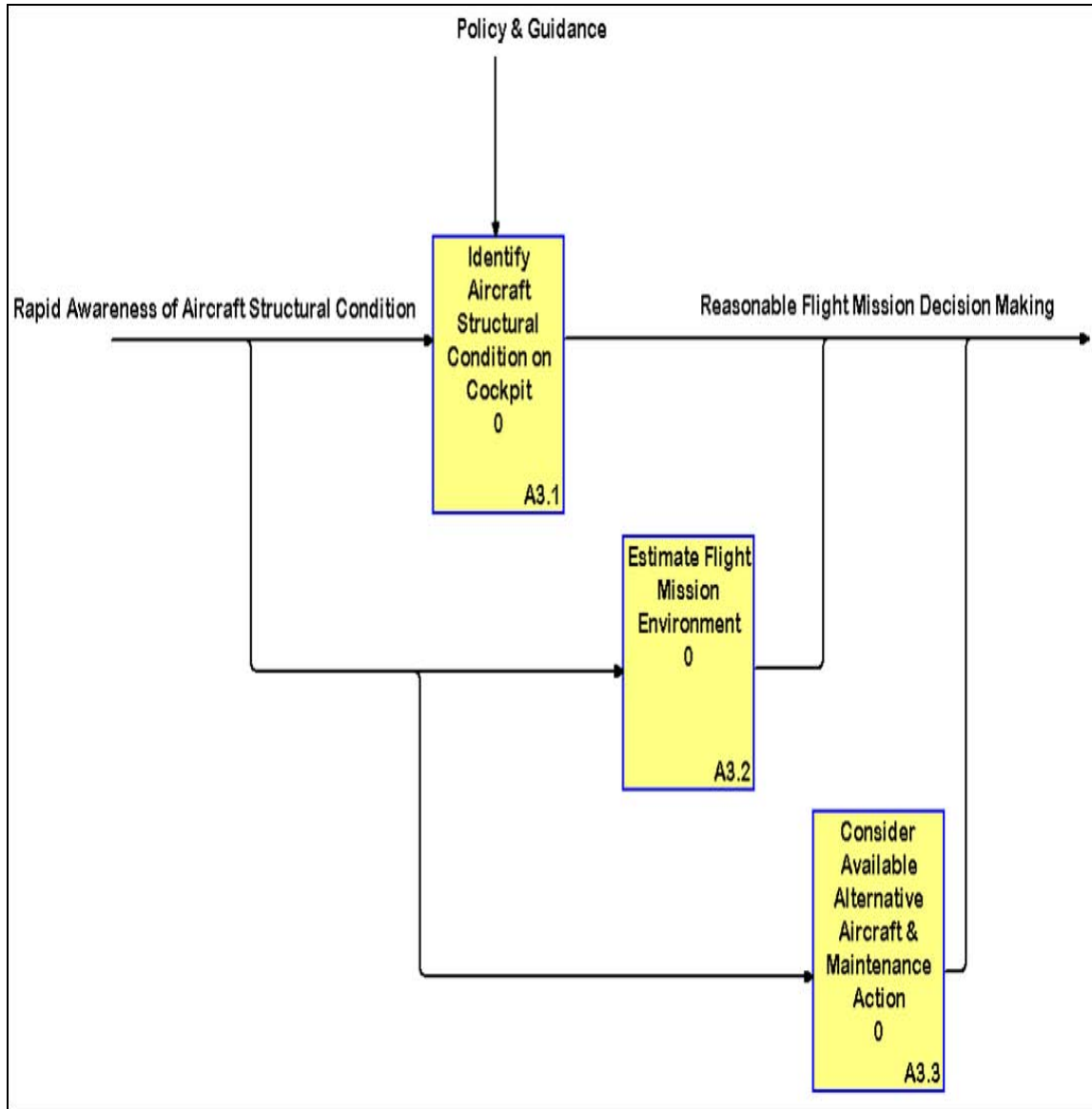


Figure 28: Monitor Aircraft Structural Condition

### 3.4.7 Assess Aircraft Structural Condition & Mission Environment (A3 Page)

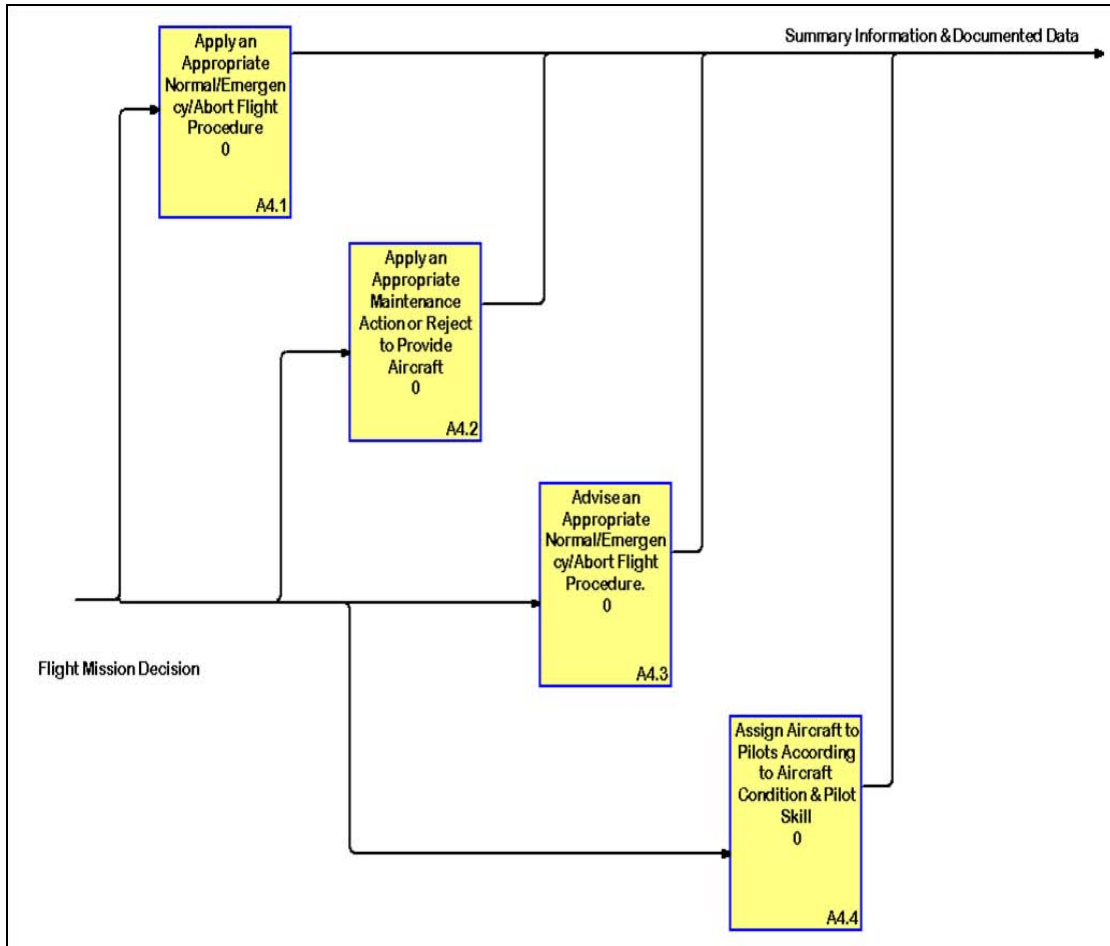
The A3 page (Figure 29) describes how the operational pilot, the operational maintainer, the flight and maintenance supervisor assess the aircraft structural condition and mission environment. The rapid and accurate assessment of aircraft structural condition & mission environment will result in rapid & accurate decisions and actions.



**Figure 29: Assess Aircraft Structural Condition & Mission Environment**

**3.4.8 Decide & Take Appropriate Action (A4 Page)**

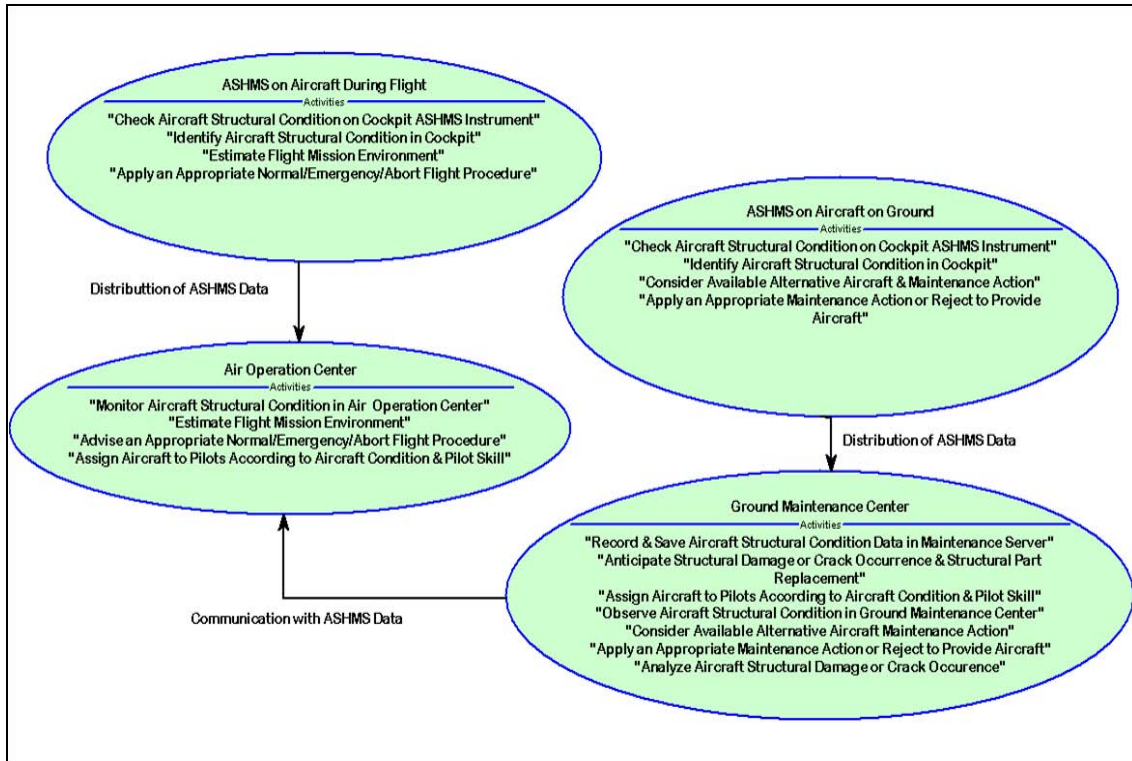
The A4 page (Figure 30) represents decisions and actions which can be conducted by the operational pilot and maintainer, and the flight and maintenance supervisor in real time by monitoring the RTASHMS.



**Figure 30: Decide & Take Appropriate Action**

**3.5 OV-2 (Operational Node Connectivity Diagram)**

The OV-2, Operational Node connectivity Diagram (Figure 31) shows each operational scenarios and activities of ASHMS on Aircraft, Air Operation Center, and Ground Maintenance Center. The OV-2 describes what kind of operational activities and scenarios can be conducted in each node – ASHMS on aircraft during flight, ASHMS on aircraft on the ground, Air Operation Center, and Ground Maintenance Center.



**Figure 31: OV-2 (Operational Node Connectivity Diagram)**

### 3.6 OV-4 (Organization Chart Diagram)

The OV-4, Organization Chart Diagram (Figure 32) describes the relationships of the RTASHMS organizations. The organization of the RTASHMS is composed of a Flight Wing Commander, Flight and Maintenance Squadron Supervisors, Operational Pilot and Maintainer, Air Operation Center, and a Ground Maintenance Center. Flight & Maintenance organizations can share the RTASHMS data provided by the RTASHMS. Therefore, all users can monitor an aircraft's structural condition in real time. These organizations can be users and stake holders for the RTASHMS.

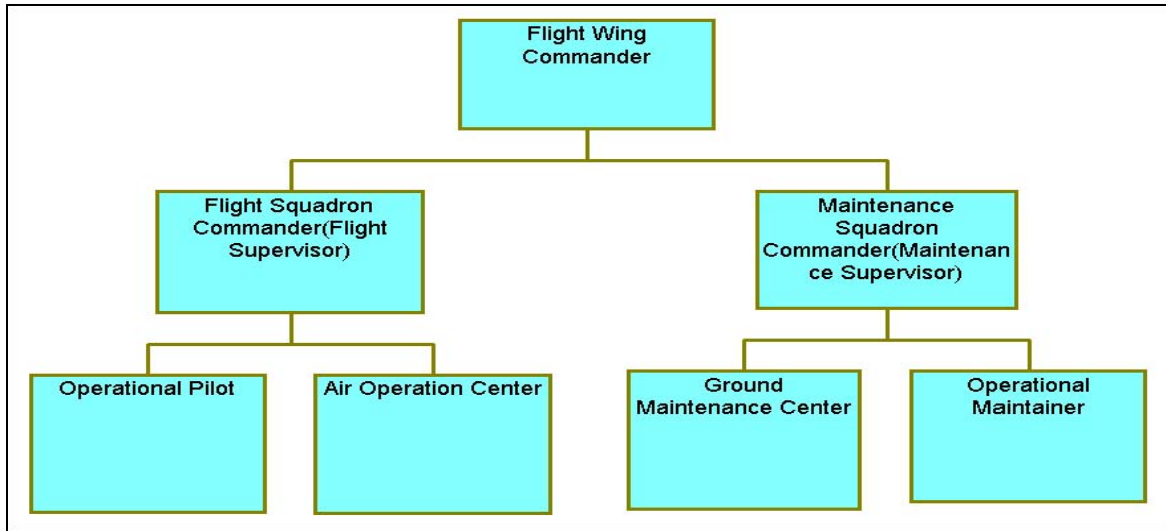


Figure 32: OV-4 (Organization Chart Diagram)

3.7 SV-4 Node Tree (Functional Decomposition Diagram)

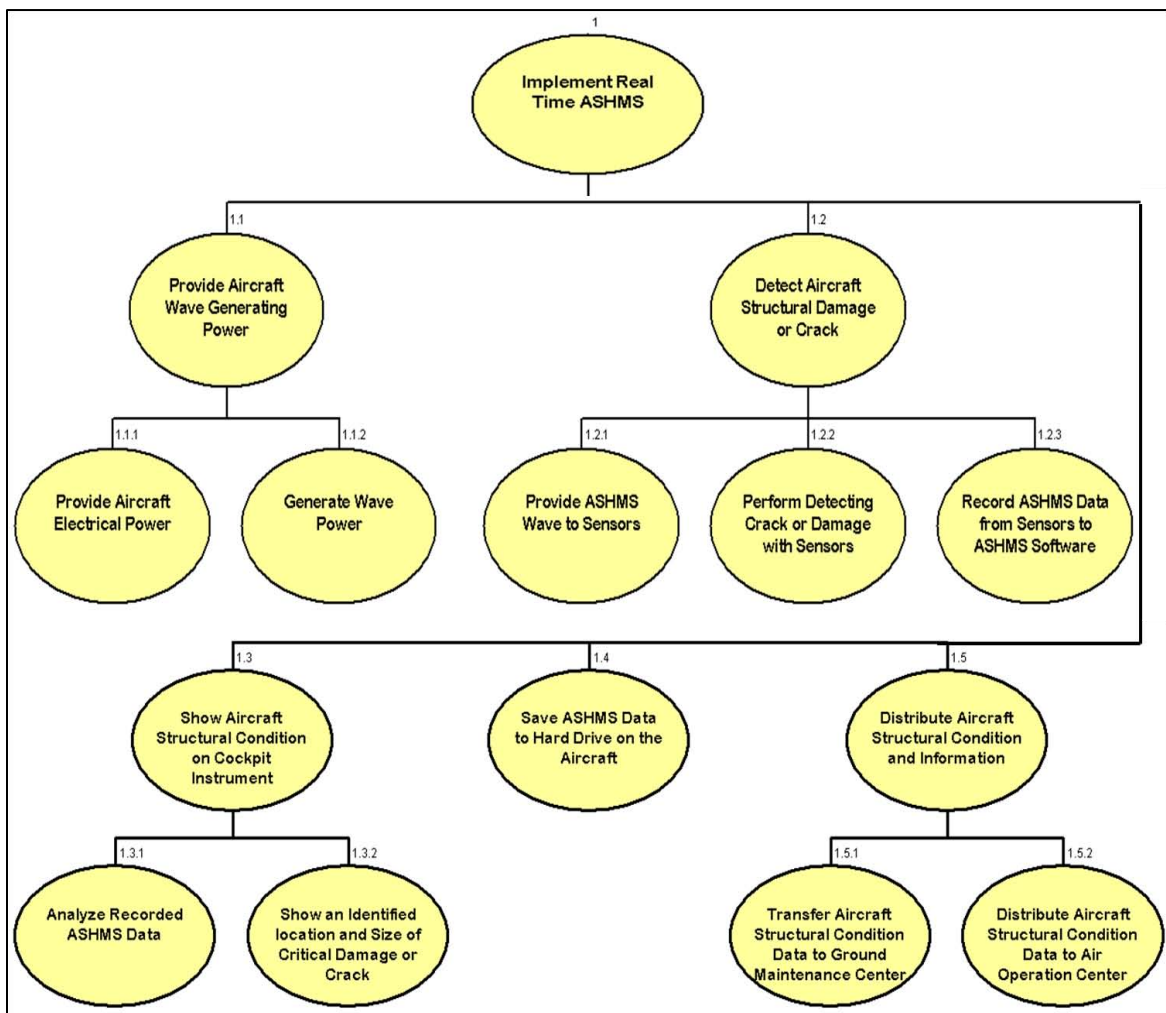
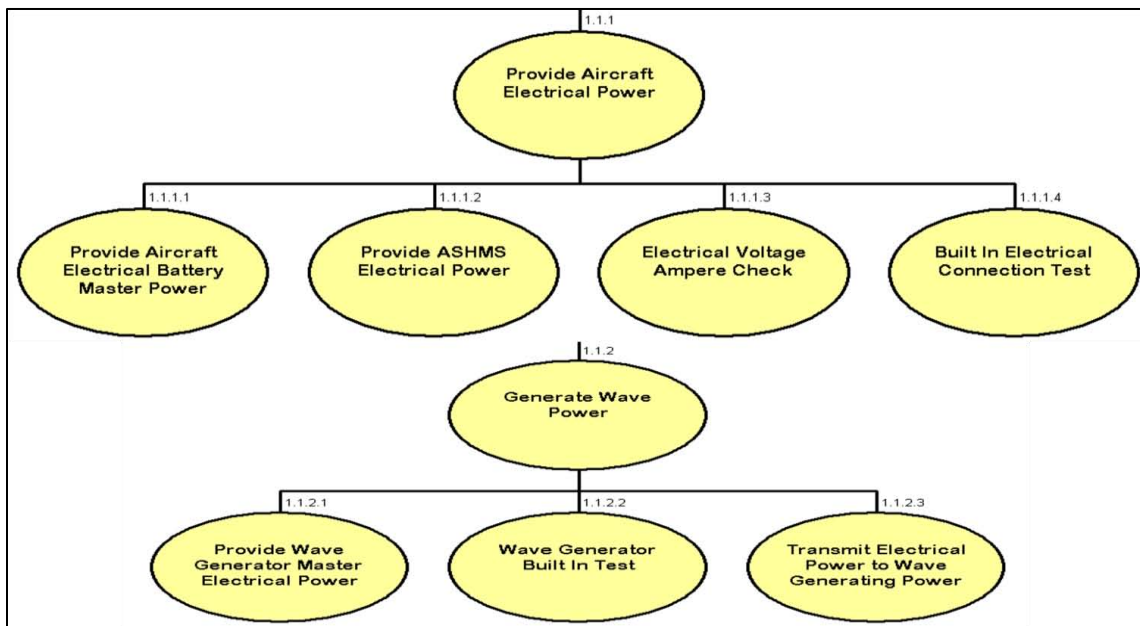


Figure 33: SV-4 Implement Real Time ASHMS

The SV-4 Node Tree architecture products (Figure 33) provide system functional hierarchies, and decompositions. The SV-4 Node Tree Diagram represents what system function would be needed to implement the RTASHMS. The SV-4 Node Tree has five system functions – Provide Aircraft Wave Generating Power, Detect Aircraft Structural Damage or Crack, Show Aircraft Structural Condition on Cockpit Instrument, Save ASHMS Data to Hard Drive on Aircraft, and Distribute Aircraft Structural Condition and Information. Due to immature and unreliable sensor technology, the most problematic system function to implement has been “Detect Aircraft Structural Damage or Crack”. This research will provide data and testing of a cutting edge sensor that has the potential to advance the community’s ability to accomplish this system function.

### 3.7.1 Provide Wave Generating Power

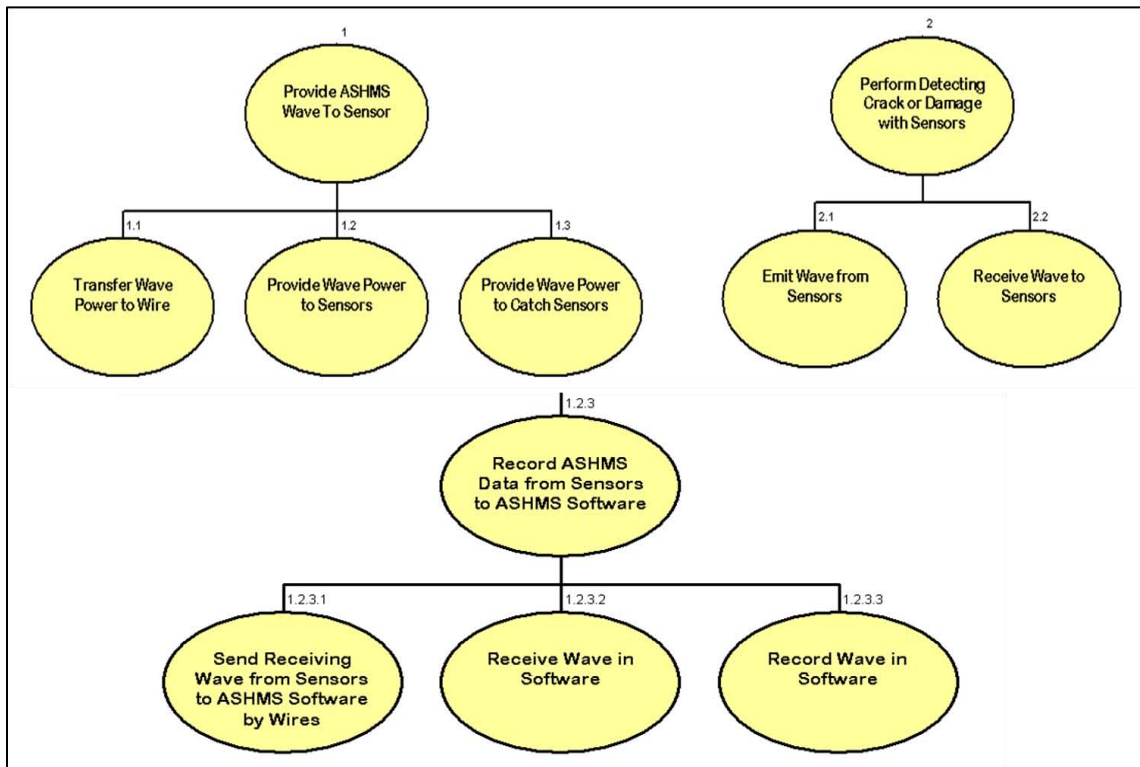
The “Providing Wave Generating Power” (Figure 34) shows the system uses aircraft internal power to operate the wave generation systems that the sensors need. The diagram (Figure 34) emphasizes the RTASHMS utilize only aircraft’s electrical power.



**Figure 34: Provide Wave Generating Power**

### 3.7.2 Detect Aircraft Structural Damage or Crack

The “Detect Aircraft Structural Damage or Crack” (Figure 35) shows how the RTASHMS detects the aircraft’s structural condition on aircraft by using various sensors. The detecting methodology of the PZT and IDT sensors need to be developed.

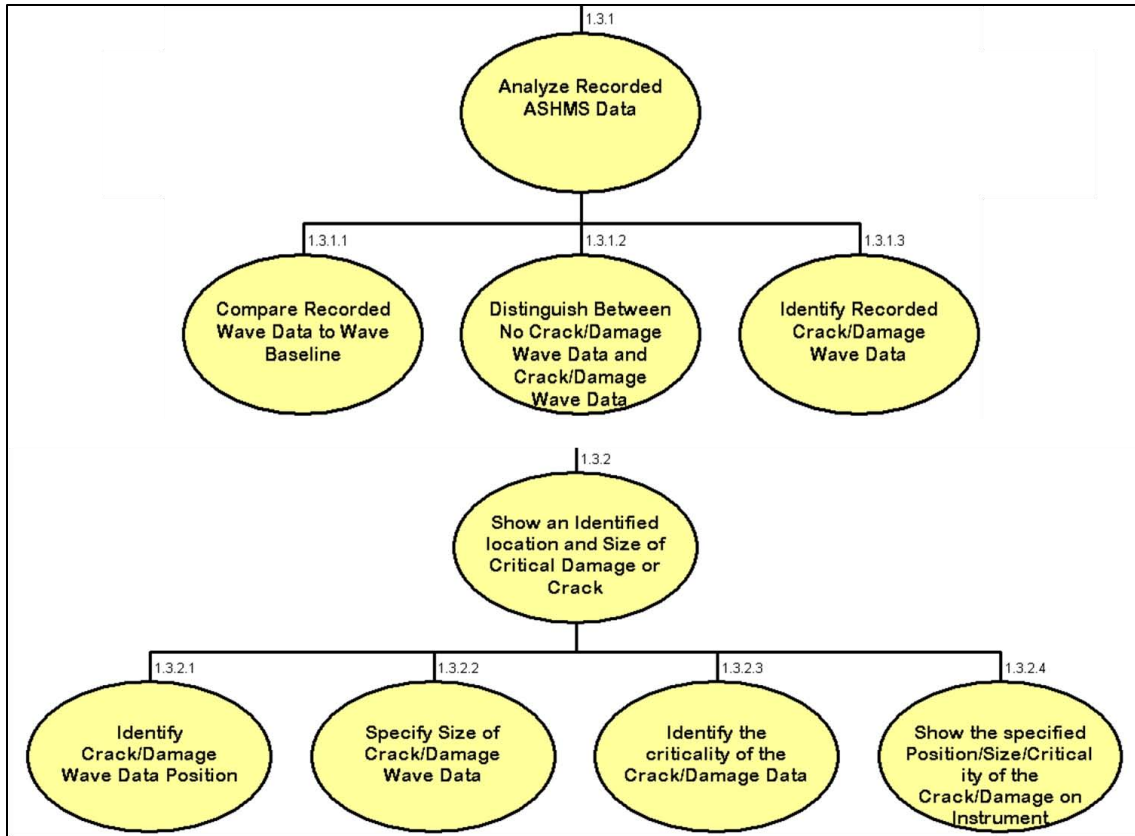


**Figure 35: Detect Aircraft Structural Damage or Crack**

### 3.7.3 Show Aircraft Structural Condition on Cockpit Instrument

The “Show Aircraft Structural Condition on Cockpit Instrument” (Figure 36) represents how the operational pilot and maintainer check aircraft structural condition in real time. The RTASHMS cockpit instrument shows the aircraft’s structural condition in real time.

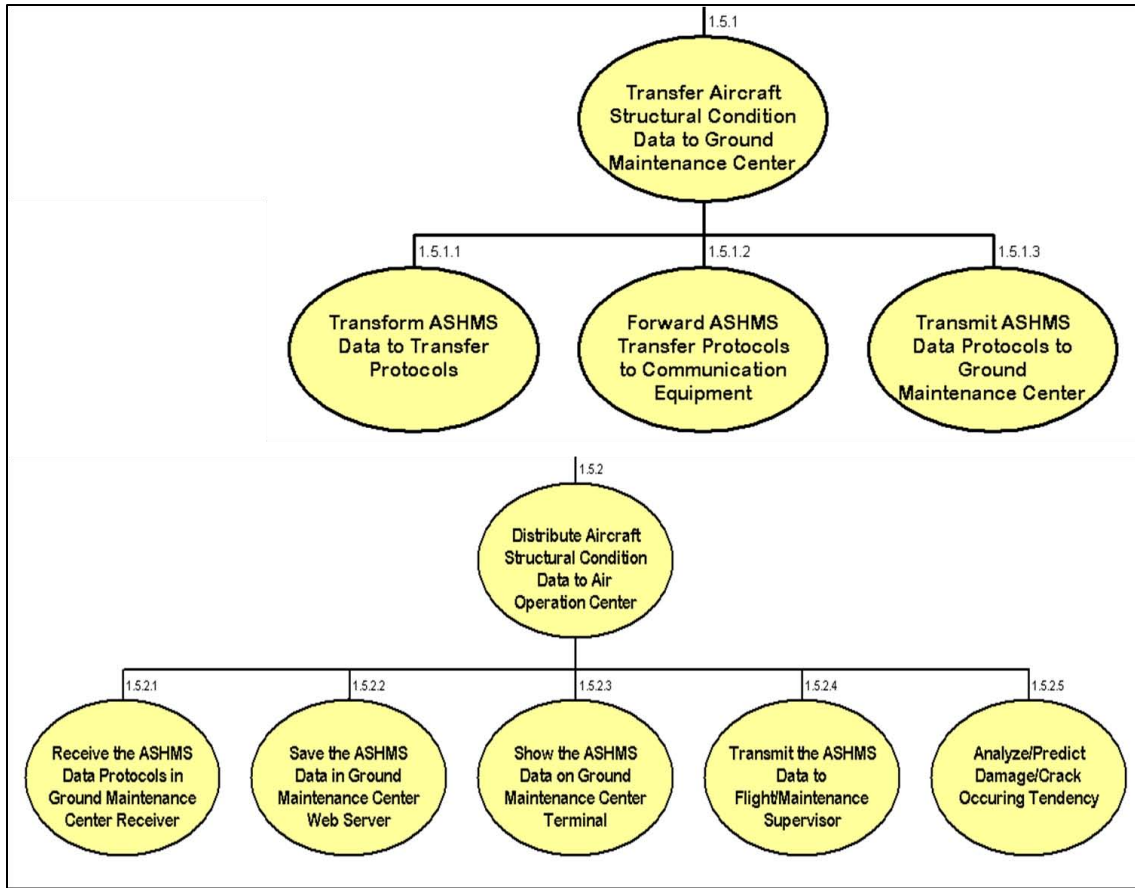




**Figure 36: Show Aircraft Structural Condition on Cockpit Instrument**

#### ***3.7.4 Distribute Aircraft Structural Condition and Information***

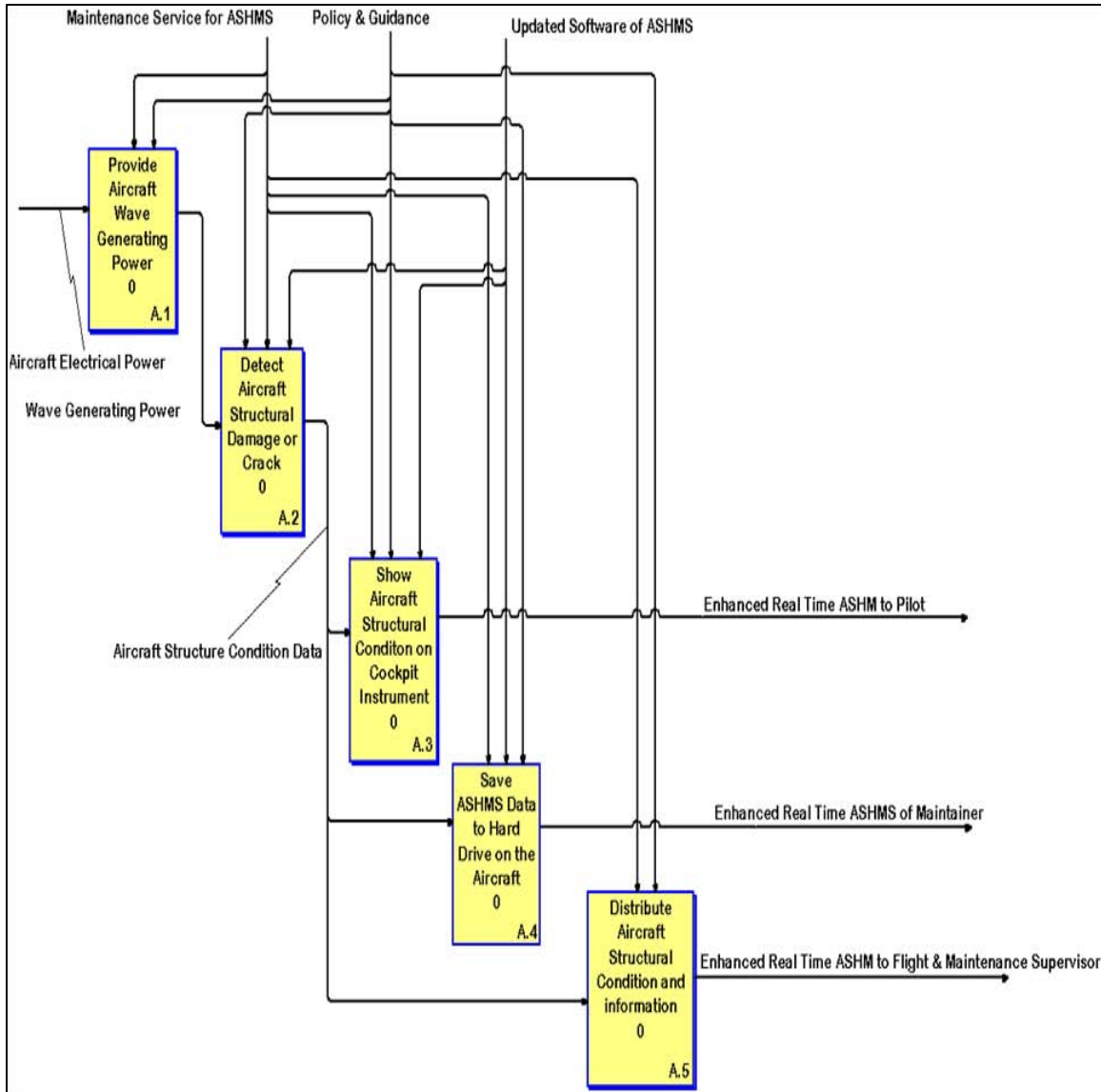
The “Distribute Aircraft Structural Condition and Information” (Figure 37) describes how the RTASHMS data could distribute data to the flight and maintenance supervisor in real time. The RTASHMS on aircraft has the system function to transmit aircraft’s structural condition data to the ground maintenance center and air operation center. The flight and maintenance supervisor in the ground maintenance center or the air operation center can monitor aircraft structural condition in real time.



**Figure 37: Distribute Aircraft Structural Condition and Information**

### 3.8 SV-4 IDEF0 Version (Systems Functionality Description)

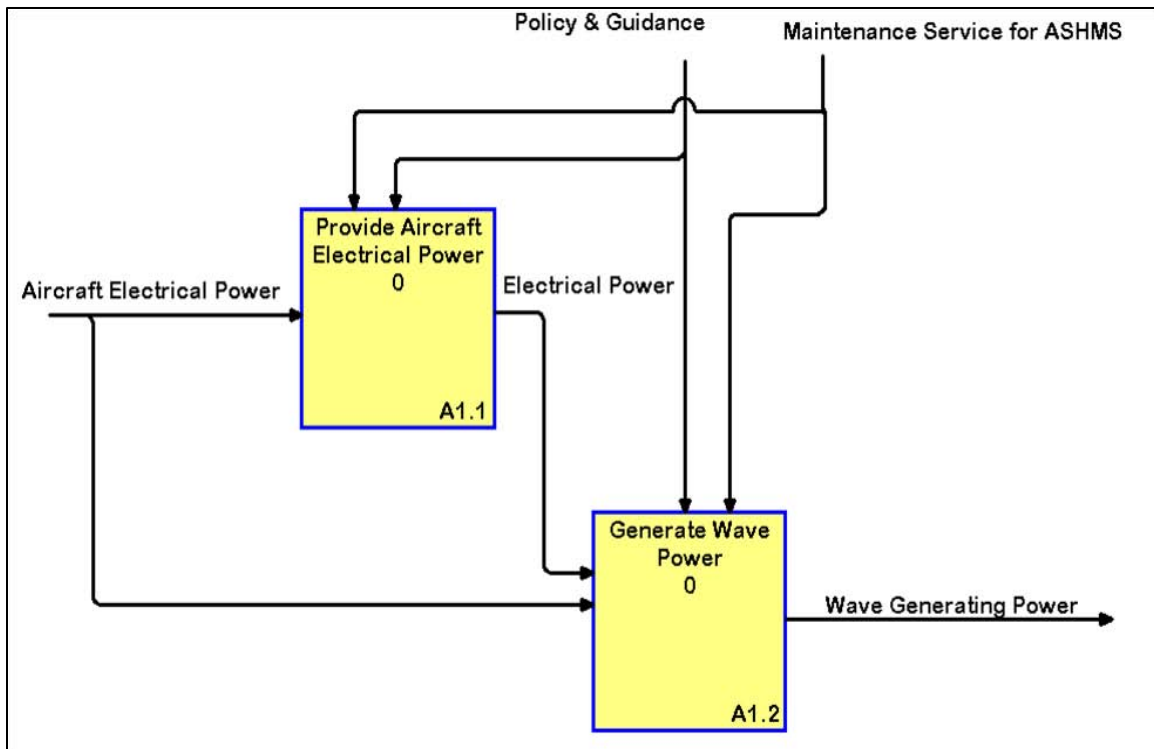
The SV-4 IDEF0 Version of Systems Functionality Description products (Figure 38, 39, 40, 41, 42) would describe the functions performed by systems and the systems data flows among system functions and activities. Each node in the SV-4 IDEF0 had already been described in the SV-4 node tree diagram. The input is aircraft electrical power. The controls are maintenance service, policy and guidance, and updated software. Throughout the functions and the service data flows, the SV-4 IDEF0 draws the output such as Enhanced Real Time ASHM to pilot, of maintainer, and to flight and maintenance supervisor.



**Figure 38: SV-4 IDEF0 Version Implement Real Time ASHMS (A0)**

### **3.8.1 Provide Aircraft Wave Generating Power (A1)**

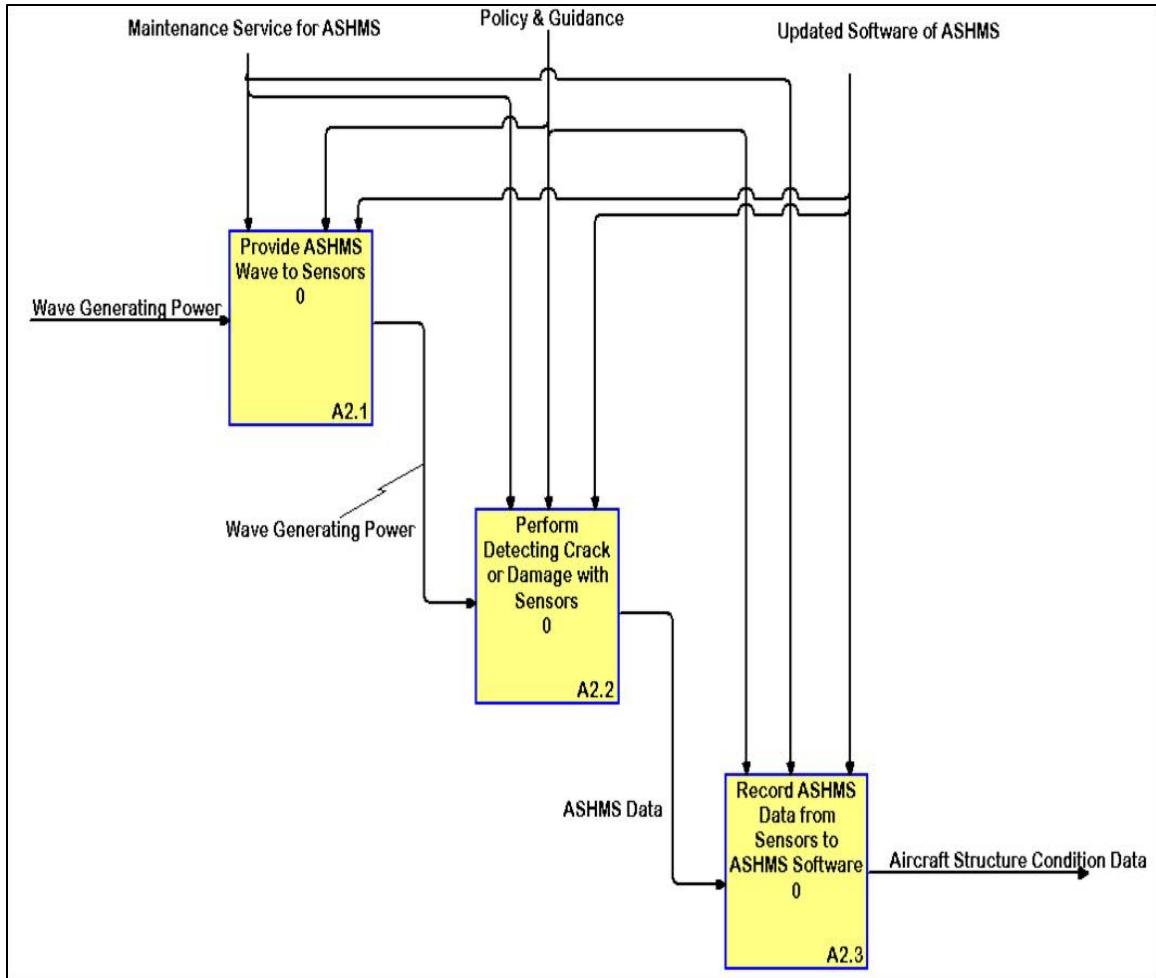
The “Provide Aircraft Wave Generating Power” (Figure 39) shows the transition from Aircraft Electrical Power to Wave Generating Power by the system functions. A wave generator would be used for generating wave power. The wave power would be used to detect structural damage or crack by various sensors.



**Figure 39: Provide Aircraft Wave Generating Power (A1)**

### ***3.8.2 Detect Aircraft Structural Damage or Crack (A2)***

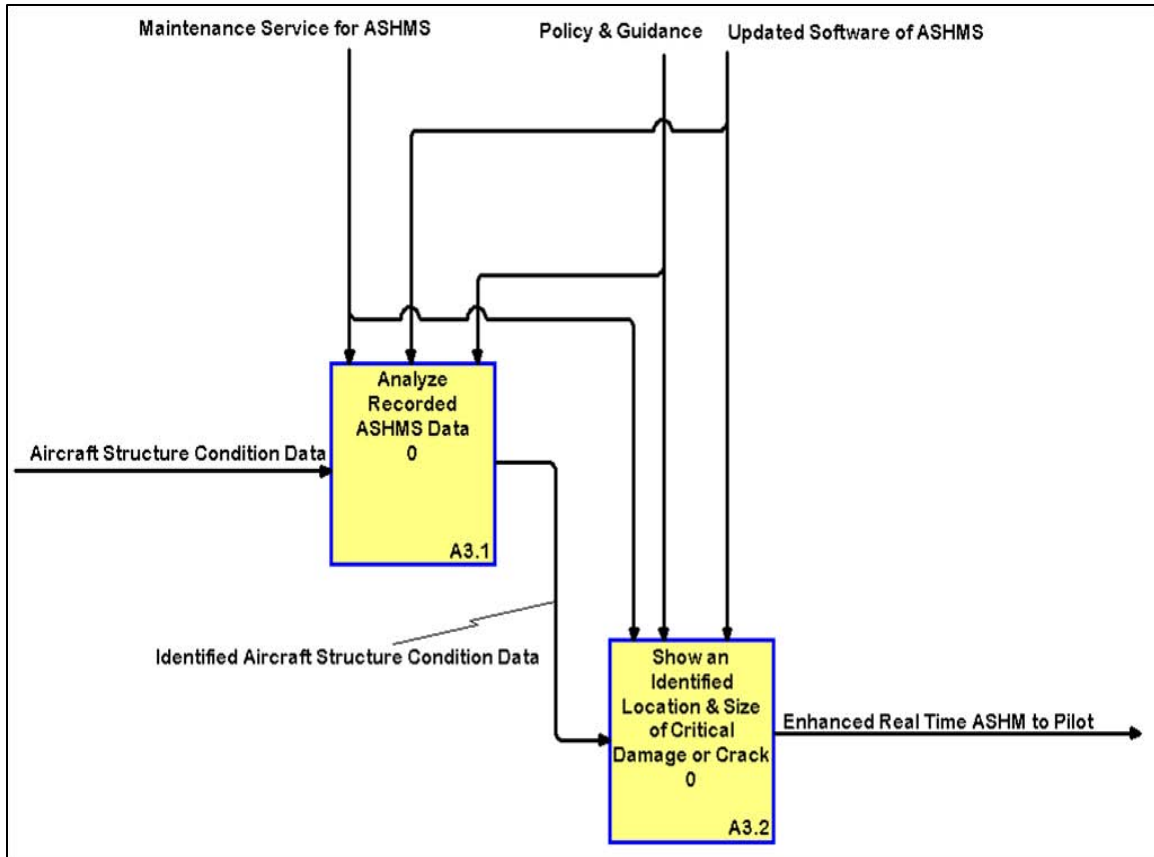
The “Detecting Aircraft Structural Damage or Crack” (Figure 40) is the most important part of the RTASHMS System Architecture. The group’s engineering effort concentrated on discovering the best methodology to detect aircraft structural damage or crack by testing of PZT and IDT sensors. The diagram (Figure 40) shows how the RTASHMS detects aircraft structural damage or crack.



**Figure 40: Detect Aircraft Structural Damage or Crack (A2)**

**3.8.3 Show Aircraft Structural Condition on Cockpit Instrument (A3)**

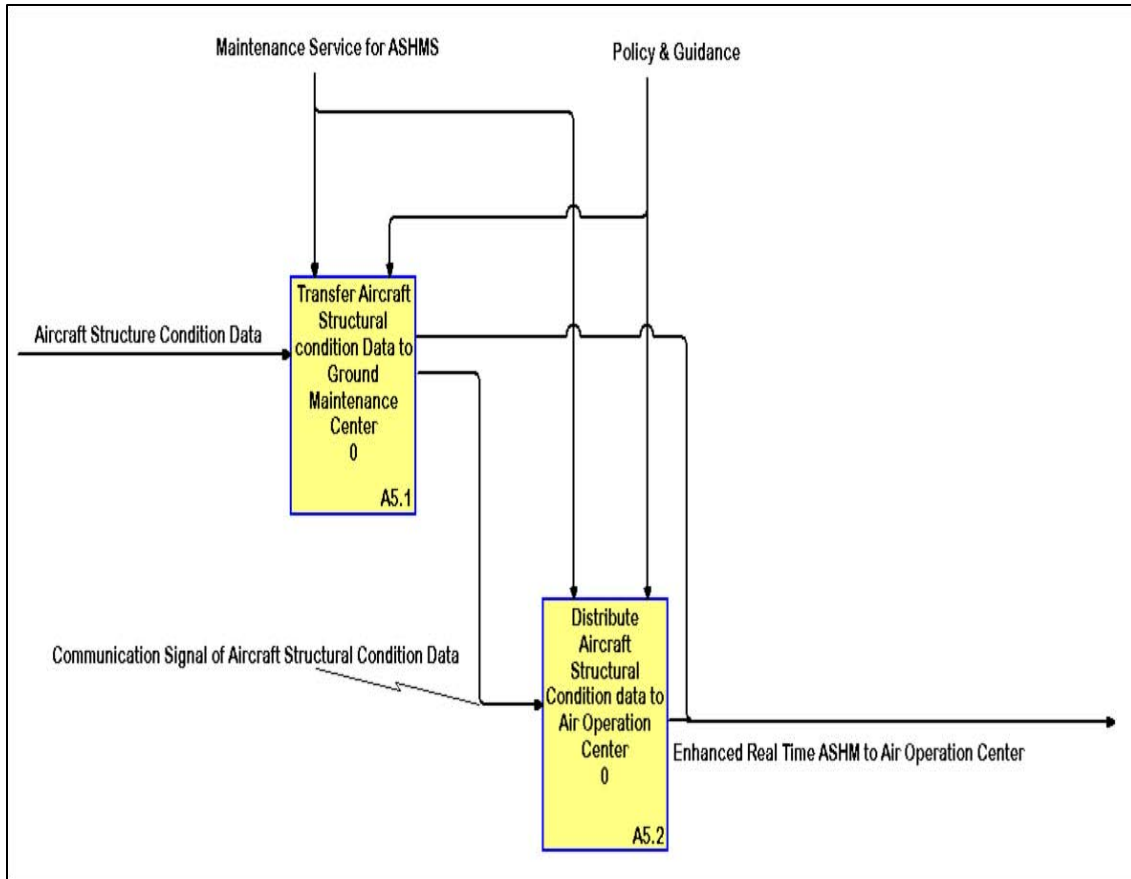
The “Show Aircraft Structural Condition on Cockpit Instrument” (Figure 41) describes how the RTASHMS shows aircraft structural condition on the cockpit instrument. After detecting the structural condition or crack, the RTASHMS software would compare collected aircraft structural condition data from the sensors to the ASHMS baseline data. The ASHMS baseline data can be collected by testing. If the software finds a crack or damage, the software would identify and show the structural damage or crack on cockpit instrument.



**Figure 41: Show Aircraft Structural Condition on Cockpit Instrument (A3)**

### ***3.8.4 Distribute Aircraft Structural Condition and Information (A5)***

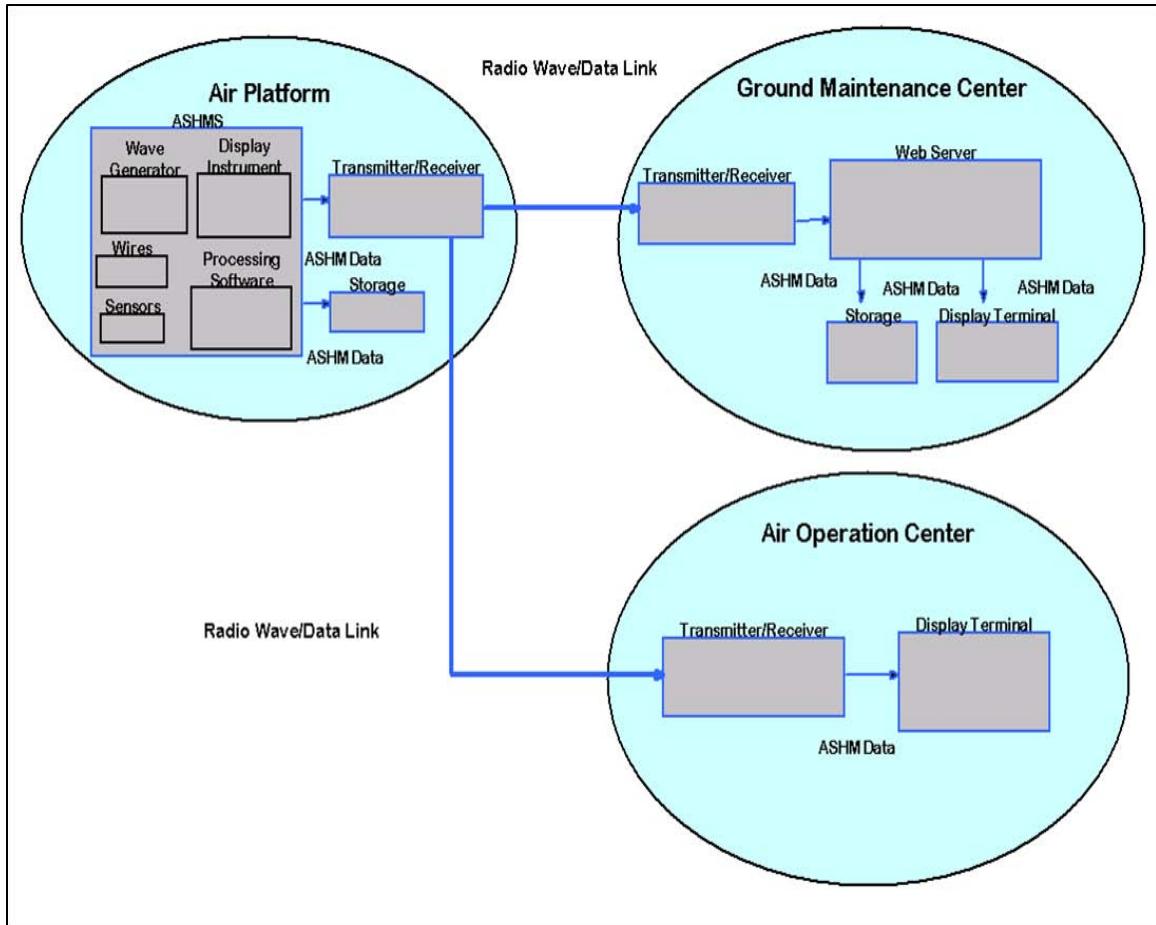
The “Distribute Aircraft Structural Condition and Information” (Figure 42) represents how the aircraft structural condition data can be distributed to the flight and maintenance supervisors. The RTASHMS software should have a system function of transmitting and receiving. Therefore, when an in flight problem occurs all users – the operational pilot and maintainer, and flight maintenance supervisor can monitor aircraft structural condition in real time. Normal structural condition data will be downloaded following each flight or maintenance check.



**Figure 42: Distribute Aircraft Structural Condition and Information (A5)**

### **3.9 SV-1 (System Interface Diagram)**

The SV-1 (Figure 43) describes system interface. The RTASHMS has three interfaces – ASHMS on air platform, ground maintenance center, and air operation center. Each interface has a function of transmitting and receiving ASHMS data. The ASHMS data can be distributed to each other by using communication system, and data link. Therefore, the operational pilot and maintainer, the flight and maintenance supervisor can share aircraft’s structural condition in real time.



**Figure 43: SV-1 (System Interface Diagram)**

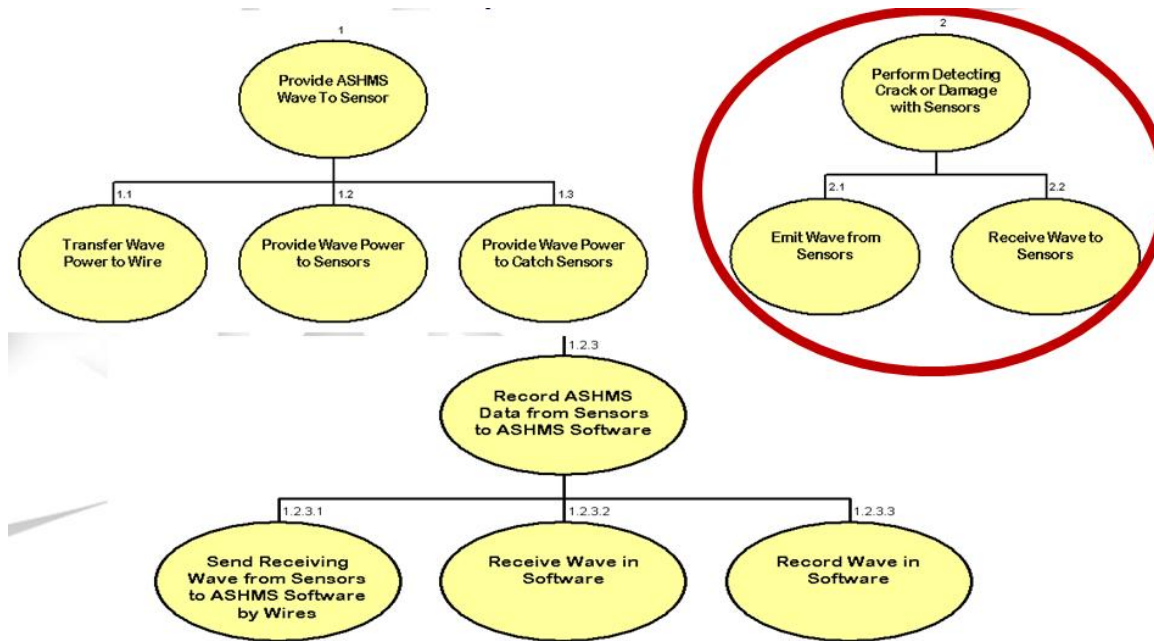
### 3.10 SV-5 (System Function to Operational Activity Chart)

The SV-5, System Function to Operational Activity Chart (Figure 45) maps operational activities to specific system functions in the architecture. This SV-5 allows decision makers to find redundant/duplicative systems, gaps in capabilities, and possible future investment.



SV-5 System Function to Operational Activity	Record & Save Aircraft Structural Condition Data on Maintenance Server	Analyze Aircraft Structural Damage or Crack Occurrence	Anticipate Structural Damage or Crack Occurrence & Structural Part Replacement	Check Aircraft Structural Condition on Cockpit ASHMS Instrument	Monitor Aircraft Structural Condition in Air Operation Center	Observe Aircraft Structural Condition in Ground Maintenance Center	Identify Aircraft Structural Condition on Cockpit	Estimate Flight Mission Environment	Consider Available Alternative Aircraft & Maintenance Action	Apply an Appropriate Normal/Emergency/Abort Flight Procedure	Apply an Appropriate Maintenance Action or Reject to Provide Aircraft	Advise an Appropriate Normal/Emergency/Abort Flight Procedure	Assign Aircraft to pilots According to Aircraft Condition & Pilot Skill
Provide Aircraft Electrical Battery Master Power				X	X								
Provide ASHMS Electrical Power				X	X								
Electrical Voltage Ampere Check				X	X								
Built In Electrical Connection Test				X	X								
Provide Wave Generator Master Electrical Power				X	X								
Built In Wave Generator Test				X	X								
Transmit Electrical Power to Wave Generating Power				X	X								
Transfer Wave Power to Wire				X	X								
Provide Wave Power to Sensors				X	X								
Emit Wave from Sensors				X	X								
Receive Wave to Sensors				X	X								
Send Receiving Wave from Sensors to ASHMS Software by Wires				X	X								
Receive Wave in Software				X	X								
Record Wave in Software				X	X								
Compare Recorded Wave Data to Wave Baseline		X		X		X	X			X			X
Identify Crack/Damage Wave Data Position		X		X		X	X			X			X
Specify Size of Crack/Damage Wave Data		X		X		X	X	X	X	X			X
Identify the Criticality of the Crack/Damage Data		X		X		X	X	X	X	X			X
Show the Specified Position/Size/Criticality of the Crack/Damage on Instrument		X		X	X		X	X	X	X			X
Transform ASHMS Data to Transfer Protocols	X				X	X		X			X	X	X
Forward ASHMS Transfer Protocols to Communication Equipment	X					X		X			X	X	X
Transmit ASHMS Data Protocols to Ground Maintenance Center	X					X		X			X	X	X
Receive the ASHMS Data Protocols in Ground Maintenance Center Receiver	X	X				X		X			X	X	X
Save the ASHMS Data in Ground Maintenance Center Web Server	X	X	X			X		X			X	X	X
Show the ASHMS Data on Ground Maintenance Center Terminal	X	X	X					X	X		X	X	X
Transmit the ASHMS Data to Flight/Maintenance Supervisor		X	X		X	X		X	X		X	X	X
Analyze/Predict Damage/Crack Occuring Tendency		X	X		X	X		X	X		X	X	X

Figure 44: SV-5 (System Function to Operational Activity Chart)



**1.2. Detect Aircraft Structural Damage or Crack**

**Figure 45 : SV-4**

No structural health monitoring systems that use sensor technology are currently being used by the aerospace community. The red circle around the nodes in the SV-4 shown in Figure 45 highlights the main reason why. Current sensor technology is immature and too unreliable to be used in an on board structural health monitoring system. This research will test emerging sensor technology that has the potential to advance the use of a Real Time Aircraft Structural Health Monitoring System.

#### ***IV. Testing Methodology and Results***

This chapter will discuss the testing methodology conducted during this research. Aluminum Dog Bone plate testing and Composite Lap Joint were used to compare PZT and IDT sensors. The purpose of the Dog Bone testing was to compare the PZT sensor technology with IDT sensor technology and to explore the promotion of using the sensors in a Real Time Structural Health Monitoring System. The purpose of the Lap Joint experiment is to investigate the effectiveness of using PZT and IDT sensors in detecting damage in a composite lap joint with various epoxy bonds. The goal of the testing is to show that new advancements in sensor technology can be applied to Structural Hot Spots for use in a Real Time Structural Health Monitoring System.

Testing was divided into two different areas. The first test included Aluminum Dog Bone articles and the second test included composite lap joints.

##### ***4.1 Aluminum Dog Bone Experiment***

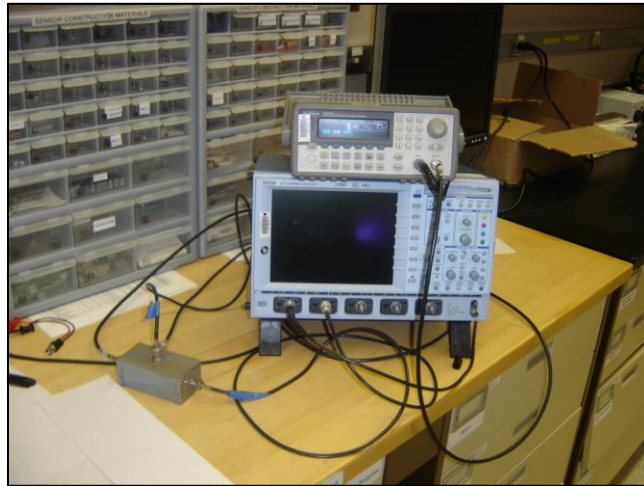
Table 3 show the test matrix for the Aluminum Dog Bone Testing

**Table 3 : Dog Bone Test Matrix**

Test Matrix for PZT/IDT Sensor Research				
Dog Bone				
PZT	Pitch Catch 1 to 2	Pitch Catch 2 to 1	Pulse Echo 1	Pulse Echo 2
Dog Bone Clean 100 kHz	Complete	Complete	Complete	Complete
Dog Bone Clean 300 kHz	Complete	Complete	Complete	Complete
Dog Bone Clean 600 kHz	Complete	Complete	Complete	Complete
Dog Bone Fatigue Crack 100 kHz	Complete	Complete	Complete	Complete
Dog Bone Fatigue Crack 300 kHz	Complete	Complete	Complete	Complete
Dog Bone Fatigue Crack 600 kHz	Complete	Complete	Complete	Complete
IDT	Pitch Catch 1 to 2	Pitch Catch 2 to 1	Pulse Echo 1	Pulse Echo 2
Dog Bone Clean 3.1 MHz	Complete	Complete	Complete	Complete
Dog Bone with Fatigue Crack 3.1 MHz	Complete	Complete	Complete	Complete

#### ***4.1.1 Test Equipment***

The equipment used in the Dog Bone experiments is shown in Figure 45 and 46. Figure 46 includes an Agilent 33250A 80MHz Function/Arbitrary waveform generator and a Lecroy WaveRunner LT 584. The function generator created a ‘tone-burst’ signal excitation, which is a sine wave of a limited number of cycles, typically 5 sine-wave oscillations. The WaveRunner software controls the excitation and measurement of the response signals. Figure 47 shows a Polytec OFU 505 is a scanning laser vibrometry system which permits the measurement of motions at different locations on the sample surface, and imaging and analysis of ultrasonic wave motions in the materials due to excitation by the piezoelectric sensors as actuators.



**Figure 46: PZT and IDT Test Equipment**



**Figure 47: Laser Vibrometry Equipment**

#### ***4.1.2 Aluminum Dog-Bone Experiment methodology:***

The purpose of this testing was to compare the signals from PZT sensors and IDT sensors in two aluminum dog bone specimens Figure 47 that are representative of typical bulkhead webbings on aircraft. The PZT tests consisted of placing the sensors near the center line approximately 50 mm apart. The tests were conducted on an undamaged specimen and a specimen that has a fatigue crack propagating from a stress concentration. Pitch-Catch readings were taken from sensor 1 to 2 and from 2 to 1. Pulse echo readings were taken from sensor 1 and from sensor 2. Readings were taken at frequencies of 100 kHz, 300 KHz and 600 kHz.

The next phase of the test consisted of placing the IDT sensors near the center line approximately 50 mm apart. The tests were conducted on an undamaged specimen and a specimen that has a fatigue crack propagating from a stress concentration. Pitch-Catch readings were taken from sensor 1 to 2 and from 2 to 1. Pulse echo readings were taken

from sensor 1 and from sensor 2. Because IDTs work on a single frequency, readings were taken at 3.1 MHz

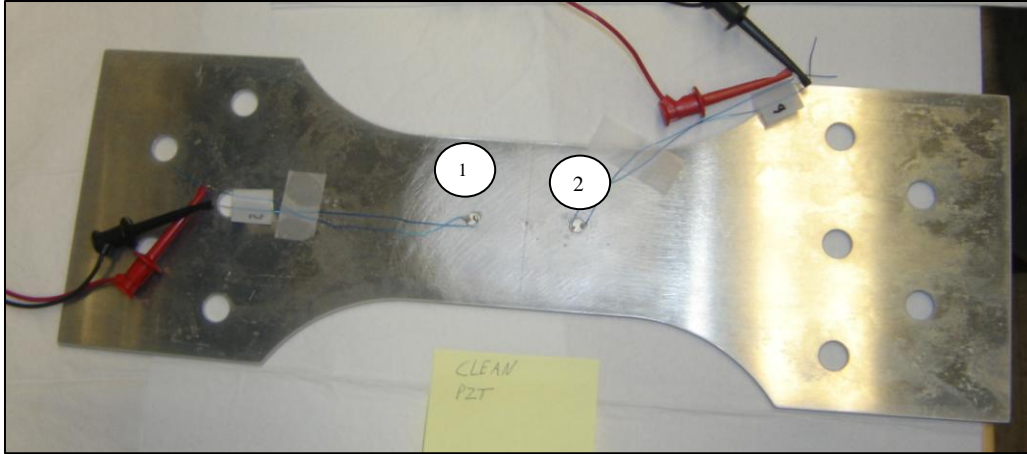


**Figure 48: Aluminum Dog Bone Test Article**

The results of the readings were analyzed for amplitude changes to test for reliable crack detection. Secondly, the PZT and IDT signals were compared to one another to see if one sensor provides a better response than the other does and will help promote the usage of a Real Time Structural Health Monitoring System. Laser vibrometry readings and energy graphs were taken to give a visual image of the energy as its propagating across the material.

#### ***4.1.3 Aluminum Dog Bone Test Results***

Initial tests were conducted on the undamaged dog bone sample, Figure 49, at 100, 300 and 600 kHz using PZT sensors. Then tests were conducted on the same undamaged specimen using IDT sensors.



**Figure 49: PZT Test Setup of Clean Dog Bone**

#### ***4.1.3.1 Signal Collection***

First the Pitch Catch method was used to collect signals at 100, 300 and 600 kilohertz frequencies from PZT Sensor 1 to PZT Sensor 2, Figure 50, and then from PZT Sensor 2 to PZT Sensor 1, Figure 51.

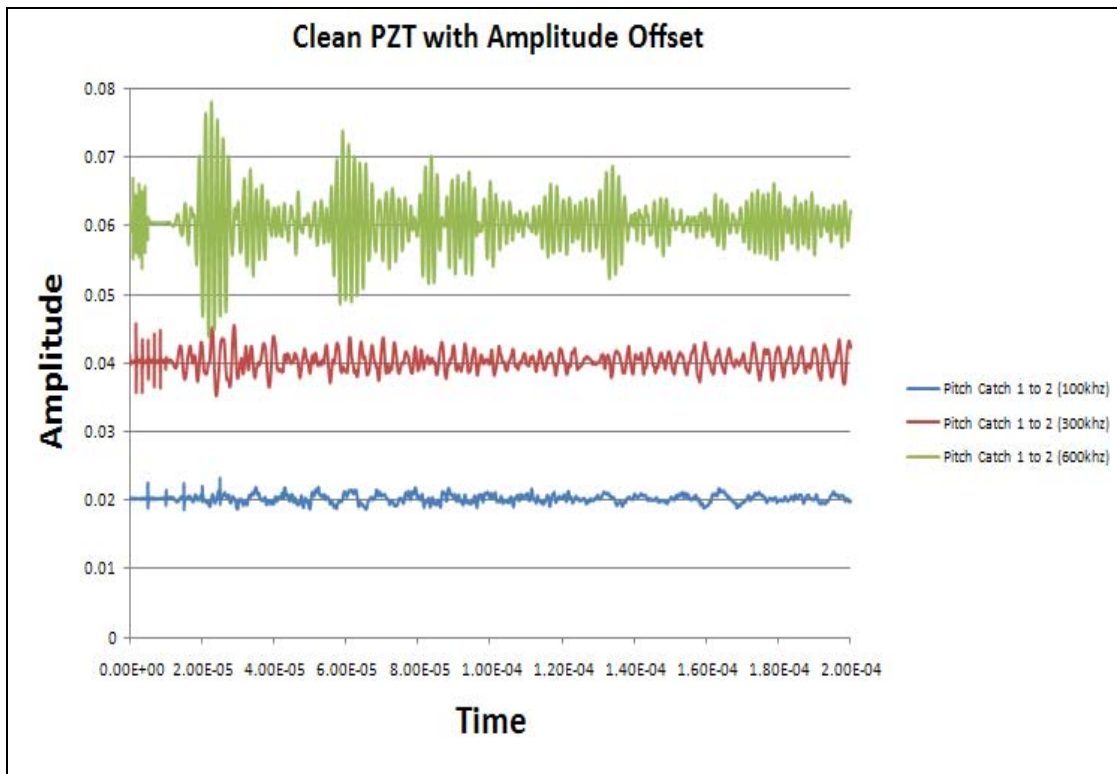


Figure 50: PZT Pitch Catch Readings of Clean Dog Bone

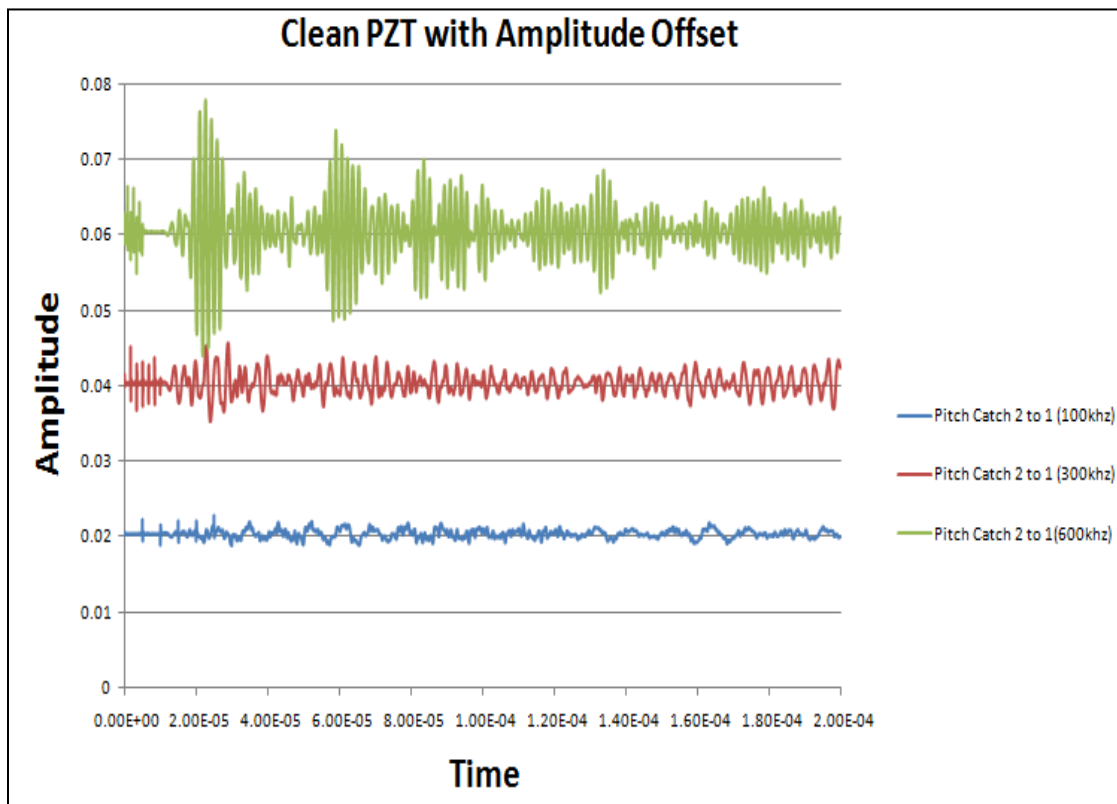
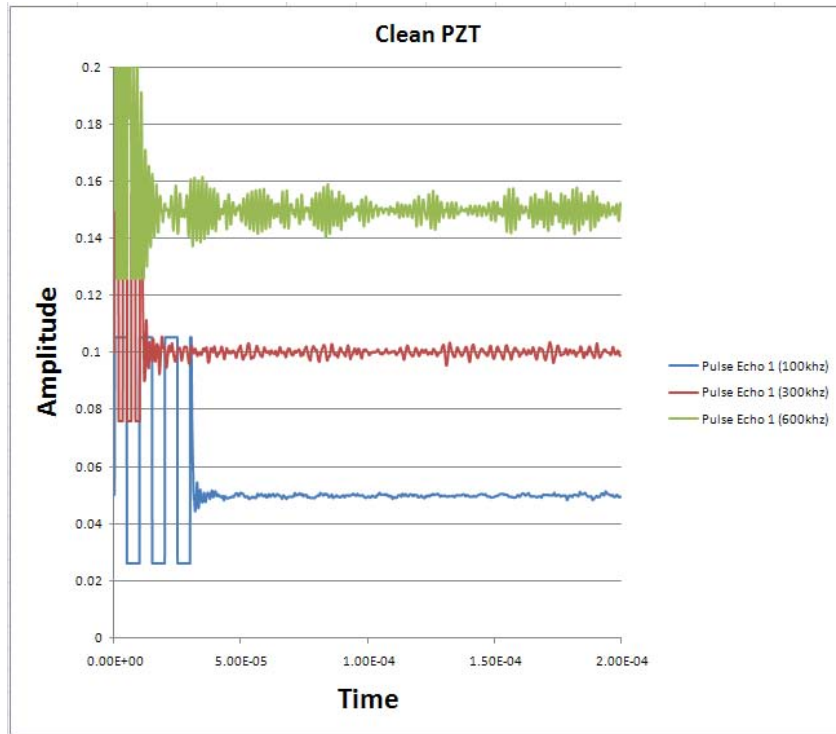


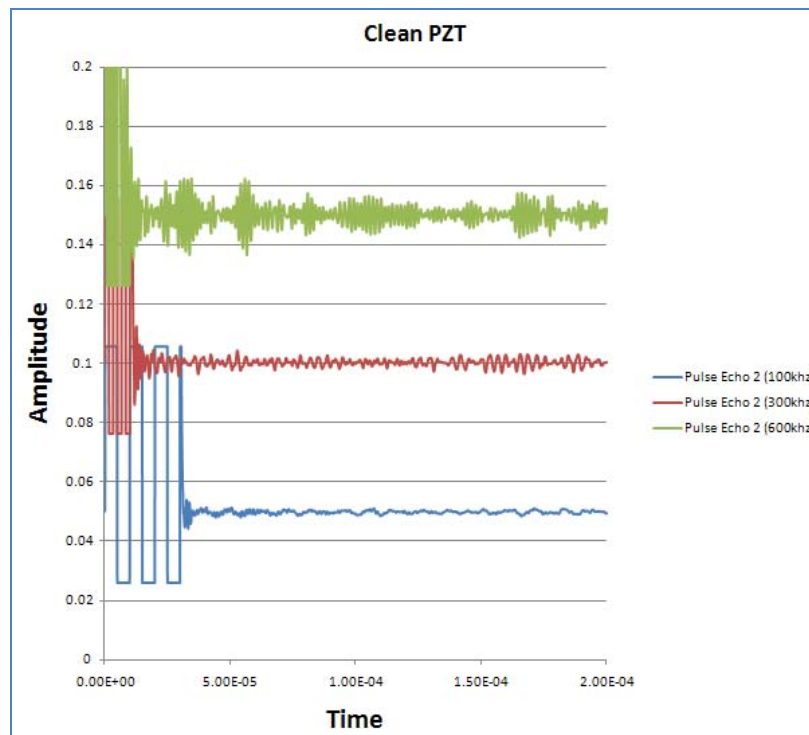
Figure 51: PZT Pitch Catch Readings of Clean Dog Bone



Secondly, Pulse Echo signals were collected from Sensors 1(Figure 52) and 2(Figure 53).



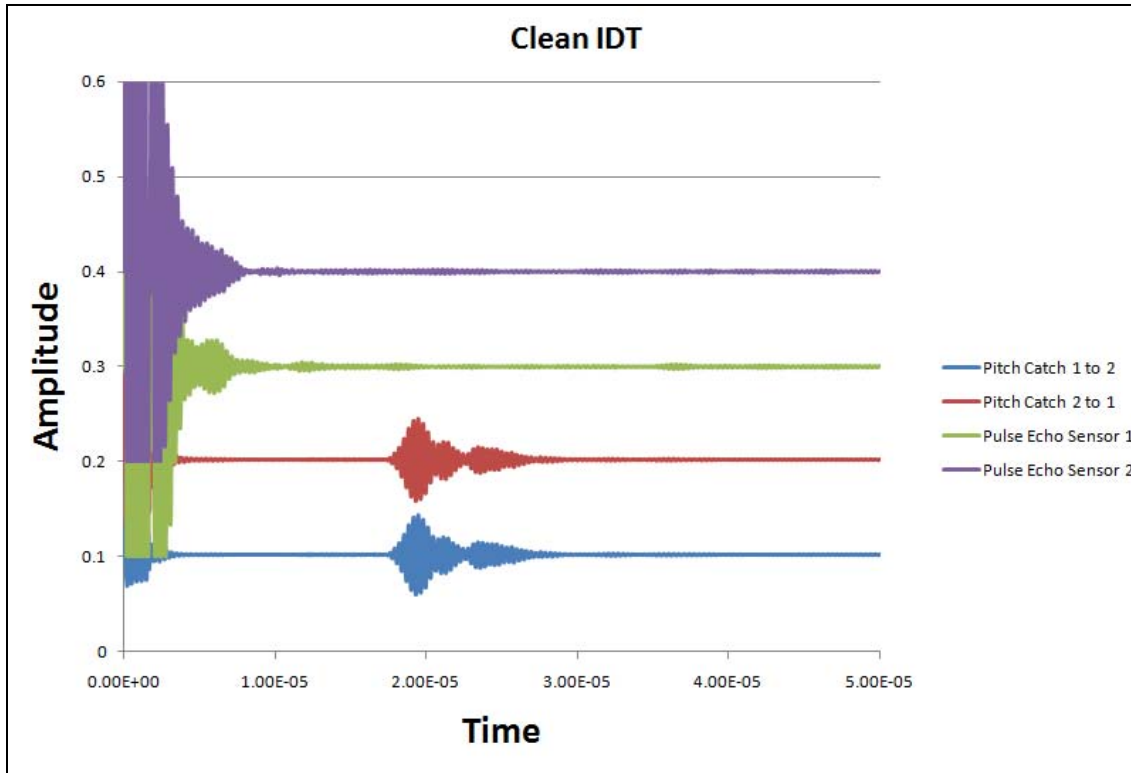
**Figure 52: Pulse Echo Signals from Sensor 1 on Dog Bone**



**Figure 53: PZT Pulse Echo Signals from Sensor 2 on Dog Bone**

For the Pitch Catch and the Pulse Echo methods, the amplitudes versus time were plotted and the 100, 300 and 600 kilohertz signals were offset on one graph for easy comparison. The 600 kilohertz mode produced the strongest signals. Higher peaks can be observed through the first part of the graph, followed by several weaker signals that show the many reflections from the Lamb waves Omni-directional behavior in both Pitch Catch Modes and in both Pulse Echo modes.

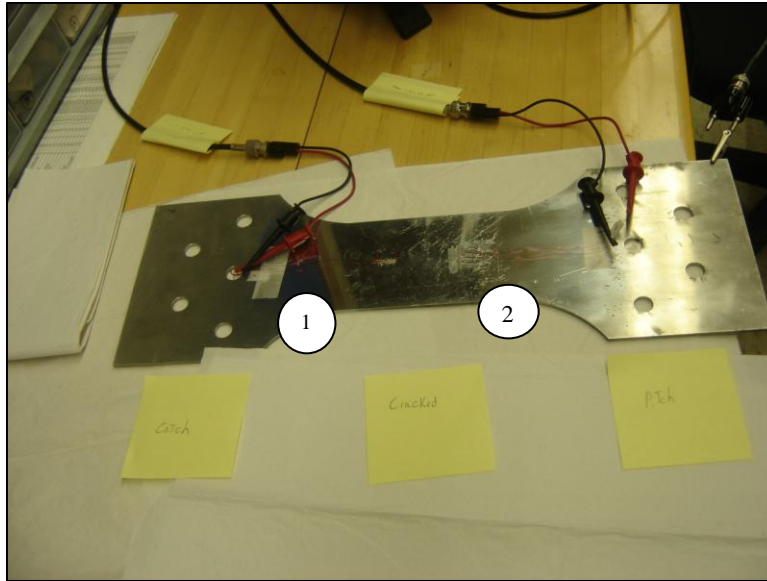
Signals were collected at 3.1 MHz in Pitch-Catch Mode from IDT Sensor 1 to IDT Sensor 2 and then from IDT Sensor 2 to IDT Sensor 1. Pulse Echo signals were collected from IDT Sensors 1 and 2 Figure 54. For each scenario, the amplitudes versus time were plotted and the signals offset on one graph for comparison.



**Figure 54 : IDT Readings of Clean Dog Bone**

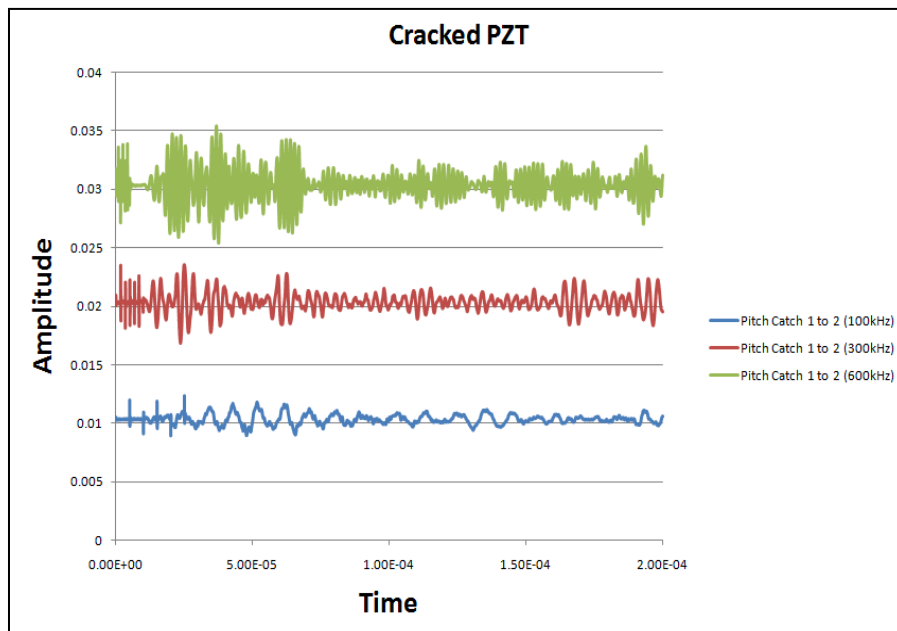
The graph shows that the pulse echo signals are virtually flat since no signals are being reflected and the pitch-catch signal is strong since all the energy is able to pass from one sensor to the other. The lack of reflected signals highlights the difference between the IDT signals with that of the multiple reflected signals collected using PZTs.

Tests were conducted on the cracked dog bone sample at 100, 300 and 600 kHz using PZT sensors. Tests were conducted on the same cracked dog bone specimen using IDT sensors Figure 55.

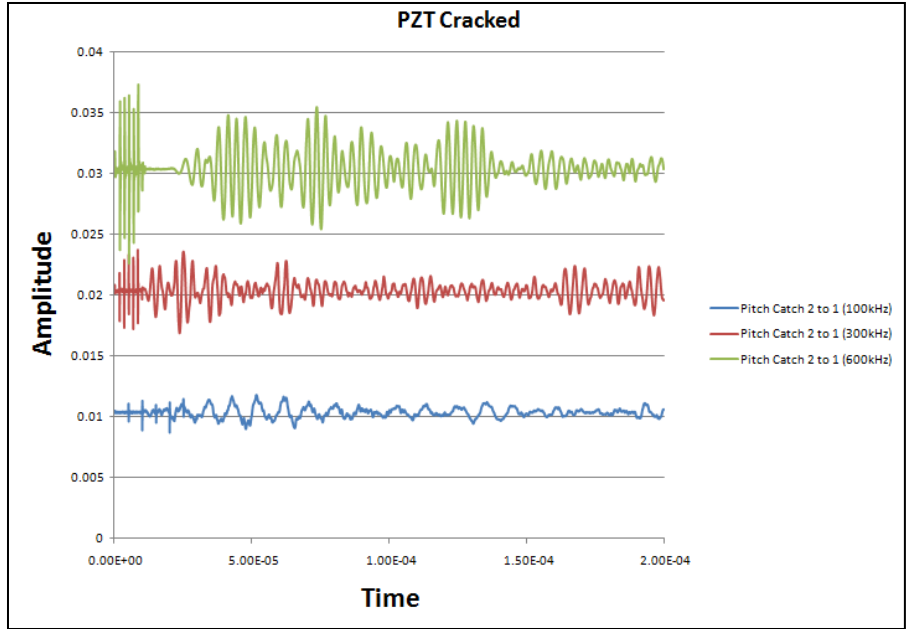


**Figure 55 : IDT Test Setup of Cracked Dog Bone**

Pitch Catch method was used to collect signals at 100, 300 and 600 kilohertz frequencies from PZT Sensor 1 to PZT Sensor 2, Figure 56, and then from PZT Sensor 2 to PZT Sensor 1, Figure 57.

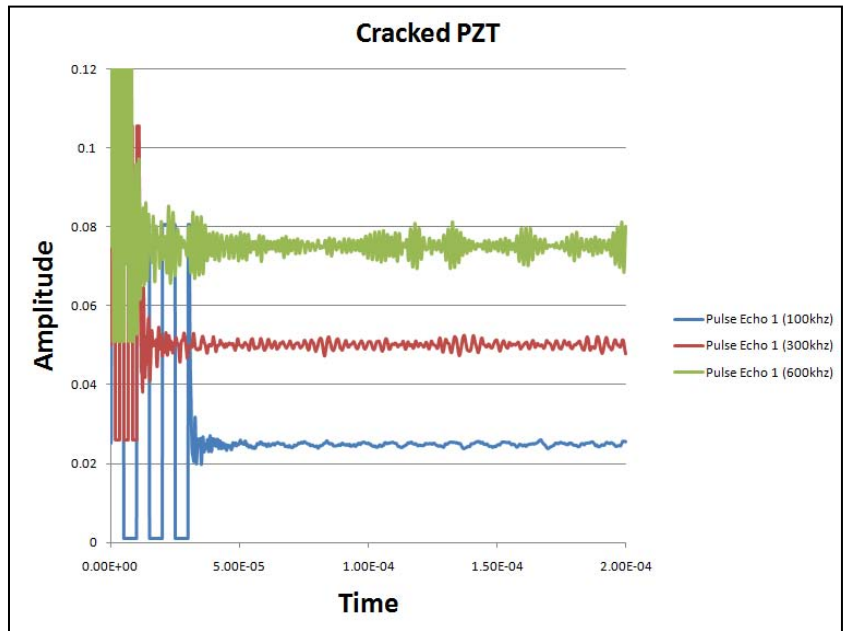


**Figure 56: PZT Pitch Catch Readings of Cracked Dog Bone**

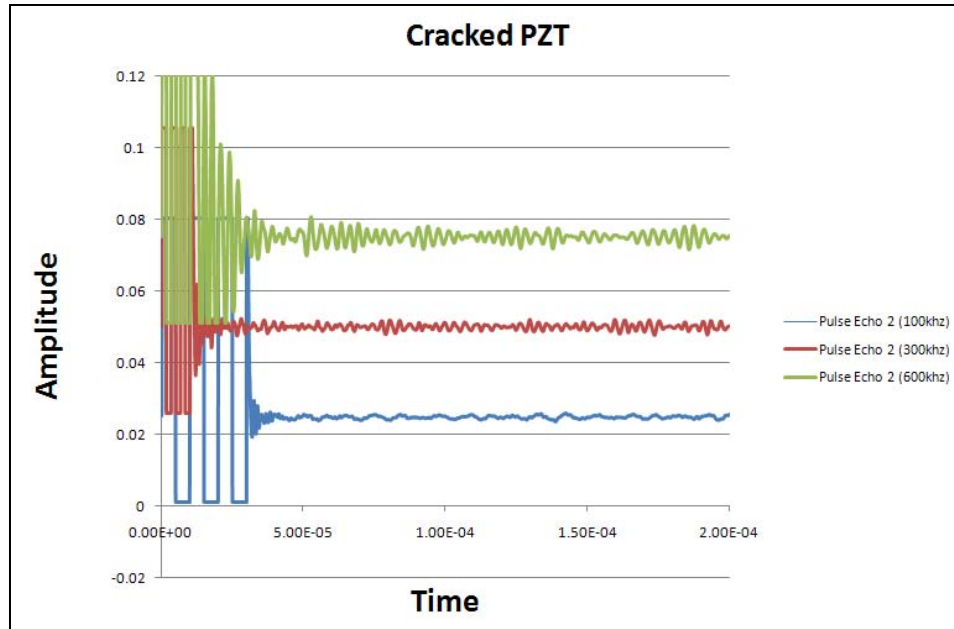


**Figure 57: PZT Pitch Catch Readings of Cracked Dog Bone**

Pulse Echo signals were collected from PZT Sensors 1 (Figure 58) and 2 (Figure 59).



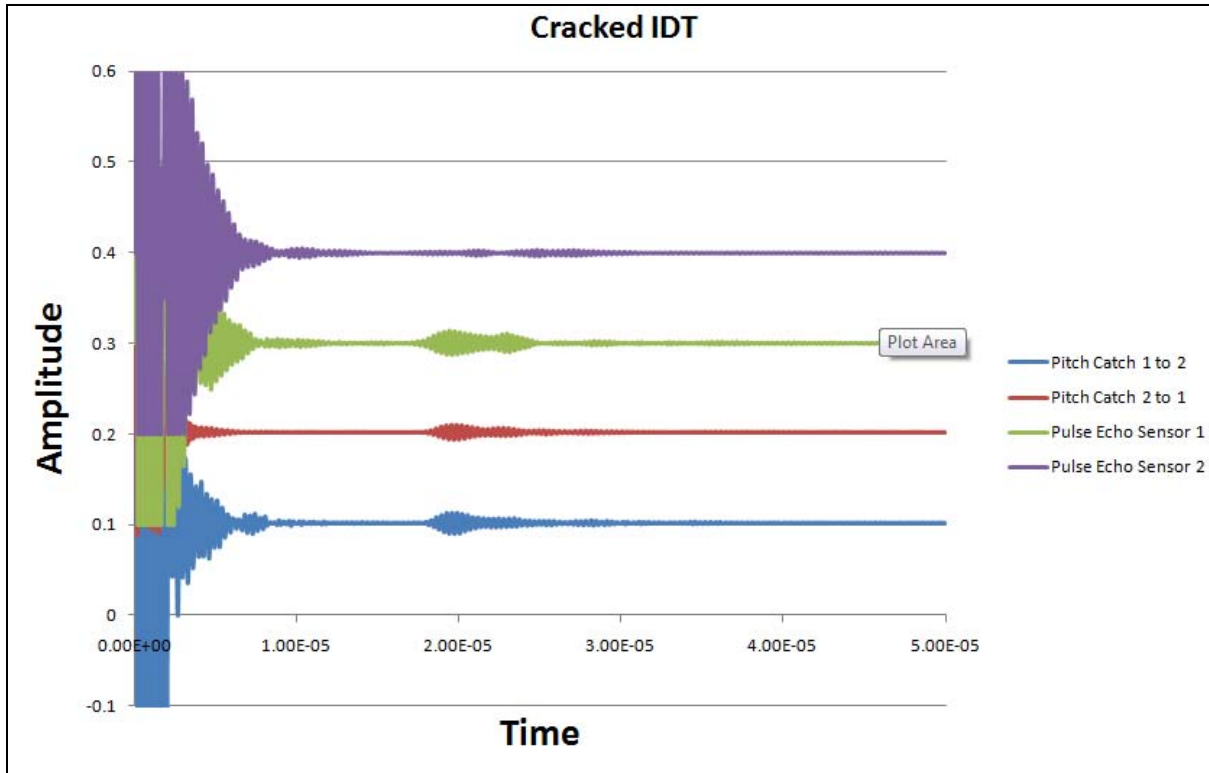
**Figure 58: PZT Pulse Echo Readings of Cracked Dog Bone**



**Figure 59 : PZT Pulse Echo Readings of Cracked Dog Bone**

For the Pitch Catch and the Pulse Echo methods, the amplitudes versus time were plotted and the 100, 300 and 600 kilohertz signals were offset on one graph for easy comparison. Again, the 600 kilohertz mode produced the strongest signals. Higher peaks can be observed through the first part of the graph, followed by several weaker signals that show the many reflections from the Lamb waves Omni-directional behavior in both Pitch Catch Modes and in both Pulse Echo modes.

Signals were collected at 3.1 MHz in Pitch-Catch Mode on the cracked Dog Bone from IDT Sensor 1 to IDT Sensor 2 and from IDT Sensor 2 to IDT Sensor. Pulse Echo signals were collected from IDT Sensors 1 and 2, Figure 60.



**Figure 60: IDT Readings of Cracked Dog Bone**

For each scenario, the Amplitudes versus time were plotted and offset on one graph for easy comparison.

The pulse echo signal from IDT 1 shows an increase from the flat signal on the clean sample. The pulse echo signal from IDT 2 shows a weaker increase. The difference is due to the crack path. The crack is slightly concave towards Sensor 1 creating a better reflective path and slightly convex away from Sensor 2 which is causing the echo signal to reflect away from the sensor. The pitch-catch signals for both the 1 to 2 and 2 to 1 modes are clearly weaker. The surface wave frequency was 3.1MHz or  $3.1 \times 10^6$  per second. The surface wave velocity in aluminum is  $\sim 3000$  meters/second. The arrival time of the pulse-echo signal from IDT 2 can be used to accurately locate the crack relative to the sensor using the basic velocity-time-distance equation: distance = velocity \* time. The nice thing about using surface waves is that the frequency you

operate at really doesn't matter because the waves are nondispersive. And so this simple equation can be used for estimating the crack location. This is not the case for Lamb waves, which are dispersive, meaning the velocity in the equation is not a constant. Estimating the crack distance is very difficult for Lamb waves because the velocity is not constant. By using known IDT sensor location, the crack location can be estimated. The distance from the IDT sensor to the crack was a known ~25 mm. The time to calculate/verify the distance of the crack from the IDT sensor in pulse-echo mode for IDT1 based on the arrival time of the tone burst signal and the 3000 m/sec velocity of a surface wave in aluminum. The distance can be estimated by a simple calculation:

Surface wave velocity= ~3000 meters per second

Measured time of arrival = ~1.7 microseconds

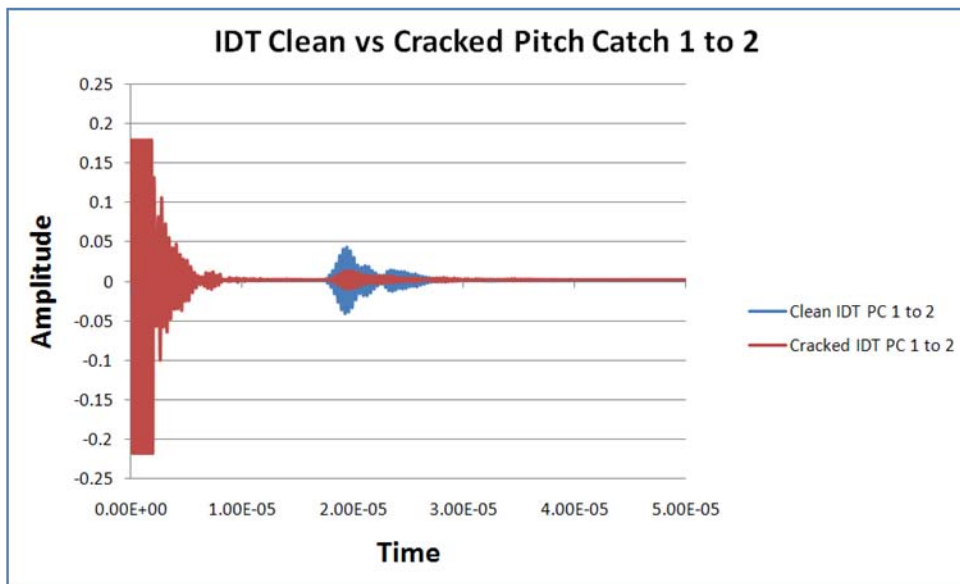
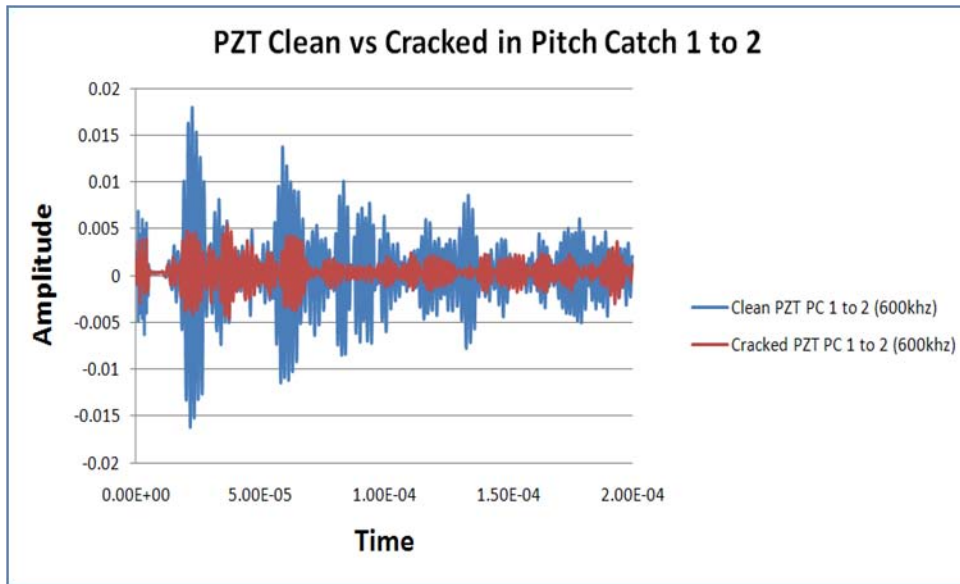
Distance=  $3000\text{m/s} * 1.7 \mu\text{s} = .051$  meters or 51 millimeters

The distance is accurate since the wave travels 25 mm to the crack and 25 mm back to the sensor.

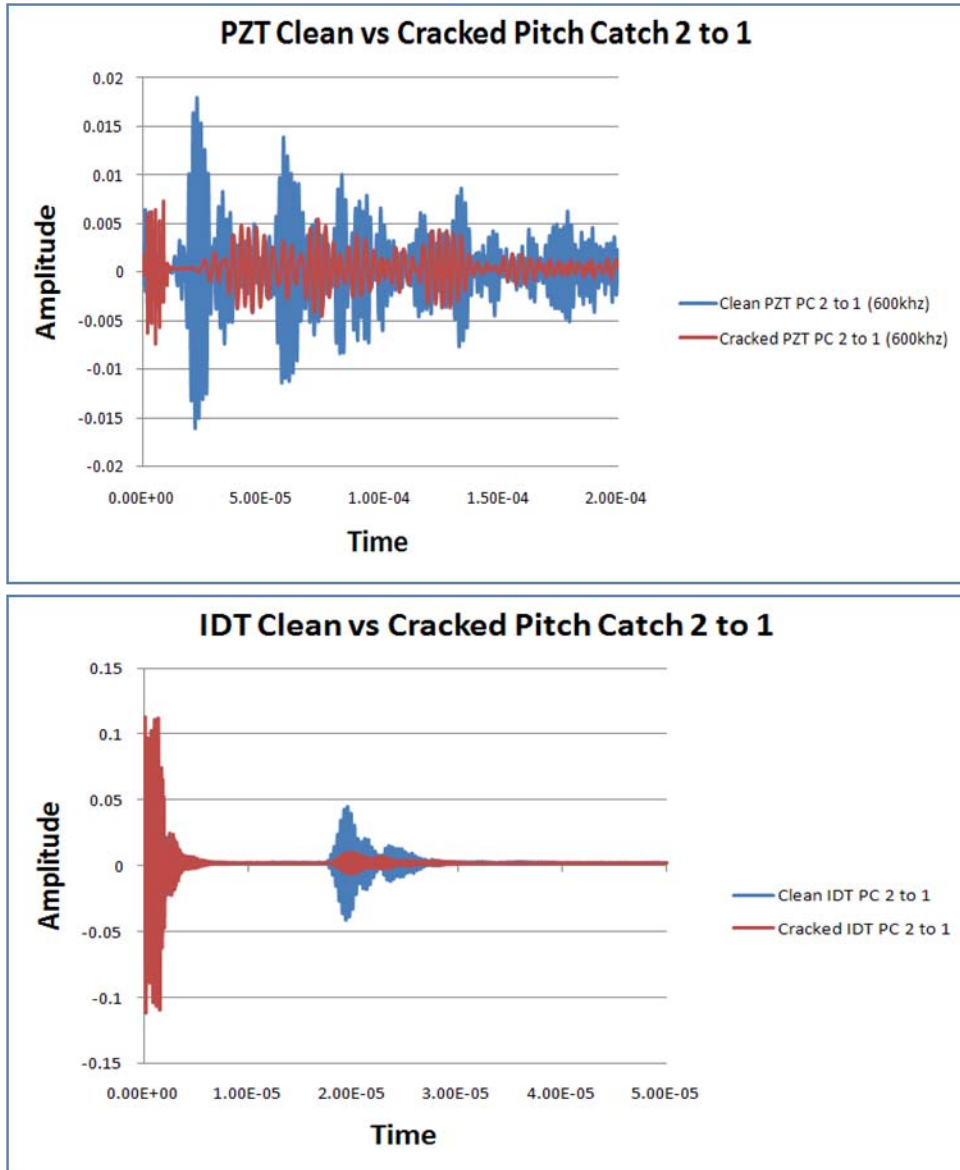
#### ***4.1.3.2 Clean versus Cracked PZT and IDT signal comparison***

Figures 61 and 62 compare the signals from PZTs and IDT sensors in Pitch Catch mode





**Figure 61 : PZT versus IDT Comparison in Pitch Catch 1 to 2**



**Figure 62 : PZT versus IDT Comparison in Pitch Catch 2 to 1**

Figures 61 and 62 illustrate the difference in signals between the PZT sensors and IDT sensors in Pitch Catch. The PZT and IDT graphs both show a decline in signal amplitude between the clean and cracked signals. However, the PZT graphs show a multitude of signals collected due to the various modes produces and the number of reflected signals. Difficulties arise when trying to isolate the proper signal and to reliably quantify the damage.

The IDT shows that only one strong signal is produced and that there is a clear decline in signal strength received. Analysis of the IDT signal would be much easier and more reliable

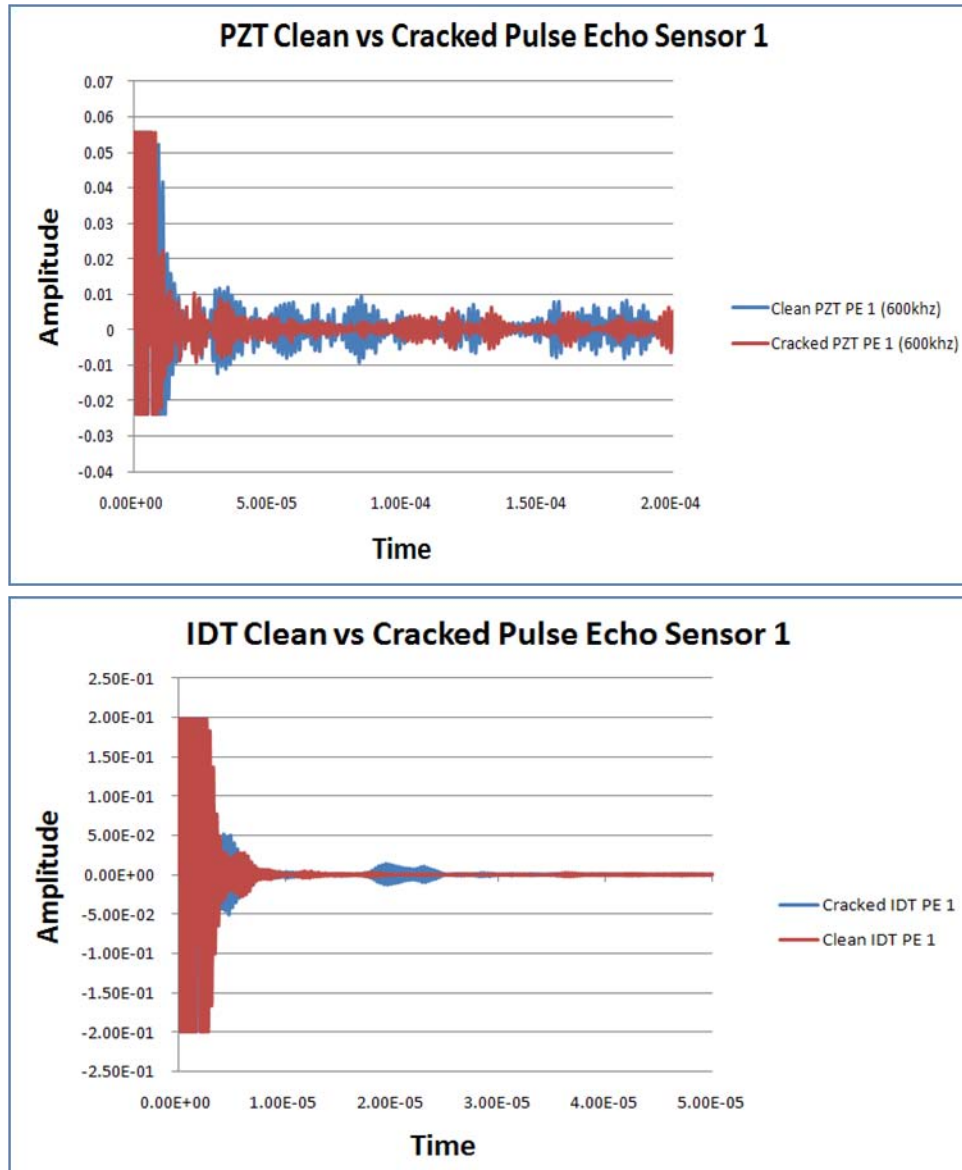
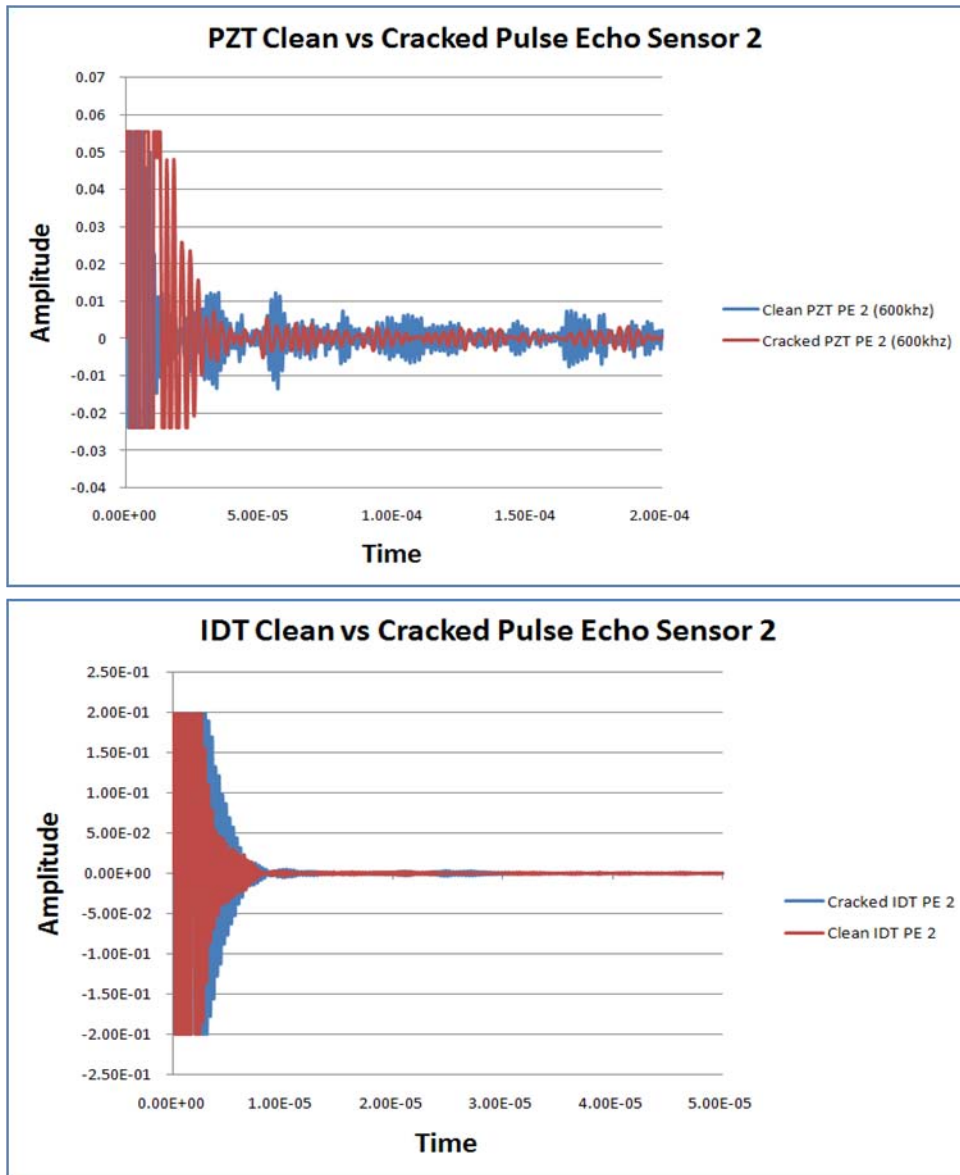


Figure 63 : PZT versus IDT Comparison of Pulse Echo Signal from Sensor 1



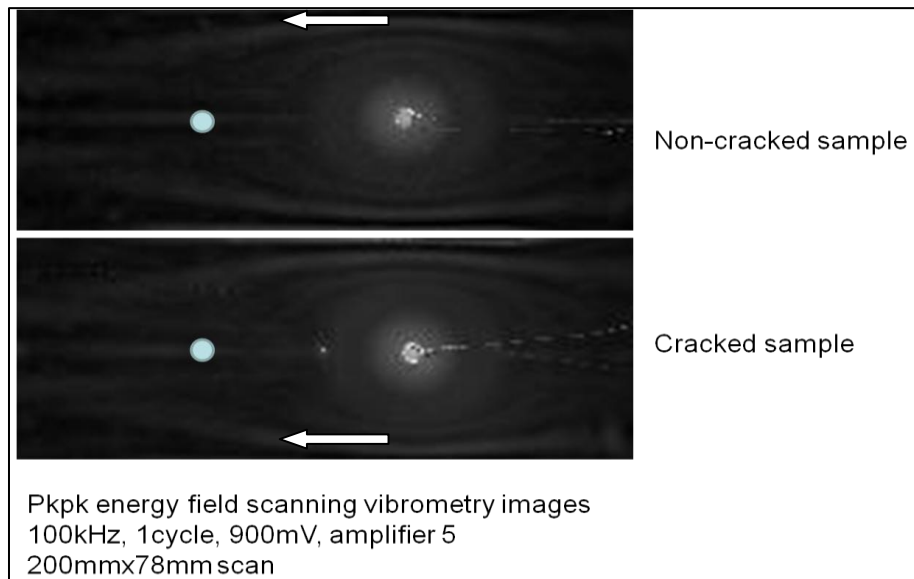
**Figure 64 : PZT versus IDT Comparison of Pulse Echo Signals from Sensor 2**

Figures 63 and 64 illustrate the difference in signals between the PZT sensors and IDT sensors in Pulse Echo. The PZT graphs show a multitude of signals collected due to the various modes produces and the number of reflected signals. There are changes in amplitudes, but isolating and quantifying damage from the change would be difficult and unreliable.

The IDT shows that only one strong signal is produced and that there is a clear increase in signal strength received from Sensor 1. Sensor 2 does not produce a large signal due to the crack morphology. Analysis of the IDT signals would be much easier and more reliable.

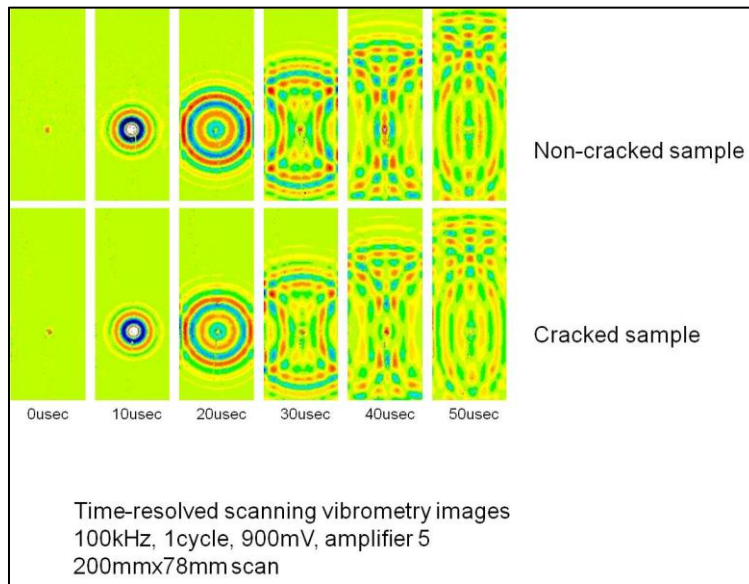
Figures 61, 62, 63, and 64 highlight the ability of two IDT sensors to produce 4 modes of redundancy that can be analyzed to account for signal differences due to crack morphology.

Scanning Laser Vibrometry readings were conducted on both the clean and cracked sample. Signals were collected using PZTs. Figure 65 shows the energy propagation from a PZT sensor over the crack and to the catch sensor. The energy fields at the catch location are very similar. The energy flow is impacted very little over the crack due to the longer wavelengths that are produced in the kilo Hertz range.



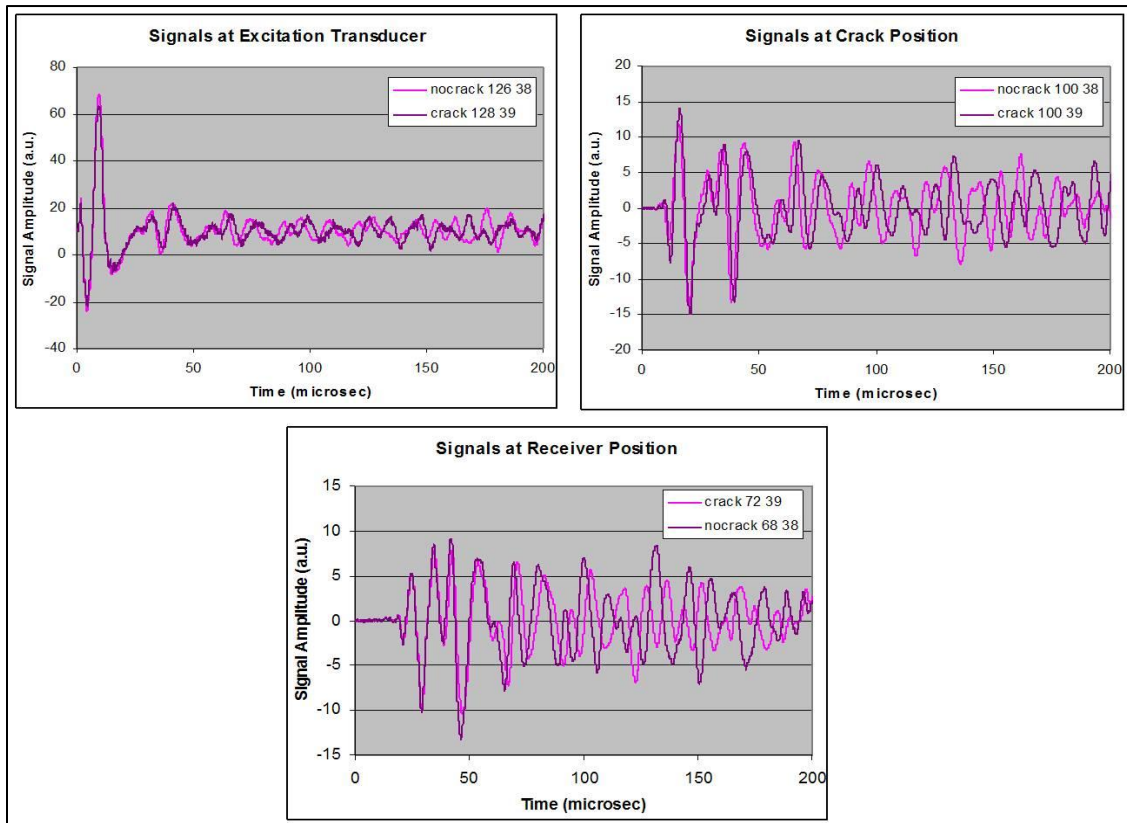
**Figure 65 : PZT Vibrometry Images in Cracked and Uncracked Specimens**

Figure 66 shows color vibrometry images of the wave energy in the same samples. The energy patterns are affected very little by the presence of the crack. The imagery highlights the omni-directional behavior of the Lamb wave signal in a tighter geometry. The signals reflect quickly off the sides and begin to overlap. The reflected waves produce numerous signals.



**Figure 66 : Color Vibrometry Images of PZT wave propagation**

The PZT signals in Figures 51-54 and 57-60 show the complexity of the signal and the difficulties in conducting reliable analysis. Figure 67 compares the clean PZT signal versus the PZT cracked signal at 3 locations, at the exciting PZT, at the crack and at the receiving PZT.

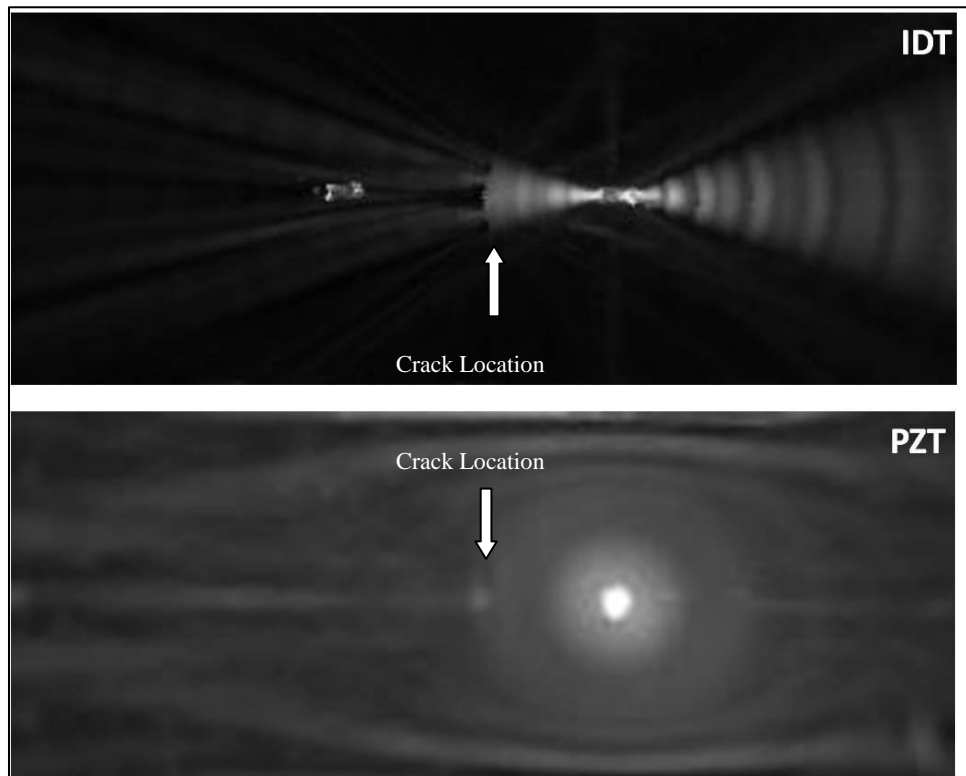


**Figure 67 : PZT signal comparison**

There are differences in the signals, but it would be difficult to determine with a great deal of reliability if any of the differences are due to damage after extracting the signal and ensuring it's the correct phase. The level of difficulty in analyzing these complex signals is the greatest challenge in building a reliable SHM system that the end user wants or can use.

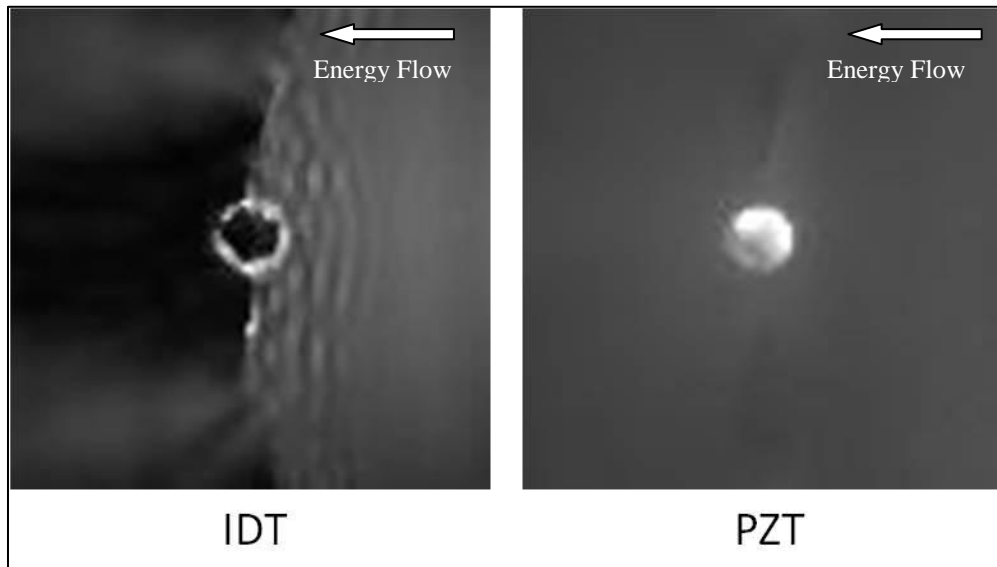
Figures 68 and 69 shows the Scanning Laser Vibrometry images of the wave energy propagation and compares the 100 kHz PZT Lamb wave and 3.1MHz IDT energy fields. The energy field is clearly blocked by the crack in the IDT image. There is very little interaction with the crack in the PZT image. This is largely due to the frequency used, where higher frequencies tend to interact more with the tight crack features versus the lower frequencies. The crack is a tightly closed fatigue crack and highlights one of the benefits of using the IDT sensor over the PZT sensor.

The blocked IDT energy accounts for the smaller signal in pitch catch and the stronger signal in the pulse echo. The weak interaction of the PZT Lamb wave signal accounts for the lack of discernable difference in the signals.



**Figure 68 : IDT versus PZT energy over test area**





**Figure 69 : IDT versus PZT over crack**

The directionality of the wave and the cleaner signal is much easier for a RTASHM system to analyze. Crack and damage detection at structural hot spots can be monitored with a much higher degree of reliability. Current LO platforms such as the F-22 and F-35 would benefit greatly from a RTASHM system. The costs of maintenance due to LO removal and reapplication due to timed maintenance checks that are for NDI on structural hot spots can be virtually eliminated if using a RTASHM system.

The results and analysis of the PZT and IDT Dog Bone testing show:

1. Lamb waves are sensitive to material thickness and geometry, operate on multiple frequencies with multiple wave modes, and need complex dispersion curves to conduct analysis.
2. Rayleigh waves are not sensitive to material thickness and geometry and operate on one frequency that is simple to analyze.

3. PZT sensors produce Lamb waves in an omni-directional pattern which produces numerous reflected signals
4. IDT sensors produce Rayleigh waves in a directional pattern which reduces or eliminates reflected signals.
5. PZT sensors produce Lamb wave signals that are difficult to analyze and would be unreliable in a RTASHMS.
6. IDT sensors produce Rayleigh wave signals that are simple to analyze and may be a good candidate for use in a RTASHMS

#### 4.2 Composite Lap Joint Testing

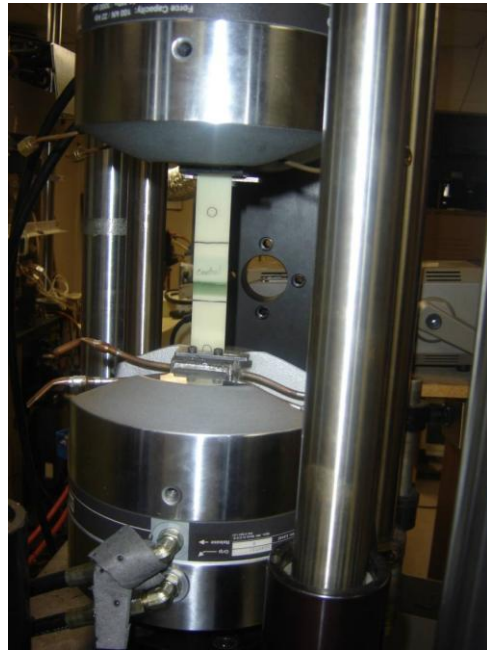
Table 4 show the test matrix for the Composite Lap Joint Testing

**Table 4 : Composite Lap Joint Test Matrix**

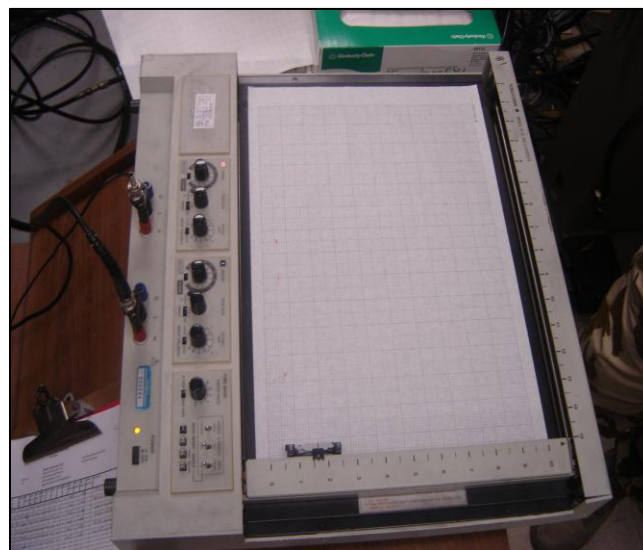
Composite Lap Joints:	Sample 1				Sample 2			
	Baseline	400 lbs	800 lbs	1200lbs	Baseline	400 lbs	800 lbs	1200lbs
XPN1 (Nickel nanomaterial) PZT	Complete	Complete	Complete	Complete	Complete	Complete	Complete	Complete
XPN1 (Nickel nanomaterial) IDT	No Signal							
XPN1 (Nickel nanomaterial) EMI	Complete	Complete	Complete	Complete	Complete	Complete	Complete	Complete
XPN1 (Nickel nanomaterial) Ultrasonic	Complete	Complete	Complete	Complete	Complete	Complete	Complete	Complete
XPN1 (Nickel nanomaterial) X-Ray	Complete	Complete	Complete	Complete	Complete	Complete	Complete	Complete
XPN3 (Nickel and Carbon micron) PZT	Complete	Complete	Complete	Complete	Complete	Complete	Complete	Complete
XPN3 (Nickel and Carbon micron) IDT	No Signal							
XPN3 (Nickel and Carbon micron) EMI	Complete	Complete	Complete	Complete	Complete	Complete	Complete	Complete
XPN3 (Nickel and Carbon micron) Ultrasonic	Complete	Complete	Complete	Complete	Complete	Complete	Complete	Complete
XPN3 (Nickel and Carbon micron) X-Ray	Complete	Complete	Complete	Complete	Complete	Complete	Complete	Complete
XPC1 (Carbon nanomaterials) PZT	Complete	Complete	Complete	Complete	Complete	Complete	Complete	Complete
XPC1 (Carbon nanomaterials) IDT	No Signal							
XPC1 (Carbon nanomaterials) EMI	Complete	Complete	Complete	Complete	Complete	Complete	Complete	Complete
XPC1 (Carbon nanomaterials) Ultrasonic	Complete	Complete	Complete	Complete	Complete	Complete	Complete	Complete
XPC1 (Carbon nanomaterials) X-Ray	Complete	Complete	Complete	Complete	Complete	Complete	Complete	Complete
Control (unfilled epoxy) PZT	Complete	Complete	Complete	Complete	Complete	Complete	Complete	Complete
Control (unfilled epoxy) IDT	No Signal							
Control (unfilled epoxy) EMI	Complete	Complete	Complete	Complete	Complete	Complete	Complete	Complete
Control (unfilled epoxy) Ultrasonic	Complete	Complete	Complete	Complete	Complete	Complete	Complete	Complete
Control (unfilled epoxy) X-Ray	Complete	Complete	Complete	Complete	Complete	Complete	Complete	Complete

#### ***4.2.1 Composite Lap Joint Test Equipment***

The equipment used in the Composite Lap Joint experiments includes the laser Vibrometry equipment in Figure 47, the MTS hydraulic tension tester shown in Figure 70 which is used to apply tension load and the Stress Strain Plotter shown in Figure 71 which is used to plot the stress strain curves during the tension tests



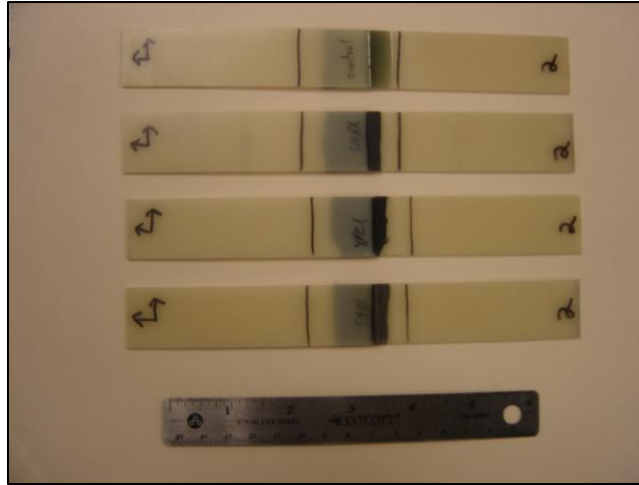
**Figure 70 : Pull Test Machine**



**Figure 71 : Stress Strain Plotter**

**4.2.2 Composite LAP Joint Experiment Methodology:**

Eight lap joint samples were provided Figure 72.



**Figure 72 : Composite Lap Joint Specimens**

The lap joints are composed of composite materials bonded with epoxy materials with various additives that may be representative of future aircraft structures, Table 4.

**Table 5 : Lap Joint Name and Epoxy Material Additives**

Sample Name	Adhesive Make Up
Control	Epoxy only, No additives
XPC1	Carbon Nano-fibers
XPN1	Nickel Nano-fibers
XPN3	Nickel and Carbon Nano-fibers

The composite lap joints underwent a series of tests to discover if the sensors could detect damage. They were tension tested at 400 lbs, 800 lbs, 1200lbs and to failure.

PZT and IDT readings will be taken initially and following each pull test. The results were analyzed for changes and the PZT and IDT results were compared to one another for differences. Laser Vibrometry were conducted on Control 1 at the Untested and 400, 800, and 1200 lb intervals.

#### ***4.2.3 Composite Lap Joint Test Results***

Initial tests were conducted at AFRL/RXLP. The possibility of using vacuum grease instead of permanent bond was explored. It was discovered that a good signal could be produced and collected with the vacuum grease Figure 73. This could help facilitate testing and reduce costs of damaging sensors. Also since the PZT sensors are sensitive to strain and stress it would be better to remove them during such testing.

During testing it was discovered that the IDT sensors would not produce a signal across the Lap Joint. Since Rayleigh waves travel on the surface it would be difficult to detect damage through the lap joint. A signal was produced in the composite material and further selectibility and sensitivty studies can be performed to see if IDT could be used to detect damage in composite materials.

The test was altered to run PZT/Lamb wave tests on the lap joints only. Good signals were produced in AFRL, albeit weaker than those produced with the Salol bond. See Figure 74. A damping effect was evident which helped produce a cleaner signal. Further analysis needs to be done to see if it is the grease bonding material or is it the composite material that is damping some of the waves.

The signal was a fairly clean signal through the joint compared with a typical signal through a metallic material and solidly bonded. The PZTs were bonded with Salol and the signal was stronger. Very strong signal responses were detected in the 100-120 kHz and 300-310 kHz range.

Tests were run on the equipment at AFIT which has the capability of conducting frequency sweeps which the equipment at AFRL does not. Ran Tests at 100 kHz-400 kHz at 10kHz increments the wave forms were fairly similar throughout testing.

Problems were discovered when using the grease and composite joints. The large initial signal collected using the AFIT equipment was a result of interference from the connectors and not a reading across the joint as initially thought. Tests were conducted that validated that the data collected from the pull tests was no good.

AFRL/RXL conducted Laser Vibrometry Tests of Control sample 1. Initial tests were conducted using Salol bond and vacuum grease bond (see Figure 73). Readings were taken at each stage of the pull tests which was able to show the energy as it propagates through the material and provide valuable data from the pull tests. See Figure 74. The wave propagation can be seen over the joint after each pull test load. The epoxy ramp shows up in all 4 tests. The clean image shows the wave strength is strong at the sensor and drops off at the joint and reaches a steady state on the other side of the lap joint.

Following the 400lb tests a peculiar phenomenon happened. There was intensification in strength just before the joint and directly beneath the epoxy excess. The signal propagating right to left starts weak and actually gets stronger in the bond region

(the intensification is localized in the bond region). The hypothesis is that there is a flapping motion because the epoxy became disbonded creating an increase in signal. The energy changes over the joint and reaches a steady state similar to that of the clean test.

Following the 800lb test, another very interesting ‘bond-line’ edge shows up in the 800lb. The intensification that appeared in the 400lb test has gone away. The damage seems to be progressing through the joint and the “flapping” has reduced. However, the steady state situation is achieved on the other side of the joint. Following the 1200lb tests there is known damage and that the energy field appears to change. The signal level across the bond has decreased in the 1200lb – maybe due to a delamination and ‘blockage’ of the energy field from the 800 lb case, but still reaches a steady state on the other side. The results show that even though there are energy changes over the joint area, the waves reaching the receiving sensor location are very similar and would be extremely difficult to detect any appreciable damage that could be reliably transmitted to a RTASHMS. Another very interesting ‘bond-line’ edge shows up in the 800lb test.

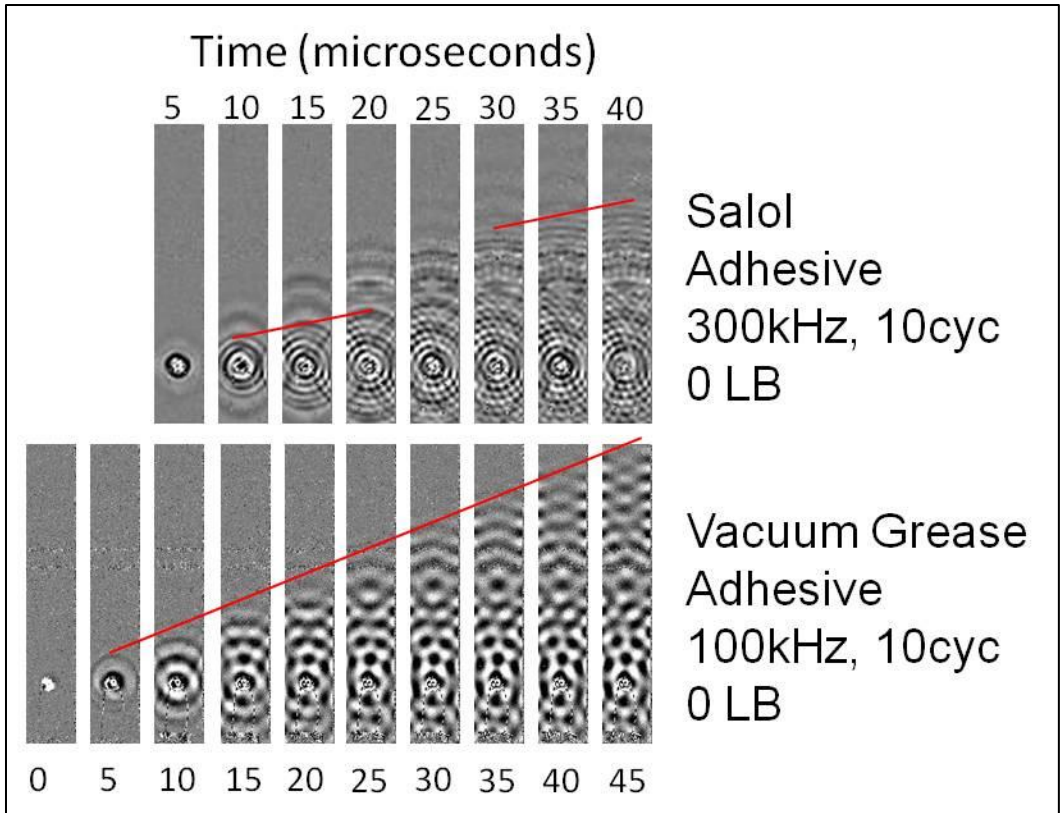


Figure 73 : Laser Vibrometry of Control 1

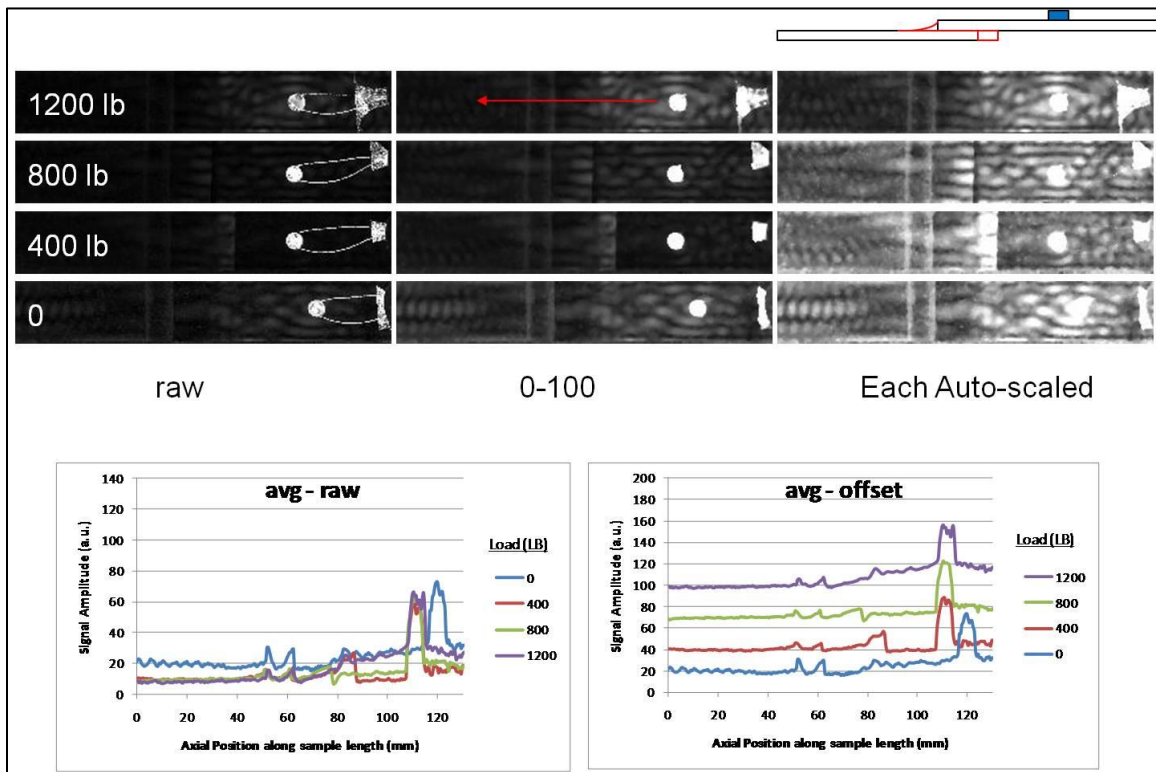
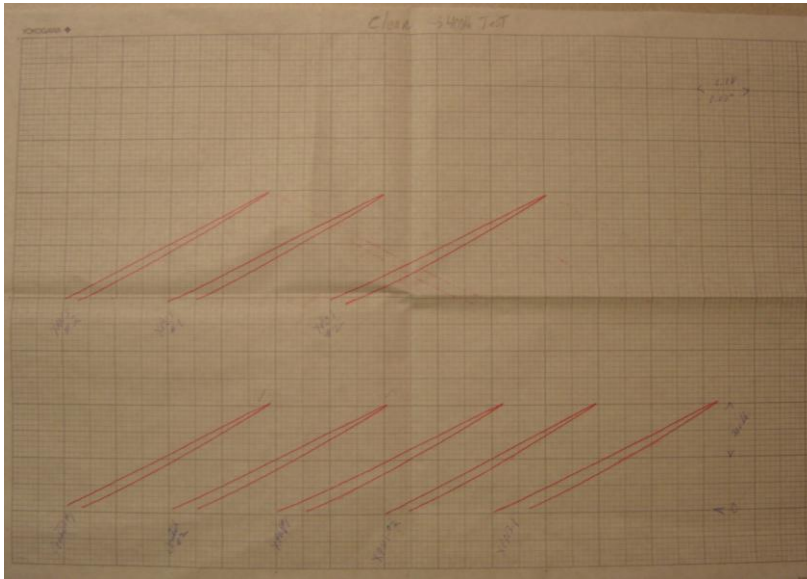


Figure 74 : Laser Vibrometry results on Control 1 Lap joint Sample



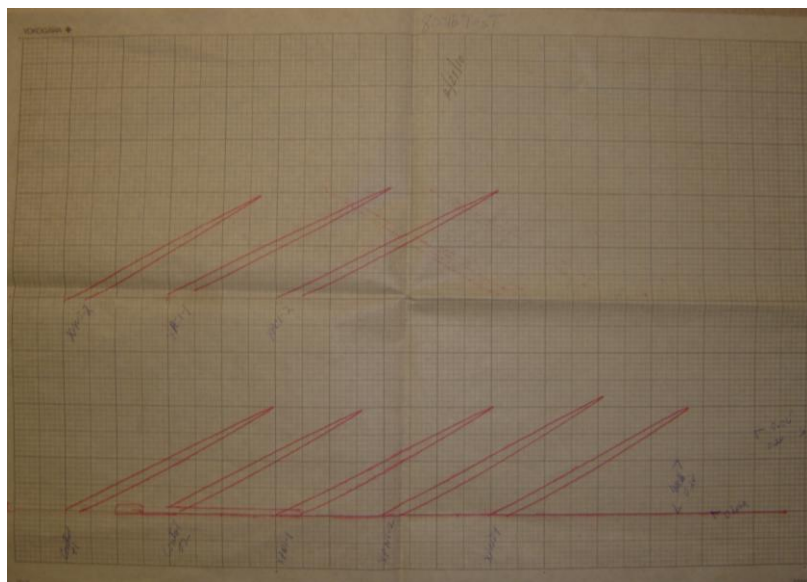
The pull Tests were conducted at an offsite location. We used a MTS machine to conduct the pull tests and a stress strain plotter to record the stress strain diagrams Figures 75-77.

1. 400 straight lines were observed meaning no clear indication of damage



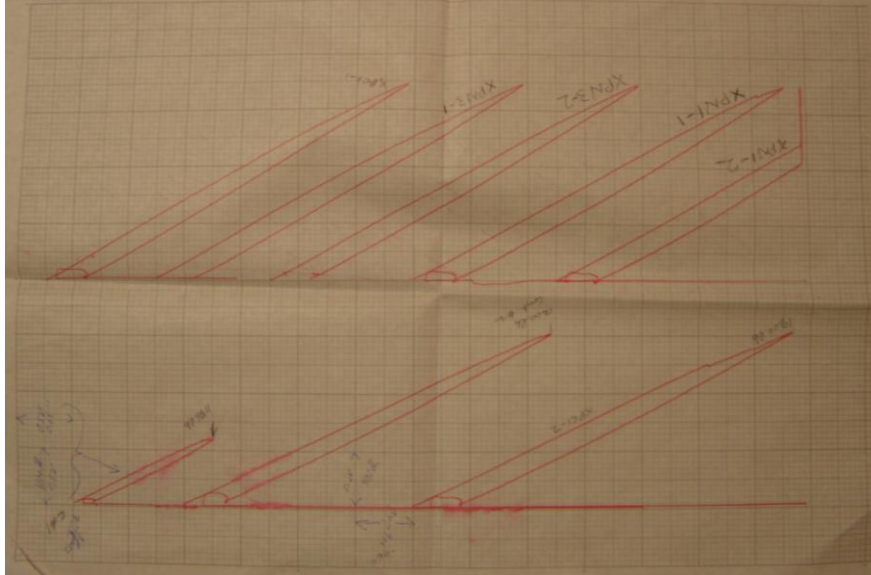
**Figure 75 : Composite Lap Joint 400 lb Pull Test Stress Strain Plots**

2. 800 straight lines no clear indications of damage



**Figure 76 : Stress Strain Plot of 800lb Test of Composite Lap Joints**

3. 1200 erratic behavior—damage is beginning to manifest.



**Figure 77 : Stress Strain Plot at 1200lb Pull Test on Composite Lap Joints**

EMI Tests were conducted on clean samples following each pull test using an Agilent Technologies E8362B PNA Series Network Analyzer and Calibration Kit X11644A. Five readings of each sample were conducted to obtain an average. The average readings will be compared for change. This additional EMI data was primarily taken for use in different research, but may be useful with the PZT data to see if damage is detectable.

Ultrasonic testing and X-ray radiography were conducted by AFRL/RXSA on the untested samples and then again following the 800lb and 1200lb tests see Figures 78 through 82. The ultrasound show if there was any separation. The scale on the right of the figures shows the percentage of bond. The comparisons show that no significant damage was detected using ultrasound or x ray.

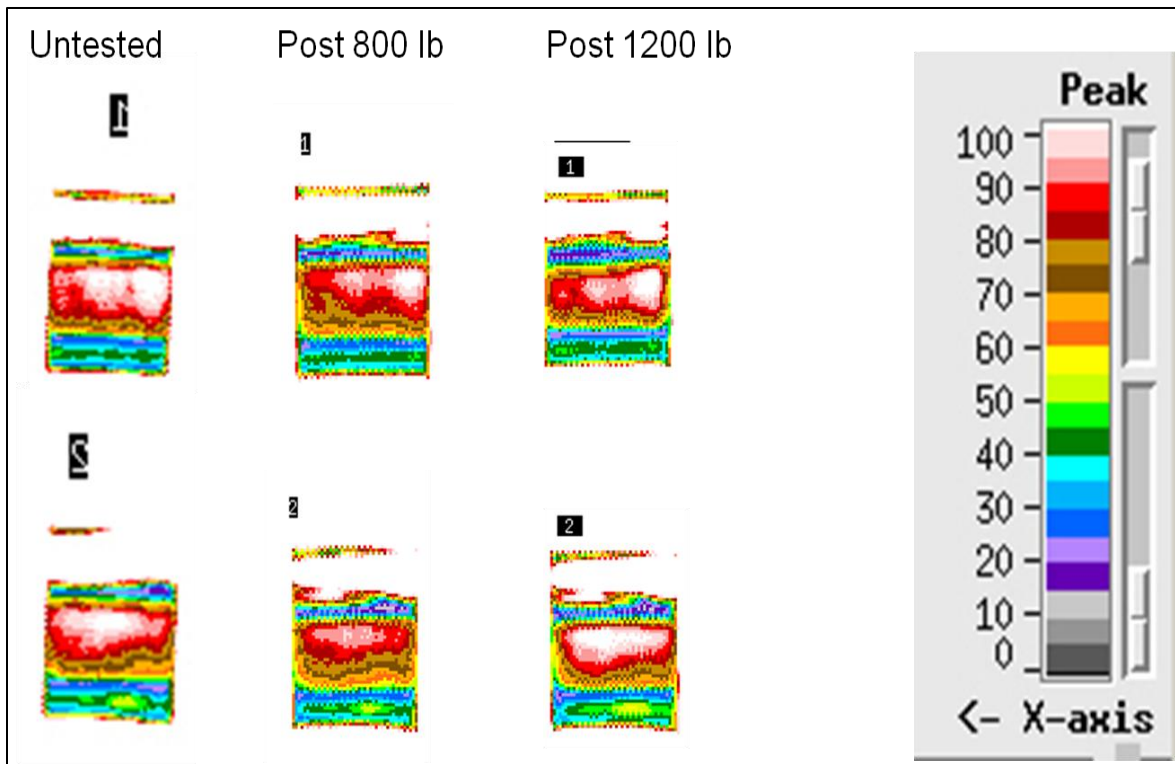


Figure 78 : Ultrasound on Control samples 1 and 2

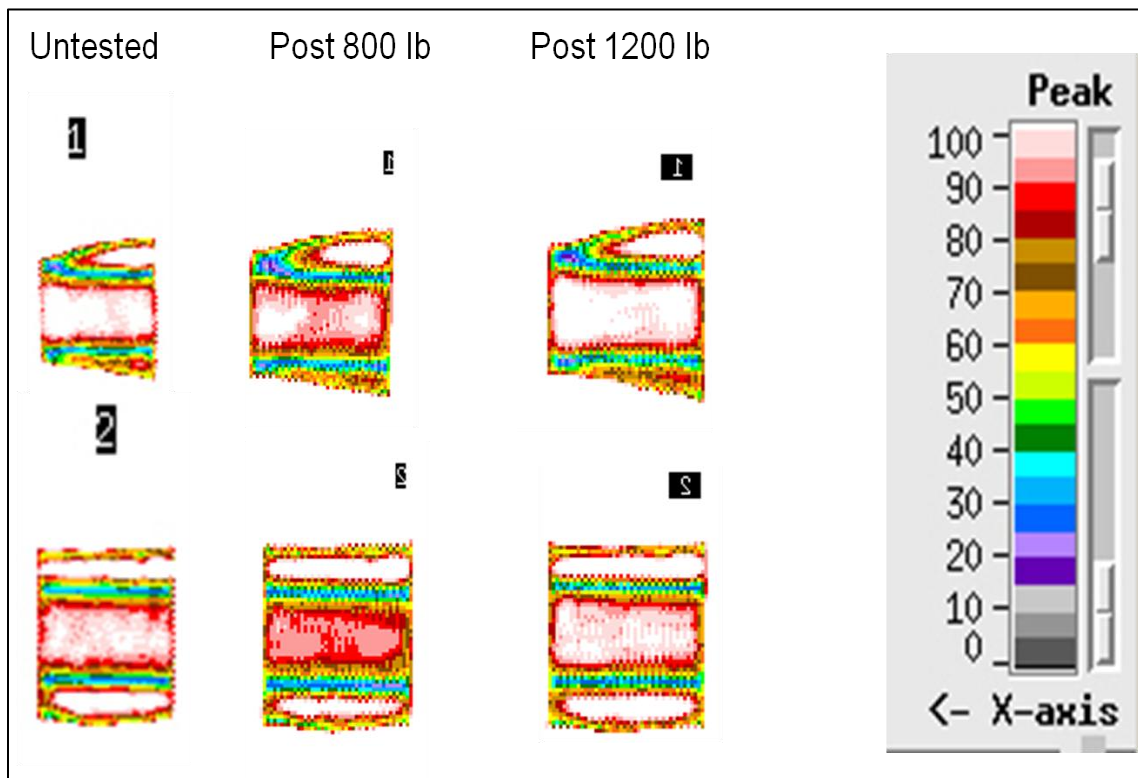


Figure 79 : Ultrasound on XPN1 samples 1 and 2

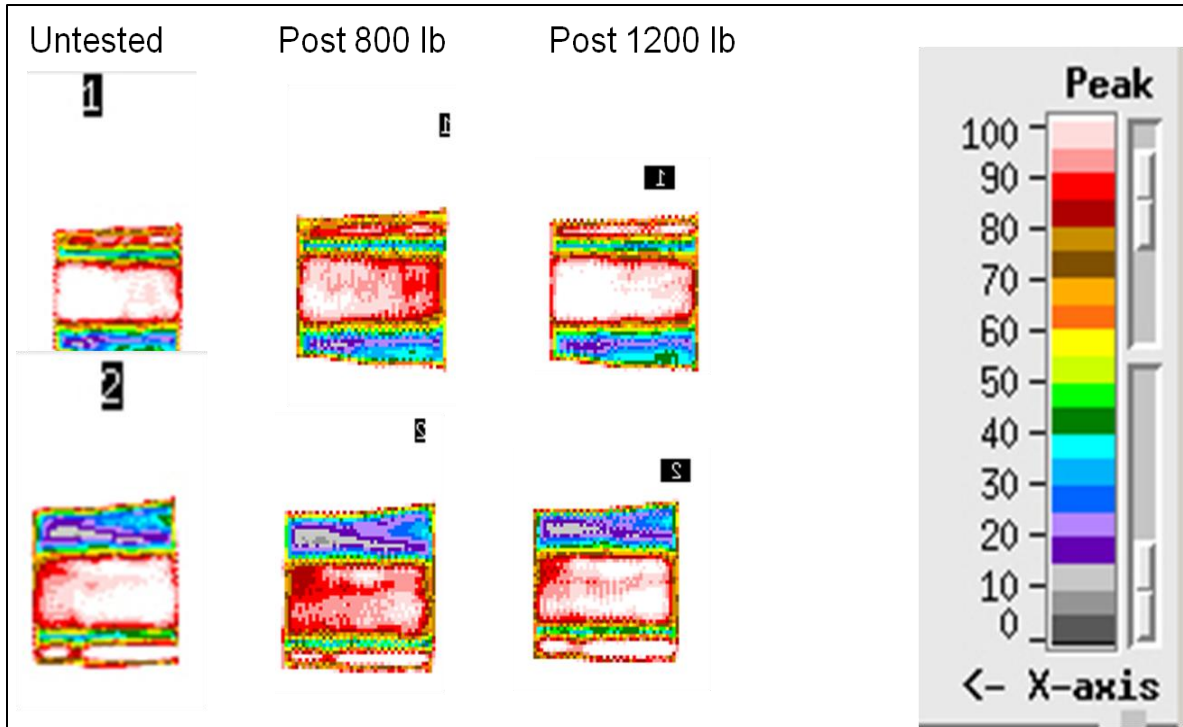


Figure 80 : Ultrasound on XPN3 samples 1 and 2

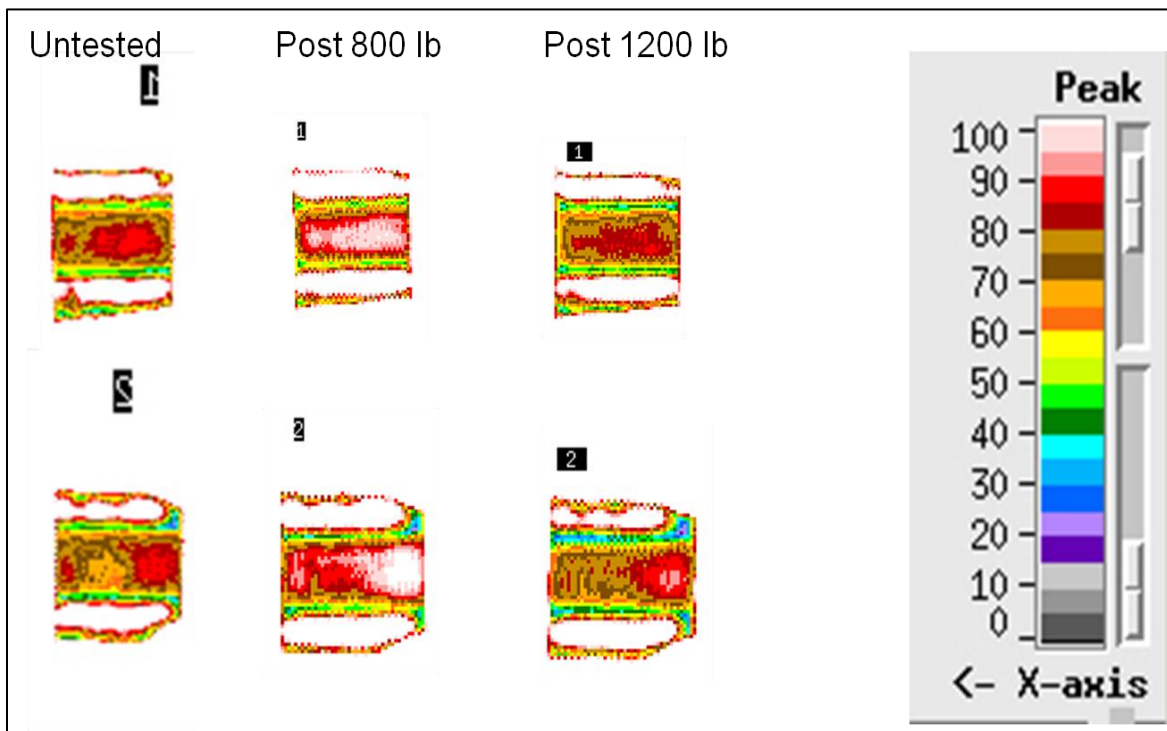
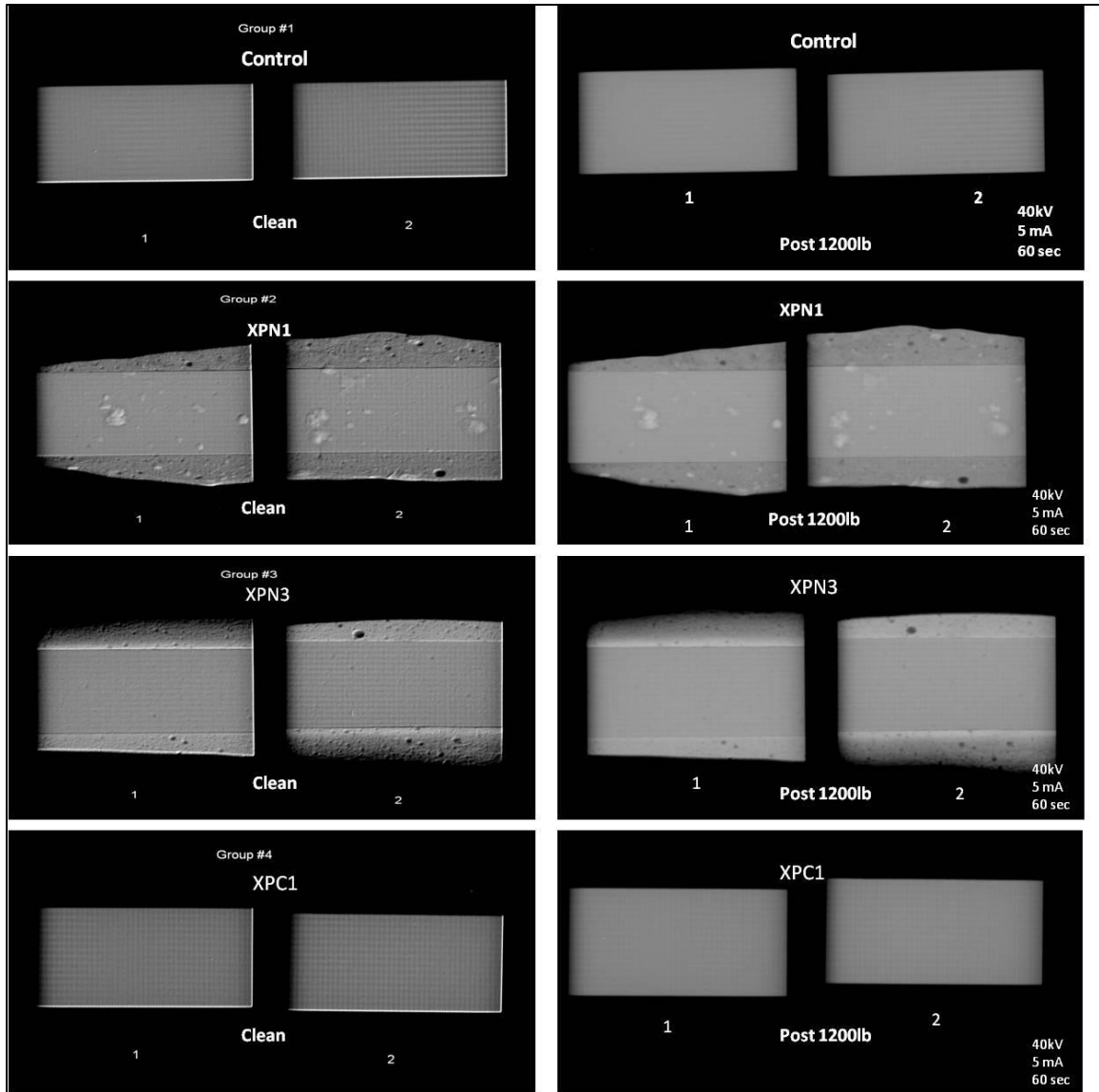
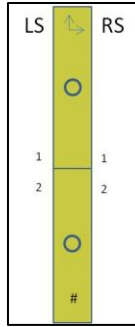


Figure 81 : Ultrasound on XPC1 Samples 1 and 2

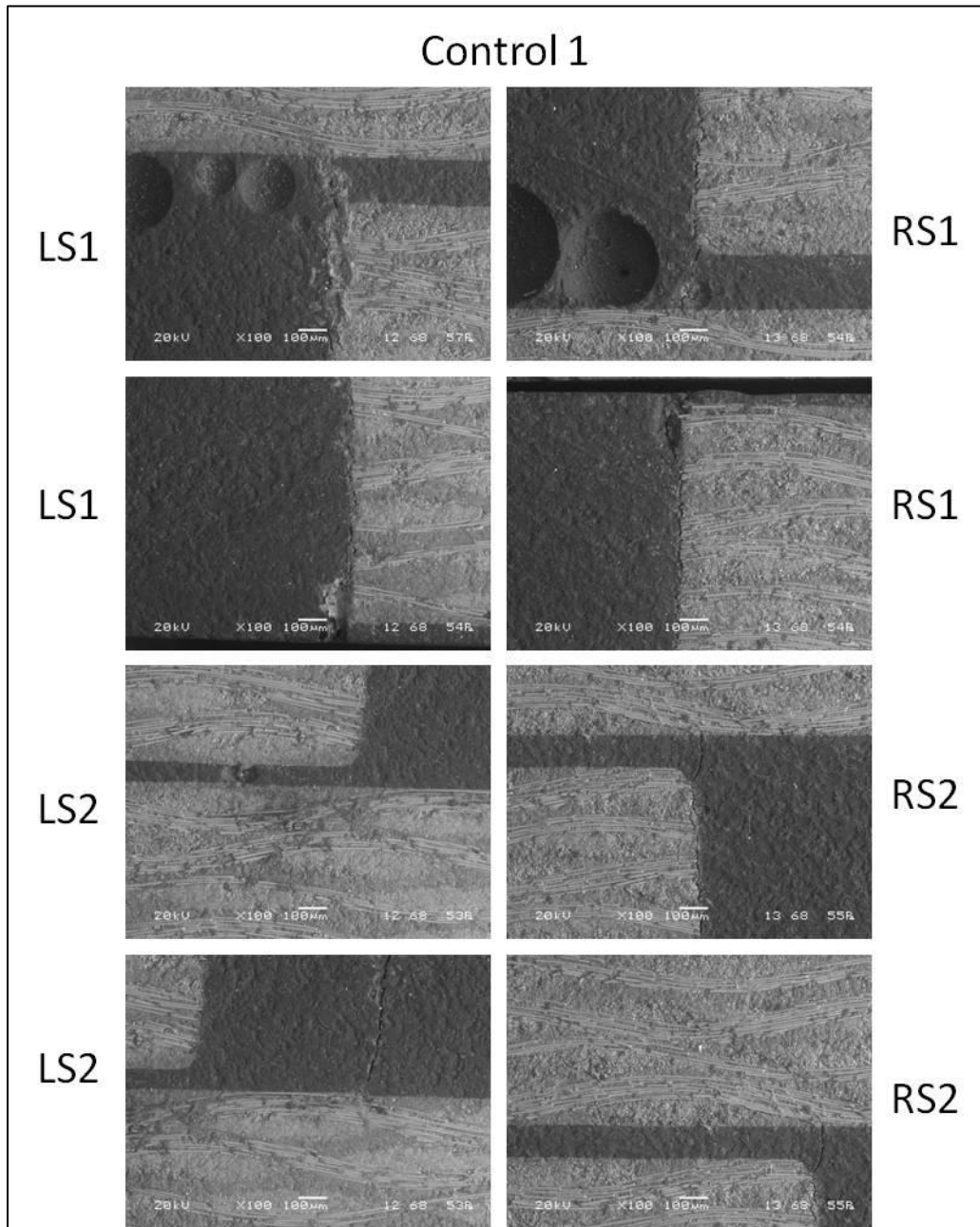


**Figure 82 : X-Ray comparison of Lap Joints**

Additionally, Scanning Electron Microscope (SEM) images were taken of the lap joints following the 1200 lb pull test to see if there was visible damage and if the PZTs signals were changing as a result of the damage. Damage can be seen in the SEM images Figure 83 and 84.



**Figure 83 : Orientation of Lap Joint Sample for SEM**



**Figure 84 : SEM Images of Control Sample 1 Post 1200lb Test**

The results and analysis of the composite lap joint testing show that:

1. IDT sensors are not a useful tool for detecting damage in composite lap joint
2. PZT sensors detect signals, but the signal is very weak and would not be useful in detecting damage
3. Ultrasonic and X ray images do not detect damage in this test
4. Stress Strain plots showed that damage was occurring at certain loads
5. SEM images confirmed the damage following the 1200lb pull test

## ***V. Conclusion***

This chapter provides a summary of the results from the experimentation, as conclusions that were found as a result of this work, and recommendations for follow on research to improve the overall understanding of this IDT versus PZT behavior and performance as a RTSHM System.

### ***5.1 Summary***

This research group presented a Real Time ASHMS by using System Architecture, DoDAF 2.0, and IBM Telelogic System Architecture 11.2 software tool. The research team represented what the Real Time ASHMS was by using System Architecture and provided the following system architecture products: AV-1, Use Case Diagram, OV-1 Concept of Operation, OV-5 Operational Node Tree Diagram, OV-5 Context Diagram, OV-5 Activity Model (A-0, A0, A1, A2, A3, and A4), OV-2 Operation Node Connectivity, OV-4 Organization Chart, SV-4 System Node Tree Diagram, SvcV-4 Service Functionality Description, SV-1 System Interface Diagram, and SV-5 System Function to Operational Activity. The purpose of the System Architecture products is to inform decision makers about the benefits of a Real Time ASHMS. The Previous Aircraft Structural Health Monitoring Concept concentrated on the ground maintenance process. Sensor technology is immature and unreliable. The key players of the Air Force Flight Mission and Operations thought the Aircraft Structural Health Monitoring System was not useful and would not commit money to Aircraft Structural Health Monitoring System development without more promising research. If aircraft and aircraft maintenance were perfect, there would be no need to develop an Aircraft Structural Health Monitoring System. Perfect maintenance and perfect condition aircraft is not possible, because



human error is a factor in aircraft maintenance problems. For more efficient and effective aircraft structural maintenance service, a RTASHMS could be useful.

Systems engineering is an interdisciplinary approach. During the system architecture design phase, this research group found that all the related science, technology, and systems of the RTASHMS could be accomplished except for detecting structural damage or crack. This research group discovered one more installation methodology of detecting structural damage or crack through testing.

How does this testing benefit a RTASHM system? Some of the greatest challenges facing the Structures community have been the lack of a reliable sensor that is durable, reliable, rugged, and eliminates false readings. The PZT sensors produce Lamb waves in an omni-directional pattern, which is erratic and very complex to analyze. Furthermore, the frequency changes as thicknesses, geometry and material changes adding additional complexity to the process. PZTs are sensitive to strain and are not durable. They would be unreliable in a RTASHM system. IDT sensors operate at higher frequencies that produce Rayleigh wave signals that are directional and simple to read. They are not sensitive to material changes or geometry changes. They have been tested on actual geometry and have been successful. The technology is a promising leap forward and could potentially be the catalyst to creating an operation RTASHMS in the near future.

## ***5.2 Future Research***

The basic testing conducted in this research revealed that the IDT sensor has potential. This sensor coupled with PZT sensor could be the catalyst in producing a functional Real Time Aircraft structural Health Monitoring System.

More testing needs to be accomplished to further verify and validate this technology.

Additional testing suggestions include but are not limited to:

1. Install the IDT sensors on a more complex structural component
2. Build a prototype Real Time Structural Health Monitoring system using the IDT sensors and then conduct fatigue testing.
3. Test PZT and IDT sensors in composite materials
4. Testing of a directional PZT sensor
5. Testing of an Omni directional IDT sensor
6. Sensor selectibility and sensitivity studies.

ENV could conduct joint research with other departments to continue experimentation and accelerate sensor technology maturation. The Air Force could benefit from this emerging technology.

## *Appendix A. AV-1*

### *1. AV-1 (All-Views Architecture-1)*

The first product suggested by DoDAF is the AV-1, which is a textual description of the problem. The AV-1 serves as an overview and summarizes information which defines the problem description, identification, scope, and purpose.

### *2. Identification*

**Name:** Real Time Aircraft Structural Health Monitoring System Architecture

**Version:** This is the first iteration of this architecture. Evolution is expected in the future.

### *3. Background*

Recent in-flight structural failures in aging aircraft have highlighted the need to monitor an Aircraft's Structural Health in real time. The purposes of a real time Aircraft Structural Health Monitoring system are to reduce the probability of catastrophic accidents caused by aircraft's structural damage or critical cracks during flight and to save life cycle maintenance cost related to a timed replacement of structural components. However, the previous concept of Aircraft Structural Health Monitoring primarily concentrated on the ground maintenance effort. Some limitations of previous Aircraft Structural Health Monitoring concepts were that the ground maintenance phase required large equipment with high power requirements, lengthy training time to become proficient which creates higher maintenance cost and time. Furthermore, Structural crack and damage detection was only possible during the maintenance phase, not in-flight. Testing or analyses was needed to apply the Aircraft Health Monitoring System. Therefore, This research group explored the best way to install an entire Aircraft Health Monitoring Systems on an operational aircraft. This will provide a more cost effective

and real time Aircraft Health Monitoring concept. This System Architecture will provide real time aircraft structural damage and crack information to pilots and maintainers. A warning from the system would alert the pilot that the aircraft has some structural damage or crack during flight and they could apply an appropriate emergency procedure to safely land the aircraft. The maintainers would be informed of crack or damage location and conduct appropriate repairs. The system would also provide maintainers and engineers real-time information on structural component condition without the need for intrusive and costly timed inspection intervals. The maintenance burden could be reduced and aircraft availability would be increased...

#### ***4. Research Goals***

The goals are virtually unchanged from the 2006 research (Albert, March 2006).

The goals are described in this section.

The implementation of an ISHMS will reduce the current aircraft inspection burden on the maintainers. The burden shall be reduced, by increasing the mean time between inspections, decreasing mean time to inspect, and/or decreasing number of inspection items, as well as reducing the risk of damage due to performing the inspections. Ideally, such a system will alert the user of current and/or impending aircraft structural health failures. The system shall be reliable and accurate such that it does not adversely impact aircraft safety or maintenance. The addition of the ISHMS should maintain the Safety of Flight within the allowable parameters. Ideally, the addition of the RTASHMS should not reduce the performance nor impose restrictions on the operational limits of the aircraft. The presence of the system on the aircraft should not limit the use of the aircraft in current and anticipated operational environments. The total life-cycle cost (development, acquisition, installation, operating/maintenance, and disposal) of the RTASHMS should not exceed the total aircraft maintenance costs (inspections and repairs) of the structural components being monitored by the RTASHMS for the extended service-life period. [1]

The goals of a Real Time Aircraft Structural Health Monitoring System are included in Table 1.

**Table 6 : Goals of the RTASHMS**

	<b>Goals</b>
1	Extend Service Life
2	Reduce Inspection Burden
3	Reduce Inspection Induced Damage
4	Maintain Safety of Flight
5	Reduce Cost
6	Collect Data in Real Time
7	Minimize Impact on Aircraft Operations
8	Easy to Maintain
9	Easy to Use Pilot and Maintenance Cuing
10	Minimize Development and Installation Time
11	Streamline Acquisition

**5. Systems Requirements**

1. The Real Time ASHMS must be a simple small device which can be installed on the aircraft structure and in the cockpit. It should utilize an aircraft internal electrical power. The equipment would include the ASHM instrument, data recording and processing software, sensors, wires, and a wave generating equipment.
2. The physical attachment and reliability of the Real time ASHMS should be enduring in the conditions of high load factors.

3. The software should have the ability to record ASHMS data. The hardware which recorded ASHMS data can be dispatched and plugged in ground equipment for analyzing damage and crack occurrences.
4. The software of ASHMS must have a function to reset the ASHMS when the system causes uncertain types of errors.
5. The Real Time ASHMS should have a function to be checked periodically and manually by the pilots and maintainers.
6. The Real Time ASHMS should contain the function of wirelessly sending and receiving the data with the ground maintenance center. The ASHMS and the ground maintenance center would communicate with each other and share the ASHMS data in real time.

## ***6. Critical Questions***

The Aircraft Structural Health Monitoring System relates to all functional concepts that rely on manned and unmanned air vehicles.

The critical questions addressed by this architecture include the following:

8. What resources need to be devoted to Real Time Aircraft Structural Health Monitoring System (hardware, software, bandwidth, and personnel)?
9. What organizations are responsible for the different parts of the Real Time Aircraft Structural Health Monitoring System architecture and how do they coordinate with one another?

10. What potential end users are there for Real Time Aircraft Structural Health Monitoring System (DoD, allies, and commercial)?
11. What is the inherent system reliability and what redundancies are built in?
12. How long will this architecture be required before it is obsolete?
13. Are there security concerns with applying this Aircraft Structural Health Monitoring System?
14. How would a system integrate a Real Time Aircraft Structural Health Monitoring System?

Analysis of these questions will occur as the architectural products described previously are developed and refined.

## ***7. Scope***

Various manned and unmanned air platforms could benefit from an Aircraft Structural Health Monitoring System. The system will reduce life cycle maintenance cost and contribute to increased flight safety.

This architecture is meant to be utilized on and would be required for aging aircraft and next generation air platforms. This architecture is broad enough to enable these areas of responsibility to include users such as the US and allied military services as well as commercial entities. The scope of the products currently in development to realize this architecture is summarized in the Table 2:

**Table 7 : Real Time ASHMS [1]**

<b>Product</b>	<b>Short Name</b>	<b>Working Form</b>
Concept of Operations	OV-1	Word Document
Overview and Summary Information	AV-1	Word Document
Operational Node Connectivity Description	OV-2	System Architect Graphic
Organization Chart	OV-4	System Architect Graphic
Activity Model	OV-5	System Architect Graphic
Logical Data Model	OV-7	System Architect Graphic
Systems Interface Description	SV-1	System Architect Graphic
Systems Functionality Description	SV-4	Excel Spreadsheet
Operational Activity to System Function Traceability Matrix	SV-5	Excel Spreadsheet
System Measures Matrix	SV-7	Excel Spreadsheet
Capability to Operational Activity Traceability Matrix	CV-6	Excel Spreadsheet
Use Case	n/a	System Architect Graphic

### ***8. Purpose and Perspective***

The purpose of the Real Time ASHMS is to provide a real time, life cycle cost effective and flight safety concept and methodology of Aircraft Health Monitoring System for aging and next generation aircraft. The developing Aircraft Health Monitoring System is too big and complicated, does not work in real time and is expensive.



Currently, various types of manned and unmanned air platforms would need to install the Real Time Aircraft Structural Health Monitoring System on the aircraft for saving life cycle maintenance costs and increasing flight safety. Ultimately, the Real Time Aircraft Structural Health Monitoring System would provide an increased operation and mission capability and air platform's availability during war time.

The Aircraft Structural Health Monitoring System relates to all functional concepts that rely on manned and unmanned air vehicles.

### ***9. Assumptions***

It is assumed that sensor technology and methodology of detecting cracks on aircraft structures will provide a continuous, reliable, simply, and timely capability to the Area of Responsibility (AOR).

It is assumed that the information and data about Aircraft Health Monitoring Systems will remain unclassified. At the time of this concept, the data concerning an Aircraft Health Monitoring System is unclassified and will remain unclassified for the foreseeable future. There are no significant concerns about data security at this time.

It is assumed that the current USAF, Allied Air Forces, and other services will continuously use various types of manned and unmanned air platforms. Furthermore, they will need to get a real time, life cycle cost effective, and safety enhancing concept and methodology for detecting an Aircraft's structural damage and crack during both flight and ground maintenance phases.

### ***10. Findings***

The development of this architecture has provided insight into only some of the prior questions.

1. This question has not yet been fully addressed by this architecture. The basic design and test effort provided some insight into simple hardware, software, and personnel requirements. Further testing and architectural construction will provide more details on equipment and personnel requirements.
2. Primarily operational pilots and operational maintainers have a responsibility for checking an aircraft's structural condition during flight and maintenance phase by using Real Time ASHMS. The flight control center and ground maintenance center have a responsibility for gathering and recording aircraft structural condition data. The flight squadron supervisor and maintenance squadron supervisor have a responsibility for identifying, analyzing, and advising an appropriate action to the pilots and maintainers. The Flight wing commander has a responsibility for managing the Real Time ASHMS.
3. Primary end users identified in the current architecture, are DoD, allied nation and commercial aircraft operators and maintainers, but it is anticipated that there will be more users than can currently be conceived. Potentially a system could be used in ground vehicles, ships and even static structures such as buildings and bridges.
4. This system relies on available or new sensor technology, wave generating and crack detecting methodology, and hardware/software technology. This system relies on the existing communications infrastructure which has redundant paths and systems already built in. One example cited is Data Link, UHF/VHF Radio, and GPS navigation system. Numerical reliability analyses were not performed.

5. As fully explained in Section 3.2., the anticipated technological advances will ultimately render this current architecture obsolete.
6. Due to the security capabilities and needs of the wide variety of anticipated users, the presence of both classified and unclassified paths will be needed.
7. Most aircraft systems have the wiring and hardware capabilities to integrate the RTASHMS processing and detection systems as well as the communication bandwidth to relay emergency data to the ground maintenance center or air operations center. Air platform specific studies will have to be conducted for integration purposes.

## ***Appendix B. OV-1***

### ***1 Purpose***

The purpose of this concept is to provide a real time, life cycle cost effective concept and methodology of Aircraft Structure Health Monitoring System for aging and next generation Aircraft.

### ***2 Time Horizon, Assumptions, and Risks***

#### **1. Time Horizon:**

The anticipated timeframe for the completion and fielding of the Aircraft Health Monitoring System architecture is approximately ten years.

#### **2. Assumptions:**

2.1. It is assumed that the developing methodology of detecting crack on aircraft structures (PZT, IDT, and etc) will have a continuous, reliable, simple, and timely capability to the Area of Responsibility (AOR).

2.2. It is assumed that the Aircraft Health Monitoring System's information and data will remain unclassified. At the time of this concept the data contained within Aircraft Health Monitoring System is unclassified and will remain unclassified for the foreseeable future. There are no significant concerns about data security at this time.

2.3. It is assumed that the current USAF, Allied Air Forces, and other services will continuously use various types of manned and unmanned air platforms. Furthermore, they will need to get a real time, life cycle cost effective, and contributing flight safety concept and methodology of detecting an Aircraft's structural damage and crack during both flight and ground maintenance phase.

### 3. Risks

3.1. A major risk of the Real Time Aircraft Structural Health Monitoring System is the physical failure of the system on the aircraft structure. Sensors, wires, and hardware can be broken by structural fatigue. This risk is mitigated by using redundancy in the system and creating a life cycle maintenance plan that includes easy and simple replacement procedures for the system or system components.

3.2. There is a risk that the software process in the Aircraft Structural Health Monitoring will experience data processing failures. This is a potential single point of failure for the Real Time Aircraft Structural Health Monitoring System data process. This risk could be mitigated with the use of backup software system and reset functions for the Real Time Aircraft Structural Health Monitoring System.

### ***3. Description of the Military Challenge***

1. The Real Time Aircraft Structure Health Monitoring System consists of data processing software, cockpit instrumentation, wave generator, oscilloscope, wires, and sensors. By using internal aircraft electrical power, the system would reduce the need for large external equipment which would ease the maintenance burden and increase war time availability and capability. The pilot or maintainer can check the aircraft's structural condition in real time during both flight and maintenance phases. If the pilot recognizes the structural damage or crack on the aircraft during flight, emergency action can be taken. If the maintainer recognized structural damage or cracks during the maintenance phase, they would replace the appropriate structural part. Life cycle maintenance costs would decrease and aircraft availability would increase.

2. Currently, various types of manned and unmanned air platforms such as fighter, striker, bomber, attacker, cargo, tanker, and UAV would need to install the Aircraft Structural Health Monitoring System. Ultimately, the Real Time Aircraft Structural Health Monitoring System would provide an increase in mission capability.

#### ***4. Synopsis***

The Real Time Aircraft Structural Health Monitoring System provides aircraft structural damage and crack information to the pilot and maintainer in real time during both flight and ground maintenance phases. It would provide increased flight safety, convenient maintenance, increase aircraft availability and capability, and reduce life cycle maintenance cost during peace time operations and war time.

#### ***5. Desired Effect, Means and End***

1. The desired effect of the Real Time Aircraft Structural Health Monitoring System is providing an aircraft structural damage and crack condition to the pilot and maintainer in real time during both flight and ground maintenance phases. The desired effects of the Real Time Aircraft Structural Health Monitoring System are maintenance conveniences, increasing maintenance availability and capability, saving lives and aircraft, and reducing life cycle maintenance cost during operation and war time. USAF, allied forces and commercial users could benefit from the Real Time Aircraft Structural Health Monitoring System Architecture.

2. The system will be a simple, small in size, with easy, controllable software, instruments, wires, sensors, and equipment. The RTASHMS would detect an aircraft's structural damage and cracks and inform pilots and maintainers during flight and maintenance phases by using the aircraft's electrical power and equipment.

## **6. Architecture**

The architecture of the Real Time ASHMS system will consist of a single data source from an aircraft structure with a standardized data set, provisions for timely dissemination to any interested parties, both pilots and maintainers(ground maintenance center), and resources to enable transmission to the ground maintenance center.

## **7. Sequenced actions (Use Cases):**

**1. Terse Case – The ASHMS on the aircraft checks the aircraft structural condition and sends the ASHMS data to the ground maintenance center periodically and automatically when the ASHMS turns on during both the flight**

**and maintenance phases:** The pilot or maintainer turns on the ASHMS switch to check aircraft structural condition. The ASHMS checks an aircraft's structural condition and detects structural damage and cracks automatically and periodically. The pilot or maintainer does not need to perform any other action. If a problem is detected in the aircraft structure, the ASHMS would show the problem on the ASHMS instrument on the aircraft during both flight and maintenance phases.

**2. Terse Case – The operational Maintainer checks an aircraft's structural condition before flight:** The operational maintainer turns on the Real Time ASHMS during a flight maintenance phase. The ASHMS checks the aircraft structural condition for damage and cracks. The ASHMS then displays the aircraft structural condition on the instrument monitor in the cockpit. If there is no structural problem, the maintainer decides the aircraft can safely fly. He turns off the ASHMS. If damage or cracks are detected, the maintainer returns the aircraft to the hanger for additional testing and conducts the appropriate maintenance.

**3. Terse Case - Pilot checks an aircraft structural condition before taking off:**

Squadron pilot performs starting engine procedure and he performs the taxiing checklist. When the aircraft is positioned at the runway entrance line, the pilot starts the inspections by depressing a start checking push button. The ASHMS inspects the structural condition and displays the results on the instrument monitor in the cockpit. If no structural problems are detected, the pilot begins take off procedures. If damage is detected, the pilot performs abort procedure and taxis back to parking area.

**4. Terse Case - Distribute ASHMS data to ground maintenance center during**

**both flight and maintenance phase:** The Real Time ASHMS data would be collected in the ASHMS software hard drive on an aircraft periodically during both flight and maintenance phase. The software would communicate with ground maintenance center through a data link or the aircraft's UHF/VHF communication system. The ASHMS would collect and transmit data approximately every 10 minutes. The ground maintenance center will store each individual aircraft's data and analyze and monitor the data for any trends that indicate the potential for structural problems

**5. Terse Case – The pilot applies an appropriate emergency procedure when**

**damage or cracks are detected during flight:** The pilot is alerted to the presence and location of damage on the aircraft structure. The pilot would apply appropriate emergency procedures and try to land as soon as possible. The ground maintenance center prepares an appropriate action after the aircraft safely lands.



**6. Terse Case – The depot maintainer replaces the appropriate structural component when damage is detected by the ASHMS during the ground maintenance phase:** The depot maintainer turns on the ASHMS during depot maintenance phase. The ASHMS checks the aircraft's structural condition. If damage is detected, the depot maintainer would replace or repair the appropriate structural part. If ASHMS trend analysis determines that further flying would be unsafe, then the appropriate component would be repaired or replaced.

## ***Bibliography***

1. Albert, A. P. (March 2006). *A Systems Engineering approach to Integrated Structural Health Monitoring for Aging Aircraft*. Air Force Institute of Technology, Master's thesis.
2. American Society of Test and Measurement. (2005). D1002-05 Standard Test Method for Apparent Shear Strength of Single-Lap-Joint Adhesively Bonded Metal Specimens by Tension Loading(Metal-to-Metal). *Annual Book of ASTM Standards Volume 03.01* . ASTM.
3. Association, G. A. (2010). Retrieved February 25, 2011, from [http://www.gama.aero/files/GAMA\\_DATABOOK\\_2011\\_web.pdf](http://www.gama.aero/files/GAMA_DATABOOK_2011_web.pdf)
4. Bond, M. S. (2007). *A Systems Engineering Process for an Integrated Structural Health Monitoring System*. Air Force Institute of Technology, Masters Thesis.
5. Crider, J. S. (2005). *Damage Detection using Lamb Waves for Structural Health Monitoring*. Air Force Institute of Technology, Masters Thesis.
6. Davisson, B. (1997). "PIREP: 1957 Cessna 172",. Retrieved from <http://www.airbum.com/pireps/PirepCessna1721957.html>
7. *DOD Architecture Framework*. (2009).
8. *F-15 Crash*. (2008, May 6). Retrieved Feb 9, 2011, from Snopes.com: <http://www.snopes.com/photos/airplane/f15crash.asp#photo2>
9. Giurgiutiu, V. (2003). Tuned Lamb Wave Excitation and Detection with Piezoelectric Wafer Active Sensors for Structural Health Monitoring. *Journal of Intelligent Material Systems and Structures* , 16(291-305): 57-65.
10. Harder, B. T. (2001). *Evaluation of Nanocomposites as Lightweight Electronic Enclosures for Satellites' Application*. Air Force Institute of Technology, Masters thesis.
11. IgorViktorov. (1967). *Rayleigh and Lamb waves*. New York: Plenum Press.
12. Jeong k. Na, J. L. (2009). detection of surface breaking fatigue crack on a complex aircraft structure with Rayleigh surface waves.
13. Jeong K. Na, J. L. (2009). Interaction of rayleigh surface waves with a tightly closed fatigue crack.

14. Jeong K. Na, s. K. (n.d.). Interaction of Rayleigh Waves Induced by Interdigital Transducer with Fatigue Crack.
15. Kuhn, J. D. (2009). *Changes in Structural Health Monitoring System Capability Due to Aircraft Environmental Factors*. AFIT Doctoral Thesis.
16. M. Malkin, M. L. (n.d.). Hot Spot Monitoring: development of a framework for SHM Systems Design.
17. M.M Derriso, S. O. (n.d.). why are There Few Fielded SHM systems for Aerospace Structures.
18. Program, 2. U. (2006, November 28). *2006 ASIP Conference*. Retrieved January 5, 2011, from 2006 ASIP Conference:  
[http://www.asipcon.com/2006/06\\_proceed/Tuesday/0430\\_Bateman.pdf](http://www.asipcon.com/2006/06_proceed/Tuesday/0430_Bateman.pdf)
19. Underwood, R. T. (2008). *Damage Detection Analysis Using Lamb Waves in Restricted Geometry for Aerospace Applications*. Air Force Institute of Technology, Masters Thesis.
20. V. Nalladgea, J. K. (n.d.). Application if IDT Sensors for Structural Health Monitoring of Windmill Turbine Blades Made of Composite Material.

<b>REPORT DOCUMENTATION PAGE</b>			<i>Form Approved OMB No. 074-0188</i>	
<p>The public reporting burden for this collection of information is estimated to average 1 hour per response, including the time for reviewing instructions, searching existing data sources, gathering and maintaining the data needed, and completing and reviewing the collection of information. Send comments regarding this burden estimate or any other aspect of the collection of information, including suggestions for reducing this burden to Department of Defense, Washington Headquarters Services, Directorate for Information Operations and Reports (0704-0188), 1215 Jefferson Davis Highway, Suite 1204, Arlington, VA 22202-4302. Respondents should be aware that notwithstanding any other provision of law, no person shall be subject to a penalty for failing to comply with a collection of information if it does not display a currently valid OMB control number.</p> <p><b>PLEASE DO NOT RETURN YOUR FORM TO THE ABOVE ADDRESS.</b></p>				
<b>1. REPORT DATE (DD-MM-YYYY)</b> 24-03-2011		<b>2. REPORT TYPE</b> Master's Thesis		<b>3. DATES COVERED (From – To)</b> Aug 2010-Mar 2011
<b>4. TITLE AND SUBTITLE</b>  A Systems Architecture and Advanced Sensors Application for Real-Time Structural Health Monitoring			<b>5a. CONTRACT NUMBER</b>	
			<b>5b. GRANT NUMBER</b>	
			<b>5c. PROGRAM ELEMENT NUMBER</b>	
			<b>5d. PROJECT NUMBER</b>	
<b>6. AUTHOR(S)</b>  Shin, Hyoungjin, Major, ROKAF, Beckett, Edward C., Captain, USAF			<b>5e. TASK NUMBER</b>	
			<b>5f. WORK UNIT NUMBER</b>	
			<b>8. PERFORMING ORGANIZATION REPORT NUMBER</b>  AFIT/GSE/ENV/11-M04	
<b>7. PERFORMING ORGANIZATION NAMES(S) AND ADDRESS(S)</b>  Air Force Institute of Technology Graduate School of Engineering and Management (AFIT/EN) 2950 Hobson Way WPAFB OH 45433-7765			<b>10. SPONSOR/MONITOR'S ACRONYM(S)</b> AFMC AFRL/RXLP	
<b>9. SPONSORING/MONITORING AGENCY NAME(S) AND ADDRESS(ES)</b> Blackshire, James L., Civ, USAF Air Force Research Laboratory, Materials and Manufacturing Directorate 2230 10th Street WPAFB, OH 45433 DSN: 785-0198 (James.Blackshire@wpafb.af.mil)			<b>11. SPONSOR/MONITOR'S REPORT NUMBER(S)</b>	
			<b>12. DISTRIBUTION/AVAILABILITY STATEMENT</b> APPROVED FOR PUBLIC RELEASE; DISTRIBUTION UNLIMITED	
<b>13. SUPPLEMENTARY NOTES</b> This material is declared a work of the United States Government and is not subject to copyright protection in the United States				
<b>14. ABSTRACT</b> Aircraft are being pushed beyond their original service life, increasing the potential for structural failures. A catastrophic in flight failure of an F-15 bulkhead and severe cracking in the C-130 Wing rainbow fitting are two recent examples that have caused major problems for the Air Force. Previous Aircraft Structural Health Monitoring Systems research primarily explored using a system during the ground maintenance phase. This research will explore a Real-Time Aircraft Structural Health Monitoring System (RTASHMS) that includes a ground phase as well as an in-flight phase. The RTASHMS will continuously analyze structural hot spots, detect critical structural damage or cracks and will alert pilots and maintainers of potential trouble before a catastrophic structural failure. Current sensor technology has limited the construction and use of a reliable aircraft structural health monitoring system. This research will compare the capabilities of current sensor technology with the capabilities of a new cutting edge sensor. The new sensor shows promise in advancing a reliable RTASHMS from theory to reality. This technology was validated in Aluminum Dog Bone specimens and Composite Lap Joint with nano-adhesives				
<b>15. SUBJECT TERMS</b> Structural Health Monitoring				
<b>16. SECURITY CLASSIFICATION OF:</b>			<b>17. LIMITATION OF ABSTRACT</b>  UU	<b>18. NUMBER OF PAGES</b>  139
<b>a. REPORT</b>  U	<b>b. ABSTRACT</b>  U	<b>c. THIS PAGE</b>  U		
			<b>19a. NAME OF RESPONSIBLE PERSON</b> Dr. Som R Soni (AFIT/ENV)	
			<b>19b. TELEPHONE NUMBER</b> (Include area code) 937-255-3636 ext 3420, som.soni@afit.edu	
<b>Standard Form 298 (Rev. 8-98)</b> Prescribed by ANSI Std. Z39-18				
			<i>Form Approved OMB No. 074-0188</i>	