

Performance of Circular Footing on Expansive Soil Bed Reinforced with Geocells of Chevron Pattern

Sanjeev Kumar ^{a*}, Anil Kumar Sahu ^b, Sanjeev Naval ^c

^a Research Scholar, IKGPTU, Kapurthala (Punjab), India.

^b Professor, Department of Civil Engineering, Delhi Technological University, Delhi, India.

^c Associate Professor, Department of Civil Engineering, DAV Institute of Engineering & Technology, Jalandhar, India

Received 13 June 2019; Accepted 21 September 2019

Abstract

Results from laboratory model tests performed on circular footing are presented in this paper to understand the performance of geocell reinforced expansive soil. Naturally occurring expansive soil was used in this study as subsoil. Geocells of chevron pattern fabricated from geotextile made up of polypropylene were used to reinforce the soil bed. The parameters studied in this testing program were the placement depth of the geocell mattress, pocket size of geocell and the height of geocell mattress. Contrary to other researchers; the improvement in the performance of reinforced bed is evaluated at a settlement level equal to the failure settlement of unreinforced soil bed. The performance of reinforced bed is evaluated through two non-dimensional factors viz. bearing capacity improvement factor (I_f) and settlement reduction factor (PRS%). Test results indicated that with the introduction of geocell as reinforcement, a substantial improvement in bearing capacity and decrease in footing settlement can be achieved. Bearing capacity of reinforced bed increases by more than 200% and 81% reduction in footing settlement was achieved by using geocell mattress of optimal dimensions and placing it just below the footing base.

Keywords: Circular Footing; Expansive Soil; Geocell Mattress; Chevron Pattern; Bearing Capacity.

1. Introduction

Due to rapid urbanization, need arises to construct structures on expansive soils. But there is difficulty in building any infrastructure facility over such soils due to its shrinkage and swelling properties. The development of any area depends upon the growth of infrastructure mainly roads, railways, buildings etc. Since the shear strength of these soils is very low, stability of structures built on such soils is a challenging job as there is a possibility of large consolidation settlement and bearing capacity failures. In order to build safe and stable structures, the expansive soils underneath need to be treated for the improvement of its bearing capacity. Reinforcing soils is one of the effective and reliable techniques to improve their strength since reinforcing soils improve bearing capacity & stability and reduce lateral deformation & settlement [1-3]. Different types of materials with many shapes and techniques are currently in use in civil engineering projects. Using fibres like polyesters, polypropylene, glass fibres, steel bars, natural fibres viz. jute, coir, sisal, palm etc. has been recognized as an effective reinforcement for soil [2, 4-6]. To improve foundations, roads, and construction of wall polymeric fibres and grids, metallic strips and meshes have been extensively used as planner reinforcement over the recent few decades [6-13]. Amongst various stabilizing techniques available providing high strength geosynthetic

* Corresponding author: snjvbansal67@gmail.com

 <http://dx.doi.org/10.28991/cej-2019-03091415>



© 2019 by the authors. Licensee C.E.J, Tehran, Iran. This article is an open access article distributed under the terms and conditions of the Creative Commons Attribution (CC-BY) license (<http://creativecommons.org/licenses/by/4.0/>).

reinforcement is yet another simple, fast, and cost effective approach. About 80% applications of geosynthetics are in road construction. The beneficial effects of geosynthetic materials as reinforcement are mainly dependent on the form in which these are being used. In the past most of the research works were carried out using geotextiles, geogrids, geomembranes, and geo-composites. But little research work has been carried out using geocells in roads on expansive soils. Therefore, there is a need to carry out research work related to geocell reinforced pavements. Providing three dimensional confinements to soil using geocell is the succeeding development in this field. Geocell mattress is a series of interconnected cells fabricated from the strips of polymer geogrids. It has been shown that geocell improve the strength of soil by reducing lateral spreading, providing confinement and causing the cramped composite to behave as a more rigid mattress [14]. It intercepts the possible failure planes, and the rigidity of mattress forces them deeper into the foundation soil and hence improving bearing capacity.

2. Literature Review

Beneficial effects of geosynthetic using as geocells have reported in the past by Lots of researchers. Yetimoglu et al. [15] through laboratory model tests also from finite element analysis investigated the bearing capacity of rectangular footing resting sand reinforced with geogrid. Mhaiskar and Mandal [16] performed plate load tests and numeric study to explore the efficiency of geocell alternative, effect of cell geometry and relative density of the backfill. Adams and Adams and Collin [17] studied the probable benefits of reinforced soil foundations using geosynthetic as reinforcing material through large scale model footing load tests with two different types of geosynthetic Viz. a stiff biaxial geogrid and a geocell. Rajagopal et al. [18] presented the effect of geocell confinement on strength and stiffness behavior of granular soils encased in single and several geocells by performing triaxial compression tests. Dash (2001) [19] performed model tests on strip footing supported on poorly graded (SP) dry river sand bed reinforced with geocell mattress fabricated from oriented polymer and non-oriented polymer, biaxial grid.

Dash et al. [20] conducted the model plate load tests on strip footing supported on geocell reinforced sand bed to examine the effect of an additional planner layer of reinforcement on the bearing capacity. Ghosh et al. [21] studied the bearing capacity of square footing resting on jute geotextile reinforced pond ash. Latha et al. [22] carried out laboratory model tests to study the advantages of geocell as reinforcement on the functioning of earth embankment build over soft soil bed and propose a straightforward method for design of geocell supported embankment. Latha et al. [23] studied the consequences of a reinforcement form on strength enhancement of geosynthetic reinforced sand through triaxial compression tests. Sitharam et al. [24] develop an understanding to the behavior of geocell reinforced soft soil, natural silty soil, foundations under circular loading by conducting plate load tests on circular footing. Zhou and Wen [14] studied improvement in bearing capacity of soft soil from geosynthetic materials included in sand cushion to fabricate composite layers through large scale model tests designed according to similarity theory.

Latha and Somwanshi [25] conducted laboratory plate load tests and numeric study to investigate the relative performance of different forms of reinforcement (viz. Planner layer, mesh elements distributed at random and geocell) to increase bearing capacity and to decrease settlement of square footing placed on sand beds. Pokharel et al. [26] reported that for each cycle of load bearing capacity, stiffness, and percentage elastic deformation can be increased using single cell reinforcement although permanent deformation reduces. Dash (2010) [27] brings out the effect of relative density of foundation soil on the behavior of geocell as reinforcement by conducting plate load tests on sand beds with or without geocells. Tafreshi and Dawson [28] performed plate load tests on strip footing placed on sand beds to evaluate bearing capacity when reinforced with the same characteristics of geotextile used as geocell and planner form. Dash (2012) [29] conducted model plate load tests to study effects of geocell reinforcement on load carrying capacity of sand bed under strip footing. Biswas et al. [30] conducted model load tests on 150mm diameter footing resting geocell reinforced foundation systems to evaluate the effect of strength of subgrade layers. Bazne et al. [31] performed numeric modelling and laboratory experiments on different composition to investigate the effects of geonet reinforcement on bearing capacity of low compacted soft soil.

Hegde and Sitharam [32] conducted plate load tests to report that both bamboo cells and bamboo grid as a planner reinforcement can be used effectively as a substitute of geocell and geogrid combination where bamboo is available in abundance. Indraratna et al. [33] performed large scale cubical triaxial tests to evaluate the behavior of sub ballast with and without reinforcement under cyclic loading. Shadmand et al. [34] investigated load settlement characteristics of large square footing through large scale loading test on unreinforced and geocell reinforced granular soil and reported that scale effect exist for geocell reinforced soils like unreinforced soils. The behaviour of small scale footing models cannot be directly related to that of the full scale footing.

Tavakoli and Motarjemi [35] carried out a series of large scale direct shear tests to investigate the influence of soil physical properties on the interfacial properties of geocell reinforced granular soil. Kaur et al. [36] conducted numerical analysis to evaluate bearing capacity of geocell reinforced sand and compared the results with that of plate load test. It was concluded that the results obtained from the software namely Plaxis 3D are in good agreement with the laboratory test. Kolathayar et al. [37] through a series of model plate load tests provides an overview of bearing capacity and

settlement characteristics of coir geocell and HDPE geocell reinforced sand bed and seashells sand bed. Liu et al. [38] assessed the failure mechanism of geocells when subjected to tensile and shear loads by presenting the observed failure patterns and an evolution of implications of practical uses of geocells. Kuo and Chou [39] performed three dimensional FEM analysis and evaluated the effect of geo-textile interlayer on the performance of flexible pavement. The results of the study indicated that with the inclusion of geo-jute performance of pavement improves significantly by producing lower stress, strain and displacement at top of the subgrade.

3. Materials and Methods

3.1. Materials

Expansive soil utilized in the study was a naturally occurring black cotton soil having a particle fraction percentage finer than 75 microns as 96% and percentage finer than 2 microns as 64.5% particle fractions, soil properties are listed in Table 1. According to Bureau of Indian Standard (BIS) Classification, the expansive soil is classified as high plasticity clay and is designated as CH. Activity of the soil indicates that it is a normal active soil and contains illite clay minerals. Figure 1 shows the particle size distribution curve. Geocell mattress was prepared from the commercially available woven geotextile, shown in Figure 2, made up of polypropylene. Geotextile properties are listed in Table 2.

Table 1. Properties of expansive soil

Parameters	Value
Specific Gravity	2.33
% Finer than 4.75 mm (%)	100
% Finer than 75 μ (%)	94.00
% Finer than 2 μ (%)	64.50
Liquid Limit, (%)	87.27
Plastic Limit, (%)	38.60
Plasticity Index, (%)	48.67
Activity	0.755
Maximum Dry Density, (kN/m ³)	14.85
Optimum Moisture Content, (%)	22.50
CBR, % Unsoaked	6.28
CBR, % Soaked	1.82
Unconfined Compressive Strength, (kN/m ²)	66.54
Cohesion, kN/m ² (uu Test)	33.27
Angle of internal friction (uu Test)	Zero

Table 2. Properties of polypropylene geotextile

Parameters	Value
Thickness, mm	0.8
Color	White
Weight per unit area, N/m ²	94.00
<i>Wide Width Tensile Strength, kN/m</i>	
WARP	80
WEFT	70
<i>Elongation at break, %</i>	
WARP	25
WEFT	25

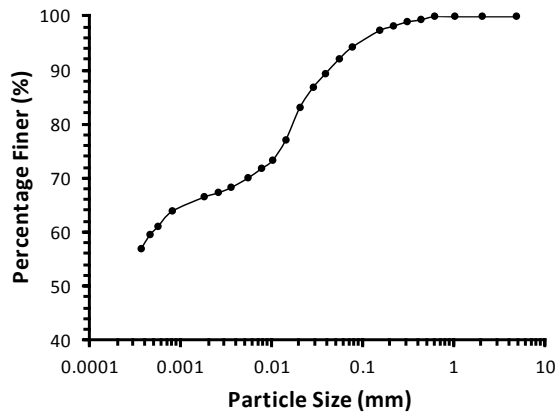

Figure 1. Particle Size Distribution Curve

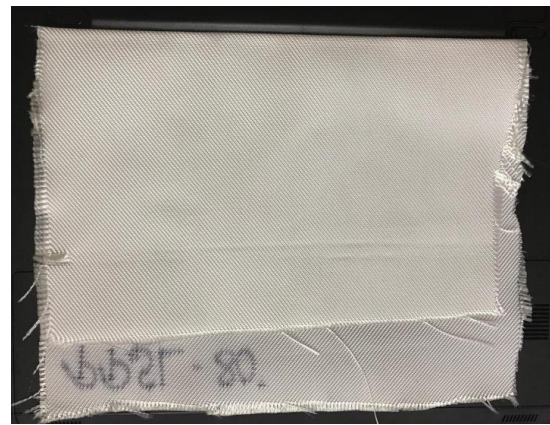

Figure 2. Woven Geotextile

3.2. Test Setup

The flowchart of the research method is shown in Figure 3.

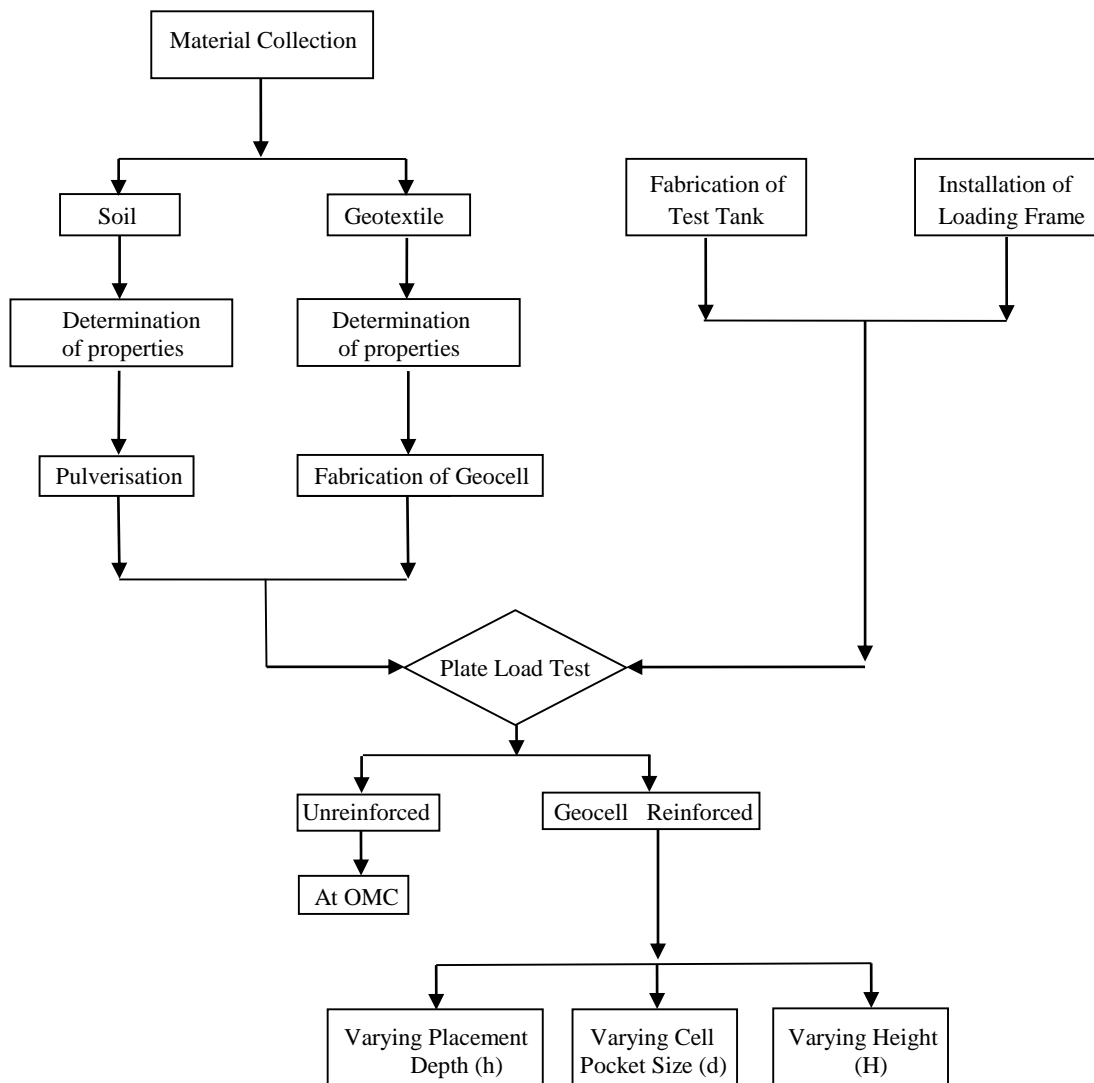

Figure 3. Flowchart showing Methodology Adopted

Model plate load tests were performed in tank fabricated from mild steel plates and having dimensions 1000 mm x 1000 mm x 850 mm. Sides of this tank were braced properly with mild steel flat to prevent yielding of tank material while applying load on model footing. In this study model footing used was a 25mm thick mild steel plate of diameter 200 mm Base of this model footing was roughened by cementing a thin layer of sand with epoxy glue [19, 20, 24, 25, 28]. To apply load on model footing a manually operated hydraulic jack resting against the reaction frame was used.

Load applied on the footing was measured with a pre calibrated pressure gauge installed on the pump attached with the hydraulic jack. Systematic diagram of the test setup used in this study is shown in figure 4.

3.3. Test Bed

The soil used in the study was first pulverized properly. To prepare a test bed having uniform properties, markings at a constant distance of 50mm was done along the height of the test tank. For each layer, requisite amount of pulverized soil was weighed and a predetermined quantity of water was mixed to this soil to have a desired bulk density. The moist soil was then kept under covers for 3-4 days for maturing and to prevent the loss of initial moisture content. The moistened soil was mixed again before placing it into the test tank to permit even distribution of water. After placing the soil into the tank, it was gently levelled and compacted with a drop hammer (weighing 48.9 N with a drop of 450 mm) to the desired thickness following the guide markings done on tank walls. Undisturbed samples were collected during the filling of the tank from different locations to determine unit weight and moisture content of compacted soil to ensure uniformity of the prepared test bed. Same has been checked using Proctor’s needle. Therefore, through careful controlling the moisture content and compaction effort reasonably uniform test conditions were accomplished during the testing program.

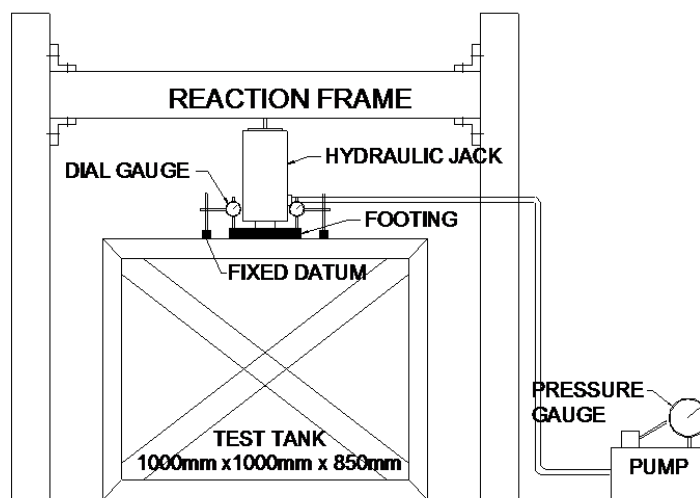

Figure 4. Systematic diagram of test setup

3.4. Geocell Mattress

Strips of requisite shape and size were cut from the rolls of geotextile and putting these together in transverse and diagonal direction to form mattress of chevron pattern as in the Figure 5. Chevron pattern of geocells was chosen since it performs better than diamond pattern [19, 20, 40]. To fabricate geocell nylon thread was for stitching geotextile strips. The number and length of stitches were kept the same for all the geocells fabricated during the testing program to have uniform conditions of the tests conducted. The geocell mattress thus fabricated was placed on the soil bed at desired depth beneath the footing level and moist soil was filled in its pockets. Soil filled in the geocell pockets was identical as in the underlying subgrade layers. To obtain similar properties of soil as that of the underlying test bed the compaction in the geocell pockets was carefully controlled. Undisturbed samples of soil were collected from a number of locations within geocells to find properties of compacted soil and to verify compaction quality.

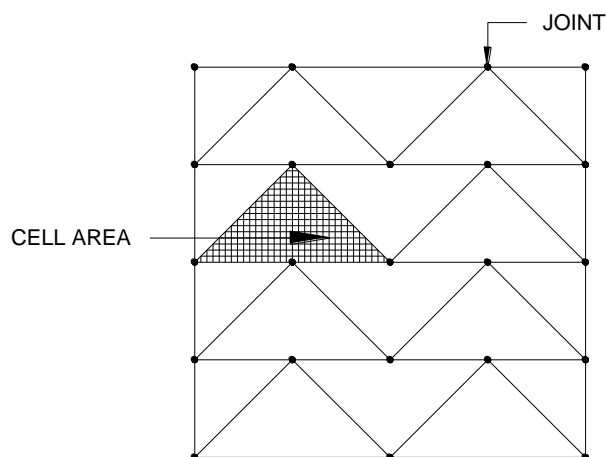

Figure 5. Chevron Pattern of Geocell

3.5. Test Procedure

Reinforcement as geocell mattress was placed above the compacted soil bed over the full length and width of the test tank. After filling, the pockets of geocell mattress with the moist soil, the top surface was levelled and model footing, 25mm thick rigid mild steel plate, was positioned along a fixed alignment so that load from the hydraulic jack would be applied without any eccentricity. To apply load, a manually operated hydraulic jack was placed between footing, and the reaction frame. A mild steel plate having 50mm diameter and of thickness 25 mm was placed between the footing surface and hydraulic jack base through which vertical loads were applied on the footing. Intensities of applied load were measured by a pre-calibrated pressure gauge installed over the pump of hydraulic jack. Loads were applied to the footing in steps with an identical load increment in all steps till failure or a settlement near to 50mm was reached. Footing settlement was measured through two dial gauges placed diametrically opposite on along the centre line of footing. Steel beams resting against tank walls were used as fixed datum to install dial gauges.

3.6. Test Variables

In Figure 6 geometry of the problem considered in this research work is shown. Geocell mattress of the shape in Figure 5 was fabricated in all the experiments conducted during this investigation programme. Four different series of tests, as detailed in the Table 3, were conducted by changing the parameter of geocell mattress viz. placement depth (h) beneath footing base, pocket size (d) and the height (H). Pocket size of the geocell is considered as the diameter of an equivalent circle having area equal to that of the opening of the geocell pocket. The tests under series A were performed on soil without any reinforcement so that a direct comparison can be made with the results of the tests conducted under series B, C and D on geocell reinforced soil.

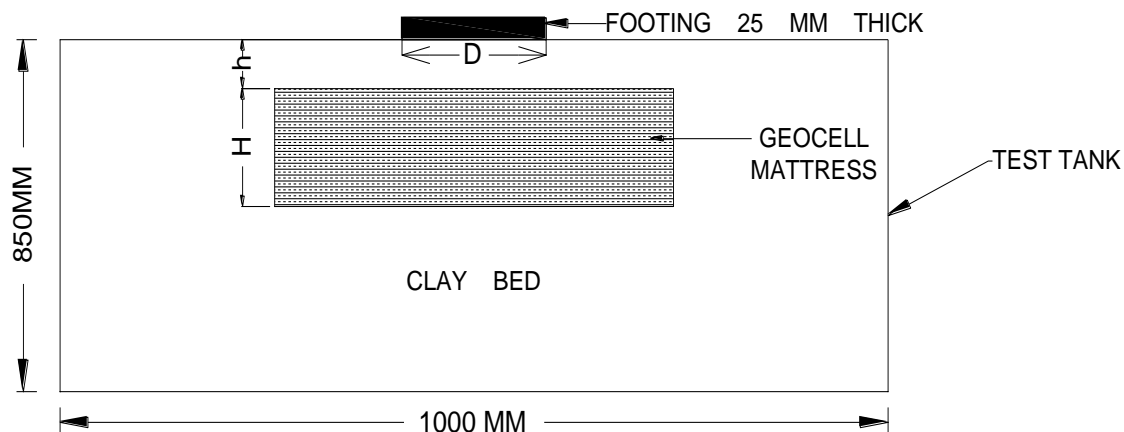

Figure 6. Geometry of geocell-reinforced bed

Table 3. Details of model test programme

Test Series	Reinforcement Type	Test Parameters
A	Unreinforced	Compacted at OMC
	Geocell	
B	Variable Parameters	$h/D = 0, 0.05, 0.1, 0.2, 0.4, 0.6, 0.8, 1.0$
	Constant Parameters	$H/D = 1, d/D = 1$
	Geocell	
C	Variable Parameters	$d/D = 0.8, 1.0, 1.2, 1.4$
	Constant Parameters	$H/D = 1, h/D = 0$
	Geocell	
D	Variable Parameters	$H/D = 0.75, 1.25, 1.75, 2.25$
	Constant Parameters	$d/D = 1, h/D = 0$

4. Results and Discussion

Behavior of bearing pressure responses with the settlement for different heights of geocell mattress is in the Figure 7. From the unreinforced case, it can be observed that about 6% settlement of the footing diameter slope of bearing

pressure-settlement curve is linear and beyond that it reduces indicating that the footing is unable to resist the additionally applied pressure due to the failure of the soil bed. Further, the response of the geocell reinforced cases shows that when settlement of bearing pressure-settlement curve approaches to 10-12 % of the footing diameter reduction in slope is observed. Beyond this settlement slope of the curve continues to be almost stable, and the pressure bearing capacity of footing increases continuously. As the foundation bed consisting of soil reinforced with geocell reinforcement continues to resist additionally applied load, it can be assumed that by providing geocell as reinforcement no clear cut failure was observed even up to a settlement of 25% of the footing diameter, the terminal settlement of the test. The ultimate bearing pressure at this settlement has increased to 2.45 times the ultimate bearing pressure of unreinforced bed. In most of the other experiments, similar observations were made. It may be due to the fact that the presence of geocell confines the soil thereby reducing the tensile forces produced in the soil resulting in reduction in the shape & size of pressure bulb.

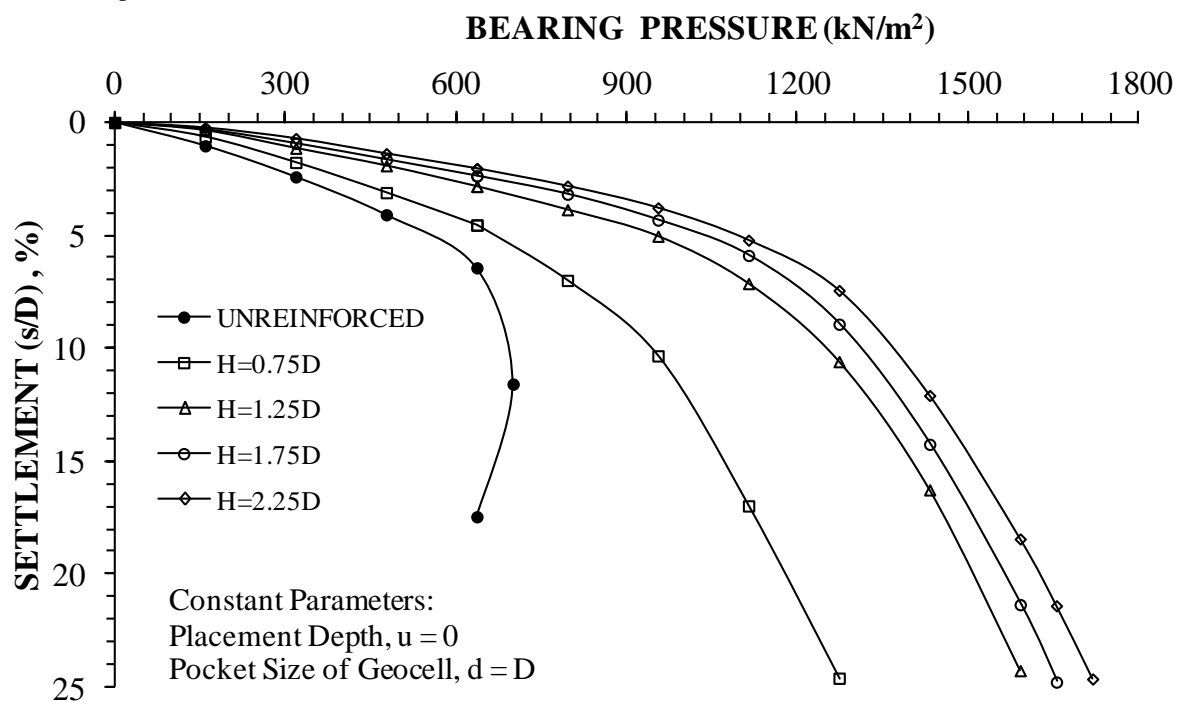

Figure 7. Variation in bearing pressure with footing settlement for various heights of geocell mattress

Figure 8 shows the behavior of bearing pressure responses with the settlement of footing for different depths of placement of geocell mattress below the footing base. From the behavior of the bearing pressure-settlement curve, it could be seen that for h/D ratio equal to 0.8 and 1 the ultimate bearing pressure is observed clearly and for other ratios of h/D footing continues to bear load up to the terminal settlement of the experiment. Interestingly in both the cases presented in Figures 7 and 8, the bearing pressure-settlement curve remained linear until approximately 5% settlement of the footing diameter for an unreinforced case and with the geocell reinforcement the curve remained linear until settlement close to 10-12% of the footing diameter and beyond this slope of the curve reduces indicating that the soil-geocell composite starts breaking up locally because of large settlement occurring under footing. Sitharam et al. [24] observed a somewhat similar result that for geocell reinforced soil bed and reported that at settlement near 10-15% of footing diameter reduction in the slope of pressure settlement curve was observed after this settlement slope remained almost constant with the footing bearing pressure continuous to increase. This phenomenon causes load bearing capacity of footing to decrease. After this geocell reinforcement start resisting further applied load through mobilization of rigidity and anchorage derived from the adjoining stable soil mass and for settlement approximately equal to 25% of footing diameter, no sign of failure for geocell reinforced soil foundation bed was observed. This fact may be due to the reason that with the geocell reinforcement the reinforcing system behaves like an interrelated cage. Because of frictional resistance, it drives an anchorage from both sides of the loaded area. Further due to bending and shear rigidity even after shear failures of the soil mass inside the geocell pockets has taken place the geocell layer continues supports the footing. This act of geocell layer is attributed as equivalent to that of a beam supporting a column in a structure.

Therefore, in the cases of soil reinforced with geocell reinforcement a sudden failure was not observed. This fact was confirmed during the removal of geocell reinforcement from the test tank upon the completion of tests. Cell walls showed buckling type deformations extending over the full height of geocell mattress which also suggests that the whole mattress acted like a single unit.

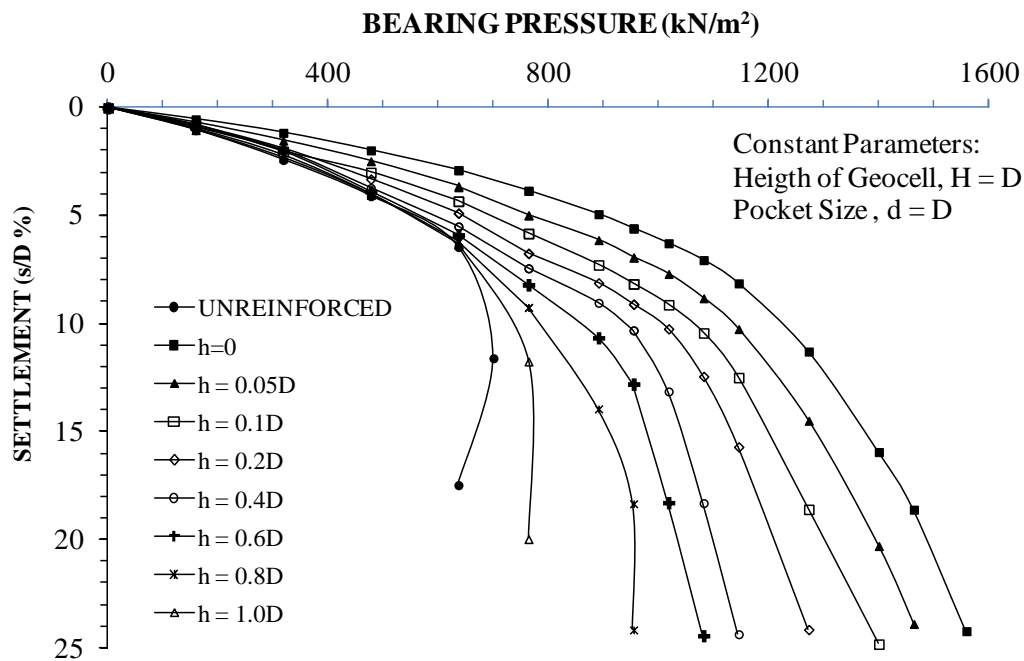

Figure 8. Variation in bearing pressure with footing settlement for various placement depths of geocell mattress below the model footing base

Two non-dimensional factors viz. (i) Bearing capacity improvement factor (I_f), (ii) Settlement reduction factor (PRS (%): percentage reduction in settlement) are used to quantify the bearing capacity of footing owing to providing geocell reinforcement.

The bearing capacity improvement factor (I_f) (it is revealed here that this improvement factor is the same as bearing capacity ratio adopted by Binquet and Lee [7] to analyze increase in bearing capacity because of planner reinforcement, and same as bearing capacity improvement factor (I_f) used by many researchers in the past [19, 20, 24, 25, 28, 32, 41] to quantify improvement in bearing pressure) compares the bearing pressure of the geocell reinforced bed with the unreinforced bed at a specified level of footing settlement.

$$I_f = \frac{\text{Bearing pressure of bed with geocell reinforced}}{\text{Bearing pressure of bed without geocell reinforced}} \tag{1}$$

It should be noted that when I_f is calculated at a settlement level greater than the failure settlement level of unreinforced bed, the ultimate failure pressure is taken as the bearing pressure of the unreinforced bed instead of actual bearing pressure at that settlement level. The settlement reduction factor (PRS %) is the same as used by some researchers in past [24, 28] compares the settlement of footing of the geocell reinforced bed with the settlement of footing of the unreinforced bed at a given level of bearing pressure.

$$PRS\% = 1 - \frac{\text{Settlement of bed with geocell reinforced}}{\text{Settlement of bed without geocell reinforced}} \tag{2}$$

It should be noted that while calculating PRS% if the level of bearing pressure is greater than the ultimate failure pressure of unreinforced bed, the settlement corresponding to the ultimate failure pressure is taken as a settlement of unreinforced bed instead of the actual settlement corresponding to the actual bearing pressure. The parameters namely settlement of footing (s), depth of geocell mattress placement below the footing base (h), pocket size of geocell mattress (d) and the height of geocell mattress (H) are also expressed as a non-dimensional quantity in diameter of footing as (s/D), (h/D), (d/D) and (H/D).

The increase in bearing capacity of soil bed because of providing reinforcement is computed normally at a higher level of settlement of the footing, 35-50% of the width of footing, [19, 20, 24, 25, 40]. In practical cases this range of settlement level must not be large; therefore, this range of settlement level may not be acceptable [28]. Hence, in the present research the performance improvement in the bearing capacity of the footing is carried out at the low settlement range, $s/D = 12\%$, equal to the ultimate failure pressure of footing resting on unreinforced soil bed.

4.1. Determination of Optimum Value for Geocell Mattress Placement Depth

Optimum value of placement depth (h/D) for geocell mattress beneath footing base is determined by conducting the tests mentioned under test series B of Table 3. During tests under this test series the placement depth (h/D) for geocell mattress beneath footing base was varied while the values of other parameters viz. H/D and d/D were kept constant at 1.0, i.e., equal to the footing diameter. Corresponding increase in bearing capacity is in Figures 9 and 10.

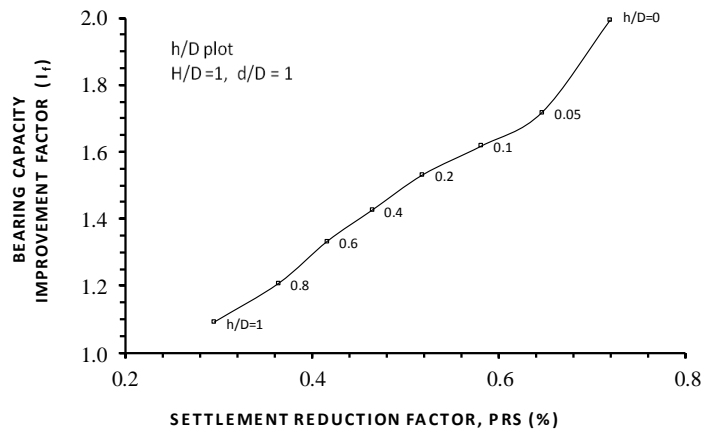

Figure 9. Variation of bearing capacity improvement factor with settlement reduction factor for various placement depths of geocell mattress corresponding to ultimate bearing pressure and failure settlement of unreinforced bed

Figure 9 shows the variation of BCIF (I_f) with PRS (%) for different placement depth (h/D) of geocell mattress beneath footing base. From this, it can be viewed that the performance improvement in load bearing capacity and decrease in footing settlement increases continuously with the reduction in placement depth of geocell mattress below footing base and the rate of an increase in performance improvement is more for a depth (h/D) less than 0.6. This fact suggests that soil mass lying within $0.6D$ from the footing base is the most active and is likely to be sheared. With the reduction in the geocell mattress placement depth, the relatively stiff geotextile enters within this depth and intercept more slip planes that cause improvement in performance. Further, when geocell mattress is placed very close to footing base, $h/D \leq 0.05$, load bearing capacity and decrease in settlement tends to improve sharply since the footing rests almost on the relatively stiffer geocell mattress- soil composite. The increase in performance improvement of the soil bed beyond depth $0.6D$ of geocell mattress placement depth is derived through friction and confinement offered by the relatively stiff and rough geocell mattress to the soil lying over it.

From Figures 9 and 10, it is observed that pressure bearing capacity of footing keeps on increasing with the reduction in the geocell mattress placement depth beneath footing base and maximum value is obtained when depth of placement is reduced to zero i.e., $h/D = 0$. This observation is within an acceptable agreement with that stated by Sitharam et al. [24] geocell reinforcement consisting of geogrid. The possible reason for the reduction in an overall performance improvement with the increase in the geocell mattress placement depth (h) beneath footing base is that the geocell reinforcement provided is a three dimensional confining structure and the soil laying freely in between the geocell mattress and footing base gets squeezed out under the pressure applied on the footing causing an increased settlement of the footing thus reducing the total improvement in performance.

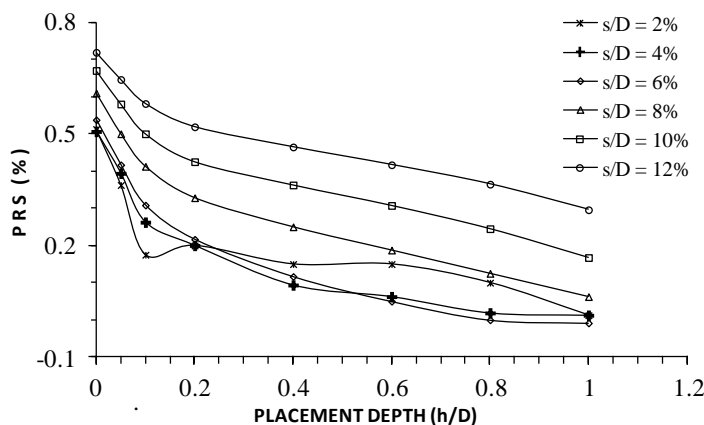

Figure 10. Variation of bearing capacity improvement factor with placement depth of geocell mattress at different footing settlement levels

Further, interestingly the effect of geocell reinforcement becomes insignificant and the reinforced bed acts like an unreinforced one when geocell mattress placement depth (h/D) was nearly equal to the footing diameter i.e., $h/D = 1$. The possible reason for this behavior is that the pressure applied by the footing on the soil mass below it. At this placement depth, geocell placement is mainly concentrated on the unreinforced one; therefore, the failure mechanism tends to be unreinforced one. Tafreshi and Dawson [28] stated similar findings for geocell reinforcement while comparing the possible benefits of reinforcing the sand bed with a planner and geocell form of geotextile reinforcement.

4.2. Effect of Geocell Mattress Pocket Size

Influence of different geocell mattress pocket size (d/D) was obtained by conducting the tests mentioned under test series C of Table 3. During tests under this test series, the pocket of (d/D) of geocell mattress below the footing base was varied while the values of other parameters viz. H/D and h/D were held constant at 1.0 and 0. Figure 11 shows that increase in bearing capacity increases with the improvement in percentage reduction in settlement when geocell pocket size (d/D) is reduced from 1.2 to 1.0 but it further decreases when pocket size is decreased to 0.8.

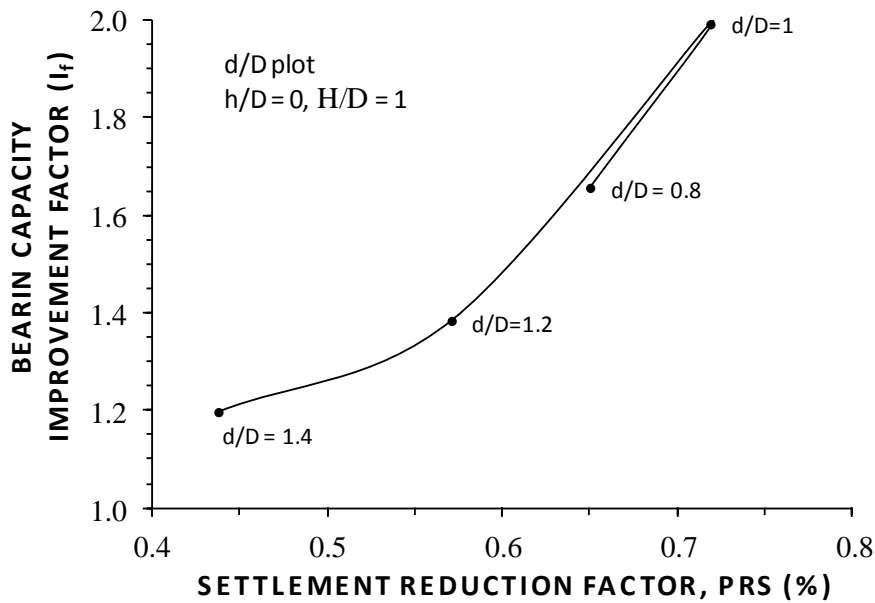

Figure 11. Variation in bearing capacity improvement factor with footing settlement factor for various geocell pocket sizes corresponding to ultimate bearing pressure and failure settlement of unreinforced bed

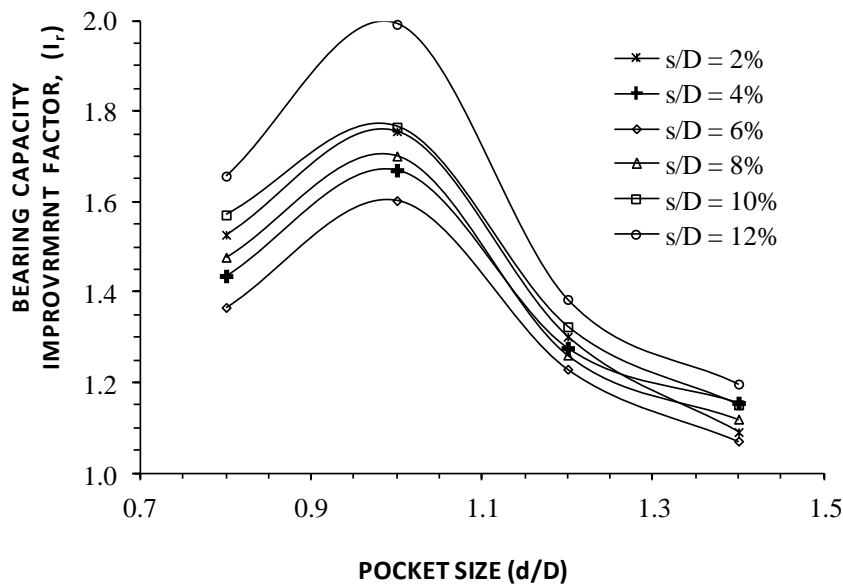

Figure 12. Variation of bearing capacity improvement factor with geocell pocket size at various footing settlement levels

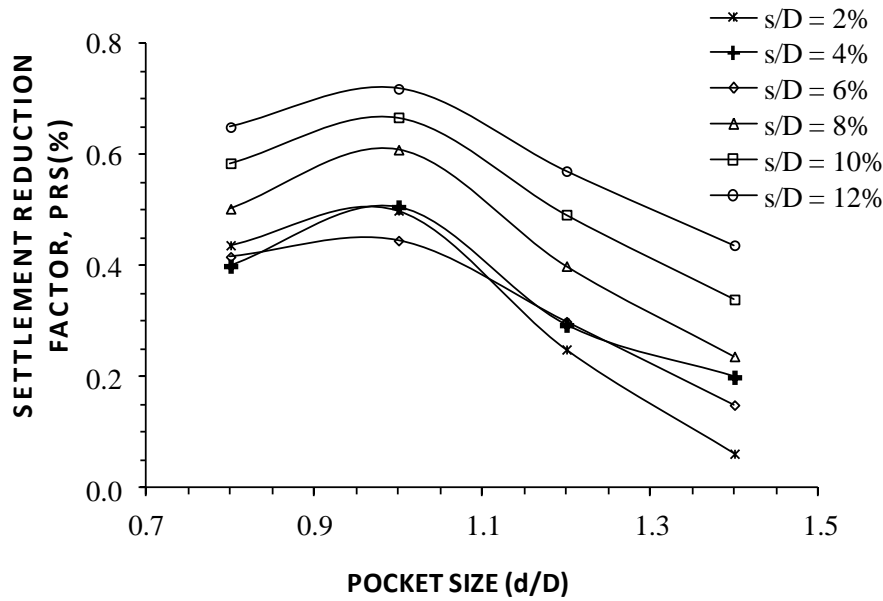

Figure 13. Variation of settlement reduction factor in footing with geocell pocket size at various footing settlement levels

From Figures 12 and 13, it is observed that there is an improvement in bearing pressure and percentage reduction in settlement when the pocket size (d/D) increases from 0.8 to 1.0. With further increase in pocket size there is a sharp decrease in the performance improvement for settlement reduction and bearing capacity of the footing. Therefore, an optimum value of pocket size is obtained when the ratio d/D reaches equal to unity i.e., 1. It is interesting to observe from Figure 13 that when pocket size (d/D) is less than one, settlement reduction factor is increasing and attains maximum value when pocket size is unity i.e., equals the size of footing diameter. However, when pocket size (d/D) is greater than one the settlement reduction factor again decreases the possible reason for this may be due to the confinement offered by the geocell pockets per unit volume and increase in the rigidity of the geocell mattress.

4.3. Effect of Geocell Mattress Height

To examine the effectiveness of geocells as reinforcement to increase bearing pressure and to reduce settlement of soil bed with increase in geocell mattress height (H/D) compared to unreinforced bed, tests mentioned under test series D of Table 3 were conducted. Height (H/D) of geocell mattress was changed starting from 0.75 to 2.25 in the steps of 0.5 while values of other parameters viz. u/D and d/D of the geocell mattress were kept constant at 0 and 1 respectively. The resulting improvement in bearing capacity and percentage reduction in settlement is in Figure 14 and 15.

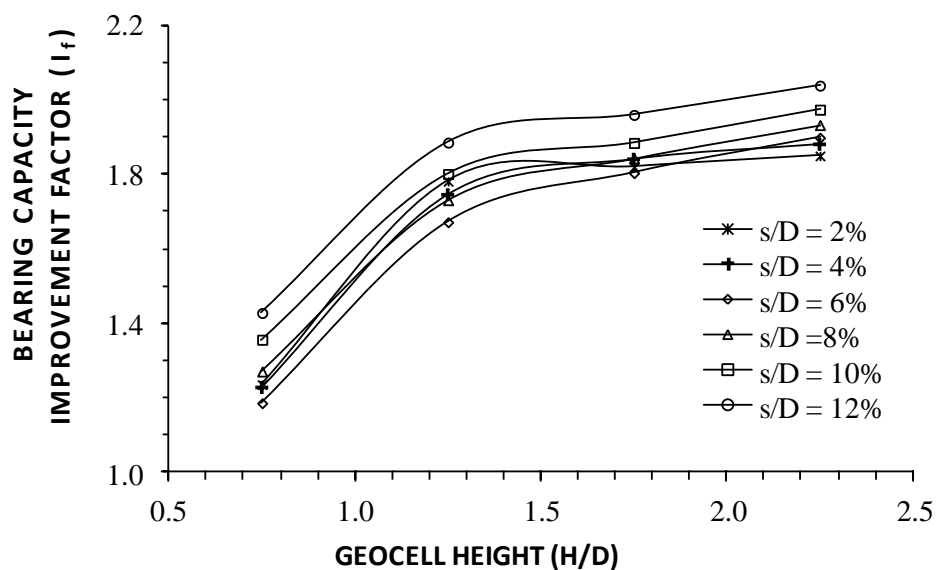

Figure 14. Variation in bearing capacity improvement factor with geocell height at various footing settlement levels

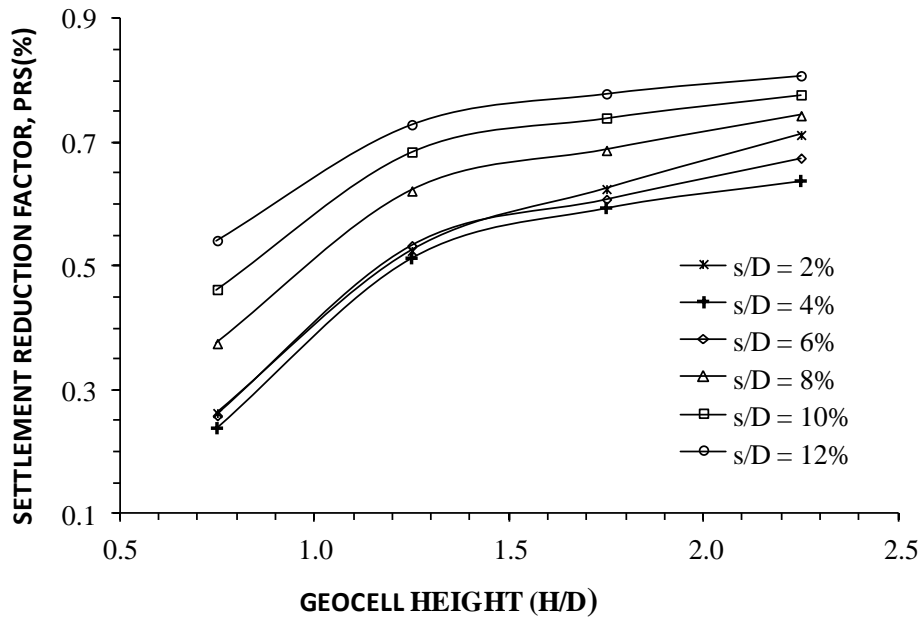

Figure 15. Variation of settlement reduction factor with geocell height at various footing settlement levels

The variation of bearing capacity improvement (I_f) factor with respect to percentage reduction in settlement (PRS%) factor is in Figure 16. From this plot, it is observed that for each height of geocell mattress increase in bearing capacity improvement factor (I_f) is very nearly proportional to the decrease in footing settlement PRS%. Figures 14 and 16 suggest that there is a substantial performance improvement in the load bearing capacity and initial stiffness of the foundation bed due to introduction of geocell mattress.

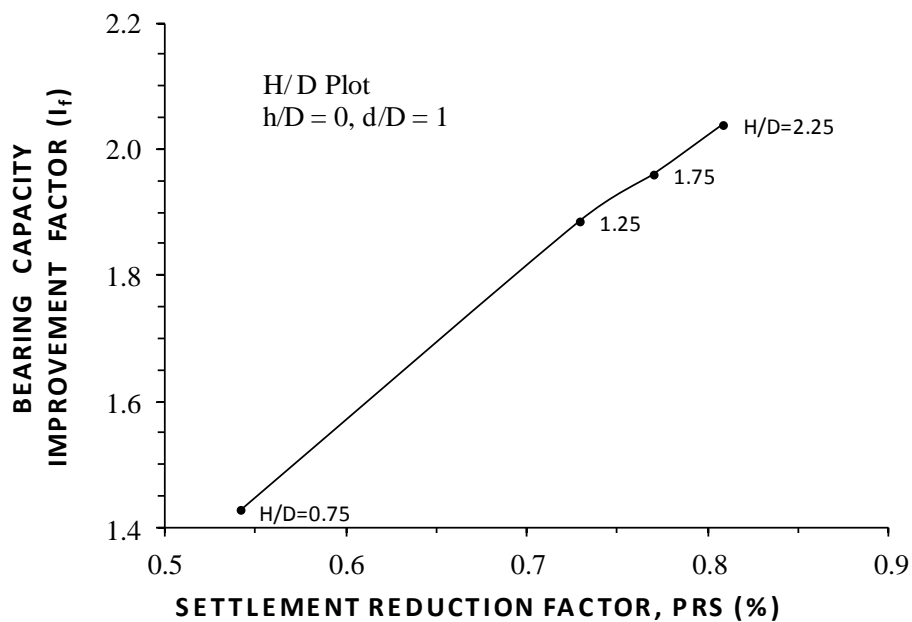

Figure 16. Variation in bearing capacity improvement factor with settlement reduction factor for various heights of geocell mattress corresponding to ultimate bearing pressure and failure settlement of unreinforced bed

Also, it is of the interest that improvement in bearing capacity improvement factor, (I_f), and settlement reduction factor (PRS%) is greater at higher settlement levels of footing which shows that with the increase in footing settlement, reinforcing efficiency of geocell mattress increases. It is also observed that up to a height (H/D) 1.25 of the geocell mattress both bearing capacity improvement factor (I_f) and settlement reduction factor PRS% increases gradually. With further increase in the height geocell mattress, performance improvement continues to increase but at a reduced rate. Similar results have been reported by Sitharam et al. [24] while studying the behavior of geocell reinforced soft clay foundations under circular footing. The increase in the thickness of the geocell mattress causes the load to distribute over a larger area following which a lesser footing pressure is distributed to the subsoil. Due to the settlement of footing,

drag is induced in the soil so adhesion and interlocking resistance of soil confined in the geocell pocket increases. These two factors are responsible for the improved performance of footing as a result of the increasing thickness of the geocell mattress.

Performance improvement at $H/D = 1.25$ is attributed to that zone of soil affected by footing pressure extends to about one to two times the footing width below the footing base and this thickness ($H/D = 1.25$) of geocell mattress intercepts most of the probable failure zones that causes performance improvement of the reinforced soil bed. With the further increase in height, $H/D = 1.75$ or more, the potential zone of failure is least intercepted by the geocell reinforcement, therefore, there is a marginal improvement in the performance of the soil bed. Hence, when the thickness of the geocell mattress approaches a value near to $2D$ one can expect a marginal improvement in the performance. Sitharam and Sireesh [42] reported this value as 1.8 with geocell reinforced clay beds. Therefore, a negligible performance improvement is observed at a thickness of $1.75D$ and $2.25D$ of the geocell mattress.

4.4. Effect of Aspect Ratio

Results obtained from tests conducted to evaluate the effect of pocket size and height of geocell mattress have been further analyzed with respect to aspect ratio, H/d ratio, of geocell pocket. Figure 17 shows the variation of bearing capacity improvement factor (I_f) with the aspect ratio. From this plot, it is observed that as an aspect ratio of geocell pocket increases load bearing capacity of footing also increases. This increase is observed up to a 1.25 aspect ratio but at 0.75 aspect ratio sudden drops in bearing capacity is observed. Rate of improvement in bearing capacity is marginal after aspect ratio 1.25.

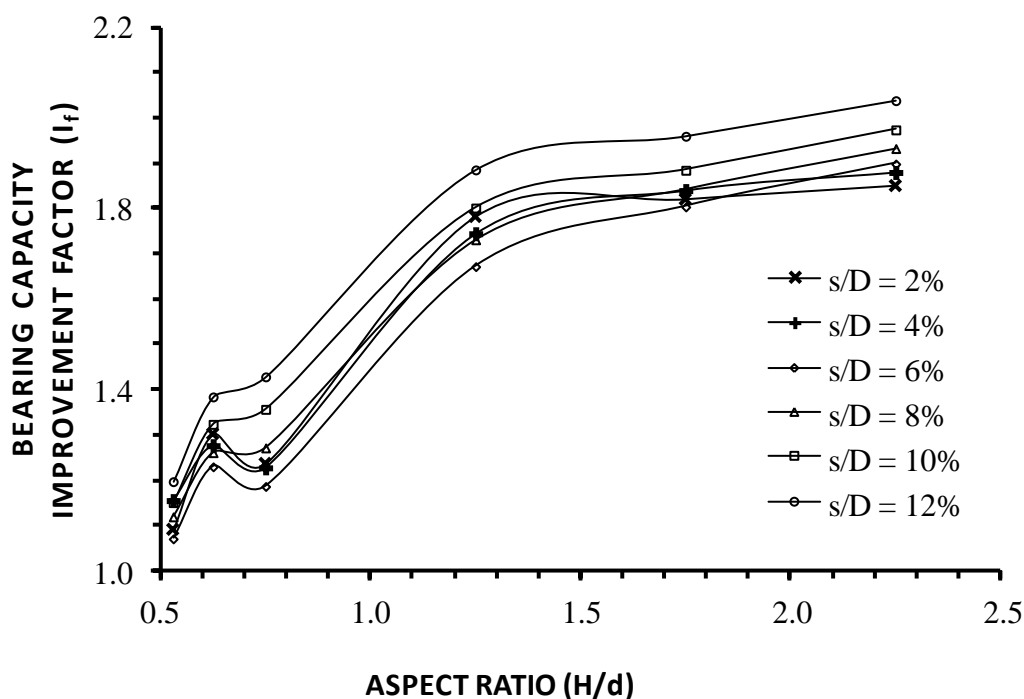

Figure 17. Variation of bearing capacity improvement factor with aspect ratio of geocell pocket at various footing settlement levels

Possible reason for the sudden drop in bearing capacity may be that until an aspect ratio 0.75 behavior of geocell mattress may be like a geotextile layer and thereafter as the geocell mattress height increases bearing capacity improvement factor also increase. Hence, maximum benefit in bearing capacity improvement can be achieved up to an aspect ratio equal to 1.25. Krishnaswamy et al. [40] reported an optimum aspect ratio as unity for embankments constructed with soft soils and reinforced with geocell while Dash et al. [19] reported 1.67 as an optimum aspect ratio for strip footing resting on sand reinforced with geocell. Possible reason for this variation in the values of optimum aspect ratio as reported by different researchers may be attributed to the different type of geosynthetic material used to fabricate the geocells, type of soil used as the foundation soil, and the type of loading applied.

5. Conclusions

Results of model tests conducted on circular footing placed on expansive soil reinforced with geocells of chevron pattern are presented in this research paper. The results of the study were analyzed for improvement in bearing capacity and reduction in settlement of a circular footing subjected to monotonic loading. Improvement in bearing capacity and reduction in footing settlement was carried out at a settlement corresponding to failure pressure of footing i.e., up to

12% of footing width. Different parameters considered in this experimental study included were geocell mattress placement depth beneath footing base, geocell pocket size; geocell mattress height and geocell pocket aspect ratio. After obtaining results from the experiments, following specific conclusions were drawn:

- Provision of geocell as reinforcement can substantially improve load bearing capacity and reduces settlement of foundation bed consisting of Expansive soil.
- For settlements up to 10-12% of footing diameter pressure settlement behavior of geocell reinforced soil bed is almost linear.
- No clear cut failure of the geocell reinforced soil bed was observed up to 25% of the footing diameter terminal settlement.
- An improvement of more than 200% in bearing capacity and 81% reduction in settlement can be attained compared to bearing pressure of unreinforced bed at failure.
- To obtain maximum benefits, geocell mattress of chevron pattern should be placed just below the footing base i.e., $h/D = 0$.
- Geocell mattress of optimum pocket size, $d/D = 1$, i.e., equal to the diameter of model footing is expected to give maximum benefits.
- At geocell height (H/D) 1.25 performance improvement is significant but it is marginal when geocell height (H/D) approaches to 2, i.e., twice the footing diameter.
- Aspect ratio at 1.25 is observed as an optimum ratio for geocell pocket supporting a circular footing.

6. Acknowledgement

This research article is based on research work carried out at the Civil Engineering Department of Delhi Technological University, Delhi and Vaish Technical Institute, Rohtak (Haryana), India. All the materials involved in this research study were procured from the outskirts of Delhi. No funding agency is involved to carry out this research work.

7. Conflicts of Interest

The authors declare no conflict of interest.

8. References

- [1] Hausmann, Manfred R. Engineering principles of ground modification. 1990.
- [2] Prabakar, J, and R.S Sridhar. "Effect of Random Inclusion of Sisal Fibre on Strength Behaviour of Soil." *Construction and Building Materials* 16, no. 2 (March 2002): 123–131. doi:10.1016/s0950-0618(02)00008-9.
- [3] Yarbaşı, Necmi, Ekrem Kalkan, and Suat Akbulut. "Modification of the Geotechnical Properties, as Influenced by Freeze–thaw, of Granular Soils with Waste Additives." *Cold Regions Science and Technology* 48, no. 1 (April 2007): 44–54. doi:10.1016/j.coldregions.2006.09.009.
- [4] Liu, Jin, Gonghui Wang, Toshitaka Kamai, Fanyu Zhang, Jun Yang, and Bin Shi. "Static Liquefaction Behavior of Saturated Fiber-Reinforced Sand in Undrained Ring-Shear Tests." *Geotextiles and Geomembranes* 29, no. 5 (October 2011): 462–471. doi:10.1016/j.geotextmem.2011.03.002.
- [5] Santoni, Rosa L., and Steve L. Webster. "Airfields and Roads Construction Using Fiber Stabilization of Sands." *Journal of Transportation Engineering* 127, no. 2 (April 2001): 96–104. doi:10.1061/(asce)0733-947x(2001)127:2(96)..
- [6] Sharma, Radhey, Qiming Chen, Murad Abu-Farsakh, and Sungmin Yoon. "Analytical Modeling of Geogrid Reinforced Soil Foundation." *Geotextiles and Geomembranes* 27, no. 1 (February 2009): 63–72. doi:10.1016/j.geotextmem.2008.07.002.
- [7] Binquet, Jean, and Kenneth L. Lee. "Bearing capacity tests on reinforced earth slabs." *Journal of Geotechnical and Geoenvironmental Engineering* 101, no. ASCE# 11792 Proceeding (1975).
- [8] El Sawwaf, Mostafa A. "Behavior of Strip Footing on Geogrid-Reinforced Sand over a Soft Clay Slope." *Geotextiles and Geomembranes* 25, no. 1 (February 2007): 50–60. doi:10.1016/j.geotextmem.2006.06.001.
- [9] Fragaszy, Richard J., and Evert Lawton. "Bearing Capacity of Reinforced Sand Subgrades." *Journal of Geotechnical Engineering* 110, no. 10 (October 1984): 1500–1507. doi:10.1061/(asce)0733-9410(1984)110:10(1500).
- [10] Guido, Vito A., Dong K. Chang, and Michael A. Sweeney. "Comparison of Geogrid and Geotextile Reinforced Earth Slabs." *Canadian Geotechnical Journal* 23, no. 4 (November 1986): 435–440. doi:10.1139/t86-073..

- [11] Hatami, K., R. J. Bathurst, and P. Di Pietro. "Static Response of Reinforced Soil Retaining Walls with Nonuniform Reinforcement." *International Journal of Geomechanics* 1, no. 4 (October 2001): 477–506. doi:10.1061/(asce)1532-3641(2001)1:4(477)..
- [12] Khing, K.H., B.M. Das, V.K. Puri, E.E. Cook, and S.C. Yen. "The Bearing-Capacity of a Strip Foundation on Geogrid-Reinforced Sand." *Geotextiles and Geomembranes* 12, no. 4 (January 1993): 351–361. doi:10.1016/0266-1144(93)90009-d.
- [13] Léonard, D., A. Vanelstraete, and S. Parewyck. "Structural Design of Flexible Pavements Using Steel Netting as Base Reinforcement." *International Journal of Geomechanics* 2, no. 3 (July 2002): 291–303. doi:10.1061/(asce)1532-3641(2002)2:3(291).
- [14] Zhou, Huabao, and Xuejun Wen. "Model Studies on Geogrid- or Geocell-Reinforced Sand Cushion on Soft Soil." *Geotextiles and Geomembranes* 26, no. 3 (June 2008): 231–238. doi:10.1016/j.geotextmem.2007.10.002.
- [15] Yetimoglu, Temel, Jonathan T. H. Wu, and Ahmet Saglamer. "Bearing Capacity of Rectangular Footings on Geogrid - Reinforced Sand." *Journal of Geotechnical Engineering* 120, no. 12 (December 1994): 2083 – 2099. doi:10.1061/(asce)0733-9410(1994)120:12(2083).
- [16] Mhaikar, S.Y., and J.N. Mandal. "Investigations on Soft Clay Subgrade Strengthening Using Geocells." *Construction and Building Materials* 10, no. 4 (June 1996): 281–286. doi:10.1016/0950-0618(95)00083-6.
- [17] Adams, Michael T., and James G. Collin. "Large Model Spread Footing Load Tests on Geosynthetic Reinforced Soil Foundations." *Journal of Geotechnical and Geoenvironmental Engineering* 123, no. 1 (January 1997): 66–72. doi:10.1061/(asce)1090-0241(1997)123:1(66).
- [18] Rajagopal, K., N.R. Krishnaswamy, and G. Madhavi Latha. "Behaviour of Sand Confined with Single and Multiple Geocells." *Geotextiles and Geomembranes* 17, no. 3 (June 1999): 171–184. doi:10.1016/s0266-1144(98)00034-x.
- [19] Dash, S. "Bearing Capacity of Strip Footings Supported on Geocell-Reinforced Sand." *Geotextiles and Geomembranes* 19, no. 4 (May 2001): 235–256. doi:10.1016/s0266-1144(01)00006-1.
- [20] Dash, Sujit Kumar, K Rajagopal, and N.R Krishnaswamy. "Strip Footing on Geocell Reinforced Sand Beds with Additional Planar Reinforcement." *Geotextiles and Geomembranes* 19, no. 8 (December 2001): 529–538. doi:10.1016/s0266-1144(01)00022-x.
- [21] Ghosh, A, and A Bera. "Bearing Capacity of Square Footing on Pond Ash Reinforced with Jute-Geotextile." *Geotextiles and Geomembranes* 23, no. 2 (April 2005): 144–173. doi:10.1016/j.geotextmem.2004.07.002.
- [22] Madhavi Latha, G., K. Rajagopal, and N. R. Krishnaswamy. "Experimental and Theoretical Investigations on Geocell-Supported Embankments." *International Journal of Geomechanics* 6, no. 1 (January 2006): 30–35. doi:10.1061/(asce)1532-3641(2006)6:1(30).
- [23] Latha, G. Madhavi, and Vidya S. Murthy. "Effects of Reinforcement Form on the Behavior of Geosynthetic Reinforced Sand." *Geotextiles and Geomembranes* 25, no. 1 (February 2007): 23–32. doi:10.1016/j.geotextmem.2006.09.002.
- [24] Sitharam Thallak, G., Sireesh Saride, and Sujit Kumar Dash. "Performance of Surface Footing on Geocell-Reinforced Soft Clay Beds." *Geotechnical and Geological Engineering* 25, no. 5 (May 22, 2007): 509–524. doi:10.1007/s10706-007-9125-8.
- [25] Madhavi Latha, G., and Amit Somwanshi. "Effect of Reinforcement Form on the Bearing Capacity of Square Footings on Sand." *Geotextiles and Geomembranes* 27, no. 6 (December 2009): 409–422. doi:10.1016/j.geotextmem.2009.03.005.
- [26] Pokharel, S. K., Han, J., Parsons, R. L., Qian, Y., Leshchinsky, D., Halahmi, I., "Experimental study on bearing capacity of geocell reinforced bases", *Bearing capacity of Roads, Railways and Airfields – Tuumluer & Al-Qadi (eds), Taylor & Francis, (2009): 1159-1166.*
- [27] Dash, Sujit Kumar. "Influence of Relative Density of Soil on Performance of Geocell-Reinforced Sand Foundations." *Journal of Materials in Civil Engineering* 22, no. 5 (May 2010): 533–538. doi:10.1061/(asce)mt.1943-5533.0000040.
- [28] Tafreshi, S.N. Moghaddas, and A.R. Dawson. "Comparison of Bearing Capacity of a Strip Footing on Sand with Geocell and with Planar Forms of Geotextile Reinforcement." *Geotextiles and Geomembranes* 28, no. 1 (February 2010): 72–84. doi:10.1016/j.geotextmem.2009.09.003.
- [29] Dash, Sujit Kumar. "Effect of Geocell Type on Load-Carrying Mechanisms of Geocell-Reinforced Sand Foundations." *International Journal of Geomechanics* 12, no. 5 (October 2012): 537–548. doi:10.1061/(asce)gm.1943-5622.0000162.
- [30] Biswas, A., A. Murali Krishna, and S.K. Dash. "Influence of Subgrade Strength on the Performance of Geocell-Reinforced Foundation Systems." *Geosynthetics International* 20, no. 6 (December 2013): 376–388. doi:10.1680/gein.13.00025.

- [31] Bazne, Mohammed O. A., Farshid Vahedifard, and Shahriar Shahrokhbabadi. "The Effect of Geonet Reinforcement on Bearing Capacity of Low-Compacted Soft Clay." *Transportation Infrastructure Geotechnology* 2, no. 1 (December 24, 2014): 47–63. doi:10.1007/s40515-014-0017-0.
- [32] Hegde, A., and T. G. Sitharam. "Experimental and Analytical Studies on Soft Clay Beds Reinforced with Bamboo Cells and Geocells." *International Journal of Geosynthetics and Ground Engineering* 1, no. 2 (April 1, 2015). doi:10.1007/s40891-015-0015-5.
- [33] Indraratna, Buddhima, M. Mahdi Biabani, and Sanjay Nimbalkar. "Behavior of Geocell-Reinforced Subballast Subjected to Cyclic Loading in Plane-Strain Condition." *Journal of Geotechnical and Geoenvironmental Engineering* 141, no. 1 (January 2015): 04014081. doi:10.1061/(asce)gt.1943-5606.0001199.
- [34] Shadmand, A., Mahmoud Ghazavi, and Navid Ganjian. "Scale Effects of Footings on Geocell Reinforced Sand Using Large-Scale Tests." *Civil Engineering Journal* 4, no. 3 (April 7, 2018): 497. doi:10.28991/cej-0309110.
- [35] Tavakoli Mehrjardi, Gholamhosein, and Fariba Motarjemi. "Interfacial Properties of Geocell-Reinforced Granular Soils." *Geotextiles and Geomembranes* 46, no. 4 (August 2018): 384–395. doi:10.1016/j.geotextmem.2018.03.002.
- [36] Kaur, Amritpal, Kulbir Singh Gill, and Pardeep Singh. "Bearing Capacity Improvement Using Geocell Reinforced Sand." *Proceedings of the 1st International Conference on Sustainable Waste Management through Design* (October 31, 2018): 160–169. doi:10.1007/978-3-030-02707-0_20.
- [37] Kolathayar, Sreevalsa, P. Suja, Varsha Nair, Swetha Krishna, and G. Tamilarasi. "Performance Evaluation of Seashell and Sand as Infill Materials in HDPE and Coir Geocells." *Innovative Infrastructure Solutions* 4, no. 1 (February 27, 2019). doi:10.1007/s41062-019-0203-6.
- [38] Liu, Yang, An Deng, and Mark Jaksa. "Failure Mechanisms of Geocell Walls and Junctions." *Geotextiles and Geomembranes* 47, no. 2 (April 2019): 104–120. doi:10.1016/j.geotextmem.2018.11.003.
- [39] Kuo, Chen-Ming, and Fang-Ju Chou. "Development of 3-D Finite Element Model for Flexible Pavements." *Journal of the Chinese Institute of Engineers* 27, no. 5 (July 2004): 707–717. doi:10.1080/02533839.2004.9670918.
- [40] Chaney, RC, KR Demars, NR Krishnaswamy, K Rajagopal, and G Madhavi Latha. "Model Studies on Geocell Supported Embankments Constructed Over a Soft Clay Foundation." *Geotechnical Testing Journal* 23, no. 1 (2000): 45. doi:10.1520/gtj11122j.
- [41] Hegde, Amarnath M., and T.G. Sitharam. "Effect of Infill Materials on the Performance of Geocell Reinforced Soft Clay Beds." *Geomechanics and Geoenvironmental Engineering* 10, no. 3 (July 15, 2014): 163–173. doi:10.1080/17486025.2014.921334.
- [42] Sitharam, T. G., and S. Sireesh. "Effects of Base Geogrid on Geocell-Reinforced Foundation Beds." *Geomechanics and Geoenvironmental Engineering* 1, no. 3 (November 24, 2006): 207–216. doi:10.1080/17486020600900596.