

University of Windsor

Scholarship at UWindor

Electronic Theses and Dissertations

Theses, Dissertations, and Major Papers

2010

The nucleolar organizer of the salivary gland polytene chromosomes as a measure of recent growth in laboratory-reared and field-collected *Chironomus* Spp. (Diptera: Chironomidae) larvae

Joshua P. Martin
University of Windsor

Follow this and additional works at: <https://scholar.uwindsor.ca/etd>

Recommended Citation

Martin, Joshua P., "The nucleolar organizer of the salivary gland polytene chromosomes as a measure of recent growth in laboratory-reared and field-collected *Chironomus* Spp. (Diptera: Chironomidae) larvae" (2010). *Electronic Theses and Dissertations*. 8017.
<https://scholar.uwindsor.ca/etd/8017>

This online database contains the full-text of PhD dissertations and Masters' theses of University of Windsor students from 1954 forward. These documents are made available for personal study and research purposes only, in accordance with the Canadian Copyright Act and the Creative Commons license—CC BY-NC-ND (Attribution, Non-Commercial, No Derivative Works). Under this license, works must always be attributed to the copyright holder (original author), cannot be used for any commercial purposes, and may not be altered. Any other use would require the permission of the copyright holder. Students may inquire about withdrawing their dissertation and/or thesis from this database. For additional inquiries, please contact the repository administrator via email (scholarship@uwindsor.ca) or by telephone at 519-253-3000ext. 3208.

NOTE TO USERS

This reproduction is the best copy available.

UMI



**THE NUCLEOLAR ORGANIZER OF THE SALIVARY GLAND POLYTENE
CHROMOSOMES AS A MEASURE OF RECENT GROWTH IN
LABORATORY-REARED AND FIELD-COLLECTED *CHIRONOMUS* SPP.
(DIPTERA: CHIRONOMIDAE) LARVAE**

by

Joshua P. Martin

A Thesis

Submitted to the Faculty of Graduate Studies
through the Department of Biological Sciences
in Partial Fulfillment of the Requirements for
the Degree of Master of Science at the
University of Windsor

Windsor, Ontario, Canada

2010

© 2010 Joshua P. Martin



Library and Archives
Canada

Published Heritage
Branch

395 Wellington Street
Ottawa ON K1A 0N4
Canada

Bibliothèque et
Archives Canada

Direction du
Patrimoine de l'édition

395, rue Wellington
Ottawa ON K1A 0N4
Canada

Your file *Votre référence*
ISBN: 978-0-494-57597-0
Our file *Notre référence*
ISBN: 978-0-494-57597-0

NOTICE:

The author has granted a non-exclusive license allowing Library and Archives Canada to reproduce, publish, archive, preserve, conserve, communicate to the public by telecommunication or on the Internet, loan, distribute and sell theses worldwide, for commercial or non-commercial purposes, in microform, paper, electronic and/or any other formats.

The author retains copyright ownership and moral rights in this thesis. Neither the thesis nor substantial extracts from it may be printed or otherwise reproduced without the author's permission.

AVIS:

L'auteur a accordé une licence non exclusive permettant à la Bibliothèque et Archives Canada de reproduire, publier, archiver, sauvegarder, conserver, transmettre au public par télécommunication ou par l'Internet, prêter, distribuer et vendre des thèses partout dans le monde, à des fins commerciales ou autres, sur support microforme, papier, électronique et/ou autres formats.

L'auteur conserve la propriété du droit d'auteur et des droits moraux qui protègent cette thèse. Ni la thèse ni des extraits substantiels de celle-ci ne doivent être imprimés ou autrement reproduits sans son autorisation.

In compliance with the Canadian Privacy Act some supporting forms may have been removed from this thesis.

While these forms may be included in the document page count, their removal does not represent any loss of content from the thesis.

Conformément à la loi canadienne sur la protection de la vie privée, quelques formulaires secondaires ont été enlevés de cette thèse.

Bien que ces formulaires aient inclus dans la pagination, il n'y aura aucun contenu manquant.

Canada

AUTHOR'S DECLARATION OF ORIGINALITY

I hereby certify that I am the sole author of this thesis and that no part of this thesis has been published or submitted for publication.

I certify that, to the best of my knowledge, my thesis does not infringe upon anyone's copyright nor violate any proprietary rights and that any ideas, techniques, quotations, or any other material from the work of other people included in my thesis, published or otherwise, are fully acknowledged in accordance with the standard referencing practices. Furthermore, to the extent that I have included copyrighted material that surpasses the bounds of fair dealing within the meaning of the Canada Copyright Act, I certify that I have obtained a written permission from the copyright owner(s) to include such material(s) in my thesis and have included copies of such copyright clearances to my appendix.

I declare that this is a true copy of my thesis, including any final revisions, as approved by my thesis committee and the Graduate Studies office, and that this thesis has not been submitted for a higher degree to any other University or Institution.

ABSTRACT

Midge larvae possess giant polytene chromosomes. Genes on these chromosomes undergoing transcription are visible as puffs. The nucleolar organizer (NOR), an especially large puff, shrinks when a larva is stressed. Two feeding experiments were conducted to examine how NOR size changes as a function of *Chironomus riparius* growth. NOR size was linearly related to an individual's recent growth rate, independent of its body size.

Chironomids were collected from wetlands constructed with oil sands mine water and tailings (OSPM), and reference wetlands to evaluate the utility of the NOR as a field-based measure of larval growth and condition. Small larvae (< 9mm) did not yield sufficient quality preparations. Five karyotypes were identified, revealing cryptic diversity in the wetlands. NOR size was measured in a single karyotype; no measures were obtained from OSPM-affected wetlands. NOR size has potential as a surrogate growth measure that can facilitate estimation of chironomid secondary production.

ACKNOWLEDGEMENTS

I would like to thank several people who have helped in one way or another with this project. I would first like to thank my supervisor, Dr. Jan Ciborowski, who gave me an opportunity early on to be involved in research as an undergraduate field-assistant. Throughout the duration of this project he gave me guidance, support, and encouragement. I would like to extend special thanks to Carla Wytrykush for all the guidance she has given me over the last few years, helping me grow as a student, a researcher, and a person. I would also like to thank Dr. Dan Mennill for his advice, and guidance over the course of my undergraduate and Masters degree. Thank you to my committee Dr. Andrew Swan, Dr. Brian Fryer, and Terry Van Meer.

I would like to thank Jesse Gardner-Costa, the ying to my yang, who was always willing to help and ready to talk research; he was also always ready to have a good time and share some laughs. Kurt Frederick, Carsten Slama, Misun Kang, Mary Sebastian, Nicole Barker, Mirna Jajo, Li Wang, and everyone in the Ciborowski lab helped in more ways than one. Thank you to Nadia Qureshi, Nicole Bloschinsky, Hao Chen, Andrew Nelson, Melanie Martin, Jennifer Thoms, and Dr. Lee Foote for all their help in the field.

Thank you to Danielle Milani from Environment Canada for sending the egg masses used for the laboratory experiments. Thank you to all the great staff working for the oil sands companies involved with this project including Neil Rutley, Terry Van Meer, Clara Qualizza, Chris Beierling, Dr. Mike Mackinnon, Lori Cyprien (Syncrude), Richard Kavanagh (CNRL), Wayne Tedder, Christine Daly, John Hornung (Suncor), Xiao Tan, Fred Kuzmic (Albian sands). I would like to thank Malcolm Butler from North Dakota State University for teaching me how to dissect and stain the polytene chromosomes. I would like to thank Steve Budinsky and Windsor TSC for constructing the "X-Press". Thank you to my mom (Lori), dad (Pete), and sister (Chrissy) for everything they have done for me over the years. Thank you to Craig, Lyn, and Jennifer for treating and supporting me like one of their own. Finally, thank you to my beautiful wife Melanie for her encouragement and support.

This research was supported by grants from Syncrude Canada Ltd., Suncor Energy Ltd., Canadian Natural Resources Ltd., Albian Sands Energy, Total E&P Canada, Ltd., the Natural Sciences and Engineering Research Council of Canada (NSERC) through a Collaborative Research and Development Grant, and the Canadian Water Network to Jan Ciborowski and coinvestigators involved in the “*Carbon Dynamics, Food Web Structure and Reclamation Strategies for Alberta Oilsands Constructed Wetlands (CFRAW)*” research project. In kind support and logistic assistance from Syncrude Canada Limited and Suncor Energy Incorporated, are also gratefully acknowledged. University of Windsor graduate assistantships, postgraduate scholarships, travel awards, and an NSERC Industrial Postgraduate Scholarship were received by Joshua P. Martin.

TABLE OF CONTENTS

AUTHOR'S DECLARATION OF ORIGINALITY.....	iii
ABSTRACT.....	iv
ACKNOWLEDGEMENTS.....	v
LIST OF TABLES.....	x
LIST OF FIGURES.....	xi
CHAPTER ONE: GENERAL INTRODUCTION.....	1
POLYTENE CHROMOSOMES AND CHROMOSOMAL PUFFS.....	2
THE NUCLEOLAR ORGANIZER.....	2
NOR SIZE AND CHIRONOMID GROWTH.....	3
OIL SANDS CONSTRUCTED WETLANDS.....	4
OIL SANDS PROCESS MATERIALS AND CHIRONOMIDS.....	5
LITERATURE CITED.....	6
CHAPTER TWO: THE RELATIONSHIP BETWEEN NUCLEOLAR ORGANIZER SIZE AND GROWTH IN FOOD-LIMITED CHIRONOMUS RIPARIUS LARVAE (DIPTERA: CHIRONOMIDAE).....	10
INTRODUCTION.....	10
MATERIALS AND METHODS.....	11
<i>Organism collection and maintenance.....</i>	11
<i>Experimental design.....</i>	11
<i>Experimental procedures.....</i>	12
<i>Biomass and growth rate measurements.....</i>	13
<i>Polytene chromosome extraction and staining.....</i>	14
<i>Measurements of NOR size.....</i>	15
<i>Statistical analyses.....</i>	17
RESULTS.....	17
<i>Uniform ration experiment.....</i>	17
<i>Variable ration experiment.....</i>	26
DISCUSSION.....	36
<i>Uniform ration experiment.....</i>	36

<i>Variable ration experiment</i>	38
<i>NOR size as an indicator of stress</i>	39
LITERATURE CITED.....	42
CHAPTER THREE: NUCLEOLAR ORGANIZER (NOR) SIZE AS A FIELD-BASED MEASURE OF CHIRONOMINI GROWTH IN OIL SANDS CONSTRUCTED WETLANDS	46
INTRODUCTION.....	46
MATERIALS AND METHODS.....	47
<i>Study design</i>	47
<i>Study site</i>	47
<i>Sample collection</i>	48
<i>Laboratory procedures</i>	49
<i>Statistical analyses</i>	52
RESULTS.....	52
<i>Water chemistry</i>	52
<i>Taxa collected</i>	54
<i>Chromosomal puffing</i>	54
DISCUSSION.....	57
<i>Chironomids in oil sands constructed wetlands</i>	57
<i>NOR size in oil sands constructed wetlands</i>	60
<i>Measuring NOR size in the field</i>	61
<i>Summary, Conclusions, and Recommendations</i>	63
LITERATURE CITED.....	64
CHAPTER FOUR: GENERAL DISCUSSION AND CONCLUSIONS	66
CHIRONOMID SECONDARY PRODUCTION.....	66
NOR SIZE AS A SURROGATE MEASURE OF SECONDARY PRODUCTION.....	67
UTILITY OF THE NOR IN OIL SANDS CONSTRUCTED WETLANDS.....	70
IMPLICATIONS AND CONCLUSIONS.....	71

LITERATURE CITED.....	72
APPENDIX I: A COMPARISON OF METHODS FOR MEASURING NUCLEOLAR ORGANIZER SIZE.....	74
INTRODUCTION.....	74
METHODS.....	75
RESULTS.....	77
DISCUSSION.....	77
LITERATURE CITED.....	83
APPENDIX II: ENVIRONMENTAL CHARACTERISTICS AND CONSTRUCTION OF THE STUDY WETLANDS.....	85
GOLDEN POND WETLAND.....	85
HIGH SULPHATE WETLAND.....	85
NATURAL WETLAND.....	85
4-M CT WETLAND.....	86
APPENDIX III: WATER CHEMISTRY OF THE STUDY WETLANDS – NAPHTHENIC ACIDS, MAJOR ION, AND MINOR ELEMENTS ANALYSES.....	91
APPENDIX IV: POLYTENE CHROMOSOME KARYOTYPES OF <i>CHIRONOMUS</i> LARVAE COLLECTED FROM THE STUDY WETLANDS.....	94
APPENDIX V: RAW DATA – CHIRONOMID LARVAE SORTED BY TAXON.....	99
VITA AUCTORIS.....	100

LIST OF TABLES

CHAPTER TWO

Table 1. Mean (\pm SE) values of water chemistry parameters during the variable ration and uniform ration experiments.....	18
Table 2. Percentage of <i>Chironomus riparius</i> larvae (from which NOR size measurements were obtained) at the end of the uniform ration experiment assigned to each of three developmental classes based on the development of their imaginal discs.....	22
Table 3. Percentage of <i>Chironomus riparius</i> larvae (from which NOR size measurements were obtained) at the end of the variable ration experiment assigned to each of three developmental classes based on the development of their imaginal discs.....	32

CHAPTER THREE

Table 1. Summary of water chemistry parameters of each study wetland during the sampling period.....	53
Table 2. Number of chironomid larvae exhibiting a given karyotype for each wetland.....	56

APPENDIX I

Table 1. Mean and standard deviation of NOR size estimates (diameter, μm ; and area, μm^2).....	80
---	----

LIST OF FIGURES

CHAPTER TWO

Fig. 1. Chromosomal map and digital image taken at 400X magnification of the IVth chromosome (G arm) of <i>Chironomus riparius</i>	16
Fig. 2. Mean survival at the end of the uniform ration experiment.....	19
Fig. 3. Biomass of midge larvae (mg dry mass) at the end of the uniform ration experiment.....	21
Fig. 4. NOR size at the end of the uniform ration experiment as a function of chromosome size at each of four different ration qualities.....	23
Fig. 5. Scatterplot showing the relationship between NOR size and larval size (biomass) at the end of the uniform ration experiment.....	24
Fig. 6. Scatterplot showing the relationship between chromosome size and larval size (biomass) at the end of the uniform ration.....	25
Fig. 7. NOR size as a function of chromosome size for larvae ‘early’, ‘intermediate’, and ‘late’ in their development at the conclusion of the uniform ration experiment.....	27
Fig. 8. Adjusted mean NOR size for larvae at different stages of development.....	28
Fig. 9. Mean survival at the end of the variable ration experiment.....	29
Fig. 10. Biomass of midge larvae (mg dry mass) at the end of the variable ration experiment.....	30
Fig. 11. Mean instantaneous growth rate of midge larvae (mg/d) during the late period (day 8-14) of the variable ration experiment.....	33
Fig. 12. NOR size at the end of the variable ration experiment as a function of chromosome size for larvae provided with a uniform ration of low quality or high quality and for larvae switched from one to the other at the midpoint of the experiment.....	34
Fig. 13. Adjusted mean NOR size of larvae provided with either a uniform or variable ration during variable ration experiment.....	35
Fig. 14. Scatterplot showing the relationship between instantaneous growth rate (from day 8-14; ‘late’ period) and NOR size at the end of the variable ration experiment.....	37

CHAPTER THREE

Fig. 1. Photograph of the polytene chromosomes of an individual collected from Golden Pond in July 2008 classified as “karyotype H”.....	51
Fig. 2. Percentage of chironomid larvae collected belonging to each taxon in reference and OSPM-affected wetlands.....	55
Fig. 3. Relationship between puff size and chromosome size for larvae collected from High Sulphate and Golden Pond.....	58

APPENDIX I

Fig. 1. The “X-Press” designed and employed to standardize the amount of pressure applied to squash the salivary glands.....	76
Fig. 2. Chromosomal map and digital image taken at 400X magnification of the IV chromosome (G arm) of <i>Chironomus riparius</i>	78
Fig. 3. NOR diameter was a significant predictor of NOR area in both Experiment One and Experiment Two.....	79

APPENDIX II

Fig. 1. Photographs of Golden Pond in May 2008 and July 2008.....	87
Fig. 2. Photographs of High Sulphate Wetland in May 2008 and July 2008.....	88
Fig. 3. Photographs of Natural Wetland in May 2008 and July 2008.....	89
Fig. 4. Photographs of 4-m CT Wetland in May 2008 and July 2008.....	90

APPENDIX IV

Fig. 1. Karyotype A.....	94
Fig. 2. Karyotype C.....	95
Fig. 3. Karyotype F.....	96
Fig. 4. Karyotype H.....	97
Fig. 5. Karyotype J.....	98

CHAPTER ONE: GENERAL INTRODUCTION

Chironomids (Diptera: Chironomidae) are an especially important component of benthic aquatic communities. They are one of the most dominant, widespread, and diverse aquatic invertebrate taxa in freshwater systems (Armittage 1995). Chironomids are an important food source to larger predatory invertebrates, fishes, and birds (e.g., Winfield and Winfield 1994; Hudson *et al.* 1995; Benke *et al.* 2001), and are important contributors of carbon and energy flow to higher trophic levels (Benke and Wallace 1997).

Chironomids are holometabolous insects. Their life cycle includes three aquatic developmental stages (egg, larva, and pupa) and a terrestrial reproductive stage (winged adult). Although the duration and attributes of each life stage are species-specific, chironomids spend most of their lives as benthic larvae living and feeding in or on the sediment [or macrophytes] (Oliver 1971). Because of their close association with the benthic zone, easily identifiable life stages, ease of culture, and sensitivity to chemical and environmental stressors, chironomid larvae are commonly used as indicator species in laboratory and field-based toxicity tests (e.g., Lindegaard 1995; Environment Canada 1997). They exhibit both developmental (e.g., Timmermans *et al.* 1992; Dube and Culp 1996) and teratogenic (e.g., Hudson and Ciborowski 1996b; Groenendijk *et al.* 1998; Martinez *et al.* 2001) responses to a wide range of chemical contaminants. Chironomid larvae also reflect chemical stress by exhibiting structural (Michailova *et al.* 1998; 2001a, b; 2003; 2006) and functional changes in the polytene chromosomes of their salivary glands (Aziz *et al.* 1991; Bentivegna and Cooper 1993; Hudson and Ciborowski 1996; Michailova *et al.* 1998; 2001a, b; 2003; 2006; Planello *et al.* 2007).

The purpose of this thesis was to determine if chironomid larval growth can be estimated by measuring functional changes in the salivary gland polytene chromosomes. This was achieved by conducting two growth experiments in the laboratory using *Chironomus riparius* larvae, as well by collecting chironomid larvae from constructed wetlands located in the oil sands region of northeastern Alberta, Canada.

POLYTENE CHROMOSOMES AND CHROMOSOMAL PUFFS

Polytene chromosomes are present in several dipteran tissues, including the salivary glands, malpighian tubules, and the epithelium of the midgut and hindgut (Staiber and Behnke 1985; Michailova 1989). They form when chromatids are replicated several times with no subsequent nuclear or cellular division (Case and Daneholt 1977). The number of chromatid strands can approximate 3000-4000 (Michailova 1989), with the degree of polyteny reaching as high as 2^{13} in the salivary glands of some chironomid species (Danaholt and Edström 1967). Polytene chromosomes are very large and are visible using a compound microscope. When properly stained, the alternating light/dark banding pattern of heterochromatin is visible. The banding pattern is species-specific and permits the identification of otherwise morphologically indistinguishable reproductively isolated species (Martin 1979; Michailova 1989).

Like other chromosomes, the salivary gland polytene chromosomes carry genetic information, most of which is found in heavily coiled and condensed chromomeric regions (Zhimulev *et al.* 1981). When genes in these regions are actively undergoing transcription, the highly condensed chromatid strands uncoil and characteristic puffs appear. Puffs are sites of RNA synthesis (reviewed by Danaholt 1975), and the degree of puffing is related to the rate of transcription. Larger puffs produce more RNA (Pelling 1964 cited by Grossbach 1977; Danaholt *et al.* 1969). The pattern of puff activation is reversible (Beermann 1956) and is tissue- and time-specific (Ashburner 1969; Grossbach 1977); certain genes, in certain tissues, at certain times are turned on or off depending on whether a given gene product needs to be up- or down-regulated. Depending on the function of their associated gene product, some polytene chromosomal puffs also respond functionally to stress (any unfavorable change that leads to reduced fitness) by increasing or decreasing in size (e.g., Yamamoto 1970; Ashburner 1970).

THE NUCLEOLAR ORGANIZER

The nucleolar organizer (NOR) is an especially large, continuously active puff that is responsible for the synthesis of preribosomal RNA (reviewed by Case and Danaholt 1977). Its ultrastructure and morphological appearance differs from that of

typical puffs, but it behaves similarly (Pelling and Beermann 1966). In addition to the gross banding pattern of the polytene chromosomes, the number (as many as three) and location of the NOR(s) provide a criterion on which to base taxonomic classifications (Michailova 1989).

Several studies have demonstrated that the NOR exhibits functional changes when chironomid larvae are exposed to chemical stress by becoming reduced in size. Hudson and Ciborowski (1996) found that the proportion of larvae exhibiting regression of the NOR increased with increasing degree of contamination of the sediment in which larvae were reared. Field-collected *Chironomus riparius* larvae living in a heavy-metal polluted river containing elevated levels of chromium, copper, and zinc showed reduced NOR size (Michailova 1998). *Chironomus riparius* larvae exposed to chromium (Michailova 2001a), lead (Michailova 2001b), aluminium (Michailova 2003), copper (Michailova 2006), and cadmium (Planello *et al.* 2007) in the laboratory exhibited reduced NOR size. Since puff regression is indicative of reduced RNA synthesis (Pelling 1964 cited by Grossbach 1977; Daneholt *et al.* 1969), reduced NOR size is assumed to represent at least a transient reduction in overall metabolic function.

NOR SIZE AND CHIRONOMID GROWTH

Previous research suggests that NOR size may also be related to chironomid growth. Pelling and Beermann (1966) reported that “condensed [nucleolar] organizers appear almost exclusively under conditions when metabolic activity is at a minimum” and that “in rapidly growing *Chironomus* larvae, the nucleolar organizer regions are most frequently found in an extremely puffed condition.” However, the relationship between NOR size and growth rate has not been quantitatively evaluated. Thus, an experiment was designed and conducted to examine how NOR size changes as a function of chironomid growth under controlled laboratory conditions (Chapter Two).

The demonstration of a relationship between NOR size and chironomid growth rate would validate the assumption that NOR size is an indicator of sublethal stress by relating it to an ecologically relevant endpoint (growth). It would also have potential to provide a method for obtaining field-based measures of chironomid growth and

secondary production. In its simplest form, secondary production is the formation of new biomass by an individual or population over time. Production (P) is calculated as the product of the mean density (D, individuals m⁻²) and change in biomass (ΔB , g dry mass) over a given sampling interval ($P = D \times \Delta B$). In order to estimate the change in biomass over time, repeated samples must be taken. Thus, methods traditionally used to estimate zoobenthic secondary production are usually labor-intensive (Waters 1977). Although midge larvae are easy to collect in the field, they often have multiple generations per year, non-recognizable cohorts, and rapid growth rates (e.g., Benke 1998), which make it difficult to obtain credible production estimates (Waters 1979). If NOR size can serve as a measure of an individual chironomid's growth rate at the time of collection, instantaneous growth estimates of multiple larvae could potentially be determined from a single field-collected sample, facilitating the estimation of chironomid secondary production.

OIL SANDS CONSTRUCTED WETLANDS

In the Athabasca region of northeastern Alberta, wetlands are constructed using oil sands process materials (OSPM; mine water and fine tailings) as part of a strategy to reclaim the landscape following mining activities (OSWWG 2000). During the extraction process, salts (sulphates and chlorides), naphthenic acids (saturated acyclic and cyclic carboxylic acids), and residual bitumen rich in polycyclic aromatic hydrocarbons, which are natural constituents of oil sands, become concentrated in OSPM (van den Heuvel *et al.* 1999). Consequently, wetlands constructed with OSPM have elevated levels of both water soluble (salts and naphthenic acids) and hydrophobic (polycyclic aromatic hydrocarbons) compounds of concern that are toxic to a variety of organisms (e.g., Rhodes *et al.* 2004; Hassell *et al.* 2006; Clemente and Fedorak 2005).

According to the Alberta Environmental Protection and Enhancement Act (AEPEA), oil sands companies must reclaim all leased land to a state of production approximating that of the environment present prior to mining operations (EPEA, section 32, 1993). As a result, oil sands companies have been constructing wetlands for over 20 years to study the effects of OSPM on wetland succession and stability (Daly and

Ciborowski 2008). Oil sands constructed wetlands therefore provide a model system in which to study the effects of stress on natural chironomid populations.

OIL SANDS PROCESS MATERIALS AND CHIRONOMIDS

Previous research on the chironomid community in oil sands wetlands has found that species composition and abundance differ between OSPM-affected and reference constructed wetlands (Whelly 1999; Ganshorn 2002; Leonhardt 2003). Overall, chironomid genus richness is reduced in the presence of OSPM (Whelly 1999; Leonhardt 2003). With respect to toxicity, OSPM have been shown not to be teratogenic in both the laboratory and field (Whelly 1999). However, they do reduce chironomid survival and growth. Whelly (1999) found that, while survival and growth of *Chironomus riparius* larvae reared in oil sands process water in the laboratory was unaffected, *Chironomus tentans* growth was reduced by 25 %. In the field, Ganshorn (2002) found that Chironomini annual production/biomass ratio (a measure of individual growth rate; Benke 1996) was 75 % lower in OSPM-affected wetlands than in reference wetlands. Thus, despite their presence and persistence, chironomid populations in OSPM-affected wetlands appear to be stressed.

In Chapter Three, results are presented from field-collections of larvae conducted to investigate the relationship between OSPM and NOR size and examine the utility of the NOR as a measure of chironomid growth and condition in oil sands constructed wetlands. Preliminary research suggests that NOR size is reduced in both *Chironomus* and *Derotanypus spp.* growing in OSPM-affected wetlands relative to reference wetlands with otherwise similar environmental characteristics (Hum and Ciborowski 2000). The practicality of obtaining field-based measures of NOR size is also discussed. Because it may serve as an individual-based indicator of stress, a measure of recent growth, and facilitate the measure of secondary production, the NOR could provide an important ecological tool useful in developing monitoring programs to track wetland reclamation success.

LITERATURE CITED

- Ashburner, M. 1970. Patterns of puffing activity in salivary gland chromosomes of *Drosophila*. V. Responses to environmental treatments. *Chromosoma* 31:356-376.
- Armittage, P. D. 1995. Introduction. Pages 1-6 in P. D. Armittage, P. S. Cranston, and L. C. V. Pinder (editors). *The Chironomidae: The Biology and Ecology of Non-Biting Midges*. Chapman and Hall, New York.
- Aziz, J. B., N. M. Akrawi and G. A. Nassori. 1991. The effect of chronic toxicity of copper on the activity of Balbiani rings and nucleolar organizing region in the salivary gland chromosomes of *Chironomus ninevah* larvae. *Environmental Pollution* 69:125-130.
- Beermann, W. 1956. Nuclear differentiation and functional morphology of chromosomes. *Cold Spring Harbor Symposia on Quantitative Biology* 21:217-232.
- Benke, A. C. 1996. Secondary production of aquatic insects. Pages 557-578 in F. R. Hauer and B. Lamberti (editors) *Methods in Stream Ecology*. Academic Press, New York.
- Benke, A. C. 1998. Production dynamics of riverine chironomids: Extremely high biomass turnover rates of primary consumers. *Ecology* 79:899-910.
- Benke, A. C. and J. B. Wallace. 1997. Trophic basis of production among riverine caddisflies: Implications for food web analysis. *Ecology* 78:1132-1145.
- Benke, A. C., J. B. Wallace, J. W. Harrison and J. W. Koebel. 2001. Food web quantification using secondary production analysis: predaceous invertebrates of the snag habitat in a subtropical river. *Freshwater Biology* 46:329-346.
- Bentivegna, C. S. and K. R. Cooper. 1993. Reduced chromosomal puffing in *Chironomus tentans* as a biomarker for potentially genotoxic substances. *Environmental Toxicology and Chemistry* 12:1001-1011.
- Case, S. T. and B. Daneholt. 1977. Cellular and molecular aspects of genetic expression in *Chironomus* salivary glands. Pages 45-77 in J. Paul (editor). *Biochemistry and Cell Differentiation II*. Volume 15. Baltimore, University Park Press.
- Clemente, J. S. and P. M. Fedorak. 2005. A review of the occurrence, analyses, toxicity, and biodegradation of naphthenic acids. *Chemosphere* 60:585-600.
- Daly, C. and J. J. H. Ciborowski. 2008. A review of wetland research at Suncor: Re-establishing wetland ecosystems in an oil-sands affected landscape. *Proceedings of the 1st International Oil Sands Tailings Conference*, Edmonton, AB.
- Daneholt, B. 1975. Transcription in Polytene Chromosomes. *Cell* 4:1-9.
- Daneholt, B. and J. E. Edström. 1967. The content of deoxyribonucleic acid in individual polytene chromosomes of *Chironomus tentans*. *Cytogenetics* 6:350-356.
- Daneholt, B., J. E. Edström, E. Egyhazi, B. Lambert and U. Ringborg. 1969. RNA synthesis in a Balbiani ring in *Chironomus tentans* salivary gland cells. *Chromosoma* 28:418-429.
- Dube, M. G. and J. M. Culp. 1996. Growth responses of periphyton and chironomids exposed to biologically treated bleached-kraft pulp mill effluent. *Environmental Toxicology and Chemistry* 15:2019-2027.

- Environment Canada. 1997. Biological test method: Test for survival and growth in sediment using larvae of freshwater midges (*Chironomus tentans* or *Chironomus riparius*) Environmental Protection Series. Ottawa, Ontario, Canada.
- Ganshorn, K.D. 2002. Secondary production, trophic position and potential for accumulation of polycyclic aromatic hydrocarbons in predatory Diptera in four wetlands of the Athabasca oil sands, Alberta, Canada. M.Sc. Thesis, University of Windsor. Windsor, Ontario, Canada. 285 pp.
- Groenendijk, D., L. W. M. Zeinstra and J. F. Postma. 1998. Fluctuating asymmetry and mentum gaps in populations of the midge *Chironomus riparius* (Diptera: Chironomidae) from a metal-contaminated river. *Environmental Toxicology and Chemistry* 17:1999-2005.
- Grossbach, U. 1977. The salivary gland of *Chironomus* (Diptera): A model system for the study of cell differentiation. *Results and Problems in Cell Differentiation* 8:147-196.
- Hassell, K. L., B. J. Kefford and D. Nugegoda. 2006. Sub-lethal and chronic salinity tolerances of three freshwater insects: *Cloeon sp.* and *Centroptilum sp.* (Ephemeroptera: Baetidae) and *Chironomus sp.* (Diptera: Chironomidae). *Journal of Experimental Biology* 209:4024-4032.
- Hudson, L. A. and J. J. H. Ciborowski. 1996. Teratogenic and genotoxic responses of larval *Chironomus salinarius* group (Diptera: Chironomidae) to contaminated sediment. *Environmental Toxicology and Chemistry* 15:1375-1381.
- Hudson, L. A. and J. J. H. Ciborowski. 1996b. Spatial and taxonomic variation in incidence of mouthpart deformities in midge larvae (Diptera: Chironomidae: Chironomini). *Canadian Journal of Fisheries and Aquatic Sciences* 53:297-304.
- Hudson, P. L., J. F. Savino, and C. R. Bronte. 1995. Predator-prey relations and competition for food between age-0 lake trout and slimy sculpins in the Apostle Island region of Lake Superior. *Journal of Great Lakes Research* 21:445-457.
- Hum, P. and J. J. H. Ciborowski. 2000. Effects of oil sands mine-process water on the nucleolar organizer region of chironomids (Diptera). Undergraduate Thesis, University of Windsor. Windsor, Ontario, Canada.
- Leonhardt, C. L. 2003. Zoobenthic succession in constructed wetlands of the Fort McMurray oil sands region: Developing a measure of zoobenthic recovery. M.Sc. Thesis, University of Windsor. Windsor, Ontario, Canada. 259 pp.
- Lindgaard, C. 1995. Classification of water-bodies and pollution. Pages 385-404 in P. D. Armittage, P. S. Cranston, and L. C. V. Pinder (editors). *The Chironomidae: The Biology and Ecology of Non-Biting Midges*. Chapman and Hall, New York.
- Martin, J. 1979. Chromosomes as tools in taxonomy and phylogeny of Chironomidae (Diptera). *Entomologica Scandinavica Supplementum* 10:67-74.
- Martinez, E. A., B. C. Moore, J. Schaumlöffel and N. Dasgupta. 2001. Induction of morphological deformities in *Chironomus tentans* exposed to zinc- and lead-spiked sediments. *Environmental Toxicology and Chemistry* 20:2475-2481.
- Michailova, P. 1989. The polytene chromosomes and their significance to the systematics and phylogeny of the family Chironomidae, Diptera. *Acta Zoologica Fennica* 186:1-107.
- Michailova, P., J. Ilkova, N. Petrova and K. White. 2001b. Rearrangements in the salivary gland chromosomes of *Chironomus riparius* Mg. (Diptera, Chironomidae) following exposure to lead. *Caryologia* 54:349-363.

- Michailova, P., J. Ilkova and K. N. White. 2003. Functional and structural rearrangements of salivary gland polytene chromosomes of *Chironomus riparius* Mg. (Diptera, Chironomidae) in response to freshly neutralized aluminium. *Environmental Pollution* 123:193-207.
- Michailova, P., N. Petrova, J. Ilkova, S. Bovero, S. Brunetti, K. White and G. Sella. 2006. Genotoxic effect of copper on salivary gland polytene chromosomes of *Chironomus riparius* Meigen 1804 (Diptera, Chironomidae). *Environmental Pollution* 144:647-654.
- Michailova, P., N. Petrova, G. Sella, S. Bovero, L. Ramella, F. Regoli and V. Zelano. 2001a. Genotoxic effects of chromium on polytene chromosomes of *Chironomus riparius* Meigen 1804 (Diptera, Chironomidae). *Caryologia* 54:59-71.
- Michailova, P., N. Petrova, G. Sella, L. Ramella and S. Bovero. 1998. Structural-functional rearrangements in chromosome G in *Chironomus riparius* (Diptera, Chironomidae) collected from a heavy metal-polluted area near Turin, Italy. *Environmental Pollution* 103:127-134.
- Oliver, D. R. 1971. Life history of Chironomidae. *Annual Review of Entomology* 16:211-230.
- Oil Sands Wetlands Working Group. 2000. Guideline for wetland establishment on reclaimed oil sands leases. Neil Chymko (Editor) Report # ESD/LM/00-1. Alberta Environment, Environmental Service.
- Pelling, C. and W. Beermann. 1966. Diversity and variation of the nucleolar organizer regions in chironomids. *National Cancer Institute Monographs* 23:393-409.
- Planello, R., J. L. Martinez-Guitarte and G. Morcillo. 2007. Ribosomal genes as early targets of cadmium-induced toxicity in *Chironomus riparius* larvae. *Science of the Total Environment* 373:113-121.
- Rhodes, S., A. Farwell, L. M. Hewitt, M. Mackinnon, D. G. Dixon. 2004. The effects of dimethylated and alkylated polycyclic aromatic hydrocarbons on the embryonic development of the Japanese medaka. *Ecotoxicology and Environmental Safety* 60:247-258.
- Staiber, W. and E. Behnke. 1985. Developmental puffing activity in the salivary gland and malpighian tubule chromosomes of *Acricotopus lucidus* (Diptera, Chironomidae). *Chromosoma* 93:1-16.
- Timmermans, K. R., W. Peeters and M. Tonkes. 1992. Cadmium, zinc, lead and copper in *Chironomus riparius* (Meigen) larvae (Diptera, Chironomidae) - Uptake and effects. *Hydrobiologia* 241:119-134.
- van den Heuvel, M. R., M. Power, M. D. MacKinnon, T. Van Meer, E. P. Dobson and D. G. Dixon. 1999. Effects of oil sands related aquatic reclamation on yellow perch (*Perca flavescens*). I. Water quality characteristics and yellow perch physiological and population responses. *Canadian Journal of Fisheries and Aquatic Sciences* 56:1213-1225.
- Waters, T. F. 1977. Secondary production in inland waters. *Advances in Ecological Research* 10:91-164.
- Waters, T. F. 1979. Influence of benthos life-history upon the estimation of secondary production. *Journal of the Fisheries Research Board of Canada* 36:1425-1430.
- Whelly, M. P. 1999. Aquatic invertebrates in wetlands of the oil sands region of

- northeast Alberta, Canada, with emphasis on Chironomidae (Diptera). M.Sc. Thesis, University of Windsor, Windsor, Ontario, Canada. 314 pp.
- Winfield, I. J. and D. K. Winfield. 1994. Feeding ecology of the Diving Ducks Pochard (*Aythya ferina*), Tufted Duck (*A. fuligula*), Scaup (*A. marila*) and Goldeneye (*Bucephala clangula*) overwintering on Lough Neagh, Northern-Ireland. *Freshwater Biology* 32:467-477.
- Yamamoto, H. 1970. Heat-shock induced puffing changes in Balbiani rings. *Chromosoma* 32:171-190.
- Zhimulev, I. F., E. S. Belyaeva and V. F. Semeshin. 1981. Informational content of polytene chromosome bands and puffs. *CRC Critical Reviews in Biochemistry* 11:303-340.

CHAPTER TWO: THE RELATIONSHIP BETWEEN NUCLEOLAR ORGANIZER SIZE AND GROWTH IN FOOD-LIMITED *CHIRONOMUS RIPARIUS* LARVAE (DIPTERA: CHIRONOMIDAE)

INTRODUCTION

Midge larvae are typical of Diptera possessing giant polytene chromosomes that form when chromatid strands replicate but fail to divide (Case and Danesholt 1977). When genes on these chromosomes undergo transcription the normally condensed chromatid strands uncoil and characteristic puffs appear. Puffs are sites of RNA synthesis (reviewed by Danesholt 1975), and the rate of transcription is proportional to the size of the puff (Pelling 1964 cited by Grossbach 1977; Danesholt *et al.* 1969).

The nucleolar organizer (NOR), visible as an especially large puff, is an area of preribosomal RNA synthesis (reviewed by Case and Danesholt 1977). It is an indicator of sublethal stress (Bentivegna and Cooper 1993; Hudson and Ciborowski 1996a), showing marked decreases in size (Aziz *et al.* 1991; Michailova *et al.* 1998; 2001a, b; 2003; 2006) and transcriptional activity (Planello *et al.* 2007) when larvae are exposed to contaminated sediments or elevated levels of trace metals.

Pelling and Beermann (1966) reported that “condensed [nucleolar] organizers appear almost exclusively under conditions when metabolic activity is at a minimum” and that “in rapidly growing *Chironomus* larvae, the nucleolar organizer regions are most frequently found in an extremely puffed condition.” While these observations suggest that NOR size is intimately linked to growth, to our knowledge this relationship has not been tested experimentally.

In this chapter we report the results from two growth experiments designed to examine how NOR size changes as a function of *Chironomus riparius* growth under controlled laboratory conditions. We expected to find a strong positive correlation between NOR size and an individual’s recent growth rate. In both experiments, ration quality was used as a limiting factor to growth, which ensured that observed physiological changes could not be interpreted as toxic responses. Based on patterns reported from previous growth experiments using *Chironomus riparius* larvae (e.g., Ristola *et al.* 1999;

Pery *et al.* 2002), we expected that growth, and thus NOR size, would increase as ration quality increased.

MATERIALS AND METHODS

Organism collection and maintenance

Chironomus riparius egg masses were obtained from a laboratory culture maintained by Environment Canada (Burlington, ON). Upon arrival, egg masses were incubated at room temperature until they hatched. Only first instar larvae (24 h old or less) were used in experiments.

Experimental design

Two independent experiments were conducted simultaneously. Two trials (each with 4 replicates per treatment) were conducted sequentially. The first trial ran from January 26th to February 9th, 2007 and the second from February 16th to March 2nd, 2007.

Uniform ration experiment. -In this experiment a uniform feeding regime was employed over the 14-d course of the trial to quantify the relationship between ration quality and measures of larval survival, size, growth, and NOR size. Larvae were provided with a daily food ration of 1.0 mg/larva. Food consisted of a mixture of ground Nutrifin[®], the food typically used in *Chironomus* cultures (eg., Naylor and Rodrigues 1995), and methylcellulose, which serves as a source of biomass that is consumed by larvae but has no nutritive value (Burt 2005). Ration quality was regulated by varying the proportions of each constituent. Treatments followed a geometric series of nutritional quality (0:1, 1:7, 1:3, 1:1, and 1:0 w/w Nutrifin[®]: methylcellulose) and ranged from having no nutritional value (0:1) to greatest nutritional value (1:0). At the conclusion of the experiment we measured survival, biomass, and NOR size. We expected growth (measured as individual final biomass) to vary as a function of ration quality. We therefore also expected NOR size to vary as a function of ration quality; better fed larvae would be growing faster and exhibit larger NOR than poorly fed larvae.

Variable ration experiment. -In this experiment a variable feeding regime was employed over the 14-d course of the trial to determine if NOR size varied as a function of recent growth independently of larval size. The experiment followed a 2 x 2 factorial design. The two factors were 'experimental period' and 'ration quality'. The time course of this experiment was divided into 'early' (days 0-7) and 'late' (days 8-14) periods. Ration quality was either 'low' (1:7 w/w Nutrifin[®]: methylcellulose) or 'high' (1:0 w/w Nutrifin[®]: methylcellulose). Thus, larvae in a treatment received a ration of either 'low' or 'high' quality for the 'early' part of the trial, after which ration quality was either kept the same or changed to the complementary treatment. At the conclusion of the experiment we measured survival, biomass, and NOR size. Additional jars (n = 4) of 'low' and 'high' ration quality had been set up and harvested at the midpoint of the experiment (day 7) to provide a second measure of biomass used to estimate the instantaneous growth rate of chironomids during the 'final' period of the study.

Because the potential for new tissue elaboration is directly proportional to the amount of food assimilated, we expected the final biomass of individual larvae to reflect the quality of the ration with which they were provided averaged over the 'early' and 'late' periods. Therefore, larvae that were given a uniformly 'low' or 'high' quality ration were expected to be small or large, respectively, and larvae whose ration was changed at the midpoint of the trial were expected to be intermediate in size.

Unlike larval size, which we expected to depend on an individual's entire feeding history, we expected larval short-term growth rates at the conclusion of the experiment to reflect the quality of the ration that they had been given during the 'late' period only. Therefore, larvae switched from a 'high' to 'low' quality ration were expected to be growing slowly at the end of the 'late' period. The converse was expected for larvae switched from a 'low' to 'high' quality ration. We expected NOR size to reflect recent growth rates, and thus also the quality of the ration provided during the 'late' period only.

Experimental procedures

Treatment jars were 12 x 12 x 15 cm, 2-L glass containers prewashed with 10 % HNO₃ and triple rinsed with distilled water. Jars contained 500 g of washed, fine silica

sand and 1-L of water aerated for 48 h prior to the addition of larvae. Ionic concentration of the water was standardized by adding salts to deionized water (CaCl₂, 79.2 mg/L; MgSO₄, 44.5 mg/L; NaHCO₃, 85.6 mg/L; KCl, 2.8 mg/L; Bedard *et al.* 1992). Each jar was covered, continuously aerated using a branching capillary tube system (Corkum and Hanes 1989), and kept at 21 ± 2 °C on a 16:8 h light:dark photoperiod within a walk-in environmental chamber. Temperature, dissolved oxygen, and pH were measured in each jar with a YSI 30 portable meter at the beginning, middle and end of each 14-d trial.

Viewed under a dissection scope, groups of 50 newly hatched larvae were randomly selected from egg masses that had been placed in Petri plates, and pipetted into 20-mL scintillation vials. Vials were then immersed into each treatment jar to release the larvae. Stock solutions of ground Nutrifin[®] (5 mg/mL of distilled water) and methylcellulose (5 mg/mL of distilled water) were made daily. Food was added daily to each treatment jar by diluting the stock solutions accordingly. All volumes were adjusted to 10-mL to keep water levels even across treatments.

At the conclusion of each trial the jar contents were emptied into a 250-µm mesh sieve, larvae were hand-picked from the retained sand with fine forceps, individually blotted on paper towel to remove excess water, counted, and immediately preserved in chilled (4°C) Carnoy's solution (3:1 v/v absolute ethanol/glacial acetic acid). Carnoy's was poured off and replaced with fresh solution after 10 min, 1 h and 24 h. Total handling time for each jar (time elapsed between first and last individual preserved) was constant among trials and treatments (uniform ration experiment, 3.5 ± 0.3 min, n = 40; variable ration experiment, 5.0 ± 1.3 min, n = 32).

Biomass and growth rate measurements

Preserved larvae were placed on their sides in a Petri plate and digitally photographed over a 5 mm² grid using a Hitachi[®] VK-C370 DSP colour video camera equipped with a macro lens and a Pixelsmart[®] video card. Each chironomid was assigned a unique number, its position was recorded on the digital image, and it was stored in its own shell vial containing Carnoy's solution. Total body length, from the anterior part of the head to the posterior edge of the last abdominal segment, was measured to the nearest

0.01 mm using Mocha[®] Version 1.2 imaging analysis software version 1.2 (Jandel Corporation[®], 1992-1994). Body length was then converted to biomass using the length-dry mass conversion method (Burgherr and Meyer 1997):

$$M = aL^b \quad [1]$$

where M is individual biomass (mg), L is body length (mm) and, *a* and *b* are constants equal to 0.00068 and 2.620, respectively, derived from a length-mass regression equation for *Chironomus* spp. (Benke *et al.* 1999). Instantaneous growth rates (*g*), where *g* represents the mean growth rate for all larvae in a single jar, were then calculated as follows:

$$g = \ln [(M_{t=14} / M_{t=7})] / t \quad [2]$$

where $M_{t=14}$ is mean final biomass, $M_{t=7}$ is mean biomass after 7 days, and *t* is the number of days between biomass measurements (Hauer and Benke 1991).

While photographing the larvae we noticed considerable variation in development among individuals of the same age. Considering that the pattern and timing of puff activation may be associated with development (e.g., Ashburner 1967, Santa-Cruz *et al.* 1978), we scored each individual according to developmental stage prior to extracting the salivary glands. Each larva was assigned to one of three classes ('early', stage 0-3; 'intermediate', stage 4-6; or 'late', stage 7-9) based on the nine developmental phases of the fourth instar illustrated by Wuelker and Goetz (1968).

Polytene chromosome extraction and staining:

All larvae were preserved for at least 24 h. Polytene chromosomes were extracted from salivary glands and stained using a modification of the aceto-orcein technique (M.G. Butler, North Dakota State University, personal communication). To extract the salivary glands from a preserved chironomid, a specimen was placed in a depression slide filled with 50% acetic acid and viewed under the low power of a dissection microscope. The head was removed and the body was severed just below the second thoracic segment. The salivary glands were then extruded anteriorly from the thorax using gentle pressure, carefully isolated, transferred to a microscope slide, and stained with aceto-orcein (1 mg

orcein/50-mL of 60% acetic acid). After 6 min, the glands were triple rinsed with 50 % acetic acid (two drops placed over each gland and immediately drawn off with bibulous paper) to remove any excess or unbound stain. Afterwards, salivary glands were rinsed with a drop of 15 % lactic acid, followed immediately with a drop of 25 % lactic acid. The glands were then transferred to a clean slide and covered with a drop of 45 % lactic acid. A coverslip was placed on top, and the glands were squashed using a press designed and constructed to deliver an even and consistent amount of pressure. The preparation was allowed to sit for 10 min at room temperature to dry. The edges of the coverslip were then rimmed with nail polish and the slide was stored in a freezer until it could be digitally photographed.

Measurements of NOR size

Previous studies have characterized puff size by calculating the relative nucleolar diameter (Bentivegna and Cooper 1993; Hudson and Ciborowski 1996a). Puff size is proportional to chromosome size, and chromosome size corresponds to the size of an individual (Bentivegna and Cooper 1993). Measurements taken from different-sized larvae can therefore be standardized by measuring both NOR and chromosome size.

We also used diameter as a measure of NOR size (Appendix I). The NOR of *C. riparius* is found on chromosome G (Michailova *et al.* 2006). NOR diameter was measured at the centre of the Dd region. The diameter of the A1b band was used as a measure of chromosome size (Fig. 1). This section is furthest away from the NOR and Balbiani rings (BRs), making it least likely to be structurally affected by changes in their activity (Zhimulev *et al.* 1981).

Polytene chromosomes were viewed at 400X magnification using a Meiji compound microscope attached to a SPOT InsightTM Firewire 2 Megapixel Color Mosaic digital video camera. Three to six chromosomes per larvae were photographed and NOR diameter was measured from the digital images to the nearest 0.1 μm using UTHSCSA ImageTool version 3.0 (© UTHSCSA 1996-2002). The mean NOR diameter for a single chironomid was then calculated. Individuals from which less than three nucleoli were measured were excluded from further analyses. For each replicate jar, mean NOR

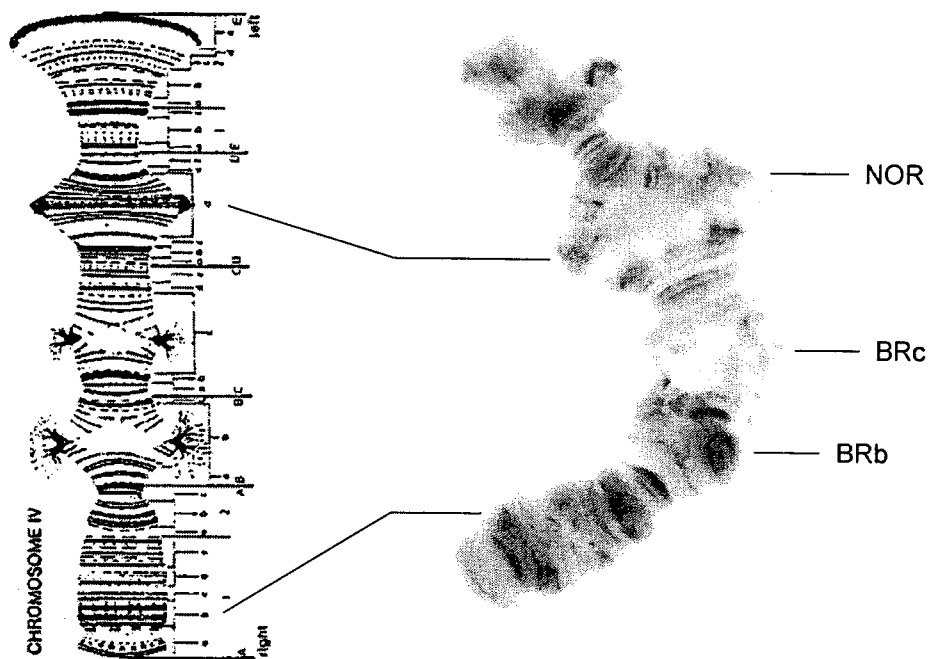

Fig. 1. Chromosomal map (*left*; source unknown) and digital image taken at 400X magnification (*right*) of the IVth chromosome (G arm) of *Chironomus riparius*. Lines indicate the location of the Dd and A1a bands used as measures of NOR and chromosome size, respectively. Also indicated are the Balbiani rings (BRb and BRc).

diameter was calculated from measures taken for between two and six individuals. In order to account for variability in size among individuals and because good quality stains were difficult to obtain from individuals smaller than 9 mm (*pers. obs.*), we systematically chose the three largest and median-sized larvae for analysis.

Statistical Analyses

Statistical analyses were performed using STATISTICA version 6.1 (Statsoft, Inc., Tulsa, OK). Statistical significance of differences among treatment groups and trials for water chemistry parameters, chironomid survival, biomass, and instantaneous growth rate was tested using planned-comparison analysis of variance (ANOVA). The statistical significance of differences among treatment groups and trials for NOR size (controlling for chromosome size) was tested using planned-comparison analysis of covariance (ANCOVA). All reported adjusted NOR values are adjusted to a mean chromosome size of 9.2 μm ; this was the greatest area of overlap among treatments. Statistical significance of differences in the proportion of larvae in each developmental stage was tested using a chi-square contingency test. The level of significance was set at $p < 0.05$ for all tests.

RESULTS

Uniform ration experiment

Water chemistry.-Mean temperature, dissolved oxygen, and pH values were all significantly higher during trial 1 than during trial 2 (analysis of variance, $p < 0.05$), but were not significantly different among treatments (Table 1; analysis of variance, $p > 0.1$).

Survival.-Mean (\pm SE) larval survival was significantly lower for trial 1 (34.25 ± 3.40 %, $n = 16$) than for trial 2 (55.75 ± 4.06 %, $n = 16$) (Fig. 2; $F_{1,30} = 11.88$, $p < 0.001$). As expected, survival was significantly lower in the starved (0:1 w/w ground Nutrifin[®]: methylcellulose) treatment ($F_{1,30} = 52.45$, $p < 0.001$). Because only a few very small larvae survived in the 0:1 treatment they were not included in further analyses. Survival among all other treatments was homogeneous (planned-comparisons, $p > 0.05$).

Table 1. Mean (\pm SE) values of water chemistry parameters during the variable ration and uniform ration experiments for both trial 1 (n = 16, n = 19, respectively) and trial 2 (n = 16, n = 20, respectively).

	Trial 1	Trial 2	F	p
<i>Variable ration experiment (n = 32)</i>				
Temperature ($^{\circ}$ C)	22.4 \pm 0.08	21.3 \pm 0.04	138.7	< 0.001
Dissolved oxygen (%)	70.4 \pm 1.6	62.9 \pm 1.8	9.33	< 0.01
pH	8.1 \pm 0.06	8.0 \pm 0.02	2.20	> 0.1
<i>Uniform ration experiment (n = 39)</i>				
Temperature ($^{\circ}$ C)	22.4 \pm 0.1	21.3 \pm 0.04	132.9	< 0.001
Dissolved oxygen (%)	71.1 \pm 1.04	63.9 \pm 0.8	34.21	< 0.001
pH	8.1 \pm 0.02	8.0 \pm 0.03	28.6	< 0.001

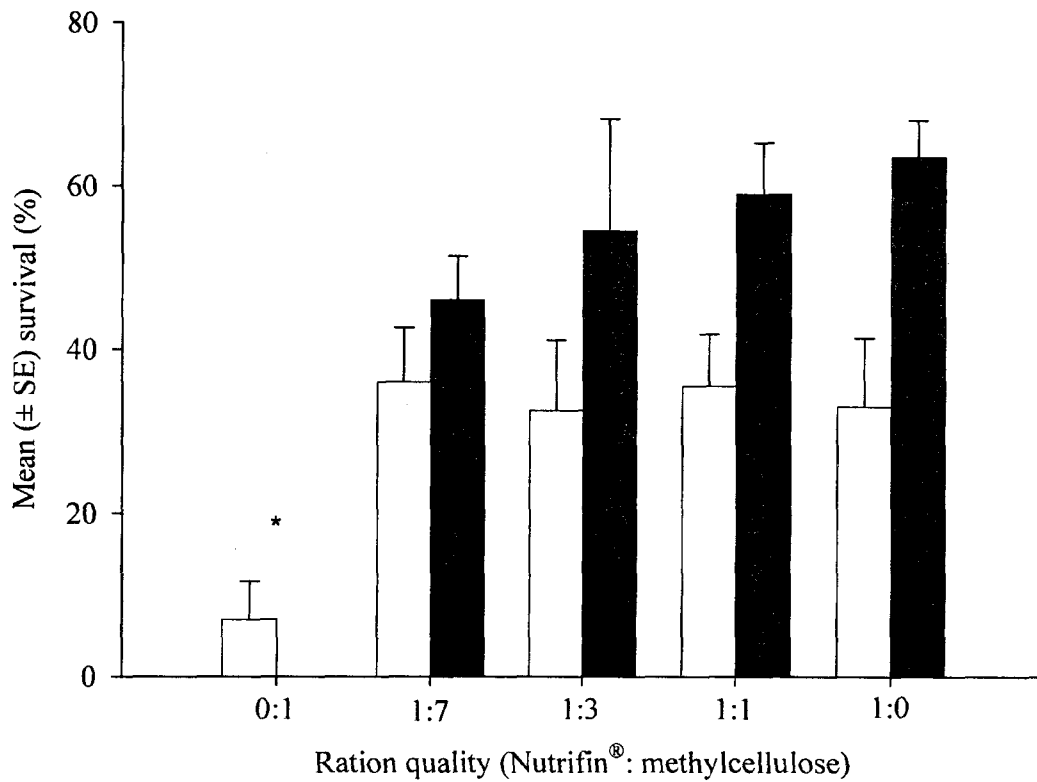

Fig. 2. Mean (\pm SE) survival at the end of the uniform ration experiment. Asterisks indicate a significant difference at $p < 0.05$. Trial 1 ($n = 4$), open bars; Trial 2 ($n = 4$), filled bars.

Biomass. -Mean (\pm SE) individual biomass was significantly different among treatments (planned comparisons, $p < 0.01$) and increased as ration quality increased (Fig. 3). Individuals provided with a low quality (1:7) ration were smallest, weighing 0.32 ± 0.02 mg ($n = 8$) on average, while those kept on the highest quality ration (1:0) were largest, weighing 0.60 ± 0.02 mg ($n = 8$) on average. There was no significant difference between trials ($F_{1,24} = 0.22$, $p > 0.1$). There was a trend for larvae in trial 1 to be larger than larvae in trial 2. The lower survivorship in trial 1 may explain this result; because there were fewer larvae in each jar, on average, larvae in trial 1 received more food per individual than larvae in trial 2.

In addition to having an effect on biomass, ration quality also influenced development. Two lines of evidence support this conclusion. First, at the conclusion of the experiment seven individuals pupated; six of these were fed one of the two highest quality rations (1:1 and 1:0 w/w Nutrifin[®]: methylcellulose). Secondly, based on the assignment of individuals to one of three developmental classes (done prior to extracting the salivary glands), the proportion of individuals ‘intermediate’ or ‘late’ in development increased as diet quality increased (Table 2; chi-square contingency test, $\chi^2 = 30.56$, d.f. = 6, $p < 0.001$).

NOR size. -A total of 906 chromosomes was photographed and measured from 173 individuals. NOR size was significantly correlated with chromosome size (regression analysis, $R^2 = 0.49$, $F_{1,30} = 28.71$, $p < 0.001$); larger chromosomes had larger NOR (Fig. 4). A test for parallelism revealed this relationship was homogeneous across larvae fed different quality rations ($F_{3,16} = 0.81$, $p > 0.1$). Mean (\pm SE) NOR size was significantly larger in trial 1 larvae (22.54 ± 0.49 μm , $n = 16$) than in trial 2 larvae (20.64 ± 0.42 μm , $n = 16$) (analysis of covariance, $F_{1,23} = 10.70$, $p < 0.01$). Contrary to our expectations, however, NOR size did not significantly differ among larvae fed different quality rations (analysis of covariance, $F_{3,23} = 2.34$, $p > 0.1$). Both NOR and chromosome size were independent of larval body size (Fig. 5 and 6; linear regression: $R^2 = 0.01$, $F_{1,30} = 0.3$, $p > 0.1$; $R^2 = 0.09$, $F_{1,30} = 3.04$, $p > 0.05$, respectively).

To account for some of the variability we contrasted the NOR of the various developmental stages, independent of treatment (Fig. 7 and 8). Larvae that were ‘early’ in

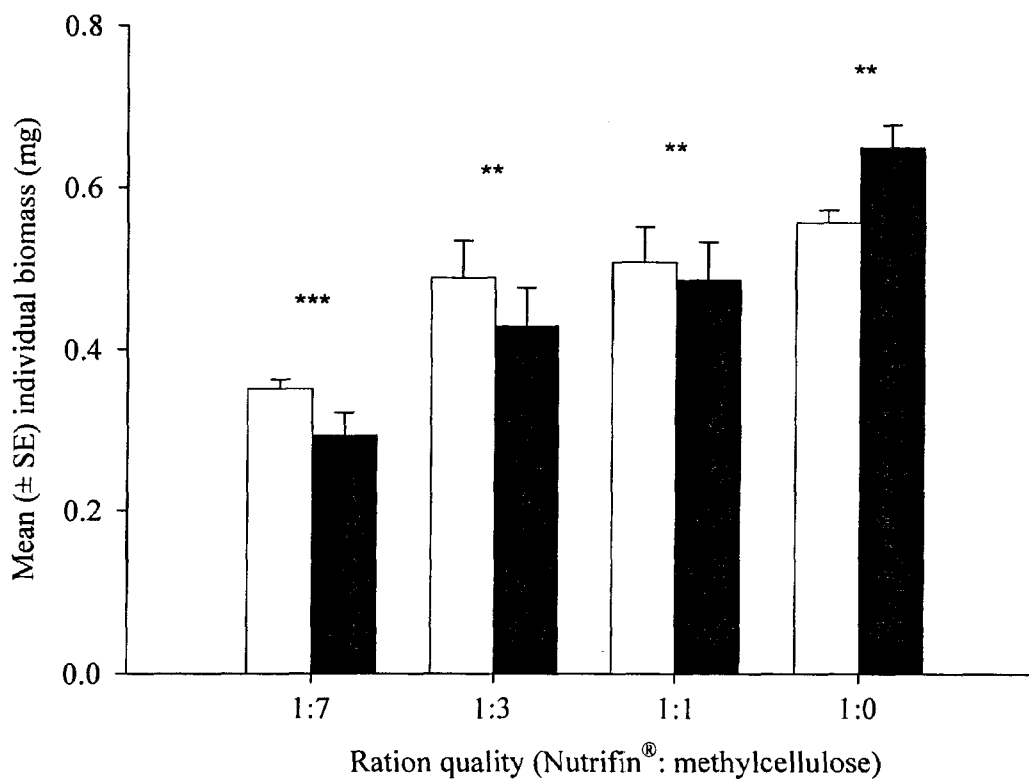

Fig. 3. Biomass of midge larvae (mg dry mass) at the end of the uniform ration experiment. Asterisks indicate a significant difference at $p < 0.05$ (*), $p < 0.01$ (**), or $p < 0.001$ (***). Trial 1 ($n = 4$), open bars; Trial 2 ($n = 4$), filled bars.

Table 2. Percentage of *Chironomus riparius* larvae (from which NOR size measurements were obtained) at the end of the uniform ration experiment assigned to each of three developmental classes based on the development of their imaginal discs.

Diet quality	Developmental class		
	Early	Intermediate	Late
1:7 (n = 41)	100	0	0
1:3 (n = 41)	92.7	4.9	2.4
1:1 (n = 45)	77.8	20	2.2
1:0 (n = 46)	58.7	30.4	10.9

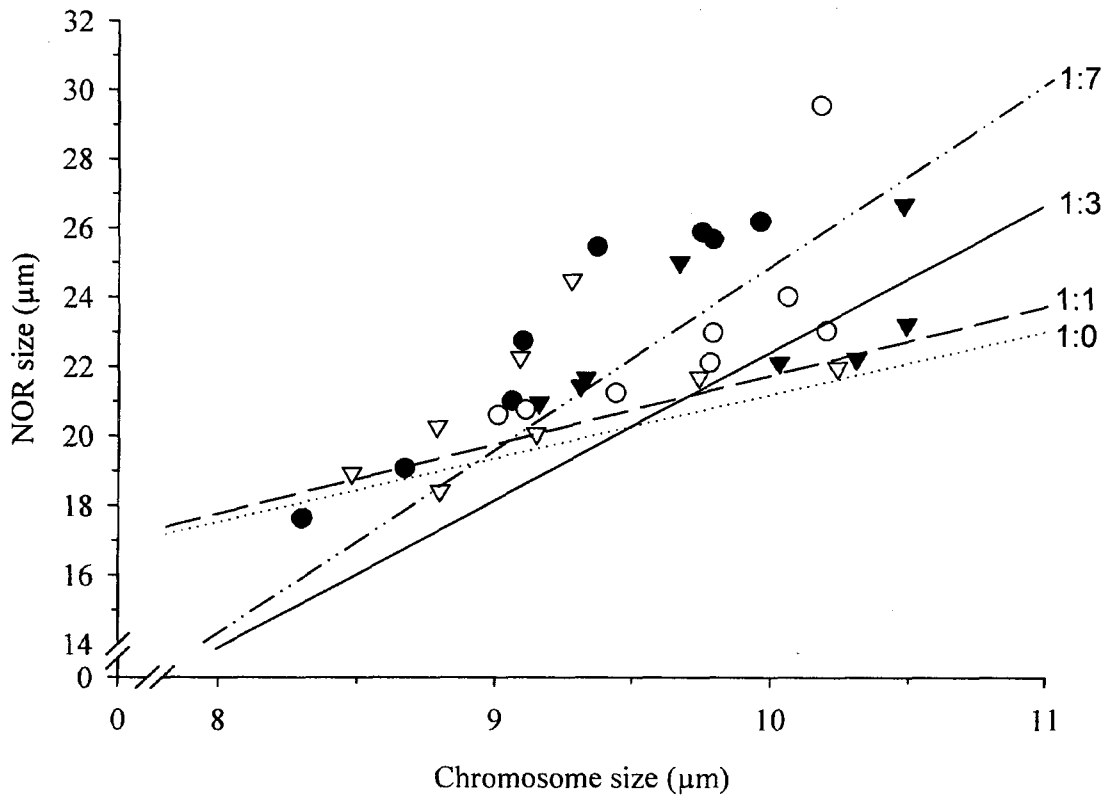

Fig. 4. NOR size at the end of the uniform ration experiment as a function of chromosome size at each of four different ration qualities (1:7, filled points; 1:3, open points; 1:1, filled triangles; 1:0, open triangles; $n = 8$). Each point represents the mean for all larvae from a single replicate jar. The slope of the relationship was only significant for the 1:7 and 1:3 ration qualities ($R^2 = 0.93$, $F_{1,6} = 78.6$, $p < 0.001$; $R^2 = 0.54$, $F_{1,6} = 6.94$, $p < 0.05$, respectively).

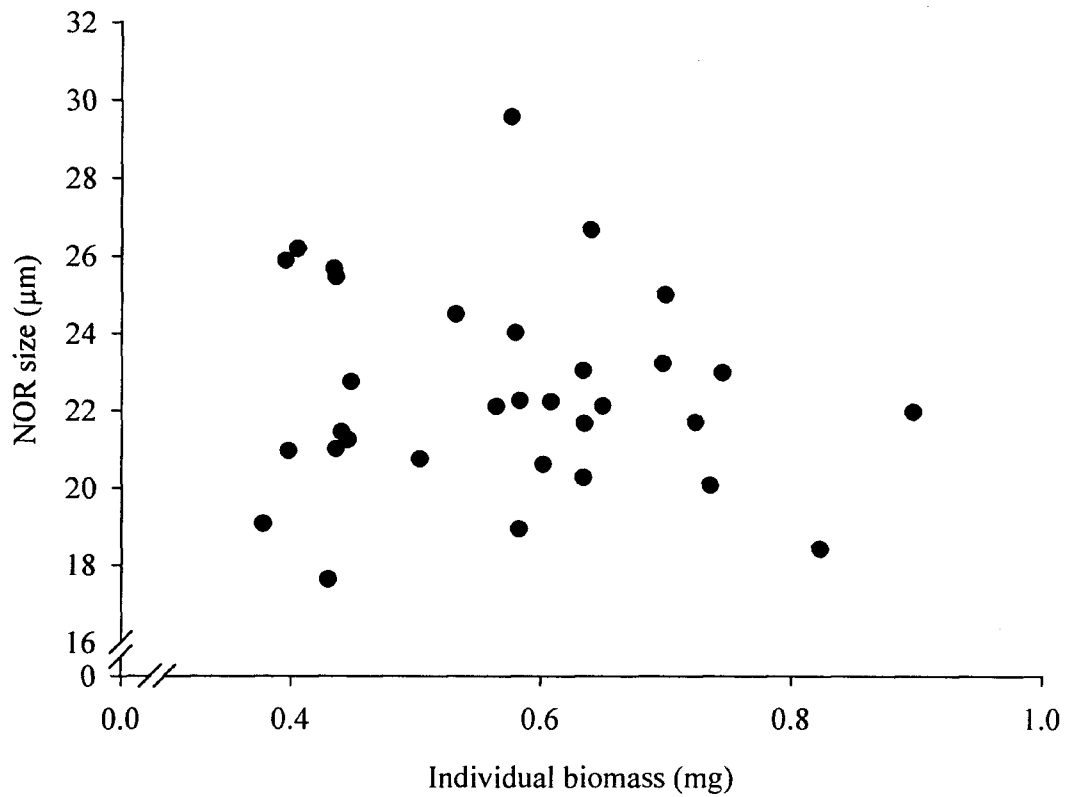

Fig. 5. Scatterplot showing the relationship between NOR size and larval size (biomass) at the end of the uniform ration experiment ($n = 32$). Each point represents the mean for a single replicate jar. The slope of the relationship was not significantly different than zero ($r^2 = 0.01$, $F_{1,30} = 0.3$, $p > 0.1$).

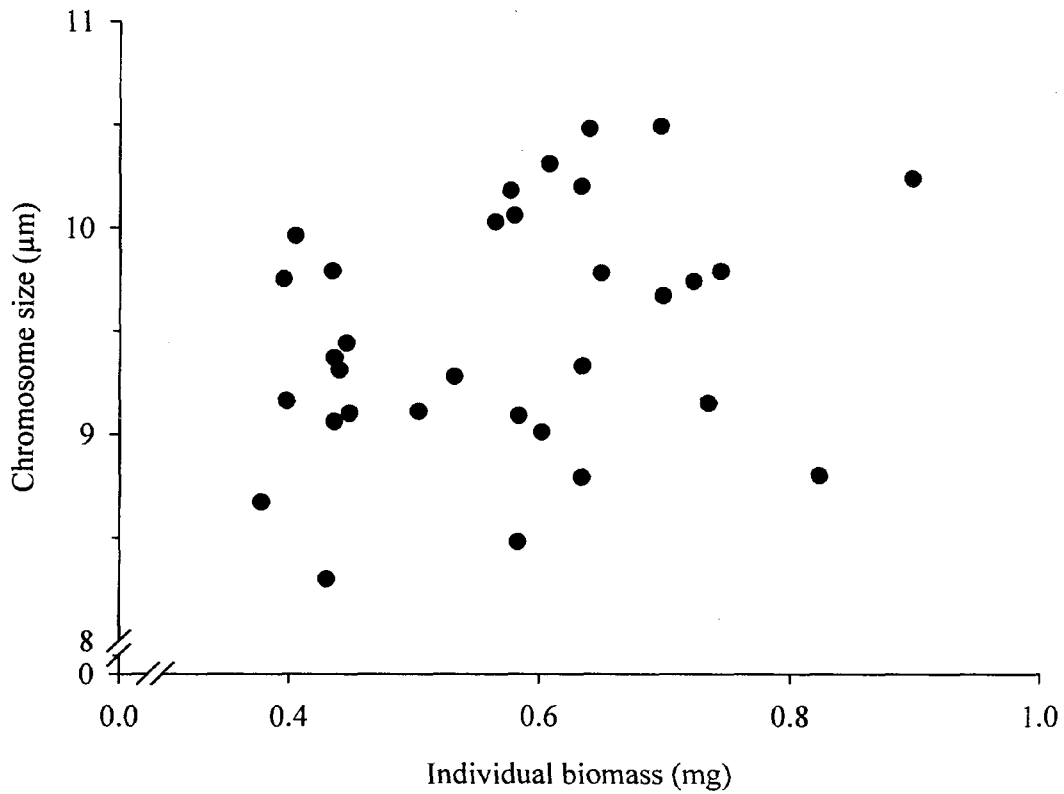

Fig. 6. Scatterplot showing the relationship between chromosome size and larval size (biomass) at the end of the uniform ration experiment ($n = 32$). Each point represents the mean for a single replicate jar ($n = 8$). The slope of the relationship was not significantly different than zero ($R^2 = 0.09$, $F_{1,30} = 3.04$, $p > 0.05$).

their development had a significantly larger mean (\pm SE) NOR ($22.10 \pm 0.29 \mu\text{m}$, $n = 141$) than those larvae who were in ‘intermediate’ ($19.64 \pm 0.66 \mu\text{m}$, $n = 25$) or ‘late’ ($18.76 \pm 1.23 \mu\text{m}$, $n = 7$) developmental stages (planned-comparison, $F_{1,169} = 14.89$, $p < 0.001$).

Variable ration experiment

Water chemistry.-Mean temperature, dissolved oxygen, and pH were similar between trials and among treatments (Table 1; analysis of variance, $p > 0.05$).

Survival.-Mean (\pm SE) survival did not significantly differ among treatments (Fig. 9; analysis of variance, $F_{3,24} = 0.42$, $p > 0.1$). Mean survival was significantly lower for trial 1 ($37.62 \pm 4.12 \%$, $n = 16$) than for trial 2 ($62.00 \pm 3.37 \%$, $n = 16$) (analysis of variance, $F_{1,24} = 19.75$, $p < 0.001$).

Biomass.-Both ‘early’ and ‘late’ ration quality significantly affected biomass (Fig. 10). At the midpoint of the experiment (day 7) the mean (\pm SE) individual biomass of larvae provided with a low quality ration was only half of ($0.027 \pm 0.003 \text{ mg}$, $n = 4$) the biomass of larvae that were provided with a high quality ration ($0.054 \pm 0.007 \text{ mg}$, $n = 4$) (one-tailed t-test, d.f. = 6, $t = -3.39$, $p < 0.05$). Larvae fed a low quality ration during the ‘early’ period were also significantly smaller at the conclusion of the experiment than larvae that were fed a high quality ration during the ‘early’ period (analysis of variance, $F_{1,24} = 61.54$, $p < 0.001$). Regardless of the quality of the ration they received during the ‘early’ period, larvae provided with a low quality ration during the ‘late’ period were significantly smaller than larvae that were fed a high quality ration during the ‘late’ period (analysis of variance, $F_{1,24} = 34.79$, $p < 0.001$). The quality of the ration provided during the ‘late’ period had more of an effect on larval biomass during trial 2 than during trial 1 (analysis of variance, $F_{1,24} = 23.12$, $p < 0.001$). Mean (\pm SE) individual biomass was significantly lower during trial 1 ($0.41 \pm 0.12 \text{ mg}$, $n = 16$) than during trial 2 ($0.46 \pm 0.15 \text{ mg}$, $n = 16$) (analysis of variance, $F_{1,24} = 7.05$, $p < 0.05$).

In accord with our expectations, planned-comparisons showed that larval size at the end of the study reflected the nutritional quality of the ration provided averaged over

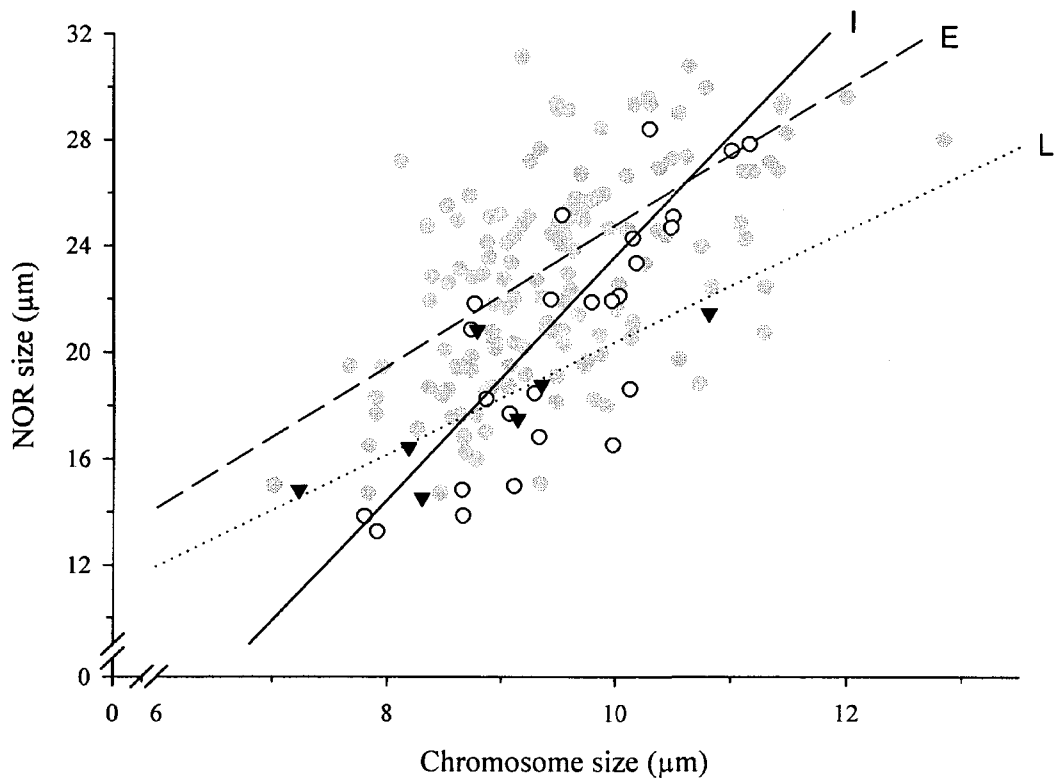

Fig. 7. NOR size as a function of chromosome size for larvae ‘early’ (gray points, $n = 141$), ‘intermediate’ (open points, $n = 25$), and ‘late’ (solid triangles, $n = 7$) in their development at the conclusion of the uniform ration experiment. Each point represents the mean for a single individual. E = early; I = intermediate; L = late.

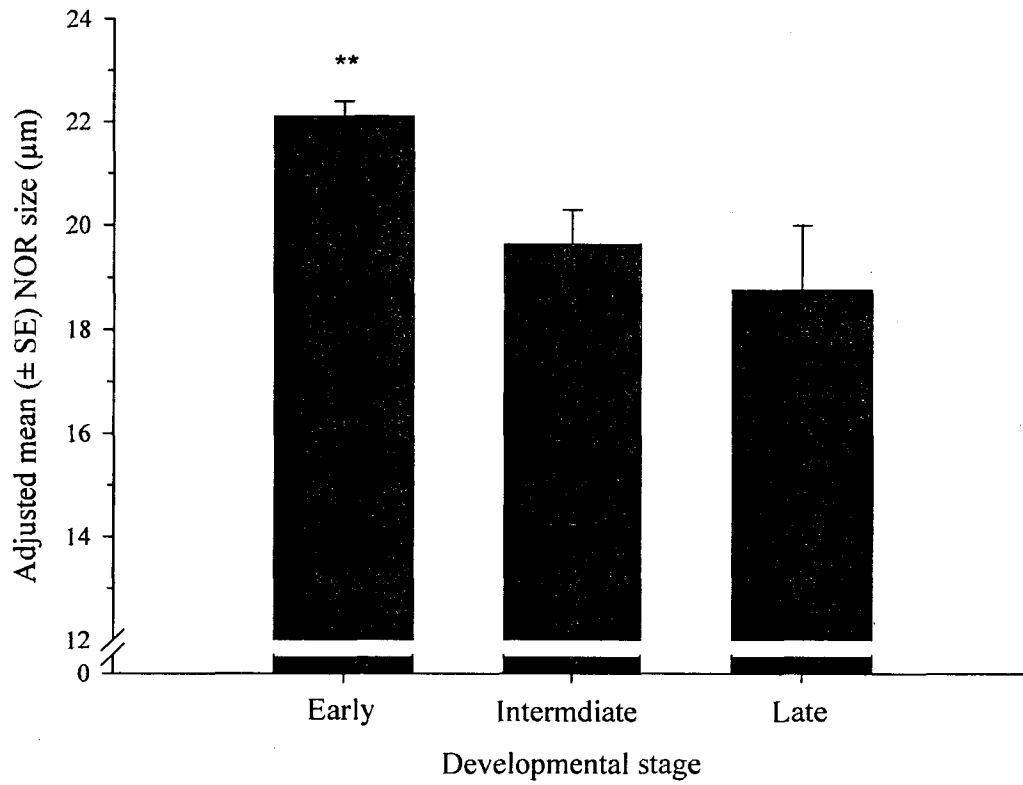

Fig. 8. Adjusted mean (\pm SE) NOR size for larvae at different stages of development (early, $n = 141$; intermediate, $n = 25$; late, $n = 7$). Values are adjusted for a chromosome size of $9.2 \mu\text{m}$. Asterisks indicate a significant difference at $p < 0.01$.

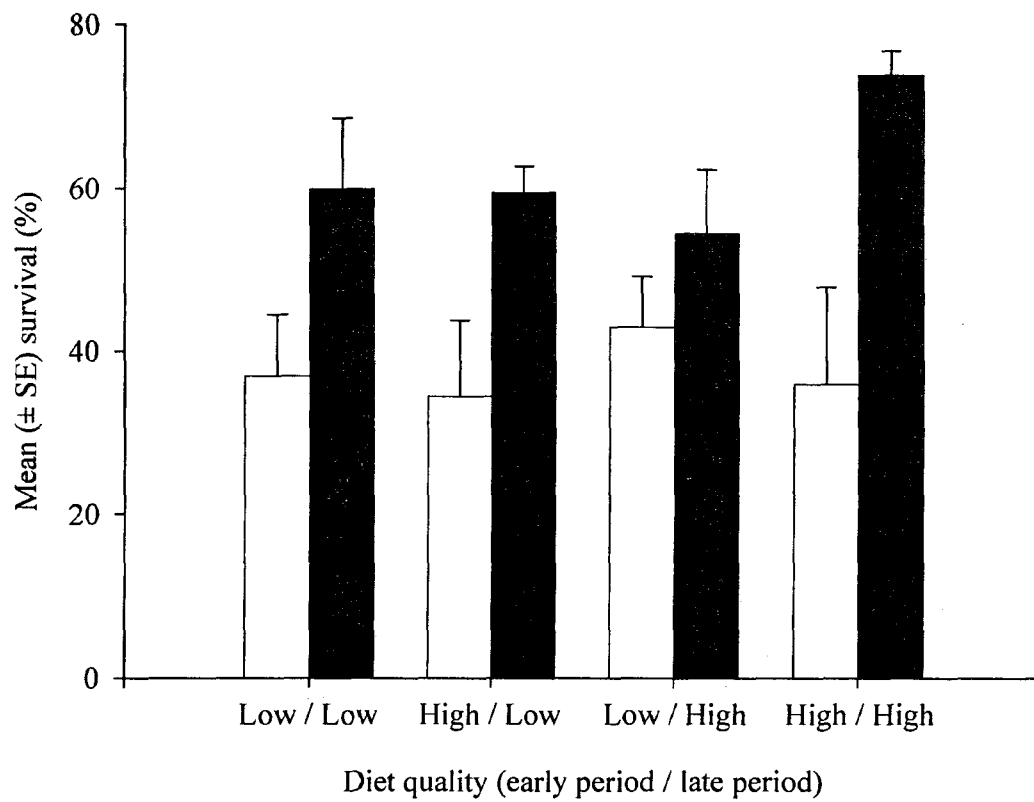

Fig. 9. Mean (\pm SE) survival at the end of the variable ration experiment. Trial 1 (n = 4), open bars; Trial 2 (n = 4), filled bars.

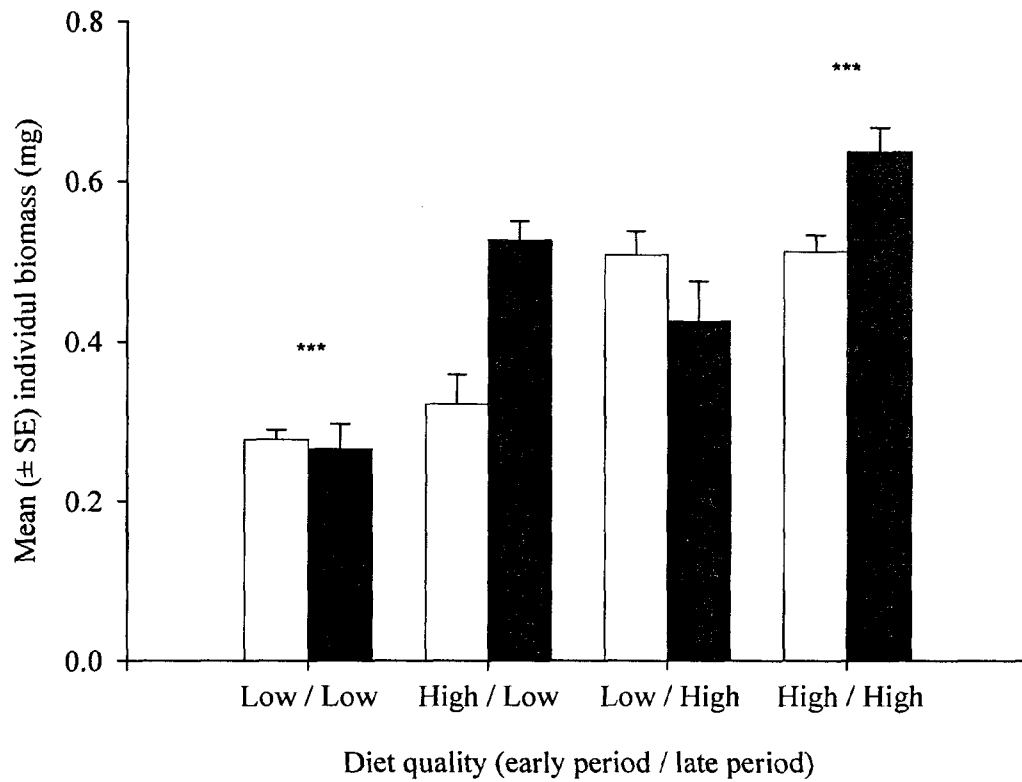

Fig. 10. Biomass of midge larvae (mg dry mass) at the end of the variable ration experiment. Asterisks indicate a significant difference ($p < 0.001$). Trial 1 ($n = 4$), open bars; Trial 2 ($n = 4$), filled bars.

both the 'early' and 'late' periods. Larvae given a 'low' quality ration throughout the study were small, larvae given a 'high' quality ration were large, and larvae whose ration was changed at the midpoint of the study were intermediate in size. Larval development proceeded at a similar rate across treatments (Table 3; chi-square contingency test, $\chi^2 = 8.17$, d.f. = 6, $p > 0.1$).

Instantaneous growth rate (day 8-14).-Growth rate measurements were calculated only for trial 2 treatments ($n = 4$) as no measurements were obtained for larval biomass on day 7 during trial 1. As expected, larval growth rate at the end of the study reflected the nutritional quality of the ration provided during the 'late' period; larvae that were given a high quality ration during the second half of the experiment were growing 25 % faster than larvae given a low quality ration (Fig. 11; analysis of variance, $F_{1,12} = 38.16$, $p < 0.001$). However, the quality of the ration provided during the 'early' period also significantly affected growth rate; larvae given the low quality ration 'early' were growing 15 % faster at the conclusion of the experiment than those larvae provided with a high quality ration 'early' (analysis of variance, $F_{1,12} = 14.59$, $p < 0.01$). Also in line with our expectations, although larvae from the two reciprocal treatments were similar in size at the end of the experiment (see Fig. 3; planned-comparison, $F_{1,24} = 1.89$, $p > 0.1$), larvae switched from a low to high quality ration had a significantly higher mean instantaneous growth rate during the 'late' period (day 8-14) than those larvae switched from a high to low quality ration (planned-comparisons, $F_{1,12} = 49.97$, $p < 0.001$).

NOR size.-A total of 495 chromosomes was photographed and measured from 93 individuals. NOR size was significantly correlated with chromosome size (regression analysis, $R^2 = 0.29$, $F_{1,14} = 5.68$, $p < 0.05$); larger chromosomes had larger NOR (Fig. 12). A test for parallelism revealed this relationship was homogeneous across all four treatments ($F_{1,8} = 0.008$, $p > 0.1$). NOR size was significantly affected by the quality of both the 'early' and 'late' rations (Fig. 13). When the quality of the ration provided during the 'early' period was low, larvae exhibited significantly larger NORs at the conclusion of the experiment (analysis of covariance, $F_{1,11} = 14.72$, $p < 0.01$). However, if larvae were given low quality food during the 'late' period, they had significantly smaller

Table 3. Percentage of *Chironomus riparius* larvae (from which NOR size measurements were obtained) at the end of the variable ration experiment assigned to each of three developmental classes based on the development of their imaginal discs.

Diet quality (early period / late period)	Developmental class		
	Early	Intermediate	Late
Low/Low (n = 23)	100	0	0
High/Low (n = 21)	100	0	0
Low/High (n = 25)	100	0	0
High/High (n = 24)	87.5	12.5	0

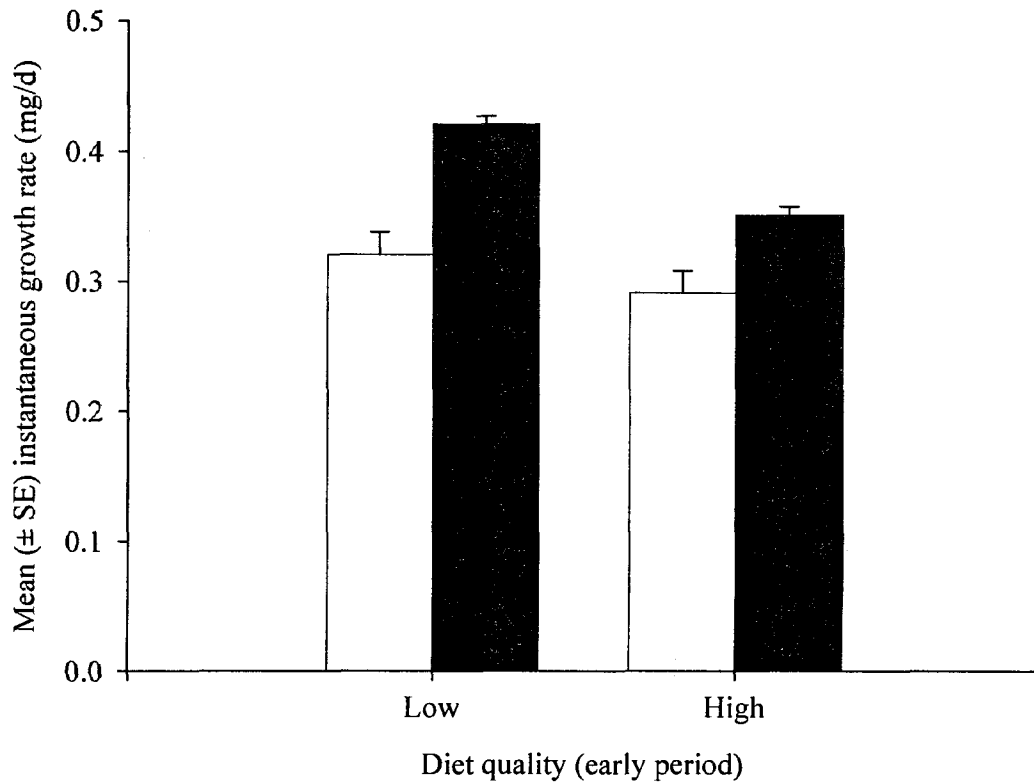

Fig. 11. Mean (\pm SE) instantaneous growth rate of midge larvae (mg/d) during the late period (day 8-14) of the variable ration experiment ($n = 4$). Diet quality (late period): low, open bars; high, filled bars.

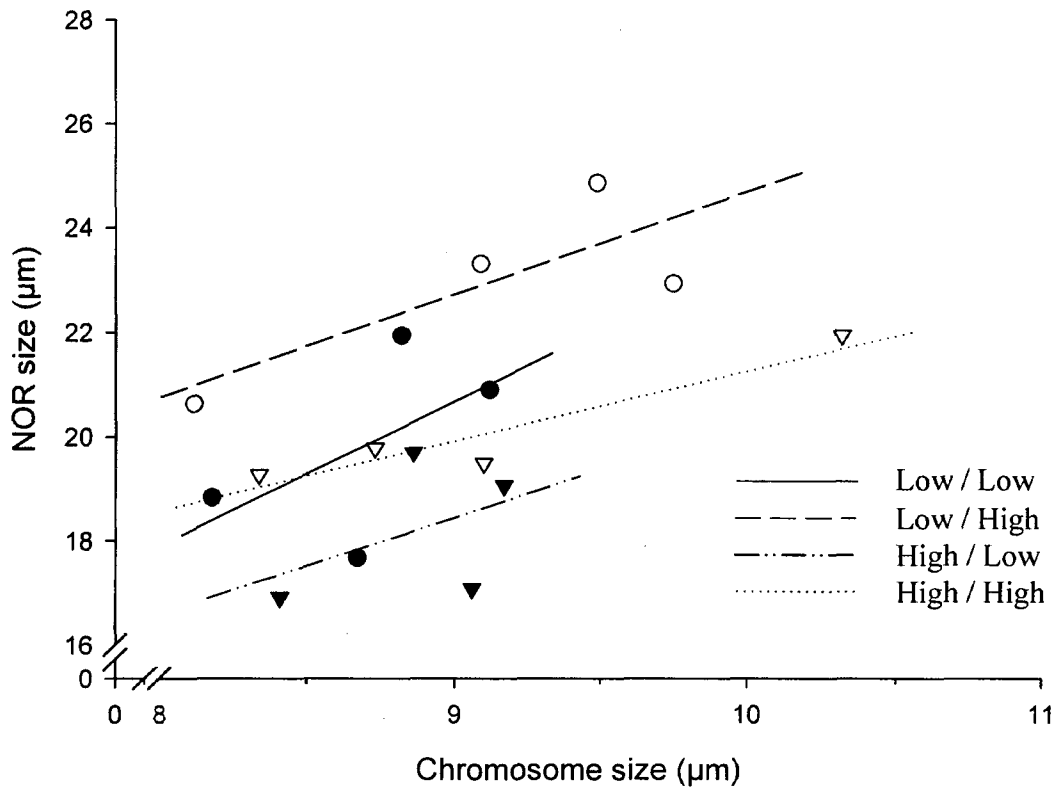

Fig. 12. NOR size at the end of the variable ration experiment as a function of chromosome size for larvae provided with a uniform ration of low quality (filled circles; $n = 4$) or high quality (filled triangles; $n = 4$) and for larvae switched from one to the other at the midpoint of the experiment (low to high, open points; high to low, open triangles; $n = 4$). Each point represents the mean for a single replicate jar.

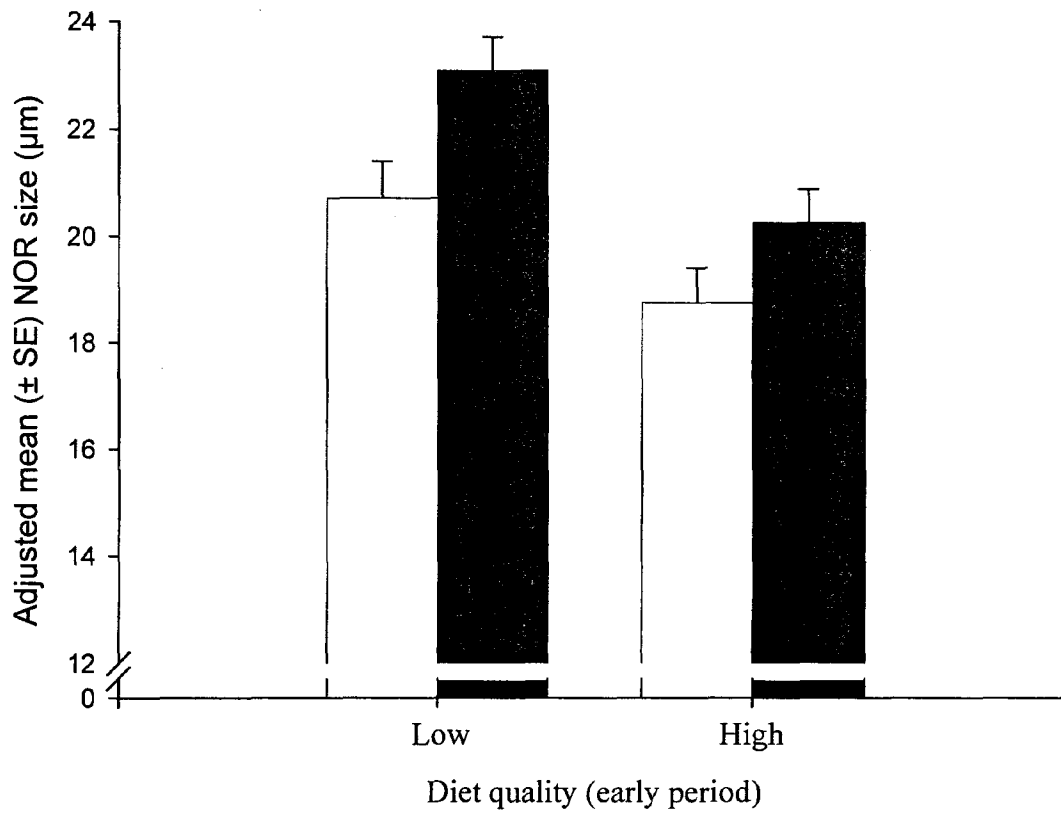

Fig. 13. Adjusted mean (\pm SE) NOR size of larvae provided with either a uniform or variable ration during variable ration experiment ($n = 4$). Diet quality (late period): low, open bars; high, filled bars. Values are adjusted for a chromosome size of $9.2 \mu\text{m}$.

NORs at the conclusion of the experiment than larvae fed a high quality ration over the same interval (analysis of covariance, $F_{1,11} = 8.74$, $p < 0.05$).

NOR size and growth rate.-Separate analyses for both growth rate and NOR size at the conclusion of trial 2 showed significant differences between treatments. When larvae were compared directly, we found a significant positive relationship between instantaneous growth rate and NOR size (Fig. 14; regression analysis, $R^2 = 0.43$, $F_{1,14} = 10.53$, $p < 0.01$). As predicted, larvae which were growing rapidly during the 'late' period of the experiment exhibited large NOR while larvae that grew slowly during the late period exhibited small NOR, regardless of treatment.

DISCUSSION

We conducted two laboratory experiments to determine if changes in NOR size reflected changes in growth. The uniform ration experiment revealed ration quality influenced both chironomid size and development. It also demonstrated that NOR size was independent of larval size, but developmentally dependent. In the variable ration experiment, we found both early and late ration quality affected chironomid size and growth. We also found that NOR size was linearly related to an individual's recent growth rate, confirming the notion that NOR size is intimately linked to growth.

Uniform ration experiment

Initial comparison of the observed and expected relationships gave results inconsistent with expectations; NOR size did not vary as a function of ration quality. However, further inspection suggests neither did chironomid growth. Typically, larval chironomid growth is nonlinear; the rate of mass accrual decreases as body size increases (Stites and Benke 1989). In the very late stages of prepupal development, fourth instar larvae may even lose biomass (Vos *et al.* 2002). Thus, as larvae approach maximum size, they allocate increasing amounts of energy to pupation rather than to growth. Eventually, growth ceases altogether (growth is restricted to the larval instars; Butler 1984) and metamorphosis takes place.

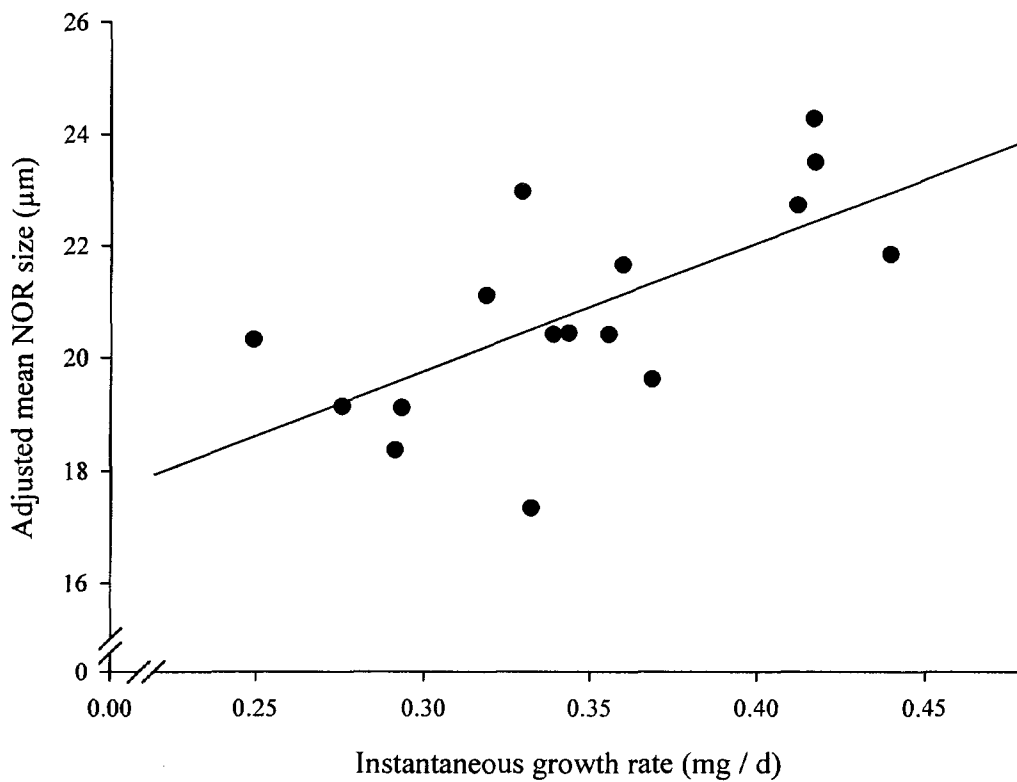

Fig. 14. Scatterplot showing the relationship between instantaneous growth rate (from day 8-14; 'late' period) and NOR size at the end of the variable ration experiment (n = 16). NOR values are adjusted for a chromosome size of 9.2 µm. Each point represents the mean for a single replicate jar.

Laboratory-reared *Chironomus riparius* larvae attain a length of 12.5-12.6 mm (Pery *et al.* 2002). At the conclusion of the uniform ration experiment, only 9 % of larvae fed the lowest quality ration (1:7 Nutrifin[®]: methylcellulose) were larger than 12.6 mm. In contrast, 57 % of the larvae fed an optimal ration (1:0 Nutrifin[®]: methylcellulose) were larger than 12.6 mm. Presumably, these large individuals were approaching, or had already reached, their maximum size. Furthermore, many of these larvae were late in development. Therefore, both larval size and the proportion of larvae whose growth had begun to slow increased as a function of ration quality.

We suggest this created a situation in which, on average, ‘recent’ growth rates were similar among treatments, but for different reasons; most individuals fed a low quality ration were growing slowly because of food limitation, whereas most individuals fed a high quality ration were growing slowly because they had attained maximum size and development. Thus, NOR size was invariable because recent growth rates were invariable. Unfortunately, the uniform ration experimental design precluded obtaining direct measures of recent growth during the late period. However, the finding that NOR size decreased as a function of prepupal stage is consistent with this scenario.

Variable ration experiment

The relationship between NOR size and growth was most clearly demonstrated by the results from the variable ration experiment. Chironomids in the reciprocal treatments displayed very different NOR size despite being similar in size and development. The differences in NOR size between the two treatments reflected differences in recent growth rate, and as expected, larvae recently fed a high quality ration had larger NOR. The finding that ‘early’ ration quality had an effect on growth rates during the ‘late’ period was not surprising. Food deprivation early in development can impact several life-history traits including survival, growth, and reproduction (Metcalf and Monaghan 2001). With respect to growth, many organisms exhibit accelerated growth rates following unfavorable conditions or a period of resource limitation in an attempt to compensate or ‘catch-up’ (Metcalf and Monaghan 2001). This is especially true when individuals are nutritionally deprived early in life (e.g., Mangel and Munch 2005; Dmitriew *et al.* 2007).

Thus, compensatory growth likely explains why, despite being starved ‘early’, larvae fed a high quality ration during the late period only had higher growth rates and higher NOR size than larvae fed a high quality ration throughout. Interestingly, as in the uniform ration experiment, larvae fed a high quality ration throughout exhibited similar NOR size to larvae fed a low quality ration throughout; direct measures of growth confirmed that these larvae were also growing at comparable rates.

Regression analysis showed a significant linear relationship between NOR size and growth rate. While it explained 43 % of the observed variation, we suggest the relationship is actually much stronger. Firstly, although NOR size was measured on an individual basis and then averaged, we measured growth (change in total biomass) at the level of the population (replicate jar). As a result, we were unable to account for among-individual growth variation. This may have increased the variability of our measures, particularly in the low quality ration and reciprocal treatments, since individual differences in growth are magnified under more stressful conditions (Koehn and Bayne 1989). Secondly, our measure of instantaneous growth reflected the average growth rate of larvae over a 7-d period. However, a significant difference in NOR activity and size is observable in as little as 12 h after exposure to cadmium (Planello *et al.* 2007). Much explanatory power was likely lost by our relating a short term putative growth indicator (NOR size) with a measure of growth estimated over a 7-d interval. Both of these concerns could be addressed in future studies by rearing and feeding larvae individually and measuring them more frequently.

NOR size as an indicator of stress

Chironomid larvae exhibit both developmental (e.g., Timmermans *et al.* 1992; Dube and Culp 1996) and teratogenic (e.g., Hudson and Ciborowski 1996b; Groenendijk *et al.* 1998; Martinez *et al.* 2001) responses to chemical contaminants. As a result, they have long been considered important bioindicators. More recently, chironomid larvae have also been shown to respond to chemical stress by exhibiting structural and functional changes in their polytene chromosomes.

The NOR is a specialized puff that displays reduced size, which is indicative of reduced transcriptional activity, in larvae exposed to toxic stress. Hudson and Ciborowski (1996a) found that the proportion of *Chironomus salinarius* group larvae exhibiting NOR regression increased with exposure to greater degrees of sediment contamination. Field-collected *Chironomus riparius* larvae living in a heavy-metal polluted river containing elevated levels of chromium, copper, and zinc showed reduced NOR size (Michailova 1998). *Chironomus riparius* larvae exposed to water treated with chromium, lead, aluminum, and copper also exhibit regressed NOR (Michailova 2001a, b; 2003; 2006). In addition to decreasing in size, the NOR of *Chironomus riparius* also showed lower levels of preribosomal RNA synthesis following exposure to cadmium (Planello *et al.* 2007). In our study, we found that the NOR of *Chironomus riparius* responded to environmental stress, showing marked differences in response to changes in food quality. We also found that NOR size varied throughout development. These findings agree with previous research conducted on the Balbiani rings, another specialized class of puffs. Similar to the NOR, they regress in size following exposure to toxic chemicals (Aziz *et al.* 1991; Bentivegna and Cooper 1993; Michailova *et al.* 1998; 2001a, b; 2003; 2006) and modify their activity throughout development (Santa-Cruz *et al.* 1978).

Most importantly, we have demonstrated that NOR size is a significant predictor of a chironomid's most recent growth rate, independent of its body size. This finding agrees with the observation of Pelling and Beermann (1966) that metabolically active chironomid larvae exhibit extremely puffed NOR, whereas inactive larvae exhibit condensed NOR. To our knowledge, this is the first experimental demonstration of the relationship between NOR size and growth. Provided that the NOR is responsible for the synthesis of preribosomal RNA (reviewed by Case and Daneholt 1977), our results are consistent with other studies linking RNA synthesis to growth. In bacteria, total RNA and ribosomal RNA (rRNA) concentrations increase as growth rates increase (Sutcliffe 1970; Binder and Liu 1998). Similarly, the ratio of RNA:DNA is positively related with growth in bacteria (Kemp *et al.* 1993) and invertebrates (McKee and Knowles 1989; Dahlhoff and Menge 1996; Vrede *et al.* 2002; Schlechtriem *et al.* 2008) and is an increasingly common indicator of growth and nutritional condition in fish (Buckley *et al.* 1999).

Our results validate the use of the NOR as a biomarker of RNA synthesis and/or metabolic function (Hudson and Ciborowski 1996); NOR regression is indicative of slowed/reduced growth and lower individual fitness (size is directly related to female fecundity; Butler and Walker 1992). Our results also have important potential for assessing chironomid growth and chironomid secondary production in natural populations. While midge larvae are often easy to collect in the field, multiple generations per year, non-recognizable cohorts, and rapid growth rates (e.g., Benke 1998) necessitate the use of time consuming and labor intensive methods to estimate secondary production (Waters 1977). In some instances, samples need to be taken no less than every three days (Benke 1984). By using NOR size as a surrogate measure of growth in the field, growth measures of individual larvae could be estimated from a single sample. Furthermore, by using the species-specific banding pattern of the polytene chromosomes to distinguish between otherwise morphologically indistinguishable species (Michailova 1989), production could potentially be estimated on a species by species basis. Such an application would require additional laboratory studies to assess how the relationship between NOR size and growth rate varies among species

LITERATURE CITED

- Ashburner, M. 1967. Patterns of puffing activity in salivary gland chromosomes of *Drosophila*. I. Autosomal puffing patterns in a laboratory stock of *Drosophila melanogaster*. *Chromosoma* 21:398-428.
- Aziz, J. B., N. M. Akrawi and G. A. Nassori. 1991. The effect of chronic toxicity of copper on the activity of Balbiani rings and nucleolar organizing region in the salivary gland chromosomes of *Chironomus ninevah* larvae. *Environmental Pollution* 69:125-130.
- Benke, A. C. 1984. Secondary production of aquatic insects. Pages 289-322 in V. H. Resh and D. M. Rosenberg. *The Ecology of Aquatic Insects*. New York, Praeger Publishers.
- Benke, A. C. 1998. Production dynamics of riverine chironomids: Extremely high biomass turnover rates of primary consumers. *Ecology* 79:899-910.
- Benke, A. C., A. D. Huryn, L. A. Smock and J. B. Wallace. 1999. Length-mass relationships for freshwater macroinvertebrates in North America with particular reference to the southeastern United States. *Journal of the North American Benthological Society* 18:308-343.
- Bentivegna, C. S. and K. R. Cooper. 1993. Reduced chromosomal puffing in *Chironomus tentans* as a biomarker for potentially genotoxic substances. *Environmental Toxicology and Chemistry* 12:1001-1011.
- Binder, B. J. and Y. C. Liu. 1998. Growth rate regulation of rRNA content of a marine *Synechococcus* (Cyanobacterium) strain. *Applied and Environmental Microbiology* 64:3346-3351.
- Buckley, L., E. Caldarone and T.-L. Ong. 1999. RNA-DNA ratio and other nucleic acid-based indicators for growth and condition of marine fishes. *Hydrobiologia* 401:265-277.
- Burgherr, P. and E. I. Meyer. 1997. Regression analysis of linear body dimensions vs. dry mass in stream macroinvertebrates. *Archiv Fur Hydrobiologie* 139:101-112.
- Burt, J. A. 1998. Deformities and fluctuating asymmetry in Chironomidae (Diptera): Baseline and stress-induced occurrence. M.Sc. Thesis, University of Windsor, Windsor, Ontario, Canada. 148 pp.
- Butler, M. G. 1984. Life Histories of aquatic insects. Pages 25-55 in V. H. Resh and D. M. Rosenberg. *The Ecology of Aquatic Insects*. New York, Praeger Publishers.
- Butler, M. G. and L. Walker. 2002. Fecundity, reproductive effort, and pupal size in the profundal midge *Chironomus succini* (Diptera: Chironomidae). *Netherlands Journal of Aquatic Ecology* 26:263-267.
- Case, S. T. and B. Daneholt. 1977. Cellular and molecular aspects of genetic expression in *Chironomus* salivary glands. Pages 45-77 in J. Paul (editor). *Biochemistry and Cell Differentiation II*. Volume 15. Baltimore, University Park Press.
- Corkum, L. D. and E. C. Hanes. 1989. A laboratory aeration system for rearing aquatic invertebrates. *Entomological News* 100:169-172.
- Dahlhoff, E. P. and B. A. Menge. 1996. Influence of phytoplankton concentration and wave exposure on the ecophysiology of *Mytilus californianus*. *Marine Ecology Progress Series* 144:97-107.
- Daneholt, B. 1975. Transcription in Polytene Chromosomes. *Cell* 4:1-9.

- Daneholt, B., J. E. Edstrom, E. Egyhazi, B. Lambert and U. Ringborg. 1969. RNA synthesis in a Balbiani ring in *Chironomus tentans* salivary gland cells. *Chromosoma* 28:418-429.
- Dmitriew, C., M. Cooray, and L. Rowe. 2007. Effects of early resource-limiting conditions on patterns of growth, growth efficiency, and immune function at emergence in a damselfly (Odonata: Coenagrionidae). *Canadian Journal of Zoology* 85: 310-318.
- Dube, M. G. and J. M. Culp. 1996. Growth responses of periphyton and chironomids exposed to biologically treated bleached-kraft pulp mill effluent. *Environmental Toxicology and Chemistry* 15:2019-2027.
- Groenendijk, D., L. W. M. Zeinstra and J. F. Postma. 1998. Fluctuating asymmetry and mentum gaps in populations of the midge *Chironomus riparius* (Diptera: Chironomidae) from a metal-contaminated river. *Environmental Toxicology and Chemistry* 17:1999-2005.
- Grossbach, U. 1977. The salivary gland of *Chironomus* (Diptera): A model system for the study of cell differentiation. *Results and Problems in Cell Differentiation* 8:147-196.
- Hauer, F. R. and A. C. Benke. 1991. Rapid growth of snag-dwelling chironomids in a blackwater river - The influence of temperature and discharge. *Journal of the North American Benthological Society* 10:154-164.
- Hudson, L. A. and J. J. H. Ciborowski. 1996a. Teratogenic and genotoxic responses of larval *Chironomus salinarius* group (Diptera: Chironomidae) to contaminated sediment. *Environmental Toxicology and Chemistry* 15:1375-1381.
- Hudson, L. A. and J. J. H. Ciborowski. 1996b. Spatial and taxonomic variation in incidence of mouthpart deformities in midge larvae (Diptera: Chironomidae: Chironomini). *Canadian Journal of Fisheries and Aquatic Sciences* 53:297-304.
- Kemp, P. F., S. Lee and L. LaRoche. 1993. Estimating the growth rate of slowly growing marine bacteria from RNA content. *Applied and Environmental Microbiology* 59:2594-2601.
- Koehn, R. K. and B. L. Bayne. 1989. Towards a physiological and genetic understanding of the energetics of the stress response. *Biological Journal of the Linnean Society* 37:157-171.
- Mangel, M. and S. B. Munch. 2005. A life-history perspective on short- and long-term consequences of compensatory growth. *The American Naturalist* 166:155-176.
- Martin, J. 1979. Chromosomes as tools in taxonomy and phylogeny of Chironomidae (Diptera). *Entomologica Scandinavica Supplementum* 10:67-74.
- Martinez, E. A., B. C. Moore, J. Schaumlöffel and N. Dasgupta. 2001. Induction of morphological deformities in *Chironomus tentans* exposed to zinc- and lead-spiked sediments. *Environmental Toxicology and Chemistry* 20:2475-2481.
- McKee, M. J. and C. O. Knowles. 1989. Temporal and spatial variation of RNA content in nymphs of the mayfly, *Stenonema femoratum* (Say). *Environmental Pollution* 58:43-55.
- Metcalfe, N. B. and P. Monaghan. 2001. Compensation for a bad start: grow now, pay later? *TRENDS in Ecology & Evolution* 16:254-260.
- Michailova, P. 1989. The polytene chromosomes and their significance to the systematics and phylogeny of the family Chironomidae, Diptera. *Acta Zoologica Fennica* 186:1-107.

- Michailova, P., J. Ilkova, N. Petrova and K. White. 2001b. Rearrangements in the salivary gland chromosomes of *Chironomus riparius* Mg. (Diptera, Chironomidae) following exposure to lead. *Caryologia* 54:349-363.
- Michailova, P., J. Ilkova and K. N. White. 2003. Functional and structural rearrangements of salivary gland polytene chromosomes of *Chironomus riparius* Mg. (Diptera, Chironomidae) in response to freshly neutralized aluminium. *Environmental Pollution* 123:193-207.
- Michailova, P., N. Petrova, J. Ilkova, S. Bovero, S. Brunetti, K. White and G. Sella. 2006. Genotoxic effect of copper on salivary gland polytene chromosomes of *Chironomus riparius* Meigen 1804 (Diptera, Chironomidae). *Environmental Pollution* 144:647-654.
- Michailova, P., N. Petrova, G. Sella, S. Bovero, L. Ramella, F. Regoli and V. Zelano. 2001a. Genotoxic effects of chromium on polytene chromosomes of *Chironomus riparius* Meigen 1804 (Diptera, Chironomidae). *Caryologia* 54:59-71.
- Michailova, P., N. Petrova, G. Sella, L. Ramella and S. Bovero. 1998. Structural-functional rearrangements in chromosome G in *Chironomus riparius* (Diptera, Chironomidae) collected from a heavy metal-polluted area near Turin, Italy. *Environmental Pollution* 103:127-134.
- Naylor, C. and C. Rodrigues. 1995. Development of a test method for *Chironomus riparius* using a formulated sediment. *Chemosphere* 31:3291-3303.
- Pelling, C. and W. Beermann. 1966. Diversity and variation of the nucleolar organizer regions in chironomids. *National Cancer Institute Monographs* 23:393-409.
- Perry, A. R. R., R. Mons, P. Flammarion, I. Lagadic and J. Garric. 2002. A modeling approach to link food availability, growth, emergence, and reproduction for the midge *Chironomus riparius*. *Environmental Toxicology and Chemistry* 21:2507-2513.
- Planello, R., J. L. Martinez-Guitarte and G. Morcillo. 2007. Ribosomal genes as early targets of cadmium-induced toxicity in *Chironomus riparius* larvae. *Science of the Total Environment* 373:113-121.
- Ristola, T., J. Pellinen, M. Ruokolainen, A. Kostamo and J. V. K. Kukkonen. 1999. Effect of sediment type, feeding level, and larval density on growth and development of a midge (*Chironomus riparius*). *Environmental Toxicology and Chemistry* 18:756-764.
- Santa-Cruz, M. C., A. Villanueva and J. L. Diez. 1978. Effect of galactose treatment in puffing pattern of *Chironomus thummi* Balbiani rings. *Chromosoma* 69:93-100.
- Schlechtriem, C., O. E. Johannsson, K. L. Bowen, R. W. Smith and M. T. Arts. 2008. Effect of fasting under different temperature conditions on nucleic acid ratios in the opossum shrimp *Mysis relicta*: A calibration approach. *Journal of Great Lakes Research* 34:461-471.
- Stites, D. L. and A. C. Benke. 1989. Rapid growth rates of chironomids in 3 habitats of a subtropical blackwater river and their implications for P/B ratios. *Limnology and Oceanography* 34:1278-1289.
- Sutcliffe, W. H. 1970. Relationship between growth rate and ribonucleic acid concentration in some invertebrates. *Journal of the Fisheries Research Board of Canada* 27:606-609.
- Timmermans, K. R., W. Peeters and M. Tonkes. 1992. Cadmium, zinc, lead and copper

- in *Chironomus riparius* (Meigen) larvae (Diptera, Chironomidae) - Uptake and effects. *Hydrobiologia* 241:119-134.
- Vos, J. H., P. J. Van den Brink, E. P. Van den Ende, M. A. G. Ooijevaar, A. J. P. Oosthoek, J. F. Postma and W. Admiraal. 2002. Growth response of a benthic detritivore to organic matter composition in sediments. *Journal of the North American Benthological Society* 21:443-456.
- Vrede, T., J. Persson and G. Aronsen. 2002. The influence of food quality (P:C ratio) on RNA:DNA ratio and somatic growth rate of *Daphnia*. *Limnology and Oceanography* 47:487-494.
- Warwick, W. F. 1985. Morphological abnormalities in Chironomidae (Diptera) larvae as measures of toxic stress in freshwater ecosystems: Indexing antennal deformities in *Chironomus* Meigen. *Canadian Journal of Fisheries and Aquatic Sciences* 42:1881-1914.
- Waters, T. F. 1977. Secondary production in inland waters. *Advances in Ecological Research* 10:91-164.
- Wulker and Goetz. 1968. Die Verwendung der Imaginalscheiben zur Bestimmung des Entwicklungszustandes von *Chironomus* Larven (Diptera). *Zeitschrift für Morphologie und Ökologie der Tiere* 62:363-388.
- Zhimulev, I. F., E. S. Belyaeva and V. F. Semeshin. 1981. Informational content of polytene chromosome bands and puffs. *CRC Critical Reviews in Biochemistry* 11:303-340.

CHAPTER THREE: NUCLEOLAR ORGANIZER (NOR) SIZE AS A FIELD-BASED MEASURE OF CHIRONOMINI (DIPTERA: CHIRONOMIDAE) GROWTH IN OIL SANDS CONSTRUCTED WETLANDS

INTRODUCTION

In the Athabasca region of northeastern Alberta, wetlands are constructed using oil sands process materials (OSPM; mine water and fine tailings) as part of a strategy to reclaim the landscape following mining activities (OSWWG 2000). During the extraction process, salts (sulphates and chlorides), naphthenic acids (saturated acyclic and cyclic carboxylic acids), and residual bitumen rich in polycyclic aromatic hydrocarbons, which are natural constituents of oil sands, become concentrated in OSPM (van den Heuvel *et al.* 1999). Consequently, constructed wetlands have elevated levels of both water soluble and hydrophobic compounds of concern.

According to the Alberta Environmental Protection and Enhancement Act (EPEA) oil sands companies must reclaim all leased land to a state of production approximating that of the environment present prior to mining operations (EPEA, section 32, 1993). Because constructed wetlands will make up 20-40 % of the final reclaimed landscape, oil sands companies have been constructing wetlands for over 20 years to study the effects of OSPM on wetland succession and stability (Daly and Ciborowski 2008).

As a dominant component of the zoobenthos and important contributors to the carbon and energy flow in aquatic food webs (Benke and Wallace 1997), chironomid growth and production in these constructed wetlands is particularly important. Previous studies have found that chironomid community composition, abundance, and genus richness differs between reference and OSPM-affected wetlands (Whelly 1999; Ganshorn 2002; Leonhardt 2003). Although OSPM is not teratogenic to chironomids (Whelly 1999; Bendell-Young 2000), it is nonetheless toxic. In both the laboratory and field, chironomid growth is reduced by up to as much as 25 % when larvae are exposed to OSPM (Whelly 1999; Ganshorn 2002). Barr (2009) found that the water component was the most important factor regulating zoobenthic community composition (especially chironomid genera) in oil sands constructed wetlands.

Recently, the nucleolar organizer region (NOR), a specialized puff of the salivary gland polytene chromosomes, has been suggested as a potentially useful tool for measuring growth and secondary production in natural chironomid populations (Chapter Two). We therefore undertook to examine its utility as a surrogate for a direct measure of growth of chironomid larvae developing in oil sands constructed wetlands. In this chapter, we present the results from a study designed to investigate the variation in NOR size of chironomids collected from OSPM-affected wetlands relative to NOR size of individuals collected from reference constructed wetlands. We also discuss and evaluate the practicality of using NOR size as a field-based indicator of chironomid growth.

MATERIALS AND METHODS

Study design

In order to test the effects of OSPM on NOR size we collected chironomid larvae from two reference and two OSPM-affected constructed wetlands. Based on preliminary research investigating NOR size in oil sands constructed wetlands (Hum and Ciborowski 2000), as well as the finding that chironomid growth is reduced in OSPM (Whelley 1999; Ganshorn 2002), we expected to find that larvae collected from OSPM-affected wetlands would have smaller NOR, thus implying slower growth, than larvae collected from reference wetlands.

We also wished to determine how NOR size changed through time within a wetland. Because we wanted to be able to relate field-based measures of growth obtained using NOR size with those obtained using traditional methods to estimate secondary production, samples were collected every three days over a two week period. While we expected to see considerable variation in NOR size among individuals, we did not expect mean NOR size (or growth) to vary significantly through time (among sampling dates).

Study site

Chironomid larvae were collected from four constructed wetlands (two reference and two OSPM-affected wetlands) located on oil sands lease sites situated in northeastern

Alberta, Canada. One wetland was located on the Syncrude Canada Ltd. lease site (Golden Pond) and three were located on the Suncor Energy Inc. lease site (High Sulphate, Natural Wetland, and 4-m CT Wetland). For a description of the construction, formation, age, and location of each wetland, see Appendix II. Chironomid larvae were also collected on a single visit to other wetlands, including seven on Syncrude Canada Ltd. lease site (Shallow wetland, South Beaver Wetland, Mike's Pond, Northwest Interceptor Ditch Wetland, Test Pond 3, Test Pond 5, Test Pond 9), one on Suncor Energy Inc. lease site (Waste Area 11 Wetland), and one on Canadian Natural Resources lease site (CNRL East Access Wetland). However, because of time constraints these samples were not examined.

Sample collection

Prior to beginning the study each wetland was radially partitioned into five zones. Samples were collected every three days between July 18th and August 5th, 2008. On each sampling date, one location within each of the five zones was randomly sampled (five samples/wetland/sampling date). Samples were collected by passing a sweep net back and forth over the sediment surface for 20 s. Each sample was then washed using a 250- μ m net to remove fine sediment. The retained material was then placed in a sorting tray filled with water. All visible chironomids were handpicked from the sediment using fine forceps, blotted on paper towel, and immediately preserved with chilled Carnoy's solution (3:1 v/v absolute ethanol/glacial acetic acid) in a single 20-mL scintillation vial. Carnoy's was poured off and replaced with fresh solution after 10 min, 1 h, and 24 h. All preserved samples were then stored in a freezer until they were analyzed.

Temperature, dissolved oxygen, conductivity, and pH were measured at each wetland with a YSI model 30 portable meter on each sampling date. On the first and last sampling date 100-mL water samples were collected and stored in amber vials from each wetland and then sent to Syncrude Canada Ltd. for naphthenic acids, major ion, and minor element analysis.

Laboratory procedures

Sample processing.-In the laboratory, each vial was emptied into a Petri dish, sorted (separated according to subfamily or tribe using external head morphology) and counted. Not all genera have easily-stained chromosomes. Because the genus *Chironomus* has suitable chromosomes and is the most widely studied cytotaxonomically (Martin 1979), only individuals identified as belonging to the tribe Chironomini were selected for further analysis.

Next, the head capsule, body, and salivary glands of each larva were mounted on microscope slides. An individual was placed in a depression slide filled with 50% acetic acid and viewed under the low power of a dissection microscope. The head capsule was then removed, placed ventral side up on a slide, and covered with two drops of CMC-9AF aqueous mounting medium (Masters Chemical Co. Elk Park, IL). A coverslip was then placed overtop and a small amount of pressure was applied to spread the mandibles. The salivary glands were then extruded anteriorly from the thorax using gentle pressure exerted with the bent tip of a dissecting needle, carefully isolated, transferred to another microscope slide, and stained using a modification of the aceto-orcein technique (see Chapter Two methods). The body was then placed next to the head capsule on the original slide, covered with CMC-9AF medium, and covered with a coverslip. That slide was allowed to air dry at room temperature for at least 48 h. The edges of the coverslip were then ringed with nail polish and the slide was stored in a slide box.

Identification.-Using currently available keys based on external morphology (Coffman and Ferrington 2008) we were able to identify larvae belonging to the genus *Chironomus*. Several studies have investigated the banding patterns of chironomids collected from natural populations around the world (e.g., Kiknadze *et al.* 1996; Kiknadze *et al.* 1998; Butler *et al.* 1999; Kiknadze *et al.* 2000). However, to date there are no taxonomic keys and only one guide to the polytene chromosomes of Chironomidae in North America (Martin 2009c). An attempt to use the guide to the cytospecies of North American *Chironomus spp.* was made (Martin 2009c), but we were unable to make definitive species identifications. Operational taxonomic units were therefore developed in order to distinguish among *Chironomus* larvae exhibiting distinct banding and puffing

patterns. In this chapter, we use the term ‘karyotype’ to refer to each distinct operational taxonomic unit that may represent a unique species.

Identification and designation of operational taxonomic units. -Polytene chromosomes were viewed at 400X magnification using a Meiji compound microscope to which was attached a SPOT Insight™ Firewire 2 Megapixel Color Mosaic digital video camera. Three to six sets of chromosomes per larvae were photographed. Operational taxonomic units were then distinguished by identifying distinct banding and puffing patterns of the polytene chromosomes. This was accomplished by individually examining the photographs from a single individual, identifying characteristic bands and puffs common to each photograph, and then assigning to this banding and puffing pattern a unique karyotype label (e.g., ‘karyotype A’). This process was then repeated for a second individual from the same sample. If the banding and puffing pattern of this individual was distinct from previously examined individuals, it was also assigned a unique karyotype label (e.g., ‘karyotype B’). This process was repeated until all individuals had been assigned to a karyotype. In order for a banding and puffing pattern to be considered distinct, two or more individuals had to have been assigned to that karyotype. Individuals that appeared to have a distinct banding and puffing pattern, but for which we did not find a corresponding match from other field-collected chironomids, were grouped under ‘Miscellaneous’.

Measurements of puffs. -Puff size is proportional to chromosome width, and chromosome width corresponds to the size of an individual (Bentivegna and Cooper 1993; Chapter Two). Measurements taken from different-sized larvae can be standardized by measuring both puff size and chromosome size. Previous studies have characterized puff size in terms of relative width, calculating the relative diameter (Bentivegna and Cooper 1993; Hudson and Ciborowski 1996). We also used puff diameter as our measure of size (Appendix I).

Puff size was measured only for individuals identified as having the H karyotype (Fig. 1). This karyotype exhibited two obvious puffs, one of which appeared to be a NOR; puff diameter was therefore measured at the centre of this region. Because the number and location of NOR(s) is species-specific (Michailova 1989), it was not possible to

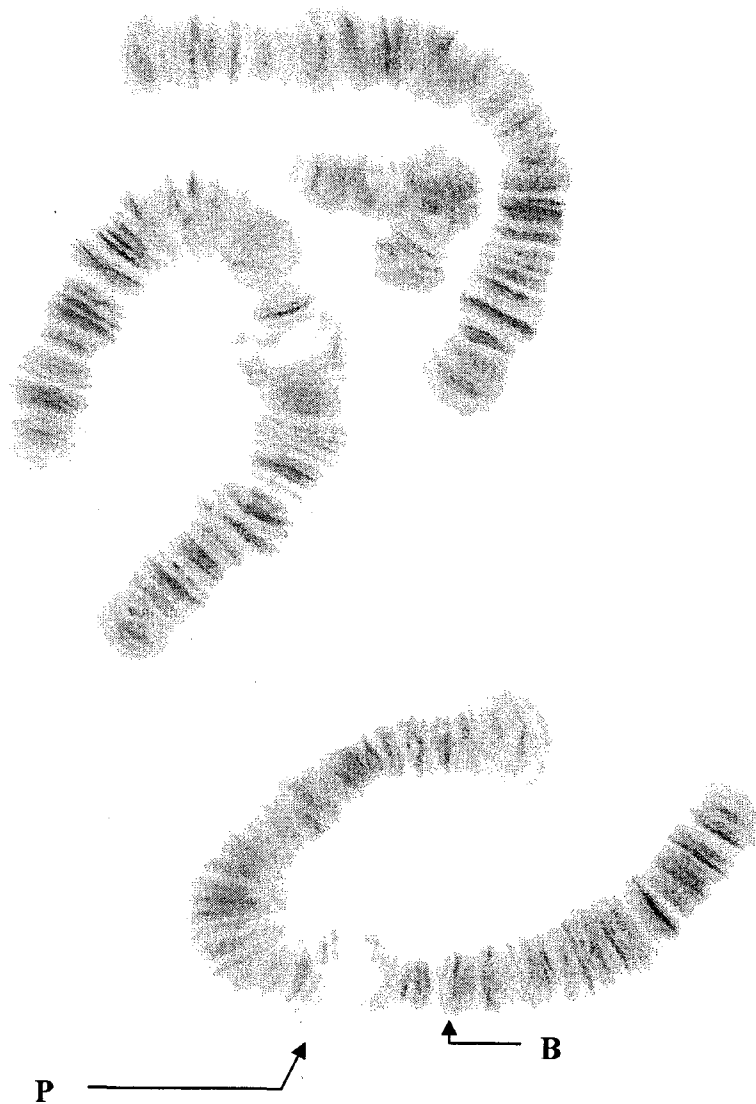

Fig. 1. Photograph of the polytene chromosomes of an individual collected from Golden Pond in July 2008 classified as “karyotype H”. P indicates the location of the puff (presumed to be the NOR) from which a measure of size was obtained. B indicates the reference band used as a measure of chromosome size. (400X magnification).

determine the location of the NOR of other karyotypes with absolute certainty. The designation of the H-karyotype puff as the NOR was based on previous experience working with the NOR of *Chironomus riparius* and by comparing its appearance to other photographs of chironomid karyotypes containing NOR.

Chromosome size was defined as the diameter of a distinct band adjacent to the puff (see Fig. 1). Three puff images per larva were measured from the digital images to the nearest 0.1 μm using UTHSCSA ImageTool version 3.0 (© UTHSCSA 1996-2002). The mean diameter of the three puffs measured was then calculated for each chironomid.

Statistical analyses

Statistical analyses were performed using STATISTICA version 6.1 (Statsoft, Inc., Tulsa, OK). Statistical significance of differences in the proportion of taxa found in reference and OSPM-affected wetlands was tested using a chi-square contingency test. Statistical significance of differences between wetlands and among sampling dates for puff size (controlling for chromosome size) was tested using analysis of covariance (ANCOVA). All reported NOR values are adjusted to a mean chromosome size of 8.3 μm ; this was the greatest area of overlap in chromosome size among larvae from different wetlands. The level of significance was set at $p < 0.05$ for all tests.

RESULTS

Water chemistry

Table 1 summarizes mean temperature ($^{\circ}\text{C}$), dissolved oxygen concentration (mg/L), conductivity (μS), salinity (ppt), and pH of the overlying water in each wetland. Overall, there were no consistent differences in these parameters among the wetlands sampled. Characteristic of OSPM-affected wetlands, Natural Wetland and 4-m CT Wetland had high concentrations of naphthenic acids (45.3 and 23.7 mg/L, respectively). Comparatively, naphthenic acid concentrations were much lower in the reference wetlands (Golden Pond, 3.5 mg/L; High Sulphate, 16.5 mg/L; see Appendix III for a summary of major ion and minor element analyses).

Table 1. Summary of the water chemistry parameters (mean \pm S.D.) of the overlying water of each wetland during the sampling period (n = 7 dates between 18 July and 5 August 2008).

Wetland	Type	Temperature (°C)	Dissolved Oxygen (mg/L)	Conductivity (μm)	Salinity (ppt)	pH
Golden Pond	Reference	21.6 \pm 1.9	5.1 \pm 2.4	1277 \pm 44.0	0.9 \pm 0.0	8.3 \pm 0.1
High Sulphate	Reference	22.2 \pm 2.0	3.1 \pm 1.2	1907 \pm 93.0	1.5 \pm 0.2	8.2 \pm 0.6
Natural Wetland	OSPM	20.5 \pm 4.1	5.8 \pm 1.2	1750 \pm 75.2	1.0 \pm 0.1	9.3 \pm 0.1
4m-CT	OSPM	20.6 \pm 3.2	4.9 \pm 2.2	3007 \pm 195.4	0.7 \pm 0.1	8.3 \pm 0.1

Taxa collected

Samples collected from OSPM-affected wetlands were dominated by Orthocladiinae and Tanytarsini; only 6 % and 23 % of the chironomids collected from Natural Wetland and 4-m CT Wetland were Chironomini (n = 520 and 600, respectively). Samples collected from reference wetlands also contained many Orthocladiinae and Tanytarsini, but contained proportionally more Chironomini (63% and 44% Chironomini in Golden Pond and High Sulphate Wetland, respectively) than samples collected from OSPM-affected Wetlands (Fig. 2; chi-square contingency test, $\chi^2 = 444$, d.f. = 2, $p < 0.001$). Very few samples contained Tanypodinae.

A total of 724 Chironomini larvae were collected; however, only a relatively small proportion (~25 %) of these larvae were large enough for chromosomal analysis. This was particularly pronounced in the OSPM-affected wetlands, where Chironomini larvae collected were very small. Of the 36 and 135 Chironomini larvae collected from Natural Wetland and 4m-CT, only 8 larvae from each wetland were large enough to stain. Of the total number of larvae for which polytene chromosomes were stained (n = 115), 70 % of the preparations were of sufficient quality to permit a karyotype to be designated.

Five distinct karyotypes (A, F, J, C, and H) were identified (Appendix IV). The most abundant karyotype observed was H; it was also the most common karyotype identified in reference wetlands. Karyotype J was the second most abundant karyotype observed and was unique to one reference wetland (High Sulphate). The other karyotypes (A, F, and C) were found in both reference and OSPM-affected wetlands, but were uncommon. Seven larvae were grouped under 'Miscellaneous' (Table 2). An attempt to relate each karyotype to published descriptions was made.

Chromosomal puffing

Only one stained larva collected from the OSPM wetlands was identified as the H karyotype. In contrast, 40 karyotype H larvae were collected from the reference wetlands.

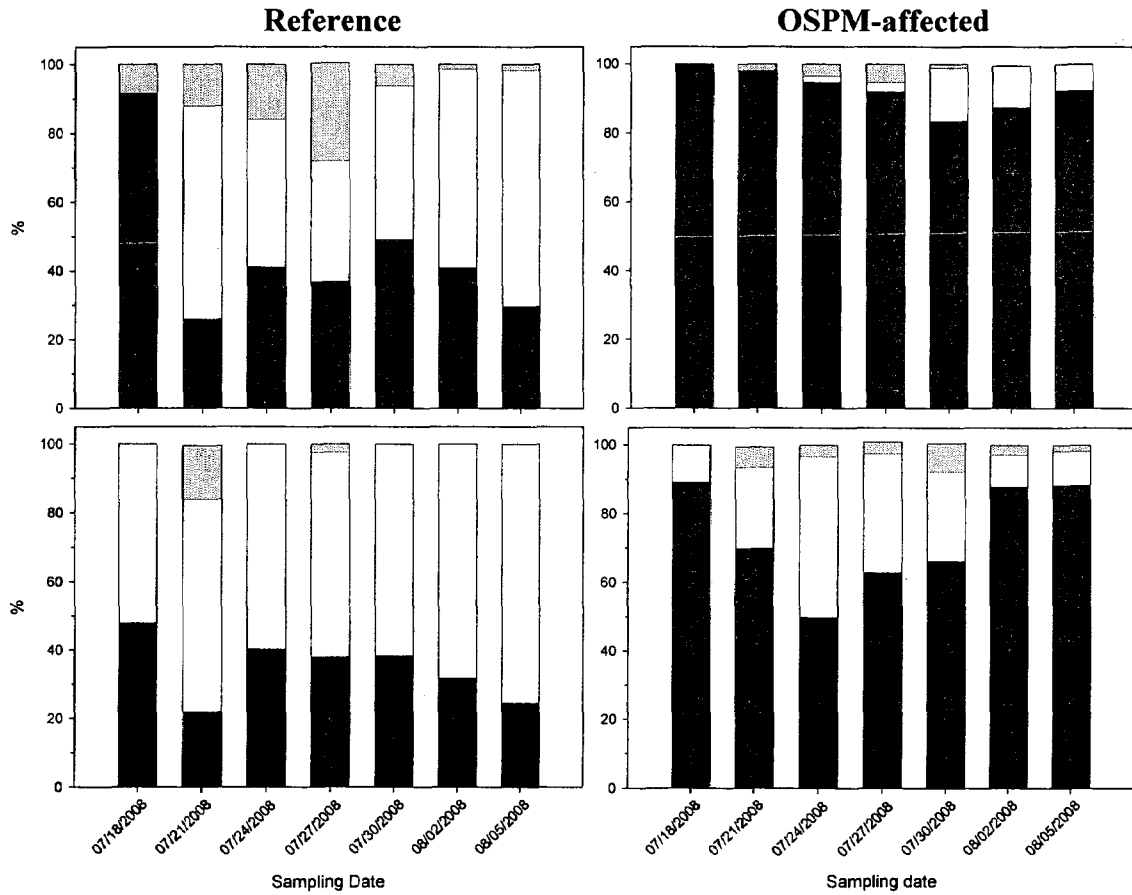

Fig. 2. Percentage of chironomid larvae collected belonging to each taxon (Tanytarsini/Orthoclaadiinae, black; Chironomini, white; Tanypodinae, gray) in reference (High Sulphate, *top*; Golden Pond, *bottom*) and OSPM-affected wetlands (Natural Wetland, *top*; 4m-CT, *bottom*) on seven sampling dates. See Appendix V for sample sizes on which these proportions are based.

Table 2. Number of chironomid larvae exhibiting a given karyotype for each wetland.

Wetland	Type	Karyotype					
		A	C	F	H	J	Misc.
Golden Pond	Reference	1	1	4	18	0	2
High Sulphate	Reference	2	4	0	22	15	2
Natural Wetland	OSPM	1	1	0	0	0	2
4-m CT	OSPM	2	0	2	1	0	1
Total		6	6	6	41	15	7

Because only a few individuals of each the A, F, and C karyotypes were collected and the J karyotype was only found in one wetland, no karyotype-specific comparisons between reference and OSPM-affected wetlands could be made. However, enough good-quality preparations of karyotype H were obtained to compare puff size between the two reference wetlands (Golden Pond and High Sulphate) and among sampling dates within the reference wetlands.

A total of 106 chromosomes were photographed and measured from larvae identified as belonging to the H karyotype. Puff size (μm) was significantly positively related to chromosome size (regression analysis, $R^2 = 0.41$, $F_{1,38} = 26.28$, $p < 0.001$); larger chromosomes had larger puffs. A test for homogeneity of slopes revealed that this relationship did not differ between wetlands (Fig. 3; $F_{1,36} = 0.2$, $p > 0.1$). Puff size was not significantly different between wetlands (analysis of covariance, $F_{1,37} = 0.92$, $p > 0.1$). Also, puff size within a wetland did not significantly differ among sampling dates (analysis of covariance; Golden Pond, $F_{2,11} = 1.73$, $p > 0.1$; High Sulphate, $F_{4,15} = 0.95$, $p > 0.1$). Only sampling dates from which puffs of three or more individuals were measured were included in the analyses.

DISCUSSION

Chironomids in oil sands constructed wetlands

The taxonomic composition of our samples agreed with previous studies examining chironomid community composition and abundance in oil sands constructed wetlands. Chironomini were the dominant taxon in reference wetlands, while Tanytarsini and Orthoclaadiinae were the dominant taxa in OSPM-affected wetlands. Whelley (1999) found that the dominant genera in reference wetlands were *Chironomus* (tribe Chironomini) and *Tanytarsus* (tribe Tanytarsini), while *Tanytarsus* and *Psectrocladius* (Tribe Orthoclaadiinae) were the dominant genera in OSPM-affected wetlands. Ganshorn (2002) found that Chironomini density, biomass, and secondary production was lower in OSPM-affected wetlands than it was in reference wetlands. Tanypodinae, Tanytarsini, and Orthoclaadiinae, on the other hand, were found to be unaffected by the presence of OSPM (Ganshorn 2002). In a study to characterize the zoobenthic community of

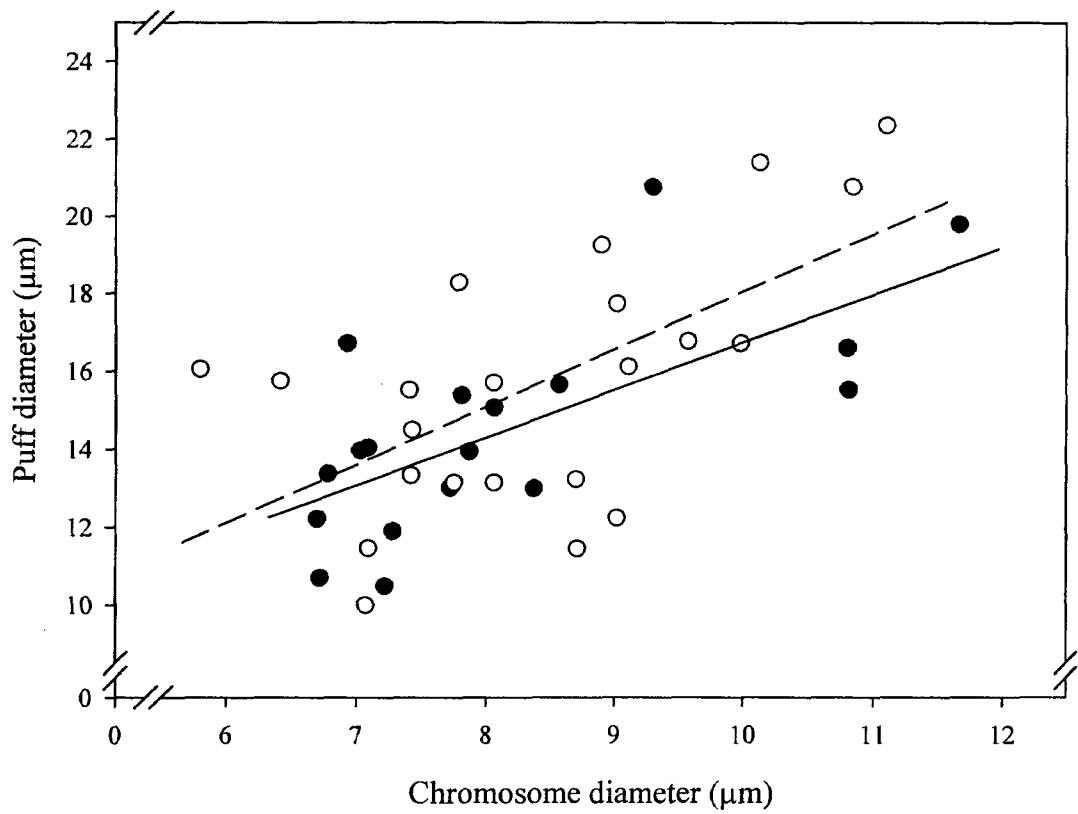

Fig. 3. Relationship between puff size and chromosome size for larvae collected from High Sulphate (n = 22; open circles, dashed line) and Golden Pond (n = 18; closed circles; solid line).

reference and OSPM-affected wetlands, Leonhardt (2003) found that Tanypodinae, Tanytarsini, and Orthoclaadiinae chironomids were characteristic of 'mature' (> 7 years old) OSPM-affected wetlands; these taxa were also characteristic of 'young' (≤ 7 years old) reference wetlands, which suggested the development of a 'mature' zoobenthic chironomid community was delayed in OSPM-affected wetlands relative to reference wetlands.

The fact that we found very few, and often very small, Chironomini larvae in OSPM-affected wetlands was not surprising. Chironomini, in particular, do not tolerate exposure to OSPM very well relative to other taxa such as *Derotanypus* (Tanypodinae) and *Psectrocladius* (Orthoclaadiinae) (Whelly 1999, Leonhardt 2003, Barr 2009). In both the laboratory and field, *Chironomus* larvae exposed to OSPM showed up to a 25 % reduction in growth rates (Whelly 1999; Ganshorn 2002). Thus, some taxa are clearly more tolerant of the conditions found in OSPM-affected wetlands than others. Previous research suggests that some species within a taxa are also more tolerant of OSPM. For example, undiluted oil sands process water was toxic to laboratory-bred *Chironomus tentans* but not to *Chironomus riparius* (Whelly 1999). Interestingly, Whelly (1999) also found evidence which suggests that, although OSPM was toxic to a laboratory-bred line of *Chironomus tentans*, larvae derived from the egg masses of an oil sands area wetland population of *Chironomus tentans* were relatively tolerant to oil sands process water.

The different composition of taxa present in reference and OSPM-affected wetlands could either reflect differences in tolerance to the chemical constituents found in OSPM, or differences between freshwater and saline chironomid assemblages. OSPM-affected wetlands have conductivity and salinity levels similar to saline lakes and wetlands in Saskatchewan (e.g., Timms *et al.* 1986) and British Columbia (e.g., Cannings and Scudder 1978). These saline wetlands are dominated by Chironominae (*Tanytarsus*, *Chironomus*), Tanypodinae (*Derotanypus*, *Procladius*), and Orthoclaadiinae (*Cricotopus*), which are also the predominant taxa found in OSPM-affected wetlands (Whelly 1999; Leonhardt 2003; Barr 2009). Though both factors are likely playing a role in shaping chironomid community assemblages, more research is needed to separate the effects of elevated salinity from the effects of the chemical constituents unique to OSPM.

Because many species of chironomids, as well as of other Diptera, are morphologically indistinguishable at the larval stage (Michailova 1989; Coffmann and Ferrington 2008), much species diversity may be cryptic, and can only be revealed by molecular genetic assays or more simply by examining the banding patterns of the polytene chromosomes. Based on our observations, at least within the genus *Chironomus*, there did not appear to be any cryptic species-specific assemblages within reference and OSPM-affected wetlands; of the five *Chironomus* karyotypes identified (each one presumably belonging to a unique species), one was found in samples from only a single wetland and none were specific to either reference or OSPM-affected wetlands. However, more extensive sampling to increase the sample size should be conducted before any conclusions can be made. Further research should therefore be conducted in these wetlands to determine if cryptic species-specific assemblages are present. One potential avenue for investigation would be to look at the banding patterns of the polytene chromosomes of larvae other than those belonging to the genus *Chironomus*.

NOR size in oil sands constructed wetlands

Preliminary research conducted on the polytene chromosomes of *Chironomus* and *Derotanypus spp.* in constructed wetlands found that NOR size was significantly reduced in larvae collected from OSPM-affected wetlands relative to reference wetlands with otherwise similar environmental characteristics (Hum and Ciborowski 2000). Unfortunately, as a result of the small number and size of Chironomini larvae collected from OSPM-affected wetlands, we were unable to draw conclusions regarding the effect of OSPM on NOR size (and thus growth) in our study. Although we obtained suitable quality stains from seven larvae, no more than two of each larvae belonged to the same karyotype; ideally, a measure of mean puff size should be obtained from three individuals in order to calculate a suitable measure of variability.

We did, however, obtain enough samples and measurements of puff size of larvae belonging to a single karyotype to perform a comparison between the two reference wetlands. As previous studies have observed, we found that puff size was linearly proportional to chromosome size (Bentivegna and Cooper 1993; Hudson and Ciborowski

1996; Chapter Two). Also as expected, we found that mean puff size was similar in both reference wetlands and that it did not change over the course of the two week sampling period. Thus, assuming the puff measured was in fact the NOR, and based on the assertion that NOR size reflects recent growth (Chapter Two), Chironomini larvae in the reference wetlands studied were growing at comparable rates. However, this result could also indicate that NOR size is not variable under natural conditions and does not reflect chironomid growth in the field. This uncertainty could be resolved by measuring the body lengths of larvae collected on each sampling date and calculating growth rates in these wetlands using traditional methods (e.g., the instantaneous growth rate method).

Measuring NOR size in the field

Several factors, specific to working with polytene chromosomes, made obtaining measures of NOR size from field-collected larvae much more difficult than it was in the laboratory (*pers. obs.*);

1. Unlike laboratory experiments, which are typically conducted using a single species, field-collected samples contain chironomids belonging to several taxa. Chironomid species richness is among some of the highest for aquatic insects, often reaching 80 species at a single site (Coffmann and Ferrington 2008). Prairie wetlands in Central Saskatchewan contain 21.3 ± 1.85 (SD) chironomid species (Driver 1977). Although there are karyological guides to the cytospecies of Bulgarian (Michailova 1989), Australian (Martin 2009a), New Zealand (Martin 2009b), and North American (Martin 2009c) chironomids, no cytotaxonomic keys have been developed that can facilitate identifications by non-experts. Thus, identifying the karyotypes or species of interest takes time. However, as non-experts we were able to construct our own operational taxonomic units. While it took time to do, this method proved to be effective and permitted the identification of five distinct karyotypes, and possibly more if we include the ‘miscellaneous’ individuals;
2. Chromosomal preparations of larvae collected from the field are generally of poorer quality than those of larvae bred in the laboratory (Michailova *et al.* 1985 cited by Michailova 1989). Although we were able to assign most larvae to a karyotype, the

quality of many preparations was poor. In most cases, the banding pattern of the three largest chromosomes was clear, but the resolution of chromosome IV (the smallest chromosome) was very poor. Unfortunately, this chromosome is where several puffs, including the NOR, are often located (Michailova 1989). Had we been able to discern puffs on chromosome IV of more preparations, NOR from several karyotypes would have likely been measured;

3. The number and location of NOR(s) is species-specific, with some species having as many as three (Michailova 1989). Thus, even when a puff is clearly visible, determining with absolute certainty that it is the NOR is not possible without being able to consult a cytotaxonomic key or getting verification from an expert. This problem could potentially be resolved, however, by staining some preparations with fluorescent probes specific to the NOR (e.g., Planello *et al.* 2007 developed probes specific to the ribosomal DNA of *Chironomus riparius*). Any intensely fluorescent areas would indicate the location of an NOR, and by comparing images obtained using fluorescent stain with those stained using aceto-orcein, their location could be mapped;
4. Although stained polytene chromosome preparations can be obtained from other genera, including those of Orthocladiinae and Tanypodinae, many species do not possess good quality chromosomes suitable for cytological analysis (Martin 1979). Furthermore, even when a species has good quality chromosomes, very small larvae (< 9 mm) do not stain well (*pers. obs.*). The genus *Chironomus*, a member of the Chironomini, is the most widely studied cytotaxonomically (Martin 1979) and the most commonly used genus in toxicity studies using puffs as a biomarker of stress. It is also the only genus in which the NOR has been related to growth (Chapter Two). Thus, the fact that very few and only very small Chironomini were collected from OSPM-affected wetlands is in and of itself a problem if the NOR is to be a broadly useful tool for monitoring stress and measuring growth in oil sands constructed wetlands; this may also be a problem in other stressed aquatic systems that contain chironomids. Fortunately, while they were not abundant in the OSPM-affected wetlands sampled in 2008, they are present; obtaining a large enough sample size may

simply be a matter of seasonal timing, among-year variation, locating suitable microhabitats, or intensifying collection efforts at OSPM-affected wetlands.

Summary, Conclusions, and Recommendations

We examined preparations of polytene chromosomes from larval chironomids living in two reference and two OSPM-affected constructed wetlands. Although detailed cytotaxonomic keys were not available, cryptic cytogenetic variation was identified and expressed as operational taxonomic units. At least five distinct karyotypes (represented by two or more individuals) were found in one or more of the four wetlands. The inconsistent quality of the chromosomal preparations made obtaining measures of NOR size proportionally more difficult, but not impossible. Based on the measures obtained for one abundant and relatively widespread karyotype, larger chromosomes had proportionally larger NOR, which supports the need to standardize measurements of NOR size in both the laboratory and the field. We also found that chironomid NOR size (and thus presumably growth) was similar in the two reference wetlands studied over the duration of the two-week sampling period. However, comparisons with OSPM-affected wetlands could not be made as we did not obtain any measures of NOR size from either of the two wetlands sampled.

Overall, it was difficult to obtain good quality chromosome preparations and measures of NOR size in oil sands constructed wetlands. This was in large part due to the small number and size of the Chironomini larvae collected in these wetlands. While the polytene chromosomes of *Chironomus spp.* are well characterized, some Tanypodinae and Orthoclaadiinae species also have usable polytene chromosomes (Martin 1979). These taxa were dominant in all of our samples and future studies may do well to examine whether or not NOR size in these species can be used as an indicator of stress and measure of growth.

LITERATURE CITED

- Barr, L. 2009. Experimental sediment exchanges between natural and constructed wetlands on oil sands leases near Fort McMurray Alberta. M.Sc. Thesis, University of Windsor. Windsor, Ontario, Canada.
- Bendell-Young, L. I., K. E. Bennett, A. Crowe, C. J. Kennedy, A. R. Kermode, M. M. Moore, A. L. Plant and A. Wood. 2000. Ecological characteristics of wetlands receiving an industrial effluent. *Ecological Applications* 10:310-322.
- Benke, A. C. and J. B. Wallace. 1997. Trophic basis of production among riverine caddisflies: Implications for food web analysis. *Ecology* 78:1132-1145.
- Bentivegna, C. S. and K. R. Cooper. 1993. Reduced chromosomal puffing in *Chironomus tentans* as a biomarker for potentially genotoxic substances. *Environmental Toxicology and Chemistry* 12:1001-1011.
- Butler, M. G., Kiknadze, I. I., V. V. Golygina, J. Martin, A. G. Istomina, W. F. Wulker, J. E. Sublette and M. F. Sublette. 1999. Cytogenetic differentiation between Palearctic and Nearctic populations of *Chironomus plumosus* L. (Diptera, Chironomidae). *Genome* 42:797-815.
- Cannings, R. A. and G. G. E. Scudder. 1978. The littoral Chironomidae (Diptera) of saline lakes in British Columbia. *Canadian Journal of Zoology* 56:1144-1155.
- Coffman, W. P. and L. Ferrington. 2008. Chironomidae. Pages 635-754 in R. W. Merritt, K.W. Cummins, and M.B. Berg (editors). *An Introduction to the Aquatic Insects of North America*. 4th Ed., Kendall/Hunt Publishing Co., Dubuque, Iowa.
- Daly, C. and J. J. H. Ciborowski. 2008. A review of wetland research at Suncor: Re-establishing wetland ecosystems in an oil-sands affected landscape. *Proceedings of the 1st International Oil Sands Tailings Conference*, Edmonton, AB.
- Driver, E. A. 1977. Chironomid communities in small prairie ponds: some characteristics and controls. *Freshwater Biology* 7:121-133.
- Ganshorn, K.D. 2002. Secondary production, trophic position and potential for accumulation of polycyclic aromatic hydrocarbons in predatory Diptera in four wetlands of the Athabasca oil sands, Alberta, Canada. M.Sc. Thesis, University of Windsor. Windsor, Ontario, Canada. 285 pp.
- Hudson, L. A. and J. J. H. Ciborowski. 1996. Teratogenic and genotoxic responses of larval *Chironomus salinarius* group (Diptera: Chironomidae) to contaminated sediment. *Environmental Toxicology and Chemistry* 15:1375-1381.
- Hum, P. and J. J. H. Ciborowski. 2000. Effects of oil sands mine-process water on the nucleolar organizer region of chironomids (Diptera). Undergraduate Thesis, University of Windsor. Windsor, Ontario, Canada.
- Leonhardt, C. L. 2003. Zoobenthic succession in constructed wetlands of the Fort McMurray oil sands region: Developing a measure of zoobenthic recovery. M.Sc. Thesis, University of Windsor. Windsor, Ontario, Canada. 259 pp.
- Kiknadze, I. I., M. G. Butler, K. G. Aimanova, L. I. Gunderina, and J. K. Cooper. 1996. Geographic variation in the polytene chromosome banding pattern of the Holarctic midge *Chironomus* (Camptochironomus) *tentans* (Fabricius). *Canadian Journal of Zoology-Revue Canadienne De Zoologie* 74:171-191.
- Kiknadze, I. I., M. G. Butler, K. G. Aimanova, E. N. Andreeva, J. Martin and L. I. Gunderina. 1998. Divergent cytogenetic evolution in nearctic and palearctic

- populations of sibling species in *Chironomus* (Camptochironomus) Kieffer. Canadian Journal of Zoology-Revue Canadienne De Zoologie 76:361-376.
- Kiknadze, I.I., M. G. Butler, V. V. Golygina, J. Martin, W. F. Wulker, J. E. Sublette and M. F. Sublette. 2000. Intercontinental karyotypic differentiation of *Chironomus entis* Shobanov, a Holarctic member of the C-plumosus group (Diptera, Chironomidae). Genome 43:857-873.
- Martin, J. 1979. Chromosomes as tools in taxonomy and phylogeny of Chironomidae (Diptera). Ent. Scand. Suppl. 10:67-74.
- Martin, J. 2009a. Australian *Chironomus* species. Copyright © 1995-2009, The University of Melbourne.
- Martin, J. 2009b. New Zealand *Chironomus* species. Copyright © 1995-2009, The University of Melbourne.
- Martin, J. 2009c. North American cytospecies of the genus *Chironomus*. Copyright © 1995-2009, The University of Melbourne.
- Michailova, P. 1989. The polytene chromosomes and their significance to the systematics and phylogeny of the family Chironomidae, Diptera. Acta Zoologica Fennica 186:1-107.
- Oil Sands Wetlands Working Group. 2000. Guideline for wetland establishment on reclaimed oil sands leases. Neil Chymko (Editor) Report # ESD/LM/00-1. Alberta Environment, Environmental Service.
- Planello, R., J. L. Martinez-Guitarte and G. Morcillo. 2007. Ribosomal genes as early targets of cadmium-induced toxicity in *Chironomus riparius* larvae. Science of the Total Environment 373:113-121.
- Timms, B. V., U. T. Hammer, and J. W. Sheard. 1986. A study of benthic communities in some saline lakes in Saskatchewan and Alberta, Canada. Internationale Revue der gesamten Hydrobiologie und Hydrographie 71:759-777.
- Whelly, M. P. 1999. Aquatic invertebrates in wetlands of the oil sands region of northeast Alberta, Canada, with emphasis on Chironomidae (Diptera). M.Sc. Thesis, University of Windsor, Windsor, Ontario, Canada. 314 pp.
- van den Heuvel, M. R., M. Power, M. D. MacKinnon, T. Van Meer, E. P. Dobson and D. G. Dixon. 1999. Effects of oil sands related aquatic reclamation on yellow perch (*Perca flavescens*). I. Water quality characteristics and yellow perch physiological and population responses. Canadian Journal of Fisheries and Aquatic Sciences 56:1213-1225.

CHAPTER FOUR: GENERAL DISCUSSION AND CONCLUSIONS

The results presented in this thesis have shown that nucleolar organizer (NOR) size is a significant predictor of a larval chironomid's recent growth rate under controlled laboratory conditions (Chapter Two). This finding is particularly important because of its potential for providing a novel method for measuring chironomid growth rates, and potentially secondary production, in natural populations.

CHIRONOMID SECONDARY PRODUCTION

In aquatic systems, the secondary production of the benthic macroinvertebrate community is an important indicator of ecosystem function (Reice and Wohlenberg 1993; Benke 2009). As a result, numerous studies on secondary production have been conducted, and several different methods have been developed to estimate it (reviewed by Waters 1977 and Benke 1996).

In its simplest form, secondary production is the formation of new biomass by an individual or population over time. Production (P) is calculated as the product of the mean density (D, individuals m⁻²) and change in biomass (ΔB , g dry mass) over a given sampling interval:

$$P = D \times \Delta B$$

Often, the secondary production of a population is estimated on an annual basis (g m⁻² y⁻¹) by calculating production over several sampling intervals (spanning a year) and adding them together. This ultimately requires the collecting and sorting of a very large number of samples, which makes obtaining an estimate of secondary production a time consuming and labour intensive process (Waters 1977).

In comparison to other aquatic invertebrates, chironomids often grow very rapidly (e.g., Benke 1998). Consequently, samples need to be taken as often as every three days in order to obtain credible estimates of growth (Benke 1984), which makes estimating chironomid secondary production even more arduous. Further complicating the estimation of chironomid secondary production is the fact that chironomid

populations often have multiple generations per year, and non-recognizable cohorts (Waters 1977). As a result, non-cohort based methods are more appropriate for estimating chironomid secondary production, especially when multiple, indistinguishable species may be involved.

The instantaneous growth rate (IGR) method is a non-cohort based method that has been increasingly used for estimating chironomid secondary production (e.g., Reynolds and Benke 2005). Using the IGR method, secondary production ($P - \text{mg m}^{-2} \text{ unit time}^{-1}$) is estimated by calculating the product of the population biomass ($B - \text{mg m}^{-2}$) and instantaneous growth rate ($g - \text{mg d}^{-1}$);

$$P = B \times g$$

Because larvae often exhibit taxon-specific and temperature-dependent growth rates (e.g., Reynolds and Benke 2005), and age (in days) of field-collected larvae can not be determined, instantaneous growth rates must be derived independently in the laboratory. This is typically done by retrieving egg masses from the field and rearing larvae under conditions specific to the area from which they were collected. Daily instantaneous growth rates are then calculated using regression analyses of biomass versus time since hatching. The calculated growth rates are then used in combination with the biomass estimates of the chironomid population from which the egg masses were collected and secondary production estimates are obtained.

NOR SIZE AS A SURROGATE MEASURE OF SECONDARY PRODUCTION

Based on the results of Chapter Two, NOR size is a reflection of a chironomid's recent growth rate (averaged over a 7-d period); faster growing larvae have larger NOR. Considering that differences in NOR size and activity are observable in as little as 12 h following exposure to cadmium (Planello *et al.* 2007), NOR size likely reflects a chironomid's instantaneous growth rate (as recent as 12 h). NOR size could therefore provide a surrogate measure of instantaneous growth rate for larvae collected in the field that, combined with a measure of population biomass, could be used to estimate secondary production using the IGR formula. Using NOR size as a surrogate measure of instantaneous growth would be desirable for several reasons;

1. An estimate of 'instantaneous' secondary production could be obtained from a single field-collected sample. Thus, half as many samples would need to be taken (current methods require at least two samples be taken in order to obtain a measure of growth). Given that production sampling and sorting is a very laborious process, a reduction of this magnitude would be extremely valuable.
2. Considering that NOR function is homologous among species (Pelling and Beermann 1966), and the polytene chromosomes provide a means for separating morphologically indistinguishable species, instantaneous growth rates and secondary production could potentially be calculated on a species by species basis.
3. A laboratory study to calibrate and estimate the instantaneous growth rates for the conditions specific to each population would not be required. If NOR is a species-specific or family-specific attribute, once the relationship between NOR size and growth rate is calibrated, it could be applied to any population.
4. NOR size reflects the growth rate of larvae under conditions prevailing at the time of collection. The current IGR method involves calculating growth rates under specific and very static conditions, which may or may not be present throughout the sampling period.

However, like all methods, using NOR size as a measure of instantaneous growth would also have limitations;

1. Smaller larvae do not provide suitable preparations for NOR analysis (*pers. obs.*). Any estimates of instantaneous growth or secondary production obtained using this method would therefore exclude very small larvae. Whether or not this would result in a significant underestimation of production would depend on how much smaller larvae contribute to the overall production of a given population. In most instances, smaller individuals make up a relatively small proportion of the overall biomass of a population. For example, Morin *et al.* (2004) found a 1-mm sieve only retained 33 % of the total number of individual invertebrates present in their benthic samples, but that these organisms accounted for over 90 % of the total biomass. A possible solution to this problem would be to use NOR size as a relative measure of growth rate by comparing it among populations; by combining

these measurements with measures of population biomass, one could determine the production of each population relative to another. One could also do a sensitivity analysis and apply the maximum growth rate observed in the laboratory or field for smaller invertebrates and calculate how much small larvae contribute to the overall production of a population.

2. Not all species have good quality chromosomes suitable for analysis (Martin 1979). Therefore, this method could not be used to estimate the instantaneous growth rates or secondary production of these taxa or species. As shown in Chapter Three, this could be problematic if community composition and abundance are very different between sites that are being compared.
3. Although several guides to the cytospecies of Chironomidae exist, no cytotaxonomic keys have been developed to facilitate identifications by non-experts. Because the number and location of the NOR(s) is species-specific, locating and obtaining measures of NOR size for poorly studied species would be difficult.
4. Chromosomal preparations of larvae collected from the field are generally of poorer quality than those of larvae bred in the laboratory (Michailova *et al.* 1985 cited by Michailova 1989). Thus, even when a large number of larvae of suitable size are collected and stained, NOR measurements can only be obtained from a small percentage of the preparations (Chapter Three). However, considering NOR measurements from only six larvae were sufficient to detect statistically significant differences in the experiments conducted in Chapter Two, one may only need to collect 10-20 good-sized larvae from a wetland to obtain a precise measure of mean growth.

Fortunately, all four limitations discussed above could be addressed through further research. In particular, by conducting studies to improve staining procedures for small larvae, poorly studied taxa and species, and for field-collected larvae, NOR measurements could be obtained from a much larger percentage of collected larvae. Future research should also compare estimates of secondary production obtained using traditional methods with estimates obtained using NOR size as a measure of instantaneous growth.

Quantitative zoobenthic samples were collected for production estimation contemporaneously with the hand-collected larval collections. However, it was beyond the scope of this thesis to generate the secondary production estimates necessary to permit a comparison of both methods. This may be undertaken at a later date.

UTILITY OF THE NOR IN OIL SANDS CONSTRUCTED WETLANDS

The results of Chapter Three demonstrate that polytene chromosomal preparations can be obtained from field-collected larvae, cryptic cytogenetic variation can be identified in constructed wetlands through the designation of distinct operational taxonomic units, and measurements of NOR size can be obtained from field-collected larvae. They also demonstrate that NOR size, and presumably growth, is similar among larvae collected from reference wetlands. Field validation of the relationship between NOR size and larval growth rate could further be addressed by analyzing the samples collected for production estimation in each wetland.

Unfortunately, as a result of the limitations mentioned above, in particular the small number and size of Chironomini larvae present, no measurements of NOR size were obtained from oil sands process material (OSPM) affected wetlands. Thus, the utility of the NOR in oil sands constructed wetlands may be limited to obtaining measures of NOR size from Orthoclaadiinae and Tanytarsini, the dominant taxa present in OSPM-affected wetlands (Whelly 1999; Ganshorn 2002; Leonhardt 2003). Nonetheless, the utility of polytene chromosomal preparations in separating morphologically indistinguishable species, the rapidity and sensitivity with which the NOR responds to chemical stress, and the finding that NOR size is related to growth, warrant further developing the use of polytene chromosomes in oil sands constructed wetlands and other aquatic systems in which chironomids are abundant.

IMPLICATIONS AND CONCLUSIONS

Organismal responses to environmental stress arise from changes at the molecular and physiological level. Accordingly, several suborganismal measures (e.g., adenylate

energy charge, enzyme activities, ion regulation) have been developed as early indicators of stress, particularly at the individual level (reviewed by Johnson *et al.* 1993). However, despite knowledge that linkages exist, few techniques are available for measuring and extrapolating the molecular and physiological responses to stress across multiple levels of organization (Parker *et al.* 1999). The finding that NOR size is related to chironomid growth validates the assumption that NOR size is an indicator of sublethal stress by relating it to an ecologically relevant endpoint (growth).

If multiple estimates of NOR size can indeed be extrapolated to estimates of chironomid larval population production, the NOR may ultimately serve as a sublethal indicator of stress that permits one to correlate changes in response to stress at the suborganismal level (NOR size) with changes at the individual (growth rate) and population (secondary production) level.

LITERATURE CITED

- Benke, A. C. 1984. Secondary production of aquatic insects. Pages 289-322 in V. H. Resh and D. M. Rosenberg (editors). *The Ecology of Aquatic Insects*. New York, Praeger Publishers.
- Benke, A. C. 1996. Secondary production of aquatic insects. Pages 557-578 in F. R. Hauer and B. Lamberti (editors) *Methods in Stream Ecology*. Academic Press, New York.
- Benke, A. C. 1998. Production dynamics of riverine chironomids: Extremely high biomass turnover rates of primary consumers. *Ecology* 79:899-910.
- Benke, A. C. 2009. Secondary production as part of bioenergetic theory - contributions from freshwater benthic science. *River Research and Applications*.
- Ganshorn, K.D. 2002. Secondary production, trophic position and potential for accumulation of polycyclic aromatic hydrocarbons in predatory Diptera in four wetlands of the Athabasca oil sands, Alberta, Canada. M.Sc. Thesis, University of Windsor. Windsor, Ontario, Canada. 285 pp.
- Johnson, R. K., T. Wiederholm and D. M. Rosenberg. 1993. Freshwater biomonitoring using individual organisms, populations, and species assemblages of benthic macroinvertebrates. Pages 40-158 in D. M. Rosenberg and V. H. Resh (editors). *Freshwater Biomonitoring and Benthic Macroinvertebrates*. New York, Chapman and Hall.
- Leonhardt, C. L. 2003. Zoobenthic succession in constructed wetlands of the Fort McMurray oil sands region: Developing a measure of zoobenthic recovery. M.Sc. Thesis, University of Windsor. Windsor, Ontario, Canada. 259 pp.
- Michailova, P. 1989. The polytene chromosomes and their significance to the systematics and phylogeny of the family Chironomidae, Diptera. *Acta Zoologica Fennica* 186:1-107.
- Martin, J. 1979. Chromosomes as tools in taxonomy and phylogeny of Chironomidae (Diptera). *Entomologica Scandinavica Supplementum* 10:67-74.
- Morin, A., J. Stephenson, J. Strike, and A. G. Solimini. Sieve retention probabilities of stream benthic macroinvertebrates. *Journal of the North American Benthological Society* 23:383-391.
- Parker, E. D., V. E. Forbes, S. L. Nielsen, C. Ritter, C. Barata, D. J. Baird, W. Admiraal, L. Levin, V. Loeschke, P. Lyytikainen-Saarenmaa, H. Høgh-Jensen, P. Calow and B. J. Ripley. 1999. Stress in ecological systems. *Oikos* 86:179-184.
- Pelling, C. and W. Beermann. 1966. Diversity and variation of the nucleolar organizer regions in chironomids. *National Cancer Institute Monographs* 23:393-409.
- Planello, R., J. L. Martinez-Guitarte and G. Morcillo. 2007. Ribosomal genes as early targets of cadmium-induced toxicity in *Chironomus riparius* larvae. *Science of the Total Environment* 373:113-121.
- Reynolds, S. K. and A. C. Benke. 2005. Temperature-dependent growth rates of larval midges (Diptera : Chironomidae) from a southeastern US stream. *Hydrobiologia* 544:69-75.
- Reice, S. R. and M. Wohlenberg. 1993. Monitoring freshwater benthic macroinvertebrates and benthic processes: Measures for assessment of ecosystem health. Pages 287-305 in D. M. Rosenberg and V. H. Resh (editors).

Freshwater Biomonitoring and Benthic Macroinvertebrates. New York, Chapman and Hall.

Waters, T. F. 1977. Secondary production in inland waters. *Advances in Ecological Research* 10:91-164.

Whelly, M. P. 1999. Aquatic invertebrates in wetlands of the oil sands region of northeast Alberta, Canada, with emphasis on Chironomidae (Diptera). M.Sc. Thesis, University of Windsor, Windsor, Ontario, Canada. 314 pp.

APPENDIX I: A COMPARISON OF METHODS FOR MEASURING NUCLEOLAR ORGANIZER SIZE

INTRODUCTION

Several different methods have been developed and employed to measure the size of chromosomal puffs. Size is used as a surrogate measure of activity since the degree of puffing is related to the rate of transcription; larger puffs produce more RNA (Pelling 1964 cited by Grossbach 1977; Daneholt *et al.* 1969). In most studies, puff size has been measured using a qualitative approach where puffs are arbitrarily scored (e.g., 0 representing no puffing and 4 representing extremely puffed; e.g., Ashburner 1967) or categorically assigned to classes (class I: puffs nearly or completely collapsed, class II: puffs significantly reduced or, class III: normal puff size; e.g., Beermann 1971) based on the degree of puffing (e.g., Santa-Cruz *et al.* 1978; Michailova 1998; 2001a, b; 2003; 2006; Meregalli *et al.* 2002).

Quantitative approaches have also been used to measure puff size. Both Bentivegna and Cooper (1993) and Hudson and Ciborowski (1996) used the following equation to calculate puff size:

$$\text{Puff diameter} = \frac{\text{Puff diameter} - \text{Chromosome diameter}}{\text{Chromosome diameter}}$$

Because puff size is proportional to chromosome size (see Chapter Two results), and larger individuals tend to have larger chromosomes, this equation permits puffs from different sized larvae to be standardized. Hum (2000) also used diameter as a measure of puff size, but utilized the statistical procedure of analysis of covariance (ANCOVA) to remove the effect of chromosome size.

The use of diameter as a measure of puff size has been recently criticized. In their study examining the relationship between mouthpart deformities and nucleolar organizer (NOR) size in *Chironomus riparius* larvae collected from a contaminated river, Meregalli *et al.* (2002) measured size by classifying nucleoli as either puffed (active) or not puffed (inactive). The authors proposed that their qualitative method was “easy and unequivocal”, and stated that using diameter as a measure of size is biased because

the NOR is not a perfectly spherical structure; the value obtained therefore depends on where and in what direction a measurement is taken. They also suggested that squashing and flattening a three-dimensional structure results in added variability to the measurement, confounding the estimation of size (Meregalli *et al.* 2002).

In this appendix we compare two methods for measuring NOR size (diameter vs. area). We describe in detail the precautions we took to address the criticisms of Meregalli *et al.* (2002) and present results that support the use of diameter as a preferred measure of NOR size.

METHODS

Salivary gland preparations were obtained from larvae recovered at the end of the two growth experiments discussed in Chapter Two. For a detailed description of the staining and squashing procedures see the methods section of that chapter.

In order to address the criticism that puffs are three-dimensional and thus flattening them confounds the estimation of size, glands were squashed using an apparatus designed to deliver an equal and even amount of pressure. The “X-Press” (Fig. 1) is a vertical push-and-lock clamp attached to a 17.5 cm x 10 cm stainless steel plate. Once the glands have been stained, the slide is placed face-up on the press against the guides and the coverslip is centered below a rubber stopper attached to the clamp (the rubber prevents the glass coverslip from being scratched). The clamp is then lowered until it is locked in place and the glands are squashed. The locking mechanism ensures that a consistent and constant amount of pressure is applied to each slide, standardizing the amount of flattening that takes place and minimizing its confounding effect. As a result, any measured differences in puff size between treatments would likely be the result of differences in the size of the puff.

To address the concern that the NOR is not perfectly spherical, we did two things; (1) diameter was always measured at the same place (a point equidistant from the two boundaries of the puff along the chromosome) and in the same direction

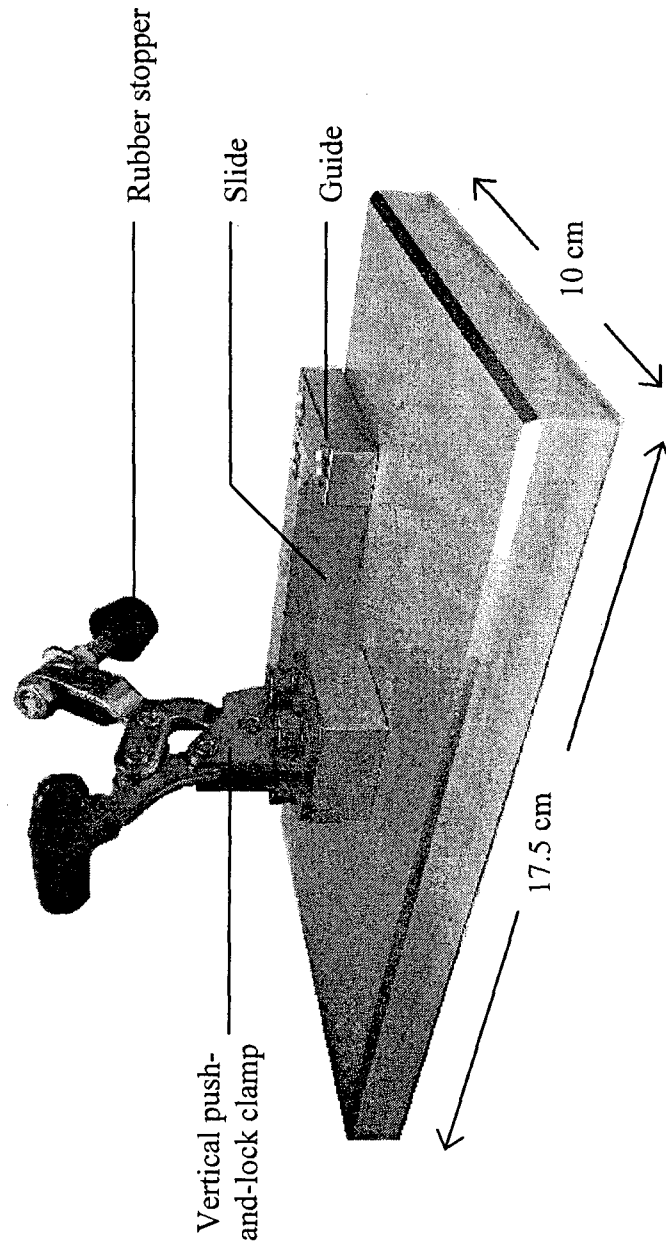

Fig. 1. The "X-Press" designed and employed to standardize the amount of pressure applied to squash the salivary glands.

(perpendicular to the length of the chromosome) and; (2) we also measured the area of the NOR. Area has been used previously as a measure of puff size in *Chironomus tentans* (Lezzi *et al.* 1981), but the two measurements (diameter vs. area) have not been compared directly. NOR diameter and area were calculated using the same procedure (for a detailed description of the measuring procedure see the methods section of Chapter Two). NOR diameter was measured at the centre of the Dd region, whereas NOR area was measured by tracing the contour of the puff (Fig. 2).

We used regression analysis to determine if our measures of diameter and area were correlated. In order to determine which method of measurement was more precise we calculated their coefficients of variation.

RESULTS

In both experiments, regression analysis revealed a highly significant positive correlation between NOR diameter and NOR area (Fig. 3; $R^2 = 0.82$, $F_{1,30} = 134.5$, $p < 0.001$; $R^2 = 0.94$, $F_{1,14} = 209.6$, $p < 0.001$, for experiments 1 and 2, respectively). Of the two measures, NOR diameter was the less variable, exhibiting only one-third of the relative variation of NOR area (Table 1).

DISCUSSION

Our results demonstrate that diameter is an appropriate and precise measure of NOR size. In both experiments, NOR diameter was a good predictor of NOR area, showing a strong positive correlation and explaining 82 % and 94 % of the observed variation in NOR area. Thus, although the NOR is not perfectly spherical, its diameter is a valid measure of NOR size when the instrument describe above is used. This finding is important for two reasons; (1) measuring diameter takes half as much time as measuring area and; (2) diameter is a more objective measure because the edges of the NOR become indistinct at many locations around its periphery, making it difficult to accurately trace the full perimeter. Depending on the condition of the preserved specimen and the quality of the stain, preparation quality varies and delimiting the contour of the NOR requires

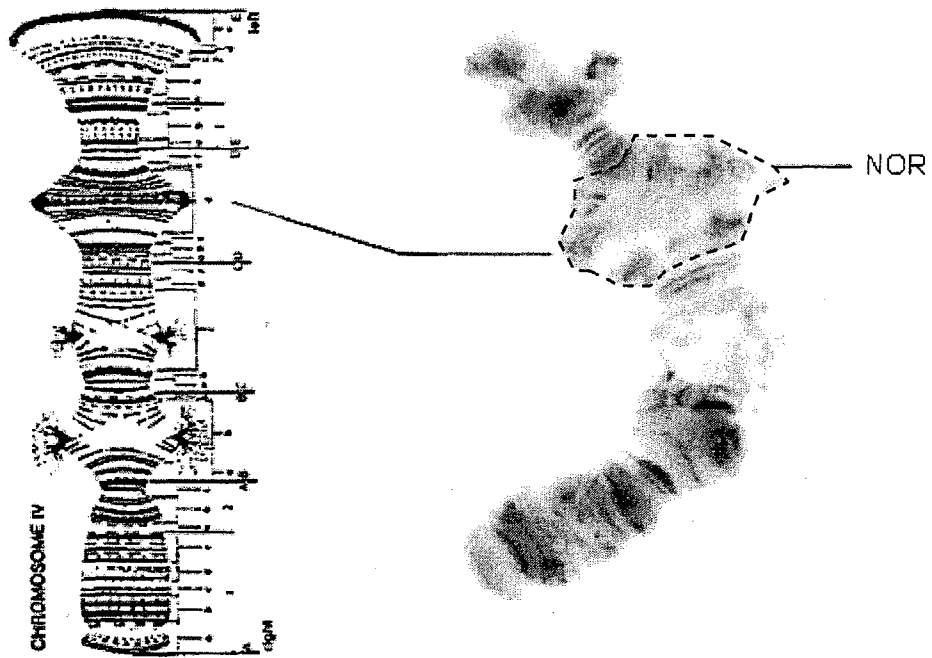

Fig. 2. Chromosomal map (*left*; source unknown) and digital image taken at 400X magnification (*right*) of the IV chromosome (G arm) of *Chironomus riparius*. The line indicates the location of the Dd band where diameter was measured for NOR size. Dashed line indicates the contour of the regions where area was measured for NOR size.

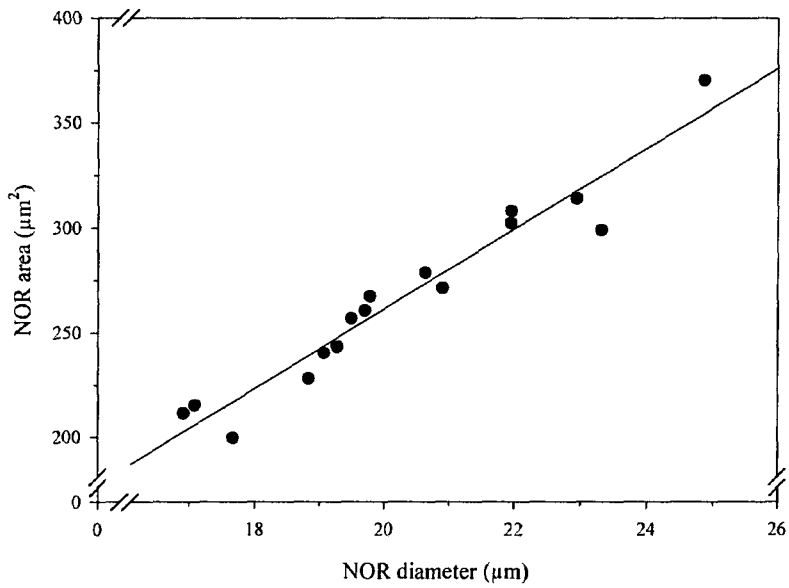
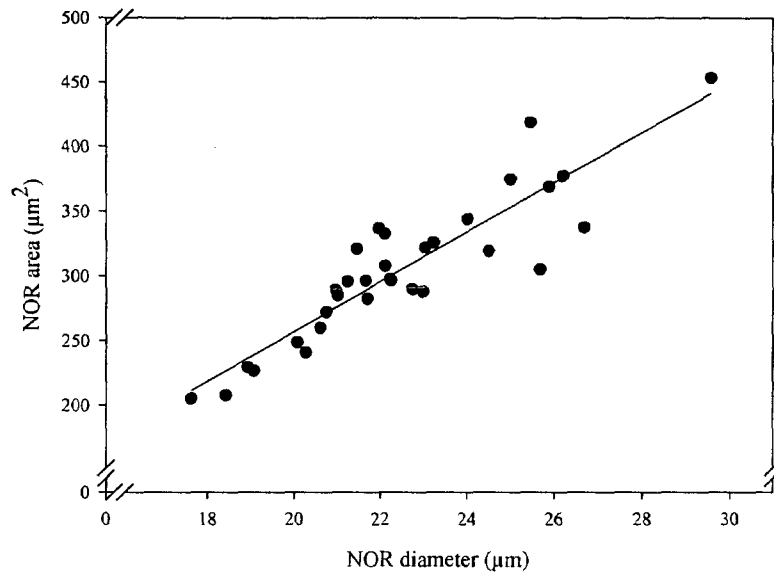

Fig. 3. NOR diameter was a significant predictor of NOR area in both Experiment One (n = 32; *top*) and Experiment Two (n = 16; *bottom*).

Table 1. Summary statistics including mean and standard deviation (s.d.) of NOR size for both measurements (diameter and area). In order to standardize our comparison, we took the $\sqrt{\text{of area}}$.

Variable Ration Experiment (n = 16)			
		NOR size	
	Mean	s.d.	C.V.
Diameter (μm)	20.27	2.27	11.1 %
$\sqrt{\text{Area}} (\mu\text{m}^2)$	16.32	6.69	40.9 %
Uniform Ration Experiment (n = 32)			
		NOR size	
	Mean	s.d.	C.V.
Diameter (μm)	22.48	2.65	11.8 %
$\sqrt{\text{Area}} (\mu\text{m}^2)$	17.45	7.49	42.9 %

interpretation. Measuring diameter also requires some interpretation (determining where the NOR begins and ends). However, this estimate is far less subjective than estimating the full perimeter of the nucleolus. Furthermore, the results obtained using diameter as a measure of size were less variable than those obtained using area (as indicated by the lower coefficient of variation).

We suggest our quantitative method is a more meaningful and useful measure of NOR size than the qualitative method of Meregalli *et al.* (2002). One major drawback of categorically classifying puffs as either puffed (active) or not puffed (inactive) is the well-established fact that certain puffs do not exhibit an all-or-none response; puff size varies over a continuous scale (Beermann 1956). For example, while studying changes in the puffing patterns of the polytene chromosomes of *Drosophila melanogaster* in response to heat-shock, Ashburner (1970) found that the size of induced puffs increased proportionally to the temperature increment. Although Ashburner (1970) also used a qualitative method for measuring puff size (arbitrarily scoring puffs from 0 to 4 based on the degree of puffing), a proportional change would not have been detected had he only classified puffs as puffed or not puffed. Thus, if a qualitative method is to be employed, it should at least recognize that puffing is a graded response.

Another drawback of using qualitative methods to characterize puff size is their subjective nature. Although Meregalli *et al.* (2002) argue that their method is “easy and unequivocal”, as with most qualitative measures, differences in the criteria used and biases among observers will make it difficult to standardize and compare results across studies. However, by using a quantitative method, such as measuring the diameter in the same direction (perpendicular to the length of the chromosome) and the same place (equidistant from the edges of the puffing region), puff size can be measured objectively and consistently. Furthermore, our method is no more time consuming than currently available qualitative measures, since measurements are obtained using a rapid and straightforward procedure; chromosomes are viewed under a compound microscope attached to a digital camera, a digital photograph is taken, and very precise estimates of diameter are calculated using computer imaging software.

In summary, after addressing the criticisms of Meregalli *et al.* (2002) and in light of the results presented in this appendix, we suggest using diameter as a measure of NOR size is an efficient and objective way to quantify puff size. Future studies could further improve this method by directly calibrating the relationship between NOR diameter and preribosomal RNA concentration. Although RNA concentration is routinely quantified to measure puff expression (e.g., Planello *et al.* 2007), it requires the use of expensive molecular equipment and intricate molecular techniques. By calibrating the relationship between NOR diameter and RNA concentration, a measure of puff expression could be obtained by anyone with access to a compound microscope and a biological stain.

LITERATURE CITED

- Ashburner, M. 1967. Patterns of puffing activity in salivary gland chromosomes of *Drosophila*. I. Autosomal puffing patterns in a laboratory stock of *Drosophila melanogaster*. *Chromosoma* 21:398-428.
- Ashburner, M. 1970. Patterns of puffing activity in salivary gland chromosomes of *Drosophila*. V. Responses to environmental treatments. *Chromosoma* 31:356-376.
- Beermann, W. 1956. Nuclear differentiation and functional morphology of chromosomes. *Cold Spring Harbor Symposia on Quantitative Biology* 21:217-232.
- Beermann, W. 1971. Effect of alpha-amanitine on puffing and intranuclear RNA synthesis in *Chironomus* salivary glands. *Chromosoma* 34:152-167.
- Bentivegna, C. S. and K. R. Cooper. 1993. Reduced chromosomal puffing in *Chironomus tentans* as a biomarker for potentially genotoxic substances. *Environmental Toxicology and Chemistry* 12:1001-1011.
- Hudson, L. A. and J. J. H. Ciborowski. 1996. Teratogenic and genotoxic responses of larval *Chironomus salinarius* group (Diptera: Chironomidae) to contaminated sediment. *Environmental Toxicology and Chemistry* 15:1375-1381.
- Hum, P. and J. J. H. Ciborowski. 2000. Effects of oil sands mine-process water on the nucleolar organizer region of chironomids (Diptera). Undergraduate Thesis, University of Windsor. Windsor, Ontario, Canada.
- Lezzi, M., B. Meyer, and R. Mahr. 1981. Heat-shock phenomena in *Chironomus tentans*. 1. In vivo effects of heat, over-heat, and quenching on salivary chromosome puffing. *Chromosoma* 83:327-339.
- Meregalli, G., R. Bettinetti, L. Pluymers, A. C. Vermeulen, B. Rossaro, and F. Ollevier. 2002. Mouthpart deformities and nucleolus activity in field-collected *Chironomus riparius* larvae. *Archives of Environmental Contamination and Toxicology* 42:405-409.
- Michailova, P., J. Ilkova, N. Petrova and K. White. 2001b. Rearrangements in the salivary gland chromosomes of *Chironomus riparius* Mg. (Diptera, Chironomidae) following exposure to lead. *Caryologia* 54:349-363.
- Michailova, P., J. Ilkova and K. N. White. 2003. Functional and structural rearrangements of salivary gland polytene chromosomes of *Chironomus riparius* Mg. (Diptera, Chironomidae) in response to freshly neutralized aluminium. *Environmental Pollution* 123:193-207.
- Michailova, P., N. Petrova, J. Ilkova, S. Bovero, S. Brunetti, K. White and G. Sella. 2006. Genotoxic effect of copper on salivary gland polytene chromosomes of *Chironomus riparius* Meigen 1804 (Diptera, Chironomidae). *Environmental Pollution* 144:647-654.
- Michailova, P., N. Petrova, G. Sella, S. Bovero, L. Ramella, F. Regoli and V. Zelano. 2001a. Genotoxic effects of chromium on polytene chromosomes of *Chironomus riparius* Meigen 1804 (Diptera, Chironomidae). *Caryologia* 54:59-71.
- Michailova, P., N. Petrova, G. Sella, L. Ramella and S. Bovero. 1998. Structural-functional rearrangements in chromosome G in *Chironomus riparius* (Diptera, Chironomidae) collected from a heavy metal-polluted area near Turin, Italy. *Environmental Pollution* 103:127-134.
- Planello, R., J. L. Martinez-Guitarte, and G. Morcillo. 2007. Ribosomal genes as early

- targets of cadmium-induced toxicity in *Chironomus riparius* larvae. *Science of the Total Environment* 373:113-121.
- Santa-Cruz, M. C., A. Villanueva and J. L. Diez. 1978. Effect of galactose treatment in puffing pattern of *Chironomus thummi* Balbiani rings. *Chromosoma* 69:93-100.
- Zhimulev, I. F., E. S. Belyaeva, and V. F. Semeshin. 1981. Informational content of polytene chromosome bands and puffs. *CRC Critical Reviews in Biochemistry* 11:303-340.

APPENDIX II: ENVIRONMENTAL CHARACTERISTICS AND CONSTRUCTION OF THE STUDY WETLANDS

What follows is a description of the construction and formation of the oil sands wetlands sampled for the study described in Chapter Three. Golden Pond and High Sulphate Wetland were classified as reference wetlands. Natural Wetland and 4-m CT Wetland were classified as oil sands process materials (OSPM) affected wetlands.

GOLDEN POND WETLAND (UTM COORDINATES: 462101E 6317245N)

The underlying and surrounding area was filled with mine tailing sand and covered with 80 cm of clay/loam till. This wetland was constructed in 2000 using wetland organic matter from the surrounding area as a surface substrate. It consists primarily of surface water. Water depth is variable and reaches up to 1.5 m in the centre.

HIGH SULPHATE WETLAND (UTM COORDINATES: 466390E 6317229N)

The area surrounding this wetland was reclaimed in 1985 following mining by Suncor, Inc. It sits on a substrate of lean oil sands. The area was initially filled with saline sodic overburden and capped with 15 cm of muskeg soil. High Sulphate Wetland formed opportunistically in 1987 in a depression. The water consists primarily of precipitation and surface runoff. Average water depth is 60 cm and is relatively uniform across the wetland.

NATURAL WETLAND (UTM COORDINATES: 469046E 6315329N)

The area in which this wetland is found was initially mined out and reclaimed to forest (Spruce, Larch and Poplar) in the early 1980's. Somewhere between 1984 and 1987, the increased settling of sand and seepage of oil sands processed water (OSPW) from a dyke forming the south wall of Pond 5 (a storage pond) resulted in the formation of Natural Wetland. Between 1991 and 1995 a series of modifications were made in order to improve the wetland's ability to treat OSPW seeping in from the dyke. In 1996, composite tailings (CT; a specific type of OSPW) water was slowly pumped into the

wetland; it was subsequently treated with gypsum to encourage the consolidation of suspended materials in the water. The sediment consists roughly 10 cm of organic substrate that has accrued through production of emergent macrophytes overlying a sandy base. The water consists primarily of dyke seepage (80 %) and surface runoff (20 %) (Golder Associates Ltd. 2002). Water depth is relatively constant across the wetland, reaching a maximum depth of 40 cm.

4-M CT WETLAND (UTM COORDINATES: 467777E 6316529N)

This wetland was constructed in the winter of 2000, along two other interconnected wetlands, in order to examine the suitability of using composite tailings in wetland reclamation (Daly *et al.* 2009). The wetland is filled with 4 m of consolidated tailings (CT) and is uncapped, except for two small peninsulas consisting of 20-30 cm of stockpiled muskeg. The water consists primarily of water rising out of the CT as it consolidates, and OSPW which flows into 4-m CT from an adjacent wetland which receives water directly from Pond 5. Water depth is uniform across the wetland and is approximately 25 cm.

LITERATURE CITED

Golder Associates Ltd. 2002. Wetland study sites associated with oil sands research and monitoring. 022-2203. 96 pp.

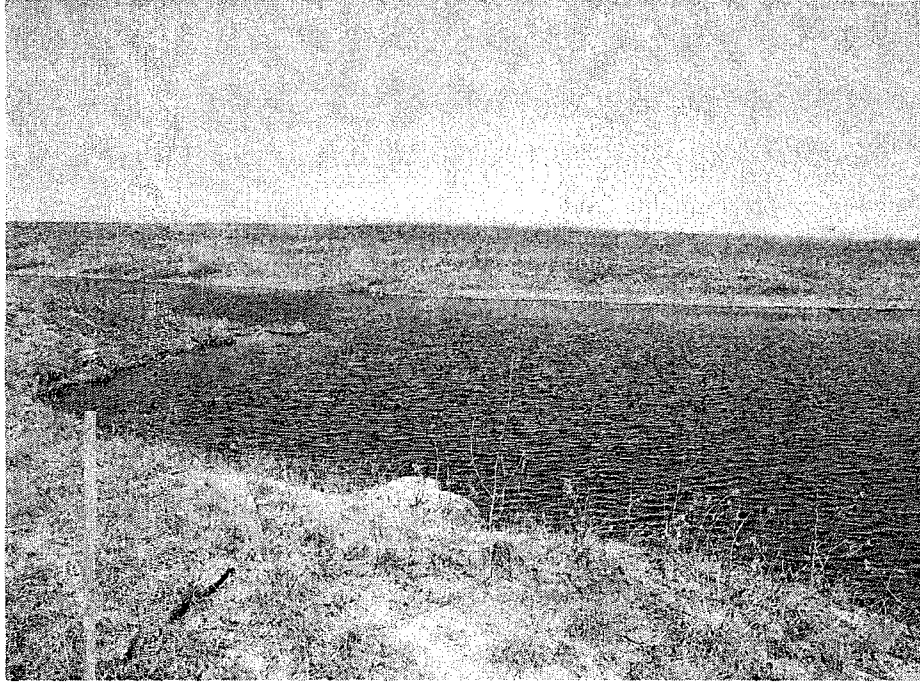

Fig. 1. Photographs of Golden Pond in May 2008 (*top*) and July 2008 (*bottom*). Photographs by Joshua P. Martin.



Fig. 2. Photographs of High Sulphate Wetland in May 2008 (*top*) and July 2008 (*bottom*). Photographs by Joshua P. Martin.

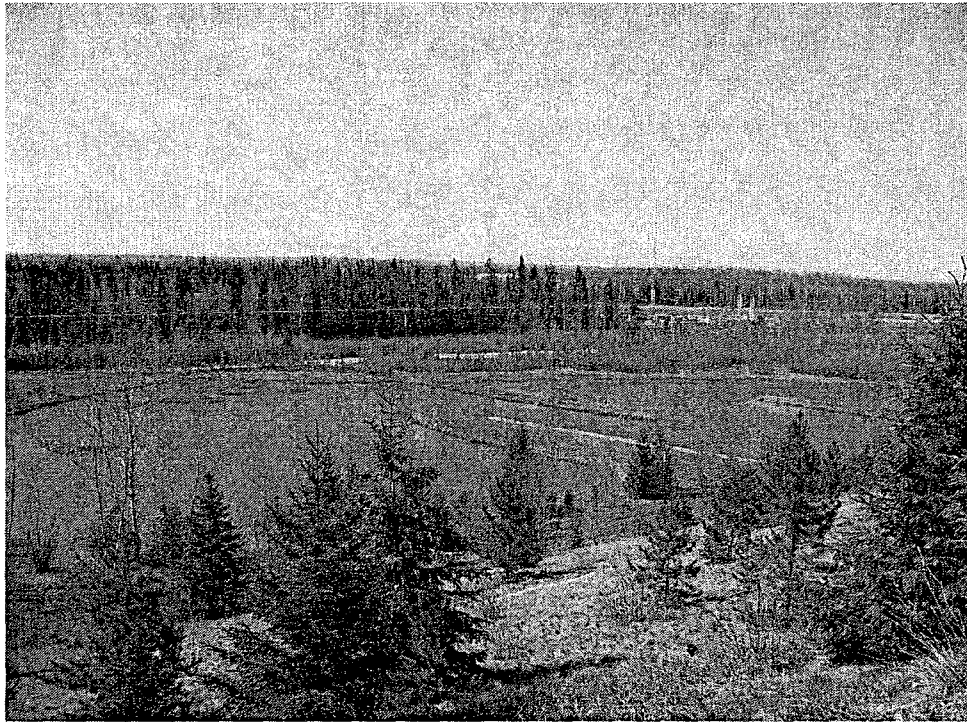

Fig. 3. Photographs of Natural Wetland in May 2008 (*top*) and July 2008 (*bottom*). Photographs by Joshua P. Martin.



Fig. 4. Photographs of 4-m CT Wetland in May 2008 (*top*) and July 2008 (*bottom*). Photographs by Joshua P. Martin.

APPENDIX III: WATER CHEMISTRY OF STUDY THE WETLANDS – NAPHTHENIC ACIDS, MAJOR ION, AND MINOR ELEMENTS ANALYSES

Wetland	Sampling Date	pH	Conductivity (µS/cm)	Temp (°C)	DO (mg/L)	Naphthenic Acids (mg/L)	NH ₄ (mg/L)	Na (mg/L)
Golden Pond	July 18 th , 2008	8.14	1745	21.7	7.0	3.7	0.34	208
Golden Pond	August 8 th , 2008	8.83	1680	23.2		3.4	0.01	225
High Sulphate	July 18 th , 2008	9.03	2890	23.0	12.6	17.8	0.01	408
High Sulphate	August 8 th , 2008	7.64	2980	23.5		15.2	0.01	437
Natural Wetland	July 18 th , 2008	9.55	1166	27.4	11.7	46.5	0.57	269
Natural Wetland	August 8 th , 2008	9.11	1242	20.7		44.1	0.56	292
4m-CT	July 18 th , 2008	8.27	1927	24.4	4.7	25.1	0.23	332
4m-CT	August 8 th , 2008	8.25	1953	20.4		22.3	0.22	326

Wetland	Sampling Date	K (mg/L)	Mg (mg/L)	Ca (mg/L)	F (mg/L)	Cl (mg/L)	SO ₄ (mg/L)	CO ₃ (mg/L)	HCO ₃ (mg/L)	Alkalinity (CaCO ₃)
Golden Pond	July 18 th , 2008	5.3	57.9	142	BDL	45.0	783	BDL	221	181
Golden Pond	August 8 th , 2008	1.1	57.6	115	BDL	38	746	BDL	163	134
High Sulphate	July 18 th , 2008	13.6	118.0	166	BDL	3.1	1710	BDL	127	104
High Sulphate	August 8 th , 2008	15.9	118	200	BDL	4.4	1590	BDL	239	196
Natural Wetland	July 18 th , 2008	8.7	9.4	11.4	1.2	18.0	239	39	347	349
Natural Wetland	August 8 th , 2008	11.9	14.1	19.4	1.3	17	204	37	504	475
4m-CT	July 18 th , 2008	12.0	62.7	58.8	BDL	44.0	469	0	672	551
4m-CT	August 8 th , 2008	13.5	58.5	83.3	BDL	43	595	16	512	446

BDL = Below detectable limits

Wetland	Sampling Date	Total Cations (mg/L)	Total Anions (mg/L)	Cation/ Anion	Na/Cl	(Ca+Mg) /HCO3	Na/ (Ca+Mg)	Al (mg/L)
Golden Pond	18-Jul-08	21.1	21.2	1.00	7.13	3.29	0.76	BDL
Golden Pond	08-Aug-08	20.4	19.3	1.06	9.14	3.95	0.93	BDL
High Sulphate	18-Jul-08	36.2	37.8	0.96	203.1	8.71	0.98	BDL
High Sulphate	08-Aug-08	39.2	37.2	1.06	153.3	5.06	0.96	BDL
Natural Wetland	18-Jul-08	13.3	12.5	1.06	23.1	0.19	8.64	1.5
Natural Wetland	08-Aug-08	15.1	14.2	1.07	26.5	0.23	5.92	0.6
4m-CT	18-Jul-08	22.9	22.0	1.04	11.6	0.74	1.77	BDL
4m-CT	08-Aug-08	23.6	22.5	1.05	11.7	1.01	1.57	BDL

Wetland	Sampling Date	B (mg/L)	Ba (mg/L)	Cd (mg/L)	Co (mg/L)	Cr (mg/L)	Cu (mg/L)	Fe (mg/L)	Li (mg/L)	Mn (mg/L)
Golden Pond	July 18 th , 2008	0.13	BDL	BDL	BDL	BDL	BDL	BDL	BDL	BDL
Golden Pond	August 8 th , 2008	0.13	BDL	BDL	BDL	BDL	BDL	BDL	BDL	BDL
High Sulphate	July 18 th , 2008	0.84	BDL	BDL	BDL	BDL	BDL	BDL	BDL	BDL
High Sulphate	August 8 th , 2008	0.93	BDL	BDL	BDL	BDL	BDL	BDL	BDL	BDL
Natural Wetland	July 18 th , 2008	2.17	BDL	BDL	BDL	BDL	BDL	1.7	BDL	BDL
Natural Wetland	August 8 th , 2008	2.46	BDL	BDL	BDL	BDL	BDL	0.9	BDL	BDL
4m-CT	July 18 th , 2008	1.76	BDL	BDL	BDL	BDL	BDL	0.3	BDL	BDL
4m-CT	August 8 th , 2008	1.73	BDL	BDL	BDL	BDL	BDL	0.3	BDL	BDL

BDL = Below detectable limits

Wetland	Sampling Date	Mo (mg/L)	Ni (mg/L)	Pb (mg/L)	Sb (mg/L)	Se (mg/L)	Si (mg/L)	Sr (mg/L)	Ti (mg/L)	V (mg/L)
Golden Pond	July 18 th , 2008	BDL	BDL	BDL	BDL	BDL	0.4	0.79	BDL	BDL
Golden Pond	August 8 th , 2008	BDL	BDL	BDL	BDL	BDL	0.5	0.8	BDL	BDL
High Sulphate	July 18 th , 2008	BDL	BDL	BDL	BDL	BDL	0.6	1.91	BDL	BDL
High Sulphate	August 8 th , 2008	BDL	BDL	BDL	BDL	BDL	0.6	2.2	BDL	BDL
Natural Wetland	July 18 th , 2008	0.4	BDL	BDL	BDL	BDL	8.5	0.28	BDL	BDL
Natural Wetland	August 8 th , 2008	0.3	BDL	BDL	BDL	BDL	6.1	0.5	BDL	BDL
4m-CT	July 18 th , 2008	BDL	BDL	BDL	BDL	BDL	7.2	0.82	BDL	BDL
4m-CT	August 8 th , 2008	BDL	BDL	BDL	BDL	BDL	6.4	1.0	BDL	BDL

Wetland	Sampling Date	Zn (mg/L)	Zr (mg/L)
Golden Pond	July 18 th , 2008	BDL	BDL
Golden Pond	August 8 th , 2008	BDL	BDL
High Sulphate	July 18 th , 2008	BDL	BDL
High Sulphate	August 8 th , 2008	BDL	BDL
Natural Wetland	July 18 th , 2008	BDL	BDL
Natural Wetland	August 8 th , 2008	BDL	BDL
4m-CT	July 18 th , 2008	BDL	BDL
4m-CT	August 8 th , 2008	BDL	BDL

BDL = Below detectable limits

**APPENDIX IV: POLYTENE CHROMOSOME KARYOTYPES OF
CHIRONOMUS LARVAE COLLECTED FROM THE STUDY WETLANDS**

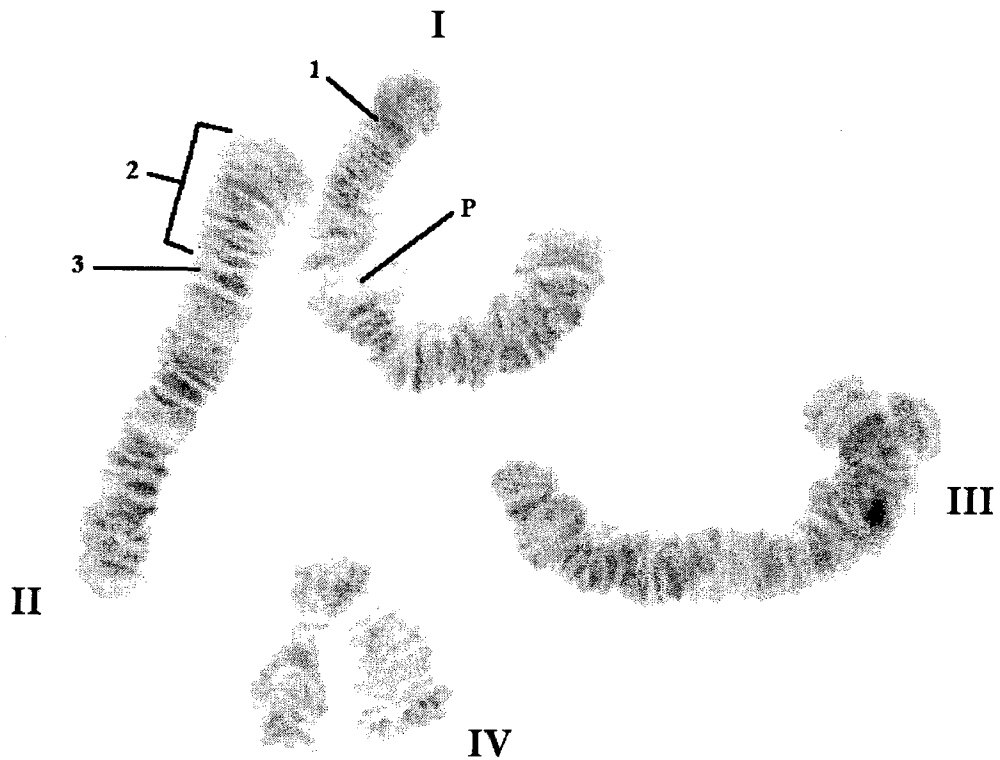

Fig. 2. Karyotype A (400X magnification). Photograph of the polytene chromosomes of a chironomid larva collected from Natural Wetland in July 2008. Numbers indicate characteristic bands and/or banding patterns. P = puff. Photograph by Joshua Martin.

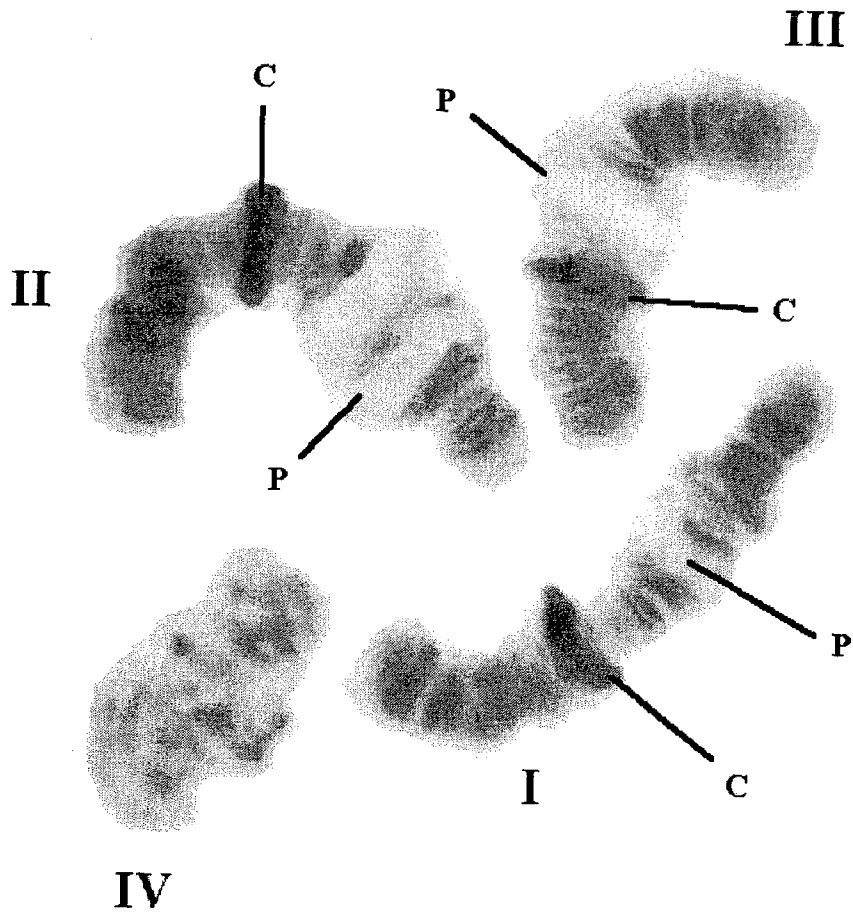

Fig. 2. Karyotype C (400X magnification). Photograph of the polytene chromosomes of a chironomid larva collected from Natural Wetland in July 2008. Numbers indicate characteristic bands and/or banding patterns. P = puff. C = centromere. Photograph by Joshua Martin.

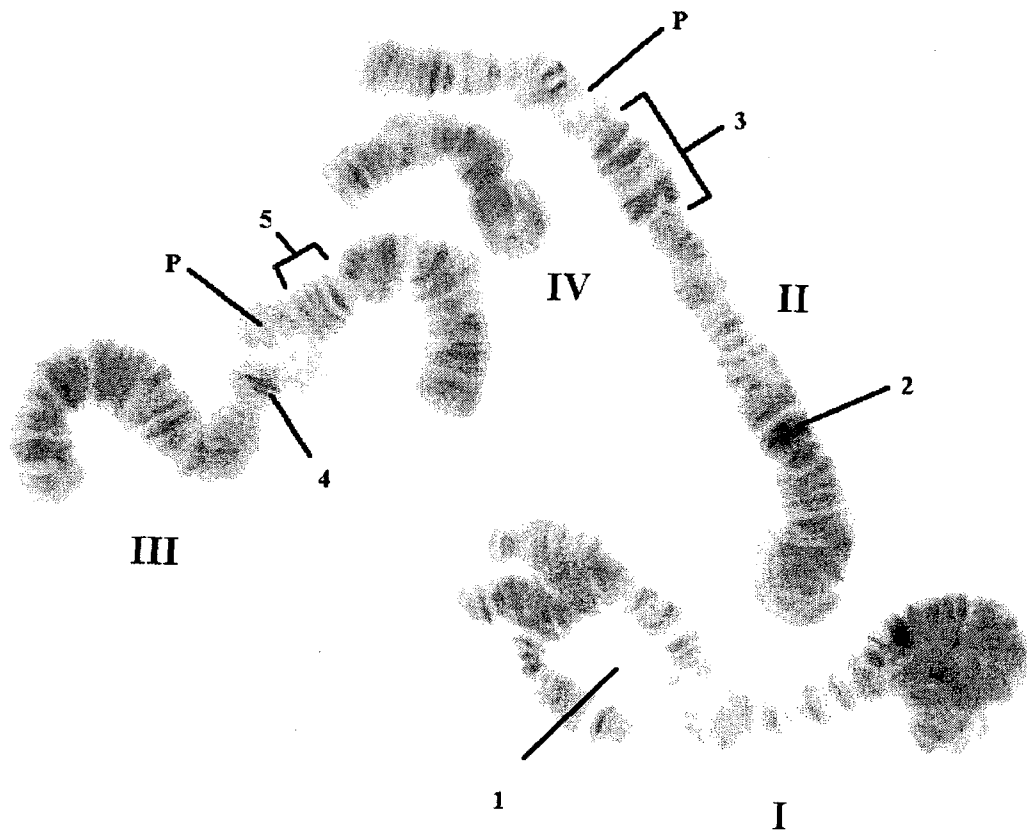

Fig. 3. Karyotype F (400X magnification). Photograph of the polytene chromosomes of a chironomid larva collected from 4-m CT in July 2008. Numbers indicate characteristic bands and/or banding patterns. P = puff. Photograph by Joshua Martin.

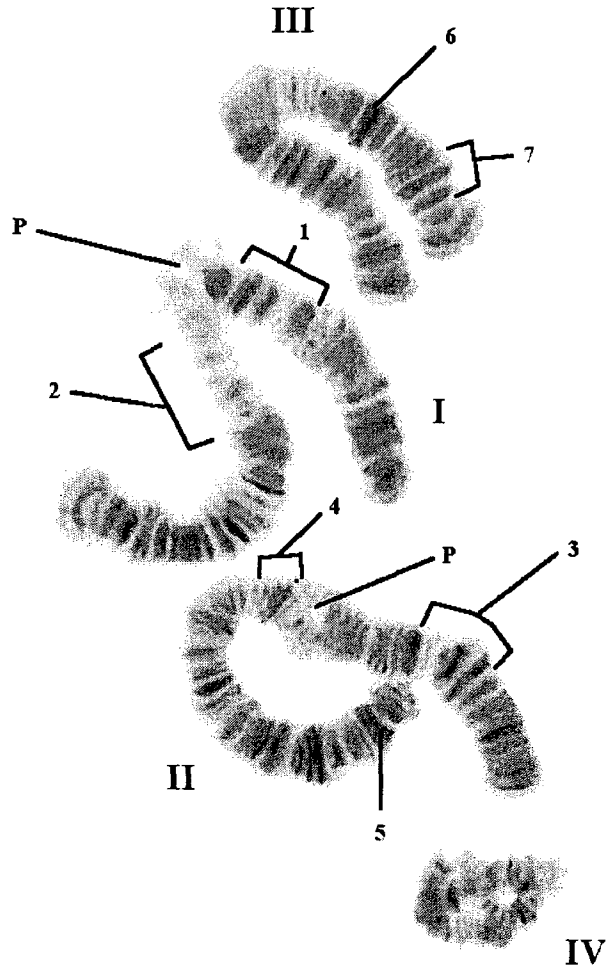

Fig. 4. Karyotype H (400X magnification). Photograph of the polytene chromosomes of a chironomid larva collected from Golden Pond Wetland in July 2008. Numbers indicate characteristic bands and/or banding patterns. P = puff. Photograph by Joshua Martin.

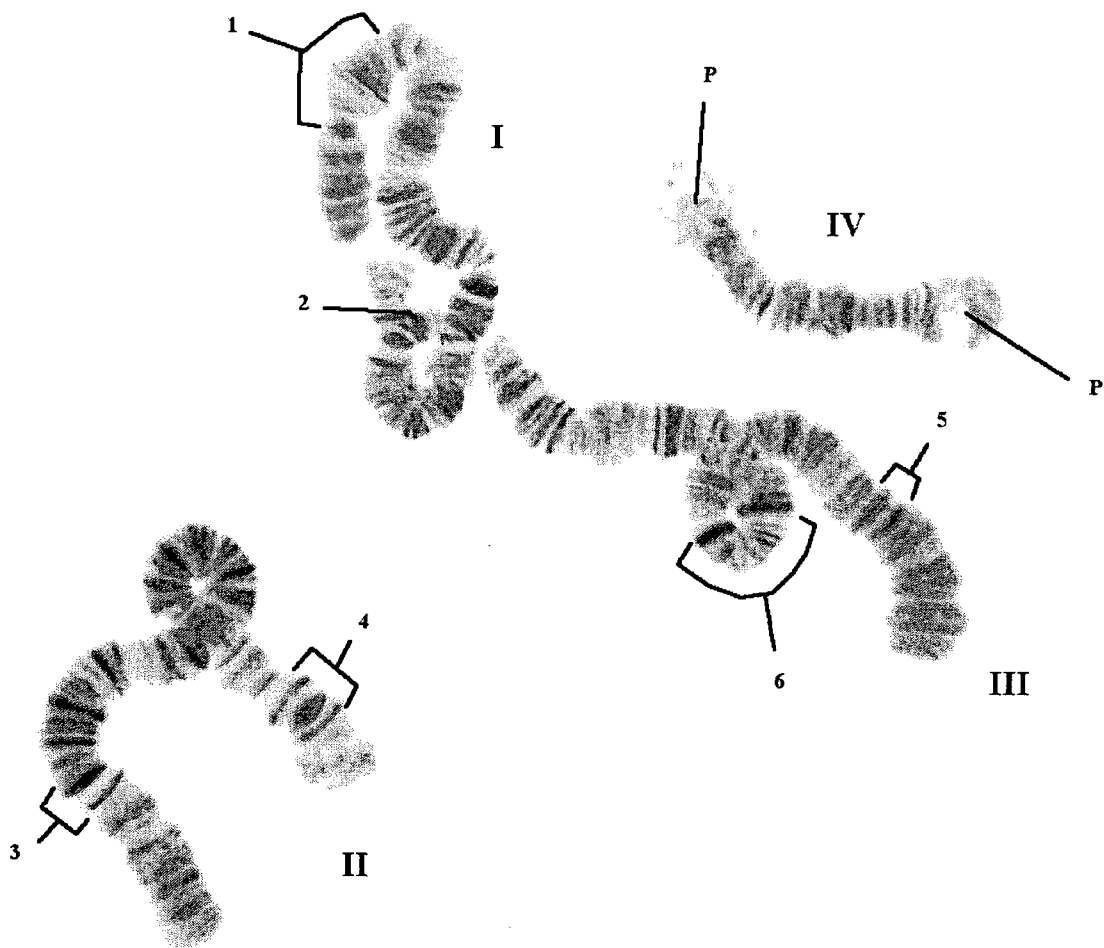

Fig. 5. Karyotype J (400X magnification). Photograph of the polytene chromosomes of a chironomid larva collected from High Sulphate Wetland in July 2008. Numbers indicate characteristic bands and/or banding patterns. P = puff. Photograph by Joshua Martin.

APPENDIX V: RAW DATA – CHIRONOMID LARVAE SORTED BY TAXON

Wetland Name	Date	Number of Chironomini	Number of Tanypodinae	Number of Tanytarsini/Orthoclaadiinae	Total
Golden Pond	July 18 th , 2008	27	0	25	52
Golden Pond	July 21 st , 2008	20	5	7	32
Golden Pond	July 24 th , 2008	34	0	23	57
Golden Pond	July 27 th , 2008	25	1	16	42
Golden Pond	July 30 th , 2008	40	0	25	65
Golden Pond	Aug. 2 nd , 2008	62	0	29	91
Golden Pond	Aug. 5 th , 2008	46	0	15	61
High Sulphate	July 18 th , 2008	0	1	11	12
High Sulphate	July 21 st , 2008	31	6	13	50
High Sulphate	July 24 th , 2008	27	10	26	63
High Sulphate	July 27 th , 2008	26	21	27	74
High Sulphate	July 30 th , 2008	58	8	64	130
High Sulphate	Aug. 2 nd , 2008	42	1	30	73
High Sulphate	Aug. 5 th , 2008	115	3	50	168
Natural Wetland	July 18 th , 2008	0	0	55	55
Natural Wetland	July 21 st , 2008	0	1	52	53
Natural Wetland	July 24 th , 2008	1	2	55	58
Natural Wetland	July 27 th , 2008	2	4	69	75
Natural Wetland	July 30 th , 2008	14	1	76	91
Natural Wetland	Aug. 2 nd , 2008	12	0	84	96
Natural Wetland	Aug. 5 th , 2008	7	0	85	92
4m-CT	July 18 th , 2008	6	0	50	56
4m-CT	July 21 st , 2008	12	3	36	51
4m-CT	July 24 th , 2008	41	3	44	88
4m-CT	July 27 th , 2008	30	3	54	87
4m-CT	July 30 th , 2008	25	8	65	98
4m-CT	Aug. 2 nd , 2008	10	3	95	108
4m-CT	Aug. 5 th , 2008	11	2	99	112

VITA AUCTORIS

NAME: Joshua P. Martin

PLACE OF BIRTH: Chatham, Ontario

YEAR OF BIRTH: 1985

EDUCATION

École Secondaire de Pain Court, Pain Court
1999-2003

University of Windsor, Windsor, Ontario
2003-2007 B.Sc.

University of Windsor, Windsor, Ontario
2007-2010 M.Sc.