



## Durham E-Theses

---

### *The impact of land reform in Zimbabwe on the conservation of cheetahs and other large carnivores*

WILLIAMS, SAMUAL, THOMAS

#### How to cite:

---

WILLIAMS, SAMUAL, THOMAS (2011) *The impact of land reform in Zimbabwe on the conservation of cheetahs and other large carnivores*, Durham theses, Durham University. Available at Durham E-Theses Online: <http://etheses.dur.ac.uk/3410/>

#### Use policy

---

The full-text may be used and/or reproduced, and given to third parties in any format or medium, without prior permission or charge, for personal research or study, educational, or not-for-profit purposes provided that:

- a full bibliographic reference is made to the original source
- a [link](#) is made to the metadata record in Durham E-Theses
- the full-text is not changed in any way

The full-text must not be sold in any format or medium without the formal permission of the copyright holders.

Please consult the [full Durham E-Theses policy](#) for further details.

---

Academic Support Office, Durham University, University Office, Old Elvet, Durham DH1 3HP  
e-mail: [e-theses.admin@dur.ac.uk](mailto:e-theses.admin@dur.ac.uk) Tel: +44 0191 334 6107  
<http://etheses.dur.ac.uk>

# The impact of land reform in Zimbabwe on the conservation of cheetahs and other large carnivores

Samual Thomas Williams

## Abstract

Prior to 2000 Zimbabwe was hailed as a conservation success story, with large areas of commercial (private) land outside of national parks being used to support wildlife. In 2000, however, a Fast-Track Land Reform Programme (FTLRP) was initiated, resulting in the resettlement of most commercial land. This had well known socio-economic impacts, but to date little research has been conducted on the effects on wildlife and human-wildlife conflict. This study aimed to determine the impact of the FTLRP on the conservation of large carnivores and on human-carnivore conflict, focussing on the cheetah (*Acinonyx jubatus*). A case study compared three land use types (LUTs): commercial (Savé Valley Conservancy private wildlife reserve); resettlement (area of the conservancy that had been resettled); and neighbouring communal land. Spoor density of large carnivores was on average 98% lower in the resettlement LUT than the commercial LUT, while sighting reports and historical written records showed that the abundance of large carnivores had declined since the onset of the FTLRP. Aerial census data demonstrated a reduction in carnivore carrying capacity in both the commercial and resettlement areas. Habitat loss and fragmentation, alongside poaching, appeared to be the main mechanisms affecting changes in carnivore abundance. Interviews revealed that in the resettlement LUT, rates of livestock losses to large carnivores were perceived to be greater than in the communal LUT, and attitudes towards carnivores were more negative than the commercial LUT. It appears that the FTLRP had a significant negative impact on wildlife conservation and human-carnivore conflict, and is estimated to have driven a 70% decline in Zimbabwe's cheetah population. It is recommended that future resettlement is carefully planned to mitigate these problems, and that schemes are established to allow communities to benefit from wildlife while minimising the impact of resettlement on human-wildlife conflict.

# **THE IMPACT OF LAND REFORM IN ZIMBABWE ON THE CONSERVATION OF CHEETAHS AND OTHER LARGE CARNIVORES**

---

Samual Thomas Williams

Thesis submitted for the degree of Doctor of Philosophy

Department of Anthropology, Durham University

September 2011

## Table of Contents

Abstract .....	1
Table of Contents .....	3
List of Figures .....	6
List of Tables .....	11
List of Abbreviations.....	14
Statement of Copyright .....	15
Acknowledgements.....	16
Chapter 1 Introduction.....	19
1.1 Introduction.....	19
1.2 Conservation and conflict .....	20
1.3 Conservation of large carnivores.....	23
1.4 Conservation in Zimbabwe.....	30
1.5 The land issue in Zimbabwe .....	32
1.6 Savé Valley Conservancy.....	41
1.7 Research objectives .....	45
1.8 Thesis structure .....	47
Chapter 2 Methods .....	48
2.1 Introduction.....	48
2.2 Time frame .....	48
2.3 Study site.....	50
2.4 People of the study area .....	55
2.5 Methods .....	59
2.5.1 Capturing and collaring cheetahs .....	59
2.5.2 Interviews.....	66
2.6 Summary .....	70
Chapter 3 Spoor counts.....	71
3.1 Introduction.....	71
3.2 Methods.....	73
3.3 Results.....	79
3.3.1 Spoor densities .....	79
3.3.2 Spoor distribution .....	81
3.3.3 Estimating true density using spoor density .....	87
3.3.4 Population density and population size estimates .....	88
3.3.5 Sampling effort, variance and precision.....	90
3.4 Discussion.....	93
3.5 Summary .....	103

Chapter 4 Cheetah sightings.....	104
4.1 Introduction.....	104
4.2 Methods .....	107
4.3 Results.....	111
4.3.1 Sighting method.....	111
4.3.2 Stakeholder method .....	113
4.3.3 Longitudinal sighting data .....	115
4.3.4 Perceived cheetah population trends .....	116
4.4 Discussion.....	118
4.5 Summary .....	123
Chapter 5 Carnivore carrying capacity .....	125
5.1 Introduction.....	125
5.2 Methods .....	126
5.3 Results.....	134
5.3.1 Current prey biomass.....	134
5.3.2 Current carrying capacity .....	137
5.3.3 Carrying capacity trends.....	144
5.4 Discussion.....	149
5.5 Summary .....	156
Chapter 6 Perceptions of livestock predation .....	158
6.1 Introduction.....	158
6.2 Methods .....	160
6.3 Results.....	163
6.3.1 Livestock holdings.....	163
6.3.2 Livestock losses and predation .....	164
6.3.3 Predation mitigation strategies .....	169
6.4 Discussion.....	174
6.5 Summary .....	183
Chapter 7 Attitudes towards cheetahs and tolerance of predation .....	185
7.1 Introduction.....	185
7.2 Methods .....	188
7.3 Results.....	190
7.3.1 Potential predictors .....	190
7.3.2 Attitudes towards predators .....	192
7.3.3 Tolerance of cheetah predation .....	200
7.4 Discussion.....	203
7.5 Summary .....	210
Chapter 8 General discussion .....	211

8.1	Introduction.....	211
8.2	Impacts of land reform on the status and distribution of carnivores.....	211
8.3	Impacts of land reform on perceptions of predation and carnivores .....	221
8.4	Outcomes of the research objectives .....	222
8.5	Recommendations.....	225
8.6	Further research .....	230
8.7	General conclusions.....	232
	References .....	233
	Appendix 1.....	262
	Appendix 2.....	266
	Appendix 3.....	272
	Appendix 4.....	276
	Appendix 5.....	278

## List of Figures

Figure 1.1 Distribution of the cheetah in 2010, shown in red (Durant <i>et al.</i> , 2010a). Cheetahs used to range throughout Africa and into Asia (Myers, 1975). .....	26
Figure 1.2 Distribution of cheetahs in Zimbabwe in 1987 (Williams, 2007; adapted from Wilson, 1987). Note that almost all cheetahs are found on commercial farms and state land. ....	27
Figure 1.3 Current distribution (shown in red) of a) lion, b) leopard, c) spotted hyena, d) brown hyena and e) wild dog (Bauer <i>et al.</i> , 2010b; Henschel <i>et al.</i> , 2008; Honer <i>et al.</i> , 2008; McNutt <i>et al.</i> , 2010; Wiesel <i>et al.</i> , 2010). .....	29
Figure 1.4 Distribution of the three main land use types in Zimbabwe prior to the Fast-Track Land Reform Programme in 2000 (Child, 1995b). Most of the country was commercial or communal land.....	33
Figure 1.5 Savé Valley Conservancy and resettlement area. The external boundary of SVC (red line) shows the location of perimeter fence prior to FTLRP. Fences were removed from internal property boundaries (black lines). The labels show the names of properties within SVC. The conservancy is surrounded largely by communal land. ....	43
Figure 2.1 Cheetah distribution in southern Africa in 2007. The study site (white box) is connected to other cheetah range areas by commercial farmland and national parks to the south. Adapted from <a href="http://cheetahandwilddog.org/images/maps/sa_cheetah_range.jpg">http://cheetahandwilddog.org/images/maps/sa_cheetah_range.jpg</a> (IUCN/SSC, 2007). ....	51
Figure 2.2 Land use types around Savé Valley Conservancy. Only the SVC resettlement area is shown as the exact locations of the other FTLRP resettlement areas were not known. Commercial land links SVC to Gonarezhou and other wildlife areas. ....	52
Figure 2.3 Distribution of the land use types in and around Savé Valley Conservancy included in the study.....	53
Figure 2.4 Distribution of cattle observed in the 2008 aerial survey (Joubert, 2008) of Savé Valley Conservancy, indicating the area that was resettled. The western properties were not surveyed in 2008 due to fuel shortages, so data from 2007 are presented for this area (triangles).....	54
Figure 2.5 Shona homestead, with an occupant grinding maize. Note the round buildings of brick or wood with thatched roofs; the kitchen with clay walls; the scotch cart for transportation, and chickens to provide food. ....	56
Figure 2.6 Design of double-door box traps constructed to capture cheetahs in Savé Valley Conservancy (Marker, 2002). ....	60
Figure 2.7 Cheetah trap set up used in Savé Valley Conservancy to capture cheetahs in 2008 and 2009. Note the cage providing a path to the bait through the thorn bush boma. ....	61
Figure 2.8 Location of traps set in Savé Valley Conservancy to capture cheetahs in 2008 and 2009. Traps were deployed exclusively in the commercial north on Bedford, Chishakwe, Msaize and Gunundwe properties. ....	62
Figure 2.9 Location of interviews conducted in and around Savé Valley Conservancy in 2008 and 2009. Most interviews were centred along the area where the commercial, resettlement and communal LUTs meet, around the former commercial properties Angus, Mukazi and Mukwazi.	



Due to the nature of Zimbabwe’s land tenure system areas sampled are represented by polygons in the commercial and resettlement LUTs, and by points in the communal LUT..... 68

Figure 3.1 Spoor transects conducted in and around Savé Valley Conservancy to determine the spoor density of large carnivores and other mammals in 2008. Note that some transects were conducted by both SW and RG (see also Table 3.1). ..... 74

Figure 3.2 The relationship between spoor frequency and sampling effort for leopards on commercial transects in Savé Valley Conservancy in 2008, using both measured inter-spoor intervals and equal inter-spoor intervals. Red circles represent means and blue lines represent 95% confidence intervals. Both methods generate similar confidence intervals. .... 78

Figure 3.3 Spoor density across land use types in and around Savé Valley Conservancy in 2008. Species are grouped into a) members of the order Carnivora; and b) members of other orders. For the commercial LUT data were collected in both the northern and southern sections for all species with the exception of genet, hare, common duiker, baboon, impala, zebra, blue wildebeest (*Connochaetes taurinus*), giraffe, buffalo, black rhino and elephant, for which data were collected only from the southern section. Error bars represent standard errors. Spoor density was greatest in the commercial LUT for almost all study species, much lower in the resettlement LUT and lowest in the communal LUT..... 80

Figure 3.4 Spoor densities in the commercial north and commercial south in Savé Valley Conservancy in 2008 for various carnivore species. Error bars represent standard errors. Spoor densities were greatest in the commercial north for almost all species. .... 81

Figure 3.5 (continued on following page). Distribution of carnivore spoor in and around Savé Valley Conservancy in 2008. Note that only roads sampled for spoor of a particular species are displayed. The location of spoor on transects conducted by DJ is estimated. Survey effort was 0.29 km of transect driven per km<sup>2</sup> of survey area (km/km<sup>2</sup>) including replicates in the commercial north, 0.34 km/km<sup>2</sup> in the commercial south, 0.16 km/km<sup>2</sup> in the resettlement LUT and 0.11 km/km<sup>2</sup> in the communal LUT. .... 83

Figure 3.6 (continued on following page). Distribution of non-carnivore spoor in and around Savé Valley Conservancy in 2008. Note that only roads sampled for spoor of a particular species are displayed. The location of spoor on transects conducted by DJ is estimated. Survey effort was 0.09 km of transect driven per km<sup>2</sup> of survey area (km/km<sup>2</sup>) including replicates in the commercial south, 0.16 km/km<sup>2</sup> in the resettlement LUT and 0.11 km/km<sup>2</sup> in the communal LUT..... 85

Figure 3.7 Comparison of population size estimates for large carnivores in the commercial LUT at Savé Valley Conservancy in 2008 using different equations. The equations in Stander (1998) performed best over a range of different spoor densities (see text). .... 88

Figure 3.8 The relationship between spoor frequency and sampling effort for large carnivores on commercial transects at Savé Valley Conservancy in 2008. Red circles represent means and blue lines represent 95% confidence intervals. For most species variation in spoor frequency decreases little after 30 spoor. .... 91

Figure 3.9 The relationship between coefficient of variance and sample size for large carnivores on commercial transects at Savé Valley Conservancy in 2008. Sampling precision increases little after 30 spoor for most species. .... 92

Figure 4.1 Distribution of cheetah sightings, including redundant sightings, in and around Savé Valley Conservancy in 2008 and 2009. Cheetah sightings were distributed mainly in the commercial north. No sightings were recorded in the resettlement or communal LUTs..... 112

Figure 4.2 Number of occasions on which cheetahs were seen on Senuko ranch between 1998 and 2009. The reduction in cheetah sightings coincided with the onset of the FTLRP on other properties in SVC (red arrow). ..... 115

Figure 4.3 Perceived trend in cheetah population size in and around Savé Valley Conservancy in 2008 and 2009 in a) commercial (n=44); b) resettlement (n=169); c) communal (n=145) LUTs. Cheetahs were perceived as being in decline more often in the resettlement than the commercial LUT. Most respondents did not know what the trends in cheetah numbers were. .... 117

Figure 4.4 Perceived trend in cheetah population size in SVC in 2008 and 2009 by a) owners and management (n=9); b) general staff (n=35). One respondent (a researcher) was omitted as no other respondents had a similar job. Management staff were more likely to believe that the cheetah population had declined. .... 118

Figure 5.1 Aerial transects, property names and land use types used in the analysis of aerial data for Savé Valley Conservancy in 2008. Data from the 2007 aerial survey were used for Mukazi, Mukwazi and Angus, the properties excluded from the 2008 aerial survey. Note that a significant area of Chigwete and Senuko fall inside the resettlement area, as delineated by the distribution of settlements (blue line). Adapted from Joubert (2008). ..... 128

Figure 5.2 Comparison of prey biomass density across land use types in and around Savé Valley Conservancy in 2008. Error bars represent standard errors. Prey biomass is much lower in the resettlement LUT than the commercial north or commercial south..... 134

Figure 5.3 Total prey biomass density on each property in Savé Valley Conservancy in 2008. .... 136

Figure 5.4 Distribution of impala (black circles) in the commercial south and resettlement LUTs in Savé Valley Conservancy in the 2008 aerial survey. Adapted from Joubert (2008). Impala are restricted almost entirely to the commercial LUT. .... 136

Figure 5.5 Comparison of prey biomass density at SVC in 2008 (this study) with Kruger National Park (Owen-Smith and Ogutu, 2003) and Gonarezhou National Park (Dunham *et al.*, 2010b). Note that total counts were employed at SVC and Kruger National Park, while sample counts were used at Gonarezhou National Park. Prey biomass at SVC is generally comparable with other sites.... 137

Figure 5.6 Comparison of carnivore carrying capacity estimates at Savé Valley Conservancy in 2008. Commercial and resettlement LUTs are pooled; the communal LUT was not sampled. True density estimates are derived from spoor counts. Data labels show population size. Equations in Hayward *et al.* (2007) (red data labels) were selected for further analysis. “Other” carrying capacity estimates were derived from Gros *et al.* (1996) (cheetah), Stander (1997b) (leopard) and van Orsdol (1985), cited in Hayward *et al.* (2007) (lion). ..... 139

Figure 5.7 Comparison of estimated true density with predicted carrying capacity across different land use types in and around Savé Valley Conservancy in 2008 for a) cheetah; b) lion; c) leopard; d) spotted hyena; and e) wild dog. Data labels show population sizes. Models 2, 4, 7 and 10 and 12 (Table 5.4) were used to estimate cheetah carrying capacity of cheetah, lion, leopard, spotted hyena and wild dog respectively. Cheetah, lion and spotted hyena appear to occur below carrying capacity, while leopard and wild dog occur at greater densities than would be expected. .... 141

Figure 5.8 Prey biomass densities in Savé Valley Conservancy in 2008 used to estimate carrying capacity of a) cheetah, b) lion, c) leopard, d) spotted hyena, e) wild dog. Biomass density intervals were generated using equal breaks. Data labels represent the number of animals predicted to occur on each property at carrying capacity. Carrying capacity was greatest in the commercial north and lowest in the resettlement areas..... 143

Figure 5.9 Carrying capacity of all large carnivores in and around Savé Valley Conservancy in 2008 combined based on prey biomass or rainfall (East, 1984), compared with true biomass density of large carnivores (estimated from spoor count data). Rainfall data were only available for the study site as a whole, so carrying capacity density estimates calculated using the rainfall model are identical. True density was similar to carrying capacity in the commercial LUT but much lower in the resettlement LUT. .... 144

Figure 5.10 Carrying capacity trends of large carnivores in Savé Valley Conservancy between 2004 and 2008 expressed as a population density for a) cheetah, b) lion, c) leopard, d) spotted hyena and e) wild dog. Carrying capacity is decreasing for all species in all LUTs..... 146

Figure 5.11 Carrying capacity trends of large carnivores in Savé Valley Conservancy between 2004 and 2008 expressed as the number of individuals of a) cheetah, b) lion, c) leopard, d) spotted hyena and e) wild dog. Carrying capacity is decreasing for all species in all LUTs..... 147

Figure 5.12 Change in carrying capacity in Savé Valley Conservancy between 2004 and 2008. Carrying capacity has generally declined. .... 148

Figure 5.13 Trends in predicted carnivore carrying capacities in Savé Valley Conservancy over the 14 years following 2008 for a) the commercial north and b) the commercial south. Carrying capacity for all species is predicted to increase..... 149

Figure 6.1 Discrepancy between reported livestock holdings in 2008 and 2009 in the resettlement and communal LUTs around Savé Valley Conservancy with holdings 12 months previously, taking into account gains and losses over the previous 12 months. Error bars represent standard errors. Relatively large discrepancies were observed..... 162

Figure 6.2 Livestock holdings in resettlement and communal areas around Savé Valley Conservancy in 2008 and 2009. Error bars represent standard errors. Resettlement farmers reported larger holdings..... 163

Figure 6.3 Reported sources of livestock loss in a) resettlement and b) communal LUTs around Savé Valley Conservancy in 2008 and 2009. Theft was said to be the most important source of livestock loss. .... 165

Figure 6.4 Perceived level of livestock lost to predation in a) resettlement and b) communal LUTs around Savé Valley Conservancy in 2008 and 2009, broken down by livestock type. Losses are expressed as a proportion of current holdings of each livestock type. Larger predators were blamed for livestock attacks in the resettlement than the communal LUT..... 166

Figure 6.5 Predators considered responsible for most livestock attacks in the resettlement and communal LUTs around Savé Valley Conservancy in 2008 and 2009. Spotted hyena and lion in particular were more likely to be blamed in the resettlement than the communal LUT. .... 168

Figure 6.6 Perceived trend in livestock predation in the resettlement and communal LUTs around Savé Valley Conservancy (predation rates in 2008 and 2009 compared with 10 years previously, or

when the respondent first moved to area). Resettlement farmers were more likely to perceive predation rates to be increasing than communal farmers.....	169
Figure 6.7 Prevalence of livestock management techniques in the resettlement and communal LUTs around Savé Valley Conservancy in 2008 and 2009. Kraaling, herding, warning dogs and bell collars were very popular in both LUTs.....	170
Figure 6.8 Mean number of herders used for herding livestock in the resettlement and communal LUTs around Savé Valley Conservancy in 2008 and 2009. Error bars represent standard errors. Resettlement farmers reported slightly larger numbers of herders protecting their stock. ....	171
Figure 6.9 Estimated distance between homestead and livestock grazing area in the resettlement and communal LUTs around Savé Valley Conservancy in 2008 and 2009. Error bars represent standard errors. Greater distances were reported amongst resettlement farmers than communal farmers. ....	171
Figure 7.1 Schematic diagram of an attitude to behavioural process model and how it relates to the study.....	187
Figure 7.2 Responses to questions assessing knowledge about cheetahs by respondents in the commercial, resettlement and communal LUTs in and around Savé Valley Conservancy in 2008 and 2009.....	192
Figure 7.3 Mean attitude score towards predators in commercial, resettlement and communal LUTs in and around Savé Valley Conservancy (1 – very negative to 5 – very positive) in 2008 and 2009. Error bars represent standard errors. Attitudes were positive in the commercial LUT, negative in the resettlement LUT and very negative in the communal LUT. ....	193
Figure 7.4 Comparison of cheetah tolerance score between resettlement and communal land use types around Savé Valley Conservancy in 2008 and 2009. Error bars represent standard errors. Resettlement farmers appeared to be more tolerant than communal farmers. ....	200
Figure 7.5 Ideal number of cheetahs relative to perceived current population in the a) commercial, b) resettlement and c) communal LUTs in and around Savé Valley Conservancy, reported in 2008 and 2009. Respondents in the commercial LUT were more likely to want more cheetahs at all than those in other LUTs. ....	202
Figure 8.1 Lioness snared on Sango, Savé Valley Conservancy (Lindsey <i>et al.</i> , 2009a). ....	218
Figure 8.2 Wire snares collected on Senuko, Savé Valley Conservancy (Lindsey <i>et al.</i> , 2009a)....	218

## List of Tables

Table 1.1 Description of categories of the IUCN Red List of Threatened Species (IUCN, 2010a). ...	26
Table 1.2 Land distribution in Zimbabwe in 1930, at independence (1980), immediately before the onset of the FTLRP (2000) and in May 2010. Adapted from Kwashirai (2009b) and Scoones <i>et al.</i> (2010). .....	34
Table 2.1 Number of trap locations and trap days used to capture cheetahs in Savé Valley Conservancy in 2008 and 2009. ....	63
Table 2.2 Species captured in Savé Valley Conservancy in 2008 and 2009, and survey effort required per capture. ....	65
Table 2.3 Number and location of interviews conducted across each LUT in and around Savé Valley Conservancy in 2008 and 2009. Some respondents referred to multiple properties. ....	67
Table 3.1 Length and number of replicates of spoor transects conducted in 2008 to determine the spoor density of large carnivores and other mammals in Savé Valley Conservancy. ....	75
Table 3.2 Areas of each land use type in and around Savé Valley Conservancy, and survey effort of spoor counts conducted in 2008 to determine the spoor density of large carnivores and other mammals. Total length surveyed takes into account both the length of the transects driven and the number of replicates conducted. ....	76
Table 3.3 Comparison of linear equations describing the relationship between spoor density and true density for cheetah, lion, leopard, spotted hyena, wild dog and wild dog. ....	87
Table 3.4 Population size and population density estimates for large carnivores across each LUT in and around Savé Valley Conservancy in 2008. Values in parentheses represent 95% confidence intervals. Stander's (1998) leopard equation was used to calculate the estimates for the leopard, while Stander's (1998) lion and wild dog equation was used to calculate the estimates for all other species. Estimates for commercial north and commercial south LUTs were calculated independently from commercial overall, so totals may not necessarily be identical. ....	89
Table 4.1 Maximum $d$ values for individual cheetahs or coalitions of cheetahs in southern Africa calculated from the literature. NP refers to national parks. Study sites not located in national parks were made up largely of private land, both game ranches and other farms. *Denotes a study that was conducted in small (<400km <sup>2</sup> ), fenced reserves where densities may not be representative of natural densities. ....	109
Table 4.2 Number of cheetah sightings recorded across all LUTs in and around Savé Valley Conservancy in 2008 and 2009. Includes redundant sightings. ....	111
Table 4.3 Cheetah population estimates in Savé Valley Conservancy in 2008 - 2009 calculated using the sighting method. A range of $d$ values were used for comparison, but 40 km (figures in bold) is thought to be the most appropriate for the study site. Redundant sightings were excluded from the analysis. ....	113
Table 4.4 Raw and adjusted stakeholder estimates of the number of cheetahs in Savé Valley Conservancy in 2008-2009, based on cheetah sightings. ....	114

Table 5.1 Average female body masses of prey species included in biomass calculations. All masses were taken from Hayward <i>et al.</i> (2007b) except that of the brown hyena, which was from Stuart and Stuart (1997).....	127
Table 5.2 Areas used for analysis of SVC aerial data on a land use type scale.....	130
Table 5.3 Selection of inputs (prey species) to carrying capacity models. Species were selected for a model if they were used in the development of that model. Adapted from Hayward <i>et al.</i> (2007b). .....	131
Table 5.4 Equations used to estimate predator carrying capacity in Savé Valley Conservancy ( $y$ ; $\log_{10}$ ; $\text{kg}/\text{km}^2$ ) based on biomass of prey species ( $x$ ; $\log_{10}$ ; $\text{kg}/\text{km}$ ). $a$ represents area and $z$ represents carnivore body mass.....	132
Table 6.1 Livestock management techniques used to protect livestock against predation (Breitenmoser <i>et al.</i> , 2005; Good <i>et al.</i> , 2007; Hodgkinson <i>et al.</i> , 2007; Inskip and Zimmermann, 2009; Nyoni and Williams, 2008; Schumann, 2004; Schumann <i>et al.</i> , 2006).....	161
Table 6.2 Spearman rank correlations between the number of cattle and small stock perceived to have been preyed for each predator in Savé Valley Conservancy between 2008 and 2009. Significant correlations are highlighted in bold. ....	167
Table 6.3 Univariate statistical tests showing relationships between whether or not cattle or small stock predation in the past 12 months in SVC and potential explanatory variables. Significant relationships are shown in bold.....	172
Table 6.4 Binary logistic regression showing relationships between whether or not respondents around Savé Valley Conservancy reported cattle or small stock predation in the previous 12 months and potential explanatory variables. Degrees of freedom for each individual variable is equal to 1. Data for individual variables are expressed as odds ratios. $R^2_N$ represents Nagelkerke's $R^2$ . Significant relationships are shown in bold.....	173
Table 7.1 Statements used to assess knowledge about cheetahs in interviews around Savé Valley Conservancy.....	189
Table 7.2 Potential predictor variables of attitudes towards large carnivores and tolerance of predation across land use types at Savé Valley Conservancy in 2008 and 2009. Percentages refer to percent of respondents within the categories presented. Certain questions were not applicable or were not asked in all land use types.....	191
Table 7.3 Chi-squared tests for association between land use type and categorical predictor variables of attitudes towards large carnivores around Savé Valley Conservancy in 2008 and 2009. Attitudes, cultural group and religion were independently grouped for analysis. Tests were not possible in blank cells or absent rows and columns. Tests on religion and whether or not respondents had attempted to remove carnivores were not possible due to expected counts of less than 5. Significant relationships are shown in bold. ....	194
Table 7.4 Kruskal-Wallis tests for differences in potential predictor variables between attitudes towards large carnivores in and around Savé Valley Conservancy in 2008 and 2009. Continued on following page. ....	195
Table 7.5 Spearman rank correlation of number of animals lost to each large carnivore in 2008 and 2009 against attitude towards that species amongst respondents in resettlement and	

communal LUTS around Savé Valley Conservancy. Blank cells represent insufficient data to conduct tests. Significant relationships are shown in bold. ....	196
Table 7.6 Likelihood ratio tests for final multinomial logistic regression model of attitude score towards each predator in and around Savé Valley Conservancy in 2008 and 2009 against baseline model. ....	197
Table 7.7 Reasons for attitudes towards cheetahs amongst respondents across all LUTs in and around Savé Valley Conservancy in 2008 and 2009.....	199
Table 7.8 Results of univariate analyses testing for differences and associations between cheetah tolerance score and predictor variables amongst respondents in resettlement and communal LUTs around SVC in 2008 and 2009.....	201
Table 8.1 Estimates of cheetah population size in different LUTs in and around Savé Valley Conservancy in 2008 - 2009.....	212
Table 8.2 Description of functions used in the model of the current cheetah population size in Zimbabwe and values used in calculations. ....	214
Table 8.3 Estimated cheetah population in Zimbabwe prior to the FTLRP (2000), and during the FTLRP (2009). ....	214
Table 8.4 Minimum number of animals recorded killed by poachers in Savé Valley Conservancy between August 2001 to July 2009 (Lindsey <i>et al.</i> , 2011b).....	217

## List of Abbreviations

ATR	African Traditional Religion
CAMPFIRE	Communal Areas Management Programme for Indigenous Resources
CITES	Convention on International Trade in Endangered Species of Wild Flora and Fauna
DWT	Dambari Wildlife Trust
FMD	Foot and mouth disease
FTLRP	Fast-Track Land Reform Programme
GPS	Global positioning system
IUCN	International Union for Conservation of Nature
LUT	Land use type
MDC	Movement for Democratic Change
PAC	Problem animal control
PWMA	Zimbabwe Parks and Wildlife Management Authority
SVC	Savé Valley Conservancy
TFCA	Transfrontier Conservation Area
ZANU-PF	Zimbabwe African National Union – Patriotic Front



## **Statement of Copyright**

The copyright of this thesis rests with the author. No quotation from it should be published without the prior written consent and information derived from it should be acknowledged.

## **Acknowledgements**

I gratefully acknowledge assistance from the many people and institutions that made this study possible. Thanks to everyone at Marwell Zimbabwe Trust for giving me the opportunity to work in carnivore conservation in Zimbabwe and for providing the resources and support to conduct the project. Thanks to the Howard G. Buffett Foundation, Sea World Busch Gardens, the Whitley Wildlife Conservation Trust, Marwell Wildlife, Colchester Zoo, the Durham University Department of Anthropology, St Mary's College, and Katy Standish for contributing funding towards the project. I am grateful to the authorities that granted permission to conduct the research and to the participants for taking part in the study. Thanks to the landowners, managers and workers of Savé Valley Conservancy for their hospitality, support and friendship, and for providing access to the aerial survey data. Humani and Chishakwe Ranches and Jannie Liebenberg were amazingly helpful in providing accommodation, goats, and for endless assistance keeping the Land Rover running. Rosemary Groom, Dusty Joubert, Peter Lindsey and Graham Connear were extremely helpful in collaborating, sharing data and photographs, and offering to assist with immobilisations. Leon Du Plessis kindly loaned me camera traps only to have them mauled by lions. Roxy Danckwerts helpfully supplied cheetah scats to bait the cheetah traps. The hard work by Innocent Mavhurere conducting interviews under challenging circumstances was very much appreciated. Many thanks to Misheck Matari, Rueben Bote who did an amazing job as our tracker, and Matha Sosera for looking after us so well. The Ann Van Dyke Cheetah Centre very generously provided access to captive cheetahs and accommodation in South Africa.

I am very grateful to my primary supervisor Russell Hill for his advice and support before, during and after the PhD. Thanks also to Rob Barton and Ben Campbell for their supervision, and Phil Stephens for writing the R script used for bootstrapping. Among the many others, thank you for the advice, support and friendship provided by Julia Chase-Grey, Pete Tomlin, Vivien Kent, Tash

Constant, Louise De Raad, and Diana Wiedemann (Team Russell), Gareth Hamilton, David Henig, Kat Shutt, Netty Purchase and Nicky Lunt. Thanks to my family for putting up with my challenging career choices. Abe helped us jump the border at regular intervals to buy food and Wonder Nyoni did an excellent job on the education project. Many thanks to Pete Tomlin for allowing me to parasitize his electricity and internet connection to help me write up this thesis while working in South Africa. Comments on earlier drafts of this thesis were gratefully received from Katy Standish, Russell Hill, Pete Tomlin and Tash Constant. I am grateful to Sarah Durant and Joanna Setchell for examining this thesis.

Finally I am extremely grateful to Katy Standish for the constant support of all kinds provided over the many years. Thank you for leaving your job to spend years volunteering in a country in which you weren't allowed to live and where there was no food. Thank you for helping me collect the data and for letting me trap you when cheetahs weren't going into the cages. Thank you for paying my rent, food and bills in Durham. You thought this day might never come, but we got there in the end. I hope it paid off. Thank you.

For Beans

# Chapter 1 Introduction

---

## 1.1 Introduction

This thesis examines the impact of Zimbabwe's Fast-Track Land Reform Programme (FTLRP) on the conservation of cheetahs (*Acinonyx jubatus*) and other large-bodied members of the order Carnivora (hereafter referred to as carnivores), and also explores the influence of land reform on human-carnivore conflict. The research was conducted while the author worked as the Cheetah Project Coordinator at Marwell Zimbabwe Trust (now Dambari Wildlife Trust, hereafter DWT) between October 2006 and August 2009. Founded in 1997, DWT is a small non-profit trust based near Bulawayo that engages in wildlife research and conservation activities in Zimbabwe. DWT was mandated by the Zimbabwe Parks and Wildlife Management Authority (PWMA) to conduct research into the abundance of cheetahs outside of state protected areas, and this research formed the main focus of this thesis. This general aim was developed to focus on the impacts of the FTLRP on cheetahs, as this had huge potential to influence cheetah conservation and human-wildlife conflict. After the onset of fieldwork, difficulties encountered while working with a rare species in a politically sensitive area at a time of national crisis (see section 2.2) caused the focus to broaden from cheetahs to include a greater emphasis on the rest of the large carnivore guild: lion (*Panthera leo*), leopard (*Panthera pardus*), spotted hyena (*Crocuta crocuta*), brown hyena (*Parahyaena brunnea*) and wild dog (*Lycaon pictus*).

This chapter begins by discussing conservation and human-wildlife conflict, before reviewing the conservation of large carnivores and the history of conservation in Zimbabwe. The land issue in Zimbabwe is then outlined, before a description of Savé Valley Conservancy is provided, and research objectives are set out.

## 1.2 Conservation and conflict

Global biodiversity is being lost at an astonishing rate. The planet's 6 billion people have transformed up to 50% of the terrestrial surface area, and utilised almost a quarter of land area for cultivation, placing increasing pressure on wildlife habitats (Loveridge *et al.*, 2010; Vitousek *et al.*, 1997). Due to anthropogenic factors the species extinction rate has increased by 100 to 1000 times in the past few hundred thousand years (Pimm *et al.*, 1995), driving the 6<sup>th</sup> mass extinction in the Earth's history (Barnosky *et al.*, 2011). At present 20% of the planet's vertebrates and 25% of all mammals are threatened with extinction, and these figures continue to rise despite ongoing conservation efforts (Hoffmann *et al.*, 2010; Schipper *et al.*, 2008).

Several factors drive people to conserve wildlife, including cultural, utilitarian, and ecological reasons, in addition to and the intrinsic value of species (Loveridge *et al.*, 2010; Ray, 2005). A number of traditional societies historically employed measures to protect wildlife populations from human-induced decline and extinction, and this trend expanded and became formalised in the 20th century conservation movement (Child, 2004).

Although contact between humans and wildlife can result in negative consequences such as extinctions, some species appear to benefit from living close to human populations (Maude and Mills, 2005). Humans may also derive benefits from living in close proximity to wildlife, including aesthetic and cultural benefits (Loveridge *et al.*, 2010). Coexisting with wildlife can also provide utilitarian benefits such as the control of pests (Packer *et al.*, 2006), and economic benefits through tourism (Frost and Bond, 2008; Gusset *et al.*, 2008a) and hunting (Lindsey *et al.*, 2007). Economic benefits can take a range of forms including direct payments to people living in wildlife areas, job creation, and the development of facilities to benefit communities such as schools and clinics (Lindsey *et al.*, 2006; Reid, 2001; Taylor, 2009a).

Although human-wildlife interactions can be positive, they also frequently result in conflict (Thirgood *et al.*, 2005). Human-wildlife conflict can be defined as situations in which “the needs and behaviour of wildlife impact negatively on the goals of humans or when the goals of humans negatively impact the needs of wildlife” (Madden, 2004, p. 248). This can take many forms such as crop-raiding, which is a common driver of conflict across the globe. For example, primates (Hill and Webber, 2010) and elephants (*Loxodonta africana*) (Webber *et al.*, 2011) raid crops in Africa, and elk (*Cervus elaphus*) are blamed for agricultural damage in North America (Walter *et al.*, 2010). Conflicts can also occur outside the context of agriculture, such as damage to cars by stone martins (*Martes foina*) in Luxembourg (Herr *et al.*, 2009). Livestock losses to predators are another source of conflict, such as damage to fisheries by otters (*Lutra lutra*) and birds in Poland (Kloskowski, 2011), depredation by jaguars (*Panthera onca*) on cattle in Brazil (Cavalcanti *et al.*, 2010; Zimmermann *et al.*, 2005), and by snow leopard (*Uncia uncia*) and Himalayan black bear (*Ursus thibetanus*) in Bhutan (Sangay and Vernes, 2008). These losses can result in substantial economic costs to farmers. For example, in Kenya livestock predation by wild dogs can cost up to US\$389 per wild dog per year (Woodroffe *et al.*, 2005a), while depredation by lions may cost US\$290 per lion per year (Patterson *et al.*, 2004). Predation of wildlife can also cause conflict between predators and reserve managers, such as hunting of game by eagles on game birds in Spain, and predation of ungulates by cheetahs in Namibia (Marker *et al.*, 2003c). Like predation on livestock, this can also result in significant financial costs, especially for species such as sable (*Hippotragus niger*), for which a single hunt can sell for over US\$16,000 (Lindsey *et al.*, 2011b). Where direct attacks on people by wildlife occurs it is often a major driver of human-wildlife conflict. This has been documented for attacks by lions in Tanzania (Packer *et al.*, 2005), by hippopotamus (*Hippopotamus amphibius*) and Nile crocodile (*Crocodylus niloticus*) in Mozambique (Dunham *et al.*, 2010a), by tigers (*Panthera tigris*) in Russia (Goodrich *et al.*, 2011), by bears in China (Liu *et al.*, 2011), and even by smaller species such as magpies (*Gymnorhina*

*tibicen*) in Australia (Jones and Thomas, 1999). In addition to economic costs, conflict can result in indirect costs to people such as fear and effort to reduce the probability of carnivore attacks, and can also impose opportunity costs, such as making livestock farming unviable (Thirgood *et al.*, 2005). Similarly, human-wildlife conflict can have large impacts on wildlife, including population decline, range collapse and extinction (Kissui, 2008; Marker *et al.*, 2003e; Mooney and Rounsevell, 2008; Woodroffe, 2000).

Human-wildlife conflict can be addressed using a number of approaches. Where crop-raiding is an issue, solutions such as using chilli to deter elephants have been recommended (Chelliah *et al.*, 2010), while the use of certain livestock husbandry techniques has been associated with reduced levels of livestock predation (Breitenmoser *et al.*, 2005; Ogada *et al.*, 2003; Woodroffe *et al.*, 2007a; see Chapter 6). Dealing with predation on game can be more challenging, but some suggestions have been put forward, including the formation of conservancies (cooperatively managed wildlife areas) which spread the cost of predation among more landowners (Lindsey *et al.*, 2009c), and using predator-proof fencing with swing gates to reduce the number of holes dug under fences (Schumann *et al.*, 2006). Translocation of carnivores has been used as a tool to mitigate predation on livestock, game or on humans, but this often results in erratic ranging behaviour and increased carnivore mortality (Massei *et al.*, 2010; Weilenmann *et al.*, 2010), and can increase the number of attacks due to a loss of fear of humans and stress associated with the process of translocation (Athreya *et al.*, 2011). Financial and development incentives have also been used to promote coexistence (Dickman *et al.*, in press; Inskip and Zimmermann, 2009). Conservation projects tend to gain more support from local communities if local people are involved in wildlife management, they gain tangible benefits that are distributed equitably, the linkage between these benefits and wildlife conservation is emphasised (Groom and Harris, 2008; Winterbach *et al.*, in press). All of these solutions address the physical conflicts between people and wildlife, but the situation is often more complex. Human-wildlife conflict frequently involves



an element of human-human conflict, and culture, society and politics are often as important as damage caused by animals (Knight, 2000b; Madden, 2004). For carnivores this is further compounded by people's innate fear of predators (Kruuk, 2002). Culturally sensitive initiatives and education projects have demonstrated some success at addressing these factors and reducing conflict based on such deep-seated prejudices (Bauer, 2003; Dickman, 2010; Knight, 2000c; Marker *et al.*, 2003e).

### **1.3 Conservation of large carnivores**

Conservation measures employed to protect particular species or communities are often justified in ecological terms by stressing their importance as flagship, keystone, indicator or umbrella species (Linnell *et al.*, 2000; Ray, 2005) although these concepts are not universally accepted (Dalerum *et al.*, 2008; Linnell *et al.*, 2000; Murphy *et al.*, 2011; Sergio *et al.*, 2008). It has been argued that many large carnivores are unique in that each of these categories apply to them (Gittleman *et al.*, 2001b). Flagship species are charismatic species that can be used to raise awareness of environmental issues, and large carnivores are often used for this purpose (Cianfrani *et al.*, 2011; Home *et al.*, 2009). They are also seen as keystone species, performing critical roles in ecosystems due to the effect that they have on shaping prey communities (Berger *et al.*, 2001; Dalerum *et al.*, 2008; Paine, 1969; Schaller, 1972). Large carnivores can be seen as indicator species whose status is diagnostic of biodiversity levels, because their high trophic position means that they can only survive if sufficient prey populations are available (Lindenmayer *et al.*, 2000). This also means that large carnivores tend to occur at relatively low densities and their conservation depends on the availability of relatively large areas of habitat (Durant *et al.*, 2010b), and protecting an area for the benefit of a large carnivore can also benefit other species, so they can function as umbrella species (Rozyłowicz *et al.*, 2011; Woodroffe and Ginsberg, 2005).

Another reason for investment in conservation of large carnivores is that they are often vulnerable to extinction. Large carnivores are inherently rare due to their high trophic level, and their large body size predisposes them to a relatively low reproductive rate, making it difficult for them to recover from disturbances (Steneck, 2005). A number of factors threaten large African carnivore populations such as interspecific competition and disease (Winterbach *et al.*, in press), but for most species the main threats are anthropogenic factors such as conflict with humans, habitat loss and reduction in prey base (Ray *et al.*, 2005). Large carnivores are more likely than many other taxa to suffer from competition and conflict with humans, leading to population declines and extinctions (Inskip and Zimmermann, 2009).

The large areas with sufficient prey populations that are necessary to support large carnivores are becoming increasingly rare (Ray *et al.*, 2005). Africa is one of the few remaining places where a relatively large area of suitable wildlife habitat persists, supporting the world's most diverse remaining carnivore guild (Dalerum *et al.*, 2009; Ray *et al.*, 2005). Setting aside formally protected areas has been the cornerstone of conservation initiatives (Child, 2004), but many African protected areas have failed to sufficiently protect large mammals from anthropogenic threats, resulting the decline of mammal populations by an average of more than 50% over the past few decades (Craigie *et al.*, 2010). The human population in Africa is growing faster than on any other continent (Ray *et al.*, 2005), bringing humans and wildlife into more frequent conflict (Madden, 2004), and as a result large carnivores are becoming increasingly endangered (Gittleman *et al.*, 2001a; Nowell and Jackson, 1996).

The most endangered large felid in Africa is the cheetah (Nowell and Jackson, 1996). Although once one of the most widely distributed large land mammals, the global cheetah population declined by over 90% in the past century, from approximately 100,000 in 1900 to 9,000-12,000

individuals in 1998 (Marker, 1998; Marker *et al.*, 2010). More recent estimates put the total population at 7,500 (Durant *et al.*, 2010a). Their distribution in the wild has contracted to just 29 countries (all in Africa with the exception of a small population in Iran; Figure 1.1), half of which no longer support viable populations (Marker, 1998, 2002; Nowell and Jackson, 1996). A relatively large number of cheetahs occur in Tanzania (569 to 1007 animals, Gros, 2002) and Kenya (793 animals, Gros, 1998), but the largest remaining population of cheetahs occurs in southern Africa. At least 2,000 cheetahs are thought to occur in Namibia, 1,800 in Botswana, 550 in South Africa, 100 in Zambia, and fewer than 75 in Mozambique, Malawi and Angola (Purchase *et al.*, 2007; Appendix 1). Estimates of the number of cheetahs in Zimbabwe have varied greatly (Williams, 2007; Appendix 2) from 400 animals in 1975 (Myers, 1975) and 470 in 1987 (Wilson, 1987) to 1,520 in 1999 (Davison, 1999), although the lower estimates seem more realistic due to the limited distribution of cheetahs in Zimbabwe (Figure 1.1) in relation to other countries such as Botswana (Klein, 2007).

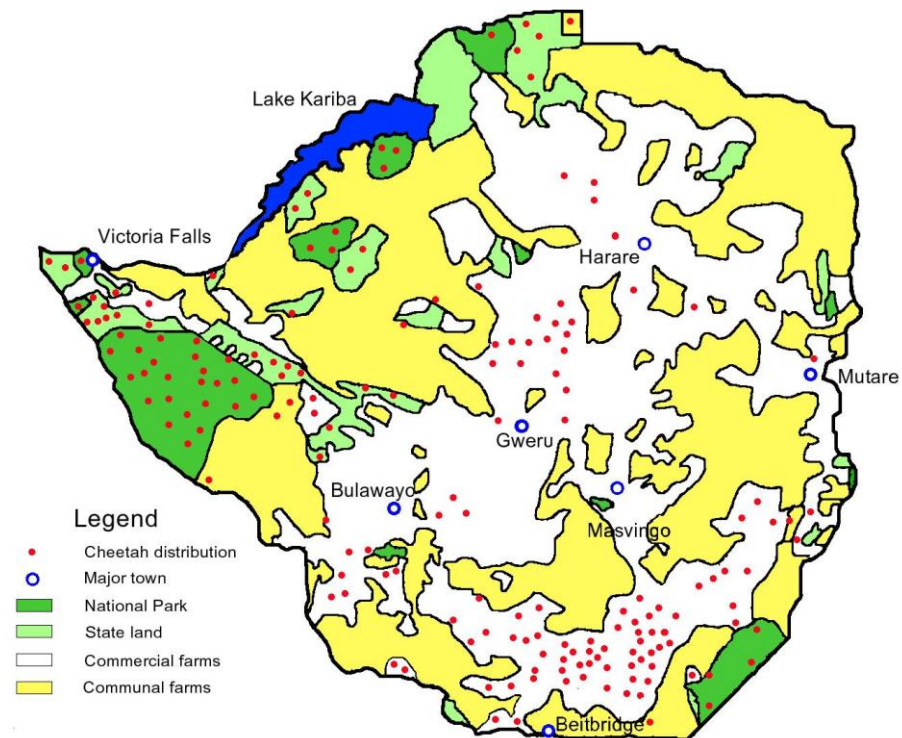
The cheetah is listed on the International Union for Conservation of Nature (IUCN) Red List of Threatened Species as vulnerable (descriptions of categories are given in Table 1.1) (Durant *et al.*, 2010a). Cheetahs are listed on Appendix I of the Convention on International Trade in Endangered Species of Wild Fauna and Flora (CITES) recognising that the species is threatened with extinction and may be affected by trade (CITES, 2011). International trade in species on Appendix I is usually banned, but annual quotas for the export of live cheetahs or hunting trophies have been approved with the aim of increasing tolerance and promoting conservation (CITES, 1992). The export quotas were approved for Zimbabwe (50 animals), Namibia (150 animals) and Botswana (5 animals) (CITES, 1992), although the actual number exported is lower (Klein, 2007; Williams, 2007).



Figure 1.1 Distribution of the cheetah in 2010, shown in red (Durant *et al.*, 2010a). Cheetahs used to range throughout Africa and into Asia (Myers, 1975).

Table 1.1 Description of categories of the IUCN Red List of Threatened Species (IUCN, 2010a).

Category	Description
Least concern	Widespread or abundant.
Near Threatened	Close to qualifying for a threatened category.
Vulnerable	Faces a high risk of extinction in the wild.
Endangered	Faces a very high risk of extinction in the wild.
Critically endangered	Faces an extremely high risk of extinction in the wild.
Extinct in the wild	Exists only in captivity.
Extinct	The last individual of the species has died.



**Figure 1.2** Distribution of cheetahs in Zimbabwe in 1987 (Williams, 2007; adapted from Wilson, 1987). Note that almost all cheetahs are found on commercial farms and state land.

Although the cheetah is the main focal species of this project, the study also focuses on the other large carnivores present in Zimbabwe (Figure 1.3). Approximately 16,500 to 30,000 free-ranging lions are thought to remain in Africa (Bauer and Van Der Merwe, 2004), and the species is designated as vulnerable in the Red List (Bauer *et al.*, 2010b). Leopard are thought to be more numerous, and are listed as near threatened (Henschel *et al.*, 2008). The most widely cited population estimate is 714,000 leopards in sub-Saharan Africa (Martin and de Meulenaer, 1988), but this has been broadly discredited as an overestimate and their numbers remain unclear (Bailey, 2005; Nowell and Jackson, 1996). Spotted hyena are thought to number in total between 27,800 and 48,200 animals and are listed as least concern (Honer *et al.*, 2008; Mills and Hofer, 1998). The brown hyena has a much more restricted range in relation to the other study species and is limited to southern Africa (Skinner and Chimimba, 2005). The species is listed as near threatened and only 5,070 to 8,020 individuals remain (Mills and Hofer, 1998; Wiesel *et al.*, 2010). The population of wild dogs is smaller still, numbering only 3,000 to 5,500 (Ginsberg and

Woodroffe, 1997), and the species is listed as endangered (McNutt *et al.*, 2010). Wild dog, spotted hyena and brown hyena are not listed under CITES (CITES, 2011). Lion is listed under Appendix II, recognising that the species could become threatened unless trade is regulated (CITES, 2011). Leopard are on Appendix I, although leopard export quotas have been allocated to 12 African countries totalling 2,648 hunting trophies (of which 500 are allocated to Zimbabwe) (Balme *et al.*, 2010; CITES, 2011). Each of the six focal species was ranked in the top ten most vulnerable large carnivores in Africa (Ray *et al.*, 2005). Data on the current status of carnivore populations and their carrying capacities is vital to their conservation (Gittleman *et al.*, 2001a; Hayward *et al.*, 2007b) and this research aims to address this issue. Although large African carnivores are becoming increasingly endangered (Ray *et al.*, 2005), well thought-out policies can lead to successful conservation initiatives (Linnell *et al.*, 2001; Winterbach *et al.*, in press) as demonstrated in Zimbabwe.

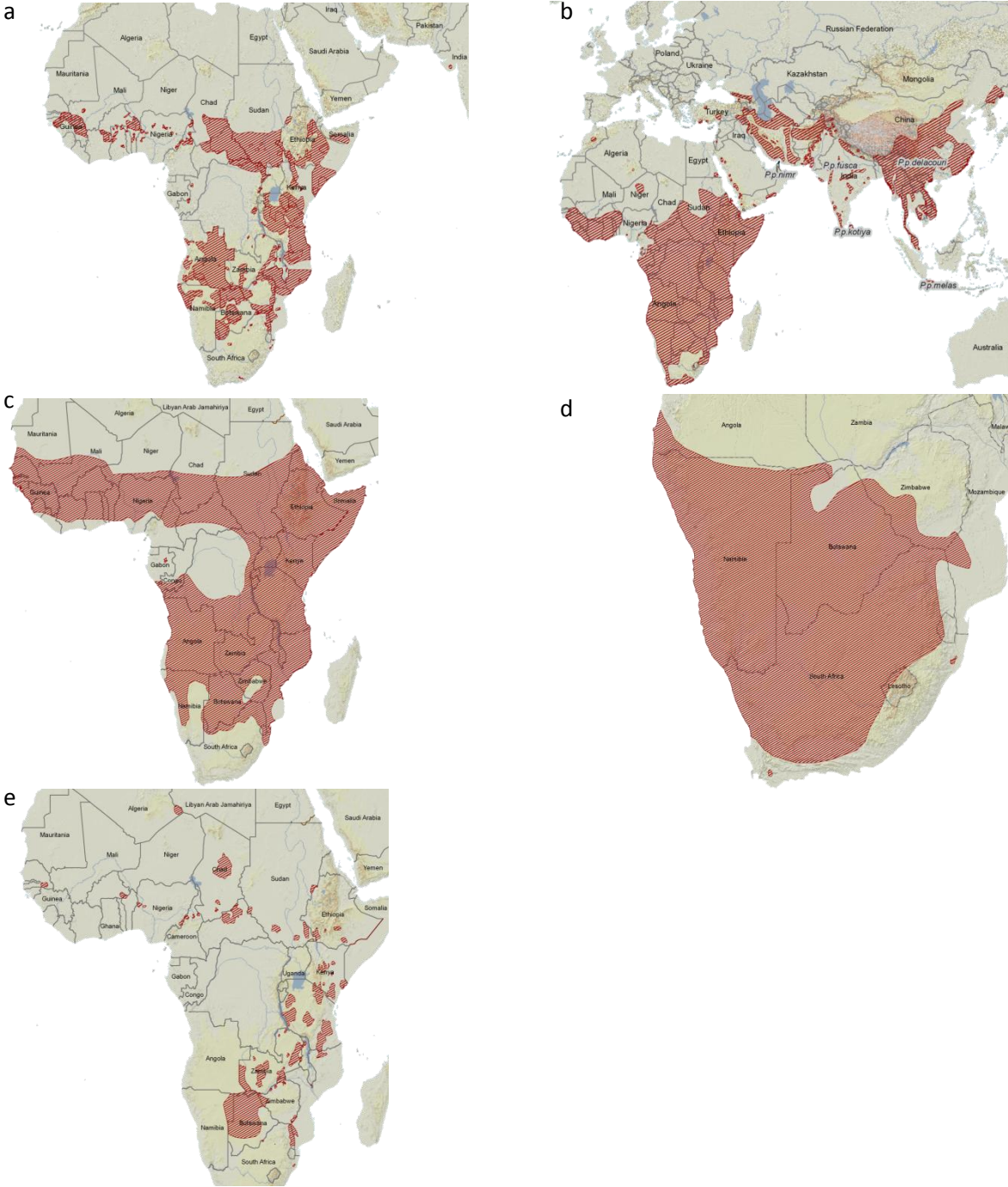


Figure 1.3 Current distribution (shown in red) of a) lion, b) leopard, c) spotted hyena, d) brown hyena and e) wild dog (Bauer *et al.*, 2010b; Henschel *et al.*, 2008; Honer *et al.*, 2008; McNutt *et al.*, 2010; Wiesel *et al.*, 2010).

## 1.4 Conservation in Zimbabwe

Before European<sup>1</sup> settlement the human population in the area that later became Zimbabwe was low (numbering a few hundred thousand people), wildlife was relatively abundant, and hunting technologies were less efficient than in later years, so elaborate conservation measures were not necessary (Child, 1995b). Although conservation measures were not strictly necessary the early years of European settlement, certain cultural practices did, however, function as relatively weak conservation measures, such as taboos against eating certain animals or hunting during certain periods (Child, 1995a; Kwashirai, 2009a). Zimbabwe's first state protected areas were established in 1902 soon after European settlement, and eventually protected 13% of the country for wildlife (Child, 2009b; Scoones *et al.*, 2010). Even outside formally protected areas many species were conserved under the laws of the European administration starting with the Game Law Amendment Act in 1891, and permits were required to hunt. This effectively disenfranchised African landholders as few understood the legislation (Child, 1995b). European farmers bemoaned the difficulties of attempting to "farm in a zoo", and destroyed large numbers of wild animals on European land (Child, 1995b, p.51). Purchasing the necessary permit allowed landowners to shoot as many individuals of most species as they deemed fit in order to protect their agricultural interests, although they were not permitted to sell the wildlife products (Child, 1995b). Despite the legal protection afforded to some species such as cheetah, few people paid attention to the legislation and large numbers of protected animals were removed indiscriminately (Wilson, 1987). Veterinary officials also killed hundreds of thousands of animals to eradicate livestock diseases, which in combination with the expansion of commercial agriculture and the development associated with the increasing human population resulted in the decline of wildlife populations, and large mammals became increasingly restricted to protected areas (Child, 2009b).

---

<sup>1</sup> People of European descent or African descent will hereafter be referred to as Europeans and Africans respectively (after Beach, 1994; Bourdillon, 1994; Wels, 2003; Wolmer, 2005). This is a contentious issue (Wade, 2002), and although this solution is not very satisfactory as respondents of both European and African descent frequently identified themselves as African (pers. obs.), this is the least cumbersome way of overcoming the problem.



With the onset of the private game ranching movement this trend was reversed. The first game ranches appeared in 1959, but their number increased rapidly after the Parks and Wild Life Act in 1975 devolved rights to utilise wildlife to the landowners, allowing them to benefit financially from the wildlife on their land by selling trophy hunts, for example (Duffy, 2000; Tomlinson, 1980). This was later also applied to communal land in the form of the Communal Areas Management Programme for Indigenous Resources (CAMPFIRE) (Child, 2009d). By 2000, 20% of all commercial land was managed for wildlife, constituting an additional 7% of the total land area to the 13% of state protected areas (Bond *et al.*, 2004; du Toit, 2004). In comparison with cattle ranching, wildlife utilisation on private land in Zimbabwe had been shown to be more profitable and generate more foreign currency, grossing approximately US\$20 million per year in hunting revenues alone by 2000 (Bond *et al.*, 2004; Child, 2009c; Lindsey *et al.*, 2006; Price Waterhouse, 1994). In low rainfall areas such as southeast Zimbabwe, wildlife ranching was also less dependent on unpredictable rainfall, more diversified, created more jobs and paid higher wages than cattle ranching (Child, 2009c; Langholz and Kerley, 2006; Price Waterhouse, 1994). In addition to economic and development benefits, wildlife production was also less extractive, utilised species that were better suited to the arid environment, and led to improved ecological conditions on many properties (Child, 2009c).

As the commercial wildlife sector became more important to wildlife conservation, the significance of the state wildlife sector began to diminish. Treasury allocations failed to keep pace with running costs, and since 1999 the PWMA has had to operate using only the income it generates (Child, 2009d). Political interference within the PWMA leadership has also resulted in the loss of capacity and a decline in morale, reducing its ability to effectively manage the wildlife in state protected areas (Child *et al.*, 2004; Child, 2009d). The formally protected areas alone are not sufficient to conserve all of Zimbabwe's ecosystems and wildlife (Child, 2009a), and some

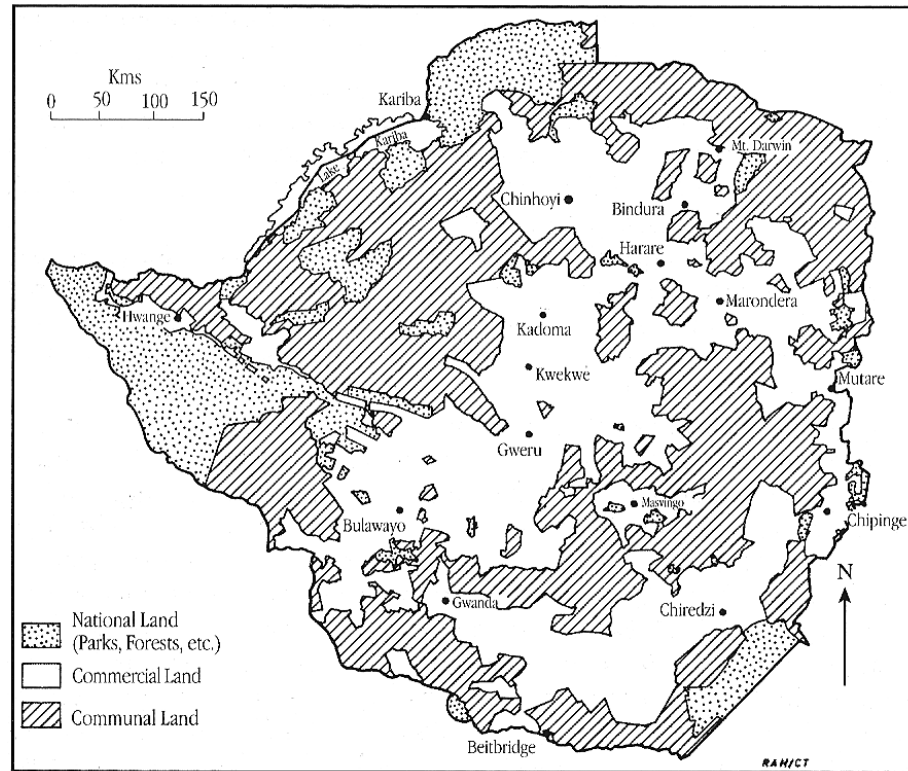
species such as cheetah occurred in greater numbers on commercial land than in state protected areas. For these reasons commercial land was of vital importance to wildlife and to the economy prior to 2000, but everything changed with the onset of the Fast-Track Land Reform Programme.

## **1.5 The land issue in Zimbabwe**

The roots of land reform in Zimbabwe go back to the early days of major European settlement, which began with the arrival of Cecil John Rhodes and his British South Africa Company who established the state of Rhodesia, later Zimbabwe. The settlers were driven by the hope of finding rich mineral resources in the region (Kwashirai, 2010), and in 1888 Rhodes' delegation secured a deal that allocated them exclusive mineral rights (Rotberg, 1988). It has been argued that the concept of land ownership had previously been alien to the inhabitants of the area who practiced shifting agriculture (Godwin, 2007; Kwashirai, 2009c), and Wels (2003) contended that this deal marked the transition of land to a commodity that could be traded, and the beginning of the land issue in Zimbabwe.

When the mineral deposits in the area fell short of expectations the focus of the pioneers shifted towards expropriating land, which led to violent uprisings in 1896-7 known as the first *Chimurenga*, or liberation struggle (Kwashirai, 2009a). After quashing the uprisings, officials governing the country began to set aside land for African use under a communal land tenure system, and Africans were evacuated from European Areas, leaving the European farmers exclusive use of the prime agricultural land (Wels, 2003). This established a system of land tenure that persisted largely unchanged until the onset of land reform at independence in 1980, and was composed of three main land use types (LUTs): commercial (private) land, which was mainly used for large-scale farming by Europeans; communal land, which was reserved for Africans and largely

utilised for subsistence agriculture; and state land (mainly national parks, safari areas, forestry areas, and other state protected areas) (Figure 1.4 and Table 1.2).



**Figure 1.4** Distribution of the three main land use types in Zimbabwe prior to the Fast-Track Land Reform Programme in 2000 (Child, 1995b). Most of the country was commercial or communal land.

The land issue galvanised support for the guerrilla war (the second *Chimurenga*) launched in 1972 (Meredith, 2006), and the government became dependent on South African military and financial support to sustain European rule, and risked destabilising the region (Meredith, 2006). Worried that this could provide the Soviet Union with an opportunity to intervene, both the American and South African governments pressured Rhodesia to accept majority rule, and began to withdraw South African military support and throttle Rhodesia's imports and exports (Meredith, 2006).

**Table 1.2 Land distribution in Zimbabwe in 1930, at independence (1980), immediately before the onset of the FTLRP (2000) and in May 2010. Adapted from Kwashirai (2009b) and Scoones *et al.* (2010).**

Land use type	1930		1980		2000		2010	
	Area (million ha)	% of total land area	Area (million ha)	% of total land area	Area (million ha)	% of total land area	Area (million ha)	% of total land area
Large-scale commercial farms	19.9	50.9	15.5	39.6	11.7	29.9	3.4	8.7
Small-scale commercial farms	3.0	7.7	1.4	3.6	1.4	3.6	1.4	3.6
Old resettlement (1980-2000)	0.0	0.0	0.0	0.0	3.5	9.0	3.5	9.0
New resettlement (2000-present)	0.0	0.0	0.0	0.0	0.0	0.0	7.6	19.5
Communal land	8.5	21.9	16.4	41.9	16.4	41.9	16.4	41.9
National parks and forest land	0.2	0.6	5.1	13.0	5.1	13.0	5.1	13.0
Other land	7.5	18.9	0.7	1.8	1.0	2.6	1.7	4.3
Total	39.1	100.0	39.1	100.0	39.1	100.0	39.1	100.0

Britain hosted a conference in 1979 at Lancaster House in London between the leaders of the United Kingdom, the Zimbabwe-Rhodesian government, and the leaders of the liberation movements (DeGeorges and Reilly, 2007). The Lancaster House agreement was signed by all parties, setting out a plan to hold elections and limit some powers of the new government for the following ten years, including its ability to conduct radical land reform (de Villiers, 2003). Widespread intimidation and violence were used to secure a victory for Robert Mugabe and his ZANU (later ZANU-PF, Zimbabwe African National Union – Patriotic Front) party in the election of February 1980, leading to the independence of Zimbabwe in April 1980 (Meredith, 2006). Many of the 200,000 Europeans feared for their future under a ruler with such a fierce reputation who had previously said that the Europeans would not be allowed to keep one acre of land (Meredith,

2006). On the day the election results were announced hundreds of European homes were put up for sale, many European-owned businesses locked up, and many made arrangements to leave the country (Blair, 2002). But Mugabe had been advised by the president of Mozambique, now struggling to cope after the mass emigration of Europeans precipitated by independence, to be careful not to make the same mistake (Meredith, 2007). Mugabe gave a television broadcast reassuring the European community:

We will ensure there is a place for everyone in this country. We want to ensure a sense of security for both the winners and losers... I urge you, whether you are black or white, to join me in a new pledge to forget our grim past, forgive others and forget, join hands in a new amity and together, as Zimbabweans, trample upon racism. (Blair, 2002, p. 14)

He went on to say:

It could never be a correct justification that because the whites oppressed us yesterday when they had power, the blacks must oppress them today because they have power. An evil remains an evil whether practised by white against black or black against white. (Meredith, 2006, p. 328)

The one group of Europeans that Mugabe made a special effort to reassure was the large-scale commercial farming community, appointing the head of the Commercial Farmer's Union as Agriculture Minister, and meeting hundreds of European farmers in May 1980 to guarantee their future (Blair, 2002). The commercial farming sector played a huge role in the economy, produced 75% of national agricultural output (totalling a third of all exports) and 90% of marketed maize (the main staple), and generated much of Zimbabwe's foreign exchange (forex) by producing almost all of the country's export crops such as tobacco, coffee, tea, sugar and wheat (Meredith,

2006). The sector was the largest employer in the country, employing 320,000 people in 1995 (a third of the formal workforce) and including workers families accommodated 2 million people, 20% of the total population (Magaramombe, 2010; Waterloos and Rutherford, 2004). With support from the government the large-scale commercial farming industry, and the economy as a whole, boomed (Meredith, 2006).

While initially supporting the commercial farming industry, the new government also initiated a land reform programme to redress the imbalance in land tenure (Table 1.2). The objectives of the land reform programme were to reduce civil conflict by transferring European-owned land to Africans; provide land for war veterans and landless people; relieve population pressure on communal lands; expand production and raise welfare; and maintain levels of agricultural production (de Villiers, 2003). Land reform was bound by the rules set out in the Lancaster House agreement until 1990, ensuring that during this period land must be acquired on a willing seller-willing buyer basis, and that the full market value must be paid for land promptly and in forex (de Villiers, 2003). From 1985 all commercial farmland placed on the market had to be first offered to the government, who would purchase the land using donor funds or supply a certificate of no interest before the property could be privately sold (Human Rights Watch, 2002).

Beneficiaries were resettled on the acquired land based on two models. The A1 model was based on subsistence farming while the A2 model was based on small-scale commercial farming (Scoones *et al.*, 2010). The Zimbabwean government set increasingly demanding targets, and in 1984 aimed to resettle 162,000 families on 8 million hectares (approximately half of all commercial land) within two years (de Villiers, 2003). These goals were seen as unrealistic by the UK, and indeed progress was slower than hoped; by the time the Lancaster House Agreement expired in 1990 only 50,000 families had been resettled on approximately 3 million hectares (de Villiers, 2003). Many considered the process corrupt, with hundreds of farms allocated to the

elite including ruling party ministers, politicians, senior civil servants and members of the security forces (Meredith, 2006).

Legal changes enacted in the 1992 Land Acquisition Act allowed for compulsory acquisitions, permitted payment of compensation in local currency, and restricted the area and number of properties an individual could own (de Villiers, 2003; Scoones *et al.*, 2010). A constitutional amendment was made to prevent farmers from contesting the amount of compensation they received in the courts (Meredith, 2006). But despite the availability of new powers and commitments being made in the run up to elections to acquire a further 5 million hectares for land reform the pace slowed down, with only 20,000 households resettled between 1990 and 1996 (Meredith, 2006; Scoones *et al.*, 2010). After spending £44 million on land reform, the UK government was forced to withdraw its support due to corruption (Meredith, 2006).

Despite these setbacks a series of events led to a rapid increase in the pace of land reform in 1997. The economy was in crisis due to mismanagement, and the government was forced to make large payouts to veterans of the liberation war, while taking part in an expensive (but highly lucrative for those involved) war in the Congo (Scoones *et al.*, 2010). Amid growing dissatisfaction with the government, an effective opposition party, the Movement for Democratic Change (MDC), was formed. In response the government took on an increasingly racist tone and blamed the European community for Zimbabwe's problems, and in 1997 used the Land Acquisition Act to designate 1,471 commercial farms totalling approximately 4 million hectares for resettlement (Scoones *et al.*, 2010). Criteria for designation included underutilisation, multiple and absentee ownership, and proximity to communal areas, but most of the farms listed were highly productive, and the following year almost all of the farms had been either degazetted or challenged in court (Buckle, 2001; Scoones *et al.*, 2010).

International concern at the escalating situation in Zimbabwe led to a donor conference in 1998, and international donor funding was pledged to support well-planned land reform, but the scheme soon collapsed. Land reform again became an important campaign issue in the run up to the 2000 parliamentary elections and constitutional referendum, with ZANU-PF campaigning under slogans such as “Land is the economy, the economy is land” and “Zimbabwe will never be a colony again” (Chaumba *et al.*, 2003a, p.543). The draft constitution proposed that compensation for land designated for resettlement would be paid by the British government while the Zimbabwean government would be liable only for improvements made to the properties since purchase, and also extended the number of terms the president could run for office (de Villiers, 2003).

A relatively small number of farm invasions began in 1999 in the run up to the referendum and election, but they escalated steeply when the constitution was rejected in February 2000, with 1,700 commercial farms invaded by the time elections were held in June (Kwashirai, 2010). Some were spontaneous occupations by locals, while others were led by war veterans or security forces, who supported invaders in some cases by providing transport and a daily allowance for their services (Meredith, 2006; Scoones *et al.*, 2010). Commercial farmers and their workers were blamed for the referendum defeat, and some argued that the farm invasions, known popularly as *jambanja* (or violence) (Scoones *et al.*, 2010), allowed ZANU-PF to disrupt this perceived support base before the parliamentary elections in June (Zunga, 2003). Across the country farmers and their workers were forced to attend political rallies, intimidated, beaten, and murdered (Buckle, 2002; Harrison, 2006; Human Rights Watch, 2002). Mugabe later proclaimed an amnesty for many of the crimes committed during the farm invasions, and few of the perpetrators were brought to justice (Buckle, 2001; Buckle, 2002). But despite the farm invasions and intense campaigning, ZANU-PF lost almost half of its parliamentary seats for the first time to the MDC in the June elections (Buckle, 2001). Before the elections were held the constitutional changes



rejected in the referendum were approved and the constitution was amended, allowing the Land Acquisition Act to be changed to streamline resettlement process (Human Rights Watch, 2002). In July 2000 the government announced its Fast-Track Land Reform Programme, retrospectively applying a legislative framework legitimising the farm invasions and representing a new phase in the land reform programme (Scoones *et al.*, 2010). The FTLRP, widely criticised by the international community, initially aimed to acquire 3,041 farms for resettlement (Scoones *et al.*, 2010).

As a result of the chaotic nature of the invasions, farms were occupied regardless of whether or not they had been formally allocated for resettlement (Buckle, 2001). Government officials were sent to some of the occupied farms to peg out plots and formally designate them as new resettlement areas, and later provide occupants with offer letters and permits to occupy (Scoones *et al.*, 2010). The government had promised to provide 99-year leases to beneficiaries of A2 plots, but this does not appear to have occurred (Scoones *et al.*, 2010). Invaded farms that were not subsequently pegged by government officials (termed informal settlements) are not formally recognised, and no offer letters or permits to occupy were provided to settlers in these areas. Even beneficiaries with offer letters do not have a great deal of security of tenure; offer letters have been overturned and plots have been re-pegged and resized or reallocated to alternative beneficiaries depending on local politics (Scoones *et al.*, 2010). Resettlements are highly politicised areas and there is much tension between the stakeholders including war veterans (often the original invaders), the state, national and local politicians, ZANU-PF structures, the competing beneficiaries and the former owners (pers. obs.; Alexander, 2006; Chaumba *et al.*, 2003a; Scoones *et al.*, 2010). Most of the beneficiaries were 'ordinary' people, largely from communal areas, but a substantial number were politicians, security services personnel, civil servants and war veterans who took advantage of the opportunity to seize the land (Scoones *et al.*, 2010). Most of the settlers had no formal agricultural training, and development and farming

of the newly acquired land was often extremely challenging due to difficulties obtaining farming inputs and credit, coupled with poor state support (Scoones *et al.*, 2010).

The FTLRP is currently ongoing (Bell, 2011; Sithole, 2011), and although estimates of the extent of resettlement vary, at least 71% (8.3 million hectares) of the large-scale commercial farmland in 2000 was thought to have been resettled by 2010 (Table 1.2). It is unlikely that these statistics account for informal settlements which may represent a further 16%, bringing the total resettled area to at least 87% (calculations based on data presented in Scoones *et al.*, 2010). Other commentators reported that 90% to 98% of Zimbabwe's commercial farms were resettled (Kwashirai, 2010; Magaramombe, 2010). In 2007 there were only 725 European-owned large-scale commercial farms remaining (Scoones *et al.*, 2010), and membership of the Commercial Farmers Union had fallen to 470 from 4,149 in 2000 (Commercial Farmers Union, pers. comm.), although not all members were still farming. Official records show that a total of 162,161 households had been resettled between 2000 and 2008, equating to 2.4 households per km<sup>2</sup> (using the resettlement area in May 2010) or 10.0 people per km<sup>2</sup> (based on data presented in Scoones *et al.*, 2010).

The collapse of commercial agriculture, the mainstay of the economy, exacerbated Zimbabwe's problems, and GDP recorded negative growth every year since 1997 (Richardson, 2007). The government attempted to compensate by printing money, leading to hyperinflation of over 500 million percent (Kwashirai, 2010). Unemployment reached 94%, salaries became worthless and prices doubled on a daily basis, while attempts to impose price controls left the shops empty (pers. obs., AFP, 2009; Scoones *et al.*, 2010). Millions fled the country as either political or economic refugees, and 75% of those that remained lived below the poverty line, requiring international food aid every year since 2000 (Kwashirai, 2010; Scoones *et al.*, 2010). In addition to the economic and social crisis, Zimbabwe's previously successful wildlife conservation

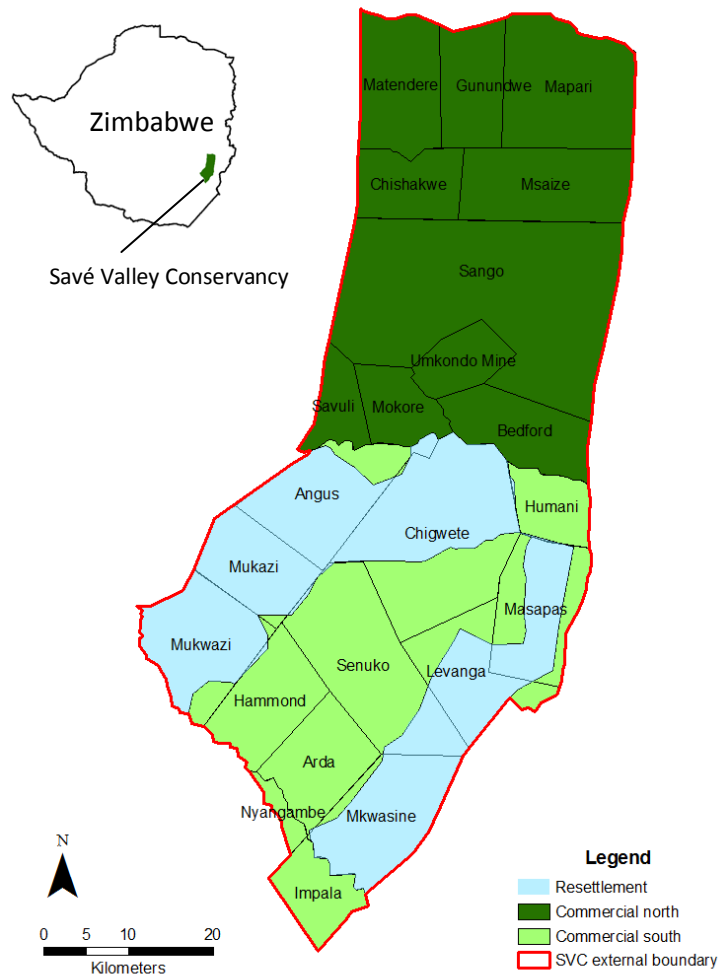
achievements may also have been reversed by the events of the past 11 years. Although the socio-economic impacts of land reform have been well studied (Chimhowu and Hulme, 2006; Kinsey, 1999, 2004; Magaramombe, 2010; Richardson, 2004; Scoones *et al.*, 2010; Thomas, 2003; Waterloos and Rutherford, 2004), there have been few systematic studies of the potential impacts on wildlife conservation and human-wildlife conflict. Reports detailing the effects on wildlife have generally been based on anecdotal evidence and are intended for a popular audience and tend to be published on websites (Gratwicke, 2004a, b; Gratwicke and Stapelkamp, 2006; Herbst, 2002; Sharman, 2001, 2008) and in newspaper articles (Fletcher, 2008; Ryan and Momberg, 2007). While these reports are invaluable in drawing attention to these issues, a more rigorous approach is necessary to gain an objective insight into the nature of situation. DeGeorges and Reilly (2007) bring the discussion of the impacts of land reform in Zimbabwe on wildlife into the academic literature, but they rely on news reports rather than empirical data. The impacts of land reform on wildlife are unknown but are potentially large, both because of the scale of the FTLRP, and because prior to the onset of the FTLRP Zimbabwe had an internationally renowned conservation record (Child *et al.*, 2004), supporting free-ranging populations of cheetahs and other large carnivores (Butler and du Toit, 2002; Pole *et al.*, 2004; Smithers and Wilson, 1979; Wilson, 1984, 1987).

## **1.6 Savé Valley Conservancy**

In the 1990s, before the FTLRP was initiated, wildlife became an increasingly common use for commercial land in Zimbabwe, which catalysed the development of conservancies. Cooperative management allowed conservancy members to benefit from economies of scale such as lower costs to maintain less fencing and fewer water points, and also provided ecological benefits such as increased resistance to unreliable rainfall and larger wildlife populations which are less susceptible to stochastic events or genetic inbreeding, increasing the viability of populations

(Lindsey *et al.*, 2009c). The more extensive effective area of conservancies also meant that they were able to more effectively support species that required home ranges that are typically larger than individual properties, such as cheetahs and wild dogs (Lindsey *et al.*, 2009c).

One of the conservancies that developed was Savé Valley Conservancy (SVC, Figure 1.5), which at 3,490 km<sup>2</sup> was said to be the largest private wildlife area in Africa (Wels, 2003). SVC was formed from 18 properties in 1991, catalysed by the reintroduction of 20 black rhinoceros (*Diceros bicornis*) between 1986 and 1988 as part of the government's conservation strategy. The conservancy was composed largely of European-owned former commercial cattle farms, but also included a property owned by a government parastatal (Arda), state land (Umkondo Mine), and a section of communal land (Nyangambe) was later incorporated (G. Hulme, pers. comm.; Lindsey *et al.*, 2009b; Wels, 2003).



**Figure 1.5** Savé Valley Conservancy and resettlement area. The external boundary of SVC (red line) shows the location of perimeter fence prior to FTLRP. Fences were removed from internal property boundaries (black lines). The labels show the names of properties within SVC. The conservancy is surrounded largely by communal land.

Populations of cheetah, lion, leopard, spotted hyena, brown hyena, elephant, hippopotamus, bushbuck (*Tragelaphus scriptus*), bushpig (*Potamochoerus porcus*), common duiker (*Sylvicapra grimmia*), eland (*Taurotragus oryx*), Sharpe's grysbok (*Raphicerus sharpei*), impala (*Aepyceros melampus*), klipspringer (*Oreotragus oreotragus*), kudu (*Tragelaphus strepsiceros*), warthog (*Phacochoerus africanus*), and zebra (*Equus burchelli*) already existed in the area when SVC was formed, and waterbuck (*Kobus ellipsiprymnus*), giraffe (*Giraffa camelopardalis*), nyala (*Tragelaphus angasi*) and white rhinoceros (*Ceratotherium simum*) had also previously been reintroduced by some of the ranchers who had experimented with wildlife production (Lindsey et

*al.*, 2009b). In order to make the new venture profitable more quickly, the landowners invested over US\$1 million in restocking the area with wildlife such as buffalo (*Syncerus caffer*) and elephants that were due to be culled in the nearby Gonarezhou National Park, while other species such as wild dogs recolonised the area naturally (Lindsey *et al.*, 2009b). To prevent the spread of foot and mouth disease to cattle the Department of Veterinary Services set out stringent requirements, including the removal of all cattle from the conservancy and the construction of a 1.8m high electrified double game fence around the perimeter of SVC (Foggin and Connear, 2005; Hargreaves *et al.*, 2004). In addition to preventing disease transmission, the fence also served to prevent the animals from entering the adjacent communal land and causing conflict (Lindsey *et al.*, 2009b). By 2000 the conservancy supported significant populations of many wildlife species, and had also forged links with neighbouring communities, including outreach activities such as irrigation schemes, scholarships, community craft projects, and access arrangements to allow collection of resources such as firewood and edible caterpillars (Lindsey *et al.*, 2009b; Wels, 2003). The Savé Valley Conservancy Trust was established in 1996 to enhance the relationship between SVC and neighbouring communities, and developed initiatives such as a wildlife endowment scheme whereby the communities would become shareholders who would derive earnings from wildlife utilisation within SVC (Lindsey *et al.*, 2009b; Wels, 2003).

These achievements were reversed with the onset of the FTLRP. In 2000 and 2001 eight properties in the south of SVC were either completely or partially resettled by subsistence farmers, covering an area of 964 km<sup>2</sup>, approximately a third of the total area (Figure 1.5) (Lindsey *et al.*, 2011b). Over 6,000 people and more than 12,000 cattle, 4,500 goats, 650 sheep, 400 donkeys, and 400 domestic dogs are thought to occupy this new resettlement area (Joubert, 2008; commercial farmer, pers. comm.). Approximately 23% (78,343 hectares) of the total area of the ranches that later formed SVC had already been developed as a resettlement area in 1981 as part of the original land reform programme (Wels, 2003; Zinyama *et al.*, 1990). Furthermore, many of

the former landowners had recently bought land in the conservancy, and had received certificates of approval from the government (Lindsey *et al.*, 2009b). But despite objections by the conservancy members, efforts to redistribute more of the land at SVC are ongoing (Afrique Avenir, 2011; Guvamombe, 2011).

There are very few data available on the impact of human activities on the abundance and distribution of cheetahs, and yet this information is crucial to cheetah conservation (Durant *et al.*, 2007). In Zimbabwe the effect of the FTLRP on carnivore populations and on human-wildlife conflict has not yet been studied, but this process could have had substantial impacts. The current population size of carnivores, and how this differs between commercial, resettlement and communal land use types, was not known. No information was available on how the ranging behaviour of cheetah varied between commercial and resettled land; nor was it available for other carnivore species. Many of the beneficiaries of resettled land came from communal areas, but it was not clear how perceived levels of human-carnivore conflict differed between these land use types. Perceived levels of human-wildlife conflict in resettlement areas have not been previously studied, but other researchers have found that relative to communal farmers, commercial farmers in Africa have more positive attitudes towards large carnivores (Romañach *et al.*, 2007), are more tolerant of livestock predation (Romañach *et al.*, 2007), and are more likely to want carnivores to live on their property (Selebatso *et al.*, 2008).

## **1.7 Research objectives**

The aim of this thesis was to establish the effect of the FTLRP on carnivores, with a particular focus on cheetahs. Levels of human-carnivore conflict were also assessed across different land use types. The commercial, resettlement, and communal LUTs in and around the Savé Valley Conservancy were used as a case study, although the results are likely to provide valuable empirical data to evaluate the significance of the FTLRP to conservation efforts across Zimbabwe.

The overarching hypothesis was that the FTLRP has reduced the population size of cheetahs and other large carnivores at SVC, and increased perceived levels of human-carnivore conflict. This hypothesis was tested by addressing the following objectives:

1. Estimate the current population size of cheetahs and other large carnivores in the commercial, resettlement and communal land use types at the study site, and to use this information to infer any changes in cheetah population sizes since the onset of the FTLRP. It is expected that the study species will occur at highest densities in the commercial LUT, intermediate densities in the resettlement LUT, and lowest densities in the communal LUT, and that the cheetah population has declined since the FTLRP was initiated.
2. Determine the carrying capacity of large carnivores in the commercial and resettlement LUTs at the study site, and assess how this is changing over time. Comparing carrying capacity with estimated density will determine whether prey abundance is a limiting factor in this system. Carrying capacity is predicted to be greater in the commercial LUT than the resettlement LUT, and prey abundance is expected to limit the carnivore populations.
3. Determine how the ranging behaviour of cheetahs is influenced by land use type. It is thought that cheetah will avoid human disturbance in the resettlement LUT, or utilise these areas nocturnally.
4. Compare levels of perceived livestock predation between farmers in the resettlement and communal LUTs. Farmers in the resettlement LUT are expected to suffer from higher levels of livestock predation than communal farmers.
5. Determine whether certain livestock management techniques are associated with lower perceived levels of livestock predation. Some livestock management techniques such as herding are likely to be associated with lower levels of livestock predation.



6. Investigate the attitudes of people towards large carnivores and tolerance of livestock predation by cheetah at the different LUTs at the study site, and estimate how land reform is affecting the likelihood that people would use lethal control of cheetahs. It is expected that attitudes towards predators will be most positive in the commercial LUT, intermediate in the communal LUT, and most negative in the resettlement LUT, where people will be more likely to use lethal control. Tolerance of livestock predation is predicted to be greater among communal farmers than resettlement farmers.

## **1.8 Thesis structure**

The thesis is divided into two main sections: determining the impact of Zimbabwe's FTLRP on the ecology of cheetahs and other large carnivores at the study site (objective 1, 2 and 3); and assessing the impact of the FTLRP on perceptions of human-carnivore conflict (objectives 4, 5 and 6). This introductory chapter is followed by a chapter outlining the general methods used in the study. Chapter 3 is concerned with estimating the abundance of large carnivores in the three different land use types at the study site using spoor counts. The abundance of cheetahs is estimated using sighting data in Chapter 4, both at present and comparing trends over time. Chapter 5 uses aerial data to estimate the carrying capacity of large carnivores in the commercial and resettlement LUTs at the study site, and how this has changed over time. Chapter 6 quantifies the perceived impacts of carnivores on livestock in the resettlement area, and investigates the effectiveness of livestock management techniques at minimising predation. Chapter 7 investigates the attitudes of people towards large carnivores, levels of tolerance of livestock predation, and the determinants of these variables. Finally Chapter 8 provides a general discussion, recommendations and conclusions of the study.

# Chapter 2 Methods

---

## 2.1 Introduction

This chapter begins by discussing the time frame of the project and describing the study site. Separate methodologies were utilised for spoor counts (Chapter 3) and estimating carnivore carrying capacity (Chapter 5) and details of these methods are provided in the methods section of those chapters. This chapter is therefore concerned with the methods used for capturing and collaring cheetah (which is not discussed further until Chapter 8) and the general methods used to conduct interviews, which form the basis of Chapter 4, Chapter 6 and Chapter 7. The data were generally analysed using non-parametric statistics due to non-normal distributions. Unless otherwise specified statistical tests were carried out using SPSS version 17.0.1 (SPSS, 2008).

## 2.2 Time frame

The initial phase of research after registering for the PhD and arriving in Zimbabwe in October 2006 was concerned with producing a project plan, obtaining the necessary permits, finding a suitable study site, ordering global positioning system (GPS) collars, and acquiring and constructing other equipment such as cheetah traps. Data collection was planned to begin in early 2008, and the first priority was to start trapping cheetahs to maximise the chances of deploying all GPS collars to investigate cheetah ranging behaviour. Once cheetah traps had been set an interview survey would then be initiated to collect cheetah sightings and assess perceived levels of human-carnivore conflict, and spoor counts would be conducted to determine the distribution and abundance of the study species. Data would be collected until June 2009, and the final months in Zimbabwe would be spent completing work for DWT before the expiry of the work and residence permit in September 2009. The onset of fieldwork was delayed, however, by

a number of factors such as acquiring permits from authorities, some of which appeared to have ceased to function as a result of the challenges through which the country was going.

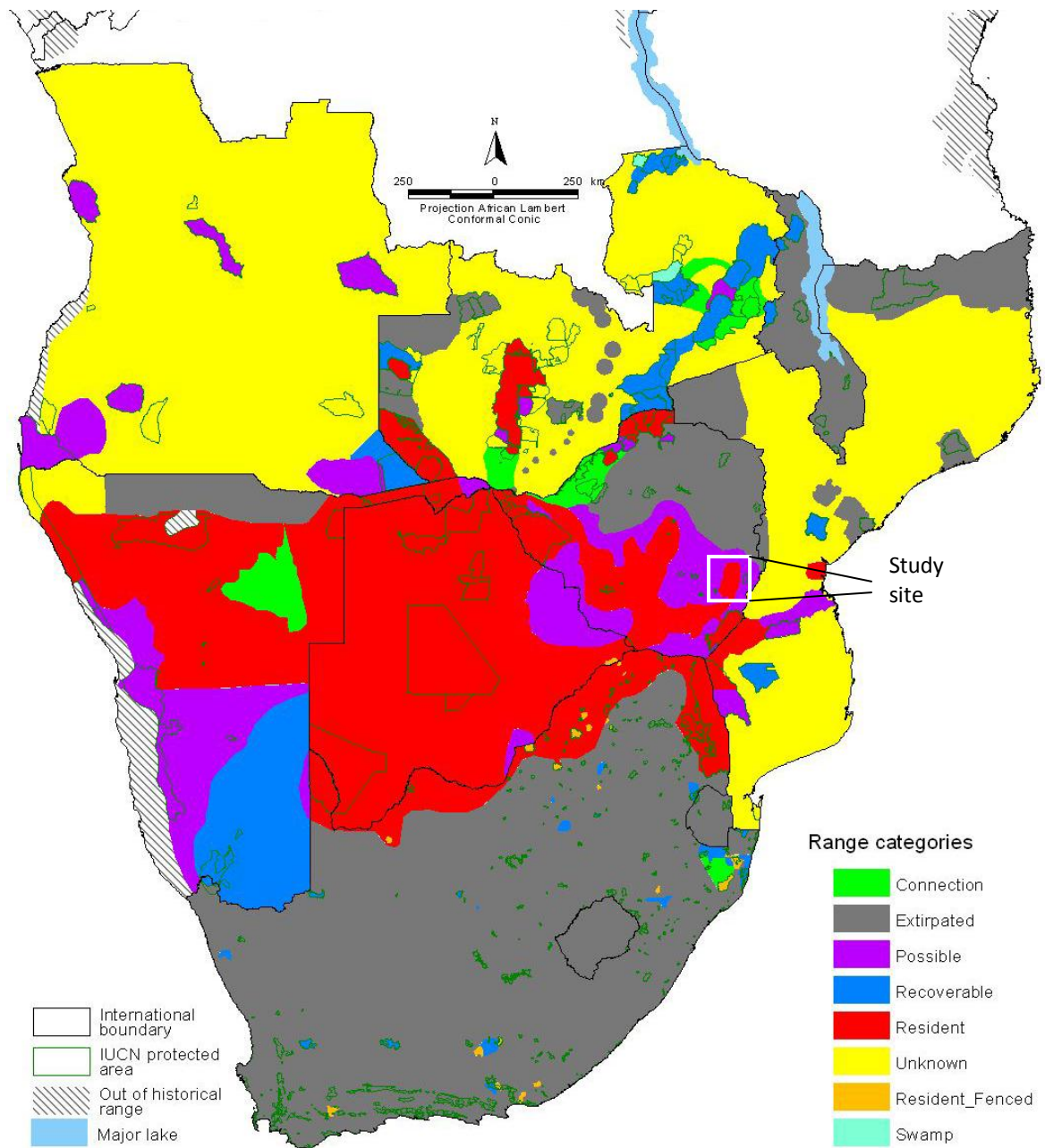
Another factor that further delayed the onset of fieldwork was the presidential elections of March 2008. Campaigning in advance of the elections led to political instability, and SVC management requested that fieldwork should be delayed until after the election. Neither of the two main candidates received an outright majority of the votes, so a second round of elections was held on the 27<sup>th</sup> of June 2008. The period after the first round of elections was marred by intense political violence across the country, resulting in hundreds of deaths, the torture and beating of thousands of people, and the displacement of hundreds of thousands of people (Amnesty International, 2008; Human Rights Watch, 2008a, b). In the Savé Valley Conservancy area, as in much of Zimbabwe, road blocks were established by war veterans and other groups in order to intimidate voters, and people were forced to attend political meetings rallies and “re-education” camps (Bell, 2011; G. Hulme, pers. comm). As a result SVC management requested that fieldwork be further postponed until the situation had stabilised. Fieldwork at SVC thus commenced in October 2008 and concluded in August 2009.

The difficulties of conducting in-situ fieldwork in Zimbabwe during the height of the political violence led to the development of an additional research project on captive cheetahs in South Africa. Spoor photography was investigated as a new tool to study the ecology of wild cheetahs, while allowing data to be collected in without being dependant on political stability in Zimbabwe. Data collection for this section of the project was conducted in June and July 2008 at the De Wildt Cheetah Centre in South Africa. The results, however, were inconsistent, so the technique was not employed at SVC. As a result it is not discussed in this thesis, although the findings will be submitted for publication elsewhere.

### 2.3 Study site

Fieldwork was centred on the Savé Valley Conservancy (Figure 1.5) in Masvingo province, south eastern Zimbabwe (central coordinates 20° 22' S and 31° 56' E). The area is linked to other cheetah populations by commercial farmland and national parks to the south (Figure 2.1). The conservancy was made up of a mosaic of land use types (LUTs) (Figure 2.2) and for the purposes of this study three LUTs were considered: commercial, fast-track resettlement (hereafter referred to as resettlement) and communal (defined in section 1.2). The conservancy was selected as the study site due to the presence of cheetahs and the absence of fencing and other physical barriers besides human settlements that could impede the free movement of cheetahs between land use types. The site was used as a case study to investigate the impact of Zimbabwe's Fast-Track Land Reform Programme (FTLRP) on the conservation of cheetahs and other large carnivores, and on perceptions of human-carnivore conflict.

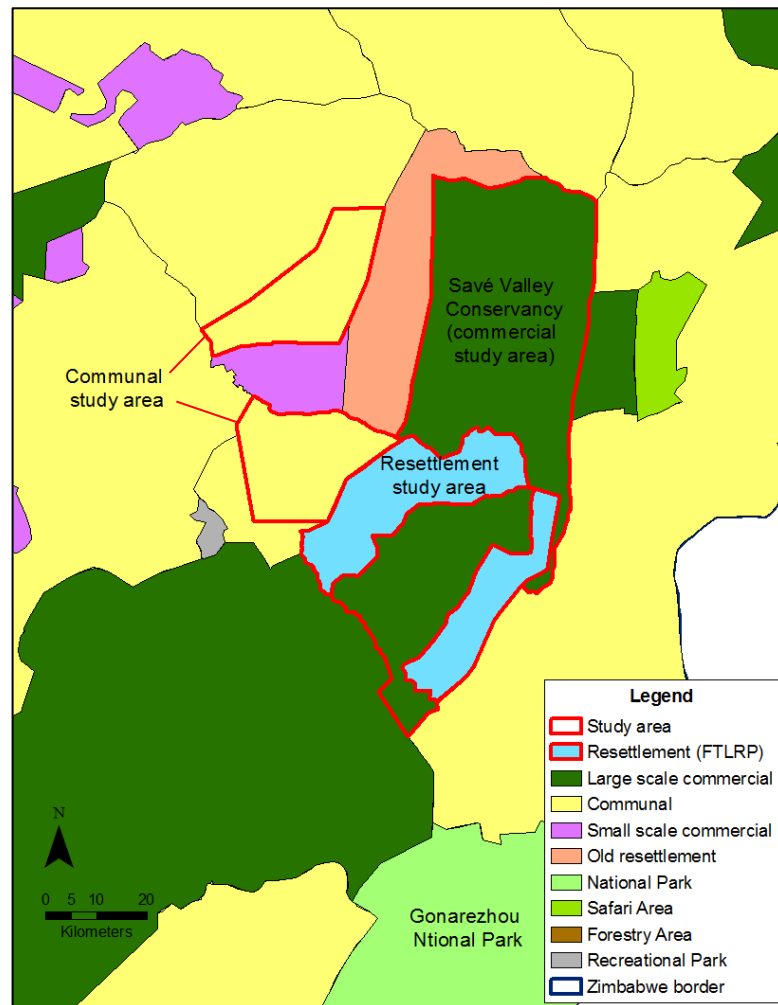
Savé Valley Conservancy is a private game reserve that has been partially resettled since 2000 as part of the FTLRP. The areas of SVC that were not resettled constitute the commercial LUT of the study area (Figure 2.2). The topography is gently undulating, with gneisse, paragneisse and granite outcrops rising up to 250m above ground (Pole, 2000), and an elevation of 480-620m above sea level (Pole *et al.*, 2004). Soil quality is poor and rainfall is low (474-540mm per annum) and highly variable, with a wet season between November and March and a dry season between April and October (Lindsey *et al.*, 2009b; Pole *et al.*, 2004). The main vegetation type is deciduous woodland savanna, with *Colophospermum mopane*, *Acacia tortillas* and *Acacia-Combretum* woodlands, and riparian vegetation along the watercourses (Pole *et al.*, 2004). The conservancy falls into the Zambezian and mopane woodlands ecoregion (Olson *et al.*, 2001).



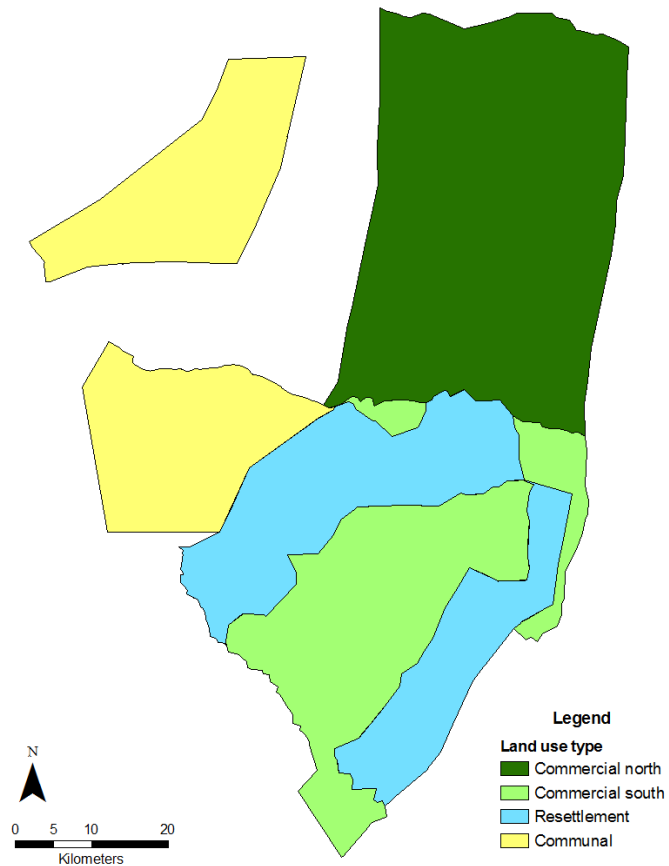
**Figure 2.1** Cheetah distribution in southern Africa in 2007. The study site (white box) is connected to other cheetah range areas by commercial farmland and national parks to the south. Adapted from [http://cheetahandwilddog.org/images/maps/sa\\_cheetah\\_range.jpg](http://cheetahandwilddog.org/images/maps/sa_cheetah_range.jpg) (IUCN/SSC, 2007).

SVC was formed in the 1991 from commercial cattle farms and state land (Wels, 2003). Almost all domestic livestock and all boundary fences between the constituent properties were removed, and a 1.8m high 12-strand electrified double game fence was constructed around the perimeter (Hargreaves *et al.*, 2004; Wels, 2003). Prior to resettlement SVC had an area of approximately 3,490 km<sup>2</sup>. For the purposes of analysis the commercial LUT was subdivided into the commercial

south (south of the Turgwe river; approximately 890 km<sup>2</sup> not including resettlement area) and commercial north (north of Turgwe river; approximately 1,640 km<sup>2</sup>). The resettlement area shares a much more extensive border with the commercial south than the commercial north (Figure 2.3).

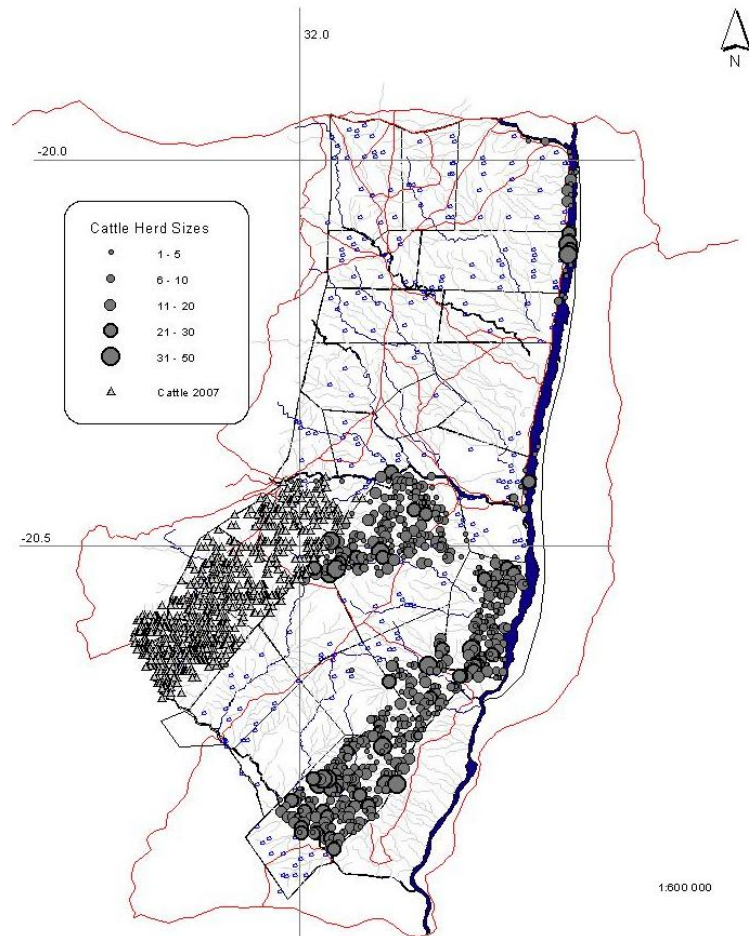


**Figure 2.2** Land use types around Savé Valley Conservancy. Only the SVC resettlement area is shown as the exact locations of the other FTLRP resettlement areas were not known. Commercial land links SVC to Gonarezhou and other wildlife areas.



**Figure 2.3** Distribution of the land use types in and around Savé Valley Conservancy included in the study.

In 2000 and 2001 an area of approximately 960 km<sup>2</sup> the south of the conservancy was resettled under the FTLRP, reducing the effective area of SVC to approximately 2,530 km<sup>2</sup> (Figure 2.3, Figure 2.4). All or parts of Mukwazi, Mukazi, Angus, Humani, Masapas, Levanga, Senuko and Mkwazine ranches (see Figure 1.5) were abandoned by their owners and taken over as resettlement areas, and the perimeter fencing around these properties was stolen (Lindsey *et al.*, 2009b). The human population density in the resettlement area is thought to be roughly 7 people per km<sup>2</sup> (commercial farmer, pers. comm.), but reliable data are very difficult to obtain. Aerial survey data indicates that the resettlement area supports more than 12,000 cattle (Figure 1.4), 4,500 goats, 650 sheep, 400 donkeys, and 400 domestic dogs (Joubert, 2008).



**Figure 2.4** Distribution of cattle observed in the 2008 aerial survey (Joubert, 2008) of Savé Valley Conservancy, indicating the area that was resettled. The western properties were not surveyed in 2008 due to fuel shortages, so data from 2007 are presented for this area (triangles).

To the south of SVC private game reserves and commercial farms link the conservancy to Gonarezhou National Park and the rest of the Greater Limpopo Transfrontier Conservation Area (TFCA) such as Kruger National Park in South Africa, while communal lands make up most of the remainder of its borders (Figure 2.2). An area of 715 km<sup>2</sup> composed of the Matsai, Ndanga and Bikita Communal Lands to the west of SVC were included in the study (Figure 2.2). Human population density in the communal areas neighbouring SVC varies between 11 and 82 people per km<sup>2</sup> (Pole, 2006, cited in Lindsey *et al.*, 2009b).



## 2.4 People of the study area

Pooling all land use types across Zimbabwe, 98% of the population were African, with the Shona making up 82%, Ndebele 14% and other African groups representing 2% (Central Intelligence Agency, 2011). Europeans made up less than 1% of the population (mainly of British descent, but some have Afrikaans and other European ancestry), while the remaining 1% were of Asian descent or mixed race (Central Intelligence Agency, 2011). The demographics of the people at the study site reflected this national pattern, although the study was conducted in a Shona area with very few Ndebele people. Ninety two percent of the 359 respondents indicated that they were Shona, 2% were white Zimbabweans of British descent, 1% were Afrikaans, and the remaining 6% represented other groups, or did not answer the question. These figures varied little between land use types, although Europeans were found only in the commercial LUT. When asked to provide their cultural group, some Shona respondents reported the dialect of Shona that they speak, such as Karanga, Duma or Ndau. Culture does not differ greatly between people of these dialects (Beach, 1994).

Subsistence farming was the main occupation for most Zimbabweans living in the communal and resettlement areas. Farms are normally located relatively near to homesteads, which included buildings constructed of wooden poles, clay or brick, often with roofs of thatching grass or occasionally corrugated metal (Figure 2.5). Maize was the main staple crop, which was ground and used to make *sadza*, a stiff porridge eaten for most meals with a relish of vegetables or meat. Subsistence agriculture was generally conducted without access to sophisticated farming equipment such as tractors, so much time was spent driving ox-drawn ploughs, hoeing, planting and reaping harvests by hand. Maize may be ground either by hand (Figure 2.5) or taken to a grinding mill. Goats, poultry, and occasionally sheep or pigs were kept to provide meat and other animal products, while donkeys were kept for draught power (Bourdillon, 1994). Cattle were also

reared for food, but they served a number of other purposes including drawing ploughs and scotch carts, acting of symbols of wealth, and they were used along with cash by the family of the groom to pay the family of the bride in marriages (Beach, 1994). In some parts of Africa the area where people graze their cattle changes seasonally (Maddox, 2003), but at the study site grazing areas were relatively static throughout the year (T. Mudadi, pers. comm.). Overcrowding and overgrazing in the communal LUT often resulted in only a single suitable grazing area being available, while in resettlement areas, a single communal grazing area was allocated to each village (Chaumba *et al.*, 2003b; de Villiers, 2003; Wolmer *et al.*, 2004; Zinyama *et al.*, 1990; T. Mudadi, pers. comm.).



**Figure 2.5** Shona homestead, with an occupant grinding maize. Note the round buildings of brick or wood with thatched roofs; the kitchen with clay walls; the scotch cart for transportation, and chickens to provide food.

Although subsistence farmers often sold any surpluses they have, such income was rarely sufficient to pay bride prices or for other services for which cash is required, so people from rural areas often also spent long periods of time away from their home searching for paid employment (Bourdillon, 1994). At the study site many of the workers in the commercial LUT were from the neighbouring communal areas, but apart from work on commercial farms employment opportunities were limited in rural areas. Although income-generating projects such as beekeeping schemes have been successful in Zimbabwe and elsewhere in Africa (Illgner *et al.*, 1998; Nel *et al.*, 2000), this was not practiced by people at the study site. A more common practice among rural Zimbabweans is to look for work in the cities (Bourdillon, 1994). Those with jobs often found themselves supporting large extended families (Beach, 1994), and remittances from employed Zimbabweans, especially those outside the country, played an important role in Zimbabwe's economy (Magaramombe, 2010). In addition to creating financial linkages with their families in their rural homes, economic migrants often maintained strong ties with their home areas, visiting whenever possible and often returning permanently when they have sufficient savings.

The rural areas to which many migrants return home had a parallel system of local authority. Since independence the legal authority rests with the elected officials at a village, ward, district, provincial and national level, but the traditional leaders were still respected and in practice continued to perform many duties in the community (Byers *et al.*, 2001). Traditionally, headmen had authority in villages, and many villages fell under a Chief, who is the representative of the ancestral spirits, who were considered the true authorities of the land (Bourdillon, 1994).

Since the arrival of European missionaries most of the population have converted to Christianity, but this had not completely replaced traditional religion and beliefs (Beach, 1994; Central Intelligence Agency, 2011). Today at least half of Zimbabweans believe in a combination of Christian and traditional beliefs (Byers *et al.*, 2001; Central Intelligence Agency, 2011). According to traditional Shona religion when people died their spirits return to the area, and may take the form of animals (Bourdillon, 1994). For example the spirits of former Chiefs, *Mhondro* spirits, were thought to take the form of lions (Gelfand, 1969). They were believed to communicate with their living descendants by possessing spirit mediums, who were thus able to convey messages about which sites were sacred, and inhabited by spirits (Byers *et al.*, 2001). Certain rules should be observed at sacred sites such as restriction of access and the inhibition of certain practices (taboos) like hunting in order to avoid punishment by the spirits and to ensure good rains (Bourdillon, 1994; Byers *et al.*, 2001). Another form of taboo is totemism, whereby people of different clans or kinships adopt a totem, frequently an animal (Kwashirai, 2009a). People should avoid harming or eating their totems, although these rules are not always observed closely, and some people reconcile their beliefs with their protein requirements by avoiding eating only a part of their totem animal (Beach, 1994). Belief in witchcraft was also very pervasive (Beach, 1994; Gelfand, 1969), and some species such as owls, snakes and hyenas were feared as they were believed to be used by witches for transport or to run errands (Kwashirai, 2009a).

Culture varied more between different cultural groups than between different land use types, although Europeans were almost exclusively found in towns and in the commercial LUT. The culture of the white Zimbabweans of European descent was much more similar to that of Europeans than the traditional culture of Africans. Rather than relying on subsistence farming, white people were generally engaged in work such as on commercial farms or at commercial enterprises in the cities. Income on commercial farms varied from growing crops in areas of

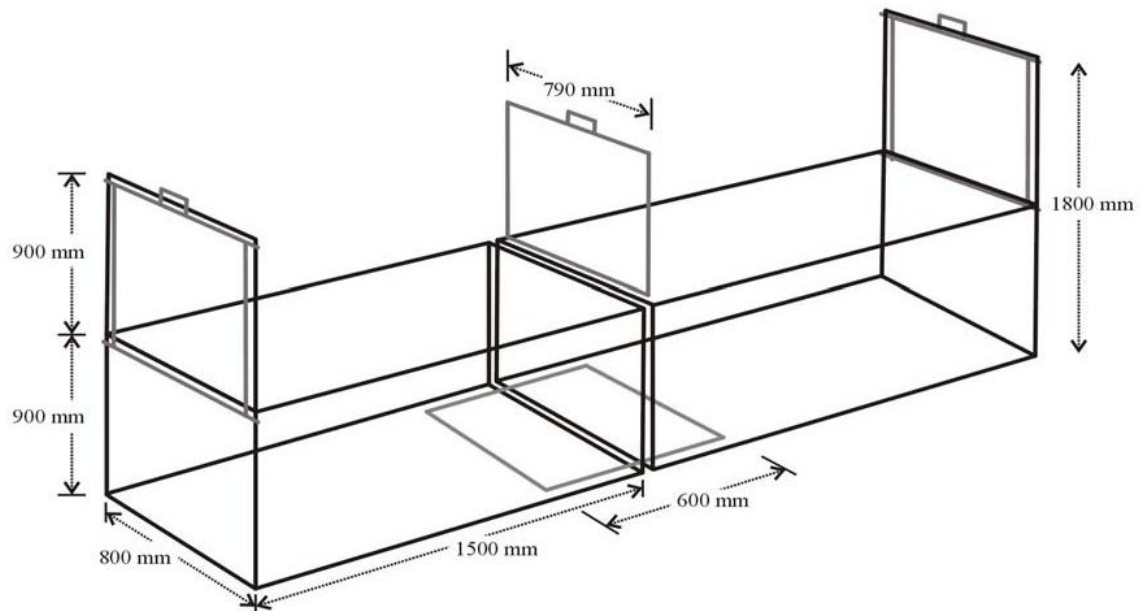
higher rainfall, raising livestock such as cattle in lower rainfall regions, to game ranching, which can lead to income from both the hunting and tourism industries. A degree of animosity was evident between the remaining commercial farmers (who were generally European) and people that took over commercial land for resettlement (who were exclusively African), although many commercial farmers worked hard to maintain cordial relations with their new neighbours or occupiers (Blair, 2002, pers. obs.).

## **2.5 Methods**

### **2.5.1 Capturing and collaring cheetahs**

In order to address objective 3 and deploy the GPS collars attempts to capture cheetahs were made using both trapping and free-darting methods. Three double-door box trap cheetah capture cages (Figure 2.6) were constructed from steel welded mesh, square tubing and angle iron according to Marker's (2002) specifications. Each trap comprised of two cages which could be separated to facilitate their transport on the back of a Land Rover pickup. This trap design has been successfully used to capture cheetahs in South Africa, Botswana and Namibia (Broomhall *et al.*, 2003; Houser *et al.*, 2009a; Marker *et al.*, 2008; Marnewick and Cilliers, 2006). Most traps were baited using a live goat weanling, which is considered the preferred method where scent marking posts are not available (K. Marnewick, pers. comm.; A.-M. Houser, pers. comm.), but various combinations of baits were used including potential scent making posts (when available), cheetah scat (collected from captive cheetahs), playback of recordings of goat calls, prey species or cheetahs, fresh game meat, and drags of impala guts around the trap. Traps were checked and goats were fed and watered daily, and goats were returned back to their herds approximately every three days and replaced with a different individual. Initially one of the three traps was split into its two constituent cages, which were used to house the goat in order to provide extra protection from predators when used as bait in the two remaining traps. However, during the

study a number of cage doors were stolen by poachers, leaving insufficient equipment to use protective cages for the goats. After this point goats were tethered and all three traps were deployed concurrently.



**Figure 2.6** Design of double-door box traps constructed to capture cheetahs in Savé Valley Conservancy (Marker, 2002).

Around the bait a thorn bush fence or ‘boma’ was constructed, so that the only point of access was through the trap cage (Broomhall *et al.*, 2003; Houser *et al.*, 2009a; Marnewick and Cilliers, 2006). Ranch owners, managers, professional hunters, and game scouts were consulted to determine at which sites traps should be set to capture cheetahs. Trapping sites included putative cheetah scent making spots, areas where cheetahs or their spoor were seen recently or in the past, areas thought to be of high cheetah density, and locations near water points (Figure 2.8).

The traps were deployed at 15 different locations, all located within the commercial north land use type in SVC (Table 2.1, Figure 2.8). This area was selected for trap deployment as cheetahs appeared to be rare or absent from other LUTs (Chapter 3, Chapter 4). Trapping effort was

initially concentrated on Bedford due to its proximity to the resettlement area, as study animals collared in this area would be most likely to have the opportunity to range within the resettlement area. Trapping effort was later shifted to Msaize in order to maximise trapping probability, as the management staff on the property believed they had the greatest density of cheetahs in the conservancy (Chapter 4). After only a brief trapping period, however, the managers suddenly requested that trapping on Msaize was terminated, and no reason was provided. Traps were also set on Chishakwe and Gunundwe. The other properties in the commercial north were not used for trapping because either they declined to take part in the trapping study, or because their management staff believed that they had a very low cheetah density.



**Figure 2.7** Cheetah trap set up used in Savé Valley Conservancy to capture cheetahs in 2008 and 2009. Note the cage providing a path to the bait through the thorn bush boma.

In addition to trapping, free-darting was used to attempt to immobilise cheetahs when they were seen opportunistically (Bissett and Bernard, 2007; Broomhall *et al.*, 2003; Caro, 1994). A researcher working on a wild dog project at SVC, Rosemary Groom, made her Dan-Inject 2944 JM dart gun available when possible. The immobilisation of cheetahs can be carried out by any individual holding a licence to immobilise wildlife, which is awarded on successful completion of a brief training course. The author did not hold an immobilisation licence, so three other licence holders in SVC were asked to assist. When cheetahs were seen, the nearest licence holder was contacted and requested come to the area of the sighting to assist with the immobilisation.

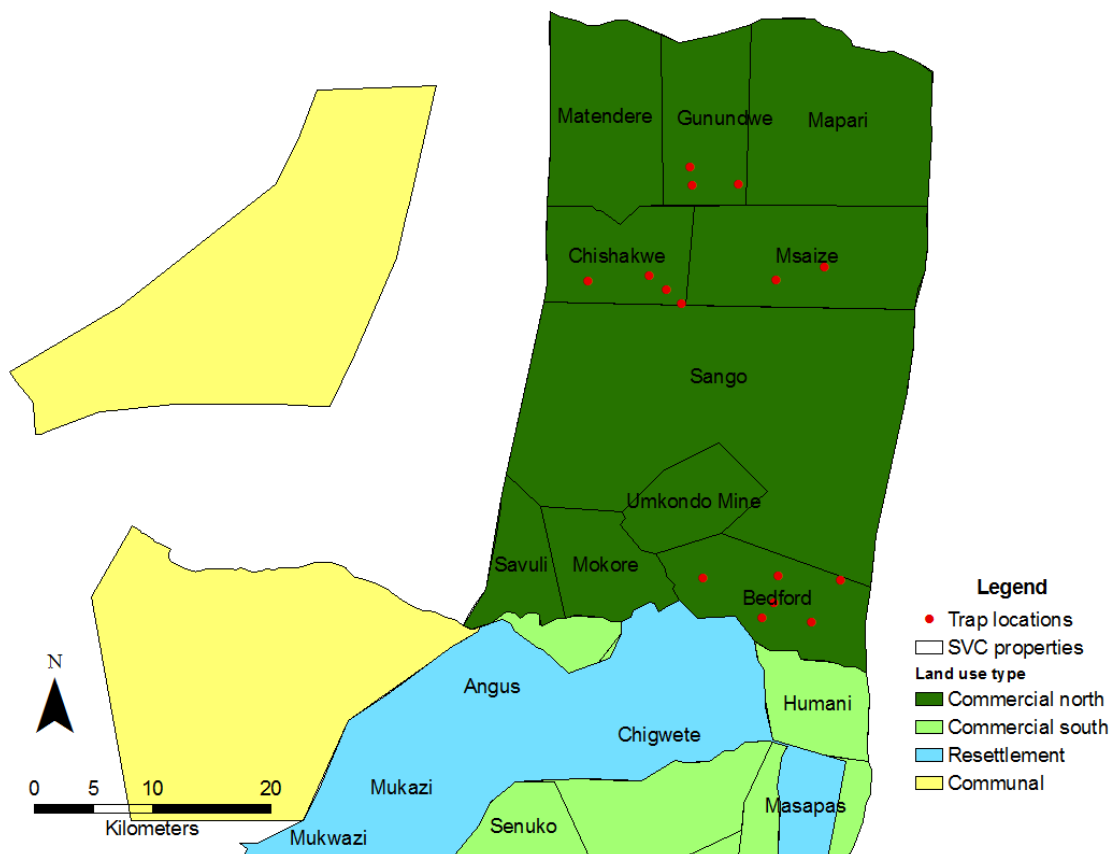


Figure 2.8 Location of traps set in Savé Valley Conservancy to capture cheetahs in 2008 and 2009. Traps were deployed exclusively in the commercial north on Bedford, Chishakwe, Msaize and Gunundwe properties.



**Table 2.1** Number of trap locations and trap days used to capture cheetahs in Savé Valley Conservancy in 2008 and 2009.

Property	Number of trap locations	Number of trap days
Bedford	6	74
Msaize	3	30
Chishakwe	3	40
Gunundwe	3	68
Total	15	212

Ketamine (dosage 2.5-3 mg/kg) and medetomidine (dosage 50-80 µg/kg) (Pfizer Animal Health, PO Box 783720, Sandton, 2146, South Africa) were carried to immobilise cheetahs captured, which would be administered with a pole syringe for trapped cheetahs or a dart gun for free-darted cheetahs. Atipamazole hydrochloride (200 µg/kg) (Bayer Animal Health, PO Box 143, Isando, 1600, South Africa) was available to reverse the immobilisation (Kock, 2001; Marnewick *et al.*, 2007; Foggin, pers. comm.).

Four Argos-linked GPS collars (Sirtrack Tracking Solutions, Private Bag 1403, Goddard Lane, Havelock North, 4157, New Zealand) were available to be fitted to immobilised cheetahs. These collars record the location of the cheetah using the GPS receiver, and transmit this information over the Argos satellite network to the user via the internet on a weekly basis. All data are also stored on a data logger, from where they can be downloaded once the collar is recovered. The collars were fitted with a timed release unit, programmed to release the collars 12 months after they were fitted. Two Lotek GPS-3300 GPS-only collars (Lotek Fish and Wildlife Monitoring Systems, 115 Pony Drive, New Market, ON L3Y7B5, Canada) were also available. These were fitted with timed release units which release the collars only six months after they are fitted, due to battery constraints. They do not transmit the data collected to the user but store it on a data logger, so the data can only be accessed at the end of the study period. Both types of collars were programmed to log the location of the cheetah at four hour intervals (0:00, 4:00, 8:00, 12:00, 16:00 and 20:00), and both also carried a VHF beacon to allow the current location of the collars

to be determined using a Wildlife Materials Inc. VHF receiver (Wildlife Materials Inc., Carbondale, IL, USA).

The Sirtrack and Lotek collars weighed 450g and 285g respectively, and therefore weighed 1.2% and 0.8% of the minimum weight of an adult female cheetah (37.7 kg, Marker and Dickman, 2003). Although some procedures can have deleterious effects on study animals (Saraux *et al.*, 2011), Kenward (2001) found little evidence for collars causing adverse effects when they weighed less than 3% of the body weight of the study animal. In a study on cheetahs Laurenson and Caro (1994) found that animals that were fitted with collars weighing up to 545g (1.5% of the body weight of the study animals) did not differ from uncollared animals in hunting success, food intake or reproductive success, so it is unlikely that the collars to be used in this study will be detrimental to the cheetahs studied.

Home ranges were to be mapped in ArcView 3.2 (ESRI, 1999) using the Animal Movement extension (Hooge *et al.*, 1999) which would be used to calculate cheetah home range sizes using kernel (Worton, 1987) and minimum convex polygon (MCP) (Jenrich and Turner, 1969) estimators, to allow comparisons with previous studies (such as Broomhall *et al.*, 2003; Marnewick and Cilliers, 2006; Purchase and du Toit, 2000). Ranges 6 (Kenward *et al.*, 2003) can be used to calculate whether home range areas reach asymptote and to investigate the degree of home range overlap (Marnewick and Cilliers, 2006). Each fix would be assigned to an LUT, and the proportion of each LUT that make up the home ranges of the cheetahs was to be calculated. The chi-square test for differences would be used to assess LUT preferences of cheetahs (Broomhall *et al.*, 2003).

Despite extensive efforts to capture and collar cheetahs, no cheetahs were captured. Three leopards, a lion and a large-spotted genet (*Genetta tigrina*) were captured in the traps and successfully released without any visible injuries (Table 2.2). Non-target species were not

immobilised and were released by opening the front door of the trap, which was operated by pulling a rope from within the vehicle that was attached to the cage door. While in theory the collars could have been deployed on the leopards and possibly the lion that were trapped in order to determine how the ranging behaviour of these species may be influenced by changes in land use type, the explicit directive from DWT was that the telemetry should focus on cheetahs alone. Free-darting of cheetahs was attempted on four occasions (totalling five animals) after cheetah sightings were made opportunistically. On one occasion the 2-way radio network was not functional, so assistance was sought by foot and by the time the licence holder arrived the cheetah could no longer be found. On the remaining three occasions visual contact with the cheetahs had been lost within approximately 30 minutes of the initial sighting, which did not allow sufficient time for the licence holder to arrive. As a consequence no collars were deployed during the study and thus objective 3 could not be addressed directly.

**Table 2.2 Species captured in Savé Valley Conservancy in 2008 and 2009, and survey effort required per capture.**

Species	Number of captures	Mean number of trap days per capture
Leopard	3	71
Lion	1	212
Large spotted genet	1	212

Failure to capture cheetahs was attributed partially to the reduced number of cheetahs remaining at the study site. The absence of fencing, permitting free movement of cheetahs (and also humans) between LUTs was the reason why SVC was selected as the study site, but this factor was perhaps also responsible for the decline in cheetah density (see Chapter 8). Delays in the onset of fieldwork due to political violence and bureaucracy also limited the amount of time available for trapping. Free-darting may have been successful if the author had been trained to immobilise wildlife and had permanent access to a dart gun, but this was not possible due to funding constraints.

## 2.5.2 Interviews

To address objectives 1, 4, 5 and 6 a series of interviews were conducted, which provided the data on cheetah sightings (Chapter 4), perceptions of livestock predation (Chapter 6) and attitudes towards large carnivores and tolerance of predation (Chapter 7). The specific methods used for each chapter are presented in the methods section of those chapters, but the general methods used for the interviews are discussed below.

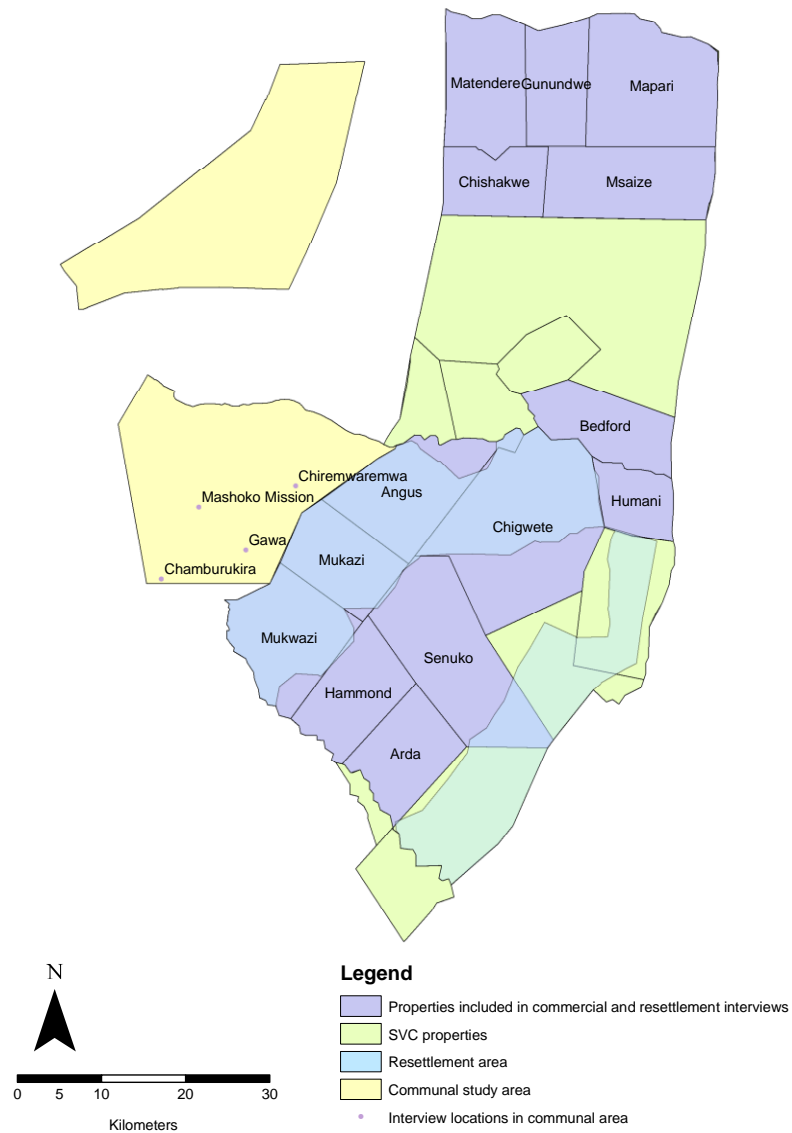
A total of 359 structured interviews were held between October 2008 and August 2009 across commercial, resettlement and communal land use types (Table 2.3, Figure 2.9). Ranch owners, ranch managers, professional hunters, game scouts and other workers were interviewed on commercial properties, and farmers, herders and political leaders such as kraal heads and village chairmen were interviewed in the resettlement and communal LUTs. Due to political instability and delays in the onset of fieldwork at SVC (see section 2.2) it was not possible to pilot test the interview schedule at the study site, so pre-testing and subsequent revision was instead conducted in communal land in Matabeleland South province prior to the onset of the study. The interviews were optimised for the collection of cheetah sightings reports (Chapter 4), so the survey strategy was designed to maximise the number of participants interviewed within the survey localities selected rather than collecting more detailed information from fewer individuals. The relatively large sample size also allowed quantitative statistical analysis of the data.

Interview design followed the recommendations of Inskip and Zimmermann (2009), White *et al.* (2005) and Browne-Nuñez and Jonker (2008). A combination of closed and open questions were used, covering general demographic data, the occurrence of large carnivores, livestock predation, and attitudes and knowledge about carnivores (Lindsey *et al.*, 2005; Romañach *et al.*, 2007; Selebatso *et al.*, 2008; Shibia, 2010). The full interview schedule is provided in Appendix 3. Permission to conduct the interviews was granted by the Provincial Administrator, Rural District

Council District Administrators, police, chiefs, kraal heads, and participants. Interviews in commercial areas were conducted by the author in English or in Shona either by the author with the help of an interpreter, or by field assistant Innocent Mavhurere (IM). Due to the politically charged situation in the resettlement areas, a local facilitator was hired to introduce the project to residents, gain their consent, and help to diffuse any problems that arose. The author was not able to interact directly with respondents in the resettlement area, and all interviews in the resettlement and communal areas were conducted by IM.

**Table 2.3 Number and location of interviews conducted across each LUT in and around Savé Valley Conservancy in 2008 and 2009. Some respondents referred to multiple properties.**

LUT	Location	Interviews
Commercial	Arda	1
	Chishakwe	9
	Gunundwe	7
	Hammond	5
	Humani, Chigwete and Bedford	14
	Mapari	1
	Matendere	1
	Msaize	3
	Senuko	3
	Whole conservancy	1
	<i>Subtotal</i>	<i>45</i>
Resettlement	Angus	49
	Chigwete	28
	Mukazi	40
	Mukwazi	42
	<i>Subtotal</i>	<i>159</i>
Communal	Chiremwaremwa	48
	Gawa	34
	Mashoko	41
	Zaka	32
	<i>Subtotal</i>	<i>155</i>
<b>Total</b>		<b>359</b>



**Figure 2.9** Location of interviews conducted in and around Savé Valley Conservancy in 2008 and 2009. Most interviews were centred along the area where the commercial, resettlement and communal LUTs meet, around the former commercial properties Angus, Mukazi and Mukwazi. Due to the nature of Zimbabwe's land tenure system areas sampled are represented by polygons in the commercial and resettlement LUTs, and by points in the communal LUT.

Employing local research assistants to conduct interviews has some advantages over interviews that are conducted by external researchers, such as fewer problems associated with language difficulties, understanding of local issues, and distrust of outsiders (Davies and du Toit, 2004; Romanach et al., 2007; pers. obs.). This method, however, also presents many disadvantages, and makes it difficult for the author to determine how well the respondents understood the questions

and whether they were answering truthfully. It makes it much more challenging to gain an understanding of the context of the responses and develop a more comprehensive understanding of the way of life of the study subjects. Furthermore, any information that was not recorded by the assistant is lost, such as body language and comments made outside the scope of the interview. Where possible many researchers prefer to interview the respondents in person (Dickman, 2008; Ogada et al., 2003; Woodroffe et al., 2007), but this was not an option for this study.

IM spent approximately one week at each locality (either a former ranch in the resettlement area or a village in the communal area), and within that period visited as many households and farms as possible, questioning the person of the most senior status present (Dickman, 2008). Preference was given to areas close to the former western boundary of SVC, where the commercial, resettlement and communal LUTs meet and there are no physical boundaries such as game fencing or large rivers. Where appropriate, photographs (Appendix 4) and descriptions of the species were used in order to reduce the possibility of confusion between species (Dickman, 2008; Gros, 2002). Respondents were informed that their participation was voluntary, and that they were free to decline to answer any questions if they wished to do so. It was stressed that it was preferable to answer “I don’t know” where they were unsure of the answers to questions. Interviews with community members were conducted in the western resettlement area and the neighbouring Matsai Communal Land (Figure 2.9). These areas were selected because unlike other regions of the study site the resettlement and communal land border each other directly, and are separated by no physical barrier. Predators are therefore more likely to have the opportunity to access both LUTs in this region, making the land use types directly comparable. Eleven commercial properties were sampled, although the staff of five ranches were not included either because their management declined to take part in the study, they could not be reached due to logistical constraints, or they had no staff on site (Figure 2.9).

The area sampled within the resettlement and communal LUTs was limited by the availability of fuel and funding. Although the official currency at the time was the Zimbabwe dollar, government price controls and hyperinflation had given rise to a widespread black market economy that operated exclusively in foreign currency. DWT only had access to cash in Zimbabwe dollars so were not able to provide the foreign currency cash necessary to hire the facilitator or pay for the accommodation for IM, so this had to be provided by the author. As a result these financial constraints limited the scope of the sampling within the resettlement and communal LUTs.

## **2.6 Summary**

The impact of the FTLRP on cheetah ranging behaviour was studied using double-door box traps and free-darting to attempt to capture animals and deploy Argos-linked GPS collars. Efforts to trap cheetah were, however, unsuccessful. Methods used to investigate the impact of the FTLRP on the ecology of cheetahs and other large carnivores are discussed in Chapter 3, Chapter 4 and Chapter 5. Interviews were conducted across each land use type totalling 359 participants to collect cheetah sighting reports and assess the perceived level of human-wildlife conflict. Further details on interviews methodology are provided in Chapter 4, Chapter 6 and Chapter 7.



# Chapter 3 Spoor counts

---

## 3.1 Introduction

Reliable data on the size and density of wildlife populations is of critical importance to wildlife management and conservation. It can be used to determine parameters such as the status, population trends, or habitat requirements of species at local and global scales (IUCN, 2010b; Sutherland, 1996a). In the current study, estimates of the abundance of wildlife populations were needed to assess the impact of changes in land use, but estimating this information is often challenging, particularly for cheetahs and other cryptic carnivores that occur at low densities (Gese, 2001; Gros *et al.*, 1996).

Direct methods, which require researchers to make sightings of the study animals (for example Durant *et al.*, 2004), can provide detailed information, but they are expensive, take several years to conduct, and are not well suited to habitats with poor visibility such as Savé Valley Conservancy (SVC) (Wilson and Delahay, 2001). Capture-recapture studies (such as Corn and Conroy, 1998) are also well established and have a sound theoretical basis for estimating abundance (Wilson and Delahay, 2001), but they depend on being able to capture and recapture a sufficient number of individuals, which may be prohibitive (see section 2.5.1). Ground based or aerial transect counts can be used to estimate population sizes using total counts or sampling methodologies such as distance sampling, but they are better suited to ungulates and other large animals rather than carnivores, which tend to occur at a relatively low density and can be difficult to detect (Mills, 1996). Call up surveys can provide reliable results, but their usefulness is limited to species that are attracted to calls such as spotted hyenas and lions (Ogutu and Dublin, 1998), so this method is not suited to surveying cheetahs.

Indirect survey methodologies are often cheaper and quicker to conduct than direct methods, and are well suited to large carnivores (Jhala *et al.*, 2011). Radio telemetry provides high quality data (for example Smith, 1993), but is relatively costly and time consuming (Durant, 2004), and depends on capturing study animals, which can be difficult. Camera trapping can provide reliable population estimates (for example Balme *et al.*, 2009), but the method is only suitable in areas where the cameras are unlikely to be stolen such as areas of low human density, and cameras and batteries can be very expensive (Silveira *et al.*, 2003). Surveys that depend on submissions of photographs of study animals taken by tourists (such as Bowland and Mills, 1994) are useful for estimating abundance, but they are not suitable at the study site as very few tourists visit the area.

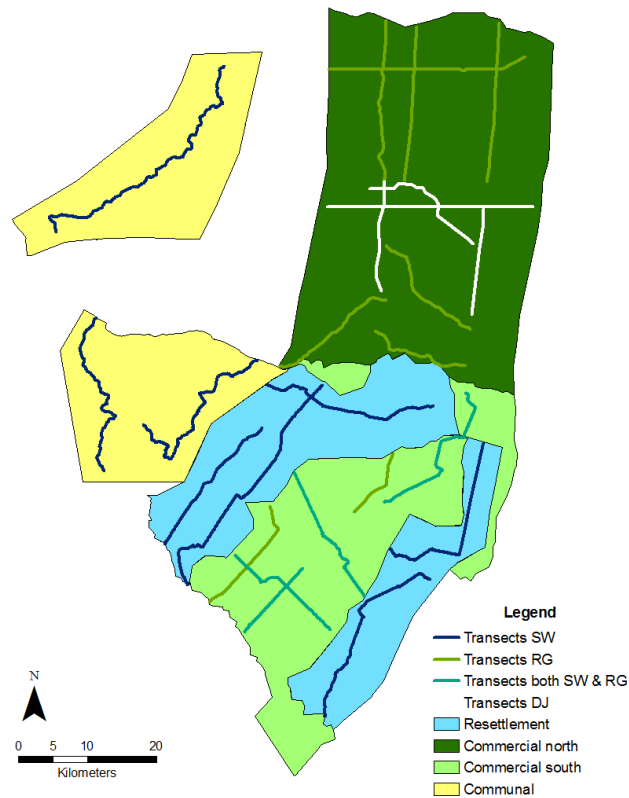
An increasingly popular indirect sampling method to estimate the abundance of large carnivores is spoor counts (e.g. Edwards *et al.*, 2000; Gusset and Burgener, 2005; O'Donoghue *et al.*, 1997; Servin *et al.*, 1987; Smallwood and Fitzhugh, 1995; Stephens *et al.*, 2006; van Dyke *et al.*, 1986). The methodology is ideally suited to dense vegetation types with sandy soils such as SVC (Bashir *et al.*, 2004), and has been applied to a number of African carnivores including the serval (*Leptailurus serval*), African wildcat (*Felis silvestris libyca*), black-backed jackal (*Canis mesomelas*), caracal (*Caracal caracal*), cheetah, lion, leopard, spotted hyena, brown hyena and wild dog (Balme *et al.*, 2009; Funston *et al.*, 2001; Funston *et al.*, 2010; Gusset and Burgener, 2005; Houser *et al.*, 2009b; Melville and Bothma, 2006; Stander, 1998). Significant linear relationships have been established between spoor density (number of spoor per 100km of transect) and true population density (Funston *et al.*, 2010; Stander, 1998). Spoor counts were used at the study site to estimate the abundance of cheetah, other carnivores, and prey species.

This chapter begins by comparing the spoor densities for each species as an index of their relative abundance between the three main land use types. It is predicted that the spoor densities of

large carnivores will be greatest in the commercial land use type (LUT), intermediate in the resettlement LUT, and lowest in the communal LUT. Furthermore spoor densities are compared between the commercial south (which is near to the resettlement area) and the commercial north (which is further from the resettlement area) of SVC. The distribution of the spoor of each species is then mapped, and equations are applied where available to estimate population density and population sizes in each LUT (objective 1). Finally sampling effort and precision are considered.

### 3.2 Methods

Spoor transects were established in each land use type along existing unsealed roads, and spoor counts were conducted in October and November 2008 (Table 3.1). The transects were generally composed of substrates that preserved spoor well such as hard sand (Stuart and Stuart, 2003). A vehicle was driven at a steady speed of 20 km/h in the early morning (generally between 05:00 and 08:00), following the methods of Stander (1998) and other studies (Balme *et al.*, 2009; Davidson and Loveridge, 2006; Funston *et al.*, 2001; Gusset and Burgener, 2005; Houser *et al.*, 2009b). An experienced tracker sat on the front of the vehicle scanning the transect for spoor, and stopping the vehicle to examine mammalian spoor encountered. Transects were driven towards the sun where possible in order to facilitate the detection and identification of spoor (Liebenberg *et al.*, 2010). The species, group size and transect name were recorded for each fresh spoor encountered. Spoor were disregarded if they were over 24 hours old or if the spoor were thought to be from an individual that had been recorded earlier on the transect that day, which was determined from spoor morphology, group size and direction of travel. It was not possible to differentiate spoor from different species of jackals (black-backed and side-striped (*Canis adustus*)), hares (scrub hare (*Lepus saxatilis*) and springhare (*Pedetes capensis*)) or genets (large-spotted or small-spotted (*Genetta genetta*)), so spoor from those species were grouped. Between one and three replicates were conducted for each transect (Table 3.1).



**Figure 3.1** Spoor transects conducted in and around Savé Valley Conservancy to determine the spoor density of large carnivores and other mammals in 2008. Note that some transects were conducted by both SW and RG (see also Table 3.1).

Spoor counts were conducted by three teams, one led by the author (SW) and two led by other researchers, Rosemary Groom (RG) and Dusty Joubert (DJ) (Table 3.1, Figure 3.1). RG and DJ conducted transects within commercial LUT, and recorded spoor from only porcupine (*Hystrix africaeaustralis*) and members of the order Carnivora (termed carnivores) with the exception of genets. In contrast SW conducted transects in each of the three LUTs and recorded the spoor of any mammal of the size of a scrub hare (*Lepus saxatillis*, approximately 2kg) or larger, including both carnivores and non-carnivores. In addition to the above data collected, RG and SW also recorded the distance along the transect and the coordinates of each spoor observation using Garmin GPS receivers.

**Table 3.1 Length and number of replicates of spoor transects conducted in 2008 to determine the spoor density of large carnivores and other mammals in Savé Valley Conservancy.**

Transect name	LUT	Transect length (km)		
		Replicate 1	Replicate 2	Replicate 3
1	Commercial north	23.5 <sup>a</sup>	23.3 <sup>a</sup>	
2	Commercial north	21.9 <sup>a</sup>	22.1 <sup>a</sup>	
3	Commercial north	22.3 <sup>a</sup>	22.2 <sup>a</sup>	
4	Commercial north	28.7 <sup>a</sup>	28.5 <sup>a</sup>	
7	Commercial north	20.4 <sup>a</sup>	20.4 <sup>a</sup>	
8	Commercial north	19.2 <sup>a</sup>	19.6 <sup>a</sup>	
9	Commercial north	15.0 <sup>a</sup>	15.0 <sup>a</sup>	
10	Commercial south	12.5 <sup>a</sup>	12.5 <sup>a</sup>	
11	Commercial south	25.0 <sup>a</sup>	25.0 <sup>a</sup>	25.8 <sup>c</sup>
12	Commercial south	21.2 <sup>a</sup>	20.0 <sup>a</sup>	
13	Commercial south	22.0 <sup>a</sup>	24.0 <sup>a</sup>	22.9 <sup>c</sup>
14	Commercial south	18.3 <sup>a</sup>	18.3 <sup>a</sup>	19.2 <sup>c</sup>
15	Commercial south	12.6 <sup>a</sup>	12.6 <sup>a</sup>	13.1 <sup>c</sup>
21	Commercial north	21.2 <sup>b</sup>	21.2 <sup>b</sup>	
22	Commercial north	29.4 <sup>b</sup>	29.4 <sup>b</sup>	
23	Commercial north	15.2 <sup>b</sup>	19.4 <sup>b</sup>	
24	Commercial north	16.9 <sup>b</sup>	16.9 <sup>b</sup>	
31	Resettlement	26.7 <sup>c</sup>		
32	Resettlement	28.3 <sup>c</sup>		
33	Resettlement	30.0 <sup>c</sup>		
34	Resettlement	40.7 <sup>c</sup>		
35	Resettlement	23.1 <sup>c</sup>		
36	Communal	45.0 <sup>c</sup>		
37	Communal	31.0 <sup>c</sup>		
38	Communal	34.1 <sup>c</sup>		

Data were collected by the team led by <sup>a</sup>RG, <sup>b</sup>DJ and <sup>c</sup>SW. Lengths of some transects varied slightly between replicates.

For non-carnivores (excluding porcupine) and genets, data collected by SW were used for analysis. For carnivores (excluding genets) and porcupine, data used for analysis was collected by SW in resettled and communal areas, and collected by RG and DJ in commercial areas. Sample penetration (ratio of sum of transect lengths (km) to survey area (km<sup>2</sup>)) for most LUTs was close to 7 (Table 3.2) as recommended (Stander, 1998).

**Table 3.2** Areas of each land use type in and around Savé Valley Conservancy, and survey effort of spoor counts conducted in 2008 to determine the spoor density of large carnivores and other mammals. Total length surveyed takes into account both the length of the transects driven and the number of replicates conducted.

Land Use Type	Area (km <sup>2</sup> )	Sum of transects (km)	Sample penetration	Total length surveyed (km)
Commercial north <sup>a</sup>	1,639	234	7.0	472
Commercial south <sup>a</sup>	891	112	7.9	224
Commercial south <sup>b</sup>	891	81	11.0	81
Resettlement <sup>c</sup>	960	149	6.5	149
Communal <sup>c</sup>	984	110	8.9	110
Total	4,474	686		1,036

<sup>a</sup>data collected by RG and DJ and used to estimate density of carnivores (excluding genets) and porcupine in commercial areas; <sup>b</sup>data collected by SW and used to estimate density of non-carnivores (excluding porcupine) and genets in commercial areas; <sup>c</sup>data collected by SW and used to estimate density of all species in resettlement and communal areas.

The relationship between spoor frequency (the number of kilometres of transect driven between records of spoor of a particular species) and sampling effort (the number of spoor recorded) was investigated by conducting bootstrap analyses on inter-spoor intervals (the distance between each spoor observation for a particular species, when transects are systematically combined). This was conducted by calculating 95% confidence intervals from two randomly sampled inter-spoor intervals with replacement, then progressively increasing the sample size and calculating fresh confidence intervals with each sample (after Stander, 1998) using R (R Development Core Team, 2010).

The distance from the start of the transect was recorded for each spoor observation in the SW and RG datasets using the odometer on a GPS receiver, and these data were used to measure the inter-spoor intervals. In the DJ dataset, however, this information was not recorded. For this dataset, inter-spoor intervals were estimated by distributing spoor for each species evenly along the transects on which they were recorded, assuming that group-living species occurred at mean group sizes. Mean group sizes were estimated using spoor count data in the RG dataset for all species with the exception of cheetah, as there were few cheetah spoor records in the RG dataset. Cheetah group sizes were therefore calculated using sighting data (see Chapter 4) as an

alternative. As the DJ dataset recorded only carnivores, all species had a mean group size of 1 with the exception of lion (mean group size 2), wild dog (mean group size 7) and cheetah (mean group size 2).

The difference between the two methods for calculating inter-spoor intervals was investigated using the leopard spoor data from the RG dataset as an example. Inter-spoor intervals were calculated from the leopard spoor data using both measured and estimated methods, and bootstrapping was carried out in R. Although the confidence intervals are slightly narrower for equal intervals than measured intervals, the difference is small and both methods produce confidence intervals that reach asymptote at approximately the same sampling effort (Figure 3.2). Inter-spoor intervals calculated using both methods were therefore pooled for analysis of sampling effort and precision.

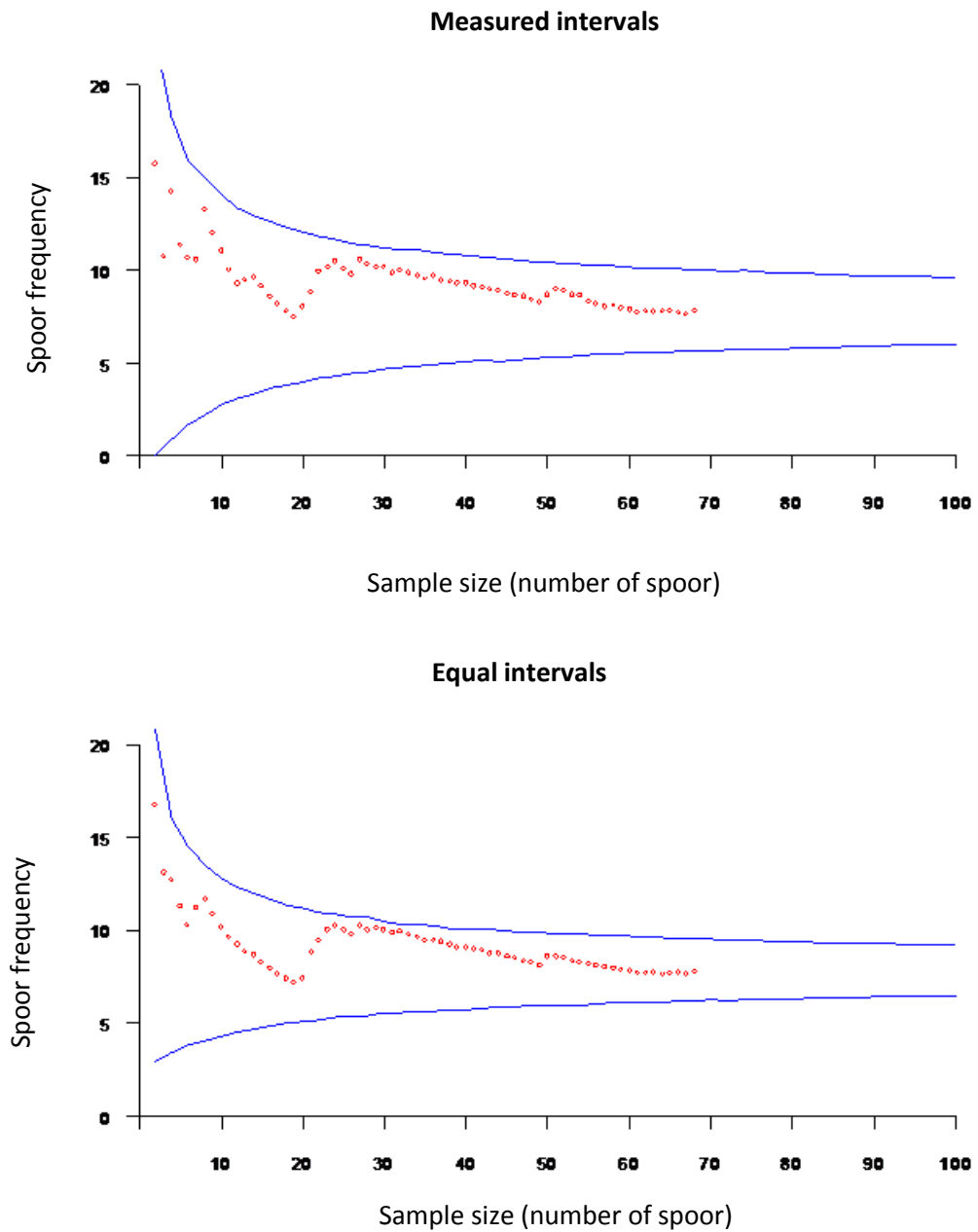


Figure 3.2 The relationship between spoor frequency and sampling effort for leopards on commercial transects in Savé Valley Conservancy in 2008, using both measured inter-spoor intervals and equal inter-spoor intervals. Red circles represent means and blue lines represent 95% confidence intervals. Both methods generate similar confidence intervals.



### 3.3 Results

#### 3.3.1 Spoor densities

Spoor were recorded from a total of 22 mammal species. Spoor were recorded from all 11 species of carnivores on commercial transects, but from only 3 species (African wild cat (*Felis silvestris lybica*), genet and spotted hyena) on resettlement transects, and from only 2 species (African wild cat and genet) on communal transects (Figure 3.3a). Spoor densities for carnivores differed significantly between LUTs (Kruskal-Wallis:  $\chi^2 = 20.933$ ,  $df = 2$ ,  $P < 0.001$ ), and were greatest on commercial transects, much lower on resettlement transects, and the lowest on communal transects (Figure 3.3a). Spoor density of large carnivores was 98% lower in the resettlement LUT than the commercial LUT. For all carnivores this figure was 92%.

The spoor densities of non-carnivore species follow a similar pattern. As shown in Figure 3.3b, on commercial transects spoor from all 11 species were recorded, while on resettlement transects spoor from 5 species were recorded (hare, common duiker, baboon (*Papio cynocephalus ursinus*), impala and elephant), and on communal transects spoor from only 2 species were recorded (hare and common duiker). Spoor density differed significantly between LUTs (Kruskal-Wallis:  $\chi^2 = 21.222$ ,  $df = 2$ ,  $P < 0.001$ ). With the exception of the common duiker, spoor densities for each species were highest on commercial transects, lower on resettlement transects and lowest on communal transects. The highest spoor density for the common duiker was recorded on resettlement transects, with an intermediate spoor density on commercial transects, and the lowest spoor density on communal transects. Spoor densities of non-carnivores were on average 72% lower in the resettlement LUT than the commercial LUT.

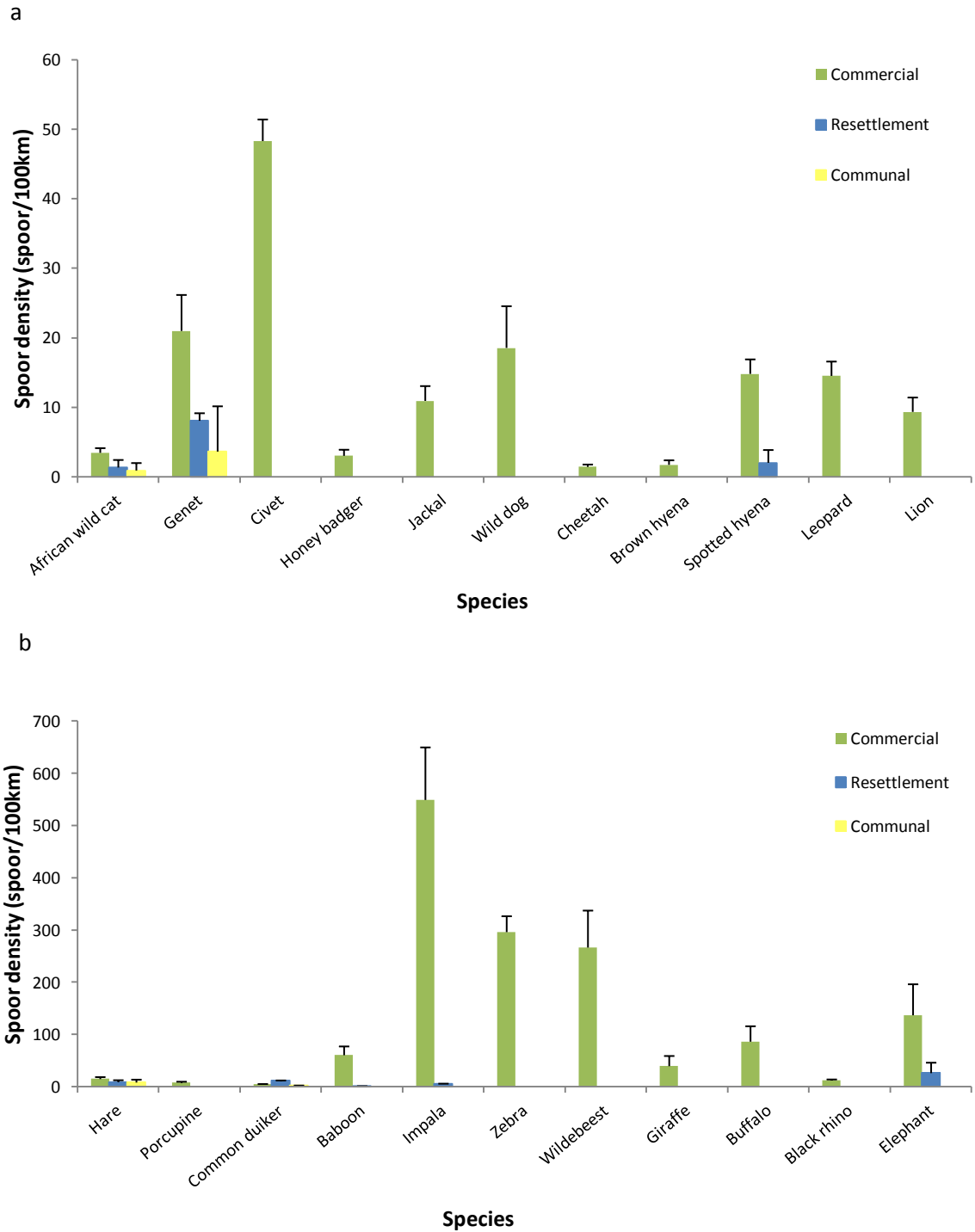
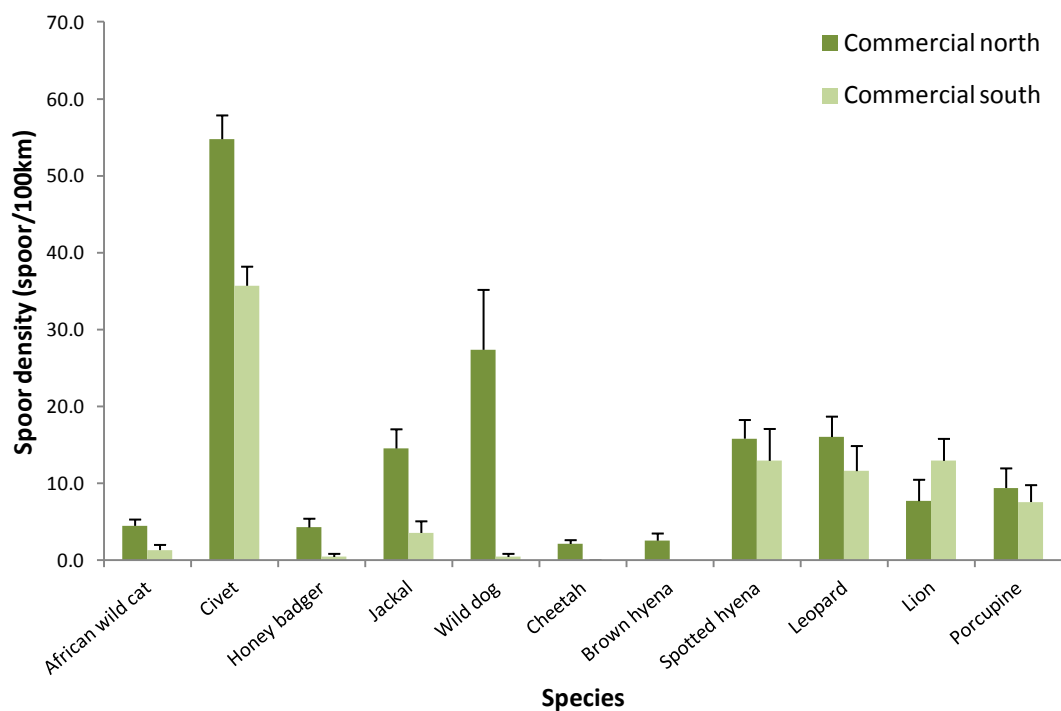


Figure 3.3 Spoor density across land use types in and around Savé Valley Conservancy in 2008. Species are grouped into a) members of the order Carnivora; and b) members of other orders. For the commercial LUT data were collected in both the northern and southern sections for all species with the exception of genet, hare, common duiker, baboon, impala, zebra, blue wildebeest (*Connochaetes taurinus*), giraffe, buffalo, black rhino and elephant, for which data were collected only from the southern section. Error bars represent standard errors. Spoor density was greatest in the commercial LUT for almost all study species, much lower in the resettlement LUT and lowest in the communal LUT.

As sampling in the commercial north was conducted by RG and DJ only, differences between spoor densities in the commercial north and commercial south could only be assessed for carnivores (excluding genets) and porcupine. Spoor densities were significantly higher in commercial north (Wilcoxon matched pairs:  $Z = -2.223$ ,  $df = 11$ ,  $P = 0.026$ ). With the exception of lion, all species for which data were available displayed this trend (Figure 3.4). Spoor density in the commercial south was on average 51% of the spoor density in the commercial north.



**Figure 3.4** Spoor densities in the commercial north and commercial south in Savé Valley Conservancy in 2008 for various carnivore species. Error bars represent standard errors. Spoor densities were greatest in the commercial north for almost all species.

### 3.3.2 Spoor distribution

Most species were distributed throughout SVC, but had limited or no distribution within the resettlement and communal areas (Figure 3.5 and Figure 3.6). Within SVC, distributions were generally wide, but spoor from some species such as the cheetah, wild dog and brown hyena were more localised, and confined mainly or exclusively to the commercial north (see also Figure

3.4). Although spoor distributions within resettlement and communal areas were generally much more restricted than those in SVC, spoor from common duiker, hare and genet were more widely distributed in these areas than spoor of most other species.

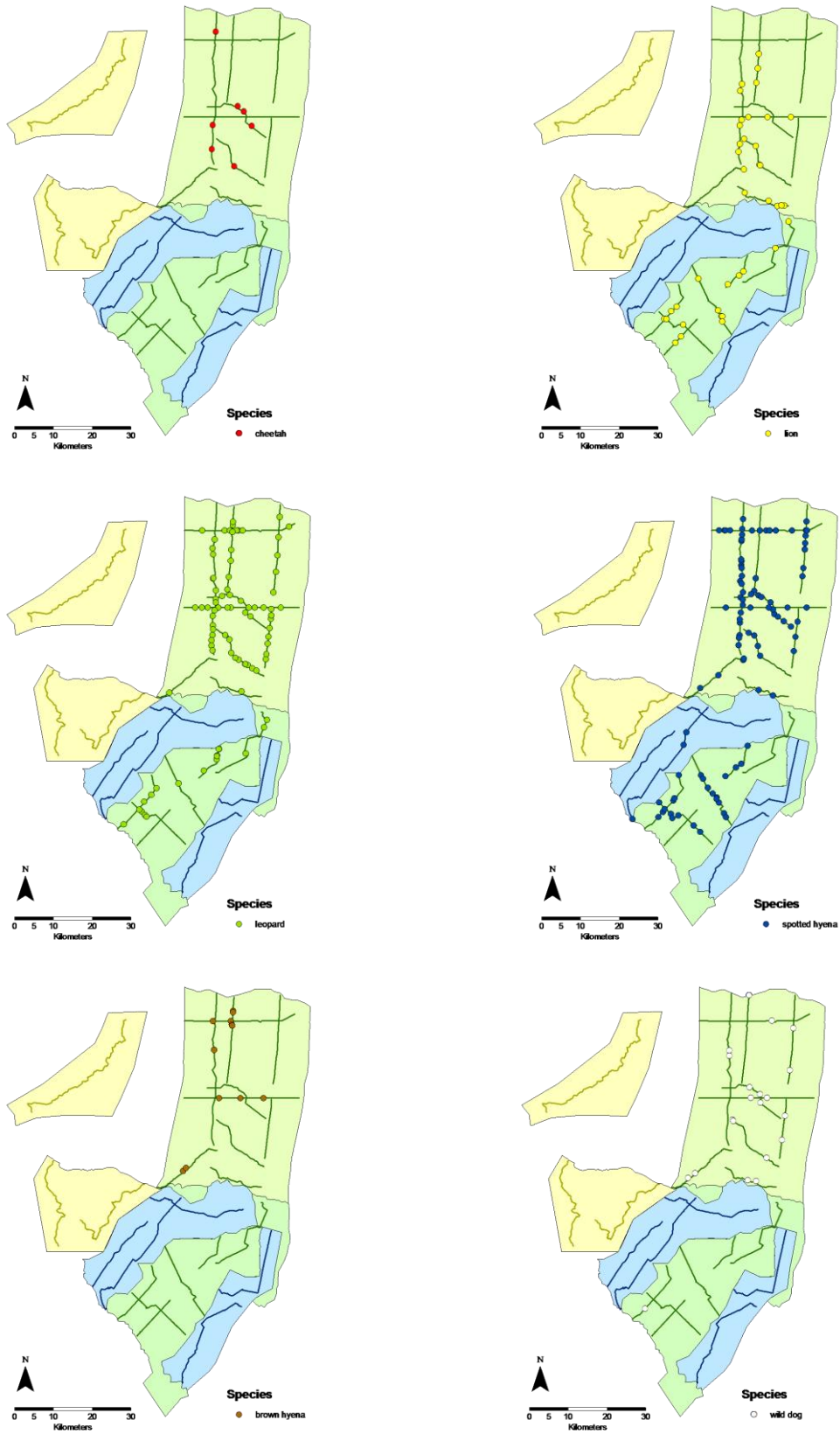


Figure 3.5 (continued on following page). Distribution of carnivore spoor in and around Savé Valley Conservancy in 2008. Note that only roads sampled for spoor of a particular species are displayed. The location of spoor on transects conducted by DJ is estimated. Survey effort was 0.29 km of transect driven per km<sup>2</sup> of survey area (km/km<sup>2</sup>) including replicates in the commercial north, 0.34 km/km<sup>2</sup> in the commercial south, 0.16 km/km<sup>2</sup> in the resettlement LUT and 0.11 km/km<sup>2</sup> in the communal LUT.

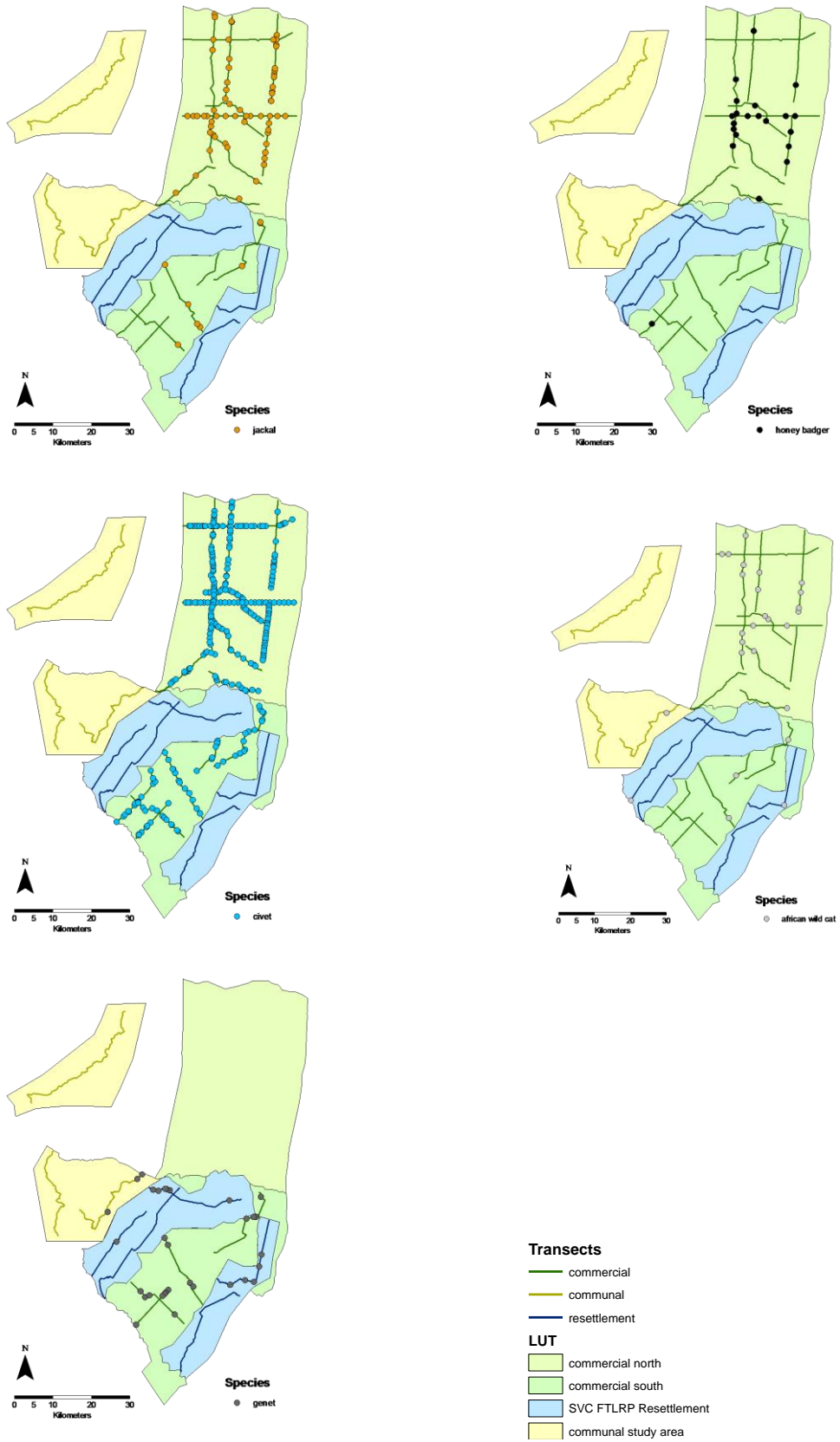


Figure 3.5 continued.

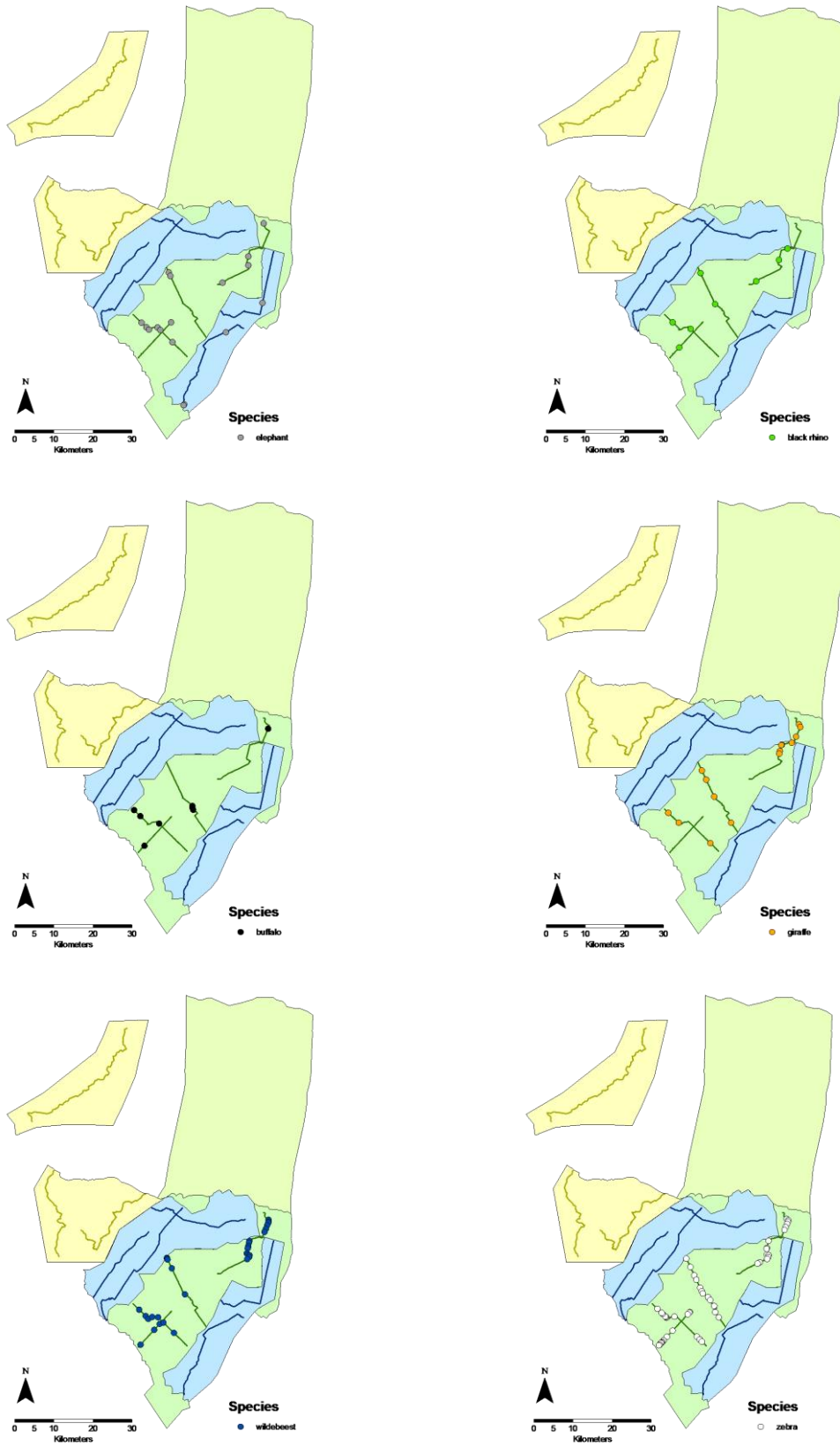


Figure 3.6 (continued on following page). Distribution of non-carnivore spoor in and around Savé Valley Conservancy in 2008. Note that only roads sampled for spoor of a particular species are displayed. The location of spoor on transects conducted by DJ is estimated. Survey effort was 0.09 km of transect driven per km<sup>2</sup> of survey area (km/km<sup>2</sup>) including replicates in the commercial south, 0.16 km/km<sup>2</sup> in the resettlement LUT and 0.11 km/km<sup>2</sup> in the communal LUT.

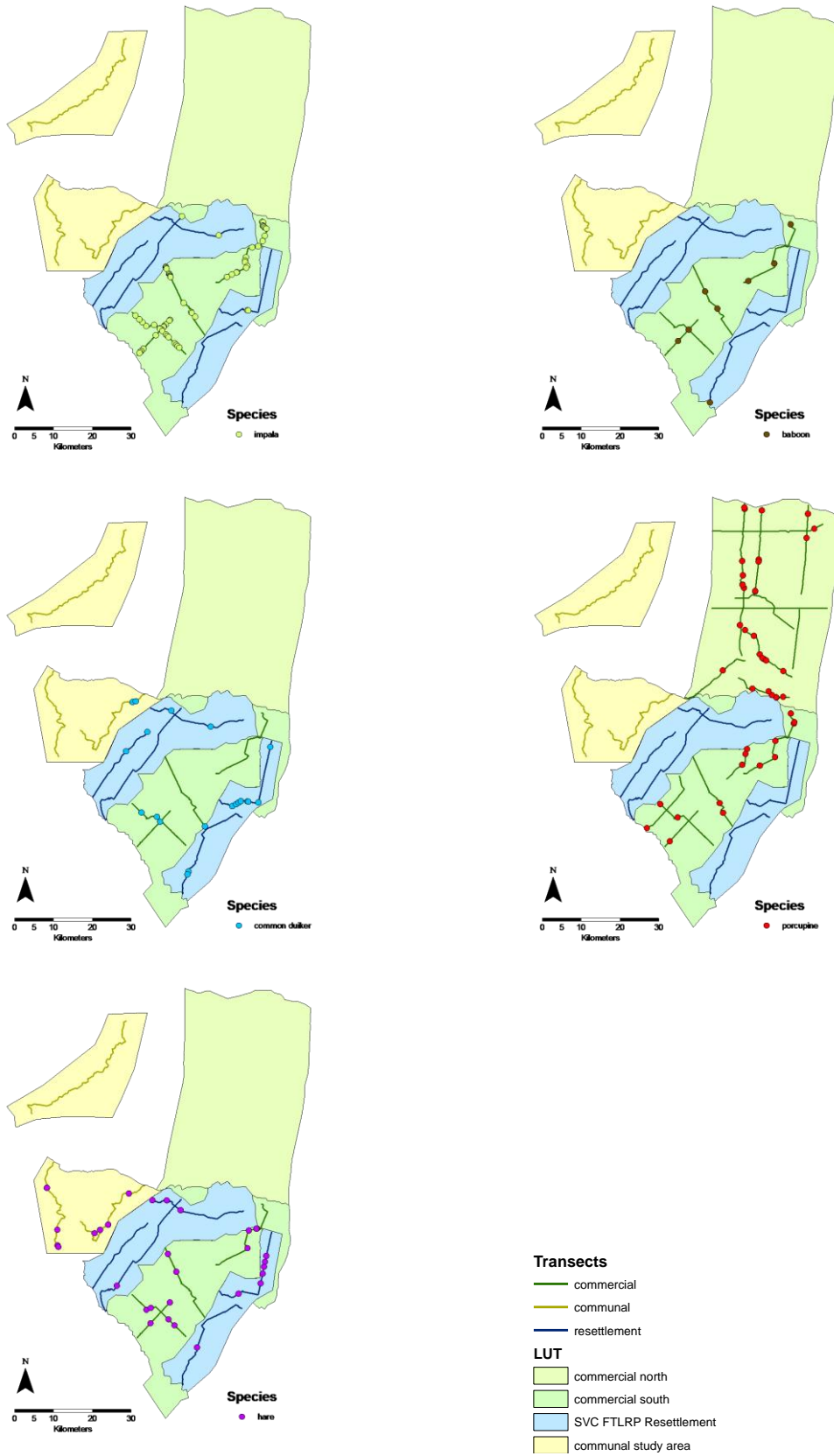


Figure 3.6 continued.



### 3.3.3 Estimating true density using spoor density

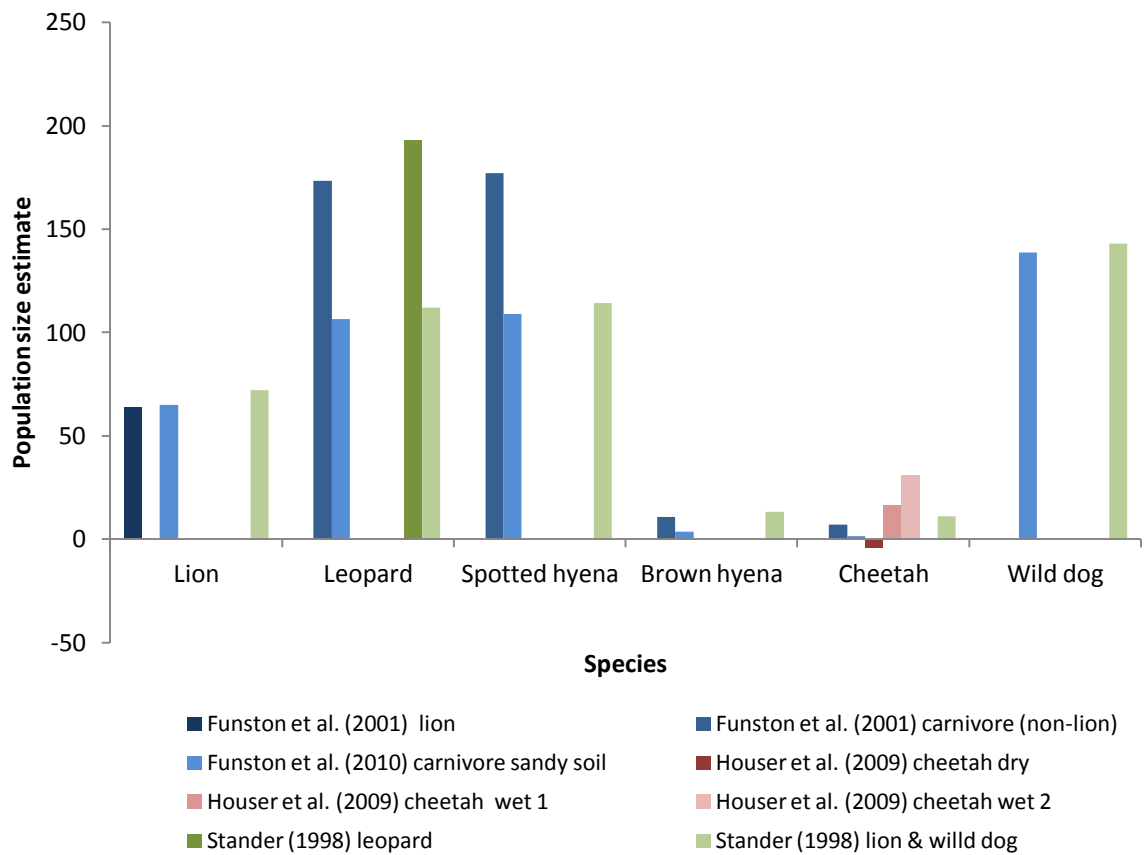
For the larger carnivores the relationship between spoor density and true density has been characterised (Table 3.3), making it possible to generate estimates of population density and size for lion, leopard, spotted hyena, brown hyena, cheetah and wild dog by applying a linear equation to spoor densities. The equation takes the following form, where  $y$  represents the true density,  $x$  represents the spoor density,  $m$  is the gradient and  $c$  is the intercept:

$$y = mx + c$$

**Table 3.3 Comparison of linear equations describing the relationship between spoor density and true density for cheetah, lion, leopard, spotted hyena, wild dog and wild dog.**

Source	Species studied	Gradient	Intercept	Notes
Stander (1998)	Leopard	0.53	0.00	
Stander (1998)	Lion and wild dog	0.30	0.00	
Funston <i>et al.</i> (2001)	Lion	0.29	-0.23	
Funston <i>et al.</i> (2001)	Cheetah, spotted hyena, brown hyena	0.50	-0.44	
Funston <i>et al.</i> (2010)	Cheetah, lion, leopard, brown hyena, honey badger ( <i>Mellivora capensis</i> )	0.32	-0.40	
Houser <i>et al.</i> (2009b)	Cheetah	0.59	-1.03	Dry season
Houser <i>et al.</i> (2009b)	Cheetah	0.40	0.07	Wet season 1
Houser <i>et al.</i> (2009b)	Cheetah	0.57	0.41	Wet season 2

Selection of the most appropriate equation is vital in order to generate accurate estimates of population density and size. A range of estimates of population size were calculated from the data collected to allow comparison of different equations (Figure 3.7). Stander's (1998) equations were considered to perform the best across a range of spoor densities (see section 3.4). Stander's (1998) lion and wild dog equation was selected to estimate the population density of cheetah, lion, spotted hyena and brown hyena, while the leopard equation he presented was used to estimate the population density of leopard.



**Figure 3.7 Comparison of population size estimates for large carnivores in the commercial LUT at Savé Valley Conservancy in 2008 using different equations. The equations in Stander (1998) performed best over a range of different spoor densities (see text).**

### 3.3.4 Population density and population size estimates

Spoor density was used to estimate the population density and population size for the cheetah, lion, leopard, spotted hyena, brown hyena, and wild dog (Table 3.4). Carnivores were most abundant in the commercial north and commercial south, and with the exception of spotted hyena were absent from the resettlement and communal LUTs. Although spotted hyena persisted in the resettlement LUT its estimated density was very low.

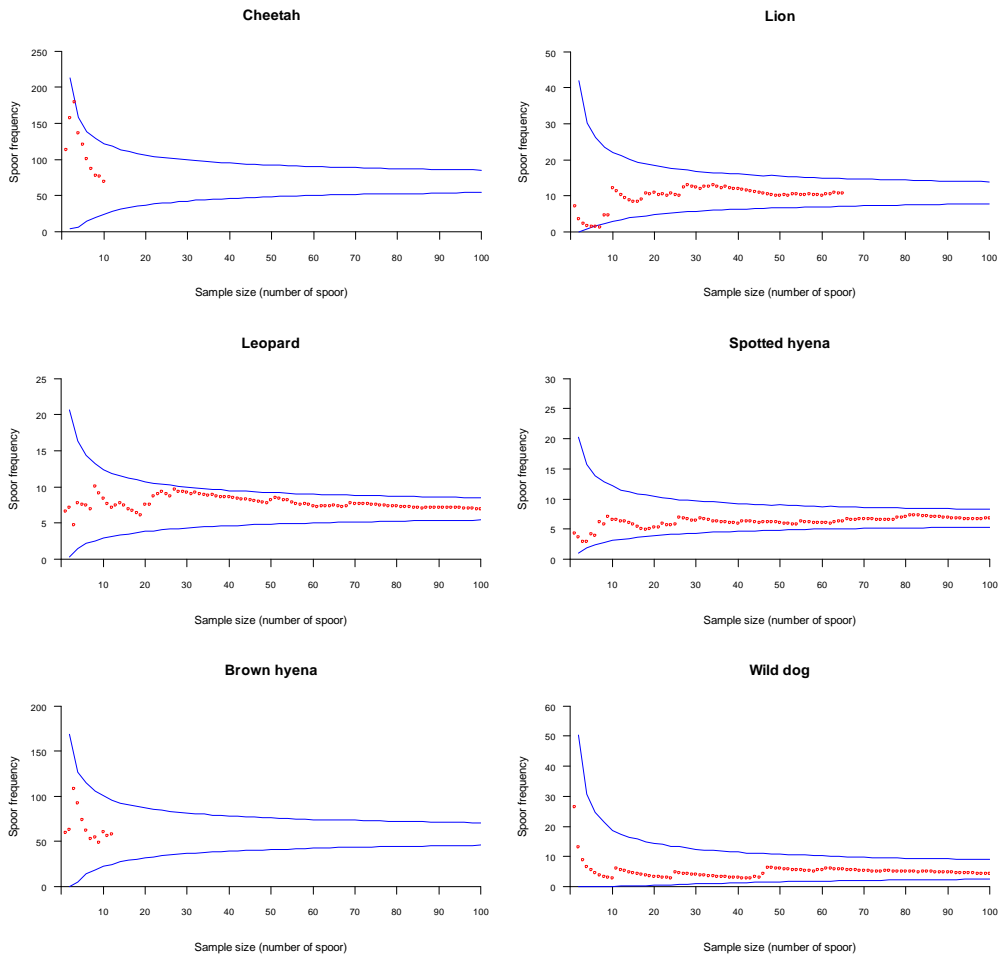
**Table 3.4 Population size and population density estimates for large carnivores across each LUT in and around Savé Valley Conservancy in 2008. Values in parentheses represent 95% confidence intervals. Stander's (1998) leopard equation was used to calculate the estimates for the leopard, while Stander's (1998) lion and wild dog equation was used to calculate the estimates for all other species. Estimates for commercial north and commercial south LUTs were calculated independently from commercial overall, so totals may not necessarily be identical.**

Species	Population density (animals/100km <sup>2</sup> )					Population size				
	Commercial			Resettlement	Communal	Commercial			Resettlement	Communal
	North	South	Overall			North	South	Overall		
Cheetah	0.65 (0.61)	0.00	0.44 (0.41)	0.00	0.00	11 (10)	0	11 (10)	0	0
Lion	2.35 (1.46)	3.95 (1.99)	2.85 (1.17)	0.00	0.00	38 (24)	35 (18)	72 (30)	0	0
Leopard	8.45 (2.04)	6.11 (3.11)	7.64 (1.73)	0.00	0.00	138 (33)	54 (28)	193 (44)	0	0
Spotted hyena	4.83 (1.27)	3.95 (1.90)	4.51 (1.05)	0.61 (0.44)	0.00	79 (21)	35 (17)	114 (27)	6 (4)	0
Brown hyena	0.78 (0.58)	0.00	0.53 (0.39)	0.00	0.00	13 (10)	0	13 (10)	0	0
Wild dog	8.35 (4.48)	0.14 (0.23)	5.65 (3.19)	0.00	0.00	137 (73)	1 (2)	143 (81)	0	0

### 3.3.5 Sampling effort, variance and precision

Assessing the effect of sample size on the variance and precision of spoor frequency estimates is useful to determine whether sufficient data have been collected. For all species the variation of mean spoor frequency estimates stabilised at approximately 30 spoor (Figure 3.8). This sample size was exceeded by all species except the cheetah and brown hyena. Using the existing dataset the 95% confidence limits around estimates of spoor density for these species are therefore wide, but could be improved by further sampling.

Sampling precision (Figure 3.9) initially increased sharply, but increased little after approximately 30 spoor for lion, leopard, spotted hyena and approximately 60 spoor for wild dog. For cheetah and brown hyena sampling precision did not follow the same curve as for other species (Figure 3.9), again indicating that the sample sizes were too small to reach asymptote for these species. This suggests that further sampling of cheetah and wild dog spoor would yield a large increase in sampling precision.



**Figure 3.8** The relationship between spoor frequency and sampling effort for large carnivores on commercial transects at Savé Valley Conservancy in 2008. Red circles represent means and blue lines represent 95% confidence intervals. For most species variation in spoor frequency decreases little after 30 spoor.

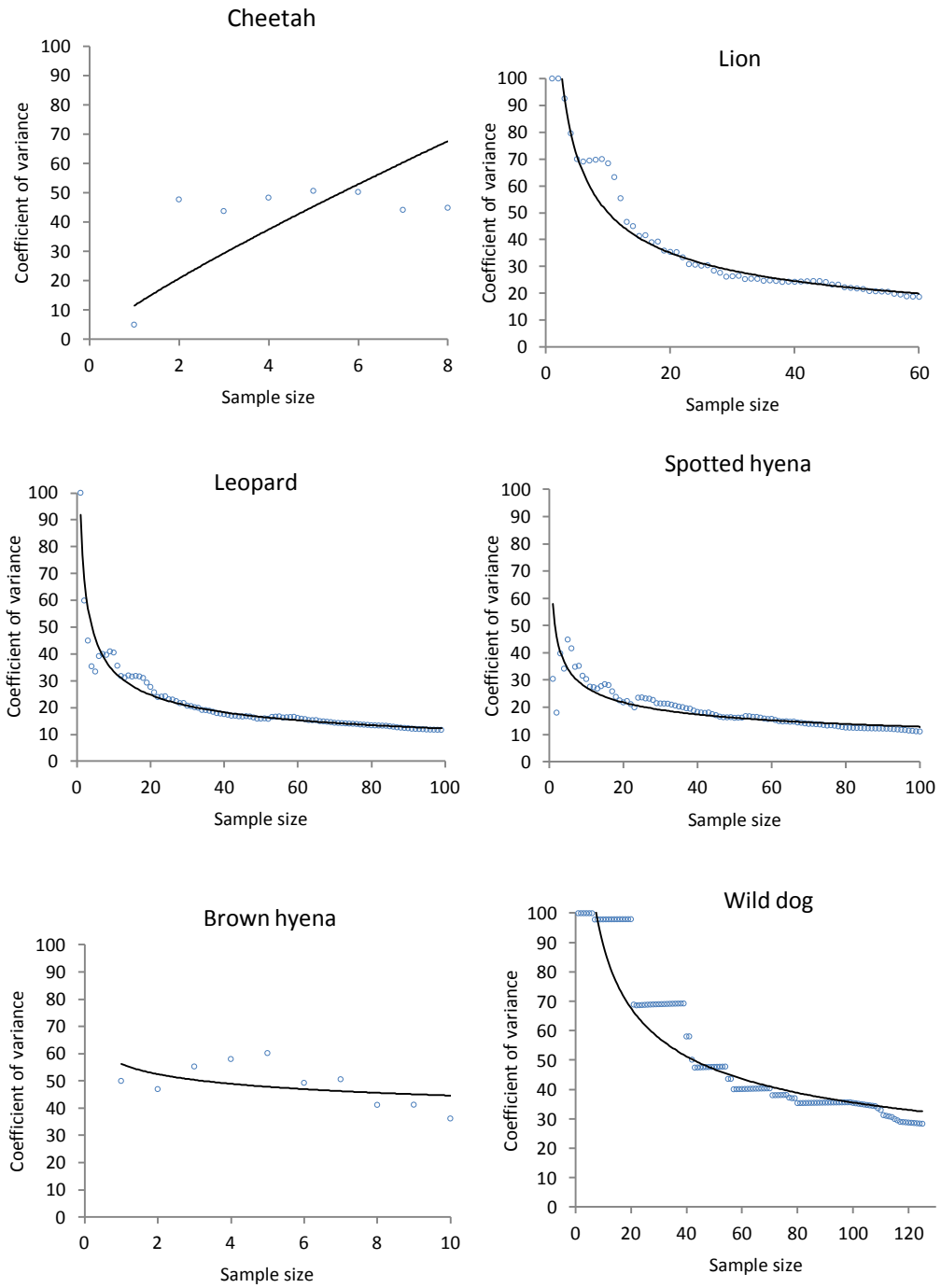


Figure 3.9 The relationship between coefficient of variance and sample size for large carnivores on commercial transects at Savé Valley Conservancy in 2008. Sampling precision increases little after 30 spoor for most species.

### 3.4 Discussion

Comparison between LUTs demonstrates a striking and significant difference in mammal spoor densities (Figure 3.3). As predicted, the greatest spoor densities of all species (except common duiker) were recorded in the commercial LUT, with much lower spoor densities in the resettlement area, and the lowest spoor densities in the communal area. Assuming that before the Fast-Track Land Reform Programme the resettlement area supported similar densities of medium and large mammals to SVC (as indicated by the landowners; J.R. Whittall, pers. comm.), the data suggest that there have been population crashes and local extinctions in the resettlement areas since they were resettled.

Although in the resettlement and communal areas spoor from most study species were not recorded, some species persisted, albeit at lower estimated densities. These were mostly smaller-bodied species that are adaptable and have fast reproductive cycles (Skinner and Chimimba, 2005), such as hares, genet and impala. This fits the expected pattern, with carnivores and larger mammals being the most susceptible to disturbance, while smaller and more generalist species are more likely to persist in more disturbed habitats (Wallgren *et al.*, 2009; Woodroffe and Ginsberg, 2005). There are, however, some exceptions to the overall trends. Higher spoor densities were recorded for the common duiker in the resettlement area than SVC. It could be argued that this trend is an artefact of the low spoor densities recorded for this species, or the spoor of domestic goats being mistaken for that of the common duiker by the tracker. But this trend could also be attributed to the highly adaptable nature of the species (Wilson, 2005), enabling them to make use of different habitats in order to exploit areas in which competitors and natural predators are absent or occur at low densities. A similar pattern was reported by Averbek *et al.* (2009), who found that the relative density of the common duiker was significantly higher in a disturbed ranching area than in a neighbouring national park, despite most other ungulate species exhibiting the opposite trend. It is also possible that spoor of domestic cats

could be mistaken for spoor of African wild cat. Although the spoor of these species is similar, it is possible for trackers to differentiate the two (Liebenberg, 2008), and the pattern of African wild cat spoor density observed in Figure 3.3a fits that of other non-domestic species, suggesting that if misidentifications took place they were relatively rare. Another unexpected result was that elephants occur in the resettlement area, with a higher spoor density than anticipated. The propensity of elephants for crop-raiding behaviour is well documented, and they may be attracted by the crops of the resettlement farmers (Jackson *et al.*, 2008; Sukumar, 1990).

Population density estimates of most of the large carnivores in the commercial area compare favourably with other comparable areas in southern Africa. Kruger National Park serves as a good site for comparison with SVC, as it is well studied, relatively close (approximately 170 km away), and falls into the same ecoregion (Olson *et al.*, 2001). The northern section of Kruger National Park has similar rainfall to SVC (Gertenbach, 1980), so it could theoretically support similar populations of ungulates and carnivores as SVC (Coe *et al.*, 1976; Hayward *et al.*, 2007b). Prey biomass at SVC is, however, lower than the northern section or any other section of Kruger National Park (see Chapter 5). Gonarezhou National Park is another interesting site for comparison as it is approximately 21 km from SVC, falls partially into the same ecoregion as SVC (Olson *et al.*, 2001), and it was the site of a recent study which used spoor counts to estimate population densities of carnivores (Groom, 2009b). Population densities at Gonarezhou National Park were, however, generally less than at SVC, possibly due to lower investment in park management, such as water provision and anti-poaching efforts.

Cheetah spoor were only recorded in the northern section of SVC, where population density was estimated at 0.65 animals per 100 km<sup>2</sup>, which fits within the normal range of 0.3-3.0 animals per 100km<sup>2</sup> (IUCN/SSC, 2007). Cheetah densities in the commercial north section were higher than densities reported in other areas in Zimbabwe such as Gonarezhou National Park (0.4 animals per



100 km<sup>2</sup>; Groom, 2009b) and Hwange National Park (0.34 animals per 100 km<sup>2</sup>; Wilson, 1997). Cheetah density at SVC was higher than in the northern section of Kruger National Park (0.10 animals per 100 km<sup>2</sup>; Davies-Mostert *et al.*, 2010). The central and southern sections of Kruger, however, had greater cheetah densities (1.11 and 2.27 animals per 100 km<sup>2</sup> respectively; Davies-Mostert *et al.*, 2010), which can be explained by higher rainfall and prey biomass in those regions (Ferreira and Funston, 2010; Gertenbach, 1980). Cheetah density in northern SVC was higher than in the Kgalagadi Transfrontier Park, which straddles the Botswana-South Africa border (0.57 animals per 100 km<sup>2</sup>; Funston *et al.*, 2001), Botswana's Central Kalahari Game Reserve (0.25-0.26 animals per 100 km<sup>2</sup>; Winterbach, 2003 cited in Klein, 2007) and some Namibian farmlands (Marker, 2002), although these regions generally have lower rainfall and would be expected to have lower densities of carnivores and prey species (Coe *et al.*, 1976; Marker, 2002). Houser *et al.* (2009b) reported an exceptionally high cheetah density of 5.23 animals per 100 km<sup>2</sup> in Jwaneng game reserve, Botswana, but this figure should be treated with caution (see p. 100).

Lion density estimates (2.35 and 3.95 animals per 100 km<sup>2</sup> in the north and south commercial sections respectively) at SVC were near the average for the region, most of which occur at densities of less than 4 animals per 100 km<sup>2</sup> (Bauer and Van Der Merwe, 2004). At SVC lion densities were higher than at Gonarezhou National Park (0.60 animals per 100 km<sup>2</sup>; Groom, 2009b), but were lower than in Kruger National Park (5.0 animals per 100 km<sup>2</sup> in the northern section, up to 17.4 animals per 100 km<sup>2</sup> in the rest of the park; Ferreira and Funston, 2010). Lion densities were greater in the southern section than the northern section of the SVC, which is opposite to the trend observed for all other species. Lion density is usually determined by prey biomass (Hayward *et al.*, 2007b), so it would be expected that lions occur at a greater density in the northern section of SVC, where prey densities were higher than in the northern section. Ranch managers suggested that this has always been the case since the conservancy was established, as the lions were recolonising SVC naturally from wildlife areas to the south such as

Gonarezhou National Park (J.R. Whittall, pers. comm.). It is important to note that data on population trends were not presented here. Although lions in southern SVC may occur at a greater density than in northern SVC, the lion population could be declining at a greater rate in the southern section.

The leopard density estimates for SVC (8.45 and 6.11 animals per 100 km<sup>2</sup> in the north and south commercial sections respectively) were higher than reported in Gonarezhou (5.1 animals per 100 km<sup>2</sup>; Groom, 2009) and Tsumkwe District, Namibia (1.45 animals per 100 km<sup>2</sup>; Stander, 1998), and were greater than average densities in Kruger National Park (3.50 animals per km<sup>2</sup>; Bailey, 2005). Leopard densities at SVC were similar to those reported in Phinda private game reserve in KwaZulu-Natal, South Africa (7.33 animals per 100 km<sup>2</sup>; Balme *et al.*, 2009). At SVC leopard densities therefore appear to be reasonably high, although they fall well short of the extremely high densities reported in riparian forests in Kruger National Park (30.30 animals per 100 km<sup>2</sup>; Bailey, 2005), but this is expected as these estimates focussed on ideal habitat only.

Estimated population densities of spotted hyena (4.83 and 3.95 animals per 100 km<sup>2</sup> in the north and south commercial sections respectively) were relatively low in comparison with other sites in southern Africa. Although densities at SVC were greater than at the Kgalagadi Transfrontier Park (0.80-1.12 animals per 100 km<sup>2</sup>; Funston *et al.*, 2001; Mills, 1994), densities at SVC were lower than at Gonarezhou National Park (8.2 animals per 100 km<sup>2</sup>; Groom, 2009b), and at Kruger National Park (7-20 animals per 100 km<sup>2</sup>; Mills and Hofer, 1998). Bowler (1991, cited in Mills and Hofer, 1998) estimated that spotted hyenas occur in Zimbabwe's national parks, safari areas and farms at densities of between 3 and 18 animals per 100 km<sup>2</sup>, exceeding spotted hyena densities at SVC at all sites except the Matetsi Safari Area. Reasons for the low density of spotted hyenas at SVC are unclear, but could be related to interspecific competition with lions (Watts and Holekamp, 2008).

The brown hyena density estimate in the northern section of SVC (0.78 animals per 100 km<sup>2</sup>; no brown hyena spoor were detected in the southern section) was lower than published densities at other sites such as the Kgalagadi Transfrontier Park (1.15-2.12 animals per 100 km<sup>2</sup>; Funston *et al.*, 2001; Mills, 1994) the Makgadikgadi National Park in Botswana (2.0 animals per 100 km<sup>2</sup>; Maude, 2005) and the Pilansberg National Park in South Africa (2.8 animals per 100 km<sup>2</sup>; Thorn *et al.*, 2009). No brown hyena spoor were detected at Gonarezhou National Park (Groom, 2009b). Fewer than 100 brown hyenas are thought to occur in Zimbabwe, mainly further west of the study site (Mills and Hofer, 1998), so it is not surprising that they occur at a low density in SVC. In comparison with northern SVC, the greater lion densities in southern SVC (Mills, 1991) and the smaller prey base in Gonarezhou National Park (Groom, 2009b) may account for the lack of spoor records in these areas.

Wild dogs were estimated to occur at 8.35 animals per 100 km<sup>2</sup> (137 individuals) and 0.14 animals per 100 km<sup>2</sup> (1 individual) in the north and south commercial sections respectively. This equates to 10 packs if using the mean pack size of 13 individuals in the commercial north (Groom, 2009a) and 1 pack in the commercial south. This fits closely with data from a long-term study of wild dogs in SVC, which indicate that there were a total of 134 wild dogs at the time that the study was conducted, all of which were in the commercial north with the exception of a single pack of 3 animals in the south (Groom, 2009a). The wild dog population density was much greater in the northern section of SVC than at other sites in southern Africa. Wild dog density was estimated at 0.80 animals per 100 km<sup>2</sup> in Gonarezhou National Park (Groom, 2009b), 0.71 - 0.78 animals per 100 km<sup>2</sup> in Zimbabwe's northern safari areas and Mana Pools National Park (Childes, 1988), 1.37 animals per 100 km<sup>2</sup> in Hwange National Park (Childes, 1988), 0.10, 0.84 and 1.68 animals per 100 km<sup>2</sup> in the northern, central and southern sections of Kruger National Park respectively (Davies-Mostert *et al.*, 2010), and 0.53 and 1.20 animals per 100 km<sup>2</sup> in Tsumkwe District and Kaudom

Game Reserve respectively (Stander, 1998). Density at SVC was greater even than the maximum rangewide density estimates of 5.90 animals per 100 km<sup>2</sup>, in a section of Selous Game Reserve in Tanzania (Woodroffe *et al.*, 1997). The reason why wild dogs occur at such an exceptionally high density in the northern section of SVC is not clear, but is explained in part by the low densities of spotted hyenas and lions, as Creel and Creel (1996) reported an inverse relationship between the density of wild dogs and both the spotted hyena and lion.

The spoor data indicate that the large carnivore guild in the northern section of SVC generally appeared to be healthy at the time of the study. When comparing the commercial north and commercial south, population density estimates of all large carnivores except the lion were lower in the south (Figure 3.4), which could be due to its greater proximity to the resettlement area which may be acting as a population sink (Woodroffe and Ginsberg, 1998). The lower wildlife population density estimates in the commercial south could also be explained by greater rates of poaching (see section 8.2) in comparison with the commercial north (Lindsey *et al.*, 2011b).

Despite the relatively high densities of many predators, a much larger area than SVC alone is required to support carnivore populations that are viable in the long term (see section 8.5). Population sizes of predators in SVC alone are relatively small, and if connectivity is lost between carnivore populations in SVC and other areas (Figure 2.1), this population may be vulnerable to stochastic processes (Caughley, 1994). Such processes include variation in demographic parameters such as sex ratio, birth rate and death rate; fluctuations in environmental conditions; and catastrophic events such as disease epidemic or drought (Sodhi and Ehrlich, 2010). These processes could explain the high densities observed, and without ongoing monitoring it is difficult to determine whether these populations are stable, dynamic, or if they fluctuate widely over time due to stochastic processes.

It is surprising that spoor from some other adaptable species such as leopards and baboons (Skinner and Chimimba, 2005) were not detected or occurred at such a low density in the resettlement area. This could be due to the limited availability of important resources such as suitable sleeping sites and water for baboons (Cowlshaw, 1997). Leopard numbers may be limited by a lack of available cover for hunting and resting and high levels of persecution (see Chapter 7). Leopards do not preferentially prey on livestock (Ott *et al.*, 2007), and the density of preferred species (Hayward *et al.*, 2006a) is low in the resettlement area (section 3.3.1), so there is little motivation for leopards to visit this LUT.

Although spoor counts provided extremely useful data, there are some caveats with the method. Most of the studies that compare spoor density with true density are based in national parks, private game reserves, and areas of low human density where there is less anthropogenic disturbance and lower densities of humans and domestic animals. It could be argued that the equations derived from these studies are not appropriate to spoor density data collected in the resettlement and communal areas, as spoor could be obliterated from roads by human and domestic animal traffic, and spoor from wild animals could be confused with spoor from domestic animals. Some of the spoor data presented by Funston *et al.* (2010), however, were collected in the Laikipia District in Kenya, which has a higher human population density than the community areas around SVC, and yet a significant relationship between spoor density and true density was found. Furthermore, measures were taken in the current study to minimise potential technical problems associated with conducting spoor counts in areas of relatively high human density. Spoor counts were conducted as soon as was possible after dawn so that transects were as undisturbed as possible. In order to minimise the possibility of misidentifying spoor from wildlife and domestic animals, experienced trackers from the local area were used. The tracker that worked on the SW and RG datasets, for example, had 14 years of experience working as a wildlife tracker in SVC, and was from the neighbouring communal land. He was confident in his ability to

differentiate the spoor of wildlife from domestic animals, and although this was not tested, previous studies have shown that it is possible for experienced trackers to be capable of examining spoor and reliably identifying the species, age and even the individual that produced it (Stander *et al.*, 1997a).

Another potential caveat with the use of spoor counts is that at very high population densities the spoor density may become saturated, and therefore its correlation with true density may change (Balme *et al.*, 2009; Caughley, 1977). In practice, however, carnivore populations rarely reach sufficient densities for this to become problematic, and for Funston *et al.* (2010) this was only an issue for spotted hyenas on clay soils in east Africa, where they occurred at much greater density than in southern Africa. Concerns about saturation may be more applicable to ungulates, as ungulates tend to occur at higher densities than carnivores so their spoor densities are more likely to become saturated, and as they often occur in large groups, accurate assessment of group sizes can be difficult. There have been few attempts to compare spoor densities with population densities of ungulates, but Funston *et al.* (2001) found no evidence of these problems, and reported a fairly strong linear correlation between the spoor density and population density of ungulates.

Selection of the appropriate calibration equations is also critical when estimating the absolute abundance of species. When determining the appropriate equation to generate estimates of true population density from spoor count data, the dry season equation published in Houser *et al.* (2009b) produced negative population estimates (Figure 3.7). The estimates calculated using the wet season equations were positive, but they are less applicable to the current study, which was conducted in the dry season. The equations of Houser *et al.* (2009b) may be unreliable, because the study area was smaller than the home range size of the study species (Houser *et al.*, 2009a), which could make it difficult to accurately estimate the true population density, and therefore the

equation. This may explain why Houser *et al.* (2009b) failed find a significant correlation between spoor density and true density. Balme *et al.* (2009) compared the spoor density with the true density of leopards, but also failed to find a significant relationship between the two variables. The equations presented in Houser *et al.* (2009b) and Balme *et al.* (2009) were therefore considered to be less useful than the other equations.

Using a comprehensive dataset Funston *et al.* (2010) demonstrated that a single equation, constructed using a combination of spoor data from cheetah, lion, leopard, spotted hyena, and brown hyena on sandy substrate across wide area including study sites in Zimbabwe, South Africa, Botswana and Namibia, was able to describe the relationship between spoor density and true density. This indicates that a single equation can be used to describe the relationship between spoor density and population density for a range of species. This equation provides a similar estimate of wild dog population size (139) to the known population of 134 (Groom, 2009a). Although this equation performs well at higher spoor densities, it provides lower estimates of true density than expected at low spoor densities because it has a negative intercept. For example it generates a cheetah population estimate of 1. There is not a known population of cheetahs to allow comparison, but at least three different cheetahs were seen by the author in 2008 and 2009, and seven individuals were seen during the 2007 aerial survey (Joubert, 2007), so it is unlikely that a population estimate of 1 cheetah is accurate. The equations presented in Funston *et al.* (2001) suffer from the same problem.

Stander's (1998) equations were selected for analysis of the current dataset because the equations produce similar estimates of population density to Funston *et al.* (2010) at high spoor densities. At low spoor densities the population estimates generated using Stander's (1998) equation are higher, and thus nearer to the expected population size. This is because the

equations presented in the two papers have similar gradients, but Stander's (1998) equation intercepts at the origin.

Variance of spoor frequency estimates for all species reached asymptote at the same level of sampling effort as in other studies, and precision of spoor frequency estimates stabilised for most species at the expected level of sampling effort (Funston *et al.*, 2001; Funston *et al.*, 2010; Stander, 1998). Sampling effort was sufficient for most species, but for cheetah and brown hyena additional sampling would produce narrower confidence intervals and more precise estimates of spoor density and population density. This was unfortunately not possible, due to constraints on the resources available to the research project. Despite the limited sample size the data collected for cheetah and brown hyena still provide useful population estimates.

Despite the problems associated with using spoor counts, the method has a number of advantages. It was well suited to the current study, as it allowed comparison of the relative and absolute densities of a range of species, including areas in which the inhabitants were often uncooperative such as the resettlement area. Collecting spoor data and obtaining permission to drive through resettlement areas on a one-off basis was relatively easy, in contrast with the process of gaining permission and support for the interviews to be conducted (see section 2.5.2), as this required repeated, long-term access and much greater involvement with the community. For these reasons, spoor counts are also more suitable than camera trapping in the study area. In areas where soils are sandy and skilled trackers are available it is relatively quick, cheap, repeatable, and can provide robust estimates of relative or absolute population density and confidence intervals (Funston *et al.*, 2010; Stander, 1998).



### 3.5 Summary

Spoor data indicate that the commercial LUT supports 11 cheetah, 72 lion, 193 leopard, 114 spotted hyena, 13 brown hyena and 143 wild dog. Six spotted hyena are estimated to occur in the resettlement LUT, and no other spoor from large carnivores were detected in the resettlement or communal LUTs. As predicted, all species of carnivore and non-carnivore (except common duiker) followed this trend, with greatest population densities in the commercial LUT, lower densities in the resettlement LUT, and lowest densities in the communal LUT. Relative to the commercial LUT, population densities in the resettlement LUT were on average 92% lower for carnivore species and 72% lower for non-carnivore species. Within the commercial LUT carnivore densities were lower on in the south, which is nearer to the resettlement area, than the north. The data suggest that the FTLRP has reduced the number of cheetahs and other large carnivores at the study site (objective 1; see section 8.2 for a detailed discussion). Chapter 4 uses an alternative methodology to estimate the population size and differences in density between LUTs.

# Chapter 4 Cheetah sightings

---

## 4.1 Introduction

Although spoor counts are an extremely useful tool for estimating the status and distribution of carnivores, the use of multiple methods facilitates validation of results while mitigating the limitations of other methods. One of the disadvantages of spoor counts is that without extensive survey effort they may fail to detect species that occur at low density (MacKenzie *et al.*, 2002). There is a reasonable chance that rare study species would not leave spoor on a transect within the 24 hour period before the transect is surveyed. If this occurs on each transect in a particular area, it will not be possible to estimate the density of the species, and it may appear to be absent. Analyses of interviews and animal sightings, on the other hand, can make use of data based on observations that occurred over a much longer period, and are therefore less likely to produce false negatives. Another advantage of the longer timeframe to which interviews can refer is that they may be used to collect data about the past in addition to the present, which makes the method useful for estimating population trends. Although spoor counting is a very useful method for estimating current species abundance, it does not provide any information on population trends unless repeated over time (Funston *et al.*, 2010). Interviews and sightings were therefore used to estimate the status, distribution and population trends of the cheetah across the different land use types (LUTs) at the study site.

The use of interviews and sightings is one of the oldest methods used to estimate cheetah abundance (such as Child and Savory, 1964). Postal questionnaires have previously been used to determine the distribution of cheetahs in Zimbabwe by collecting information on cheetah presence/absence from respondents in the field (Child and Savory, 1964). Questionnaires and interviews have also been used to estimate the status of cheetahs throughout sub-Saharan Africa

(for example Myers, 1975), although analysing the data was problematic as the large home range of cheetahs results in some animals being counted more than once by different observers. To account for this Wilson (1987) arbitrarily multiplied his population estimate by 0.46 in order to arrive at a figure which he considered more reasonable. In contrast White (1996) did not reduce the total number of cheetahs reported, while Myers (1975) did not describe how he analysed the data. This process is thus very subjective, and different researchers apply different analyses, making it difficult to compare different estimates. For the purposes of this study population estimates will be calculated using both the total number of cheetahs (after White, 1996) and an estimate reduced by 54% (after Wilson, 1987).

These early studies were based on estimates made by stakeholders of how many animals occurred in a given area, which could be a very subjective process (Foley *et al.*, 2004). Gros *et al.* (1996) developed a new, more objective interview method, that was based on collecting details about specific sightings of cheetahs. The number of cheetahs reported is summed, while assuming that any sightings of cheetahs with identical group composition within a certain radius refer to a single coalition of cheetahs. Gros *et al.* (1996) compared the results from this method at three test sites in east Africa with results of three other indirect methods of estimating cheetah abundance, which were based on average cheetah density, prey biomass, and home range size. The average density method involved calculating the mean cheetah density across 13 protected areas in east and southern Africa, and using the average density to estimate the cheetah population at the test sites. Gros *et al.* (1996) found a significant association between the biomass of prey species in the 15 to 60 kg weight range and cheetah biomass at ten sites in east and southern Africa, and they used this relationship to predict cheetah abundance at the test sites. Finally, the home range size and degree of overlap of five female cheetahs were estimated using sighting data collected for one year in the Serengeti National Park. This information was used to estimate cheetah abundance at the test sites using the home range method. Estimates of

cheetah population size at the three test sites calculated using these four methods were compared with reference population sizes determined using long-term studies based on individual recognition.

Gros *et al.* (1996) found that the interview method performed the best, and provided estimates of cheetah population density that differed from the reference densities by just 12% on average. Results calculated using the prey biomass method differed from reference densities by 37% on average, while the results of the home range method and the average density method differed from the reference densities by a mean of 51% and 53% (Gros *et al.*, 1996). The interview method, average density method and the prey biomass method each underestimated cheetah density, but the home range method did not display a consistent trend. The interview method has been used to estimate the abundance and distribution of cheetahs and other carnivores in a number of areas at different spatial scales (Creel and Creel, 1995; Gros, 1996, 1998, 2002; Gros and Rejmanek, 1999; Lindsey *et al.*, 2004; Rodriguez and Delibes, 2002).

This chapter describes the results of an interview survey conducted to estimate the status, distribution and population trends of the cheetah at the study site using interviews and historical records (objective 1). It begins by estimating the current cheetah population size and distribution across LUTs. It is predicted that sighting data will indicate that at present most cheetahs occur in the commercial LUT, fewer if any in the resettlement LUT, and none in the communal LUT. Details of both cheetah sightings and stakeholder estimates of cheetah abundance are used to estimate cheetah population size. Data on the population trends of cheetahs are then presented, using historical cheetah sighting records and stakeholder perceptions of the trends.

## 4.2 Methods

Cheetah abundance was estimated using two methods based on cheetah sighting data. The first method involved collating and mapping cheetah sightings after Gros *et al.* (1996) (hereafter referred to as the sighting method). An interview survey was conducted with 359 respondents across the commercial, resettlement and communal land use types (see section 2.5.2). Respondents were asked to report the details of all clearly memorable sightings of cheetahs in the area, specifying the date, location, and land use type where the sighting was made, the group size, and where possible the age classes of the cheetahs (Gros *et al.*, 1996) (see Appendix 3 for interview schedule). The reliability of respondents was also assessed using four variables: their knowledge of cheetahs based on their ability to describe their behaviour and recognise a photograph of the species (Appendix 4); the precision of their responses; absence of contradictions in responses; and their cooperativeness (how willing they appeared to take part in the study) (Gros, 2002). Respondents were scored either 0, 0.5 or 1 point for each variable, and sightings reported by respondents that scored less than a total of 2 points were excluded from analyses of cheetah abundance (Gros, 2002). Photographs of cheetahs, leopards and other predators (Appendix 4) were used along with descriptions of behaviour and morphology to ensure that respondents were referring to cheetahs, and were not confused with other carnivores.

In addition to interviews, informal reports of cheetah sightings were also collected opportunistically from throughout SVC (including areas of the study site not included in the interview survey). Sightings were reported to the author in person, in writing, or over the conservancy's 2-way radio network. The radio network was established to facilitate communication throughout the conservancy between managers of different properties and between managers and their workers, and is used as the primary form of long-distance

communication in the area. Reports of sightings of cheetahs made over the radio were made either directly to the author, or were overheard by the author who then requested further details.

Sightings of cheetah groups with identical compositions were assumed to refer to a single group if they were separated by less than a particular distance ( $d$ ) within a certain period of time ( $t$ ). Previous studies using this methodology to estimate cheetah abundance have failed to define the spatial and temporal cut-off points selected (Gros, 1996, 1997, 1998, 2002; Gros *et al.*, 1996; Gros and Rejmanek, 1999; P. Gros, pers. comm.). In the current study sightings were included in the analysis if they were made in 2008 or 2009 ( $t$  was set at up to 15 months) in order to make the estimate as up to date as possible. As no telemetry data were available from the study site an appropriate value for the maximum distance between two locations within the home range of a particular cheetah (or coalition of cheetahs;  $d$ ) was calculated from the literature (Table 4.1) by measuring the dimensions of cheetah home ranges (Broomhall *et al.*, 2003; Houser *et al.*, 2009a; Jacquier and Woodfine, 2007; Marker *et al.*, 2008; Marnewick and Cilliers, 2006; Purchase and du Toit, 2000; Rasband, 2009) using ImageJ (Rasband, 2009). The studies presented home range maps of both males and females, coalitions and single cheetahs, and territorial cheetahs along with non-territorial animals over a range of periods of time. Home range data were collected using a mixture of sightings and radio telemetry, and were analysed using either 95% minimum convex polygon (Jenrich and Turner, 1969) or kernel estimators (Worton, 1989). Caution should therefore be used when comparing maximum home range dimension values presented in Table 4.1 with one another, but despite these caveats the data provide a useful basis for selecting appropriate  $d$  values that was lacking in previous literature on the subject.

**Table 4.1** Maximum  $d$  values for individual cheetahs or coalitions of cheetahs in southern Africa calculated from the literature. NP refers to national parks. Study sites not located in national parks were made up largely of private land, both game ranches and other farms. \*Denotes a study that was conducted in small (<400km<sup>2</sup>), fenced reserves where densities may not be representative of natural densities.

Country	Location	Maximum dimension of home range (km)	Source
South Africa	Limpopo	20	Marnewick and Cilliers (2006)
Zimbabwe	Matusadona NP	22	Purchase and du Toit (2000)
Zimbabwe	Matusadona NP	33	Zank (1995, cited in Purchase and du Toit, 2000)
South Africa	Kruger NP	40	Broomhall <i>et al.</i> (2003)
Zimbabwe	Malilangwe	40	Jacquier and Woodfine (2007)
Botswana	Jwaneng*	75	Houser <i>et al.</i> (2009)
Namibia	Otjiwarongo	165	Marker <i>et al.</i> (1998)

A  $d$  value of 40 km was considered the most appropriate for analysis of the current dataset, as this is the maximum distance between cheetah home range locations on the Malilangwe Private Wildlife Reserve, which borders SVC (Jacquier and Woodfine, 2007). This value also corresponds to the upper limit of the maximum distances recorded between cheetah home range locations in other areas of Zimbabwe and South Africa (Table 4.1). A larger  $d$  value was calculated from the home range data presented by Houser *et al.* (2009a) on one cheetah in Botswana, but this individual shifted its home range during the course of the study, so had an unusually large  $d$  value. Other  $d$  values calculated from cheetahs in Houser *et al.* (2009a) were smaller than 40 km. Namibian cheetah home ranges and  $d$  values are exceptionally large, but Namibia falls into different ecoregions to the study site (Olson *et al.*, 2001), so the data from cheetahs in Zimbabwe and South Africa are more applicable to the current study.

The locations of cheetah sightings were plotted using ArcMap 9.3 (ESRI, 2008), and buffers of diameter  $d$  were created around each sighting. The total number of cheetahs in non-redundant sightings (i.e. non-overlapping buffers within each different group composition) was summed to estimate cheetah population size. A  $d$  value of 40 km was used as it was thought to be the most appropriate, but in order to assess the sensitivity of population estimates to the  $d$  value, the analysis was repeated with  $d$  values of 15, 30, 50 and 75 km. Only sightings of adults were

included in the analysis, as cubs can suffer extremely high mortality rates (up to 95%; Laurenson, 1994). Sightings of a single litter over a period of time are therefore likely to contain varying numbers of cubs, which would inflate the population estimate if included in the analysis. Cheetah sighting data were also used to estimate cheetah distribution.

The second method used to estimate cheetah abundance followed the methods of Wilson (1987), hereafter referred to as the stakeholder estimate method. This method was used only in the commercial LUT. Stakeholders were interviewed on most ranches (see section 2.5.2), and were asked to estimate the maximum, minimum and true number of cheetahs present on their property at present. The total number of cheetahs reported was summed, following White (1996), to produce the raw stakeholder estimate. Wilson's (1987) correction factor of 0.46 was also multiplied by the raw stakeholder estimate in order to account for overestimation, generating the adjusted stakeholder estimate. One stakeholder was selected per property, preferably ranch owners and managers where possible, but estimates made by senior game scouts or supervisors were used where necessary. Some properties were omitted as explained above, so the population estimates calculated using this method were presumably lower than they would have been if more ranches were included.

In addition to estimating cheetah population size, cheetah sighting data were also used to estimate cheetah population trends in SVC. Ranchers were asked if any longitudinal data were available on sightings of cheetahs on their properties. The number of occasions on which cheetahs were observed was compared over a number of years. The perceived trends in cheetah numbers were assessed by asking the respondents whether they believe there are more cheetahs, the same number of cheetahs, or fewer cheetahs in their area compared to 10 years ago, or when they first moved to their current location if less than 10 years ago.



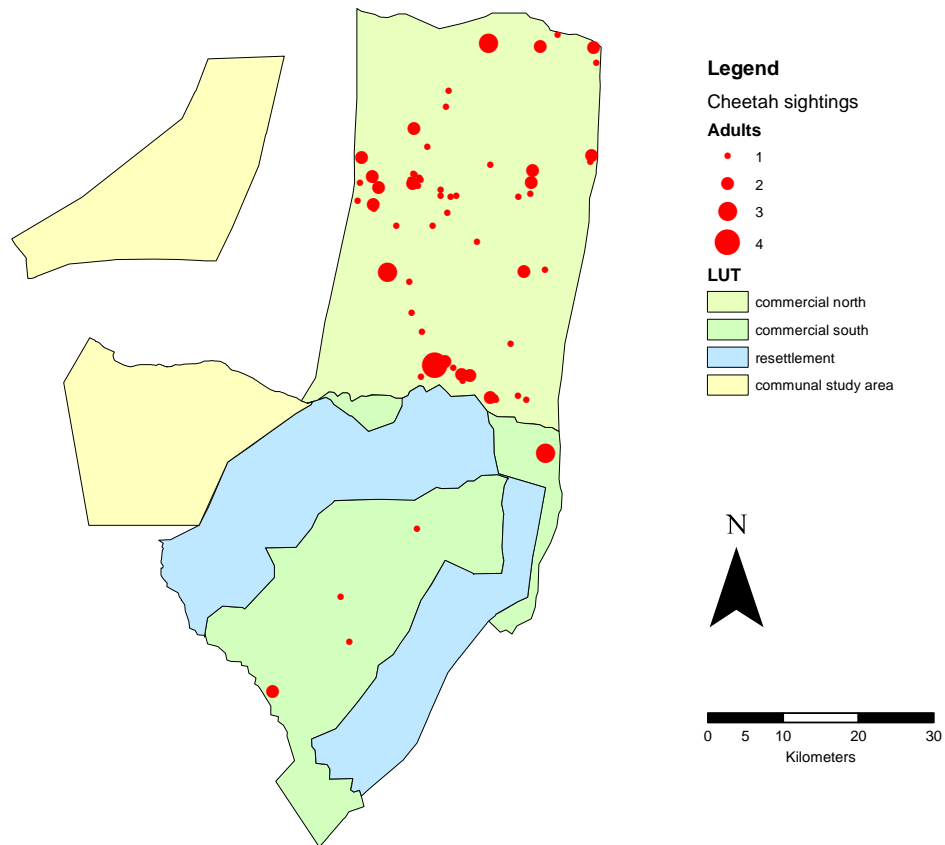
## 4.3 Results

### 4.3.1 Sighting method

A total of 67 sightings of cheetahs (either individuals or coalitions) were recorded, including redundant sightings (Table 4.2; Figure 4.1). Sightings were distributed throughout the commercial LUT, but no sightings were reported in the resettlement or communal LUTs. Cheetah sightings were much more common and more widely distributed throughout the commercial north than the commercial south. Most sightings were of single individuals but there were also sightings of coalitions of 2, 3 and 4 animals (Table 4.2).

**Table 4.2 Number of cheetah sightings recorded across all LUTs in and around Savé Valley Conservancy in 2008 and 2009. Includes redundant sightings.**

Group size	Number of occasions cheetahs seen				Total
	North	Commercial South	Overall	Resettlement	
1	43	3	46	0	46
2	16	1	17	0	17
3	2	1	3	0	3
4	1	0	1	0	1
Total	62	5	67	0	67



**Figure 4.1** Distribution of cheetah sightings, including redundant sightings, in and around Savé Valley Conservancy in 2008 and 2009. Cheetah sightings were distributed mainly in the commercial north. No sightings were recorded in the resettlement or communal LUTs.

Results of the sighting data analysis using a  $d$  value of 40 km (hereafter referred to as the sighting estimate) indicate that a total of 19 cheetahs occur on SVC. Thirteen cheetahs occurred in the commercial north, 6 cheetahs occurred in the commercial south, and no cheetahs were reported in resettlement or communal areas of the study site (Table 4.3). This corresponds to population densities of 0.75 animals per 100 km<sup>2</sup> overall in SVC, with densities of 0.79 and 0.67 animals per 100 km<sup>2</sup> in the northern and southern sections respectively.

When comparing the effect of different  $d$  values, total cheetah population estimates range from 13 to 31 for the greatest and smallest  $d$  values respectively (Table 4.3). These estimates differ

from the 19 cheetahs estimated using the 40 km  $d$  value by -32% and +63% respectively. The analysis was therefore considered to be sensitive to the selection of different  $d$  values.

**Table 4.3** Cheetah population estimates in Savé Valley Conservancy in 2008 - 2009 calculated using the sighting method. A range of  $d$  values were used for comparison, but 40 km (figures in bold) is thought to be the most appropriate for the study site. Redundant sightings were excluded from the analysis.

LUT	Number of cheetahs in sighting	$d$ (km)				
		15	30	<b>40</b>	50	75
Commercial north	1	6	3	<b>2</b>	1	1
	2	8	6	<b>4</b>	2	2
	3	6	6	<b>3</b>	3	3
	4	4	4	<b>4</b>	4	4
<i>Commercial north subtotal</i>		24	19	<b>13</b>	10	10
Commercial south	1	2	1	<b>1</b>	1	1
	2	2	2	<b>2</b>	2	2
	3	3	3	<b>3</b>	3	0
	4	0	0	<b>0</b>	0	0
<i>Commercial south subtotal</i>		7	6	<b>6</b>	6	3
<i>Commercial overall subtotal</i>		31	25	<b>19</b>	16	13
Resettlement	Any	0	0	<b>0</b>	0	0
Communal	Any	0	0	<b>0</b>	0	0
Grand total		31	25	<b>19</b>	16	13

### 4.3.2 Stakeholder method

Estimates of cheetah population sizes provided by ranch owners, managers, or senior game scouts and supervisors (hereafter referred to as the stakeholder estimate) are provided in Table 4.4. The raw stakeholder estimate indicates that 43 cheetahs (minimum 37, maximum 60) occupy SVC while the adjusted stakeholder estimate is 20 cheetahs (minimum 17, maximum 28). This is

equivalent to a density of 1.70 (1.46 - 2.37) animals per 100km<sup>2</sup> using the raw stakeholder estimate and 0.79 (0.67 - 1.11) animals per 100km<sup>2</sup> using the adjusted stakeholder estimate. The high population estimates generated using these methods are largely due to the large estimates of cheetah numbers on Msaize and Mapari ranches, which appear to be unrealistically high.

**Table 4.4 Raw and adjusted stakeholder estimates of the number of cheetahs in Savé Valley Conservancy in 2008-2009, based on cheetah sightings.**

North or South	Property	Estimated number of cheetahs		
		Best estimate	Maximum	Minimum
North	Matendere and Gunundwe	5	6	5
	Mapari	10	15	10
	Msaize	20	30	15
	Chishakwe	1	1	0
	<i>North subtotal</i>	<i>36</i>	<i>52</i>	<i>30</i>
South	Senuko	0	0	0
	Hammond	0	0	0
	Arda	1	2	1
<i>South subtotal</i>	<i>1</i>	<i>2</i>	<i>1</i>	
Both north and south	Humani, Chigwete and Bedford <sup>1</sup>	6	6	6
Total (raw stakeholder estimate)		43	60	37
Adjusted total stakeholder estimate		20	28	17

<sup>1</sup>Bedford falls into the north while Humani and Chigwete fall into the south. The three properties are owned and managed by a single landowner, who was able to provide only a combined estimate for all three properties together. This estimate was excluded from the subtotals for the commercial north and south, but was included in the total estimates.

Separate comparisons of cheetah population estimates in the northern and southern sections of SVC were difficult to make. One stakeholder owned three properties, one of which was located in the northern section and two were located in the southern section. The landowner was able to provide only an estimate of the combined number of cheetahs on all three properties. Excluding his estimate of 6 cheetahs results in a raw stakeholder estimate of 36 cheetahs in north SVC (minimum 30, maximum 52) and 1 cheetah in south SVC (minimum 1, maximum 2) (Table 4.4).

This represents densities of 2.20 and 0.11 cheetahs per 100 km<sup>2</sup> in the northern and southern sections of SVC respectively.

### 4.3.3 Longitudinal sighting data

Systematic records of cheetah sightings made over a number of years were kept only on one property, Senuko which is in the commercial south. There was a significant negative correlation between the number of cheetahs seen on Senuko and the year (Spearman rank correlation:  $r_s = -0.950$ ,  $df = 11$ ,  $P < 0.001$ ). Cheetahs were seen on more than 20 occasions per year in 1998 and 1999, but the number of sightings began to decline from 2000 at the onset of resettlement. Despite ongoing monitoring of sightings of cheetahs on Senuko, no further cheetah sightings were recorded after 2004 (Figure 4.2).

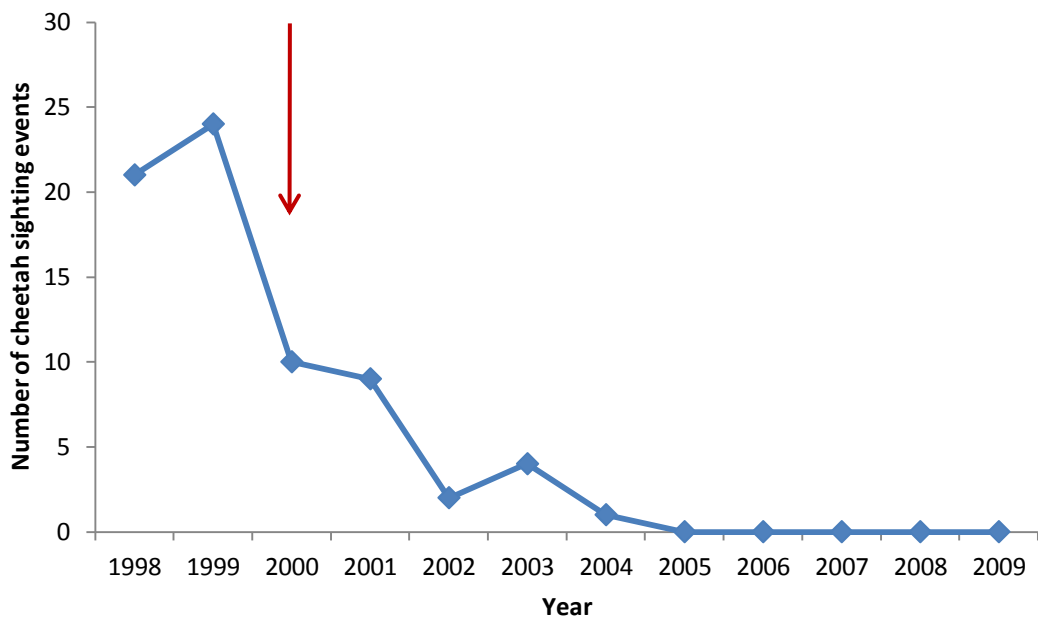


Figure 4.2 Number of occasions on which cheetahs were seen on Senuko ranch between 1998 and 2009. The reduction in cheetah sightings coincided with the onset of the FTLRP on other properties in SVC (red arrow).

#### **4.3.4 Perceived cheetah population trends**

Most respondents from the commercial LUT believed that the cheetah population on their property had declined (Figure 4.3a). Closer inspection shows that within SVC, management staff (managers, owners and professional hunters) held different views to general staff (game scouts, trackers and supervisors) about cheetah population trends (Figure 4.4). This difference was significant (Mann-Whitney U test:  $U = 52.000$ ,  $df = 30$ ,  $P = 0.013$ ; “Don’t know” responses excluded, “Increased” and “Same” responses grouped). All but one of the management staff reported that the cheetah population on their property had declined. In contrast the general staff gave much more varied responses, with “Don’t know” the most common response, and a roughly equal number of respondents reporting that the cheetah population had declined and increased. In the resettlement area most respondents considered the cheetah to be in decline (Figure 4.3b). This was also the second most common response in the communal area, although most respondents stated that they did not know the cheetah population trend (Figure 4.3c).

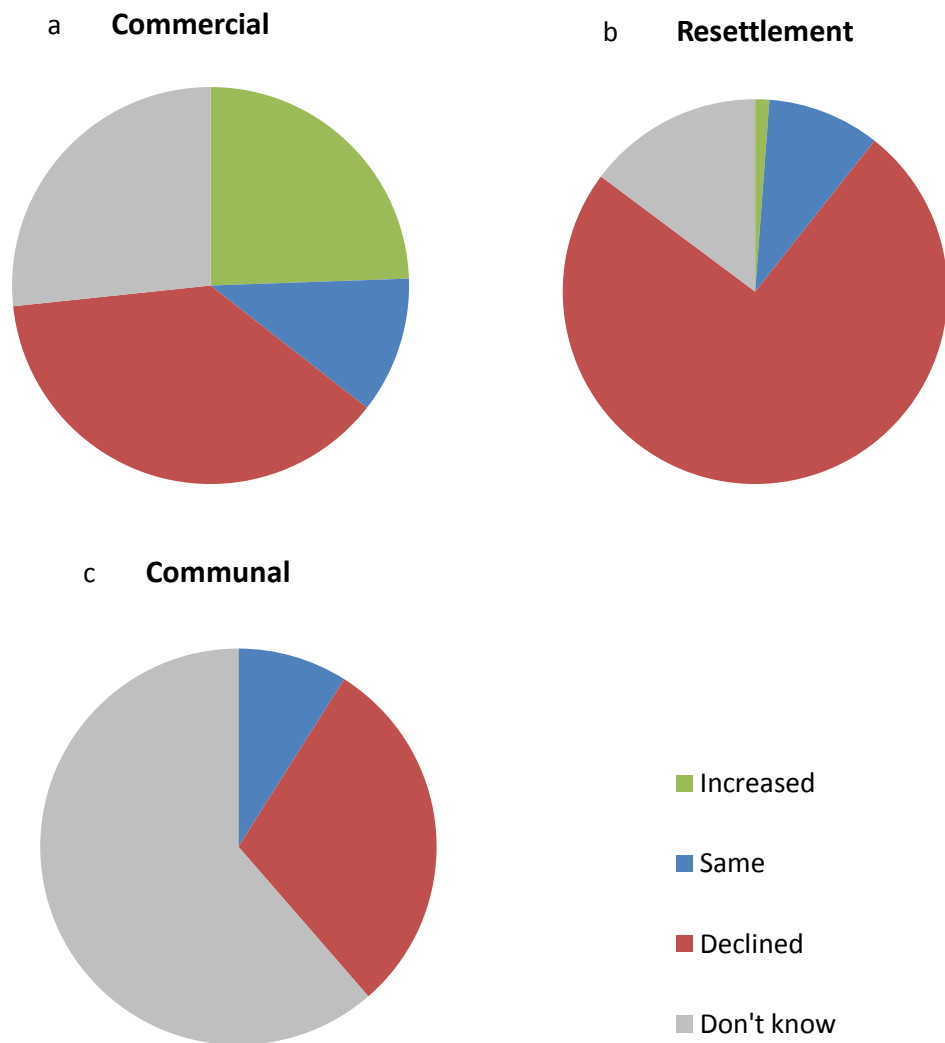


Figure 4.3 Perceived trend in cheetah population size in and around Savé Valley Conservancy in 2008 and 2009 in a) commercial (n=44); b) resettlement (n=169); c) communal (n=145) LUTs. Cheetahs were perceived as being in decline more often in the resettlement than the commercial LUT. Most respondents did not know what the trends in cheetah numbers were.

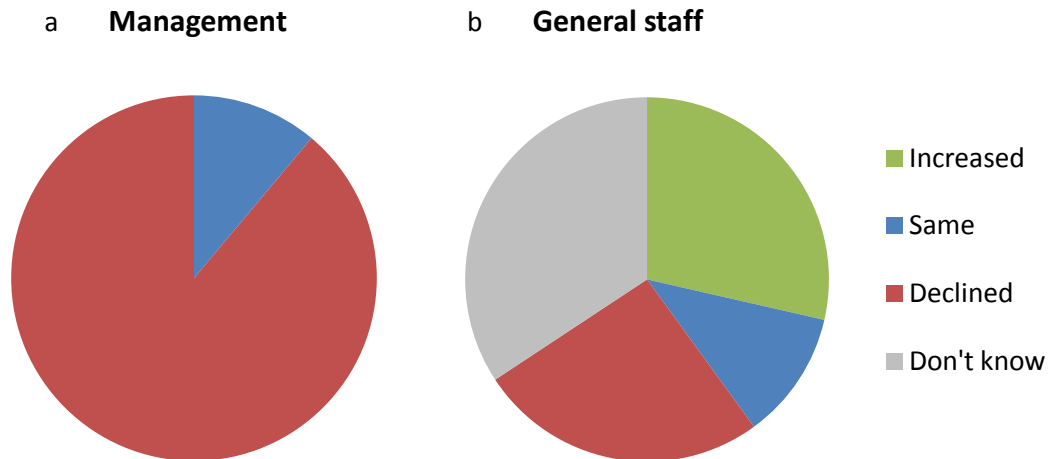


Figure 4.4 Perceived trend in cheetah population size in SVC in 2008 and 2009 by a) owners and management (n=9); b) general staff (n=35). One respondent (a researcher) was omitted as no other respondents had a similar job. Management staff were more likely to believe that the cheetah population had declined.

#### 4.4 Discussion

Cheetah sightings were limited to the commercial LUT, in line with predictions and with other studies demonstrating that respondents in commercial farming areas are more likely to have seen cheetahs than those in communal areas (Selebatso *et al.*, 2008). The sighting estimate showed a similar pattern to the cheetah population estimate calculated from spoor count data (Chapter 3). Both methods indicate that the largest cheetah population is found in northern SVC, and no cheetahs in the resettlement or communal areas. These findings concur with the conclusions of Chapter 3 that the number of cheetahs appear to have declined steeply in response to the FTLRP. In contrast to the spoor count estimate, however, sighting data indicate that several cheetahs still utilise the commercial south. This may not have been detected in the spoor count because this method could be less sensitive to populations that occur at low densities than the sighting method, unless much greater sampling effort is applied.

The sighting estimate (19 animals) fell within the 95% confidence limits of the spoor count estimate ( $11 \pm 10$  animals), but it was almost twice as high. Both methods produced similar estimates of population size for northern SVC, so this disparity is largely due to a relatively high



sighting estimate for southern SVC. As such the cheetah density derived from the sighting estimate in north SVC (0.79 animals per 100 km<sup>2</sup>) compares reasonably well with the literature. It is greater than the densities reported in northern Kruger National Park and Kgalagadi Transfrontier Park, and lower than cheetah densities in central and southern sections of Kruger National Park and Jwaneng Game Reserve in Botswana (Davies-Mostert *et al.*, 2010; Funston *et al.*, 2001; Houser *et al.*, 2009b). The sighting estimate in south SVC, however, generates a similar cheetah density (0.67 cheetahs per 100 km<sup>2</sup>) to the sighting estimate of density in northern SVC. This appears to be a great overestimate given that the spoor count data demonstrates a large disparity in the number of cheetahs in northern and southern SVC, despite similar survey effort being applied throughout the conservancy.

A small number of cheetah sighting reports had a very large influence on the population estimate. The inclusion of the only sighting of a group of 4 cheetahs increased the total population estimate from 15 to 19, an increase of 26%. The inclusion of sightings that were not corroborated by additional sightings of the group also had a disproportionately large effect on the population estimate. The buffers of a single sighting of 3 cheetahs and of the single sighting of 4 cheetahs did not overlap with the buffers of any other sightings of these groups. Inclusion of these two sightings increased the total population estimate from 12 to 19, an increase of 58%. The sparse information on these groups could indicate that their occurrence is less certain than the occurrence of groups that had many sightings, such as the 46 sightings of lone individuals which accounted for a population of only 3 cheetahs. Home range overlap and selection of representative areas of appropriate size could bias the sighting estimate (Durant *et al.*, 2007). It is suggested that in future studies a minimum of 2 sightings of a particular group of cheetahs with overlapping buffers should be required in order to include the sighting in the estimate of cheetah population size. If this criteria were applied, the resulting sighting estimate would be 10 cheetahs in the commercial LUT, with 9 cheetahs in the north and 1 in the south. This is much closer to the

estimate based on spoor data of 11 cheetahs in SVC, all of which occurred in the north (Table 3.4). It is not clear if this agreement is coincidental, so it would be interesting to see if these findings could be replicated at other study sites.

The sighting method is likely to generate less accurate population estimates than spoor counts, as there are a number of issues with the accuracy of the sighting estimate (Durant, 2004). The sighting method assumes that cheetahs form stable groups, and does not account for the flexibility in their social system. For example coalition members can temporarily or permanently separate, males and females may temporarily consort, and adolescent siblings can separate and reunite (Caro, 1994; Durant *et al.*, 2004). Mistakes can also be made by observers, such as failing to record the entire group, or reporting adult females with cubs as adult groups. It can also be very difficult to differentiate transient and resident cheetahs using this method, in contrast to long-term studies (Durant *et al.*, 2007). Furthermore, it is not possible to calculate the precision of the population estimates generated using sighting data, making it difficult to monitor trends, both of which are major disadvantages of the method relative to spoor counts (Funston *et al.*, 2010). Although every effort was made to standardise the analysis of sighting data, not all subjectivity was removed from the process, and it is possible that different researchers could arrive at different sighting estimates when using the same data and protocol. Furthermore, Table 4.3 highlights the importance of the selection of the correct  $d$  value, which should be given greater consideration if this method is used in future studies. It is suggested that at the very least the values used for parameters such as  $d$  and  $t$  should be reported in the literature. The sighting method was not considered to work effectively in this study, and spoor counts were the preferred method used for estimating cheetah abundance.

Nonetheless, sighting estimates were probably less subjective than the stakeholder estimates. Relative to spoor count estimates, stakeholder estimates for the commercial LUT overestimated

cheetah abundance by approximately four times (raw stakeholder estimate) and two times (adjusted stakeholder estimate). These inconsistencies were driven largely by the very unlikely estimates provided by some stakeholders such as on Msaize and Mapari ranches. Twenty cheetahs (min 15, max 30 animals) were said to occupy Msaize, which is equivalent to a population density of 11.72 (8.79 - 17.58) animals per 100km<sup>2</sup>. This is much greater than the highest densities in Kruger National Park (2.27 animals per 100 km<sup>2</sup>; Davies-Mostert *et al.*, 2010), cheetah density in the Serengeti (2.00 animals per 100 km<sup>2</sup>; Durant *et al.*, 2011), and in Timbavati Private Nature Reserve in South Africa (5.00 animals per 100 km<sup>2</sup>; Myers, 1975). This may be simply because some stakeholders hold inaccurate perceptions of wildlife populations, or could be the result of intentionally inaccurate reporting, for example due to political reasons. In Zimbabwe cheetah hunting quotas are allocated by Parks and Wildlife Management Authority, and are influenced by estimates of cheetah abundance made by landowners (Lindsey *et al.*, 2007; World Wildlife Fund for Nature, 1997). Intentional over reporting of cheetah abundance could be used as a mechanism to ensure that hunting quotas are secured. It is interesting to note that the two properties that provided very high estimates of cheetah abundance are the only two properties that regularly hunt cheetah in SVC. Irrespective of the reason for the exceptionally high estimates on some properties, it is likely that some estimates provided by stakeholders are very inaccurate, so the stakeholder estimates should be viewed with caution. The estimates would probably have been greater still if all the properties of SVC were included in the stakeholder estimate. It is interesting that the total adjusted stakeholder estimate for SVC (20 animals) is similar to the sighting estimate (19 animals), but this could be a coincidence, as both methods seem to be less reliable than spoor counts. Wilson (1987) provides no data to justify the correction factor he uses to calculate his adjusted stakeholder estimate. This correction factor may not be generally applicable to other studies as it is likely to depend on variables such as which stakeholders are interviewed, how well informed they are, and whether they have any motivation to manipulate their estimates. Comparing the raw stakeholder estimate for SVC (43

cheetahs) with the estimate based on spoor counts (11 cheetahs) results in a correction factor of 0.26, which is very different to Wilson's (1987) correction factor of 0.46.

Longitudinal data indicate that the cheetah population of Senuko began to decline in 2000, after which the number of cheetah sightings per year declined steadily and reached zero within 4 years. An important caveat of this data is that survey effort also declined from 2000, as fewer clients visited Senuko (C. Stockil, pers. comm.), in line with the steep decline in the number of international visitors to Zimbabwe following the farm invasions (Lindsey *et al.*, 2007). This resulted in fewer game drives and hunts being conducted, decreasing the number of opportunities to see cheetahs. No data are available to quantify the change in survey effort, but the manager of the property believed that the decline in cheetah sightings observed reflects the true trend in cheetah numbers on Senuko (C. Stockil, pers. comm.).

The longitudinal sighting data supports the beliefs of the commercial farmers that the cheetah population in SVC has declined, although there is an interesting disparity between the responses of the management staff and general staff of properties in the conservancy (Figure 4.4). One of the responsibilities of management staff is to estimate the abundance of large mammals of interest to SVC on their property, as this information is used to apply for hunting quotas and for wildlife management purposes. As such, management staff utilise a number of sources to make their estimates, including aerial counts, road strip counts, and trophy quality in addition to sightings made by professional hunters, game scouts, and other sources. They have also typically lived and worked in the area for longer than general staff (mean residence 16 years and 8 years respectively). In contrast the general staff are not normally required to make assessments of wildlife populations, and are generally engaged in activities such as anti-poaching. General staff are unlikely to have access to the broader range of resources available to managers, so they can draw only on their own, sometimes limited, personal experience. For these reasons the perceived

cheetah population trend data that were collected from the management staff are probably more accurate than the responses of the general staff.

Management staff from SVC maintain that the cheetah population has declined on their properties since other areas of the conservancy were resettled (Figure 4.4a). This could explain the current low density of cheetahs in the commercial south (see Chapter 3 and sections 4.3.1 and 4.3.2). The beginning of the decline coincides with the resettlement of parts of SVC, supporting the hypothesis that resettlement played a role in the decline of the cheetah population in SVC. The perceived decline in the cheetah population of the resettled area (Figure 4.3b) is probably accurate, and supports the findings based on sightings (Figure 4.1) and spoor count data (Chapter 3) that cheetahs are now likely to be absent from this area. The broad agreement that the cheetah population has declined is consistent with the suggestion by the ranchers that at the beginning of the resettlement period cheetahs were present in the area that became resettled, but they have now been extirpated (J.R. Whittall, pers. comm.). The same is likely to be true of other medium-sized and large mammals. In the communal area the large proportion of “Don’t know” responses (Figure 4.3c) is probably explained by the long-term absence of cheetahs from that area. Zimbabwe’s communal lands are thought to support very few cheetahs (Wilson, 1987) due to factors associated with the high human density (Woodroffe, 2000), so people in this region are probably not very familiar with cheetahs.

## **4.5 Summary**

Estimates of cheetah population size across the study site calculated using sightings of cheetahs indicate that cheetahs occur at the highest density in northern SVC, and are absent from the resettlement and communal areas (objective 1). This supports the findings of Chapter 3 that the FTLRP has had a substantial negative impact on the number of cheetahs. In contrast to the spoor

count data, however, sighting data suggest that cheetahs still utilise parts of southern SVC, although they occur at a lower density than in northern SVC. The sighting estimate (a total of 19 cheetahs in SVC) and stakeholder estimates (raw: 43 cheetahs, adjusted: 20 cheetahs) were both much greater than the spoor count estimate (11 cheetahs). As a consequence sighting methods are not thought to provide reliable estimates of cheetah abundance, and spoor counts are preferred. The longitudinal data available for part of SVC suggest that cheetah numbers have declined steeply since 2000, coinciding with the resettlement of parts of the conservancy. This is consistent with the cheetah population trend perceived by respondents in the resettlement area and by management staff at SVC, but the general staff have more mixed perceptions. The following chapter considers the data presented on the abundance of large carnivores relative to their carrying capacity.

# Chapter 5 Carnivore carrying capacity

---

## 5.1 Introduction

Estimation of the abundance of carnivores is essential to their conservation and management, but information on carrying capacity helps to put this in context and determine what limits populations. Carrying capacity can be defined as the biomass or number of individuals of a given species that can be supported by a habitat (Odum, 1993). If a population exceeds its carrying capacity it can crash, or can have negative impacts on the environment (McCullough, 1979). Declines in prey populations in small, enclosed reserves have been observed after lions exceeded their carrying capacity, sometimes driving wildlife managers to intervene to reduce lion populations (Hayward *et al.*, 2007a; Hayward *et al.*, 2007b; Hunter, 1998; Tambling and Du Toit, 2005). Similarly, information on carrying capacity can warn conservation biologists when populations are much smaller than they could be (for example Timmins *et al.*, 2008). Assessment of carrying capacity is almost as important as assessment of population size (Chapter 3), as the two parameters both inform wildlife managers about the health of an ecosystem and allow them to decide whether intervention is necessary. Information on carnivore carrying capacities is extremely useful to managers of the study site as it helps them to determine whether hunting quotas should be adjusted or if restocking or destocking should be implemented in order to maintain sustainable wildlife populations.

The carrying capacity of a population is influenced by a number of factors, the most important of which is generally thought to be the abundance of resources (Fuller and Sievert, 2001). Attempts have been made to estimate species carrying capacity based on the size of a site in relation to the home range size and the degree of home range overlap of the study species (such as Boshoff *et al.*, 2002), but this approach has been criticised as inaccurate because other resources such as

prey abundance are more relevant (Hayward *et al.*, 2007b). In southern Africa prey abundance is a key determinant of carnivore carrying capacity, which is in turn closely related to annual rainfall (Coe *et al.*, 1976; East, 1984). Significant relationships have been established between carnivore carrying capacity and prey density for cheetah (Gros *et al.*, 1996; Hayward *et al.*, 2007b), lion, (Hayward *et al.*, 2007b; van Orsdol *et al.*, 1985), leopard (Hayward *et al.*, 2007b; Stander *et al.*, 1997b), spotted hyena (Hayward *et al.*, 2007b) and wild dog (Hayward *et al.*, 2007b), and for carnivores in general (Carbone and Gittleman, 2002; East, 1984).

In this chapter aerial survey data will be analysed to determine the biomass of species preyed upon by the six large carnivores that occur in the study site: cheetah, lion, leopard, spotted hyena, brown hyena and wild dog (objective 2). These data will then be used along with the annual rainfall to estimate the carrying capacity of the carnivores using a range of models. The most appropriate model will be selected, and used to estimate carnivore carrying capacity across different land use types (LUTs) and trends through time. Carnivore carrying capacity is predicted to be greatest in the commercial LUT and much lower in the resettlement LUT.

## 5.2 Methods

The Technical Advisory Committee of SVC conducted annual aerial surveys of the mammals in the commercial and resettlement areas of the study site between 2004 and 2008. No communal land was included. The surveys focussed on medium and large herbivores but also collected data on other species and physical features such as settlements. Survey reports (Joubert, 2005, 2006, 2007, 2008; Technical Advisory Committee of the Savé Valley Conservancy, 2004) provided total counts and population trends over time of all mammals observed, and the results were used to inform wildlife management practices. The reports were confidential, but permission was granted to use the 2004-2008 aerial survey reports in this study. In this chapter the data



presented in the aerial survey reports are used to estimate the biomass of potential prey species (listed in Table 5.1) and carrying capacities of the cheetah, lion, leopard, spotted hyena, brown hyena and wild dog.

**Table 5.1 Average female body masses of prey species included in biomass calculations. All masses were taken from Hayward *et al.* (2007b) except that of the brown hyena, which was from Stuart and Stuart (1997).**

Species	Body mass (kg)	Species	Body mass (kg)
Cheetah	50.0	Bushbuck	46.0
Lion	142.0	Bushpig	46.0
Leopard	46.5	Nyala	47.0
Spotted hyena	58.6	Lichtenstein's hartebeest ( <i>Sigmoceros lichtensteinii</i> )	95.0
Brown hyena	45.0	Kudu	135.0
Wild dog	25.0	Blue wildebeest	135.0
Sharpe's grysbok	7.0	Zebra	175.0
Klipspringer	10.0	Sable	180.0
Baboon	12.0	Waterbuck	188.0
Common duiker	16.0	Eland	345.0
Impala	30.0	Buffalo	432.0
Warthog	45.0	Giraffe	550.0

The aerial survey generally followed the standard methods described in the literature (Norton-Griffiths, 1978; Owen-Smith and Ogutu, 2003; Sutherland, 1996a). The surveys were conducted over approximately 14 days in September and October each year, flying a Cessna 206 aircraft between 05:30 and 09:50 when many diurnal species are most visible (Joubert, 2008). Height above ground level was approximately 90 m and the mean speed was approximately 85 km/h (Joubert, 2008). Transects ran east-west and were separated by 750 m intervals (Figure 5.1). The Mukwazi, Mukazi and Angus ranches (now resettled; see Figure 1.5 and Figure 5.1) were omitted from the 2008 aerial survey due to severe fuel shortages affecting Zimbabwe (Joubert, 2008). Aerial survey data collected in 2007 on these three ranches was combined with the 2008 aerial survey dataset for analysis of 2008 data.

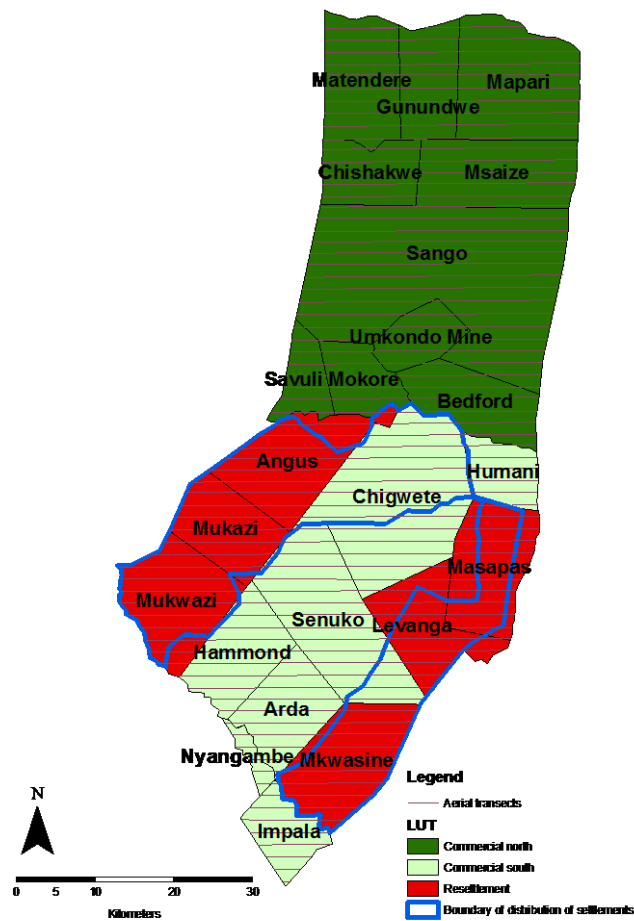


Figure 5.1 Aerial transects, property names and land use types used in the analysis of aerial data for Savé Valley Conservancy in 2008. Data from the 2007 aerial survey were used for Mukazi, Mukwazi and Angus, the properties excluded from the 2008 aerial survey. Note that a significant area of Chigwete and Senuko fall inside the resettlement area, as delineated by the distribution of settlements (blue line). Adapted from Joubert (2008).

The aircraft was crewed by a pilot, a scribe and two teams of two observers, one team observing each side of the transect. Strip widths of 375 m either side of the aircraft were marked using streamers on the wing struts, and for each mammal observed within the strip the species and group size were recorded by the scribe. A Garmin GPSMAP 496 GPS receiver was also used to record the locations of sightings (Joubert, 2008). In order to ensure greater accuracy of counts elephant herds were circled when encountered to allow greater time to count individuals, and buffalo herds were photographed using an Olympus C740 digital camera. Individual buffalo were marked using Photohouse software and counted. The number of individuals of each species was

summed to provide the total count of population sizes (Joubert, 2008). For baboons the number of troops rather than individuals was recorded. This was multiplied by the mean group size of 42 (Henzi *et al.*, 1999) to estimate the total number of individuals. The location of physical features such as settlements was also recorded (Joubert, 2008).

A range of linear regression models were used to calculate carnivore carrying capacity based on prey densities or rainfall (Table 5.4). For each potential prey species total biomass was calculated by multiplying the total number of individuals recorded in the aerial survey (Joubert, 2008) by three quarters of the average adult female body mass, in order to account for young and sub-adult animals consumed (Schaller, 1972). Body masses were taken from Hayward *et al.* (2007b) with the exception of brown hyena which was taken from Stuart and Stuart (1997). Biomass was then divided by the area under consideration to generate a biomass density (kg/km<sup>2</sup>; Table 5.2). Areas were measured from ArcGIS 9.3 (ESRI, 2008) using property boundaries digitised from 1:250,000 maps (Surveyor General, 1993, 1995) and updated where necessary following discussions with current ranch managers and stakeholders. Prey species were selected for inclusion in the analysis (Table 5.3) if they were used in the development of the model (Table 5.4). Criteria used to select prey species were based on either the carnivore's preferred body mass range of prey species, or on which prey species were preferred. For all except models 14 and 15 (Carbone and Gittleman, 2002), the sources used to select preferred prey species were listed (Hayward, 2006; Hayward *et al.*, 2006a; Hayward *et al.*, 2006b; Hayward and Kerley, 2005; Hayward *et al.*, 2006c; Maude and Mills, 2005). Carbone and Gittleman (2002) selected the prey species that constituted a minimum of 70% of the predator's diet, but the particular species selected, or the source of their information was not provided. Two separate models were therefore calculated using Carbone and Gittleman's (2002) equation (Table 5.4): model 14 used the preferred species of each predator; while model 15 used the preferred prey body mass range

(Hayward, 2006; Hayward *et al.*, 2006a; Hayward *et al.*, 2006b; Hayward and Kerley, 2005; Hayward *et al.*, 2006c; Maude and Mills, 2005).

**Table 5.2 Areas used for analysis of SVC aerial data on a land use type scale.**

Land use type	Area (km <sup>2</sup> )
Commercial north	1,633
Commercial south	978
Commercial overall	2,612
Resettlement	898
Total	3,510

It should be noted that a number of the publications from which the equations were obtained contained typographical errors that had to be detected and corrected before use on the dataset. Models 1, 2, 4, 5, 7, 8, 10, 11, 12 and 13 had to be corrected for errors including  $x$  actually referring to  $y$ ,  $y$  actually referring to  $x$ , and omission of superscript necessary to signify the exponent (Carbone and Gittleman, 2002; Hayward *et al.*, 2007b). These errors were confirmed by the authors (C. Carbone, pers. comm., M. Hayward, pers. comm.).

Models take the form of  $y = mx + c$ , where  $y$  represents carnivore biomass density (kg/km<sup>2</sup>);  $m$  represents the gradient;  $x$  represents the prey biomass density (kg/km<sup>2</sup>) for models 1-16 or mean annual rainfall for model 17 and  $c$  represents the intercept (Table 5.4). Models 14 and 15 also include area  $a$  and carnivore body mass  $z$  (provided in Table 5.1). Lindsey *et al.* (2009b) gave the mean annual rainfall at the study site as 474-540 mm, so the value selected for analysis was 474 mm in order to generate conservative estimates of carrying capacity. Although there may be variations in rainfall across the study site, no data are available, so a single value was used across each land use type. The various carrying capacity estimates were then compared with one another and with the estimates of true density calculated from spoor transect data (Figure 5.6). The most appropriate equation for each carnivore was then selected based on consistency and

size of estimates relative to estimates of true density, and was used to estimate carrying capacity for each section of the study site.

Aerial survey reports (Joubert, 2005, 2006, 2007, 2008; Technical Advisory Committee of the Savé Valley Conservancy, 2004) detail the location of species on a property-by-property basis. Properties were classified as commercial north, commercial south or resettlement land use types as described in Chapter 2, but as they were measured on a property-by-property basis the sizes used for analysis (Table 5.2) were different to the areas used in Chapter 3 and Chapter 4. Estimates of true density were adjusted to account for the different sizes of the area of the LUTs used.

**Table 5.3 Selection of inputs (prey species) to carrying capacity models. Species were selected for a model if they were used in the development of that model. Adapted from Hayward *et al.* (2007b).**

	Selection of inputs for models of Hayward <i>et al.</i> (2007b) and Carbone and Gittleman (2002)		Selection of inputs for other models <sup>2, 4, 6</sup>
Carnivore	Preferred prey species present at study site	Preferred prey body mass range (kg)	Body mass range (kg)
Cheetah	Impala <sup>1</sup>	23-561 <sup>1</sup>	15-60 <sup>2</sup>
Lion	Blue wildebeest, buffalo, giraffe, zebra <sup>3</sup>	190-550 <sup>3</sup>	190-550 <sup>4</sup>
Leopard	Impala, bushbuck, common duiker <sup>5</sup>	10-40 <sup>5</sup>	10-40 <sup>6</sup>
Spotted hyena	Blue wildebeest, buffalo, giraffe, zebra <sup>a, 7</sup>	56-182 <sup>7</sup>	N/A
Brown hyena	Blue wildebeest, zebra <sup>8</sup>	Blue wildebeest, zebra, kudu, common duiker, impala <sup>b, 8</sup>	N/A
Wild dog	Kudu, impala, bushbuck <sup>9</sup>	16-32 and 120-140 <sup>9</sup>	N/A

<sup>a</sup> Preferred prey species of the lion were used. Hayward (2006) did not find any prey species that were significantly preferred by the spotted hyena, but did find a high degree of overlap between the diets of spotted hyena and lion. Hayward *et al.* (2007b) derived a significant association between the density of spotted hyenas and the density of the preferred prey species of the lion.

<sup>b</sup> Hayward's group did not calculate the preferred prey body mass range of the brown hyena. Data presented by Maude and Mills (2005) on all wild mammalian prey species consumed were therefore used in lieu of these data.

Sources: <sup>1</sup>Hayward *et al.* (2006b); <sup>2</sup>Gros *et al.* (1996); <sup>3</sup>Hayward and Kerley (2005); <sup>4</sup>van Orsdol *et al.* (1985); <sup>5</sup>Hayward *et al.* (2006a); <sup>6</sup>Stander *et al.* (1997b); <sup>7</sup>Hayward (2006); <sup>8</sup>Maude and Mills (2005); <sup>9</sup>Hayward *et al.* (2006c).

**Table 5.4** Equations used to estimate predator carrying capacity in Savé Valley Conservancy ( $y$ ;  $\log_{10}$ ;  $\text{kg}/\text{km}^2$ ) based on biomass of prey species ( $x$ ;  $\log_{10}$ ;  $\text{kg}/\text{km}$ ).  $a$  represents area and  $z$  represents carnivore body mass.

Species	Model	Prey selection	Equation	Equation derived from
Cheetah	1*	Preferred species	$y = 0.369x - 2.543$	Hayward <i>et al.</i> (2007b)
	2*	Preferred body mass range	$y = 0.411x - 2.641$	Hayward <i>et al.</i> (2007b)
	3	15-60 kg body mass	$y = 0.002x + 0.21$	Gros <i>et al.</i> (1996) <sup>†</sup>
Lion	4*	Preferred species	$y = 0.377x - 2.158$	Hayward <i>et al.</i> (2007b)
	5*	Preferred body mass range	$y = 0.152x - 1.363$	Hayward <i>et al.</i> (2007b)
	6	Preferred body mass range	$y = 0.0001x + 0.0870$	Van Orsdol (1985), cited in Hayward <i>et al.</i> (2007b) <sup>†</sup>
Leopard	7*	Preferred species	$y = 0.405x - 2.248$	Hayward <i>et al.</i> (2007b)
	8*	Preferred body mass range	$y = 0.456x - 2.455$	Hayward <i>et al.</i> (2007b)
	9	15-60 kg body mass	$y = 0.0048x + 0.5793$	Stander (1997b) <sup>†</sup>
Spotted hyena	10*	Preferred species	$y = 0.349x - 1.959$	Hayward <i>et al.</i> (2007b)
	11*	Preferred body mass range	$y = 0.467x - 2.195$	Hayward <i>et al.</i> (2007b)
Wild dog	12*	Preferred species	$y = 0.470x - 2.780$	Hayward <i>et al.</i> (2007b)
	13*	Preferred body mass range	$y = 0.494x - 3.012$	Hayward <i>et al.</i> (2007b)
Each carnivore species separately <sup>‡</sup>	14*	Preferred species	$y = \frac{94.54z^{-1.03} \cdot \frac{x}{10,000}}{a}$	Carbone and Gittleman (2002)
	15*	Preferred body mass range	$y = \frac{94.54z^{-1.03} \cdot \frac{x}{10,000}}{a}$	Carbone and Gittleman (2002)
All carnivore species combined <sup>‡</sup>	16	15-450 kg body mass	$y = 0.00063x + 0.63$	East (1984) <sup>†</sup>
	17	474 mm annual rainfall	$y = 1.88x - 4.0$	East (1984)

\*Equation corrected from incorrect form presented in original publication.

<sup>†</sup>These equations are based on untransformed data.

<sup>‡</sup>Carbone and Gittleman (2002) equation allows estimation of carrying capacity for each species of carnivore, while East's (1984) equations allow only estimation of the combined sum of all carnivore biomass.

It was not possible to model future population dynamics of carnivores directly due to insufficient data on life-history parameters (Kelly and Durant, 2000). Lindsey *et al.* (2011b), however, were able to model population trends of the main prey species (impala, kudu, sable, waterbuck, warthog, wildebeest, zebra, giraffe, and buffalo) over the next 14 years in the commercial north and commercial south of SVC. Analyses were based on wildlife population density data collected in the annual aerial surveys (Joubert, 2005, 2006, 2007, 2008; Technical Advisory Committee of the

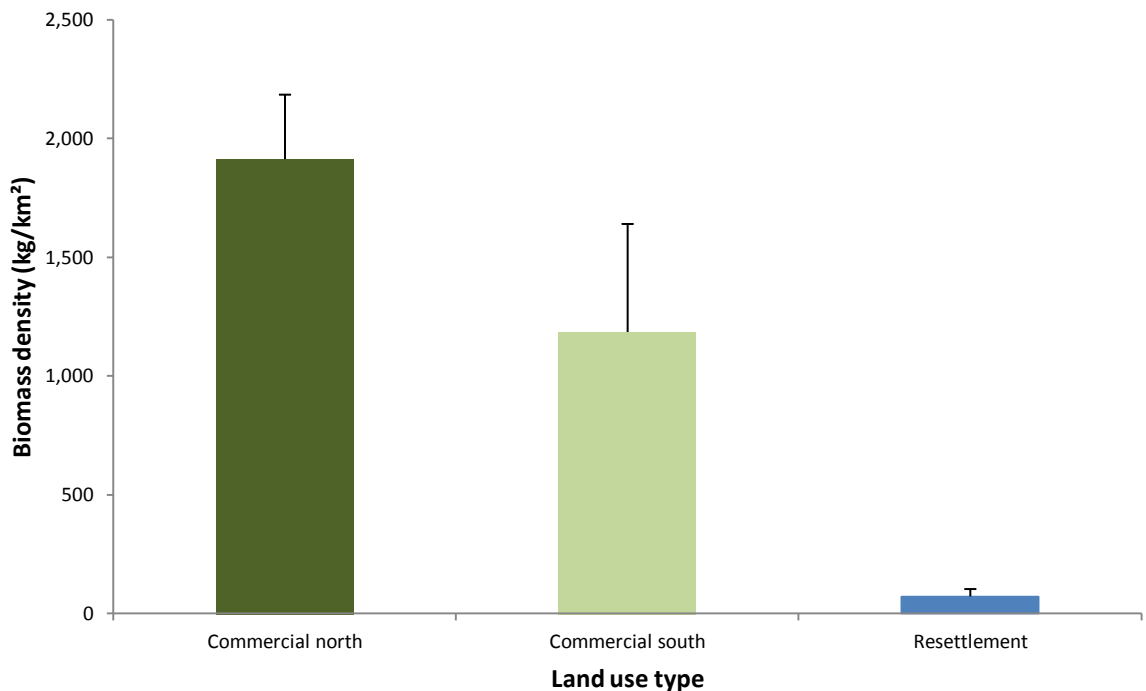
Savé Valley Conservancy, 2004), and on recorded losses to illegal poaching (recorded by conservancy anti-poaching teams) and to legal trophy hunting. Poaching rates applied to the models were increased by 100% and 250% in the commercial north and south respectively in order to account for undetected poaching incidents, in line with estimates provided by ranch managers (Lindsey *et al.*, 2011b).

The prey population sizes predicted by Lindsey *et al.* (2011b) were used to model changes in carnivore carrying capacity between 2009 and 2022. Lindsey *et al.* (2011b) collected data over a slightly different area than the current study (for example they included Masapas and part of Levanga, but excluded Arda, see Figure 1.5). To account for this predicted prey population density was calculated by dividing Lindsey *et al.*'s (2011b) predicted prey population sizes by their study areas (1,669 km<sup>2</sup> and 874 km<sup>2</sup> in the commercial north and south respectively, calculated by importing their figure into ArcGIS 9.3 (ESRI, 2008) and digitising and measuring their study area). These data were used to predict carnivore carrying capacity densities, which were converted to population sizes by multiplying the densities by the areas used in the current study (1,633 km<sup>2</sup> and 978 km<sup>2</sup> in the commercial north and south respectively). The same prey species (Table 5.3) and equations (Table 5.4) selected for modelling current and past carnivore carrying capacity were applied to predicted prey populations. Population size of bushbuck and common duiker were incorporated into current and past carrying capacity models for some carnivores (leopard and wild dog), but were omitted from models of future carrying capacities because they were not computed by Lindsey *et al.* (2011b). However these species constitute a minor component of prey biomass (0.4% and 0.5% of the 2008 commercial overall prey biomass applied to models of leopard and wild dog carrying capacity respectively) so this should have minimal effect.

## 5.3 Results

### 5.3.1 Current prey biomass

Total biomass density of all mammalian potential prey species differed significantly between the LUTs (Kruskal-Wallis:  $\chi^2 = 13.510$ ,  $df = 2$ ,  $P < 0.001$ ). Total prey biomass density was smallest in the resettled area and greatest in the commercial north (Figure 5.2). In relation to the resettlement area, total biomass density was 17 times greater in the commercial south and 27 times greater in the commercial north.



**Figure 5.2 Comparison of prey biomass density across land use types in and around Savé Valley Conservancy in 2008. Error bars represent standard errors. Prey biomass is much lower in the resettlement LUT than the commercial north or commercial south.**

In the commercial south high prey biomass densities persist on Impala, Hammond and Humani, which are comparable with prey biomass densities in the commercial north (Figure 5.3). Relative to other commercial properties, Arda and Nyangambe have exceptionally low biomass densities (Figure 5.3). On Chigwete and Senuko prey biomass density was relatively low. Although these



two properties were classified as commercial for the purposes of this analysis, large sections of them fall into the resettlement area (Figure 5.1). The species distribution figures presented in Joubert (2008) indicate that biomass is distributed unevenly within these two properties, with most sightings of prey species located within the sections of these properties that have not yet been resettled, and very little prey biomass located in the resettled components. This is illustrated in Figure 5.4, using the distribution of impala as an example. If it is assumed that all sightings occurred in the commercial sections (323 km<sup>2</sup>) and no individuals were recorded in the resettled sections, biomass of all potential prey species equates to 1205 kg/km<sup>2</sup> in the remaining 323 km<sup>2</sup>. Although this assumption is invalid, it may be more realistic than assuming that all species were distributed at equal density between the resettled and commercial sections of Chigwete and Senuko. This is 37% lower than the mean prey biomass density in the rest of the commercial area of SVC (1,906 kg/km<sup>2</sup> when the commercial north and south are combined).

Although the prey biomass in the resettled LUT was very low, most sightings of potential prey species were concentrated in the pockets of un-cleared land that still exist in some resettled properties such as Levanga and Masapas. Prey biomass will therefore be lower across most of the resettlement area than Figure 5.2 and Figure 5.3 indicate.

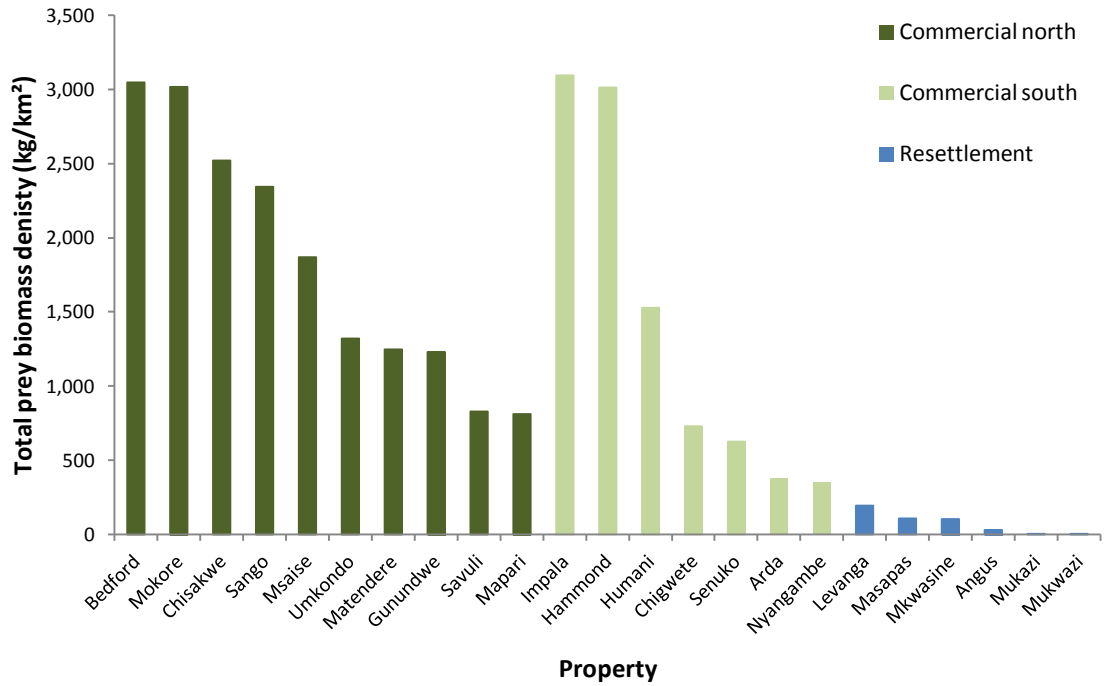


Figure 5.3 Total prey biomass density on each property in Savé Valley Conservancy in 2008.

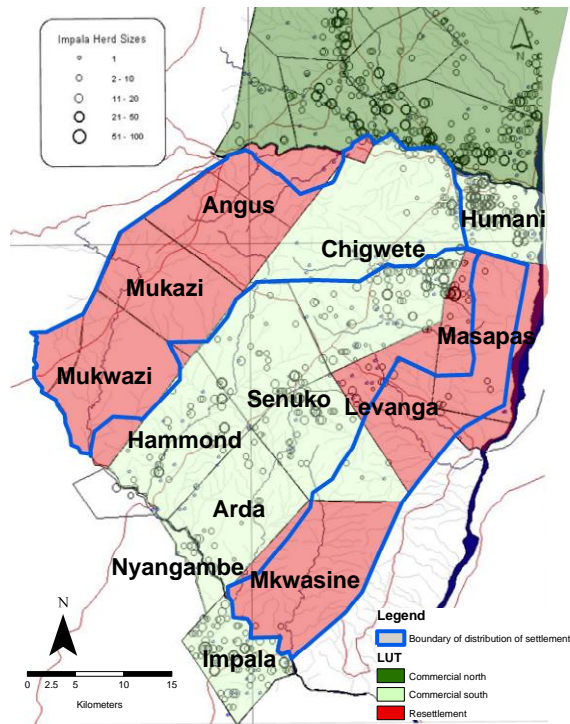


Figure 5.4 Distribution of impala (black circles) in the commercial south and resettlement LUTs in Savé Valley Conservancy in the 2008 aerial survey. Adapted from Joubert (2008). Impala are restricted almost entirely to the commercial LUT.

Biomass density of most prey species at SVC (Figure 5.5) was comparable to that at Kruger National Park (Owen-Smith and Ogutu, 2003). Although buffalo had a much greater density at Kruger National Park, all other species compared occurred at similar densities in SVC. Prey biomass densities were generally greater at Gonarezhou National Park (Dunham *et al.*, 2010b) than the resettlement area of SVC, but much lower than the commercial north and south of SVC (Figure 5.5).

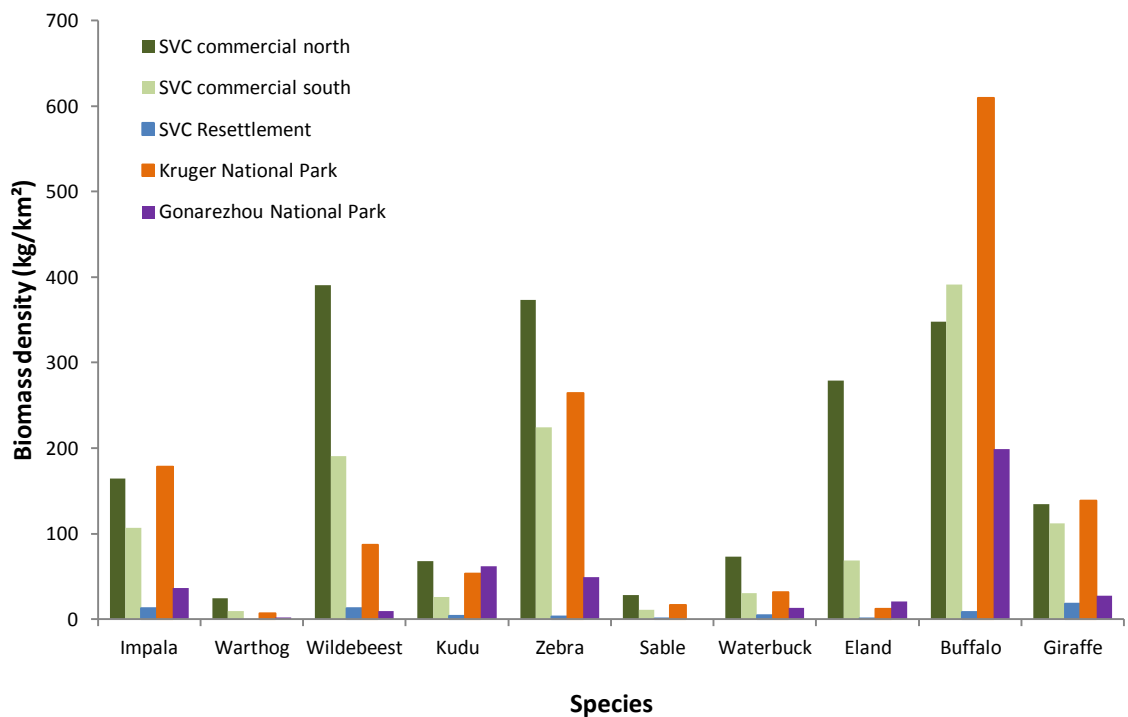


Figure 5.5 Comparison of prey biomass density at SVC in 2008 (this study) with Kruger National Park (Owen-Smith and Ogutu, 2003) and Gonarezhou National Park (Dunham *et al.*, 2010b). Note that total counts were employed at SVC and Kruger National Park, while sample counts were used at Gonarezhou National Park. Prey biomass at SVC is generally comparable with other sites.

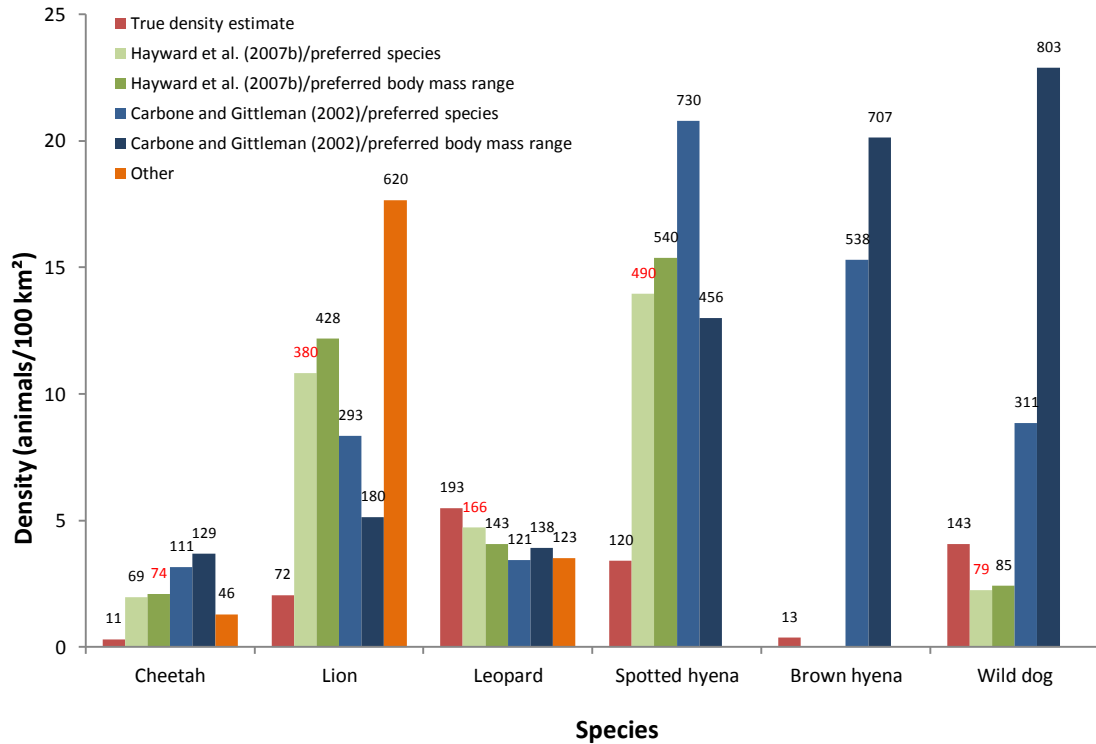
### 5.3.2 Current carrying capacity

Models 3, 6 and 9 (Gros *et al.*, 1996; Stander *et al.*, 1997b; van Orsdol *et al.*, 1985) predicted inconsistent carrying capacity predictions for the cheetah, leopard and lion respectively (Figure 5.6). These models predicted carrying capacities that were often the greatest or the smallest of all estimates. Models 14 and 15 (Carbone and Gittleman, 2002) were sensitive to the selection of

different prey biomass, with estimates differing by a factor of up to 2.6 depending on which criteria were used to select prey species included in the analysis (Figure 5.6). In general this model produced larger estimates than Hayward *et al.*'s (2007b) models (models 1, 2, 4, 5, 7, 8 and 10-13; Figure 5.6). This may be because the latter were calculated based on datasets derived from carnivores sympatric with other competitor species and therefore account for interspecific competition (for example Creel and Creel, 1996; Laurenson, 1995) and dietary overlap (Hayward and Kerley, 2008) rather than relying on metabolic determinants of population size (Carbone and Gittleman, 2002; Hayward *et al.*, 2007b). Overpopulation of carnivores can have severe consequences, so more moderate estimates calculated using the models of Hayward *et al.* (2007b) are preferred. These equations provided more consistent estimates, and are derived from data collected from a wider range of habitat types, with a larger sample size than most studies. The carrying capacity estimates calculated using Hayward *et al.*'s (2007b) models were fairly robust to the selection of different prey biomasses. Hayward *et al.* (2007b) found that the models that explained the most variance were based on preferred prey species for lion (model 4), leopard (model 7), spotted hyena (using the preferred prey species of lion; model 10) and wild dog (model 12), while for cheetah the equation that explained the most variation was based on the preferred body mass range of prey (model 2). These models were therefore selected for further analysis (Figure 5.7 to Figure 5.12). The models selected often generated carrying capacities that were closest to estimates of true density (Figure 5.6).

The estimates of brown hyena carrying capacity are very high and vary greatly from the reference density, so this species was excluded from further analysis. Although general models (Carbone and Gittleman, 2002) were applied that are intended to explain the density of all carnivores based on prey biomass, it is difficult to apply it these models to the brown hyena because the species has such a varied diet. Vertebrates can compose most of the diet or as little as 5% of the diet of

brown hyenas, depending on the population (Maude and Mills, 2005), so determining the prey biomass available to the brown hyena is challenging.



**Figure 5.6 Comparison of carnivore carrying capacity estimates at Savé Valley Conservancy in 2008. Commercial and resettlement LUTs are pooled; the communal LUT was not sampled. True density estimates are derived from spoor counts. Data labels show population size. Equations in Hayward *et al.* (2007) (red data labels) were selected for further analysis. “Other” carrying capacity estimates were derived from Gros *et al.* (1996) (cheetah), Stander (1997b) (leopard) and van Orsdol (1985), cited in Hayward *et al.* (2007) (lion).**

Application of the selected models demonstrated that carrying capacity for each carnivore was greatest in the commercial north, slightly lower in the commercial south and much lower in the resettlement LUT (Figure 5.7). This followed a similar pattern to the biomass of all prey species combined (Figure 5.2), which was expected as the models are based on linear regressions of selected prey biomass data. This pattern was also followed by estimates of true density for all species with the exception of lion. Lion was the only species that occurred at a greater density in the commercial south than the commercial north despite having a lower carrying capacity in the south. For the cheetah, leopard, spotted hyena and wild dog the difference between the density estimate in the commercial north and the commercial south was greater (mean 39% lower in the

south) than would be expected based on the difference in carrying capacity (mean 16% lower; Figure 5.7). In relation to the commercial south, the resettlement LUT had 79% lower mean carnivore carrying capacity and 97% lower mean carnivore density estimates.

The density estimate of cheetah, lion and spotted hyena was lower than the carrying capacity predictions, representing on average only 30% of the carrying capacity (Figure 5.7). In contrast the reverse was true for leopard and wild dog (Figure 5.7), for which the density estimates were on average 201% of carrying capacity estimates. For leopard this holds true regardless of the equation applied, but for the wild dog this finding would be reversed if Carbone and Gittleman's (2002) models were employed (Figure 5.6). The wild dog carrying capacity estimates provided by Carbone and Gittleman's (2002) models (22.8 animals per 100 km<sup>2</sup>), however, are probably erroneous as they are up to 20 times greater than the highest density population found in a literature search (5.9 animals per 100 km<sup>2</sup>, in an area of Selous Game Reserve in Tanzania; Woodroffe *et al.*, 1997).

When examining carrying capacity spatially (Figure 5.8) it becomes clear that although total biomass of potential prey species is relatively high and consistent in the commercial north, the southern section of the study site is a mosaic of biomass densities. Islands of high carrying capacities on commercial properties Impala, Hammond and Humani are separated by large areas of moderate carrying capacity (on other commercial properties) and low carrying capacity (e.g. on resettlement properties). Although carrying capacity is low on all properties in the resettlement area, it appears to be greater in the eastern section of the resettlement area than the western section (Figure 5.8).

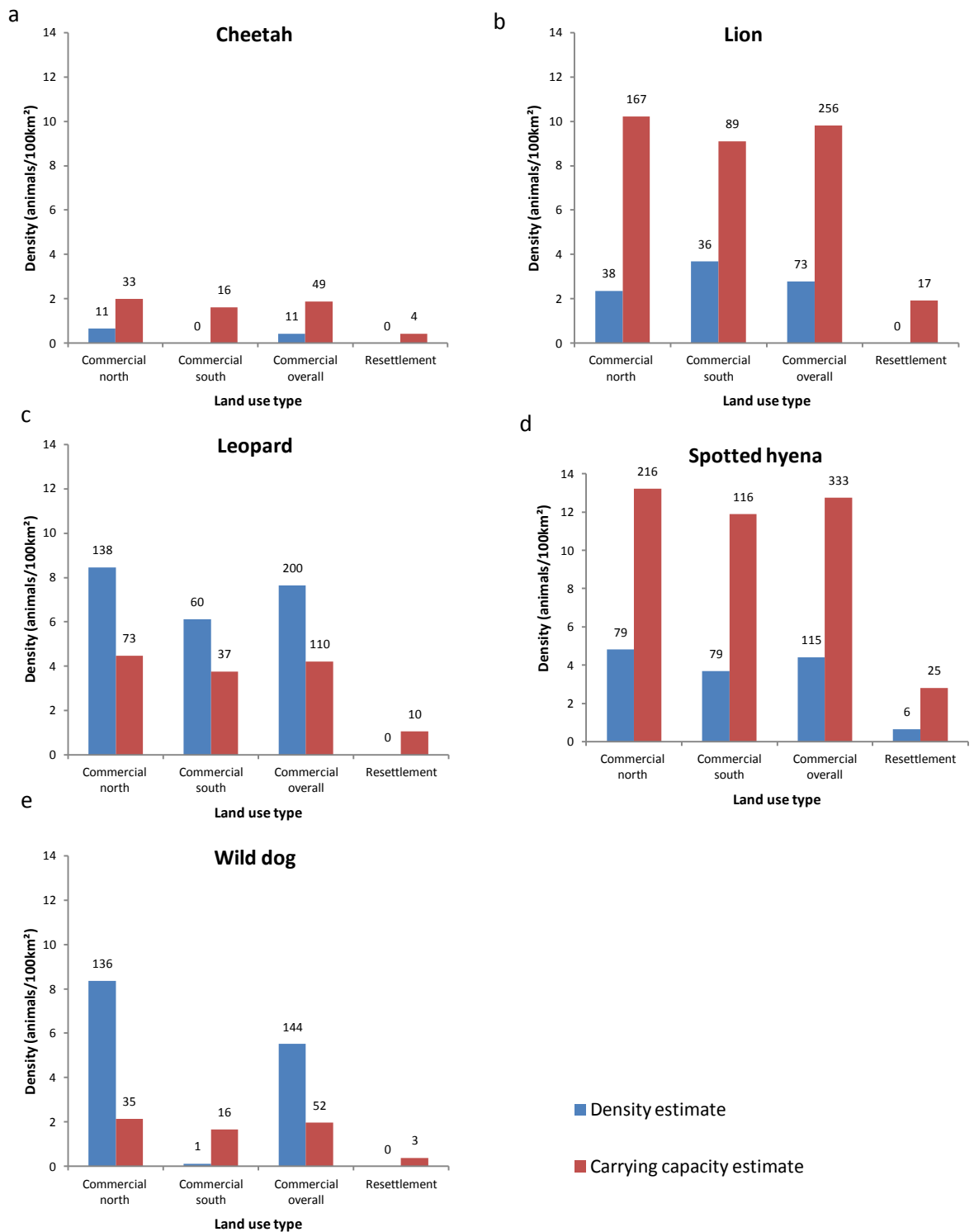


Figure 5.7 Comparison of estimated true density with predicted carrying capacity across different land use types in and around Savé Valley Conservancy in 2008 for a) cheetah; b) lion; c) leopard; d) spotted hyena; and e) wild dog. Data labels show population sizes. Models 2, 4, 7 and 10 and 12 (Table 5.4) were used to estimate cheetah carrying capacity of cheetah, lion, leopard, spotted hyena and wild dog respectively. Cheetah, lion and spotted hyena appear to occur below carrying capacity, while leopard and wild dog occur at greater densities than would be expected.

Hayward *et al.* (2007b) found that the models that explained the most variance were based on preferred prey species for lion (model 4), leopard (model 7) and spotted hyena (using the preferred prey species of lion; model 10), while for cheetah the equation that explained the most variation was based on the preferred body mass range of prey (model 2).

In the commercial LUTs the biomass density of all large carnivores combined was comparable to carrying capacities estimated using East's (1984) models based on either prey biomass (model 16) or rainfall (model 17; Figure 5.9). In the resettlement area model 16 predicted that large carnivore carrying capacity would be much lower than in other LUTs, as prey biomass density was much lower in this area (Figure 5.2), but estimated carnivore density was lower still, representing only 52% of this carrying capacity. Estimated density was much lower in the resettlement area in comparison with model 17, representing only 4% of this predicted carrying capacity.



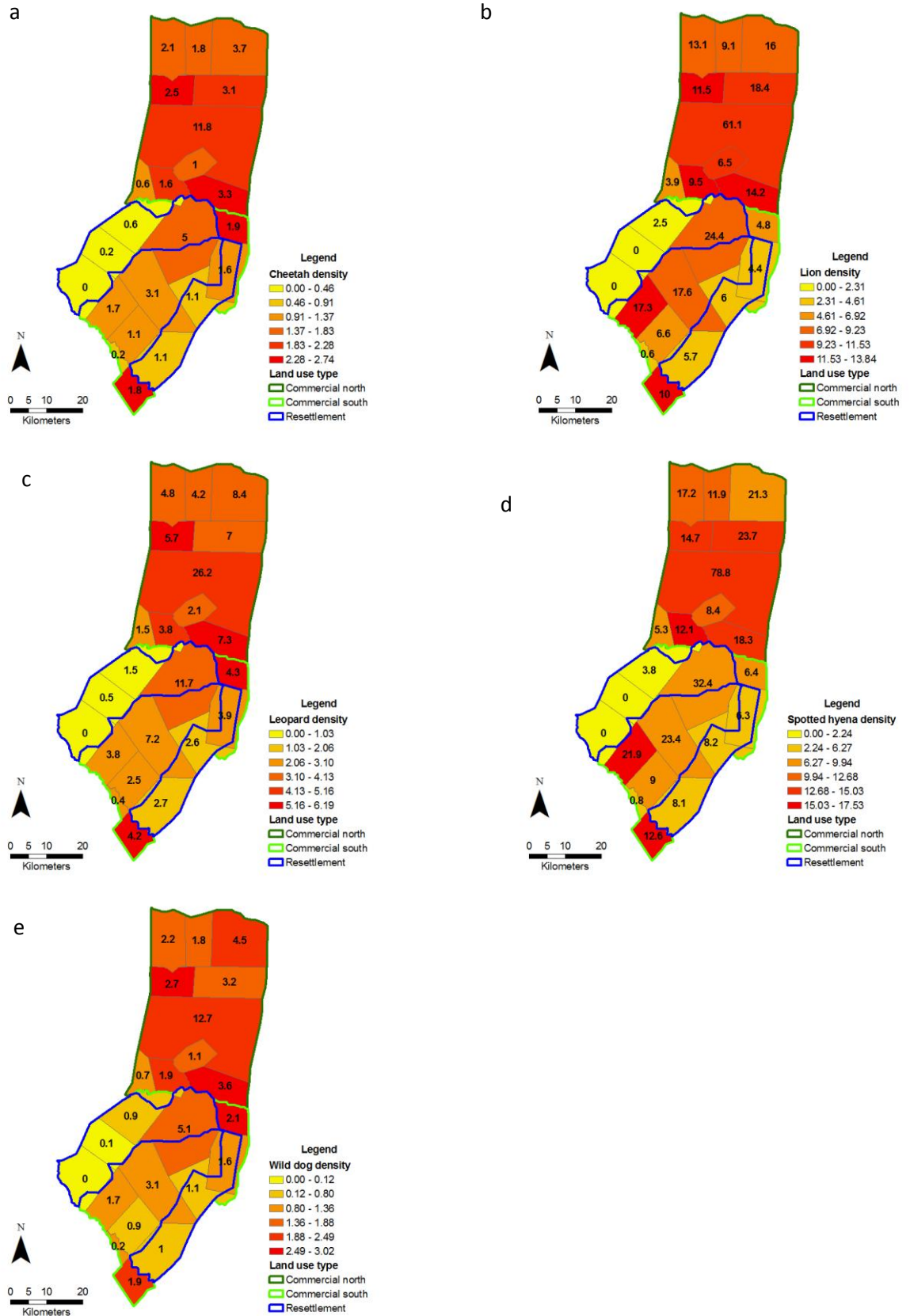


Figure 5.8 Prey biomass densities in Savé Valley Conservancy in 2008 used to estimate carrying capacity of a) cheetah, b) lion, c) leopard, d) spotted hyena, e) wild dog. Biomass density intervals were generated using equal breaks. Data labels represent the number of animals predicted to occur on each property at carrying capacity. Carrying capacity was greatest in the commercial north and lowest in the resettlement areas.

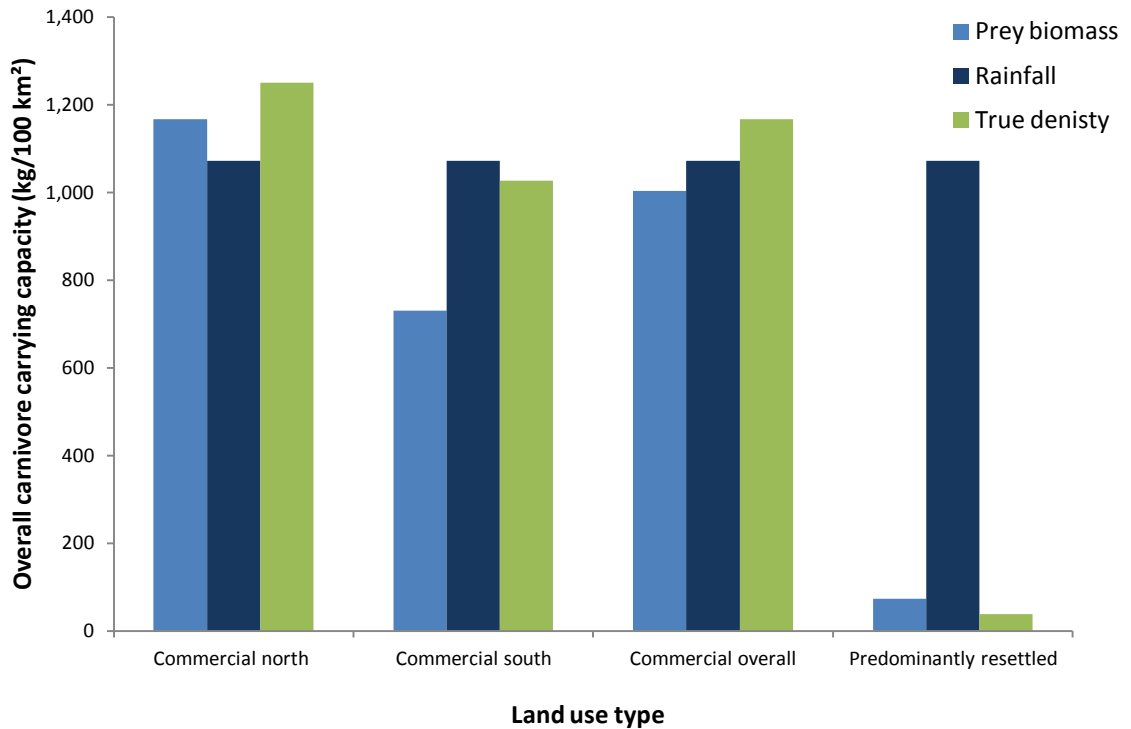


Figure 5.9 Carrying capacity of all large carnivores in and around Savé Valley Conservancy in 2008 combined based on prey biomass or rainfall (East, 1984), compared with true biomass density of large carnivores (estimated from spoor count data). Rainfall data were only available for the study site as a whole, so carrying capacity density estimates calculated using the rainfall model are identical. True density was similar to carrying capacity in the commercial LUT but much lower in the resettlement LUT.

### 5.3.3 Carrying capacity trends

Since annual aerial surveys began in 2004, carrying capacities in all years for all carnivores has been greatest in the commercial north, lower in the commercial south and lowest in the resettlement area in terms of both population density (Figure 5.10) and size (Figure 5.11), with just one exception. Leopard carrying capacity density was slightly greater in the commercial south than the north in 2007. Although carrying capacity density was almost always greater in the commercial north than south, these two LUTs generally cluster together relative to the resettlement area, which has much lower carrying capacity densities (Figure 5.10). In contrast, differences between carnivore population size and carrying capacity were more evenly distributed between LUTs (Figure 5.11). Carrying capacity population size in the commercial south was

intermediate between the commercial north and the resettlement area. This is explained by the lower density (Figure 5.10) combined with a smaller area.

A decrease was observed in the carrying capacity of all species in all LUTs displayed between 2004 and 2008, with the exception of lion and spotted hyena which exhibited a 2% increase in the commercial north (Figure 5.10, Figure 5.11, Figure 5.12). On average between 2004 and 2008 carrying capacity declined by 13% in the commercial north, 22% in the commercial south and 33% in the resettlement area.

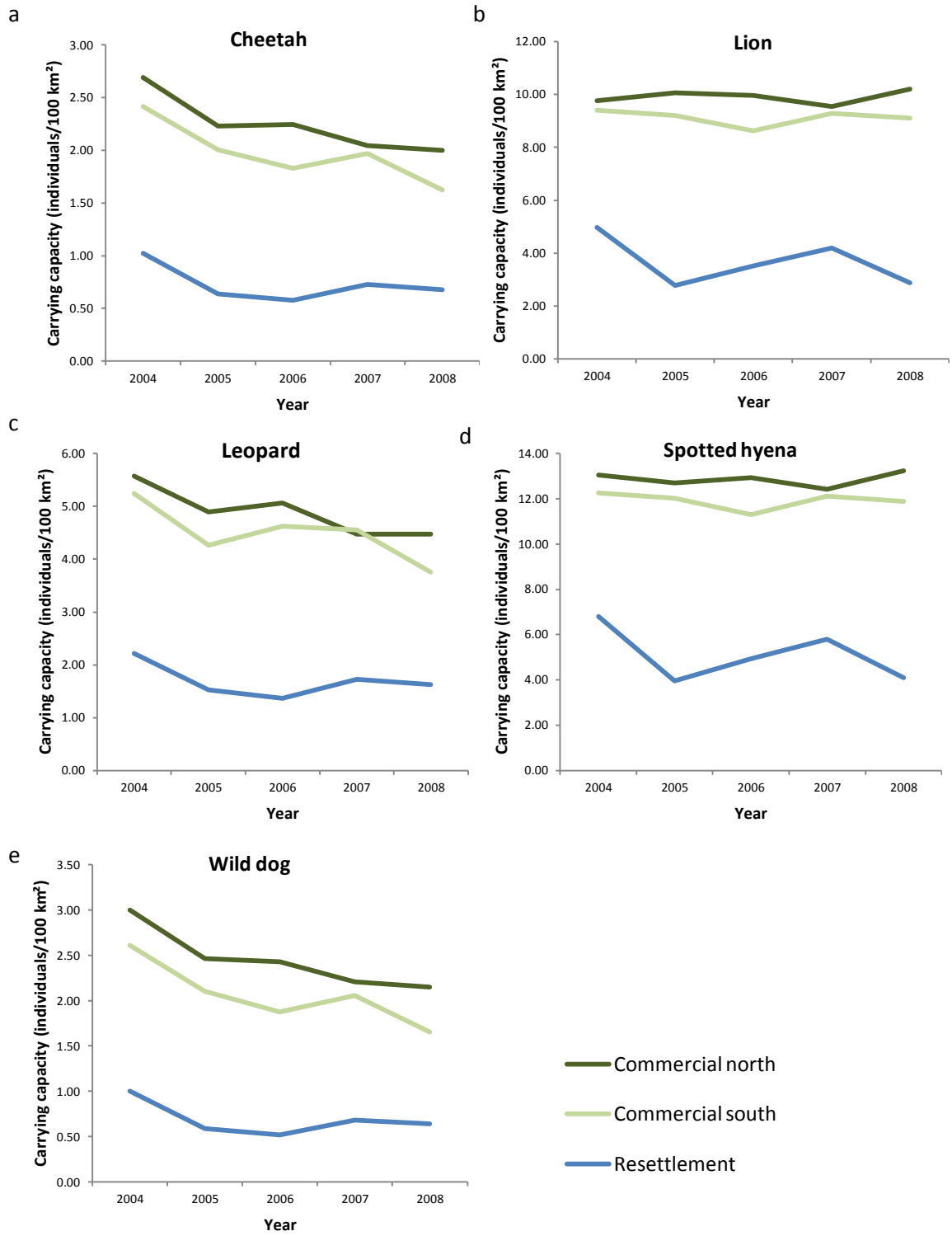


Figure 5.10 Carrying capacity trends of large carnivores in Savé Valley Conservancy between 2004 and 2008 expressed as a population density for a) cheetah, b) lion, c) leopard, d) spotted hyena and e) wild dog. Carrying capacity is decreasing for all species in all LUTs.

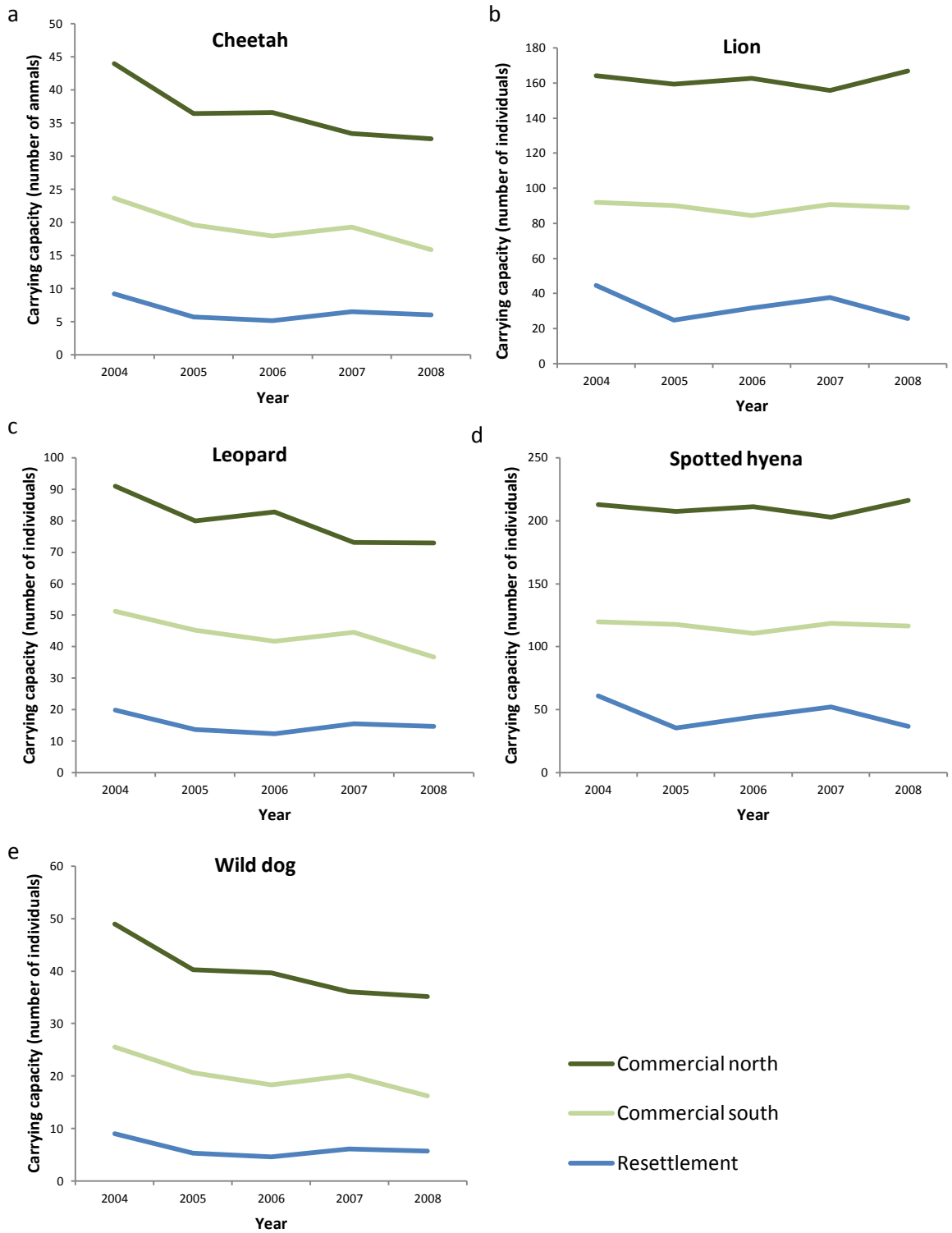


Figure 5.11 Carrying capacity trends of large carnivores in Savé Valley Conservancy between 2004 and 2008 expressed as the number of individuals of a) cheetah, b) lion, c) leopard, d) spotted hyena and e) wild dog. Carrying capacity is decreasing for all species in all LUTs.

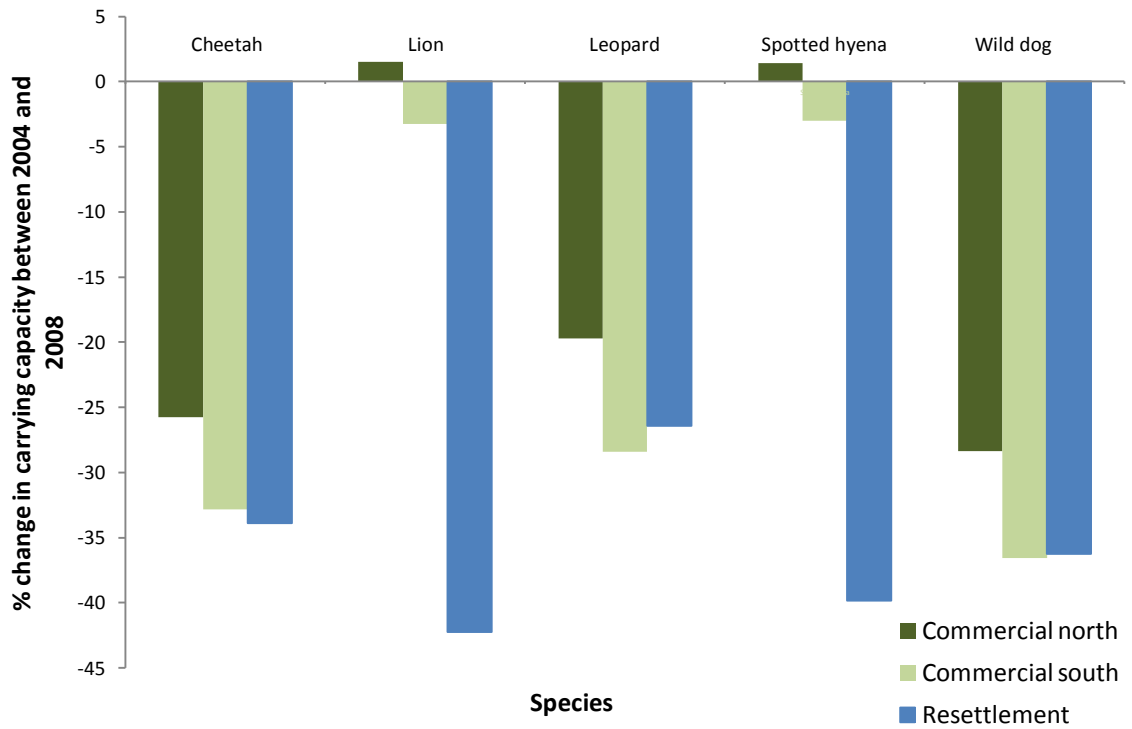


Figure 5.12 Change in carrying capacity in Savé Valley Conservancy between 2004 and 2008. Carrying capacity has generally declined.

Despite the observed decline in carrying capacity between 2004 and 2008 (Figure 5.11, Figure 5.12), projected increases in prey abundance (Lindsey *et al.*, 2011b) predicted increases in carrying capacity for each carnivore (mean 20%) between 2009 and 2022 in both the commercial north and the commercial south (Figure 5.13).

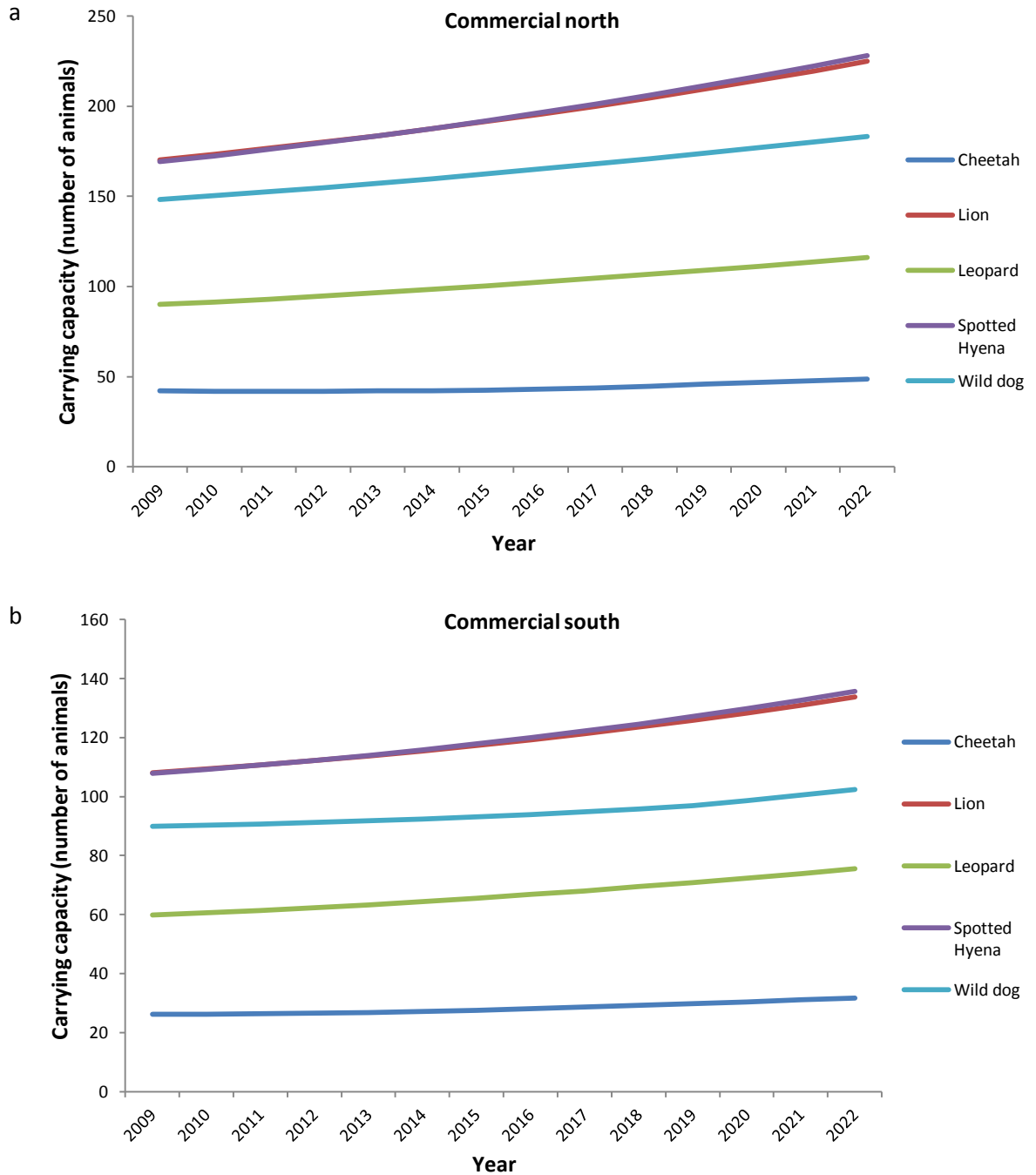


Figure 5.13 Trends in predicted carnivore carrying capacities in Savé Valley Conservancy over the 14 years following 2008 for a) the commercial north and b) the commercial south. Carrying capacity for all species is predicted to increase.

### 5.4 Discussion

Prey biomass and carnivore carrying capacity were greater in the commercial north than in the commercial south and the resettlement area (Figure 5.2), in line with predictions. The reduced density of herbivores in the resettlement area is likely to be due to the clearing of land and

conversion into agricultural plots, increased competition and disease transmission due to relatively high human and livestock densities, and direct persecution of wildlife. The observation of lower prey biomass in the commercial south than the commercial north is probably due to increased proximity to the resettlement area (see section 8.2), which could be acting as a population sink (Woodroffe and Ginsberg, 1998). It appears that reducing prey abundance is one way in which the FTLRP is decreasing the number of carnivores, although other mechanisms are also probably also important (see section 8.2).

Arda and Nyangambe had exceptionally low prey biomass densities (Figure 5.3). Arda is owned by a government parastatal, and it was suggested by owners and managers of other ranches that it is managed very poorly and is neglected by its owners (G. Hulme, pers. comm.). The level of poaching on Arda was extremely high, and was greater than on any other commercial property (P. Lindsey, pers. comm.). The low levels of total prey biomass on Nyangambe could be explained by its recent incorporation into SVC. Until several years ago Nyangambe was communal land that was used for grazing cattle, and it was added to the conservancy as an attempt to help neighbouring communities to benefit from the wildlife in SVC (G. Hulme, pers. comm.). Restocking and possibly rehabilitation could raise wildlife densities to similar levels to elsewhere in the conservancy, although it would first be necessary to mitigate the drivers of decline such as poaching. The proximity of Nyangambe to large-scale poaching operations on Arda could also contribute to low wildlife densities.

Relative to other commercial properties Chigwete and Senuko also had fairly low prey biomass densities (Figure 5.3), even if it was assumed that all prey biomass occurred in the sections of these properties that have not yet been resettled. This is likely to be due to increased poaching



pressure as a result of their close proximity to the resettlement area, and suggests that the impacts of resettlement on wildlife extend outside of the resettlement areas themselves.

Biomass densities of most prey species were relatively large in the commercial north (Figure 5.5), often greater than in Kruger National Park (Owen-Smith and Ogutu, 2003). Prey biomass densities in the commercial south were lower than the north, but were still relatively high in relation to other areas. This demonstrates that although prey populations are in decline in the remaining commercial area (Joubert, 2008), they have not yet declined to extremely low levels. This contrasts with the resettlement LUT, where prey biomass densities are very low in comparison with Kruger National Park. Prey biomass densities at Gonarezhou are more similar to densities at the SVC resettlement area than any other site.

The current estimated population density of cheetah, lion and spotted hyena was substantially below carrying capacity (Figure 5.7), indicating that prey density is not the limiting factor of these populations. Variables such as poaching of prey may be important, but this does not account for the differences in estimated density between carnivores. Both cheetahs and wild dogs show a much greater difference in population densities between the commercial north and south in relation to other large carnivores (Table 3.4). The large disparity in cheetah and wild dog densities between the commercial north and south is much greater than the difference in prey biomass between these LUTs (Figure 5.2). Figure 5.8 illustrates that habitat fragmentation could have a significant impact on these species. There is more heterogeneity in prey biomass and carrying capacity in the southern section of the study site in relation to the north (Figure 5.8). Cheetahs and wild dogs may be more susceptible to this effect as they require substantially larger home ranges than would be suggested from their energy requirements alone (Durant *et al.*, 2010b;

IUCN/SSC, 2007), and they have larger home ranges than other carnivores at the study site (Jacquier and Woodfine, 2007; Pole, 2000; Skinner and Chimimba, 2005). This is thought to be linked to their competitive inferiority relative to larger predators such as lion and spotted hyena (Creel and Creel, 1996; Durant, 1998). Cheetahs and wild dogs would therefore be less capable of persisting on small patches of suitable habitat, making them more sensitive to habitat fragmentation.

East's (1984) models of the combined biomass of all carnivores suggest that in the commercial LUT there is much less of a disparity between carrying capacity and estimated density than the other models used based on individual carnivores (Figure 5.7). This could imply that the other models produce incorrect estimates, but this seems unlikely as the other models are all based on larger datasets and on prey biomass, which should be a stronger determinant of carnivore population density than rainfall (Hayward *et al.*, 2007b). Alternatively the closer match between East's (1984) carrying capacities and estimated population densities could be consistent with the results of the other models, as Hayward *et al.*'s (2007b) models show that some carnivores occur below carrying capacity and others occur above carrying capacity, so when considering all species combined the figures balance out. Although to an extent the large carnivores exploit different niches there is also a degree of overlap in their diets (Hayward, 2006; Hayward *et al.*, 2006a; Hayward *et al.*, 2006b; Hayward and Kerley, 2005; Hayward and Kerley, 2008; Hayward *et al.*, 2006c). They are therefore competing for some of the same resources, such as water and space as well as food. The data could support the hypothesis that when some large carnivores occur at high densities above their carrying capacities (such as wild dogs in the commercial north), other large carnivores (such as cheetahs) may be out competed and are limited to densities below their carrying capacities. Competitive interactions have been reported between some members of the large carnivore guild such as more dominant species like lions or spotted hyenas and subordinate species such as cheetahs and wild dogs (Creel and Creel, 1996; Laurenson, 1995; Mills, 1991), but

interactions between more ecologically similar species such as cheetahs and wild dogs have received less attention (but see Hayward and Kerley, 2008; Mills, 1991).

In the resettlement area the results of East's (1984) models (Figure 5.9) support the results of the other models (Figure 5.7) that prey density is not the factor that limits carnivore density in this LUT. In this LUT there appear to be far fewer prey than would be predicted by rainfall, and fewer still carnivores than would be predicted by prey density. Here habitat fragmentation is much less of an issue, as the resettlement area has fairly uniformly low prey densities (Figure 5.2, Figure 5.3, Figure 5.4). Habitat loss is a more important factor, as land is cleared for dry land cropping by the settlers.

Although most carnivores generally occurred at densities below their carrying capacity, the wild dog population consistently exceeded the predicted carrying capacity for each LUT except the commercial south and resettlement areas. For the wild dog this is feasible as the overall population at SVC has increased from 2.4 animals/100 km<sup>2</sup> in 1999 (Pole, 2000) to 5.5 animals/100 km<sup>2</sup> in 2008 (Chapter 3; confirmed by long-term study of the population (R. Groom, pers. comm.)). Relative to other populations across Africa wild dogs at SVC occur at an exceptionally high density (Childes, 1988; Davies-Mostert *et al.*, 2010; Groom, 2009b; Stander, 1998). If wild dogs did exceed their carrying capacity they could have exerted another suppressive influence on the cheetah population at the study site. There have been few data published on interspecific competition between cheetahs and wild dogs, although Hayward and Kerley (2008) suggest that this is a possibility. It is also possible, however, that the carrying capacity estimate is inaccurate, as if the alternative models (models 14 and 15) had been selected wild dog density would be below carrying capacity (Figure 5.6). But it seems unlikely that models 14 and 15 are accurate for wild dogs as they predict enormous populations (up to 803 animals) at densities that are much greater than those reported in the literature.

Leopard also exceeded their carrying capacity in all LUTs except the resettlement area. This is more difficult to explain, as leopard densities at SVC are fairly high relative to other sites (for example Balme *et al.*, 2009; Stander, 1998), but are by no means the greatest reported in the literature (such as Bailey, 2005). Leopards are the most adaptable of the large carnivores that occur at SVC, and are capable of occupying a range of habitats and a wide gradient of human population densities and prey densities (Nowell and Jackson, 1996). This makes estimation of their carrying capacities more problematic, so it is not completely clear if their carrying capacity is genuinely approximately 50% lower than their estimated densities (Figure 5.7). If so this could be another instance, as for wild dogs, of some carnivores benefiting from the suppression of others. Leopards are potentially vulnerable to high levels of intraguild competition (Caro and Stoner, 2003), and Mills (1991) suggested that spotted hyena had a negative competitive impact on leopards in the Kalahari. Low hyena densities could have facilitated the competitive release of leopards at SVC (as reported for other predators for example Elmhagen and Rushton, 2007), but these relationships are far from clear.

The disparity between carnivore carrying capacity in the eastern and western resettlement areas (Figure 5.8) can be explained by the different extent to which resettlement has occurred. The western resettlement area was resettled earlier (commercial farmer, pers. comm.) and has a much greater density of settlements in comparison with the eastern resettlement area (Joubert, 2007).

The longitudinal aerial data demonstrate a progressive decline of up to 40% in carrying capacity for all large carnivores in the commercial south and resettlement area (Figure 5.10, Figure 5.11, Figure 5.12). The same applies to the commercial north for all carnivores except lion and spotted

hyena, estimates for both of which are calculated based on the biomass of the exact same prey species. This reinforces the hypothesis that declining prey biomass is driving declines in large carnivores. The effect is the strongest in the resettlement area, followed by the commercial south then the commercial north, suggesting that proximity to the resettlement LUT could be a key determinant of wildlife density. The mechanism is likely to be increased poaching rates in the properties nearer to the resettlement area (Lindsey *et al.*, 2011b) as discussed in section 8.2. The data highlight the worrying observation that carrying capacity has declined by up to 24% over 5 years in the commercial north alone, even though it is the furthest from the resettlement LUT (Figure 5.12). This implies that the land reform programme in Zimbabwe can have a large impact on wildlife populations even beyond the boundaries of the resettlements. And despite the declines observed at SVC since 2004, the reduction in wildlife densities was probably steeper still between 2000 and 2004 when resettlement first occurred.

The carnivore carrying capacity declines observed between 2004 and 2008 (Figure 5.11, Figure 5.12) contradict the predicted increases between 2009 and 2022 (Figure 5.13). For example the impala populations declined by 41% and 56% in the commercial north and south respectively between 2004 and 2008, (Joubert, 2008), while Lindsey *et al.*'s (2011b) models predict that between 2009 and 2013 impala numbers will increase by 19% and 15% in the commercial north and south respectively. Predicted population changes were also more positive than previous trends would suggest for other many species. These differences could be due to inaccurate data on parameters such as mortality and sex ratio being used in the analysis. But because predicted population trends are so different from observed trends across such a wide range of species, it is more likely that the poaching rates used by Lindsey *et al.* (2011b) were underestimates, even when attempting to take into account undetected poaching events as this is very difficult to predict accurately (Liberg *et al.*, in press). As such the predicted carnivore carrying capacities are extremely unrealistic.

Although the aerial survey methodology was generally well designed, there were some flaws. The strip width of 750 m (375 m either side of the plane) was similar to that used by Owen-Smith and Ogutu (2003) in Kruger National Park, but is greater than is recommended by other sources. Recommended strip widths range from 100 to 500 m (Sutherland, 1996b). Norton-Griffiths (1978) recommends a strip width of 200 m in fairly open savannas when surveying multiple species, and up to 500 m when surveying very conspicuous species such as elephants. Vegetation at the study site is often fairly dense, so a narrower strip width such as 300 m (as was used by Dunham *et al.*, 2003 in Gonarezhou National Park) seems more appropriate. Furthermore, photographs were taken only of buffalo herds, but Jachmann (2002) recommends that the size all herds of 20 animals or more should be determined using photography. Both of these issues suggest that the population sizes obtained are likely to be underestimates. A further caveat is that the total counts tend to systematically underestimate population size, and for large areas such as the study site total counts are only recommended for highly conspicuous species (Caughley, 1974; Jachmann, 2002; Norton-Griffiths, 1978). Aerial sampling may be a more appropriate method than total counts (Dunham *et al.*, 2003). Nevertheless, the method employed still provides a useful estimate of the minimum prey population sizes, and provided that biases remain constant between surveys the data can be used as an index of population trends.

## 5.5 Summary

Carnivore carrying capacity is greatest in the commercial LUT and much lower in the resettlement LUT, and has generally declined since aerial surveys began in 2004 (objective 2). Decline in carrying capacity has been the most marked in the resettlement area and the commercial properties nearby, but large declines were also recorded in the areas further from the resettlement. Mechanisms such as poaching and habitat fragmentation appear to be driving the

decline in prey abundance and carnivore carrying capacity, which is one mechanism by which FTLRP has reduced the number of large carnivores. The decline in carrying capacity is probably mirrored by the population trends of carnivores, although no long term data are available to verify this. Future dynamics of prey populations modelled by Lindsey *et al.* (2011b) were used to predict carnivore carrying capacities, but the findings are not realistic and depend on underestimates of poaching rates.

# Chapter 6 Perceptions of livestock predation

---

## 6.1 Introduction

Data on the impacts of recent changes in land use on carnivore populations is of great importance to conservation efforts in Zimbabwe, but this process could also have had substantial impacts on the human dimension of human-wildlife conflict. Carnivores are among the world's most threatened mammals (Gittleman *et al.*, 2001b), and human-wildlife conflict is one of the major drivers of their decline (Woodroffe, 2000, 2005), but the conservation needs of wildlife can be difficult to reconcile with the needs of communities (Thirgood *et al.*, 2005). Interactions between people and wildlife can be positive, but the costs incurred by humans often lead to persecution of wildlife (Woodroffe *et al.*, 2005b). This is particularly true for carnivores, as they can prey on livestock (Goldman *et al.*, 2010) or game (Pole *et al.*, 2004), transmit disease (Courtin *et al.*, 2000) and even threaten human lives (Dunham *et al.*, 2010a). Predation of livestock is the most common cause of human-wildlife conflict (Thirgood *et al.*, 2005). It can impose significant costs on both farmers (Butler, 2000) and predators, as significant positive correlations have been observed between rates of livestock predation and the number of predators killed by farmers (Marker *et al.*, 2003c; Ogada *et al.*, 2003). Information on livestock predation is vital to address this issue, yet few studies of this nature have been conducted, particularly in Africa (Thirgood *et al.*, 2005).

The use of certain livestock management techniques can be effective at minimising livestock losses without resorting to lethal control (Breitenmoser *et al.*, 2005). The use of livestock herding, kraaling, warning dogs, and livestock guarding animals (techniques are defined in methods, Table



6.1) have been associated with lower rates of predation (Dickman, 2008; Ogada *et al.*, 2003; Stein *et al.*, 2010; Woodroffe *et al.*, 2007a), while some methods such as the use of scarecrows have been associated with increased rates of predation (Woodroffe *et al.*, 2007a). The effectiveness of many other techniques such as bell collars has not yet been assessed (Inskip and Zimmermann, 2009; Zimmermann *et al.*, 2010). Research on the few techniques that have been assessed was conducted in east or west Africa, so it remains to be seen if they are effective under the different conditions of southern Africa (Bauer *et al.*, 2010a; Dickman, 2008; Marker *et al.*, 2005; Ogada *et al.*, 2003; Woodroffe *et al.*, 2007a). Promotion of effective livestock management techniques can result in reduced rates of livestock predation, which in turn can reduce the number of predators killed by farmers in retaliation, benefitting both people and predators (Marker *et al.*, 2003c; Woodroffe *et al.*, 2007a). Educational material detailing techniques that could be used by farmers to reduce livestock predation are available in Zimbabwe (Nyoni and Williams, 2008; Appendix 5), South Africa (Hodgkinson *et al.*, 2007), Botswana (Good *et al.*, 2007) and Namibia (Schumann, 2004), but they often lack information on the efficacy of the techniques listed. This information is urgently required in order to promote successful techniques to minimise livestock predation, and promote coexistence of people and predators (Inskip and Zimmermann, 2009).

Investigating the causes of livestock losses in the context of Zimbabwe's land reform programme would allow quantification for the first time of how the risk of livestock predation is changing in the affected areas. There is huge potential for conflict as farmers are resettled onto private land, much of which previously supported relatively large populations of predators, but this has not as yet been studied (Williams, 2007). This chapter begins by describing the patterns of livestock holdings and quantifying the sources of losses, before focussing on predation by individual species (objective 4). The resettlement land use type (LUT) is expected to have higher perceived rates of livestock predation by large carnivores than the communal LUT. Techniques used to mitigate

livestock losses are then considered, and the effectiveness of these techniques is assessed (objective 5).

## 6.2 Methods

During the interview survey (section 2.5.2) respondents in resettlement and communal LUTs were asked to describe the number of cattle, goats, sheep, donkeys and chickens that they held on the day of the interview, and on that date 12 months ago (see Appendix 3 for interview schedule). Commercial farmers were excluded from this analysis as they did not generally keep domestic livestock. The number of animals that respondents had gained and lost over that period was also recorded, including the cause of the loss. In some parts of Africa compensation schemes are in place to compensate farmers for livestock lost to predation (Gusset *et al.*, 2009; Maclennan *et al.*, 2009), but like in most African states there was no such scheme operating at the study site, so there was no financial gain to be made from exaggerating livestock losses. To reduce the risk of exaggerated responses, participants were informed that their participation in the study would be anonymous and would not be used to influence initiatives such as predation compensation schemes (Romañach *et al.*, 2007). It was not possible to calculate the financial impacts of these losses (as is recommended by Inskip and Zimmermann, 2009) due to the hyperinflationary economic situation (Hanke and Kwok, 2009). Details of the number of livestock that had been killed by each predator over the past 12 months were also noted (Gusset *et al.*, 2009). Respondents were also asked which predator they believed caused the most problems in their area (Dickman, 2008). The livestock management techniques used to mitigate predation (defined in Table 6.1), were recorded and respondents were also asked if they used any techniques not listed to defend their animals against predators. Other possible predictors of predation were also documented including the presence of cheetah marking spots, the number of herders that accompany the livestock (where appropriate) and the distance between the grazing area and the

homestead (following Marker *et al.*, 2003c; Ogada *et al.*, 2003; Wang and Macdonald, 2006). Finally, respondents were asked if they believed that they had lost a greater, smaller or the same proportion of their livestock to predation over the past 12 months in relation to the same period 10 years ago (or when they first moved to the area if less than 10 years ago).

**Table 6.1 Livestock management techniques used to protect livestock against predation (Breitenmoser *et al.*, 2005; Good *et al.*, 2007; Hodgkinson *et al.*, 2007; Inskip and Zimmermann, 2009; Nyoni and Williams, 2008; Schumann, 2004; Schumann *et al.*, 2006).**

Technique	Description
Kraaling	Livestock are kept together overnight somewhere they can be protected such as within a fenced area near the homestead
Herding	Livestock are accompanied by at least one person when out grazing
Calving camps	Heavily pregnant livestock are kept in a protective kraal until they give birth, facilitating protection of young animals
Scarecrow	Pieces of cloth hung near livestock to deter predators
Synchronised breeding	Attempting to ensure that livestock breed at the same time of year, facilitating protection of young animals
High game density	Encouraging growth of local populations of natural prey species such as impala in order to supply predators with an alternative food source
Bell collars	Collars with bells attached are fitted to livestock to help people locate them and possibly to deter predators directly
Protective collars	Collars such as king collars are fitted to livestock, to prevent access to the neck by predators
Warning dog	A dog barks to alert people to the presence of predators
Livestock guarding animal	An animal stays with the herd and actively defends against attacking predators
Fencing	A large area outside the kraal is fitted with fencing to provide livestock with a predator-free area to graze or to limit livestock movements to an area in which they are easier to protect
Swing gates	Gates are fitted to fencing that permit the passage of species such as warthogs, reducing the number of holes dug under fences
Trapping	Attempting to capture predators in order for them to be relocated or killed
Lethal control	Killing predators using means such as shooting, poisoning, or lethal traps

It is important to note that the information provided by participants was not verified and all data are presented as the opinion of the respondents (after Butler, 2000; Gusset *et al.*, 2009). In an attempt to quantify the consistency of the factual details provided by the respondents, the number of each livestock type held at present was compared with the number of livestock held 12

months ago, taking into account the total number of livestock lost and gained over that period, using the following equation:

$$\text{Discrepancy} = \text{number of animals at present} - (\text{number of animals 12 months ago} - \text{number of animals gained} + \text{number of animals lost})$$

Absolute discrepancies were small (generally less than five animals, Figure 6.1), but discrepancies were large in relation to current herd sizes for cattle (-36% and +21% of current livestock numbers in the resettlement and communal areas respectively), goats, (-162% and -90%), sheep (-118% and -58%), donkeys (-45% and +52%) and chickens (-228% and -308%). This indicates that the quantitative data provided on livestock should be treated with caution.

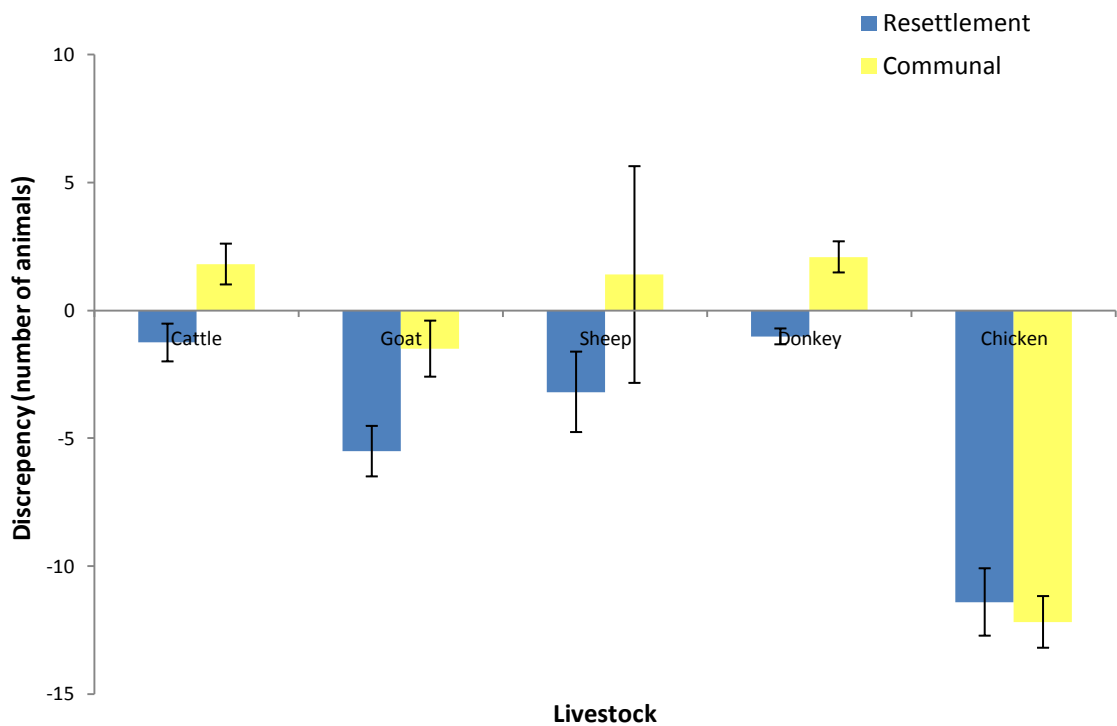


Figure 6.1 Discrepancy between reported livestock holdings in 2008 and 2009 in the resettlement and communal LUTs around Savé Valley Conservancy with holdings 12 months previously, taking into account gains and losses over the previous 12 months. Error bars represent standard errors. Relatively large discrepancies were observed.

Goats and sheep (collectively referred to as small stock) were grouped for statistical analysis of predation levels, as they are of similar body size and are likely to be preyed upon by the same

predators (Maddox, 2003; Ogada *et al.*, 2003; Woodroffe *et al.*, 2007b). The livestock management techniques were not recorded on a livestock-specific basis, so analyses of the predictors of livestock losses were therefore made by grouping cattle and small stock (and excluding respondents that owned neither), as these techniques are generally aimed at these species. The Yates continuity correction was applied to  $\chi^2$  tests conducted on 2x2 tables.

## 6.3 Results

### 6.3.1 Livestock holdings

Livestock holdings differed significantly between LUTs for cattle (Mann-Whitney U test:  $U = 7564.5$ ,  $Z = -6.197$ ,  $P < 0.001$ ), goats ( $U = 9040$ ,  $Z = -4.062$ ,  $P < 0.001$ ), sheep ( $U = 9377$ ,  $Z = -5.137$ ,  $P < 0.001$ ), and donkeys ( $U = 10752.5$ ,  $Z = -2.823$ ,  $P = 0.005$ ), although there were no significant differences in the number of chickens kept ( $U = 11924$ ,  $Z = -0.764$ ,  $P = 0.445$ ). This disparity was greatest for cattle, sheep and goats (Figure 6.2).

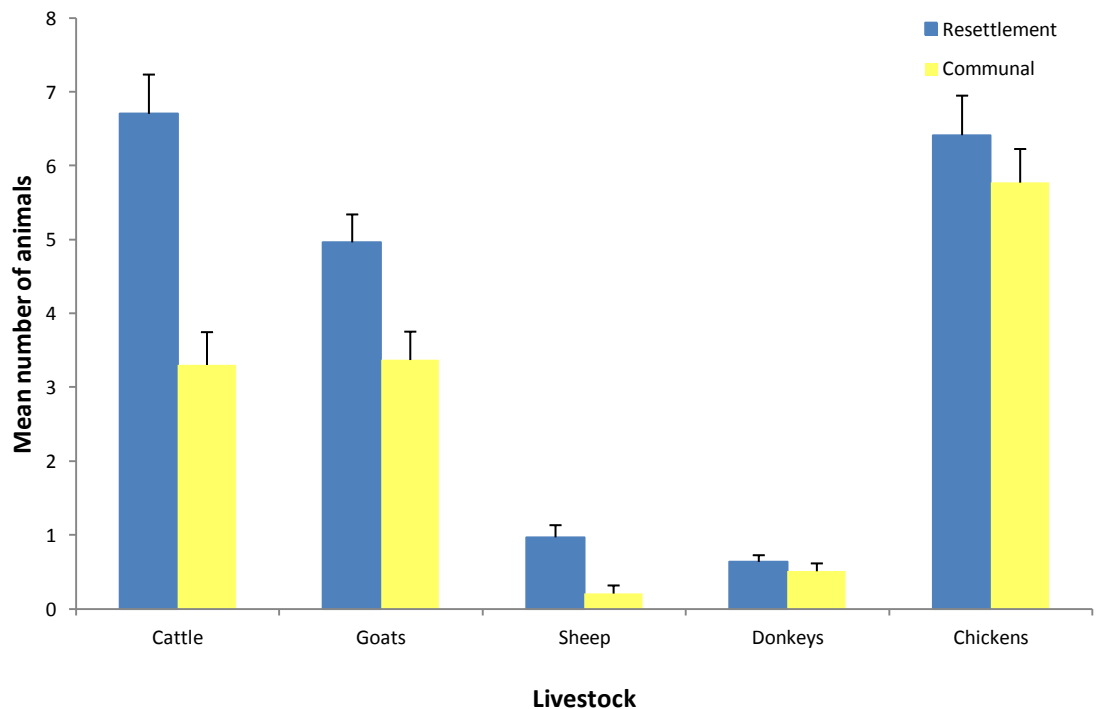


Figure 6.2 Livestock holdings in resettlement and communal areas around Savé Valley Conservancy in 2008 and 2009. Error bars represent standard errors. Resettlement farmers reported larger holdings.

### 6.3.2 Livestock losses and predation

Predation was generally said to account for most of the livestock losses across each LUT, although disease and theft were also considered important causes of mortality (Figure 6.3). A significantly greater proportion of cattle was reported to be lost to predation in the resettlement area ( $U = 3452$ ,  $Z = -2.544$ ,  $P = 0.011$ ), and a significantly greater proportion of chickens were said to be taken by predators in the communal area ( $U = 4883$ ,  $Z = -4.137$ ,  $P < 0.001$ ). A significantly larger proportion of cattle ( $U = 3816.5$ ,  $Z = -2.150$ ,  $P = 0.032$ ) and chickens ( $U = 6160$ ,  $Z = -2.114$ ,  $P = 0.035$ ) were reported stolen in the communal area than the resettlement. No other significant differences were found between the LUTs.

No livestock predation was attributed to cheetahs or domestic dogs, and respondents were aware of no cheetah marking spots. In general larger predators such as lion were reported to be a bigger problem in the resettlement area, where greater cattle losses were reported, while communal farmers suffered greater rates of predation by smaller predators on small stock and chickens (Figure 6.4). In relation to communal farmers, resettlement farmers reported predation of a significantly larger proportion of their cattle by lions ( $U = 2925$ ,  $Z = -4.850$ ,  $P < 0.001$ ) and a significantly larger proportion of small stock were said to have been killed by leopard ( $U = 4432$ ,  $Z = -1.958$ ,  $P = 0.050$ ) and spotted hyena ( $U = 4245$ ,  $Z = -2.170$ ,  $P = 0.030$ ). Communal farmers, however, reported greater proportions of their cattle herds lost to predation by leopard ( $U = 3750$ ,  $Z = -2.277$ ,  $P = 0.023$ ); larger proportions of small stock holdings were said to be lost to aardwolf (*Proteles cristatus*) ( $U = 4433$ ,  $Z = -3.305$ ,  $P = 0.001$ ) and crocodile (*Crocodylus niloticus*) ( $U = 4254$ ,  $Z = -3.953$ ,  $P < 0.001$ ); and more chickens were killed by civet (*Civetticus civetta*) ( $U = 5793$ ,  $Z = -4.067$ ,  $P < 0.001$ ), jackal ( $U = 6552$ ,  $Z = -2.022$ ,  $P = 0.043$ ) and aardwolf ( $U = 6427$ ,  $Z = -1.987$ ,  $P = 0.047$ ).

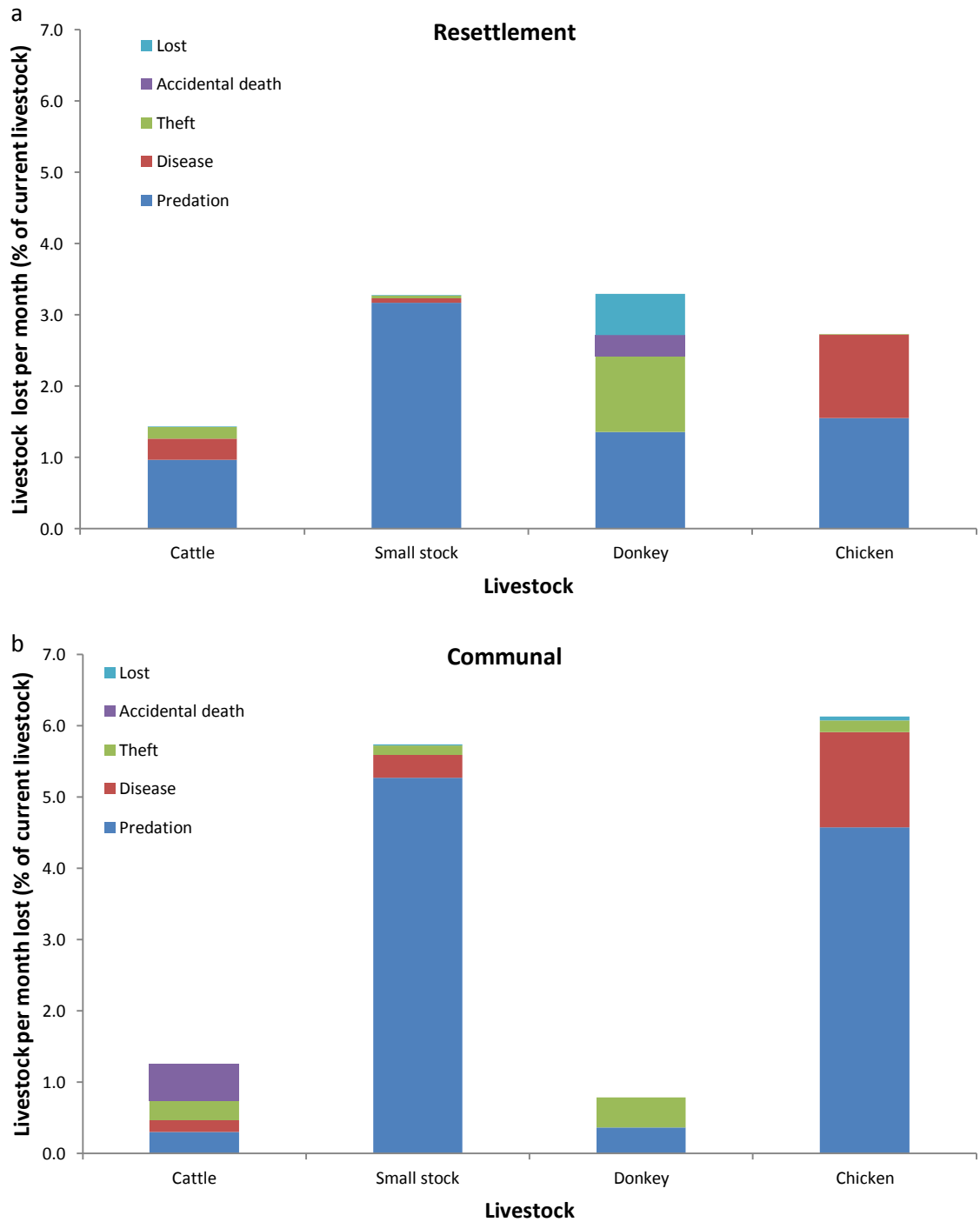


Figure 6.3 Reported sources of livestock loss in a) resettlement and b) communal LUTs around Savé Valley Conservancy in 2008 and 2009. Theft was said to be the most important source of livestock loss.

Rates of reported predation were significantly correlated between predators (Table 6.2).

Respondents that reported predation by lions were also more likely to report predation by

spotted hyena. Predation by leopard, brown hyena and wild dog were also correlated with each other.

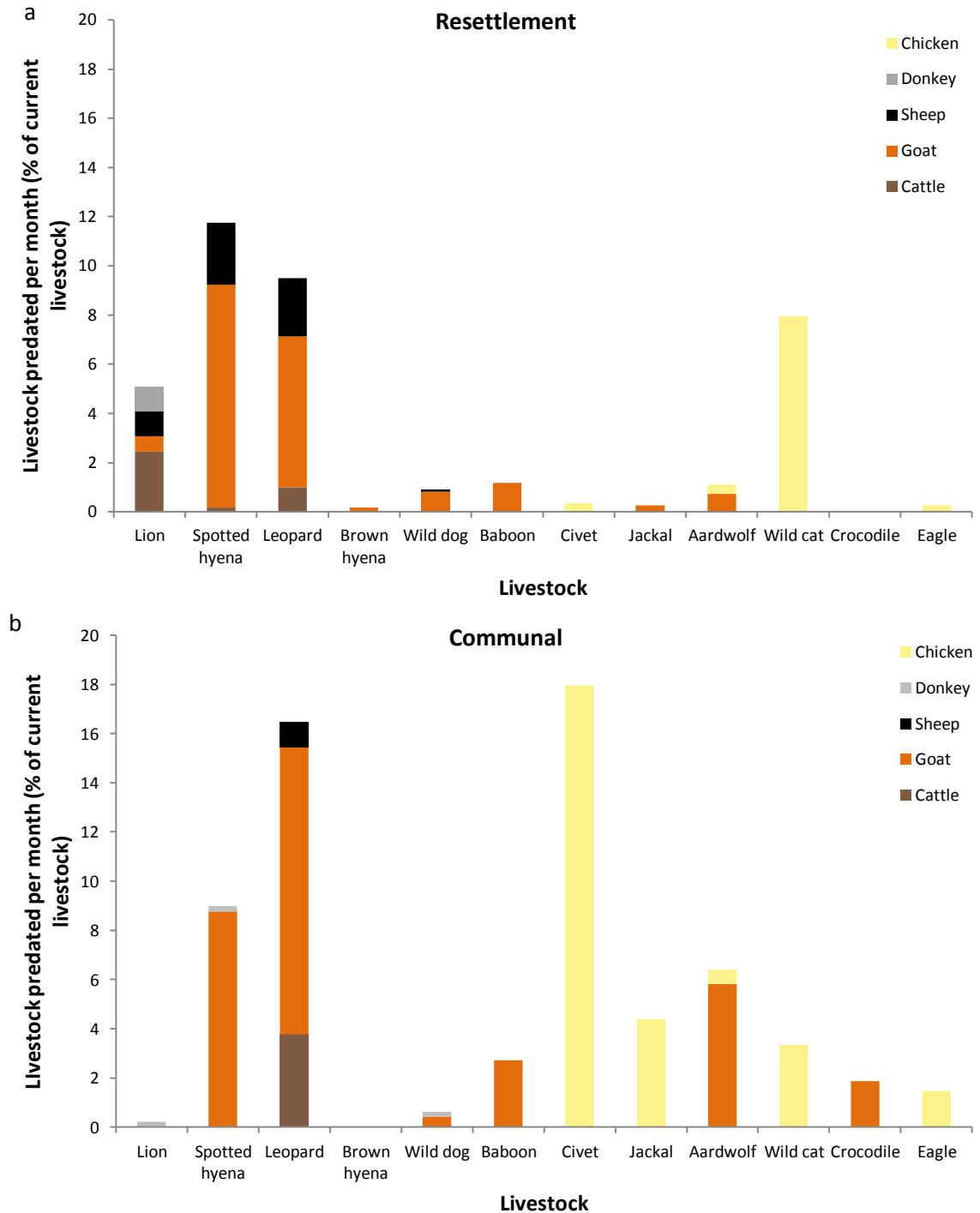


Figure 6.4 Perceived level of livestock lost to predation in a) resettlement and b) communal LUTs around Savé Valley Conservancy in 2008 and 2009, broken down by livestock type. Losses are expressed as a proportion of current holdings of each livestock type. Larger predators were blamed for livestock attacks in the resettlement than the communal LUT.



**Table 6.2 Spearman rank correlations between the number of cattle and small stock perceived to have been predated for each predator in Savé Valley Conservancy between 2008 and 2009. Significant correlations are highlighted in bold.**

	Cattle lost to lion	Cattle lost to leopard	Cattle lost to spotted hyena	Small stock lost to lion	Small stock lost to leopard	Small stock lost to spotted hyena	Small stock lost to brown hyena
No. cattle lost to leopard	$r_s = -0.036,$ $P = 0.525$						
No. cattle lost to spotted hyena	$r_s = -0.029,$ $P = 0.604$	$r_s = -0.018,$ $P = 0.745$					
No. small stock lost to lion	$r_s = 0.022,$ $P = 0.693$	$r_s = 0.032,$ $P = 0.570$	$r_s = -0.011,$ $P = 0.844$				
No. small stock lost to leopard	$r_s = -0.046,$ $P = 0.446$	$r_s = 0.962,$ $P < 0.001$	$r_s = -0.020,$ $P = 0.736$	$r_s = -0.035,$ $P = 0.556$			
No. small stock lost to spotted hyena	<b><math>r_s = 0.167,</math></b> <b><math>P = 0.003</math></b>	$r_s = 0.047,$ $P = 0.402$	$r_s = 0.073,$ $P = 0.193$	<b><math>r_s = 0.194,</math></b> <b><math>P = 0.001</math></b>	$r_s = 0.048,$ $P = 0.422$		
No. small stock lost to brown hyena	$r_s = 0.051,$ $P = 0.363$	$r_s = 0.104,$ $P = 0.066$	$r_s = -0.009,$ $P = 0.873$	$r_s = -0.016,$ $P = 0.780$	<b><math>r_s = 0.160,</math></b> <b><math>P = 0.008</math></b>	$r_s = -0.051,$ $P = 0.365$	
No. small stock lost to wild dog	$r_s = 0.072,$ $P = 0.205$	<b><math>r_s = 0.128,</math></b> <b><math>P = 0.023</math></b>	$r_s = -0.008,$ $P = 0.890$	$r_s = -0.014,$ $P = 0.809$	<b><math>r_s = 0.160,</math></b> <b><math>P = 0.008</math></b>	$r_s = -0.044,$ $P = 0.424$	<b><math>r_s = 0.864,</math></b> <b><math>P &lt; 0.001</math></b>

The most important problem predators identified by respondents differed between the two land use types (chi-squared tests:  $\chi^2 = 103.104$ ,  $df = 6$ ,  $P < 0.001$ , Figure 6.5). Tests were restricted to lion, leopard, spotted hyena, civet, aardwolf, “none” (no predators thought to be a problem), and “other” due to the low frequency that other predators were cited. Lion and spotted hyena were more frequently cited in the resettlement area, while all other predators tested were more common responses in the communal area. A relatively large proportion of respondents in the communal area (8%) believed that aardwolf were the most problematic predator, and that side striped jackal and brown hyena were also occasionally thought to be the worst livestock predators. A greater proportion of respondents in the communal area than the resettlement area claimed that no predators were a big problem (“none” category).

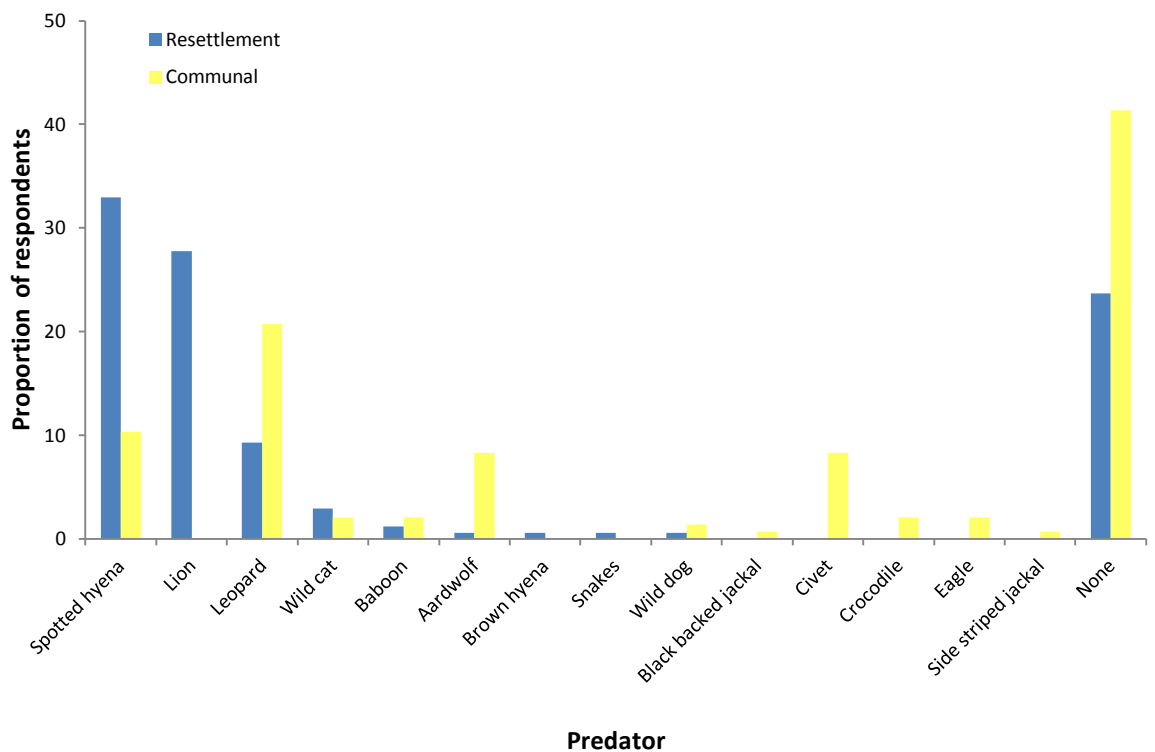
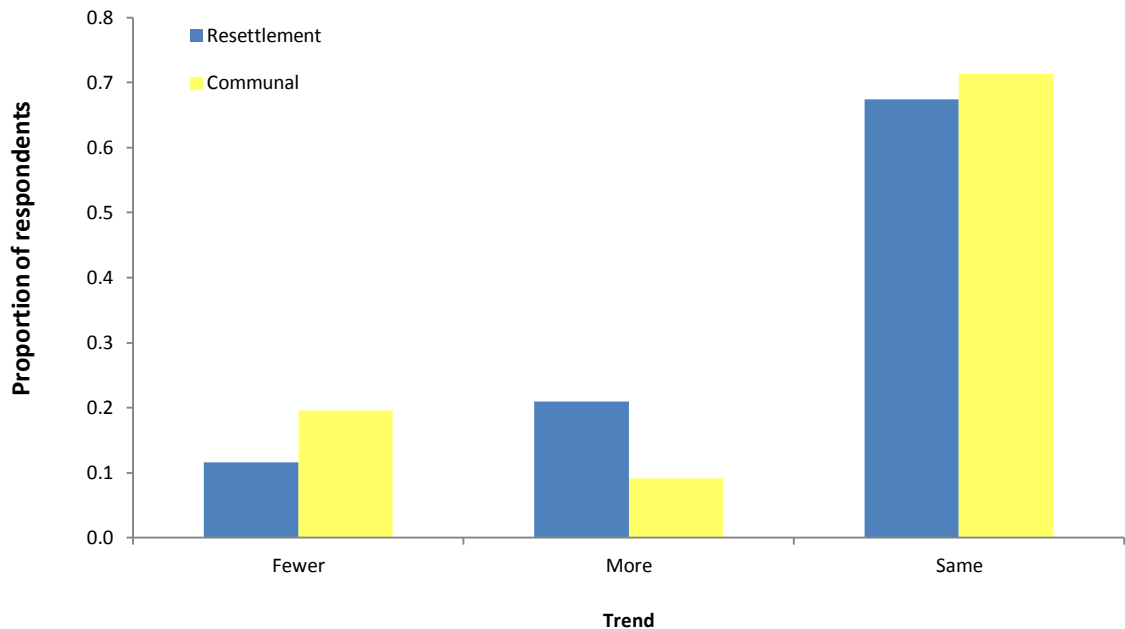


Figure 6.5 Predators considered responsible for most livestock attacks in the resettlement and communal LUTs around Savé Valley Conservancy in 2008 and 2009. Spotted hyena and lion in particular were more likely to be blamed in the resettlement than the communal LUT.

Opinions on whether livestock predation rates were greater than previously varied significantly ( $\chi^2 = 0.005$ ,  $df = 2$ ,  $P = 0.002$ , Figure 6.6). Most respondents, however, believed that predation rates had remained constant, but of those that reported a change, more resettlement farmers considered predation to be increasing, while more communal farmers believed predation to be decreasing. Mean duration of residence in the area was 7.5 years and 28.8 years for respondents in the resettlement and communal areas respectively (see Chapter 7), so both groups are discussing a period close to the maximum of ten years.



**Figure 6.6** Perceived trend in livestock predation in the resettlement and communal LUTs around Savé Valley Conservancy (predation rates in 2008 and 2009 compared with 10 years previously, or when the respondent first moved to area). Resettlement farmers were more likely to perceive predation rates to be increasing than communal farmers.

### 6.3.3 Predation mitigation strategies

Kraaling and herding were the most commonly used livestock management techniques, with almost 100% adoption in both LUTs (Figure 6.7). Most farmers also used dogs to warn of the presence of predators and bell collars on livestock, and some used scarecrows to protect their livestock. All other techniques (described in Table 6.1) were used by less than 10% of

respondents. Dogs were the only animal used as livestock guarding animals. Very low incidence of trapping or lethal control of predators was reported. In relation to communal farmers, resettlement farmers were significantly more likely to use warning dogs ( $\chi^2 = 7.548$ ,  $df = 1$ ,  $P = 0.017$ ), bell collars ( $\chi^2 = 20.916$ ,  $df = 1$ ,  $P < 0.001$ ) and scarecrows ( $\chi^2 = 28.422$ ,  $df = 1$ ,  $P < 0.001$ ) to protect their livestock. It was not possible to test for associations between other techniques and land use type. The number of herders used to guard livestock was slightly larger in the resettlement area (Mann-Whitney U test:  $U = 8716$ ,  $Z = -5.805$ ,  $P < 0.001$ , Figure 6.8) and the estimated distance between homesteads and livestock grazing areas ( $U = 3381.5$ ,  $Z = -7.990$ ,  $P < 0.001$ , Figure 6.9) were both significantly greater in the resettlement area than the communal area. Land use type was excluded from further analyses due to significant associations with other variables. The only livestock management techniques used were previously known from the literature (Table 6.1), and no farmers reported any alternative methods.

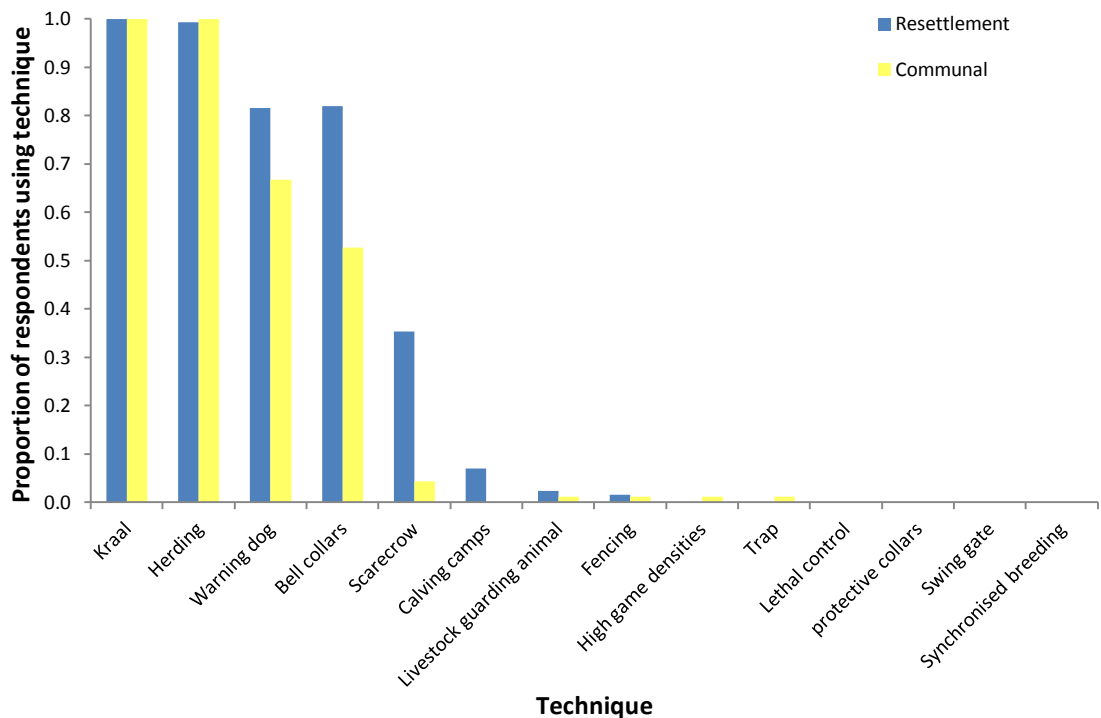


Figure 6.7 Prevalence of livestock management techniques in the resettlement and communal LUTs around Savé Valley Conservancy in 2008 and 2009. Kraaling, herding, warning dogs and bell collars were very popular in both LUTs.

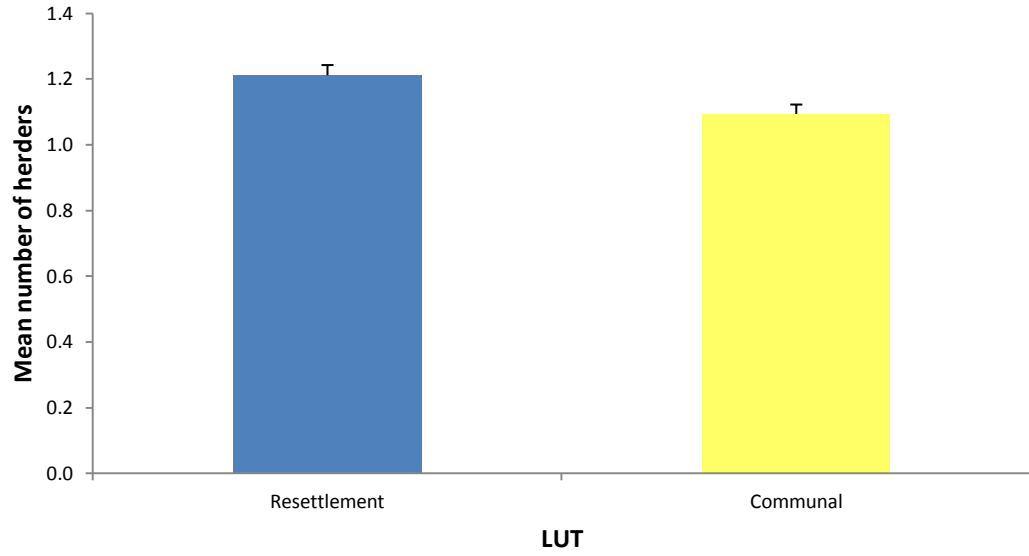


Figure 6.8 Mean number of herders used for herding livestock in the resettlement and communal LUTs around Savé Valley Conservancy in 2008 and 2009. Error bars represent standard errors. Resettlement farmers reported slightly larger numbers of herders protecting their stock.



Figure 6.9 Estimated distance between homestead and livestock grazing area in the resettlement and communal LUTs around Savé Valley Conservancy in 2008 and 2009. Error bars represent standard errors. Greater distances were reported amongst resettlement farmers than communal farmers.

The use of bell collars and scarecrows ( $\chi^2 = 15.437$ ,  $df = 1$ ,  $P < 0.001$ ) were significantly associated with one another. It was not possible to test for associations between use of other techniques

with experience of predation, or with each other due to rates of adoption being too low or too high. Further analyses were therefore restricted to the use of bell collars, warning dogs, the number of herders and the distance from the kraal to the grazing area.

Univariate statistical tests demonstrated that the use of bell collars was significantly associated with the number of respondents that reported cattle or small stock predation by lion or spotted hyena over the past 12 months, with those using bell collars more likely to have experienced predation (Table 6.3). Respondents that claimed to experience predation by lion also used significantly more herders and had a significantly greater distance between their kraal and grazing area (Table 6.3). No other trends were significant.

**Table 6.3 Univariate statistical tests showing relationships between whether or not cattle or small stock predation in the past 12 months in SVC and potential explanatory variables. Significant relationships are shown in bold.**

	Lion	Leopard	Spotted hyena	Brown hyena	Wild dog
Bell collars	<b><math>\chi^2 = 7.807</math></b> <b>df = 1</b> <b>P = 0.005</b>	$\chi^2 = 0.344$ df = 1 P = 0.558	<b><math>\chi^2 = 5.974</math></b> <b>df = 1</b> <b>P = 0.015</b>	$\chi^2 = 0.000$ df = 1 P = 1.000	$\chi^2 = 0.274$ df = 1 P = 0.600
Warning dog	$\chi^2 = 1.750$ df = 1 P = 0.186	$\chi^2 = 0.633$ df = 1 P = 0.426	$\chi^2 = 1.390$ df = 1 P = 0.238	$\chi^2 = 0.334$ df = 1 P = 0.563	$\chi^2 = 0.110$ df = 1 P = 0.740
Number of herders	<b>U = 2538.5</b> <b>Z = -2.250</b> <b>P = 0.024</b>	U = 771 Z = -1.435 P = 0.151	U = 3960.5 Z = -1.337 P = 0.181	U = 370 Z = -0.829 P = 0.407	U = 279 Z = -0.716 P = 0.474
Distance from kraal to grazing area	<b>U = 3037.5</b> <b>Z = -2.465</b> <b>P = 0.014</b>	U = 727.5 Z = -0.559 P = 0.576	U = 3246.5 Z = -1.659 P = 0.097	U = 338.5 Z = -0.652 P = 0.514	U = 291 Z = -0.218 P = 0.827

**Table 6.4 Binary logistic regression showing relationships between whether or not respondents around Savé Valley Conservancy reported cattle or small stock predation in the previous 12 months and potential explanatory variables. Degrees of freedom for each individual variable is equal to 1. Data for individual variables are expressed as odds ratios.  $R^2_N$  represents Nagelkerke's  $R^2$ . Significant relationships are shown in bold.**

	Lion	Leopard	Spotted hyena	Brown hyena	Wild dog
Overall model	$\chi^2 = 22.543$ df = 4 P < 0.001 $R^2_N = 0.182$	$\chi^2 = 4.609$ df = 4 P = 0.330 $R^2_N = 0.074$	$\chi^2 = 13.538$ df = 4 P = 0.009 $R^2_N = 0.096$	$\chi^2 = 5.074$ df = 4 P = 0.280 $R^2_N = 0.139$	$\chi^2 = 6.22$ df = 4 P = 0.183 $R^2_N = 0.210$
Variable					
Use warning dog	2.66	2.42	2.20	6.74E+07	2.42E+07
Use bell collars	<b>4.15</b>	3.06	<b>2.50</b>	1.25	8.90E+12
Number of herders	1.93	1.60	1.54	0.10	0.00
Distance from kraal to grazing area	<b>1.43</b>	0.57	1.14	1.47	0.49
Constant	<b>0.01</b>	<b>0.01</b>	<b>0.04</b>	0.00	0.00

The ability of the multivariate binary logistic regression model (using the forced entry method) to predict whether or not respondents reported cattle or small stock predation was significantly improved in relation to the constant alone by incorporation of some of the livestock management techniques into the model for lion and spotted hyena, but not for leopard, brown hyena or wild dog predation (Table 6.4). The models fit the data relatively poorly, however, explaining only 18% and 10% of the variation for lion and spotted hyena predation respectively. Other than the constant the only variables that significantly influenced the models were the use of bell collars (for both lion and spotted hyena predation), and the distance between the kraal and the grazing area (for lion predation only). All variables that significantly influenced the models had positive odds ratios, indicating that the use of bell collars and larger distances between kraals and to grazing areas were associated with increased likelihood of experiencing livestock predation by these species.

#### **6.4 Discussion**

Interview data detected differences in rates of perceived livestock predation between LUTs. Predation on livestock by large carnivores was a bigger problem for resettlement farmers, where more large livestock such as cattle were thought to be predated upon by larger predators such as spotted hyena and lion. At the study site respondents in the commercial LUT kept wildlife rather than livestock, so it was not possible to assess their perceptions of livestock predation. Other studies in Africa, however, have found that relative to community farmers, a greater proportion of commercial livestock farmers had positive attitudes towards large carnivores (Romañach *et al.*, 2007), and private landholders were more likely to want large carnivores on their land than communal farmers (Selebatso *et al.*, 2008). Communal farmers had more positive attitudes towards wildlife if they received benefits from wildlife (Groom and Harris, 2008). At SVC the FTLRP has resulted in the displacement of commercial farmers who hold positive attitudes towards



carnivores in favour of resettlement farmers who do not derive benefits from wildlife and have few incentives to conserve animals in their area, resulting in negative attitudes (see Chapter 7). The FTLRP therefore has increased the potential for conflict between humans and large carnivores.

Overall, predation, theft and disease were thought to be responsible for most livestock losses (Figure 6.3). Theft was a bigger problem for communal farmers than resettlement farmers, with both cattle and chickens more likely to be stolen in the communal area. This is probably due to the greater human density in the communal land (11-82 people per km<sup>2</sup> (Lindsey *et al.*, 2009b)) in relation to the resettlement area (approximately 7 people per km<sup>2</sup> (commercial farmer, pers. comm.)). At other study sites disease is often considered the most important source of livestock mortality (Butler, 2000; Dickman, 2008; Kissui, 2008; Maddox, 2003; Thirgood *et al.*, 2005), but at SVC predation is thought to be responsible for the most livestock deaths, resulting in the loss of up to 5% of livestock per month (Figure 6.3). These levels are higher than at a number of other sites in Zimbabwe (Butler, 2000; Davies and du Toit, 2004) and elsewhere in Africa, where depredation rates are generally around 0.5% to 3% of livestock populations (Dickman, 2008; Kissui, 2008; Kolowski and Holekamp, 2006; Maddox, 2003; McShane and Grettenberger, 1984; Patterson *et al.*, 2004; Rudnai, 1979; Scheiss-Meier *et al.*, 2007; Stein *et al.*, 2010). Similar levels were reported in Graham *et al.*'s (2005) global review. The resettlement situation at the study site, whereby large numbers of people and livestock suddenly occupy an area that previously had high predator populations, is highly conducive to livestock predation and human-wildlife conflict, which could explain this pattern.

Farmers that experienced livestock predation by lion were more likely to experience predation by spotted hyena, and similarly predation by leopard, wild dog and brown hyena were intercorrelated (Table 6.2). The relationship between predation by lion and spotted hyena was

also noted by Dickman (2008), and can be explained by overlap in their diet and distribution (Hayward, 2006; Mills and Hofer, 1998; Nowell and Jackson, 1996). Wild dog and leopard also have overlap in their diet (Hayward *et al.*, 2006a; Hayward *et al.*, 2006c), although wild dogs have a more restricted distribution and a very different activity pattern. Correlation of predation by these two predators with predation by brown hyena is more surprising as they feed primarily on carrion and are not known to actively hunt livestock or any other mammals larger than springhares (Maude and Mills, 2005; Skinner and Chimimba, 2005). This is most likely due to respondents misattributing kills to brown hyenas found scavenging livestock that died due to other causes, or confusion with other predators (Mills and Hofer, 1998).

It is possible that the reported predation levels could be an exaggeration of the true rate of predation. Respondents in the current study were asked to summarise livestock holdings on the day of the interview and discuss sources of livestock losses over the previous 12 months (after Butler, 2000; Gusset *et al.*, 2009). While this approach can yield useful information over a brief period, it may overestimate predation in relation to more long-term, in depth methodologies such as maintaining records of livestock losses as they occur over the year and verifying them where possible (Dickman, 2008). This technique has been used by some researchers (Dickman, 2008; Ogada *et al.*, 2003; Woodroffe *et al.*, 2007a), but would have been difficult at the study site due to the political situation, and the need to collect cheetah sighting data (Chapter 4) from as many participants as possible over a short period, while conducting fieldwork within SVC. Nevertheless, the data presented here suggest there may be elevated levels of livestock predation, and further study of this phenomenon would be worthwhile.

Records of predation by large predators conflict with spoor count data (Chapter 3), which found no evidence for lion in the resettlement area, and no large carnivores in the communal area. It is possible that these species persist in these areas at densities below the detectability threshold for

this technique, or that they enter temporarily from the commercial area, which would be very difficult to detect in a brief spoor survey. This mismatch could alternatively be due to misidentification of the causes of livestock losses, or a combination of these factors. Relative to the communal area, rates of cattle predation were regarded as greater in the resettlement area (Figure 6.3) due to increased predation by lions (Figure 6.4). This is consistent with predictions, and with the perception of lion and spotted hyena as the main problem predators in the resettlement areas (Figure 6.5), and the belief that predation levels are increasing (Figure 6.6). Communal farmers lost a smaller proportion of their cattle but more chickens in comparison with resettlement farmers, particularly due to predation by civet, jackal and aardwolf. Aardwolf and crocodile were blamed for a greater proportion of small stock predation in the communal area. Accordingly aardwolf and civet were considered to be the most problematic predators by communal farmers after leopard and spotted hyena. Resettlement farmers therefore believe that they are dealing with larger predators due to increased proximity to the commercial area, where relatively large predator populations are found, and as such resettlement farmers experience more intense predation on large livestock such as cattle (Dickman, 2008; Gusset *et al.*, 2009; van Bommel *et al.*, 2007). Conversely, large predators are less common in the communal area where human population density is greater and has been established for several decades (Lindsey *et al.*, 2009b; Wolmer, 2005; Woodroffe, 2000), permitting the competitive release of mesopredators (Elmhagen and Rushton, 2007; Gusset *et al.*, 2009), leading to increased predation on small livestock such as chickens. The lack of reports of cheetah predation or cheetah marking spots in either LUT supports earlier findings that cheetahs are now absent or extremely rare in these areas (Chapter 3, Chapter 4). Domestic dogs were not thought to be a source of livestock mortality, in contrast to other studies elsewhere in Zimbabwe (Butler and du Toit, 2002; Butler *et al.*, 2004) and other countries (Young *et al.*, 2011).

Livestock predation by brown hyena and side striped jackal are probably due to confusion of these species with spotted hyena and black backed jackal respectively (although respondents were shown photographs of each species to attempt to minimise such problems), as livestock predation by the former are usually rare (Maude, 2005; Skinner and Chimimba, 2005). It was very surprising that livestock predation by aardwolf was reported and that such a high proportion of respondents considered it to be the most problematic predator, despite the fact that they lack the appropriate dentition to attack livestock (Anderson *et al.*, 1992), and they feed almost exclusively on termites and other invertebrates (Kruuk and Sands, 1972; Matsebula *et al.*, 2009). It is possible that a rabid aardwolf may attempt to attack small livestock, but this is very unlikely. Aardwolf are generally rare (Anderson and Mills, 2008) and are not sufficiently abundant at the study site to be detected in the spoor counts (Chapter 3) so it is unlikely that respondents see them frequently. Confusion between aardwolf and spotted hyena or jackal may be the cause of this belief (Kruuk, 2002), but the species vary greatly in morphology. Domestic dogs could also be responsible for some of the attacks attributed to aardwolf and other species (Butler, 2000; Young *et al.*, 2011). Reports of perceived aardwolf attacks on livestock are not common in the literature, although belief in aardwolf predation on lambs has been noted in South Africa (Koehler and Richardson, 1990). A number of respondents expressed a very specific belief that aardwolf target the udders of female goats (I. Mavhurere, pers. comm.), and similar beliefs were expressed by communal farmers in Matabeleland South province during pre-testing of the interview (pers. obs.). The reason for these beliefs remain unclear, and would make an interesting follow-up study.

In comparison with resettlement farmers, communal farmers believed that a greater proportion of their livestock were predated by aardwolf, civets, jackals, crocodiles and eagles, killing up to 18% of current livestock holdings per month (Figure 6.4). No spoor from these species were detected in either LUT (Figure 3.3), although crocodile and eagle signs were not expected as the

survey was optimised for mammals. Respondents were not asked how they knew which predators were responsible for predation of their livestock or how certain they were of the species of predator responsible. It is possible that livestock that could not be accounted for were assumed to have been predated, and the predator responsible was blamed, in some cases somewhat arbitrarily.

The high rate of livestock predation explains the widespread uptake of some livestock management techniques, with almost 100% of farmers practicing kraaling and herding, most using warning dogs and bell collars, and some using scarecrows. Most other techniques were used very rarely, if at all. Some of these techniques, such as kraaling and herding, are also used to protect against theft, which could be an additional reason for their adoption. It is difficult to compare levels of livestock husbandry with other sites as few studies provide details, but the levels reported here are higher than others reported in southern Africa. The near universal use of kraaling and herding was similar to patterns of livestock management techniques in the communal lands bordering Kruger National Park, where farmers also are experienced high levels of livestock predation and were exposed to large predators such as lions (Lagendijk and Gusset, 2008). Very few cattle farmers in the Ghanzi district of Botswana used kraaling or herding (0% and 33% of respondents respectively, Kent, 2011). In Marker's (2003b) study in Namibia only 19% of farmers kraaled cattle and 42% herded their small stock. Calving/lambing camps, however, were more commonly used than in the current study (38% of cattle farmers and 49% of small stock farmers, compared with 7% at the study site). The level of livestock protection was much greater near Ruaha National Park in Tanzania, where the proportions of farmers that used kraaling, herding and warning dogs to protect their livestock from predators was similar to the current study (Dickman, 2008). The variation in livestock husbandry practices across Africa can be explained by differences in the factors such as the risk of predation and stock theft, the

availability of labour, and traditions of the use of husbandry methods (Frank *et al.*, 2005; Kent, 2011; Ogada *et al.*, 2003).

While dogs were frequently used in the current study to alert people to the presence of predators, they were only used by less than 3% of respondents to chase away predators. Dogs kept by respondents were small mongrels, which are not well suited to fending off attacks from large predators. Anatolian shepherds have been successfully used to actively defend against predators in Namibia and South Africa (Hodgkinson *et al.*, 2007; Marker *et al.*, 2005), but providing and caring for these animals at the study site would require donor funding, and no such project exists at present. No animals other than dogs were used to actively defend against predators, although donkeys and baboons are sometimes used in this way (Hodgkinson *et al.*, 2007; Schumann, 2004; Smith *et al.*, 2000). As donkeys are already kept by many farmers at the study site, it could be relatively simple to encourage their use as livestock guarding animals. It would be more difficult and expensive to implement other techniques such as protective collars, fencing, and swing gates explaining their low rates of use.

Although almost all farmers in both LUTs used kraaling and herding, respondents in the resettlement area were more likely to protect their livestock overall (Figure 6.7, Figure 6.8, Figure 6.9). Resettlement farmers were significantly more likely to use warning dogs, bell collars and scarecrows, and had significantly more herders guarding the livestock than communal farmers. This is probably in response to the increased predation pressure on cattle and the perception of larger predators such as lion and spotted hyena as being the most problematic.

No livestock management techniques were found to significantly reduce the likelihood of experiencing livestock predation at the study site. No support was found for the findings of earlier studies, which concluded that using kraaling, herding, warning dogs, and livestock guarding

animals can be been effective at reducing livestock predation, while scarecrows had been associated with increased predation (Dickman, 2008; Gusset *et al.*, 2009; Marker *et al.*, 2005; Ogada *et al.*, 2003; Woodroffe *et al.*, 2007a). It was not possible, however, to test all these techniques at SVC due to insufficient variability and intercorrelations between their use. Distance from the kraal to the grazing area was significantly greater among respondents that experienced livestock predation by lion, a relationship identified for other carnivores in another study (Wang and Macdonald, 2006). Minimising this distance could help to reduce predation where lion attacks are common. Contrary to expectations, the use of bell collars and a greater number of herders was found to be associated with an increased probability of livestock predation by lion and spotted hyena using both univariate and multivariate analyses (Table 6.3, Table 6.4). It is likely that the use of these livestock protection methods at SVC is reactionary rather than preventative in this case, with farmers that suffer from greater predation levels resorting to higher levels of livestock protection. This highlights a problem with the bulk of the studies on this subject to date. The literature on the effectiveness of livestock husbandry practices (including this study) tends to employ an observational approach, searching for associations or differences between predation and predictor variables such as livestock husbandry practices (Bauer *et al.*, 2010a; Kolowski and Holekamp, 2006; Ogada *et al.*, 2003; van Bommel *et al.*, 2007; Woodroffe *et al.*, 2007a). It is therefore not completely clear whether husbandry affects predation or predation affects husbandry. Many human-wildlife mitigation projects in Africa attempt to encourage better livestock husbandry with the aim of reducing livestock predation and human-wildlife conflict. It is suggested that this opportunity could be used to investigate the effectiveness of livestock management techniques using an experimental approach, by monitoring the losses of farmers both before and after they change their practices. This would provide more robust evidence for the efficacy of the techniques used, and would help to circumvent the problems experienced in the current study.

Although this chapter focuses on livestock predation, this is not the only mechanism by which wildlife can come into conflict with humans. The dangerous animals that occur in SVC also pose a direct threat to the large human population that moved into the resettlement area. Between 2000 and 2007 at least 21 people have been killed by elephants alone in and around SVC (Lindsey, 2007). Other resident species such as lion, leopard, buffalo, rhinoceros, hippopotamus and crocodile also present potential risk of injury or death to resettlement farmers, and, since the perimeter fence was removed, to communal farmers as well (Dunham *et al.*, 2010a; Kruuk, 2002; Packer *et al.*, 2005). Other mechanisms such as crop-raiding by species such as elephant have significant potential for causing conflict at the study site (pers. obs.). Obtaining more information on these facets of human-wildlife conflict would help to build a greater understanding of these processes.

While the methods used provide some useful information, the results should be interpreted carefully. The inconsistencies in reported livestock holdings noted in Figure 6.1, and the lack of validation of responses suggests that the information obtained should not be accepted without scrutiny. The data were collected on a more coarse scale (one-off interviews) than some other studies, which collected long-term data on individual attacks by predators on an ongoing basis (Dickman, 2008; Ogada *et al.*, 2003; Woodroffe *et al.*, 2007a). As such the elevated rates of predation reported (Figure 6.3) could be exaggerated, as long-term monitoring can result in much lower estimates of livestock losses (Dickman, 2008). Long-term monitoring might also be better for assessing the effectiveness of livestock management techniques at reducing predation. Independent verification of information provided could also increase the quality of the data, as previous studies have found that actual levels of livestock predation and husbandry standards tended to be lower than reported during interviews (Dickman, 2008; Marker *et al.*, 2003e; Rasmussen, 1999). This would also help to determine the techniques that were used when livestock attacks occurred, rather than which techniques are used in general. Although long term



monitoring and independent verification would be beneficial techniques, they were not practical in the context of the current study, and the approach taken allowed data to be collected from a larger sample than several comparable published studies (for example Gusset *et al.*, 2009; Hemson *et al.*, 2009; Selebatso *et al.*, 2008). Due to the nature of the study encompassing multiple predators and several different types of livestock it was not possible to avoid conducting multiple statistical tests, resulting in an increased risk of obtaining statistically significant results where these are not present. Caution should be used when examining the results, but despite the resulting limitations of conducting multiple tests, this practice is common in the literature (Lindsey *et al.*, 2005; Ogada *et al.*, 2003; Romañach *et al.*, 2007). Despite the caveats the data presented here help to fill a gap in the understanding of livestock predation in Zimbabwe, and highlight the dynamics brought about by the land reform programme.

## 6.5 Summary

Predation was the most important cause of livestock mortality. Cattle predation was more intense in the resettlement area, while predation in chickens was a bigger problem for communal farmers, suggesting that the FTLRP has increased conflict between humans and large carnivores (objective 4). Cheetahs were not thought to be responsible for livestock predation, further evidence supporting their absence from these areas. Some interesting reports were made of livestock attacks by unexpected species, most notably aardwolf. The causes of this are not known, but may be due to popular beliefs about the species. Larger predators such as lion were said to be responsible for cattle predation by resettlement farmers, while smaller predators such as jackal were blamed for more livestock attacks in the communal area. This pattern is also reflected in farmers' perceptions of which predator was most problematic. The different distribution of predator attacks in the two land use types could be explained by the greater proximity of the resettlement farms to the remaining commercial farms, which still support relatively large populations of predators. Resettlement farmers were also more likely than communal farmers to

believe that the level of livestock predation was increasing, and invested more heavily in livestock protection, although all farmers practiced some techniques. Some protective measures were associated with an increased probability of predation (objective 5). Rather than causing increased predation, however, this is probably because farmers increase their level of livestock protection in response to increased predation risk. The following chapter considers how levels of livestock predation and other factors influence the attitudes of people towards predators and how this has been affected by the FTLRP.

# Chapter 7 Attitudes towards cheetahs and tolerance of predation

---

## 7.1 Introduction

The establishment of national parks and other state protected areas have long been the focus of efforts to conserve endangered species (Bond *et al.*, 2004). In recent years, however, it has become increasingly evident that the survival of a number of species is dependent on their conservation outside of formally protected areas. Species such as cheetahs and wild dogs occur at low densities inside protected areas due to competition with relatively large populations of dominant predators such as lions and spotted hyenas (Creel and Creel, 1996; Durant, 1998; Laurenson, 1995). Private land is extremely important to the survival of such animals, and it was estimated that 80% of the remaining cheetahs in Zimbabwe ranged on commercial farms (Stuart and Wilson, 1988). The persistence of national parks alone may not be sufficient to safeguard even species that are relatively abundant in protected areas, as national parks may not be large enough or may not include a sufficient diversity of habitat types to support viable populations of each species (Child, 2009a). This is particularly true for large carnivores, which are inherently rare and require large home ranges and prey populations due to their trophic position and large body size (Sillero-Zubiri and Laurenson, 2001).

Although the importance of unprotected areas to biodiversity conservation is becoming increasingly clear (Bond *et al.*, 2004), there is significant potential for human-wildlife conflict in these areas. Large carnivores frequently cause conflicts due to their potential to attack humans or prey on livestock and game (Thirgood *et al.*, 2005). This can cause people to hold negative attitudes towards the species responsible (Gusset *et al.*, 2008b; Naughton-Treves *et al.*, 2003),

making them more likely to practice lethal control (Marker *et al.*, 2003c) and support measures to reduce carnivore populations (Don Carlos *et al.*, 2009). In addition to livestock predation (Chapter 6), a number of factors can affect the attitudes of people towards predation (Dickman, 2008). Persecution by people is the largest source of mortality for a number of predators both within and outside of protected areas (Davidson *et al.*, 2011; Marker *et al.*, 2003a; Woodroffe and Ginsberg, 1998), and it can result in carnivore population declines and extinctions (Woodroffe, 2000; Woodroffe and Frank, 2005). Positive attitudes, in contrast, are associated with support for conservation measures that can lead to increasing populations (Kaczensky *et al.*, 2004). Gaining an understanding of the factors that influence the attitudes and tolerance of people living with large carnivores towards these species is therefore crucial to developing effective conservation strategies (Legendijk and Gusset, 2008; Romañach *et al.*, 2007).

Although the study of people's attitudes towards wildlife is of interest in its own right, determining the attitudes towards species of conservation concern is a useful tool to help predict their behaviour (Kellert *et al.*, 1996; Rigg *et al.*, 2011). Other factors, however, also influence behaviour, and information on attitudes alone is not necessarily sufficient (Bohner and Wanke, 2002; Liu *et al.*, 2011). Several conceptual models have been developed in social psychology to understand the relationship between attitudes and behaviour, but despite the potential benefits of these approaches they are rarely applied to conservation research (McCleery *et al.*, 2006; St John *et al.*, 2010) as most conservationists are biologists by training and are not familiar with such techniques (Adams, 2007). Attitude to behavioural process models are one type of model that can be applied to studies of human-wildlife interactions (Fazio, 1990). These models contend that attitudes can influence perceptions, or in the context of the current study, negative attitudes towards cheetahs can lead to favourable perceptions of the opportunity to kill a cheetah, which in turn can result in the performance of that behaviour (Figure 7.1). In order for attitudes to influence perceptions they must be available to the decision making process, or accessible (Eagly

and Chaiken, 1998). Attitudes are more accessible and therefore more likely to influence perceptions if the individual has more experience with the behaviour in question, such as having killed a cheetah before. Social norms also influence behaviour, so individuals would be less likely to kill a cheetah if they believe that people important to them would view the behaviour unfavourably. In addition to attitudes, assessing people's level of tolerance of livestock predation is another valuable technique used to determine how people perceive carnivores and predict their behaviour towards them (Romañach *et al.*, 2007).

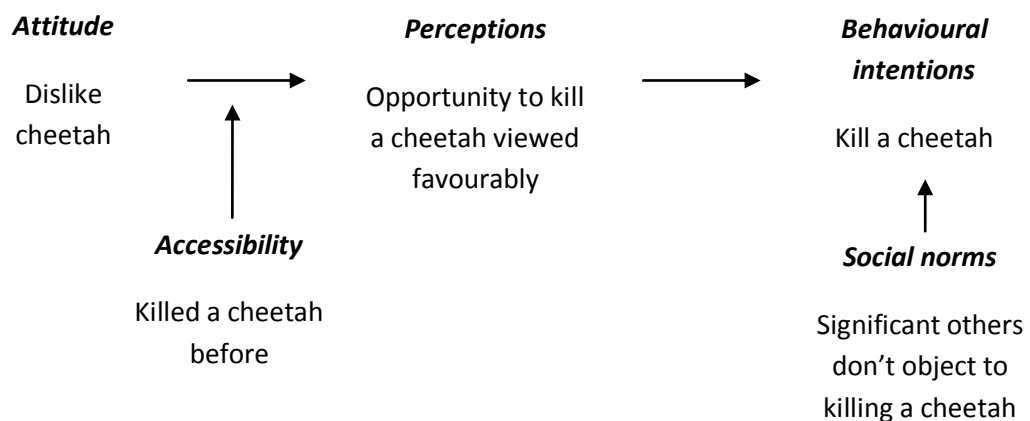


Figure 7.1 Schematic diagram of an attitude to behavioural process model and how it relates to the study.

The Fast-Track Land Reform Programme (FTLRP) initiated in Zimbabwe has resulted in the resettlement of many subsistence farmers onto private land (Kwashirai, 2009b) which previously supported significant populations of carnivores (Stuart and Wilson, 1988). The FTLRP is likely to have had a huge impact on the level of human-wildlife conflict in Zimbabwe and people's attitudes towards wildlife, but the attitudes and tolerance of resettlement farmers in Zimbabwe towards wildlife has not yet been assessed. This chapter focuses on comparing the attitudes towards cheetahs and tolerance of cheetah predation between land use types (LUTs; objective 6), although attitudes towards the lion, leopard, spotted hyena, brown hyena and wild dog are also

considered. Predictors of attitudes towards cheetahs and tolerance of cheetah predation such as the level of knowledge about the species are then outlined. The implications of the findings on the propensity of people to kill cheetahs and how this has changed since the onset of the FTLRP is discussed. It is predicted that attitudes will be most negative and tolerance of predation will be lowest in the resettlement area, and that the FTLRP has increased perceived levels of human-carnivore conflict.

## 7.2 Methods

Interviews were conducted as described in section 2.5.2. Respondents in the commercial, resettlement and communal LUTs were asked about their attitudes towards predators and tolerance of predation. The first questions were concerned with demographic details about the participants, which may be associated with attitudes and tolerance. The location and land use type of the place where the respondent lived (which could be different from the interview location) was recorded, along with their number of years of residence in that area, and their sex, age, cultural group, religion and the number of years of formal education received (after Dickman, 2008; Hazzah *et al.*, 2009; Jew and Bonnington, 2011; Lindsey *et al.*, 2005; Romañach *et al.*, 2007). Respondents were also asked if in their area they had ever seen a cheetah, lion, leopard, spotted hyena, brown hyena or wild dog, whether each species caused a problem, and whether they had ever tried to trap or kill each predator. Photographs (Appendix 4) and descriptions of morphology and behaviour were used to ensure that the interviewer and respondent were referring to the same species. The number of livestock said to have been killed by each predator over the past 12 months (recorded in Chapter 6) was also added to the dataset for analysis. Knowledge about cheetahs was tested using five statements (Table 7.1) to which respondents responded “True”, “False” or “Don’t know” (after Ericsson and Heberlein, 2003). The number of correct responses was then summed, to give a knowledge score of between 0 and 5.

**Table 7.1 Statements used to assess knowledge about cheetahs in interviews around Savé Valley Conservancy.**

Statement	Correct response
Cheetahs can run at over 100km/h	True
Cheetahs often kill people	False
Cheetahs only eat meat	True
Cheetahs roam freely today in North America	False
Cheetahs can breed and have cubs with domestic cats	False

Attitudes towards cheetah, lion, leopard, spotted hyena, brown hyena and wild dog, were assessed using a five-point scale ranging from 1 (very negative) to 5 (very positive) (Lindsey *et al.*, 2005). This was termed the “attitude score”. The reasons for attitudes towards cheetah were also recorded. Tolerance of cheetahs was investigated by asking how many small stock respondents would tolerate losing to cheetah predation before they would attempt to kill the cheetah responsible (Murphy and Macdonald, 2010; Romañach *et al.*, 2007; Stein *et al.*, 2010). This was termed the “tolerance score”. As a further indicator of tolerance, respondents in all LUTs were asked whether they would like to have fewer, the same number, or more cheetahs in their area (Romañach *et al.*, 2007). Data on cheetah removals described above were also used as a measure of tolerance of the presence of cheetahs (Marker *et al.*, 2003c).

Some questions were asked only to respondents in communal and resettlement areas as they were less relevant in the commercial land use type. Questions on livestock predation were not applicable in the commercial area, and the cultural group and religion were not collected from commercial respondents. Management staff of the commercial ranches were excluded from the questions to assess knowledge about cheetah, but these questions were administered to general staff on commercial ranches and respondents in other land use types.

## 7.3 Results

### 7.3.1 Potential predictors

Potential predictor variables of attitudes towards large carnivores and tolerance of cheetah predation are compared between land use types in Table 7.2. Cheetah knowledge score differed significantly between land use types (Kruskal-Wallis test:  $\chi^2 = 148.452$ ,  $df = 2$ ,  $P < 0.001$ ), with lowest scores recorded in the communal LUT. The responses to individual questions also show some interesting trends (Figure 7.2), in particular the question concerning cheetah attacks on humans. Only 5% of communal farmers were aware that cheetahs are not a threat to human life, while 39% of resettlement farmers and 64% of general staff from the communal area answered the question correctly. Most respondents were aware that cheetahs can run very quickly, that they cannot breed with domestic cats, and that they are exclusively carnivorous. Few respondents knew that cheetahs do not occur in North America.



**Table 7.2 Potential predictor variables of attitudes towards large carnivores and tolerance of predation across land use types at Savé Valley Conservancy in 2008 and 2009. Percentages refer to percent of respondents within the categories presented. Certain questions were not applicable or were not asked in all land use types.**

Variable	Land use type		
	Commercial	Resettlement	Communal
Sex (%)	Male: 97.8 Female: 2.2	Male: 59.8 Female: 40.2	Male: 49.0 Female: 51.0
Cultural group (%)	Excluded	Karanga: 46.7 Duma: 24.9 Ndau: 24.9 Other: 3.6	Karanga: 49.7 Duma: 26.9 Ndau: 13.8 Other: 9.7
Religion (%)	Excluded	Christian: 88.6 ATR: 11.4	Christian: 66.7 ATR: 33.3
Age (years)	34.2	58.7	37.7
Years of residence	8.6	7.5	28.8
Years of formal education	8.4	9.4	10.1
Knowledge score <sup>a</sup> (0-5)	3.6	3.7	3.0
Experienced cattle or small stock predation (%)	N/A	48.5	37.2
Cheetah seen (%)	70.5	4.7	2.1
Cheetah problem (%)	5.9	0.0	0.0
Cheetah remove (%)	18.8	0.0	0.0
Lion seen (%)	77.3	50.3	4.1
Lion problem (%)	26.3	22.5	0.7
Lion remove (%)	25.8	0.0	0.7
Leopard seen (%)	80.0	34.3	52.4
Leopard problem (%)	7.9	14.9	29.7
Leopard remove (%)	35.5	0.6	2.1
Spotted hyena seen (%)	65.1	66.3	42.8
Spotted hyena problem (%)	2.9	29.8	15.9
Spotted hyena remove (%)	13.3	0.0	0.0
Brown hyena seen (%)	28.9	1.8	1.4
Brown hyena problem (%)	2.9	1.2	0.7
Brown hyena remove (%)	3.3	0.0	0.0
Wild dog seen (%)	82.2	10.1	2.8
Wild dog problem (%)	20.5	1.2	2.1
Wild dog remove (%)	12.9	0.0	0.7

<sup>a</sup>within the commercial LUT general workers only (not management staff) were asked the questions to assess the knowledge score.

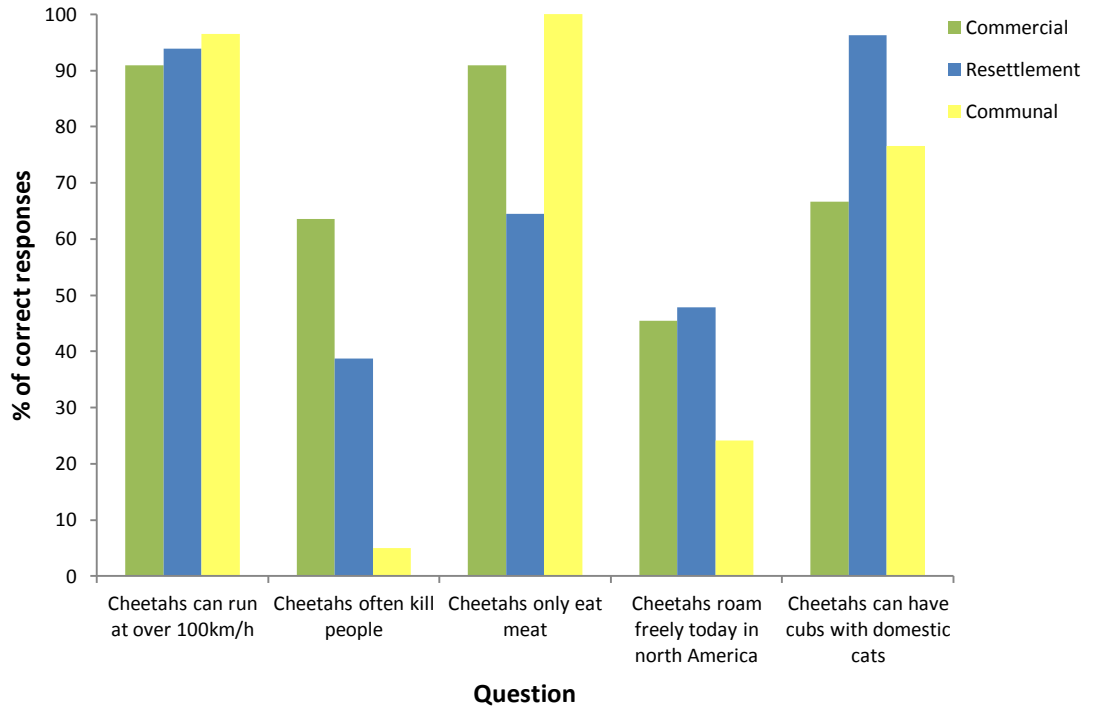


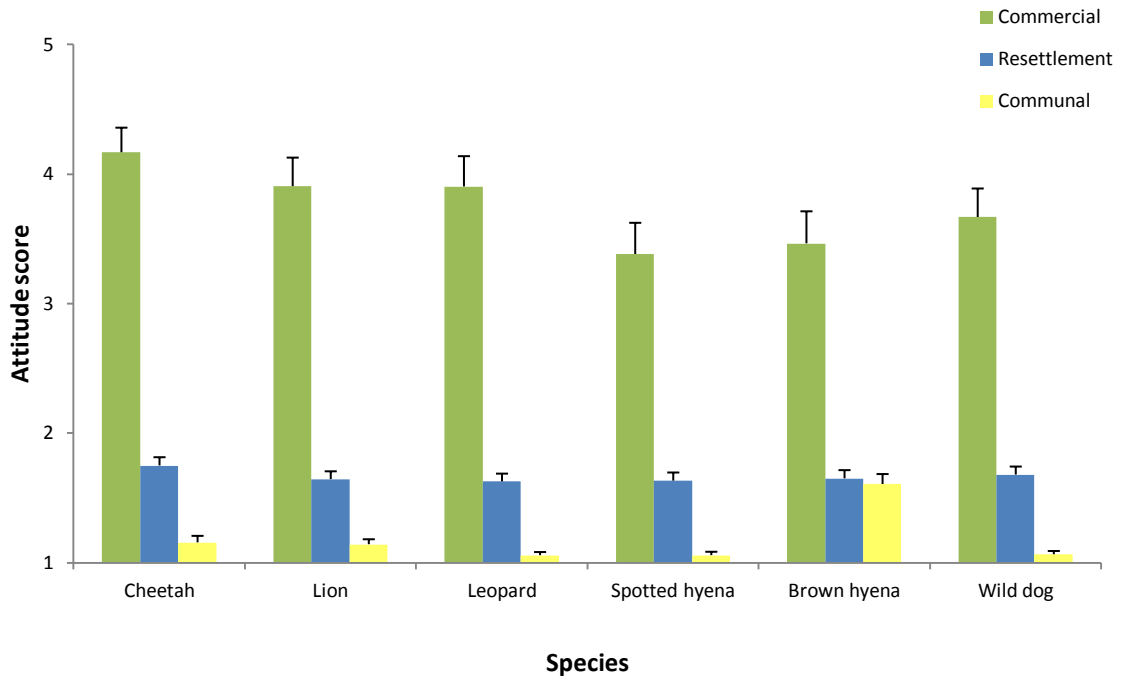
Figure 7.2 Responses to questions assessing knowledge about cheetahs by respondents in the commercial, resettlement and communal LUTs in and around Savé Valley Conservancy in 2008 and 2009.

### 7.3.2 Attitudes towards predators

Attitude scores towards predators differed significantly between land use types for each predator (Kruskal-Wallis test: cheetah:  $\chi^2 = 148.452$ ,  $df = 2$ ,  $P < 0.001$ ; lion:  $\chi^2 = 124.760$ ,  $df = 2$ ,  $P < 0.001$ ; leopard:  $\chi^2 = 138.315$ ,  $df = 2$ ,  $P < 0.001$ ; spotted hyena:  $\chi^2 = 123.007$ ,  $df = 2$ ,  $P < 0.001$ ; brown hyena:  $\chi^2 = 53.598$ ,  $df = 2$ ,  $P < 0.001$ ; wild dog:  $\chi^2 = 138.501$ ,  $df = 2$ ,  $P < 0.001$ ), with most positive attitudes in the commercial area, intermediate attitudes in the resettlement area and most negative attitudes in the communal area (Figure 7.3).

Attitudes did not differ significantly between different predators within any land use type, although differences approached the level of significance in the commercial and communal land use types (Kruskal-Wallis test: commercial:  $\chi^2 = 10.239$ ,  $df = 5$ ,  $P = 0.069$ ; resettlement:  $\chi^2 = 3.286$ ,  $df = 5$ ,  $P = 0.656$ ; communal:  $\chi^2 = 9.717$ ,  $df = 5$ ,  $P = 0.084$ , Figure 7.3). When pooling all six large

predators positive attitudes were expressed by 71.9% of commercial respondents, 0.5% of resettlement respondents and 0.2% of communal respondents.



**Figure 7.3 Mean attitude score towards predators in commercial, resettlement and communal LUTs in and around Savé Valley Conservancy (1 – very negative to 5 – very positive) in 2008 and 2009. Error bars represent standard errors. Attitudes were positive in the commercial LUT, negative in the resettlement LUT and very negative in the communal LUT.**

Predictors of attitudes towards cheetahs and other large carnivores were tested separately for commercial, resettlement and communal land, as attitudes differed significantly between LUTs (Table 7.2). In the resettlement area attitudes towards spotted hyena were significantly associated with whether or not respondents had seen the species before, and if they considered them to be a problem (Table 7.3). Attitudes towards the species were more negative among respondents who had seen spotted hyenas and considered them to be a problem. No significant differences were observed in respondent age, length of residence in the area, duration of formal education and cheetah knowledge score (for attitudes towards cheetahs only) between different attitudes towards predators (Table 7.4). A large number of statistical tests needed to be

conducted in order to determine these relationships in each land use type using univariate statistical methods. This increases the chance of type 1 statistical errors. Multivariate statistical tests (see below) are therefore more appropriate. The number of cattle perceived to have been predated by lion displayed a significant negative correlation with attitude towards that species in the resettlement area (Table 7.5).

**Table 7.3 Chi-squared tests for association between land use type and categorical predictor variables of attitudes towards large carnivores around Savé Valley Conservancy in 2008 and 2009. Attitudes, cultural group and religion were independently grouped for analysis. Tests were not possible in blank cells or absent rows and columns. Tests on religion and whether or not respondents had attempted to remove carnivores were not possible due to expected counts of less than 5. Significant relationships are shown in bold.**

Species		Land use type	
		Communal	Resettlement
Cheetah	Sex		$\chi^2 = 0.771$ , df = 1, P = 0.380
Lion	Sex		$\chi^2 = 2.787$ , df = 1, P = 0.095
	Seen species before		$\chi^2 = 0.809$ , df = 1, P = 0.368
	Considered a problem		$\chi^2 = 2.368$ , df = 1, P = 0.124
Leopard	Sex		$\chi^2 = 2.787$ , df = 1, P = 0.095
	Seen species before		$\chi^2 = 2.886$ , df = 1, P = 0.089
Spotted hyena	Sex		$\chi^2 = 2.787$ , df = 1, P = 0.095
	Seen species before		<b><math>\chi^2 = 7.306</math>, df = 1, P = 0.007</b>
	Considered a problem		<b><math>\chi^2 = 8.106</math>, df = 1, P = 0.004</b>
Brown hyena	Sex	$\chi^2 = 2.630$ , df = 1, P = 0.105	$\chi^2 = 2.921$ , df = 1, P = 0.087
Wild dog	Cultural group		$\chi^2 = 1.317$ , df = 1, P = 0.251

**Table 7.4** Kruskal-Wallis tests for differences in potential predictor variables between attitudes towards large carnivores in and around Savé Valley Conservancy in 2008 and 2009. Continued on following page.

Species	Variable	Land use type		
		Communal	Commercial	Resettlement
Cheetah	Age	$\chi^2 = 3.376$ , df = 3, P = 0.337	$\chi^2 = 3.868$ , df = 4, P = 0.424	$\chi^2 = 3.274$ , df = 3, P = 0.351
	Duration of formal education (years)	$\chi^2 = 0.882$ , df = 3, P = 0.830	$\chi^2 = 1.782$ , df = 4, P = 0.776	$\chi^2 = 4.113$ , df = 2, P = 0.128
	Duration of residence in area (years)	$\chi^2 = 5.435$ , df = 3, P = 0.143	$\chi^2 = 8.059$ , df = 4, P = 0.089	$\chi^2 = 0.755$ , df = 3, P = 0.860
	Number of cattle and small stock lost to cheetah in past year	N/A	N/A	N/A
	Cheetah knowledge score	$\chi^2 = 7.281$ , df = 3, P = 0.062	$\chi^2 = 1.586$ , df = 4, P = 0.811	$\chi^2 = 0.570$ , df = 3, P = 0.903
Lion	Age	$\chi^2 = 0.247$ , df = 2, P = 0.884	$\chi^2 = 2.588$ , df = 3, P = 0.460	$\chi^2 = 0.048$ , df = 2, P = 0.976
	Duration of formal education (years)	$\chi^2 = 3.480$ , df = 2, P = 0.176	$\chi^2 = 2.583$ , df = 3, P = 0.460	$\chi^2 = 2.449$ , df = 2, P = 0.294
	Duration of residence in area (years)	$\chi^2 = 0.724$ , df = 2, P = 0.696	$\chi^2 = 4.855$ , df = 3, P = 0.183	$\chi^2 = 0.201$ , df = 2, P = 0.905
	Number of cattle and small stock lost to lion in past year	$\chi^2 = 0.000$ , df = 2, P = 1.000	N/A	$\chi^2 = 3.210$ , df = 2, P = 0.201
Leopard	Age	$\chi^2 = 0.382$ , df = 2, P = 0.826	$\chi^2 = 4.500$ , df = 4, P = 0.343	$\chi^2 = 0.290$ , df = 2, P = 0.865
	Duration of formal education (years)	$\chi^2 = 5.817$ , df = 2, P = 0.055	$\chi^2 = 1.343$ , df = 3, P = 0.719	$\chi^2 = 0.916$ , df = 2, P = 0.633
	Duration of residence in area (years)	$\chi^2 = 0.326$ , df = 2, P = 0.850	$\chi^2 = 4.848$ , df = 4, P = 0.303	$\chi^2 = 0.190$ , df = 2, P = 0.909
	Number of cattle and small stock lost to leopard in past year	$\chi^2 = 0.512$ , df = 2, P = 0.774	N/A	$\chi^2 = 2.191$ , df = 2, P = 0.334
Spotted hyena	Age	$\chi^2 = 0.656$ , df = 2, P = 0.720	$\chi^2 = 6.203$ , df = 4, P = 0.185	$\chi^2 = 1.340$ , df = 3, P = 0.720
	Duration of formal education (years)	$\chi^2 = 2.972$ , df = 2, P = 0.226	$\chi^2 = 5.793$ , df = 4, P = 0.215	$\chi^2 = 1.720$ , df = 3, P = 0.632
	Duration of residence in area (years)	$\chi^2 = 1.849$ , df = 2, P = 0.397	$\chi^2 = 2.003$ , df = 4, P = 0.735	$\chi^2 = 0.649$ , df = 3, P = 0.847
	Number of cattle and small stock lost to spotted hyena in past year	$\chi^2 = 0.615$ , df = 2, P = 0.735	N/A	$\chi^2 = 7.105$ , df = 3, P = 0.069
Brown hyena	Age	$\chi^2 = 0.116$ , df = 2, P = 0.943	$\chi^2 = 5.950$ , df = 4, P = 0.203	$\chi^2 = 1.514$ , df = 3, P = 0.679
	Duration of formal education (years)	$\chi^2 = 2.935$ , df = 2, P = 0.231	$\chi^2 = 4.495$ , df = 4, P = 0.343	$\chi^2 = 1.720$ , df = 3, P = 0.632
	Duration of residence in area (years)	$\chi^2 = 1.705$ , df = 2, P = 0.426	$\chi^2 = 0.984$ , df = 4, P = 0.912	$\chi^2 = 0.817$ , df = 3, P = 0.845

	Number of cattle and small stock lost to brown hyena in past year	$\chi^2 = 2.5$ , df = 2, P = 0.287	N/A	$\chi^2 = 2.451$ , df = 3, P = 0.484
Wild dog	Age	$\chi^2 = 1.197$ , df = 2, P = 0.550	$\chi^2 = 3.393$ , df = 4, P = 0.494	$\chi^2 = 3.263$ , df = 3, P = 0.353
	Duration of formal education (years)	$\chi^2 = 4.708$ , df = 2, P = 0.095	$\chi^2 = 5.003$ , df = 4, P = 0.287	$\chi^2 = 1.679$ , df = 2, P = 0.432
	Duration of residence in area (years)	$\chi^2 = 1.827$ , df = 2, P = 0.401	$\chi^2 = 2.038$ , df = 4, P = 0.729	$\chi^2 = 1.864$ , df = 3, P = 0.601
	Number of cattle and small stock lost to wild dog in past year	$\chi^2 = 0.053$ , df = 2, P = 0.974	N/A	$\chi^2 = 1.843$ , df = 3, P = 0.606

**Table 7.5 Spearman rank correlation of number of animals lost to each large carnivore in 2008 and 2009 against attitude towards that species amongst respondents in resettlement and communal LUTS around Savé Valley Conservancy. Blank cells represent insufficient data to conduct tests. Significant relationships are shown in bold.**

Species	Resettlement		Communal	
	Cattle	Small stock	Cattle	Small stock
Cheetah				
Lion	<b><math>r_s = -0.162</math>, P = 0.040</b>	$r_s = 0.010$ , P = 0.899		
Leopard	$r_s = -0.121$ , P = 0.128	$r_s = -0.120$ , P = 0.141	$r_s = -0.058$ , P = 0.495	$r_s = -0.064$ , P = 0.502
Spotted hyena	$r_s = -0.096$ , P = 0.226	$r_s = -0.101$ , P = 0.207		$r_s = -0.067$ , P = 0.435
Brown hyena		$r_s = -0.119$ , P = 0.134		$r_s = 0.132$ , P = 0.121
Wild dog		$r_s = -0.103$ , P = 0.198		$r_s = -0.019$ , P = 0.820

Multinomial logistic regression was used to test for associations between attitudes towards each predator and the number of cattle and small stock perceived to have been killed by each predator over the past 12 months, whether respondents had seen each species, considered them to be a problem, and tried to remove them, the cultural group, religion, sex, age, duration of formal education and cheetah knowledge score (for attitudes towards cheetah only). Categorical variables were grouped and dummy coded where necessary (Field, 2009; Murphy and Macdonald, 2010). Models constructed from the independent variables, however, were not significantly better at predicting the attitude towards predators than the baseline model (Table 7.6).

A variety of reasons were provided as justifications for attitudes towards cheetahs (Table 7.7). The most frequent reason for negative attitudes was the belief that cheetahs kill livestock or that they are dangerous. These two responses were pooled, as it was conservatively assumed that respondents were referring to danger of livestock predation, unless they explicitly mentioned danger towards people. This finding is difficult to reconcile with the findings of Chapter 6, which found no evidence of livestock attacks by cheetahs over the previous 12 months. The second most frequently cited reason for negative attitude was that cheetahs can kill people (also illustrated in Figure 7.2). Reasons for neutral attitudes tended to be based on the observation that cheetahs had not caused the respondents any problems in the past, or on ignorance about the species. Positive attitudes (mainly respondents in the commercial LUT) focussed on the intrinsic qualities of the cheetah such as beauty, and also on benefits derived from cheetahs such as income through ecotourism. Some respondents stressed the important role that cheetahs played in the ecosystem.

**Table 7.6 Likelihood ratio tests for final multinomial logistic regression model of attitude score towards each predator in and around Savé Valley Conservancy in 2008 and 2009 against baseline model.**

	Land use type		
	Communal	Commercial	Resettlement
Cheetah	$\chi^2 = 50.084$ , df = 279, P = 1.000	$\chi^2 = 40.612$ , df = 52, P = 0.874	$\chi^2 = 86.906$ , df = 82, P = 0.334
Lion	$\chi^2 = 28.534$ , df = 182, P = 1.000	$\chi^2 = 25.707$ , df = 30, P = 0.690	$\chi^2 = 82.318$ , df = 82, P = 0.469
Leopard	$\chi^2 = 2.096$ , df = 164, P = 1.000	$\chi^2 = 21.778$ , df = 27, P = 0.749	$\chi^2 = 75.284$ , df = 76, P = 0.502
Spotted hyena	$\chi^2 = 20.774$ , df = 200, P = 1.000	$\chi^2 = 21.888$ , df = 20, P = 0.347	$\chi^2 = 75.708$ , df = 120, P = 0.999
Brown hyena	$\chi^2 = 61.538$ , df = 176, P = 1.000	$\chi^2 = 21.888$ , df = 20, P = 0.347	$\chi^2 = 74.433$ , df = 120, P = 1.000
Wild dog	$\chi^2 = 28.473$ , df = 180, P = 1.000	$\chi^2 = 30.067$ , df = 40, P = 0.873	$\chi^2 = 79.545$ , df = 76, P = 0.368

An unexpectedly high number of respondents provided reasons that appeared to conflict with their attitudes. For example, some respondents cited the beauty of cheetahs or the observation that they have never caused any problems as reasons for their negative attitude towards them (Table 7.7). Similarly some individuals with positive perceptions of cheetahs provided reasons for their attitudes including their perceived risk to livestock and people.

No respondents in the resettlement or communal LUTs reported killing any predators in the past. Commercial farmers had trophy hunted cheetahs as per the safari hunting quota allocated (up to two animals per year, commercial farmer, pers. comm.) but did not report killing any additional cheetahs. Hunting of cheetah was likely to continue in some properties in the commercial LUT, not because of their attitudes towards cheetahs (which were positive), but because their livelihood depended on trophy hunting. Attitudes towards cheetahs were very negative in both the resettlement and communal LUTs (Figure 7.3) so attitude to behavioural process models suggest that people in these areas would be likely to have a favourable perception of the opportunity to kill a cheetah, for example if they saw a cheetah near their farm (Figure 7.1). No reports were made in these land use types of people killing cheetahs in the past so it is difficult to know whether these attitudes are accessible. Respondents may have been reluctant to discuss such sensitive issues as illegal poaching in a brief encounter with unknown researchers. Rates of poaching are extremely high within SVC, with over 4,000 poachers captured between 2001 and 2009 (Lindsey *et al.*, 2011b), most of whom came from the surrounding area (Lindsey *et al.*, 2011a), so it is possible that some respondents had killed cheetahs or other species in the past, and also that social norms perceived by respondents towards killing predators would not be unfavourable. Although far from conclusive, the conceptual framework employed indicate that if cheetahs were detected in the resettlement or communal areas, some people may attempt to kill them.

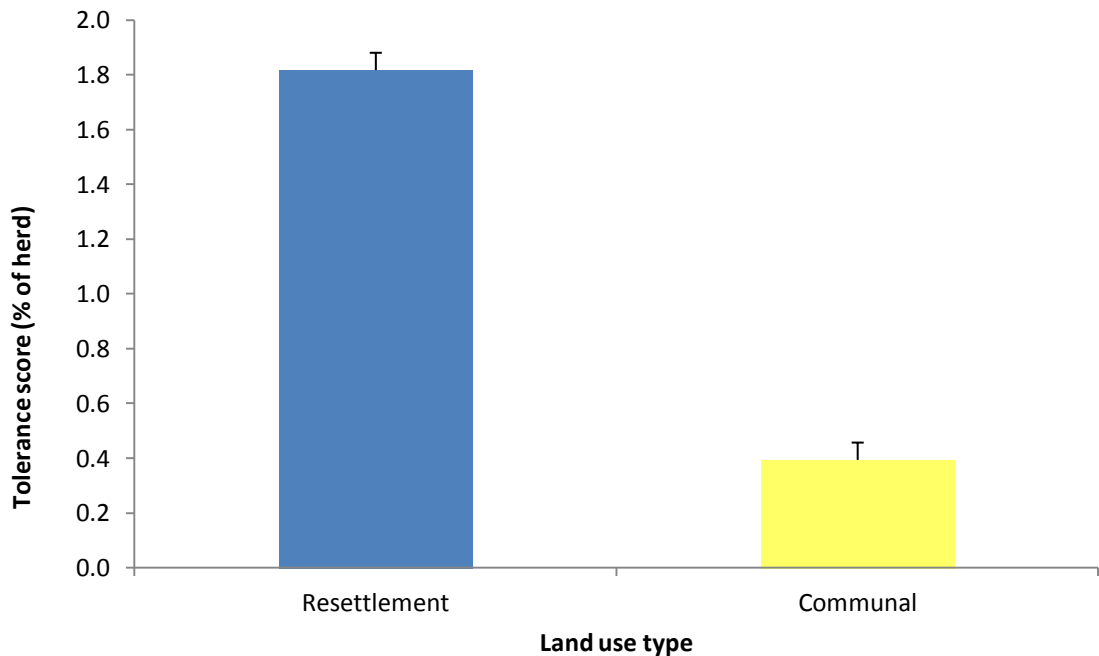


**Table 7.7 Reasons for attitudes towards cheetahs amongst respondents across all LUTs in and around Savé Valley Conservancy in 2008 and 2009.**

Reason for attitude	Percent of respondents		
	Commercial	Resettlement	Communal
<b>Negative</b>			
They kill livestock/are dangerous	5	66	90
They can kill people	5	6	3
I just don't like carnivores	0	0	1
Don't know	0	0	1
They have intrinsic beauty/charisma	2	1	1
They provide financial benefits/ecotourism	0	0	1
Should preserve them for future generations	0	1	0
They haven't caused any problems	0	1	0
<b>Neutral</b>			
They haven't caused any problems	0	10	0
I don't know much about them	0	3	1
They kill livestock/dangerous	0	1	1
They don't kill too many livestock	0	1	0
They are the fastest animal	0	1	0
Should preserve them for future generations	0	1	0
They are dangerous but keep the ecosystem balanced	0	1	0
They are dangerous but useful in traditional culture	2	1	0
They are dangerous but bring tourism	0	2	0
They are dangerous but have a right to live	0	2	0
<b>Positive</b>			
They have intrinsic beauty/charisma	25	0	0
They provide financial benefits/ecotourism	20	0	1
They are part of the ecosystem	18	0	0
They don't kill people	2	0	0
They can kill people	2	0	0
They are not as dangerous to humans as other predators	2	0	0
They don't kill as many animals as other predators	2	1	0
I don't know much about them	2	0	0
Should preserve them for future generations	7	0	0
They are the fastest animal	2	1	0
They are endangered	2	0	0
They kill livestock/dangerous	2	0	0

### 7.3.3 Tolerance of cheetah predation

Respondents in the resettlement LUT claimed that they would tolerate losing significantly more small stock to cheetahs before attempting to remove the predator, expressed as either the number of animals (Mann-Whitney U test:  $U = 1131$ ,  $Z = -10.891$ ,  $P < 0.001$ ) or as a proportion of current small stock holdings ( $U = 992.5$ ,  $Z = -9.614$ ,  $P < 0.001$ ; Figure 7.4). Three percent of resettlement farmers said they would kill cheetahs in their area even if they were not experiencing any livestock predation, while for communal farmers this figure was 80%.



**Figure 7.4** Comparison of cheetah tolerance score between resettlement and communal land use types around Savé Valley Conservancy in 2008 and 2009. Error bars represent standard errors. Resettlement farmers appeared to be more tolerant than communal farmers.

Univariate analyses failed to identify significant relationships between tolerance of cheetah predation and cultural group, religion, sex, age, whether respondents had seen cheetahs before, length of residence, the number of years spent in formal education or cheetah knowledge score (Table 7.8). Analyses were conducted using the cheetah knowledge score expressed as both the number of small stock that respondents were willing to lose to cheetah predation and the arcsine

transformed proportion of the current herd they were willing to lose. It was not possible to include in the analyses the number of livestock that were perceived to have been killed by cheetah in the past 12 months, whether or not respondents had seen cheetah, consider them to be a problem, or attempted to remove cheetah, because sample sizes of positive responses to these questions were too small.

**Table 7.8 Results of univariate analyses testing for differences and associations between cheetah tolerance score and predictor variables amongst respondents in resettlement and communal LUTs around SVC in 2008 and 2009.**

Variable	Land use type			
	Communal	Communal	Resettlement	Resettlement
	Number of animals	Proportion of herd	Number of animals	Proportion of herd
Cultural group <sup>a</sup>	$\chi^2 = 3.081$ , df = 3, P = 0.379	$\chi^2 = 1.968$ , df = 3, P = 0.579	$\chi^2 = 3.338$ , df = 3, P = 0.342	$\chi^2 = 2.287$ , df = 3, P = 0.515
Religion <sup>a</sup>	$\chi^2 = 0.838$ , df = 2, P = 0.658	$\chi^2 = 3.521$ , df = 2, P = 0.172	$\chi^2 = 3.353$ , df = 2, P = 0.187	$\chi^2 = 0.178$ , df = 2, P = 0.915
Sex <sup>b</sup>	U = 2346.5, Z = -0.931, P = 0.352	U = 758, Z = -1.325, P = 0.185	U = 3171.5, Z = -0.524, P = 0.600	U = 1339.5, Z = -1.868, P = 0.062
Seen <sup>b</sup>	U = 156, Z = -0.987, P = 0.324	U = 65.0, Z = -0.690, P = 0.490	U = 611, Z = -0.174, P = 0.862	U = 175, Z = -1.439, P = 0.150
Age <sup>c</sup>	$r_s = 0.077$ , P = 0.362	$r_s = -0.18$ , P = 0.873	$r_s = 0.049$ , P = 0.534	$r_s = -0.030$ , P = 0.747
Duration of formal education (years) <sup>c</sup>	$r_s = -0.174$ , P = 0.264	$r_s = -0.062$ , P = 0.796	$r_s = -0.066$ , P = 0.458	$r_s = -0.053$ , P = 0.657
Length of residence in area (years) <sup>c</sup>	$r_s = 0.075$ , P = 0.377	$r_s = -0.049$ , P = 0.661	$r_s = 0.030$ , P = 0.699	$r_s = -0.175$ , P = 0.058
Cheetah knowledge score <sup>c</sup>	$r_s = -0.082$ , P = 0.332	$r_s = 0.107$ , P = 0.335	$r_s = 0.124$ , P = 0.117	$r_s = -0.131$ , P = 0.161

<sup>a</sup>Kruskal-Wallis test; <sup>b</sup>Mann-Whitney U test; <sup>c</sup>Spearman rank correlation

Multiple regression analysis was conducted on cheetah tolerance score (dependant variable, expressed as both the number of animals and the arcsine transformed proportion of current small stock holdings) against the following independent variables: cheetah knowledge score, years of

formal education, whether or not respondents had seen cheetah, cultural group, religion, sex, age, and years of residence in the area. Variables were dummy coded for analysis where necessary. No reports were made of livestock losses to cheetah in the previous 12 months, of cheetah being problems, or of attempting to remove cheetah so these variables were excluded from analyses. The models were not significantly better than the mean at predicting the dependant variable for either resettlement farmers (number of animals: sum of squares = 4.430, df = 11, P = 0.757; proportion of herd: sum of squares = 1.516, df = 10, P = 0.206) or communal farmers (number of animals: sum of squares = 4.432, df = 11, P = 0.688; proportion of herd: sum of squares = 0.452, df = 11, P = 0.588).

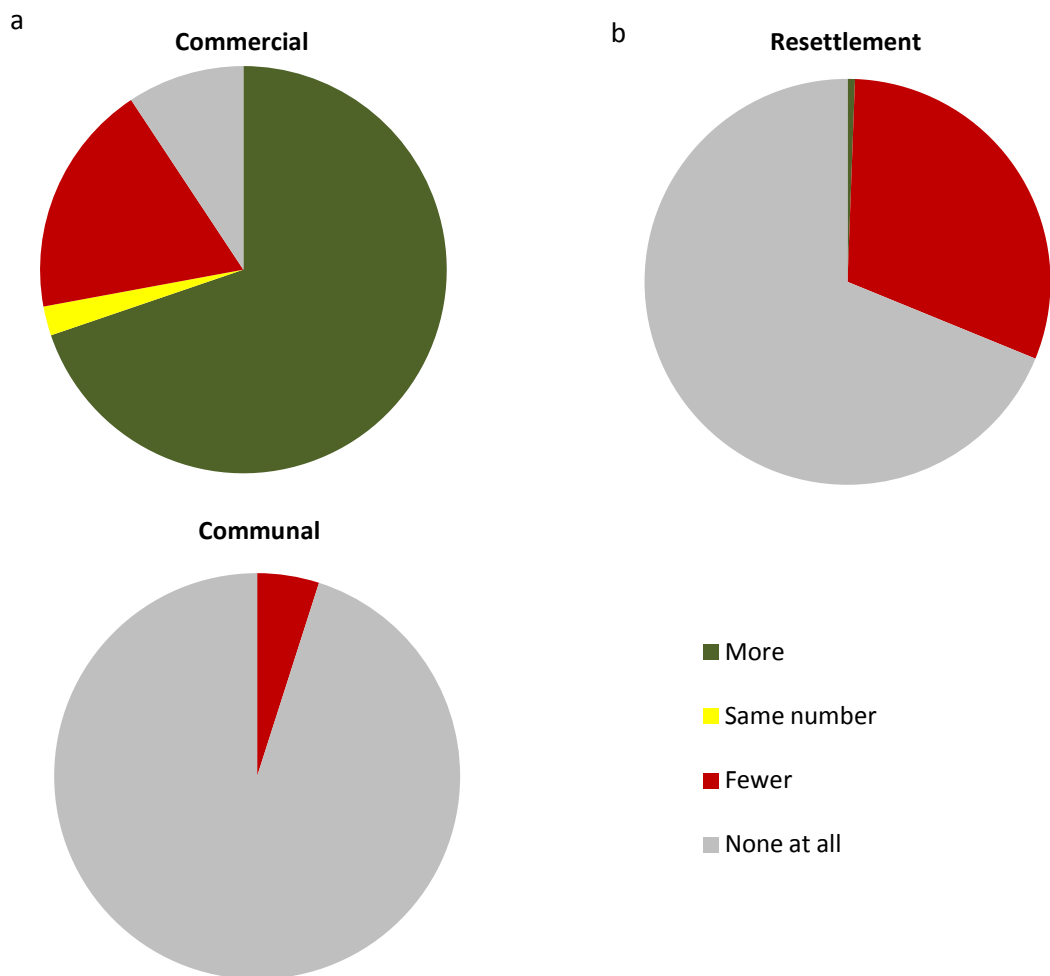


Figure 7.5 Ideal number of cheetahs relative to perceived current population in the a) commercial, b) resettlement and c) communal LUTs in and around Savé Valley Conservancy, reported in 2008 and 2009. Respondents in the commercial LUT were more likely to want more cheetahs at all than those in other LUTs.

There was a large discrepancy between land use types in the preferred number of cheetahs relative to perceived current local populations (Figure 7.5). Most respondents in the commercial area reported that they would like to have more cheetahs living in their area, while most respondents in the resettlement and communal areas preferred no cheetahs at all. Resettlement farmers were more likely than communal farmers to want fewer cheetahs rather than no cheetahs. It was not possible to test for associations between preferred number of cheetahs relative to the current perceived population and land use type due expected counts of less than 5, including grouping responses.

#### **7.4 Discussion**

Attitudes towards large carnivores were mainly positive in the commercial LUT, and were negative in the resettlement and communal areas (Figure 7.3), as predicted. This is consistent with previous studies, which concluded that commercial farmers are more likely to want large carnivores on their properties and support their conservation than community farmers (Romañach *et al.*, 2007; Selebatso *et al.*, 2008). Commercial farmers are generally wealthier than communal farmers, so are in a better position to absorb the costs of predation and are less likely to develop negative perceptions (Romañach *et al.*, 2007). Respondents in the commercial LUT generally held positive attitudes towards predators, despite game farming and safari hunting constituting the main source of income of commercial farmers at SVC. Commercial game farmers can have more negative attitudes towards predators than commercial livestock farmers (Marker *et al.*, 2003c), and hunters can have more negative attitudes towards predators than non-hunters due to competition for animals to hunt (Ericsson and Heberlein, 2003; Naughton-Treves *et al.*, 2003). Positive attitudes of commercial farmers at SVC were more prevalent than in another study of commercial livestock and game farmers pooled from South Africa and Zimbabwe (Lindsey *et al.*, 2005, but note that these data include SVC farmers also), although positive attitudes at SVC

were not as prevalent as in Kenya (Romañach *et al.*, 2007). This could be because a range of species at SVC are hunted including leopard, lion and cheetah, so farmers can benefit financially from the presence of some carnivores. Indeed economic value was frequently put forward as the reason for the positive attitudes of commercial farmers (Table 7.7).

Off-take of cheetah was relatively low (typically one or two animals per year, commercial farmer, pers. comm.), but clients can pay over US\$14,000 to hunt (Lindsey *et al.*, 2011b), so even low rates of hunting may help to encourage positive attitudes, although this may not be sustainable (see section 8.5). Economic benefit was by no means the only reason given for liking cheetahs, with many respondents in the commercial LUT citing that the intrinsic beauty of cheetahs, or their important role in the ecosystem as common justifications for positive attitudes (Table 7.7). Furthermore landowners of larger, unfenced properties, in particular those that are part of conservancies like SVC, tend to have more positive attitudes towards predators (Lindsey *et al.*, 2005; Lindsey *et al.*, 2009c; Schumann *et al.*, 2008). Involvement in tourism has also been associated with more positive attitudes towards conservation (Groom and Harris, 2008; Hemson *et al.*, 2009), although this is probably not an important factor at the study site. Some properties within SVC still engage in non-consumptive tourism, but this occurs at a very low level due to poor demand as a consequence of the political and economic crisis in Zimbabwe (D. Goosen, pers. comm., section 1.2). The safari hunting industry is much more robust to political instability than tourism (Lindsey *et al.*, 2006), and revenue from hunting is likely to represent the major income to commercial farmers at SVC in the near future. Attitudes did not differ significantly between different predators within each land use type, in contrast to other studies (Dickman, 2008; Lindsey *et al.*, 2005; Romañach *et al.*, 2007).

Unlike in the commercial LUT, respondents in the communal and resettlement areas held much more negative attitudes towards large carnivores (Figure 7.3). A much lower percentage of

respondents in the resettlement and communal LUTs reported positive attitudes towards predators than has been recorded in other studies of community members (Davies and du Toit, 2004; Maddox, 2003; Romañach *et al.*, 2007). Although both communal and resettlement farmers held very negative attitudes towards predators, communal farmers were more negative than resettlement farmers (Figure 7.3), which was unexpected. This is surprising given that communal farmers tended to report lower levels of predation, particularly to larger predators such as lion which can threaten not only small stock, but also cattle and human life (Chapter 6). Livestock predation can be a very important factor driving attitudes (Dickman, 2008; Mishra, 1997; Ogada *et al.*, 2003; Sillero-Zubiri and Laurenson, 2001), but perceptions of predators are not always linked with predation history (Conforti and de Azevedo, 2003; Marker *et al.*, 2003c). In fact the results presented suggest that the lack of experience of living with large carnivores in the communal area results in their attitudes being influenced more strongly by other factors, such as the instinctive fear of humans towards carnivores (Kruuk, 2002). While communal farmers almost always held very negative perceptions, resettlement farmers were more likely to adapt their attitudes towards carnivores based on their experience of predation (Table 7.5) (as also noted by Naughton-Treves *et al.*, 2003) and whether or not they considered predators to be problems. The less negative attitudes of resettlement farmers towards predators indicates that exposure to predators can make attitudes more positive, as suggested by Lindsey *et al.* (2005), who found that commercial ranchers had more positive attitudes towards wild dogs if the species occurred on their properties. The reality of living with large carnivores might not be as problematic as perceived by those that do not live with carnivores. Resettlement farmers held more livestock than communal farmers (Chapter 6), which could also explain their less negative attitudes, as livestock predation events may account for a lower proportion of their herd.

The most common reason given for the negative perceptions of cheetahs in resettlement and communal areas was the belief that they are dangerous to livestock (Table 7.7), a common reason

for negative perceptions in other areas (Dickman, 2008; Gusset *et al.*, 2008b; Maddox, 2003; Marker *et al.*, 2003c). These perceptions, however, are often much worse than the actual number of livestock killed by predators (Marker *et al.*, 2003d; Maude and Mills, 2005; Mizutani, 1993; Rasmussen, 1999), and perceived levels may be more important determinants of attitude (Gusset *et al.*, 2008b; Madden, 2004). Many people thought that cheetahs were dangerous to humans (Figure 7.2, Table 7.7). Fear of attacks on humans is a common reason for negative attitudes towards carnivores (Dickman, 2008; Kruuk, 2002; Lagendijk and Gusset, 2008), but while attacks on humans are a potential threat from some carnivores such as lion and to a lesser extent leopard and spotted hyena (Dunham *et al.*, 2010a; Kruuk, 2002; Löe and Röskaf, 2004; Loveridge *et al.*, 2010; Packer *et al.*, 2005) there is no evidence that cheetahs attack humans (Inskip and Zimmermann, 2009). Unlike in the commercial land use type, people in the resettlement and communal LUTs did not gain financially through trophy hunting for example, and they generally cited the perceived costs imposed by predators as reasons for their negative attitudes. Financial incentives to facilitate coexistence have shown some promise to ameliorate negative attitudes (Dickman *et al.*, in press), but the resources to implement such schemes are unlikely to become available in the near future due to the economic and political climate in Zimbabwe.

A small number of reasons given for positive or negative attitudes towards cheetahs appear to be contradictory, such as negative attitudes being justified with the beauty of the animal, or the risk to livestock or people as a reason for a positive attitude. This could demonstrate a lack of understanding of the question, or could simply indicate what moderates the attitude. For example respondents may mean that they would strongly like cheetahs but they only mildly like them due to the perceived risks to livestock, although this was not made clear by the interviewer. The issue would have been investigated further if the author had been able to conduct the interviews with all respondents, but this was unfortunately not possible.



Other than land use type and predation history, the only other variables that varied significantly with attitude towards carnivores was whether or not respondents in the resettlement area had seen spotted hyenas and considered them to be a problem (Table 7.3), and the number of livestock lost to lions in the resettlement LUT (Table 7.5). This suggests that resettlement farmers were more likely to adapt their attitudes based on their experience with predators, whereas communal farmers held negative attitudes irrespective of their predation history. The presence of play trees was associated with negative attitudes towards cheetahs in Namibia (Marker *et al.*, 2003c), but no play trees were reported at the study site. Within each land use type no significant association was detected between cheetah knowledge score and attitude towards cheetah, which conflicts with the findings of other studies (Ericsson and Heberlein, 2003; Romañach *et al.*, 2007; Selebatso *et al.*, 2008). Socio-demographic variables such as cultural group also had no significant effect on attitudes, unlike in Tanzania (Dickman, 2008; Jew and Bonnington, 2011). Attitudes in the current study show little variation, however, making this very difficult to test.

The attitude to behaviour process models suggest that people may attempt to kill cheetahs if they occurred in the resettlement and communal areas, while hunting of cheetahs will probably continue in the commercial area as part of the trophy hunting activities. Only one or two cheetahs per year would be at risk of being hunted in the commercial area, but all cheetahs that enter resettlement and communal areas would be at risk of persecution. This supports the data collected on tolerance towards cheetahs. Tolerance of cheetah predation was low in both the resettlement and communal areas, with many respondents stating that they would attempt to kill cheetahs even if they did not kill any livestock (Figure 7.4). Respondents in the commercial area generally said they would like to have more cheetahs on their properties, while resettlement and communal farmers generally wanted fewer or none at all (Figure 7.5). The same factors that drive differences in attitudes towards carnivores can also explain the differences in tolerance. Land use type was the only variable that was significantly associated with tolerance. Religion was not

associated with level of tolerance of cheetah predation, but previous research suggests those that practice external religion are less tolerant of predation than people that subscribe to traditional indigenous religions (Dickman, 2008; Hazzah *et al.*, 2009), partly because they are more likely to emphasise the superiority of humans over other animals (White, 1967), and less likely to protect their livestock themselves as they believe that God will protect them (Hazzah *et al.*, 2009). As an alternative method of assessing tolerance of cheetahs Marker *et al.* (2003c) monitored cheetah removals. At the study site, however, no respondents admitted to removing cheetahs other than the animals hunted as trophy animals in the commercial area. Although respondents in the resettlement and communal areas say they would kill cheetahs if they preyed on their livestock or if they just occurred in the area (Figure 7.4), they either did not act on those intentions, they did not feel comfortable discussing the matter honestly during interviews, or they did not have the opportunity. Removal of cheetahs without permits is illegal in Zimbabwe, and it is difficult to gain sufficient trust from respondents for them to divulge such sensitive information within the context of the interview survey conducted at SVC. As such cheetah removals were not a useful measure of tolerance in the current study, but methods such as the randomised response technique could be used to gain an insight into this sensitive topic in the future (St John *et al.*, 2011).

The Fast-Track Land Reform Programme resulted in the displacement of people who held positive attitudes towards predators from the commercial land that became the resettlement areas. The settlers that replaced them held negative attitudes and had low tolerance of predators (although not quite as negative or intolerant as communal farmers), so the FTLRP has increased the number of people in cheetah habitat that are likely to attempt to kill predators. This human landscape matches the same pattern as the ecological landscape, with suitable cheetah habitat remaining in the commercial area but no longer in the resettlement or communal areas (Chapter 3). These

factors probably both play a role in influencing the distribution and abundance of cheetahs across the study site.

Although this study was able to describe the nature, determinants and potential implications of attitudes and tolerance towards predators, there are limitations to the research. The project as a whole focussed on the wildlife dimension of human-wildlife conflict rather than on the human dimension. For this reason the amount of time spent collecting data and the depth of information collected from respondents was lower than in some other studies that focus on the human dimension of the interaction between predators and people (such as Dickman, 2008; Hazzah *et al.*, 2009). Furthermore due to the challenging political environment the author was not able to interact directly most of the respondents (see section 2.5.2), making it very difficult to gain a complete understanding of the situation. This could explain the lack of reports of illegal cheetah removals in the current study area, as the interview period was too brief to gain sufficient trust from respondents to discuss such sensitive topics. Alternatively the low abundance of cheetahs in the resettlement and communal LUTs could account for this (Chapter 3, Chapter 4). The study identified a narrow range of factors that influence attitudes and tolerance, but it is likely that a much broader suite of factors are also important, such as local culture, traditional beliefs, government policy, economics, and conflict between groups of people (Campbell, 2000; Knight, 2000a; Kruuk, 2002; Madden, 2004; Morris, 2000; Peterson *et al.*, 2010; Thirgood *et al.*, 2005; Woodroffe, 2000). A more intensive study may have uncovered these more complex and subtle relationships. A further limitation of the study is that the tolerance score and reasons for attitudes towards predators were assessed for cheetahs only, as they were the focal study species. The absence of this species from resettlement and communal areas means that assessment of reasons for attitudes and degree of tolerance towards species other than cheetah would have been useful. Pre-testing in the study area was not possible due to political instability (Chapter 2), so this pattern was not detected until the study had began. Performing multiple statistical tests

was also an issue due to the nature of the dataset. Separate tests were performed for each land use type and each predator, increasing the probability of calculating apparently statistically significant differences or associations when these do not in fact exist. It was unavoidable given the nature of the dataset, and the results presented should be treated with due caution. Nevertheless the results are sensible in light of previous research and the context of the study site. Despite these caveats, the relatively large sample size allowed a quantitative analysis of the attitude and tolerance towards predators among resettlement communities in Zimbabwe, and how these factors vary between different stakeholders and are affected by the land reform programme.

## **7.5 Summary**

Commercial farmers hold more positive attitudes towards large carnivores and are likely to want more cheetahs on their land than respondents in other land use types. Attitudes of resettlement farmers were negative, but were less extreme if perceived predation was low and if the predator was not considered to be a problem in the area (objective 6). Communal farmers held more negative attitudes which were not dependant on these or other factors. The resettlement and communal LUTs would probably represent high risk areas for killing of cheetahs by people. This is supported by the data on tolerance of cheetahs which followed the same trend, with resettlement farmers more tolerant than communal farmers, but both relatively intolerant. Level of tolerance did not differ significantly with any variables other than land use type. This indicates that the FTLRP has resulted in more negative attitudes being held towards predators in the SVC area, and lower tolerance of predation, increasing the potential for human-wildlife conflict.

# Chapter 8 General discussion

---

## 8.1 Introduction

This chapter synthesises the data presented in Chapter 3 (spoor counts), Chapter 4 (cheetah sightings) and Chapter 5 (carnivore carrying capacity) and discusses how changes in land use type (LUT) due to Zimbabwe's Fast-Track Land Reform Programme (FTLRP) have influenced the status and distribution of cheetahs and other large carnivores. The findings relating to cheetah ranging behaviour (section 2.5.1), livestock predation (Chapter 6) and attitudes towards carnivores (Chapter 7) are reviewed only relatively briefly as they are discussed in detail within previous chapters. The outcomes of the research objectives are then recapped, recommendations and suggestions for further research are put forward, and general conclusions are drawn.

## 8.2 Impacts of land reform on the status and distribution of carnivores

Estimates of cheetah population size at the study site varied depending on the methods used, although each method generated an estimate of 0 cheetahs for the resettlement and communal LUTs (Table 8.1). The true cheetah population size at SVC is unknown, so cannot be used as a reference with which to compare estimated population densities, but other wildlife areas with similar rainfall to SVC, such as Gonarezhou National Park, Hwange National Park and the northern section of Kruger National Park, support approximately 0.1-0.4 cheetahs per 100km<sup>2</sup> (Davies-Mostert *et al.*, 2010; Groom, 2009b; Wilson, 1997). If cheetahs occurred at these densities at SVC this would correspond to 3-10 cheetahs overall in the commercial LUT. Within the commercial LUT the spoor count estimate (11 cheetahs in the commercial area overall; Chapter 3) was closest to the expected population size (Table 8.1). The sighting estimate (Chapter 4) was almost twice as large (19 cheetahs), and was highly sensitive to rare sighting events that were not corroborated by many additional reports, such as sightings of an unusual number of cheetahs. Careful

consideration must also be paid to the values used for the  $d$  and  $t$  parameters. The raw stakeholder method (Chapter 4) provided the highest estimate (43 animals), and was based on unrealistically high predictions on some properties (Table 8.1). The adjusted stakeholder estimate was more reasonable (20 animals), but was dependant on an arbitrary correction factor developed by Wilson (1987) that probably varies substantially between different study sites.

**Table 8.1 Estimates of cheetah population size in different LUTs in and around Savé Valley Conservancy in 2008 - 2009.**

Method	Commercial north	Commercial south	Commercial overall	Resettlement	Communal
Spoor count <sup>a</sup>	11 (1-21)	0	11 (1-21)	0	0
Sighting <sup>b</sup>	13 (10-24)	6 (3-7)	19 (13-31)	0	0
Stakeholder (raw) <sup>b</sup>	36 (30-52) <sup>c</sup>	1 (1-2) <sup>c</sup>	43 (37-60)	N/A	N/A
Stakeholder (adjusted) <sup>b</sup>	17 (14-24) <sup>c</sup>	0 (0-1) <sup>c</sup>	20 (17-28)	N/A	N/A

Values in parentheses represent <sup>a</sup>95% confidence limits or <sup>b</sup>minimum and maximum estimates. <sup>c</sup>Excludes data from Humani, Chigwete and Bedford ranches which straddle the north-south border (Table 4.4), although these ranches are included in estimates of the overall commercial area.

The most accurate method used to determine the number of cheetahs at the study site is therefore thought to be spoor counts. The technique was based on a relatively robust methodology (Funston *et al.*, 2010; Stander, 1998), and provided a realistic estimate of 11 cheetahs (95% confidence limits 1-21). The large confidence limits are due to the small sample size, and could be improved by conducting additional replicates of spoor transects. In addition to being the most accurate method it was also the most practical, given the difficult political situation in the resettlement LUT. In resettlement areas it was much easier, quicker and cheaper to gain permission to drive the spoor transects than it was to conduct the interviews, as interviews required a much higher level of involvement with the communities. It was also much quicker and cheaper to conduct the spoor counts than the interviews in the resettlement LUT, as the entire area could be surveyed in days rather than weeks.

Spoor data indicate that almost all study species followed a similar distribution pattern, with greatest densities observed in the commercial north, slightly lower densities in the commercial south, much lower densities in the resettlement LUT and the lowest densities in the communal LUT (Figure 3.3, Figure 3.4, Figure 4.1, Figure 5.2). This was true for both carnivores and non-carnivore species (Figure 3.3). In addition to 11 cheetahs the spoor data were used to calculate total population estimates of 72 lions, 193 leopards, 114 spotted hyenas, 13 brown hyenas and 143 wild dogs in the commercial area overall (Table 3.4). No spoor from focal study species was detected in the resettlement or communal LUTs, with the exception of spotted hyena (6 animals estimated to occur in the resettlement area). Assuming that prior to resettlement each species occurred at a similar density within the present-day resettlement LUT and commercial LUT (J.R. Whittall, pers. comm.), the resettlement process has resulted in a population decline of 100% for cheetah, lion, leopard, brown hyena and wild dog, and an 85% decline in the density of spotted hyena in resettlement areas. Although this general trend was expected, the extent to which the ecology of the mammals in the resettlement LUT resembled that in the communal LUT is of great concern.

The following equation (defined in Table 8.2) was applied to the data collected in order to estimate the impact of the FTLRP on the current cheetah population size on commercial land in Zimbabwe based on the trends observed at SVC. This assumes that the observed trends at SVC are representative of the processes occurring across Zimbabwe. Landowners of other properties elsewhere in Zimbabwe perceived that free ranging mammal populations have declined by similar proportions to those observed at SVC since the onset of the FTLRP (Lindsey *et al.*, 2011b), and anecdotal evidence further supports this trend (DeGeorges and Reilly, 2007), although further research is necessary to confirm this assumption.

$$P_{current} = (P_{previous} \times A_{resettled} \times C_{remaining}) + (P_{previous} \times A_{remaining})$$

**Table 8.2 Description of functions used in the model of the current cheetah population size in Zimbabwe and values used in calculations.**

	Description	Values used
$P_{current}$	Current cheetah population size in Zimbabwe	
$P_{previous}$	Cheetah population size in Zimbabwe before the onset of the FTLRP	See Table 8.3
$A_{resettled}$	Proportion of commercial land that has been resettled	0.87 <sup>a</sup>
$A_{remaining}$	Proportion of commercial land remaining	0.13 <sup>a</sup>
$C_{remaining}$	Proportion of cheetahs that remain in resettled land	0.00

<sup>a</sup>based on data presented in Scoones *et al.* (2010)

**Table 8.3 Estimated cheetah population in Zimbabwe prior to the FTLRP (2000), and during the FTLRP (2009).**

Period	Land use type	Minimum <sup>1,2</sup>	Maximum <sup>3</sup>
Before FTLRP (prior to 2000)	Commercial land	320	1,200
	Other land <sup>4</sup>	80	320
	<i>Total</i>	<i>400</i>	<i>1,520</i>
Ten years after onset of FTLRP (2010)	Commercial land	42	156
	Other land <sup>4</sup>	80	320
	<i>Total</i>	<i>122</i>	<i>476</i>

<sup>1</sup>Assuming that 80% of cheetahs occurred on commercial land (Stuart and Wilson, 1988); Sources: <sup>2</sup>Myers (1975), Purchase *et al.* (2007); <sup>3</sup>Davison (1999); <sup>4</sup>Outside of commercial land most cheetahs are located in state land (particularly national parks and safari areas), although this category also includes communal land.

Based on maximum population estimates the results (Table 8.3) indicate that the total number of cheetahs in Zimbabwe has fallen from 1,520 to 476 animals. The more conservative, and probably more realistic estimates, however, suggest that the population has fallen from 400 to just 122 animals. Both estimates postulate a population decline of approximately 70% between 2000 and 2010. This is a much more dramatic decline than the 30% decline in the global cheetah population over the past 18 years (Durant *et al.*, 2010a).

These calculations also assumed that since the onset of the FTLRP cheetah populations have remained constant outside of commercial land (mainly in state protected areas such as national parks and safari areas) and on commercial land that has not been resettled, but this is unlikely to be true. The impacts of the resettlement on wildlife appear to extend far beyond the boundaries



of the resettlement areas themselves. Relative to the commercial north at SVC the commercial south supported lower population densities of all carnivores with the exception of lion, despite greater rainfall in the south (Figure 3.3). Lions have occurred at greater densities in the south of the conservancy since the establishment of SVC, as they are thought to be recolonising the area from Gonarezhou National Park. Furthermore prey abundance and carnivore carrying capacity have declined more steeply in the resettlement area and in the commercial south than in the commercial north (Figure 5.12).

In addition to declining in resettlement areas, cheetah population declines are therefore likely to have also occurred in the remaining commercial areas and in the state protected areas that are near resettlement areas. Indeed some protected areas have also been partially resettled (Mombeshora and Le Bel, 2009), and the Parks and Wildlife Management Authority is badly underfunded and poorly managed (Child, 2009b), making it likely that cheetah populations have declined within state protected areas as well. Detailed information on the distribution of resettlement areas was not available, so it was not possible to calculate a more accurate estimate of the current cheetah population, but the figures in Table 8.3 are likely to be overestimates. The current size of the cheetah population of Zimbabwe is therefore tentatively put at approximately 100 cheetahs. The cheetah population at SVC therefore could represent a substantial proportion of the remaining national cheetah population.

The observed trend in large carnivore population density was predicted because the commercial LUT had the lowest human density, the resettlement LUT had supported relatively high human densities for several years, and the communal LUT had supported higher human densities for decades. Furthermore the commercial LUT was managed for wildlife, while the resettlement and communal LUTs were primarily used for livestock and crop farming. Resettlement farmers practice slash and burn agriculture due to the poor soils, which increases the area of land cleared

(Lindsey *et al.*, 2009b). Anthropogenic disturbance, habitat loss and depletion of prey base were therefore likely to be responsible for the absence of most carnivores from these LUTs. Problem animal control (PAC) could also contribute towards the decline of some species, particularly in the resettlement area. Parks and Wildlife Management Authority (PWMA) officials frequently visit the resettlement areas and shoot wildlife in response to PAC requests from settlers (J.R. Whittall, pers. comm.). Between 2000 and 2007 PAC resulted in the death of at least 53 elephants in and around SVC, with a further 25 elephant deaths due to PAC reported by respondents but not listed in PWMA records (Lindsey, 2007). Requests are also made for PAC of carnivores including lion (G. Connear, pers. comm.), but no quantitative data are available.

Although these factors can explain the differences in carnivore abundance between the three LUTs, other factors such as poaching are likely to be responsible for the lower carnivore density in the commercial south relative to the commercial north. Large carnivores are particularly susceptible to poaching as they typically occur at low densities and have slow rates of population growth (Liberg *et al.*, in press). Rates of poaching per unit area were over 2.5 times higher in the commercial south than in the commercial north (Lindsey *et al.*, 2011b), which is likely to be linked to the greater proximity of southern SVC to the resettlement area. Poachers can easily move from the resettlement area into southern SVC, as there is no physical barrier between the LUTs. Although a larger problem in the south, levels of poaching are extremely high in the conservancy as a whole. Between August 2001 and June 2009 a total of 10,231 poaching incidents were recorded in the commercial LUT (Lindsey *et al.*, 2011b). Rates of poaching can be very difficult to determine (Liberg *et al.*, in press), but during this period the remains of 6,454 animals poached animals were recovered (Table 8.4), representing 48 species including 2 cheetah, 5 leopard, 7 lion (Figure 8.1), and 27 wild dog (Lindsey *et al.*, 2011b). Over 84,000 snares were removed, corresponding to 289 km of wire (Figure 8.2), and 4,148 poachers were captured (Lindsey *et al.*, 2011b). Poaching rates in the commercial LUT increased substantially after the FTLRP began. On

the one property in the commercial south for which records were available, the snaring rate increased dramatically from 0.68 snares/km<sup>2</sup> in 1999 to 89.8 snares/km<sup>2</sup> between 2005-2009, a 132-fold increase (Lindsey et al., 2011b).

**Table 8.4 Minimum number of animals recorded killed by poachers in Savé Valley Conservancy between August 2001 to July 2009 (Lindsey et al., 2011b).**

Species	Total number recorded killed by poachers
Cheetah	2
Lion	7
Leopard	5
Wild dog	27
Impala	2,606
Warthog	1,018
Bushpig	85
Bushbuck	64
Kudu	788
Wildebeest	266
Zebra	306
Sable	20
Waterbuck	122
Eland	190
Buffalo	43
Giraffe	21
Black rhinoceros	29
White rhinoceros	2
Elephant	12
Other species	836
<b>Total</b>	<b>6,454</b>



**Figure 8.1** Lioness snared on Sango, Savé Valley Conservancy (Lindsey *et al.*, 2009a).



**Figure 8.2** Wire snares collected on Senuko, Savé Valley Conservancy (Lindsey *et al.*, 2009a).

Legal hunting of carnivores occurs at a much lower level than rates of poaching, so is unlikely to be as important in driving carnivore population dynamics. It is recommended, however, that the trophy hunting quotas of some species such as cheetah should be reviewed. At the time of the study approximately one or two cheetah were hunted per year in SVC (commercial farmer, pers. comm.). To ensure a sustainable off take cheetah trophy hunting quotas should be set no higher

than the growth rates of the population, and a maximum of 5% of the total population (World Wildlife Fund for Nature, 1997). As the cheetah population at SVC appears to be declining and too small to support any trophy hunting at present, it is recommended that a moratorium on cheetah hunting is introduced to remove this additional pressure on the population. Trophy hunting moratoria have successfully increased carnivore populations elsewhere in Zimbabwe (Davidson *et al.*, 2011), and this could help to restore the declining cheetah population at SVC if all landowners agree. Most landowners at SVC indicated that they were against hunting cheetahs at the time of the study, and it was only one landowner that continued to market cheetah hunts, so gaining agreement on a moratorium could be possible.

Increased poaching of prey in the commercial south was probably responsible for the declines observed in prey populations observed in this area (Joubert, 2008), decreasing the carnivore carrying capacity in the south (Chapter 5). But fewer cheetahs, lions and spotted hyena occur in SVC than would be expected based on prey availability (Figure 5.7), so other factors must also drive carnivore population dynamics, such as habitat fragmentation and reduction in the area of suitable habitat. Carnivore carrying capacity is more heterogeneous in the commercial south where cheetah numbers declined more dramatically (Figure 5.8). Cheetahs are more sensitive to these effects than most other large carnivores as they require larger home ranges and are out competed by species such as lions and spotted hyenas (Durant, 1998; Woodroffe and Ginsberg, 2005). Cheetahs are now the rarest large carnivore in SVC (Table 3.4), which is consistent with the observation that species like cheetah are often the first species to decline during the collapse of a large African carnivore community (Woodroffe and Ginsberg, 2005).

Disease outbreaks could also be contributing to the declines in wildlife populations. The removal of the conservancy perimeter fence, which served as a veterinary barrier between the wildlife and

domestic livestock in the neighbouring communities, increased the risk of disease transmission. Furthermore, the settlers brought livestock with them into the resettlement areas, totalling an estimated 18,000 domestic animals in 2008 (Joubert, 2008). Since resettlement began there have been outbreaks of anthrax and rabies in SVC, resulting in the death or disappearance of a number of animals including cheetah and wild dogs (L. Du Plessis, pers. comm.; Lindsey *et al.*, 2009b). The anthrax outbreak in 2004 (Clegg *et al.*, 2007; Technical Advisory Committee of the Savé Valley Conservancy, 2004) could have played a role in the decline in cheetah numbers, and indeed several cheetah carcasses were found during the outbreak (L. Du Plessis, pers. comm.). But the outbreak was much more severe in the commercial north than the commercial south, and it occurred after the cheetah population had already declined on Senuko (see Chapter 4), so it is unlikely to be the most important factor. Although disease outbreaks can affect wildlife species, the livelihoods of community farmers are also put at risk as disease transmission can occur both ways. Outbreaks of foot and mouth disease (FMD) occurred in cattle near the conservancy since resettlement, which were infected from the FMD-carrying wildlife within SVC (Foggin and Connear, 2005).

Another potential contributing factor to the observed trends is intraguild competition. The greater population densities of lions in the commercial south could be another reason for the lower population densities of some other carnivores in that region (Caro and Stoner, 2003; Creel and Creel, 1996; Laurenson, 1995; Watts and Holekamp, 2008), and the high density of wild dogs and leopards above carrying capacity could also impact the cheetah population (Hayward and Kerley, 2008; Macdonald *et al.*, 2010), although evidence for this process is not clear (Woodroffe and Ginsberg, 2005).

All of these factors could influence the observed patterns in the abundance of large carnivores. The differences in cheetah distribution and numbers suggest that loss of habitat and prey base in

the resettlement LUT, and poaching and the resulting habitat fragmentation and contraction of the commercial LUT are likely to have been the major factors influencing the decline in the cheetah population, but a combination of other factors may have also played a role. Irrespective of the mechanism, distance to resettlement area seems to be very important. This was evident on a coarse scale (comparing the commercial north and commercial south) but it was unfortunately not possible to test this effect in more detail (such as on a property by property basis) as there was no variation in distance to resettlement and all properties in the commercial south border the resettlement area. A significant negative correlation was observed between carnivore density and distance from the boundary of a national park, supporting the results observed at SVC (Kiffner *et al.*, 2009).

### **8.3 Impacts of land reform on perceptions of predation and carnivores**

In relation to communal farmers, respondents in the resettlement LUT reported greater rates of livestock predation by large carnivores, resulting in higher losses of large livestock such as cattle. It was not possible to identify any techniques that were associated with reduced predation rates. Attitudes towards large carnivores were positive in the commercial LUT and negative other LUTs. Resettlement farmers were more tolerant of predation and expressed more positive attitudes towards large carnivores than communal farmers. Land use type was the major determinant of attitude and tolerance. The FTLRP has therefore resulted in the displacement of people that held positive attitudes towards carnivores in favour of others that held negative attitudes, increasing human-wildlife conflict.

## **8.4 Outcomes of the research objectives**

- 1. Estimate the current population size of cheetahs and other large carnivores in the commercial, resettlement and communal land use types at the study site, and to use this information to infer any changes in cheetah population sizes since the onset of the FTLRP.**

The commercial LUT is estimated to support 11 cheetahs, 72 lions, 193 leopards, 114 spotted hyenas, 13 brown hyenas and 143 wild dogs (Table 3.4). All large carnivores with the exception of lion occurred at approximately double the density in the commercial north than the commercial south. Six spotted hyena occur in the resettlement LUT, no large carnivore spoor was detected in the communal LUT. These results suggest that the FTLRP has drastically reduced the number of large carnivores at the study site, and that the effects of land reform are not limited to the resettlement area but also extend to remaining commercial land near resettlement areas. It is estimated that the cheetah population in Zimbabwe has fallen by over 70% to approximately 100 individuals.

- 2. Determine the carrying capacity of large carnivores in the commercial and resettlement LUTs at the study site, and assess how this is changing over time.**

Based on prey abundance the commercial LUT could support 49 cheetah, 256 lion, 110 leopard, 333 spotted hyena and 52 wild dog (Figure 5.7). It was not possible to estimate brown hyena carrying capacity. Cheetah, lion and spotted hyena occurred below carrying capacity, while leopard and wild dog occurred at greater densities than predicted. Prey abundance was therefore not thought to be a major factor limiting carnivore populations. Carrying capacity based on prey abundance or rainfall for the combined biomass of all carnivores demonstrated that when pooled all species occurred near carrying capacity (Figure 5.9). Carrying capacity declined between 2004 and 2008 for all large carnivores. Declines were greatest in the resettlement and commercial south LUTs. Poaching, habitat fragmentation and intraguild competition are thought to be



important factors shaping the dynamics of carnivore populations, but other factors such as disease could also play a role.

**3. Determine how the ranging behaviour of cheetahs is influenced by land use type.**

It was not possible to deploy GPS collars on to any cheetah, as efforts to capture cheetah were unsuccessful (section 2.5.1). This objective could therefore not be achieved directly, although spoor and sighting data suggest that cheetah populations were heavily influenced by human activity and appeared to avoid the communal and resettlement LUTs.

**4. Compare levels of perceived livestock predation between farmers in the resettlement and communal LUTs.**

Predation of cattle by large carnivores such as lion was perceived to be a larger problem for farmers in the resettlement LUT, while predation of chickens was by smaller carnivores such as civet was more prevalent in the communal LUT (Figure 6.3, Figure 6.4). These differences demonstrate mesopredator release in the communal LUT, and were thought to be driven by differences in proximity to the commercial LUT, the source of large carnivore populations. No predation by cheetahs was reported.

**5. Determine whether certain livestock management techniques are associated with lower perceived levels of livestock predation.**

No associations were found between the use of certain livestock management techniques and the probability of experiencing livestock predation. Some techniques were associated with increased

predation rates, but this is not thought to be a causal link. A more in-depth study would be more likely to elucidate these relationships.

**6. Investigate the attitudes of people towards large carnivores and tolerance of livestock predation by cheetah at the different LUTs at the study site, and estimate how land reform is affecting the likelihood that people would use lethal control of cheetahs.**

Attitudes towards large carnivores were the most positive among respondents in the commercial LUT, as they benefitted from their presence. Resettlement farmers held more negative attitudes towards carnivores, but the most negative attitudes were found amongst communal farmers. Both resettlement and communal farmers were relatively intolerant of predation, but tolerance was lower among communal farmers. This was unexpected, as resettlement farmers suffer greater rates of predation from large carnivores. The resettlement and communal LUTs are considered high risk areas for retributive killing of cheetahs by humans. The FTLRP has resulted in the displacement of people with positive attitudes towards large carnivores in favour of people that hold negative attitudes and were likely to use lethal control of cheetahs, although this trend is not as extreme as expected.

The overarching hypothesis that the FTLRP has reduced the population size of cheetahs and other large carnivores, and increased perceived levels of human-carnivore conflict was generally supported. Carnivore populations declined dramatically in the resettlement LUT, and also declined in the commercial LUT, particularly the areas near to resettlement. The FTLRP has also increased perceived levels of human-carnivore conflict, as the people that move into resettlement areas suffer from greater rates of livestock predation by large carnivores and are also sometimes killed by wildlife. The FTLRP has resulted in more negative attitudes and lower levels of tolerance

of predation, and increased the risk of retributive killing of cheetahs, although these effects were not as strong as expected. Land reform thus has enormous consequences for the potential for large carnivore conservation in Zimbabwe.

## **8.5 Recommendations**

In order to minimise the effects of land reform on carnivore conservation and human-carnivore conflict, the most effective solution would be to reverse the FTLRP, at least in certain areas that support key wildlife populations such as SVC. This is extremely unlikely, however, as there is no political will to support such a measure and it would be deeply unpopular with ZANU-PF and their supporters, the war veterans and other groups, and the beneficiaries of the FTLRP. A more realistic approach would be to restructure the existing resettlement areas. The configuration of the resettlement at SVC blocks connectivity between the commercial north and the commercial south (Figure 2.2), forming a barrier between the wildlife populations in the north and most of the other wildlife areas in the region such as Gonarezhou National Park, Kruger National Park, and the rest of the Greater Limpopo Transfrontier Conservation Area. Maintaining connectivity between these populations is essential, as population sizes of less than 300 individuals are unlikely to be demographically viable (Durant, 2000) and at least 5,000 may be required in order to ensure genetic viability (Lande, 1995). This disruption of linkages between SVC and other areas stemmed from a lack of planning of the resettlement process, but connectivity between these populations could be enhanced by reconfiguring the resettlement area in such a way as to re-establish wildlife corridors to connect the commercial north and south, and also increase connectivity between SVC, the neighbouring Malilangwe Private Wildlife Reserve and Gonarezhou National Park. Resettlement farmers would need to be relocated from parts of Chigwete and/or Masapas, and parts of Mkwesine to other regions of the resettlement area (Figure 1.5). It would take a number of years before the habitat recovered to sufficiently to support large mammals, and moving

resettlement farmers would be a challenge dependant on political will. It seems unlikely that this will occur under the current government, but the opposition MDC have committed to setting aside land for wildlife conservancies (Movement for Democratic Change, 2007), and if they were to win the elections expected in 2012 this may enable positive changes to future land reform policies. Thorough planning before resettlement takes place would allow consideration of wildlife corridors to maintain connectivity where necessary. Furthermore it is advisable to minimise the length of the boundary between resettlement and wildlife areas as this would reduce the exposure of resettlement farmers and carnivores to each other. If the resettlement of SVC had been planned in this way, the resettlement area could have been placed in one contiguous region at the northern extreme of the conservancy. This would reduce the declines in wildlife numbers and result in lower levels of human-carnivore conflict.

Allowing local communities to benefit economically from the wildlife in SVC would create an incentive for them to protect wildlife populations in the area, encourage self-policing of poaching, and reduce the need for people to turn to poaching (Campbell, 2000). This could be achieved in a number of ways, such as the development of a CAMPFIRE-style scheme for the resettlement areas. The CAMPFIRE scheme, whereby devolution of rights to utilise wildlife allowed the development of sustainable wildlife utilisation schemes in communal areas, has demonstrated some successes at reducing the rate of habitat loss and slowing the declines of some species while fostering rural development (Frost and Bond, 2008; Taylor, 2009a, b), although the scheme has faced a number of challenges (Alexander and McGregor, 2000; Balint and Mashinya, 2008). If a similar scheme could be established in the resettlement area, particularly where wildlife corridors are necessary, this could encourage resettlement farmers to set aside land for wildlife, reduce the incentive to poach, and support development. Such a scheme would operate independently of SVC, but an alternative approach would be to reincorporate parts of the resettlement area into the conservancy, and share trophy hunting profits with the community. The experiences of

incorporating communal land (Nyangambe) into the conservancy in this way will demonstrate whether this can be successful. Expanding the scheme may be problematic, however, as the conservancy has searched for donor funding to support this, but so far has had little success (Wels, 2003). This may become a more attractive opportunity to the donor community if international perceptions of Zimbabwe change in the future.

The principle of allowing the beneficiaries of resettlement to engage in the wildlife industry would be more effective if it were used in future as an alternative resettlement model. The current resettlement models used are based on subsistence and small-scale commercial cropping and livestock farming (Scoones *et al.*, 2010), but the semi-arid regions of Zimbabwe such as SVC are poorly suited to agriculture, and wildlife is much more ecologically and economically suitable land use (Child, 1995b; Price Waterhouse, 1994; Vincent and Hack, 1960). This could operate in a similar way to the land claim by the Makuleke of a section of the Kruger National Park in South Africa, whereby the area is co-managed by both the community and the park, and the community are paid dividends from tourism activities (de Villiers and van den Berg, 2006; Grossman and Holden, 2009; Reid, 2001). Wildlife-based land reform models are recognised by the government (Government of Zimbabwe, 2002), but have not been widely adopted, although in recent years the government has expressed an interest in developing and implementing these models in areas such as SVC (Lindsey *et al.*, 2009b), and this now appears to be occurring (Guvamombe, 2011; Saxon, 2011).

These long-term solutions would not be quick to implement, and there is a need to address the urgent issues such as the extremely high rates of poaching that threaten carnivores at SVC. Poaching at SVC is carried out mainly by young unemployed men in order to generate a cash income (Lindsey *et al.*, 2011a) and this is unlikely to change as long as Zimbabwe's political and economic crisis lasts (Wittemyer, 2011). Until this problem is solved a number of measures could

be implemented more quickly. Lindsey *et al.* (2009b) suggest that providing an affordable, legal and sustainable supply of protein from wildlife could help to curb demand for illegal bushmeat. Snaring is indiscriminate, and 86% of animals killed by snares in SVC are not successfully extracted by poachers, and are left to rot in the bush (Lindsey *et al.*, 2011b). Providing a legal supply of meat would be a much more efficient use of resources, and could be carefully targeted towards certain species such as elephant that were increasing in number, and would therefore have a much smaller impact on wildlife populations. Plans are underway to establish such a scheme at SVC, whereby a number of elephants would be culled each year and the meat would be sold to the neighbouring communities at subsidised rates (P. Lindsey, pers. comm.). Another way to reduce poaching rates would be to invest more heavily in anti-poaching (Hilborn *et al.*, 2006).

As a result of the declines observed in the cheetah population at SVC it is also recommended that a moratorium on trophy hunting in SVC is introduced to allow the population to recover. Indeed if the national cheetah population has fallen to approximately 100 individuals the CITES quota for the export of cheetah trophies should also be reviewed. The current quota of 50 cheetahs per year (CITES, 1992) or the actual number exported (up to 24 animals per year (Williams, 2007)) would not be sustainable, and a maximum of 2 cheetah hunted per year may be more suitable, although the likely decline of the national cheetah population suggests that cheetah trophy hunting should perhaps be suspended across Zimbabwe until the population shows signs of recovery (World Wildlife Fund for Nature, 1997).

Gaining the support of local communities and ameliorating negative attitudes is also vital to conservation efforts (Browne-Nuñez and Jonker, 2008). Attitudes towards wildlife and game reserves can change over time (Infield and Namara, 2001; Marker *et al.*, 2010; Marker *et al.*, 2003c) and can be positive under the right circumstances (Hartter and Goldman 2011; Legendijk and Gusset, 2008). Increasing outreach activities at SVC may be effective at engendering more

positive attitudes towards the conservancy, which in turn may reduce poaching (Hartter and Goldman 2011), although this is not always the case (Lewis and Phiri, 1998). The owners of some properties are currently supporting outreach activities and working with local schools in the neighbouring communal land (R. Groom, pers. comm.), although the effects of these efforts would only be evident in the long term. Education programmes aimed at resettlement farmers could also help to ameliorate negative attitudes and low tolerance towards carnivores (Gusset *et al.*, 2008b; Lagendijk and Gusset, 2008; Marker *et al.*, 2003c; Romañach *et al.*, 2007; Selebatso *et al.*, 2008), especially where these are based on misconceptions. Although this study was unable to identify techniques successfully reduced perceived predation rates, this may be because the methods employed lacked sufficient depth to detect these trends. Had the study been focussed on this aspect of the project such patterns may have been identified, as in other studies (Dickman, 2008; Ogada *et al.*, 2003; Stein *et al.*, 2010; Woodroffe *et al.*, 2007a). Therefore education on effective ways of improving livestock husbandry, and on the actual level of predation, may help to improve attitudes and tolerance based on livestock losses. A more in depth study in the resettlement LUT Dissemination of information about the behaviour of predators and the actual risk of attacks on humans, which cause much less mortality than other factors such as HIV/AIDS (Lagendijk and Gusset, 2008), may also encourage more rational attitudes. Implementation of these solutions would, however, require the investment of significant resources.

Attitudes towards carnivores at SVC may become more positive if the authorities provided more security of land tenure to beneficiaries of the FTLRP. Ownership of land is associated with more positive attitudes towards carnivores and conservation (Infield and Namara, 2001; Romañach *et al.*, 2007), and title deeds can be used as collateral to obtain loans and promote investment (Romañach *et al.*, 2007). Land tenure is very insecure in the resettlement area, as resettlement farmers may have their plots reallocated to different beneficiaries or may be removed entirely

(Scoones *et al.*, 2010). Priority may therefore be given to short-term exploitation of resources rather than careful management for long-term sustainability.

As in Zimbabwe, a number of other countries in the region such as South Africa and Namibia have struggled to redress skewed racial distribution of ownership of the large areas of private (commercial) land, and their governments are looking to Zimbabwe as a model for land reform. Private land in these countries is as important to cheetah conservation as in Zimbabwe. Although some people have benefitted from Zimbabwe's FTLRP (Scoones *et al.*, 2010) this study demonstrates that in addition to terrible socio-economic consequences, the programme has been disastrous in terms of wildlife conservation and human-carnivore conflict. The Zimbabwean model of land reform is therefore not recommended.

## **8.6 Further research**

The estimates of carnivore abundance presented here are extremely valuable, but they provide information about a single point in time. Repeating them at regular intervals would allow estimation of population trends and establish a more comprehensive dataset on the effect of the FTLRP. The conservancy intends to continue aerial counts to estimate the abundance of ungulates and other species, and if spoor counts were replicated it would allow repeated comparison of carnivore abundance and carrying capacity based on prey abundance. Continued monitoring would help to confirm the impact of the FTLRP on carnivores and rule out other causes such as cycles in predator and prey abundance (O'Donoghue *et al.*, 2010). It would also be interesting to expand the research beyond mammals and determine if other taxa such as birds, reptiles, invertebrates and plants are affected in the same way.



As the investigation of the impact of land reform on cheetah ranging behaviour was not possible, it would be useful to attempt to capture and collar cheetahs again with additional resources such as a dart gun and licence to immobilise wildlife. Collaring other species could also yield valuable information on this subject. The wild dog research project conducts radio telemetry studies on wild dogs in this area, so they may be able to address these questions. This would also facilitate the collection of data such as the sex ratio and rates of mortality of cheetahs at SVC, permitting population viability analysis (Broomhall, 2001).

Although all available information supports the assumption that the processes occurring at SVC are representative of those occurring in association with resettlement across Zimbabwe it would be useful to collect data at other sites across the country to confirm this empirically. The extent to which carnivore populations on commercial land that is not primarily used for wildlife would be of particular interest. This would also lend itself to making a more accurate assessment of the current status of cheetah in Zimbabwe, which is urgently needed.

Another objective that would be worth revisiting is determining the effectiveness of different livestock management techniques at reducing predation. The interview survey conducted did not explore this aspect in great depth, and a more intensive interview survey that spent more time determining the true level of use of the various techniques and the circumstances under which livestock were lost may be more likely to be able to determine which techniques are effective. A study of the true level of livestock predation around SVC rather than the perceived level would also yield useful results.

## **8.7 General conclusions**

A decline in the cheetah population was associated with the onset of the FTLRP, and only 11 individuals are thought to remain in the commercial area of SVC. Cheetahs and many other species are now absent from the resettlement and communal LUTs, and wildlife in the remaining commercial land has also been affected, probably due to increased poaching and habitat fragmentation. In the resettlement area rates of livestock predation by large carnivores are high, negative attitudes are held towards carnivores and tolerance of predation is low, although not as low as expected. This thesis demonstrates that in addition to severe socio-economic consequences, the FTLRP has also had a significant negative impact in terms of both wildlife conservation and human-carnivore conflict. The implementation of measures to mitigate these effects is thus urgently required.

## References

- Adams, W.M. (2007) Thinking like a human: social science and the two cultures problem. *Oryx* **41**, 275-276.
- AFP (2009) Zimbabwe unemployment soars to 94% [online]. Available from [http://www.google.com/hostednews/afp/article/ALeqM5imTkGEP84\\_3QTVcSGu\\_8W3YrP8wA](http://www.google.com/hostednews/afp/article/ALeqM5imTkGEP84_3QTVcSGu_8W3YrP8wA) [Accessed 01 June 2011].
- Afrique Avenir (2011) Germany protests to Zimbabwe over seizures of game conservancies [online]. Available from <http://www.afriqueavenir.org/en/2011/01/29/germany-protests-to-zimbabwe-over-seizures-of-game-conservancies/> [Accessed 31 Jan 2011].
- Alexander, J. (2006) *The unsettled land: state-making & the politics of land in Zimbabwe, 1893-2003*. James Currey, Oxford.
- Alexander, J. and McGregor, J. (2000) Wildlife and politics: CAMPFIRE in Zimbabwe. *Development and Change* **31**, 605-627.
- Amnesty International (2008) *Zimbabwe: a trail of destruction after the ballot*. Amnesty International, London.
- Anderson, M. and Mills, G. (2008) *Proteles cristata*. In: IUCN 2010. IUCN red list of threatened species. Version 2010.4 [online]. Available from <http://www.iucnredlist.org/apps/redlist/details/18372/0> [Accessed 06 April 2011].
- Anderson, M.D., Richardson, P.R.K. and Woodall, P.F. (1992) Functional analysis of the feeding apparatus and digestive tract anatomy of the aardwolf *Proteles cristatus*. *Journal of Zoology* **228**, 423-434.
- Athreya, V., Odden, M., Linnell, J.D.C. and Karanth, K.U. (2011) Translocation as a tool for mitigating conflict with leopards in human-dominated landscapes of India. *Conservation Biology* **25**, 133-141.
- Averbeck, C., Apio, A., Plath, M. and Wronski, T. (2009) Environmental parameters and anthropogenic effects predicting the spatial distribution of wild ungulates in the Akagera savannah ecosystem. *African Journal of Ecology* **47**, 756-766.
- Bailey, T.N. (2005) *The African leopard: ecology and behavior of a solitary felid*, 2nd edn. Blackburn Press, Caldwell.
- Balint, P.J. and Mashinya, J. (2008) CAMPFIRE during Zimbabwe's national crisis: local impacts and broader implications for community-based wildlife management. *Society and Natural Resources* **21**, 783-796.
- Balme, G.A., Hunter, L.T.B., Goodman, P., Fergusson, H., Craigie, J. and Slotow, R. (2010) An adaptive management approach to trophy hunting of leopards (*Panthera pardus*): a case study from KwaZulu-Natal, South Africa, In *The biology and conservation of wild felids*. Eds D.W. Macdonald and A.J. Loveridge, pp. 341-352. Oxford University Press, Oxford.

- Balme, G.A., Hunter, L.T.B. and Slotow, R. (2009) Evaluating methods for counting cryptic carnivores. *Journal of Wildlife Management* **73**, 433-441.
- Barnosky, A.D., Matzke, N., Tomiya, S., Wogan, G.O.U., Swartz, B., Quental, T.B., Marshall, C., McGuire, J.L., Lindsey, E.L., Maguire, K.C., Mersey, B. and Ferrer, E.A. (2011) Has the Earth's sixth mass extinction already arrived? *Nature* **471**, 51-57.
- Bashir, S., Daly, B., Durant, S.M., Forster, H., Grisham, J., Marker, L., Wilson, K. and Friedmann, Y. (2004) Global cheetah (*Acinonyx jubatus*) monitoring workshop: final workshop report., p. 69. IUCN/SSC Conservation Breeding Specialist Group, Ngorogoro Conservation Area.
- Bauer, H. (2003) Lion conservation in West and Central Africa: integrating social and natural science for wildlife conflict resolution around Waza National Park, Cameroon. PhD Thesis, Leiden University.
- Bauer, H., de longh, H. and Sogbohossou, E. (2010a) Assessment and mitigation of human-lion conflict in West and Central Africa. *Mammalia* **74**, 363-367.
- Bauer, H., Nowell, K. and Packer, C. (2010b) *Panthera leo*. IUCN red list of threatened species. Version 2010.4 [online]. Available from <http://www.iucnredlist.org/apps/redlist/details/15951/0> [Accessed 03 June 2011].
- Bauer, H. and Van Der Merwe, S. (2004) Inventory of free-ranging lions *Panthera leo* in Africa. *Oryx* **38**, 26-31.
- Beach, D.N. (1994) *The Shona and their neighbours*. Blackwell, Oxford.
- Bell, A. (2011) Farm invasions continue across Zimbabwe [online]. Available from <http://www.swradioafrica.com/news180811/farm180811.htm> [Accessed 24 August 2011].
- Berger, J., Stacey, P.B., Bellis, L. and Johnson, M.P. (2001) A mammalian predator-prey imbalance: grizzly bear and wolf extinction affect avian neotropical migrants. *Ecological Applications* **11**, 947-960.
- Bissett, C. and Bernard, R.T.F. (2007) Habitat selection and feeding ecology of the cheetah (*Acinonyx jubatus*) in thicket vegetation: is the cheetah a savanna specialist? *Journal of Zoology* **271**, 310-317.
- Blair, D. (2002) *Degrees in violence: Robert Mugabe and the struggle for power in Zimbabwe*. Continuum, London.
- Bohner, G. and Wanke, M. (2002) *Attitudes and attitude change*. Psychology Press, East Sussex.
- Bond, I., Child, B., de la Harpe, D., Jones, B., Barnes, J. and Anderson, H. (2004) Private land contribution to conservation in South Africa, In *Parks in transition: biodiversity, rural development, and the bottom line*. Ed. B. Child, pp. 29-61. Earthscan, London.
- Boshoff, A.F., Kerley, R.M., Cowling, R.M. and Wilson, S.L. (2002) The potential distributions, and estimated spatial requirements and population sizes, of the medium to large-sized mammals in the planning domain of the Greater Addo Elephant National Park project. *Koedoe* **45**, 85-116.

- Bourdillon, M.F.C. (1994) The Shona peoples. Mambo press, Gweru.
- Bowland, A.E. and Mills, M.G.L. (1994) The 1990/1991 cheetah photographic survey. Scientific Report 6/94. SANParks, Skukuza.
- Breitenmoser, U., Angst, C., Landry, J.M., Breitenmoser-Wursten, C., Linnell, J.D.C. and Weber, J.M. (2005) Non-lethal techniques for reducing depredation, In People and wildlife: conflict or coexistence? Eds R. Woodroffe, S. Thirgood and A.R. Rabinowitz, pp. 49–71. Cambridge University Press, Cambridge.
- Broomhall, L.S. (2001) Cheetah *Acinonyx jubatus* ecology in the Kruger National Park: a comparison with other studies across the grassland-woodland gradient in African savannas. MSc Thesis, University of Pretoria.
- Broomhall, L.S., Mills, M.G.L. and du Toit, J.T. (2003) Home range and habitat use by cheetahs (*Acinonyx jubatus*) in the Kruger National Park. Journal of Zoology **261**, 119-128.
- Browne-Nuñez, C. and Jonker, S.A. (2008) Attitudes toward wildlife and conservation across Africa: a review of survey research. Human Dimensions of Wildlife **13**, 47 - 70.
- Buckle, C. (2001) African tears: the Zimbabwe land invasions. Jonathan Ball Publishers, Jeppestown.
- Buckle, C. (2002) Beyond tears: Zimbabwe's tragedy. Jonathan Ball Publishers, Johannesburg.
- Butler, J.R.A. (2000) The economic costs of wildlife predation on livestock in Gokwe communal land, Zimbabwe. African Journal of Ecology **38**, 23-30.
- Butler, J.R.A. and du Toit, J.T. (2002) Diet of free-ranging domestic dogs (*Canis familiaris*) in rural Zimbabwe: implications for wild scavengers on the periphery of wildlife reserves. Animal Conservation **5**, 29-37.
- Butler, J.R.A., du Toit, J.T. and Bingham, J. (2004) Free-ranging domestic dogs (*Canis familiaris*) as predators and prey in rural Zimbabwe: threats of competition and diseases to large wild carnivores. Biological Conservation **115**, 369-378.
- Byers, B., Cunliffe, R. and Hudak, A. (2001) Linking the conservation of culture and nature: a case study of sacred forests in Zimbabwe. Human Ecology **29**, 187-218.
- Campbell, B. (2000) Animals behaving badly: indigenous perceptions of wildlife protection in Zimbabwe, In Natural enemies: people-wildlife conflict in anthropological perspective. Ed. J. Knight, pp. 124-144. Routledge, London.
- Carbone, C. and Gittleman, J.L. (2002) A common rule for the scaling of carnivore density. Science **295**, 2273-2276.
- Caro, T.M. (1994) Cheetah of the Serengeti plains: group living in an asocial species. University of Chicago Press, Chicago.
- Caro, T.M. and Stoner, C.J. (2003) The potential for interspecific competition among African carnivores. Biological Conservation **110**, 67-75.

- Caughley, G. (1974) Bias in aerial survey. *Journal of Wildlife Management* **38**, 921-933.
- Caughley, G. (1977) *Analysis of vertebrate populations*. Wiley, London.
- Caughley, G. (1994) Directions in conservation biology. *Journal of Animal Ecology* **63**, 215 - 244.
- Cavalcanti, S.M.C., Marchini, S., Zimmermann, A., Gese, E.M. and Macdonald, D.W. (2010) Jaguars, livestock, and people in Brazil: realities and perceptions behind the conflict, In *The biology and conservation of wild felids*. Eds D.W. Macdonald and A.J. Loveridge, pp. 383-402. Oxford University Press, Oxford.
- Central Intelligence Agency (2011) *The World Factbook: Zimbabwe* [online]. Available from <https://www.cia.gov/library/publications/the-world-factbook/geos/zi.html> [Accessed 09 January 2012].
- Chaumba, J., Scoones, I. and Wolmer, W. (2003a) From jambanja to planning: the reassertion of technocracy in land reform in south-eastern Zimbabwe? *Journal of Modern African Studies* **41**, 533-554.
- Chaumba, J., Scoones, I. and Wolmer, W. (2003b) New politics, new livelihoods: agrarian change in Zimbabwe. *Review of African Political Economy* **30**, 585-608.
- Chelliah, K., Kannan, G., Kundu, S., Abilash, N., Madhusudan, A., Baskaran, N. and Sukumar, R. (2010) Testing the efficacy of a chilli-tobacco rope fence as a deterrent against crop-raiding elephants. *Current Science* **99**, 1239-1243.
- Child, B. (2004) Introduction, In *Parks in transition: biodiversity, rural development, and the bottom line*. Ed. B. Child, pp. 1-6. Earthscan, London.
- Child, B. (2009a) Conservation in transition, In *Evolution and innovation in wildlife conservation in southern Africa*. Eds B. Child, H. Suich and A. Spenceley, pp. 3-15. Earthscan, London.
- Child, B. (2009b) The emergence of parks and conservation narratives in southern Africa, In *Evolution and innovation in wildlife conservation in southern Africa*. Eds B. Child, H. Suich and A. Spenceley, pp. 19-33. Earthscan, London.
- Child, B. (2009c) Game ranching in Zimbabwe, In *Evolution and innovation in wildlife conservation in southern Africa*. Eds B. Child, H. Suich and A. Spenceley, pp. 127-145. Earthscan, London.
- Child, B., McKean, S., Kiss, A., Munthali, S., Jones, B., Mtsambiwa, M., Castley, G., Patton, C., Magome, H., Pangeti, G., Fearnhead, P., Johnson, S. and Chilikusha, G. (2004) Park agencies, performance, and society in southern Africa, In *Parks in transition: biodiversity, rural development, and the bottom line*. Ed. B. Child, pp. 123-163. Earthscan, London.
- Child, G. (1995a) Managing wildlife successfully in Zimbabwe. *Oryx* **29**, 171-177.
- Child, G. (1995b) *Wildlife and people: the Zimbabwean success*. Wisdom Foundation, Harare.

- Child, G. (2009d) The emergence of modern nature conservation in Zimbabwe, In Evolution and innovation in wildlife conservation in southern Africa. Eds B. Child, H. Suich and A. Spenceley, pp. 67-83. Earthscan, London.
- Child, G. and Savory, C.R. (1964) The distribution of large mammal species in Southern Rhodesia. *Arnoldia Rhodesia* **1**, 1-15.
- Childes, S.L. (1988) The past history, present status and distribution of the hunting dog *Lycan pictus* in Zimbabwe. *Biological Conservation* **44**, 301-316.
- Chimhowu, A. and Hulme, D. (2006) Livelihood dynamics in planned and spontaneous resettlement in Zimbabwe: converging and vulnerable. *World Development* **34**, 728-750.
- Cianfrani, C., Lay, G.L., Maiorano, L., Satizábal, H.F., Loy, A. and Guisan, A. (2011) Adapting global conservation strategies to climate change at the European scale: the otter as a flagship species. *Biological Conservation* **144**, 2068-2080.
- CITES (1992) Quotas for trade in specimens of cheetah. In Eighth meeting of the Convention of International Trade in Endangered Species of Wild Flora & Fauna, pp. 1-5.
- CITES (2011) Appendices I, II and III. CITES, Geneva.
- Clegg, S.B., Turnbull, P.C.B., Foggin, C.M. and Lindeque, R.M. (2007) Massive outbreak of anthrax in wildlife in the Malilangwe Wildlife Reserve, Zimbabwe. *Veterinary Record* **160**, 113-118.
- Coe, M.J., Cumming, D.H. and Phillipson, J. (1976) Biomass and production of large African herbivores in relation to rainfall and primary production. *Oecologia* **22**, 341-354.
- Conforti, V.A. and de Azevedo, F.C.C. (2003) Local perceptions of jaguars (*Panthera onca*) and pumas (*Puma concolor*) in the Iguacu National Park area, south Brazil. *Biological Conservation* **111**, 215-221.
- Corn, J.L. and Conroy, M.J. (1998) Estimation of density of mongooses with capture-recapture and distance sampling. *Journal of Mammalogy* **79**, 1009-1015.
- Courtin, F., Carpenter, T.E., Paskin, R.D. and Chomel, B.B. (2000) Temporal patterns of domestic and wildlife rabies in central Namibia stock-ranching area, 1986-1996. *Preventive Veterinary Medicine* **43**, 13-28.
- Cowlishaw, G. (1997) Refuge use and predation risk in a desert baboon population. *Animal Behaviour* **54**, 241-253.
- Craigie, I.D., Baillie, J.E.M., Balmford, A., Carbone, C., Collen, B., Green, R.E. and Hutton, J.M. (2010) Large mammal population declines in Africa's protected areas. *Biological Conservation* **143**, 2221-2228.
- Creel, S. and Creel, N.M. (1995) Status of African wild dogs in the Selous Game Reserve and Mikumi National Park. *Canid News* **31**, 34-35.
- Creel, S. and Creel, N.M. (1996) Limitation of African wild dogs by competition with larger carnivores. *Conservation Biology* **10**, 526-538.

- Dalerum, F., Cameron, E.Z., Kunkel, K. and Somers, M.J. (2009) Diversity and depletions in continental carnivore guilds: implications for prioritizing global carnivore conservation. *Biology Letters* **5**, 35-38.
- Dalerum, F., Somers, M.J., Kunkel, K.E. and Cameron, E.Z. (2008) The potential for large carnivores to act as biodiversity surrogates in southern Africa. *Biodiversity and Conservation* **17**, 2939-2949.
- Davidson, Z. and Loveridge, A. (2006) The Gwai conservancy: lion density and quota recommendations based on spoor density estimation. Wildlife Conservation Research Unit, University of Oxford, Oxford.
- Davidson, Z., Valeix, M., Loveridge, A.J., Madzikanda, H. and Macdonald, D.W. (2011) Socio-spatial behaviour of an African lion population following perturbation by sport hunting. *Biological Conservation* **144**, 114-121.
- Davies-Mostert, H.T., Burger, M., Mills, M.G.L., Somers, M., Hofmeyr, M. and Ferreira, S. (2010) Baseline results of the 5th wild dog & 3rd cheetah photographic census of greater Kruger National Park, In 8th annual savanna science networking meeting. SANParks scientific services department, Skukuza, Kruger National Park.
- Davies, H.T. and du Toit, J.T. (2004) Anthropogenic factors affecting wild dog *Lycaon pictus* reintroductions: a case study in Zimbabwe. *Oryx* **38**, 32-39.
- Davison, B. (1999) An estimate of the status of the cheetah in Zimbabwe. Zimbabwe Department of National Parks and Wildlife Management, Harare.
- de Villiers, B. (2003) Land reform: issues and challenges. A comparative overview of experiences in Zimbabwe, Namibia, South Africa and Australia. Konrad-Adenauer-Stiftung, Johannesburg.
- de Villiers, B. and van den Berg, M. (2006) Land reform: trailblazers. Seven successful case studies. Konrad-Adenauer-Stiftung, Johannesburg.
- DeGeorges, A. and Reilly, B. (2007) Politicization of land reform in Zimbabwe: impacts on wildlife, food production and the economy. *International Journal of Environmental Studies* **64**, 571-586.
- Dickman, A. (2008) Key determinants of conflict between people and wildlife, particularly large carnivores, around Ruaha National Park, Tanzania. PhD Thesis, University College London.
- Dickman, A.J. (2010) Complexities of conflict: the importance of considering social factors for effectively resolving human-wildlife conflict. *Animal Conservation* **13**, 458-466.
- Dickman, A.J., Macdonald, E.A. and Macdonald, D.W. (in press) A review of financial instruments to pay for predator conservation and encourage human-carnivore coexistence. *Proceedings of the National Academy of Sciences*.
- Don Carlos, A.W., Bright, A.D., Teel, T.L. and Vaske, J.J. (2009) Human-black bear conflict in urban areas: an integrated approach to management response. *Human Dimensions of Wildlife* **14**, 174-184.



- du Toit, R. (2004) Review of wildlife issues associated with the land reform programme in Zimbabwe. World Wide Fund for Nature (WWF), Southern African Regional Programme Office, Harare.
- Duffy, R. (2000) Killing for conservation: wildlife policy in Zimbabwe. James Currey, Oxford.
- Dunham, K.M., Ghiurghi, A., Cumbi, R. and Urbano, F. (2010a) Human-wildlife conflict in Mozambique: a national perspective, with emphasis on wildlife attacks on humans. *Oryx* **44**, 185-193.
- Dunham, K.M., Robertson, E.F. and Swanepoel, C.M. (2003) Population decline of tsessebe antelope (*Damaliscus lunatus lunatus*) on a mixed cattle and wildlife ranch in Zimbabwe. *Biological Conservation* **113**, 111-124.
- Dunham, K.M., van der Westhuizen, E., van der Westhuizen, H. and Gandiwa, E. (2010b) Aerial survey of elephants and other large herbivores in Gonarezhou National Park (Zimbabwe), Zinave National Park (Mozambique) and surrounds: 2009. Frankfurt Zoological Society, Chiredzi.
- Durant, S. (2004) Introduction to survey methodologies, In Global cheetah (*Acinonyx jubatus*) monitoring workshop: final workshop report. eds S. Bashir, B. Daly, S.M. Durant, H. Forster, J. Grisham, L. Marker, K. Wilson and Y. Friedmann. IUCN/SSC Conservation Breeding Specialist Group, Ngorogoro Conservation Area.
- Durant, S., Marker, L., Purchase, N., Belbachir, F., Hunter, L., Packer, C., Breitenmoser-Wursten, C., Sogbohossou, E. and Bauer, H. (2010a) *Acinonyx jubatus*. IUCN red list of threatened species. Version 2010.4 [online]. Available from <http://www.iucnredlist.org/apps/redlist/details/219/0> [Accessed 02 June 2011].
- Durant, S.M. (1998) Competition refuges and coexistence: an example from Serengeti carnivores. *Journal of Animal Ecology* **67**, 370-386.
- Durant, S.M. (2000) Living with the enemy: avoidance of hyenas and lions by cheetahs in the Serengeti. *Behavioral Ecology* **11**, 624-632.
- Durant, S.M., Bashir, S., Maddox, T. and Laurenson, M.K. (2007) Relating long-term studies to conservation practice: the case of the Serengeti Cheetah Project. *Conservation Biology* **21**, 602-611.
- Durant, S.M., Craft, M.E., Hilborn, R., Bashir, S., Hando, J. and Thomas, L. (2011) Long-term trends in carnivore abundance using distance sampling in Serengeti National Park, Tanzania. *Journal of Applied Ecology* **48**, 1490-1500.
- Durant, S.M., Dickman, A., Maddox, T., Waweru, M.N., Caro, T. and Pettorelli, N. (2010b) Past, present and future of cheetahs in Tanzania: their behavioural ecology and conservation, In *The biology and conservation of wild felids*. Eds D.W. Macdonald and A.J. Loveridge, pp. 373-382. Oxford University Press, Oxford.
- Durant, S.M., Kelly, M. and Caro, T.M. (2004) Factors affecting life and death in the Serengeti cheetahs: environment, age, and sociality. *Behavioral Ecology* **15**, 11-22.

- Eagly, A.H. and Chaiken, S. (1998) Attitudes structure and function, In *The handbook of social psychology*. Eds D.T. Gilbert, S.T. Fiske and G. Lindzey, pp. 269–322. McGraw-Hill, Boston and New York.
- East, R. (1984) Rainfall, soil nutrient status and biomass of large African savanna mammals. *African Journal of Ecology* **22**, 245-270.
- Edwards, G.P., de Preu, N.D., Shakeshaft, B.J. and Crealy, I.V. (2000) An evaluation of two methods of assessing feral cat and dingo abundance in central Australia. *Wildlife Research* **27**, 143-149.
- Elmhagen, B. and Rushton, S.P. (2007) Trophic control of mesopredators in terrestrial ecosystems: top-down or bottom-up? *Ecology Letters* **10**, 197-206.
- Ericsson, G. and Heberlein, T.A. (2003) Attitudes of hunters, locals, and the general public in Sweden now that the wolves are back. *Biological Conservation* **111**, 149-159.
- ESRI (1999) ArcView 3.2 [Computer Program]. Environmental Systems Research Institute, Redlands.
- ESRI (2008) ArcMap 9.3 [Computer Program]. Environmental Systems Research Institute, Redlands.
- Fazio, R.H. (1990) Multiple processes by which attitudes guide behavior: the mode model as an integrative framework. *Advances in Experimental Social Psychology* **23**, 75-109.
- Ferreira, S.M. and Funston, P.J. (2010) Estimating lion population variables: prey and disease effects in Kruger National Park, South Africa. *Wildlife Research* **37**, 194-206.
- Field, A.P. (2009) *Discovering statistics using SPSS*, 3rd edn. SAGE publications, London.
- Fletcher, M. (2008) Zimbabwe: extinction looms in a paradise lost to guns, greed and hunger. *The Times*, 18 December 2008.
- Foggin, C. and Conner, G. (2005) Introduction of foot and mouth disease-infected buffalo into the Save Valley Conservancy in Zimbabwe: success or failure?, In *Conservation and development interventions at the wildlife/livestock interface: implications for wildlife, livestock and human health*. Eds S.A. Osofsky, S. Cleaveland, W.B. Karesh, M.D. Kock, P.J. Nyhus, L. Starr and A. Yang, p. xxix. Occasional paper of the IUCN Species Survival Commission No. 30. IUCN, Gland and Cambridge.
- Foley, L., Purchase, G., Locora, A., Cilliers, D., Bashir, S. and Daly, B. (2004) Carnivore atlas/questionnaires/GIS data technique, In *Global cheetah (*Acinonyx jubatus*) monitoring workshop: final workshop report*. eds S. Bashir, B. Daly, S.M. Durant, H. Forster, J. Grisham, L. Marker, K. Wilson and Y. Friedmann. IUCN/SSC Conservation Breeding Specialist Group, Ngorogoro Conservation Area.
- Frank, L.G., Woodroffe, R. and Ogada, M.O. (2005) People and predators in Laikipia District, Kenya, In *People and wildlife: conflict or coexistence?* Eds R. Woodroffe, S. Thirgood and A.R. Rabinowitz, pp. 286-304. Cambridge University Press, Cambridge.

- Frost, P.G.H. and Bond, I. (2008) The CAMPFIRE programme in Zimbabwe: payments for wildlife services. *Ecological Economics* **65**, 776-787.
- Fuller, T.K. and Sievert, P.R. (2001) Carnivore demography and the consequences of changes in prey availability, In *Carnivore Conservation*. pp. 163-178. Cambridge University Press, Cambridge.
- Funston, P., Herrman, E., Babupi, P., Kruiper, A., Krupier, H., Jagers, H., Masule, L. and Kruiper, K. (2001) Spoor frequency estimates as a method of determining lion and other large mammal densities in the Kalahari Transfrontier Park. Unpublished research report to the management committee of the Kgalagadi Transfrontier Park.
- Funston, P.J., Frank, L., Stephens, T., Davidson, Z., Loveridge, A., Macdonald, D.M., Durant, S., Packer, C., Mosser, A. and Ferreira, S.M. (2010) Substrate and species constraints on the use of track incidences to estimate African large carnivore abundance. *Journal of Zoology* **281**, 56-65.
- Gelfand, M. (1969) The shona religion. *Zambezia Vol 1*, 37-46.
- Gertenbach, W.P.D. (1980) Rainfall patterns in the Kruger National Park. *Koedoe* **23**, 35-43.
- Gese, E.M. (2001) Monitoring of terrestrial carnivore populations, In *Carnivore Conservation*. Eds J.L. Gittleman, S.M. Funk, D. Macdonald and R.K. Wayne, pp. 372-396. Cambridge University Press, Cambridge.
- Ginsberg, J.R. and Woodroffe, R. (1997) Extinction risks faced by remaining wild dog populations, In *The African wild dog: status survey and conservation action plan*. Eds J.R. Ginsberg and D.W. Macdonald, pp. 75-87. IUCN Canid Specialist Group, Gland.
- Gittleman, J.L., Funk, S.M., Macdonald, D.W. and Wayne, R.K. (eds). (2001a) *Carnivore conservation*. Cambridge University Press, Cambridge.
- Gittleman, J.L., Macdonald, D.W. and Wayne, R.K. (2001b) Why 'carnivore conservation'?, In *Carnivore Conservation*. Eds J.L. Gittleman, S.M. Funk, D.W. Macdonald and R.K. Wayne, pp. 1-7. Cambridge University Press, Cambridge.
- Godwin, P. (2007) *When a crocodile eats the sun*. Picador, London.
- Goldman, M.J., Roque De Pinho, J. and Perry, J. (2010) Maintaining complex relations with large cats: Maasai and lions in Kenya and Tanzania. *Human Dimensions of Wildlife* **15**, 332 - 346.
- Good, K., Houser, A.M., Jones, B., Karen, S., Klein, R. and Segaletsho, T. (eds). (2007) *The predator-safe livestock guide: an introduction to protecting livestock & deterring predators*. Cheetah Conservation Botswana, Gaborone.
- Goodrich, J.M., Seryodkin, I., Miquelle, D.G. and Bereznuik, S.L. (2011) Conflicts between Amur (Siberian) tigers and humans in the Russian Far East. *Biological Conservation* **144**, 584-592.
- Government of Zimbabwe (2002) *Wildlife-based land reform policy*. Government of Zimbabwe, Harare.
- Graham, K., Beckerman, A.P. and Thirgood, S. (2005) Human-predator-prey conflicts: ecological correlates, prey losses and patterns of management. *Biological Conservation* **122**, 159-171.

- Gratwicke, B. (2004a) Wildlife on a roller-coaster [online]. Available from <http://www.zimconservation.com/synthesis1.htm> [Accessed 29 September 2008].
- Gratwicke, B. (2004b) Zimbabwe's wildlife tragedy [online]. Available from [http://www.davidmixner.com/2007/06/brian\\_gratwicke.html](http://www.davidmixner.com/2007/06/brian_gratwicke.html) [Accessed 29 September 2008].
- Gratwicke, B. and Stapelkamp, B. (2006) Wildlife conservation and environmental management in an "outpost of tyranny". ZimConservation, Washington D.C.
- Groom, R. (2009a) Carnivore densities in the Save Valley Conservancy: results of the 2008 spoor survey. Lowveld Wild Dog Project, Chiredzi.
- Groom, R. (2009b) Carnivore densities in Gonarezhou National Park: results of the May/June 2009 spoor survey. Lowveld Wild Dog Project, Chiredzi.
- Groom, R. and Harris, S. (2008) Conservation on community lands: the importance of equitable revenue sharing. *Environmental Conservation* **35**, 242-251.
- Gros, P.M. (1996) Status of the cheetah in Malawi. *Nyala* **19**, 33-38.
- Gros, P.M. (1997) Conservation status of cheetahs in east Africa: estimation, determinants and projections. PhD Thesis, University of California, Davis.
- Gros, P.M. (1998) Status of the cheetah *Acinonyx jubatus* in Kenya: a field-interview assessment. *Biological Conservation* **85**, 137-149.
- Gros, P.M. (2002) The status and conservation of the cheetah *Acinonyx jubatus* in Tanzania. *Biological Conservation* **106**, 177-185.
- Gros, P.M., Kelly, M. and Caro, T.M. (1996) Estimating carnivore densities for conservation purposes: indirect methods compared to baseline demographic data. *Oikos* **77**, 197-206.
- Gros, P.M. and Rejmanek, M. (1999) Status and habitat preferences of Uganda cheetahs: an attempt to predict carnivore occurrence based on vegetation structure. *Biodiversity and Conservation* **8**, 1461-1583.
- Grossman, D. and Holden, P. (2009) Towards transformation: contractual parks in South Africa, In *Evolution and innovation in wildlife conservation in southern Africa*. Eds B. Child, H. Suich and A. Spenceley, pp. 357–372. Earthscan, London.
- Gusset, M. and Burgener, N. (2005) Estimating larger carnivore numbers from track counts and measurements. *African Journal of Ecology* **43**, 320-324.
- Gusset, M., Maddock, A.H., Gunther, G.J., Szykman, M., Slotow, R., Walters, M. and Somers, M.J. (2008a) Conflicting human interests over the re-introduction of endangered wild dogs in South Africa. *Biodiversity and Conservation* **17**, 83-101.
- Gusset, M., Maddock, A.H., Gunther, G.J., Szykman, M., Slotow, R., Walters, M. and Somers, M.J. (2008b) Conflicting human interests over the re-introduction of endangered wild dogs in South Africa. *Biodiversity and Conservation* **17**, 83-101.

- Gusset, M., Swarner, M.J., Mponwane, L., Keletile, K. and McNutt, J.W. (2009) Human-wildlife conflict in northern Botswana: livestock predation by endangered African wild dog *Lycaon pictus* and other carnivores. *Oryx* **43**, 67-72.
- Guvamombe, I. (2011) Wildlife land reform begins. *The Herald*, 08 March 2011.
- Hanke, S.H. and Kwok, A.K.F. (2009) On the Measurement of Zimbabwe's Hyperinflation. *Cato Journal* **29**, 353-364.
- Hargreaves, S.K., Foggin, C.M., Anderson, E.C., Bastos, A.D.S., Thomson, G.R., Ferris, N.P. and Knowles, N.J. (2004) An investigation into the source and spread of foot and mouth disease virus from a wildlife conservancy in Zimbabwe. *Revue Scientifique et Technique - Office International des Epizooties* **23**, 783-790.
- Harrison, E. (2006) *Jambanja: a memoir and personal account of a Zimbabwean farmer and the land invasions*. Maioio Publishers, Harare.
- Hartter, J. and Goldman, A. (2011) Local responses to a forest park in western Uganda: alternate narratives on fortress conservation. *Oryx* **45**, 60-68.
- Hayward, M.W. (2006) Prey preferences of the spotted hyaena (*Crocuta crocuta*) and degree of dietary overlap with the lion (*Panthera leo*). *Journal of Zoology* **270**, 606-614.
- Hayward, M.W., Adendorff, J., O'Brien, J., Sholto-Douglas, A., Bissett, C., Moolman, L.C., Bean, P., Fogarty, A., Howarth, D., Slater, R. and Kerley, G.I.H. (2007a) The reintroduction of large carnivores to the Eastern Cape, South Africa: an assessment. *Oryx* **41**.
- Hayward, M.W., Henschel, P., O'Brien, J., Hofmeyr, M., Balme, G. and Kerley, G.I.H. (2006a) Prey preferences of the leopard (*Panthera pardus*). *Journal of Zoology* **270**, 298-313.
- Hayward, M.W., Hofmeyr, M., O'Brien, J.O. and Kerley, G.I.H. (2006b) Prey preferences of the cheetah (*Acinonyx jubatus*) (Felidae: Carnivora): morphological limitations or the need to capture rapidly consumable prey before kleptoparasites arrive. *Journal of Zoology* **270**, 615-627.
- Hayward, M.W. and Kerley, G.I.H. (2005) Prey preferences of the lion (*Panthera leo*). *Journal of Zoology* **267**, 309-322.
- Hayward, M.W. and Kerley, G.I.H. (2008) Prey preferences and dietary overlap amongst Africa's large predators. *South African Journal of Wildlife Research* **38**, 93-108.
- Hayward, M.W., O'Brien, J., Hofmeyr, M. and Kerley, G.I.H. (2006c) Prey preferences of the African wild dog *Lycaon pictus* (Canidae: Carnivora): Ecological requirements for conservation. *Journal of Mammalogy* **87**, 1122-1131.
- Hayward, M.W., O'Brien, J. and Kerley, G.I.H. (2007b) Carrying capacity of large African predators: predictions and tests. *Biological Conservation* **139**, 219-229.
- Hazzah, L., Mulder, M.B. and Frank, L. (2009) Lions and Warriors: Social factors underlying declining African lion populations and the effect of incentive-based management in Kenya. *Biological Conservation* **142**, 2428-2437.

- Hemson, G., Maclennan, S., Mills, G., Johnson, P. and Macdonald, D. (2009) Community, lions, livestock and money: a spatial and social analysis of attitudes to wildlife and the conservation value of tourism in a human-carnivore conflict in Botswana. *Biological Conservation* **142**, 2718-2725.
- Henschel, P., Hunter, L., Breitenmoser, U., Purchase, N., Packer, C., Khorozyan, I., Bauer, H., Marker, L., Sogbohossou, E. and Breitenmoser-Wursten, C. (2008) *Panthera pardus*. IUCN red list of threatened species. Version 2010.4 [online]. Available from <http://www.iucnredlist.org/apps/redlist/details/15954/0> [Accessed 03 June 2011].
- Henzi, S.P., Weingrill, T. and Barrett, L. (1999) Male behaviour and the evolutionary ecology of chacma baboons. *South African Journal of Science* **95**, 240-242.
- Herbst, W. (2002) Decimation of Zimbabwe's Wildlife [online]. Available from [http://www.kubatana.net/html/archive/wild/020613wpa.asp?sector=WILD&range\\_start=1](http://www.kubatana.net/html/archive/wild/020613wpa.asp?sector=WILD&range_start=1) [Accessed 30 September 2008].
- Herr, J., Schley, L. and Roper, T.J. (2009) Stone martens (*Martes foina*) and cars: investigation of a common human-wildlife conflict. *European Journal of Wildlife Research* **55**, 471-477.
- Hilborn, R., Arcese, P., Borner, M., Hando, J., Hopcraft, G., Loibooki, M., Mduma, S. and Sinclair, A.R.E. (2006) Effective enforcement in a conservation area. *Science* **314**, 1266.
- Hill, C.M. and Webber, A.D. (2010) Perceptions of non-human primates in human-wildlife conflict scenarios. *American Journal of Primatology* **72**, 919-924.
- Hodgkinson, C., Komen, H., Snow, T. and Davies-Mostert, H. (2007) *Predators and farmers*, 2nd edn. Endangered Wildlife Trust, Johannesburg.
- Hoffmann, M., Hilton-Taylor, C., Angulo, A., Bohm, M., Brooks, T.M., Butchart, S.H.M., Carpenter, K.E., Chanson, J., Collen, B., Cox, N.A., Darwall, W.R.T., Dulvy, N.K., Harrison, L.R., Katariya, V., Pollock, C.M., Quader, S., Richman, N.I., Rodrigues, A.S.L., Tognelli, M.F., Vie, J.C., Aguiar, J.M., Allen, D.J., Allen, G.R., Amori, G., Ananjeva, N.B., Andreone, F., Andrew, P., Ortiz, A.L.A., Baillie, J.E.M., Baldi, R., Bell, B.D., Biju, S.D., Bird, J.P., Black-Decima, P., Blanc, J.J., Bolanos, F., Bolivar, W., Burfield, I.J., Burton, J.A., Capper, D.R., Castro, F., Catullo, G., Cavanagh, R.D., Channing, A., Chao, N.L., Chenery, A.M., Chiozza, F., Clausnitzer, V., Collar, N.J., Collett, L.C., Collette, B.B., Fernandez, C.F.C., Craig, M.T., Crosby, M.J., Cumberlidge, N., Cuttelod, A., Derocher, A.E., Diesmos, A.C., Donaldson, J.S., Duckworth, J.W., Dutton, G., Dutta, S.K., Emslie, R.H., Farjon, A., Fowler, S., Freyhof, J., Garshelis, D.L., Gerlach, J., Gower, D.J., Grant, T.D., Hammerson, G.A., Harris, R.B., Heaney, L.R., Hedges, S.B., Hero, J.M., Hughes, B., Hussain, S.A., Icochea, J., Inger, R.F., Ishii, N., Iskandar, D.T., Jenkins, R.K.B., Kaneko, Y., Kottelat, M., Kovacs, K.M., Kuzmin, S.L., La Marca, E., Lamoreux, J.F., Lau, M.W.N., Lavilla, E.O., Leus, K., Lewison, R.L., Lichtenstein, G., Livingstone, S.R., Lukoschek, V., Mallon, D.P., McGowan, P.J.K., McIvor, A., Moehlman, P.D., Molur, S., Alonso, A.M., Musick, J.A., Nowell, K., Nussbaum, R.A., Olech, W., Orlov, N.L., Papenfuss, T.J., Parra-Olea, G., Perrin, W.F., Polidoro, B.A., Pourkazemi, M., Racey, P.A., Ragle, J.S., Ram, M., Rathbun, G., Reynolds, R.P., Rhodin, A.G.J., Richards, S.J., Rodriguez, L.O., Ron, S.R., Rondinini, C., Rylands, A.B., de Mitcheson, Y.S., Sanciangco, J.C., Sanders, K.L., Santos-Barrera, G., Schipper, J., Self-Sullivan, C., Shi, Y.C., Shoemaker, A., Short, F.T., Sillero-Zubiri, C., Silvano, D.L., Smith, K.G., Smith, A.T., Snoeks, J., Stattersfield, A.J., Symes, A.J., Taber, A.B., Talukdar, B.K., Temple, H.J., Timmins, R., Tobias, J.A., Tsytsulina, K., Tweddle, D., Ubeda, C., Valenti, S.V., van Dijk, P.P., Veiga, L.M., Veloso, A., Wege,

- D.C., Wilkinson, M., Williamson, E.A., Xie, F., Young, B.E., Akcakaya, H.R., Bennun, L., Blackburn, T.M., Boitani, L., Dublin, H.T., da Fonseca, G.A.B., Gascon, C., Lacher, T.E., Mace, G.M., Mainka, S.A., McNeely, J.A., Mittermeier, R.A., Reid, G.M., Rodriguez, J.P., Rosenberg, A.A., Samways, M.J., Smart, J., Stein, B.A. and Stuart, S.N. (2010) The impact of conservation on the status of the world's vertebrates. *Science* **330**, 1503-1509.
- Home, R., Keller, C., Nagel, P., Bauer, N. and Hunziker, M. (2009) Selection criteria for flagship species by conservation organizations. *Environmental Conservation* **36**, 139-148.
- Honer, O., Holekamp, K.E. and Mills, G. (2008) *Crocuta crocuta*. IUCN red list of threatened species. Version 2010.4 [online]. Available from <http://www.iucnredlist.org/apps/redlist/details/5674/0> [Accessed 03 June 2011].
- Hooge, P.N., Eichenlaub, W. and Soloman, E. (1999) Animal movement [Computer Program]. USGS, Alaska Biologic Science Centre.
- Houser, A., Somers, M.J. and Boast, L.K. (2009a) Home range use of free-ranging cheetah on farm and conservation land in Botswana. *South African Journal of Wildlife Research* **39**, 11-22.
- Houser, A.M., Somers, M.J. and Boast, L.K. (2009b) Spoor density as a measure of true density of a known population of free-ranging wild cheetah in Botswana. *Journal of Zoology* **278**, 108-115.
- Human Rights Watch (2002) Fast track land reform in Zimbabwe. Human Rights Watch, New York.
- Human Rights Watch (2008a) "Bullets for each of you": state-sponsored violence since Zimbabwe's March 29 elections. Human Rights Watch, New York.
- Human Rights Watch (2008b) "They beat me like a dog": political persecution of opposition activists and supporters in Zimbabwe. Human Rights Watch, New York.
- Hunter, L.T.B. (1998) Behavioural ecology of reintroduced lions and cheetahs in the Phinda resource reserve, Kwazulu-Natal, South Africa. PhD Thesis, University of Pretoria.
- Illgner, P.M., Nel, E.L. and Robertson, M.P. (1998) Beekeeping and local self-reliance in rural southern Africa. *Geographical Review* **88**, 349-362.
- Infield, M. and Namara, A. (2001) Community attitudes and behaviour towards conservation: an assessment of a community conservation programme around Lake Mburo National Park, Uganda. *Oryx* **35**, 48-60.
- Inskip, C. and Zimmermann, A. (2009) Human-felid conflict: a review of patterns and priorities worldwide. *Oryx* **43**, 18-34.
- IUCN (2010a) Guidelines for Using the IUCN Red List Categories and Criteria. Version 8.1. IUCN, Gland.
- IUCN (2010b) IUCN red list of threatened species. Version 2010.2 [online]. Available from <http://www.iucnredlist.org> [Accessed 07 July 2010].
- IUCN/SSC (2007) Regional conservation strategy for the cheetah and African wild dog in Southern Africa. IUCN/SSC, Gland.

- Jachmann, H. (2002) Comparison of aerial counts with ground counts for large African herbivores. *Journal of Applied Ecology* **39**, 841-852.
- Jackson, T.R., Mosojane, S., Ferreira, S.M. and van Aarde, R.J. (2008) Solutions for elephant *Loxodonta africana* crop raiding in northern Botswana: moving away from symptomatic approaches. *Oryx* **42**, 83-91.
- Jacquier, M. and Woodfine, T. (2007) A pilot GPS study on a single male cheetah in Zimbabwe. *Cat News* **47**, 15-17.
- Jenrich, R.I. and Turner, F.B. (1969) Measurement of non-circular home range. *Journal of Theoretical Biology* **2**, 227-237.
- Jew, E. and Bonnington, C. (2011) Socio-demographic factors influence the attitudes of local residents towards trophy hunting activities in the Kilombero Valley, Tanzania. *African Journal of Ecology* **49**, 277-285.
- Jhala, Y., Qureshi, Q. and Gopal, R. (2011) Can the abundance of tigers be assessed from their signs? *Journal of Applied Ecology* **48**, 14-24.
- Jones, D.N. and Thomas, L.K. (1999) Attacks on humans by Australian magpies: management of an extreme suburban human-wildlife conflict. *Wildlife Society Bulletin* **27**, 473-478.
- Joubert, C.J. (2005) Aerial survey of the Savé Valley Conservancy. Savé Valley Conservancy Technical Advisory Committee, Harare.
- Joubert, C.J. (2006) Aerial survey of the Savé Valley Conservancy. Savé Valley Conservancy Technical Advisory Committee, Harare.
- Joubert, C.J. (2007) Aerial survey of the larger herbivores, Savé Valley Conservancy, Zimbabwe. Savé Valley Conservancy Technical Advisory Committee, Harare.
- Joubert, C.J. (2008) Aerial survey of the larger herbivores, Savé Valley Conservancy, Zimbabwe. Savé Valley Conservancy Technical Advisory Committee, Harare.
- Kaczensky, P., Blazic, M. and Gossow, H. (2004) Public attitudes towards brown bears (*Ursus arctos*) in Slovenia. *Biological Conservation* **118**, 661-674.
- Kellert, S.R., Black, M., Rush, C.R. and Bath, A.J. (1996) Human culture and large carnivore conservation in North America. *Conservation Biology* **10**, 977-990.
- Kelly, M.J. and Durant, S.M. (2000) Viability of the Serengeti cheetah population. *Conservation Biology* **14**, 786-797.
- Kent, V. (2011) The status and conservation potential of carnivores in semi-arid rangelands, Botswana. PhD Thesis, Durham University.
- Kenward, R.E. (2001) A manual for wildlife tracking. Academic Press, San Diego.



- Kenward, R.E., South, A.B. and Walls, S.S. (2003) Ranges 6 [Computer Program]. Anatrack Ltd., Wareham.
- Kiffner, C., Meyer, B., Muhlenberg, M. and Waltert, M. (2009) Plenty of prey, few predators: what limits lions *Panthera leo* in Katavi National Park, western Tanzania? *Oryx* **43**, 52-59.
- Kinsey, B.H. (1999) Land reform, growth and equity: emerging evidence from Zimbabwe's resettlement programme. *Journal of Southern African Studies* **25**, 173-196.
- Kinsey, B.H. (2004) Zimbabwe's land reform program: underinvestment in post-conflict transformation. *World Development* **32**, 1669-1696.
- Kissui, B.M. (2008) Livestock predation by lions, leopards, spotted hyenas, and their vulnerability to retaliatory killing in the Maasai steppe, Tanzania. *Animal Conservation* **11**, 422-432.
- Klein, R. (2007) Status report for the cheetah in Botswana. *Cat News Special issue 3: Status and Conservation Needs of Cheetahs in Southern Africa*, 14-21.
- Kloskowski, J. (2011) Human-wildlife conflicts at pond fisheries in eastern Poland: perceptions and management of wildlife damage. *European Journal of Wildlife Research* **57**, 295-304.
- Knight, J. (2000a) Culling demons: the problem bears of Japan, In *Natural enemies: people-wildlife conflict in anthropological perspective*. Ed. J. Knight, pp. 145-169. Routledge, London.
- Knight, J. (2000b) Introduction, In *Natural enemies: people-wildlife conflict in anthropological perspective*. Ed. J. Knight, pp. 1-35. Routledge, London.
- Knight, J. (ed.) (2000c) *Natural enemies: people-wildlife conflicts in anthropological perspective*. Routledge, London.
- Kock, M.D. (2001) *Chemical and physical restraint of wild animals*. Zimbabwe Veterinary Association Wildlife Group, Harare.
- Koehler, C.E. and Richardson, P.R.K. (1990) *Proteles cristatus*. *Mammalian Species* **363**, 1-6.
- Kolowski, J.M. and Holekamp, K.E. (2006) Spatial, temporal, and physical characteristics of livestock depredations by large carnivores along a Kenyan reserve border. *Biological Conservation* **128**, 529-541.
- Kruuk, H. (2002) *Hunter and hunted: the relationship between carnivores and people*. Cambridge University Press, Cambridge.
- Kruuk, H. and Sands, W.A. (1972) The aardwolf (*Proteles cristatus* Sparrman 1783) as predator of termites. *African Journal of Ecology* **10**, 211-227.
- Kwashirai, V.C. (2009a) *Conservationism in Zimbabwe: 1850-1950*. Nova Science Publishers, New York.
- Kwashirai, V.C. (2009b) Ecological and poverty impacts of Zimbabwe's land struggles: 1980 to present. *Global Environment* **2**, 222-253.

- Kwashirai, V.C. (2009c) Green colonialism in Zimbabwe, 1890-1980. Cambria Press, Amherst.
- Kwashirai, V.C. (2010) Zimbabwe: poverty, poverty and poverty. Nova Science, Hauppauge.
- Lagendijk, D.D.G. and Gusset, M. (2008) Human-carnivore coexistence on communal land bordering the greater Kruger area, South Africa. *Environmental Management* **42**, 971-976.
- Lande, R. (1995) Mutation and conservation. *Conservation Biology* **9**, 782-791.
- Langholz, J.A. and Kerley, G.I.H. (2006) Combining conservation and development of private lands: an assessment of ecotourism-based private game reserves in the Eastern Cape. Centre for African Conservation Ecology, Nelson Mandela Metropolitan University, Port Elizabeth.
- Laurenson, M.K. (1994) High juvenile mortality in cheetahs (*Acinonyx jubatus*) and its consequences for maternal care. *Journal of Zoology* **234**, 387-408.
- Laurenson, M.K. (1995) Implications of high offspring mortality for cheetah population dynamics, In *Serengeti II: research, conservation and management of an ecosystem*. Eds A.R.E. Sinclair and P. Arcese, pp. 385-399. University of Chicago Press, Chicago.
- Laurenson, M.K. and Caro, T.M. (1994) Monitoring the effects of non-trivial handling in free-living cheetahs. *Animal Behaviour* **47**, 547-557.
- Lewis, D.M. and Phiri, A. (1998) Wildlife snaring – an indicator of community response to a community-based conservation project. *Oryx* **32**, 111-121.
- Liberg, O., Chapron, G., Wabakken, P., Pedersen, H.C., Hobbs, N.T. and Sand, H. (in press) Shoot, shovel and shut up: cryptic poaching slows restoration of a large carnivore in Europe. *Proceedings of the Royal Society B: Biological Sciences*.
- Liebenberg, L. (2008) A field guide to the animal tracks of southern Africa. David Philip Publishers, Claremont.
- Liebenberg, L., Louw, A. and Elbroch, M. (2010) Practical tracking: a guide to following footprints and finding animals. Stackpole Books, Mechanicsburg.
- Lindenmayer, D.B., Margules, C.R. and Botkin, D.B. (2000) Indicators of biodiversity for ecologically sustainable forest management. *Conservation Biology* **14**, 941-950.
- Lindsey, P., du Toit, J.T. and Mills, M.G.L. (2004) The distribution and population status of African wild dogs (*Lycaon pictus*) outside protected areas in South Africa. *South African Journal of Wildlife Research* **34**, 143-151.
- Lindsey, P., Romañach, S., Tambling, C., Chartier, K., Matema, S., Mupamhadzi, I., Matema, C. and Muvengwi, J. (2009a) The illegal wild meat trade affecting wildlife based land use in the South East Lowveld of Zimbabwe: drivers, impacts and solutions.doc. EU-PARSEL, Harare.
- Lindsey, P.A. (2007) Human elephant conflict in and around Savé Valley Conservancy. Unpublished report to Savé Valley Conservancy.

- Lindsey, P.A., Alexander, R., Frank, L.G., Mathieson, A. and Romañach, S.S. (2006) Potential of trophy hunting to create incentives for wildlife conservation in Africa where alternative wildlife-based land uses may not be viable. *Animal Conservation* **9**, 283-291.
- Lindsey, P.A., du Toit, J.T. and Mills, M.G.L. (2005) Attitudes of ranchers towards African wild dogs *Lycaon pictus*: conservation implications on private land. *Biological Conservation* **125**, 113-121.
- Lindsey, P.A., du Toit, R., Pole, A. and Romañach, S. (2009b) Savé Valley Conservancy: a large scale African experiment in cooperative wildlife management, In *Evolution and innovation in wildlife conservation in southern Africa*. Eds B. Child, H. Suich and A. Spenceley, pp. 163-184. Earthscan, London.
- Lindsey, P.A., Romañach, S.S. and Davies-Mostert, H.T. (2009c) The importance of conservancies for enhancing the value of game ranch land for large mammal conservation in southern Africa. *Journal of Zoology* **277**, 99-105.
- Lindsey, P.A., Romañach, S.S., Matema, S., Matema, C., Mupamhadzi, I. and Muvengwi, J. (2011a) Dynamics and underlying causes of illegal bushmeat trade in Zimbabwe. *Oryx* **45**, 84-95.
- Lindsey, P.A., Romañach, S.S., Tambling, C.J., Chartier, K. and Groom, R. (2011b) Ecological and financial impacts of illegal bushmeat trade in Zimbabwe. *Oryx* **45**, 96-111.
- Lindsey, P.A., Roulet, P.A. and Romañach, S.S. (2007) Economic and conservation significance of the trophy hunting industry in sub-Saharan Africa. *Biological Conservation* **134**, 455-469.
- Linnell, J., Swenson, J. and Andersen, R. (2001) Predators and people: conservation of large carnivores is possible at high human densities if management policy is favourable. *Animal Conservation* **4**, 345-349.
- Linnell, J.D.C., Swenson, J.E. and Andersen, R. (2000) Conservation of biodiversity in Scandinavian boreal forests: large carnivores as flagships, umbrellas, indicators, or keystones? *Biodiversity and Conservation* **9**, 857-868.
- Liu, F., McShea, W.J., Garshelis, D.L., Zhu, X.J., Wang, D.J. and Shao, L.K. (2011) Human-wildlife conflicts influence attitudes but not necessarily behaviors: factors driving the poaching of bears in China. *Biological Conservation* **144**, 538-547.
- Löe, J. and Röskaft, E. (2004) Large carnivores and human safety: a review. *Ambio* **33**, 283-288.
- Loveridge, A.J., Wang, S.W., Frank, L.G. and Seidensticker, J. (2010) People and wild felids: conservation of cats and management of conflicts, In *The biology and conservation of wild felids*. Eds D.W. Macdonald and A.J. Loveridge, pp. 161-195. Oxford University Press, Oxford.
- Macdonald, D.W., Loveridge, A. and Nowell, K. (2010) *Dramatis personae*: an introduction to the wild felids, In *The biology and conservation of wild felids*. Eds D.W. Macdonald and A.J. Loveridge, pp. 3-58. Oxford University Press, Oxford.
- MacKenzie, D.I., Nichols, J.D., Lachman, G.B., Droege, S., Royle, J.A. and Langtimm, C.A. (2002) Estimating site occupancy rates when detection probabilities are less than one. *Ecology* **83**, 2248-2255.

- MacLennan, S.D., Groom, R.J., Macdonald, D.W. and Frank, L.G. (2009) Evaluation of a compensation scheme to bring about pastoralist tolerance of lions. *Biological Conservation* **142**, 2419-2427.
- Madden, F. (2004) Creating coexistence between humans and wildlife: global perspectives on local efforts to address human-wildlife conflict. *Human Dimensions of Wildlife* **9**, 247-257.
- Maddox, T.M. (2003) The ecology of cheetahs and other large carnivores in a pastoralist-dominated buffer zone. PhD Thesis, University College, London and Institute of Zoology, London.
- Magaramombe, G. (2010) 'Displaced in place': agrarian displacements, replacements and resettlement among farm workers in Mazowe district. *Journal of Southern African Studies* **36**, 361-375.
- Marker, L. (1998) Current status of the cheetah (*Acinonyx jubatus*). In Proceedings of a Symposium on Cheetahs as Game Ranch Animals. Onderstepoort, South Africa., ed. B.L. Penzorn, pp. 1-17. De Wildt Cheetah and Wildlife Trust, Onderstepoort.
- Marker, L. (2002) Aspects of cheetah (*Acinonyx jubatus*) biology, ecology and conservation strategies on Namibian farmlands. DPhil Thesis, University of Oxford.
- Marker, L., Dickman, A. and Macdonald, D. (2005) Perceived effectiveness of livestock-guarding dogs placed on Namibian farms. *Rangeland Ecology and Management* **58**, 329-336.
- Marker, L. and Dickman, A.J. (2003) Morphology, physical condition, and growth of the cheetah (*Acinonyx jubatus jubatus*). *Journal of Mammalogy* **84**, 840-850.
- Marker, L., Dickman, A.J., Jeo, R.M., Mills, M.G.L. and Macdonald, D.W. (2003a) Demography of the Namibian cheetah, *Acinonyx jubatus jubatus*. *Biological Conservation* **114**, 413-425.
- Marker, L., Dickman, A.J., Mills, G. and Macdonald, D. (2010) Cheetahs and ranchers in Namibia: a case study, In *The biology and conservation of wild felids*. Eds D.W. Macdonald and A.J. Loveridge, pp. 353-372. Oxford University Press, Oxford.
- Marker, L., Kraus, D., Barnett, D. and Hurlbut, S. (2003b) *Cheetah survival on Namibian farmlands*, 3rd edn. Solitaire Press, Windhoek.
- Marker, L., Mills, M.G.L. and Macdonald, D.W. (2003c) Factors influencing perceptions of conflict and tolerance towards cheetahs on Namibian farmlands. *Conservation Biology* **17**, 1290-1298.
- Marker, L., Muntifering, J.R., Dickman, A.J., Mills, M.G.L. and Macdonald, D.W. (2003d) Quantifying prey preferences of free-ranging Namibian cheetahs. *South African Journal of Wildlife Research* **33**, 43-53.
- Marker, L.L., Dickman, A.J., Mills, M.G.L., Jeo, R.M. and Macdonald, D.W. (2008) Spatial ecology of cheetahs on north-central Namibian farmlands. *Journal of Zoology* **274**, 226-238.
- Marker, L.L., Dickman, A.J., Mills, M.G.L. and Macdonald, D.W. (2003e) Aspects of the management of cheetahs, *Acinonyx jubatus jubatus*, trapped on Namibian farmlands. *Biological Conservation* **114**, 401-412.

- Marnewick, K., Beckhelling, A., Cilliers, D., Lane, E., Mills, G., Herring, K., Caldwell, P., Hall, R. and Meintjes, S. (2007) The status of the cheetah in South Africa. *Cat News Special issue 3: Status and Conservation Needs of Cheetahs in Southern Africa*, 22-31.
- Marnewick, K. and Cilliers, D. (2006) Range use of two coalitions of male cheetahs, *Acinonyx jubatus*, in the Thabazimbi district of the Limpopo Province, South Africa. *South African Journal of Wildlife Research* **36**, 147-151.
- Martin, R.B. and de Meulenaer, T. (1988) Survey of the status of the leopard (*Panthera pardus*) in sub-Saharan Africa. Secretariat of the Convention on International Trade in Endangered Species of Wild Fauna and Flora, Lausanne.
- Massei, G., Quay, R.J., Gurney, J. and Cowan, D.P. (2010) Can translocations be used to mitigate human-wildlife conflicts? *Wildlife Research* **37**, 428-439.
- Matsebula, S.N., Monadjem, A., Roques, K.G. and Garcelon, D.K. (2009) The diet of the aardwolf, *Proteles cristatus* at Malolotja Nature Reserve, western Swaziland. *African Journal of Ecology* **47**, 448-451.
- Maude, G. (2005) The comparative ecology of the brown hyaena (*Hyaena brunnea*) in Makgadikgadi National Park and a neighbouring community cattle area in Botswana. MSc Thesis, University of Pretoria.
- Maude, G. and Mills, M.G.L. (2005) The comparative feeding ecology of the brown hyaena in a cattle area and a national park in Botswana. *South African Journal of Wildlife Research* **35**, 201-214.
- McCleery, R.A., Ditton, R.B., Sell, J. and Lopez, R.R. (2006) Understanding and improving attitudinal research in wildlife sciences. *Wildlife Society Bulletin* **34**, 537-541.
- McCullough, D.R. (1979) The George Reserve deer herd: population ecology of a K-selected species. University of Michigan Press, Ann Arbor.
- McNutt, J.W., Mills, M.G.L., McCreery, K., Rasmussen, G., Robbins, R. and Woodroffe, R. (2010) *Lycaon pictus*. IUCN red list of threatened species. Version 2010.4 [online]. Available from <http://www.iucnredlist.org/apps/redlist/details/12436/0> [Accessed 03 June 2011].
- McShane, T.O. and Grettenberger, J.F. (1984) Food of the golden jackal (*Canis aureus*) in central Niger. *African Journal of Ecology* **22**, 49-53.
- Melville, H. and Bothma, J.D. (2006) Using spoor counts to analyse the effect of small stock farming in Namibia on caracal density in the neighbouring Kgalagadi Transfrontier Park. *Journal of Arid Environments* **64**, 436-447.
- Meredith, M. (2006) *The state of Africa*. The Free Press, London.
- Meredith, M. (2007) *Mugabe: power, plunder and the struggle for Zimbabwe*. PublicAffairs, New York.
- Mills, G. and Hofer, H. (1998) *Hyaenas: status survey and conservation action plan*. IUCN/SSC Hyaena Specialist Group, Gland.

- Mills, M.G.L. (1991) Conservation management of large carnivores in Africa. *Koedoe* **34**, 81-90.
- Mills, M.G.L. (1994) *Kalahari hyenas: comparative behavioral ecology of two species*. Chapman and Hall, London.
- Mills, M.G.L. (1996) Methodological advances in capture, census, and food-habits studies of large African carnivores, In *Carnivore behaviour, ecology, and evolution*. Ed. J.L. Gittleman, pp. 223-242. Cornell University Press, Ithaca.
- Mishra, C. (1997) Livestock depredation by large carnivores in the Indian trans-Himalaya: conflict perceptions and conservation prospect. *Environmental Conservation* **24**, 338-343.
- Mizutani, F. (1993) Home range of leopards and their impact upon livestock on Kenyan ranches. In *Symposia of the Zoological Society of London*, pp. 425-439.
- Mombeshora, S. and Le Bel, S. (2009) Parks-people conflicts: the case of Gonarezhou National Park and the Chitsa community in south-east Zimbabwe. *Biodiversity and Conservation* **18**, 2601-2623.
- Mooney, N. and Rounsevell, D.E. (2008) Thylacine, *Thylacinus cynocephalus*, In *The mammals of Australia*. Eds S.V. Dyck and R. Strahan, pp. 167-168. Reed New Holland, Sydney.
- Morris, B. (2000) *The power of animals: an ethnography*. Berg, Oxford.
- Movement for Democratic Change (2007) *A new Zimbabwe, a new beginning*. Movement for Democratic Change, Harare.
- Murphy, D.D., Weiland, P.S. and Cummins, K.W. (2011) A critical assessment of the use of surrogate species in conservation planning in the Sacramento-San Joaquin Delta, California (U.S.A.). *Conservation Biology* **25**, 873-878.
- Murphy, T. and Macdonald, D.W. (2010) Pumas and people: lessons in the landscape of tolerance from a widely distributed felid, In *The biology and conservation of wild felids*. Eds D.W. Macdonald and A.J. Loveridge, pp. 431-451. Oxford University Press, Oxford.
- Myers, N. (1975) *The cheetah, *Acinonyx jubatus*, in Africa*. IUCN Monograph 4. International Union for Conservation of Nature and Natural Resources, Morges.
- Naughton-Treves, L., Grossberg, R. and Treves, A. (2003) Paying for tolerance: rural citizens' attitudes toward wolf depredation and compensation. *Conservation Biology* **17**, 1500-1511.
- Nel, E., Illgner, P.M., Wilkins, K. and Robertson, M.P. (2000) Rural self-reliance in Bondolfi, Zimbabwe: the role of beekeeping. *Geographical Journal* **166**, 26-34.
- Norton-Griffiths, M. (1978) *Counting Animals*, 2nd edn. African Wildlife Leadership Foundation, Nairobi.
- Nowell, K. and Jackson, P. (1996) *Wild cats: status survey and conservation action plan*. IUCN/SSC Cat Specialist Group, Gland.

- Nyoni, W. and Williams, S. (2008) Living with predators: a farmers guide. Marwell Zimbabwe Trust, Bulawayo.
- O'Donoghue, M., Boutin, S., Krebs, C.J. and Hofer, E.J. (1997) Numerical responses of coyotes and lynx to the snowshoe hare cycle. *Oikos* **80**, 150-162.
- O'Donoghue, M., Slough, B.G., Poole, K.G., Boutin, S., Hofer, E.J., Mowat, G. and Krebs, C.J. (2010) Cyclical dynamics and behaviour of Canada lynx in northern Canada, In *The biology and conservation of wild felids*. Eds D.W. Macdonald and A.J. Loveridge, pp. 521-536. Oxford University Press, Oxford.
- Odum, E.P. (1993) *Ecology and our endangered life-support systems*, 2nd edn. Sinauer Associates, Sunderland.
- Ogada, M.O., Woodroffe, R., Oguge, N.O. and Frank, L.M. (2003) Limiting depredation by African carnivores: the role of livestock husbandry. *Conservation Biology* **17**, 1-10.
- Ogutu, J.O. and Dublin, H.T. (1998) The response of lions and spotted hyaenas to sound playbacks as a technique for estimating population size. *African Journal of Ecology* **36**, 83-95.
- Olson, D.M., Dinerstein, E., Wikramanayake, E.D., Burgess, N.D., Powell, G.V.N., Underwood, E.C., D'Amico, J.A., Itoua, I., Strand, H.E., Morrison, J.C., Loucks, C.J., Allnutt, T.F., Ricketts, T.H., Kura, Y., Lamoreux, J.F., Wettengel, W.W., Hedao, P. and Kassem, K.R. (2001) Terrestrial ecoregions of the worlds: a new map of life on Earth. *Bioscience* **51**, 933-938.
- Ott, T., Kerley, G.I.H. and Boshoff, A.F. (2007) Preliminary observations on the diet of leopards (*Panthera pardus*) from a conservation area and adjacent rangelands in the Baviaanskloof region, South Africa. *African Zoology* **42**, 31-37.
- Owen-Smith, N. and Ogutu, J. (2003) Rainfall influences on ungulate population dynamics, In *The Kruger experience: ecology and management of savannah heterogeneity*. Eds J.D. Toit, H. Biggs and K. Rogers, pp. 310–331. Island Press, Washington, DC.
- Packer, C., Ikanda, D., Kissui, B. and Kushnir, H. (2005) Lion attacks on humans in Tanzania - understanding the timing and distribution of attacks on rural communities will help to prevent them. *Nature* **436**, 927-928.
- Packer, C., Ikanda, D., Kissui, B. and Kushnir, H. (2006) The ecology of man-eating lions in Tanzania. *Nature & Fauna* **21**, 10-15.
- Paine, R.T. (1969) A note on trophic complexity and community stability. *American Naturalist* **103**, 91-&.
- Patterson, B.D., Kasiki, S.M., Selempo, E. and Kays, R.W. (2004) Livestock predation by lions (*Panthera leo*) and other carnivores on ranches neighboring Tsavo National Parks, Kenya. *Biological Conservation* **119**, 507-516.
- Peterson, M.N., Birckhead, J.L., Leong, K., Peterson, M.J. and Peterson, T.R. (2010) Rearticulating the myth of human-wildlife conflict. *Conservation Letters* **3**, 74-82.

- Pimm, S.L., Russell, G.J., Gittleman, J.L. and Brooks, T.M. (1995) The future of biodiversity. *Science* **269**, 347-350.
- Pole, A., Gordon, I.J., Gorman, M.L. and MacAskill, M. (2004) Prey selection by African wild dogs (*Lycaon pictus*) in southern Zimbabwe. *Journal of Zoology* **262**, 207-215.
- Pole, A.J. (2000) The behaviour and ecology of African wild dogs, *Lycaon pictus*, in an environment with reduced competitor density. PhD Thesis, University of Aberdeen.
- Price Waterhouse (1994) The lowveld conservancies: new opportunities for productive and sustainable land-use. Savé Valley, Bubiana and Chiredzi River Conservancies, Harare.
- Purchase, G., Marker, L., Marnewick, K., Klein, R. and Williams, S. (2007) Regional assessment of the status, distribution and conservation needs of cheetahs in southern Africa. *Cat News Special issue 3: Status and Conservation Needs of Cheetahs in Southern Africa*, 44-46.
- Purchase, G.K. and du Toit, J.T. (2000) The use of space and prey by cheetahs in Matusadona National Park, Zimbabwe. *South African Journal of Wildlife Research* **30**, 139-144.
- R Development Core Team (2010) R: a language and environment for statistical computing, version 2.12.1 [Computer Program]. The R Foundation for Statistical Computing, Vienna.
- Rasband, W.S. (2009) ImageJ, version 1.37v [Computer Program]. National Institutes of Health, Bethesda.
- Rasmussen, G.S.A. (1999) Livestock predation by the painted hunting dog *Lycaon pictus* in a cattle ranching region of Zimbabwe: a case study. *Biological Conservation* **88**, 133-139.
- Ray, J.C. (2005) Large carnivorous animals as tools for conserving biodiversity: assumptions and uncertainties, In *Large carnivores and the conservation of biodiversity*. Eds J.C. Ray, K.H. Redford, R.S. Steneck and J. Berger, pp. 34-56. Island Press, Washington, DC.
- Ray, J.C., Hunter, L. and Zigouris, J. (2005) Setting conservation and research priorities for larger African carnivores. Working paper number 24. Wildlife Conservation Society, New York.
- Reid, H. (2001) Contractual national parks and the Makuleke community. *Human Ecology* **29**, 135-155.
- Richardson, C. (2004) The collapse of Zimbabwe in the wake of the 2000-2003 land reforms. Edwin Mellen Press, Lewiston.
- Richardson, C.J. (2007) How much did droughts matter? Linking rainfall and GDP growth in Zimbabwe. *African Affairs* **106**, 463-478.
- Rigg, R., Findo, S., Wechselberger, M., Gorman, M.L., Sillero-Zubiri, C. and Macdonald, D.W. (2011) Mitigating carnivore-livestock conflict in Europe: lessons from Slovakia. *Oryx* **45**, 272-280.
- Rodriguez, A. and Delibes, M. (2002) Internal structure and patterns of contraction in the geographic range of the Iberian lynx. *Ecography* **25**, 314-328.



- Romañach, S., Lindsey, P.A. and Woodroffe, R. (2007) Determinants of attitudes towards predators in central Kenya and suggestions for increasing tolerance in livestock dominated landscapes. *Oryx* **41**, 185-195.
- Rotberg, R.I. (1988) *The founder: Cecil Rhodes and the pursuit of power*. Oxford University Press, New York.
- Rozyłowicz, L., Popescu, V., Pătroescu, M. and Chișamera, G. (2011) The potential of large carnivores as conservation surrogates in the Romanian Carpathians. *Biodiversity and Conservation* **20**, 561-579.
- Rudnai, J. (1979) Ecology of lions in Nairobi National Park and the adjoining Kitengela Conservation Unit in Kenya. *African Journal of Ecology* **17**, 85-95.
- Ryan, M. and Momberg, E. (2007) Poachers decimate Zimbabwe's wildlife. *The Sunday Tribune*, 16 December 2007.
- Sangay, T. and Vernes, K. (2008) Human-wildlife conflict in the Kingdom of Bhutan: patterns of livestock predation by large mammalian carnivores. *Biological Conservation* **141**, 1272-1282.
- Saroux, C., Le Bohec, C., Durant, J.M., Viblanc, V.A., Gauthier-Clerc, M., Beaune, D., Park, Y.-H., Yoccoz, N.G., Stenseth, N.C. and Le Maho, Y. (2011) Reliability of flipper-banded penguins as indicators of climate change. *Nature* **469**, 203-206.
- Saxon, T. (2011) Wildlife land reform enacted. *The Zimbabwean*, 11 March 2011.
- Schaller, G.B. (1972) *The Serengeti lion: a study of predator-prey relations*. University of Chicago Press, Chicago.
- Scheiss-Meier, M., Ramsauer, S., Gabanapelo, T. and König, B. (2007) Livestock predation - insights from problem animal control registers in Botswana. *Journal of Wildlife Management* **71**, 1267-1274.
- Schipper, J., Chanson, J.S., Chiozza, F., Cox, N.A., Hoffmann, M., Katariya, V., Lamoreux, J., Rodrigues, A.S.L., Stuart, S.N., Temple, H.J., Baillie, J., Boitani, L., Lacher, T.E., Mittermeier, R.A., Smith, A.T., Absolon, D., Aguiar, J.M., Amori, G., Bakkour, N., Baldi, R., Berridge, R.J., Bielby, J., Black, P.A., Blanc, J.J., Brooks, T.M., Burton, J.A., Butynski, T.M., Catullo, G., Chapman, R., Cokeliss, Z., Collen, B., Conroy, J., Cooke, J.G., da Fonseca, G.A.B., Derocher, A.E., Dublin, H.T., Duckworth, J.W., Emmons, L., Emslie, R.H., Festa-Bianchet, M., Foster, M., Foster, S., Garshelis, D.L., Gates, C., Gimenez-Dixon, M., Gonzalez, S., Gonzalez-Maya, J.F., Good, T.C., Hammerson, G., Hammond, P.S., Happold, D., Happold, M., Hare, J., Harris, R.B., Hawkins, C.E., Haywood, M., Heaney, L.R., Hedges, S., Helgen, K.M., Hilton-Taylor, C., Hussain, S.A., Ishii, N., Jefferson, T.A., Jenkins, R.K.B., Johnston, C.H., Keith, M., Kingdon, J., Knox, D.H., Kovacs, K.M., Langhammer, P., Leus, K., Lewison, R., Lichtenstein, G., Lowry, L.F., Macavoy, Z., Mace, G.M., Mallon, D.P., Masi, M., McKnight, M.W., Medellín, R.A., Medici, P., Mills, G., Moehlman, P.D., Molur, S., Mora, A., Nowell, K., Oates, J.F., Olech, W., Oliver, W.R.L., Oprea, M., Patterson, B.D., Perrin, W.F., Polidoro, B.A., Pollock, C., Powel, A., Protas, Y., Racey, P., Ragle, J., Ramani, P., Rathbun, G., Reeves, R.R., Reilly, S.B., Reynolds, J.E., Rondinini, C., Rosell-Ambal, R.G., Rulli, M., Rylands, A.B., Savini, S., Schank, C.J., Sechrest, W., Self-Sullivan, C., Shoemaker, A., Sillero-Zubiri, C., De Silva, N., Smith, D.E., Srinivasulu, C., Stephenson, P.J., van Strien, N., Talukdar, B.K., Taylor, B.L., Timmins, R., Tirira, D.G., Tognelli, M.F., Tsytsulina, K., Veiga, L.M., Vié, J.-C., Williamson, E.A., Wyatt, S.A., Xie, Y. and

- Young, B.E. (2008) The status of the world's land and marine mammals: diversity, threat, and knowledge. *Science* **322**, 225-230.
- Schumann, M. (2004) Integrated livestock and predator management: a farmer's guide. Cheetah Conservation Fund, Windhoek.
- Schumann, M., Schumann, B., Dickman, A., Watson, L.H. and Marker, L. (2006) Assessing the use of swing gates in game fences as a potential non-lethal predator exclusion technique. *South African Journal of Wildlife Research* **36**, 173-181.
- Schumann, M., Watson, L.H. and Schumann, B.D. (2008) Attitudes of Namibian commercial farmers toward large carnivores: the influence of conservancy membership. *South African Journal of Wildlife Research* **38**, 123-132.
- Scoones, I., Marongwe, N., Mavedzenge, B., Mahenehene, J., Murimbarimba, F. and Sekume, C. (2010) Zimbabwe's land reform: myths & realities. James Currey, Woodbridge.
- Selebatso, M., Mor, S.R. and Swenson, J.E. (2008) Do farmers support cheetah *Acinonyx jubatus* conservation in Botswana despite livestock depredation? *Oryx* **42**, 430-436.
- Sergio, F., Caro, T., Brown, D., Clucas, B., Hunter, J., Ketchum, J., McHugh, K. and Hiraldo, F. (2008) Top predators as conservation tools: ecological rationale, assumptions, and efficacy. *Annual Review of Ecology Evolution and Systematics* **39**, 1-19.
- Servin, J.I., Rau, J.R. and Delibes, M. (1987) Use of radio tracking to improve the estimation by track counts of the relative abundance of red fox. *Acta Theriologica* **32**, 489-492.
- Sharman, J. (2001) ZANU-PF's legacy to Zimbabwe [online]. Available from <http://www.cathybuckle.com/intro.htm> [Accessed 01 June 2011].
- Sharman, J. (2008) News update & emergency appeal [online]. Available from <http://www.cathybuckle.com/update2008.htm> [Accessed 01 June 2011].
- Shibia, M.G. (2010) Determinants of attitudes and perceptions on resource use and management of Marsabit National Reserve, Kenya. *Journal of Human Ecology* **30**, 55-62.
- Sillero-Zubiri, C. and Laurenson, M.K. (2001) Interactions between carnivores and local communities: conflict or coexistence?, In *Carnivore Conservation*. Eds J.L. Gittleman, S.M. Funk, D.W. Macdonald and R.K. Wayne, pp. 282-312. Cambridge University Press, Cambridge.
- Silveira, L., Jacomo, A.T.A. and Diniz-Filho, J.A.F. (2003) Camera trap, line transect census and track surveys: a comparative evaluation. *Biological Conservation* **114**, 351-355.
- Sithole, Z. (2011) Fresh wave of farm invasions. *The Zimbabwean*, 17 May 2011.
- Skinner, D. and Chimimba, T. (2005) *The mammals of the southern African subregion*, 3rd edn. Cambridge University Press, Cambridge.
- Smallwood, K.S. and Fitzhugh, E.L. (1995) A track count for estimating mountain lion *Felis concolor californica* population trends. *Biological Conservation* **71**, 251-259.

- Smith, J.L.D. (1993) The role of dispersal in structuring the Chitwan tiger population. *Behaviour* **124**, 165-195.
- Smith, M.E., Linnell, J.D.C., Odden, J. and Swenson, J.E. (2000) Review of methods to reduce livestock depredation: I. Guardian animals. *Acta Agriculturae Scandinavica Section A: Animal Science* **50**, 279-290.
- Smithers, R.H.N. and Wilson, V.J. (1979) Check list and atlas of the mammals of Zimbabwe Rhodesia. The Trustees of the National Museums and Monuments of Rhodesia, Salisbury.
- Sodhi, N.S. and Ehrlich, P.R. (2010) *Conservation biology for all*. Oxford University Press, Oxford.
- SPSS (2008) SPSS statistics version 17.0.1 [Computer Program]. SPSS, Chicago.
- St John, F.A.V., Edwards-Jones, G. and Jones, J.P.G. (2010) Conservation and human behaviour: lessons from social psychology. *Wildlife Research* **37**, 658-667.
- St John, F.A.V., Keane, A.M., Edwards-Jones, G., Jones, L., Yarnell, R.W. and Jones, J.P.G. (2011) Identifying indicators of illegal behaviour: carnivore killing in human-managed landscapes. *Proceedings of the Royal Society B: Biological Sciences*.
- Stander, P.E. (1998) Spoor counts as indices of large carnivore populations: the relationship between spoor frequency, sampling effort and true density. *Journal of Applied Ecology* **35**, 378-385.
- Stander, P.E., Ghau, Tsisaba, D., Troma and Ui, I.I. (1997a) Tracking and the interpretation of spoor: a scientifically sound method in ecology. *Journal of Zoology* **242**, 329-341.
- Stander, P.E., Haden, P.J., Kagece and Ghau (1997b) The ecology of asociality in Namibian leopards. *Journal of Zoology* **242**, 343-364.
- Stein, A.B., Fuller, T.K., Damery, D.T., Sievert, L. and Marker, L.L. (2010) Farm management and economic analyses of leopard conservation in north-central Namibia. *Animal Conservation* **13**, 419-427.
- Steneck, R.S. (2005) An ecological context for the role of large carnivores in conserving biodiversity, In *Large carnivores and the conservation of biodiversity*. Eds J.C. Ray, K.H. Redford, R.S. Steneck and J. Berger, pp. 9-33. Island Press, Washington, DC.
- Stephens, P.A., Zaumyslova, O.Y., Miquelle, D.G., Myslenkov, A.I. and Hayward, G.D. (2006) Estimating population density from indirect sign: track counts and the Formozov-Malyshev-Pereleshin formula. *Animal Conservation* **9**, 339-348.
- Stuart, C. and Stuart, T. (1997) *Field guide to the larger mammals of Africa*. Struik, Cape Town.
- Stuart, C. and Stuart, T. (2003) *A field guide to the tracks and signs of southern and east African wildlife*, 3rd edn. Struik, Cape Town.
- Stuart, C.T. and Wilson, V.J. (1988) *The cats of southern Africa*. The Chipangali Wildlife Trust, Bulawayo.

- Sukumar, R. (1990) Ecology of the asian elephant in southern india: feeding-habits and crop raiding patterns. *Journal of Tropical Ecology* **6**, 33-53.
- Surveyor General (1993) Sheet SF-36-2 Chipinge. Surveyor General, Harare.
- Surveyor General (1995) Sheet SE-36-14 Chimanimani. Surveyor General, Harare.
- Sutherland, W.J. (1996a) *Ecological census techniques: a handbook*. Cambridge University Press, Cambridge.
- Sutherland, W.J. (1996b) Mammals, In *Ecological census techniques: a handbook*. Ed. W.J. Sutherland, pp. 260-280. Cambridge University Press, Cambridge.
- Tambling, C.J. and Du Toit, J.T. (2005) Modelling wildebeest population dynamics: implications of predation and harvesting in a closed system. *Journal of Applied Ecology* **42**, 431-441.
- Taylor, R. (2009a) Community based natural resource management in Zimbabwe: the experience of CAMPFIRE. *Biodiversity and Conservation* **18**, 2563-2583.
- Taylor, R. (2009b) The performance of CAMPFIRE in Zimbabwe: 1989-2006, In *Evolution and innovation in wildlife conservation in southern Africa*. Eds B. Child, H. Suich and A. Spenceley, pp. 201-222. Earthscan, London.
- Technical Advisory Committee of the Savé Valley Conservancy (2004) *Aerial survey of the Savé Valley Conservancy*.
- Thirgood, S., Woodroffe, R. and Rabinowitz, A.R. (2005) The impact of human-wildlife conflict on human lives and livelihoods, In *People and wildlife: conflict or coexistence?* Eds R. Woodroffe, S. Thirgood and A.R. Rabinowitz, pp. 13-26. Cambridge University Press, Cambridge.
- Thomas, N.H. (2003) Land reform in Zimbabwe. *Third World Quarterly* **24**, 691-712.
- Thorn, M., Scott, D.M., Green, M., Bateman, P.W. and Cameron, E.Z. (2009) Estimating brown hyaena occupancy using baited camera traps. *South African Journal of Wildlife Research* **39**, 1-10.
- Timmins, R.J., Duckworth, J.W., Hedges, S., Pattanavibool, A., Steinmetz, R., Semiadi, G., Tyson, M. and Boeadi (2008) *Muntiacus muntjak*. IUCN red list of threatened species. Version 2010.4 [online]. Available from <http://www.iucnredlist.org/apps/redlist/details/42190/0> [Accessed 17 December 2010].
- Tomlinson, D.N.S. (1980) Nature conservation in Rhodesia - a review. *Biological Conservation* **18**, 159-177.
- van Bommel, L., de Vaate, M.D.B., de Boer, W.F. and de longh, H.H. (2007) Factors affecting livestock predation by lions in Cameroon. *African Journal of Ecology* **45**, 490-498.
- van Dyke, F.G., Brocke, R.H. and Shaw, H.G. (1986) Use of road track counts as indices of mountain lion presence. *Journal of Wildlife Management* **50**, 102-109.
- van Orsdol, K.G., Hanby, J.P. and Bygott, J.D. (1985) Ecological correlates of lion social-organization (*Panthera leo*). *Journal of Zoology* **206**, 97-112.

- Vincent, V. and Hack, H.R. (1960) Land use and recommended farming systems for different land capability classes in different areas of Southern Rhodesia. In Annual conference of the professional officers of the Department of Research and Specialist Services, pp. 16-27. Government of Southern Rhodesia, Salisbury.
- Vitousek, P.M., Mooney, H.A., Lubchenco, J. and Melillo, J.M. (1997) Human domination of earth's ecosystems. *Science* **277**, 494-499.
- Wade, P. (2002) *Race, nature and culture*. Pluto Press, London.
- Wallgren, M., Skarpe, C., Bergstrom, R., Danell, K., Granlund, L. and Bergstrom, A. (2009) Mammal community structure in relation to disturbance and resource gradients in southern Africa. *African Journal of Ecology* **47**, 20-31.
- Walter, W.D., Lavelle, M.J., Fischer, J.W., Johnson, T.L., Hygnstrom, S.E. and VerCauteren, K.C. (2010) Management of damage by elk (*Cervus elaphus*) in North America: a review. *Wildlife Research* **37**, 630-646.
- Wang, S.W. and Macdonald, D.W. (2006) Livestock predation by carnivores in Jigme Singye Wangchuck National Park, Bhutan. *Biological Conservation* **129**, 558-565.
- Waterloos, E. and Rutherford, B. (2004) Land reform in Zimbabwe: challenges and opportunities for poverty reduction among commercial farm workers. *World Development* **32**, 537-553.
- Watts, H.E. and Holekamp, K.E. (2008) Interspecific competition influences reproduction in spotted hyenas. *Journal of Zoology* **276**, 402-410.
- Webber, C.E., Sereivathana, T., Maltby, M.P. and Lee, P.C. (2011) Elephant crop-raiding and human-elephant conflict in Cambodia: crop selection and seasonal timings of raids. *Oryx* **45**, 243-251.
- Weilenmann, M., Gusset, M., Mills, D.R., Gabanapelo, T. and Schiess-Meier, M. (2010) Is translocation of stock-raiding leopards into a protected area with resident conspecifics an effective management tool? *Wildlife Research* **37**, 702-707.
- Wels, H. (2003) *Private wildlife conservation in Zimbabwe: joint ventures and reciprocity*. Brill, Leiden.
- White, J. (1996) Survey of cheetah and leopard population on commercial farms. The Wildlife Producers Association, Harare.
- White, L. (1967) Historical roots of our ecologic crisis. *Science* **155**, 1203-1207.
- White, P.C.L., Jennings, N.V., Renwick, A.R. and Barker, N.H.L. (2005) Questionnaires in ecology: a review of past use and recommendations for best practice. *Journal of Applied Ecology* **42**, 421-431.
- Wiesel, I., Maude, G., Scott, D. and Mills, G. (2010) *Hyaena brunnea*. IUCN red list of threatened species. Version 2010.4 [online]. Available from <http://www.iucnredlist.org/apps/redlist/details/10276/0> [Accessed 03 June 2011].

- Williams, S. (2007) Status of the cheetah in Zimbabwe. *Cat News Special issue 3: Status and Conservation Needs of Cheetahs in Southern Africa*, 32-36.
- Wilson, G.J. and Delahay, R.J. (2001) A review of methods to estimate the abundance of terrestrial carnivores using field signs and observation. *Wildlife Research* **28**, 151-164.
- Wilson, V.J. (1984) The distribution and present day status of the felids of Zimbabwe. Chipangali Wildlife Trust, Bulawayo.
- Wilson, V.J. (1987) Distribution and status of cheetah in Zimbabwe. Chipangali Wildlife Trust, Bulawayo.
- Wilson, V.J. (1997) Biodiversity of Hwange National Park, Zimbabwe. Chipangali Wildlife Trust, Bulawayo.
- Wilson, V.J. (2005) *Duikers of Africa*. Zimbi Books, Menlo Park.
- Winterbach, H.E.K., Winterbach, C.W., Somers, M.J. and Hayward, M.W. (in press) Key factors and related principles in the conservation of large African carnivores. *Mammal Review*.
- Wittemyer, G. (2011) Effects of economic downturns on mortality of wild African elephants. *Conservation Biology* **25**, 1002-1009.
- Wolmer, W. (2005) Wilderness gained, wilderness lost: wildlife management and land occupations in Zimbabwe's southeast lowveld. *Journal of Historical Geography* **31**, 260-280.
- Wolmer, W., Chaumba, J. and Scoones, I. (2004) Wildlife management and land reform in southeastern Zimbabwe: a compatible pairing or a contradiction in terms? *Geoforum* **35**, 87-98.
- Woodroffe, R. (2000) Predators and people: using human densities to interpret declines of large carnivores. *Animal Conservation* **3**, 165-173.
- Woodroffe, R. (2005) Strategies for carnivore conservation: lessons from contemporary extinctions, In *People and wildlife: conflict or coexistence?* Eds R. Woodroffe, S. Thirgood and A.R. Rabinowitz, pp. 31-92. Cambridge University Press, Cambridge.
- Woodroffe, R. and Frank, L.G. (2005) Lethal control of African lions (*Panthera leo*): local and regional population impacts. *Animal Conservation* **8**, 91-98.
- Woodroffe, R., Frank, L.G., Lindsey, P.A., ole Ranah, S.M.K. and Romanach, S. (2007a) Livestock husbandry as a tool for carnivore conservation in Africa's community rangelands: a case-control study. *Biodiversity and Conservation* **16**, 1245-1260.
- Woodroffe, R. and Ginsberg, J.R. (1998) Edge effects and the extinction of populations inside protected areas. *Science* **280**, 2126-2128.
- Woodroffe, R. and Ginsberg, J.R. (2005) King of the beasts? Evidence for guild redundancy among large mammalian carnivores, In *Large carnivores and the conservation of biodiversity*. Eds J.C. Ray, K.H. Redford, R.S. Steneck and J. Berger, pp. 154-175. Island Press, Washington, DC.

- Woodroffe, R., Ginsberg, J.R. and Macdonald, D.W. (1997) The African wild dog: status survey and conservation action plan. IUCN, Gland.
- Woodroffe, R., Lindsey, P. and Romañach, S. (2007b) African wild dogs (*Lycaon pictus*) can subsist on small prey: implications for conservation. *Journal of Mammalogy* **88**, 181-193.
- Woodroffe, R., Lindsey, P., Romañach, S., Stein, A. and ole Ranah, S.M.K. (2005a) Livestock predation by endangered African wild dogs (*Lycaon pictus*) in northern Kenya. *Biological Conservation* **124**, 225-234.
- Woodroffe, R., Thirgood, S. and Rabinowitz, A.R. (2005b) The impact of human-wildlife conflict on natural systems, In *People and wildlife: conflict or coexistence?* Eds R. Woodroffe, S. Thirgood and A.R. Rabinowitz, pp. 1-12. Cambridge University Press, Cambridge.
- World Wildlife Fund for Nature (1997) *Wildlife management series: quota setting manual*. World Wildlife Fund for Nature Programme office, Zimbabwe, Zimbabwe Trust and Safari Club International, Harare.
- Worton, B.J. (1987) A review of models of home range for animal movement. *Ecological Modelling* **38**, 277-298.
- Worton, B.J. (1989) Kernel methods for estimating the utilization distribution in home-range studies. *Ecology* **70**, 164-168.
- Young, J.K., Olson, K.A., Reading, R.P., Amgalanbaatar, S. and Berger, J. (2011) Is wildlife going to the dogs? Impacts of feral and free-roaming dogs on wildlife populations. *Bioscience* **61**, 125-132.
- Zimmermann, A., Baker, N., Inskip, C., Linnell, J.D.C., Marchini, S., Odden, J., Rasmussen, G. and Treves, A. (2010) Contemporary views of human-wildlife conflicts on wild rangelands, In *Wild rangelands: conserving wildlife while maintaining livestock in semi-arid ecosystems*. Eds J.T.d. Toit, R. Kock and J.C. Deutsch., pp. 129-151. Wiley-Blackwell, Chichester.
- Zimmermann, A., Walpole, M.J. and Leader-Williams, N. (2005) Cattle ranchers' attitudes to conflicts with jaguar *Panthera onca* in the Pantanal of Brazil. *Oryx* **39**, 406-412.
- Zinyama, L.M., Campbell, D.J. and Matiza, T. (1990) Land policy and access to land in Zimbabwe: the Dewure resettlement scheme. *Geoforum* **21**, 359-370.
- Zunga, L. (2003) *Farm invasions in Zimbabwe: is Zimbabwe a democracy?* Truth House Publishing, Randburg.

## Appendix 1

Purchase, G., Marker, L., Marnewick, K., Klein, R. and Williams, S. (2007) Regional assessment of the status, distribution and conservation needs of cheetahs in southern Africa. *Cat News Special issue 3: Status and Conservation Needs of Cheetahs in Southern Africa*, 44-46.



## Regional Assessment of the Status, Distribution and Conservation Needs of Cheetahs in Southern Africa

Gianetta Purchase<sup>1</sup>, Laurie Marker<sup>2</sup>, Kelly Marnewick<sup>3</sup>, Rebecca Klein<sup>4</sup> and Samuel Williams<sup>5</sup>

<sup>1</sup>The Zambezi Society, P.O Box FM 441, Bulawayo, Zimbabwe, dnp@mweb.co.zw

<sup>2</sup>Cheetah Conservation Fund, Namibia,

<sup>3</sup>De Wildt Wild Cheetah Project, De Wildt Cheetah and Wildlife Trust, P.O. Box 16, De Wildt, 0215. kelly@dewildt.org.za

<sup>4</sup>Cheetah Conservation Botswana,

<sup>5</sup>Marwell Zimbabwe Trust, PO Box 3863, Bulawayo, Zimbabwe, carnivore@dambari.com

A country by country assessment of the status, distribution and conservation needs for cheetah *Acinonyx jubatus* in the southern African region indicates that this area holds a significant proportion of the global population of cheetahs, at least 4 500 adults. The largest proportion of this regional population occurs in four range states, Namibia, Botswana, South Africa and Zimbabwe where it is under threat as a result of conflict with livestock and wildlife ranchers, removal of animals (both legally and illegally) for trade, loss of habitat and prey base due to an increasing human population and possible health and genetic problems. Although more information is required, it appears that cheetahs are present in the other range states, but in low numbers and disjointed populations. No information is currently available regarding threats to cheetahs in these countries.

The cheetah is the only species in a unique genus, and there is concern that it is declining over its range, both in terms of overall numbers and in terms of areas that it occurs. As a result of this concern, various initiatives have started to document where cheetahs still occur, their status in these areas and the threats to their survival. In December 2005 at a meeting of conservationists working in the Southern African region of the cheetah's range, it was agreed that the status, distribution and major threats to the cheetah would be documented for all range states within the region. The findings of these assessments are summarised in this paper, and full reports are included in this Special Issue of Cat News.

### Status and distribution within the Southern African region

*Overall.* It was documented that cheetahs occurred within all the range states included in this assessment, with the possible exception of Malawi where only one protected area was reported to have cheetah, but this report is contested. From the information collected cheetahs occur predominantly in the central area of the southern African region, including the central and western districts of Namibia, Botswana, Zimbabwe (except for the populated north eastern districts, and the northern dis-

tricts of South Africa (Fig. 1). Cheetahs were also reported as present in one protected area in Angola, from protected areas in the west and central part of Zambia, and from a small area in the Tete province of Mozambique, and also the Limpopo National Park in Mozambique (Fig. 1). There were large areas of Angola and Zambia, for which no information was available, and information from Mozambique was limited, but the indications are that the species is absent from much of the country.

Population estimates for many of the range states were not available, and only rough estimates were given. The minimum population of adult cheetahs in the region can be tentatively estimated to be not more than 5000: Namibia – 2000; Botswana – 1800; Zimbabwe – 400; South Africa – 550; Angola – not known; Mozambique – <50; Zambia – 100; Malawi – <10.

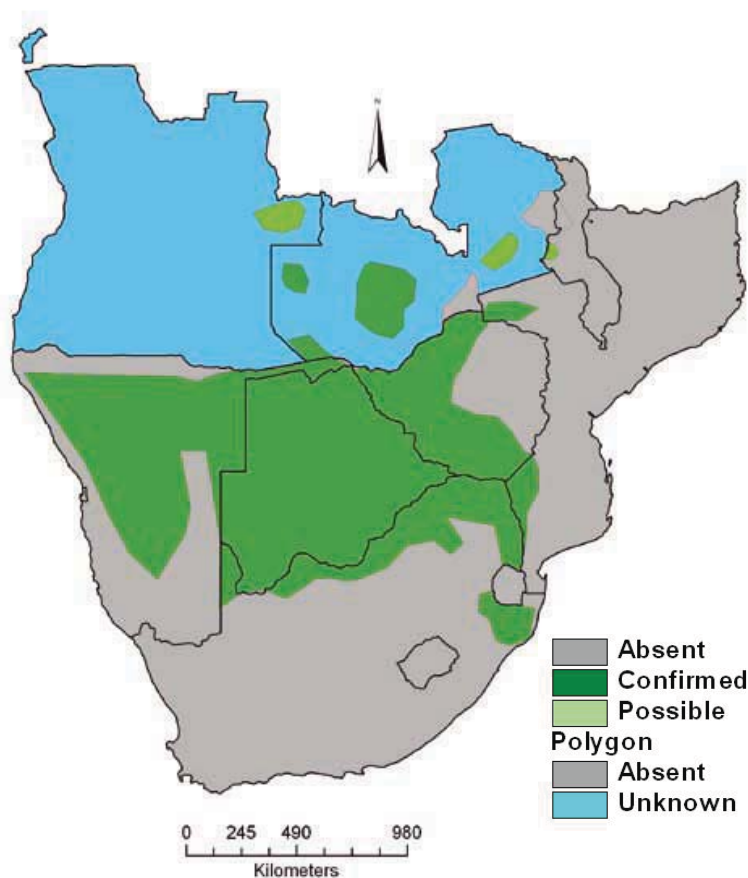
### Major range states within the region.

The major range states within the region are Namibia (with the largest documented population of cheetah ranging from 2000 to a possible 5000). The largest proportion of the population occurs on commercial farmland as these areas provided refuges from competition with other large predators. Numbers in protected areas are relatively low. Overall, it is felt that the population is

increasing. Botswana has the next highest documented population of cheetahs, distributed throughout the country. The highest densities are recorded from the south western part of the country, with the eastern, more populated districts, recording the lowest densities. South Africa's population is well studied and is confined to the northern part of the country. Approximately 250 cheetahs occur in protected areas, with a similar number occurring on commercial farmland. Cheetah in Zimbabwe are also documented to be more common on commercial farmland, especially in the southern lowveld area of the country. Estimates vary enormously depending on the method used, but it is acknowledged that at least 400 cheetahs occur in the country, and possible as many as 1500. Zimbabwe has undergone significant land use change in the last 7 years, with 90% of farmland being converted from large scale commercial farmland to small scale resettlement farmland. The impact on the cheetah population is not clear, but indications are that the population may be declining due to this increase of human activity and loss of prey.

### Other range states within the region.

Cheetahs were reported as present in protected areas of Angola (Kameia National Park in the north eastern cor-



**Fig. 1.** Distribution of cheetahs in Southern Africa. The most important range countries in this region for the conservation of the species are Namibia, Botswana, Zimbabwe and South Africa. In the other countries, cheetahs have lost most of their ground.

ner of the country); Zambia (Liuwa Plains, Sioma Ngwezi and Kafue National Parks); Malawi (Kasungu national Park, although this record is contested) and Mozambique (Limpopo National Park). Cheetahs were also reported as present in the subsistence farming area around the Caborra Bassa area. However, overall these range states do not appear to have large populations of cheetahs, either reporting that cheetahs have never been common (Zambia) or that cheetahs have disappeared from large areas of the country (Malawi and Mozambique).

#### Major Threats identified

In all the major range states the main threat to the survival of the species is conflict with livestock and wildlife ranchers. In Namibia this has histori-

cally been a major cause of death and removal of cheetahs from the wild, although there is evidence that this threat is reducing. Retaliatory killing was also reported as a major problem both now and historically in South Africa and Zimbabwe. In the other range states no conflict was documented during this assessment, perhaps due to low numbers of cheetahs, and lower densities of livestock. Other threats reported included the following:

- Capture of wild cheetahs for live sales. This is especially a problem in Namibia, Botswana and South Africa.
- Decreasing wild prey base. This is a concern in Zimbabwe.
- Conflict with other large predators in protected areas, reducing the suitability of such areas for cheetah conservation.

- Bush encroachment as a result of historical over grazing. In Namibia this is documented as both a direct and indirect threat to cheetah as it reduces hunting success of the species, as well as reducing the overall productivity of ranches increasing intolerance to livestock depredation by cheetahs.
- Unregulated captive breeding. This is linked to the illegal trade in wild cheetahs as it is known that many of these cheetahs end up in captive breeding centres. This is especially a problem in South Africa.
- Due to the loss of range at the end of the last glacial period the few surviving cheetah experienced at least one severe demographic bottleneck that potentially significantly reduced levels of molecular genetic variation. The bottleneck and associated loss of genetic variation have been linked to several important life history characteristics of cheetah including relatively low levels of normal sperm in males, focal palatine erosion (FPE), kinked tails, and an increased susceptibility to infectious disease agents.

#### Overview of Policy and legislation

Policy and legislation varies across the range states:

- The cheetah is listed as a protected species in Zambia, Mozambique and Malawi where cheetahs cannot be destroyed.
- It is gazetted as protected species in Botswana and Zimbabwe but cheetahs can be destroyed with a permit from the Director of the relevant Wildlife Management Authority.
- It is gazetted as a protected species in Namibia, but can be destroyed to protect life and property without permission from a government authority.
- In South Africa legislation regarding the protection of cheetah is complex as each of the nine provinces has its own legislations, and there is separate legislation for protected areas as they fall under a different legal entity. However, within all the existing legislation there is some degree of protection afforded to the cheetah, and removal or destruction of animals requires a permit.

The cheetah is listed as an Appendix I species under the Convention in International Trade in Endangered Species

**Table 1.** Summary of the status, distribution and major threats to cheetahs in the Southern African region.

Country	Estimated minimum population	Trend	Occurrence (% of country)	Major threat	Legal status
Angola	Unknown but present	Unknown	Unknown	Unknown	
Botswana	1800	Increasing	100	Conflict with humans	Protected species
Malawi	< 25	Decreasing	5	Habitat loss	Protected species
Mozambique	< 50	Unknown	5	Unknown	Protected species
Namibia	2000	Increasing	50	Conflict with humans	Partially protected species*
South Africa	550	Increasing	10	Conflict with humans	Protected species
Zambia	100	Unknown	Unknown	Unknown	Protected species
Zimbabwe	400	Decreasing	60	Habitat loss	Protected species

\* Cheetahs can be destroyed without a permit if threatening life or property

(CITES). All the range states within the region are signatories to this convention and therefore cannot trade in live animals or products with, unless they have been granted a CITES quota. Namibia, Zimbabwe and Botswana all have annual CITES quotas to enable cheetahs to be traded to offset the costs borne by communities living with the species (150, 50 and 5 respectively). In all range states there does not appear to be clear legislation regarding the sale and movement of cheetahs bred in captivity and this of major concern, as it is a loophole for trade in wild cheetahs that are moved to captive centres.

#### Ongoing efforts to conserve the species and recommended solutions

In all the major range states efforts are ongoing to find solutions to the threats mentioned above. Current efforts include:

- Improving awareness of the importance of the cheetah especially within governments and management communities such as commercial and subsistence farmers.
- Improving livestock husbandry to reduce depredation by cheetah and improve tolerance of livestock and wildlife producers.
- Encouraging the formation of conservancies to allow for more effective management of wildlife and cheetahs.

- Relocation of problem cheetah to areas where they are tolerated.

#### Other solutions recommended by each country include

- Effective regulation of captive breeding centres as many of these are conduits for trade in cheetahs caught in the wild.
- Effective policing of borders to prevent the movement of illegally caught wild cheetahs, especially from Namibia and Botswana to South Africa.
- Increased research into the conservation needs of the species, especially the impact of increasing human populations and decreasing wild prey bases, and including an assessment of the minimum area required to sustain a viable population, as well as health and genetic threats.
- Increased education at all levels of society.
- Evaluation of alternative livelihoods for communities currently dependent on livestock to reduce conflict with all predators including the cheetah.

#### Conclusions

The Southern African region still holds a significant proportion of the overall global cheetah population (Table 1). However, this population is under threat from an increasing human (and subsequently livestock) population resulting in an increase in conflict that is detrimental

to the survival of the species (Table 1). Trade in live animals is also of concern as many of these animals originate in the wild. Disjointed and unclear policy and legislation in the region hampers efforts to control retaliatory killing and removal of cheetahs in each of the range states, and there is a need for policy and legislation to become more regional (Table 1).

In the four major ranges states conservation initiatives are ongoing to try and reverse these threats, but more support and resources are required. The region already has a history of working across boundaries to try and share experiences and conserve the species, but more transboundary initiatives are required, given that many cheetah populations in the region appear to exist across national borders (see Fig. 1). There is also a need to determine the status and distribution of the species in the poorly documented range states that could have viable populations of cheetahs present that are also under threat.

## Appendix 2

Williams, S. (2007) Status of the cheetah in Zimbabwe. Cat News Special issue 3: Status and Conservation Needs of Cheetahs in Southern Africa, 32-36.

## Status of the Cheetah in Zimbabwe

Samual Williams<sup>1, 2</sup>

<sup>1</sup>Marwell Zimbabwe Trust, PO Box 3863, Bulawayo, Zimbabwe, carnivore@dambari.com

<sup>2</sup>Department of Anthropology, Durham University, 43 Old Elvet, Durham, UK, samual\_williams@yahoo.co.uk

The cheetah *Acinonyx jubatus* once occurred throughout Zimbabwe, but is now largely absent from the north and east of the country. Estimates of the cheetah population over the last 30 years range from 400 to 1,500, but many of these figures are not based on reliable data, and no current estimates are available. The cheetah population is thought to have been stable or decreasing in protected areas, and increasing on private land. The fast track land resettlement programme (FTLRP) initiated in 2000 may have affected the present status and distribution of the cheetah, but this has not yet been investigated. Cheetahs are legally hunted as problem animals and as trophies, but insufficient data are available to assess the impact of hunting on the population. Illegal removals may also have an important impact on the population. It is suggested that research is conducted to determine the current status and distribution of the cheetah population, and how this may have been affected by recent land use changes. In addition, it is recommended that trophy quality should be monitored, and information on non-lethal predator management techniques should be provided to farmers.

### History of cheetahs in Zimbabwe

Historically the cheetah (Fig. 1) was thought to have been distributed throughout Zimbabwe (Kingdon 1997, Stuart & Wilson 1988). In the 1960s cheetahs had a patchy but wide distribution in Zimbabwe, and resident cheetah populations were recorded in each province (Child & Savory 1964, Smithers 1966). By the end of the 1970s cheetahs were virtually absent from much of the north east of the country where crop farming is the dominant land use, but cheetahs were more abundant in the south, west and centre of the county, where commercial wildlife and livestock production is common (du Toit 2004, Myers 1975, Smithers & Wilson 1979, White 1996). Subsequent studies reported a similar distribution (Fig. 2; Marker 1998, Stuart & Wilson 1988, White 1996, Wilson 1984, 1988).

There have been few surveys of cheetah abundance in Zimbabwe. Most population estimates were generated using questionnaire & interview surveys in which respondents were asked to estimate the number of cheetahs on their property. Estimates were then summed to give total population size. However, as home ranges of cheetahs are large and frequently include several properties, this method may lead to overestimation of total population size (Bashir *et al.* 2004, Wilson 1988).

Interview and questionnaire surveys were used to estimate the total cheetah population at 400 in 1973 (Myers 1975) and 470 in 1987 (Wilson 1988). Wilson (1988) accounted for overestimation by using educated guesswork to reduce his totals. White (1996) estimated that 728 cheetahs were present on commercial farmland alone in 1996 based on a postal questionnaire survey, but he did not reduce the sum of the respondents' estimates, so his findings are not directly comparable with those of Wilson (1988). In 1991 a national total of 1,391 cheetahs was calculated using a computer model by the Zimbabwe Department of Parks and Wildlife Management (DPWLM, the former name of Zimbabwe Parks and Wildlife Management Authority, PWMA), although the accuracy of this has been questioned (DPWLM 1991, cited in Davison 1999a, Zank 1995, cited in Marker 1998). Davison (1999a) used the figures given by White (1996) and DPWLM (1991, cited in Davison 1999a) to calculate the annual growth rate of the cheetah population during this period, which he used to extrapolate to a total of 1,500 cheetahs in 1999.

Several reports have suggested that before 2000 the cheetah population in protected areas was stable or decreasing (total 292 in 1999), but was increasing

on commercial farmland (total 728 in 1996) (Heath 1997, White 1996, Wilson 1988).

### Current distribution and status

As the 1996 and 1999 population estimates (Davison 1999a, White 1996) are based on questionable data, and there have been no subsequent studies of status or distribution, the current distribution, status and trends of the cheetah population in Zimbabwe remain unclear.

### Habitat

In Zimbabwe cheetahs occur in plains or open scrub or woodland, but avoid dense forest (Smithers 1966, Smithers & Wilson 1979). Purchase & du Toit (2000) found that in Matusadona National Park, cheetahs displayed a preference for the boundary between the foreshore of Lake Kariba (which was a grassland dominated by *Panicum repens*) and woodland (comprised mainly of *Colophospermum mopane* with a mixture of *Combretum* and *Terminalia* tree species and a thin herbaceous layer). The foreshore was characterised by a high density of prey species, while the woodland provided cover for hunting and from other predators, which may explain the cheetahs' habitat selection. In Hwange National Park cheetahs oc-

cur in open grassland, closed mopane woodland, and *Baikiea* woodland (Wilson 1975).

It has been estimated that 80% of the cheetahs in Zimbabwe occur on privately owned farmland (Stuart & Wilson 1988). Since independence in 1980 many large-scale farms were converted from cattle to wildlife ranches in Zimbabwe (du Toit 1998, cited in du Toit 2004). In 2000, at least 20% of the country's commercial farmland (5% of the total land area of Zimbabwe), in addition to the 12% managed by PWMA, was managed for wildlife production and tourism (du Toit 2004). This probably facilitated the expansion of the cheetah population on private land between 1986 and 1996 reported by White (1996). However, in 2000 the FTLRP was initiated in Zimbabwe, which resulted in the conversion of many large-scale commercial farms to small-scale subsistence farms (du Toit 2004, Wolmer 2005). This had a detrimental impact on several wildlife populations including cheetah prey species such as impala *Aepyceros melampus* (du Toit 2004). Although the impact of the FTLRP on cheetahs has not yet been thoroughly investigated, preliminary data collected by Marwell Zimbabwe Trust (MZT) suggest that cheetahs may occur in lower numbers in resettlement areas than commercial farms, and it seems likely that the population may have declined since the initiation of the FTLRP, as cheetahs depend on a sufficient prey base (Laurenson 1995).

#### Prey

Cheetahs in Zimbabwe have been reported to hunt a range of mammals, including warthog *Phacochoerus aethiopicus*, grey duiker *Sylvicapra grimmia*, steenbok *Raphicerus campestris*, impala, waterbuck *Kobus ellipsiprymnus*, bushbuck *Tragelaphus scriptus*, reedbuck *Redunca arundinum*, zebra *Equus burchelli*, tsessebe *Damaliscus lunatus*, kudu *Tragelaphus strepsiceros*, sable *Hippotragus niger*, and buffalo *Syncerus caffer* (Purchase & du Toit 2000, Smithers 1966, Smithers & Wilson 1979, Wilson 1975). In Hwange and Matusadona National Parks impala make up the majority of the cheetah kills (41% and 87% respectively; Purchase & du Toit 2000, Wilson 1975). Ground



Fig. 1. Cheetahs in Matusadona National Park (Photo Zambezi Society).

living birds such as guinea fowl *Numida meleagris*, francolin *Francolinus* spp, bustards *Otis* spp, and ostrich *Struthio camelus* are also hunted (Purchase & du Toit 2000, Smithers & Wilson 1979, Wilson 1975). Domestic stock, including sheep, goats, and calves may also be taken (MZT, unpubl. data, Smithers 1966).

#### Health and Genetics

The Wildlife Unit of the Zimbabwe Department of Veterinary Services has investigated the deaths of 22 cheetahs over the past 20 years. Of the five wild cheetah deaths investigated, one died during translocation as a result of multiple causes related to its poor condition, one was killed for hunting livestock, one was euthanased after a road traffic accident, and the causes of the remaining two deaths were unknown. Of the 17 investigated deaths that occurred in captive animals, six were killed by ingestion of anthrax infected meat, two by pneumonia, one by nephritis, one by asphyxiation, one by exsanguination as a result of flea infestation, one by accidental poisoning, one was euthanased due to fracture of the vertebral column, and four were due to unknown causes (Foggin, unpubl. data). No data are available on genetics.

#### Human Population

Data collected from the Zimbabwe Census Office indicates that between 1992 and 2002 the human population increased by an average of 1.1% per year to over 11.6 million. The four provinces in which cheetahs are thought to occur in greatest numbers (Matabeleland North and South, Midlands and Masvingo) are among the provinces with the lowest human population densities in Zimbabwe (9-30 people/km<sup>2</sup>). The number of people living in resettlement areas has grown by 87%, the largest increase of any land use type, while the population on large-scale commercial farmland has fallen by 16%.

#### Threats and Problems

Competition with large carnivores may limit the cheetah population size within protected areas (Durant 2000, Laurenson 1995). This may be why 80% of cheetahs in Zimbabwe are thought to occur on private farmland where lions *Panthera leo* and spotted hyenas *Crocutta crocutta* have been eliminated (Stuart & Wilson 1988). This brings cheetahs into conflict with humans in several ways. Farmers report that cheetahs prey on livestock, and although in Zimbabwe permits are issued to enable legal destruction of problem cheetahs,

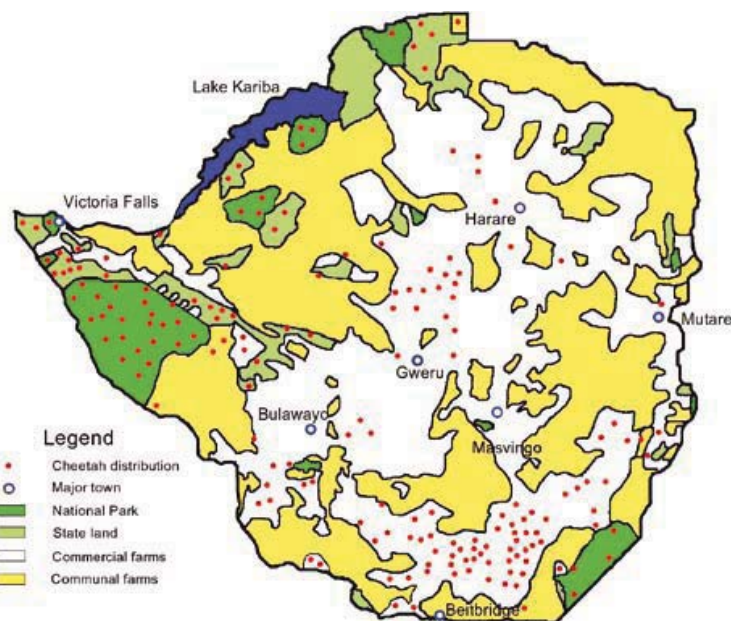


Fig. 2. Distribution of the cheetah in Zimbabwe in 1987. Subsequent studies have revealed similar distributions. Adapted from Wilson (1988).

the system is slow and cumbersome, and many farmers are thought to destroy cheetahs illegally (Purchase 2004, Wilson 1988). Myers (1975) reported that 28 of around 40 ranchers interviewed in Zimbabwe in 1972 removed cheetahs from their property illegally in the previous three years, and he estimated that 100 cheetahs per year were destroyed by livestock farmers in Zimbabwe's lowveld (low elevation southern areas) alone. Illegal removals of cheetahs on farm land is believed to have halved the cheetah population of Namibia during the 1980s (Morsbach 1987), and it may be a major threat to cheetahs in Zimbabwe, although as the number of commercial farmers operating in Zimbabwe is decreasing (Commercial Farmers Union, unpubl. data), this may become less important.

In an attempt to reduce illegal removals, the Convention on International Trade in Endangered Species of Wild Flora and Fauna (CITES) approved a quota of 50 cheetahs to be trophy hunted in Zimbabwe and exported annually since 1992 (CITES 1992). However, in order for an export quota to be approved, evidence must be supplied to demonstrate that the off take would not

be detrimental to the population. The quota was approved, despite the fact the no such evidence was ever submitted (Purchase 2004). There is currently no way of monitoring the effects of hunting on trophy quality, as trophy quality is not recorded by PWMA (Purchase 2004). Therefore it is not known if trophy hunting is a threat to the cheetah population.

The FTLRP could potentially be a very serious threat to cheetahs, due to increased habitat loss. Wildlife and livestock commercial farms thought to be most suitable for cheetahs are being converted to subsistence crop farms through the FTLRP, which may support lower cheetah densities (MZT, unpubl. data, Wolmer 2005). This threat has not been studied in detail, but it could be very important to the future of cheetahs in Zimbabwe.

#### Solutions

The CITES trophy hunting export quota system aims to encourage landowners to tolerate the presence of cheetahs by allowing them to gain income by selling cheetah hunts, although Purchase (2004) suggests that this has not improved tolerance.

#### Policy and Legislation

Cheetahs are specially protected in Zimbabwe under the 1996 revised Parks and Wildlife Act, and as such cannot be removed without permission from the Director General of PWMA (Anonymous 1996, Davison 1999b, Purchase 2004). A permit is required from PWMA in order to keep captive cheetahs. In order to breed cheetahs a breeder's permit is additionally required from PWMA. Cheetahs are also listed on Appendix 1 of CITES, prohibiting international trade of cheetahs or cheetah products in all but under certain circumstances, such as the export of privately owned trophies hunted under a quota granted by CITES to aid their conservation (CITES 1992). Cheetahs can be removed as problem animals or as trophies if permits are obtained from PWMA. There is no Red Data Book for Zimbabwe, although Sharp (1986) provided a Red Data Book inventory in 1986. He did not classify the cheetah into a Red Data Book category.

PWMA has used translocation of problem animals as a conservation tool. Between 1993 and 1994 fourteen adult cheetahs (eight males and six females) and three juvenile cheetahs were captured on private ranches as problem animals and translocated to Matusadona National Park (Zank 1995, cited in Purchase 1998). The translocated cheetahs appear to have become established in the park, and formed a breeding population (Purchase & Vhurumuku 2005). Chipangali Wildlife Trust captured a number of nuisance cheetahs, which it held in captivity, sometimes for several years, and subsequently released into National Parks. They released a pair of cheetahs into Matobo National Park in 2002, which still occur in the area (Wilson 2006). A group of four cheetahs were released into Hwange National Park in 2003, but three are now dead or missing and only one survived (Wilson 2006). A second group of cheetahs was reintroduced to the park (group size and release date not reported), and is thought to have become established (Wilson 2006). A pair of cheetahs were released into the park in 2005, and this release was also considered to be successful (Wilson 2006).

### Sustainable Use

No direct data are available from PWMA on the number of cheetahs hunted as trophy animals, but the numbers of cheetah trophy export permits allocated is given in Table 1 as an indication of this.

### Trade

#### Legal trade

Myers (1975) noted that 10 cheetah skins were legally exported between 1968 and 1972. Table 1 gives data on the number of CITES export tags issued since the trophy hunting export quota was introduced in 1992. Prior to 2005, export tags could be purchased at any time after the animal was hunted (often several years), meaning that a reasonable estimate of the number of export tags allocated for animals hunted in a given year cannot be calculated until several years later (G. Purchase, pers. comm.). The data provided in Table 1 should therefore be treated with caution. To address this problem the legislation was changed. From 2005 onwards if an export tag was required, the application must be made before the end of the year in which the cheetah was hunted (G. Purchase, pers. comm.).

The number of trophies exported has always been less than 50% of the maximum of 50 cheetah trophy exports permitted per year. Although no data are available from PWMA on the total number of cheetah on quota per year, the number of cheetahs for which trophy hunting quotas are applied is always greater than the maximum permitted (Masulani 1999). It is not clear if the low off take is attributable to failures of safari operators to sell sufficient hunts, failures of hunting clients to successfully hunt a cheetah, cheetahs being trophy hunted but not exported, or a combination of these factors (Purchase 2004). It is not known if the current off take is sustainable.

#### Illegal trade

There are little data available on current illegal trade in cheetahs in Zimbabwe. However, Myers (1975) came across 34 skins without documentation for sale from Zimbabwean fur dealers during his 3 month survey in 1972.

### Cheetahs in Captivity

The current international cheetah stud-

**Table 1.** Numbers of metal CITES export tags allocated since cheetah trophy hunting was permitted in Zimbabwe by CITES in 1992. Data were collected from PWMA records at PWMA Head Office. Data collected in 2003 are from Purchase (2004). Data for 2006 were collected for this report. \*These figures are likely to be lower than the actual values, as they were collected within 5 years of the hunting period being investigated.

Year cheetah was hunted	Metal export tags allocated	Year data collected
1992	7	2003
1993	8	2003
1994	5	2003
1995	24	2003
1996	12	2003
1997	4	2003
1998	5	2003
1999	10*	2003
2000	3*	2003
2001	7*	2003
2002	8*	2003
2003	11*	2006
2004	1*	2006
2005	2	2006
2006	1	2006
Mean 7.6, Total 68		

book lists only two cheetahs in one facility in Zimbabwe in 2005 (Marker 2007), but they have now left the country (V. Wilson, pers. comm.). There are currently three captive cheetahs in Zimbabwe kept at two private facilities: one facility is training two male cheetahs for outreach work, and one rancher has a single female cheetah. There are no known breeding centres in Zimbabwe.

### Future Conservation Measures

An accurate assessment of the current cheetah population size and distribution is urgently needed to determine the status of the cheetah in Zimbabwe, and would help to assess the suitability of the trophy hunting quota. Trophy size should also be monitored in order to study the effects of hunting on the population. Research into the effect of the FTLRP on the status of the cheetah could help to guide future land use planning, management and development policies to minimise the impact on the cheetah, such as maintaining corridors between isolated cheetah populations. Research into non-lethal predator management techniques would allow the most efficient and cost effective techniques to be identified. This could be run in conjunction with an education programme, to show farmers how they can minimise

their livestock losses while reducing the impact on the cheetah population. An awareness programme aimed at children may also help to improve tolerance of cheetahs. Some of these issues are being addressed by MZT.

### Acknowledgements

I gratefully acknowledge the assistance of Dr Gianetta Purchase, Justice Muvengwi, Dr Chris Foggin, Roxy Dankwerts, Kelly Marnewick, the Natural History Museum of Zimbabwe, the Commercial Farmers Union, Marwell Zimbabwe Trust, Dr Russell Hill, Vivian Wilson, and PWMA for the information or support they provided for this report.

### References

- Anonymous. 1996. Parks and Wild Life Act. Chapter 20:14. Rev. edition 1996. 48 pp.
- Bashir S., Daly B., Durant S. M., Forster H., Grisham J., Marker L., Wilson K. and Friedmann Y. (eds) 2004. Global cheetah (*Acinonyx jubatus*) monitoring workshop: final workshop report. Global cheetah monitoring workshop, Ngorongoro Conservation Area, Serengeti, Tanzania. IUCN/SSC Conservation Breeding Specialist Group and Endangered Wildlife Trust. 86 pp.
- Child G. and Savory C. R. 1964. The distribution of large mammal species in Southern Rhodesia. *Arnoldia Rhodesia* 1, 1-15.



- Convention on the International Trade of Endangered Species of Wild Flora and Fauna CITES. 1992. Quotas for trade in specimens of cheetah. Doc 8.22 (Rev.). Eighth meeting of the Convention of International Trade in Endangered Species of Wild Flora & Fauna, pp. 1-4.
- Davison B. 1999a. An estimate of the status of the cheetah in Zimbabwe. Zimbabwe Department of National Parks and Wildlife Management, Harare. 4 pp.
- Davison B. 1999b. Zimbabwe's cheetah policy and management plan. Zimbabwe Department of National Parks and Wildlife Management, Harare. 8 pp.
- du Toit R. 2004. Review of wildlife issues associated with the land reform programme in Zimbabwe. World Wide Fund for Nature (WWF), Southern African Regional Programme Office, Harare. 63 pp.
- Durant S. M. 2000. Predator avoidance, breeding experience and reproductive success in endangered cheetahs, *Acinonyx jubatus*. *Animal Behaviour* 60, 121-30.
- Heath D. 1997. Leopard and cheetah management in Zimbabwe. Ministry of Environment and Tourism, Zimbabwe Department of National Parks and Wildlife Management, Harare. 4 pp.
- Kingdon J. 1997. The Kingdon field guide to African mammals. Academic Press, San Diego. 464 pp.
- Laurenson M. K. 1995. Implications of high offspring mortality for cheetah population dynamics. In Sinclair A. R. E. and P. Arcese P. (eds). *Serengeti II: Research, conservation and management of an ecosystem*. University of Chicago Press, Chicago, pp. 385-399.
- Marker L. 1998. Current status of the cheetah (*Acinonyx jubatus*). In Penzorn B. L. (ed). *Proceedings of a symposium on Cheetahs as Game Ranch Animals*, Onderstepoort, South Africa. De Wildt Cheetah and Wildlife Trust, Pretoria, pp. 1-17.
- Marker L. 2007. 2005 International cheetah studbook. Cheetah Conservation Fund, Otjiwarongo. 61 pp.
- Marker L., Dickman A. J., Mills M. G. L. and Macdonald D. W. 2003. Aspects of the management of cheetahs, *Acinonyx jubatus jubatus*, trapped on Namibian farmlands. *Biological Conservation* 114, 401-412.
- Masulani R. 1999. Cheetah and leopard in Zimbabwe and the CITES quota. Zimbabwe Department of Parks and Wildlife Management, Harare. 11 pp.
- Morsbach D. 1987. Cheetah in Namibia. *Cat News* 6, 25-26.
- Myers N. 1975. The cheetah, *Acinonyx jubatus*, in Africa. *International Union for the Conservation of Nature, Morges*. 90 pp.
- Purchase G. K. 1998. An assessment of the success of a cheetah re-introduction project in Matusadona National Park. Unpublished MSc thesis, University of Zimbabwe, Harare. 118 pp.
- Purchase G. K. 2004. Evaluation of the CITES tag incentive system to promote co-existence between farmers and cheetahs and leopards in Zimbabwe. Marwell Zimbabwe Trust on behalf of the Parks and Wildlife Management Authority, Bulawayo. 13 pp.
- Purchase G. K. and du Toit J. T. 2000. The use of space and prey by cheetahs in Matusadona National Park, Zimbabwe. *South African Journal of Wildlife Research* 30, 139-144.
- Purchase G. K. and Vhurumuku G. 2005. Evaluation of a wild-wild translocation of cheetah (*Acinonyx jubatus*) from private land to Matusadona National Park, Zimbabwe (1994-2005). *Zambezi Society, Bulawayo*. 32 pp.
- Sharp G. J. 1986. Inventory Report - IUCN Red Data Book. Parks and Wildlife Management Authority, Harare. 8 pp.
- Smithers R. H. N. 1966. *The mammals of Rhodesia, Zambia and Malawi*. Collins, London. 159 pp.
- Smithers R. H. N. and Wilson V. J. 1979. Check list and atlas of the mammals of Zimbabwe, Rhodesia. *The Trustees of the National Museums and Monuments of Rhodesia, Salisbury*. 193 pp.
- Stuart C. T. and Wilson V. J. 1988. *The cats of southern Africa*. Chipangali Wildlife Trust, Bulawayo. 32 pp.
- White J. 1996. Survey of cheetah and leopard population on commercial farms. *Wildlife Producers Association, Harare*. 6 pp.
- Wilson V. J. 1975. *Mammals of the Wankie National Park, Rhodesia*. The Trustees of the National Museums and Monuments of Rhodesia, Salisbury. 147 pp.
- Wilson V. J. 1984. The distribution and present day status of the felids of Zimbabwe. *Chipangali Wildlife Trust, Bulawayo*, pp. 2-6.
- Wilson V. J. 1988. *Distribution and status of cheetah in Zimbabwe*. Chipangali Wildlife Trust, Bulawayo. 27 pp.
- Wilson V. J. 2006. Up-date of all research projects December 2006. *Chipangali Wildlife Trust, Bulawayo*, 30 pp.
- Wolmer W. 2005. Wilderness gained, wilderness lost: wildlife management and land occupations in Zimbabwe's south-east lowveld. *Journal of Historical Geography* 31, 260-280.

### Appendix I - List of projects

Marwell Zimbabwe Trust is conducting research into the status and distribution of cheetahs in Zimbabwe, outside of Parks Estates and running an education project with the aim of minimising human-cheetah conflict.

Chipangali Wildlife Trust (Wildlife Research Unit) is also conducting a survey of cheetah status and distribution in Zimbabwe.

The Zambezi Society is conducting research within the Zambezi basin, including an investigation of the distribution of cheetahs.

Roxy Dankwerts is training two cheetahs for community outreach work.

### Appendix II - Organisations involved

Marwell Zimbabwe Trust, PO Box 3863, Bulawayo, Zimbabwe  
carnivore@dambari.com  
+263 9 280029/30

Chipangali Wildlife Trust (Wildlife Research Unit), PO Box 105, Bulawayo, Zimbabwe, duiker@ecoweb.co.zw

The Zambezi Society, PO Box, HG744, Highlands, Harare, Zimbabwe  
zambezi@mweb.co.zw  
+263 4 747002/3/4/5

Roxy Dankwerts, Chedgelow Farm, Box AP 32, Harare Airport  
roxy@mycheetah.org  
+263 4 575180

### Appendix III - Responsible Authority

Zimbabwe Parks and Wildlife Management Authority, PO Box CY140, Causeway, Harare, Zimbabwe  
natparks@africaonline.co.zw  
+263 4 706077/8

# Appendix 3

Interview schedule

## MZT carnivore survey

### A - Interview and respondent information

Date:	Interviewer:
Language:	Coordinates:
LUT of interview:	Interview location:
LUT discussing:	Area discussing:
Years of residence in area:	Cultural group:
Age:	Sex:
Job:	

### B – Wildlife occurrence

1. In your farm/village/grazing area, which of these carnivores
  - a. Have you seen?
  - b. Are problem animals?
  - c. Have you ever tried to trap or kill?

	Seen	Problem	Trap/kill
Cheetah			*
Wild dog			
Leopard			
Lion			
Spotted hyena			
Brown hyena			

\* give details

2. How frequently (e.g. never, once per year etc) in your farm/village/grazing area do you see cheetahs?

3. Please give details of all clearly memorable cheetah sightings in the table below:

Species	Date	Time	Location	LUT	Km from here	° from here	Adults	Young	Total	Behaviour

4. In your farm/village/area:
  - a. How many cheetahs are there?
  - b. What is the maximum number of cheetahs?
  - c. What is the minimum number of cheetahs?
5. Do you think that the number of cheetahs that live in this area is larger/the same/smaller than it was 10 years ago?
6. What are the reasons for these trends?
7. Do you have any cheetah marking spots on your farm/village/grazing area (give details)?

Character:

Species knowledge                      /10  
 Precision                                      /10

Consistency /10  
 Cooperativeness /10

C – livestock and predation

8. How many of the following animals did you have 12 months ago, how many do you have at present, and how many have you gained?

	Now	12 Months ago	Gained in last 12 months
Cattle			
Goats			
Sheep			
Donkey			
Chickens			
Other			

9. How many of your animals have been lost in the past 12 months?

	Slaughtered	Sold	Given Away	Predation	Disease	Stolen	Accident	Lost	Other
Cattle									
Goats									
Sheep									
Donkey									
Chickens									
Other									

10. How many of your livestock were killed by cheetahs in the past 12 months?

Adult cattle	Young cattle	Small stock	Chickens	Other

11. Which predators are the biggest problem on your farm/village/grazing area (please rank):

1	4
2	5
3	6

12. What is the distance (km) between your home and your grazing area?

13. Which of the following techniques to protect livestock from predation on your cattle and small stock have you used in the last 12 months?

Kraaling at night		Protective collars (specify)	
Calving camps		Animal to chase predators (specify)	
Scarecrow		Dog to warn me of predators	
Synchronised breeding		Fencing (specify e.g. predator-proof)	

High game density		Swing gates	
Herding (specify no. animals and herders)		Trapping	
Bell collars		Lethal control (specify)	

14. Are you aware of any other techniques that can be used to protect you livestock (specify)?
15. Compared to 10 years ago, within the last 12 months you have:
- Lost more livestock to predation
  - Lost about the same number of livestock to predation
  - Lost fewer livestock to predation
16. What are the reasons for these trends?

*D - Attitudes, knowledge and traditional culture*

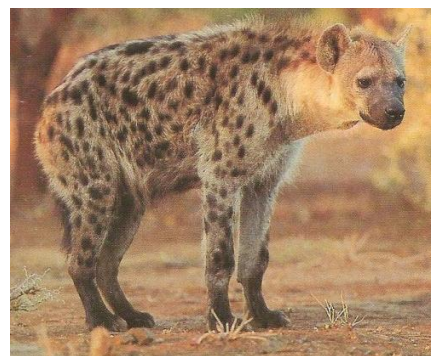
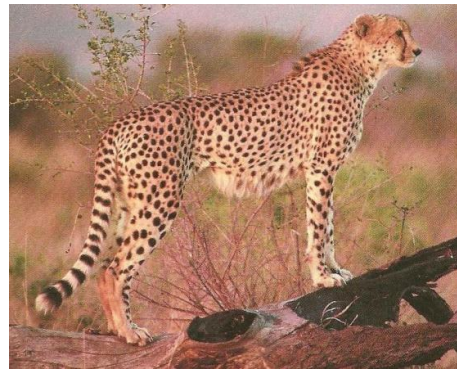
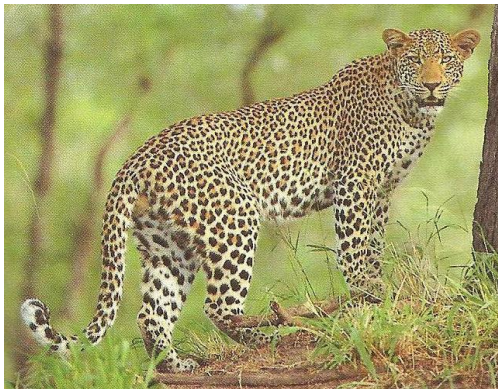
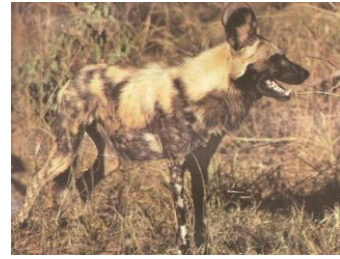
17. How strongly do you like/dislike the following animals?

	Strongly dislike (1)	Mildly dislike (2)	Neutral/don't know (3)	Mildly like (4)	Strongly like (5)
Cheetah					
Wild dog					
Leopard					
Lion					
Spotted hyena					
Brown hyena					

18. Why do you like or dislike cheetahs?
19. In your area would you like to have fewer, more or the same number of cheetahs?
20. How many small stock would you be willing to lose to cheetahs before you tried to kill a cheetah?
21. Are the following statements true or false? Cheetahs...
- |   |                   |
|---|-------------------|
| a. can run at over 100km/h                                    | <b>True/False</b> |
| b. often kill people  | <b>True/False</b> |
| c. only eat meat  | <b>True/False</b> |
| d. roam freely today in North America                         | <b>True/False</b> |
| e. can breed with domestic cats to produce live, fertile cubs | <b>True/False</b> |
22. What is your religion?
23. How many years of formal education have you had?

# Appendix 4

Photographs used to identify carnivores



## **Appendix 5**

Nyoni, W. and Williams, S. (2008) Living with predators: a farmers guide. Marwell Zimbabwe Trust, Bulawayo.



# Living With Predators



## *A Farmer's Guide*

Wonder Nyoni  
Sam Williams



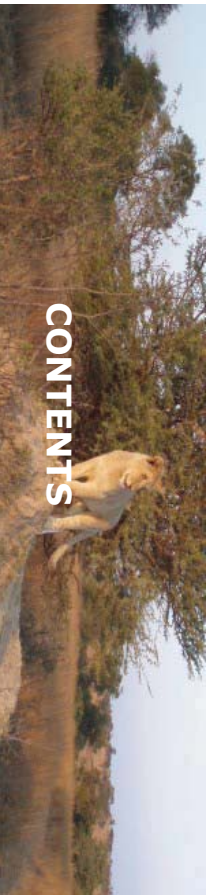
# Living With Predators



## *A Farmer's Guide*

Wonder Nyoni  
Sam Williams





We gratefully acknowledge the financial support provided by the Howard G. Buffett Foundation, Sea World Busch Gardens, the Belt Trust, Marwell Preservation Trust, Paignon Zoo, and Colchester Zoo. Thanks also to Angiesea Farm, Dornoch Estates, The Glade farm, Africa Centre for Holistic Management and Dr Gianetta Purchase for providing information on anti-predator livestock management techniques used in Zimbabwe. Thanks to the Endangered Wildlife Trust (EWT), Cheetah Conservation Fund (CCF), Cheetah Conservation Botswana (CCB) and Chris and Tilde Stuart for allowing material to be reproduced from the following publications:

Hodkinson, C., Davies-Mostert, H., Komen, H. and Snow, T. (2007) Predators and farmers. Endangered Wildlife Trust, Johannesburg.

Jones, B., Karen, S. Sullivan, B., Letubo, W., Klein, R., Antrobus, C., Good, K., Houser, A.M., Maiketso (2007). Cheetah: a predator resource for the students of Botswana. Cheetah Conservation Botswana, Gaborone.

Schumann, M. (2004) Integrated livestock and predator management: A farmer's guide. Cheetah Conservation Fund, Ojjiwarongo.

Stuart, C. and Stuart, T. (2003) A field guide to the tracks and signs of southern and east African wildlife. Third edition. Struik, Cape Town.

*This edition has been printed for evaluation purposes*

**Photo credits:**  
 Many thanks to EWT, CCF, CCB, Villiers Steyn, Marwell Zimbabwe trust, Sam Williams, Nicola Lunt, Kelly Marmewick, Africa Centre for Holistic Management, Cape Nature, Philip Daniel, Chris and Tilde Stuart, The Zambezi Society, and PAL collars for allowing their photographs to be published in this book.

Published by Marwell Zimbabwe Trust, Bulawayo © 2008. Evaluation edition. All rights reserved. Printed in Bulawayo by RCP printers. With the exception of the images reproduced here (which may be copyrighted by third parties), the information in this booklet may be used freely, for non-commercial purposes only.

Marwell Zimbabwe Trust will not be held responsible for any condition/s that may arise from any action or from any wildlife predator management system or method discussed in this guide. It remains the sole responsibility of the stock farmer to use products legally and strictly according to the instructions provided with such products.

	<b>Page</b>
Acknowledgements.....	ii
1.0 Introduction.....	1
1.1 Why are predators important?.....	2
1.2 Are predators 'problem animals' or opportunistic hunters?.....	3
2.0 Identifying the cause of death.....	4
2.1 Matching the predator with an appropriate technique.....	6
2.2 Spot the difference.....	9
3.0 Livestock management techniques to reduce predation.....	10
3.1 Kraals.....	10
3.1.1 Building different types of kraals.....	10
3.1.2 When to use kraals.....	14
3.2 Herding.....	15
3.3 Livestock collars.....	16
3.4 Livestock guarding animals.....	16
3.5 Predator-proof fencing.....	20
3.6 Synchronised breeding.....	22
3.7 High density of game.....	22
3.8 Lethal control.....	24
4.0 Conclusion.....	25
Appendix: Predator identification chart.....	26



**M**any predators, including the cheetah, are vulnerable to extinction. Protected areas support only a few cheetahs due to competition with more powerful predators. In Zimbabwe, about 80% of cheetahs depend on private land or land outside national park estates. Cheetahs and many other predators need the help of farmers to survive.

Predators do not kill animals for fun or to be spiteful, but because they need to eat meat. They prefer to hunt wild game when available rather than domestic livestock. When farmers lose livestock to predators there are a number of ways to reduce these losses, but some farmers resort to lethal control measures, often illegally. This can make the problem worse for the farmer, while putting predator species at risk of extinction. However, farmers can coexist with most predators, including cheetahs, if appropriate management practices are used.

Marwell Zimbabwe Trust (MZT) is a non-profit organisation that was founded in 1997 to conserve wildlife and promote sustainable utilisation of natural resources in southern Africa. The MZT cheetah project aims to help farmers reduce their livestock losses to predators and minimise their conflict with cheetahs and other predators. This booklet provides information for farmers about livestock management techniques that have been shown to reduce livestock predation. Many of these cost little to implement, but could benefit both farmers and predators.

Please contact us at the address below if you would like any further advice concerning anti-predator livestock management, or if you are having a problem with livestock predation by cheetahs.

Marwell Zimbabwe Trust Cheetah Project  
 PO Box 3863  
 Bulawayo  
 Tel: 09 280029/30  
 Email: [carlivoire@dambari.com](mailto:carlivoire@dambari.com)  
[education@dambari.com](http://education@dambari.com)

Please also notify the Parks and Wildlife Management Authority (PWMA) office nearest to you or your local Rural District Council of losses.

Parks and Wildlife Management Authority (Head Office)  
 P O Box CY 140  
 Causeway  
 Harare, Zimbabwe  
 Tel: 04 703376, 707624/9  
 Fax 04 724914, 792782  
 Email: [natparks@africaonline.co.zw](mailto:natparks@africaonline.co.zw)



### 1.1 Why are predators important?

**T**he positioning of predators at the top of the food chain makes them ecologically important. Predators play a vital role in controlling and managing prey populations, especially small mammals such as rodents, hares, and dassies, which can damage crops or reduce the amount of grazing available.



Caracal diet includes dassies, hares and rodents

Since predators are at the top of the food chain, they are particularly vulnerable to environmental disturbance. Their presence in an area often indicates a healthy ecosystem, so farmers who have predators on their properties should be proud!



Sick reedbuck killed and fed upon by a Cheetah

Predators may also attract tourists and some can be harvested for trophies



Leopards are popular as trophies for hunters



If you found money (which didn't appear to belong to anyone) would you pick it up?

<p>Is this man opportunistic or a thief?</p>	<p>This man is opportunistic</p>
<p>Is this cheetah opportunistic or a problem predator?</p>	<p>Predators are also opportunistic. Protect Your Livestock</p>

**'Problem animal' or poor management?**

- Every farmer that puts livestock onto the veld is responsible for the survival of that livestock should not be to the detriment of a system that existed before farming ever started in the country
- Predators and scavengers are opportunists
- If a meal presents itself, they grab it, not always knowing when the next meal will come along
- If predators are repeatedly presented with the opportunity to hunt livestock, they may become habitual livestock hunters
- It's better to prevent the "problem predator" developing in the first instance
- Livestock losses to predators can be reduced by using sound live-stock management techniques

There are many causes of livestock mortality. It may be easy to blame wild predators for killing livestock, when in fact other causes may be responsible, such as:

- Disease
- Injury
- Theft
- Drought
- Domestic dogs

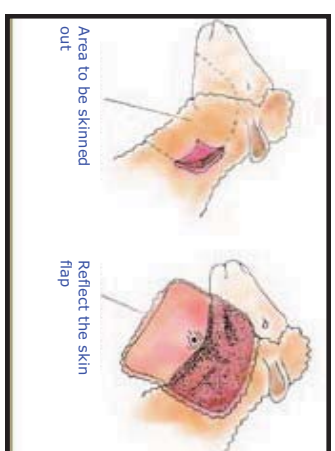
All livestock losses should be investigated in order to determine the cause, so that further losses can be prevented. The following steps can be used in conjunction with the predator identification chart provided at the back of this book (page 26) to identify which predator may have been responsible. However, it should be noted that killing and feeding patterns may vary significantly among individuals and also overlap extensively between species.



The teeth of animals affect what kinds of food they can eat. The bat eared fox eats insects, and its teeth are too small to allow it to eat meat.

**Step I**

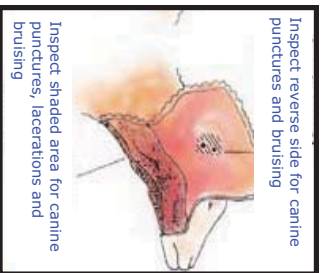
Before you disturb the ground around the carcass, look out for paw prints and refer to the spoor identification key in the predator identification chart.



**Step II**

It is important to determine whether the animal was killed by a predator or died of other causes.

- ◆ Skin out the throat, beginning on the side of the neck, slightly behind the ear.



- ◆ Fold back the flap of skin and look for puncture wounds and bruising on the throat and reverse side of the skin, which would indicate predation. Measure the distance between any puncture wounds and compare with the predator identification chart.
- ◆ Cut open the food pipe and wind pipe and look for foam. Check inside mouth for regurgitated stomach contents. These signs suggest that the animal was alive when the injuries occurred.

- ◆ You may also decide to skin the whole carcass in order to identify bites elsewhere on the body.

**Step III**  
Estimate the size of the animal that was killed. Refer to predator identification chart.

**Step IV**  
Examine the carcass carefully and systematically for wounds, to determine which parts were eaten. Refer to predator identification chart.

**Step V**  
If you do not find any signs of injuries that occurred before the animal's death, it is unlikely that it was killed by a predator. Predator control measures are therefore not necessary. Remember that if animals fed on or near the carcass that does not necessarily mean that they were responsible for the animal's death. Animals including the side-striped jackal, aardwolf, bat-eared fox, serval, small spotted cat, aardvark and porcupine do not prey on small stock or cattle, but they are often blamed and killed retaliation for losses that they are not responsible for. These animals may be seen near livestock kills as many of them feed on carrion or insects that are found at kills.

If you find evidence that the animal was killed by a predator, make sure that you employ appropriate livestock management techniques to reduce the chances of further stock loss occurring (see section 3).



**Black-backed jackal**

*Canis mesomelas*  
Ikhanka (Ndebele), Gava (Shona), Mhungubwe (Khalanga), Phokojwe (Sesotho)

Black-backed jackals seldom enter cage traps. Management measures should therefore employ exclusion systems such as fencing and kraaling animals at night. They often kill lambs, so kraaling breeding small livestock is necessary. Guarding dogs may also be effective.



**Leopard**

*Panthera pardus*  
Ingwe (Ndebele), Mbada (Shona), Ngwe (Khalanga), Lengau (Sesotho)



Leopards are usually nocturnal animals and will may prey on unprotected livestock at night. Leopards are known to climb into kraals, especially if there are branches of adjacent trees hanging into the kraal. In one study, farmers who used scarecrows to deter predators experienced more livestock attacks from leopards. Appropriate control measures against the leopard include the use of kraals with tall walls and thorn bushes along the top, calving camps, mobile kraals, herding, fencing and using warning dogs or livestock guarding animals.

**Spotted Hyaena**

*Crocuta crocuta*  
Impisi (Ndebele), Bere (Shona), Mhele (Kalanga), Phiri (Sesotho)

Spotted hyaenas may kill livestock including adult cattle. Livestock management techniques that include kraaling animals at night can be very effective. Spotted hyaenas typically hunt during the night, so it is important to locate kraals near areas of high human activity near settlements. Using domestic dogs to warn people if predators approach may also help reduce predation.



**Cheetah**

*Acinonyx jubatus*  
Ihlosi (Ndebele), Dindingwe (Shona, Kalanga), Letlotsi (Sesotho)

Cheetahs hunt mainly during morning hours and late afternoons, so they may pose a threat to livestock during their grazing times. Cheetah attacks on livestock can be reduced if livestock management techniques such as cattle herding, calving camps, kraaling calves and lambs, use of repellents such as noise and warning dogs or livestock guarding animals are used.



**Caracal**

*Felis caracal*  
Ithwane (Ndebele), Ntwana (Shona), Thoane (Sesotho)



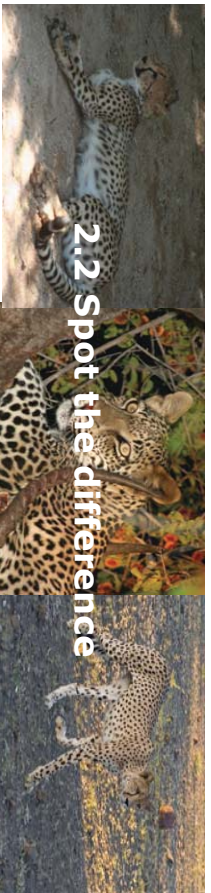
Caracals can develop a taste for livestock, but this can be avoided if the correct preventative methods to protect livestock such as fencing and kraaling have been implemented (see section 3 for anti-predator techniques). Caracals readily enter cage traps which have been properly set and therefore problem individuals can be readily captured and relocated.

**Lion**

*Panthera leo*  
Isilwane (Ndebele), Shumba (Shona), Humba (Kalanga), Tau (Sesotho)

Due to their large size, lions may be difficult to deter from attacking livestock. Use of donkeys to protect livestock from lion attacks has proven successful in Kenya. Other effective livestock management techniques include kraaling stock at night in robust kraals made of solid walls. Stones and acacia branches can be used to construct compact kraals. However, lions also appear to be reluctant to jump on walls made up of packed loose stones.





## 2.2 Spot the difference

Cheetahs and leopards are two different predators that often occur in areas outside of National Parks and other protected areas. They are in some respects similar in appearance and behaviour, but there are important differences and characteristics that help identify one from the other.



**CHEETAH** (Ihlosi/Dindingwe)

**Head:** Small, has black 'tear' marks from eyes to mouth

**Body:** Thin, with long legs. Tail has black and white bands at the end

**Spoor:**



**Spots:**



**Habits:**

- Mainly daytime hunters.
- Males routinely mark trees, anthills or dwalas
- Can be solitary or occur in groups
- Does not return to kills
- Hunts by stalking prey, then sprinting after it and tripping the prey animal
- Suffocates prey animal, regains its breath and then feeds as quickly as possible



**LEOPARD** (Ingwe/Mbada)

**Head:** Wide with large canines, no tear marks

**Body:** Short thick body with stocky legs

**Spoor:**



**Spots:**



**Habits:**

- Predominantly night-time hunter
- Usually solitary, except mother with cubs
- Will store a kill in a tree or under cover of vegetation
- Hunts by stalking and then pouncing on prey
- Suffocates prey



## 3.0 LIVESTOCK MANAGEMENT TECHNIQUES TO REDUCE PREDATION

Zimbabwe has laws to conserve biodiversity and ensure protection of threatened and endangered species, including predators. In Zimbabwe the cheetah (*Acinonyx jubatus*), aardwolf (*Proteles cristatus*) and the banded fox (*Otocyon megalotis*) are classified as specially protected species. Hunting or removing these animals from any land is a criminal offence unless a permit has been issued under section 46 of the 1996 Parks and Wildlife Act by the Minister of Environment and Tourism. Killing or removing any animal, even those not listed as specially protected, is only allowed in the protection of human life.

Farmers experiencing problems with wild animals should therefore seek advice from wildlife authorities before exterminating them. Predation problems should be reported to the local Rural District Council. District or regional offices for Parks and Wildlife Management Authority (PWMA) should also be contacted for advice. As a last resort, the PWMA may issue a permit for translocation of the animal in the event that all other recommended non-lethal predator management techniques fail to be effective. This section discusses techniques that can be used by farmers to reduce predation.



### 3.1 Kraals

Kraals (also known as camps or bomas) are small enclosures into which livestock are brought when they are most vulnerable to predation. Kraals also protect livestock against theft, and make it easier for farmers to monitor the health of their animals.

#### 3.1.1 Building different types of kraals

To construct a kraal, you can make fencing from thorn branches, wood, wicker, wire, stone or other materials. If using thorn branches, arrange the branches with the trunks facing inside the kraal so that the thorns face outwards. Always remember that the kraal is only as strong as its weakest point. The fencing should be strong and high enough to deter whichever predators inhabit your area, and ideally provide both a physical and a visual barrier. Kraals work best when they are located near settlements, in areas of high human activity. They should not be placed in areas where predators are frequently seen. Clearing the bush around Kraals will reduce the cover available to predators. Make sure that you cut down any high

branches near the kraal, as leopards could use these to help them jump inside.

**Visual barriers**

A visual barrier is important in reducing the chances of attacks on livestock in kraals. This can be made from a number of different materials, but the important thing is that it stops the predators from seeing the animals inside the kraal. Some farmers use plastic sheeting, conveyor belting, hessian sacks, cloth, shade netting, wood, acacia branches or stone. In Kenya it was found that farmers that used kraals that predators could not see through reduced predation by up to 80% compared to kraals with no visual barrier. These materials are cheap and locally available, especially for communal and small scale farmers.



Conveyor belting is most suitable for small stock



before



after

When constructing a kraal with a visual barrier:

- Use opaque material to surround the kraal from the ground to at least 1m high for small stock, or 1.5m for cattle
- Make sure that the material is securely fastened onto the kraal and that there is no gap between the material and the ground.
- Bend down so that your eyes are at the height of predators' eyes and fill in any gaps in your visual barrier where you can see inside the kraal.

**Case study**

One farmer in the Figtree area kraaled livestock at night time and when calving, but was still experiencing losses to cheetahs and leopards. Predators could see through his kraal fencing, so he put old conveyor belting around the kraal to stop predators from seeing inside, and found that the predators stopped killing his livestock.



**Mobile Kraals**



Using this technique, farmers can move their herds to different areas in order to increase the grazing available, and take the kraal wherever their herd goes. These kraals are adapted from a technique used by the Lozi people in the western area of the Zambezi floodplains.

The first stage involves building "mats" made of young pliable branches usually of *Bauhinia* species but sometimes using Mopane branches.

These branches are woven together to make mats that are 2m high and 5m wide with supporting branches every 50cm. These supporting branches are sharpened at the top and bottom to prevent predators from crawling underneath, or climbing over the top.



Making a new mat





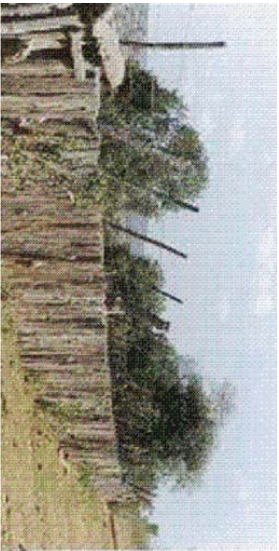
Inter-woven mopane branches form a mat

The mats are then placed upright so that they overlap until a suitable area to hold all the livestock is made. The mats are held upright by supporting poles. They can be placed in areas that have rocks and where the ground is uneven.



*Lion-proof kraals*

When larger and more powerful predators live in your area you will need to build a more robust kraal. If you need to protect your livestock from lions you should build your kraal with strong wooden walls that are at least 2.7m tall, with three strands of outward-angled barbed wire along the top. Make sure that you cannot see through the walls.



Lion Proof kraals must have tall, robust, opaque walls with barbed wire at the top



**3.1.2 When to use Kraals?**

*Kraaling at night*

Bringing livestock into kraals at night can be a very effective way of protecting them against predation by nocturnal predators such as spotted hyaenas. The livestock should be brought into the kraal before sunset, and can be taken out to graze around dawn. A study carried out in Kenya showed that livestock that were kraaled at night and closely herded by day were less likely to be killed by wild predators.

Case study

This method was used on Glade Farm, Shangani district, Zimbabwe where about 32 calves were killed by cheetahs between January and July 2001. After kraaling animals from about 4pm to 8am the next day, a considerable reduction in livestock loss was achieved.

*Calving/lambing camps*

Cattle and goats that are about to calve & lamb can be kept in kraals. The calves and lambs should be kept in the kraal with their mother for until they are 3 months old so that they can be protected when they are most vulnerable. Many farmers in Namibia utilise these camps for their breeding herds.



It is also helpful to coordinate your livestock breeding season with that of the resident wildlife, as predators will prey on the young of wildlife in preference to calves.

*Monitoring the health of calves becomes simpler*



### 3.2 Herding



Livestock herders in Botswana

When using this technique (also known as patrolling) a herder accompanies the livestock as they graze, and keeps watch for predators. Many predators are afraid of humans, especially if they make lots of noise. If the herder sees a predator he chases it away. This method is used extensively in east Africa, and is very successful at preventing both predation and theft of livestock. However, a study on human-predator conflict found that larger groups of child herders are less effective in preventing loss, as they tend to play and be less attentive than single herders.

- A farmer in the Matobo district of Zimbabwe uses this technique in the following way:
- The herd is collected one hour before the sun has risen, as this is the time predators such as cheetahs start hunting
  - The men stay with the herd, singing, clapping, banging sticks together and making lots of noise
  - The herds are left unattended from about 11am until 3pm in the afternoon, when they must be collected again and brought back to the kraal by the 'cheetah patrol', again making loud noise.

**Case Study**

The Anglesea farm in Figtree district lost 24 calves to predators between 1999 and 2000. After introducing a 'cheetah patrol' who herded the cattle in the early morning and the afternoon, only 4 calves were killed in 2002.



### 3.3 Livestock collars

#### Bell or scent collars

These collars work by distracting predators. They are easy to use. They must be used in conjunction with other methods, and cannot be used continuously or predators become used to them. They are best used at times when the risk of predation to livestock is at its highest, such as at lambing times.



Bell or scent collars become less effective as predators get used to them

#### Protective collars

These are designed to protect livestock by making it difficult for predators to bite the neck. They are reasonably priced, and can be easily adjusted and fitted to entire herds of small stock easily.



King collars are fitted to the necks of livestock and make it difficult for predators to kill by throat bite

The King Collar is made from PVC, which is ideal for preventing predators such as cheetahs from killing livestock.

The Dead Stop Collar is constructed from mesh wire, so is able to protect livestock against attacks by predators with a more powerful bite.



### 3.4 Livestock-guarding animals

Some farmers use animals to guard their livestock against predators. These may simply warn the farmer when predators approach, allowing him to chase the predator away, or the dog may actively chase away predators themselves. Both dogs and donkeys have been shown to be successful.

Donkeys

Donkeys are naturally aggressive towards predators, and will bray, chase or attempt to kick them. Many farmers find that using donkeys as guarding animals is both cost-effective and capable of protecting both small stock goats and cattle.



Donkeys are not afraid of predators. Their kick makes them formidable opponents.

When using donkeys as livestock-guarding animals, remember:

- The donkey must be female (or a castrated male) as stallions may even be aggressive towards livestock
- Use only one donkey per herd of up to 40 animals
- Female donkeys will protect the livestock more effectively if they are pregnant when put in with the herd. Ideally she should have her foal about 1 month before the livestock are due to calve or lamb.
- When the donkey has her foal she then will protect it against any predators and protect the cows and calves at the same time.
- Donkeys can be tested by challenging them with a large dog and seeing if they respond aggressively. If they do not react then they are unlikely to be good animals to use to protect cattle against predators. Use a donkey that is aggressive.
- Feed the donkey at the same time and place as you feed the livestock. This improves the bond between the donkey and the livestock.
- Donkeys generally require little veterinary care, but should be wormed once per year.

Donkeys are cheaper to care for than dogs, need no training, and can protect livestock against even large predators.



Dogs



Local breed of dog guarding goats in Botswana

being kraaled near a homestead. These dogs should never be allowed to roam freely away from the owner, as they may chase and kill wildlife.



Anatolian shepherd dogs with goats in Namibia

Alternatively, dogs can be trained to live with the livestock even when unattended by humans, and actively chase away predators. Larger breeds of dogs such as the Anatolian shepherd are used for this in Namibia and South Africa. However, this requires lots of time, patience, and careful training of the puppy from the age of six weeks to ensure that the dog stays with the herd, and is aggressive towards predators but not towards other wildlife or the livestock.

Note that the use of livestock-guarding dogs is not recommended in areas where African wild dogs occur, as one study in Kenya found that the presence of domestic dogs increased the chances of livestock attacks by African wild dogs.



### Training your dog to live with your herd and chase away predators

- The dog must be raised with the livestock from a pup, so the first step is to select the parents that will produce the pup. Choose parents that are known to be good livestock-guarding animals, that do not display overly shy or aggressive behaviour, and do not show inheritable health defects.
- Tell your neighbours that you are getting a dog so that they do not mistake the dog for a feral animal or a predator and trap or kill it.
- Introduce the pup to the herd at 6 weeks when it has been weaned. When first introducing a young puppy to a herd, place the puppy with some young livestock to avoid injury that may result from older aggressive animals.
- Build the pup's shelter and feed the pup in the kraal when the livestock are fed.
- The puppy must develop a bond with the young animals. The older livestock must be introduced gradually to the puppy. Livestock not accustomed to a guard dog may view the pup as an enemy. Over time, the livestock herd will become accustomed to the presence of the guard dog and they will tend to ignore the dog's presence.
- As the pup gets older and more playful correct any inappropriate behavior such as chasing or biting the livestock or wildlife and praise the pup for good behavior.
- Treat the dog as a working dog, not a pet.
- Consider neutering the pup at 6 months to prevent problems due to heat cycles in females and males seeking females on heat. Neutering of males or females does not diminish their guarding capability.
- The dog should stay with the herd at all times and should act aggressively towards predators. Ensure that the dog can also be handled when necessary.
- Consult a veterinarian and vaccinate, de-worm, and treat the dog as required. Monitor the health of the dog.

### 3.5 Predator-proof fencing

Surrounding your farm with predator-proof fencing can be an effective way of protecting your animals. This is one of the only techniques that is suitable for both livestock farmers and game farmers. However, erecting and maintaining the fence is very costly, so this option is not available to small-scale farmers. You should also consider the effects that fencing will have on the wildlife that use your farm. Predator-proof fences restrict movement of many wildlife species, so can obstruct migration routes and prevent animals from leaving your farm in search of food or water, which can result in high mortality of wildlife. You should think carefully about this before installing predator-proof fencing.



If you decide to install predator-proof fencing, your fence should be over 2m tall and electrified at the top and bottom. When using mesh wire, the strand spacing must be less than 15cm horizontally, and at less than 8cm vertically.



Predator-proof fence



#### Use of swing-gates on fences

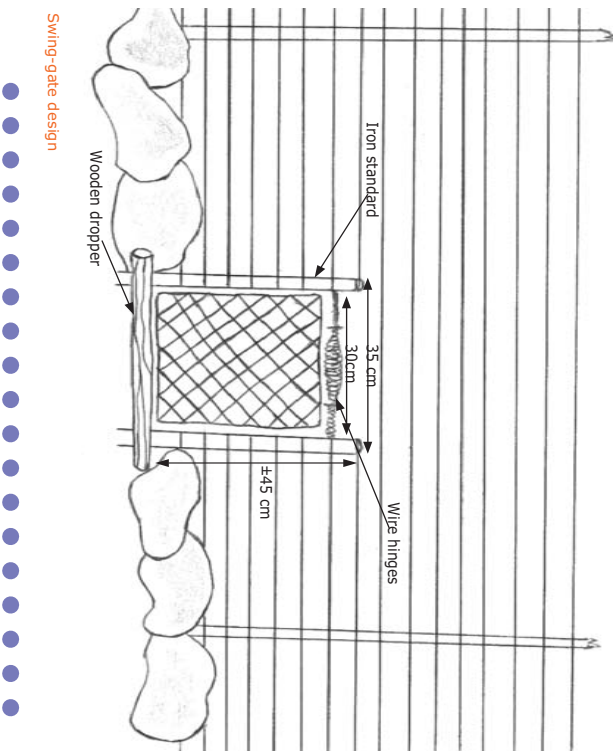
Many farmers that use fencing find that holes are often dug under the fences by digging animals such as the warthog, porcupine and aardvark. These holes also allow access to predators such as cheetahs. Some farmers attempt to eradicate digging species, but this is often non-selective and therefore affects non-target species. An alternative way of reducing the number of holes is to

electrify the fence. A much more economical method, however, uses swing-gates.

These gates open when pushed, but they leave no visual openings in the fence. Digging animals learn to use the gates, while the visual barrier deters other species from attempting to enter. This reduces the number of holes created under the fence by digging species, and therefore helps to exclude predators. Swing gates were tested in Namibia, where they successfully reduced the number of holes created under fences. Digging animals were photographed using the gates, while predators were photographed walking past the gates but not entering them.

Gates installed at sites where the most commonly used holes are found are the most effective. Sites near water sources or the burrows of digging

animals are also good places to install swing gates. It may help to tie the gates open for several weeks to allow digging animals to get used to using the gates. This technique works best on rocky ground, where it is difficult for animals to dig holes.



### 3.6 Synchronised breeding

Some wild animals produce young in seasons linked to rainfall, vegetation, and nutrition. At this time of year there is plenty of wild prey available for predators, so there is less chance that they will prey on the young of domestic livestock. If



livestock reproductive seasons are synchronised with those of wild game, the livestock will be at a reduced risk of predation. New born animals should be kraaled with their mothers and monitored closely (see calving camps, page 14).



### 3.7 High density of game

When given the chance, predators prefer hunting wild game rather than domestic livestock. Farms with high game densities therefore have a lower risk of predators killing their livestock. This also increases chances of co-existence between the farmer and predators.



Different carnivores prefer different prey preferences. For instance, cheetahs would generally prefer small-medium sized antelope even if livestock were readily available. Hence increasing densities of these antelope on a farm would help to reduce the risk of livestock being attacked by cheetahs. Lions generally prefer larger prey than cheetahs.

Ways of increasing game populations include:

- Providing adequate sources of water (water holes)
- Increasing productivity of the land to ensure adequate food source for game
- Protecting game from poachers



### 3.8 Lethal control

Lethal control of predators is often illegal unless permits are obtained from PWMA in advance. Lethal control can be an inefficient way of reducing predation, and may also harm many species.

Many species are killed for livestock predation, when in fact they are not responsible. Sometimes they are killed deliberately, but they are often killed accidentally when other predators are targeted using indiscriminate methods such as poisoning and gin trapping (snap traps or leg-hold traps).

Using poison to attempt to control predators responsible for livestock attacks is not recommended as it is likely have a big impact on the environment and kill lots of non-target animals. It may even contaminate your drinking water.

Even when lethal control affects only the target species (such as shooting), it may make predation problems worse. When a predator is killed, other predators will flood into the area to claim the territory. Furthermore, even if you are able to determine that livestock was killed by a cheetah, it could be very difficult to find and kill the individual cheetah responsible. Killing the first cheetah encountered may remove an animal that does not kill livestock, making the territory available for a potential livestock killer. Also, wounded predators are more likely to become livestock hunters since they are less able to hunt natural prey. Predators accustomed to continual persecution usually change habits, making them more difficult to control. Lethal control causes more problems than it solves.



Lethal control of predators may not solve problems with livestock losses



**P**redators can cause livestock losses, but these losses can be reduced by using appropriate management techniques. In general, livestock that are closely herded by day and kept in kraals at night, guarded by livestock-guarding animals in areas with high levels of human activity are less likely to be killed by predators. Factors such as density of predators, availability of wild prey and the behaviour of individual predators also affect rates of predation. Good animal husbandry can have dual effects of reducing livestock losses in the short term and prevent predators from developing a taste for killing livestock in the long term.

Various aspects of livestock husbandry have been tested, and techniques such as kraaling, herding practices, and guarding livestock animals proved to be very effective in reducing predator attacks. By making this information available to farmers in Zimbabwe, we hope to benefit both the farmers and the predators with which they share the land. ■



People and predators often come into conflict - when predators kill livestock, farmers kill predators. When this happens, both sides lose. Some people don't realise that predators are an important part of the ecosystem, and that many predators depend on farmland to survive. People and predators can live together - if appropriate techniques are used by farmers, they will lose fewer animals to predation, and will kill fewer predators. This book is designed to help farmers manage their livestock to minimise predation, benefiting both the farmers and the predators with which they share the land.



Wonder Nyoni is the cheetah project education officer for Marwell Zimbabwe Trust. He completed his BSc (Hons) in Environmental Science and Health at the National University of Science and Technology, Zimbabwe. Wonder has extensive experience in teaching and working with communities.



Sam Williams is the cheetah project coordinator for Marwell Zimbabwe Trust. He completed his BSc (Hons) and Master of Research degrees in Biological Science at the University of Manchester (UK), and is studying for a PhD in Anthropology at Durham University (UK). He has worked on wildlife research and conservation projects in Africa, Asia, Latin America and Europe.

# Appendix: Predator Identification Chart

Species	Conflict Potential	Tracks		Prey Location	Prey Size	Claw Marks	Stomach Contents	Fang/Location	Bite Width	Parts Eaten	Bones	Other Evidence
		Front	Rear									
Domestic Dog	Higher			Anywhere	0-400 kg	None	Partly eaten/ripped/strewn about	All over-random bites	36-58mm 3 fingers		Long bones chewed	Wool, fur, skin and remains scattered. No marks on throat. Face and ears chewed or torn.
Caracal	Higher			In grass/hole/under bush	10-25 kg	4 short	Intact/dism-bowled	Mostly throat/back of neck	29-32mm thumb length		Rib ends chewed off	Wool, fur pulled out and scattered. Does not eat skin or guts. Red hair on prey skin.
Black-backed Jackal	Higher			Anywhere	0-50 kg	None	Partly eaten/ripped/strewn about	Side of neck and lower jaw, hindquarters of larger prey	19-21mm thumb width		Rib ends chewed off	Face and ears chewed or torn. Forearms of larger prey may be separated from carcass. Meat taken leaving skin flap.
Cheetah	Lower			Under bush/in grass	Over 10 kg	1 long	Intact/dism-bowled	Throat	36-39mm 3 fingers		Rib ends chewed off	Does not eat skin or guts.
Leopard	Lower			In tree/grass/hole	Over 10 kg	4 short	Intact/dism-bowled	Back of neck, throat	40-46mm 4 fingers		Rib ends chewed off	Fur, wool pulled out and scattered. Does not eat skin or guts.
Brown Hyaena	Lower			In bush/hole	0-50 kg	None	Partly eaten/ripped/strewn about	Huge fang bites in back of skull. Hindquarters of medium - larger prey	47-58mm 4 fingers		Skull crushed	Wool, fur, skin and remains scattered. Bites on rump. Only crushed bones, wool, hooves, blood and guts remain. Ears torn or chewed off.
Spotted Hyaena	Lower			At kill site, in grass	0-400 kg	None	Partly eaten	First flanks, then udder and back	4 fingers		All bones crushed	Messy carcass remains. With a large pack, no evidence remains.
Lion	Lower			Anywhere	All sizes	Claw marks on belly	Fully eaten	Throat	75mm		Large bones intact	Massive tissue damage.
Wild Dog	Lower			No Remains	0-400 kg	None	Fully eaten	All over	Thumb length		No remains	No evidence remains.

Source: Schumann (2004); Stuart & Stuart (2000)