

Power Quality Issues of Grid Connected DFIG Wind Farm System

Shazly A. Mohamed^{1*}, Montaser Abd El Sattar²

¹Department of Electrical Engineering, Faculty of Engineering, South Valley University Qena, Egypt

²Department of Electrical and Computers Engineering, El-Minia High Institute of Engineering and technology, El-Minia, Egypt

*corresponding authors: Eng_shazlyabdo@yahoo.com, Drshazlyabdo@eng.svu.edu.eg

Abstract – Power quality is known as any power problem manifested as non-standard frequency, current and voltage which causes failure on end customer apparatus. The wind utilization, generation and its penetration into utility grid are increasing worldwide. One of the main issues in wind generation is the insertion to the network. When the wind energy is injected into the grid, it generally produce the voltage disturbances in the power system network. Variation of voltage is the most prevalent kind of disturbance which affects the stability and the power quality for grid-inserted wind system. This paper hence, investigates the two kinds of voltage variations such as voltage dip and swell, which can happen if large amount of wind system are connected to an electrical grid. Furthermore, the response and performance under faults of a wind farm inserted to distribution systems are also studied. In this paper, a wind turbine with doubly-fed induction generator (DFIG) is simulated using MATLAB/Simulink program. The simulated model is subjected to disturbances which are known as voltages dip and rise. The results of the simulation shows that, how both variations; voltage dip and voltage rise lead to mal-operation as well as shut-down of entire system, therefore deteriorating the improvement of power quality for the grid.

Keywords: Doubly-fed induction generator (DFIG) system, Power quality issues, Voltage disturbances, Wind farm

Article History

Received 27 June 2019

Received in revised form 28 July 2019

Accepted 31 July 2019

I. Introduction

Conventionally, the utility grid has been prepared to integrate various kinds of traditional generation plants like: gas, hydro and nuclear etc. Power quality is a big interest to the network operators particularly if large wind system is connected to the utility grid. Rated frequency means maintaining voltage and current waveforms to be sinusoidal [1].

The wind energy is unpredictable to anticipate in providing quality of power desired into preserve system stability, precision and dependability to be accepted by the end users of the utility grid. A wind farm is a combination of wind turbines in the same site and applied for the generation of wind energy. Installing different turbines in groups at a location leads to large-scale utilization of wind power. This has operation, maintenance as well as economic features. Wind power system is attractive with due to the abundant source of energy available.

Indeed, wind energy can effectively be a viable option to the other traditional energy sources in the market [2]. Consequently, as suggested by Rini Ann Jerin in [3], wind

power is starting to challenge the other traditional renewable energy sources. Clean energy such as wind power is utilized to generate electricity and reduce the reliance on the fossil fuels. The power quality (PQ) is connected with electrical distribution and a utilization system. It can have a direct economic impact on numerous industrial users.

PQ is one of the important roles in electrical energy system owing to increasing penetration standard of renewable energy resources. The PQ is the basis customer concentrated measure and extremely affected by the working of a transmission and distribution grid [4]. One of the modest techniques of a wind energy operation is to employ the induction machine linked directly to the utility grid. One of the most important problems for the power system is the PQ requirement. The main issues of the PQ such as; voltage dip and voltage rise in low voltage distribution systems and on the transmission side owing to sensitive loads.

Unfortunately, harvesting wind energy is a stochastic process and can cause interruption due to oscillating power connected to the utility grid. It leads to numerous working issues, herewith impacting power quality of the

system. Likewise, effects like wind disturbance and shear which can lead to impulses in the output energy [5]. Outcomes from recent studies discovered higher wind energy permeation, power quality effect and system stability. Thus, voltage at the point of common coupling (PCC) should be maintained in a specific boundary to keep the power quality desired by consumers [6]-[7].

II. Doubly-Fed Induction Generator (DFIG) System

Wind turbines (WTs) employ a doubly fed induction generator system that composed of a wound rotor and an AC/DC/AC based on pulse width modulation (PWM) converter. The stator winding of DFIG is directly linked into the utility grid, whereas the rotor is fed meanwhile the power electronic converter model at the variable frequency. The working of DFIG is depending on the principle of induction generator. By regulating the converter's parameters, it is bearable to control the active and reactive power fed to the utility grid independently of the generators turning speed, giving it a distinct merit over other traditional power generators. The DFIG technology is usually applied in wind farms; this is an important wind conversion system having variable-speed ability. DFIG is the most commonly used generator system in modern wind turbines, since with its partial rated frequency converter in the rotor circuit it combines high flexibility with adequate costs. These machines are also famous as wound rotors or slip-ring induction generators [8]-[9]. According to the application, the DFIG is obtainable in various ranges of power from (1.5-6 MW). Fig. 1 illustrates schematic representation main parts of a DFIG-WT setup.

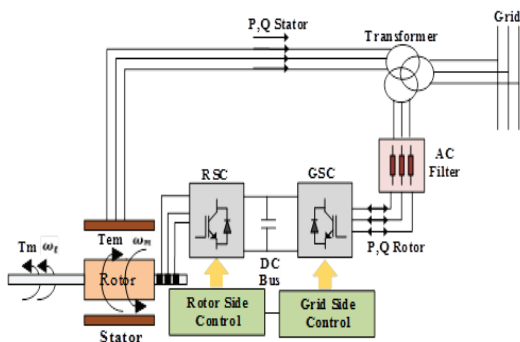

Fig. 1. Schematic representation of a DFIG-WT setup

Where:

- ω_t : turbine rotational speed.
- ω_m : mechanical speed of the generator.
- T_{em} : generator torque.
- T_m : gearbox torque.

WT is a collection of mechanical and electrical parts, the DFIG system, rotor-side converter control, DC-link, grid-side converter control and the control unit. The function of the grid-side converter is to regulate the bus voltage V_{dc} . The task of the rotor-side converter is to control the speed for realizing power from the wind through an extent of wind speeds. Nowadays DFIG was designed for the variable speed wind turbine. There are numerous types of wind generator, but this paper focus about DFIG system. In general, features of the DFIG based WT system can be brief as follows: control of power factor can be executed at lower cost, power quality improvement and reduced acoustic noise, the capability to operate in a wide extent of wind speed, plain means of pitch control and another advantage of DFIG technology has top performance through a voltage sag, disturbance situation and transient time [9]-[10].

A. Constant speed wind turbine

Constant speed permits the use of simple generators; whose speed is fixed by the frequency, pole-pairs and gear ratio of the utility grid. For fixed WT speed, the generator is inserted to the utility grid which stator is injected and will constantly work at fixed speed anyhow rapidly the wind strikes. Fixed WT's speed is essentially utilizing induction machine for generation and it is still regulated. The 3-phase rotor windings are immediately injected into the electric grid, whereas the stator supplies excitation to the machine. The shaft rotation speed in (r.p.m) can be calculated in terms of frequency of electrical power supply (f) and pole-pairs (p) [11]-[13].

$$N_s = \frac{120 f}{p} \quad (1)$$

The second parameter which applied in the machine is the slip in per-unit that is known as the variation among the synchronous and rotor speeds (N_s and N_r) illustrated as a proportion of synchronous speed which calculated as:

$$\text{Slip, } s = \frac{N_s - N_r}{N_r} \quad (2)$$

The slip has two modes, (+ve) for motoring and (-ve) for generating. So, wind generation for induction machine can provide power to the electric grid if the, N_r overtakes synchronous speed, N_s .

B. Variable speed wind turbine

In this case, the machine is pliable to be driven with wind at varying speed. For this target, a converter model is utilized to switch AC output to DC of the machine and then to electrical grid, AC variable WTs speed must be stall, pitch and active-stall regulated types. For stall, the blades of the turbine are sure fixed to the hub and this technique is simple, cheap and robust. Whilst in pitch, the blades angle is adjusted to determine the torque, that can

be carried out by changing the blade pitch or the direction and changes its aerodynamic competence. On the other hand, in last regulated type, the rotor rotation is carried out by pitching the blades [12].

III. Variations of Voltage in Grid-Connected Wind Power

The variations of voltage are immediately associated to real and reactive power owing to the fluctuations in the WT and are described as the changes in the rms value of the source voltage through a short duration [13]. For grid-inserted wind power, the parent variations of voltage can be in the forms such as: voltage dip, voltage rise, transient, harmonics and short interruptions. Fig. 2 depicts a grid-connected wind turbine configuration.

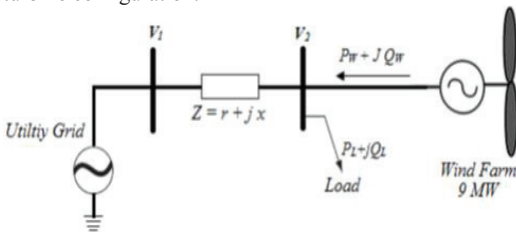

Fig. 2. A grid-connected wind turbine configuration

Applying Kirchhoff's voltage law to Fig. 2 gives:

$$V_1 = V_2 + \sqrt{3} i(r + jx) \quad (3)$$

Where:

V₁: Grid voltage.

V₂: Voltage at the WT connected point.

r + j x: Impedance of the grid.

If the wind turbine produces the power desired and no current towed from the utility grid, V₁ shall be equal to V₂ according to Eq. (3). However, if the wind turbine produces more power than demanded, then, V₁ will be less than V₂. Similarly, if the wind turbine produces lower power, the difference among the load and generated power of the turbines shall be supplied to the utility grid. The current will pass through the impedance, thus, grid voltage shall be greater than at the point of common coupling. Therefore, the short circuit power (S_{sc}) for wind connected point may be calculated as follows:

$$S_{sc} = \frac{V_1^2}{z} \quad (4)$$

Where:

Z: Impedance of the grid (Z = r + J x).

Short circuit power in Eq. (4) is inversely proportional to the impedance and directly depends on the grid configuration and their components. Voltage variations at the point of interconnection for wind turbine ΔV could be represented in terms of real (P_w), reactive (Q_w) powers, system impedance (Z) and phase voltage of the network [14].

$$\Delta V = \frac{(rP - xQ)}{V_n} \quad (5)$$

Where:

V_n: Nominal phase voltage.

Among all types of variations; voltage dip and rise are widespread. So, they are the major focused in this paper as follows:

A. Voltage dip

Voltage dip means a short sudden decrease in the voltage of utility grid. It happens at any instant of the time usually ranging through 10 to 90 percent of its nominal voltage. It typically lasts for duration from one-half cycle to one minute and may affect either phase or amplitude [15]. In general, voltage sags are caused by weather and utility equipment issues. It associated as a result of faults, electric heaters turning on and starting of large motors. Fig. 3 shows an RMS depiction of voltage sag.

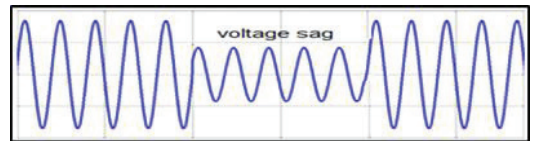

Fig. 3. Depiction of voltage sag

The decrease of relative voltage change ΔV_d at interconnection point for wind could be illustrated in terms of voltage change factor (K_v), the apparent (S_r) and short circuit (S_{sc}) power of the utility grid for wind turbine as shown in Eq. (6). The allowable voltage sags limiting rate is ≤ 3 percentage [16].

$$\Delta V_d = K_v \frac{S_r}{S_{sc}} \quad (6)$$

Where:

ΔV_d: Voltage dip change.

K_v: Sudden voltage reduction factor.

S_r: Rated apparent of the wind.

B. Voltage rise

Voltage rise means a short duration increase in the RMS value of the supply voltage which is among 110 and 180 percent, at the fundamental frequency for time interval of 0.5-cycle to a minute. For grid-connected WT, voltage rise can happen owing to the inrush currents or shut down of large capacity of the WT's. One more sources of voltage rise encompass grid lightning, fault on other phase and improper tuning of substations [17]. Fig. 4 illustrates an RMS depiction of voltage swell.

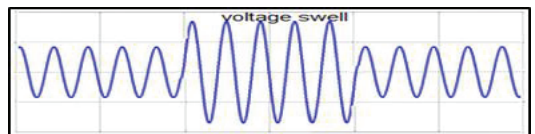

Fig. 4. Depiction of voltage rise

The increase of relative voltage change, ΔV_r at interconnection point of the wind can be expressed as terms of turbine's power maximum (S_{max}), grid impedance (Z) of the utility grid, the phase difference (ϕ) and the phase voltage of the electrical grid as shown in Eq. (7). The allowable voltage swell acceptable rate is < 2 percentage [16]-[18].

$$\Delta V_r = \frac{S_{max} (r \cos\phi - x \sin\phi)}{V_r^2} \quad (7)$$

Where:

ΔV_r : Voltage rise change.

S_{max} : Maximum power of the wind.

IV. Simulation Model and Experimental Setup

The system is simulated based MATLAB/Simulink program as shown in Fig. 5. It is a three-phase source inserted to a 9 MW wind farm based on DFIG system. It composed of (6*1.5MW) each wind turbine at 0.9 power factor which inserted to distribution system with a 25 kV. At bus B25, a factory of 2*106 VA, 2.3 kV with 1.68 MW induction motor load, p.f of 0.92 lagging and a resistive load of 0.2 MW is inserted. Also, 0.5 MW of a resistive load is injected on the 575V. A safeguard unit is integrated into the wind and motor load that observes the parameters such as: machine speed, current and voltage. Also, this system is used to investigate the steady-state and dynamic response of a wind farm based DFIG technology. The system parameters are listed in Appendix.

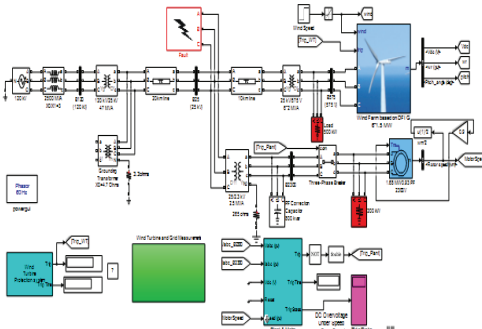

Fig. 5. Simulink model of a wind farm based on DFIG system

V. Cases Study and Results

The voltage variation and dynamic response of a wind farm based on the DFIG system is tested as follows:

Case 1: Impact of voltage dip

Fig. 6 shows the effect of a voltage dip based wind turbine parameters adjust to VAR regulation form. At 9 m/s fixed speed, a fault is used to the 120 kV utility grid, so a 0.2pu voltage falling lasting 0.52s is adjust in the utility grid to happen at the simulation time of 8s. The

results of wind farm in VAR regulation mode are depicted in Fig. 6. In Fig. 6-a, voltage dip is registered for period of 0.52s that the grid voltage falls to 0.92 pu for the specific period. Fig. 6-b depicts the (+ve) component of the factory current that, the safeguard unit drives the factory at $t=8.24s$ in order to the revelation of an under-voltage which lasting more than 0.22s. The speed of motor as shown in Fig. 6-c decreases progressively as soon as the protection system drives the factory. Fig. 6-d illustrates the wind turbine that maintains on real power generating at 1.85 MW. So, at B25, real power with 1.35 MW is transmitted to the utility grid as shown in Fig. 6-e.

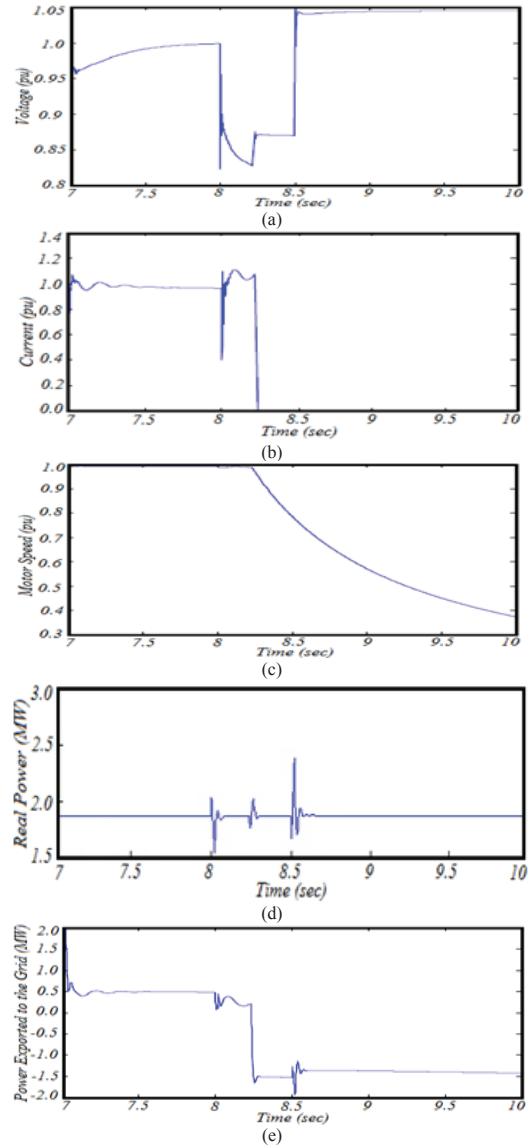

Fig. 6. Voltage dip based VAR regulation form

As well, if the wind parameters are varied to voltage regulation form and the simulation is renewed. The factory does not trip anymore. The simulation results of wind farm in voltage regulation mode are depicted in Fig. 7. Fig. 7-a depicts the voltage dip applied for a period of 0.52s that the factory voltage falls to 1 pu but keeps the plant voltage up to 0.9 pu threshold value. The factory current illustrated in Fig. 7-b does not trip since, voltage support presented by wind turbine parameters through the trouble. The speed of the motor, Fig. 7-c is confused through the sagging duration. Fig. 7-d shows the power produced by the wind turbine in MW and Fig. 7-e depicts exported active power to the utility grid.

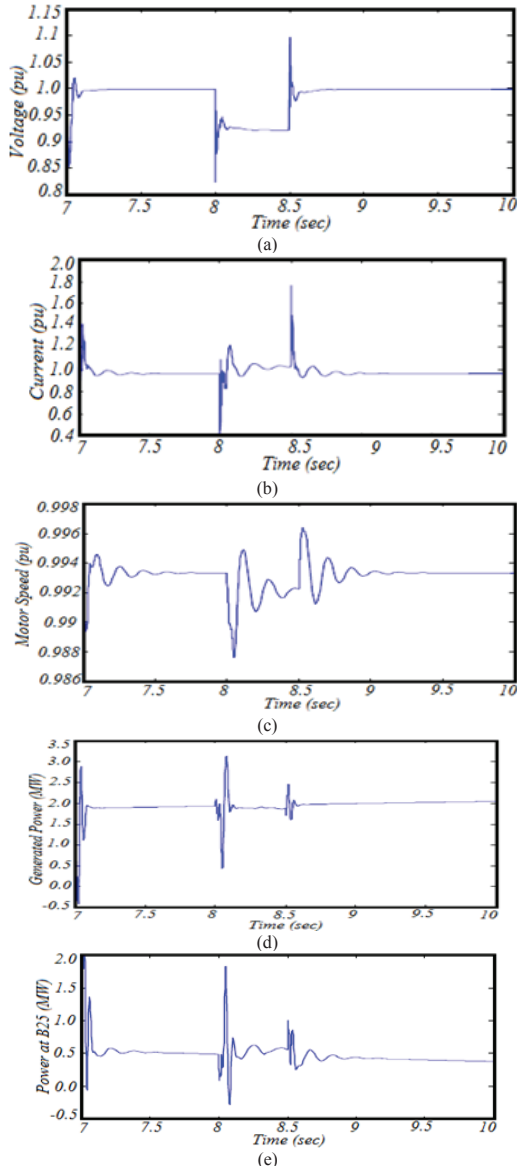

Fig. 7. Voltage dip based voltage regulation mode

Case 2: Impact of voltage rise

In this case, a 0.2 pu voltage swell lasting 0.52s is adjusted to the 120 kV network to happen at simulation time of 8s with the wind turbine control adjust to VAR regulation mode. The simulation results of wind farm in VAR regulation mode are shown in Fig. 8 at 9 m/s fixed wind speed. From Fig. 8 (a-e) a voltage swell for period of 0.52s overriding the threshold boundary trips the factory 0.22s after it is measured whereas, the speed of motor starts decreasing progressively.

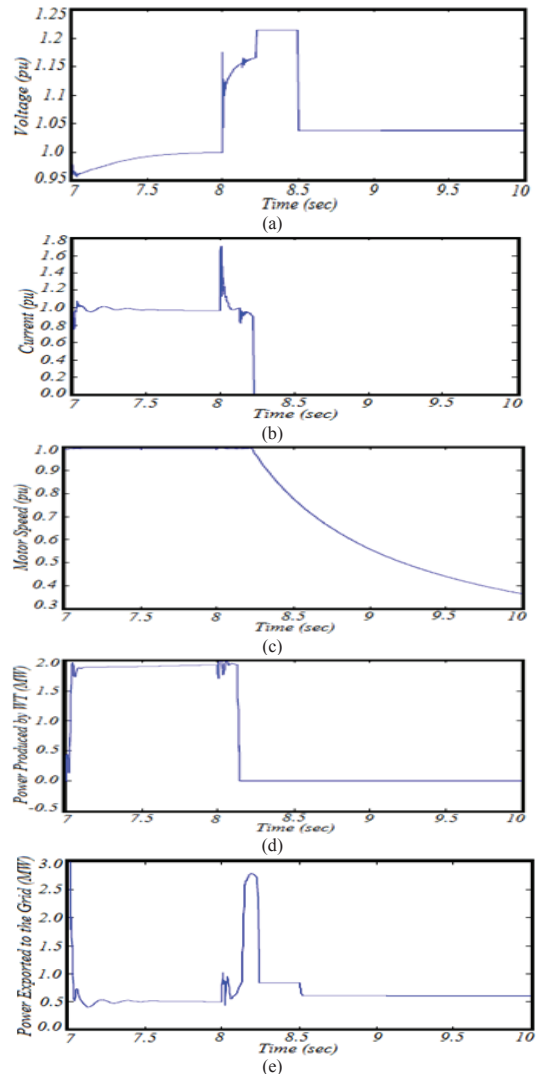

Fig. 8. Voltage rise based VAR regulation mode

However, if the simulation is renewed and the wind turbine parameters adjusted to voltage regulation form. The simulation results of wind farm in this mode are depicted in Fig. 9. From results of Fig. 9 (a-e) it can be

seen, the factory does not trip since, voltage support presented by the reactive power generated based on WT's through the voltage dip that maintains the voltage over the protection threshold value of 0.92.

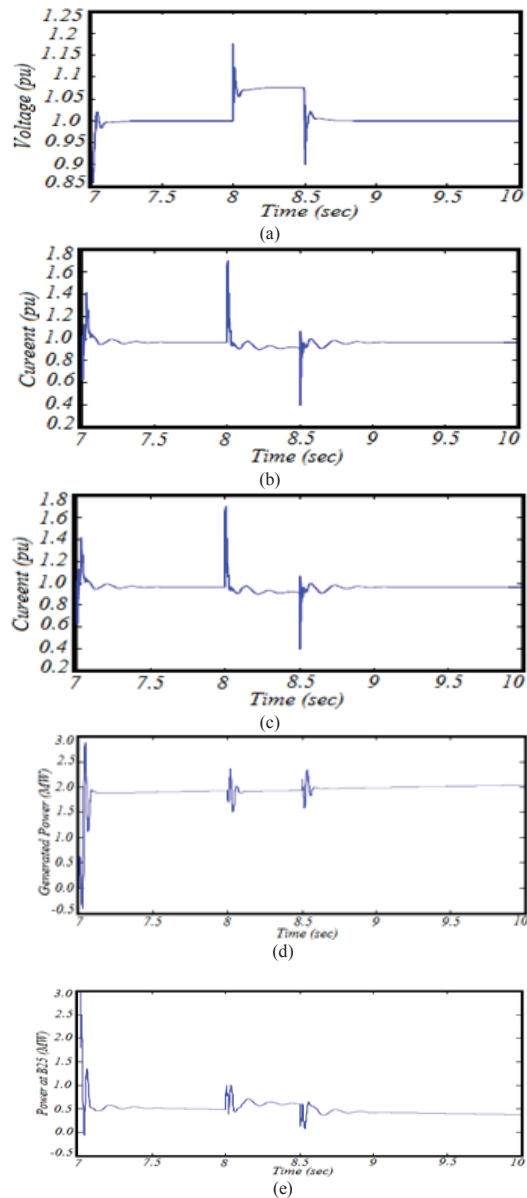

Fig. 9. Voltage rise based voltage regulation mode

Case 3: Response of wind to variation in wind speed

The performance of WT to variation in wind speed. At first is introduced. It is regulated at 8 m/s as well at t=5s and increased unexpectedly to 14 m/s. The response of a wind farm in voltage regulation mode represents the waveforms connected to simulation. At t=5s, the real

power generated starts increasing simply with each other based on turbine speed to arrive its rated value of 9 MW in about 15s. During this time, the turbine speed increases among 0.82 pu to 1.24 pu. At the beginning, the pitch angle is (0) deg., the turbine working point follows the red curve of the wind characteristics up to point D as depicted in Fig. 10. Hence, the pitch angle is increased among zero deg. to 0.75 deg. in order to limit the mechanical power. The DFIG technology is controlled to follow the curve (ABCD) in wind power characteristics. The optimization of the turbine speed is obtained among points (B&C). In this paper, the rotor is operating at sub-synchronous for speeds less than 10 m/s and it is operating at a super-synchronous for higher speeds of the wind. The turbine output power is presented for various speeds ranging between 5 m/s to 16.2 m/s.

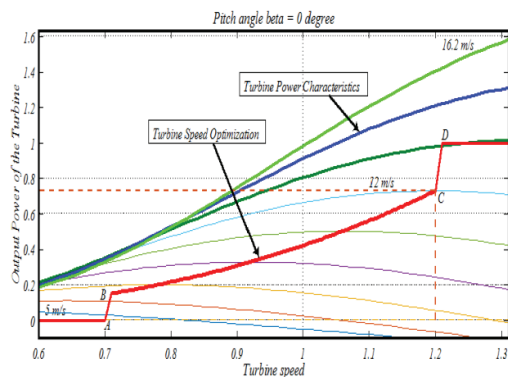

Fig. 10. Wind power characteristics based DFIG system

Also, the voltage and the generated reactive power are controlled to keep a 1 pu voltage. The turbine absorbs 0.69 MVAR to control voltage at unity. If the mode is modified to VAR regulation based on the reactive power generated Q_{ref} adjust to 0, the voltage will increase to 1.024 pu if the wind produces its normal power at power factor is unity (p.f = 1). Fig. 11-12 illustrate the wind farm waveforms based on VAR regulation and voltage regulation modes respectively.

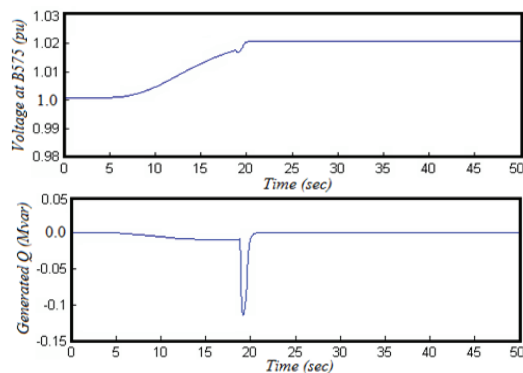

Fig. 11. Waveforms based VAR regulation mode

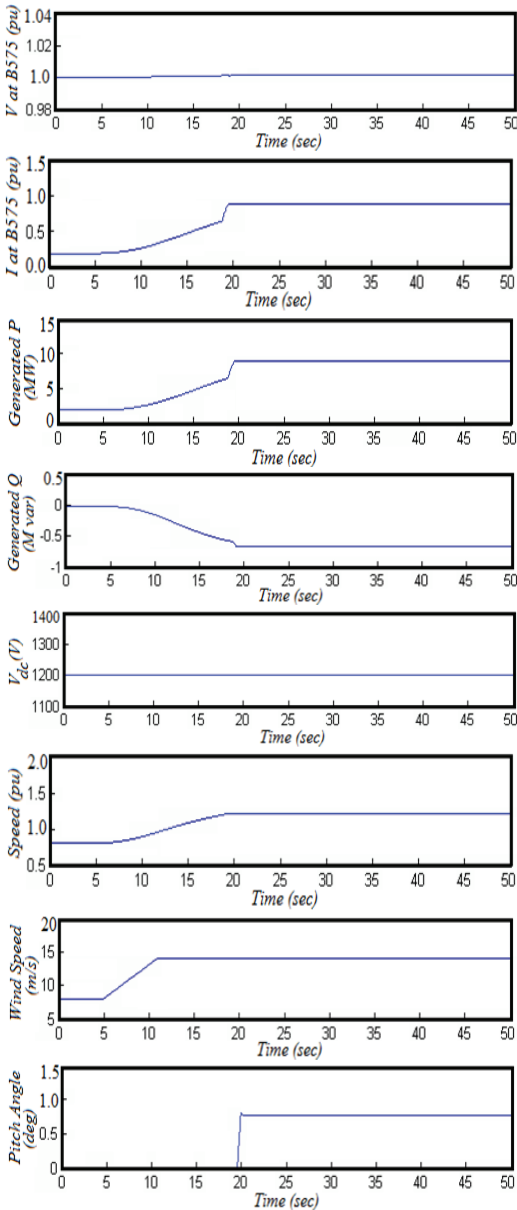

Fig. 12. Waveforms based voltage regulation mode

Case 4: Impact of a single phase fault

In this case, the effect of a single ground fault occurs on 25 kV system at $t = 5s$ on phase (A) at B25. If the wind based on voltage regulation form, the (+ve) sequence at a wind drops to 0.8 pu through this fault, that up the under-voltage threshold (0.75 pu for a $t > 0.12 s$). Therefore, the wind farm remains in service. The simulation results through fault at B25 in voltage regulation mode are depicted in Fig. 13. Nevertheless, when the VAR regulation form is applied based Q_{ref}

adjust to zero, the voltage falls to 0.72 pu where under-voltage trips the wind farm and the turbine speed will increase. At $t=40s$ the pitch angle initiates to increase in order to limit the speed. Fig. 14 shows the simulation results of wind farm waveforms through fault at B25 based on VAR regulation mode.

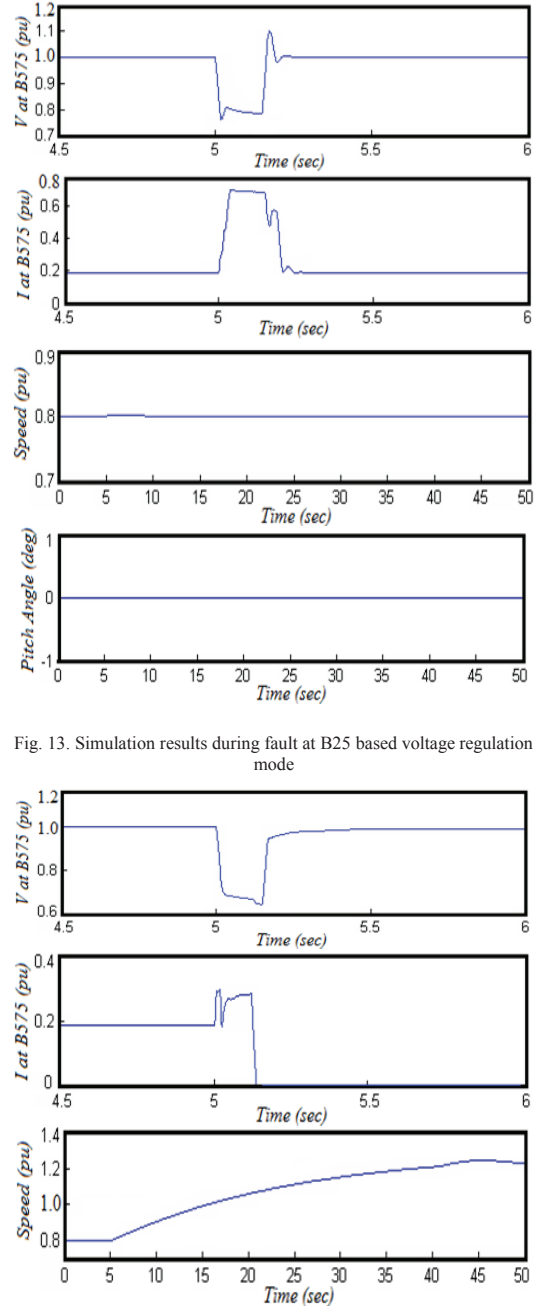

Fig. 13. Simulation results during fault at B25 based voltage regulation mode

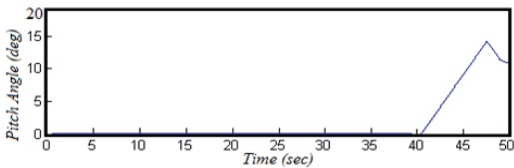

Fig. 14. Simulation results during fault at B25 based VAR regulation mode

VI. Conclusion

This paper investigated the effects of voltage dip and voltage rise on the power quality of the grid-inserted doubly fed induction generator (DFIG) system with wind farm. The simulation results represent the major effects of voltage dip; encompass isolation of sensitive loads, loss of data, system pause, fail functions and whole system shutdown. Otherwise, voltage rise can isolate the equipment, shorten lifespan of electrical appliances and discomfort tripping. Grid-connected DFIG system based wind farm is expected to respond with specific grid codes, such as power quality, frequency, voltage, real and reactive power control and low voltage ride through (LVRT) capability at the point of interconnection with the utility grid. Wind energy with LVRT system can resist disturbance on the transmission line since it will resist the disturbances injected to the electrical grid.

Appendix

The output parameters used for the system are given as follows:

Grid Voltage:

Three-phase, 25 kV, 60 Hz.

Generator Parameters:

Power rated: 6*1.5 MW at 0.9 PF, 575 V, 60 Hz.

Stator resistance and reactance = $R_s = 0.0072$ and $L_s = 0.172$ pu

Rotor resistance and reactance = $R_r = 0.01$ and $L_r = 0.16$ pu

Magnetizing inductance $L_m = 3$ pu

Wind turbine Parameters

Nominal mechanical output power: 6*1.5MW

Controller gain of pitch angle $[K_p] = 500$ with max. (deg) = 45

Converter parameters:

Maximum power = 0.5 pu

Grid-side $[L \ R] = [0.15 \ 0.15/100]$ pu

IGBT with 3 arms, 6 pulse and sample time 5 μ s.

Nominal DC-bus voltage = 1200 V

Nominal DC-bus capacitor = $6 * 10000e^{-6}$ F

Control Parameters:

Reference voltage $V_{ref} = 1$ pu

Gains of grid voltage $[K_p \ K_i] = [1.25 \ 300]$

Generated reactive power Q_{ref} (pu) = 0 pu

Gains of reactive power $[K_p \ K_i] = [0.05 \ 5]$

Load Parameters:

Plant with induction machine load 1.68 MW at 0.92 PF, 2300

V, 60 Hz with resistive load = 200 Kw

Load = 500 kW inserted on the 575 V bus.

References

- [1] Nazir M, Wu Q, Li M. Symmetrical short-circuit parameters comparison of DFIG-WT. *International Journal of Electrical and Computer Engineering Systems*. 2017; 8: 77-83.
- [2] Subramanian Ch, Casadei D, Tani A, Rossi C. Modeling and Simulation of Grid Connected Wind Energy Conversion System Based on a Doubly Fed Induction Generator (DFIG). *International Journal of Electrical Energy*. 2014; 2: 161-166.
- [3] Jerin R, Prabakaran N, Palanisamy K, Umashankar S. FRT Capability in DFIG based wind turbines using DVR with Combined Feed-Forward and Feed-Back Control. *Energy Procedia*. 2017; 138: 1184-1189.
- [4] Mohod S, Aware M. A STATCOM Control Scheme for Grid Connected Wind Energy System for Power Quality Improvement. *IEEE Systems Journal*. 2010; 4: 346-352.
- [5] Valentine S. Understanding the variability of wind power costs. *Renewable and Sustainable Energy Reviews*. 2011; 15: 3632-3639.
- [6] Shazly A, Mohamed, N. Luo, J.R. González, T. Pujol and L. Pacheco, "FACTS Family for Voltage Sag Alleviation: Performance Study and Analysis", *Renewable Energies and Power Quality Journal (RE&PQJ)*, Vol. (1), No. (17), pp. 561-566, July 2019.
- [7] Ceyhun Y, et al. Power Quality Measurement and Evaluation of a Wind Farm Connected to Distribution Grid. *Procedia - Social and Behavioral Sciences*, 2015; 195: 2370 – 2375.
- [8] Gaona D, Goytia E, Lara O. Fault Ride-Through Improvement of DFIG-WT by Integrating a Two-Degrees-of-Freedom Internal Model Control. *IEEE Transactions on Industrial Electronics*, 2013; 60 (3): 1133-1145.
- [9] Khajeh A, Ghazi R, Abardeh M. Implementation of the Maximum Power Point Tracking Algorithm on Indirect Matrix Converter Controlled DFIG wind Turbine. *The 4th International Conference on Renewable Energy and Distributed Generation*, Iran, Mashhad; 2016: 11-15.
- [10] Safaei, A., Hosseini, S., Abyaneh, H.: "Investigation and enhancement of SFCL impacts on DFIG-based wind turbine during fault and post-fault", *Int. Trans. Electr. Energ. Syst.*, Wiley. 2016: 1-13.
- [11] Pfister P, Perriard Y. Torque Measurement Methods for Very High Speed Synchronous Motors. *Proceedings of the 2008 International Conference on Electrical Machines*; 2008: 1-5.
- [12] Whitby B, Ugalde-Loo C. Performance of Pitch and Stall Regulated Tidal Stream Turbines. *IEEE Transactions on Sustainable Energy*. 2014; 5 (1): 64-72.
- [13] Kadandani N, Maiwada Y. Impact of Voltage Sag and Swell on the Power Quality of Grid Connected Wind Power Plant. *the International Journal of Engineering and Science (IJES)*. 2015; 4 (7): 56-64.
- [14] Zhong Q, Ma Z, Ming W, George C. Grid-friendly wind power systems based on the synchronverter technology. *Energy Conversion and Management Journal*. 2015; 89: 719-726.
- [15] Mohammed S, Abdel-Moamen M., Hasanin B. Analysis, Modeling and Simulation of Dynamic Voltage Restorer for Compensation of Voltage Quality Disturbances. *International Journal of Control, Automation and System*. 2013; 1 (2): 23-29.
- [16] Thirupathiah M, Prasad P. Analysis of Various Compensation Devices for Power Quality Improvement in Wind Energy System. *International Journal of Electrical Engineering & Technology (IJEET)*. 2016; 7 (3): 25-39.
- [17] Babae E, Shahir F, Tabrizi S, Sabahi. Compensation of Voltage Sags and Swells using Photovoltaic Source Based DVR. *2017 IEEE 14th International Conference on Electrical Engineering/Electronics, Computer, Telecommunications and Information Technology (ECTI-CON)*. 2017: 930-906.
- [18] Yuvaraj V, Deepa S, Rozario A., Kumar M. Improving Grid Power Quality with FACTS Device on Integration of Wind Energy System. *IEEE fifth Asia Modeling Symposium*. pp.157-162,2011.