



Automatic structural design by a set-based parametric design method

Downloaded from: <https://research.chalmers.se>, 2020-01-17 15:59 UTC

Citation for the original published paper (version of record):

Rempling, R., Mathern, A., Tarazona Ramos, D. et al (2019)
Automatic structural design by a set-based parametric design method
Automation in Construction, 108(December)
<http://dx.doi.org/10.1016/j.autcon.2019.102936>

N.B. When citing this work, cite the original published paper.



Automatic structural design by a set-based parametric design method

Rasmus Rempling^{a,*}, Alexandre Mathern^b, David Tarazona Ramos^c, Santiago Luis Fernández^d

^a Chalmers University of Technology, Civil and Environmental Engineering, Structural Engineering, Gothenburg, Sweden

^b NCC AB, Gothenburg, Sweden

^c Volvo Cars, Gothenburg, Sweden

^d Grupo Navac, Llanera, Spain

ARTICLE INFO

Keywords:

Bridge design
Structural design
Buildability
Sustainability
Set-based design
Parametric design
Finite element analysis
Multi-criteria decision analysis

ABSTRACT

Modern structural design faces new challenges, such as addressing the needs of several stakeholders and satisfying the criteria for achieving sustainability. The traditional design process does not allow resolution of these challenges. The purpose of this project was to investigate the applicability of a Set-Based Parametric Design method to the structural design process of bridges. The focus was on the early design stage, in which the design team evaluates design alternatives against a chosen set of criteria. The main challenge in this stage of design is that the process should be cost- and time-effective while allowing comparison of the different alternatives and their evaluation in terms of the different design criteria. Certainly, structural design is often performed by a discussion between the different stakeholders involved in this process, i.e. the client, contractor, and engineering team. An evaluation of alternatives against criteria requires a more detailed design, which is contradictory to the early design stage when information is scarce. The selected approach was to develop a script that can generate information for decision-making, automate the structural design process, perform common routine design tasks, and control the numerical analysis. The method combined Set-Based Design, Parametric Design, Finite Element Analysis and Multi-Criteria Decision Analysis. Three existing bridges were selected to demonstrate the applicability of the developed method. The method was successfully applied and it was observed that it resulted in bridges that were more efficient in terms of material costs and carbon dioxide equivalent emissions compared with existing bridges. By delaying the decisions and developing the sets of alternatives, various alternatives can be assessed and evaluated, in the design stage, against different sustainability criteria.

1. Introduction

The concept of this research originated from discussions on the effectiveness and automation of the structural design process. The current structural design process is exclusively formed as a Point-Based Design (PBD), in which the development of the design is based on a single decision in a step-by-step process.

The ineffectiveness of PBDs has motivated the development of alternative design approaches. Toyota was one of the first companies that started using a novel concept based on parallel and delayed decision-making processes, called Set-Based Design (SBD) [1]. In such a design, the decisions involved in the design process are not made with a single alternative, instead, a set of alternatives is generated by the method and successively filtered based on the limitations and decisions of those involved in the project.

In contrast with a PBD, a SBD is based on the consideration of a broad range of design possibilities, explicit discussion and reasoning

regarding the sets of design alternatives, and the gradual narrowing of these sets to eliminate the inferior alternatives until a final solution is reached [2].

As identified by Liker et al. [3], the success of a SBD approach requires the stakeholders to follow the same principles and cooperate via appropriate communication. In addition, even though the individual steps may appear inefficient, it is assumed that the reasoning and discussion for the various sets of alternatives lead to more robust and optimised systems and a higher overall efficiency than working with a single concept at a time [3].

This concept was developed to improve the car manufacturing process and was called Toyota's Second Paradox [1]. Over the years, the theory and principles of SBD were developed [4] based on the research in [5], [6], and [7], and subsequently discussed in [8].

Recent research has led to the development of the Integrated Project Delivery (IPD) method [9, 10]. Although its main purpose is to improve the low profitability of the construction industry [9], IPD motivates

* Corresponding author.

E-mail address: rasmus.rempling@chalmers.se (R. Rempling).

collaboration throughout the design and construction process and between the stakeholders, relating stakeholder success to the project success [10]. One of the identified principles in the IPD of structures is the parametric design approach, which is based on a theoretical framework of computer-aided design, knowledge-based engineering and generative design.

Regarding the area of application, the concept of SBD has already been widely applied and assessed in the field of manufacturing and production development [11-15]. In addition, SBD has been studied for its applicability in the field of software engineering. Researchers developed a new concept called Set-Based Parametric Design (SBPD) [16], that combined a SBD method with the parametric modelling technique widely used in most three dimensional Computer-Aided Design (3D-CAD) systems [16]. This concept has also been studied in heating, ventilation, and air conditioning system design [17], by suggesting the use of 'constraint solving' to express large families of acceptable solutions to facilitate and shorten the negotiation process.

There has not been much progress in evaluating or implementing SBD in Structural Engineering. Examples include a SBD method for reinforcement design [18, 19], a system to improve the approval process for rebar estimation based on the communication between the different stakeholders [20], and a method for evaluating the capabilities of SBD using Structural-Building Information modelling (S-BIM) [21]. More recently, researchers presented a promising approach built on an automated procedure for optimising the design of pre-cast and pre-stressed concrete U-beam road bridges [22], sustainable design of post-tensioned concrete box-girder pedestrian bridges [23], and an interesting hybrid glow-worm swarm algorithm for solving structural optimisation problems [24].

In the building industry, the development and implementation of prefabrication strategies and design automation have increased productivity dramatically. Researchers have used parametrization and cut-to-fit modularity, performed by CAD, to automate the design of configurable modules [25].

Despite efforts to exploit the potential of SBD, their applicability in the construction sector needs attention, particularly in the early stage of the design process.

To conclude, the research on SBD has mainly been concentrated on the later stage of design, focusing on obtaining optimal solutions by automated routines. The potential in early stage design has not yet been explored.

The purpose of this study was to investigate the applicability of SBPD in the early stage of structural design of bridges.

2. Framework for set-based parametric design

The framework for the proposed SBPD method includes the theories of Integrated Design proposed by the American Institute of Architects (AIA) and parametric design with regard to the geometrical parameters. Integrated Design [10], which is closely related to the conceptual design proposed in [26], integrates engineering disciplines and the stakeholders, whereas parametric design utilizes computer calculations to design several parameters in an automated process. The early stage of the design process is traditionally referred to as the schematic design stage by the AIA. The AIA has modernized the traditional design process and proposed IPD, the main idea of the IPD process is to delay decision-making and include more disciplines earlier in the design process. The design process of IPD is divided into two main stages: Criteria Design and Detailed Design [10]. The International Federation for Structural Concrete (FIB) has also addressed the Criteria Design stage, as Conceptual Design [26]. The conclusion of the FIB on the deliverables of Conceptual Design is more concrete. The FIB lists three important aspects: choice of materials, structural system as well as the layout, and member size of the important structural elements. Evaluating alternatives against criteria becomes easier with more information. However, the amount of information at an early design stage is scarce. In

practice, another aspect comes into play: the cost of the design work in the early stages of design. In most projects, Criteria Design is part of the procurement stage, when the contract has not yet been awarded, implying that the process must be cost- and time-effective and practical. To summarize, two international associations suggest a cost-effective process that evaluate alternatives against common decided criteria that address the materials, structural system, and member size.

3. Method

The applicability and potential of the proposed method were assessed by implementing an automated SBPD for three common types of single-span bridges:

- a concrete beam bridge,
- a steel-concrete composite bridge with integral abutments, and
- a concrete frame bridge.

For these cases, existing bridge projects in Sweden were selected as case studies. The design of the bridges was completed before this research was initiated, and the data used in this study was taken from the construction documents.

The approach to automate the structural design process included the development of a script capable of performing the design tasks in the criteria design stage as well as controlling the numerical analysis. The script was developed in Python, and the numerical analyses were performed in the finite element (FE) software, Abaqus. A flow chart of the script is presented in Fig. 1.

4. Set-based parametric design method

4.1. Selection of parameter ranges and sets

The proposed SBPD method requires the definition of an initial set of alternatives. This initial set is generated by selected parameters and their corresponding range of values. In this study, possible values for parameters were chosen based on the characteristics of the existing bridges, allowing lower and higher values around the ones originally chosen for these bridges. Besides, some additional considerations were needed:

- For the steel-concrete composite bridge, owing to the manufacturing issues related to the benefits of design homogeneity, all the girders were defined identical.
- The concrete beam bridge did not have the same manufacturing issues. Therefore, the dimensions of the beam were kept constant, but the reinforcement layout and amount were allowed to vary between the beams, as well as in different regions along the beams.
- Another aspect to consider when designing reinforced concrete is the diameter of the rebars and concrete cover. As it was considered an important factor for reducing secondary costs and avoiding construction errors, for each alternative, a single diameter was considered for the longitudinal reinforcement and a single diameter for the stirrups over the whole bridge.

4.2. Automation of structural preliminary design process

The preliminary design process should consider the materials, structural system, and member size. Because the iterative process should be cost-effective, the stiffness of the structural system has been simplified and does not account for the added stiffness of the reinforcement. The design is based on the sectional actions calculated by linear elastic theory in line with common design practice [27].

The proposed automated structural design process is based on a parameterized script adapted for three common types of short- and medium-span bridges: concrete beam bridges, steel-concrete composite

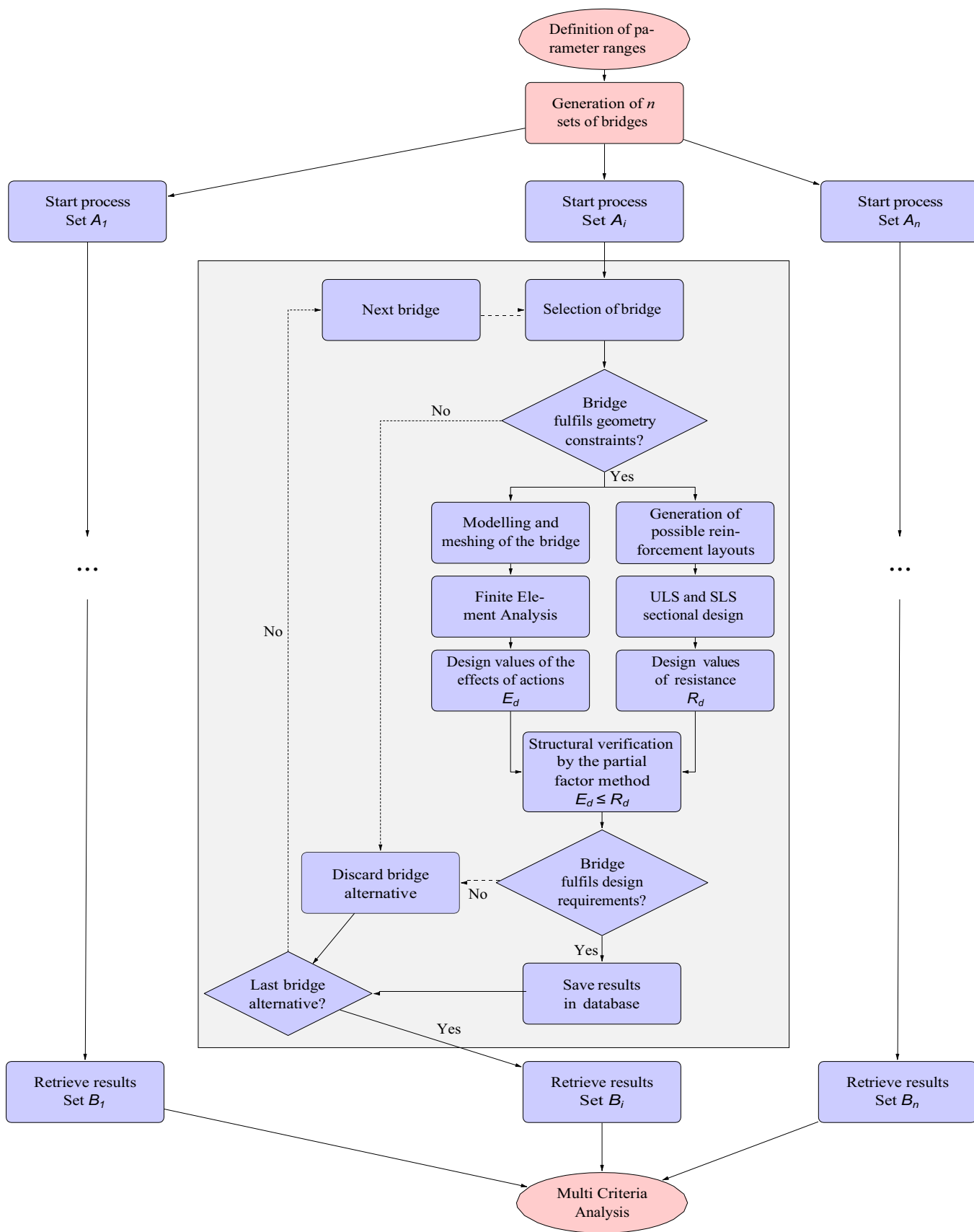

Fig. 1. Flow chart of python script performing the numerical analyses and controlling the SBPD.

Table 1
Explanation of the main steps implemented in the developed script.

Step	Explanation
1	Definition of parameter ranges
2	Selection of bridge
3	Examination of geometry constrains
4.1a	Modelling and meshing of bridge
4.1b	Finite element analysis
4.1c	Design values of actions
4.2a	Generation of possible reinforcement layouts
4.2b	Design resistance
5	Examination of structural resistance
6	Saving results in database
7	Next bridge
8	Last bridge alternative
9	Multi-criteria analysis

bridges, and concrete frame bridges. In Table 1, each of the steps in the script is briefly explained, and in the following sections, the implementation of the common design tasks in the script is elaborated.

4.3. Definition of loads

Permanent and traffic loads were considered in the design process. The following methods were used to ensure consistency with the different bridge geometries considered.

Lateral torsional buckling during construction was considered for the steel girders according to [28]. The self-weight of the model was introduced as a gravity load by defining the density of the materials. Traffic loads were introduced according to Load Model 1 of [29] and applied on a plate with an infinitesimal stiffness tied to the deck of the bridge. This approach made it possible to simulate the bridge response while it was subjected to different loading positions of Load Model 1.

The effect of the soil pressure acting on the abutment walls of the concrete frame bridge was also considered.

4.4. Finite element analysis

The bridges were modelled and analysed using the FE software Abaqus/CAE (version 6.11-1 was used for the two types of beam bridges and version 6.13-3 was used for the frame bridge). All the bridges were modelled entirely with shell elements to simplify the assembly between the different parts and extraction of sectional forces for the design. It was not considered necessary for the preliminary design of the superstructure of the beam bridges to analyse the behaviour of the abutments. Therefore, abutments were not introduced into the FE model of the beam bridges.

The following boundary conditions were directly applied at the end of the beams: the concrete beam bridge was modelled as simply supported and the steel-concrete composite bridge as fixed along their height at the ends as the bridge has integral abutments. The model for the concrete frame bridge included the abutment walls, fixed at their base. In Fig. 2, the boundary conditions and the mesh of the concrete beam bridge are presented.

Regarding the structural interaction of the steel-concrete composite bridge, because the deck and I-girders have different material properties, it became necessary to connect them with Abaqus' tie constraint, assuming full interaction between concrete and steel. In the other cases, the different parts were merged and meshed together.

Owing to the large amount of computational time needed for the analysis, convergence studies were conducted to determine the largest element size yielding results of acceptable accuracy for each bridge model built in Abaqus. An acceptable accuracy was defined as a deviation of 5% for stresses and 0.2% for displacement from the result of a

model with half the element size. This resulted in element sizes of 0.15 m for the concrete beam bridge and concrete frame bridge and 0.2 m for the steel-concrete composite bridges. The different parts of the bridges were modelled and partitioned so that the mesh could consist of quadrilateral elements. Additionally, despite the possibility of slightly stiffer behaviour, reduced integration was chosen to save computational resources. Consequently, S4R elements, which are known to be suitable for general purpose analyses, were used in Abaqus. The number of integration points along the thickness of the shell elements was set to five according to the recommendations for the integration method selected, i.e. Simpson. In a typical FE-model of the concrete beam bridge, 13965 S4R elements (0.15 m element size) were used for the bridge and 1000 S4R elements (0.4 m element size) were used for traffic plate. While, for a typical concrete-steel composite bridge model, 9817 S4R elements (0.2 m element size) were used for the bridge, and 1900 S4R elements (0.4 m element size) were used for the traffic plate.

4.5. Limitations in the sectional design

Because the design is preliminary, there are some limitations in the sectional design of the concrete beams, steel girders, and concrete decks. These are as follows:

- No shear reinforcement at the beam-deck interface has been considered, and full interaction was assumed.
- Fatigue has not been considered.

4.6. Ultimate limit state

4.6.1. Concrete beams

The sectional design of the concrete beams was performed by simple calculations using the dimensional parameters defining the bridge. Concrete beams are normally not homogeneously reinforced along the span owing to the variations in the shear force and bending moment distributions; therefore, three different regions were designed for each beam: two close to the supports with a length equal to a quarter of the span length and one central region of half the span length.

First, the amount of reinforcing steel and layout of the rebars necessary to resist the maximum bending moment within the region were estimated. Owing to the buildability limitations, the maximum number of layers of the reinforcement bars was set to three. Based on the principles of SBD, different alternatives had to be preserved along the design process, and therefore, varying rebar diameters were introduced. For each diameter and region, the script computed the number of rebars necessary to reach a sufficient bending moment capacity based on the limitation of the number of layers and to satisfy the spacing, concrete cover, or ductility restrictions. When the number of bars for any

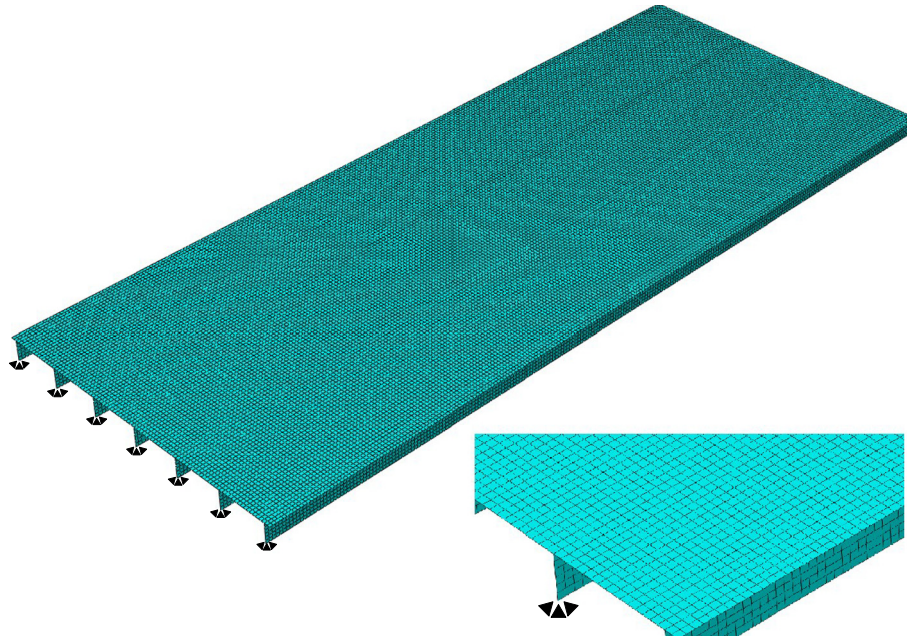

Fig. 2. Boundary conditions of the concrete beam bridge. The beams were modelled as simply supported by fixing the point at the support in all directions, but free to rotate.

diameter did not fit within the width of the beam, the region was defined as impossible to reinforce, and the bridge alternative was discarded.

Second, the script calculated the requirement for shear reinforcement. For buildability reasons, the spacing of the stirrups was limited and rounded down (e.g. 103.3 mm rounded to 100 mm).

4.6.2. Steel girders

The sectional design of the steel girders was performed according to [30] using the maximum shear force and bending moment. The following two loading scenarios were considered for the steel-concrete composite bridge:

- During construction, simply-supported girders supported the weight of the formwork and fresh concrete.
- During operation, loads were supported by the composite action between the deck, girder, and monolithic connections at the abutments.
- Lateral torsional buckling was controlled at the mid-span during construction and at the supports during operation.
- The steel girder had a variable section, and its shear buckling resistance was examined at the most critical sections.

4.6.3. Concrete deck

For the design of the concrete decks, the maximum positive and negative moments were defined as the design values for all the longitudinal and transversal sections. These moments were combined with the corresponding torsional moment and membrane forces when appropriate. The reinforcement area was estimated using sectional equilibrium.

To assess the feasibility of the concrete beams and deck, the following criteria were used:

- Three different regions along the length of the bridges were analysed and tagged as feasible or unfeasible regions.
- If all the regions of a bridge were considered feasible for a certain rebar diameter, the bridge was considered feasible and its material cost was estimated as the sum of the individual costs of the concrete, reinforcement of the beams, and reinforcement of the deck.

- Otherwise, if there was at least one unfeasible region, the bridge was discarded.

4.7. Serviceability limit state

The deflection was defined as the maximum vertical displacement in all the load cases in the Serviceability Limit State. This value was then compared with the standard limitation ($L/400$), according to [31], and was used to determine whether the bridge was feasible. Among the various load combinations in the Serviceability Limit State of Eurocode, the quasi-permanent combination of the loads was selected based on a recommendation in [32].

Two different variables were extracted from the numerical results to estimate the maximum crack width: the stress in the tension reinforcement assuming a cracked section, determined from the stress produced at the reinforcement level by the maximum bending moment in the Serviceability Limit State, and the area of longitudinal reinforcement, defined by a previously performed reinforcement design.

4.8. Evaluation of the results

Because of the iterative design process, large amounts of data were extracted. In the project, the practicality and usability of the method at a design office were important. This implied that the design process should be separated from the process of selecting the alternatives. For the scope of the project, two criteria were considered as a minimum requirement.

In this study, the following two criteria were selected: material costs and carbon dioxide (CO_2) equivalent emissions of the materials. Even though these two criteria are both based on the material amount, their use enabled the implementation and study of the potential use of the proposed method. The results for each criterion were normalised by dividing them by the lowest value obtained for that criterion.

In this project, the sustainability of the solution was assessed in a simplified manner by considering, for each material used, the cost as well as CO_2 equivalent emissions (during extraction, production, and manufacturing) per weight of the material.

The prices and CO_2 equivalent emissions of the materials were adopted from the NCC supplier catalogue and Svensk Byggtjänst with

the following values: steel 10,000 SEK/tonne and 830 kg CO₂/tonne, concrete 1000 SEK/m³ and 360 kg CO₂/m³, and stainless-steel 30,000 SEK/tonne and 2580 kg CO₂/tonne [33].

The material cost was defined as the sum of the individual costs of the various elements.

5. Case studies of the applicability of set-based design in structural engineering

The applicability of the method was verified using existing bridges. Three different Swedish bridges were selected: a concrete bridge in Örebro, a steel-concrete composite bridge in Nynäshamn, and a concrete frame bridge in Stockholm.

5.1. Concrete beam bridge in Örebro

Reinforced concrete beam bridges commonly have span lengths between 15 m and 30 m. The bridge considered in this study is situated in Örebro (59°04'36.2"N 15°12'53.7"E) and was built in 1996. The bridge is a road bridge crossing a double track railway. The geometry of this concrete bridge incorporates a concrete deck resting on eight simply supported concrete beams with a span length of 20 m. The exposure class used for the design was XC3. The concrete class and reinforcement type were, C30/37 and K500, respectively. Numerous bridges were analysed by varying the parameters. Though some of the parameters were common to the entire set of bridges, such as the length or width of the bridge, others were iteratively changed to generate the various bridge alternatives within each set. The latter constituted primarily the cross-sectional properties of the beams (e.g. height, width, thickness of the slab) as well as the number of beams. The geometry of the bridge is presented in Fig. 3 and the parameters used in the analyses are presented in Table 2.

5.2. Steel-concrete composite bridge in Nynäshamn

Steel-concrete composite bridges typically have span lengths between 15 m and 70 m. The bridge considered is located in Nynäshamn (58°55'53.6"N 17°58'02.4"E) and was built in 2011. The geometry of the considered steel-concrete composite bridge was quite different from the previous bridge. This integral abutment bridge has two curved high-strength stainless-steel girders with a span length of 20 m and a concrete deck. The exposure class used for the design was XC3. The concrete class and reinforcement type were, C40/50 and K500, respectively. For the steel girders duplex stainless-steel 2205 was used. The slab was provided with longitudinal reinforcement for negative bending moments.

This bridge has curved girders with a variation in the cross-section along their length. Therefore, it was necessary to include the parameters defining the curvature as well as the regions and properties of the different sections. The distribution of the different regions was symmetrical across the length of the bridge, which reduced the number of necessary parameters. For the composite bridge, different regions with positive and negative moment were identified for the deck and

Table 2

Parameters and variations used to produce alternatives of the concrete beam bridge. Spacing of the longitudinal reinforcement and the stirrups were calculated according to [29].

Parameter	Values
Bridge length	20.00 m
Bridge width	7.00 m
Slab thickness	0.20, 0.25, 0.30 m
Beam width	0.30, 0.50, 0.75, 1.00 m
Beam height	0.50, 0.75, 1.00, 1.25, 1.50 m
Number of beams	6, 7, 8, 10, 11
Longitudinal reinforcement diameter	10, 14, 16, 20, 25, 28, 32 mm
Stirrup reinforcement diameter	12 mm
Concrete cover	20 mm

used to define the design regions. The geometry of the second bridge is presented in Fig. 4, with the parameters used in the analyses presented in Table 3.

5.3. Concrete frame bridge in Stockholm

Reinforced concrete frame bridge is the most common type of bridge for spans between 10 m and 30 m in Sweden. It is used mainly for crossing rivers and small roads.

The considered bridge is situated in Viggbyholm, outside Stockholm, (59°26'38.7"N 18°05'49.2"E). The frame is built by reinforced concrete walls and a concrete slab. The bridge is not supported by a bottom slab and has a span length of 12.5 m. The exposure class used for the design was XC3. The concrete class and reinforcement type were, C40/50 and K500, respectively. It has been provided with longitudinal reinforcement for negative bending moments. The elevation of the bridge is presented in Fig. 5 and the parameters used in the analyses are presented in Table 4.

6. Results

The performed study resulted in the analysis of approximately 300 concrete beam bridges (2100 considering the different reinforcement layouts), 360 steel-concrete composite bridges, and 36 concrete frame bridges (216 considering the different reinforcement layouts). Figs. 6–8 show the normalised material cost and CO₂ equivalent emissions of the alternatives. The figures also indicate the results for the existing bridges. The normalisation of the results was performed by dividing the material costs and CO₂ equivalent emissions by the obtained minimum values.

The trends in the figures are similar for the three bridges. The result is a nonlinear variation, with a higher rate of change in the material cost and CO₂ equivalent for the most promising and least promising alternatives. Between these sets, with a higher reduction rate, a linear rate is observed.

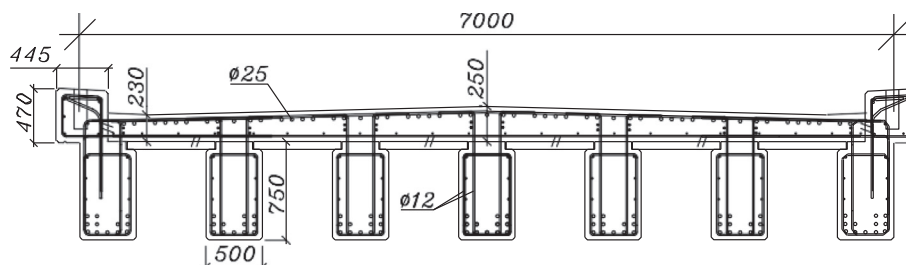

Fig. 3. Section of the concrete beam bridge in Örebro with dimensions in mm.

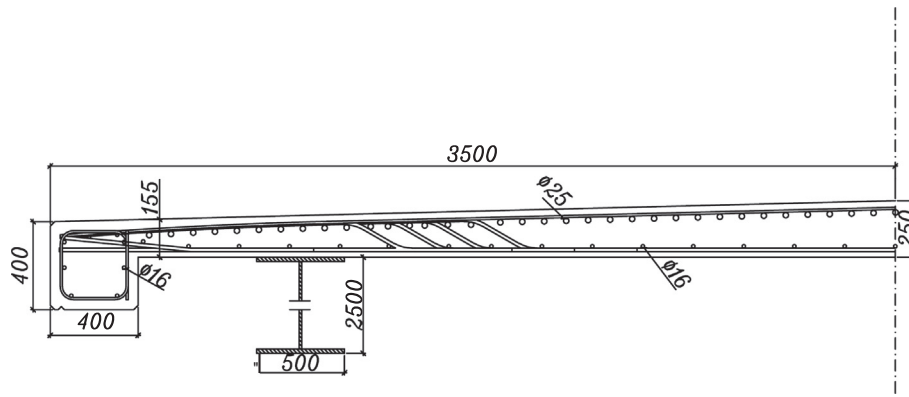

Fig. 4. Section of the composite bridge in Nynäshamn, with dimensions in mm.

Table 3

Parameters and variations used to produce alternatives for the steel-concrete composite bridge. Spacing of the longitudinal reinforcement were calculated according to [29].

Parameter	Values
Bridge length	20 m
Bridge width	7 m
Slab thickness	0.25, 0.30 m
Number of girders	2, 3
Girder dimensions in support region:	
Web height	1.8, 2.2, 2.5, 2.8, 3.5 m
Web thickness	16, 20, 25 mm
Upper flange width/thickness	450 mm/20 mm
Lower flange width/thickness	500 mm/40, 50 mm
Girder dimensions in midspan region:	
Web height	1.0, 1.2, 1.5 m
Web thickness	12 mm
Upper flange width/thickness	50 mm/30 mm
Lower flange width/thickness	550 mm/40 mm
Concrete cover	35 mm

Table 4

Parameters and variations used to produce alternatives for the concrete frame bridge. Spacing of the longitudinal reinforcement and the stirrups were calculated according to [29].

Parameter	Values
Bridge length	12.5 m
Bridge width	10 m
Slab thickness	0.4, 0.45, 0.5, 0.55, 0.6 m
Leg thickness	0.4, 0.45, 0.5, 0.55, 0.6, 0.7 m
Leg height	4.0 m
Reinforcement diameter	14, 16, 20, 25, 28, 32 mm
Stirrup reinforcement diameter	12 mm
Concrete cover	35 mm

reinforcement layouts. In this way, numerous bridge alternatives were generated, and various reinforcement layouts were added to the bridge alternatives, an addition that generated sets of alternatives.

Three existing bridges were used to evaluate the potential of the method. For the three different bridges, the number and types of parameters were similar: five for the concrete bridge, six for the steel-concrete composite bridge, and three for the frame-bridge. However, the range of values considered were different, i.e. three, two, and six values for the slab thickness of the concrete beam bridge, steel-concrete composite bridge, and concrete frame bridge, respectively. The difference in the considered ranges renders a larger or smaller number of alternatives. Consequently, this point requires special attention in a real design scenario. A more optimised solution can be expected with more

7. Discussion

One objective of this research was to propose a method for the preliminary design of structures while applying the principles of Set-Based Parametric Design.

In this project, the concept of SBPD was adopted by setting geometrical bridge parameter ranges and generating possible

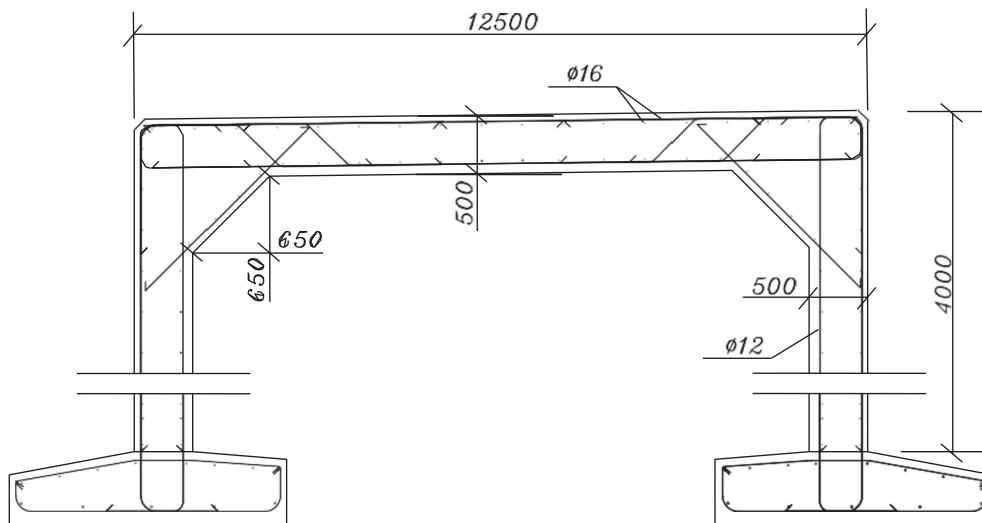

Fig. 5. Elevation of the concrete frame bridge in Stockholm.

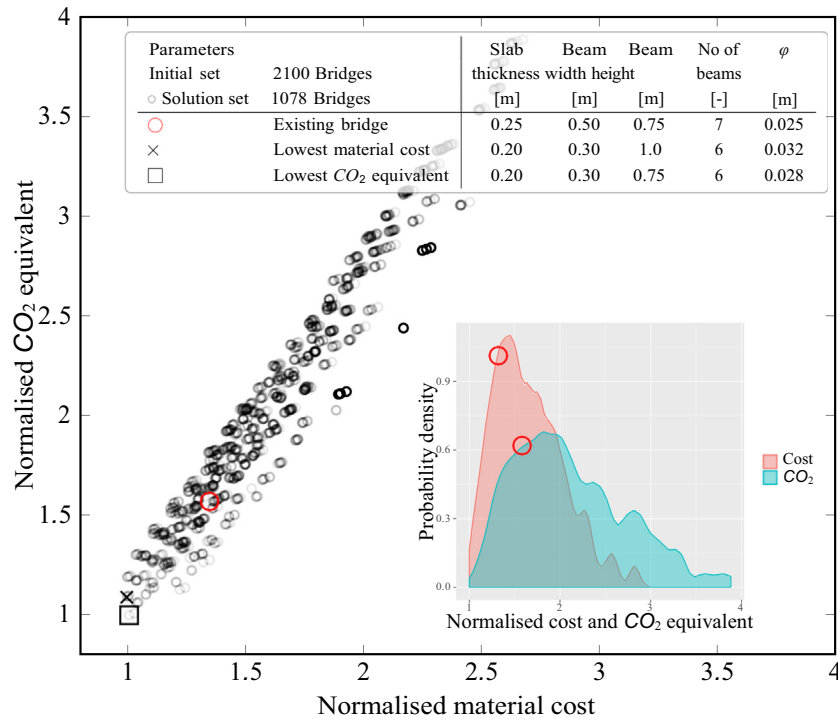

Fig. 6. Correlation between material cost and CO₂ equivalent for the concrete beam bridge.

alternatives in the initial set. However, it is not believed that the size of the chosen ranges for the cases studied affected the verification or the reliability of the proposed method.

The method may be similarly applied to a real preliminary design scenario. Then, the sets of alternatives would be composed of different types of bridges, material combinations, and/or building technologies that imply different construction methods. There is a difference between these two scenarios with regard to the CPU-time. For this project,

there was an option of using a limited range of parameters, whereas for a real-design scenario, numerous parameters would be needed, which would require a longer CPU-time. The final FE-models of the existing bridges were analysed in 92 and 54 s on a PC with 4 multi-threaded CPUs, for the concrete beam and concrete-steel composite bridges, respectively.

In Figs. 6–8, the criteria normalised cost and CO₂ equivalent emissions for the three existing bridges are presented. In order to analyse the

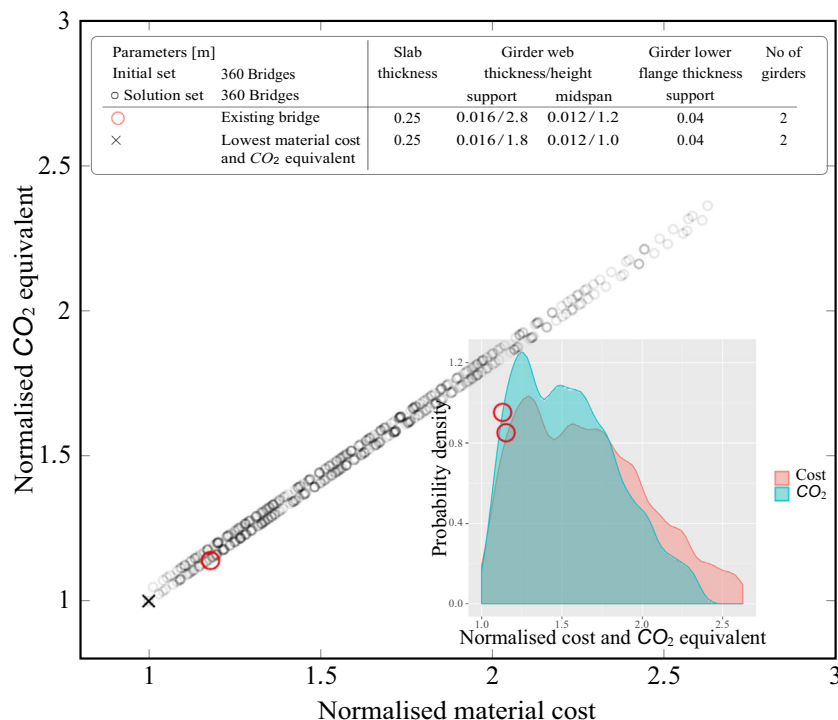

Fig. 7. Correlation between material cost and CO₂ equivalent for the steel-concrete composite bridge.

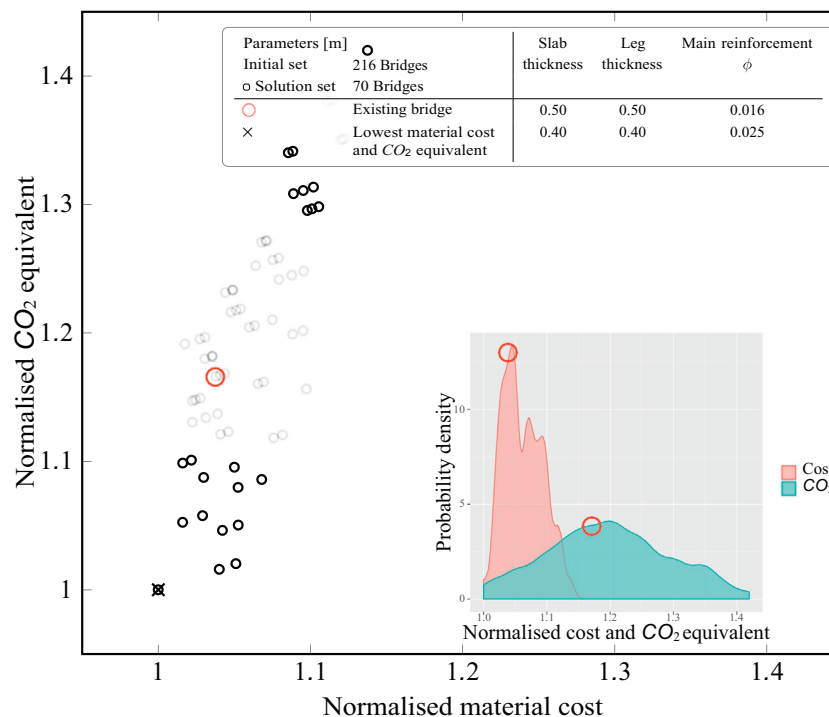

Fig. 8. Correlation between material cost and CO₂ equivalent concrete frame bridge.

results, the existing bridges are marked in the solution set and the corresponding input parameters are given, together with parameters of the most promising alternatives.

A remark can be made on the choice of the initial set of ranges. For the steel-concrete composite bridge, not one of the generated bridges in the initial set was discarded in the design. Consequently, the bridge with the smallest material volume was the best alternative. This points out that the choice of initial set of value ranges must be chosen carefully. In the present example, the initial set was chosen 'too high' in comparison to the real bridge, i.e. there are possible better performing solutions. If the method does not discard any alternative the initial set should be reconsidered.

Due to the linear correlation, there are only few alternatives on the pareto front of the plotted criteria. In the graph of the concrete beam bridge, two alternatives are concluded to be promising. An analysis of the parameters of these two alternatives reveals a disagreement. The alternative that shows the lowest material cost has a larger section than the alternative that shows the lowest CO₂ equivalent. To find the reason for this disagreement, the number of bars and the corresponding diameter of the bars in each region were studied in detail. The study revealed that the total number of reinforcement bars was 15% less for the lowest cost alternative compared to the lowest CO₂ equivalent alternative. In order to get a better basis of alternatives to choose from there is need for including criteria that have a weaker linear relationship, such as time of construction activities, disturbance of construction activities and emissions from construction equipment used.

Previous research shows that a key to a more effective design and construction is the automation of the routine design tasks [34, 35], which has been implemented in this project. The proposed method automates routine design tasks, and the applicability of this approach has been assessed to be very promising. As the development of a bridge concept includes a complete set of geometrical parameters, with the SBPD method, it is possible to adjust the concept, and thereby, create a wider basis for the design decisions based on the evaluated material cost and CO₂ equivalent emissions or other criteria.

8. Conclusion

The purpose of this research was to investigate the potential of applying a Set-Based Parametric Design method in the early stages of structural design of bridges. The potential of the proposed method has been verified against two sustainability criteria by implementing the method for three existing bridges and evaluating the results. The implemented method automates the design process to a high level and evaluates numerous alternatives.

Although only three bridges were used for the verification, it was observed that the proposed method design bridges that are more efficient in terms of material cost and CO₂ equivalent emissions compared to a traditional point-based design. A reduction of 20%–60% in material cost and CO₂ equivalent emissions were observed for the three evaluated bridges.

Acknowledgements

NCC provided documentation of the concrete beam bridge as well as the steel-concrete composite bridge. The documentation of the concrete frame bridge was provided by WSP. The authors acknowledge both companies for their helpfulness in providing documentation and completing the project.

References

- [1] A. Ward, J.K. Liker, J.J. Cristiano, D.K. Sobek, The second Toyota paradox: how delaying decisions can make better cars faster, *Sloan Manage. Rev.* (1995) 43–61 <http://sloanreview.mit.edu/article/the-second-toyota-paradox-how-delaying-decisions-can-make-better-cars-faster/>.
- [2] Y.-E. Nahm, H. Ishikawa, Novel space-based design methodology for preliminary engineering design, *Int. J. Adv. Manuf. Technol.* 28 (11–12) (2005) 1056–1070, <https://doi.org/10.1007/s00170-004-2463-2> <http://link.springer.com/10.1007/s00170-004-2463-2>.
- [3] J.K. Liker, D.K. Sobek, A.C. Ward, J.J. Cristiano, Involving suppliers in product development in the United States and Japan: evidence for set-based concurrent engineering, *IEEE Trans. Eng. Manag.* 43 (2) (1996) 165–178, <https://doi.org/10.1109/17.509982> <http://ieeexplore.ieee.org/lpdocs/epic03/wrapper.htm?arnumber=509982>.
- [4] D.K. Sobek, A.C. Ward, J.K. Liker, Toyota's principles of set-based concurrent

- engineering, *Sloan Manag. Rev.* 40 (2) (1999) 1–67 https://www.researchgate.net/publication/248139929_Toyota's_Principles_of_Set-Based_Concurrent_Engineering.
- [5] J. Stephenson, R.A. Callander, *Engineering Design*, Wiley, Sydney; New York, 1974.
- [6] S. Finger, J.R. Dixon, A review of research in mechanical engineering design. Part I: descriptive, prescriptive, and computer-based models of design processes, *Res. Eng. Des.* 1 (1989) 51–67, <https://doi.org/10.1007/BF01580003>.
- [7] S. Finger, J.R. Dixon, A review of research in mechanical engineering design. Part II: representation, analysis, and design for the life cycle, *Res. Eng. Des.* 1 (1989) 121–137, <https://doi.org/10.1007/BF01580205>.
- [8] D. Aganovic, M. Bjelkemyr, B. Lindberg, Applicability of engineering design theories on manufacturing system design in the context of concurrent engineering, in: S. Tichkiewitch, D. Brissaud (Eds.), *Methods and Tools for Co-operative and Integrated Design*, Kluwer Academic Publisher, 2004, pp. 145–158.
- [9] S.J. Egan, *Rethinking Construction*, The Construction Task Force, 1998, http://constructingexcellence.org.uk/wp-content/uploads/2014/10/rethinking_construction_report.pdf.
- [10] AIA, *Integrated Project Delivery: A Guide*, American Institute of Architects, Chicago, 2007 http://info.aia.org/siteobjects/files/ipd_guide_2007.pdf.
- [11] K.T. Ulrich, S.D. Eppinger, *Product Design and Development*, fifth, McGraw-Hill, New York, NY, USA, 2012.
- [12] C. Levandowski, D. Corin-Stig, D. Bergsjö, A. Forslund, U. Högman, R. Söderberg, H. Johannesson, An integrated approach to technology platform and product platform development, *Concurr. Eng.* 21 (2012) 65–83, <https://doi.org/10.1177/1063293X12467808>.
- [13] C.E. Levandowski, *Platform Lifecycle Support Using Set-Based Concurrent Engineering*, Phd Chalmers University of Technology, 2014, <https://research.chalmers.se/publication/203912>.
- [14] C. Levandowski, D. Raudberget, H. Johannesson, *Set-Based Concurrent Engineering for Early Phases in Platform Development*, International Conference on Concurrent Engineering CE2014, Beijing, China, 2014, pp. 564–576, <https://doi.org/10.3233/978-1-61499-440-4-564>.
- [15] D.N. Ford, D.K. Sobek, Adapting real options to new product development by modeling the second Toyota paradox, *IEEE Transactions on Engineering Management* 52 (2) (2005) 175–185, <https://doi.org/10.1109/TEM.2005.844466>.
- [16] Y.-E. Nahm, H. Ishikawa, A new 3D-CAD system for set-based parametric design, *Int. J. Adv. Manuf. Technol.* 29 (1–2) (2006) 137–150, <https://doi.org/10.1007/s00170-004-2213-5>.
- [17] B.C. Lottaz, D.E. Cle, B.V. Faltings, I.F.C. Smith, Constraint-based support for collaboration in design and construction, *J. Comput. Civ. Eng.* 13 (January) (1999) 23–35, [https://doi.org/10.1061/\(ASCE\)0887-3801\(1999\)13:1\(23\)](https://doi.org/10.1061/(ASCE)0887-3801(1999)13:1(23)).
- [18] K. Parrish, J.-M. Wong, I.D. Tommelein, Exploration of set-based design for reinforced concrete structures, *July Proc. IGLC-15*, Michigan, USA, 2007, pp. 213–222 <https://asu.pure.elsevier.com/en/publications/exploration-of-set-based-design-for-reinforced-concrete-structure>.
- [19] K.D. Parrish, *Applying a Set-based Design Approach to Reinforcing Steel Design*, PhD University of California, Berkeley, 2009, <http://faculty.ce.berkeley.edu/tommelein/papers/2009-Parrish-PhD.pdf>.
- [20] D. Castro-Lacouture, M.J. Skibniewski, Implementing a B2B e-Work system to the approval process of rebar design and estimation, February, *J. Comput. Civ. Eng.* 20 (2006) 28–37, [https://doi.org/10.1061/\(ASCE\)0887-3801\(2006\)20:1\(28\)](https://doi.org/10.1061/(ASCE)0887-3801(2006)20:1(28)).
- [21] S.-I. Lee, J.-S. Bae, Y.S. Cho, Efficiency analysis of set-based design with structural building information modeling (S-BIM) on high-rise building structures, *Autom. Constr.* 23 (2012) 20–32, <https://doi.org/10.1016/j.autcon.2011.12.008>.
- [22] J.V. Martí, T. García-Segura, V. Yepes, Structural design of precast-prestressed concrete U-beam road bridges based on embodied energy, *J. Clean. Prod.* 120 (2016) 231–240, <https://doi.org/10.1016/j.jclepro.2016.02.024>.
- [23] T. García-Segura, V. Yepes, J. Alcalá, E. Pérez-López, Hybrid harmony search for sustainable design of post-tensioned concrete box-girder pedestrian bridges, *Eng. Struct.* 92 (2015) 112–122, <https://doi.org/10.1016/j.engstruct.2015.03.015>.
- [24] T. García-Segura, V. Yepes, J.V. Martí, J. Alcalá, Optimization of concrete I-beams using a new hybrid glowworm swarm algorithm, *Lat. Am. J. Solids and Struct.* 11 (7) (2014) 1190–1205, <https://doi.org/10.1590/S1679-78252014000700007>.
- [25] P. Jensen, T. Olofsson, H. Johnsson, Configuration through the parameterization of building components, *Autom. Constr.* 23 (2012) 1–8, <https://doi.org/10.1016/j.autcon.2011.11.016>.
- [26] CEB-fib, *Bulletin 51: Structural Concrete-Textbook on Behaviour, Design and Performance*, International Federation for Structural Concrete, Lausanne, Switzerland, 2009, <https://www.fib-international.org/publications/fib-bulletins/structural-concrete-textbook,-volume-1-detail.html>.
- [27] CEN, *Eurocode - Basis of Structural Design (EN1990:2002)*, CEN - European Committee for Standardization, Brussels, 2005, <https://eurocodes.jrc.ec.europa.eu/showpage.php?id=130>.
- [28] A., Bureau, NCCI: Elastic Critical Moment for Lateral Torsional Buckling, *Access Steel*, 2008, <https://eurocodes.jrc.ec.europa.eu/doc/WS2008/SN003a-EN-EU.pdf>.
- [29] CEN, *Eurocode 2 - Design of Concrete Structures - Part 2: Concrete Bridges - Design and Detailing Rules (EN1992-2:2005)*, CEN - European Committee for Standardization, Brussels, 2005, <https://eurocodes.jrc.ec.europa.eu/showpage.php?id=132>.
- [30] CEN, *Eurocode 4: Design of Composite Steel and Concrete Structures - Part 2: General Rules and Rules for Bridges (EN 1994-2:2005)*, CEN - European Committee for Standardization, Brussels, 2005, <https://eurocodes.jrc.ec.europa.eu/showpage.php?id=134>.
- [31] TDOK 2016:0204 Requirements for Bridge Construction, Swedish Transport Administration (In Swedish), 2016, <http://trvdokument.trafikverket.se/Versioner.aspx?spid=4052&dokumentid=TDOK2020163a0204>.
- [32] A.W. Beeby, R.S. Narayanan, *Designers' Handbook to Eurocode 2: 1. Design of Concrete Structures*, *Designers' Handbook to Eurocode 2*, in: Thomas Telford (Ed.), 1995 <http://books.google.se/books?id=PQ4tV80BGjW4C>.
- [33] M. Gustafsson, *Byggmästarnas kostnads kalkylator: för värderingar, indexberäkningar och kostnadsutredningar*. (The Contractor's Cost Estimation Calendar), Svensk Byggtjänst, 2018, <https://byggtjanst.se/bokhandel/kategorier/projektering-upphandling/bk-2019.-byggmastarnas-kostnads-kalkylator/>.
- [34] R. Rempling, D. Fall, K. Lundgren, Aspects of integrated design of structures: parametric models, creative space and linked knowledge, *Civil Eng. Arch.* 3 (5) (2015) 143–152, <https://doi.org/10.13189/cea.2015.030507>.
- [35] W.J.C. Verhagen, P. Bermell-García, R.E.C. van Dijk, R. Curran, A critical review of knowledge-based engineering: an identification of research challenges, *Adv. Eng. Inform.* 26 (1) (2012) 5–15, <https://doi.org/10.1016/j.aei.2011.06.004>.