

A TOPOLOGICAL JOIN CONSTRUCTION AND THE TODA SYSTEM ON COMPACT SURFACES OF ARBITRARY GENUS

ALEKS JEVIKAR⁽¹⁾, SADOK KALLEL⁽²⁾, ANDREA MALCHIODI⁽³⁾

ABSTRACT. We consider the following *Toda system* of Liouville equations on a compact surface Σ :

$$\begin{cases} -\Delta u_1 = 2\rho_1 \left(\frac{h_1 e^{u_1}}{\int_{\Sigma} h_1 e^{u_1} dV_g} - 1 \right) - \rho_2 \left(\frac{h_2 e^{u_2}}{\int_{\Sigma} h_2 e^{u_2} dV_g} - 1 \right), \\ -\Delta u_2 = 2\rho_2 \left(\frac{h_2 e^{u_2}}{\int_{\Sigma} h_2 e^{u_2} dV_g} - 1 \right) - \rho_1 \left(\frac{h_1 e^{u_1}}{\int_{\Sigma} h_1 e^{u_1} dV_g} - 1 \right), \end{cases}$$

which arises as a model for non-abelian Chern-Simons vortices. Here h_1, h_2 are smooth positive functions and ρ_1, ρ_2 two positive parameters.

For the first time the range $\rho_1 \in (4k\pi, 4(k+1)\pi)$, $k \in \mathbb{N}$, $\rho_2 \in (4\pi, 8\pi)$ is studied with a variational approach on surfaces with arbitrary genus. We provide a general existence result by means of a new improved Moser-Trudinger type inequality and introducing a topological join construction in order to describe the interaction of the two components u_1 and u_2 .

1. INTRODUCTION

We are interested here in the following *Toda system* on a compact surface Σ

$$(1) \quad \begin{cases} -\Delta u_1 = 2\rho_1 \left(\frac{h_1 e^{u_1}}{\int_{\Sigma} h_1 e^{u_1} dV_g} - 1 \right) - \rho_2 \left(\frac{h_2 e^{u_2}}{\int_{\Sigma} h_2 e^{u_2} dV_g} - 1 \right), \\ -\Delta u_2 = 2\rho_2 \left(\frac{h_2 e^{u_2}}{\int_{\Sigma} h_2 e^{u_2} dV_g} - 1 \right) - \rho_1 \left(\frac{h_1 e^{u_1}}{\int_{\Sigma} h_1 e^{u_1} dV_g} - 1 \right), \end{cases}$$

where Δ is the Laplace-Beltrami operator, ρ_1, ρ_2 are two non-negative parameters, $h_1, h_2 : \Sigma \rightarrow \mathbb{R}$ are smooth positive functions and Σ is a compact orientable surface without boundary with a Riemannian metric g . For the sake of simplicity, we normalize the total volume of Σ so that $|\Sigma| = 1$.

The above system has been widely studied in the literature since it is motivated by problems in both differential geometry and mathematical physics. In geometry it relates to the Frenet frame of holomorphic curves in $\mathbb{C}\mathbb{P}^n$, see [5, 8, 13]. In mathematical physics, it models non-abelian Chern-Simons theory in the self-dual case, when a scalar Higgs field is coupled to a gauge potential, see [21, 45, 46, 48].

Equation (1) is variational, and solutions correspond to critical points of the Euler-Lagrange functional $J_{\rho} : H^1(\Sigma) \times H^1(\Sigma) \rightarrow \mathbb{R}$ ($\rho = (\rho_1, \rho_2)$) given by

$$(2) \quad J_{\rho}(u_1, u_2) = \int_{\Sigma} Q(u_1, u_2) dV_g + \sum_{i=1}^2 \rho_i \left(\int_{\Sigma} u_i dV_g - \log \int_{\Sigma} h_i e^{u_i} dV_g \right),$$

where $Q(u_1, u_2)$ is a quadratic form which has the expression

$$(3) \quad Q(u_1, u_2) = \frac{1}{3} (|\nabla u_1|^2 + |\nabla u_2|^2 + \nabla u_1 \cdot \nabla u_2).$$

The structure of J_{ρ} strongly depends on the range of the two parameters ρ_1, ρ_2 . An important tool in treating this kind of functionals is the Moser-Trudinger inequality, see (7). For the Toda system, a similar sharp inequality was derived in [27]:

$$(4) \quad 4\pi \log \int_{\Sigma} e^{u_1 - \bar{u}_1} dV_g + 4\pi \log \int_{\Sigma} e^{u_2 - \bar{u}_2} dV_g \leq \int_{\Sigma} Q(u_1, u_2) dV_g + C_{\Sigma}, \quad (u_1, u_2) \in H^1(\Sigma) \times H^1(\Sigma);$$

here \bar{u}_i stands for the average of u_i on Σ .

2000 *Mathematics Subject Classification.* 35J50, 35J61, 35R01.

Key words and phrases. Geometric PDEs, Variational Methods, Min-max Schemes.

A.J. and A.M. have been supported by the PRIN *Variational and perturbative aspects of nonlinear differential problems*. A.J. and A.M. acknowledge support from the Mathematics Department at the University of Warwick.

By means of the latter inequality we immediately get existence of a critical point provided both ρ_1 and ρ_2 are less than 4π : indeed for these values one can minimize J_ρ using standard methods of the calculus of variations. The case of larger ρ'_i s is subtler due to the fact that J_ρ is unbounded from below.

Before describing the main difficulties of (1), we consider its scalar counterpart: the Liouville equation

$$(5) \quad -\Delta u = 2\rho \left(\frac{h e^u}{\int_\Sigma h e^u dV_g} - 1 \right),$$

where h is a smooth positive function on Σ and ρ a positive real number.

Equation (5) appears in conformal geometry in the problem of prescribing the Gaussian curvature, whereas in mathematical physics it describes models in abelian Chern-Simons theory. The literature on (5) is broad with many results regarding existence, blow-up analysis, compactness, etc., see [33, 46].

As many geometric problems, (5) presents blow-up phenomena. It was proved in [7, 29, 30] that for a sequence of solutions $(u_n)_n$ that blow-up around a point p , the following quantization property holds:

$$\lim_{r \rightarrow 0} \lim_{n \rightarrow +\infty} \int_{B_r(p)} h e^{u_n} dV_g = 4\pi.$$

Moreover, the limit function (after rescaling) can be viewed as the logarithm of the conformal factor of the stereographic projection from S^2 onto \mathbb{R}^2 , composed with a dilation.

Concerning the Toda system (1), a sequence of solutions can blow-up in three different ways: one component blows-up and the other stays bounded, one component blows-up faster than the other or both components diverge at the same rate. In [26] the authors proved that the volume quantizations in these scenarios are $(0, 4\pi)$ or $(4\pi, 0)$ in the first case, $(4\pi, 8\pi)$ or $(8\pi, 4\pi)$ for the second one and $(8\pi, 8\pi)$ for the last situation. Moreover, each alternative may indeed occur, see [15, 16, 17, 22, 40].

With this at hand, with some further analysis it is possible to obtain a compactness property, see Theorem 2.1, namely that the set of solutions to (1) is bounded (in any smoothness norm) for (ρ_1, ρ_2) bounded away from multiples of 4π (see Theorem 2.1). This fact, combined with a monotonicity method from [43], allows to attack problem (1) via min-max methods.

Let us now discuss the variational strategy for proving existence of solutions and how our result compares to the existing literature. The goal is to introduce min-max schemes based on the study of the sub-levels of the Euler-Lagrange functional. Consider the scalar case (5), with Euler-Lagrange energy

$$(6) \quad I_\rho(u) = \frac{1}{2} \int_\Sigma |\nabla_g u|^2 dV_g + 2\rho \left(\int_\Sigma u dV_g - \log \int_\Sigma h e^u dV_g \right).$$

By the classical Moser-Trudinger inequality

$$(7) \quad 8\pi \log \int_\Sigma e^{(u-\bar{u})} dV_g \leq \frac{1}{2} \int_\Sigma |\nabla u|^2 dV_g + C_{\Sigma, g},$$

the latter energy is coercive if and only if $\rho < 4\pi$. A key result in treating this kind of problems without coercivity conditions (i.e. when $\rho > 4\pi$) is an improved version of (7), usually referred to as Chen-Li's inequality and obtained in [11], [19] (see also [20]); roughly speaking, it states that if the function e^u is *spread* (in a quantitative sense) among at least $(k+1)$ regions of Σ , $k \in \mathbb{N}$, then the constant in the left-hand side of (7) can be taken nearly $(k+1)$ times larger. This in turn implies that, for such functions u , $I_\rho(u)$ is bounded below even when $\rho < 4(k+1)\pi$. Therefore, if ρ satisfies the latter inequality and if $I_\rho(u)$ attains large negative values (i.e. when the lower bounds fail) e^u should be concentrated near at most k points of Σ , see [19] for a formal proof of this fact.

To describe such low sublevels it is then natural to introduce the family of unit measures Σ_k which are supported in at most k points of Σ , known as *formal barycenters* of Σ of order k :

$$(8) \quad \Sigma_k = \left\{ \sum_{i=1}^k t_i \delta_{x_i} : \sum_{i=1}^k t_i = 1, t_i \geq 0, x_i \in \Sigma, \forall i = 1, \dots, k \right\}.$$

Endowed with the weak topology of distributions Σ_1 is homeomorphic to Σ , while for $k \geq 2$ Σ_k is a stratified set (union of open manifolds of different dimensions): it is possible to show that the homology

of Σ_k is always non trivial and, using suitable test functions, that it injects into that of sufficiently low sub-levels of I_ρ : this gives existence of solutions to (5) via suitable min-max schemes for every $\rho \notin 4\pi\mathbb{N}$.

Returning to the Toda system (1), a first existence result was presented in [35] for $\rho_1 \in (4k\pi, 4(k+1)\pi)$, $k \in \mathbb{N}$ and $\rho_2 < 4\pi$ (see also [26] for the case $k = 1$). When one of the two parameters is small, the system (1) resembles the scalar case (5) and one can adapt the above argument to this framework as well. When both parameters exceed the value 4π , the description of the low sublevels becomes more involved due to the interaction of the two components u_1 and u_2 .

The first variational approach to understand this interaction was given in [36], where the authors obtained an existence result for $(\rho_1, \rho_2) \in (4\pi, 8\pi)^2$. This was done in particular by showing that if both components of the system concentrate near the same point and with the same *rate*, then the constants in the left-hand side of (4) can be nearly doubled.

Later, the case of general parameters $(\rho_1, \rho_2) \notin \Lambda$ was considered in [3], but only for surfaces of positive genus. Using improved inequalities a' la Chen-Li, it is possible to prove that if $\rho_1 < 4(k+1)\pi$, $\rho_2 < 4(l+1)\pi$, $k, l \in \mathbb{N}$, and if $J_\rho(u_1, u_2)$ is sufficiently low, then either e^{u_1} is close to Σ_k or e^{u_2} is close to Σ_l in the distributional sense. This (non-mutually exclusive) alternative can be expressed in term of the *topological join* of Σ_k and Σ_l . Recall that, given two topological spaces A and B , their join $A * B$ is defined as the family of elements of the form

$$(9) \quad A * B = \frac{\{(a, b, s) : a \in A, b \in B, s \in [0, 1]\}}{E},$$

where E is an equivalence relation such that

$$(a_1, b, 1) \stackrel{E}{\sim} (a_2, b, 1) \quad \forall a_1, a_2 \in A, b \in B \quad \text{and} \quad (a, b_1, 0) \stackrel{E}{\sim} (a, b_2, 0) \quad \forall a \in A, b_1, b_2 \in B.$$

This construction allows to map low sublevels of J_ρ into $\Sigma_k * \Sigma_l$, with the join parameter s expressing whether distributionally e^{u_1} is closer to Σ_k or e^{u_2} is closer to Σ_l .

The hypothesis on the genus of Σ in [3] was used in the following way: on such surfaces one can construct two disjoint simple non-contractible curves γ_1, γ_2 such that Σ retracts on each of them through continuous maps Π_1, Π_2 . By means of these retractions, low energy sublevels may be described in terms of $(\gamma_1)_k$ or $(\gamma_2)_l$ only. On the other hand, one can build test functions modelled on $(\gamma_1)_k * (\gamma_2)_l$ for which each component u_i only concentrates near γ_i , to somehow *minimize* the interaction between the two components u_1 and u_2 , due to the fact that γ_1 and γ_2 are disjoint.

We prove here the following result, which for the first time applies to surfaces of arbitrary genus when both parameters ρ_i are supercritical and one of them also arbitrarily large.

Theorem 1.1. *Let h_1, h_2 be two positive smooth functions and let Σ be any compact surface. Suppose that $\rho_1 \in (4k\pi, 4(k+1)\pi)$, $k \in \mathbb{N}$ and $\rho_2 \in (4\pi, 8\pi)$. Then problem (1) has a solution.*

Remark 1.2. *Theorem 1.1 is new when Σ is a sphere and $k \geq 3$. As we already discussed, the case of surfaces with positive genus was covered in [3]. The case of $\Sigma \simeq S^2$ and $k = 1$ was covered in [36], while for $k = 2$ it was covered in [31]. In the latter paper the authors indeed computed the Leray-Schauder degree of the equation for the range of ρ_i 's in Theorem 1.1. It turns out that the degree of (1) is zero for the sphere when $k \geq 3$: since solutions do exist by Theorem 1.1, it means that either they are degenerate, or that degrees of multiple ones cancel, so a global degree counting does not detect them. A similar phenomenon occurs for (5) on the sphere, when $\rho > 12\pi$, see [12]. Even for positive genus, we believe that our approach could be useful in computing the degree of the equation, as it happened in [34] for the scalar equation (5). More precisely we speculate that the degree should be computable as $1 - \chi(Y)$, where the set Y is given in (51). This is verified for example in the case of the sphere thanks to Lemma 5.4.*

Other results on the degree of the system, but for different ranges of parameters, are available in [37].

As described above, in the situation of Theorem 1.1 it is natural to characterize low sublevels of the Euler-Lagrange energy J_ρ by means of the topological join $\Sigma_k * \Sigma_l$ (notice that $\Sigma_l \simeq \Sigma$). However, differently from [3], we crucially take into account the interaction between the two components u_1 and u_2 . As one can see from (3), the quadratic energy Q penalizes situations in which the gradients of the

two components are aligned, and we would like to make a quantitative description of this effect. Our proof uses four new main ingredients.

- A refinement of the projection from low-energy sublevels onto the topological join $\Sigma_k * \Sigma_1$ from [3], see Section 3, which uses the scales of concentration of the two components, and which extends some construction in [36]. Having to deal with arbitrarily high values of ρ_1 , differently from [36] we also need to take into account of the stratified structure of Σ_k and to the closeness in measure sense to its substrata.

- A new, scaling invariant improved Moser-Trudinger inequality for system (1), see Proposition 3.5. This is inspired from another one in [7] for singular Liouville equations, i.e. of the form (5) but with Dirac masses on the right-hand side. The link between the two problems arises in the situation when one of the two components in (1) is much more concentrated than the other: in this case the measure associated to its exponential function resembles a Dirac delta compared to the other one. The above improved inequality gives extra constraints to the projection on the topological join, see Proposition 3.7 and Corollary 3.8.

- A new set of test functions showing that the characterisation of low energy levels of J_ρ is sharp, as a subset Y of $\Sigma_k * \Sigma_1$. We need indeed to build test functions modelled on a set which contains $\Sigma_{k-1} * \Sigma_1$, and the stratified nature of Σ_{k-1} makes it hard to obtain uniform upper estimates on such functions.

- A new topological argument showing the non-contractibility of the above set Y , which we use then crucially to develop our min-max scheme. The fact that Y is simply connected and has Euler characteristic equal to 1 forces us to use rather sophisticated tools from algebraic topology.

We expect that our approach might extend to the case of general physical parameters ρ_1, ρ_2 , including the *singular Toda system*, in which Dirac masses (corresponding to ramification or vortex points) appear in the right-hand side of (1), see also [2] for some results with this approach.

The paper is organized as follows. In Section 2 we recall some improved versions of the Moser-Trudinger inequality, first some which rely on the *macroscopic* spreading of the components u_1, u_2 and then some refined ones, which are scaling invariant. In Section 3 we derive a new - still scaling invariant - improved version of the Moser-Trudinger inequality for systems, and we use it to find a characterization of low energy levels of J_ρ by means of a subset Y of the topological join $\Sigma_k * \Sigma_1$. In Section 4 we construct then suitable test functions which show the optimality of the above characterization. In Section 5 we finally introduce the variational method to prove the existence of solutions.

Notation

The symbol $B_r(p)$ stands for the open metric ball of radius r and centre p , while $A_p(r_1, r_2)$ is the open annulus of radii r_1, r_2 and centre p . For the complement of a set Ω in Σ we will write Ω^c . Given a function $u \in L^1(\Sigma)$ and $\Omega \subset \Sigma$, the average of u on Ω is denoted by the symbol

$$\int_{\Omega} u dV_g = \frac{1}{|\Omega|} \int_{\Omega} u dV_g,$$

while \bar{u} stands for the average of u in Σ : since we are assuming $|\Sigma| = 1$, we have

$$\bar{u} = \int_{\Sigma} u dV_g = \int_{\Sigma} u dV_g.$$

The sublevels of the functional J_ρ will be denoted by

$$J_\rho^a = \{(u_1, u_2) \in H^1(\Sigma) \times H^1(\Sigma) : J_\rho(u_1, u_2) \leq a\}.$$

Throughout the paper the letter C will stand for large constants which are allowed to vary among different formulas or even within the same lines. To stress the dependence of the constants on some parameter, we add subscripts to C , as C_δ , etc. We will write $o_r(1)$ to denote quantities that tend to 0 as $r \rightarrow 0$ or $r \rightarrow +\infty$; we will similarly use the symbol $O_r(1)$ for bounded quantities.

2. PRELIMINARIES

We begin by stating a compactness property that is needed in order to run the variational methods. Letting Λ be the set defined as

$$(10) \quad \Lambda = (4\pi\mathbb{N} \times \mathbb{R}) \cup (\mathbb{R} \cup 4\pi\mathbb{N}) \subseteq \mathbb{R}^2,$$

by the local blow-up in [26] and some analysis, see [4], one deduces the following result.

Theorem 2.1. ([4], [26]) *For (ρ_1, ρ_2) in a fixed compact set of $\mathbb{R}^2 \setminus \Lambda$ the family of solutions to (1) is uniformly bounded in $C^{2,\beta}$ for some $\beta > 0$.*

In the next two subsections we will discuss some improved versions of the Moser-Trudinger inequality (4) which hold under suitable assumptions on the components of the system. The first type of inequality relies on the spreading of the (exponentials of the) components over the surface (see [3]). The second one, from [36], relies instead on comparing the scales of concentration of the two components.

2.1. Macroscopic improved inequalities. Here comes the first kind of improved inequality: basically, if the *mass* of both e^{u_1} and e^{u_2} is *spread* respectively on at least $k+1$ and $l+1$ different sets, then the logarithms in (4) can be multiplied by $k+1$ and $l+1$ respectively. Notice that this result was given in [35] in the case $l=0$ and in [36] in the case $k=l=1$. The proof relies on localizing (4) by using cut-off functions near the regions of volume concentration. For (7) this was previously shown in [9].

Lemma 2.2. ([3]) *Let $\delta > 0$, $\theta > 0$, $k, l \in \mathbb{N}$ and $\{\Omega_{1,i}, \Omega_{2,j}\}_{i \in \{0, \dots, k\}, j \in \{0, \dots, l\}} \subset \Sigma$ be such that*

$$\begin{aligned} d(\Omega_{1,i}, \Omega_{1,i'}) &\geq \delta & \forall i, i' \in \{0, \dots, k\} \text{ with } i \neq i'; \\ d(\Omega_{2,j}, \Omega_{2,j'}) &\geq \delta & \forall j, j' \in \{0, \dots, l\} \text{ with } j \neq j'. \end{aligned}$$

Then, for any $\varepsilon > 0$ there exists $C = C(\varepsilon, \delta, \theta, k, l, \Sigma)$ such that any $(u_1, u_2) \in H^1(\Sigma) \times H^1(\Sigma)$ satisfying

$$\begin{aligned} \int_{\Omega_{1,i}} e^{u_1} dV_g &\geq \theta \int_{\Sigma} e^{u_1} dV_g & \forall i \in \{0, \dots, k\}; \\ \int_{\Omega_{2,j}} e^{u_2} dV_g &\geq \theta \int_{\Sigma} e^{u_2} dV_g & \forall j \in \{0, \dots, l\} \end{aligned}$$

verifies

$$4\pi(k+1) \log \int_{\Sigma} e^{u_1 - \bar{u}_1} dV_g + 4\pi(l+1) \log \int_{\Sigma} e^{u_2 - \bar{u}_2} dV_g \leq (1 + \varepsilon) \int_{\Sigma} Q(u_1, u_2) dV_g + C.$$

As one can see, larger constants in the left-hand side of (4) can be helpful in obtaining lower bounds on the functional J_ρ even when the coefficients ρ_1, ρ_2 exceed the threshold value $(4\pi, 4\pi)$. A consequence of this fact is that when the energy $J_\rho(u_1, u_2)$ is large negative, then e^{u_1}, e^{u_2} are forced to *concentrate* near certain points in Σ whose number depends on ρ_1, ρ_2 . To make this description rigorous it is convenient to introduce some further notation.

We denote by $\mathcal{M}(\Sigma)$ the set of all Radon measures on Σ , and introduce a distance on it by using duality versus Lipschitz functions, that is, we set:

$$(11) \quad \mathbf{d}(\nu_1, \nu_2) = \sup_{\|f\|_{L^1(\Sigma)} \leq 1} \left| \int_{\Sigma} f d\nu_1 - \int_{\Sigma} f d\nu_2 \right|; \quad \nu_1, \nu_2 \in \mathcal{M}(\Sigma).$$

This is known as the *Kantorovich-Rubinstein distance*.

In [3], using the improved inequality from Lemma 2.2, the following result was proven.

Proposition 2.3. ([3]) *Suppose $\rho_1 \in (4k\pi, 4(k+1)\pi)$ and $\rho_2 \in (4l\pi, 4(l+1)\pi)$. Then, for any $\varepsilon > 0$, there exists $L > 0$ such that any $(u_1, u_2) \in J_\rho^{-L}$ verifies either*

$$\mathbf{d} \left(\frac{e^{u_1}}{\int_{\Sigma} e^{u_1} dV_g}, \Sigma_k \right) < \varepsilon \quad \text{or} \quad \mathbf{d} \left(\frac{e^{u_2}}{\int_{\Sigma} e^{u_2} dV_g}, \Sigma_l \right) < \varepsilon.$$

When a measure is \mathbf{d} -close to an element in Σ_k , see (8), it is then possible to map it continuously to a nearby element in this set. The next proposition collects some properties of this map, from Proposition 2.2 in [3] and Lemma 2.3 in [20] (together with the proof of Lemma 3.10).

Proposition 2.4. *Given $l \in \mathbb{N}$, for ε_l sufficiently small there exists a continuous retraction*

$$\psi_l : \{\nu \in \mathcal{M}(\Sigma), \mathbf{d}(\nu, \Sigma_l) < 2\varepsilon_l\} \rightarrow \Sigma_l.$$

Here continuity is referred to the distance \mathbf{d} . In particular, if $\nu_n \rightarrow \nu$ in the sense of measures, with $\nu \in \Sigma_l$, then $\psi_l(\nu_n) \rightarrow \nu$.

Furthermore, the following property holds: given any $\varepsilon > 0$ there exists $\varepsilon' \ll \varepsilon$, ε' depending on l and ε such that if $\mathbf{d}(\nu, \Sigma_{l-1}) > \varepsilon$ then there exist l points x_1, \dots, x_l such that

$$d(x_i, x_j) > 2\varepsilon' \quad \text{for } i \neq j; \quad \int_{B_{\varepsilon'}(x_i)} \nu > \varepsilon' \quad \text{for all } i = 1, \dots, l.$$

The alternative in Proposition 2.3 can be expressed naturally in terms of the topological join of $\Sigma_k * \Sigma_l$, see also the comments after (9). Indeed, we can define a map from the low sublevels J_ρ^{-L} onto this set.

Proposition 2.5. ([3]) *Suppose $\rho_1 \in (4k\pi, 4(k+1)\pi)$ and $\rho_2 \in (4l\pi, 4(l+1)\pi)$. Then for $L > 0$ sufficiently large there exists a continuous map*

$$\Psi : J_\rho^{-L} \rightarrow \Sigma_k * \Sigma_l.$$

PROOF. The proof is carried out exactly as in Proposition 4.7 of [3]. We repeat here the argument for the reader's convenience, as we will need to suitably modify it later on. By Proposition 2.3 we know that for any $\varepsilon > 0$, taking $L > 0$ sufficiently large, $(u_1, u_2) \in J_\rho^{-L}$ verifies either $\mathbf{d}\left(\frac{e^{u_1}}{\int_\Sigma e^{u_1} dV_g}, \Sigma_k\right) < \varepsilon$ or $\mathbf{d}\left(\frac{e^{u_2}}{\int_\Sigma e^{u_2} dV_g}, \Sigma_l\right) < \varepsilon$ (or both). Using then Proposition 2.4 it follows that either $\psi_k\left(\frac{e^{u_1}}{\int_\Sigma e^{u_1} dV_g}\right)$ or $\psi_l\left(\frac{e^{u_2}}{\int_\Sigma e^{u_2} dV_g}\right)$ is well-defined. We let $d_1 = \mathbf{d}\left(\frac{e^{u_1}}{\int_\Sigma e^{u_1} dV_g}, \Sigma_k\right)$, $d_2 = \mathbf{d}\left(\frac{e^{u_2}}{\int_\Sigma e^{u_2} dV_g}, \Sigma_l\right)$, and introduce a function $\tilde{s} = \tilde{s}(d_1, d_2)$ in the following way:

$$\tilde{s}(d_1, d_2) = f\left(\frac{d_1}{d_1 + d_2}\right),$$

where f is given by

$$f(t) = \begin{cases} 0 & \text{if } t \in [0, 1/4], \\ 2z - \frac{1}{2} & \text{if } t \in (1/4, 3/4), \\ 1 & \text{if } t \in [3/4, 1]. \end{cases}$$

We finally set

$$(12) \quad \Psi(u_1, u_2) = (1 - \tilde{s})\psi_k\left(\frac{e^{u_1}}{\int_\Sigma e^{u_1} dV_g}\right) + \tilde{s}\psi_l\left(\frac{e^{u_2}}{\int_\Sigma e^{u_2} dV_g}\right).$$

One has just to observe that when one of the two ψ 's is not defined, the other necessarily is. Therefore the map is well-defined by the equivalence relation of the topological join, see (9). ■

2.2. Scaling-invariant improved inequalities. In [36] the authors set up a tool to deal with situations to which Lemma 2.2 does not apply, for example in cases when both e^{u_1}, e^{u_2} are concentrated around only one point. They provided a definition of the *center* and the *scale of concentration* of such functions, to obtain new improved inequalities in terms of these. We are interested here in measures concentrated around possibly multiple points. We need therefore a localized version of the argument in [36], which applies to measures supported in a ball and sufficiently concentrated around its center.

Given $x_0 \in \Sigma$ and $r > 0$ small, consider the set

$$\mathcal{A}_{x_0, r} = \left\{ f \in L^1(B_r(x_0)) : f > 0 \text{ a. e. and } \int_{B_r(x_0)} f dV_g = 1 \right\},$$

endowed with the topology inherited from $L^1(\Sigma)$.

Fix a constant $R > 1$ and let $R_0 = 3R$. Define $\sigma : B_r(x_0) \times \mathcal{A}_{x_0,r} \rightarrow (0, +\infty)$ such that:

$$(13) \quad \int_{B_{\sigma(x,f)}(x) \cap B_r(x_0)} f dV_g = \int_{(B_{R_0\sigma(x,f)}(x))^c \cap B_r(x_0)} f dV_g.$$

It is easy to check that $\sigma(x, f)$ is uniquely determined and continuous (both in $x \in B_r(x_0)$ and in $f \in L^1$). Moreover, see (3.2) in [36], σ satisfies:

$$(14) \quad d(x, y) \leq R_0 \max\{\sigma(x, f), \sigma(y, f)\} + \min\{\sigma(x, f), \sigma(y, f)\}.$$

We now define $T : B_r(x_0) \times \mathcal{A}_{x_0,r} \rightarrow \mathbb{R}$ as

$$T(x, f) = \int_{B_{\sigma(x,f)}(x) \cap B_r(x_0)} f dV_g.$$

Lemma 2.6. ([36], with minor adaptations) *If $\bar{x} \in \overline{B_r(x_0)}$ is such that $T(\bar{x}, f) = \max_{y \in \overline{B_r(x_0)}} T(y, f)$, then $\sigma(\bar{x}, f) < 3\sigma(x, f)$ for any other $x \in \overline{B_r(x_0)}$.*

As a consequence of the previous lemma and of a covering argument, one can obtain the following:

Lemma 2.7. ([36], with minor adaptations) *There exists a fixed $\tau > 0$ such that*

$$\max_{x \in \overline{B_r(x_0)}} T(x, f) > \tau > 0 \quad \text{for all } f \in \mathcal{A}_{x_0,r}.$$

Let us define $\sigma : \mathcal{A}_{x_0,r} \rightarrow \mathbb{R}$ by

$$\sigma(f) = 3 \min \left\{ \sigma(x, f) : x \in \overline{B_r(x_0)} \right\},$$

which is obviously a continuous function.

Given τ as in Lemma 2.7, consider the set:

$$(15) \quad S(f) = \left\{ x \in \overline{B_r(x_0)} : T(x, f) > \tau, \sigma(x, f) < \sigma(f) \right\}.$$

If $\bar{x} \in \overline{B_r(x_0)}$ is such that $T(\bar{x}, f) = \max_{x \in \overline{B_r(x_0)}} T(x, f)$, then Lemmas 2.6 and 2.7 imply that $\bar{x} \in S(f)$. Therefore, $S(f)$ is a non-empty set for any $f \in \mathcal{A}_{x_0,r}$. Moreover, recalling (13) and the notation before it, from (14) we have that:

$$(16) \quad \text{diam}(S(f)) \leq (R_0 + 1)\sigma(f).$$

We will now restrict ourselves to a class of functions in $L^1(B_r(x_0))$ which are almost entirely concentrated near the center x_0 . In this case one expects $\sigma(f)$ to be small and points in $S(f)$ to be close to x_0 : see Remark 2.8 for precise estimates in this spirit. Given $\varepsilon > 0$ small, let us introduce the class of functions

$$(17) \quad \mathcal{C}_{\varepsilon,r}(x_0) = \left\{ f \in \mathcal{A}_{x_0,r} : \int_{B_\varepsilon(x_0)} f dV_g > 1 - \varepsilon \right\}.$$

Remark 2.8. *For this class of functions we claim that $T(x, f) \leq \varepsilon$ when $d(x, x_0) > 2\varepsilon$. In fact, if $\sigma(x, f) \leq d(x, x_0) - \varepsilon$ then we are done, since*

$$T(x, f) = \int_{B_{\sigma(x,f)}(x) \cap B_r(x_0)} f dV_g \leq \int_{B_\varepsilon(x_0)^c \cap B_r(x_0)} f dV_g \leq \varepsilon.$$

If this is not the case, i.e. $\sigma(x, f) > d(x, x_0) - \varepsilon$, then using $d(x, x_0) > 2\varepsilon$ we obtain

$$\begin{aligned} R_0\sigma(x, f) &> R_0(d(x, x_0) - \varepsilon) > \frac{R_0}{2} d(x, x_0) \\ &> d(x, x_0) + \varepsilon. \end{aligned}$$

Similarly as before we get

$$T(x, f) = \int_{(B_{R_0\sigma(x,f)}(x))^c \cap B_r(x_0)} f dV_g \leq \int_{B_\varepsilon(x_0)^c \cap B_r(x_0)} f dV_g \leq \varepsilon.$$

Being τ universal, ε can be taken so small that $(T(x, f) - \tau)^+ = 0$ outside $B_{2\varepsilon}(x_0)$, $\forall f \in \mathcal{C}_{\varepsilon,r}(x_0)$.

By the Nash embedding theorem, we can assume that $\Sigma \subset \mathbb{R}^N$ isometrically, $N \in \mathbb{N}$. Take an open tubular neighborhood $\Sigma \subset U \subset \mathbb{R}^N$ of Σ , and $\delta > 0$ small enough so that:

$$(18) \quad co[B_x((R_0 + 1)\delta) \cap \Sigma] \subset U \quad \forall x \in \Sigma,$$

where co denotes the convex hull in \mathbb{R}^N .

For $f \in \mathcal{C}_{\varepsilon,r}(x_0)$ we define now

$$\eta(f) = \frac{\int_{\Sigma} (T(x, f) - \tau)^+ (\sigma(f) - \sigma(x, f))^+ x dV_g}{\int_{\Sigma} (T(x, f) - \tau)^+ (\sigma(f) - \sigma(x, f))^+ dV_g} \in \mathbb{R}^N,$$

which is well-defined, see Remark 2.8. The map η yields a sort of center of mass in \mathbb{R}^N of the measure induced by f . Observe that the integrands become non-zero only on the set $S(f)$. However, whenever $\sigma(f) \leq \delta$, (16) and (18) imply that $\eta(f) \in U$, and so we can define:

$$\beta : \{f \in \mathcal{A}_{x_0,r} : \sigma(f) \leq \delta\} \rightarrow \Sigma, \quad \beta(f) = P \circ \eta(f),$$

where $P : U \rightarrow \Sigma$ is the orthogonal projection.

We finally define the map $\psi : \mathcal{C}_{\varepsilon,r}(x_0) \rightarrow \Sigma \times (0, r)$, which will be the main tool of this subsection.

$$(19) \quad \psi(f) = (\beta, \sigma).$$

Roughly, this map expresses the center of mass of f and its scale of concentration around this point.

In [36] it was proved that if both components (u_1, u_2) of the Toda system concentrate around the same point in Σ , with the same scale of concentration, then the constants in the left-hand side of (4) can be nearly doubled.

Remark 2.9. *The core of the argument of the improved inequality in [36] consists in proving that*

$$\psi \left(\frac{e^{u_1}}{\int_{B_r(x)} e^{u_1} dV_g} \right) = \psi \left(\frac{e^{u_2}}{\int_{B_r(y)} e^{u_2} dV_g} \right)$$

implies the existence of $\sigma > 0$ and of two balls $B_{\sigma}(z_1), B_{\sigma}(z_2)$ such that

$$(20) \quad \frac{\int_{B_{\sigma}(z_i)} e^{u_i} dV_g}{\int_{\Sigma} e^{u_i} dV_g} \geq \gamma_0, \quad \frac{\int_{(B_{R\sigma}(z_i))^c \cap B_r(z_i)} e^{u_i} dV_g}{\int_{\Sigma} e^{u_i} dV_g} \geq \gamma_0, \quad \text{for } i = 1, 2 \quad \text{with} \quad d(z_1, z_2) \lesssim \sigma,$$

for some fixed positive constant γ_0 . Once this is achieved, the improved inequality is obtained by scaling arguments and Kelvin inversions (see Section 3 in [36] for full details).

Even when e^{u_1}, e^{u_2} are not necessarily concentrated near a single point, the assumptions of the next proposition still allow to obtain (20), and hence again nearly double constants in the left-hand side of (4).

Proposition 2.10. ([36], with minor changes) *Let $\tilde{\varepsilon} > 0$ and $\delta' > 0$. Then there exist $R = R(\tilde{\varepsilon})$ and ψ as in definition (19) such that: for any $(u_1, u_2) \in H^1(\Sigma) \times H^1(\Sigma)$ such that there exist $x, y \in \Sigma$ with*

$$\begin{aligned} \int_{B_r(x)} e^{u_1} dV_g &\geq \delta' \int_{\Sigma} e^{u_1} dV_g, & \int_{B_r(y)} e^{u_2} dV_g &\geq \delta' \int_{\Sigma} e^{u_2} dV_g; \\ \frac{e^{u_1}}{\int_{B_r(x)} e^{u_1} dV_g} &\in \mathcal{C}_{\tilde{\varepsilon},r}(x), & \frac{e^{u_2}}{\int_{B_r(y)} e^{u_2} dV_g} &\in \mathcal{C}_{\tilde{\varepsilon},r}(y) \end{aligned}$$

and

$$(21) \quad \psi \left(\frac{e^{u_1}}{\int_{B_r(x)} e^{u_1} dV_g} \right) = \psi \left(\frac{e^{u_2}}{\int_{B_r(y)} e^{u_2} dV_g} \right),$$

the following inequality holds:

$$(22) \quad 8\pi \left(\log \int_{\Sigma} e^{u_1 - \bar{u}_1} dV_g + \log \int_{\Sigma} e^{u_2 - \bar{u}_2} dV_g \right) \leq (1 + \tilde{\varepsilon}) \int_{\Sigma} Q(u_1, u_2) dV_g + C,$$

for some $C = C(\tilde{\varepsilon}, \delta', \Sigma)$.

Remark 2.11. (i) Condition (21) can be relaxed. In fact, let $C_1 > 1$ and $C_2 > 0$ be two positive constants and define

$$\psi \left(\frac{e^{u_1}}{\int_{B_r(x)} e^{u_1} dV_g} \right) = (\beta_1, \sigma_1), \quad \psi \left(\frac{e^{u_2}}{\int_{B_r(y)} e^{u_2} dV_g} \right) = (\beta_2, \sigma_2).$$

Then, the result still holds true if

$$\frac{1}{C_1} \leq \frac{\sigma_1}{\sigma_2} \leq C_1, \quad d(\beta_1, \beta_2) \leq C_2 \sigma_1.$$

In such case, the constant C would also depend on C_1 and C_2 .

(ii) In the right-hand side of (22) one can actually integrate $Q(u_1, u_2)$ only in any set compactly containing $B_r(x) \cup B_r(y)$. This can be seen using suitable cut-off functions, see the comments before Lemma 2.2.

We can now improve this result for situations in which the first component of the system is concentrated around l points of Σ , $l \in \mathbb{N}$. The proof relies on combining the argument for Proposition 2.10 with the macroscopic improved inequality of Lemma 2.2 (see also Remark 2.11 (ii)).

Proposition 2.12. Let $\tilde{\varepsilon} > 0$, $\delta' > 0$ and $k \in \mathbb{N}$. Then there exist $R = R(\tilde{\varepsilon})$ and ψ as in definition (19) such that: for any $(u_1, u_2) \in H^1(\Sigma) \times H^1(\Sigma)$ with the property that there exist $\{x_i\}_{i \in \{1, \dots, k\}} \subset \Sigma$, $y \in \Sigma$ with

$$d(x_i, x_j) > 4\delta' \quad \forall i, j \in \{1, \dots, k\} \text{ with } i \neq j;$$

$$\int_{B_{\delta'}(x_i)} e^{u_1} dV_g \geq \delta' \int_{\Sigma} e^{u_1} dV_g \quad \text{for } i = 1, \dots, k; \quad \int_{B_{\delta'}(y)} e^{u_2} dV_g \geq \delta' \int_{\Sigma} e^{u_2} dV_g,$$

such that

$$\frac{e^{u_1}}{\int_{B_{\delta'}(x_i)} e^{u_1} dV_g} \in \mathcal{C}_{\varepsilon, \delta'}(x_i) \quad \text{for } i = 1, \dots, k; \quad \frac{e^{u_2}}{\int_{B_{\delta'}(y)} e^{u_2} dV_g} \in \mathcal{C}_{\varepsilon, \delta'}(y)$$

and

$$\psi \left(\frac{e^{u_1}}{\int_{B_{\delta'}(x_i)} e^{u_1} dV_g} \right) = \psi \left(\frac{e^{u_2}}{\int_{B_{\delta'}(y)} e^{u_2} dV_g} \right) \quad \text{for some } l \in \{1, \dots, k\},$$

the following inequality holds:

$$4\pi(k+1) \log \int_{\Sigma} e^{u_1 - \bar{u}_1} dV_g + 8\pi \log \int_{\Sigma} e^{u_2 - \bar{u}_2} dV_g \leq (1 + \tilde{\varepsilon}) \int_{\Sigma} Q(u_1, u_2) dV_g + C,$$

for some $C = C(\tilde{\varepsilon}, \delta', l, \Sigma)$.

In the next section we will derive a new improved inequality for the Toda system with scaling invariant features, see Proposition 3.5. The result is inspired by arguments developed in [1] for the singular Liouville equation where a Dirac delta is involved, see Remark 3.6, and for the first time this type of inequality is presented for a two-component problem.

3. A REFINED PROJECTION ONTO THE TOPOLOGICAL JOIN

Suppose that $\rho_1 \in (4k\pi, 4(k+1)\pi)$ and $\rho_2 \in (4\pi, 8\pi)$. By Proposition 2.5 we have the existence of a map Ψ from the low sublevels of J_ρ onto the topological join $\Sigma_k * \Sigma_1$, see (8) and (9). However, we will need next to take also into account the fine structure of the measures e^{u_1} and e^{u_2} , as described in (19). For this reason we will modify the map Ψ so that the join parameter s in (9) will depend on the local centres of mass and the local scales defined in (19) and (23). We will see in the sequel that this will provide extra information for describing functions in the low sublevels of J_ρ .

3.1. Construction. We start by defining the local centres of mass and the local scales of functions which are concentrated around l well separated points of Σ .

Let $l \geq 2$ and consider $0 < \varepsilon_l \ll \varepsilon_{l-1} \ll 1$ as given in Proposition 2.4 and suppose it holds $\mathbf{d}\left(\frac{e^{u_1}}{\int_{\Sigma} e^{u_1} dV_g}, \Sigma_l\right) < 2\varepsilon_l$ so that ψ_l is well-defined. Assume moreover $\mathbf{d}\left(\frac{e^{u_1}}{\int_{\Sigma} e^{u_1} dV_g}, \Sigma_{l-1}\right) > \varepsilon_{l-1}$. By the second part of Proposition 2.4 there exist $\varepsilon'_{l-1} \ll \varepsilon_{l-1}$ and l points x'_1, \dots, x'_l such that

$$d(x'_i, x'_j) > 2\varepsilon'_{l-1} \quad \text{for } i \neq j; \quad \int_{B_{\varepsilon'_{l-1}}(x'_i)} e^{u_1} dV_g > \varepsilon'_{l-1} \int_{\Sigma} e^{u_1} dV_g \quad \text{for all } i = 1, \dots, l.$$

We localize then u_1 around the point x'_i and define

$$f_{loc}^{x'_i}(u_1) = \frac{e^{u_1} \chi_{B_{\varepsilon'_{l-1}}(x'_i)}}{\int_{B_{\varepsilon'_{l-1}}(x'_i)} e^{u_1} dV_g}.$$

Given $\varepsilon > 0$, by the second assertion of Proposition 2.4, taking ε_l sufficiently small one gets

$$\int_{B_{\varepsilon}(x'_i)} f_{loc}^{x'_i}(u_1) dV_g > 1 - \varepsilon; \quad \text{for } \mathbf{d}\left(\frac{e^{u_1}}{\int_{\Sigma} e^{u_1} dV_g}, \Sigma_l\right) < 2\varepsilon_l.$$

It follows that $f_{loc}^{x'_i}(u_1) \in \mathcal{C}_{\varepsilon, \varepsilon'_{l-1}}(x'_i)$, see (17), and hence the map ψ in (19) is well-defined on $f_{loc}^{x'_i}(u_1)$. We then set

$$(23) \quad (\beta_{x'_i}, \sigma_{x'_i}) := \psi\left(f_{loc}^{x'_i}(u_1)\right).$$

In this way, starting from a function with $\mathbf{d}\left(\frac{e^{u_1}}{\int_{\Sigma} e^{u_1} dV_g}, \Sigma_l\right) < 2\varepsilon_l$ and such that $\mathbf{d}\left(\frac{e^{u_1}}{\int_{\Sigma} e^{u_1} dV_g}, \Sigma_{l-1}\right) > \varepsilon_{l-1}$ we obtain, around each point x'_i , a notion of local center of mass and scale of concentration.

When $l = 1$ we have to deal with just one point x'_1 of Σ . We then apply the map ψ to the function $f_{loc}^{x'_1}$ directly.

As we discussed above, we would like to map low energy sublevels of J_{ρ} into the topological join $\Sigma_k * \Sigma_1$ taking the above scales into account. More precisely, the parameter s in (9) will depend on the local scale $\sigma_{x'_i}$ only of the points nearby the center of mass of e^{u_2} (in case of ambiguity, we will define a sort of averaged scale).

To proceed rigorously, let $0 < \varepsilon_k \ll \varepsilon_{k-1} \ll \dots \ll \varepsilon_1 \ll 1$ be as before. We consider cut-off functions $\mathbf{f}, \mathbf{g}_l, \mathbf{h}$ for $l = 1, \dots, k-1$ such that

$$(24) \quad \mathbf{f}(t) = \begin{cases} 0 & t \geq 2\varepsilon_k, \\ 1 & t \leq \varepsilon_k, \end{cases} \quad \mathbf{g}_l(t) = \begin{cases} 0 & t \geq 2\varepsilon_l, \\ 1 & t \leq \varepsilon_l, \end{cases} \quad l = 1, \dots, k-1,$$

$$(25) \quad \mathbf{h}(t) = \begin{cases} 0 & t \geq \frac{\varepsilon'_{k-1}}{8}, \\ 1 & t \leq \frac{\varepsilon'_{k-1}}{16}. \end{cases}$$

We define now a *global scale* $\sigma_1(u_1) \in (0, 1]$ for e^{u_1} in three steps. Suppose $\mathbf{d}\left(\frac{e^{u_2}}{\int_{\Sigma} e^{u_2} dV_g}, \Sigma_1\right) < 2\varepsilon_1$, so that $\psi(f_{loc}^z(u_2)) = (\beta_z, \sigma_z)$ is well-defined.

First of all, we define an *averaged scale* for e^{u_1} by recurrence in the following way. If we have $\mathbf{d}\left(\frac{e^{u_1}}{\int_{\Sigma} e^{u_1} dV_g}, \Sigma_1\right) < 2\varepsilon_1$, we set $C_1(u_1) = \sigma_{x'_1}$. For $l \in \{2, \dots, k-1\}$, we define recursively

$$C_l(u_1) = \mathbf{g}_{l-1}\left(\mathbf{d}\left(\frac{e^{u_1}}{\int_{\Sigma} e^{u_1} dV_g}, \Sigma_{l-1}\right)\right) C_{l-1}(u_1) + \left(1 - \mathbf{g}_{l-1}\left(\mathbf{d}\left(\frac{e^{u_1}}{\int_{\Sigma} e^{u_1} dV_g}, \Sigma_{l-1}\right)\right)\right) \frac{1}{l} \sum_{i=1}^l \sigma_{x'_i}^l.$$

Secondly, we interpolate between $C_{k-1}(u_1)$ and the local scale of the closest point to β_z among the $\beta_{x_i^k}$'s (provided they are well-defined), setting

$$B(u_1, u_2) = \mathfrak{h} \left(d(\beta_z, \{\beta_{x_1^k}, \dots, \beta_{x_k^k}\}) \right) \sigma_x + \left(1 - \mathfrak{h} \left(d(\beta_z, \{\beta_{x_1^k}, \dots, \beta_{x_k^k}\}) \right) \right) \frac{1}{k} \sum_{i=1}^k \sigma_{x_i^k},$$

$$A(u_1, u_2) = \mathfrak{g}_{k-1} \left(\mathbf{d} \left(\frac{e^{u_1}}{\int_{\Sigma} e^{u_1} dV_g}, \Sigma_{k-1} \right) \right) C_{k-1}(u_1) + \left(1 - \mathfrak{g}_{k-1} \left(\mathbf{d} \left(\frac{e^{u_1}}{\int_{\Sigma} e^{u_1} dV_g}, \Sigma_{k-1} \right) \right) \right) B(u_1, u_2),$$

where $x = x_j^k$ was chosen so that it realizes the minimum of $d(\beta_z, \{\beta_{x_1^k}, \dots, \beta_{x_k^k}\})$: notice that since $d(x_j^k, x_l^k) \geq 2\varepsilon'_{k-1}$ for $j \neq l$, by (25) the point realizing the latter minimum is unique if $\mathfrak{h} \neq 0$.

As a third and final step, to check whether e^{u_1} is \mathbf{d} -close to Σ_k , we set

$$\sigma_1(u_1) = \mathfrak{f} \left(\mathbf{d} \left(\frac{e^{u_1}}{\int_{\Sigma} e^{u_1} dV_g}, \Sigma_k \right) \right) A(u_1, u_2) + \left(1 - \mathfrak{f} \left(\mathbf{d} \left(\frac{e^{u_1}}{\int_{\Sigma} e^{u_1} dV_g}, \Sigma_k \right) \right) \right).$$

We define next the *global scale* $\sigma_2(u_2) \in (0, 1]$ of e^{u_2} . We will be interested here in functions concentrated near just one point of Σ . Therefore we just need the single local scale $C_1(u_2) = \sigma_z$ if $\psi(f_{loc}^z(u_2)) = (\beta_z, \sigma_z)$ is well-defined. Moreover, we have to check the \mathbf{d} -closeness of e^{u_2} to Σ_1 . Hence the scale reads

$$\sigma_2(u_2) = \mathfrak{g}_1 \left(\mathbf{d} \left(\frac{e^{u_2}}{\int_{\Sigma} e^{u_2} dV_g}, \Sigma_1 \right) \right) \sigma_z + \left(1 - \mathfrak{g}_1 \left(\mathbf{d} \left(\frac{e^{u_2}}{\int_{\Sigma} e^{u_2} dV_g}, \Sigma_1 \right) \right) \right).$$

We can now specify the join parameter s in (9). Fix a constant $M \gg 1$ and consider the function

$$F_M(t) = \begin{cases} 0 & t \leq 1/M, \\ \frac{t}{1+t} & t \in [1/M, M], \\ 1 & t \geq 2M. \end{cases}$$

We then define

$$(26) \quad s(u_1, u_2) = F_M \left(\frac{\sigma_1(u_1)}{\sigma_2(u_2)} \right).$$

We now pass to considering the maps ψ_k and ψ_1 which are needed in the projection onto the join $\Sigma_k * \Sigma_1$, see (12). As mentioned in the introduction of this section, it is convenient to modify these maps in such a way that they take into account the local centres of mass defined in (19) and (23). More precisely, when e^{u_1} is concentrated in k well separated points of Σ , we rather consider the local centres of mass $\beta_{x_i^k}$ in (23) than the supports of the map ψ_k in Proposition 2.4.

Suppose $\mathbf{d} \left(\frac{e^{u_1}}{\int_{\Sigma} e^{u_1} dV_g}, \Sigma_k \right) < 2\varepsilon_k$ so that ψ_k is well-defined and suppose $\mathbf{d} \left(\frac{e^{u_1}}{\int_{\Sigma} e^{u_1} dV_g}, \Sigma_{k-1} \right) > \varepsilon_{k-1}$ so that $\beta_{x_i^k}$ are defined for $i = 1, \dots, k$. Let

$$\psi_k \left(\frac{e^{u_1}}{\int_{\Sigma} e^{u_1} dV_g}, \Sigma_k \right) = \sum_{i=1}^k t_i \delta_{y_i}, \quad t_i \in [0, 1], y_i \in \Sigma.$$

Observe that, by construction and by the second statement in Proposition 2.4, $d(\beta_{x_i^k}, y_i) \rightarrow 0$ as $\varepsilon_k \rightarrow 0$. Hence there exists a geodesic γ_i joining y_i and $\beta_{x_i^k}$ in unit time. We then perform an interpolation in the following way:

(27)

$$\tilde{\psi}_k \left(\frac{e^{u_1}}{\int_{\Sigma} e^{u_1} dV_g} \right) = \begin{cases} \sum_{i=1}^k t_i \delta_{y_i} & \text{if } \mathbf{d} \left(\frac{e^{u_1}}{\int_{\Sigma} e^{u_1} dV_g}, \Sigma_{k-1} \right) \leq \varepsilon_{k-1}, \\ \sum_{i=1}^k t_i \delta_{\gamma_i \left(\frac{1}{\varepsilon_{k-1}} \mathbf{d} \left(\frac{e^{u_1}}{\int_{\Sigma} e^{u_1} dV_g}, \Sigma_{k-1} \right) - 1 \right)} & \text{if } \mathbf{d} \left(\frac{e^{u_1}}{\int_{\Sigma} e^{u_1} dV_g}, \Sigma_{k-1} \right) \in (\varepsilon_{k-1}, 2\varepsilon_{k-1}), \\ \sum_{i=1}^k t_i \delta_{\beta_{x_i^k}} & \text{if } \mathbf{d} \left(\frac{e^{u_1}}{\int_{\Sigma} e^{u_1} dV_g}, \Sigma_{k-1} \right) \geq 2\varepsilon_{k-1}. \end{cases}$$

For a function u_2 with $\mathbf{d}\left(\frac{e^{u_2}}{\int_{\Sigma} e^{u_2} dV_g}, \Sigma_1\right) < 2\varepsilon_1$, letting $\psi_1\left(\frac{e^{u_2}}{\int_{\Sigma} e^{u_2} dV_g}\right) = \delta_z$ we let

$$(28) \quad \tilde{\psi}_1\left(\frac{e^{u_2}}{\int_{\Sigma} e^{u_2} dV_g}\right) = \delta_{\beta_z}.$$

With these maps and this join parameter we finally define the refined projection $\tilde{\Psi} : J_{\rho}^{-L} \rightarrow \Sigma_k * \Sigma_1$ as

$$(29) \quad \tilde{\Psi}(u_1, u_2) = (1-s)\tilde{\psi}_k\left(\frac{e^{u_1}}{\int_{\Sigma} e^{u_1} dV_g}\right) + s\tilde{\psi}_1\left(\frac{e^{u_2}}{\int_{\Sigma} e^{u_2} dV_g}\right).$$

3.2. A new improved Moser-Trudinger inequality. Using the improved geometric inequality in [1] for the singular Liouville equation we can provide a dilation-invariant improved inequality for system (1). Before stating the main result we prove some auxiliary lemmas; we first recall our notation on annuli at the end of the Introduction.

Lemma 3.1. *Let $\gamma_0 > 0, \tau_0 > 0, z \in \Sigma$ and $r_2 > r_1 > 0$ (both small) be such that*

$$(30) \quad \frac{\int_{A_z(r_1, r_2)} e^{u_2} dV_g}{\int_{\Sigma} e^{u_2} dV_g} > \gamma_0 \quad \text{and} \quad \sup_{y \in A_z(r_1, r_2)} \frac{\int_{B_{\tau_0 d(y, z)}(y)} e^{u_2} dV_g}{\int_{A_z(r_1, r_2)} e^{u_2} dV_g} < 1 - \tau_0.$$

Then, for any $\varepsilon > 0$ there exist $C = C(\varepsilon, \tau_0, \gamma_0)$, $\tilde{\tau}_0 = \tilde{\tau}_0(\tau_0, \gamma_0)$, $\tilde{r}_1 \in [\frac{r_1}{C}, \frac{r_1}{4}]$, $\tilde{r}_2 \in [4r_2, Cr_2]$ and $\tilde{u}_2 \in H^1(\Sigma)$ such that

- a) \tilde{u}_2 is constant in $B_{\tilde{r}_1}(z)$ and on $\partial B_{\tilde{r}_2}(z)$;
- b) $\int_{A_z(\tilde{r}_1, \tilde{r}_2)} |\nabla \tilde{u}_2|^2 dV_g \leq \int_{A_z(\tilde{r}_1, \tilde{r}_2)} |\nabla u_2|^2 dV_g + \varepsilon \int_{\Sigma} |\nabla u_2|^2 dV_g$;
- c) $\sup_{y \in A_z(\tilde{r}_1, \tilde{r}_2)} \frac{\int_{B_{\tilde{\tau}_0 d(y, z)}(y)} e^{\tilde{u}_2} dV_g}{\int_{A_z(\tilde{r}_1, \tilde{r}_2)} e^{\tilde{u}_2} dV_g} < 1 - \tilde{\tau}_0$.

PROOF. First of all, we modify u_2 so it becomes constant in $B_{\tilde{r}_1}(z)$ and on $\partial B_{\tilde{r}_2}(z)$. Take $\varepsilon > 0$: we can find $C = C(\varepsilon)$ and properly chosen $\tilde{r}_1 \in [\frac{r_1}{C}, \frac{r_1}{4}]$, $\tilde{r}_2 \in [4r_2, Cr_2]$ such that

$$\int_{A_z(\tilde{r}_1, 2\tilde{r}_1)} |\nabla u_2|^2 dV_g \leq \varepsilon \int_{\Sigma} |\nabla u_2|^2 dV_g, \quad \int_{A_z(\tilde{r}_2/2, \tilde{r}_2)} |\nabla u_2|^2 dV_g \leq \varepsilon \int_{\Sigma} |\nabla u_2|^2 dV_g.$$

We denote by $\bar{u}_2(\tilde{r}_1)$ and $\bar{u}_2(\tilde{r}_2)$ the following averages;

$$(31) \quad \bar{u}_2(\tilde{r}_1) = \int_{A_z(\tilde{r}_1, 2\tilde{r}_1)} u_2 dV_g, \quad \bar{u}_2(\tilde{r}_2) = \int_{A_z(\tilde{r}_2/2, \tilde{r}_2)} u_2 dV_g.$$

Let now χ be a cut-off function, with values in $[0, 1]$, such that

$$\chi = \begin{cases} 0 & \text{in } B_{\tilde{r}_1}(z), \\ 1 & \text{in } A_z(2\tilde{r}_1, \tilde{r}_2/2), \\ 0 & \text{in } (B_{\tilde{r}_2}(z))^c \end{cases}$$

and define

$$(32) \quad \tilde{u}_2 = \begin{cases} \chi(d(x, z))u_2 + (1 - \chi(d(x, z)))\bar{u}_2(\tilde{r}_1) & \text{in } B_{2\tilde{r}_1}(z), \\ u_2 & \text{in } A_z(2\tilde{r}_1, \tilde{r}_2/2), \\ \chi(d(x, z))u_2 + (1 - \chi(d(x, z)))\bar{u}_2(\tilde{r}_2) & \text{in } (B_{\tilde{r}_2/2}(z))^c. \end{cases}$$

By Poincaré's inequality the Dirichlet energy of \tilde{u}_2 is bounded by

$$\int_{A_z(\tilde{r}_1, 2\tilde{r}_1)} |\nabla \tilde{u}_2|^2 dV_g \leq \tilde{C}\varepsilon \int_{\Sigma} |\nabla u_2|^2 dV_g, \quad \int_{A_z(\tilde{r}_2/2, \tilde{r}_2)} |\nabla \tilde{u}_2|^2 dV_g \leq \tilde{C}\varepsilon \int_{\Sigma} |\nabla u_2|^2 dV_g,$$

where \tilde{C} is a universal constant. Hence one gets

$$\int_{A_z(\tilde{r}_1, \tilde{r}_2)} |\nabla \tilde{u}_2|^2 dV_g \leq \int_{A_z(\tilde{r}_1, \tilde{r}_2)} |\nabla u_2|^2 dV_g + 2\tilde{C}\varepsilon \int_{\Sigma} |\nabla u_2|^2 dV_g.$$

We are left with proving that there exists $\tilde{\tau}_0 = \tilde{\tau}_0(\tau_0, \gamma_0)$ such that

$$(33) \quad \sup_{y \in A_z(\tilde{r}_1, \tilde{r}_2)} \frac{\int_{B_{\tilde{\tau}_0 d(y,z)}(y)} e^{\tilde{u}_2} dV_g}{\int_{A_z(\tilde{r}_1, \tilde{r}_2)} e^{\tilde{u}_2} dV_g} < 1 - \tilde{\tau}_0.$$

If this is not the case, there exist $(u_{2,n})_n \subset H^1(\Sigma)$ verifying (30), $(\tilde{r}_{1,n})_n \subset [\frac{r_1}{C}, \frac{r_1}{4}]$, $(\tilde{r}_{2,n})_n \subset [4r_2, Cr_2]$, cut-off functions $(\chi_n)_n$ and $(\tilde{u}_{2,n})_n \subset H^1(\Sigma)$ defined in analogous way as \tilde{u}_2 in (32), such that

$$(34) \quad \frac{e^{\tilde{u}_{2,n}}}{\int_{A_z(\tilde{r}_{1,n}, \tilde{r}_{2,n})} e^{\tilde{u}_{2,n}} dV_g} \rightharpoonup \delta_{\bar{x}}$$

in the sense of measures, for some $\bar{x} \in A_z(\frac{r_1}{C}, Cr_2)$. We distinguish between three situations.

Case 1. Suppose first that $\bar{x} \in A_z(r_1, 2r_2)$. By the choices of the cut-off functions and (32), as $\tilde{u}_{2,n}$ coincides with $u_{2,n}$ on $A_z(r_1/2, 2r_2)$, it follows that

$$(35) \quad \frac{e^{u_{2,n}}}{\int_{A_z(r_1, 2r_2)} e^{u_{2,n}} dV_g} = \frac{e^{\tilde{u}_{2,n}}}{\int_{A_z(r_1, 2r_2)} e^{\tilde{u}_{2,n}} dV_g} \rightharpoonup \delta_{\bar{x}}.$$

Case 1.1. Let $\bar{x} \in A_z(r_1, \frac{3}{2}r_2)$. To get a contradiction to (35), we prove that there exists $\bar{\tau}_0 = \bar{\tau}_0(\tau_0, \gamma_0)$ such that

$$(36) \quad \sup_{y \in A_z(r_1, \frac{3}{2}r_2)} \int_{B_{\bar{\tau}_0 d(y,z)}(y)} e^{u_{2,n}} dV_g \leq (1 - \bar{\tau}_0) \int_{A_z(r_1, 2r_2)} e^{u_{2,n}} dV_g.$$

Let $\bar{\tau}_0 = \tau_0/2$. If $B_{\bar{\tau}_0 d(y,z)}(y) \subseteq A_z(r_1(1 - \tau_0), r_2(1 + \tau_0))$ we can use directly the second part of the assumption (30) on $u_{2,n}$ to get the bound on the left-hand side of (36) (taking $\bar{\tau}_0$ sufficiently small). Moreover, by the first part of (30) on $u_{2,n}$ we deduce

$$\int_{A_z(r_1, r_2)} e^{u_{2,n}} dV_g \geq \gamma_0 \int_{\Sigma} e^{u_{2,n}} dV_g \geq \gamma_0 \int_{A_z(r_1, 2r_2)} e^{u_{2,n}} dV_g.$$

Given then $B_r(y) \subseteq A_z(r_2, 2r_2)$, since $B_r(y) \cap A_z(r_1, r_2) = \emptyset$, by the first inequality in (30) it follows that

$$(37) \quad \int_{B_r(y)} e^{u_{2,n}} dV_g \leq (1 - \gamma_0) \int_{A_z(r_1, 2r_2)} e^{u_{2,n}} dV_g \quad \text{for any } B_r(y) \subseteq A_z(r_2, 2r_2).$$

Now, if $B_{\bar{\tau}_0 d(y,z)}(y) \subseteq A_z(r_2, 2r_2)$ we exploit (37) to deduce the bound on the left-hand side of (36) taking a possibly smaller $\bar{\tau}_0$. This concludes the proof of the claim (36).

Case 1.2. Suppose $\bar{x} \in A_z(\frac{5}{4}r_2, 2r_2)$. Using again (37) we obtain a contradiction to (35).

Case 2. Consider now $\bar{x} \in A_z(r_1/2, r_2)$: reasoning exactly as in Case 1 we get a contradiction.

Case 3. We are left with the case $\bar{x} \in (A_z(r_1/2, 2r_2))^c$: notice that differently from the previous two cases, the cut-off functions χ_n might not be identically equal to 1 near \bar{x}_0 . For this choice of \bar{x} and by (34) one gets

$$(38) \quad \frac{\int_{A_z(r_1, r_2)} e^{\tilde{u}_{2,n}} dV_g}{\int_{A_z(\tilde{r}_{1,n}, \tilde{r}_{2,n})} e^{\tilde{u}_{2,n}} dV_g} \rightarrow 0.$$

Using the definition of $\tilde{u}_{2,n}$ in $A_z(\tilde{r}_{2,n}/2, \tilde{r}_{2,n})$ given by (32) and applying Young's inequality with $1/p = \chi_n$ and $1/q = 1 - \chi_n$ we have

$$(39) \quad e^{\tilde{u}_{2,n}} = e^{\chi_n u_{2,n}} e^{(1-\chi_n)\bar{u}_2(\tilde{r}_{2,n})} \leq \chi_n e^{u_{2,n}} + (1 - \chi_n) e^{\bar{u}_{2,n}(\tilde{r}_{2,n})} \quad \text{in } A_z(\tilde{r}_{2,n}/2, \tilde{r}_{2,n}).$$

Recall the notation in (31): by Jensen's inequality it follows that

$$e^{\bar{u}_{2,n}(\tilde{r}_{2,n})} \leq \int_{A_z(\tilde{r}_{2,n}/2, \tilde{r}_{2,n})} e^{u_{2,n}} dV_g.$$

Therefore, integrating (39) one can show that

$$\int_{A_z(\tilde{r}_{2,n}/2, \tilde{r}_{2,n})} e^{\tilde{u}_{2,n}} dV_g \leq 2 \int_{A_z(\tilde{r}_{2,n}/2, \tilde{r}_{2,n})} e^{u_{2,n}} dV_g.$$

Similarly we get

$$\int_{A_z(\tilde{r}_{1,n}, 2\tilde{r}_{1,n})} e^{\tilde{u}_{2,n}} dV_g \leq 2 \int_{A_z(\tilde{r}_{1,n}, 2\tilde{r}_{1,n})} e^{u_{2,n}} dV_g.$$

In conclusion we have

$$\int_{A_z(\tilde{r}_{1,n}, \tilde{r}_{2,n})} e^{\tilde{u}_{2,n}} dV_g \leq 2 \int_{\Sigma} e^{u_{2,n}} dV_g.$$

This, together with (38), implies that

$$\frac{\int_{A_z(r_1, r_2)} e^{u_{2,n}} dV_g}{\int_{\Sigma} e^{u_{2,n}} dV_g} \leq 2 \frac{\int_{A_z(r_1, r_2)} e^{\tilde{u}_{2,n}} dV_g}{\int_{A_z(\tilde{r}_{1,n}, \tilde{r}_{2,n})} e^{\tilde{u}_{2,n}} dV_g} \rightarrow 0,$$

which is in contradiction with (30). Therefore we are done. ■

Lemma 3.2. *Under the same assumptions of Lemma 3.1, let $\tilde{u}_2 \in H^1(\Sigma)$ be the function given there. Then, property c) can be extended to the following one: there exists $\bar{\tau}_0 > 0$ such that*

$$(40) \quad \sup_{y \in B_{\bar{\tau}_2}(z), y \neq z} \frac{\int_{B_{\bar{\tau}_0 d(y,z)}(y)} e^{\tilde{u}_2} dV_g}{\int_{B_{\bar{\tau}_2}(z)} e^{\tilde{u}_2} dV_g} < 1 - \bar{\tau}_0.$$

PROOF. By property c) of Lemma 3.1 we just have to show (40) for $y \in B_{\tilde{r}_1}(z)$. Observe that, by definition, \tilde{u}_2 is constant in $B_{\tilde{r}_1}(z)$. Therefore, for any $B_{\bar{\tau}_0 d(y,z)}(y) \subseteq B_{\tilde{r}_1}(z)$, which implies $d(y, z) \leq \tilde{r}_1$, we have

$$\int_{B_{\bar{\tau}_0 d(y,z)}(y)} e^{\tilde{u}_2} dV_g = \frac{\bar{\tau}_0^2 d(y, z)^2}{\tilde{r}_1^2} \int_{B_{\tilde{r}_1}(z)} e^{\tilde{u}_2} dV_g \leq \bar{\tau}_0^2 \int_{B_{\tilde{r}_1}(z)} e^{\tilde{u}_2} dV_g \leq \bar{\tau}_0^2 \int_{B_{\bar{\tau}_2}(z)} e^{\tilde{u}_2} dV_g,$$

and we conclude that (40) holds true for $\bar{\tau}_0$ small enough. For the same choice of $\bar{\tau}_0$ we are left with the case $B := B_{\bar{\tau}_0 d(y,z)}(y) \cap (B_{\tilde{r}_1}(z))^c \neq \emptyset$. The integral over B will be bounded by the integral over a larger ball with center shifted onto $\partial B_{\tilde{r}_1}(z)$. Using normal coordinates at z consider the shift of center $y \mapsto \tilde{r}_1 \frac{y}{d(y,z)}$. Then we have, using the property c);

$$\int_B e^{\tilde{u}_2} dV_g \leq \int_{B_{\bar{\tau}_0 \tilde{r}_1}(\tilde{r}_1 \frac{y}{d(y,z)})} e^{\tilde{u}_2} dV_g \leq (1 - \bar{\tau}_0) \int_{B_{\bar{\tau}_2}(z)} e^{\tilde{u}_2} dV_g.$$

Therefore, we get

$$\int_{B_{\bar{\tau}_0 d(y,z)}(y)} e^{\tilde{u}_2} dV_g \leq \bar{\tau}_0^2 \int_{B_{\bar{\tau}_2}(z)} e^{\tilde{u}_2} dV_g + \int_B e^{\tilde{u}_2} dV_g \leq \bar{\tau}_0^2 \int_{B_{\bar{\tau}_2}(z)} e^{\tilde{u}_2} dV_g + (1 - \bar{\tau}_0) \int_{B_{\bar{\tau}_2}(z)} e^{\tilde{u}_2} dV_g.$$

Taking $\bar{\tau}_0$ possibly smaller we obtain the conclusion. ■

We recall here the improved geometric inequality stated in Proposition 4.1 of [1], with $k = 1$ and $\alpha = 1$.

Proposition 3.3. ([1]) *Let $p \in \Sigma$ and let $r > 0$, $\tau_0 > 0$. Then, for any $\varepsilon > 0$ there exists $C = C(\varepsilon, r)$ such that*

$$\log \int_{B_r(p)} d(x, p)^2 e^{2v} dV_g \leq \frac{1 + \varepsilon}{8\pi} \int_{B_r(p)} |\nabla v|^2 dV_g + C,$$

for every function $v \in H_0^1(B_r(p))$ such that

$$\sup_{y \in B_r(p); y \neq p} \frac{\int_{B_{\tau_0 d(y, p)}(y)} d(x, p)^2 e^{2v} dV_g}{\int_{B_r(p)} d(x, p)^2 e^{2v} dV_g} < 1 - \tau_0.$$

We state now the new improved Moser-Trudinger inequality.

Remark 3.4. *In what follows, the number r is supposed to be small but not tending to zero, while σ could be arbitrarily small.*

Proposition 3.5. *Let $r > 0$, $\gamma_0 > 0$ and $\tau_0 > 0$. For any $\varepsilon > 0$ there exists $C = C(\varepsilon, r, \tau_0, \gamma_0)$ such that, if for some $\sigma \in (0, \frac{r}{C^2})$ and $z \in \Sigma$ it holds*

$$(41) \quad \frac{\int_{B_{\sigma/2}(z)} e^{u_1} dV_g}{\int_{\Sigma} e^{u_1} dV_g} > \gamma_0, \quad \frac{\int_{A_z(C\sigma, \frac{r}{C})} e^{u_2} dV_g}{\int_{\Sigma} e^{u_2} dV_g} > \gamma_0$$

and

$$(42) \quad \sup_{y \in A_z(C\sigma, \frac{r}{C})} \frac{\int_{B_{\tau_0 d(y, z)}(y)} e^{u_2} dV_g}{\int_{A_z(C\sigma, \frac{r}{C})} e^{u_2} dV_g} < 1 - \tau_0,$$

then

$$4\pi \log \int_{\Sigma} e^{u_1 - \bar{u}_1} dV_g + 8\pi \log \int_{\Sigma} e^{u_2 - \bar{u}_2} dV_g \leq \int_{B_r(z)} Q(u_1, u_2) dV_g + \varepsilon \int_{\Sigma} Q(u_1, u_2) dV_g + C.$$

PROOF. Taking r sufficiently small we may suppose that we have the Euclidean flat metric in the ball $B_{C_r}(z)$. Suppose for simplicity that $\bar{u}_1 = \bar{u}_2 = 0$ and that $z = 0$. Observe that we can write

$$\log \int_{B_r(0)} e^{u_2} dV_g = \log \int_{B_r(0)} |x|^2 e^{2(\frac{u_2}{2} - \log|x|)} dV_g.$$

We wish to apply Proposition 3.3 to $\frac{u_2}{2} - \log|x|$, so we need to modify this function in such a way that it becomes constant outside a given ball. Moreover, it will be useful to also replace it with a constant inside a smaller ball. In this process we should not lose the volume-spreading property (42). By Lemma 3.1 this can be done and we let $C = C(\varepsilon, \tau_0, \gamma_0)$, $\tilde{r}_1 \in [\sigma, \frac{C\sigma}{4}]$, $\tilde{r}_2 \in [\frac{4r}{C}, r]$ and $\tilde{u}_2 \in H^1(\Sigma)$ be as in the statement of the lemma. By property a) in Lemma 3.1 and by Lemma 3.2 we are in position to apply Proposition 3.3 to $(\tilde{u}_2 - \tilde{u}_2(\tilde{r}_2)) \in H_0^1(B_{\tilde{r}_2}(0))$ and get

$$(43) \quad \begin{aligned} \log \int_{\Sigma} e^{u_2} dV_g &\leq \log \int_{A_0(C\sigma, \frac{r}{C})} e^{u_2} dV_g + C = \log \int_{A_0(C\sigma, \frac{r}{C})} |x|^2 e^{2(\frac{u_2}{2} - \log|x|)} dV_g + C \\ &\leq \log \int_{B_{\tilde{r}_2}(0)} |x|^2 e^{2\tilde{u}_2} dV_g + C = \log \int_{B_{\tilde{r}_2}(0)} |x|^2 e^{2(\tilde{u}_2 - \tilde{u}_2(\tilde{r}_2))} dV_g + \tilde{u}_2(\tilde{r}_2) + C \\ &\leq \frac{1 + \varepsilon}{8\pi} \int_{A_0(\tilde{r}_1, \tilde{r}_2)} |\nabla \tilde{u}_2|^2 dV_g + \tilde{u}_2(\tilde{r}_2) + C \\ &\leq \frac{1 + \varepsilon}{8\pi} \int_{A_0(\tilde{r}_1, \tilde{r}_2)} \left| \nabla \left(\frac{u_2}{2} - \log|x| \right) \right|^2 dV_g + \varepsilon \int_{\Sigma} |\nabla u_2|^2 dV_g + \tilde{u}_2(\tilde{r}_2) + C \\ &\leq \frac{1}{8\pi} \int_{A_0(\sigma, r)} \left| \nabla \left(\frac{u_2}{2} - \log|x| \right) \right|^2 dV_g + \varepsilon \int_{\Sigma} Q(u_1, u_2) dV_g + \tilde{u}_2(\tilde{r}_2) + C, \end{aligned}$$

where in the first row we exploited (41), while in the last one we used the definition of \tilde{r}_1, \tilde{r}_2 . Observe that by the definition (32) of \tilde{u}_2 we have

$$\tilde{u}_2(\tilde{r}_2) = \int_{A_z(\tilde{r}_2/2, \tilde{r}_2)} \left(\frac{u_2}{2} - \log|x| \right) dV_g.$$

Applying Hölder's and Poincaré's inequalities one gets

$$(44) \quad \begin{aligned} \int_{A_z(\tilde{r}_2/2, \tilde{r}_2)} \left(\frac{u_2}{2} - \log|x| \right) dV_g &\leq \int_{A_z(\tilde{r}_2/2, \tilde{r}_2)} |u_2| dV_g + \tilde{C}_r \leq C_r \|u_2\|_{L^2(\Sigma)} + \tilde{C}_r \\ &\leq C_r \left(\int_{\Sigma} |\nabla u_2|^2 dV_g \right)^{1/2} + \tilde{C}_r \leq \varepsilon \int_{\Sigma} |\nabla u_2|^2 dV_g + \frac{\tilde{C}_r C_r}{\varepsilon}. \end{aligned}$$

Inserting the latter estimate into (43) we deduce

$$(45) \quad \log \int_{\Sigma} e^{u_2} dV_g \leq \frac{1}{8\pi} \int_{A_0(\sigma, r)} \left| \nabla \left(\frac{u_2}{2} - \log|x| \right) \right|^2 dV_g + \varepsilon \int_{\Sigma} Q(u_1, u_2) dV_g + C.$$

Using the integration by parts we get

$$\int_{A_0(\sigma, r)} \left| \nabla \left(\frac{u_2}{2} - \log|x| \right) \right|^2 dV_g = \frac{1}{4} \int_{A_0(\sigma, r)} |\nabla u_2|^2 dV_g - 2\pi \log \sigma + 2\pi \int_{\partial B_\sigma(0)} u_2 dS_g - 2\pi \int_{\partial B_r(0)} u_2 dS_g.$$

Observe now that by the L^1 embedding of H^1 and the trace inequalities, there exists $C > 0$ such that

$$\left| \int_{B_\sigma(0)} u_2 dV_g - \int_{\partial B_\sigma(0)} u_2 dS_g \right| \leq C \left(\int_{B_\sigma(0)} |\nabla u_2|^2 dV_g \right)^{1/2},$$

where C is independent of σ since the latter inequality is dilation invariant. Therefore, reasoning as in (44) we obtain

$$\int_{A_0(\sigma, r)} \left| \nabla \left(\frac{u_2}{2} - \log|x| \right) \right|^2 dV_g \leq \frac{1}{4} \int_{A_0(\sigma, r)} |\nabla u_2|^2 dV_g - 2\pi \log \sigma + 2\pi \bar{u}_2(\sigma) + \varepsilon \int_{\Sigma} |\nabla u_2|^2 dV_g + C,$$

where $\bar{u}_2(\sigma) = \int_{B_\sigma(0)} u_2 dV_g$. Finally, by the fact that

$$\frac{1}{4} |\nabla u_2|^2 = Q(u_1, u_2) - \frac{1}{12} |\nabla(u_2 + 2u_1)|^2,$$

we get

$$(46) \quad \begin{aligned} \int_{A_0(\sigma, r)} \left| \nabla \left(\frac{u_2}{2} - \log|x| \right) \right|^2 dV_g &\leq \int_{A_0(\sigma, r)} Q(u_1, u_2) dV_g - \frac{1}{12} \int_{A_0(\sigma, r)} |\nabla(u_2 + 2u_1)|^2 dV_g + \\ &\quad - 2\pi \log \sigma + 2\pi \bar{u}_2(\sigma) + \varepsilon \int_{\Sigma} |\nabla u_2|^2 dV_g + C. \end{aligned}$$

We claim now that for any $\tilde{\varepsilon} > 0$ one has

$$(47) \quad \int_{A_0(\sigma, r)} |\nabla(u_2 + 2u_1)|^2 dV_g \geq 2\pi \left(\frac{2}{\tilde{\varepsilon}} (\bar{u}_2(\sigma) + 2\bar{u}_1(\sigma)) + \frac{1}{\tilde{\varepsilon}^2} \log \sigma \right) - \varepsilon \int_{\Sigma} Q(u_1, u_2) dV_g - C.$$

Letting $v(x) = u_2(x) + 2u_1(x)$ we have to prove

$$\int_{A_0(\sigma, r)} |\nabla v|^2 dV_g \geq 2\pi \left(\frac{2}{\tilde{\varepsilon}} \bar{v}(\sigma) + \frac{1}{\tilde{\varepsilon}^2} \log \sigma \right),$$

where $\bar{v}(\sigma) = \bar{u}_2(\sigma) + 2\bar{u}_1(\sigma)$. Choose $k \in \mathbb{N}$ such that

$$\int_{A_0(2^k \sigma, 2^{k+1} \sigma)} |\nabla v|^2 dV_g \leq \varepsilon \int_{\Sigma} |\nabla v|^2 dV_g,$$

and define

$$\begin{cases} \tilde{u}(x) = \bar{v}(\sigma) & \text{if } x \in B_{2^k \sigma}(0), \\ \Delta \tilde{u}(x) = 0 & \text{if } x \in A_0(2^k \sigma, 2^{k+1} \sigma), \\ \tilde{u}(x) = v(x) & \text{if } x \notin B_{2^{k+1} \sigma}(0). \end{cases}$$

Then there exists a universal constant C_0 such that

$$\begin{aligned} \int_{A_0(2^k\sigma,r)} |\nabla \tilde{u}|^2 dV_g &\leq \int_{A_0(\sigma,r)} |\nabla v|^2 dV_g + C_0 \varepsilon \int_{\Sigma} |\nabla v|^2 dV_g \\ &\leq \int_{A_0(\sigma,r)} |\nabla v|^2 dV_g + C_0 \varepsilon \int_{\Sigma} Q(u_1, u_2) dV_g. \end{aligned}$$

Solving the Dirichlet problem in $A_0(2^k\sigma, r)$ with constant data $\bar{v}(\sigma)$ on $\partial B_{2^k\sigma}(0)$ one gets

$$\begin{cases} w(x) = A \log \sigma & \text{if } |x| > 2^k \sigma, \\ w(2^k \sigma) = A \log(2^k \sigma) = \bar{v}(\sigma) & \text{if } |x| = 2^k \sigma, \end{cases}$$

for some constant A . We have that

$$\int_{A_0(2^k\sigma,r)} |\nabla w|^2 dV_g = 2\pi A^2 \log \frac{1}{2^k \sigma} - C = 2\pi \frac{\bar{v}(\sigma)^2}{\log \frac{1}{2^k \sigma}} - C.$$

Moreover

$$\int_{A_0(2^k\sigma,r)} |\nabla w|^2 dV_g \leq \int_{A_0(2^k\sigma,r)} |\nabla \tilde{u}|^2 dV_g.$$

Finally, using Young's inequality

$$\bar{v}(\sigma) \log \frac{1}{\sigma} \leq \frac{1}{2} \left(\tilde{\varepsilon} \bar{v}(\sigma)^2 + \frac{1}{\tilde{\varepsilon}} \left(\log \frac{1}{\sigma} \right)^2 \right),$$

we end up with

$$\frac{\bar{v}(\sigma)^2}{\log \frac{1}{\sigma}} \geq \left(\frac{2}{\tilde{\varepsilon}} \bar{v}(\sigma) + \frac{1}{\tilde{\varepsilon}^2} \log \sigma \right).$$

Therefore we conclude

$$\begin{aligned} 2\pi \left(\frac{2}{\tilde{\varepsilon}} \bar{v}(\sigma) + \frac{1}{\tilde{\varepsilon}^2} \log \sigma \right) - C &\leq 2\pi \frac{\bar{v}(\sigma)^2}{\log \frac{1}{\sigma}} - C = \int_{A_0(2^k\sigma,r)} |\nabla w|^2 dV_g \\ &\leq \int_{A_0(2^k\sigma,r)} |\nabla \tilde{u}|^2 dV_g \leq \int_{A_0(\sigma,r)} |\nabla v|^2 dV_g + C_0 \varepsilon \int_{\Sigma} Q(u_1, u_2) dV_g, \end{aligned}$$

which proves the claim (47).

Inserting (47) into (46) we have

$$\begin{aligned} \int_{A_0(\sigma,r)} \left| \nabla \left(\frac{u_2}{2} - \log |x| \right) \right|^2 dV_g &\leq \int_{A_0(\sigma,r)} Q(u_1, u_2) dV_g - \frac{1}{12} 2\pi \left(\frac{2}{\tilde{\varepsilon}} (\bar{u}_2(\sigma) + 2\bar{u}_1(\sigma)) + \frac{1}{\tilde{\varepsilon}^2} \log \sigma \right) + \\ &\quad - 2\pi \log \sigma + 2\pi \bar{u}_2(\sigma) + \varepsilon \int_{\Sigma} Q(u_1, u_2) dV_g + C. \end{aligned}$$

Choosing $\tilde{\varepsilon} = 1/6$ we obtain

$$(48) \quad \int_{A_0(\sigma,r)} \left| \nabla \left(\frac{u_2}{2} - \log |x| \right) \right|^2 dV_g \leq \int_{A_0(\sigma,r)} Q(u_1, u_2) dV_g - 4\pi \bar{u}_1(\sigma) - 8\pi \log \sigma + \\ + \varepsilon \int_{\Sigma} Q(u_1, u_2) dV_g + C.$$

We use then (48) in (45) to get

$$(49) \quad 8\pi \log \int_{\Sigma} e^{u_2} dV_g \leq \int_{A_0(\sigma,r)} Q(u_1, u_2) dV_g - 4\pi \bar{u}_1(\sigma) - 8\pi \log \sigma + \varepsilon \int_{\Sigma} Q(u_1, u_2) dV_g + C.$$

For the first component we consider the scalar local Moser-Trudinger inequality, see for example Proposition 2.3 of [36], namely

$$\begin{aligned} \log \int_{B_{r/2}(0)} e^{u_1} dV_g &\leq \frac{1}{16\pi} \int_{B_r(0)} |\nabla u_1|^2 dV_g + \bar{u}_1(r) + \varepsilon \int_{\Sigma} |\nabla u_1|^2 dV_g + C \\ &\leq \frac{1}{4\pi} \int_{B_r(0)} Q(u_1, u_2) dV_g + \bar{u}_1(r) + \varepsilon \int_{\Sigma} Q(u_1, u_2) dV_g + C. \end{aligned}$$

Performing a dilation to $B_\sigma(0)$ one gets

$$4\pi \log \int_{B_{\sigma/2}(0)} e^{u_1} dV_g \leq \int_{B_\sigma(0)} Q(u_1, u_2) dV_g + 4\pi \bar{u}_1(\sigma) + 8\pi \log \sigma + \varepsilon \int_{\Sigma} Q(u_1, u_2) dV_g + C.$$

We then use the assumption (41) and we obtain

$$(50) \quad 4\pi \log \int_{\Sigma} e^{u_1} dV_g \leq \int_{B_\sigma(0)} Q(u_1, u_2) dV_g + 4\pi \bar{u}_1(\sigma) + 8\pi \log \sigma + \varepsilon \int_{\Sigma} Q(u_1, u_2) dV_g + C.$$

Summing equations (49) and (50) we deduce

$$4\pi \log \int_{\Sigma} e^{u_1} dV_g + 8\pi \log \int_{\Sigma} e^{u_2} dV_g \leq \int_{B_r(z)} Q(u_1, u_2) dV_g + \varepsilon \int_{\Sigma} Q(u_1, u_2) dV_g + C,$$

which concludes the proof. ■

Remark 3.6. *The above result is inspired by the work [1] (see in particular Proposition 4.1 there) where the singular Liouville equation is considered. The authors derive a geometric inequality by means of the angular distribution of the conformal volume near the singularities. Somehow the singular equation can be seen as the limit case of the regular one. Roughly speaking, when one component is much more concentrated with respect to the other one, its effect resembles that of a Dirac delta.*

3.3. Lower bounds on the functional J_ρ . We are going to exploit the improved inequality stated in Proposition 3.5 to derive new lower bounds of the energy functional J_ρ defined in (2), see Proposition 3.7. This will give us some extra constraints for the map from the low sublevels of J_ρ onto the topological join $\Sigma_k * \Sigma_1$, see (9).

Given a small $\delta > 0$, our aim is to describe the low sublevels of the functional J_ρ by means of the set

$$(51) \quad Y := (\Sigma_k * \Sigma_1) \setminus S \subseteq \Sigma_k * \Sigma_1,$$

where

$$(52) \quad S = \left\{ \left(\nu, \delta_z, \frac{1}{2} \right) \in \Sigma_k * \Sigma_1 : \nu = \sum_{i=1}^k t_i \delta_{x_i} ; d(x_i, x_j) \geq \delta \forall i \neq j, \delta \leq t_i \leq 1 - \delta \forall i ; z \in \text{supp}(\nu) \right\}.$$

We will show that there is a lower bound for J_ρ whenever $\tilde{\Psi}$, which is defined in (29), has image inside S , see Proposition 3.7.

Consider $\mathcal{C}_{\varepsilon, r}(x_0)$ as given in (17), $f \in \mathcal{C}_{\varepsilon, r}(x_0)$ and ψ defined in (19). Before stating the next main result we recall some properties of the map ψ , see Proposition 3.1 in [36] (with minor adaptations).

Fact. Let $\psi(f) = (\beta, \sigma)$. Then, given $R > 1$ there exists $p \in \Sigma$ with the following properties:

$$(53) \quad \begin{aligned} d(p, \beta) &\leq C' \sigma \text{ for some } C' = C'(R); \\ \int_{B_\sigma(p) \cap B_r(x_0)} f dV_g &> \tau, \quad \int_{(B_{R\sigma}(p))^c \cap B_r(x_0)} f dV_g > \tau, \end{aligned}$$

where τ depends only on R and Σ .

Recall also the distance \mathbf{d} between measures in (11), the numbers $\varepsilon_i > 0$ in Proposition 2.4, the projections $\tilde{\psi}_k, \tilde{\psi}_1$ in (27), (28) and the definition of the parameter s in the topological join given by (26).

Proposition 3.7. *Suppose that $\rho_1 \in (4k\pi, 4(k+1)\pi)$, $\rho_2 \in (4\pi, 8\pi)$ and that $\mathbf{d}\left(\frac{e^{u_1}}{\int_{\Sigma} e^{u_1} dV_g}, \Sigma_k\right) < 2\varepsilon_k$, $\mathbf{d}\left(\frac{e^{u_2}}{\int_{\Sigma} e^{u_2} dV_g}, \Sigma_1\right) < \varepsilon_1$. Let*

$$\tilde{\psi}_k\left(\frac{e^{u_1}}{\int_{\Sigma} e^{u_1} dV_g}\right) = \sum_{i=1}^k t_i \delta_{x_i}, \quad \tilde{\psi}_1\left(\frac{e^{u_2}}{\int_{\Sigma} e^{u_2} dV_g}\right) = \delta_{\beta_z}.$$

There exist $\delta > 0$ and $L > 0$ such that, if the following properties hold true:

- 1) $d(x_i, x_j) \geq \delta \forall i \neq j$ and $t_i \in [\delta, 1 - \delta] \forall i = 1, \dots, k$;
- 2) $s(u_1, u_2) = 1/2$;
- 3) $\beta_z = x_l$ for some $l \in \{1, \dots, k\}$;

then

$$J_{\rho}(u_1, u_2) \geq -L.$$

PROOF. Suppose w.l.o.g. that $\bar{u}_1 = \bar{u}_2 = 0$. We first observe that exploiting the assumption $s(u_1, u_2) = 1/2$ we deduce $\sigma_1(u_1) = \sigma_2(u_2)$. Secondly, it is not difficult to show that from property 1) it follows $\mathbf{d}\left(\frac{e^{u_1}}{\int_{\Sigma} e^{u_1} dV_g}, \Sigma_{k-1}\right) \geq 2\varepsilon_{k-1}$. Therefore, by the definition of $\tilde{\psi}_k$ we deduce that $x_i = \beta_{x_i^k}$ for $i = 1, \dots, k$, where the $\beta_{x_i^k}$ are the local centres of mass given by (23). Hence we get

$$\tilde{\psi}_k\left(\frac{e^{u_1}}{\int_{\Sigma} e^{u_1} dV_g}\right) = \sum_{i=1}^k t_i \delta_{\beta_{x_i^k}}.$$

Recalling that we have set (see Subsection 3.1)

$$\sigma_2(u_2) = \mathfrak{g}_1\left(\mathbf{d}\left(\frac{e^{u_2}}{\int_{\Sigma} e^{u_2} dV_g}, \Sigma_1\right)\right) \sigma_z + \left(1 - \mathfrak{g}_1\left(\mathbf{d}\left(\frac{e^{u_2}}{\int_{\Sigma} e^{u_2} dV_g}, \Sigma_1\right)\right)\right),$$

using the fact that $\mathbf{d}\left(\frac{e^{u_2}}{\int_{\Sigma} e^{u_2} dV_g}, \Sigma_1\right) < \varepsilon_1$, by the definition of \mathfrak{g}_1 in (24), $\sigma_2(u_2)$ reduces to σ_z . We recall now also the definition of $\sigma_1(u_1)$, namely

$$\sigma_1(u_1) = \mathfrak{f}\left(\mathbf{d}\left(\frac{e^{u_1}}{\int_{\Sigma} e^{u_1} dV_g}, \Sigma_k\right)\right) A(u_1, u_2) + \left(1 - \mathfrak{f}\left(\mathbf{d}\left(\frac{e^{u_1}}{\int_{\Sigma} e^{u_1} dV_g}, \Sigma_k\right)\right)\right),$$

where $A(u_1, u_2)$ is defined in Subsection 3.1. The assumption $\mathbf{d}\left(\frac{e^{u_1}}{\int_{\Sigma} e^{u_1} dV_g}, \Sigma_k\right) < 2\varepsilon_k$ implies that $\mathfrak{f}\left(\mathbf{d}\left(\frac{e^{u_1}}{\int_{\Sigma} e^{u_1} dV_g}, \Sigma_k\right)\right) > 0$. As before, using property 1) we obtain from $\mathbf{d}\left(\frac{e^{u_1}}{\int_{\Sigma} e^{u_1} dV_g}, \Sigma_{k-1}\right) \geq 2\varepsilon_{k-1}$ that $\mathfrak{g}_{k-1}\left(\mathbf{d}\left(\frac{e^{u_1}}{\int_{\Sigma} e^{u_1} dV_g}, \Sigma_{k-1}\right)\right) = 0$ and hence $A(u_1, u_2) = B(u_1, u_2)$ (see the notation before (26)). Moreover, the condition 3) implies that $\mathfrak{h}(d(\beta_z, \{\beta_{x_1^k}, \dots, \beta_{x_k^k}\})) = 1$. Therefore $B(u_1, u_2) = \sigma_{x_l^k}$. Hence one finds

$$\sigma_{u_1} = \mathfrak{f}\left(\mathbf{d}\left(\frac{e^{u_1}}{\int_{\Sigma} e^{u_1} dV_g}, \Sigma_k\right)\right) \sigma_{x_l^k} + \left(1 - \mathfrak{f}\left(\mathbf{d}\left(\frac{e^{u_1}}{\int_{\Sigma} e^{u_1} dV_g}, \Sigma_k\right)\right)\right).$$

We distinguish between two cases.

Case 1. Suppose first that $\mathfrak{f}\left(\mathbf{d}\left(\frac{e^{u_1}}{\int_{\Sigma} e^{u_1} dV_g}, \Sigma_k\right)\right) = 1$. In this case we obtain $\sigma_{x_l^k} = \sigma_1(u_1) = \sigma_2(u_2) = \sigma_z$. By this fact and by property 3) we get $(\beta_{x_l^k}, \sigma_{x_l^k}) = (\beta_z, \sigma_z)$. Let $r = \delta/4$: from (53) and the definition of $\beta_z, \beta_{x_i^k}$, there exists $\tilde{\gamma}_0 > 0$ such that

$$(54) \quad \int_{B_r(\beta_{x_i^k})} e^{u_1} dV_g \geq \tilde{\gamma}_0 \int_{\Sigma} e^{u_1} dV_g \quad \text{for } i = 1, \dots, k; \quad \int_{B_r(\beta_z)} e^{u_2} dV_g \geq \tilde{\gamma}_0 \int_{\Sigma} e^{u_2} dV_g.$$

Therefore, we are in position to apply Proposition 2.12 and get

$$4(k+1)\pi \log \int_{\Sigma} e^{u_1} dV_g + 8\pi \log \int_{\Sigma} e^{u_2} dV_g \leq (1 + \varepsilon) \int_{\Sigma} Q(u_1, u_2) dV_g + C_r.$$

The conclusion then follows from the expression of J_{ρ} and from the upper bounds on ρ_1, ρ_2 .

Case 2. Suppose now that $\mathfrak{f}\left(\mathbf{d}\left(\frac{e^{u_1}}{\int_{\Sigma} e^{u_1} dV_g}, \Sigma_k\right)\right) < 1$: we deduce immediately that $\mathbf{d}\left(\frac{e^{u_1}}{\int_{\Sigma} e^{u_1} dV_g}, \Sigma_k\right) \in (\varepsilon_k, 2\varepsilon_k)$.

Given $\varepsilon > 0$, let $R = R(\varepsilon)$ be such that Proposition 2.10 holds true. Let $C' = C'(R)$ and $\tau = \tau(R)$ be as in (53). Take $\tau_0 = \tau/100$, $\gamma_0 = \tilde{\gamma}_0\tau$, where γ_0 is given as in (54), and let $C = C(\varepsilon, r, \tau_0, \gamma_0)$ be the constant obtained in Proposition 3.5. We then define $\tilde{C} = \max\{C', C\}$. Moreover, observe that by construction $\sigma_{x_l^k} \leq \sigma_1(u_1) = \sigma_2(u_2) = \sigma_z$.

If $\sigma_{x_l^k} \leq \sigma_z \leq \tilde{C}^8 \sigma_{x_l^k}$ we still can apply Proposition 2.12 as before, see Remark 2.11. Consider now the case $\tilde{C}^8 \sigma_{x_l^k} \leq \sigma_z$. We distinguish between two situations.

Case 2.1. If r is as in Case 1, suppose that

$$(55) \quad \int_{B_{\tilde{C}^4 \sigma_{x_l^k}}(\beta_z)} e^{u_2} dV_g > \tau_0 \int_{B_r(\beta_z)} e^{u_2} dV_g \left(> \tilde{\gamma}_0 \tau_0 \int_{\Sigma} e^{u_2} dV_g : \text{ see (54)} \right).$$

By the fact that $\tilde{C}^4 \sigma_{x_l^k} \ll \sigma_z$, from (53) we also get

$$(56) \quad \int_{(B_{R\tilde{C}^4 \sigma_{x_l^k}}(\beta_z))^c \cap B_r(\beta_z)} e^{u_2} dV_g > \tau_0 \int_{B_r(\beta_z)} e^{u_2} dV_g > \tilde{\gamma}_0 \tau_0 \int_{\Sigma} e^{u_2} dV_g.$$

The conditions on the local scale of u_1 , given by $(\beta_{x_l^k}, \sigma_{x_l^k}) = \psi(f_{loc}^{x_l^k}(u_1))$, yield by (53) the existence of $p \in \Sigma$ such that

$$\begin{aligned} \int_{B_{\sigma_{x_l^k}(p)}} e^{u_1} dV_g &> \tau \int_{B_r(\beta_{x_l^k})} e^{u_1} dV_g > \tilde{\gamma}_0 \tau \int_{\Sigma} e^{u_1} dV_g, \\ \int_{(B_{R\sigma_{x_l^k}(p)})^c \cap B_r(\beta_{x_l^k})} e^{u_1} dV_g &> \tau \int_{B_r(\beta_{x_l^k})} e^{u_1} dV_g > \tilde{\gamma}_0 \tau \int_{\Sigma} e^{u_1} dV_g. \end{aligned}$$

The latter formulas, together with (55) and (56) imply an improved Moser-Trudinger inequality, see Remarks 2.9 and 2.11:

$$(57) \quad 8\pi \left(\log \int_{\Sigma} e^{u_1} dV_g + \log \int_{\Sigma} e^{u_2} dV_g \right) \leq (1 + \varepsilon) \int_{B_r(\beta_z)} Q(u_1, u_2) dV_g + C_0(\varepsilon, r, \tau, \tilde{\gamma}_0).$$

Case 2.2. Suppose now that the second situation occurs, namely

$$(58) \quad \int_{B_{\tilde{C}^4 \sigma_{x_l^k}}(z)} e^{u_2} dV_g \leq \tau_0 \int_{B_r(\beta_z)} e^{u_2} dV_g.$$

The goal is to apply the improved inequality stated in Proposition 3.5. Take $\sigma = (C')^2 \sigma_{x_l^k}$ and $A_{\beta_z}(C\sigma, \frac{r}{C})$ as the annulus on which we will test the conditions (41) and (42). We start by considering (41). Observe that

$$\int_{B_{\sigma/2}(z)} e^{u_1} dV_g > \gamma_0 \int_{\Sigma} e^{u_1} dV_g$$

follows from (53) and (54) by the choice of σ and γ_0 . Similarly, using the volume concentration of u_2 in $(B_{R\sigma_z}(p))^c \cap B_r(\beta_z)$ in (53) and (recalling the definition of \tilde{C}) $C\sigma \ll R\sigma_z$ we get

$$\int_{A_{\beta_z}(C\sigma, \frac{r}{C})} e^{u_2} dV_g > \gamma_0 \int_{\Sigma} e^{u_2} dV_g$$

by taking ε_1 sufficiently small in Proposition 3.7. We are left by proving condition (42), i.e.

$$\sup_{y \in A_{\beta_z}(C\sigma, \frac{r}{C})} \frac{\int_{B_{\tau_0 d(y,z)}(y)} e^{u_2} dV_g}{\int_{A_{\beta_z}(C\sigma, \frac{r}{C})} e^{u_2} dV_g} < 1 - \tau_0.$$

If this is not the case, then there exists $y \in A_{\beta_z}(C\sigma, \frac{r}{C})$ such that

$$\int_{B_{\tau_0 d(y,z)}(y)} e^{u_2} dV_g \geq (1 - \tau_0) \int_{A_{\beta_z}(C\sigma, \frac{r}{C})} e^{u_2} dV_g.$$

Using the assumption (58) and $\sigma < \tilde{C}^4 \sigma_{x_i^k}$ we get

$$\begin{aligned} \int_{B_{\tau_0 d(y,z)}(y)} e^{u_2} dV_g &\geq (1 - \tau_0) \int_{A_{\beta_z}(C\sigma, \frac{r}{C})} e^{u_2} dV_g \geq (1 - \tau_0) \int_{A_{\beta_z}(C\sigma, \frac{r}{C})} e^{u_2} dV_g \\ &= (1 - \tau_0) \int_{B_r(\beta_z)} e^{u_2} dV_g - (1 - \tau_0) \int_{B_{C\sigma}(\beta_z)} e^{u_2} dV_g \geq (1 - 2\tau_0) \int_{B_r(\beta_z)} e^{u_2} dV_g. \end{aligned}$$

Moreover, by the property of the local scale of u_2 given by $(\beta_z, \sigma_z) = \psi(f_{loc}^z(u_2))$, see (53), we have

$$\int_{B_{\sigma_z}(p)} e^{u_2} dV_g > \tau \int_{B_r(\beta_z)} e^{u_2} dV_g; \quad \int_{(B_{R\sigma_z}(p))^c \cap B_r(\beta_z)} e^{u_2} dV_g > \tau \int_{B_r(\beta_z)} e^{u_2} dV_g.$$

Notice that by the choice of τ_0 the three properties above cannot hold simultaneously. Hence, we have a contradiction. Finally, we are in position to apply Proposition 3.5 and deduce that

$$4\pi \log \int_{\Sigma} e^{u_1} dV_g + 8\pi \log \int_{\Sigma} e^{u_2} dV_g \leq \int_{B_r(\beta_z)} Q(u_1, u_2) dV_g + \varepsilon \int_{\Sigma} Q(u_1, u_2) dV_g + C.$$

Observe that by the latter formula and by (57), in both *Case 2.1* and *Case 2.2* we can assert that

$$(59) \quad 4\pi \log \int_{\Sigma} e^{u_1} dV_g + 8\pi \log \int_{\Sigma} e^{u_2} dV_g \leq \int_{B_r(\beta_z)} Q(u_1, u_2) dV_g + \varepsilon \int_{\Sigma} Q(u_1, u_2) dV_g + C.$$

Recall that under Case 2 we have $\mathbf{d}\left(\frac{e^{u_1}}{\int_{\Sigma} e^{u_1} dV_g}, \Sigma_k\right) > \varepsilon_k$. By the second part of Proposition 2.4 (applied with $l = k + 1$) there exist $\bar{\varepsilon}_k > 0$, depending only on ε_k , and $k + 1$ points $\bar{x}_1, \dots, \bar{x}_{k+1}$ such that

$$d(\bar{x}_i, \bar{x}_j) > 2\bar{\varepsilon}_k \quad \text{for } i \neq j; \quad \int_{B_{\bar{\varepsilon}_k}(\bar{x}_i)} e^{u_1} dV_g > \bar{\varepsilon}_k \int_{\Sigma} e^{u_1} dV_g \quad \text{for all } i = 1, \dots, k + 1.$$

Without loss of generality we can assume $\delta < \bar{\varepsilon}_k/8$. By this the choice of δ there exist k points $\bar{y}_1, \dots, \bar{y}_k$ such that

$$d(\bar{y}_i, \bar{y}_j) > \bar{\varepsilon}_k \quad \text{for } i \neq j; \quad d(\bar{y}_i, \beta_{x_i^k}) > \delta \quad \text{for all } i = 1, \dots, k;$$

$$\int_{B_{\bar{\varepsilon}_k}(\bar{y}_i)} e^{u_1} dV_g > \bar{\varepsilon}_k \int_{\Sigma} e^{u_1} dV_g \quad \text{for all } i = 1, \dots, k.$$

We perform then a local Moser-Trudinger inequality for u_1 in each region, see (50), and summing up we have (recall that $r = \delta/4$)

$$(60) \quad 4k\pi \log \int_{\Sigma} e^{u_1} dV_g \leq \int_{(B_r(\beta_{x_i^k}))^c} Q(u_1, u_2) dV_g + \varepsilon \int_{\Sigma} Q(u_1, u_2) dV_g + C_r,$$

where the average was estimated using Hölder's and Poincaré's inequalities as in (44). By summing equations (59) and (60) we deduce

$$4(k + 1)\pi \log \int_{\Sigma} e^{u_1} dV_g + 8\pi \log \int_{\Sigma} e^{u_2} dV_g \leq (1 + \varepsilon) \int_{\Sigma} Q(u_1, u_2) dV_g + C,$$

so we conclude as in Case 1. ■

By Proposition 3.7 we obtain the following corollary.

Corollary 3.8. *Let S be as in (52) and let $Y = (\Sigma_k * \Sigma_1) \setminus S$. Then, for $\tilde{L} > 0$ large $\tilde{\Psi}$ (defined in (29)) maps the low sublevels $J_p^{-\tilde{L}}$ into the set Y .*

4. TEST FUNCTIONS

We show that the lower bound in Proposition 3.7 is optimal, see also Corollary 3.8. In fact, we will construct suitable test functions modelled on Y on which J_ρ attains arbitrarily negative values.

To describe our construction, let us recall the test functions employed for the scalar case (5). When $\rho > 4\pi$, as mentioned in the Introduction, the energy I_ρ in (6) is unbounded below. One can see that using test functions of the type

$$(61) \quad \varphi_{\lambda,z}(x) = \log \left(\frac{\lambda}{1 + \lambda^2 d(x,z)^2} \right)^2,$$

for a given point $z \in \Sigma$ and for $\lambda > 0$, as $\lambda \rightarrow +\infty$ these satisfy the properties

$$(62) \quad e^{\varphi_{\lambda,z}} \rightarrow \delta_z \quad \text{and} \quad I_\rho(\varphi_{\lambda,z}) \rightarrow -\infty \quad (\rho > 4\pi),$$

holding uniformly in $z \in \Sigma$. More in general, if $\rho \in (4k\pi, 4(k+1)\pi)$, a natural family of test functions can be modelled on Σ_k , see [19, 20]. In fact, setting

$$(63) \quad \varphi_{\lambda,\nu}(x) = \log \sum_{i=1}^k t_i \left(\frac{\lambda}{1 + \lambda^2 d(x, x_i)^2} \right)^2; \quad \nu = \sum_{i=1}^k t_i \delta_{x_i},$$

similarly to (62), for $\lambda \rightarrow +\infty$ one has uniformly in $\nu \in \Sigma_k$

$$\mathbf{d}(e^{\varphi_{\lambda,\nu}}, \nu) \rightarrow 0 \quad \text{and} \quad I_\rho(\varphi_{\lambda,\nu}) \rightarrow -\infty \quad (\rho \in (4k\pi, 4(k+1)\pi)).$$

When dealing with the energy functional J_ρ in (2) one can expect to interpolate between the $\varphi_{\lambda,\nu}$ for the component u_1 and the $\varphi_{\lambda,z}$ for u_2 when $\rho_1 \in (4k\pi, 4(k+1)\pi)$, $\rho_2 \in (4\pi, 8\pi)$. Therefore, the topological join $\Sigma_k * \Sigma_1$ represents a natural object to parametrize globally this family, with the join parameter s playing the role of interpolation parameter. However, as mentioned in the Introduction, the cross term in the quadratic energy penalizes gradients pointing in the same direction. By this reason, not all elements in $\Sigma_k * \Sigma_1$ will give rise to test functions with low energy. It will turn out that the subset Y of $\Sigma_k * \Sigma_1$, see (51), will be the right one to look at.

4.1. A convenient deformation of $Y \cap \{s = \frac{1}{2}\}$. We construct here a continuous deformation of $Y \cap \{s = \frac{1}{2}\}$, which is relatively open in the join $\Sigma_k * \Sigma_1$, onto some closed subset: see Corollary 4.6. This will allow us to build test functions depending on a compact space of parameters, which is easier. Before doing this, we recall some facts from Section 3 of [34].

There exists a deformation retract $H_0(t, \cdot)$ of a neighborhood (with respect to the metric induced by \mathbf{d} in (11)) of Σ_{k-1} in Σ_k onto Σ_{k-1} . To see this, one can take a positive δ_1 small enough and consider a non-increasing continuous function $F_0 : (0, +\infty) \rightarrow (0, +\infty)$ such that

$$(64) \quad F_0(t) = \frac{1}{t} \text{ for } t \in (0, \delta_1]; \quad F_0(t) = \frac{1}{2\delta_1} \text{ for } t > 2\delta_1.$$

We then define $F : \Sigma_k \setminus \Sigma_{k-1} \rightarrow \mathbb{R}$ as

$$(65) \quad F \left(\sum_{i=1}^k t_i \delta_{x_i} \right) = \underbrace{\sum_{i \neq j} F_0(d(x_i, x_j))}_{F_1((x_i)_i)} + \underbrace{\sum_{i=1}^k \frac{1}{t_i(1-t_i)}}_{F_2((t_i)_i)}.$$

Notice that F is well defined on $\Sigma_k \setminus \Sigma_{k-1}$, as it is invariant under permutation of the couples $(t_i, x_i)_{i=1, \dots, k}$. Observe also that it tends to $+\infty$ as its argument approaches Σ_{k-1} . Moreover, the gradient of F with respect to the metric of $\Sigma^k \times T_0$ (where T_0 is the simplex containing the k -tuple $T := (t_i)_i$) tends to $+\infty$ in norm as $\sum_{i=1}^k t_i \delta_{x_i}$ tends to Σ_{k-1} . It follows that, sending L to $+\infty$, we get a deformation retract of $F_L := \{F \geq L\} \cup \Sigma_{k-1}$ onto Σ_{k-1} for L sufficiently large. We then obtain H_0 by a reparametrization of the (positive) gradient flow of F .

We introduce now the set $\tilde{Y}_{\frac{1}{2}} \subseteq Y \cap \{s = \frac{1}{2}\} \subseteq \Sigma_k * \Sigma_1$ defined as

$$\tilde{Y}_{\frac{1}{2}} = \left\{ \left(\nu, \delta_z, \frac{1}{2} \right) : \nu \in \Sigma_{k-1} \right\} \cup \left\{ \left(\nu, \delta_z, \frac{1}{2} \right) : \nu \in \Sigma_k \setminus \Sigma_{k-1}, z \notin \text{supp}(\nu) \right\}.$$

The next result holds true.

Lemma 4.1. *There exists a continuous deformation $\tilde{H}(\mathbf{t}, \cdot)$ of the set $Y \cap \{s = \frac{1}{2}\}$ onto $\tilde{Y}_{\frac{1}{2}}$.*

PROOF. Let $\delta > 0$ be as in (52). Consider $0 < \tilde{\delta} \ll \delta$ and let $\tilde{f} : (0, +\infty) \rightarrow (0, +\infty)$ be a non-increasing continuous function given by

$$\tilde{f}(t) = \begin{cases} \frac{1}{t^2} & \text{in } t \leq \tilde{\delta}, \\ 0 & \text{in } t \geq 2\tilde{\delta}. \end{cases}$$

Moreover, recall the deformation retract $H_0(\mathbf{t}, \cdot)$ of a neighborhood of Σ_{k-1} in Σ_k onto Σ_{k-1} constructed above. To define \tilde{H} we distinguish among four situations, fixing $\hat{\delta} \ll \tilde{\delta}$ (in particular we take $\hat{\delta}$ so small that H_0 is well-defined on $3\hat{\delta}$ -neighbourhood of Σ_{k-1} in the metric \mathbf{d}).

(i) $\mathbf{d}(\nu, \Sigma_{k-1}) \leq \hat{\delta}$. Recall that elements in $Y \cap \{s = \frac{1}{2}\}$ are triples of the form $(\nu, \delta_z, \frac{1}{2})$ with $\nu \in \Sigma_k$. In this first case we project ν onto Σ_{k-1} , while δ_z remains fixed. If H_0 is the retraction described above, we simply define \tilde{H} to be

$$\tilde{H} \left(\mathbf{t}, \nu, \delta_z, \frac{1}{2} \right) = \left(H_0(\mathbf{t}, \nu), \delta_z, \frac{1}{2} \right).$$

(ii) $\mathbf{d}(\nu, \Sigma_{k-1}) \in [\hat{\delta}, 2\hat{\delta}]$. Let

$$\nu_1(\mathbf{t}) = H_0(\mathbf{t}, \nu) = \sum_{i=1}^k t_i(\mathbf{t}) \delta_{x_i(\mathbf{t})}.$$

If \tilde{f} is as before, we introduce the following flow acting on the support of δ_z :

$$(66) \quad \frac{d}{dt} z(\mathbf{t}) = \sum_{i=1}^k t_i(\mathbf{t}) \tilde{f}(d(z(\mathbf{t}), x_i(\mathbf{t}))) \nabla_z d(z(\mathbf{t}), x_i(\mathbf{t})).$$

To define \tilde{H} in this case we interpolate from a constant motion in z and (66) depending on $\mathbf{d}(\nu, \Sigma_{k-1})$:

$$\tilde{H} \left(\mathbf{t}, \nu, \delta_z, \frac{1}{2} \right) = \left(\nu_1(\mathbf{t}), \delta_z \left(\mathbf{t} \frac{\mathbf{d}(\nu, \Sigma_{k-1}) - \hat{\delta}}{\hat{\delta}} \right), \frac{1}{2} \right).$$

Notice that when $\mathbf{d}(\nu, \Sigma_{k-1}) = 2\hat{\delta}$ we get $z \left(\mathbf{t} \frac{\mathbf{d}(\nu, \Sigma_{k-1}) - \hat{\delta}}{\hat{\delta}} \right) = z(\mathbf{t})$ and this point never intersects the support of $\nu_1(\mathbf{t})$, unless $\nu_1(\mathbf{t}) \in \Sigma_{k-1}$. Therefore, as for case (i), $\tilde{H} \left(1, \nu, \delta_z, \frac{1}{2} \right) \in \tilde{Y}_{\frac{1}{2}}$.

(iii) $\mathbf{d}(\nu, \Sigma_{k-1}) \in [2\hat{\delta}, 3\hat{\delta}]$. In this case the evolution of ν interpolates between the projection onto Σ_{k-1} and staying fixed, i.e. we set

$$\nu_2(\mathbf{t}) = H_0 \left(\mathbf{t} \frac{3\hat{\delta} - \mathbf{d}(\nu, \Sigma_{k-1})}{\hat{\delta}}, \nu \right)$$

and let $z(\mathbf{t})$ evolve according to (66) with $t_i(\mathbf{t}), x_i(\mathbf{t})$ given by $\sum_{i=1}^k t_i(\mathbf{t}) \delta_{x_i(\mathbf{t})} = \nu_2(\mathbf{t})$, so we define \tilde{H} as

$$\tilde{H} \left(\mathbf{t}, \nu, \delta_z, \frac{1}{2} \right) = \left(\nu_2(\mathbf{t}), \delta_{z(\mathbf{t})}, \frac{1}{2} \right).$$

(iv) $\mathbf{d}(\nu, \Sigma_{k-1}) \geq 3\hat{\delta}$. The deformation \tilde{H} leaves now ν fixed, while we let $z(\mathbf{t})$ evolve by (66) with $t_i(\mathbf{t}) \equiv t_i$ and $x_i(\mathbf{t}) \equiv x_i$.

$$\tilde{H} \left(\mathbf{t}, \nu, \delta_z, \frac{1}{2} \right) = \left(\nu, \delta_{z(\mathbf{t})}, \frac{1}{2} \right).$$

Observe that in this case, by the definition of \tilde{f} and by the choice of $\tilde{\delta}$, the latter flow of z does not intersect the support of ν and $d(z, z(1)) = O(\tilde{\delta})$. ■

We next *slice* the set $\tilde{Y}_{\frac{1}{2}}$ in the second entry δ_z : for $p \in \Sigma$ we introduce $\tilde{Y}_{(\frac{1}{2}, p)} \subseteq \Sigma_k$ given by

$$(67) \quad \tilde{Y}_{(\frac{1}{2}, p)} = \left\{ \nu \in \Sigma_k : \left(\nu, \delta_p, \frac{1}{2} \right) \in \tilde{Y}_{\frac{1}{2}} \right\},$$

so that

$$\tilde{Y}_{\frac{1}{2}} = \bigcup_{p \in \Sigma} \left(\tilde{Y}_{(\frac{1}{2}, p)}, \delta_p, \frac{1}{2} \right).$$

In Proposition 4.4 we will further deform $\tilde{Y}_{(\frac{1}{2}, p)}$ to some compact subset of Σ_k (depending on p).

Let $\delta_2 > 0$ be a small number, $p \in \Sigma$ and χ_{δ_2} a cut-off function such that

$$(68) \quad \chi_{\delta_2} = \begin{cases} 0 & \text{in } B_{\delta_2}(p), \\ 1 & \text{in } (B_{2\delta_2}(p))^c. \end{cases}$$

We start by proving the following lemmas (we are extending the notation in (8) to any subset of Σ).

Lemma 4.2. *Let $p \in \Sigma$ and let $\delta_2 > 0$ be as before. There exists $\delta_3 > 0$ sufficiently small such that the above defined map $H_0(\mathbf{t}, \cdot)$ is a deformation retract of $\left\{ \nu \in \tilde{Y}_{(\frac{1}{2}, p)} : \int_{\Sigma} \chi_{\delta_2} d\nu \geq \delta_2, \mathbf{d} \left(\frac{\chi_{\delta_2} \nu}{\|\chi_{\delta_2} \nu\|}, \Sigma_{k-2} \right) \in (0, \delta_3) \right\} \cap \{\mathbf{d}(\nu, \Sigma_{k-1}) < \delta_3\}$ onto $(\Sigma \setminus \{p\})_{k-1}$ with the property that $\forall \mathbf{t} \in [0, 1]$ we have $p \notin \text{supp } H_0(\mathbf{t}, \nu)$.*

PROOF. Let δ_1 be as in (64). We can assume that $\delta_1 \leq \delta_2/16$. We first prove that $H_0(\mathbf{t}, \cdot)$ has the property that as the \mathbf{d} -distance of ν from Σ_{k-1} tends to zero then the support of the measure $H_0(\mathbf{t}, \nu)$ is contained in a shrinking neighborhood of the support of ν (uniformly in ν). We will then show that H_0 restricted to the particular set considered in the statement gives the desired deformation retract.

To prove the first assertion we endow Σ^k , which the k -tuple $X := (x_i)_i$ belongs to, with the product metric, and the simplex T_0 , containing the k -tuple $T := (t_i)_i$, with its standard metric induced from \mathbb{R}^k . Then one can notice that, as the singularities of F_1 and F_2 behave like the inverse of the distance from the boundaries of their domains, there exists a constant C such that

$$(69) \quad \frac{1}{C} F_1(X)^2 - C \leq |\nabla_X F_1(X)| \leq C F_1(X)^2 + C; \quad \frac{1}{C} F_2(T)^2 - C \leq |\nabla_T F_2(T)| \leq C F_2(T)^2 + C.$$

We now consider the evolution $\mathfrak{s} \mapsto \zeta(\nu, \mathfrak{s})$ with initial datum ν in a small neighborhood of Σ_{k-1} , where, we recall, F attains large values and its gradient does not vanish. If we evolve by the gradient of F then X evolves by the gradient of F_1 and T by the gradient of F_2 . By the last formula we then have

$$\left| \frac{dX}{d\mathfrak{s}} \right| = |\nabla_X F_1| \leq C F_1(X)^2 + C.$$

On the other hand, still by (69), we have that

$$\frac{dF}{d\mathfrak{s}} = |\nabla_X F_1(X)|^2 + |\nabla_T F_2(T)|^2 \geq \frac{1}{C^2} F_1(X)^4 + \frac{1}{C^2} F_2(T)^4 - 2C.$$

Notice that this quantity is strictly positive if F is large enough, see (65), which allows to invert the function $\mathfrak{s} \mapsto F(\zeta(\nu, \mathfrak{s}))$. Therefore, if \mathfrak{s}_ν is the maximal time of existence for $\zeta(\nu, \mathfrak{s})$ we can write that

$$\int_0^{\mathfrak{s}_\nu} \left| \frac{dX}{d\mathfrak{s}} \right| d\mathfrak{s} = \int_{F(\nu)}^{\infty} \left| \frac{dX}{d\mathfrak{s}} \right| \frac{1}{\frac{dF}{d\mathfrak{s}}} dF.$$

By the above two inequalities we deduce that

$$\int_0^{\mathfrak{s}_\nu} \left| \frac{dX}{d\mathfrak{s}} \right| d\mathfrak{s} \leq \int_{F(\nu)}^{\infty} \frac{C F_1(X)^2 + C}{\frac{1}{C^2} F_1(X)^4 + \frac{1}{C^2} F_2(T)^4 - 2C} dF.$$

By elementary inequalities, recalling that $F = F_1(X) + F_2(T)$ we also find

$$\int_0^{\mathfrak{s}_\nu} \left| \frac{dX}{d\mathfrak{s}} \right| d\mathfrak{s} \leq \tilde{C} \int_{F(\nu)}^{\infty} \frac{1}{F^2 - \tilde{C}} dF.$$

Therefore, as ν approaches Σ_{k-1} , namely for $F(\nu)$ large, we find that the displacement of X becomes smaller and smaller. This gives us the claim stated at the beginning of the proof.

Next, we observe that by being $\nu \in \tilde{Y}_{(\frac{1}{2}, p)}$ and $\mathbf{d}\left(\frac{\chi_{\delta_2}\nu}{\|\chi_{\delta_2}\nu\|}, \Sigma_{k-2}\right) > 0$ by assumption, it follows the existence of at most one point of the support of ν in the ball $B_{\frac{3}{4}\delta_2}(p)$ which does not coincide with p . Moreover, by the above claim we have that the points outside $B_{\delta_2}(p)$ following the flow induced by F move by a distance of order $o_{\delta_3}(1)$, since $\mathbf{d}(\nu, \Sigma_{k-1}) < \delta_3$. Therefore, choosing δ_3 sufficiently small we get the existence of at most one point in the ball $B_{\frac{3}{4}\delta_2}(p)$, different from p , even while the flow is acting.

By the choice of F_1 , see (64), (65), and by the choice $\delta_1 \leq \frac{\delta_2}{16}$, we deduce that the point inside $B_{\frac{3}{4}\delta_2}(p)$ it is not affected by the flow and in particular it does not collapse onto p : the proof is complete. ■

Lemma 4.3. *There exists a deformation retract $H(\mathbf{t}, \cdot)$ of $\left\{ \nu \in \tilde{Y}_{(\frac{1}{2}, p)} : \int_{\Sigma} \chi_{\delta_2} d\nu \geq \delta_2 \right\}$ to the set:*

$$\mathcal{B} := (\Sigma \setminus B_{\delta_2}(p))_k \cup \left\{ \text{card}(\text{supp}(\nu) \setminus B_{\delta_2}(p)) \leq k - 2 \right\}.$$

PROOF. Let us first consider a deformation retract which pushes points in $\Sigma \setminus \{p\}$ away from p . Define $H_1(\mathbf{t}, \cdot)$, $\mathbf{t} \in [0, 1]$ as follows: if $\nu = \sum_{i=1}^k t_i \delta_{x_i}$, $x_i \neq p$, then (using normal coordinates around p)

$$H_1(\mathbf{t}, \nu) = \sum_{i=1}^k t_i \delta_{x_{i,\mathbf{t}}}, \quad \text{where} \quad x_{i,\mathbf{t}} = \begin{cases} \frac{x_i}{|x_i|} ((1-\mathbf{t})|x_i| + \mathbf{t}\delta_2) & \text{if } d(p, x_i) < \delta_2. \\ x_i & \text{if } d(p, x_i) \geq \delta_2. \end{cases}$$

We next introduce two cut-off functions $\chi_1^{\delta_3}, \chi_2^{\delta_3}$ as in Figure 1 ($\chi_2^{\delta_3}$ corresponds to the dashed graph).

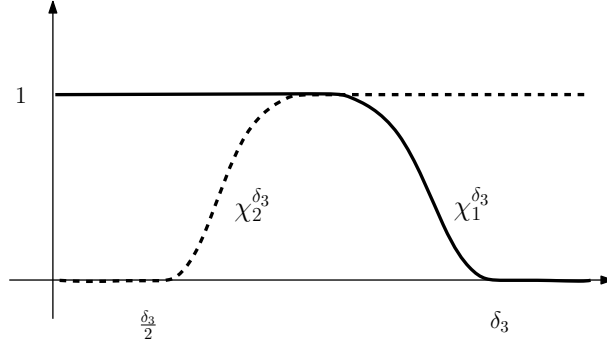

FIGURE 1

For $\{\mathbf{d}(\nu, \Sigma_{k-1}) < \delta_3\}$ we define the deformation retract $H_2(\mathbf{t}, \cdot)$ as an *interpolation* between the homotopies H_0 and H_1 , precisely

$$H_2(\mathbf{t}, \nu) = H_1\left(\mathbf{t} \chi_2^{\delta_3}\left(\mathbf{d}\left(\frac{\chi_{\delta_2}\nu}{\|\chi_{\delta_2}\nu\|}, \Sigma_{k-2}\right)\right), H_0\left(\mathbf{t} \chi_1^{\delta_3}\left(\mathbf{d}\left(\frac{\chi_{\delta_2}\nu}{\|\chi_{\delta_2}\nu\|}, \Sigma_{k-2}\right)\right), \nu\right)\right).$$

The introduction of the cut-off functions makes the deformation retract continuous with respect to the topology induced by the \mathbf{d} -distance.

For $\mathbf{d}(\nu, \Sigma_{k-1})$ arbitrary we instead define H as

$$H(\mathbf{t}, \nu) = H_1\left(\mathbf{t} \chi_2^{\delta_3}(\mathbf{d}(\nu, \Sigma_{k-1})), H_2(\chi_1^{\delta_3}(\mathbf{d}(\nu, \Sigma_{k-1})), \nu)\right).$$

Again, notice that the cut-off functions in the first argument of H_1 give continuity in ν . ■

The main result of this subsection is the following proposition: we retract $\tilde{Y}_{(\frac{1}{2}, p)}$ to a set of measures $\Sigma_{k,p,\bar{r}}$ (see (70)) for which either the support is bounded away from p , or for which there are at most $k-2$ points not closest to p . As we will see, these conditions will be helpful to find suitable test functions with low Euler-Lagrange energy, see the next subsections.

Proposition 4.4. *There exist $\bar{\tau} \gg 1$ and a retraction \mathcal{R}_p of $\tilde{Y}_{(\frac{1}{2}, p)}$ to the following set:*

$$(70) \quad \Sigma_{k,p,\bar{\tau}} = \left\{ \nu = \sum_{i=1}^k t_i \delta_{x_i} \in \Sigma_k : d(x_i, p) \geq \frac{1}{\bar{\tau}} \forall i \right\} \cup \\ \cup \left\{ \nu = \sum_{i=1}^k t_i \delta_{x_i} \in \Sigma_k : \text{card}\{x_j : d(x_j, p) > \min_i d(x_i, p)\} \leq k-2 \right\}.$$

PROOF. Recall first the definition (68) of χ_{δ_2} . We then extend the result in Lemma 4.3 to arbitrary values of $m_2(\nu) = \int_{\Sigma} \chi_{\delta_2} d\nu$, namely also for $m_2 < \delta_2$, finding a retraction onto \mathcal{B} . Consider normal coordinates around p . Define $m(\nu) = \left\| \nu \left(\chi_{\delta_2}(m_2(\nu)) + (1 - \chi_{\delta_2}(|x|))(1 - \chi_{\delta_2}(m_2(\nu))) \right) \right\|$ and let

$$T(\nu) = \begin{cases} \frac{\nu \left(\chi_{\delta_2}(m_2(\nu)) + (1 - \chi_{\delta_2}(|x|))(1 - \chi_{\delta_2}(m_2(\nu))) \right)}{m(\nu)} & \text{if } m_2(\nu) < 2\delta_2, \\ \nu & \text{if } m_2(\nu) \geq 2\delta_2. \end{cases}$$

We then define the retraction as

$$\tilde{R}(\nu) = T(H(\chi_{\delta_2}(m_2(\nu)), \nu)).$$

Let $\nu_H = H(\chi_{\delta_2}(m_2(\nu)), \nu)$. To have \tilde{R} well-defined we need to ensure that whenever T is acting, namely for $m_2(\nu_H) < 2\delta_2$, we have $m(\nu_H) > 0$. Clearly, it is enough to show that

$$(71) \quad \int_{\Sigma} (1 - \chi_{\delta_2}) d\nu_H > 0.$$

We point out that

$$m_2(\nu_H) + \int_{\Sigma} (1 - \chi_{\delta_2}) d\nu_H = 1.$$

Therefore, by $m_2 < 2\delta_2$ we obtain

$$\int_{\Sigma} (1 - \chi_{\delta_2}) d\nu_H > 1 - 2\delta_2.$$

Finally, we construct a retraction of \mathcal{B} onto $\Sigma_{k,p,\bar{\tau}}$. For $\nu \in \mathcal{B}$ with $\|(1 - \chi_{\delta_2})\nu\| > 0$ we define a parameter $\tau = \tau(\nu) \in (0, +\infty]$ in the following way:

$$(72) \quad \frac{1}{\tau} = \mathbf{d} \left(\frac{(1 - \chi_{\delta_2})\nu}{\|(1 - \chi_{\delta_2})\nu\|}, \delta_p \right).$$

Consider normal coordinates around p . Let $\bar{\tau} \gg 1$ be such that $\frac{1}{\bar{\tau}} \ll \delta_2 \ll 1$ and let $f : \mathcal{B} \times \Sigma \rightarrow \mathbb{R}^+$ and $g : \mathbb{R}^+ \rightarrow \mathbb{R}^+$ be two smooth functions such that

$$f(\nu, x) = \begin{cases} 0 & \text{if } \tau = +\infty, \\ \frac{x}{|x|} \frac{1}{\tau} & \text{if } \tau < +\infty \text{ and } |x| \leq \frac{1}{\bar{\tau}}, \\ 1 & \text{if } \tau < +\infty \text{ and } |x| \geq \frac{2}{\bar{\tau}}, \end{cases} \quad g(t) = \begin{cases} t & \text{if } t \leq \frac{1}{\bar{\tau}}, \\ 1 & \text{if } t \geq \frac{2}{\bar{\tau}}. \end{cases}$$

For $\nu = \sum_{i=1}^k s_i \delta_{y_i} \in \mathcal{B}$ with $\|(1 - \chi_{\delta_2})\nu\| > 0$ we consider $(1 - \chi_{\delta_2})\nu = \sum_{i=1}^k t_i \delta_{x_i}$ and then define

$$(73) \quad \tilde{\nu} = \frac{\sum_{i=1}^k t_i g(|x_i|) \delta_{x_i f(\nu, x_i)}}{\sum_{i=1}^k t_i g(|x_i|)}.$$

Observe that for $d(x_i, p) \leq \frac{1}{\bar{\tau}} \forall i$, (73) reads as

$$\tilde{\nu} = \frac{\sum_{i=1}^k t_i |x_i| \delta_{\frac{x_i}{|x_i|} \frac{1}{\tau}}}{\sum_{i=1}^k t_i |x_i|},$$

while for $d(x_i, p) \geq \frac{2}{\bar{\tau}} \forall i$, we obtain $\tilde{\nu} = \sum_{i=1}^k t_i \delta_{x_i}$.

For a general $\nu \in \mathcal{B}$ the retraction is given by

$$(74) \quad \mathcal{R}_p(\nu) = (1 - m_2)\tilde{\nu} + \chi_{\delta_2}\nu.$$

Observe that when $\|(1 - \chi_{\delta_2})\nu\| = 0$, τ is not defined. However, the map $\mathcal{R}_p(\nu)$ is well-defined since in this case we have $m_2 = 1$. Notice furthermore that $\mathcal{R}_p(\nu) \in \Sigma_k$ since $\|\mathcal{R}_p(\nu)\| = 1$ and since we do not increase the number of points in the support of ν , due to the fact that the map $\nu \mapsto \tilde{\nu}$ does not affect the points x_i with $d(x_i, p) \geq \frac{2}{\bar{\tau}}$, which was chosen such that $\frac{2}{\bar{\tau}} \ll \delta_2$. ■

Remark 4.5. (i) *With the above definitions, letting δ_2 tend to zero, one shows that the map \mathcal{R}_p is homotopic to the identity on its domain.*

(ii) *The parameter δ_2 is chosen so that $\delta_2 \ll \delta$.*

Combining Lemma 4.1 and Proposition 4.4 (applying its proof uniformly in $p \in \Sigma$) we obtain the following result; notice that by construction, the retraction \mathcal{R}_p from Proposition 4.4 depends continuously on p .

Corollary 4.6. *There exist $\bar{\tau} \gg 1$ and a continuous deformation \mathcal{R} of $Y \cap \{s = \frac{1}{2}\}$ onto the set*

$$\bigcup_{p \in \Sigma} \left\{ \left(\nu, \delta_p, \frac{1}{2} \right) : \nu \in \Sigma_{k,p,\bar{\tau}} \right\},$$

where $\Sigma_{k,p,\bar{\tau}}$ is as in (70).

In the next two subsections we perform the construction of test functions using the above deformations.

4.2. Test functions modelled on $\tilde{Y}_{(\frac{1}{2},p)} * \delta_p$. In this subsection we introduce a class of test functions parametrized on $\tilde{Y}_{(\frac{1}{2},p)} * \delta_p \subseteq Y$, see (67) and (51). The latter subset of Y is where the interaction between the two components of (1) is stronger, and hence where more refined energy estimates will be needed. The remainder of Y will be taken care of in the next subsection.

The retraction \mathcal{R}_p defined in Proposition 4.4 will play a crucial role in the construction of the test functions. Indeed, starting from a measure in $\tilde{Y}_{(\frac{1}{2},p)}$ we will consider, through the map \mathcal{R}_p , a configuration belonging to $\Sigma_{k,p,\bar{\tau}}$, see (70). When considering $\tilde{Y}_{(\frac{1}{2},p)} * \delta_p$ and the corresponding join parameter s , our goal is to pass continuously from vector-valued functions (φ_1, φ_2) with $e^{\varphi_1} \simeq \hat{\nu} \in \Sigma_{k,p,\bar{\tau}}$ (in the distributional sense) to functions (φ_1, φ_2) with $e^{\varphi_2} \simeq \delta_p$. This needs to be done so that the energy $J_p(\varphi_1, \varphi_2)$ stays arbitrarily low.

As the formulas are rather involved, we first discuss the general ideas beyond them. Our construction relies on superpositions of *regular bubbles* and *singular bubbles*. Regular bubbles are functions as in (61) which (roughly) optimize inequality (7) in the scalar case. Singular bubbles instead are profiles of solutions to (5) when a Dirac mass is present in the right-hand side: this singular version of (5) *shadows* system (1) when one component has a higher concentration than the other.

From the computational point of view, regular (respectively singular) bubbles behave like logarithmic functions of the distance from a point truncated at a proper scale, with coefficient -4 (respectively -6). By this reason we sometimes substitute an expression as in (61) (or in the subsequent formula) with truncated logarithms.

Another aspect of the construction is the following: at a scale where the function φ_i dominates, the gradient of the other component φ_j of (1) will behave like $-\frac{1}{2}\nabla\varphi_i$: the reason of this relies in the fact that this choice minimizes $Q(\varphi_1, \varphi_2)$, see (3), for φ_i fixed.

We introduce now the test functions (φ_1, φ_2) as in Figure 2, starting by motivating the definitions of the parameters involved. Consider $p \in \Sigma$ and $\nu \in \tilde{Y}_{(\frac{1}{2},p)}$: recalling Proposition 4.4 and defining

$$(75) \quad \hat{\nu} := \mathcal{R}_p(\nu) = \sum_{i=1}^k t_i \delta_{x_i} \in \Sigma_{k,p,\bar{\tau}},$$

let τ be as given in (72). Consider parameters $\tilde{\tau} \gg \mu \gg \lambda \gg 1$ and let $\mathfrak{s} \geq 1$ be a scaling parameter which will be used to deform one component into the other one: this will be chosen to depend on the

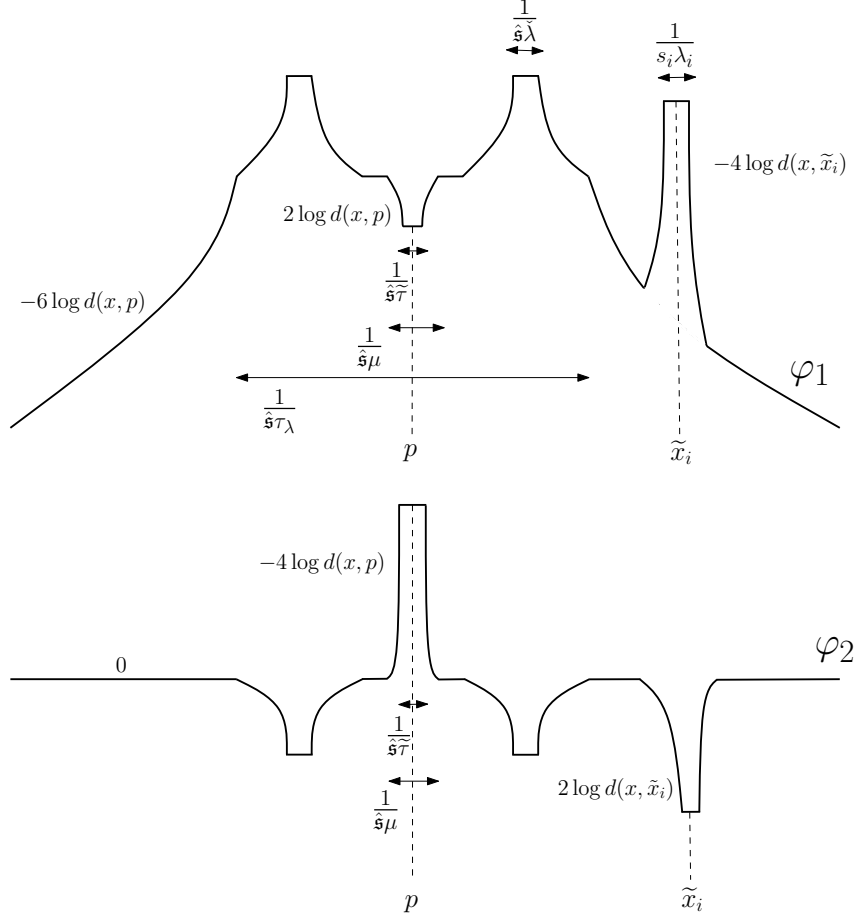

FIGURE 2

join parameter s . Roughly speaking, φ_1 is made by a singular bubble at scale $\frac{1}{\hat{s}\tau_\lambda}$, where \hat{s} is given by (78) (but one can think $\hat{s} = \mathfrak{s}$ for the moment) and

$$(76) \quad \tau_\lambda := \min\{\tau, \lambda\},$$

on top of which we add regular bubbles at scales $\frac{1}{s_i\lambda_i}$ centred at points \tilde{x}_i with $d(\tilde{x}_i, p) \geq \frac{1}{\hat{s}\tau}$ for all i . The parameters s_i, λ_i are defined by (81) and (80) in order to get comparable integrals of e^{φ_1} near all points \tilde{x}_i ; we will discuss later why we take sometimes $\hat{s} \neq \mathfrak{s}$. The centres \tilde{x}_i of the regular bubbles are defined as follows: letting $\bar{\delta}$ small but fixed, we set in normal coordinates at p :

$$(77) \quad \tilde{x}_i = \frac{1}{\hat{s}_i} x_i, \quad \hat{s}_i = \begin{cases} \hat{s} & \text{if } d(x_i, p) \leq \bar{\delta}, \\ 1 & \text{if } d(x_i, p) \geq 2\bar{\delta}. \end{cases}$$

We point out that for $d(x_i, p) \leq \bar{\delta}$ we get $\tilde{x}_i = \frac{1}{\hat{s}} x_i$, which gives continuity when x_i approaches the plateau $\{d(\cdot, p) \leq \frac{1}{\tau_\lambda}\}$. For $d(x_i, p) \geq \bar{\delta}$ instead the position of the points does not depend on \hat{s} .

The effect of the increasing parameter \mathfrak{s} depends on the starting configuration $\nu \in \tilde{Y}_{(\frac{1}{2}, p)}$: in case we have points x_i on the plateau of the singular bubble, i.e. $d(x_i, p) \leq \frac{1}{\tau_\lambda}$ for some i , the support of the singular and regular bubbles of φ_1 shrinks; moreover, the points \tilde{x}_i approach p . On the other hand, φ_2 is (qualitatively) dilated by a factor $\frac{1}{\hat{s}}$ so that e^{φ_2} loses concentration at the expense of e^{φ_1} .

In case we do not have points on the plateau, namely when $d(\tilde{x}_i, p) \geq \frac{1}{\tau_\lambda}$ for all i , it is not convenient anymore to develop a singular bubble with center p as \mathfrak{s} increases. To prevent this situation we give an upper bound on \hat{s} depending on τ . For $\tau_1 \geq 1$ large but fixed we let $\hat{P} : (0, +\infty) \rightarrow (0, +\infty)$ be a

non-decreasing continuous function defined by

$$\begin{cases} \hat{P}(t) = 1 & \text{for } t \leq \tau_1, \\ \hat{P}(t) \rightarrow +\infty & \text{for } t \rightarrow 2\tau_1. \end{cases}$$

If τ is as in (72), we then define $\hat{\mathfrak{s}} = \hat{\mathfrak{s}}(\mathfrak{s}, \tau)$ as

$$(78) \quad \hat{\mathfrak{s}} = \begin{cases} \min\{\mathfrak{s}, \hat{P}(\tau)\} & \text{if } \tau < 2\tau_1, \\ \mathfrak{s} & \text{if } \tau \geq 2\tau_1. \end{cases}$$

Notice that by construction of the retraction \mathcal{R}_p , see Proposition 4.4, when there are no points on the plateau $\{d(\cdot, p) \leq \frac{1}{\tau_\lambda}\}$ it follows that $\tau \leq C$ and therefore, taking $2\tau_1 > C$, we get $\hat{\mathfrak{s}} \leq \hat{P}(C) < +\infty$.

In this situation, namely for $\hat{\mathfrak{s}}$ bounded from above, the second component φ_2 remains fixed when we start to concentrate the first component φ_1 . To do this we develop more and more concentrated bubbles around the points \tilde{x}_i ; we introduce a parameter $\check{\lambda} = \check{\lambda}(\tau)$ so that $\check{\lambda} \rightarrow +\infty$ even for $\tau \leq 2\tau_1$ when \mathfrak{s} increases. Let $\check{P} : (0, +\infty) \rightarrow (0, +\infty)$ be a non-increasing continuous functions such that

$$\begin{cases} \check{P}(t) \rightarrow +\infty & \text{for } t \rightarrow 2\tau_1, \\ \check{P}(t) = 1 & \text{for } t \geq 4\tau_1. \end{cases}$$

We then let

$$(79) \quad \check{\lambda} = \check{\mathfrak{s}}\lambda, \quad \check{\mathfrak{s}} = \begin{cases} \mathfrak{s} & \text{if } \tau \leq 2\tau_1, \\ \min\{\mathfrak{s}, \check{P}(\tau)\} & \text{if } \tau > 2\tau_1. \end{cases}$$

To have comparable integral of e^{φ_1} at each peak around \tilde{x}_i for $i = 1, \dots, k$, we impose the conditions

$$(80) \quad \begin{cases} \log \lambda_i - \log d(x_i, p) = \log \tau_\lambda + \log \check{\lambda} & \text{if } d(x_i, p) > \frac{1}{\tau_\lambda}, \\ \lambda_i = \check{\lambda} & \text{if } d(x_i, p) \leq \frac{1}{\tau_\lambda} \end{cases}$$

and

$$(81) \quad \log s_i + \log \tilde{s}_i = 2 \log \hat{\mathfrak{s}},$$

which determine λ_i and s_i .

Recall the definitions of $\hat{\nu}$ in (75): motivated by the above discussion, we define the functions (φ_1, φ_2) as follows (see Figure 2). The positive peaks of φ_1 are given by

$$v_1(x) = v_{1,1}(x) + v_{1,2}(x) = \log \sum_{i=1}^k t_i \frac{\max \left\{ 1, \min \left\{ \left(\frac{4}{d(\tilde{x}_i, p)} d(x, \tilde{x}_i) \right)^{-4}, \left(\frac{4}{d(\tilde{x}_i, p)} \frac{1}{s_i \lambda_i} \right)^{-4} \right\} \right\}}{((\hat{\mathfrak{s}}\tau_\lambda)^{-2} + d(x, p)^2)^3},$$

where

$$v_{1,1}(x) = \log \sum_{i=1}^k t_i \max \left\{ 1, \min \left\{ \left(\frac{4}{d(\tilde{x}_i, p)} d(x, \tilde{x}_i) \right)^{-4}, \left(\frac{4}{d(\tilde{x}_i, p)} \frac{1}{s_i \lambda_i} \right)^{-4} \right\} \right\},$$

$$v_{1,2}(x) = \log \frac{1}{((\hat{\mathfrak{s}}\tau_\lambda)^{-2} + d(x, p)^2)^3}.$$

The positive peak of φ_2 is instead defined by

$$v_2(x) = \log \left(\max \left\{ 1, \min \left\{ (\hat{\mathfrak{s}}\mu d(x, p))^{-4}, \left(\frac{\mu}{\tilde{\tau}} \right)^{-4} \right\} \right\} \right).$$

We finally set

$$(82) \quad \varphi_{\lambda, \tilde{\tau}, \mathfrak{s}}(x) = \begin{pmatrix} \varphi_1(x) \\ \varphi_2(x) \end{pmatrix} := \begin{pmatrix} v_1(x) - \frac{1}{2}v_2(x) \\ -\frac{1}{2}v_{1,1}(x) + v_2(x) \end{pmatrix}.$$

The main result of this subsection is the following proposition.

Proposition 4.7. *Suppose that $\rho_1 \in (4k\pi, 4(k+1)\pi)$, $\rho_2 \in (4\pi, 8\pi)$, let $\tilde{\Psi}$ be defined in (29), and let $\varphi_{\lambda, \tilde{\tau}, \mathfrak{s}}$ be defined in (82), with $p \in \Sigma$ and $\nu \in \tilde{Y}_{(\frac{1}{2}, p)}$. Then, for suitable values of $\tilde{\tau} \gg \mu \gg \lambda \gg 1$ and for $\mathfrak{s} = 1$, $\tilde{\Psi}(\varphi_{\lambda, \tilde{\tau}, 1})$ is valued into the second component of the join $\Sigma_k * \Sigma_1$. Moreover there is a value $\mathfrak{s}_{p, \nu} > 1$ of \mathfrak{s} , which depends continuously on p, ν such that $\tilde{\Psi}(\varphi_{\lambda, \tilde{\tau}, \mathfrak{s}_{p, \nu}})$ is valued into the first component of the join, and such that*

$$J_\rho(\varphi_{\lambda, \tilde{\tau}, \mathfrak{s}}) \rightarrow -\infty \quad \text{as } \lambda \rightarrow +\infty \quad \text{uniformly in } \mathfrak{s} \in [1, \mathfrak{s}_{p, \nu}] \text{ and in } p, \nu.$$

PROOF. As some of the estimates are rather technical, most of the proof is postponed to the Appendix.

Concerning the first statement, when $\mathfrak{s} = 1$, by construction (see in particular Lemma 6.2) one can see that most of the integral of e^{φ_2} is concentrated in a ball centred at p with radius of order $\frac{1}{\tilde{\tau}}$, while that of e^{φ_1} near at most k balls of larger scale. From the definitions of scales $\sigma_1(u_1), \sigma_2(u_2)$ in Subsection 3.1 it follows that for $\mathfrak{s} = 1$ the quantity $s(\varphi_1, \varphi_2)$ defined in (26) is equal to 1, provided we choose the parameters $\tilde{\tau} \gg \mu \gg \lambda \gg 1$ properly. By the way $\tilde{\Psi}$ is defined, this implies our first statement.

As \mathfrak{s} increases, see again Lemma 6.2, the scale $\sigma_1(\varphi_1)$ (as defined in Subsection 3.1) decreases while, depending on τ , the scale of $\sigma_2(\varphi_2)$ reaches some positive value bounded away from zero. In particular for $\tau \geq 2\tau_1$ (recall (78)), by the estimates in Lemma 6.2, for $\mathfrak{s} \simeq \log \tilde{\tau} - 2 \log \mu$ the scale $\sigma_2(\varphi_2)$ becomes of order 1. In any case, for \mathfrak{s} sufficiently large $s(\varphi_1, \varphi_2) = 0$, so $\tilde{\Psi}$ maps the test function into the first component of the joint. As the scales $\sigma_1(\varphi_1), \sigma_2(\varphi_2)$ vary continuously in φ_1 and φ_2 , $\mathfrak{s}_{p, \nu}$ can be chosen to depend continuously in p and ν .

Regarding the energy estimates, the most delicate situation is when τ is large, i.e. when $\hat{\mathfrak{s}} = \mathfrak{s}$, see (78). In this case $\mathfrak{s}_{p, \nu} \simeq \log \tilde{\tau} - 2 \log \mu$ and the computations are worked-out in the Appendix. When τ instead is smaller than the fixed number $2\tau_1$ (see again (78)) the *singular* part of the first component of the test function (with slope $-6 \log d(\cdot, p)$) has negligible contribution and the support of the measure $\hat{\nu}$ in (75) is bounded away from p by a fixed positive amount. In this case the interaction between the two components is negligible, and similar estimates as those in Proposition 3.3 of [3] can be applied. ■

We proceed now with parameterizing the above functions via the number s in the topological join. Ideally, one would like to have \mathfrak{s} varying from 1 to $\mathfrak{s}_{p, \nu}$ as s decreases from 1 to 0. However, for this map to be well defined on the topological join, we will need to eliminate the dependence of the test function on the first (resp. second) component of the join when $s = 1$ (resp. $s = 0$). For this reason, we will need some extra deformations depending on s . The construction goes as follows, depending on three ranges of the join parameter s .

4.2.1. *The case $s \in [\frac{1}{4}, \frac{3}{4}]$.* Let $\varphi_{\lambda, \tilde{\tau}, \mathfrak{s}}$ be defined in (82), with $p \in \Sigma$ and $\nu \in \tilde{Y}_{(\frac{1}{2}, p)}$. We set

$$(83) \quad \Phi_\lambda(\nu, p, s) = \varphi_{\lambda, \tilde{\tau}, 2(1-\mathfrak{s}_{p, \nu})s + \frac{3}{2}\mathfrak{s}_{p, \nu} - \frac{1}{2}},$$

so that $\Phi_\lambda(\nu, p, \frac{1}{4}) = \varphi_{\lambda, \tilde{\tau}, \mathfrak{s}_{p, \nu}}$ and $\Phi_\lambda(\nu, p, \frac{3}{4}) = \varphi_{\lambda, \tilde{\tau}, 1}$.

4.2.2. *The case $s \in [0, \frac{1}{4}]$.* Starting from test functions of the form $\varphi_{\lambda, \tilde{\tau}, \mathfrak{s}_{p, \nu}}$, the goal will be to eliminate the dependence on the second component of the join, namely on the measure δ_p . To this end, we divide the interval $[0, \frac{1}{4}]$ in several subintervals in which we perform different operations on the test functions. Moreover, we want J_ρ to attend arbitrarily low values while doing these procedures. Notice that in what follows, this range of the join parameter s will correspond to $\mathfrak{s} = \mathfrak{s}_{p, \nu}$ which is given in Proposition 4.7.

Step 1. Let $s \in [\frac{3}{16}, \frac{1}{4}]$. We flatten here the function v_2 in the second component of (82) by considering the following deformation:

$$\check{\varphi}_{\lambda, \tilde{\tau}}^t(x) = \begin{pmatrix} \check{\varphi}_1^t(x) \\ \check{\varphi}_2^t(x) \end{pmatrix} := \begin{pmatrix} v_1(x) - \frac{1}{2} t v_2(x) \\ -\frac{1}{2} v_{1,1}(x) + t v_2(x) \end{pmatrix}, \quad t \in [0, 1].$$

We will then take

$$(84) \quad \Phi_\lambda(\nu, p, s) = \check{\varphi}_{\lambda, \tilde{\tau}}^t(x), \quad t = 16 \left(s - \frac{3}{16} \right).$$

It is easy to see that J_ρ attains arbitrarily low values on this deformation by minor modifications in the proof of Proposition 4.7.

Step 2. Let $s \in [\frac{1}{8}, \frac{3}{16}]$. Starting from $s = \frac{3}{16}$ we deform the test functions introduced in (82) to the standard test functions of the form given as in (63). Roughly speaking, the idea is to modify the profile of the first component φ_1 (see Figure 2) by performing the following two continuous deformations: we first flatten the singular bubble $v_{1,2}$, see above (82). On the other hand we eliminate the dependence of the point p in the regular bubbles $v_{1,1}$. Therefore, we set

$$v_1^t(x) = v_{1,1}^t(x) + v_{1,2}^t(x),$$

where

$$v_{1,1}^t(x) = \log \sum_{i=1}^k t_i \max \left\{ 1, \min \left\{ \left(\left(\frac{4}{d(\tilde{x}_i, p)} \right)^t d(x, \tilde{x}_i) \right)^{-4}, \left(\left(\frac{4}{d(\tilde{x}_i, p)} \right)^t \frac{1}{s_i \lambda_i} \right)^{-4} \right\} \right\},$$

and $v_{1,2}^t(x) = t v_{1,2}(x)$. Finally, recalling that we have flattened v_2 in Step 1, we consider

$$(85) \quad \tilde{\varphi}_{\lambda, \tilde{\tau}}^t(x) = \begin{pmatrix} \tilde{\varphi}_1^t(x) \\ \tilde{\varphi}_2^t(x) \end{pmatrix} := \begin{pmatrix} v_1^t(x) \\ -\frac{1}{2} v_{1,1}^t(x) \end{pmatrix}, \quad t \in [0, 1].$$

We will then take

$$(86) \quad \Phi_\lambda(\nu, p, s) = \tilde{\varphi}_{\lambda, \tilde{\tau}}^t(x), \quad t = 16 \left(s - \frac{1}{8} \right).$$

Concerning $\tilde{\varphi}_1^t$, its peaks around \tilde{x}_i for $i = 1, \dots, k$, are truncated at scale $\frac{1}{s_i \lambda_i}$, with s_i given by (81) and λ_i to be chosen in the following way in order to have comparable volume at any \tilde{x}_i :

$$(87) \quad \begin{cases} \log \lambda_i + \log s_i - t \log d(\tilde{x}_i, p) = (t+1) \log \hat{s} + \log \check{\lambda} + t \log \tau_\lambda & \text{if } d(x_i, p) > \frac{1}{\tau_\lambda}, \\ \lambda_i = \check{\lambda} & \text{if } d(x_i, p) \leq \frac{1}{\tau_\lambda}. \end{cases}$$

Observe that for $t = 0$ we get again (80). The following result holds true.

Proposition 4.8. *Suppose that $\rho_1 \in (4k\pi, 4(k+1)\pi)$, $\rho_2 \in (4\pi, 8\pi)$. Let $\tilde{\varphi}_{\lambda, \tilde{\tau}}^t$ be defined as in (85), with $p \in \Sigma$ and $\nu \in \tilde{Y}_{(\frac{1}{2}, p)}$. Then, one has*

$$J_\rho(\tilde{\varphi}_{\lambda, \tilde{\tau}}^t) \rightarrow -\infty \quad \text{as } \lambda \rightarrow +\infty \quad \text{uniformly in } t \in [0, 1] \text{ and in } p, \nu.$$

The most delicate case is when the set of the points on the plateau is not empty, i.e. for $I_1 \neq \emptyset$, see (120). We give the proof of the latter result just in this situation, skipping the case $I_1 = \emptyset$ where the singular bubble of the first component of the test function (with slope $-6 \log d(\cdot, p)$) has negligible contribution and the estimates are rather easy. As observed in Case 1 of the proof of Proposition 4.7, see below (133), for $I_1 \neq \emptyset$ we deduce $\hat{s} = \mathfrak{s}$ and $\check{\lambda} \leq C\lambda$. Moreover, for this range of the join parameter s , we have $\mathfrak{s} = \mathfrak{s}_{p, \nu} \gg 1$. The proof will follow from the estimates below, which are obtained exactly as Lemmas 6.1, 6.2, 6.3 by using (81) and (87).

Lemma 4.9. *For $t \in [0, 1]$ we have that*

$$\int_{\Sigma} \tilde{\varphi}_1^t dV_g = O(1), \quad \int_{\Sigma} \tilde{\varphi}_2^t dV_g = O(1).$$

Lemma 4.10. *Recalling the notation in (113), for $t \in [0, 1]$ it holds that*

$$\int_{\Sigma} e^{\tilde{\varphi}_1^t} dV_g \simeq_C \hat{\mathfrak{s}}^{2+2t} \tau_\lambda^{2t} \check{\lambda}^2, \quad \int_{\Sigma} e^{\tilde{\varphi}_2^t} dV_g \simeq_C 1.$$

Lemma 4.11. *Let $I_1, I_2 \subseteq I$ be as in (120). Then, for $t \in [0, 1]$ we have*

$$\begin{aligned} \int_{\Sigma} Q(\tilde{\varphi}_1^t, \tilde{\varphi}_2^t) dV_g &\leq 8|I_1| \pi (\log \check{\lambda} - t \log \tau_\lambda + (1-t) \log \hat{\mathfrak{s}}) + \sum_{i \in I_2} 8\pi (\log s_i + \log \lambda_i - t \log d(\tilde{x}_i, p)) + \\ &+ 16t\pi \sum_{i \in I_2} \log d(\tilde{x}_i, p) + 24t^2 \pi (\log \tau_\lambda + \log \hat{\mathfrak{s}}) + C, \end{aligned}$$

for some $C = C(\Sigma)$.

PROOF OF PROPOSITION 4.8. Using Lemmas 4.9, 4.10 and 4.11, the energy estimate we obtain is

$$\begin{aligned} J_\rho(\tilde{\varphi}_1^t, \tilde{\varphi}_2^t) &\leq 8|I_1|\pi(\log \check{\lambda} - t \log \tau_\lambda + (1-t) \log \hat{s}) + \sum_{i \in I_2} 8\pi(\log s_i + \log \lambda_i - t \log d(\tilde{x}_i, p)) + \\ &\quad + 16t\pi \sum_{i \in I_2} \log d(\tilde{x}_i, p) + 24t^2\pi(\log \tau_\lambda + \log \hat{s}) - \rho_1((2+2t) \log \hat{s} + 2t \log \tau_\lambda + 2 \log \check{\lambda}) + C, \end{aligned}$$

for some constant $C > 0$. Inserting the condition (87) we obtain

$$\begin{aligned} J_\rho(\tilde{\varphi}_1^t, \tilde{\varphi}_2^t) &\leq 8|I_1|\pi(\log \check{\lambda} - t \log \tau_\lambda + (1-t) \log \hat{s}) + \sum_{i \in I_2} 8\pi((t+1) \log \hat{s} + \log \check{\lambda} + t \log \tau_\lambda) + \\ &\quad + 16t\pi \sum_{i \in I_2} \log d(\tilde{x}_i, p) + 24t^2\pi(\log \tau_\lambda + \log \hat{s}) - \rho_1((2+2t) \log \hat{s} + 2t \log \tau_\lambda + 2 \log \check{\lambda}) + C. \end{aligned}$$

Notice that for $t = 1$ we get exactly the estimate in (133) (recall that we have flattened v_2). The latter estimate can be rewritten as

$$\begin{aligned} J_\rho(\tilde{\varphi}_1^t, \tilde{\varphi}_2^t) &\leq \log \hat{s} \left(8(1-t)|I_1|\pi + 8(t+1)|I_2|\pi + 24t^2\pi - (2+2t)\rho_1 \right) + \log \check{\lambda} (8(|I_1| + |I_2|)\pi - 2\rho_1) + \\ &\quad + \log \tau_\lambda (8t|I_2|\pi - 8t|I_1|\pi + 24t^2\pi - 2t\rho_1) + 16t\pi \sum_{i \in I_2} \log d(\tilde{x}_i, p) + C. \end{aligned}$$

As observed in Case 1 of the proof of Proposition 4.7, by construction of $\Sigma_{k,p,\bar{\tau}}$, see (70), it holds $|I_2| \leq k-2$ whenever $|I_1| \neq \emptyset$. Therefore, we conclude that the latter estimate is uniformly large negative in $t \in [0, 1]$ since $\rho_1 > 4k\pi$ and by the fact that $\hat{s} = \hat{s}_{\rho,\nu} \gg \check{\lambda} \geq \tau_\lambda$. Observe that for $t = 0$ we get

$$J_\rho(\tilde{\varphi}_1^t, \tilde{\varphi}_2^t) \leq \log \hat{s} (8(|I_1| + |I_2|)\pi - 2\rho_1) + \log \check{\lambda} (8(|I_1| + |I_2|)\pi - 2\rho_1) + C,$$

which is the estimate one expects by considering standard bubbles as in (63), see for example part (i) of Proposition 4.2 in [35]. ■

Recall now the definition of $\hat{\nu}$ given in (75): $\hat{\nu} = \mathcal{R}_p(\nu) = \sum_{i=1}^k t_i \delta_{x_i} \in \Sigma_{k,p,\bar{\tau}}$. Notice that in the construction of the test functions (82), the points x_i are dilated according to (77), so deformed to the points \tilde{x}_i . Observe that for $t = 0$ we obtain in (85) standard test functions as in (63). Roughly speaking, the first component resembles the form of $\varphi_{\lambda,\hat{\nu}}$, see (63), where $\hat{\nu} = \sum_{i=1}^k t_i \delta_{\tilde{x}_i}$.

In what follows we will skip the energy estimates since they are quite standard for test functions as in (63), see for example part (i) of Proposition 4.2 in [35].

Step 3. Consider $s \in [\frac{1}{16}, \frac{1}{8}]$. We will deform here the points \tilde{x}_i to the original points x_i . Observe that by construction, see (77), we have $d(x_i, \tilde{x}_i) \leq 2\bar{\delta}$ for all i . Hence there exists a geodesic $\tilde{\gamma}_i$ joining \tilde{x}_i and x_i in unit time and we set $x_i^t = \tilde{\gamma}_i(t)$ with $t \in [0, 1]$. Denoting by $\hat{\varphi}_{\lambda,\bar{\tau}}^t = (\hat{\varphi}_1^t, \hat{\varphi}_2^t)$ the corresponding test functions, we will then take

$$(88) \quad \Phi_\lambda(\nu, p, s) = \hat{\varphi}_{\lambda,\bar{\tau}}^t(x), \quad t = 16 \left(\frac{1}{8} - s \right).$$

Once we have deformed the points \tilde{x}_i to the original one x_i , i.e. for $t = 1$, we get test functions for which the first component has the form of $\varphi_{\lambda,\mathcal{R}_p(\nu)}$.

Step 4. Consider $s \in [0, \frac{1}{16}]$. In this step we eliminate the dependence on the map \mathcal{R}_p . Observe that \mathcal{R}_p is homotopic to the identity map, see Remark 4.5, and let $\mathcal{H}_{\mathcal{R}_p} : \tilde{Y}_{(\frac{1}{2},p)} \times [0, 1] \rightarrow \tilde{Y}_{(\frac{1}{2},p)}$ be a continuous map such that $\mathcal{H}_{\mathcal{R}_p}(\cdot, 0) = \mathcal{R}_p$ and $\mathcal{H}_{\mathcal{R}_p}(\cdot, 1) = \text{Id}_{\tilde{Y}_{(\frac{1}{2},p)}}$. We consider then the deformation $\nu_t = \mathcal{H}_{\mathcal{R}_p}(\nu, t)$ and letting $\bar{\varphi}_{\lambda,\bar{\tau}}^t = (\bar{\varphi}_1^t, \bar{\varphi}_2^t)$ be the corresponding test functions, we set

$$(89) \quad \Phi_\lambda(\nu, p, s) = \bar{\varphi}_{\lambda,\bar{\tau}}^t(x), \quad t = 16 \left(\frac{1}{16} - s \right).$$

Such a deformation will bring us to test functions which resemble the form of $\varphi_{\lambda,\nu}$.

4.2.3. *The case $s \in [\frac{3}{4}, 1]$.* The goal here will be to continuously deform the initial test functions in (82), with $\mathfrak{s} = \mathbf{1}$, to a configuration which does not depend on the measure ν , see (75). Furthermore, we want in this procedure J_ρ to attend arbitrarily low values. For this purpose we flatten v_1 , see (82), by using the following deformation:

$$(90) \quad \varphi_{\lambda, \tilde{\tau}}^t(x) = \begin{pmatrix} \varphi_1^t(x) \\ \varphi_2^t(x) \end{pmatrix} := \begin{pmatrix} t v_1(x) - \frac{1}{2} v_2(x) \\ -\frac{1}{2} t v_{1,1}(x) + v_2(x) \end{pmatrix}, \quad t \in [0, 1].$$

We will then take

$$(91) \quad \Phi_\lambda(\nu, p, s) = \varphi_{\lambda, \tilde{\tau}}^t(x), \quad t = 4(1 - s).$$

The next result holds true.

Proposition 4.12. *Suppose that $\rho_1 \in (4k\pi, 4(k+1)\pi)$, $\rho_2 \in (4\pi, 8\pi)$ and let $\varphi_{\lambda, \tilde{\tau}}^t$ be defined as in (90), with $p \in \Sigma$ and $\nu \in \tilde{Y}_{(\frac{1}{2}, p)}$. Then, one has*

$$J_\rho(\varphi_{\lambda, \tilde{\tau}}^t) \rightarrow -\infty \quad \text{as } \lambda \rightarrow +\infty \quad \text{uniformly in } t \in [0, 1] \text{ and in } p, \nu.$$

The latter result follows from the next estimates which are obtained similarly as in Lemmas 6.1, 6.2, 6.3, using the fact that $\mathfrak{s} = \mathbf{1}$.

Lemma 4.13. *For $t \in [0, 1]$ we have that*

$$\int_{\Sigma} \varphi_1^t dV_g = O(1), \quad \int_{\Sigma} \varphi_2^t dV_g = O(1).$$

Lemma 4.14. *Recalling the notation in (113), there exists a constant $C_1(\tau_\lambda, \lambda)$ such that for $t \in [0, 1]$*

$$\int_{\Sigma} e^{\varphi_1^t} dV_g \simeq_C \int_{\Sigma} e^{t v_1} dV_g = C_1(\tau_\lambda, \lambda), \quad \int_{\Sigma} e^{\varphi_2^t} dV_g \simeq_C \int_{\Sigma} e^{v_2} dV_g \simeq_C \frac{\tilde{\tau}^2}{\mu^4}.$$

Lemma 4.15. *For $t \in [0, 1]$ we have that*

$$\int_{\Sigma} Q(\varphi_1^t, \varphi_2^t) dV_g \leq 8\pi(\log \tilde{\tau} - \log \mu) + C_2(\tau_\lambda, \lambda),$$

for some constant $C_2(\tau_\lambda, \lambda)$.

PROOF OF PROPOSITION 4.12. Exploiting Lemmas 4.13, 4.14 and 4.15 we deduce

$$\begin{aligned} J_\rho(\varphi_1^t, \varphi_2^t) &\leq 8\pi(\log \tilde{\tau} - \log \mu) - \rho_2(2 \log \tilde{\tau} - 4 \log \mu) + \tilde{C}_1(\tau_\lambda, \lambda) + C_2(\tau_\lambda, \lambda) \\ &\leq \log \tilde{\tau}(8\pi - 2\rho_2) + \log \mu(4\rho_2 - 8\pi) + \tilde{C}_1(\tau_\lambda, \lambda) + C_2(\tau_\lambda, \lambda), \end{aligned}$$

for some constant $\tilde{C}_1(\tau_\lambda, \lambda)$. The latter upper bound is large negative since $\rho_2 > 4\pi$ and by the choice of the parameters $\tilde{\tau} \gg \mu \gg \lambda \geq \tau_\lambda$. ■

4.3. The global construction. In this subsection we will perform a global construction of a family of test functions modelled on Y , relying on the estimates of the previous subsection. More precisely, as Y is not compact, we will consider a compact retraction of it.

Letting $(\mathfrak{D}, \frac{1}{2}) \subseteq (\Sigma_k \times \Sigma_1, \frac{1}{2})$ be the domain of the map \mathcal{R} in Corollary 4.6, we extend it to $\{(\mathfrak{D}, s) : s \in (0, 1)\}$ fixing the second component and considering the same action of \mathcal{R} on the first one.

Secondly, we retract the set Y to a subset where the (extended) map \mathcal{R} is well-defined or where $s \in \{0, 1\}$. In order to do this, for $\nu = \sum_{i=1}^k t_i \delta_{x_i} \in \Sigma_k$ we let

$$\mathcal{D}(\nu) = \min_{i=1, \dots, k, i \neq j} \{d(x_i, x_j), t_i, 1 - t_i\}.$$

Moreover, recall the choices of δ, δ_2 given in (52) and (68) respectively. Observe that for $\mathcal{D}(\nu) \leq \delta$ we are in the domain of \mathcal{R} . Moreover, for $\mathcal{D}(\nu) > \delta$ and $d(p, \text{supp}(\nu)) \geq \delta_2$ the map \mathcal{R} is still well-defined. The idea is then to retract the set Y to a subset where one of the above alternatives holds true or where $s \in \{0, 1\}$. We define now the retraction of Y in three steps.

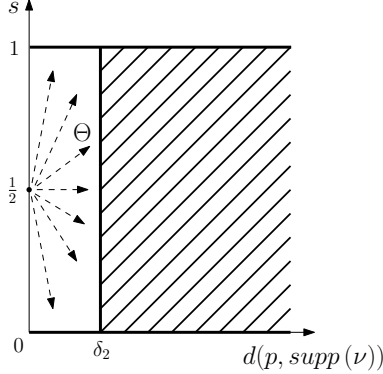

FIGURE 3

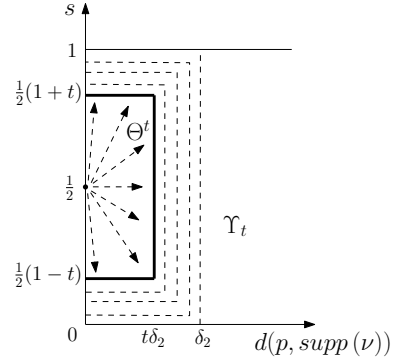

FIGURE 4

Step 1. Let $\mathcal{D}(\nu) \geq 2\delta$. In this situation we can deform a configuration (ν, δ_p, s) to a configuration $(\nu, \delta_{\tilde{p}}, \tilde{s}) \in Y$ (recall (51)) where either $d(\tilde{p}, \text{supp}(\nu)) \geq \delta_2$ or $\tilde{s} \in \{0, 1\}$. Let

$$\Theta = (\Theta_1, \Theta_2) : [0, +\infty) \times [0, 1] \setminus \left\{ \left(0, \frac{1}{2}\right) \right\} \rightarrow [0, +\infty) \times [0, 1] \setminus ((0, \delta_2) \times (0, 1))$$

be the radial projection as in Figure 3.

Observe now that by the fact that $\delta_2 \ll \delta$ (recall Remark 4.5), for $\mathcal{D}(\nu) \geq 2\delta$ we get the existence of a unique point $x_{j_p} \in \{x_1, \dots, x_k\}$ such that $d(p, x_{j_p}) \leq \delta_2$. To get then the above-described deformation we define, in normal coordinates around x_{j_p} , the following map:

$$(\nu, \delta_p, s) \mapsto \left(\nu, \delta_{\Theta_1(d(p, \text{supp}(\nu)), s)} \frac{p}{|p|}, \Theta_2(d(p, \text{supp}(\nu)), s) \right) \in \tilde{\Upsilon}_\Theta,$$

where

$$(92) \quad \begin{aligned} \tilde{\Upsilon}_\Theta &= \left\{ (\nu, \delta_p, s) : \mathcal{D}(\nu) \geq 2\delta, d(p, \text{supp}(\nu)) \geq \delta_2 \right\} \cup \\ &\cup \left\{ (\nu, \delta_p, s) : \mathcal{D}(\nu) \geq 2\delta, d(p, \text{supp}(\nu)) \leq \delta_2, s \in \{0, 1\} \right\}. \end{aligned}$$

Step 2. Let $\mathcal{D}(\nu) \in [\delta, 2\delta]$. In this range we interpolate between the deformation Θ and the identity map. Consider the radial projection $\Theta^t = (\Theta_1^t, \Theta_2^t)$ given as in Figure 4, with $t = \frac{\mathcal{D}(\nu) - \delta}{\delta}$:

$$\Theta^t = (\Theta_1^t, \Theta_2^t) : [0, +\infty) \times [0, 1] \setminus \left\{ \left(0, \frac{1}{2}\right) \right\} \rightarrow \Upsilon_t,$$

where

$$\Upsilon_t = [0, +\infty) \times [0, 1] \setminus \left((0, t\delta_2) \times \left(\frac{1}{2}(1-t), \frac{1}{2}(1+t) \right) \right).$$

Observe that for $\mathcal{D}(\nu) = 2\delta$ one gets $\Theta^t = \Theta^1 = \Theta$, while for $\mathcal{D}(\nu) = \delta$ one deduces $\Theta^t = \Theta^0 = \text{Id}$. We then set

$$(\nu, \delta_p, s) \mapsto \left(\nu, \delta_{\Theta_1^t(d(p, \text{supp}(\nu)), s)} \frac{p}{|p|}, \Theta_2^t(d(p, \text{supp}(\nu)), s) \right).$$

Step 3. Let us now introduce the set we obtain after the deformation performed in Step 2:

$$\tilde{\Upsilon}_\delta = \{ (\nu, \delta_p, s) : \mathcal{D}(\nu) = t \in [\delta, 2\delta], (p, s) \in \Upsilon_t \},$$

which we will deform using the radial projection $\tilde{\Theta}_\delta : \tilde{\Upsilon}_\delta \rightarrow \hat{\Upsilon}_\delta$ given as in Figure 5, where $\hat{\Upsilon}_\delta$ is defined by (see Figure 6, where $\partial\hat{\Upsilon}_\delta$ is represented):

$$(93) \quad \begin{aligned} \hat{\Upsilon}_\delta &= \left\{ (\nu, \delta_p, s) : \mathcal{D}(\nu) \in [\delta, 2\delta], d(p, \text{supp}(\nu)) \leq \delta_2, s \in \{0, 1\} \right\} \cup \left\{ (\nu, \delta_p, s) : \mathcal{D}(\nu) = \delta \right\} \cup \\ &\cup \left\{ (\nu, \delta_p, s) : \mathcal{D}(\nu) \in [\delta, 2\delta], d(p, \text{supp}(\nu)) \geq \delta_2 \right\}. \end{aligned}$$

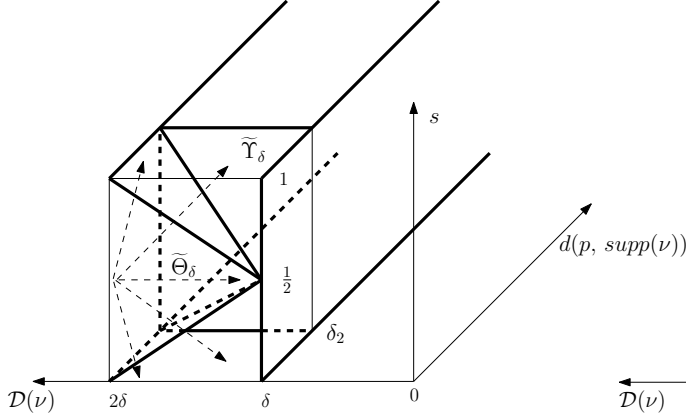

FIGURE 5

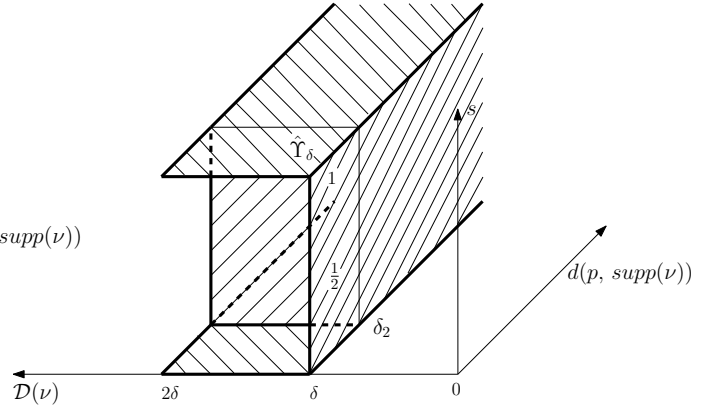

FIGURE 6

Construction of the test functions. Observing that for $\mathcal{D}(\nu) \leq \delta$ we are already in the domain of \mathcal{R} and recalling the sets (92), (93), we have found a retraction $\mathcal{F} : Y \rightarrow Y_{\mathcal{R}}$, where

$$(94) \quad \begin{aligned} Y_{\mathcal{R}} &= \left\{ (\nu, \delta_p, s) : \mathcal{D}(\nu) \leq \delta \right\} \cup \tilde{Y}_{\delta} \cup \tilde{Y}_{\Theta} \\ &= \left\{ (\nu, \delta_p, s) : \mathcal{D}(\nu) \leq \delta \right\} \cup \left\{ (\nu, \delta_p, s) : \mathcal{D}(\nu) \geq \delta, d(p, \text{supp}(\nu)) \geq \delta_2 \right\} \cup \\ &\quad \cup \left\{ (\nu, \delta_p, s) : \mathcal{D}(\nu) \geq \delta, d(p, \text{supp}(\nu)) \leq \delta_2, s \in \{0, 1\} \right\}, \end{aligned}$$

on which the map \mathcal{R} is well-defined or where $s \in \{0, 1\}$.

Remark 4.16. *By the way the retraction \mathcal{F} is constructed, it is clear that we have indeed a deformation retract of the set Y onto $Y_{\mathcal{R}}$, i.e. there exists a continuous map $\mathcal{F}_t : Y \times [0, 1] \rightarrow Y$ such that $\mathcal{F}_0 = \text{Id}_Y$, $\mathcal{F}_1 = \mathcal{F} : Y \rightarrow Y_{\mathcal{R}}$ and $\mathcal{F}_1(\xi) = \xi$ for all $\xi \in Y_{\mathcal{R}}$.*

We finally call $\Phi_{\lambda} = \Phi_{\lambda}(\nu, p, s)$ the test functions in the Subsections 4.2.1, 4.2.2 and 4.2.3 (see (83), (84), (86), (88), (89) and (91)) using as parameters $(\nu, p, s) \in Y_{\mathcal{R}}$ (where we use the identification $p \simeq \delta_p$). By the estimates obtained in Subsection 4.2 the next result holds true.

Proposition 4.17. *Suppose that $\rho_1 \in (4k\pi, 4(k+1)\pi)$, $\rho_2 \in (4\pi, 8\pi)$. Then, we have*

$$J_{\rho}(\Phi_{\lambda}(\nu, p, s)) \rightarrow -\infty \quad \text{as } \lambda \rightarrow +\infty \quad \text{uniformly in } (\nu, p, s) \in Y_{\mathcal{R}}.$$

The definition of Φ_{λ} reflects naturally the join element (ν, p, s) in the sense that, once composed with the map $\tilde{\Psi}$ in (29) we obtain a map homotopic to the identity on $Y_{\mathcal{R}}$, see the next section.

5. PROOF OF THEOREM 1.1

In this section we introduce the variational scheme that we will use to prove Theorem 1.1. As we already observed, the case of surfaces with positive genus was obtained in [3]. Therefore, for now on we will consider the case when Σ is homeomorphic to S^2 . We will first analyze the topological structure of the set Y in (51) and then introduce a suitable min-max scheme.

5.1. On the topology of Y when Σ is a sphere. In this subsection we will use the notation \simeq for a homotopy equivalence and \cong for an isomorphism. Consider the topological join $X = S_k^2 * S^2$ (observe that S_1^2 is homeomorphic to S^2) and recall the definition of its subset S given in (52), that is

$$S = \left\{ \left(\nu, \delta_y, \frac{1}{2} \right) \in S_k^2 * S^2 : \nu \in S_k^2 \setminus (S_{k-1}^2)^{\delta}, y \in \text{supp}(\nu) \right\},$$

where we have set

$$(S_{k-1}^2)^\delta = \left\{ \nu \in S_k^2 : \nu = \sum_{i=1}^k t_i \delta_{x_i}; d(x_i, x_j) < \delta \text{ for some } i \neq j \right\} \cup \\ \cup \left\{ \nu \in S_k^2 : \nu = \sum_{i=1}^k t_i \delta_{x_i}; t_i < \delta \text{ for some } i \right\} \cup \left\{ \nu \in S_k^2 : \nu = \sum_{i=1}^k t_i \delta_{x_i}; t_i > 1 - \delta \text{ for some } i \right\}.$$

Notice that S is a smooth manifold of dimension $3k - 1$, with boundary of dimension $3k - 2$.

The key point of this subsection is to prove that the complementary subspace $Y = (S_k^2 * S^2) \setminus S$ is not contractible, see Proposition 5.6. Before we do so, we establish some properties of Y and S . Below, U_δ will represent an open neighborhood of S not meeting $(S_{k-1}^2)^\delta * S^2$ with the property that \bar{U}_δ is a manifold with boundary $\partial\bar{U}_\delta$, where both U_δ and \bar{U}_δ deformation retract onto S and such that $\bar{U}_\delta \setminus S$ deformation retracts onto $\partial\bar{U}_\delta$ (see Figure 7).

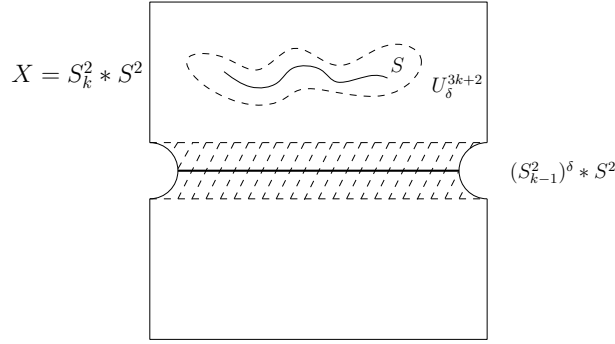

FIGURE 7. Here $X = S_k^2 * S^2$ is the ambient, $(S_{k-1}^2)^\delta * S^2$ is a neighborhood of $S_{k-1}^2 * S^2$ in X , S misses this neighborhood and U_δ is a neighborhood of S in that complement.

For a metric space \mathcal{X} , throughout this subsection we use the notation for the k -tuples in \mathcal{X}

$$F(\mathcal{X}, k) := \{(x_1, \dots, x_k) \in \mathcal{X}^k \mid x_i \neq x_j, i \neq j\}$$

and $B(\mathcal{X}, n)$ to denote its quotient by the permutation action of the symmetric group. These are respectively the ordered and unordered k -th *configuration spaces* of \mathcal{X} .

Lemma 5.1. *S is up to homotopy equivalence a degree- k covering of $B(S^2, k)$. Its homological dimension is at most k and its mod-2 homology is completely described by*

$$H_*(S) \cong H_*(S^2) \otimes H_*(B(\mathbb{R}^2, k - 1)).$$

PROOF. The barycentric set S_k^2 is a suitable quotient of

$$\Delta_{k-1} \times_{\mathfrak{S}_k} (S^2)^k,$$

with \mathfrak{S}_k acting diagonally by permutations and $\Delta_{k-1} = \{(t_0, \dots, t_k) \mid t_i \in [0, 1], \sum t_i = 1\}$. The identification occurs when $x_i = x_j$ for some $i \neq j$ or when $t_i = 0$ for some i . When this happens we are identifying points in S_{k-1}^2 . This means that if $\dot{\Delta}_{k-1}$ is the open simplex, then

$$(95) \quad S_k^2 \setminus S_{k-1}^2 = \dot{\Delta}_{k-1} \times_{\mathfrak{S}_k} F(S^2, k),$$

where $F(S^2, k)$ is the configuration space of k distinct points on S^2 . The action of \mathfrak{S}_k on $F(S^2, k)$ is free, so we have a bundle

$$\dot{\Delta}_{k-1} \times_{\mathfrak{S}_k} F(S^2, k) \rightarrow B(S^2, k),$$

where $B(S^2, k) := F(S^2, k)/\mathfrak{S}_k$ is the configuration of k -unordered points on S^2 . The preimages, being copies of the simplex, are contractible so that necessarily

$$S_k^2 \setminus S_{k-1}^2 \simeq B(S^2, k).$$

In fact $\{\frac{1}{k}\}$ maps to $\dot{\Delta}_{k-1}$ with image $(\frac{1}{k}, \dots, \frac{1}{k})$ and the induced map

$$B(S^2, k) = \left\{ \frac{1}{k} \right\} \times_{\mathfrak{S}_k} F(S^2, k) \rightarrow \dot{\Delta}_{k-1} \times_{\mathfrak{S}_k} F(S^2, k)$$

is an equivalence. To summarize, S can be deformed onto the subspace

$$W_k = \{([x_1, \dots, x_k], x) \in B(S^2, k) \times S^2 \mid x = x_i \text{ for some } i\}.$$

By projecting W_k onto $B(S^2, k)$ we get a covering. This implies that the homological dimension hd of W_k is that of $B(S^2, k)$, which is also the homological dimension of its covering space $F(S^2, k)$. We claim that this dimension is at most k . The projection onto the first coordinate $F(S^2, k) \rightarrow S^2$ is a bundle map with fiber $F(\mathbb{R}^2, k-1)$, so $hd(F(S^2, k)) \leq 2 + hd(F(\mathbb{R}^2, k-1))$. Since we also have a fibration $F(\mathbb{R}^2, k-1) \rightarrow F(\mathbb{R}^2, k-2)$ given by projecting onto the first $(k-2)$ -entries, with fiber a copy of $\mathbb{R}^2 \setminus \{x_1, \dots, x_{k-2}\}$ which is a bouquet of circles, the claim follows immediately by induction, knowing that $F(\mathbb{R}^2, 2) \simeq S^1$.

Note that we can identify W_k with the quotient $F(S^2, k)/\mathfrak{S}_{k-1}$ where the symmetric group acts on the first $(k-1)$ -coordinates. In particular in the case $k=2$, $S \simeq W_2 = F(S^2, 2) \simeq S^2$.

By projecting W_k onto S^2 via the last coordinate, we get a bundle with fiber $B(\mathbb{R}^2, k-1)$. Let us look at the inclusion of the fiber over $\{\infty\} \in S^2 = \mathbb{R}^2 \cup \{\infty\}$ in this bundle

$$\begin{aligned} B(\mathbb{R}^2, k-1) &\hookrightarrow W_k = F(S^2, k)/\mathfrak{S}_{k-1}, \\ [x_1, \dots, x_{k-1}] &\mapsto ([x_1, \dots, x_{k-1}], \infty). \end{aligned}$$

Let S^∞ be the direct union of the S^n 's under inclusion: this is a contractible space. Now S^2 embeds in S^∞ and we have a map of quotients

$$F(S^2, k)/\mathfrak{S}_{k-1} \rightarrow F(S^\infty, k)/\mathfrak{S}_{k-1}.$$

The space on the right-hand side projects onto S^∞ with fiber $B(\mathbb{R}^\infty, k-1)$. Since the base space is contractible, there is a homotopy equivalence $F(S^\infty, k)/\mathfrak{S}_{k-1} \simeq B(\mathbb{R}^\infty, k-1)$. Let us consider the composition

$$(96) \quad B(\mathbb{R}^2, k-1) \xrightarrow{\iota} W_k = F(S^2, k)/\mathfrak{S}_{k-1} \rightarrow B(\mathbb{R}^\infty, k-1).$$

This composition is homotopic to the map induced on configuration spaces from the inclusion $\mathbb{R}^2 \subset \mathbb{R}^\infty$. It is a known useful fact that each embedding $B(\mathbb{R}^n, k) \hookrightarrow B(\mathbb{R}^{n+1}, k)$ induces a monomorphism in mod-2 homology¹. In the case $k=2$ for example, this is $B(\mathbb{R}^n, 2) \simeq \mathbb{R}P^{n-1} \rightarrow B(\mathbb{R}^{n+1}, 2) \simeq \mathbb{R}P^n$. This then implies that $B(\mathbb{R}^2, k-1) \hookrightarrow B(\mathbb{R}^\infty, k-1)$ induces in homology mod-2 a monomorphism as well, which then means that the first portion of the composition in (96), which is inclusion of the fiber, injects in homology. Consider the Wang long exact sequence in homology associated to the bundle $W_k \rightarrow S^2$ (Theorem 2.5 in [39]):

$$H_{q+1}(W_k) \rightarrow H_{q-n+1}(B(\mathbb{R}^2, k-1)) \rightarrow H_q(B(\mathbb{R}^2, k-1)) \xrightarrow{\iota_*} H_q(W_k) \rightarrow H_{q-n}(B(\mathbb{R}^2, k-1))$$

with $n=2$ in our case. Since ι_* is a monomorphism, the long exact sequence splits into short exact sequences and because we are working over a field, $H_q(W_k) \cong H_q(B(\mathbb{R}^2, k-1)) \oplus H_{q-2}(B(\mathbb{R}^2, k-1))$. Since $H_*(W_k) \cong H_*(S)$, the proof is complete. ■

Remark 5.2. The top mod-2 homology group $H_k(S)$ is trivial if $k-1$ is not a binary power and is a copy of \mathbb{Z}_2 if $k-1$ is a binary power. By Lemma 5.1, this is because $H_{k-2}(B(\mathbb{R}^2, k-1))$ satisfies the same condition ([23], p. 146).

Lemma 5.3. *Suppose $k \geq 3$. The manifold S defined in (52) is non-orientable.*

PROOF. We first observe that the manifold $S_k^2 \setminus S_{k-1}^2$ is not orientable for any $k \geq 2$. From the proof of Lemma 5.1

$$S_k^2 \setminus S_{k-1}^2 = \dot{\Delta}_{k-1} \times_{\mathfrak{S}_k} F(S^2, k)$$

is a bundle over $B(S^2, k)$ with fiber the open simplex. Since $B(S^2, k)$ is orientable (because unordered configuration spaces of smooth manifolds are orientable if and only if the dimension of the manifold

¹This follows from the work of F. Cohen [14] who first calculated $H_*(B(\mathbb{R}^n, k); \mathbb{F})$ for all n, k , and for $\mathbb{F} = \mathbb{Z}_2, \mathbb{Z}_p, p$ odd.

is even), the orientability of the total space is the same as the orientability of the bundle. But the braids generators of the fundamental group of $B(S^2, k)$ act (after restriction to the open simplex) by transpositions on the vertices of $\overline{\Delta}_{k-1}$ and this is orientation reversing, so the bundle is not orientable.

Now let V_k be the subset of $S_k^2 \setminus S_{k-1}^2$ of all sums $\sum t_i \delta_{x_i}$ with $x_i = \{\infty\}$ for some i . Again $\{\infty\}$ stands for the north pole of $S^2 = \mathbb{R}^2 \cup \{\infty\}$. Here $V_k \simeq B(\mathbb{R}^2, k-1)$. Note that $\pi_1(B(\mathbb{R}^2, k-1))$ embeds in $\pi_1(B(S^2, k))$ with similar braid generators. For the exact same reason as for $S_k^2 \setminus S_{k-1}^2$, V_k is not orientable.

Consider finally the manifold

$$\mathbf{S} = \left\{ \left(\nu, \delta_y, \frac{1}{2} \right) \in S_k^2 * S^2 : \nu \in S_k^2 \setminus S_{k-1}^2, y \in \text{supp}(\nu) \right\}.$$

Then S is a codimension 0 submanifold of \mathbf{S} (with boundary) which is also a deformation retract. Both S and \mathbf{S} have the same orientation. But there is a bundle map $\mathbf{S} \rightarrow S^2$ with fiber V_k . It is easy to see now that the orientation of \mathbf{S} is that of V_k . Indeed the bundle over the open upper hemisphere D of S^2 is trivial homeomorphic to $V_k \times D$. This is an open subset of \mathbf{S} which is non-orientable, thus \mathbf{S} must be non-orientable. ■

Lemma 5.4. *Let $k \geq 3$. Then Y has the Euler characteristic of a contractible space, i.e. $\chi(Y) = 1$.*

PROOF. By the previous lemma, S is up to homotopy a degree- k covering of $B(S^2, k)$. This gives that

$$\chi(S) = k\chi(B(S^2, k)) = k \frac{1}{k!} \chi(F(S^2, k)) = \frac{1}{(k-1)!} \chi(S^2) \chi(F(\mathbb{R}^2, k-1)) = 0.$$

Here what vanishes is $\chi(F(\mathbb{R}^2, k-1)) = 0$ since, letting $\mathbb{C}^* = \mathbb{C} \setminus \{0\}$, there are homeomorphisms

$$F(\mathbb{R}^2, k-1) = \mathbb{R}^2 \times F(\mathbb{R}^2 \setminus \{(0,0)\}, k-2) = \mathbb{R}^2 \times \mathbb{C}^* \times F(\mathbb{C}^* \setminus \{1\}, k-3)$$

and $\chi(\mathbb{C}^*) = \chi(S^1) = 0$.

On the other hand, S is a smooth $(3k-1)$ -dimensional manifold with boundary. A neighborhood of S in $S_k^2 * S^2$ is a $(3k+2)$ -dimensional open manifold U_δ . This neighborhood is the union of two open subspaces A and B , where A is a fiberwise cone over the interior of S and B is a bundle over ∂S with fiber the cone over a hemisphere. The complement $\overline{U}_\delta \setminus S$ is the union of two subspaces \tilde{A} and \tilde{B} , where \tilde{A} retracts onto an S^2 -bundle over the interior of S , while \tilde{B} is up to homotopy ∂S . Clearly $\tilde{A} \cap \tilde{B}$ retracts onto an S^2 -bundle over ∂S . We can then write

$$\begin{aligned} \chi(U_\delta \setminus S) &= \chi(\tilde{A} \cup \tilde{B}) = \chi(\tilde{A}) + \chi(\tilde{B}) - \chi(\tilde{A} \cap \tilde{B}) = 2\chi(S) + \chi(\partial S) - 2\chi(\partial S) \\ &= 2\chi(S) - \chi(\partial S). \end{aligned}$$

We know that for a manifold S of dimension m with boundary it holds

$$\chi(\partial S) = \chi(S) - (-1)^m \chi(S).$$

If $m = 3k-1$ is odd, then $\chi(\partial S) = 2\chi(S)$ and so $\chi(U_\delta \setminus S) = 0$. If m is even, ∂S is odd dimensional closed and its Euler characteristic is null. But $\chi(S) = 0$ and here again $\chi(U_\delta \setminus S) = 0$.

Now cover $X = S_k^2 * S^2$ by means of $U_\delta \simeq S$ and $Y = X \setminus S$. The universal property of the Euler characteristic gives that

$$\chi(X) = \chi(U_\delta) + \chi(Y) - \chi(U_\delta \setminus S) = \chi(S) + \chi(Y) = \chi(Y),$$

so that $\chi(Y) = \chi(X) = 1$ as claimed. The second equality follows from the fact that $\chi(X) = \chi(S_k^2 * S^2) = \chi(S_k^2) + \chi(S^2) - \chi(S_k^2) \chi(S^2)$ and that

$$\chi(Z_k) = 1 - \frac{1}{k!} (1 - \chi)(2 - \chi) \cdots (k - \chi)$$

for any surface Z , see [34], and more generally for any simplicial complex Z , see [28], with $\chi = \chi(Z)$. ■

Lemma 5.5. *The set Y is simply connected.*

PROOF. Using the same notation as in the proof of the previous lemma, we have the push-out

$$\begin{array}{ccc} \tilde{A} \cap \tilde{B} & \longrightarrow & \tilde{A} \\ \downarrow & & \downarrow \\ \tilde{B} & \longrightarrow & U_\delta \setminus S \end{array}$$

Recall that \tilde{A} is up to homotopy an S^2 -bundle over S , $\tilde{B} \simeq \partial S$ and that $\tilde{A} \cap \tilde{B}$ is an S^2 -bundle over ∂S . This means that $\pi_1(\tilde{A} \cap \tilde{B}) = \pi_1(\partial S)$ and $\pi_1(\tilde{A}) \cong \pi_1(S)$. We therefore have the following push-out in the category of groups (by the Van-Kampen theorem):

$$\begin{array}{ccc} \pi_1(\partial S) & \longrightarrow & \pi_1(S) \\ \downarrow \cong & & \downarrow \\ \pi_1(\partial S) & \longrightarrow & \pi_1(U_\delta \setminus S) \end{array}$$

which shows that $\pi_1(U_\delta \setminus S) \cong \pi_1(S)$. On the other hand we can use the same open covering of $X = S_k^2 * S^2$ by U_δ and $Y = X \setminus S$. Since X is a join of connected spaces, it is 1-connected. The push-out of groups

$$\begin{array}{ccc} \pi_1(U_\delta \setminus S) & \longrightarrow & \pi_1(X \setminus S) \\ \downarrow \cong & & \downarrow \\ \pi_1(U_\delta) & \longrightarrow & 0 \end{array}$$

implies that because the left-hand vertical map is an isomorphism, then so is the right-hand vertical map and $\pi_1(X \setminus S) = \pi_1(Y) = 0$. ■

Despite the fact that Y is simply connected and has unit Euler characteristic, it is non contractible.

Proposition 5.6. *Suppose $k \geq 2$, $k \neq 4$. Then the set*

$$Y = (S_k^2 * S^2) \setminus S$$

is not contractible.

PROOF. We assume that Y is contractible and derive a contradiction. The main step is to prove that under this condition with mod-2 coefficients we must have

$$(97) \quad H_*(S) \cong H_{3k-1-*}(S_k^2), \quad 0 \leq * \leq k.$$

This will then be shown to be impossible.

The closed subset S has a neighborhood U_δ which is $(3k+2)$ -dimensional with $(3k+1)$ -dimensional boundary $\partial \bar{U}_\delta$. Using Poincaré's duality with mod-2 coefficients for the closed manifold $\partial \bar{U}_\delta$ gives us

$$H^*(\partial \bar{U}_\delta) \cong H_{3k+1-*}(\partial \bar{U}_\delta).$$

Since $\bar{U}_\delta \setminus S$ retracts onto $\partial \bar{U}_\delta$, and homology is dual to cohomology for finite type spaces and field coefficients, we can conclude that

$$(98) \quad H_*(\bar{U}_\delta \setminus S) \cong H_{3k+1-*}(\bar{U}_\delta \setminus S), \quad * \geq 0.$$

Next we turn to the open covering of $X = S_k^2 * S^2$ by U_δ and $Y = X \setminus S$. Using that $Y \cap U_\delta = U_\delta \setminus S$ and $U_\delta \simeq S$, the Mayer-Vietoris sequence for this union takes the form

$$H_*(U_\delta \setminus S) \rightarrow H_*(S) \oplus H_*(Y) \rightarrow H_*(X) \rightarrow H_{*-1}(U_\delta \setminus S) \rightarrow H_{*-1}(S) \oplus H_{*-1}(Y) \rightarrow H_{*-1}(X) \rightarrow \dots$$

Since Y has trivial reduced homology by assumption, the sequence becomes

$$(99) \quad H_*(U_\delta \setminus S) \rightarrow H_*(S) \rightarrow H_*(X) \rightarrow H_{*-1}(U_\delta \setminus S) \rightarrow H_{*-1}(S) \rightarrow H_{*-1}(X) \rightarrow \dots$$

But S has homological dimension k (see Lemma 5.1), so for $* > k+1$ we have the isomorphism $H_{*-1}(U_\delta \setminus S) \cong H_*(X)$. Since X is the third suspension of S_k^2 , $H_*(X) \cong H_{*-3}(S_k^2)$ and thus

$$(100) \quad H_*(U_\delta \setminus S) \cong H_{*-2}(S_k^2), \quad * > k.$$

It is known generally (see [28]) that the barycentric set Z_k is $(2k + r - 2)$ -connected whenever Z is r -connected, $r \geq 1$. If $Z = S^2$, which is 1-connected, S_k^2 is $(2k - 1)$ -connected and so X is $(2k + 2)$ -connected. In the range $* \leq 2k + 2$, $\tilde{H}_*(X) = 0$. The Mayer-Vietoris sequence (99) leads in this case to

$$H_*(U_\delta \setminus S) \cong H_*(S), \quad * < 2k + 2.$$

Since S has no homology beyond degree k , we can focus on the range below so that

$$(101) \quad H_*(U_\delta \setminus S) \cong H_*(S), \quad 0 \leq * \leq k.$$

We can now combine all previous isomorphisms into one for $0 \leq * \leq k$

$$H_*(S) \xrightarrow[(101)]{\cong} H_*(U_\delta \setminus S) \xrightarrow[(98)]{\cong} H_{3k+1-*}(U_\delta \setminus S) \xrightarrow[(100)]{\cong} H_{3k-1-*}(S_k^2).$$

This is the claim in (97). Note that S_k^2 is $(3k - 1)$ -dimensional as a CW-complex and is $(2k - 1)$ -connected, so its homology is non-zero only in the range $2k \leq * \leq 3k - 1$.

The isomorphism $H_*(S) \cong H_{3k-1-*}(S_k^2)$ cannot hold. First let us check the case $k = 2$. In that case we pointed out in the proof of Lemma 5.1 that $S \simeq F(S^2, 2) \simeq S^2$. Since $S_2^2 \simeq \Sigma^3 \mathbb{R}P^2$ (the 3-fold suspension of $\mathbb{R}P^2$: see [28], Corollary 1.6), the isomorphism obviously cannot hold: in fact $H_1(S^2) = 0$ but $H_4(\Sigma^3 \mathbb{R}P^2) = H_1(\mathbb{R}P^2) = \mathbb{Z}_2$.

Suppose that $k \geq 3$. According to Theorem 1.3 in [28], S_k^2 has the same homology as (one desuspension) of the symmetric smash product $\overline{\mathbb{S}P}^k(S^3) = (S^3)^{\wedge k} / \mathfrak{S}_k$; i.e. $H_*(S_k^2) \cong H_{*+1}(\overline{\mathbb{S}P}^k(S^3))$. Combining this with (97) we get

$$(102) \quad H_*(S) \cong H_{3k-*}(\overline{\mathbb{S}P}^k(S^3)), \quad 0 \leq * \leq k.$$

We will show that this is impossible. To that end we need describe the groups on both sides of (102). We work again mod-2. From Lemma 5.1 we have that

$$H_*(S) \cong H_*(B(\mathbb{R}^2, k - 1)) \oplus H_{*-2}(B(\mathbb{R}^2, k - 1)), \quad * \geq 0.$$

(when $* - 2 < 0$ the corresponding group is zero). The mod-2 homology of $B(\mathbb{R}^2, k - 1)$ has been computed by D.B. Fuks in [23] and it is best described as a subspace of the polynomial algebra (viewed as an infinite vector space generated by powers of the indicated generators)

$$(103) \quad \mathbb{Z}_2[a_{(1,2)}, a_{(3,4)}, \dots, a_{(2^i-1, 2^i)}, \dots],$$

where the notation $a_{i,j}$ refers to a generator having homological degree i and a certain *filtration* degree j , both degrees being additive under multiplication of generators. Now the condition for an element $a_{(2^{i_1}-1, 2^{i_1})} \cdots a_{(2^{i_r}-1, 2^{i_r})} \in H_*(B(\mathbb{R}^2, k - 1))$ is that its filtration degree is less or equal than $k - 1$; that is if and only if $\sum_{i_s} k_{i_s} 2^{i_s} \leq k - 1$.

For example $\tilde{H}_*(B(\mathbb{R}^2, 2)) = \mathbb{Z}_2\{a_{(1,2)}\}$ (one copy of \mathbb{Z}_2 generated by $a_{(1,2)}$ having homological degree one and filtration degree two). Similarly $\tilde{H}_*(B(\mathbb{R}^2, 4)) = \mathbb{Z}_2\{a_{(1,2)}, a_{(1,2)}^2, a_{(3,4)}\}$, so that

$$H_1(B(\mathbb{R}^2, 4)) = \mathbb{Z}_2\{a_{(1,2)}\}, \quad H_2(B(\mathbb{R}^2, 4)) = \mathbb{Z}_2\{a_{(1,2)}^2\}, \quad H_3(B(\mathbb{R}^2, 4)) = \mathbb{Z}_2\{a_{(3,4)}\}.$$

Now $H_*(B(\mathbb{R}^2, 5)) \cong H_*(B(\mathbb{R}^2, 4))$ and this turns out to be a general fact that is explained in Lemma 5.9 in more geometric terms.

On the other hand, the reduced groups $\tilde{H}_*(\overline{\mathbb{S}P}^k(S^3))$ form a subvector space of the polynomial algebra

$$(104) \quad \mathbb{Z}_2[\iota_{(3,1)}, f_{(5,2)}, f_{(9,4)}, \dots, f_{(2^{i+1}+1, 2^i)}, \dots],$$

consisting of those elements of second filtration degree precisely k (see the Appendix in [28] and references therein). Here again $f_{(2^{i+1}+1, 2^i)}$ denotes an element of homological degree $2^{i+1} + 1$ and filtration degree 2^i . For example (here $\iota = \iota_{(3,1)}$)

$$\tilde{H}_*(\overline{\mathbb{S}P}^4 S^3) = \mathbb{Z}_2\{\iota^4, \iota^2 f_{(5,2)}, f_{(5,2)}^2, f_{(9,4)}\},$$

which is better listed as follows:

$$H_{12}(\overline{\mathbb{S}P}^4 S^3) = \mathbb{Z}_2\{\iota^4\}, \quad H_{11}(\overline{\mathbb{S}P}^4 S^3) = \mathbb{Z}_2\{\iota^2 f_{(5,2)}\},$$

$$H_{10}(\overline{\mathbb{S}\mathbb{P}^4} S^3) = \mathbb{Z}_2\{f_{(5,2)}^2\}, \quad H_9(\overline{\mathbb{S}\mathbb{P}^4} S^3) = \mathbb{Z}_2\{f_{(9,4)}\}.$$

This space $\overline{\mathbb{S}\mathbb{P}^4}(S^3)$ is 8-connected, and more generally $\overline{\mathbb{S}\mathbb{P}^k}(S^3)$ is $2k$ -connected, see [28].

Let us now compare the groups in (102). When $* = 0$, $H_0(S) = \mathbb{Z}_2$ but so is $H_{3k}(\overline{\mathbb{S}\mathbb{P}^k}(S^3))$ generated by the class $\iota_{(3,1)}^k$. Also when $* = 1$, $k \geq 3$, $H_1(S) = H_1(B(\mathbb{R}^2, k-1)) = \mathbb{Z}_2$ but so is $H_{3k-1}(\overline{\mathbb{S}\mathbb{P}^k}(S^3))$ generated by $\{\iota^{k-2} f_{5,2}\}$. There is no contradiction yet. When $* = 2$, we get the generator $a_{(1,2)}^2 \in H_2(B(\mathbb{R}^2, k-1)) \cong \mathbb{Z}_2$ as soon as $k \geq 5$ ($a_{(1,2)}^2$ is in filtration 4). This gives that $H_2(S) = \mathbb{Z}_2 \oplus \mathbb{Z}_2$.

We claim however that $H_{3k-2}(\overline{\mathbb{S}\mathbb{P}^k}(S^3)) = \mathbb{Z}_2$, which will give a contradiction in that case. Indeed a generator in filtration degree k in (104) is written as a finite product

$$\iota^{k_0} f_{5,2}^{k_1} \cdots f_{(2^{i+1}+1, 2^i)}^{k_i} \cdots, \quad \sum_{i \geq 0} k_i 2^i = k.$$

The homological degree of this class is $\sum_{i \geq 0} k_i(2^{i+1} + 1) = 2 \sum_{i \geq 0} k_i 2^i + \sum_{i \geq 0} k_i$. To obtain the rank of H_{3k-2} we need to find all the possible sequences of integers (k_0, k_1, k_2, \dots) such that $\sum_{i \geq 0} k_i 2^i = k$ and $2 \sum_{i \geq 0} k_i 2^i + \sum_{i \geq 0} k_i = 3k - 2$. We have to solve for

$$\sum_{i \geq 0} k_i 2^i = k = 2 + \sum_{i \geq 0} k_i.$$

This immediately gives that $k_i = 0, i \geq 2$. There is one and only one solution: $k_0 = k - 4$ and $k_1 = 2$; and the group $H_{3k-2}(\overline{\mathbb{S}\mathbb{P}^k}(S^3)) \cong \mathbb{Z}_2$ is generated by $\iota^{k-4} f_{5,2}^2$.

The isomorphism (102) cannot hold for $k \geq 5$. We are left to consider the cases $k = 3$: here $H_3(S) = \mathbb{Z}_2$ but $H_6(\overline{\mathbb{S}\mathbb{P}^3}(S^3)) = 0$ giving a contradiction.

In conclusion since the isomorphism (102) (equivalently (97)) cannot hold, Y must have non trivial mod-2 homology and thus cannot be contractible as we had asserted. ■

The next proposition treats the case $k = 4$: in preparation we need the following lemma. Recall that S is a manifold with boundary embedded in $\overline{U}_\delta \subset S_k^2 * S^2$. We can write \overline{U}_δ as the union of two sets \overline{A} and \overline{B} , where \overline{A} is a three-dimensional-disk-bundle over S and $\overline{A} \cap \overline{B}$ its restriction over ∂S . We refer to this bundle as the *normal disk bundle* and its boundary as the *sphere normal bundle*. Note that in the proof of Lemma 5.4, we have used $\tilde{A} = \overline{A} \setminus S$ and $\tilde{B} = \overline{B} \setminus S$.

Lemma 5.7. *The sphere normal bundle over ∂S is orientable.*

PROOF. We will view this bundle as an extension of a normal sphere bundle over the interior $\dot{S} := \text{int}(S)$ which is orientable (in so doing we give more details on the construction of \overline{A} and $\overline{A} \cap \overline{B}$).

We recall that the join is given by the equivalence relation $X * Y = X \times Y \times I / \sim$, where \sim are identifications at the endpoints of $I = [0, 1]$, see (9). The join contains the open dense subset $X \times Y \times (0, 1)$ (let us call it the *big cell*). This subset is a manifold of dimension $n + m + 1$ if X, Y are manifolds of dimensions n and m , respectively. In our case S is a subset of the big cell

$$(S_k^2 \setminus (S_{k-1}^2)^\delta) \times S^2 \times (0, 1) \subset (S_k^2 \setminus (S_{k-1}^2)^\delta) * S^2$$

and $\text{int}(S)$ is regularly embedded as a differentiable submanifold. It has therefore a unit normal disk bundle (of dimension 3) in there. This is homeomorphic to a tubular neighborhood V^δ of $\text{int}(S)$. Let us use the same name for the neighborhood and the normal bundle. The normal bundle of \dot{S} in $(S_k^2 \setminus (S_{k-1}^2)^\delta) \times S^2 \times (0, 1)$ is the normal bundle of \dot{S} in $(S_k^2 \setminus (S_{k-1}^2)^\delta) \times S^2 \times \{\frac{1}{2}\}$ to which we add a trivial line bundle. We can then consider directly \dot{S} as a subset of $(S_k^2 \setminus (S_{k-1}^2)^\delta) \times S^2$ and show that it has an orientable rank 2 normal bundle there. Write $D_k := S_k^2 \setminus (S_{k-1}^2)^\delta$ and

$$S = \left\{ \left(\sum_{i=1}^k t_i \delta_{x_i}, x \right) \in D_k \times S^2, x = x_i \text{ for some } i \right\}.$$

Define V^δ the neighborhood of S in $D_k \times S^2$ as follows:

$$V^\delta = \left\{ \left(\sum_{i=1}^k t_i \delta_{x_i}, x \right) \in D_k \times S^2, |x - x_i| < \frac{\delta}{2} \text{ for some and hence unique } x_i \right\}.$$

The choice of x_i is unique as x cannot be strictly within $\delta/2$ from two distinct x_i, x_j since $d(x_i, x_j) \geq \delta$ according to the definition of S . The neighborhood retracts back to S via the map

$$\left(\sum_{i=1}^k t_i \delta_{x_i}, x \right) \mapsto \left(\sum_{i=1}^k t_i \delta_{x_i}, x_i \right),$$

where $d(x, x_i) < \delta/2$. Consider the projection map $\pi : \dot{S} \rightarrow S^2$ sending $\left(\sum_{i=1}^k t_i \delta_{x_i}, x \right) \mapsto x$. We claim that the normal bundle of \dot{S} in $D_k \times S^2$ is isomorphic to the pullback via π of the tangent bundle TS^2 over S^2 . We assume δ to be less than the injectivity radius of S^2 . Define a homeomorphism between the tubular neighborhood V^δ of \dot{S} and a normal disk bundle of the pullback of TS^2 over \dot{S} by sending $\left(\sum_{i=1}^k t_i \delta_{x_i}, x \right)$ with $|x - x_i| < \delta$ for some i to the element in the pullback

$$\left(\left(\sum_{i=1}^k t_i \delta_{x_i}, x \right), v_i \right),$$

where $v_i = \exp_{x_i}^{-1}(x)$ and \exp_{x_i} is the exponential map at $x_i \in S^2$. This map is a homeomorphism onto its image and the normal bundle to \dot{S} in $D_k \times S^2$ is isomorphic to TS^2 . Since TS^2 is orientable (although non trivial), the normal bundle over \dot{S} is orientable. This bundle can be extended to S by taking the closure of V^δ in $D_k \times S^2 := (S^2 \setminus (S_{k-1}^\delta)^\delta) \times S^2 \times \{\frac{1}{2}\}$. This extension is orientable over all of S since it is orientable over the interior. By adding a line bundle we get the disk bundle over S in the big cell (which we have labeled \bar{A}). This bundle is orientable over all of S and in particular over ∂S . This is our claim. ■

Proposition 5.8. *The set $Y = (S_4^2 * S^2) \setminus S$ is not contractible.*

PROOF. As before we assume Y is contractible and derive a contradiction. We first show that for any field coefficients \mathbb{F} and $* > k$

$$(105) \quad H_{*+3}(U_\delta \setminus S) \cong H_*(\partial S).$$

Write as before $\bar{U}_\delta \setminus S$ as the union $\tilde{A} \cup \tilde{B}$, with $\tilde{A} \cap \tilde{B}$ retracting onto the S^2 -bundle over ∂S discussed earlier. The Mayer-Vietoris sequence for the union $\tilde{A} \cup \tilde{B}$ is given by

$$H_{n+1}(\tilde{A} \cap \tilde{B}) \rightarrow H_{n+1}(\tilde{A}) \oplus H_{n+1}(\tilde{B}) \rightarrow H_{n+1}(U_\delta \setminus S) \rightarrow H_n(\tilde{A} \cap \tilde{B}) \rightarrow H_n(\tilde{A}) \oplus H_n(\tilde{B}) \rightarrow H_n(U_\delta \setminus S).$$

As S has homological dimension at most k and \tilde{A} is an S^2 -bundle over it, $H_n(\tilde{A})$ vanishes for $n > k + 2$. On the other hand, the S^2 -bundle over ∂S is orientable (Lemma 5.7) and has a global section given by the variation in the s -parameter (defining the join). By the Gysin sequence ([24], §4.D) one has a splitting

$$H_n(\tilde{A} \cap \tilde{B}) \simeq H_n(\partial S) \oplus H_{n-2}(\partial S).$$

Replacing in the Mayer-Vietoris sequence gives for $n > k + 2$

$$\cdots \longrightarrow \begin{array}{c} H_{n+1}(\partial S) \\ \oplus \\ H_{n-1}(\partial S) \end{array} \xrightarrow{\phi_{n+1}} H_{n+1}(\partial S) \longrightarrow H_{n+1}(U_\delta \setminus S) \longrightarrow \begin{array}{c} H_n(\partial S) \\ \oplus \\ H_{n-2}(\partial S) \end{array} \xrightarrow{\phi_n} H_n(\partial S) \longrightarrow \cdots$$

Now, in every inclusion of $\tilde{A} \cap \tilde{B}$ into \tilde{B} , the fibers (i.e. S^2) contract to a point. Therefore ϕ_n is trivial on the bottom group, while restricted to the top group it is a bijection. This map is an epimorphism and the long exact sequence for $n > k + 2$ splits into short exact sequences

$$0 \rightarrow H_{n+1}(U_\delta \setminus S) \rightarrow H_n(\partial S) \oplus H_{n-2}(\partial S) \rightarrow H_n(\partial S) \rightarrow 0.$$

As vector spaces we get $H_{n+1}(U_\delta \setminus S) \cong H_{n-2}(\partial S)$ which is our claim. Combined with (100) this yields

$$(106) \quad H_*(\partial S) \cong H_{*+1}(S_k^2), \quad * > k.$$

Next we look at the Mayer-Vietoris sequence for the union $S_k^2 = (S_k^2 \setminus S_{k-1}^2) \cup (S_{k-1}^2)^\delta$. It is shown in [34] that $(S_{k-1}^2)^\delta \setminus S_{k-1}^2$ retracts onto $\partial(S_{k-1}^2)^\delta$ so that the long exact sequence becomes

$$\cdots \rightarrow H_{n+1}(\partial(S_{k-1}^2)^\delta) \rightarrow H_{n+1}(S_{k-1}^2) \oplus H_{n+1}(S_k^2 \setminus S_{k-1}^2) \rightarrow H_{n+1}(S_k^2) \rightarrow H_n(\partial(S_{k-1}^2)^\delta) \rightarrow \cdots$$

Since the inclusion of S_{k-1}^2 in S_k^2 is contractible, and since $S_k^2 \setminus S_{k-1}^2 \simeq B(S^2, k)$ has homological dimension k (see Lemma 5.1), for $n > k$ the following short sequence is exact

$$0 \rightarrow H_{n+1}(S_k^2) \rightarrow H_n(\partial(S_{k-1}^2)^\delta) \rightarrow H_n(S_{k-1}^2) \rightarrow 0$$

and we have the splitting

$$(107) \quad H_*(\partial(S_{k-1}^2)^\delta) \cong H_*(S_{k-1}^2) \oplus H_{*+1}(S_k^2), \quad * > k.$$

Both isomorphisms (106) and (107) cannot hold simultaneously as we now explain.

A key point is to observe that ∂S is a degree- k regular covering of $\partial(S_{k-1}^2)^\delta$. A property of a covering $\pi : X \rightarrow Y$ is the existence of a transfer morphism $tr : H_*(Y) \rightarrow H_*(X)$ so that $\pi_* \circ tr$ is multiplication in $H_*(Y)$ by the degree of the covering i.e. by k , see [24], Section 3.G. If the characteristic of the field of coefficients is prime to k , then this composite is non trivial and $H_*(Y)$ injects into $H_*(X)$.

When $k = 4$, we have a degree-4 covering $\partial S \rightarrow \partial(S_3^2)^\delta$ so that with $\mathbb{F} = \mathbb{F}_3$ -coefficients (the finite field with 3 elements) we must have a monomorphism $H_*(\partial(S_3^2)^\delta; \mathbb{F}_3) \hookrightarrow H_*(\partial S; \mathbb{F}_3)$. When $* > 4$, upon combining (106) and (107) we get a monomorphism

$$H_*(S_3^2; \mathbb{F}_3) \oplus H_{*+1}(S_4^2; \mathbb{F}_3) \rightarrow H_{*+1}(S_4^2; \mathbb{F}_3).$$

This leads immediately to a contradiction if $H_*(S_3^2; \mathbb{F}_3) \neq 0$ in that range of dimensions.

We know that $H_*(S_3^2) \cong H_{*+1}(\overline{\mathbb{S}\mathbb{P}^3}(S^3))$. We therefore wish to show that $H_*(\overline{\mathbb{S}\mathbb{P}^3}(S^3); \mathbb{F}_3) \neq 0$ for some $* \geq 6$. It turns out that old calculations of Nakaoka give us precisely the answer [41]. Nakaoka's Theorem 15.5 states that

$$H^r(\mathbb{S}\mathbb{P}^3(S^n); \mathbb{F}_3) \cong \mathbb{F}_3$$

for $r = 0, n, n + 4k$ with $1 \leq k \leq [n/2]$ and $k \neq [n/4]$, $r = n + 4k + 1$ with $1 \leq k \leq [(2n - 1)/4]$ and $k \neq [(n - 1)/4]$, and $r = 2n$ with $n \equiv -2$ or $1 \pmod{4}$. In our case $n = 3$, so $H^r(\mathbb{S}\mathbb{P}^3(S^3); \mathbb{F}_3) \cong \mathbb{F}_3$ for $r = 0, 3, 7, 8$. Dually we obtain the same groups for $H_r(\mathbb{S}\mathbb{P}^3(S^3); \mathbb{F}_3)$ (since working over a field). But $H_r(\mathbb{S}\mathbb{P}^3(S^3); \mathbb{F}_3) \cong H_r(\overline{\mathbb{S}\mathbb{P}^3}(S^3); \mathbb{F}_3)$ for $r > 3$ for the following three reasons:

- By construction $H_r(\overline{\mathbb{S}\mathbb{P}^3}(S^3); \mathbb{F}_3) = H_r(SP^3(S^3), SP^2(S^3); \mathbb{F}_3)$, $r \geq 1$.
- There is a splitting due originally to Steenrod (any coefficients, see [28]):

$$H_r(\mathbb{S}\mathbb{P}^3(S^3)) \cong H_r(SP^3(S^3), SP^2(S^3)) \oplus H_r(SP^2(S^3)).$$

- $H_r(\mathbb{S}\mathbb{P}^2(S^3); \mathbb{F}_3) = 0$ if $r > 3$. In fact, from the covering $(S^3)^2 \rightarrow \mathbb{S}\mathbb{P}^2(S^3)$, by a consequence of the transfer construction, $H_*(\mathbb{S}\mathbb{P}^2(S^3); \mathbb{F}_3)$ is the subvector space of invariant cohomology classes in $H_*(S^3 \times S^3)$ under the induced permutation action interchanging the two spheres. Since S^3 is an odd sphere, the involution acts via $\tau_*([S^3] \otimes [S^3]) = -[S^3] \otimes [S^3]$ and the class $[S^3] \otimes [S^3]$ is not invariant so maps to zero in $H_*(\mathbb{S}\mathbb{P}^2(S^3); \mathbb{F}_3)$.

As a consequence $H_r(\overline{\mathbb{S}\mathbb{P}^3}(S^3); \mathbb{F}_3) \cong \mathbb{F}_3$ for $r = 7, 8$ which gives a contradiction as we had asserted. The proof is complete. ■

Using the above transfer property but with \mathbb{F}_2 coefficients, one can find an alternative proof of Proposition 5.6 for k odd. To conclude this topological discussion, it is worthwhile noting that Lemma 5.1 can be used to give a novel proof of the following result on the mod-2 homology of unordered configurations of points in \mathbb{R}^n .

Proposition 5.9. *For k odd and $n \geq 2$ one has*

$$H_*(B(\mathbb{R}^n, k); \mathbb{Z}_2) \cong H_*(B(\mathbb{R}^n, k - 1); \mathbb{Z}_2).$$

PROOF. All homology is with mod-2 coefficients. A starting point is the homology splitting

$$(108) \quad H_q(B(S^n, k)) \cong H_q(B(\mathbb{R}^n, k)) \oplus H_{q-n}(B(\mathbb{R}^n, k-1)).$$

One reference to this result is Theorem 18 (1) of [42]. It is also a special case of a similar result of the second author where one can replace the sphere by any closed manifold M and \mathbb{R}^n by $M \setminus \{p\}$ its punctured version. Let $W_{n,k} := F(S^n, k)/\mathfrak{S}_{k-1}$ where \mathfrak{S}_{k-1} acts by permutations on the first $(k-1)$ -coordinates. By projecting onto the last coordinate we obtain a bundle over S^n with fiber $B(\mathbb{R}^n, k-1)$. Precisely as in the proof of Lemma 5.1, we see that

$$(109) \quad H_*(W_{n,k}) \cong H_*(B(\mathbb{R}^n, k-1)) \oplus H_{*-n}(B(\mathbb{R}^n, k-1)).$$

Consider next the degree- k regular covering $\pi : W_{n,k} \rightarrow B(S^n, k) := F(S^n, k)/\mathfrak{S}_k$. There is a transfer morphism $tr : H_*(B(S^n, k)) \rightarrow H_*(W_{n,k})$ so that the composite $\pi_* \circ tr$ is multiplication by k . Since k is odd and thus prime to the characteristic of the field \mathbb{Z}_2 , multiplication by k is injective and necessarily $H_*(B(S^n, k))$ embeds in $H_*(W_{n,k})$; that is (108) embeds into (109). But $H_*(B(\mathbb{R}^n, k-1))$ always embeds into $H_*(B(\mathbb{R}^n, k))$ (in fact for any coefficients as it is relatively easy to see). This means that $H_*(B(\mathbb{R}^n, k); \mathbb{Z}_2) \cong H_*(B(\mathbb{R}^n, k-1); \mathbb{Z}_2)$ if k is odd as claimed. It also means that $H_*(B(S^n, k)) \cong H_*(W_{n,k})$. ■

5.2. Min-max scheme. To prove Theorem 1.1 we will run a min-max scheme based on (a retraction of) the set Y in (51). More precisely, we will consider the set $Y_{\mathcal{R}}$ introduced in (94) on which the test functions Φ_λ are modelled. Some parts are quite standard and follow the ideas of [18] (see [34] for a Morse theoretical point of view): for the specific problem (1) the crucial step is Proposition 5.10, giving information on the topology of the low sublevels of J_ρ : see also the comments after the proof.

Given any $L > 0$, Proposition 4.17 guarantees us the existence of $\lambda > 1$ sufficiently large such that $J_\rho(\Phi_\lambda(\nu, p, s)) < -L$ for any $(\nu, p, s) \in Y_{\mathcal{R}}$. Recalling $\tilde{\Psi}$ in (29), we take L so large that Corollary 3.8 applies, i.e. such that $\tilde{\Psi}(J_\rho^{-L}) \subseteq Y$. The crucial step in describing the topology of the low sublevels of J_ρ is the following result.

Proposition 5.10. *Let L, λ be as above and let \mathcal{F} be the retraction given before (94). Then the composition*

$$Y_{\mathcal{R}} \xrightarrow{\Phi_\lambda} J_\rho^{-L} \xrightarrow{\mathcal{F} \circ \tilde{\Psi}} Y_{\mathcal{R}}$$

is homotopically equivalent to the identity map on $Y_{\mathcal{R}}$.

PROOF. We divide the proof in three cases, depending on the values of the join parameter s .

Case 1. Let $s \in [\frac{3}{4}, 1]$. In this case the test functions we are considering have the form $(\varphi_1^t, \varphi_2^t)$, $t = t(s)$, as defined in Subsection 4.2.3. Notice that, as discussed at the beginning of the proof of Proposition 4.7, most of the integral of $e^{\varphi_2^t}$ is localized near p and $\sigma_2(\varphi_2^t) \ll \sigma_1(\varphi_1^t)$ for these values of s , which again implies $s(\varphi_1^t, \varphi_2^t) = 1$, see (26). It turns out that, by the construction in Subsection 3.1, one has

$$\tilde{\Psi}(\Phi_\lambda(\nu, p, s)) = \tilde{\Psi}(\varphi_1^t, \varphi_2^t) = (*, \tilde{p}, 1),$$

where $*$ is an irrelevant element of Σ_k (recall that they are all identified when the join parameter equals 1, see (9)) and where $\tilde{p} \in \Sigma$ is a point close to p . If $p(t) : [0, 1] \rightarrow \Sigma$ is a geodesic joining p to \tilde{p} , one can realize the desired homotopy as

$$((\nu, p, s); t) \mapsto (\nu, p(t), (1-t)s + t), \quad t \in [0, 1].$$

Case 2. Let $s \in [\frac{1}{4}, \frac{3}{4}]$. The test functions we are considering here are given in Subsection 4.2.1. For this range of s the exponential of the first component φ_1 (see (82)) is well concentrated around the points \tilde{x}_i , see (77). The exponential of the second component φ_2 , depending on the value of s , will be instead either concentrated near p or will be spread over Σ in the sense that $\sigma_2(\varphi_2)$ might not be small. Recall the maps $\tilde{\psi}_l$ given in Proposition 2.4 and the definition of $\hat{\nu}$ involved in the construction of the test functions

given in (75): $\hat{\nu} = \mathcal{R}_p(\nu) = \sum_{i=1}^k t_i \delta_{x_i}$. We then have

$$\tilde{\Psi}(\Phi_\lambda(\nu, p, s)) = \tilde{\Psi}(\varphi_1, \varphi_2) = \begin{cases} \left(\tilde{\psi}_k(\varphi_1), \tilde{\psi}_1(\varphi_2), s(\varphi_1, \varphi_2) \right) & \text{if } \sigma_2(\varphi_2) \text{ small,} \\ \left(\tilde{\psi}_k(\varphi_1), *, 0 \right) & \text{otherwise,} \end{cases}$$

with $\tilde{\psi}_1(\varphi_2)$ close to p (whenever defined, i.e. for $\sigma_2(\varphi_2)$ small) and $\tilde{\psi}_k(\varphi_1)$ close to $\sum_{i=1}^k t_i \delta_{\tilde{x}_i}$ in the distributional sense. Furthermore, writing $\varphi_1 = \varphi_{1,\lambda}$ to emphasize the dependence on λ , it turns out that

$$\tilde{\psi}_k(\varphi_{1,\lambda}) \rightarrow \sum_{i=1}^k t_i \delta_{\tilde{x}_i} \quad \text{as } \lambda \rightarrow +\infty,$$

which gives us the following homotopy:

$$(\nu; \mathfrak{t}) \mapsto \tilde{\psi}_k \left(\varphi_{1, \frac{1}{\mathfrak{t}}} \right), \quad \mathfrak{t} \in [0, 1].$$

Reasoning as in Step 3 of Subsection 4.2.2 we get a homotopy which deforms the points \tilde{x}_i to the original one x_i . Letting $\tilde{\gamma}_i$ be the geodesic joining \tilde{x}_i and x_i in unit time we consider

$$(\nu; \mathfrak{t}) \mapsto \sum_{i=1}^k t_i \delta_{\tilde{\gamma}_i(1-\mathfrak{t})}, \quad \mathfrak{t} \in [0, 1].$$

Notice that for $\mathfrak{t} = 0$ we get in the above homotopy $(\nu; 0) = \mathcal{R}_p(\nu)$. Observe now that \mathcal{R}_p is homotopic to the identity map, see Remark 4.5, and let $\mathcal{H}_{\mathcal{R}_p}$ be the map introduced in Step 4 of Subsection 4.2.2 which realizes this homotopy. We then consider

$$(\nu; \mathfrak{t}) \mapsto \mathcal{H}_{\mathcal{R}_p}(\nu, 1 - \mathfrak{t}), \quad \mathfrak{t} \in [0, 1].$$

Finally, letting \mathcal{H} be the concatenation of the above homotopies (rescaling the respective domains of definition) and letting $p(\mathfrak{t}) : [0, 1] \rightarrow \Sigma$ be again a geodesic joining p to $\tilde{\psi}_1(\varphi_2)$ (whenever defined) we get the desired homotopy:

$$(110) \quad ((\nu, p, s); \mathfrak{t}) \mapsto \begin{cases} (\mathcal{H}(\nu; \mathfrak{t}), p(\mathfrak{t}), (1 - \mathfrak{t})s + \mathfrak{t}s(\varphi_1, \varphi_2)), & \mathfrak{t} \in [0, 1] \text{ if } \sigma_2(\varphi_2) \text{ small,} \\ (\mathcal{H}(\nu; \mathfrak{t}), p, (1 - \mathfrak{t})s), & \mathfrak{t} \in [0, 1] \text{ otherwise.} \end{cases}$$

Case 3. Let $s \in [0, \frac{1}{4}]$. In this case the test functions we are considering are as in Subsection 4.2.2. Notice that for this range of s we always get $\sigma_2(\hat{\varphi}_2^t) \ll \sigma_1(\hat{\varphi}_1^t)$, see the beginning of the proof of Proposition 4.7, and therefore $s(\hat{\varphi}_1^t, \hat{\varphi}_2^t) = 0$. We have further to subdivide this case depending on the values of s due to the construction of the test functions in the Steps 1-4 of Subsection 4.2.2.

Emphasizing in the test functions the dependence on λ and recalling that $t = t(s)$, for $s \in [\frac{3}{16}, \frac{1}{4}]$ we get the following property: $\tilde{\psi}_k(\hat{\varphi}_{1,\lambda}^t) \xrightarrow{\lambda \rightarrow \infty} \sum_{i=1}^k t_i \delta_{\tilde{x}_i}$ (see Step 1). When $s \in [\frac{1}{8}, \frac{3}{16}]$ one has by construction that $\tilde{\psi}_k(\hat{\varphi}_{1,\lambda}^t) \xrightarrow{\lambda \rightarrow \infty} \sum_{i=1}^k t_i \delta_{\tilde{x}_i}$ (see Step 2). For $s \in [\frac{1}{8}, \frac{3}{16}]$ we get instead $\hat{\psi}_k(\hat{\varphi}_{1,\lambda}^t) \xrightarrow{\lambda \rightarrow \infty} \sum_{i=1}^k t_i \delta_{\tilde{\gamma}_i}$ (see Step 3). Finally, when $s \in [\frac{1}{8}, \frac{3}{16}]$ we obtain $\tilde{\psi}_k(\hat{\varphi}_{1,\lambda}^t) \xrightarrow{\lambda \rightarrow \infty} \mathcal{H}_{\mathcal{R}_p}(\nu, t)$ (see Step 4).

In any case we then proceed analogously as in Step 2 and the desired homotopy is given as in the second part of (110). ■

In this situation one says that the set J_ρ^{-L} dominates $Y_{\mathcal{R}}$ (see [24], page 528). Recall now that Y is not contractible, see Proposition 5.6; being $Y_{\mathcal{R}}$ a deformation retract of Y , see Remark 4.16, we get that $Y_{\mathcal{R}}$ is not contractible too. Therefore, by the latter result we deduce that

$$\Phi_\lambda(Y_{\mathcal{R}}) \text{ is not contractible in } J_\rho^{-L}.$$

Moreover, one can take λ large enough so that $\Phi_\lambda(Y_{\mathcal{R}}) \subset J_\rho^{-2L}$. We next define the topological cone over $Y_{\mathcal{R}}$ by the equivalence relation

$$\mathcal{C} = Y_{\mathcal{R}} \times [0, 1] / Y_{\mathcal{R}} \times \{0\},$$

where $Y_{\mathcal{R}} \times \{0\}$ is identified to a single point and consider the min-max value:

$$m = \inf_{h \in \Gamma} \max_{\xi \in \mathcal{C}} J_\rho(h(\xi)),$$

where

$$(111) \quad \Gamma = \left\{ h : \mathcal{C} \rightarrow H^1(\Sigma) \times H^1(\Sigma) : h(\nu, p, s) = \Phi_\lambda(\nu, p, s) \quad \forall (\nu, p, s) \in \partial\mathcal{C} \simeq Y_{\mathcal{R}} \right\}.$$

First, we observe that the map from \mathcal{C} to $H^1(\Sigma) \times H^1(\Sigma)$ defined by $(\cdot, t) \mapsto t\Phi_\lambda(\cdot)$ belongs to Γ , hence this is a non-empty set. Moreover, by the choice of Φ_λ we have

$$\sup_{(\nu, p, s) \in \partial\mathcal{C}} J_\rho(h(\nu, p, s)) = \sup_{(\nu, p, s) \in Y_{\mathcal{R}}} J_\rho(\Phi_\lambda(\nu, p, s)) \leq -2L.$$

The crucial point is to show that $m \geq -L$. Indeed, $\partial\mathcal{C}$ is contractible in \mathcal{C} , and hence in $h(\mathcal{C})$ for any $h \in \Gamma$. On the other hand by the fact that $Y_{\mathcal{R}}$ is not contractible and by Proposition 5.10 $\partial\mathcal{C}$ is not contractible in J_ρ^{-L} , so we deduce that $h(\mathcal{C})$ is not contained in J_ρ^{-L} . Being this valid for any $h \in \Gamma$, we conclude that necessarily $m \geq -L$.

It follows from standard variational arguments (see [44]) that the functional J_ρ admits a Palais-Smale sequence at level m . However, this does not guarantee the existence of a critical point, since it is not known whether the Palais-Smale condition holds or not. To bypass this problem one needs a different argument, usually named as *monotonicity trick*. This technique was first introduced by Struwe in [43] (see also [18, 25, 32]) and has been used intensively, so we will be sketchy.

Let us take $\eta > 0$ such that $[\rho_1 - 2\eta, \rho_1 + 2\eta] \times [\rho_2 - 2\eta, \rho_2 + 2\eta] \subset \mathbb{R}^2 \setminus \Lambda$, where Λ is the set defined in (10). Consider then a parameter $\gamma \in [-\eta, \eta]$. It is easy to see that the above min-max geometry holds uniformly for any $\rho_\gamma = (\rho_1 + \gamma, \rho_2 + \gamma)$. In particular, for any $L > 0$, there exists λ large enough so that

$$(112) \quad \sup_{(\nu, p, s) \in \partial\mathcal{C}} J_{\rho_\gamma}(h(\nu, p, s)) < -2L; \quad m_\gamma = \inf_{h \in \Gamma} \sup_{\xi \in \mathcal{C}} J_{\rho_\gamma}(h(\xi)) \geq -L.$$

In this setting, the following result is well-known.

Lemma 5.11. *The functional $J_{\rho_{\tilde{\gamma}}}$ possesses a bounded Palais-Smale sequence $(u_{1,n}, u_{2,n})_n$ at level $m_{\tilde{\gamma}}$ for almost every $\tilde{\gamma} \in \Upsilon = [-\eta, \eta]$.*

Standard arguments show that a bounded Palais-Smale sequence yields the existence of a critical point, see e.g. Proposition 5.4 in [33]. Consider now $\tilde{\gamma}_n \in \Upsilon$ such that $\tilde{\gamma}_n \rightarrow 0$, and let $(u_{1,n}, u_{2,n})_n$ denote the corresponding solutions. To conclude, it is then sufficient to apply the compactness result given in Theorem 2.1, which implies convergence of $(u_{1,n}, u_{2,n})$ to a solution of (1).

6. APPENDIX: PROOF OF PROPOSITION 4.7

The energy estimates of Proposition 4.7 will follow from the next three Lemmas.

Lemma 6.1. *If φ_1, φ_2 are defined as in (82), we have that*

$$\int_{\Sigma} \varphi_1 dV_g = O(1), \quad \int_{\Sigma} \varphi_2 dV_g = O(1).$$

PROOF. From elementary inequalities (see also Figure 2) it is easy to show that there exists a constant C so that

$$|\varphi_1| + |\varphi_2| \leq C \left(1 + \log \frac{1}{d(\cdot, p)} + \sum_i \frac{1}{d(\cdot, \tilde{x}_i)} \right).$$

As the logarithm of the distance from a fixed point is integrable, the conclusion easily follows. ■

In the following, for positive numbers a, b we will use the notation

$$(113) \quad a \simeq_C b \quad \Leftrightarrow \quad \exists C > 1 \text{ such that } \frac{b}{C} \leq a \leq Cb.$$

Lemma 6.2. *Under the above assumptions one has*

$$\int_{\Sigma} e^{\varphi_1} dV_g \simeq_C \hat{\mathfrak{s}}^4 \tau_\lambda^2 \check{\lambda}^2, \quad \int_{\Sigma} e^{\varphi_2} dV_g \simeq_C \max \left\{ \frac{\tilde{\tau}^2}{\hat{\mathfrak{s}}^2 \mu^4}, 1 \right\}.$$

PROOF. Let $\tau \in (0, +\infty]$ be fixed and let $\hat{\nu} \in \Sigma_{k,p,\bar{\tau}}$ be as in (75). For simplicity we may assume that there is only one point in the support of $\hat{\nu}$, i.e. $\hat{\nu} = \delta_{x_j}$. The case of a general $\hat{\nu}$ is then treated in analogous way. It is not difficult to show that the terms $-\frac{1}{2}v_2, -\frac{1}{2}v_{1,1}$ do not affect the integrals of e^{φ_1} and e^{φ_2} , respectively, and that

$$\int_{\Sigma} e^{\varphi_1} dV_g \simeq_C \int_{\Sigma} e^{v_1} dV_g, \quad \int_{\Sigma} e^{\varphi_2} dV_g \simeq_C \int_{\Sigma} e^{v_2} dV_g.$$

Therefore, it is enough to prove the following:

$$(114) \quad \int_{\Sigma} e^{v_1} dV_g \simeq_C \hat{s}^4 \tau^2 \check{\lambda}^2, \quad \int_{\Sigma} e^{v_2} dV_g \simeq_C \max \left\{ \frac{\tilde{\tau}^2}{\hat{s}^2 \mu^4}, 1 \right\}.$$

We start by observing that, by definition, for $d(x_j, p) \leq \frac{4}{\lambda_j}$ one has

$$v_1(x) = \log \frac{1}{((\hat{s}\tau\lambda)^{-2} + d(x, p)^2)^3}.$$

By an elementary change of variables we find

$$(115) \quad \int_{\Sigma} e^{v_1} dV_g = \int_{\Sigma} \frac{1}{((\hat{s}\tau\lambda)^{-2} + d(x, p)^2)^3} dV_g \simeq_C \hat{s}^4 \tau^4.$$

By the definition of τ and $\hat{\nu} \in \Sigma_{k,p,\bar{\tau}}$ (see in particular (72) and (73)), recalling that $d(x_j, p) \leq \frac{4}{\lambda_j}$ and that $\lambda_j \geq \lambda$ by construction, we get

$$(116) \quad \frac{1}{\tau} \leq d(x_j, p) \leq \frac{4}{\lambda_j} \leq \frac{C}{\lambda}.$$

By taking λ sufficiently large we deduce $\tau \gg 1$. It follows that $\check{s} = 1$ and $\check{\lambda} = \lambda$, see (79). Moreover, by (116) we have

$$\frac{C}{\lambda} \leq \tau\lambda \leq \lambda.$$

Therefore, we can rewrite (115) as

$$\int_{\Sigma} e^{v_1} dV_g = \int_{\Sigma} \frac{1}{((\hat{s}\tau)^{-2} + d(x, p)^2)^3} dV_g \simeq_C \hat{s}^4 \tau^2 \check{\lambda}^2$$

and the proof of the first part of (114) is concluded. Suppose now $d(x_j, p) > \frac{4}{\lambda_j}$ and divide Σ into three subsets:

$$\mathcal{A} = A_{\tilde{x}_j} \left(\frac{1}{s_j \lambda_j}, \frac{d(\tilde{x}_j, p)}{4} \right), \quad \mathcal{B} = B_{\frac{1}{s_j \lambda_j}}(\tilde{x}_j), \quad \mathcal{C} = \Sigma \setminus (\mathcal{A} \cup \mathcal{B}).$$

We start by estimating

$$\int_{\mathcal{B}} e^{v_1} dV_g = \int_{B_{\frac{1}{s_j \lambda_j}}(\tilde{x}_j)} \frac{s_j^4 \lambda_j^4 d(\tilde{x}_j, p)^4}{((\hat{s}\tau\lambda)^{-2} + d(x, p)^2)^3} dV_g.$$

Observe that if in the latter formula we substitute $d(x, p)$ with $d(\tilde{x}_j, p)$ we get negligible errors which will be omitted. Therefore, we can rewrite it as

$$\begin{aligned} \int_{\mathcal{B}} e^{v_1} dV_g &= \int_{B_{\frac{1}{s_j \lambda_j}}(\tilde{x}_j)} \frac{s_j^4 \lambda_j^4}{d(\tilde{x}_j, p)^2} \frac{1}{((\hat{s}\tau\lambda d(\tilde{x}_j, p))^{-2} + 1)^3} dV_g \\ &= \frac{s_j^2 \lambda_j^2}{d(\tilde{x}_j, p)^2} \frac{C}{((\hat{s}\tau\lambda d(\tilde{x}_j, p))^{-2} + 1)^3} = s_j^2 \tilde{s}_j^2 \frac{\lambda_j^2}{d(x_j, p)^2} \frac{C}{((\hat{s}\tau\lambda d(\tilde{x}_j, p))^{-2} + 1)^3}, \end{aligned}$$

where in the last equality we have used (77). Exploiting now the conditions (80) and (81), the assumption $d(x_j, p) > \frac{4}{\lambda_j}$ and recalling that $d(x_j, p) \geq \frac{1}{\tau}$ by definition (73), we conclude that

$$\int_{\mathcal{B}} e^{v_1} dV_g = \hat{s}^4 \tau^2 \check{\lambda}^2 \frac{C}{((\hat{s}\tau\lambda d(\tilde{x}_j, p))^{-2} + 1)^3} \simeq_C \hat{s}^4 \tau^2 \check{\lambda}^2.$$

It is then not difficult to show that

$$\int_{\mathcal{A}} e^{v_1} dV_g \leq \hat{s}^4 \tau_\lambda^2 \check{\lambda}^2 C, \quad \int_{\mathcal{C}} e^{v_1} dV_g \leq \hat{s}^4 \tau_\lambda^2 \check{\lambda}^2 C,$$

for some $C > 0$. This concludes the proof of the first part of (114).

For the second part of (114), similarly as before, we divide Σ into

$$\tilde{\mathcal{A}} = A_p \left(\frac{1}{\hat{s}\tilde{\tau}}, \frac{1}{\hat{s}\mu} \right), \quad \tilde{\mathcal{B}} = B_{\frac{1}{\hat{s}\tilde{\tau}}}(p), \quad \tilde{\mathcal{C}} = \Sigma \setminus (\tilde{\mathcal{A}} \cup \tilde{\mathcal{B}}).$$

For $x \in \tilde{\mathcal{B}}$ we have $v_2(x) = \log\left(\frac{\mu}{\tilde{\tau}}\right)^{-4}$, hence

$$(117) \quad \int_{\tilde{\mathcal{B}}} e^{v_2} dV_g = \int_{B_{\frac{1}{\hat{s}\tilde{\tau}}}(p)} \left(\frac{\mu}{\tilde{\tau}}\right)^{-4} dV_g = \frac{\tilde{\tau}^2}{\hat{s}^2 \mu^4} C.$$

Moreover, working in normal coordinates around p one gets

$$(118) \quad \int_{\tilde{\mathcal{A}}} e^{v_2} dV_g \leq \frac{\tilde{\tau}^2}{\hat{s}^2 \mu^4} C,$$

for some $C > 0$. On the other hand, we have

$$(119) \quad \int_{\tilde{\mathcal{C}}} e^{v_2} dV_g \simeq_C 1.$$

From (117), (118) and (119) it follows that

$$\int_{\Sigma} e^{v_2} dV_g \simeq_C \max \left\{ \frac{\tilde{\tau}^2}{\hat{s}^2 \mu^4}, 1 \right\},$$

which concludes the proof of the second part of (114). ■

Recalling the definition of $\hat{\nu} \in \Sigma_{k,p,\tilde{\tau}}$ in (75) we introduce now the following sets of indices: let $I \subseteq \{1, \dots, k\}$ be given by

$$I = \left\{ i : d(x_i, p) > \frac{4}{\lambda_i} \right\}.$$

We then subdivide I into two subsets $I_1, I_2 \subseteq I$:

$$(120) \quad I_1 = \left\{ i : d(x_i, p) \leq \frac{1}{\tau_\lambda} \right\}, \quad I_2 = \left\{ i : d(x_i, p) > \frac{1}{\tau_\lambda} \right\}.$$

Lemma 6.3. *Under the above assumptions one has*

$$\begin{aligned} \int_{\Sigma} Q(\varphi_1, \varphi_2) dV_g &\leq 8\pi(\log \tilde{\tau} - \log \mu) + 8|I_1|\pi(\log \check{\lambda} - \log \tau_\lambda) + \sum_{i \in I_2} 8\pi(\log s_i + \log \lambda_i - \log d(\tilde{x}_i, p)) + \\ &+ 16\pi \sum_{i \in I_2} \log d(\tilde{x}_i, p) + (24\pi \log \tau_\lambda + 24\pi \log \hat{s}) + C, \end{aligned}$$

for some $C = C(\Sigma)$.

PROOF. We start by observing that, by definition, $\nabla v_{1,1} = 0$ in $\Sigma \setminus \bigcup_{i \in I} A_{\tilde{x}_i} \left(\frac{1}{s_i \lambda_i}, \frac{d(\tilde{x}_i, p)}{4} \right)$, while $\nabla v_2 = 0$ in $\Sigma \setminus A_p \left(\frac{1}{\hat{s}\tilde{\tau}}, \frac{1}{\hat{s}\mu} \right)$. We next prove the following estimates on the gradients of $v_{1,1}, v_{1,2}$ and v_2 :

$$(121) \quad |\nabla v_{1,1}(x)| \leq \frac{4}{d_{\min}(x)} \quad \text{in } \bigcup_{i \in I} A_{\tilde{x}_i} \left(\frac{1}{s_i \lambda_i}, \frac{d(\tilde{x}_i, p)}{4} \right),$$

$$(122) \quad |\nabla v_2(x)| \leq \frac{4}{d(x, p)} \quad \text{in } A_p \left(\frac{1}{\hat{s}\tilde{\tau}}, \frac{1}{\hat{s}\mu} \right),$$

$$(123) \quad |\nabla v_{1,2}(x)| \leq \frac{6}{d(x, p)} \quad \text{for every } x \in \Sigma,$$

where $d_{min}(x) = \min_{i \in I} d(x, \tilde{x}_i)$ and

$$(124) \quad |\nabla v_{1,2}(x)| \leq C \hat{s} \tau_\lambda \quad \text{for every } x \in \Sigma,$$

where C is a constant independent of τ_λ and \hat{s} .

Concerning (121) and (122) we show the inequalities just for $v_{1,1}$, as for v_2 the proof is similar. We have that

$$\begin{aligned} \nabla v_{1,1}(x) &= -4 \frac{\sum_{i=1}^k t_i \left(\frac{d(x, \tilde{x}_i)}{d(\tilde{x}_i, p)} \right)^{-5} \nabla_x \left(\frac{d(x, \tilde{x}_i)}{d(\tilde{x}_i, p)} \right)}{\sum_{j=1}^k t_j \left(\frac{d(x, \tilde{x}_j)}{d(\tilde{x}_j, p)} \right)^{-4}} = -4 \frac{\sum_{i=1}^k t_i \left(\frac{d(x, \tilde{x}_i)}{d(\tilde{x}_i, p)} \right)^{-4} \frac{\nabla_x d(x, \tilde{x}_i)}{d(x, \tilde{x}_i)}}{\sum_{j=1}^k t_j \left(\frac{d(x, \tilde{x}_j)}{d(\tilde{x}_j, p)} \right)^{-4}} \\ &= -4 \frac{\sum_{i=1}^k t_i \left(\frac{d(x, \tilde{x}_i)}{d(\tilde{x}_i, p)} \right)^{-4} \frac{\nabla_x d(x, \tilde{x}_i)}{d_{min}(x)}}{\sum_{j=1}^k t_j \left(\frac{d(x, \tilde{x}_j)}{d(\tilde{x}_j, p)} \right)^{-4}}. \end{aligned}$$

Exploiting the fact that $|\nabla_x d(x, \tilde{x}_i)| \leq 1$ we obtain (121). Moreover, by direct computations one gets (122). We consider now

$$\nabla v_{1,2}(x) = -3 \frac{\hat{s}^2 \tau_\lambda^2 \nabla_x (d^2(x, p))}{1 + \hat{s}^2 \tau_\lambda^2 d^2(x, p)}.$$

Using the estimate $|\nabla_x (d^2(x, p))| \leq 2d(x, p)$ the properties (123) and (124) easily follow by the inequalities

$$\frac{\hat{s}^2 \tau_\lambda^2 d^2(x, p)}{1 + \hat{s}^2 \tau_\lambda^2 d^2(x, p)} \leq 1, \quad \frac{\hat{s} \tau_\lambda d(x, p)}{1 + \hat{s}^2 \tau_\lambda^2 d^2(x, p)} \leq 1; \quad \text{for every } x \in \Sigma,$$

respectively. Recalling the definitions of φ_1, φ_2 in (82) and that $v_1 = v_{1,1} + v_{1,2}$, we obtain

$$\begin{aligned} (125) \quad \int_\Sigma Q(\varphi_1, \varphi_2) dV_g &= \frac{1}{3} \int_\Sigma (|\nabla \varphi_1|^2 + |\nabla \varphi_2|^2 + \nabla \varphi_1 \cdot \nabla \varphi_2) dV_g \\ &= \frac{1}{3} \int_\Sigma \left(|\nabla v_1|^2 + \frac{1}{4} |\nabla v_2|^2 - \nabla v_1 \cdot \nabla v_2 \right) dV_g + \frac{1}{3} \int_\Sigma \left(|\nabla v_2|^2 + \frac{1}{4} |\nabla v_{1,1}|^2 - \nabla v_2 \cdot \nabla v_{1,1} \right) dV_g + \\ &+ \frac{1}{3} \int_\Sigma \left(\nabla v_1 - \frac{1}{2} \nabla v_2 \right) \cdot \left(\nabla v_2 - \frac{1}{2} \nabla v_{1,1} \right) dV_g \\ &= \frac{1}{4} \int_\Sigma |\nabla v_{1,1}|^2 dV_g + \frac{1}{4} \int_\Sigma |\nabla v_2|^2 dV_g + \frac{1}{3} \int_\Sigma |\nabla v_{1,2}|^2 dV_g + \int_\Sigma \left(\frac{1}{6} \nabla v_{1,1} \cdot \nabla v_{1,2} - \frac{7}{12} \nabla v_{1,1} \cdot \nabla v_2 \right) dV_g. \end{aligned}$$

We start by observing that the integral of the mixed terms is uniformly bounded. Indeed, we claim that

$$(126) \quad \nabla v_{1,1} \cdot \nabla v_2 = 0.$$

By the remark before (121), (126) will follow by proving that $A_{\tilde{x}_i} \left(\frac{1}{s_i \lambda_i}, \frac{d(\tilde{x}_i, p)}{4} \right) \cap A_p \left(\frac{1}{\hat{s} \tau}, \frac{1}{\hat{s} \mu} \right) = \emptyset$ for all $i \in I$. Recall the constant $\bar{\delta}$ in (77). Clearly, when all the points of the support of $\hat{\nu}$ are bounded away from p , i.e. $d(x_i, p) > \bar{\delta}$ for all i , we get the conclusion. Consider now the case $d(x_i, p) \leq \bar{\delta}$ for some i and observe that in this case $\tilde{s}_i = \hat{s}$, see (77). Moreover, by taking $\bar{\delta}$ sufficiently small, one has also $\check{s} \leq C$ by the definition (79) (see also (116) and the motivation above it). To prove that the above two subsets are disjoint, one has just to ensure that $d(\tilde{x}_i, p) \gg \frac{1}{\hat{s} \mu}$. We distinguish between two cases. Suppose first that $d(x_i, p) > \frac{1}{\tau_\lambda}$. By the assumptions we have made and by (80), one gets

$$d(\tilde{x}_i, p) = \frac{1}{\tilde{s}_i} d(x_i, p) = \frac{1}{\hat{s}} d(x_i, p) \geq \frac{1}{\hat{s} \lambda_i} = \frac{1}{\hat{s} d(x_i, p) \tau_\lambda \check{\lambda}} \geq \frac{1}{C \hat{s} \tau_\lambda \check{\lambda}} = \frac{1}{C \hat{s} \tau_\lambda \check{s} \lambda} \geq \frac{1}{C \hat{s} \tau_\lambda \lambda} \gg \frac{1}{\hat{s} \mu}$$

by the choice of the parameters μ and λ . The case $d(x_i, p) \leq \frac{1}{\tau_\lambda}$ is treated in the same way with minor modifications. This concludes the proof of (126).

We claim now that

$$(127) \quad \int_\Sigma \nabla v_{1,1} \cdot \nabla v_{1,2} dV_g \leq C.$$

We introduce the sets

$$(128) \quad A_i = \left\{ x \in \Sigma : d(x, \tilde{x}_i) = \min_{j \in I} d(x, x_j) \right\}.$$

By (121) and (124) we get

$$\begin{aligned} \int_{\Sigma} \nabla v_{1,1} \cdot \nabla v_{1,2} dV_g &\leq \int_{\Sigma} \frac{C}{d_{\min}(x) d(x, p)} dV_g \leq \sum_{i \in I} \int_{A_i} \frac{C}{d(x, \tilde{x}_i) d(x, p)} dV_g \\ &\leq \sum_{i \in I} \int_{A_{\tilde{x}_i} \left(\frac{1}{s_i \lambda_i}, \frac{d(\tilde{x}_i, p)}{4} \right)} \frac{C}{d(x, \tilde{x}_i) d(\tilde{x}_i, p)} dV_g \leq C, \end{aligned}$$

which proves the claim (127).

Using the estimate (121) one has

$$\begin{aligned} \frac{1}{4} \int_{\Sigma} |\nabla v_{1,1}|^2 dV_g &\leq 4 \int_{\Sigma} \frac{1}{d_{\min}^2(x)} dV_g \leq 4 \sum_{i \in I} \int_{A_i} \frac{1}{d^2(x, \tilde{x}_i)} dV_g \\ &\leq 4 \sum_{i \in I} \int_{A_{\tilde{x}_i} \left(\frac{1}{s_i \lambda_i}, \frac{d(\tilde{x}_i, p)}{4} \right)} \frac{1}{d^2(x, \tilde{x}_i)} dV_g \\ (129) \quad &\leq \sum_{i \in I} 8\pi (\log s_i + \log \lambda_i + \log d(\tilde{x}_i, p)) + C. \end{aligned}$$

Recalling the definition of $I_1, I_2 \subseteq I$ given in (120) we observe the following: for $i \in I_1$ we get $\lambda_i = \check{\lambda}$ and $\tilde{s}_i = \hat{\mathfrak{s}}$, see (80) and (77), respectively. Moreover, taking into account (81) we deduce

$$\begin{aligned} \frac{1}{4} \int_{\Sigma} |\nabla v_{1,1}|^2 dV_g &\leq 8|I_1| \pi (\log \check{\lambda} - \log \tau_{\lambda}) + \sum_{i \in I_2} 8\pi (\log s_i + \log \lambda_i + \log d(\tilde{x}_i, p)) + C \\ (130) \quad &= 8|I_1| \pi (\log \check{\lambda} - \log \tau_{\lambda}) + \sum_{i \in I_2} 8\pi (\log s_i + \log \lambda_i - \log d(\tilde{x}_i, p)) + \\ &+ 16\pi \sum_{i \in I_2} \log d(\tilde{x}_i, p) + C. \end{aligned}$$

Similarly as for (129), by (122) we get

$$(131) \quad \frac{1}{4} \int_{\Sigma} |\nabla v_{1,2}|^2 dV_g = 4 \int_{A_p \left(\frac{1}{\tilde{s}\tilde{\tau}}, \frac{1}{\tilde{s}\tilde{\mu}} \right)} \frac{1}{d^2(x, p)} dV_g \leq 8\pi (\log \tilde{\tau} - \log \mu) + C.$$

To estimate the term $|\nabla v_{1,2}|^2$ we consider $\Sigma = B_{\frac{1}{\tilde{s}\tilde{\tau}\lambda}}(p) \cup (\Sigma \setminus B_{\frac{1}{\tilde{s}\tilde{\tau}\lambda}}(p))$. From (123) we deduce that

$$\int_{B_{\frac{1}{\tilde{s}\tilde{\tau}\lambda}}(p)} |\nabla v_{1,2}|^2 dV_g \leq C.$$

Using then (123) one finds

$$(132) \quad \frac{1}{3} \int_{\Sigma \setminus B_{\frac{1}{\tilde{s}\tilde{\tau}\lambda}}(p)} |\nabla v_{1,2}|^2 dV_g \leq 12 \int_{\Sigma \setminus B_{\frac{1}{\tilde{s}\tilde{\tau}\lambda}}(p)} \frac{1}{d^2(x, p)} dV_g \leq 24\pi (\log \tau_{\lambda} + \log \hat{\mathfrak{s}}) + C.$$

Finally, by (126), (127) and inserting (130), (131) and (132) into (125) we get the conclusion. \blacksquare

PROOF OF PROPOSITION 4.7. Using Lemmas 6.1, 6.2 and 6.3, the energy estimate we get is

$$J_p(\varphi_1, \varphi_2) \leq 8\pi (\log \tilde{\tau} - \log \mu) + 8|I_1| \pi (\log \check{\lambda} - \log \tau_{\lambda}) + \sum_{i \in I_2} 8\pi (\log s_i + \log \lambda_i - \log d(\tilde{x}_i, p)) + 16\pi \sum_{i \in I_2} \log d(\tilde{x}_i, p) +$$

$$\begin{aligned}
& + (24\pi \log \tau_\lambda + 24\pi \log \hat{\mathfrak{s}}) - \rho_1(4 \log \hat{\mathfrak{s}} + 2 \log \tau_\lambda + 2 \log \check{\lambda}) - \rho_2 \log \max \left\{ \frac{\tilde{\tau}^2}{\hat{\mathfrak{s}}^2 \mu^4}, 1 \right\} + C \\
& \leq 8\pi(\log \tilde{\tau} - \log \mu) + 8|I_1|\pi(\log \check{\lambda} - \log \tau_\lambda) + \sum_{i \in I_2} 8\pi(\log s_i + \log \tilde{s}_i + \log \lambda_i - \log d(x_i, p)) + \\
& + 16\pi \sum_{i \in I_2} \log d(\tilde{x}_i, p) + (24\pi \log \tau_\lambda + 24\pi \log \hat{\mathfrak{s}}) - \rho_1(4 \log \hat{\mathfrak{s}} + 2 \log \tau_\lambda + 2 \log \check{\lambda}) + \\
& - \rho_2 \log \max \left\{ \frac{\tilde{\tau}^2}{\hat{\mathfrak{s}}^2 \mu^4}, 1 \right\} + C,
\end{aligned}$$

for some constant $C > 0$. Exploiting the conditions (80) and (81) we obtain

$$\begin{aligned}
(133) \quad J_\rho(\varphi_1, \varphi_2) & \leq 8\pi(\log \tilde{\tau} - \log \mu) + 8|I_1|\pi(\log \check{\lambda} - \log \tau_\lambda) + \sum_{i \in I_2} 8\pi(2 \log \hat{\mathfrak{s}} + \log \check{\lambda} + \log \tau_\lambda) + \\
& + 16\pi \sum_{i \in I_2} \log d(\tilde{x}_i, p) + (24\pi \log \tau_\lambda + 24\pi \log \hat{\mathfrak{s}}) - \rho_1(4 \log \hat{\mathfrak{s}} + 2 \log \tau_\lambda + 2 \log \check{\lambda}) + \\
& - \rho_2 \log \max \left\{ \frac{\tilde{\tau}^2}{\hat{\mathfrak{s}}^2 \mu^4}, 1 \right\} + C.
\end{aligned}$$

Recalling the definition of I_1, I_2 in (120), we distinguish between two cases.

Case 1. Suppose first that $I_1 \neq \emptyset$. By construction it follows that $\tau \gg 1$, see (72) and (73). Therefore, by (78) we get $\hat{\mathfrak{s}} = \mathfrak{s}$. On the other hand, using (79) and the definition of $\check{\lambda}$ under it, we deduce $\check{\lambda} \leq C\lambda$.

For $\hat{\mathfrak{s}} \ll \frac{\tilde{\tau}}{\mu^2}$ we get in (133) the following:

$$(134) \quad \max \left\{ \frac{\tilde{\tau}^2}{\hat{\mathfrak{s}}^2 \mu^4}, 1 \right\} = \frac{\tilde{\tau}^2}{\hat{\mathfrak{s}}^2 \mu^4}.$$

In this case (133) can be rewritten as

$$\begin{aligned}
(135) \quad J_\rho(\varphi_1, \varphi_2) & \leq \log \tilde{\tau} (8\pi - 2\rho_2) + \log \lambda (8(|I_1| + |I_2|)\pi - 2\rho_1) + \log \hat{\mathfrak{s}} (24\pi + 16|I_2|\pi - 4\rho_1 + 2\rho_2) + \\
& + \log \tau_\lambda (8|I_2|\pi - 8|I_1|\pi + 24\pi - 2\rho_1) + \log \mu (4\rho_2 - 8\pi) + C.
\end{aligned}$$

Recalling that $\hat{\mathfrak{s}} \ll \frac{\tilde{\tau}}{\mu^2}$, the latter estimate is negative by the choice of the parameters $\tilde{\tau} \gg \mu \gg \lambda$ and $\rho_2 > 4\pi$.

When instead $\hat{\mathfrak{s}} = \frac{\tilde{\tau}}{\mu^2} + O(1)$ we have

$$(136) \quad \max \left\{ \frac{\tilde{\tau}^2}{\hat{\mathfrak{s}}^2 \mu^4}, 1 \right\} = 1.$$

Considering now (133) and observing that $\log \hat{\mathfrak{s}} = \log \tilde{\tau} - 2 \log \mu + C$, we end up with

$$\begin{aligned}
J_\rho(\varphi_1, \varphi_2) & \leq \log \tilde{\tau} (32\pi + 16|I_2|\pi - 4\rho_1) + \log \lambda (8(|I_1| + |I_2|)\pi - 2\rho_1) \\
& + \log \tau_\lambda (8|I_2|\pi - 8|I_1|\pi + 24\pi - 2\rho_1) + \log \mu (8\rho_1 - 56\pi - 32|I_2|\pi) + C.
\end{aligned}$$

The crucial fact is that by construction of $\Sigma_{k,p,\tilde{\tau}}$, see (70), it holds $|I_2| \leq k - 2$ whenever $|I_1| \neq \emptyset$. Hence, we conclude that

$$\begin{aligned}
J_\rho(\varphi_1, \varphi_2) & \leq \log \tilde{\tau} (16k\pi - 4\rho_1) + \log \lambda (8(|I_1| + |I_2|)\pi - 2\rho_1) + \log \tau_\lambda (8|I_2|\pi - 8|I_1|\pi + 24\pi - 2\rho_1) + \\
& + \log \mu (8\rho_1 - 56\pi - 32|I_2|\pi) + C.
\end{aligned}$$

which is large negative since $\rho_1 > 4k\pi$ and by the choice of the parameters.

Case 2. Suppose now $I_1 = \emptyset$. By construction we deduce that $\tau \leq C$, see (72) and (73). Therefore, using (78) we obtain $\hat{\mathfrak{s}} \leq C$. In this case the equality in (134) always holds true. Moreover, by (79) we have $\check{\lambda} = \mathfrak{s}\lambda$. Hence, (133) can be rewritten as

$$\begin{aligned}
J_\rho(\varphi_1, \varphi_2) & \leq \log \mathfrak{s} (8|I_2|\pi - 2\rho_1) + \log \tilde{\tau} (8\pi - 2\rho_2) + \log \lambda (8|I_2|\pi - 2\rho_1) + \\
& + \log \tau_\lambda (8|I_2|\pi + 24\pi - 2\rho_1) + \log \mu (4\rho_2 - 8\pi) + C.
\end{aligned}$$

Observing that $|I_2| \leq k$ we conclude that the latter estimate is large negative since $\rho_1 > 4k\pi$, $\rho_2 > 4\pi$ and by the choice of the parameters. ■

Acknowledgements

The authors would like to thank D. Ruiz for the discussions concerning the topic of this paper. Gratitude is also expressed to F. Callegaro, A. Carlotto, F. Cohen and F. De Marchis for their helpful comments.

REFERENCES

- [1] D. Bartolucci, A. Malchiodi, An improved geometric inequality via vanishing moments, with applications to singular liouville equations, *Comm. Math. Phys.* 322, no. 2, 415-452, 2013.
- [2] L. Battaglia, Existence and multiplicity result for the singular Toda system, *J. Math. Anal. Appl.* 424, no. 1, 49-85, 2015.
- [3] L. Battaglia, A. Jevnikar, A. Malchiodi, D. Ruiz, A general existence result for the Toda System on compact surfaces, preprint, 2013, arXiv <http://arxiv.org/abs/1306.5404>.
- [4] L. Battaglia, G. Mancini, A note on compactness properties of singular Toda systems, preprint, 2014, arXiv <http://arxiv.org/abs/1410.4991>.
- [5] J. Bolton, L. M. Woodward, Some geometrical aspects of the 2-dimensional Toda equations, In *Geometry, topology and physics (Campinas, 1996)*, 69-81. de Gruyter, Berlin, 1997.
- [6] R. Bott, L.W. Tu, *Differential forms in algebraic topology*, Graduate Texts in Mathematics 82. Springer-Verlag, New York-Berlin, 1982.
- [7] H. Brezis, F. Merle, Uniform estimates and blow-up behavior for solutions of $-\Delta u = V(x)e^u$ in two dimensions, *Commun. Partial Differ. Equations* 16, no. 8-9, 1223-1253, 1991.
- [8] E. Calabi, Isometric imbedding of complex manifolds, *Ann. of Math. (2)* 58, 1-23, 1953.
- [9] W.X. Chen, C. Li, Prescribing Gaussian curvatures on surfaces with conical singularities, *J. Geom. Anal.* 1, no. 4, 359-372, 1991.
- [10] W.X. Chen, C. Li, Classification of solutions of some nonlinear elliptic equations, *Duke Math. J.* 63, no. 3, 615-622, 1991.
- [11] W.X. Chen, C. Li, Prescribing scalar curvature on S^n , *Pacific J. Math.* 199, no. 1, 61-78, 2001.
- [12] C.C. Chen, C.S. Lin, Topological degree for a mean field equation on Riemann surfaces, *Comm. Pure Appl. Math.* 56, no. 12, 1667-1727, 2003.
- [13] S.S. Chern, J. G. Wolfson, Harmonic maps of the two-sphere into a complex Grassmann manifold. II, *Ann. of Math. (2)* 125, no. 2, 301-335, 1987.
- [14] F.R. Cohen, The homology of C_{n+1} -spaces, *Springer Lecture Notes in Math.* 533, 207-351, 1976.
- [15] T. D'Aprile, A. Pistoia, D. Ruiz, A continuum of solutions for the SU(3) Toda System exhibiting partial blow-up, preprint, 2014, arXiv <http://arxiv.org/abs/1407.8407>.
- [16] T. D'Aprile, A. Pistoia, D. Ruiz, Asymmetric blow-up for the SU(3) Toda System, preprint, 2014, arXiv <http://arxiv.org/abs/1411.3482>.
- [17] M. del Pino, M. Kowalczyk, M. Musso, Singular limits in Liouville-type equations, *Calc. Var. Partial Differential Equations* 24, no. 1, 47-81, 2005.
- [18] W. Ding, J. Jost, J. Li, G. Wang, Existence results for mean field equations, *Ann. Inst. Henri Poincaré, Anal. Non Linéaire* 16, no. 5, 653-666, 1999.
- [19] Z. Djadli, Existence result for the mean field problem on Riemann surfaces of all genus, *Comm. Contemp. Math.* 10, no. 2, 205-220, 2008.
- [20] Z. Djadli, A. Malchiodi, Existence of conformal metrics with constant Q -curvature, *Annals of Math.* 168, no. 3, 813-858, 2008.
- [21] G. Dunne, Self-dual Chern-Simons Theories, *Lecture Notes in Physics*, vol. 36, Springer-Verlag, Berlin, 1995.
- [22] P. Esposito, M. Grossi, A. Pistoia, On the existence of blowing-up solutions for a mean field equation, *Ann. Inst. H. Poincaré Anal. Non Linéaire* 22, no. 2, 227-257, 2005.
- [23] D.B. Fuks, Cohomology of the braid group mod 2, *Funkcional. Anal. i Priložen.* 4, no. 2, 62-73, 1970.
- [24] A. Hatcher, *Algebraic Topology*, Cambridge University Press, 2002.
- [25] L. Jeanjean, On the existence of bounded Palais-Smale sequences and applications to a Landesman-Lazer type problem set on R^N , *Proc. Roy. Soc. Edinburgh A* 129, no. 4, 787-809, 1999.
- [26] J. Jost, C.S. Lin, G. Wang, Analytic aspects of the Toda system II. Bubbling behavior and existence of solutions, *Comm. Pure Appl. Math.* 59, no. 4, 526-558, 2006.
- [27] J. Jost, G. Wang, Analytic aspects of the Toda system I. A Moser-Trudinger inequality, *Comm. Pure Appl. Math.* 54, no. 11, 1289-1319, 2001.
- [28] S. Kallel, R. Karoui, Symmetric joins and weighted barycenters, *Advanced Nonlinear Studies* 11, 117-143, 2011.
- [29] Y.Y. Li, Harnack type inequality: The method of moving planes, *Commun. Math. Phys.* 200, no. 2, 421-444, 1999.
- [30] Y.Y. Li, I. Shafirir, Blow-up analysis for solutions of $-\Delta u = Ve^u$ in dimension two, *Indiana Univ. Math. J.* 43, no. 4, 1255-1270, 1994.

- [31] C.S. Lin, J. Wei, W. Yang, Degree counting and shadow system for $SU(3)$ Toda system: one bubbling, preprint, 2014, arXiv <http://arxiv.org/abs/1408.5802>.
- [32] M. Lucia, A deformation lemma with an application to a mean field equation, *Topol. Methods Nonlinear Anal.* 30, no. 1, 113-138, 2007.
- [33] A. Malchiodi, Topological methods for an elliptic equation with exponential nonlinearities, *Discrete Contin. Dyn. Syst.* 21, no. 1, 277-294, 2008.
- [34] A. Malchiodi, Morse theory and a scalar field equation on compact surfaces, *Adv. Diff. Eq.* 13, no. 11-12, 1109-1129, 2008.
- [35] A. Malchiodi, C.B. Ndiaye, Some existence results for the Toda system on closed surfaces, *Atti Accad. Naz. Lincei Cl. Sci. Fis. Mat. Natur. Rend. Lincei (9) Mat. Appl.* 18, no. 4, 391-412, 2007.
- [36] A. Malchiodi, D. Ruiz, A variational analysis of the Toda system on compact surfaces, *Comm. Pure Appl. Math.* 66, no. 3, 332-371, 2013.
- [37] A. Malchiodi, D. Ruiz, On the Leray-Schauder degree of the Toda system on compact surfaces, to appear in *Proc. A.M.S.*, arXiv <http://arxiv.org/abs/1311.7375>.
- [38] J.W. Milnor, Construction of Universal Bundles, II, *Ann. of Math.* 2, no. 63, 430-436, 1956.
- [39] M. Mimura, H. Toda, *Topology of Lie Groups I and II*, Translations of Math. Monographs 91, American Mathematical Society, Providence, RI, 1991.
- [40] M. Musso, A. Pistoia, J. Wei, New blow-up phenomena for $SU(n+1)$ toda system, preprint, 2013, arXiv <http://arxiv.org/abs/1402.3784>.
- [41] M. Nakaoka, Cohomology theory of a complex with a transformation of prime period and its applications, *J. Inst. Polytech. Osaka City Univ. Ser. A.* 7, no. 1-2, 51-102, 1956.
- [42] P. Salvatore, Configuration spaces on the sphere and higher loop spaces, *Math. Zeitschrift* 248, 527-540, 2004.
- [43] M. Struwe, On the evolution of harmonic mappings of Riemannian surfaces, *Comment. Math. Helv.* 60, no. 1, 558-581, 1985.
- [44] M. Struwe, *Variational Methods. Applications to Nonlinear Partial Differential Equations and Hamiltonian Systems*, 3rd edn. Springer-Verlag, Berlin, 2000.
- [45] G. Tarantello, *Self-Dual Gauge Field Vortices: An Analytical Approach*, Progress in Nonlinear Differential Equations and their Applications 72, Birkhäuser Boston, Inc., Boston, MA, 2007.
- [46] G. Tarantello, Analytical, geometrical and topological aspects of a class of mean field equations on surfaces, *Discrete Contin. Dyn. Syst.* 28, no. 3, 931-973, 2010.
- [47] G. Wang, Moser-Trudinger inequalities and Liouville systems, *C. R. Acad. Sci. Paris. Sér. I Math.* 328, no. 10, 895-900, 1999.
- [48] Y. Yang, *Solitons in Field Theory and Nonlinear Analysis*, Springer-Verlag, 2001.

(1) SISSA, VIA BONOMEA 265, 34136 TRIESTE (ITALY).

(2) AMERICAN UNIVERSITY OF SHARJAH, UNIVERSITY CITY, 26666 SHARJAH (UAE) AND LABORATOIRE PAINLEVÉ UNIVERSITÉ DE LILLE 1, CITÉ SCIENTIFIQUE, BATIMENT M2, 59655 VILLENEUVE D'ASCQ (FRANCE)

(3) SCUOLA NORMALE SUPERIORE, PIAZZA DEI CAVALIERI 7, 50126 PISA (ITALY)

E-mail address: ajevnika@sisssa.it, sadok.kallel@math.univ-lille1.fr, andrea.malchiodi@sns.it