

**PERFORMANCE ANALYSIS OF VARIOUS
DOMESTIC LIGHTING LUMINAIRES**

KEVIN KUMAR A/L SANTIAGO GEORGE

**FACULTY OF ENGINEERING
UNIVERSITY OF MALAYA
KUALA LUMPUR**

2018

**PERFORMANCE ANALYSIS OF VARIOUS DOMESTIC
LIGHTING LUMINAIRES**

KEVIN KUMAR A/L SANTIAGO GEORGE

**RESEARCH PROJECT SUBMITTED TO THE
FACULTY OF ENGINEERING
UNIVERSITY OF MALAYA, IN PARTIAL
FULFILMENT OF THE REQUIREMENTS FOR
THE DEGREE OF MASTER OF POWER SYSTEM
ENGINEERING**

2018

UNIVERSITY OF MALAYA
ORIGINAL LITERARY WORK DECLARATION

Name of Candidate: **Kevin Kumar a/l**

Santiago George

Registration/Matric No: **KQI 160010**

Name of Degree: **Master of Power System Engineering**

Title of Project Paper: **Performance Analysis of Various Domestic
Lighting Luminaires**

Field of Study: **Power System**

I do solemnly and sincerely declare that:

- (1) I am the sole author/writer of this Work;
- (2) This Work is original;
- (3) Any use of any work in which copyright exists was done by way of fair dealing and for permitted purposes and any excerpt or extract from, or reference to or reproduction of any copyright work has been disclosed expressly and sufficiently and the title of the Work and its authorship have been acknowledged in this Work;
- (4) I do not have any actual knowledge nor do I ought reasonably to know that the making of this work constitutes an infringement of any copyright work;
- (5) I hereby assign all and every rights in the copyright to this Work to the University of Malaya ("UM"), who henceforth shall be owner of the copyright in this Work and that any reproduction or use in any form or by any means whatsoever is prohibited without the written consent of UM having been first had and obtained;
- (6) I am fully aware that if in the course of making this Work I have infringed any copyright whether intentionally or otherwise, I may be subject to legal action or any other action as may be determined by UM.

Candidate's Signature

Date:

Subscribed and solemnly declared before,

Witness's Signature

Date:

Name:

Designation:

PERFORMANCE ANALYSIS OF VARIOUS DOMESTIC LIGHTING LUMINAIRES

ABSTRACT

Lighting consumes nearly 20% of total power consumption around the world and with the advancement of technology in this present day, there is a high probability that abundant energy savings can be achieved. Over the years, these lighting fittings have progressively been improved in terms of their efficiency, cost, brightness and other contributing factors. However, there are certain population of the public who still rely on old technology as there are not many made aware of the benefits. These are more prominent in the 3rd world countries that do not have the latest technology in hand. Based on their limited knowledge, the older technology in reality is consuming more power and the cost of maintaining the fitting is higher. The focus of this report is on the advancement of lighting luminaires present in the market. This report entails a thorough comparative analysis focusing on the major usage of lamps such as Incandescent Lamp (IL), Fluorescent Lamp (FL) and Light Emitting Diodes (LED). Other types of lamps are also compared in this report for analysis purposes. This report presents the utilization of lighting design software DIALux to carry out the tests of various lamps made available in the market in the present day. Results portray that utilizing LED lamps are key to obtain lower power consumption, reduce cost, and reduce number of fittings all whilst keeping an area of space well lit. The advancement in the development of LED lamps is progressing at a rapid pace and can be foreseen to lead the lighting industry in the years to come.

PERFORMANCE ANALYSIS OF VARIOUS DOMESTIC LIGHTING

LUMINAIRES

ABSTRAK

Kegunaan lampu menggunakan hampir 20% daripada jumlah penggunaan tenaga di seluruh dunia dan dengan kemajuan teknologi pada masa kini, terdapat peluang yang tinggi untuk penjimatan tenaga yang dapat dicapai. Baru-baru ini, teknologi lampu semakin meningkat dari segi kecekapan, kos, kecerahan dan faktor penyumbang yang lain. Walau bagaimanapun, terdapat penduduk tertentu yang masih bergantung pada teknologi lama oleh kerana kebanyakan tidak menyedari manfaatnya. Ini lebih menonjol di negara-negara dunia ke-3 yang tidak mempunyai teknologi terkini. Berdasarkan pengetahuan mereka yang terhad, teknologi lama dalam realiti menggunakan lebih kuasa dan kos untuk mengekalkan dan menggunakan lampu tersebut. Tumpuan laporan ini adalah mengenai kemajuan lampu yang terdapat di pasaran. Maka, analisis ini mempersembahkan komparatif menyeluruh yang memberi tumpuan kepada penggunaan utama lampu seperti lampu pijar (LP), lampu pendarfluor (LP) dan pemancar cahaya diod (PCD). Jenis lampu yang lain juga dibandingkan dalam laporan ini untuk tujuan analisis. Maka, analisis ini menggunakan perisian lampu bernama DIALux untuk menjalankan ujian beberapa jenis lampu yang terdapat di pasaran pada masa kini. Keputusan menggambarkan bahawa penggunaan lampu LED adalah kunci untuk mengurangkan penggunaan kuasa, kos, dan bilangan lampu sambil mengekalkan keterangan yang memuaskan. Kemajuan dalam teknologi lampu LED sedang maju pesat dan boleh diramalkan untuk memimpin industri lampu pada tahun-tahun yang akan datang.

ACKNOWLEDGEMENTS

I would like to express my gratitude to my supervisor, Professor Ir. Dr. Hazlie Bin Mokhlis for his valuable comments, advice and engagements through the process of writing this report. Professor Hazlie was always there when I faced a problem and provided solutions to the problem. His advice steered me in the right direction which ultimately, allowed me to complete this project paper.

Finally, I must express my profound gratitude to my family and other family members who were directly/indirectly involved in the process of writing this report. Their unfailing help and continuous encouragement is what drove me to complete this research report. This accomplishment would not have been achieved if not for their help. Thank you.

University of Malaya

TABLE OF CONTENTS

Abstract	iii
Abstrak	iv
Acknowledgements	v
Table of Contents	vi
List of Figures	ix
List of Tables.....	xii
List of Symbols and Abbreviations.....	xiv
List of Appendices	xix
CHAPTER 1: INTRODUCTION	1
1.1 Introduction	1
1.2 Problem Statement	2
1.3 Objectives.....	2
1.4 Scope of Work.....	2
1.5 Thesis Outline	3
CHAPTER 2: LITERATURE REVIEW.....	4
2.1 Introduction	4
2.1.1 Incandescent Lamps	4
2.1.2 Discharge Lamps.....	6
2.1.3 Light Emitting Diode (LED) Lamps	10

2.2	Comparison between incandescent, discharge and LED lamps.....	13
2.2.1	Efficacy	14
2.2.2	Environmental Concerns.....	17
2.2.3	Life-span and Lumens Depreciation	20
2.2.4	Cost Comparison.....	24
2.2.5	Correlated Colour Temperature and Colour Rendering Index.....	28
2.3	Life Cycle Assessment (LCA) for Different Lamps	31
2.4	Summary	37
CHAPTER 3: METHODOLOGY.....		38
3.1	Introduction.....	38
3.2	Fittings Selection.....	41
3.2.1	Fluorescent Lamp.....	43
3.2.2	Compact Fluorescent Lamp	44
3.2.3	Light Emitting Diode Lamp.....	45
3.3	Floor Layout Details	46
3.3.1	Case 1: Small Office Layout.....	46
3.3.2	Case 2: Large Office Layout.....	47
3.3.3	Case 3: Convenience Store Layout	48

CHAPTER 4: RESULTS AND DISCUSSION	49
4.1 Introduction	49
4.2 Photometric Chart, Illumination Levels and Costing.....	49
4.2.1 Photometric Chart	49
4.2.2 Illumination Levels of Different Light Fittings	50
4.2.3 Costing	50
4.3 Illumination Level, Total Power Consumption and Cost Estimate for Different Cases	51
4.3.1 Case 1: Small Office Summary.....	51
4.3.2 Case 2: Large Office Summary.....	56
4.3.3 Case 3: Convenience Store Summary	62
4.4 Discussion	68
CHAPTER 5: CONCLUSION.....	70
5.1 Conclusion	70
5.2 Recommendation for Future Works.....	71
REFERENCES.....	73
APPENDIX	81

LIST OF FIGURES

Figure 2.1:	Structure of a low-pressure mercury discharge lamp	7
Figure 2.2:	Demand for high-powered LED	11
Figure 2.3:	(a) Basic structure of an LED (b) Electro-luminescence.....	12
Figure 2.4:	(a) Basic LED operation. (b) radiated combination of electron-hole pair with emission of photon. (c) nonradiated combination:energy converted to phonons	13
Figure 2.5:	Average efficacy for different sectors	15
Figure 2.6:	Evolution of several lamps efficacies	16
Figure 2.7:	Lumen maintenance for different lamps.....	20
Figure 2.8:	Lumen maintenance for rated lamps	21
Figure 2.9:	Lumen depreciation under different temperatures.....	23
Figure 2.10:	Relationship of power usage and lamp life	23
Figure 2.11:	Relationship of efficiency and lamp life.....	23
Figure 2.12:	Lamp cost for 3 hour operation over several years	25
Figure 2.13:	Lamp cost for 12 hour operation over several years	26
Figure 2.14:	Standard Label	29
Figure 2.15:	General Life-Cycle of a Lamp.....	32
Figure 2.16:	Detailed Life Cycle of a Lamp	33

Figure 2.17:	Electricity Consumption for Use and Manufacturing Phase	34
Figure 2.18:	LCA on Environmental Impacts of Lamps.....	36
Figure 3.1:	Flowchart of Overall Design Methodology.....	40
Figure 3.2:	Philips TBS165 G 2xTL5-28W/840 HFS M2 PIP	43
Figure 3.3:	Philips FBS120 2xPL-C/2P26W L_840.....	44
Figure 3.4:	Philips SM530C L1450 1xLED50S/840	45
Figure 3.5:	Small office layout (9.6m x 9.6m x 3.353m)	46
Figure 3.6:	Large office layout (9.6m x 21.72m x 3.353m).....	47
Figure 3.7:	Convenience store layout (5.7m x 13.41m x 3.353m).....	48
Figure 4.1:	Typical Photometric Chart.....	51
Figure 4.2:	ISO Contour for Fluorescent Lamp.....	52
Figure 4.3:	ISO Contour for Compact Fluorescent Lamp	52
Figure 4.4:	ISO Contour for LED Lamp.....	52
Figure 4.5:	Power Consumption Comparison.....	55
Figure 4.6:	Total Cost Comparison.....	55
Figure 4.7:	Typical Photometric Chart.....	56
Figure 4.8:	ISO Contour for Fluorescent Lamp.....	57
Figure 4.9:	ISO Contour for Compact Fluorescent Lamp	57
Figure 4.10:	ISO Contour for LED Lamp.....	58

Figure 4.11: Power Consumption Comparison.....	61
Figure 4.12: Total Cost Comparison.....	61
Figure 4.13: Typical Photometric Chart.....	62
Figure 4.14: ISO Contour for Fluorescent Lamp.....	63
Figure 4.15: ISO Contour for Compact Fluorescent Lamp	63
Figure 4.16: ISO Contour for LED Lamp.....	64
Figure 4.17: Power Consumption Comparison.....	67
Figure 4.18: Total Cost Comparison.....	67

University of Malaya

LIST OF TABLES

Table 2.1:	Lighting measurement parameters	14
Table 2.2:	Typical efficacies of different lamps	14
Table 2.3:	Emissions for various fossil fuels used to generate electricity	17
Table 2.4:	Yearly emissions for various lamps (kg)	18
Table 2.5:	GHG emanations savings (KgCO ₂ -e /year) transitioning from incandescent lamp to energy-efficient lamps	19
Table 2.6:	Various lamp ratings	25
Table 2.7:	Energy usage (kWh/annum) for 8 hours operation of different percentage of lamps in use	27
Table 2.8:	Cost of energy consumption (RM/year) for 8 hours operation of different percentage of lamps in use	28
Table 2.9:	Standard characteristics of different lamps.....	30
Table 3.1:	Layout Details	46
Table 3.2:	Layout Details	47
Table 3.3:	Layout Details	48
Table 4.1:	Power Consumption for Different Lamps.....	53
Table 4.2:	Costing for Fluorescent Lamp	54
Table 4.3:	Costing for Compact Fluorescent Lamp	54

Table 4.4:	Costing for LED Lamp	54
Table 4.5:	Power Consumption for Different Lamps.....	59
Table 4.6:	Costing for Fluorescent Lamp	60
Table 4.7:	Costing for Compact Fluorescent Lamp	60
Table 4.8:	Costing for LED Lamp	60
Table 4.9:	Power Consumption for Different Lamps.....	65
Table 4.10:	Costing for Fluorescent Lamp	66
Table 4.11:	Costing for Compact Fluorescent Lamp	66
Table 4.12:	Costing for LED Lamp	66

University of Malaya

LIST OF SYMBOLS AND ABBREVIATIONS

EIA : Energy Information Administration

U.S. : United States

MWhs : Megawatt-hours

Btu : British thermal unit

DoE : Department of Energy

IL : Incandescent Lamp

FL : Fluorescent Lamp

CFL : Compact Fluorescent Lamp

LED : Light Emitting Diode

HID : High Intensity Discharge

W : Watt

K : Kelvin

M : Million

Hz : Hertz

h : hours

mm : millimetre

lm/W : lumens per Watt

EC : European Commission

TWh	:	Terawatt-hour
EU	:	European Union
S.O.X	:	Low Pressure Sodium
EPA	:	Environmental Protection Agency
mg	:	milligrams
LPS	:	Low Pressure Sodium
HPS	:	High Pressure Sodium
HPM	:	High Pressure Mercury
MH	:	Metal Halide
CMH	:	Ceramic Metal Halide
SSL	:	Solid-State Lighting
%	:	percentage
\$:	Dollar
€	:	Euros
RM	:	Ringgit Malaysia
klm	:	kilo lumens
m	:	metres
nm	:	nanometres
p-n	:	positive-negative

kg/kWh:	kilogram per kilowatt hour
CO ₂ :	Carbon Dioxide
SO ₂ :	Sulphur Dioxide
NO ₂ :	Nitrogen Dioxide
CO :	Carbon Monoxide
Hg :	Mercury
GHG :	Green House Gas
KgCO ₂ :	kilogram carbon dioxide
mg/L :	milligram per litre
TCLP :	Toxicity Characteristic Leaching Procedure
°C :	degree Celsius
°F :	degree Fahrenheit
LLD :	Lamp Lumen Depreciation
SPD :	Spectral Power Distribution
CCT :	Correlated Colour Temperature
CRI :	Colour Rendering Index
THD :	Total Harmonic Distortion
PF :	Power Factor
BE :	Bio-Effects

LCA	:	Life Cycle Assessment
ISO	:	The International Organization for Standardization
Q_v	:	Luminous Energy
Φ	:	Luminous Flux
TP&N	:	Three Pole & Neutral
E	:	Intensity of Illumination
L	:	Luminance
H	:	Luminous Efficacy
ω_v	:	Luminous Density
H_v	:	Luminous Exposure
l	:	length
w	:	width
h	:	height
p_c	:	ceiling reflectance
p_w	:	wall reflectance
p_f	:	floor reflectance
lx	:	lux
W/m^2	:	Watt per metre sq.
IEC	:	International Electrotechnical Commission

BS : British Standard

MS : Malaysian Standard

SIRIM : Standard and Industrial Research Institute of Malaysia

University of Malaya

LIST OF APPENDICES

Appendix A	82
Appendix B	86
Appendix C	90

University of Malaya

CHAPTER 1: INTRODUCTION

1.1 Introduction

Technology has advanced at a phase far beyond the understanding of man. New technology from around the world has contributed to the advancement of theories and mathematical calculations to which advanced technology has progressed beyond human apprehension. With the advancement of technology in this present day, the old technology is being phased out. This can be due to many hard-hitting facts resulting in continuous improvement of products. Of late, energy usage and its impact on the environment have been an alarming concern over the years (Li et al., 2010). Due to the high demand of energy usage in the world, researchers have gravitated towards experimenting and finding a solution to minimize this growing concern (Verma, Patel & Nair, 2017). Ghisi and Tinker (2005) deduced that lighting systems in a building is one of the reasons for high energy consumption. In the operations of running a commercial sector, it has been reported that 25% of electricity is consumed by the lighting in the building. Trifunovic et al. (2009) performed an experiment which interprets a reduction of electricity consumption of approximately 27% in the residential area and 30% in the commercial sector by turning to energy saving technologies as a solution. With that, new and advanced technologies are penetrating the market to successfully reduce energy usage and ensure cost efficiency over the long run. This project paper is aimed to provide a thorough description on the monetary gains, energy savings and also eco-friendly benefits that can be possibly achieved by switching to the newer lighting technologies available in the market. This will be achieved by utilizing lighting software named DIALux, comparing several cases and their correlated cost implementation and illumination levels.

1.2 Problem Statement

Selection of lighting fixtures can cause some inconvenience for the illumination of a given area. As such, there are many queries that need to be resolved. Firstly, the general public are unaware of new lighting technologies available in the market. Hence, the older lamps being utilized incur higher cost when put into operation. This can be avoided if the consumer were to upgrade to the newer lamp technology in the market. Many lamps in the market are environmentally friendly and require minimal light fittings necessary to keep an area of space well lit.

1.3 Objectives

The main focus of this report is to analyse and choose the appropriate type of lamp to be utilized in a convenience store or an office lot. Therefore, the objectives of this report are as listed below:-

1. To choose appropriate light luminaire for office and convenience store layout.
2. To specify the appropriate number of light luminaires required in a certain area of space.
3. To satisfy point above by way utilizing a software with given set of parameters.
4. To analyse power consumption the light luminaire consumes.
5. To analyse cost effectiveness based on different light fittings.
6. To introduce new compact and powerful light luminaires.

1.4 Scope of Work

This research report mainly focuses on determining the most suitable light luminaire to be utilized in an office building or convenience store. Different luminaires are applied and compared with one another to determine the best suited lamp to be used. The lux level readings are presented and the best option of selection of light fitting was based on

these criteria; cost, power consumption and lumen output. The table readings attached portray the cost element and power consumption of each of these lamps.

1.5 Thesis Outline

This research report comprises of 6 different chapters, of which each entails information on their particular relevant topics.

Chapter 1 provides the background and reason of the proposed research along with the problem statement. The objectives of the study are presented followed by the scope of work. Finally, the thesis outline is presented describing what individual chapters entail.

Chapter 2 provides information of the different types of lighting technologies available in the market today. The advantages and disadvantages associated with these lamps are also discussed in this chapter.

Chapter 3 presents the methodologies of obtaining readings provided by selection of different lamps. Different cases are presented varying in terms of layout and dimension.

Chapter 4 provides results obtained upon application of the light luminaires on the layout. The readings that are achieved are based upon the cost of application of the lamps and also their respective power consumption.

Chapter 5 is based upon a brief discussion of the method and results obtain from the test. This chapter compares and describes the readings obtained in further detail.

Chapter 6 concludes the whole report upon taking into consideration the information provided in the results and discussion. This chapter also confirms the best luminaire option to be selected for the layouts.

CHAPTER 2: LITERATURE REVIEW

2.1 Introduction

This section of the report will provide understanding of the different lighting technologies available to date. In depth review of the light luminaires in terms of their life span, environmental effect, cost and other information on the lamps will be discussed. The advantages and disadvantages associated with the lamps will also be discussed briefly according to several published journals.

2.1.1 Incandescent Lamps

Incandescent lamps (IL) are traditional lights that require a tungsten filament contained in the bulb to be heated up to produce illumination when supplied by an electrical source. Generally, the filaments can operate at a working temperature of 2700K. A researcher reported that the conventional incandescent lights made its appearance in the market as early as 130 years ago. These lamps, however, are only able to absorb 5% to 10% of the energy supplied to produce light, whilst the remaining energy is transformed into heat and is emitted from the bulb. Seeing as the lamp has been around in the early age, it has been classified as one of the rather incompetent lamps to be utilized for daily use in the present day (Howarth & Rosenow, 2014). Not only that, light flicker, also known as voltage flicker is no stranger to incandescent lamps. A report prepared by Gilde-Castro et al. (2017) reported that this is mainly due to spiking of voltage levels in the frequency range of 0.5Hz to 25Hz. This voltage flicker often occurs in the incandescent bulbs of rating 60W.

According to the U.S. Department of Energy, DoE (2012), IL's has the ability to produce a mere 10 to 20 lumens per Watt, all whilst taking into account the different working temperatures of the filament and construction of the bulb. According to a tabulated data comparing lightings in various sectors, the report states that the residential sector performed the worst. The residential sector remained in their comfort zone by pursuing with incandescent lamps as their daily source of illumination, hence resulting in a mediocre efficacy reading of 19 lumens per Watt. This reading was far from the other sectors experimented which reported a result of 70 lumens per Watt efficacy. Over time, the residential sector did see an improvement of 2 lumens per Watt (from 17 lm/W) when switching over to CFL's for artificial illumination purposes.

After observing the efficacy of IL's and its futility in the cost section, many countries around the world are phasing out IL's as their primary source of illumination. According to the European Commission, EC (2009), when the year 2012 approaches, incompetent lamps such as the IL's should be phased out completely from the lighting market. By doing so, calculation have projected savings of close to 40TWh for the EU residents. To put into perspective, this value is equivalent to electricity consumption of 11 million homes in Europe, or even to supply of the whole of the Romanian country. Taking this leap also depletes the CO₂ emission by approximately 15 million tons per annum. The EU is expected to witness a staggering 5 - 10 billion euros injected back into its economy.

2.1.2 Discharge Lamps

According to Philips, Limatel & DoE, (n.d.), the illumination provided by gas discharge lamps requires a fusion of several types of gas and an electrical source. To be more detailed, the lamps are artificial sources of illumination that produce light by the electrical discharge of 2 separate electrodes contained in a ionized gas filled translucent tube. The theory behind the constant illumination of the tube is via the electrical discharge producing an arc that is constant and uninterrupted. However, not all discharge lamps have the ability to control the illumination brightness it provides. The illumination provided is far more sufficient and brighter as compared to traditional incandescent and halogen lamps. Another benefit the discharge lamps have over its predecessors is they last approximately 10 times longer than the traditional incandescent lamp.

Philips, (n.d.) states that gas discharge lamps can be split into 2 different categories; Low Pressure and High pressure. It states that the typical, every day-use low pressure gas discharge lamps are fluorescent lamps, compact fluorescent lamps and S.O.X lamps. Różowicz and Deląg (2016) finds that these fluorescent tubes are injected with a slight amount of mercury gas filling. The ultraviolet radiation (blue) generated is then translated into visible light (white) with the aid of a phosphor layer. The literature also states that external influences such as ambient temperature has impact on the durability and illumination intensity of the lamp. Figure 2.1 below shows the basic structure of a low-pressure mercury discharge lamp.

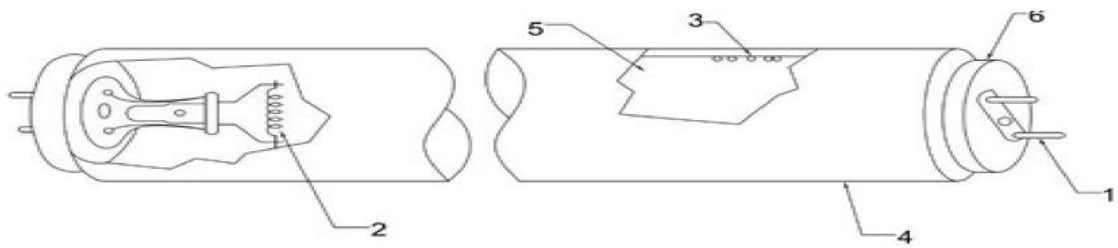

Figure 2.1: Structure of a low-pressure mercury discharge lamp.

- 1) Contact pins. 2) Electrode. 3) Mercury in cold state. 4) Glass tube with phosphor coating on the inner wall. 5) Gas. 6) Base.**

(Różowicz and Deląg, 2016)

A research report concludes that CFL's are typically designed in a way that they are able to re-use the housing of the former incandescent lamps, hence promoting cost-effectiveness when transitioning from one bulb to another. CFL's are moulded in a way that they are shrunk to fit into the former incandescent bulbs fixture (Guan, Berrill & Brown, 2015). The U.S. Department of Energy, DoE (n.d.) states that these specific set of lights are moulded in their own detailed design and size to suit different fittings. CFL's presents a variety of types which includes:

- A-line and A-line spiral lamps which use the screw-in technique intended for standard domestic fittings such as desk lamps and ceiling fixtures.
- Globe lamps, which has a decorative globe housing the CFL lamp. This particular fixture is commonly used for decorative designs such as restroom and ceiling illumination.
- Floodlight and reflector lamps which are intended to concentrate the illumination on the object ahead of them. This specific design is meant for indoor fittings such as recessed down lights and outdoor floodlights.
- Pin-type tubular CFL works on a pin-based construction. These lights are made for specific set of fixtures which are commonly used in the commercial sectors.

According to the U.S. Environmental Protection Agency, EPA (n.d.), CFL's are manufactured with a small amount of mercury which aids in the illumination process. A typical CFL embodies mercury of approximately 4 mg, which does not discharge or leak unless tempered with or if the tube is broken. In any instance of the CFL lamp needing replacement, proper care of disposal of the lamp is vital for environmental protection. Failure to properly recycle the lamp may result in damage to the environment and human health. EPA also stresses that recycling the worn out lamps aids in the re-use of materials which makes up the CFL to produce new lights.

According to a couple of literatures, High-intensity Discharge lamps (HID lamps) are installed in almost every part of the world illuminating large areas of space such as roadways, pathways, sports stadiums and parking lots. HID lamps generally comprises of the following; mercury vapour, sodium lamps and metal halide lamps (Bakshi & Roy, 2016; Chitnis et al., 2016). The aforementioned lamps are made up of a glass tube occupied with metals and gases. The tungsten electrode energized by an electrical arc also makes up the inert of the tube of which when energized, the arc flows between the cathodes, initiating the vaporization of the metallic additives, which ultimately produces light (Chitnis et al., 2016). In another literature, Molina, Sainz and Monjo (2013) suggested that HID's offer long life-span and excellent illumination, along with minor drawbacks such as poor choice of colour selection (yellow) and cost of operation of the lamp is high. It was reported that HID lamps consumes approximately 70 - 500W of energy and can be told apart following the gas and pressure present in the lamp; low pressure sodium (LPS), high pressure sodium (HPS), high pressure mercury (HPM), metal halide (MH) and ceramic metal halide (CMH). Following the above mentioned lamps, it was reported that HPS and MH were widely utilized due to its efficiency of 40 - 140 lumens per Watt, long life-span of 5,000 - 22,000 hours of operation, lumens generation of approximately 7,000 - 40,000 and high colour-rendering index of 15 - 62.

According to Energy Star (n.d.), majority of HID lamps come fitted with ballast, an application used to regulate the flow of power to the lamp. Electrical conditioners present in the ballasts controls the power supplied without taking into account the discrepancies in power supply and fluctuations. Tests were conducted by Yan and Hui (2004) and have reported that when operating at high frequency, the performance of the HID lamps becomes complicated due to the acoustic vibration it faces. This acoustic vibrations build up in the lamp may affect the lamp in terms of light flickering, extinction or may even damage the inert workings of the lamp (Chhun et al., 2011).

Chung et al. (2007) affirms reports that electromagnetic and electronic ballasts acquire both advantage and short-comings. Conventional magnetic ballasts can function at a frequency range of 50 - 60 Hz. The build of the magnetic ballasts is said to be rather simple, sturdy and dependable. The real reason this ballast served for many years is due to the lengthy life-span of the device. Another literature review shows that the inductor core and winding materials both in the magnetic ballast are easily biodegradable (Chen & Chung, 2011). However, this device does have its downsides such as poor energy controllability and peak power losses due to the iron and copper losses in the magnetic choke (Chung et al., 2007). Molina, Sainz and Monjo (2013) provides information that newer and more advanced electronic ballasts have over run the production of traditional magnetic ballasts, all thanks to its improved efficiency and ability to provide uninterrupted power to the lamp. One reporter suggests that the downside of this electronic ballast is due to the limitation of frequency the ballast can handle before acoustic resonance causes interference in the system (Orletti et al., 2009).

2.1.3 Light Emitting Diode (LED) Lamps

In a recent literature, Wang, Alonso and Ruan (2017) reported that LED's are finding its way into many domestic and commercial sectors in the near future due to its staggering luminous efficacy reasons. Wang, Alonso and Ruan (2017); Alonso et al. (2012) produced reports that suggested LED lamps acquires more advantage over its predecessors as they are;

- Considered energy efficient as 40% of the energy consumed is converted for illumination.
- Able to operate for long hours, more than 100,000 hours.
- Able to provide illumination within the nanosecond.
- Green sources of light, heavy metals such as mercury and lead absent from tube.
- Wide range of colour-rendering index

LED's are classified to be one of the rather new solid-state lighting (SSL) sources which are typically installed different application for illumination serving as backlights for devices, in automobiles indicators, roadways and parking lots to name a few (Liu & Luo, 2011; DoE, 2014). It has been reported that of late, LED manufacturers have been performing tests on newer materials, innovative engineering and packaging technology, thermal control and also on its dependability. These tests are carried out mainly due to the concern of operating temperatures and life span of high-power consumption LED's being a hazard to the lamp (Sun et al., 2017).

Following to the Multi-Year Program Plan 2012 prepared by DoE (2012), LED's should see a spike in efficacy from 135 lumens per Watt in the year 2011 to 235 lumens per Watt when the year 2020 approaches. Prediction made on the cost of the lamp has been reported to witness a drop of 0.7\$/klm when the year 2020 draws near. Cree, a LED manufacturer reported in the midst of year 2014, that it had broken the record in terms of lighting efficacy, yielding a count of 303 lm/W from a white high powered LED. This resulted in an increase of approximately 10% from their previously held record, 276 lm/W (MingTan & Singh, 2016). It can be observed from Figure 2.2 below that the demand for high-power LED is on the rise and is highly used for lighting applications and outdoor signage.

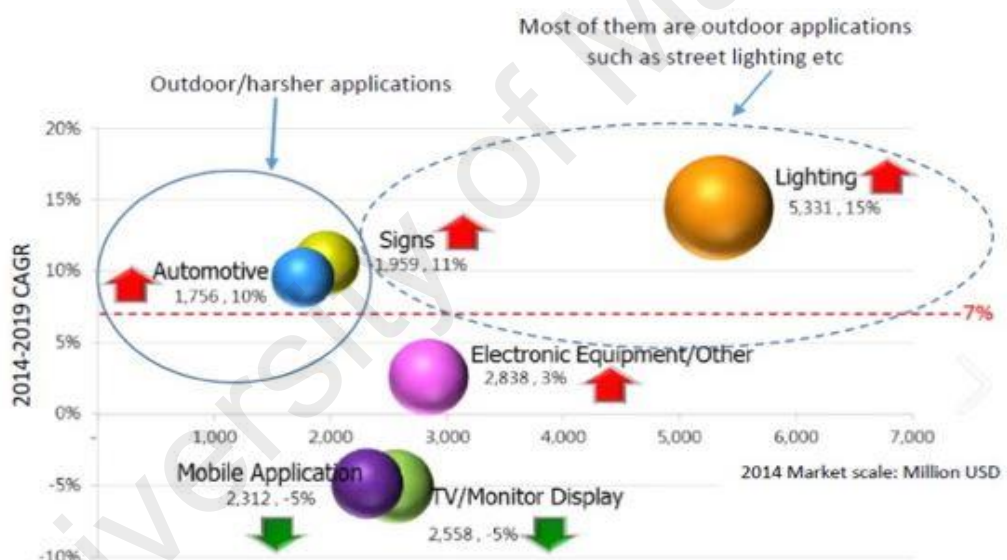

Figure 2.2: Demand for high-powered LED.

(Singh and MingTan, 2016)

The working principle of an LED as reported by Chitnis et al., (2016) is by energizing the formulated diode by way of electrical current. This in turn, causes the semiconducting material to illuminate. This occurrence is better known as electroluminescence. Phosphor ingredients of different shades can be then combined with the luminance produced to create different colours of light. Figure 2.3 below depicts the above mentioned steps.

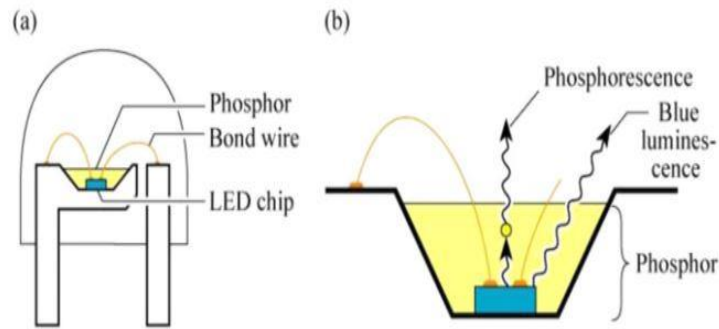

Figure 2.3: (a) Basic structure of an LED. (b) Electro-luminescence.

(Chitnis et al., 2016)

Another literature supports the statement of mixing blue LED's with phosphor to create white light. These LED lights can either emit lights of single colours; red, green, blue or a wide range of spectral group of white providing different shades and intensity depending on the mixture of colour and package design (Chang et al., 2012).

A couple of literatures produced by Bender, Marchesan and Alonso (2015); Gayral (2017) shed light on the operation principle of these SSL devices. Both these literatures found that LED lights come fitted with doped semiconducting materials. This allows the semiconductor to emit light by the movement of electrons and photons from one junction to another. Doping in the n-region is responsible for holding negative charges, better known as electrons and the dopant in the p-region is responsible for holding positive charges, better known as holes. Therefore, under an electrical influence, the electrons and holes which flow in opposing directions ultimately meet the p-n junction where they attach with one another thus, producing light. Figure 2.4 below provides visual explanation of process previously mentioned.

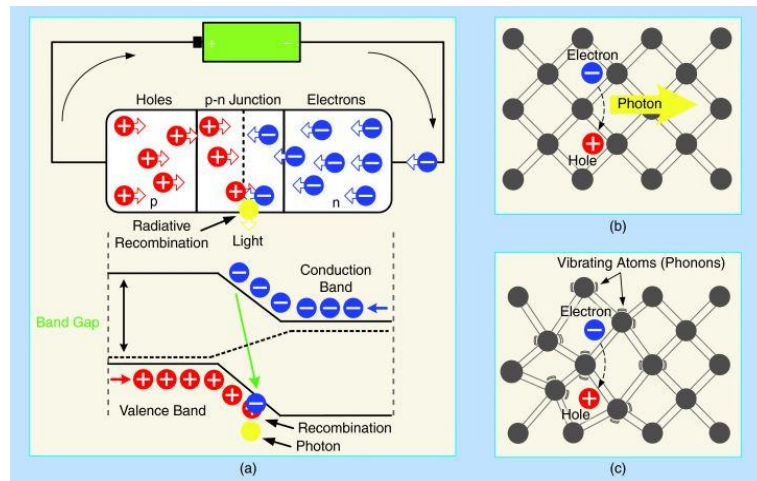

Figure 2.4: (a) Basic LED operation. (b) radiated combination of electron-hole pair with emission of photon. (c) nonradiated combination: energy converted to phonons

(Bender, Marchesan and Alonso, 2015)

2.2 Comparison between incandescent, discharge and LED lamps.

Based on the data of the lamps provided previously, an assessment of the lamps can be made based on technical and economic aspects. A certain percentage of the general public are not aware of the advancements the lamps have improved over the years. Certain percentage of the public still rely on old technology as they are not made aware of the benefits or are afraid of the limitations these new technologies may possess. Based on their limited knowledge, the older technology is actually consuming more power and costing more when maintenance of the fitting is required. Consumers tend to lean towards the lower wattage lamps for cost-savings, ignoring other factors that come with it such as spread of lumens in a given area or even the cost of maintenance. Before progressing on, Table 2.1 below provides an overview of the general terminologies used in the lighting industry.

Table 2.1: Lighting measurement parameters.**(Chitnis et al., 2016)**

Lighting terminology	Symbol	Definition	Unit
Luminous energy	Q_v	Energy emitted or propagated in the form of light.	lumen-second (lm-s)
Luminous flux	Φ	Luminous energy per unit time.	lumen(lm)
Luminous intensity	I	Luminous power per unit solid angle.	candela (cd)
Intensity of illumination	E	Luminous power incident on a surface.	lux(lx)
Luminance	L	Luminous power per unit solid angle per unit projected source area.	candela per square metre (cd/m ²)
Luminous efficacy	H	Ratio of luminous flux to radiant flux.	lumen per Watt (lm/W)
Luminous density	ω_v	Luminous energy per unit volume.	lumen second per cubic metre (lm-s/m ³)
Luminous exposure	H_v	Illuminance at the given point, over the given duration.	lux second(lx-s)

2.2.1 Efficacy

Several literatures have compared and studied the lamps (IL, CFL and LED) in terms of their efficacy. The U.S. Energy Information Administration, EIA (2017) prepared a table interpreting the different everyday use lamps and their correlating efficacies as shown in Table 2.2 below.

Table 2.2: Typical efficacies of different lamps.**(EIA, 2017)**

	Efficacy (lumens/Watt)
Standard fluorescent	
Fluorescent - T5	25 - 55
Fluorescent - T8	35 - 87
Fluorescent - T12	35 - 92
Compact fluorescent	40 - 70
Incandescent	10-19
High-intensity discharge	
Mercury vapor	25 - 50
Metal halide	50 - 115
High-pressure sodium	50 - 124
Halogen	14 - 20
LED	20 - 100

It can be deduced from the table above that the poorest lamps listed in terms of its efficacy are Halogen and Incandescent, ranging 14 lm/W - 20 lm/W and 10 lm/w - 19lm/W respectively. However, the lamps with the highest output efficacy are LED and high-pressure sodium discharge lamps ranging 20 lm/W - 100 lm/W and 50 lm/W - 124 lm/W respectively. It was reported by EIA (2017) that the peak luminous efficacy of white light hypothetically is 220 lm/W. The U.S. Department of Energy, DoE (2012) tabulated a graph depicting the average efficacy from the year 2001 up to 2010 by sectors. Figure 2.5 below portrays the average efficacy in lumens per watt for diverse sectors.

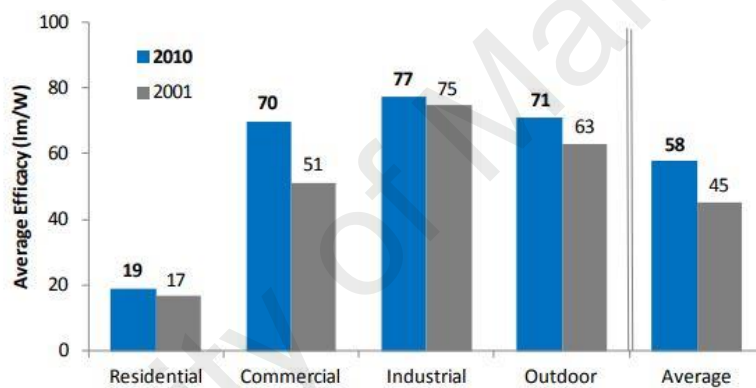

Figure 2.5: Average efficacy for different sectors.

(DoE, 2012)

It is reported that the reason for such low consumption of energy over the course of 10 years is due to the transition to the more efficient lighting. The graph is based upon the total lumen produced divided by the total energy consumed for each sector. It can also be seen from the graph that the most inefficient lighting sector is the residential sector, which is mainly due to the consumers who are banking on incandescent lamps as their primary source of illumination (DoE, 2012).

However, as the years progressed, it has been reported by Montoya et al. (2017) that Light Emitting Diodes have made its presence known in the market and to consumers worldwide. A graph prepared by the researcher illustrates the steady rise of LED's in terms of its luminous efficacy past the year 2000. It is portrayed that as of March 2014, LED had reached its peak illumination, far beyond the other lamps efficacies at an overwhelming 303 lumens per watt. Calculations show that it is an increase of approximately 196 lumens per watt from its contender, the linear fluorescent. The researcher also includes DoE's forecast which shows LED lamps seeing a steady increase in efficacy until the year 2020. With the current increase in demand for LED lighting, as of year 2017, the graph seems to portray accurate results.

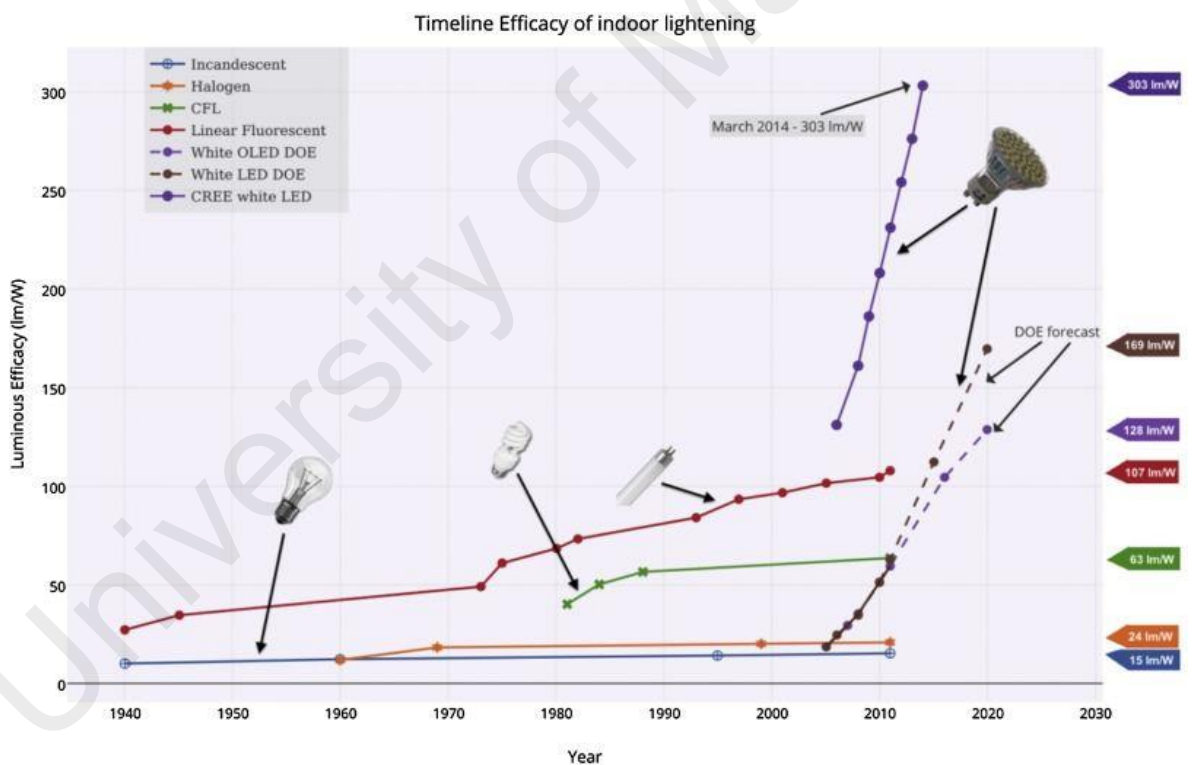

Figure 2.6: Evolution of several lamps efficacies.

(Montoya et al., 2017)

2.2.2 Environmental Concerns

In a report prepared by U.S. Energy Information Administration, EIA (2013), it was stated that Malaysia's dependency on coal as its source of electricity production posed as the highest demanding country amongst the other countries. According to a literature prepared by Mahlia (2002), tests were carried out in Table 2.3 which shows that coal produces much more emissions as compared to the other fossil fuels.

**Table 2.3: Emissions for various fossil fuels used to generate electricity.
(Mahlia, 2002)**

Fuels	Emission (kg/kWh)			
	CO ₂	SO ₂	NO _x	CO
Coal	1.18	0.0139	0.0052	0.0002
Petroleum	0.85	0.0164	0.0025	0.0002
Gas	0.53	0.0005	0.0009	0.0005
Hydro	0.00	0.0000	0.0000	0.0000
Other	0.00	0.0000	0.0000	0.0000

Fuel emanation can be defined as the usage of the various mechanisms of fuel has contributed to the high pollution in order to generate electricity in Malaysia. The formulae used to calculate the amount of CO₂ produced from combustion of fossil fuels is as depicted in Equation 2.1 below (Khorasanizadeh et al., 2015).

$$\text{Fuel emission} = \sum \text{Fuel type for electricity generation} \% \times \text{Emission for a unit of electricity generation} \quad (2.1)$$

(Khorasanizadeh et al., 2015)

The amount of energy a lamp uses to produce illumination varies according to the emissions produced by various fossil fuels. The literature produced by Khorasanizadeh et al. (2015) tabulated values in Table 2.4 displaying the different lamps and their generated emissions from usage.

Table 2.4: Yearly emissions for various lamps (kg).

(Khorasanizadeh et al., 2015)

	CO ₂	SO ₂	NO _x	CO
LED	22.77	0.10	0.05	0.01
CFL	53.81	0.23	0.11	0.02
Incandescent	206.97	0.90	0.42	0.08

It can be observed from the table that LED produced the least amount of emissions from its lamp as compared to the other two infamous lamps in the market. Though the emission may not seem to pose a huge threat to the environment, it is substantially critical when taking into account the application of these lamps throughout the whole of Malaysia. By taking that into account, it is approximated that the emissions may reach up to 0.725M tons in the year 2012 in the domestic sector. It is tabulated that emission levels can see a significant diminution in value by the year 2020 if 62% of all incandescent lamps were traded out for LED lamps in the residential sector (Khorasanizadeh et al., 2015).

Enongene et al. (2017) produced a report on environmental cleanliness that can be achieved in Cameroon when switching out traditional lightings to the energy-efficient lightings in the domestic sector. The researchers agreed that the highest emissions from these lamps are carbon, hence producing Table 2.5 tabulating GHG emissions savings if the general public in Cameroon make the transition to the newer technological lamps. A different literature promotes the idea of switching out traditional lamps with newer energy-efficient lamps may result in environmental cleanliness due to low emissions of carbon radiating from the lamps (Khorasanizadeh et al., 2016).

Table 2.5: GHG emanations savings (KgCO_{2-e}/year) transitioning from incandescent lamp to energy-efficient lamps.

(Enongene et al., 2017)

Building class	T1	T2	T3	T4	T5	T6
Emissions from incandescent	113	339.01	452.02	565.02	678.02	452.02
Emissions from CFL	37.67	113	150.67	188.34	226.01	150.67
Emissions from LED	18.83	56.50	75.34	94.17	113	75.34
CFL emission saving	75.34	226.01	301.34	376.68	452.02	301.34
LED Emission saving	94.17	282.51	376.68	470.85	565.02	376.68
CFL % emission reduction	66.6	66.6	66.6	66.6	66.6	66.6
LED % emission reduction	83.3	83.3	83.3	83.3	83.3	83.3

As mentioned previously, a small amount of mercury can be found in the fluorescent lamps which aids in the illumination process. However, when these lamps reach the end of their life-span, they are normally disposed of without bearing in mind about health hazards and environmental safety. More often than not, these disposed lamps break, hence releasing the inert gases and metals to its surroundings. It was reported by the U.S. Environmental Protection Agency, EPA (1998) that approximately 1.2% to 6.8% of mercury is emitted from the broken lamp into its surroundings. However, Li and Jin (2011) states that different brands of CFL's contain different levels of mercury ranging from 0.1mg up to 3.6mg of which, less than 4% of CFL's were toxicity characteristic leaching procedure - leachable (TCLP). It was tested that the newer CFL's contain a mere 0.2mg/L of Hg, which sits below the monitoring level and is not categorized as a hazardous waste.

2.2.3 Life-span and Lumens Depreciation

The average life-span and lumens depreciation can have a significant impact on the performance and illumination generated by the lamps. Lumen maintenance is a term which generally describes the deprivation of light production during its working stages in terms of hours (Qian et al., 2016). With that, a report prepared by the U.S. Department of Energy, DoE (2013) generalizes several typical lamps with their lifespan and lumens maintenance which may vary according to the product type. It can be seen from Figure 2.7 below that lumen depreciation is at a constant decline for the short-lived incandescent and halogen lamps. As for the fluorescent lamp, the lumens maintenance is noted to be depreciating over time, nearing the asymptote. Lumens maintenance as depicted from the graph varies unsteadily for HID lamps as the lumens output increases and decreases unsteadily.

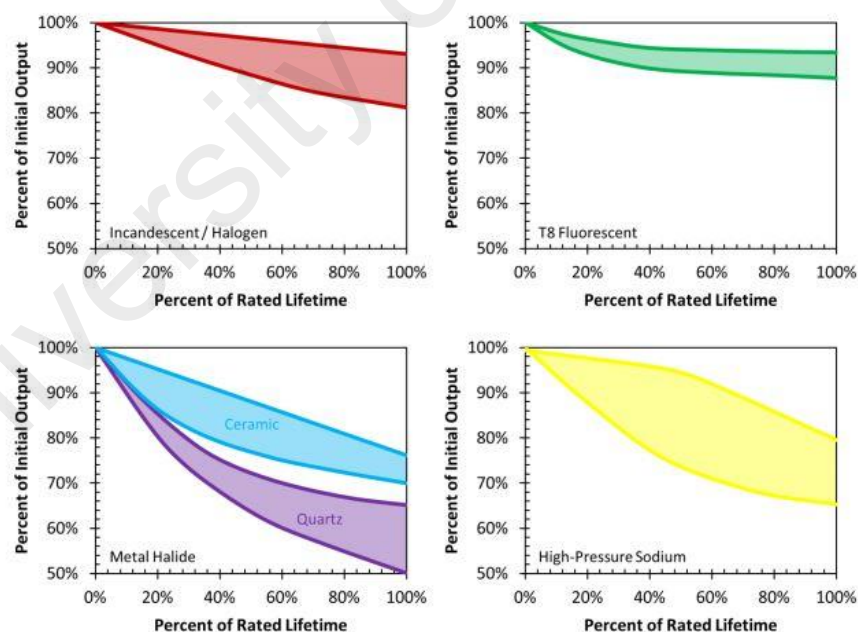

Figure 2.7: Lumen maintenance for different lamps.

(DoE, 2013)

Lumen depreciation often occurs progressively over the working life of the lamps. As for the incandescent lamps, the filament enclosed in the lamp depletes progressively emitting tungsten particles which ultimately, stick onto the wall of the bulb. Thus, this decreases the lumens output by approximately 10 - 15% as compared to its initial output (DoE, 2011). A typical fluorescent lamp often sees a depletion in lumens output of a maximum 20%, in comparison to the higher quality fluorescent lamp, T5 and T8 which sees a total lumens output loss of approximately 5% (DoE, 2009). Lumens depreciation for LED lamps is often dependant on the junction temperature, which not only indicates the performance of the lamp but also alters the design of the light itself (Sauli et al., 2013; Poppe & Lasance, 2009).

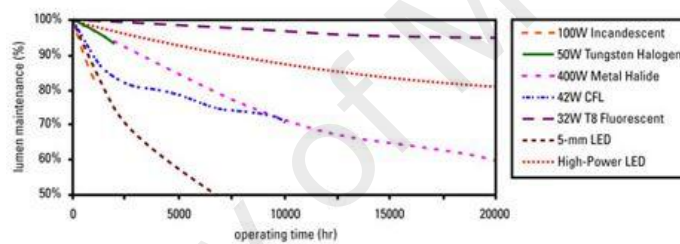

Figure 2.8: Lumen maintenance for rated lamps.
(DoE, 2009)

According to the produced by DoE (2009), it can be observed from Figure 2.8 that the 5-mm LED sees a drastic decline in terms of lumen maintenance over its operating time as compared to the other lamps. Report states that this could be due to the heat build-up in the lamp which is not properly conducted out. With the temperature rise in the lamp, the illumination produced from the lamp drops. It has been reported that though the illumination of the LED lamp dims to low levels, they are still able to operate without interruption.

However, temperature is not the only cause of reduced illumination, lamps that are exposed to the environment such as dirt and rain causes light loss. Coureaux et al. (2013) suggests that dirt accumulation on the inner and outer part of the lamp affects the amount of light emitted from a bulb. The reporter suggests suitable sealing around the lamp compartment will aid in reducing the accumulation of dirt particles in and around the lamp.

It has been reported by DoE (2015) that LED usage of more than 60,000h portrays lumen depreciation of approximately 90%. As compared to their initial outputs, illumination provided by the lamp is greater when it is in operation for more than 5,000h. This was tested under normal working conditions and also at a 105°C (221°F) temperature. Hence, lumen depreciation of LED's did not pose a vital threat in determining the installation of the lamp for indoor and outdoor purposes, even considering the lamp undergoing operations in extreme conditions.

According to several literatures, a form of test called accelerated testing is the preferred way to test the lumen depreciation of LED lamps (Sauli et al., 2013; Qian et al., 2016; Hu & Luo, 2017). It was reported that an LED that was tested under harsh environment; high current, high temperature, and high humidity and room temperature performed for 3,000h and 50,000h respectively in terms of lifespan. Under harsh environment, performing at a temperature of 85°C and humidity of over 85%, the LED lamp performed at its worst in terms of lifetime. Qian et al. (2016) performed a test on LED lamps under 25°C and 55°C respectively. Typically, lumens depreciation tests for LED involves 6,000h of testing under a temperature of 25°C. Along with that, an accelerated test was introduced which was experimented below 2,000h at a temperature of 55°C. Figure 2.9 below depicts the results gathered from the experiment.

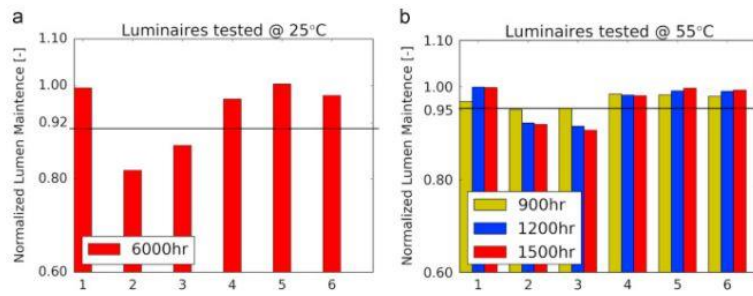

Figure 2.9: Lumen depreciation under different temperatures.

(Qian et al., 2016)

A research report performed a study on several catalogues and gathered readings of several lamps in terms of their lifespan compared to power usage and efficiency respectively (Nardelli et al., 2017). Figure 2.10 below represents statistically the lifespan of different lamps compared to its power usages and Figure 2.11 below depicts the lifespan of different lamps compared to the efficiency it is able to provide.

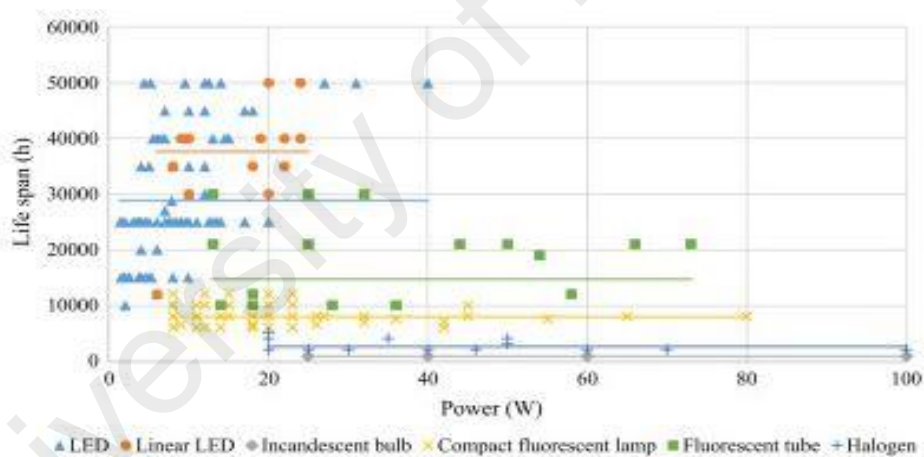

Figure 2.10: Relationship of power usage and lamp life.

(Nardelli et al., 2017)

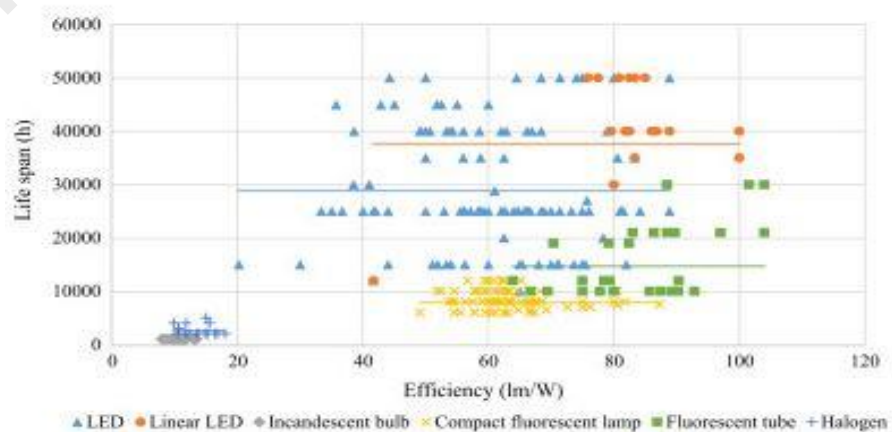

Figure 2.11: Relationship of efficiency and lamp life.

(Nardelli et al., 2017)

Figure 2.11 above simplifies the lifespan of each lamp stated in the above graphs previously. It can be observed that the average working life of LED as compared to fluorescent tube is 2.5 times longer as shown in the graph. To put that into perspective, LED's have a working life of approximately 30 times longer when compared to that of fluorescent tubes (Nardelli et al., 2017).

However, with all the advancements manufacturers and suppliers are achieving in the lamp industry, lesser attention is being directed towards the overall lamp's life, cost and overall illumination. It has been reported by the U.S. Department of Energy, DoE (2013) that changing the Lamp Lumen Depreciation (LLD) factor for an LED lamp from 0.70 to 0.80 aids in the reduction of electricity consumption by approximately 13%. Though performing this transition may improve the lumen depreciation of a lamp, better efficacy comes with a higher primary cost which is covered over the working life of the lamp and also has minimal environmental impact.

2.2.4 Cost Comparison

The lighting market worldwide is widely dominated by traditional and more commonly known lamps such as the halogen, compact fluorescent and high-intensity discharge lamps. Many sectors to this date still rely on these lamps as their daily source of artificial illumination. Of late, LED's are gradually making its way into the market, delivering a wide range of lamps in terms of their vividness output and cost variances. Seeing as lighting market is rather competitive, LED lamps have made its way into the market at a desirable cost, competing on equal ground with its predecessors.

Though the initial cost of purchasing and installation of LED's are high, the benefits these lamps yield over time are more favourable as compared to the other lamps. Installation of these lamps can benefit the consumer in terms of longer lamp life, hence minimizing maintenance cost and replacement of fixtures/lamp. To put into perspective, several researchers carried out calculations for the different lamps available in their country in terms of cost and period of usage.

Gayral (2017) carried out a test in his country in Europe, purchasing several lamps; incandescent lamp (IL), compact fluorescent lamp (CFL) and light emitting diode (LED), available at a store for a real-life analysis. The lamps were selected according to the parameter of which the lamp is required to produce 1500 lumens and costs 0.15€/ kWh. Below is a summary of his findings of different lamps along with their price, energy consumption and lifetime. The author notes that incandescent lamp ratings were an assumption considering they are not being sold in stores around Europe

Table 2.6: Various lamp ratings.
(Gayral, 2017)

Lamps	Cost (€)	Energy Usage (W)	Lifetime (h)
Incandescent	1	100	2000
CFL	4	25	8000
LED	10	13.5	25,000

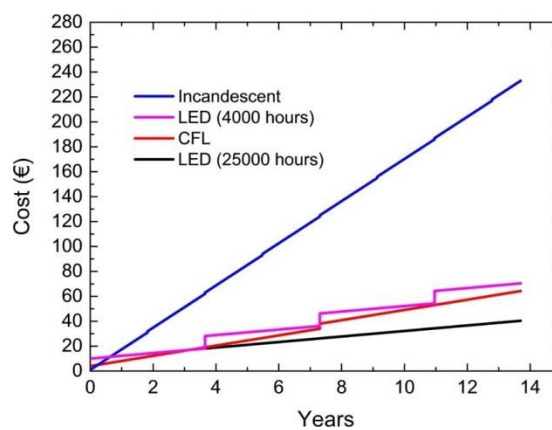

Figure 2.12: Lamp cost for 3 hour operation over several years.
(Gayral, 2017)

The researcher plotted a graph as shown in Figure 2.12 depicting the cost of operating the lamp for a local household for duration of 3 hours/ day over a span of several years. It is clear from the graph that the operation of incandescent lamps over the years produces a steep incline in terms of costing as compared to CFL and LED. When comparing the cost to operate CFL's and LED's, the cost of LED spikes from year to year, of which, is still as beneficial as running a compact fluorescent lamp for a household. The cost variance is merely 2€ per annum when operating CFL and LED lamps. The advantage LED's have over CFL's is that they are non-mercury manufactured and have a longer lifespan for lesser energy consumption (Gayral, 2017). This very reason is what may influence the consumer's decision to select LED as a solution to be their primary source of illumination in the household.

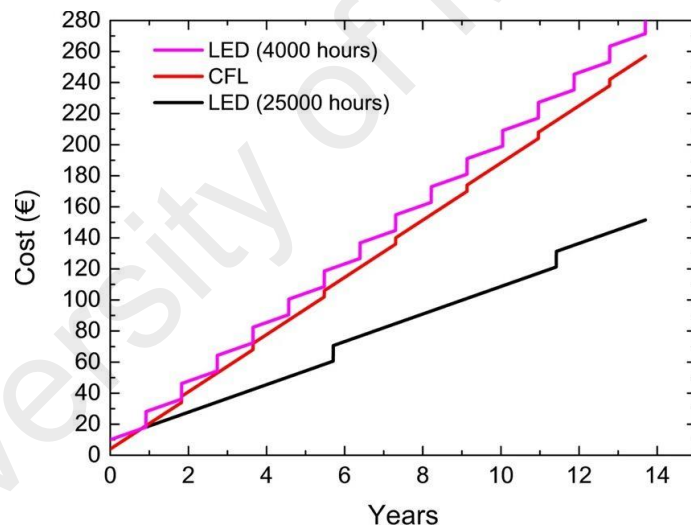

Figure 2.13: Lamp cost for 12 hour operation over several years.

(Gayral, 2017)

The figure indicated above portrays costing over several years for various types of lighting. It is to be noted that incandescent lamps are not included in this graph as this is for the commercial and industrial sectors for duration of 12 hours/ day. Incandescent lamps are not known to be widely used in commercial and industrial sectors as they are too costly to operate for long hours and are highly energy inefficient. It is to be noted

that neither graphs are considering maintenance costs and replacement of bulbs (Gayral, 2017). However, if that were to be considered, LED would be the preferable solution.

The research presented previously delivered a general overview of the cost of different lamps for different sectors. Khorasanizadeh et al. (2015) produced calculations of typically occupied Malaysian household utilizing lamps in different areas in the house for approximately 8 hours, in terms of percentage. The readings are as depicted in Table 2.7 below.

Table 2.7: Energy usage (kWh/annum) for 8 hours operation of different percentage of lamps in use.

(Khorasanizadeh et al., 2015)

	100%	90%	80%	70%	60%	50%
Incandescent	6716.00	6044.40	5372.80	4701.20	4029.60	3358.00
CFL	1214.72	1093.25	971.78	850.30	728.83	607.36
LED	770.88	693.79	616.70	539.62	462.53	385.44

The actual costs of implementing these different lamps per annum are as depicted in Table 2.8 below. The table displays the percentage of lamps which are in use at the time of testing along with the high margin of energy consumption cost of RM 0.334 and low margin of energy consumption cost of RM 0.218 respectively. It is to be noted that there is a large variance in terms of pricing when comparing incandescent lamps to the newer CFL and LED lamps. It is reported that by transitioning to CFL and LED's from incandescent lamps, yearly electricity consumption can be reduced by approximately 81.91% and 88.52% correspondingly. Not only that, an average saving of 36.54% can be achieved annually per household when changing over CFL's to LED's. According to the real-time lamp costs in the Malaysian market, lighting cost for an individual household operating daily would total up to RM 1150 for Incandescent lamps and RM 1920 for CFL's/ LED's (Khorasanizadeh et al., 2015).

Table 2.8: Cost of energy consumption (RM/year) for 8 hours operation of different percentage of lamps in use.

(Khorasanizadeh et al., 2015)

	Usage percentage	100%	90%	80%	70%	60%	50%
RM 0.218	Incandescent	1464.09	1317.68	1171.27	1024.86	878.45	732.04
	CFL	264.81	238.33	211.85	185.37	158.89	132.40
	LED	168.05	151.25	134.44	117.64	100.83	84.03
RM 0.334	Incandescent	2243.14	2018.83	1794.52	1570.20	1345.89	1121.57
	CFL	405.72	365.14	324.57	284.00	243.43	202.86
	LED	257.47	231.73	205.98	180.23	154.48	128.74

2.2.5 Correlated Colour Temperature and Colour Rendering Index

Islam (2015) produced a report stating that spectral power distribution, also known as SPD defines the ambience of illumination a certain lamp emits onto a given space. However, different SPDs can alter the illumination of a room index and its appearance, even at equal luminance. The ambience a light source produces can be established by its Correlated Colour Temperature (CCT) and Colour Rendering Index (CRI).

Each artificial lighting present in the market possesses their individual colour temperatures of which it discharges to its surrounding, in terms of coolness or warmness (Flamm et al., 2012). According to Lighting Facts (2018), cool colours typically have higher Kelvin temperatures ranging from 3600 – 5500K and warmer colours have lower Kelvin temperatures ranging from 2700 – 3500K. However, attempting to distinguish the precise colour temperature can be a tedious process as the colour spectrum is broad. Hence, the authors provided a typical label along with Correlated Colour Temperature spectrum as shown in Figure 2.14 below supporting the aforementioned statement.

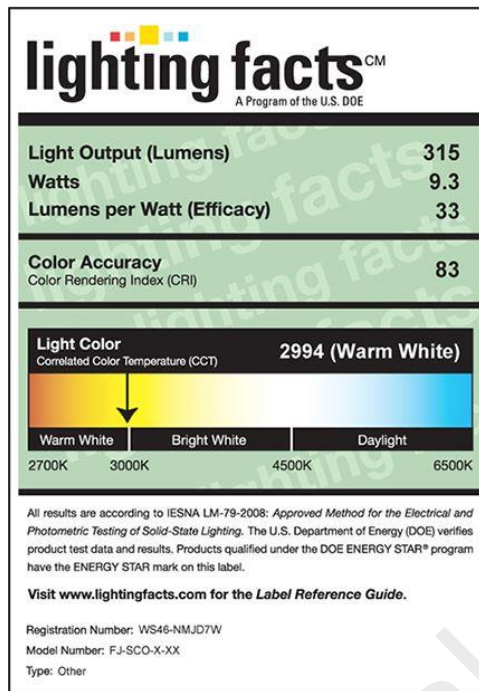

Figure 2.14: Standard Label.
(Lighting Facts, 2018)

Khan and Abas (2011) provided a breakdown of several lamps along with their associated CCT and CRI in Table 2.9 as shown below. It is to be noted that the more modern lamps introduced to the market have higher CCT as compared to its predecessors. It can be deduced from the table that bulbs have a CCT of 2500 – 3000K, hence providing a warm ambience of light, better known as warm white. CFL's and LED's also possess CCT of their own of which reads 2500 – 6500K and 3500 – 5500K respectively. The 2 more modern lamps mentioned previously provide a brighter shade of white light as compared to the traditional incandescent.

Table 2.9: Standard characteristics of different lamps.**(Khan and Abas, 2011)**

Lamps	Sizes (W)	THD ₁	PF	P _{loss} (W)	CCT (K)	BE ^a	Glare	CRI ^b
Bulbs	25–1000	0%	1	0%	2500–3000	No	Yes	90–99
Tube	20–40	10–180%	0.6–0.8	12.50%	2500–6500	Yes	Yes	55–70
CFL	8–36	10–180%	0.4–0.6	6.25%	2500–6500	Yes	Yes	55–75
LED	5–400	10–180%	0.4–0.7	4.25%	3500–5500	No	Yes	70–80
EEFL	15–400	2.7%	0.98	15.10%	2500–6500	Yes	No	>80

a

BE = bio-effects.

b

Sunlight color rendering index (CRI) = 100.

Thejokalyani and Dhoble (2014) deduced that the colour rendering index of a certain illuminating source is achieved by comparing its colour brilliance on an object with a standard illuminating source of same correlated colour temperature. This simply means that if the illuminating source in question is equal in relation to the natural illuminant; typically associated with natural daylight, the CRI between them are indifferent. CRI is typically measured on a scale of 0 – 100, where 100 is the peak outcome.

Table 2.9 above also provides a range of test readings of CRI values for several bulbs. It can be deduced from the table that IL, CFL and LED's provides readings of 90 - 99, 55 - 75 and 70 - 80 respectively (Khan & Abas, 2011). Though incandescent bulbs have very high CRI readings, the colour ambience the incandescent bulb provides is not as appealing when compared to CFL and LED lights. The author also deduced that incandescent lamps is emitted across wavelengths of 400 – 850 nm while LED lamps emits light across wavelengths of 500 – 700nm. Though LED emits light through a narrow band of wavelength, it produces bright white light by incorporating a mix of several phosphors. Another author supports this theory by testing the mix of phosphors to emit white light from an LED. It was reported that testing with double-deck

phosphors provided better readings in terms of CRI and lumens per Watt when compared to mixed phosphors (Yang et al., 2013).

The CALiPER Programme, in collaboration with the U.S. Department of Energy, DoE (2013) experimented with several types of Recessed/ Surface-Mounted LED Downlights and LED Troffers along with standard T8, T5 and T12 LED lamps. Tests carried out were designed to observe the CRI and CCT range of values for every lamp type. It was reported that all lamp types portrayed CRI of approximately 80, with several types of T5, T8 and T12 lamps dipping below the 80 mark and high correlated colour temperatures above 5000K. The troffers proved to be victorious in terms of CRI of approximately 80-90, being the highest reading amongst the other experimented lamp types. Most common rooms such as workplaces and classrooms utilizes troffers as their CCT of 3500 – 4000K is proven ideal for working conditions.

2.3 Life Cycle Assessment (LCA) for Different Lamps

Tähkämö et al. (2012) suggests it is rather important to evaluate the overall life cycle of lamps from its production stage until its end-of-life. Life cycle assessment provides an overview of the method of production of certain lamps along with their environmental impacts during production, along with the procedure indicated in the ISO Standard. The current ISO Standard is prepared so as to protect the environment from any chemical harm based on the current products being manufactured. This also does not mean that the products manufactured currently should also have a forecast for the future.

A couple of reports prepared by Principi and Fioretti (2014); DoE (2012) studied the life cycle phases the lamps generally undergo from the time of production until the time of disposal, better known as the “cradle to gate” approach. The general life cycle phases are as depicted in Figure 2.15, which will be discussed thoroughly in the next section. A more detailed description of the life cycle is as depicted in Figure 2.16.

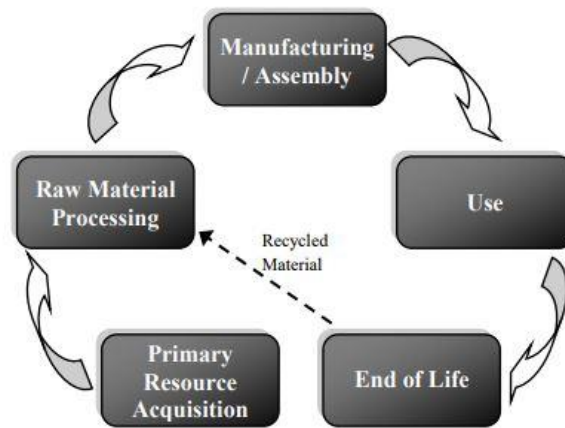

Figure 2.15: General Life-Cycle of a Lamp.
(DoE, 2012)

Typically, the end product from the time it is manufactured until the end of its useful life can be categorized into 5 separate stages as shown in Figure 2.15 being; Primary Resource Acquisition, Raw Material Processing, Manufacturing/ Assembly, Use and Maintenance and End-of-Life (Principi & Fioretti, 2014; DoE, 2012).

Primary Resource Acquisition includes the process which gathers raw materials from the earth by way of excavating non-renewable resources for aluminium which is used for heat sink of an LED, mercury which is used in a CFL, or the tungsten to make the filament for an IL.

Raw Material Processing converts the excavated materials into a product that can be used in the production of the lamp. Transportation of the material is normally included in this phase.

Manufacturing/ Assembly is the step which packages the end product, making it ready for transportation by means of a truck, plane or shipment. The products are typically transported either to the end user directly or to retail stores.

Use and Maintenance is a process by which the end user is using the lamp on a daily basis. The warranty and the product life are in effect once the product is consumed by the end user. In order to put into effect of the product, relevant energy is required to be generated of which may cause unforeseen harm to the environment.

End of Life is a process of disposal of the lamp as it reaches the end of its useful life. The consumer is to ensure the product is disposed of appropriately so as not to damage the environment. Hence the consumer should take care of the disposal to ensure that the environment is adhered to in compliance with the environmental act as stipulated by laws.

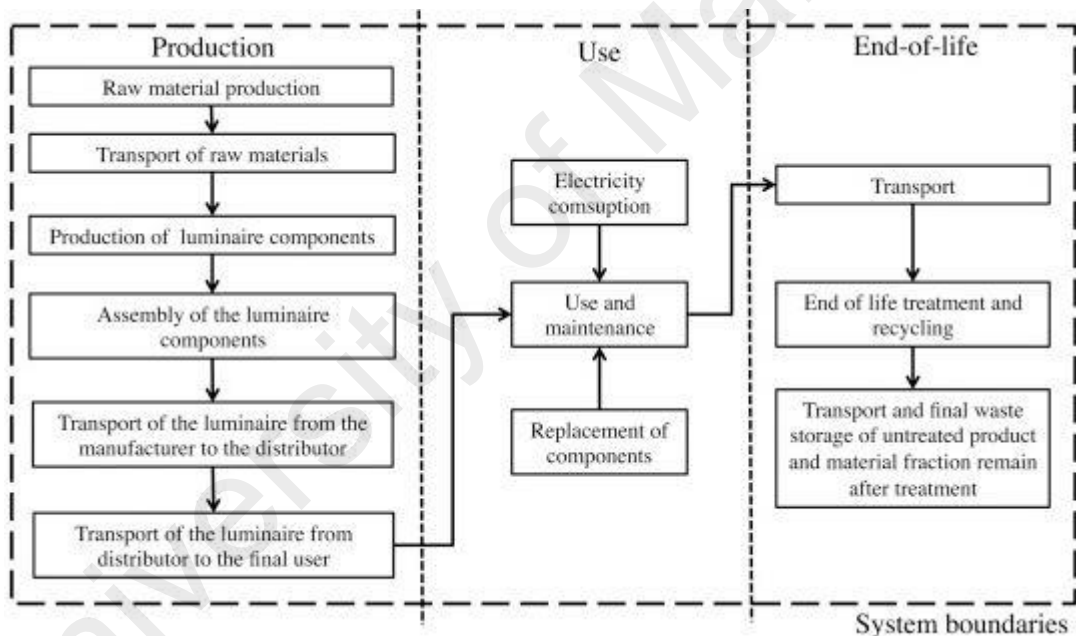

Figure 2.16: Detailed Life Cycle of a Lamp.

(Principi and Fioretti, 2014)

In a report prepared by OSRAM Opto Semiconductors GmbH, OSRAM (2009), the life cycle of a 40W Incandescent lamp, 8W of CFL and 8W of LED lamp was assessed. Observing that LED's and CFL's require less power to operate providing higher lumen output as compared to IL's, a common referral factor of 25,000 hours was set altering the number of lamps used for each type. LED uses less burning hours in comparison to CFL's and IL's which require 2.5% and 25% more respectively in order to achieve 25,000 hours of life expectancy.

OSRAM (2009) carried out experiments using these 3 lamps mentioned previously in order to attain the electricity consumption over the whole life cycle of these lamps, from the time they are manufactured until the end of its useful life. It has been reported that during the use phase of these lamps, the end user consumes more electricity as compared to the manufacturing phase of these lamps. A graph was tabulated portraying the primary energy demand for these 3 lamps respectively as shown in Figure 2.17 below.

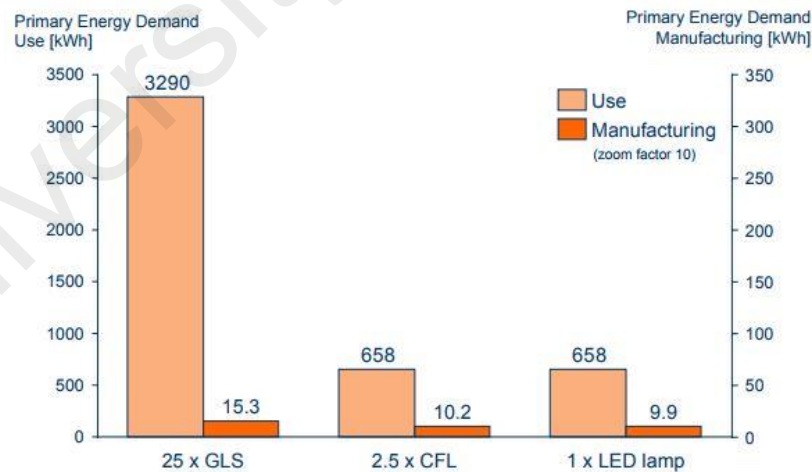

Figure 2.17: Electricity Consumption for Use and Manufacturing Phase.
(OSRAM, 2009)

OSRAM (2009) tabulated the figure above stating that the total energy demand required to operate LED's and CFL's are approximately 668 kWh each and 3305 kWh to operate incandescent lamps. It is to be noted that operation of incandescent lamps requires approximately 5 times more energy when put alongside operation of CFL's and LED's. As for the electricity consumption, it is clear that from previous literatures, incandescent lamps require higher wattage to operate the lamps compared to compact fluorescent lamps and light emitting diodes. It can be noticed from the graph that incandescent lamps utilize approximately 1000 kWh whereas CFL's and LED's only require 200kWh. Based on the rational, it is clear that CFL's and LED's require only 20% of that as compared to IL's and the manufacturing stage requires only a small amount of the primary energy demand.

Another researcher concludes that during the entire life cycle of these lamps, the use stage consumes the highest amount of energy to put into operations the lamps. The total energy consumed during the use phase accounts for approximately 82% - 99%, whilst the production phase accounts for 1% - 18% and end-of-life phase accounts for 0.1% - 4% of the total environmental damage (Principi & Fioretti, 2014).

In a report prepared by Department of Energy Part 2, DoE (2012), 3 different lamps were tested with their respective lamp ratings in order to achieve the associated environmental impacts. Lamp ratings of 15W CFL, 12.5W LED and 60W IL were used in this test with an output of 850 lumens each which formed Figure 2.18 as shown below.

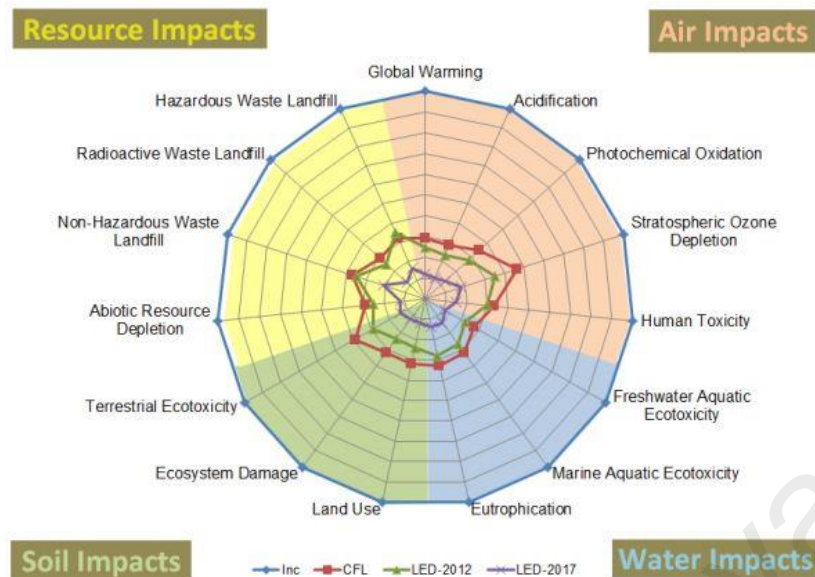

Figure 2.18: LCA on Environmental Impacts of Lamps.
(DoE, 2012)

It can be extracted from the figure above that:

1. Incandescent lamps acquire by far the biggest environmental impact when compared to LED's and CFL's as they require large amount of energy to provide illumination with very low efficacy.
2. CFL and the 2012 LED have almost similar implications to the environment, with the 2012 LED having the upper hand only by a fraction.
3. LED poses more of a threat to the environment when compared to CFL's due to its large aluminium heat sink.
4. LED 2017 portray the smallest amount of environmental damage due to improved technology over the years.

2.4 Summary

This chapter has compared various types of lighting technologies available in the market to date. The lighting luminaires that were included in this comparison are incandescent, discharge and LED lamps respectively. Comparisons were also made based upon their efficacy, life span, environmental effect, cost and correlated colour temperature and colour rendering index.

Firstly, incandescent lamps were investigated and were found that implementing this lamp provides very low lumen output with high power consumption. In that, majority of the power consumed are transmitted into heat, with only a minor percentage being utilized to produce light. With that, major power and cost savings can be achieved by upgrading to the later, more technological lighting luminaires available in the market.

Discharge lamps were also included in this comparison. Discharge lamps were understood to withstand a lifespan of at least 10 times longer than traditional incandescent lamps. However, a vast majority of these lamps utilize a mixture of various types of gases in order to provide illumination. Therefore, proper care of disposal of the lamp is vital as mercury and other gases in the tube may leak causing damage to the environment. Majority of these lamps are also used to provide illumination outdoors for parking lots, highways, pathways and stadiums. Hence, proper casing of the lamp should be looked into to avoid rainwater or dust entering the lamp casing, thus reducing its efficiency.

Thirdly, LED lamps were used in this comparison as they are one of the leading lighting technologies in the market to date. These lamps are known to be utilized worldwide in various types of sectors. This is because these lamps consume minimal power to provide bright illumination, able to operate for long hours, absence of mercury and lead in the tube and has wide range of colour rendering index.

CHAPTER 3: METHODOLOGY

3.1 Introduction

Light fitting selection to provide artificial illumination for a certain area of space can be a complex task to accomplish. There are many lamp manufacturers in the market, each with their particular lamp ratings and fixtures. Hence, a lighting company titled DIAL created a software called DIALux. This lighting design software is able to plan, calculate and provide visualization of selected lamp fittings which is to be applied to the desired layout.

With that, 3 different cases have been trialled using the DIALux software to visualize the selected lamps that is to be applied for various layouts. The DIALux software was utilized in this report to compare and analyse the different lamp fittings in terms of its lumen output, power consumption, lux levels and other results which will be discussed in the latter part of this report. The method of carrying out this research is as depicted in the flow chart figure below. This flow chart briefly explains the steps taken to attain the desired results by the end of the design.

In order for a user to attain the desired readings, several tasks need to be accomplished in preparation for it. Initially, the project starts by setting the design parameter. Any AutoCAD drawing of the desired layout needs to be imported into the DIALux software for the preparation of the lighting layout. This architectural drawing needs to be accompanied with the proposed furniture arrangement and dimensions of the layout. With the knowledge of the furniture layouts, the arrangement of the lighting fixtures can be positioned to provide sufficient illumination on the working plane or where deemed necessary. Once the user is satisfied with the architectural layout imported, the appropriate lighting fixture for the layout is to be chosen from the vast array of catalogues provided by the DIALux software. These catalogues comprise of many different lighting manufacturers worldwide such as Philips, Thorn, OSRAM, and etc., each with their own design specifications. The user can choose as to which lamp manufacturer best suits the design parameters of the layout, in terms of total power consumption and its corresponding lumen output. Once the user is satisfied with the criterion mentioned above, the program can be executed to display the number of lighting fixtures required in the given area of the layout, along with its corresponding total power consumption. However, if the user is not satisfied with the lamp of choice, there are many other lighting manufacturers available in the catalogue to which the lighting fittings can be chosen from. By doing so, the best lumen output from a chosen lamp with minimal power consumption can be achieved. This would also prove beneficial for the consumer in the long run with satisfactory illumination. Once the user is satisfied with the positioning and layout of the lighting fixtures, the program calculates and provides data readings for the applied lighting fixtures. If the design calculations fall within the required lux level requirements, then the readings of the ISO contour and other data can be printed out and analysed.

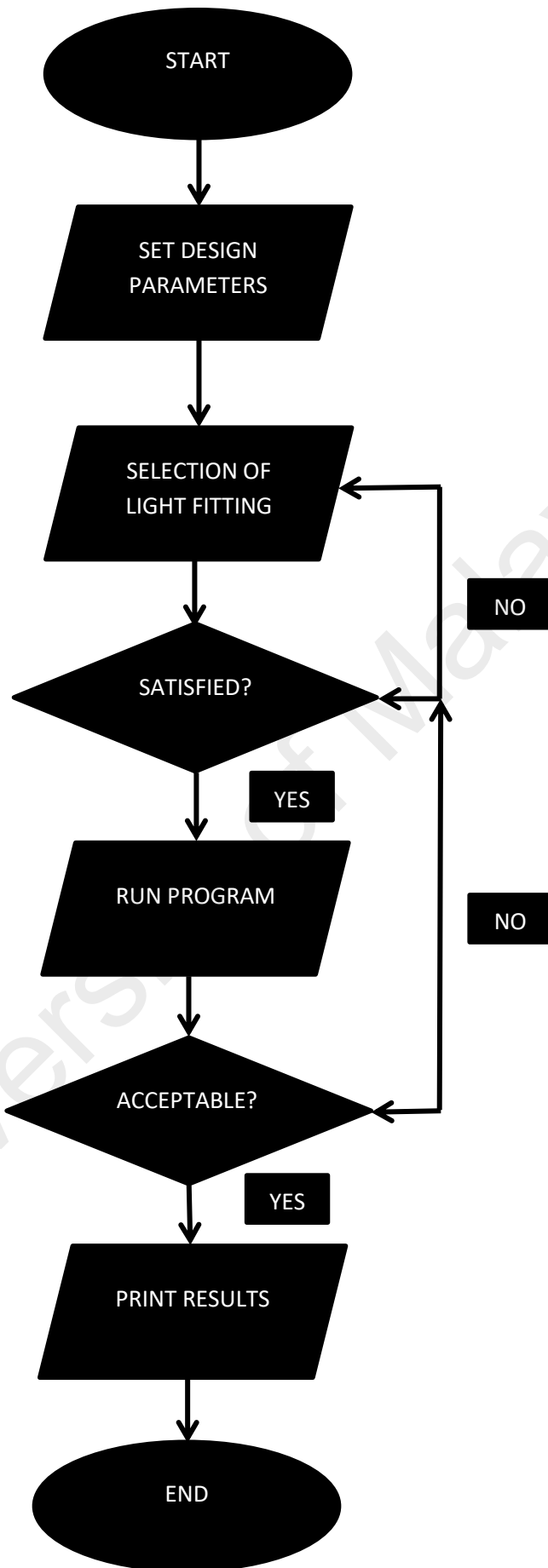

Figure 3.1: Flowchart of Overall Design Methodology

3.2 Fittings Selection

There are many lighting manufacturers in the market and each manufacturer has their own design parameters. Generally, all manufacturers comply with the illumination levels as spelt out in the relevant guidelines. With that, the DIALux software provides the user with sufficient design parameters for the selection of the lighting luminaires. The software provides adequate information in the catalogues selection for the various lighting fittings.

However, it is to be noted that DIALux software does not offer any selections for incandescent lamps in their catalogue as the technology for incandescent lamps is phased out due to the poor performance when compared to the newer lightings. Hence, this analysis comprises of fluorescent, compact fluorescent and LED lamps being proposed in order to achieve a minimum of 300 lx on the work plane.

Taking into consideration the Philips catalogue offers many light fittings of diverse ratings and lumen output, this analysis highlights the selection of lowest power consumption with high lumen output from each class of lighting. These lamps were repeated for all 3 cases to compare and analyse the different lamps utilized from several aspects. By doing so, the best option among the 3 lamps proposed can be determined.

It is also to be noted that there are other different methods to determine the number of light fittings to be utilized in an area of space. Apart from using the automated DIALux software calculation, the lumen method calculation can aid in determining the number of light fittings required to be used in a room. However, in order to utilize this formula, information needs to be gathered about the light fitting that is of interest.

The light fitting of interest should provide information such as lumen output of the light, the room index, flux distribution, utilization factor table and average luminance table. This information is vital for the formulation to calculate the number of fittings required as shown in equation 3.1.

The formula that is used in the lumen method to determine the number of light fitting to be installed in a given area of space can be formulated as such:

$$N = \frac{E \times A}{F \times UF \times MF} \quad (3.1)$$

Where

N = number of luminaire

A = area of the horizontal working plane

E = average illuminance over the horizontal working plane

F = lighting design lumens per lamp, i.e. initial bare lamp luminous flux

UF = utilisation factor for the horizontal working plane

MF = maintenance factor, light loss factor due to deterioration and dirt

Light loss factor (LLF) can also be determined by manual calculation using formula 3.2:

$$LLF = LLMF \times LMF \times RSMF \quad (3.2)$$

Where

LLMF = lamp lumen maintenance factor

LMF = luminaire maintenance factor

RSMF = room surface maintenance factor

3.2.1 Fluorescent Lamp

The class of lighting that was chosen for this analysis was Philips TBS165. This group comprises of lamps that are believed to be energy efficient as it replaces its predecessors with newer TL5 technology. This group can be introduced for a wide range of applications such as offices, markets and hallways. The combination of high-frequency gear, sensors and MASTER TL5 lamp allows this group to save on electricity consumption.

The choice of fitting to be used in this analysis was Philips TBS165 G 2xTL5-28W/840 HFS M2 PIP SC as shown in Figure 3.2 below. This lamp was chosen because of its high lumen output with minimal energy consumption in its class. The fitting consists of 2xTL5 lamps which consumes total of 28W per fitting with a CCT of 840, emitting a neutral white colour.

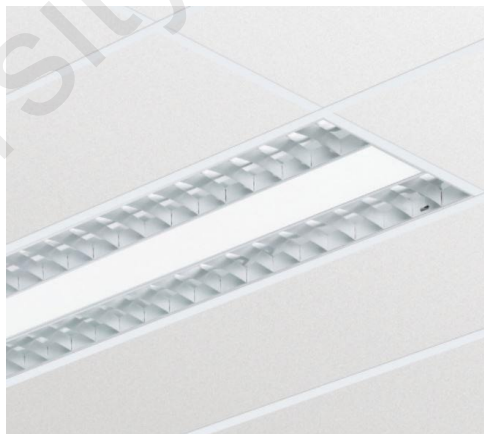

Figure 3.2: Philips TBS165 G 2xTL5-28W/840 HFS M2 PIP

3.2.2 Compact Fluorescent Lamp

In order to carry out the performance analysis for compact fluorescent lamp, the lamp was chosen from the Europa 2 class in the Philips catalogue. These recessed downlight PL-C lamps offer highly efficient optics and the illumination intensity can be altered. Similar to fluorescent lamp above, these lamps possess high frequency gear which aids in energy savings and are simple to install. This group can be introduced for a wide range of applications such as offices, retail and hospitality.

The lamp model Philips FBS120 2xPL-C/2P26W L_840 was selected from the Europa 2 family for the purpose of this analysis. This fitting consists of 2xPL-C lamps which uses 26W of power to operate with CCT of 840, emitting neutral white colour, similar to the fluorescent lamp as mentioned above. Though many of the features of the compact fluorescent lamp are similar to the fluorescent lamp mentioned previously, these downlights consume less power without compensating the output illumination. The choice of lamp is as depicted in Figure 3.3 below.



Figure 3.3: Philips FBS120 2xPL-C/2P26W L_840

3.2.3 Light Emitting Diode Lamp

The class of lighting that was chosen for this analysis was TrueLine, surface mounted from the Philips catalogue. Philips manufactured these TrueLine, surface mounted lamps as it was established that the illumination output of these fittings was able to give sufficient lux level on a working plane. This lamp family also offers sleek, elegant fittings to accommodate for architectural requirements and are energy-efficient.

The choice of fitting to be used in this analysis was Philips SM530C L1450 1xLED50S/840 OC. This fitting consists of 1xLED50S lamps which uses 37W of power to operate with CCT of 840, emitting neutral white colour. Though each fitting consumes 37W of power to operate, LED's emit wide illumination range at high intensity, hence installation of the fittings are kept minimal. The choice of lamp is as depicted in Figure 3.4 below.



Figure 3.4: Philips SM530C L1450 1xLED50S/840

3.3 Floor Layout Details

Measurements and other details of the cases are presented in this section.

3.3.1 Case 1: Small Office Layout

The illumination of a typical small office layout as depicted in Figure 3.5 below has been conducted using various luminants. Other details of the layout are provided in Table 3.1 below.

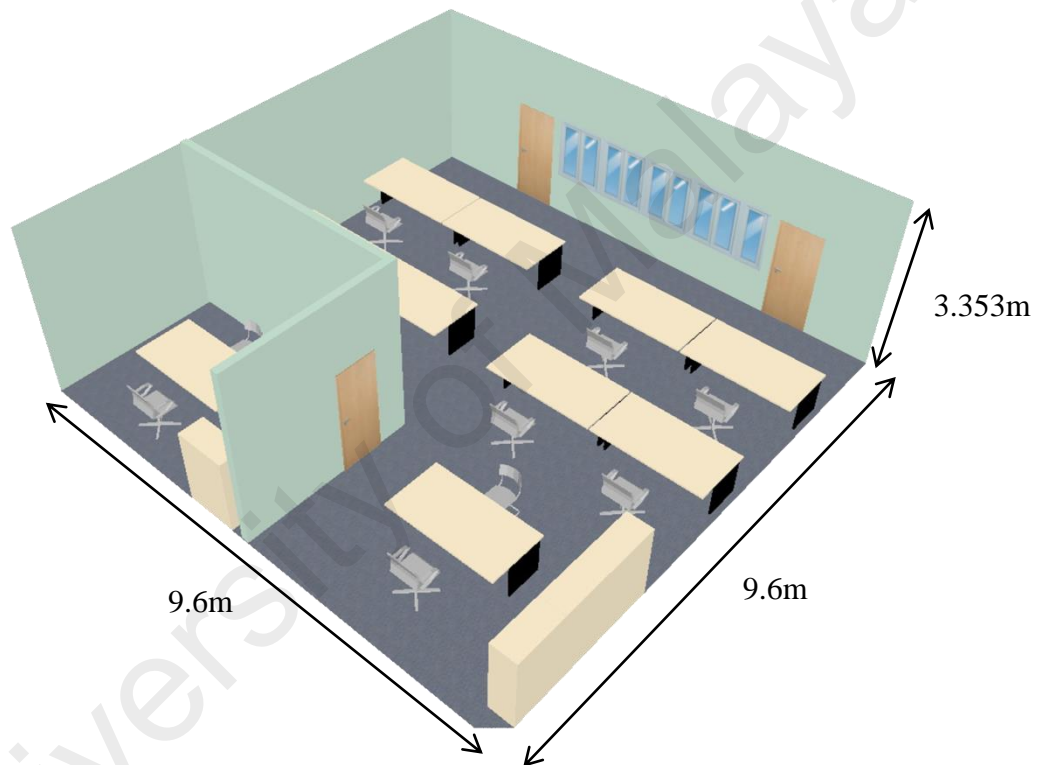

Figure 3.5: Small office layout (9.6m x 9.6m x 3.353m)

Table 3.1: Layout Details

Room Details	Value
Dimension (l x w x h)	9.6m x 9.6m x 3.353m
Reflectance (p_c x p_w x p_f)	0.2 x 0.7 x 0.61
Other Object Reflectance	1.0
Light Loss Factor	0.8
Desired Illumination Level	300 lx

3.3.2 Case 2: Large Office Layout

The illumination of a typical large office layout as depicted in Figure 3.6 below has been conducted using various luminants. Other details of the layout are provided in Table 3.2 below.

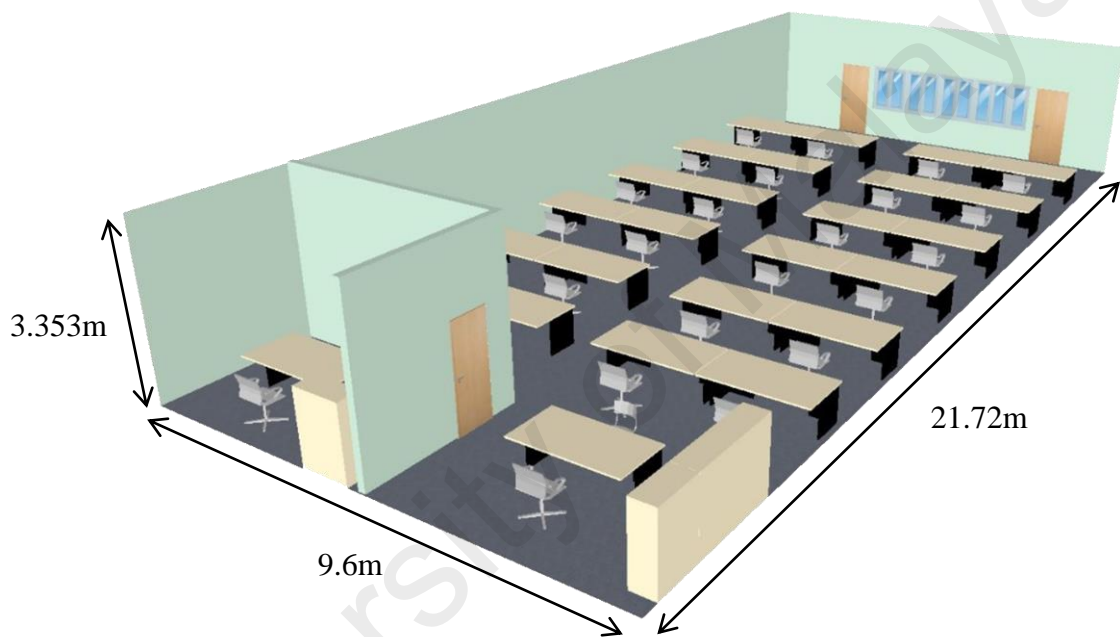

Figure 3.6: Large office layout (9.6m x 21.72m x 3.353m)

Table 3.2: Layout Details

Room Details	Value
Dimension (l x w x h)	9.6m x 21.72m x 3.353m
Reflectance ($p_c \times p_w \times p_f$)	0.2 x 0.7 x 0.61
Other Object Reflectance	1.0
Light Loss Factor	0.8
Desired Illumination Level	300 lx

3.3.3 Case 3: Convenience Store Layout

The illumination of a typical convenience store layout as depicted in Figure 3.7 below has been conducted using various luminants. Other details of the layout are provided in Table 3.3 below.

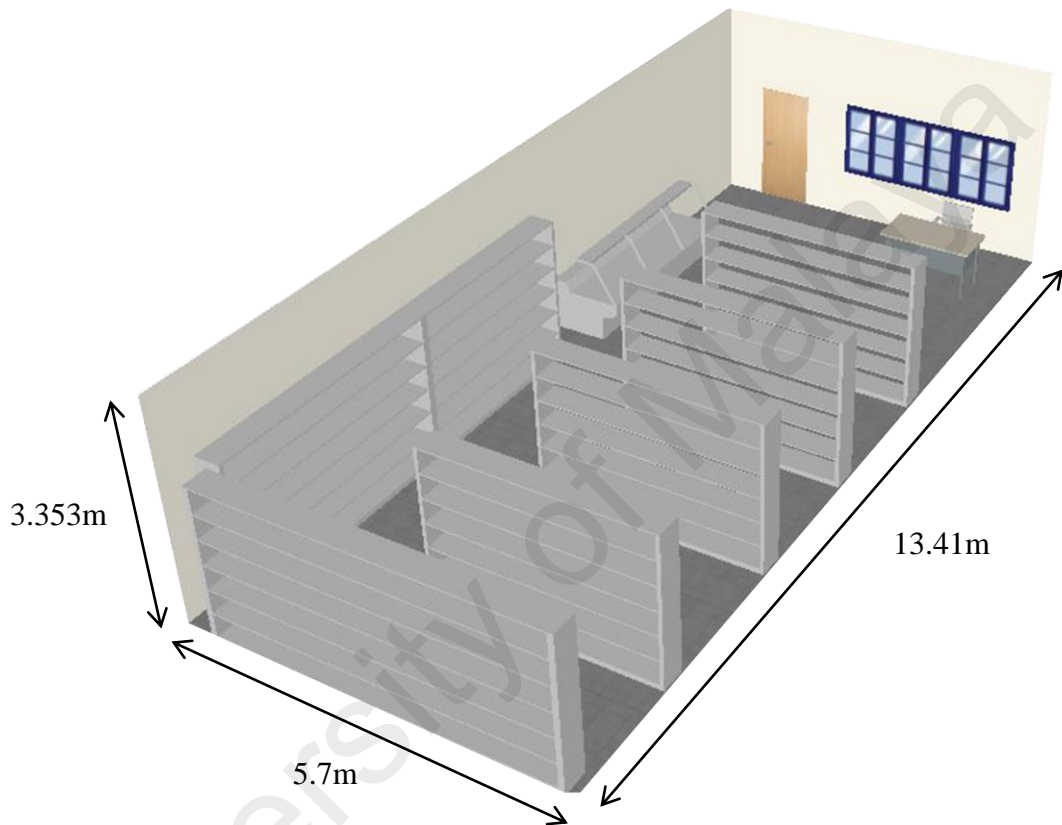

Figure 3.7: Convenience store layout (5.7m x 13.41m x 3.353m)

Table 3.3: Layout Details

Room Details	Value
Dimension (l x w x h)	5.7m x 13.41m x 3.353m
Reflectance ($p_c \times p_w \times p_f$)	0.2 x 0.7 x 0.61
Other Object Reflectance	1.0
Light Loss Factor	0.8
Desired Illumination Level	300 lx

CHAPTER 4: RESULTS AND DISCUSSION

4.1 Introduction

In this chapter, the 3 different cases mentioned previously will be investigated upon application of the selected lamps stated on the layout. This chapter provides readings based on photometric charts, lux level readings of the selected lamps, along with their ISO contours and total power consumption. The cost element is also calculated for the installation of these light fixtures. A brief discussion of the report will also be presented.

4.2 Photometric Chart, Illumination Level and Costing

In this section, a general description of a photometric chart will be provided. Illumination levels will also be provided and the costing of implementing the lamps to the layout will be given.

4.2.1 Photometric Chart

A photometric chart for the spread of lumen on a given surface allows one to gauge the illumination intensity emitted from a certain lamp. Typically, the lux level for any given room, whether providing illumination on a working plane or for general lighting should be between ranges of 200 - 400 lx. By affirming the optimum lux level an area should satisfy, the DIALux software allows the user to adjust the layout and number of fittings to achieve the desired requirements.

In this report, typical photometric charts are presented for the different cases of repeated lamp selections. Upon selecting the appropriate lamps, the software produced photometric images displaying the spread of lumens on the working plane. The images portray typical illumination level to be achieved for all lamps, with emphasis of illumination on the working plane. The charts produced show the illumination levels at the working plane wherein, the yellow indicates the highest intensity of the lighting

level illumination and dims as it moves further away from the working plane. However, it is to be noted that overall the illumination level and the selection of the light fittings were sufficient enough to achieve the illumination level between 200 - 400lx.

4.2.2 Illumination Levels of Different Light Fittings.

In order to achieve a photometric image, the most compatible types of fluorescent, compact fluorescent and LED lamps were chosen and applied to the layout. Options of selecting other luminaires in the same class from the Philips catalogue were provided in the DIALux software. However, the lamp with the lowest power consumption providing highest lumen output was selected simply for the fact that the illumination level output from the selected lighting fixtures exceeded the other lighting fixtures provided in the catalogue and as such, the calculation output provided by DIALux met the required design illumination level. Also it is to be noted that by doing so, fewer lightings were required to be installed versus other lighting fixtures.

4.2.3 Costing

The estimated cost for supply, delivery, installation, testing and commissioning of the 3 cases shall comprise of the following:-

1 no. 60 amps TP&N Electrical Distribution Board.	RM 4,000.00
Final sub circuits.	RM60.00 per point
TNBs Meter panel.	RM 300.00
1-gang switch outlet.	RM 12.00 per no.
2-gang switch outlet.	RM 15.00 per no.
4-gang switch outlet.	RM 21.00 per no.
Lighting Fixtures.	Light fitting varies Case by Case.

4.3 Illumination Level, Total Power Consumption and Cost Estimate for Different Cases

In this section, 3 different cases will be analysed upon implementation of the lamps stated previously. The analysis will comprise of the illumination level, total power consumption and cost estimate of implementing these lamps.

4.3.1 Case 1: Small Office Summary



Figure 4.1: Typical Photometric Chart.

Upon adjusting the position and layout of the selected luminaries, readings were obtained for each type of lamp as shown in Figure 4.1, Figure 4.2, Figure 4.3 and Figure 4.4. These figures indicate the photometric chart and ISO contour for each lamp, in relation to their respective lux levels. It is to be noted that the average lux level output the lamps provide is approximately 300lx, hence satisfying the desired lux level requirement. There are certain cases whereby the average lux level exceeds or drops below the 300lx requirement due to the number of lamps and their intensity of output. To be specific, the readings obtained from the DIALux software shows that the fluorescent, compact fluorescent and LED lamps provided average lux level readings of 310lx, 336lx and 285lx respectively on the working plane. Other important details of the lamps used in this case can be found in Appendix A.

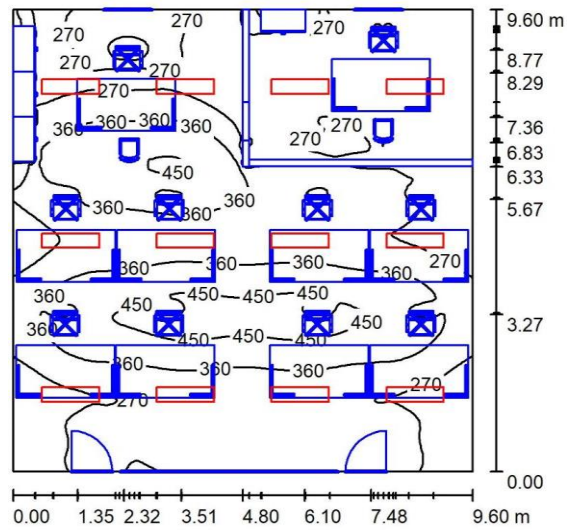

Figure 4.2: ISO Contour for Fluorescent Lamp

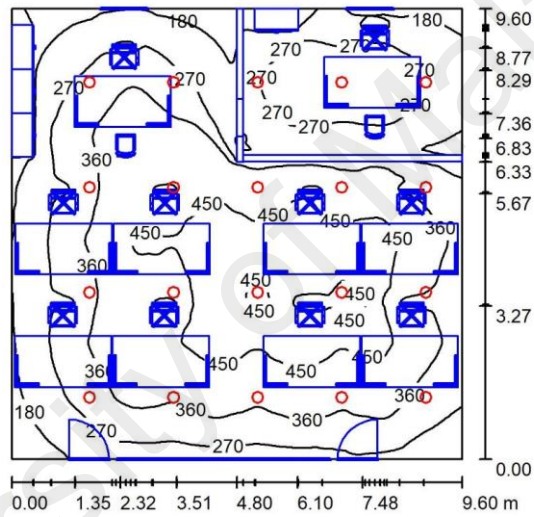

Figure 4.3: ISO Contour for Compact Fluorescent Lamp

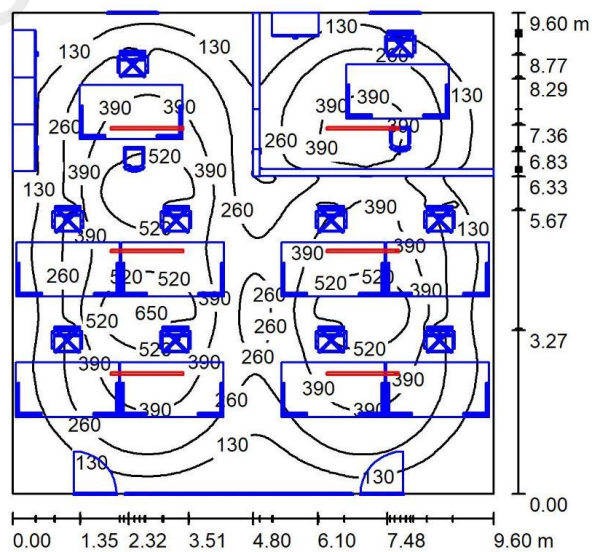

Figure 4.4: ISO Contour for LED Lamp

Although the lamps mentioned previously provide equal and adequate illumination, the lamps power consumption may vary from one another. With that being said, the breakdown of the lamps utilized and their respective power consumption characteristics is as tabulated in Table 4.1. It is to be noted that all of these information has been provided in the single data sheet output upon completing the tests for each lamp in Appendix A.

Table 4.1: Power Consumption for Different Lamps.

Lamp Type	Avg. Lux (lx)	No. of Luminaires Required	Total Power Consumed (W)	Watt/sq.metre (W/m²)	Watt/sq.metre/100 Lux (W/m²)
Fluorescent	310	12	732	7.94	2.56
Compact Fluorescent	336	20	1,320	14.32	4.26
LED	285	6	222	2.41	0.85

The output readings proves that all the lamps used for the experiment satisfies the average lux level requirement of 300lx. However, in order to achieve this reading, every lamp differs from one another in terms of the number of luminaires used and its related power usage. It can be observed from the table above that compact fluorescent lamp performed the poorest amongst its counterparts. Not only does implementing compact fluorescent consume more power, more luminants are also required to achieve satisfactory illumination. On the contrary, LED lamps excelled in terms of performance when implemented. Its low power consumption per square metre proved superior and the required luminaires are much lower than its predecessors. It is to be noted that the life expectancy and lumens depreciation of the lamps were not taken into account in this calculation.

The costing for fluorescent, compact fluorescent and LED lamps can be broken down as follows:-

Table 4.2: Costing for Fluorescent Lamp

Unit	Description of item	Quantity	Unit rate (RM)	Amount (RM)
1	Electrical DB	1	4,000.00	4,000.00
2	TNB Meter	1	300.00	300.00
3	Final sub circuit	12	60.00	720.00
4	4-gang switch point	1	21.00	21.00
5	Fluorescent fixture	12	28.00	336.00
6	Total (RM)			5,377.00

Table 4.3: Costing for Compact Fluorescent Lamp

Unit	Description of item	Quantity	Unit rate (RM)	Amount (RM)
1	Electrical DB	1	4,000.00	4,000.00
2	TNB Meter	1	300.00	300.00
3	Final sub circuit	20	60.00	1,200.00
4	4-gang switch point	1	21.00	21.00
5	Compact Fluorescent fixture	20	38.00	760.00
6	Total (RM)			6,281.00

Table 4.4: Costing for LED Lamp

Unit	Description of item	Quantity	Unit rate (RM)	Amount (RM)
1	Electrical DB	1	4,000.00	4,000.00
2	TNB Meter	1	300.00	300.00
3	Final sub circuit	6	60.00	360.00
4	2-gang switch point	1	12.00	12.00
5	LED fixture	6	60.00	360.00
6	Total (RM)			5,032.00

The two figures below depict the comparison between the 3 types of lamps utilized in this analysis. The figures consist of comparison between the power consumption depending on number of lamps used and their respective cost estimates.

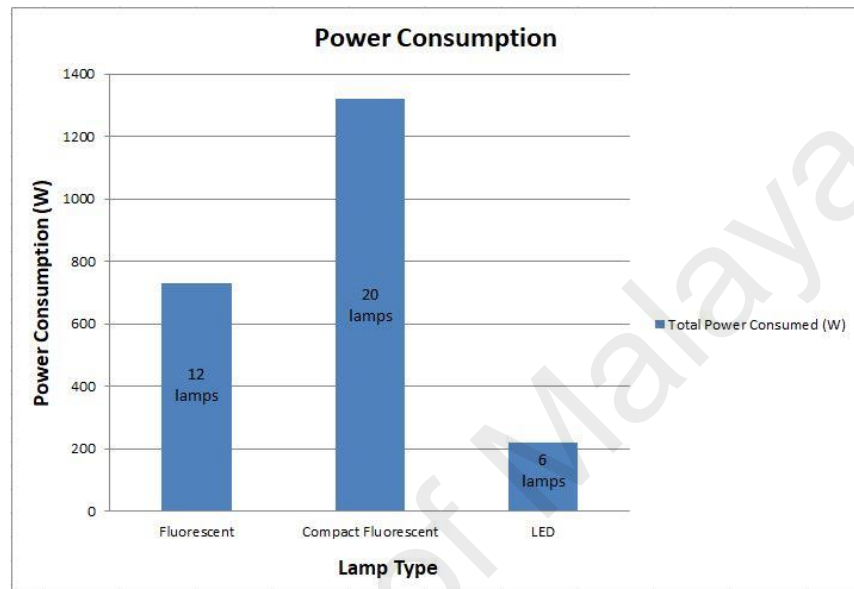

Figure 4.5: Power Consumption Comparison

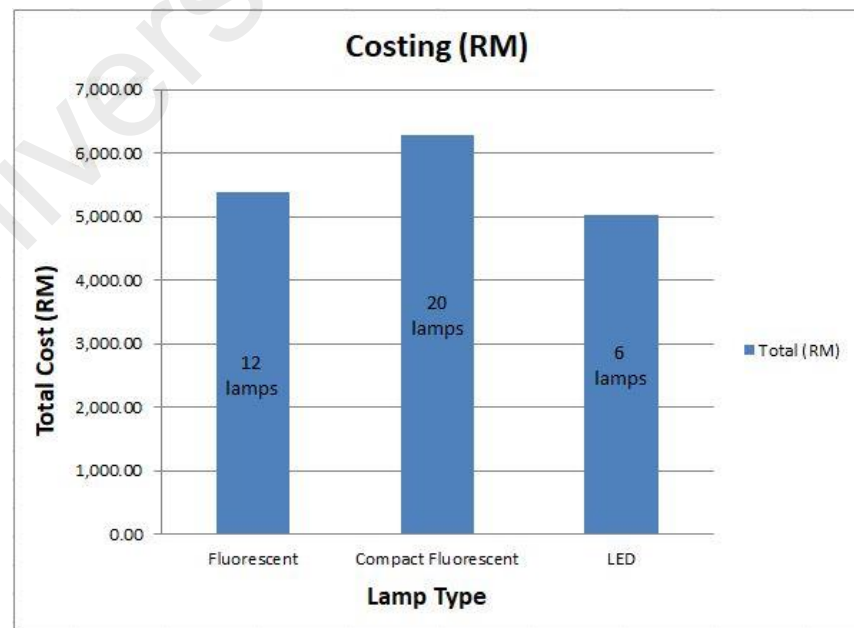

Figure 4.6: Total Cost Comparison

4.3.2 Case 2: Large Office Summary

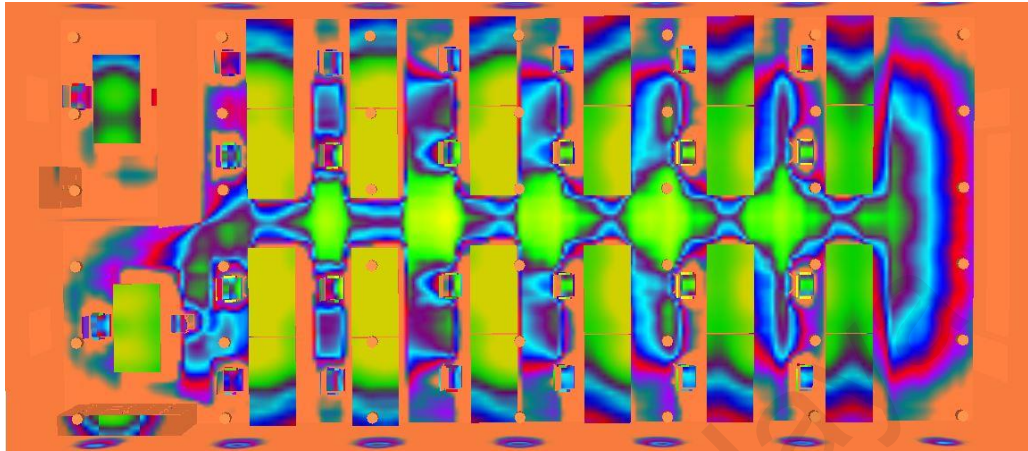

Figure 4.7: Typical Photometric Chart.

Upon adjusting the position and layout of the selected luminaires, readings were obtained for each type of lamp as shown in Figure 4.7, Figure 4.8, Figure 4.9 and Figure 4.10. These figures indicate the photometric chart and ISO contour for each lamp, in relation to their respective lux levels. It is to be noted that the average lux level output the lamps provide is approximately 300lx, hence satisfying the desired lux level requirement. There are certain cases whereby the average lux level exceeds or drops below the 300lx requirement due to the number of lamps and their intensity of output. To be specific, the readings obtained from the DIALux software shows that the fluorescent, compact fluorescent and LED lamps provided average lux level readings of 320lx, 335lx and 264lx respectively on the working plane. Other important details of the lamps used in this case can be found in Appendix B.

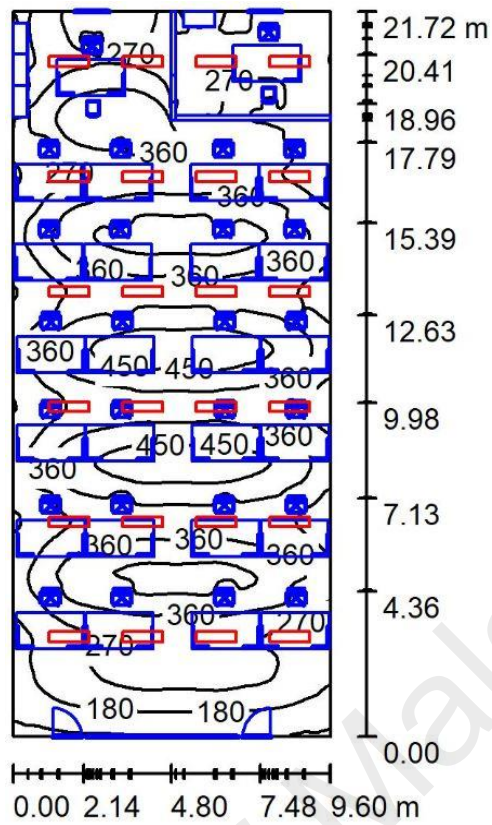

Figure 4.8: ISO Contour for Fluorescent Lamp

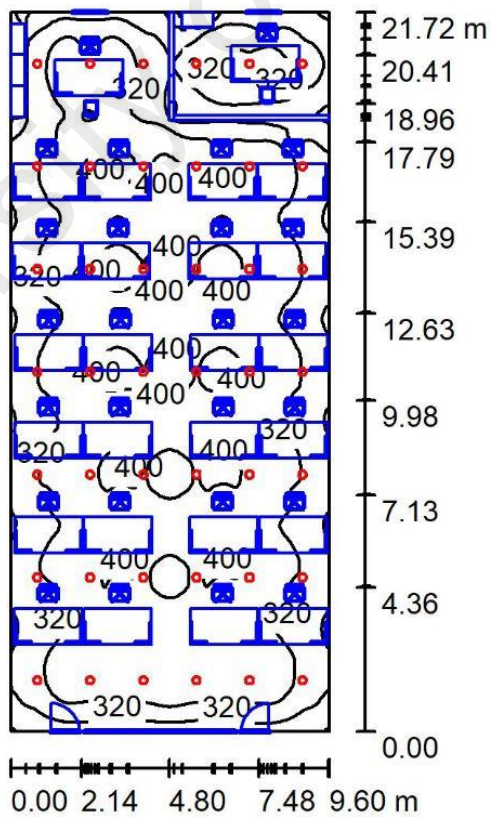

Figure 4.9: ISO Contour for Compact Fluorescent Lamp

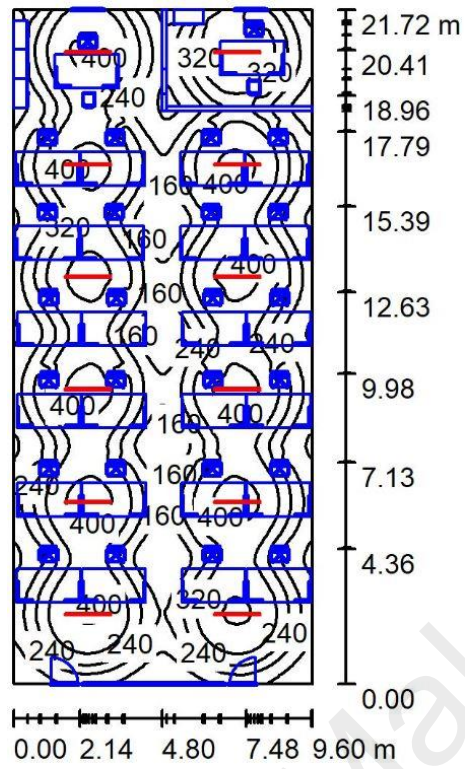

Figure 4.10: ISO Contour for LED Lamp

Although the lamps mentioned previously provide equal and adequate illumination, the lamps power consumption may vary from one another. With that being said, the breakdown of the lamps utilized and their respective power consumption characteristics is as tabulated in Table 4.5. It is to be noted that all of these information has been provided in the single data sheet output upon completing the tests for each lamp in Appendix B.

Table 4.5: Power Consumption for Different Lamps.

Lamp Type	Avg. Lux (lx)	No. of Luminaires Required	Total Power Consumed (W)	Watt/sq.metre (W/m²)	Watt/sq.metre/100 Lux (W/m²)
Fluorescent	320	24	1,464	7.02	2.19
Compact Fluorescent	335	42	2,772	13.29	3.97
LED	264	12	444	2.13	0.81

The output readings proves that all the lamps used for the experiment satisfies the average lux level requirement of 300lx. However, in order to achieve this reading, every lamp differs from one another in terms of the number of luminaires used and its related power usage. It can be observed from the table above that compact fluorescent lamp performed the poorest amongst its counterparts. Not only does implementing compact fluorescent consume more power, more luminants are also required to achieve satisfactory illumination. On the contrary, LED lamps excelled in terms of performance when implemented. Its low power consumption per square metre proved superior and the required luminaires are much lower than its predecessors. It is to be noted that the life expectancy and lumens depreciation of the lamps were not taken into account in this calculation.

The costing for fluorescent, compact fluorescent and LED lamps can be broken down as follows:-

Table 4.6: Costing for Fluorescent Lamp

Unit	Description of item	Quantity	Unit rate (RM)	Amount (RM)
1	Electrical DB	1	4,000.00	4,000.00
2	TNB Meter	1	300.00	300.00
3	Final sub circuit	24	60.00	1,440.00
4	4-gang switch point	1	21.00	21.00
5	Fluorescent fixture	24	28.00	672.00
6	Total(RM)			6,433.00

Table 4.7: Costing for Compact Fluorescent Lamp

Unit	Description of item	Quantity	Unit rate (RM)	Amount (RM)
1	Electrical DB	1	4,000.00	4,000.00
2	TNB Meter	1	300.00	300.00
3	Final sub circuit	42	60.00	2,520.00
4	1-gang switch point	1	12.00	12.00
5	2-gang switch point	2	15.00	30.00
6	Compact Fluorescent fixture	42	38.00	1,596.00
7	Total (RM)			8,459.00

Table 4.8: Costing for LED Lamp

Unit	Description of item	Quantity	Unit rate (RM)	Amount (RM)
1	Electrical DB	1	4,000.00	4,000.00
2	TNB Meter	1	300.00	300.00
3	Final sub circuit	12	60.00	720.00
4	4-gang switch point	1	21.00	21.00
5	LED fixture	12	60.00	720.00
6	Total (RM)			5,761.00

The two figures below depict the comparison between the 3 types of lamps utilized in this analysis. The figures consist of comparison between the power consumption depending on number of lamps used and their respective cost estimates.

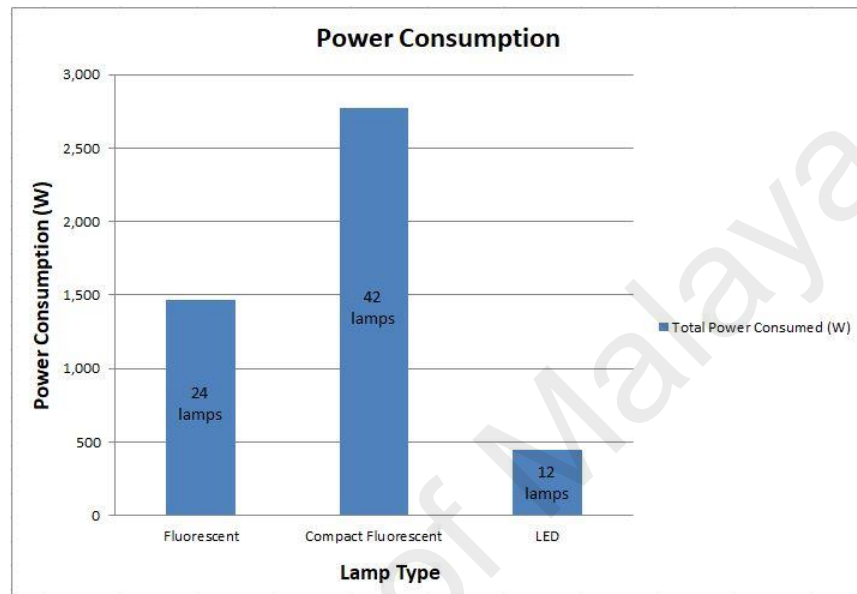

Figure 4.11: Power Consumption Comparison

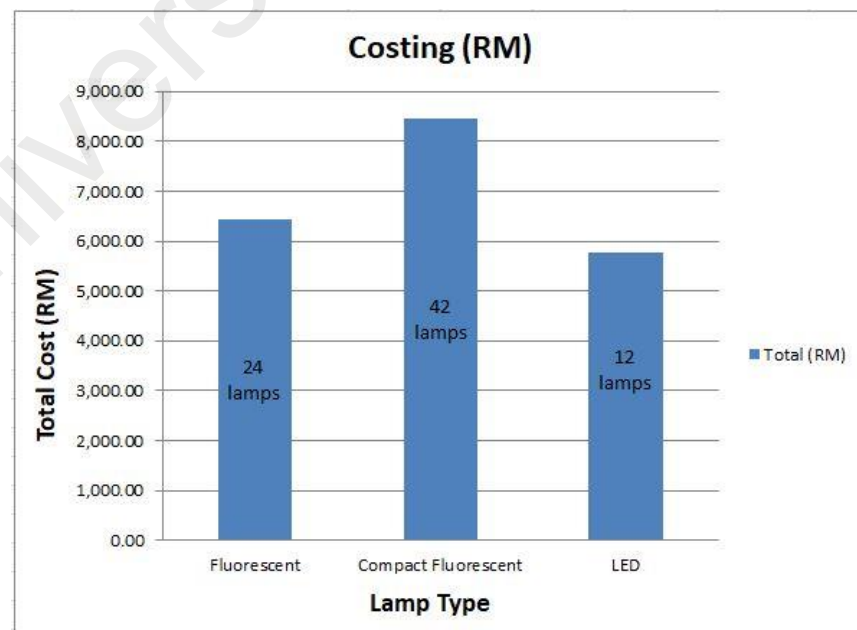

Figure 4.12: Total Cost Comparison

4.3.3 Case 3: Convenience Store Summary

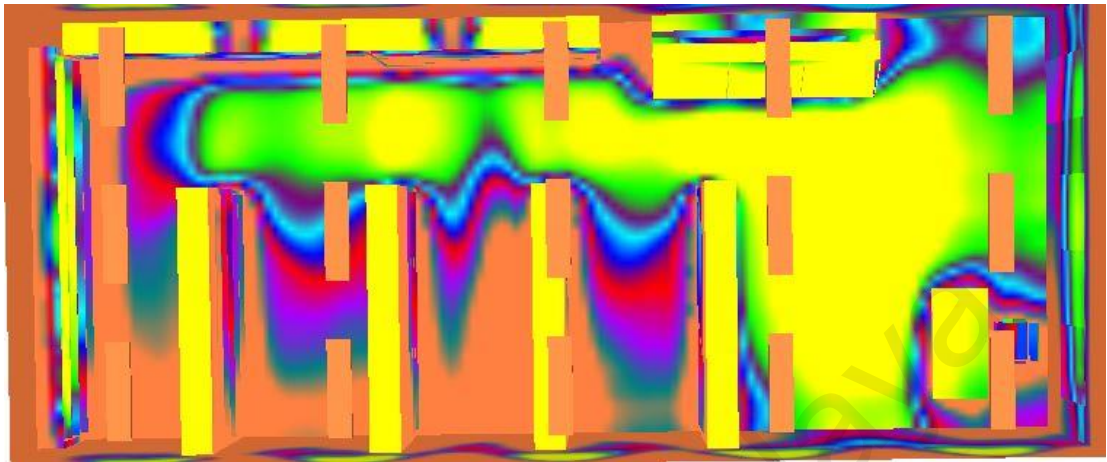

Figure 4.13: Typical Photometric Chart.

Upon adjusting the position and layout of the selected luminaries, readings were obtained for each type of lamp as shown in Figure 4.13, Figure 4.14, Figure 4.15 and Figure 4.16. These figures indicate the photometric chart and ISO contour for each lamp, in relation to their respective lux levels. It is to be noted that the average lux level output the lamps provide is approximately 300lx, hence satisfying the desired lux level requirement. There are certain cases whereby the average lux level exceeds or drops below the 300lx requirement due to the number of lamps and their intensity of output. To be specific, the readings obtained from the DIALux software shows that the fluorescent, compact fluorescent and LED lamps provided average lux level readings of 333lx, 350lx and 317lx respectively on the working plane. Other important details of the lamps used in this case can be found in Appendix C.

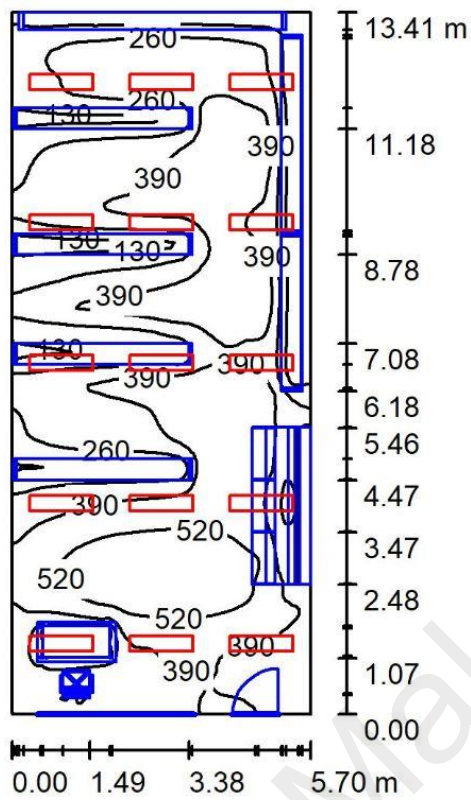

Figure 4.14: ISO Contour for Fluorescent Lamp

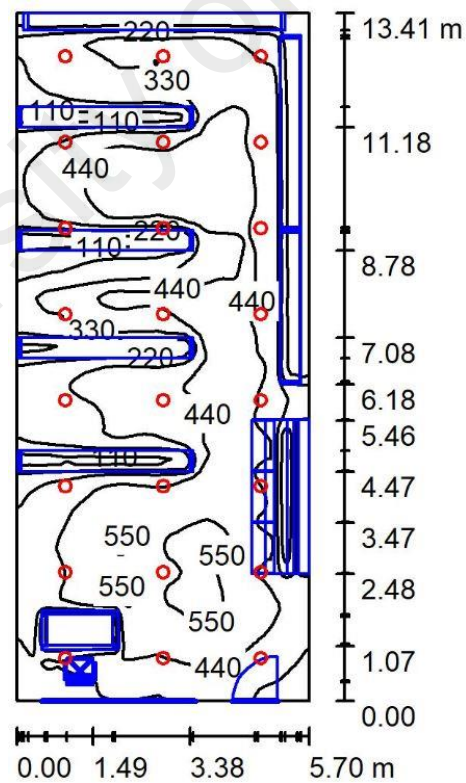

Figure 4.15: ISO Contour for Compact Fluorescent Lamp

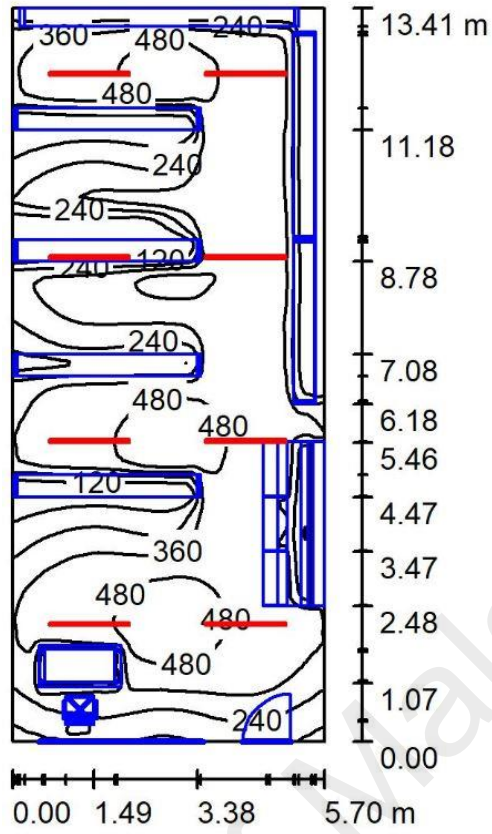

Figure 4.16: ISO Contour for LED Lamp

Although the lamps mentioned previously provide equal and adequate illumination, the lamps power consumption may vary from one another. With that being said, the breakdown of the lamps utilized and their respective power consumption characteristics is as tabulated in Table 4.9. It is to be noted that all of these information has been provided in the single data sheet output upon completing the tests for each lamp in Appendix C.

Table 4.9: Power Consumption for Different Lamps.

Lamp Type	Avg. Lux (lx)	No. of Luminaires Required	Total Power Consumed (W)	Watt/sq.metre (W/m²)	Watt/sq.metre/100 Lux (W/m²)
Fluorescent	333	15	915	11.97	3.59
Compact Fluorescent	350	24	1,584	20.72	5.92
LED	317	8	296	3.87	1.22

The output readings proves that all the lamps used for the experiment satisfies the average lux level requirement of 300lx. However, in order to achieve this reading, every lamp differs from one another in terms of the number of luminaires used and its related power usage. It can be observed from the table above that compact fluorescent lamp performed the poorest amongst its counterparts. Not only does implementing compact fluorescent consume more power, more luminants are also required to achieve satisfactory illumination. On the contrary, LED lamps excelled in terms of performance when implemented. Its low power consumption per square metre proved superior and the required luminaires are much lower than its predecessors. It is to be noted that the life expectancy and lumens depreciation of the lamps were not taken into account in this calculation.

The costing for fluorescent, compact fluorescent and LED lamps can be broken down as follows:-

Table 4.10: Costing for Fluorescent Lamp

Unit	Description of item	Quantity	Unit rate (RM)	Amount (RM)
1	Electrical DB	1	4,000.00	4,000.00
2	TNB Meter	1	300.00	300.00
3	Final sub circuit	24	60.00	1,440.00
4	4-gang switch point	1	21.00	21.00
5	Fluorescent fixture	24	28.00	672.00
6	Total (RM)			6,433.00

Table 4.11: Costing for Compact Fluorescent Lamp

Unit	Description of item	Quantity	Unit rate (RM)	Amount (RM)
1	Electrical DB	1	4,000.00	4,000.00
2	TNB Meter	1	300.00	300.00
3	Final sub circuit	42	60.00	2,520.00
4	1-gang switch point	1	12.00	12.00
5	2-gang switch point	2	15.00	30.00
6	Compact Fluorescent fixture	42	38.00	1,596.00
7	Total (RM)			8,458.00

Table 4.12: Costing for LED Lamp

Unit	Description of item	Quantity	Unit rate (RM)	Amount (RM)
1	Electrical DB	1	4,000.00	4,000.00
2	TNB Meter	1	300.00	300.00
3	Final sub circuit	12	60.00	720.00
4	4-gang switch point	1	21.00	21.00
5	LED fixture	12	60.00	720.00
6	Total (RM)			5,761.00

The two figures below depict the comparison between the 3 types of lamps utilized in this analysis. The figures consist of comparison between the power consumption depending on number of lamps used and their respective cost estimates.

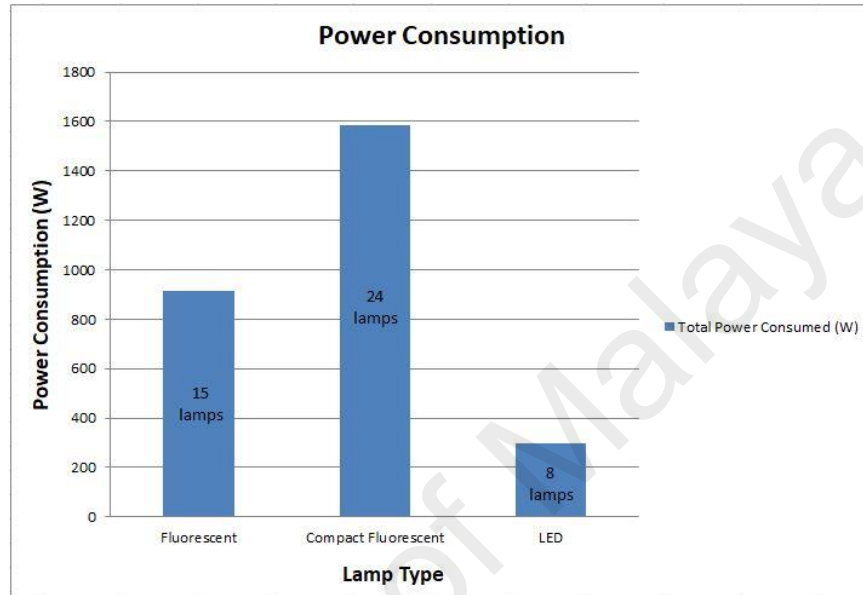

Figure 4.17: Power Consumption Comparison

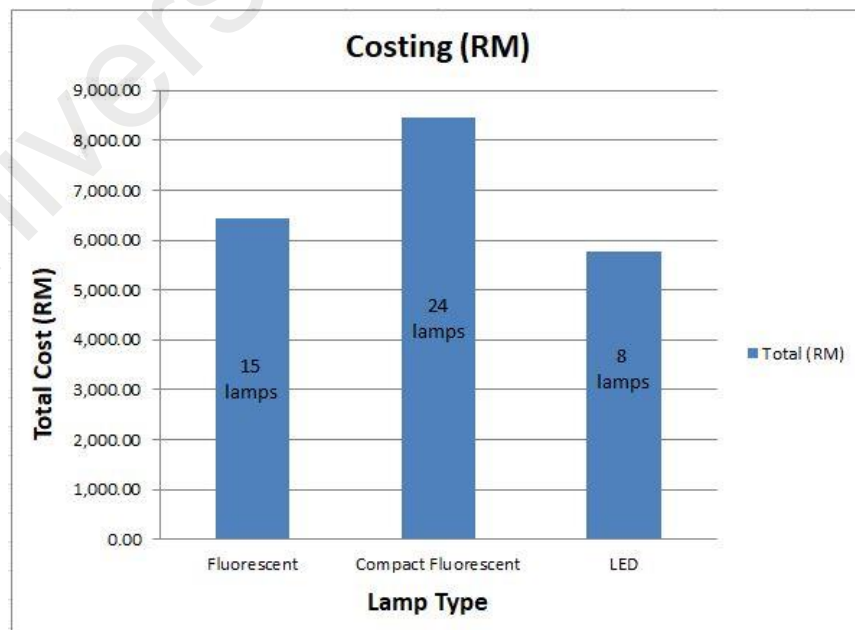

Figure 4.18: Total Cost Comparison

4.4 Discussion

It is important to note that in order to choose the appropriate light source, it is essential to consider several aspects of the luminaire; efficacy, correlated colour temperature, colour rendering index, long term environmental impacts, lumen depreciation and cost factor of the lamp. Considering there are many luminaires made available in the market, catalogues are normally provided to make aware the previously mentioned characteristics of a lamp. Results garnered from the experiment indicate clearly that LEDs are the most viable option when choosing an appropriate luminaire. LEDs have made their way into the market and are currently being installed in many domestic and commercial sectors. Many sectors are making the transition from the older lighting technologies upon comprehending the advantages LEDs withhold.

LED lamps have the upper hand when weighed against other types of lamps in the market. These lamps are able to produce the same luminance output when compared to incandescent or fluorescent lighting fixtures for a mere fraction of the cost and minimal installation of lighting fixtures. Furthermore, LEDs possess longer lifespan expectancy, broad range of correlated colour temperature and minimal environmental impact. However, due to the ever-growing technology in the present day, many unauthorized manufacturers are taking advantage of mass developing LED lamps, not taking into consideration the quality, lifespan and the illumination of the lamp.

LEDs correspondingly possess several drawbacks upon production of the lamps. These lamps are engineered by the use of new and improved technology, hence boosting initial cost of purchase and installation of the fitting. However, over the long run, the power consumption of these LED lamps are kept at a minimal as compared to its predecessors. The newer mechanics of these lamps allow the user to save on electricity bills when operating on LED lamps. Taking into consideration LEDs have a longer lifespan, it is easily noticeable that lumen depreciation produces poorer performance over time.

With all that has been said, unlike older lamp technology such as incandescent and fluorescent lamps, LED lamps still possess great potential to improve and cater to the requirements to provide satisfactory illumination. The rapid developments in manufacturing LED lamps are witnessing the older technology become obsolete in the market.

CHAPTER 5: CONCLUSION

5.1 Conclusion

This research report presented a detailed comparison of several major types of lamps commonly used. These lamps include incandescent lamp (IL), fluorescent lamp (FL), compact fluorescent lamp (CFL) and light emitting diode (LED). It has been outlined several times in this report that in order to select the most compatible lighting fixture, several aspects needs to be taken into consideration such as efficacy, lifespan, correlated colour temperature, colour rendering index, long term environmental impacts, lumen depreciation and cost factor of the lamp. With the aid of DIALux software, accurate details of the lamps are provided via catalogues from numerous lighting manufacturers. Hence, the software was utilized to visualize the implementation of various luminaires in order to analyse their performances in terms of power consumption, number of luminaires required and its illumination output. It can be concluded that LED lamps proved dominant over its predecessors as it excelled in its low power consumption with minimal fittings to provide equal illumination. Hence, replacement and installation of newer lighting technology such as LED can aid the consumer in savings of electricity bill as well as attain satisfactory illumination. However, it is to be noted that many unauthorized lighting manufacturers are taking advantage of mass developing LED lamps, not taking into consideration the quality, lifespan and the illumination of the lamp. Hence, all lighting manufacturers should seek the acceptance of the international governing bodies such as IEC and BS, and in Malaysia, MS and SIRIM.

5.2 Recommendation for Future Works

With everything that has been discussed, there is still room for improvement in the lighting market. In order for the consumer to obtain satisfactory illumination, the consumer has to ensure that the products are manufactured to BS, IEC, MS and SIRIM standards.

On the consumer's side, the consumer has to ensure that the lighting fixture is installed in a sound engineering manner to obtain the full performance of the lighting fixtures. Not only that, the consumer needs to certify that the lighting fixtures are manufactured to the manufacturing standards. This is because countries like China are producing sub-standard lighting fixtures products which are currently penetrating general market. The consumer need to understand that the mass production of these lighting fixtures do not comply to the required burning hours and the illumination output do not perform as the original from the authorised manufacturers. Therefore, the consumer has to request for the warranty and has to seek assurance that the manufacturer guarantees the performance of the lighting fixtures.

In order to protect the consumers from these unscrupulous manufacturers, the Government needs to put into effect strict control on the importation of these lighting fixtures. The Customs Department need to work in hand with the manufacturers to ensure that only original products with proper documentation are allowed to import these lighting fixtures. Importers of these lighting fixtures should be cautioned and educated so as to stop the flow of under rated lighting fixtures into the general market. The Government could also educate the general public by way of advertisements on the basic lighting terminologies. With that, the general public can differentiate the sub-standard lightings from the original manufactured ones.

Furthermore, a new initiative by the Government is looking to encourage developers to delve into green technology for buildings. This initiative introduced by the Government is better known as Green Building. With that, the architectural layout plays an important role when designing a building. The design has to be environmentally friendly by way of allocating sufficient windows to allow natural light to penetrate into the building. This is a new generation of engineering design that aids in minimizing the use of artificial sources of lights. With that, the lighting luminaires can be reduced thus, saving energy consumption and reduces the generation of electricity.

As time progress, the technology of lighting fixtures is being gradually improved. Newer manufacturing of the lighting fixtures is being developed and the technology is being constantly reinvented. This is evident from the incandescent lighting fixtures progressing to LED lighting fixtures. Thus, the manufacturers are looking into the possibility of manufacturing lighting fittings that produce higher illumination per watt. It would be prudent that the lighting manufactures manufacture fittings that produce higher illumination and at the same time reducing the energy consumption.

REFERENCES

- Alonso, J. M., Viña, J., Vaquero, D. G., Martínez, G., & Osorio, R. (2012). Analysis and design of the integrated double buck–boost converter as a high-power-factor driver for power-LED lamps. *IEEE Transactions on Industrial Electronics*, 59(4), 1689-1697.
- Anatomy of the Label* (n.d.). Retrieved 19 February 2018, from <http://www.lightingfacts.com/Library/Content/Label>
- Bakshi, B. G., & Roy, B. (2016, November). Development & simulation of dynamic conductance based high intensity discharge lamp model driven by low frequency square wave electronic ballast. In *Power India International Conference (PIICON), 2016 IEEE 7th* (pp. 1-6). IEEE.
- Bender, V. C., Marchesan, T. B., & Alonso, J. M. (2015). Solid-state lighting: a concise review of the state of the art on LED and OLED modeling. *IEEE Industrial Electronics Magazine*, 9(2), 6-16.
- CALiPER Snapshot Indoor Ambient Lighting* (1 April 2013). Retrieved 18 December 2017, from https://www1.eere.energy.gov/buildings/publications/pdfs/ssl/lf-snapshot_ambient-lighting.pdf
- Chang, M. H., Das, D., Varde, P. V., & Pecht, M. (2012). Light emitting diodes reliability review. *Microelectronics Reliability*, 52(5), 762-782.
- Chen, N., & Chung, H. S. H. (2011). A driving technology for retrofit LED lamp for fluorescent lighting fixtures with electronic ballasts. *IEEE Transactions on Power Electronics*, 26(2), 588-601.

- Chhun, L., Maussion, P., Bhosle, S., & Zissis, G. (2011). Characterization of acoustic resonance in a high-pressure sodium lamp. *IEEE Transactions on Industry Applications*, 47(2), 1071-1076.
- Chitnis, D., Swart, H. C., & Dhoble, S. J. (2016). Escalating opportunities in the field of lighting. *Renewable and Sustainable Energy Reviews*, 64, 727-748.
- Chung, H. S. H., Ho, N. M., Yan, W., Tam, P. W., & Hui, S. Y. (2007). Comparison of dimmable electromagnetic and electronic ballast systems—An assessment on energy efficiency and lifetime. *IEEE Transactions on Industrial Electronics*, 54(6), 3145-3154.
- Enongene, K. E., Murray, P., Holland, J., & Abanda, F. H. (2017). Energy savings and economic benefits of transition towards efficient lighting in residential buildings in Cameroon. *Renewable and Sustainable Energy Reviews*, 78, 731-742.
- Frequently asked questions about the regulation on ecodesign requirements for non-directional household lamps* (18 March 2009). Retrieved 2 January 2018, from http://europa.eu/rapid/press-release_MEMO-09-113_en.htm
- Flamm, G., Howlett, O., & Taylor, G. D. *Voluntary California Quality Light-Emitting Diode (LED) Lamp Specification*, California Energy Commission, High Performance Buildings and Standards Development Office, 2012.
- Fluorescent lighting* (n.d.). Retrieved 12 January 2018, from <https://www.energy.gov/energysaver/save-electricity-and-fuel/lighting-choices-save-you-money/fluorescent-lighting>
- Gayral, B. (2017). LEDs for lighting: Basic physics and prospects for energy savings. *Comptes Rendus Physique*, 18(7-8), 453-461.

- Ghisi, E., & Tinker, J. A. (2005). An ideal window area concept for energy efficient integration of daylight and artificial light in buildings. *Building and environment*, 40(1), 51-61.
- Gil-de-Castro, A., Rönnerberg, S. K., & Bollen, M. H. (2017). Light intensity variation (flicker) and harmonic emission related to LED lamps. *Electric Power Systems Research*, 146, 107-114.
- Guan, L., Berrill, T., & Brown, R. J. (2015). Measurement of actual efficacy of compact fluorescent lamps (CFLs). *Energy and Buildings*, 86, 601-607.
- Howarth, N. A., & Rosenow, J. (2014). Banning the bulb: Institutional evolution and the phased ban of incandescent lighting in Germany. *Energy Policy*, 67, 737-746.
- How Energy-Efficient Light Bulbs Compare with Traditional Incandescents* (n.d.). Retrieved 24 June 2017, from <https://www.energy.gov/energysaver/save-electricity-and-fuel/lighting-choices-save-you-money/how-energy-efficient-light>
- International Energy Outlook 2013* (July 2013). Retrieved 17 August 2017, from [https://www.eia.gov/outlooks/ieo/pdf/0484\(2013\).pdf](https://www.eia.gov/outlooks/ieo/pdf/0484(2013).pdf)
- Islam, M. S. (2015). *User acceptance studies for LED office lighting: light spectrum and correlated colour temperature* (Doctoral thesis, Aalto University, Helsinki, Finland). Retrieved from <https://aaltodoc.aalto.fi/bitstream/handle/123456789/15268/isbn9789526061207.pdf?sequence=4>
- Khan, N., & Abas, N. (2011). Comparative study of energy saving light sources. *Renewable and sustainable energy reviews*, 15(1), 296-309.

LED Adoption Report (n.d.). Retrieved 24 September 2017, from <https://www.energy.gov/eere/ssl/led-adoption-report>

LED System Performance in a Trial Installation—One Year Later (April 2015). Retrieved 19 September 2017, from https://www.pnnl.gov/main/publications/external/technical_reports/PNNL-24253.pdf

Li, D. H., Cheung, K. L., Wong, S. L., & Lam, T. N. (2010). An analysis of energy-efficient light fittings and lighting controls. *Applied Energy*, 87(2), 558-567.

Li, Y., & Jin, L. (2011). Environmental release of mercury from broken compact fluorescent lamps. *Environmental Engineering Science*, 28(10), 687-691

Life-Cycle Assessment of Energy and Environmental Impacts of LED Lighting Products Part I: Review of the Life-Cycle Energy Consumption of Incandescent, Compact Fluorescent, and LED Lamps (August 2012). Retrieved 8 February 2018, from https://www1.eere.energy.gov/buildings/publications/pdfs/ssl/2012_LED_Lifecycle_Report.pdf

Life-Cycle Assessment of Energy and Environmental Impacts of LED Lighting Products Part 2: LED Manufacturing and Performance (June 2012). Retrieved 8 February 2017, from https://www1.eere.energy.gov/buildings/publications/pdfs/ssl/2012_led_lca-pt2.pdf

Life Cycle Assessment of Illuminants A Comparison of Light Bulbs, Compact Fluorescent Lamps and LED Lamps (November 2009). Retrieved 15 October 2017, from http://www.energetica.eu/mediapool/99/993141/data/OSRAM_LED_LCA_Summary_November_2009.pdf

Lifetime of White LEDs (n.d.). Retrieved 14 November 2017, from https://betterbuildingssolutioncenter.energy.gov/sites/default/files/attachments/lifetime_white_leds.pdf

Lighting Technologies: A Guide to Energy-Efficient Illumination (n.d.). Retrieved 19 January 2018, from https://www.energystar.gov/ia/partners/promotions/change_light/downloads/Fact%20Sheet_Lighting%20Technologies.pdf

Liu, S., & Luo, X. (2011). *LED packaging for lighting applications: design, manufacturing, and testing*. John Wiley & Sons.

Lumen Depreciation in Traditional Light Sources (n.d.). Retrieved 9 January 2018, from <http://www.gilus.us/Lumen%20Depreciation%20in%20Traditional%20Light%20Sources.html>

Lumen Maintenance and Light Loss Factors: Consequences of Current Design Practices for LEDs (September 2013). Retrieved 10 October 2017, from https://www.pnnl.gov/main/publications/external/technical_reports/PNNL-22727.pdf

Mercury Emissions from the Disposal of Fluorescent Lamps (31 March 1998). Retrieved 3 July 2017, from <https://archive.epa.gov/epawaste/hazard/web/pdf/emmrpt.pdf>

MingTan, C., & Singh, P. (2016, July). A review on degradation physics of high power LEDs in outdoor applications. In *Physical and Failure Analysis of Integrated Circuits (IPFA), 2016 IEEE 23rd International Symposium on the* (pp. 383-386). IEEE.

- Molina, J., Sainz, L., & Monjo, L. (2013). Model of discharge lamps with saturated magnetic ballast and non-square arc voltage. *Electric power systems research, 104*, 42-51.
- Montoya, F. G., Peña-García, A., Juaidi, A., & Manzano-Agugliaro, F. (2017). Indoor lighting techniques: An overview of evolution and new trends for energy saving. *Energy and Buildings, 140*, 50-60.
- Orletti, R., C6, M. A., Simonetti, D. S. L., & de Freitas Vieira, J. L. (2009). HID lamp electronic ballast with reduced component number. *IEEE Transactions on Industrial Electronics, 56*(3), 718-725.
- Philips Gas Discharge Lamps (HID / Outside)* (n.d.). Retrieved 6 October 2017, from <http://limatel.nl/en/philips/philips-gas-discharge-lamps-hid-outside/>
- Principi, P., & Fioretti, R. (2014). A comparative life cycle assessment of luminaires for general lighting for the office—compact fluorescent (CFL) vs Light Emitting Diode (LED)—a case study. *Journal of Cleaner Production, 83*, 96-107.
- Recycling and Disposal of CFLs and Other Bulbs that Contain Mercury* (n.d.). Retrieved 4 July 2017, from <https://www.epa.gov/cfl/recycling-and-disposal-cfls-and-other-bulbs-contain-mercury#important>
- R6zowicz, A., & Deląg, M. (2016, May). The effect of ambient temperature upon selected light parameters of the radiation emitted by phosphors used in the production of low-pressure mercury discharge lamps. In *Selected Issues of Electrical Engineering and Electronics (WZEE), 2016 13th* (pp. 1-6). IEEE.
- Singh, P., & MingTan, C. (2016). A review on the humidity reliability of high power white light LEDs. *Microelectronics Reliability, 61*, 129-139.

Solid-State Lighting Research and Development Multi-Year Program Plan (April 2014). Retrieved 13 December 2017, from https://www1.eere.energy.gov/buildings/publications/pdfs/ssl/ssl_mypp2012_web.pdf

Solid-State Lighting Research and Development Multi-Year Program Plan (May 2014). Retrieved 13 December 2017, from https://www1.eere.energy.gov/buildings/publications/pdfs/ssl/ssl_mypp2014_web.pdf

Sun, B., Jiang, X., Yung, K. C., Fan, J., & Pecht, M. G. (2017). A review of prognostic techniques for high-power white LEDs. *IEEE Transactions on Power Electronics*, 32(8), 6338-6362.

Tähkämö, L., Puolakka, M., Halonen, L., & Zissis, G. (2012). Comparison of life cycle assessments of LED light sources. *Journal of Light & Visual Environment*, 36(2), 44-54.

Thejokalyani, N., & Dhoble, S. J. (2014). Novel approaches for energy efficient solid state lighting by RGB organic light emitting diodes—A review. *Renewable and Sustainable Energy Reviews*, 32, 448-467.

Trends in Lighting in Commercial Buildings (17 May 2017). Retrieved 5 October 2017, from <https://www.eia.gov/consumption/commercial/reports/2012/lighting/>

Trifunovic, J., Mikulovic, J., Djuricic, Z., Djuric, M., & Kostic, M. (2009). Reductions in electricity consumption and power demand in case of the mass use of compact fluorescent lamps. *Energy*, 34(9), 1355-1363.

- Verma, P., Patel, N., & Nair, N. K. C. (2017). Demand side management perspective on the interaction between a non-ideal grid and residential LED lamps. *Sustainable Energy Technologies and Assessments*, 23, 93-103.
- Wang, Y., Alonso, J. M., & Ruan, X. (2017). A review of LED drivers and related technologies. *IEEE Transactions on Industrial Electronics*, 64(7), 5754-5765.
- What are gas discharge lamps?*(n.d.). Retrieved 26 September 2017, from <http://www.lighting.philips.com/main/education/lighting-university/lighting-university-browser/video/gas-discharge-lamps#>
- What are the Connections between Mercury and CFLs?* (n.d.). Retrieved 26 September 2017, from <https://www.epa.gov/cfl/what-are-connections-between-mercury-and-cfls>
- Yan, W., & Hui, S. Y. (2004). An improved high-intensity discharge lamp model including acoustic resonant effect on the lamp arc resistance. *IEEE transactions on power electronics*, 19(6), 1661-1667.
- Yang, S. H., Lin, J. S., Juang, F. S., Chou, D. C., Chung, M. H., Chen, C. M., & Liu, L. C. (2013). White light emitting diodes (LEDs) with good color rendering indices (CRI) and high luminous efficiencies by the encapsulation of mixed and double-deck phosphors. *Current Applied Physics*, 13(5), 931-934.
- 2010 U.S. Lighting Market Characterization* (January 2012). Retrieved 27 December 2017, from <https://www1.eere.energy.gov/buildings/publications/pdfs/ssl/2010-lmc-final-jan-2012.pdf>