

**PRODUCT BENCHMARKING  
USING DFA AND DFD TOOLS**

**AMIR REZA AKHIANI**

**DISSERTATION SUBMITTED IN FULFILMENT OF THE  
REQUIREMENT FOR THE DEGREE OF MASTER OF  
ENGINEERING**

**INSTITUTE OF GRADUATE STUDIES  
UNIVERSITY OF MALAYA  
KUALA LUMPUR  
2013**

## ABSTRAK

Persaingan sengit antara pengeluar memaksa mereka mencari cara baru meningkatkan produktiviti dan kualiti sambil mengurangkan kos. Usaha sebegini membawa penyelidik membangunkan kaedah seperti DFX Tools: Rekabentuk Pembuatan, Rekabentuk Pemasangan, Rekabentuk Penguraian Pemasangan, Rekabentuk Alam Sekitar, Rekabentuk Kitar Semula, dan lain-lain.

Dalam kajian ini, kaedah Rekabentuk Pemasangan (DFA) dan Rekabentuk Penguraian Pemasangan (DFD) digunakan untuk menganalisis dan mengoptimumkan sebuah produk automotif. DFA mengurangkan masa dan kos melalui pengurangan bilangan alat ganti, lalu memudahkan pemasangan dan meningkatkan kebolehharapan. DFD mengurangkan kos dengan mempercepat proses kitar semula atau penguraian (secara langsung) dan mengurangkan impak dan kesan terhadap alam sekitar.

Kebanyakan syarikat pembuatan besar seperti Sony, Hitachi, Ford, dan Chrysler mempunyai kaedah mereka sendiri melaksanakan DFA dan DFD, dibangunkan untuk produk tertentu. Salah satu kaedah terawal dan umum untuk DFA dan DFD ialah Kaedah Boothroyd.

Matlamat utama kajian ini adalah mengoptimumkan pemasangan lampu belakang kereta Proton Waja dengan membekalkan data pemasangan kepada perisian DFA dan DFD, dan melaksanakan syor perisian untuk menambahbaik rekabentuk awal. Apabila dibandingkan dengan rekabentuk lama, rekabentuk baru jelas memperbaiki pemasangan, seperti yang ditunjukkan oleh indeks DFA dan graf pecahan kos.

Perisian tersebut mengambilkira pengurangan kos akibat pengurangan alat ganti sahaja; kos menghasilkan alat ganti baharu seperti acuan alat ganti plastik atau acuan terap untuk alat ganti logam tidak diambilkira.

# ABSTRACT

Tight competition between manufacturers forces them to look for new ways to increase productivity and quality and hence reduce costs. These efforts have led researchers to develop methods such as the DFX Tools: Design for Manufacturing, Design for Assembly, Design for Disassembly, Design for Environment, Design for Recyclability, etc.

In this research, Design for Assembly (DFA) and Design for Disassembly (DFD) methods are used to analyze and optimize an automotive product. DFA reduces time and cost through parts reduction, which simplifies assembly and increases reliability. DFD reduces cost by hastening the recycling or dismantling processes (direct effect) and decreases environmental impact and damage to the environment (indirect effect).

Most big manufacturing companies such as Sony, Hitachi, Ford, and Chrysler have their own method for implementing DFA and DFD, which are developed for a specific product. One of the oldest and general methods for DFA and DFD is the Boothroyd Method.

The main goal of this research is to optimize assembly of the rear light of Proton Waja cars through supply of the assembly data to the DFA and DFD software, and to implement the software's recommendations into improving the initial design. When compared with the old design, the new design markedly improves assembly, as shown by the DFA index and cost breakdown graph.

The software considers only the cost reduction that is due to parts reduction; costs of producing new parts such as molds for the plastic parts or stamping die for the metallic parts were not considered.

## **ACKNOWLEDGMENT**

This project would not have been possible without the support of many people. First, I would like to thank my supervisor, Prof. Dr. Zahari Bin Taha, who provided timely and instructive comments and evaluation at every stage of the dissertation process, allowing me to complete this project. Thanks to Raja Ariffin Bin Raja Ghazilla for his guidance and Centre of Product Design and Manufacture (CPDM) for allowing me to use their facilities to complete this project. And finally, I would like to thank my parents for their unending love and support. My mother instilled in me, from an early age, the desire and skills to further my studies.

University of Malaysia

# TABLE OF CONTENTS

|   |             |
|---|-------------|
| <b>ABSTRAK .....</b>                                      | <b>ii</b>   |
| <b>ABSTRACT .....</b>                                     | <b>iii</b>  |
| <b>ACKNOWLEDGMENT .....</b>                               | <b>iv</b>   |
| <b>LIST OF FIGURES .....</b>                              | <b>ix</b>   |
| <b>LIST OF TABLES .....</b>                               | <b>xi</b>   |
| <b>LIST OF ABBREVIATIONS .....</b>                        | <b>xiii</b> |
| <b>CHAPTER 1 INTRODUCTION .....</b>                       | <b>1</b>    |
| 1.1 Background .....                                      | 1           |
| 1.2 Problem Statement and Research Objectives.....        | 3           |
| 1.3 Organization of the dissertation .....                | 4           |
| <b>CHAPTER 2 LITERATURE REVIEW .....</b>                  | <b>6</b>    |
| 2.1 Importance of Design and Assembly Considerations..... | 6           |
| 2.2 Design for Manufacture and Assembly (DFMA) .....      | 8           |
| 2.2.1 A brief historical review .....                     | 8           |
| 2.2.2 Definition .....                                    | 9           |
| 2.2.3 DFA objectives .....                                | 10          |
| 2.2.4 General DFA steps.....                              | 11          |
| 2.2.5 Benefits of DFA.....                                | 12          |
| 2.2.6 DFA Guidelines.....                                 | 12          |
| 2.2.7 DFA methods .....                                   | 14          |
| 2.2.8 Boothroyd and Dewhurst Method.....                  | 14          |

|  |           |
|--|-----------|
| 2.2.9 DFA practices .....                                | 16        |
| 2.3 Design for Environment (Disassembly).....            | 19        |
| 2.3.1 Principles of DFD .....                            | 20        |
| 2.3.2 DFD evaluation methods .....                       | 21        |
| 2.3.3 BDI & TNO analysis procedure .....                 | 21        |
| 2.3.4 DFE (Disassembly) practices.....                   | 22        |
| 2.4 Summary .....  | 23        |
| <b>CHAPTER 3 METHODOLOGY .....</b>                       | <b>24</b> |
| 3.1 Design overview: .....                               | 28        |
| 3.2 Details of the DFA software panels .....             | 29        |
| 3.2.1 Minimum-part criteria.....                         | 30        |
| 3.2.2 Envelope dimensions .....                          | 30        |
| 3.2.3 Symmetry .....                                     | 30        |
| 3.2.4 Handling difficulties .....                        | 31        |
| 3.2.5 Insertion difficulties .....                       | 31        |
| 3.2.6 Securing method .....                              | 31        |
| 3.2.7 Assembly.....                                      | 31        |
| 3.3 Details of the components for the DFA software ..... | 32        |
| 3.3.1 Light shell .....                                  | 32        |
| 3.3.2 Bolts .....  | 32        |
| 3.3.3 Light cover .....                                  | 33        |
| 3.3.4 Rubber seal (1).....                               | 33        |

|   |           |
|---|-----------|
| 3.3.5 Rubber seal (2).....  | 34        |
| 3.3.6 Plastic board.....  | 34        |
| 3.3.7 Copper connectors .....   | 35        |
| 3.3.8 Electrical circuit.....   | 35        |
| 3.3.9 White bulbs .....   | 36        |
| 3.3.10 Orange Bulb .....  | 36        |
| 3.3.11 Plastic base.....  | 36        |
| 3.3.12 Rubber washer .....  | 37        |
| 3.3.13 Metallic clip .....  | 37        |
| 3.3.14 Harness connector.....   | 38        |
| 3.4 The assembly process .....  | 39        |
| 3.5 Details of the DFE software panels .....                          | 43        |
| 3.6 Details of the components for the DFE software.....               | 45        |
| 3.7 Summary .....   | 47        |
| <b>CHAPTER 4 RESULT AND DISCUSSION.....</b>                           | <b>48</b> |
| 4.1 The structure chart of the original design .....                  | 48        |
| 4.2 DFA analysis of the original design.....                          | 48        |
| 4.2.1 Summary of the initial-design analysis.....                     | 49        |
| 4.2.2 Guidelines from the DFA software.....                           | 52        |
| 4.2.3 Implementing the redesign suggestions of the DFA software ..... | 54        |
| 4.3 DFA analysis of the redesigned product.....                       | 60        |
| 4.3.1 Summary of the DFA redesign analysis .....                      | 60        |

|  |           |
|--|-----------|
| 4.3.2 Comparing the initial and the redesigned product ..... | 62        |
| 4.4 DFE analysis .....                                       | 64        |
| 4.4.1 DFE analysis of the initial product .....              | 64        |
| 4.4.2 DFE of the redesigned product .....                    | 68        |
| 4.5 Summary .....  | 70        |
| <b>CHAPTER 5 CONCLUSION .....</b>                            | <b>71</b> |
| <b>REFERENCES</b>  |           |
| <b>APPENDIX A</b>  |           |
| <b>APPENDIX B</b>  |           |
| <b>APPENDIX C</b>  |           |
| <b>APPENDIX D</b>  |           |
| <b>APPENDIX E</b>  |           |

University of Malaya



## LIST OF FIGURES

|   |    |
|---|----|
| Figure 2.1 Total time in production .....   | 6  |
| Figure 2.2 Total unit production cost.....  | 7  |
| Figure 2.3 Costs influence lever and the design .....                                   | 8  |
| Figure 2.4 Typical stages in DFA procedure .....  | 11 |
| Figure 2.5 The product architecture-based approach to DFA.....                          | 18 |
| Figure 2.6 DFE analysis procedure.....  | 22 |
| Figure 3.1 The general scheme of the method .....                                       | 25 |
| Figure 3.2 DFA methodology flow chart.....  | 26 |
| Figure 3.3 DFE methodology flow chart .....   | 27 |
| Figure 3.4 Assembly Chart (initial design).....   | 29 |
| Figure 3.5 Subassembly of Electrical connection fastener .....                          | 39 |
| Figure 3.6 Assembly of the copper connector onto the board .....                        | 39 |
| Figure 3.7 The stamping and melting places on the electrical board.....                 | 40 |
| Figure 3.8 Exploded depiction of the bulbs and electrical board.....                    | 40 |
| Figure 3.9 Assembly of the electrical-connection fastener to the electrical board ..... | 41 |
| Figure 3.10 Light-shell subassembly, top view .....                                     | 41 |
| Figure 3.11 Light-shell subassembly, bottom view .....                                  | 42 |
| Figure 3.12 Assembly of the electrical board onto the light.....                        | 42 |
| Figure 3.13 Disassembly Worksheet Window.....   | 43 |
| Figure 3.14 The disassembly-questions panel .....                                       | 44 |
| Figure 3.15 The environmental-questions panel.....                                      | 44 |
| Figure 4.1(a) The structure chart; (b) The minimum-part criteria (initial design).....  | 48 |
| Figure 4.2 Labor cost per part and operation (initial design).....                      | 51 |
| Figure 4.3 Breakdown of costs per product (initial design).....                         | 52 |
| Figure 4.4 Breakdown of time per product (initial design).....                          | 52 |

|  |    |
|--|----|
| Figure 4.5 The redesigned of the plastic base, rubber washer, and metallic clip..... | 54 |
| Figure 4.6 Back view of the redesigned plastic board .....                           | 55 |
| Figure 4.7 Securing the main circuit .....   | 56 |
| Figure 4.8 Securing the narrow circuits .....  | 56 |
| Figure 4.9 Plastic-board redesign.....   | 57 |
| Figure 4.10 Electrical-circuit redesign.....   | 57 |
| Figure 4.11 Assembly of the electrical-board components (redesign) .....             | 58 |
| Figure 4.12 Assembly of the electrical board onto the light .....                    | 58 |
| Figure 4.13 The redesign assembly chart.....   | 59 |
| Figure 4.14 The redesign structure chart.....  | 60 |
| Figure 4.15 Breakdown of time per product (redesign).....                            | 61 |
| Figure 4.16 Breakdown of cost per product (redesign).....                            | 62 |
| Figure 4.17 Comparing the time breakdown.....  | 63 |
| Figure 4.18 Comparing the costs breakdown.....                                       | 63 |
| Figure 4.19 Disassembly results (initial product) .....                              | 65 |
| Figure 4.20 The optimized subassembly results of the initial product .....           | 66 |
| Figure 4.21 Disassembly Costs .....  | 67 |
| Figure 4.22 Disassembly Time .....   | 67 |
| Figure 4.23 The disassembly result of the redesigned product.....                    | 69 |
| Figure 4.24 Comparing the disassembly results .....                                  | 70 |

## LIST OF TABLES

|  |    |
|--|----|
| Table 2.1 General DFA Guidelines.....                    | 13 |
| Table 2.2 Criteria for minimum number of parts.....      | 15 |
| Table 2.3 Example of DFE additional to DFA analysis..... | 16 |
| Table 3.1 Parts specification .....                      | 28 |
| Table 3.2 Specifications for a light shell.....          | 32 |
| Table 3.3 Specifications for the bolts.....              | 32 |
| Table 3.4 Light-cover specifications.....                | 33 |
| Table 3.5 Rubber seal (1) specifications .....           | 33 |
| Table 3.6 Rubber seal (2) specifications .....           | 34 |
| Table 3.7 Plastic-board specifications.....              | 34 |
| Table 3.8 Copper-connector specifications.....           | 35 |
| Table 3.9 Electrical-circuit specifications.....         | 35 |
| Table 3.10 White-bulb specifications .....               | 36 |
| Table 3.11 Orange-bulb specifications .....              | 36 |
| Table 3.12 Plastic-base specifications.....              | 37 |
| Table 3.13 Washer Specifications.....                    | 37 |
| Table 3.14 Metallic-clip specifications .....            | 38 |
| Table 3.15 Harness-connector specifications.....         | 38 |
| Table 3.16 Components disassembly specifications.....    | 45 |
| Table 3.17 The material properties .....                 | 46 |
| Table 3.18 The manufacturing processes.....              | 46 |
| Table 3.19 End-of-life considerations.....               | 47 |
| Table 3.20 Glued-joint specifications .....              | 47 |
| Table 4.1 Assembly worksheet (initial design).....       | 49 |
| Table 4.2 General Summary (initial design).....          | 50 |

|  |    |
|--|----|
| Table 4.3 Breakdown of the costs (initial design).....               | 50 |
| Table 4.4 Breakdown of the time (initial design) .....               | 50 |
| Table 4.5 Manual assembly times.....                                 | 51 |
| Table 4.6 Parts reduction.....                                       | 53 |
| Table 4.7 Operation reduction.....                                   | 53 |
| Table 4.8 Insertion difficulties .....                               | 53 |
| Table 4.9 Handling difficulty .....                                  | 53 |
| Table 4.10 Assembly worksheet of the redesign .....                  | 61 |
| Table 4.11 General summary (comparison).....                         | 62 |
| Table 4.12 Comparing the costs breakdown .....                       | 62 |
| Table 4.13 Comparing the time breakdown.....                         | 63 |
| Table 4.14 Disassembly result of the initial design .....            | 64 |
| Table 4.15 Optimized disassembly sequence of the initial design..... | 66 |
| Table 4.16 Disassembly specifications of the redesign .....          | 68 |
| Table 4.17 Disassembly result of the redesign.....                   | 69 |

## LIST OF ABBREVIATIONS

|      |  |
|------|--|
| DFX  | Design for X                               |
| DFE  | Design for Environment                     |
| DFA  | Design for Assembly                        |
| DFD  | Design for Disassembly                     |
| MET  | Material cycle, Energy use, Toxic emission |
| LCA  | Life Cycle Assessment                      |
| BDI  | Boothroyd Dewhurst, Inc.                   |
| IP   | Instrument Panel                           |
| DPN  | Disassembly Petri Net                      |
| PS   | Phase Selector                             |
| ABS  | Acrylonitrile Butadiene Styrene            |
| PMMA | Poly Methyl Methacrylate                   |

# CHAPTER 1

## INTRODUCTION

The automotive industry is always subject to change and continuously striving for improvement. Sustainability has become a very critical issue as it determines the success of automotive design and material developments. Consumers are demanding for products of high quality but low cost. This motivates automotive manufacturers into looking for new ways to increase productivity and quality at little cost.

The manufacturing of new designs today need consideration from a very early stage. There is increasing pressure to manufacturers, from legislators and consumers, to minimise a product's impact on the environment through designing for the environment (DFE) concepts. Design for Disassembly (DFD) reduces energy usage, wastage and disposal mainly through recycling. DFD is part of DFE in product development.

### 1.1 Background

Brake lamps first appeared as early as 1905. The requirements for them were presented in eleven U.S. states in 1928; after 1960, more general requirements for brake lamps were considered (Moore, 1999).

In the history of rear lights, many functions were added to the rear signalling system. Some functions have been studied but have yet to be implemented. The value of a rear light includes (Moore, 1999):

- attracting attention by indicating vehicular presence
- indicating vehicular width
- indicating the distance between vehicles
- indicating the driver's intention to brake
- indicating the driver's application of the brakes
- indicating the driver's intention to halt the vehicle

- indicating the driver's intention to turn (left or right)
- indicating vehicular turning (to left or to right)
- indicating change in vehicular movement from the main direction (from forward to reverse)
- indicating that the vehicle is parked
- indicating a present emergency situation (hazard warning) of the vehicle

Several factors to automotive rear lighting were investigated in the late 1960s and early 1970s. The importance of distinguishing function and redundancy of each model was also considered at the time (Cameron, 1995). Rear-end car accidents still highly occur in various countries. Approximately two million rear-end collisions occur in the U.S. each year. To reduce the incidence of such accidents, automotive rear lighting was improved by specifying one color to each light function (McIntyre, 2008).

One lifecycle requirement for many products is assemble ability. Assembly is a major part in product manufacturing; its function is to join all the components and turn it into a complete product (Boothroyd et al. 2002). Assembly is the process that has high potential for improvement of the product development method and manufacturing strategy. Assembly considerations link all levels of product development - from customer requirements to supply chain design, to management of variety and customization. Assembly oriented products can greatly improve a company's prospects for higher success in developing its products (Whitney, 2004).

The DFA software was developed in the 1980s, to analyze manufacturability of mechanical designs. During the conceptual stage of product development, this software comprehensively analyzes a design, its material requirements and manufacturability, and the estimated costs. The data helps engineers build an information-based analysis for evaluating the manufacturability of a design, step by step (Pennino & Potechin, 1993).

Boothroyd Dewhurst Inc. (BDI) was the first company to commercialize Design for Assembly (DFA) methods and software tools. The software simplifies product and reduces cost through its evaluation and estimation of product manufacturing cost and time in the design phase. Hundreds of Fortune 1,000 companies among the 1,000 largest American companies (including Dell, John Deere, Harley-Davidson and Whirlpool) have used DFA software to reduce the cost of manufacturing their products and to establish market design innovation (Parker & Group, 2010).

Through cooperation with the BDI (USA) and the TNO (Institute of Industrial Technology in the Netherlands), Boothroyd and Dewhurst Inc. (BDI) released DFE (Design for Environment) in 1996. This product simulates 'end of life' disassembly of the product and quantifies the economic and environmental effects as disassembly proceeds. With help from this software, designers with no ecology background can also consider environment factors in the design process (Winston Knight & Curtis, 1999). DFE is one of the earliest software used in the analysis of disassembly and environment cost, providing opportunities aimed at optimizing recycling (Xie, 2006).

PROTON is the first automaker in Malaysia, established in 1983 and is at present having the largest production capacity. This national car company pioneered Malaysia's capabilities in automobile engineering, research, development, and manufacturing (Abdullah & Keshav Lall, 2003). Through a joint venture with HICOM and the Japanese Mitsubishi, Proton succeeded in becoming the dominant market player in 1987, in the wake of the economic crisis of 1985-86, the collapse of the car market, and the return to operational managerial control by the Japanese (Wad, 2004).

## **1.2 Problem Statement and Research Objectives**

Tight competition between manufacturers have forced them to look for new ways to increase productivity and quality while reducing costs. The effort has led researchers into developing methods such as DFX Tools: Design for Manufacturing, Design for



Assembly, Design for Disassembly, Design for Environment, Design for Recyclability, etc.

DFA reduces production time and cost by decreasing the number of parts. Part reduction simplifies assembly and increases reliability. DFD reduces costs by directly speeding up and easing up recycling and dismantling, indirectly decreasing environment-damaging impact.

Most articles on the two methods report of separate studies of DFA and DFD. An analysis of various articles on design optimizing processes has led to a conclusion that implementing DFA and DFD sequentially may increase a manufacturer's optimization of their production, i.e., implementing them together on the same product will increase efficiency in product assembly and disassembly.

The goal of this dissertation is to provide a review of the design of car rear light from the assembly and disassembly standpoints and to concentrate on redesigning through DFA and DFD principles. The effectiveness of DFA and DFD methods is accordingly evaluated.

This dissertation will focus on:

- Providing a better understanding of DFA and DFD methods
- Reviewing a case from the automotive industry through the Boothroyd and Dewhurst DFA and DFD methods
- Redesigning the reviewed product to show the effectiveness of Boothroyd and Dewhurst DFA and to maximize through DFD method the returns from component recovery.

### **1.3 Organization of the dissertation**

Chapter 2 presents a comprehensive review of literatures on assembly and disassembly, divided into DFA and DFD. The literature review presents assembly and

disassembly modeling, techniques of estimating values and costs, and solution approaches to optimization.

Chapter 3 identifies the product design, assembly, and disassembly, detailing each of the parts involved in assembly and disassembly. This information will be used in the Boothroyd and Dewhurst assembly and disassembly software, for product analysis in the next chapter.

Chapter 4 describes importing (exporting) of the DFA data on all the components (from Chapter 3) to the software to calculate the assembly time for each part. Issues in assembly and improvements areas are identified and discussed. Comparisons are made through DFA between the initial design and the new design to show the product's potential development. Next the disassembly problems and possible improvements are investigated through DFE software.

Chapter 5 concludes, summarizing validation of the objectives. Specific contributions to each area that involved DFA and DFD are described.

## CHAPTER 2

### LITERATURE REVIEW

#### 2.1 Importance of Design and Assembly Considerations

A major part of product manufacturing process is assembly, whose function is to join all the components, turning them into a complete product (Geoffrey Boothroyd et al., 2002). According to Whitney (2004) “Assembly is more than putting parts together. Assembly is the capstone process in manufacturing. It brings together all the upstream processes of design, engineering, manufacturing, and logistics to create an object that performs a function.”

Surveys show that the assembly of manufactured goods accounts for over 50% of the total production time (see Figure 2.1), and approximately 50% of all the labor in the mechanical and electrical industries involve assembly (De Lit & Delchambre, 2003; Swift & Booker, 2003).

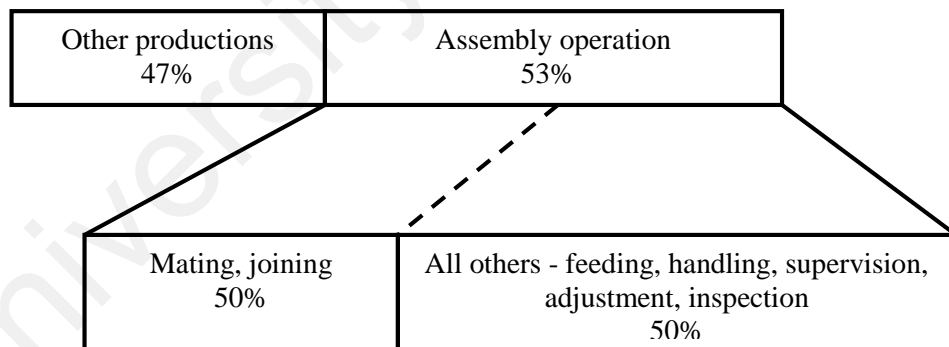

Figure 2.1 Total time in production  
(Choi et al., 2002)

The assembly phase represents a significant proportion of a product’s total production cost, which in some industries can outweigh manufacturing costs. Assembly allocates 20% to production cost, and 30%-50% to labor costs. It is a major source of late engineering change, reworking, and production variability in product development. The

cost of recovering from these problems during assembly is high, about 5%-10% of the final cost (De Lit & Delchambre, 2003; Swift & Booker, 2003).

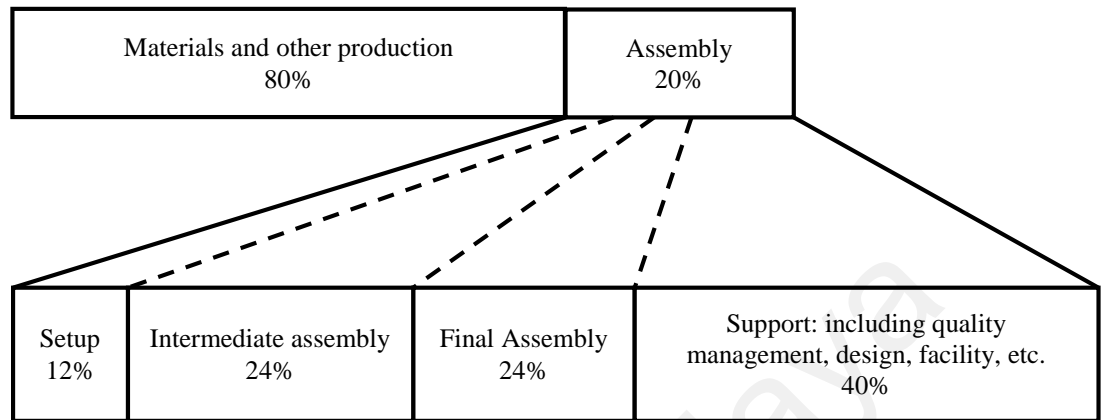

Figure 2.2 Total unit production cost (Choi, Chan, & Yuen, 2002)

Design is the series of activities by which the known and inscribed information about a designed object is added to, refined, and modified. During successful design, the amount of attainable information about the designed objects increases and becomes less obscure. Thus as design proceeds, the information becomes more complete and more comprehensive until finally there is adequate information to perform manufacturing. Design, therefore, is a process that adjusts the information we have about an artifact or designed object, whereas manufacturing (i.e., production) modifies its physical state (Poli, 2001).

The cost of design for a new car is widely accepted as being approximately 5-8% of the total costs. At that point, the design had determined 70%-80% of the product cost (see Figure 2.3), whereas the material and direct and indirect costs represent 30% of the total costs (Bayoumi, 2000; Geoffrey Boothroyd et al., 2002; Choi et al., 2002; Krumenauer, Matayoshi, Silva, Stipkovic Filho, & Batalha, 2008). The design stage thus has high impact on product final cost; various methods, especially in the automotive industry, have been investigated in several studies to optimize product design (G Boothroyd & Alting, 1992; Mayyas, Qattawi, Omar, & Shan, 2012; Ulrich, 2003; Wang & Shan, 2007). DFA

and DFD are two methods for optimizing the costs of an inferior design, and are considered in this study.

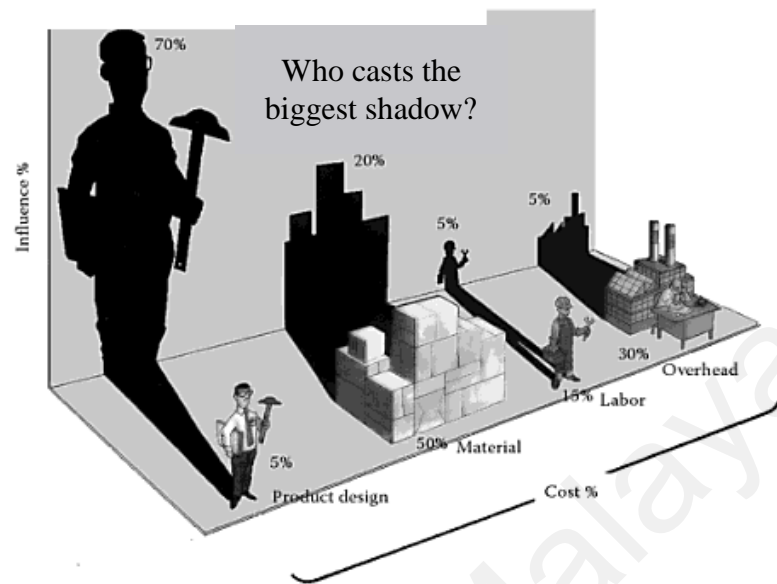

Figure 2.3 Costs influence lever and the design (Geoffrey Boothroyd, Dewhurst, & Knight, 2010)

## 2.2 Design for Manufacture and Assembly (DFMA)

### 2.2.1 A brief historical review

Eli Whitney was a person of science whose work on the application of DFM had been significant. His contribution was on “redesigning” each part to a specific dimension and with limited tolerance. Henry Ford was one among the first manufacturers who intentionally focused their design attention on the assembly process. Ford’s early cars had a simpler design and fewer parts than those of many of his competitors. His methods were widely used in the United State but less so in Europe until World War II, during which and under pressure from the military, design considerations became significant in the U.S., Russia, and Britain, with the aim of increasing the quantity of production and to contrast with the methods used in German industry (Bralla, 1998; Whitney, 2004).

General Electric is one of the best examples from 1940. They implemented a systematic review of the cost of producing a component or product and the evaluation of design alternatives that could produce the desired results at the lowest cost. Bolz was

actually one of the first to organize DFM methodology, although he did not mention the term (Bolz, 1977). The terms producibility and manufacturability was first used in the 1960s by General Electric in their Manufacturing Producibility Handbook. Since then several companies have developed manufacturing guidelines for use during product design (Bralla, 1998; Kuo, Huang, & Zhang, 2001).

DFA was first systematized in the 1960s by Geoffrey Boothroyd and his colleagues Alan Redford and Ken Swift at the University Of Salford, England. Geoffrey Boothroyd and A. H. Redford studied automatic assembly, which induced them to consider product and parts design to expedite assembly. Their book, *Mechanized Assembly*, published in 1968, contains a series of design guidelines for facilitating assembly. Design considerations turned in the 1970s to classifying parts and assembly tasks in an effort to provide a simple way for engineers to judge the assembly feasibility of their designs. The DFA time standards for small mechanical products resulting from research supported by the U.S. National Science Foundation (NSF) were initially published in handbook form in the late 1970s, and the first successes resulting from the application of DFA was a reduction in costs at the Xerox company (Geoffrey Boothroyd et al., 2002; Bralla, 1998; Whitney, 2004). In 1981, Boothroyd and Peter Dewhurst developed a computerised version of the DFA method and in 1983 the BDI Company was established. These packages allowed DFMA concepts to be approved by a wide range of companies and accepted by some of the world's largest manufacturers. One example, in 1988, is the Ford Motor Company, who was credited for DFMA software and saved \$1 billion overall. A famous, early example of a good DFA product is the Sony Walkman (Bogue, 2012).

### **2.2.2 Definition**

Design for manufacturing (DFM) is a systematic evaluating procedure to maximize the use of manufacturing processes in the design of components through the selection of materials and processes, providing estimates of manufacturing and tooling costs. Design

for assembly (DFA) is a systematic analysis procedure to maximize the use of components in the design of products by characterizing the difficulties while mounting the parts and estimating assembly times or costs. DFMA is an integration of DFM and DFA to increase effectiveness in product design. Thus DFMA is a systematic procedure for analyzing the suggested design from the aspect of assembly processes (Choi et al., 2002; Edwards, 2002; Zandin, 2001). DFA relates to product design whereas DFM relates to processing design (Goubergen & Vancauwenberghe, 2007).

The best assembly is usually the one that has the fewest part count and the least costly type of fastening (Bralla, 1998). An important role of DFA is to determine the most effective fastening methods for the necessary interfaces between separate items in a design. It is important because separate fasteners are often the most labor intensive items to consider in mechanical assembly work (Zandin, 2001).

### **2.2.3 DFA objectives**

The objectives of DFA are as follows (Geoffrey Boothroyd, 2005; Geoffrey Boothroyd et al., 2002; Whitney, 2004):

1. To guide the design team in choosing the best fabrication and assembly process and method for each part by simplifying the product.
2. To design the part to suit the process and method by providing as much assembly information as needed to design the new product with ease of assembly.
3. To design the product to achieve its functions and to quantify the improvements by gathering information (usually possessed by experienced design engineers) and arranging them in a convenient way.
4. To reduce manufacturing and assembly costs by establishing a database that considers the assembly times and cost factors in various design situations and production conditions.

5. To benchmark existing products against a competitor's products and to quantify the manufacturing and assembly difficulties.

#### 2.2.4 General DFA steps

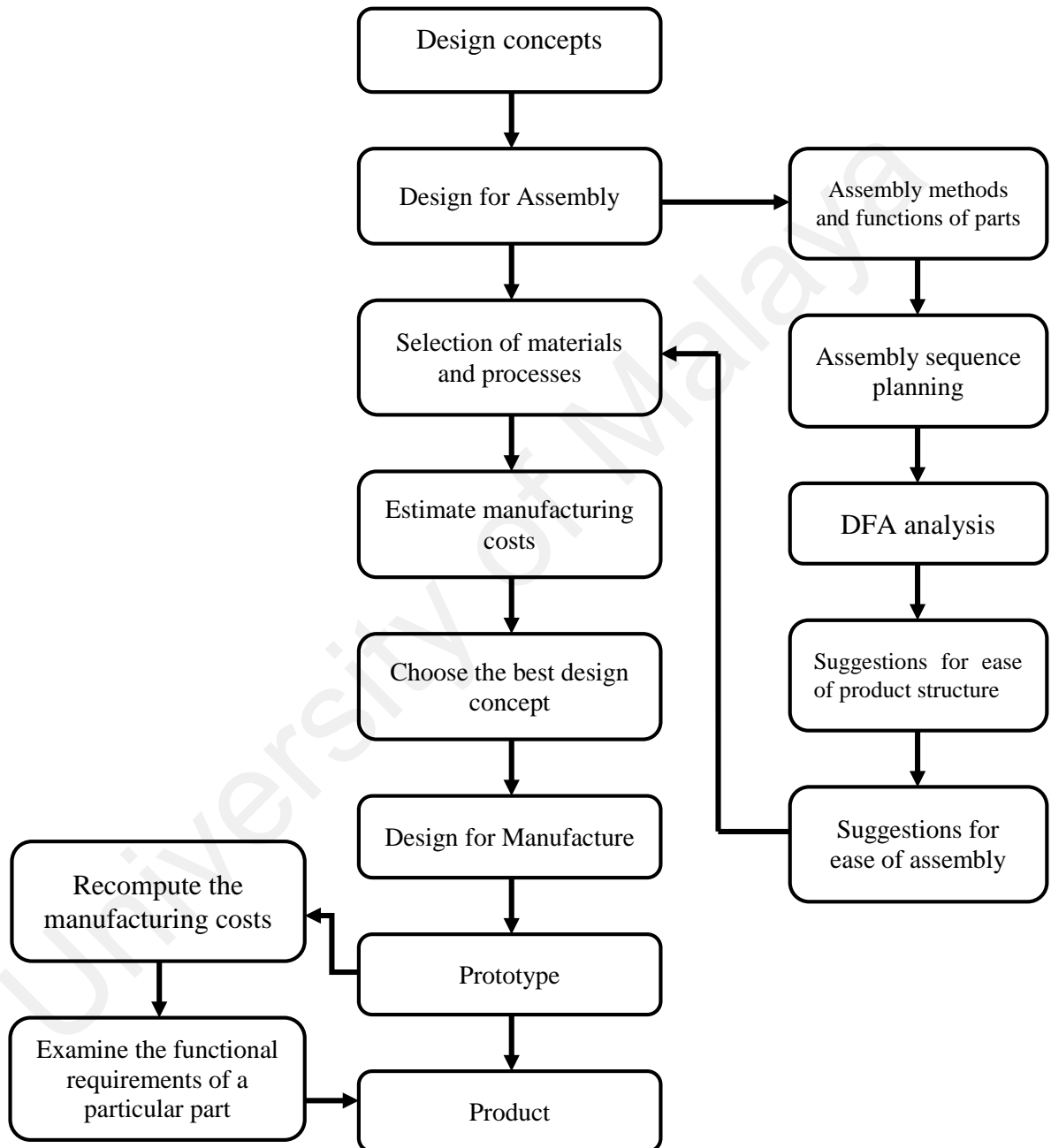

Figure 2.4 Typical stages in DFA procedure  
(Geoffrey Boothroyd, Dewhurst, & Knight, 2002; Ciciulla, 2006 ; Edwards, 2002; Mamat, Wahab, & Abdullah, 2009)



### **2.2.5 Benefits of DFA**

The obvious benefits include lower production cost. Lower assembly costs results from easy assembly and fewer parts minimizing manual labor (Bayoumi, 2000). Reduction in product manufacturing cost, however, is not necessarily considered to be the most desired outcome of redesign efforts (Geoffrey Boothroyd et al., 2002). DFA also gives benefits such as improved ergonomics, reduced work, higher quality, increased reliability, improved serviceability, reduced time to market launch and fewer production challenges (Coma, Mascle, & Véron, 2003; Huang & Mak, 1998; Krumenauer et al., 2008).

DFA thus not only helps the manufactures who embrace it become more profitable and more competitive, it also helps industries address other societal keys, e.g., considering the factory floor operator in the design ergonomics reduces workplace injuries and related health care costs (Munro, 1998).

DFA generates product and process benefits and enables a company to increase plant capacity without having to expand facilities.

### **2.2.6 DFA Guidelines**

Otto and Wood (2001) compiled the following list of general DFA guidelines from various sources including Iredale, Crow, Tipping and Paterson. These are the fundamental principles and thought processes that exemplify assembly-oriented design. Systematic DFA methodologies were born on these principles and through use of these types of guidelines.

Applying these types of design guidelines is the simplest way to approach DFA in the product design. The designers need to be mindful of the fact that to every rule and guideline there are exceptions. These guidelines should be approached and implemented parallel with clear delineation of the design goals.

Table 2.1 General DFA Guidelines

|    |   |
|----|---|
| 1  | Minimize part count by incorporating multiple functions into single parts.                          |
| 2  | Modularize multiple parts into single sub-assemblies.   |
| 3  | Assemble in open space, not in confined spaces.<br>Never bury important components.                 |
| 4  | Identify how to orient parts for insertion  |
| 5  | Standardize to reduce part variety.   |
| 6  | Maximize part symmetry.   |
| 7  | Design in geometric or weight polar properties if non-symmetric.                                    |
| 8  | Eliminate tangled parts.  |
| 9  | Color code or otherwise mark parts that are different by shape                                      |
| 10 | Prevent nesting of parts.   |
| 11 | Provide orienting features on non-symmetries.   |
| 12 | Design mating features for easy insertion.  |
| 13 | Provide aligning features   |
| 14 | Insert from above the new parts into assembly   |
| 15 | Insert from the same direction, or very seldomly.<br>Never require the assembly to be turned over.  |
| 16 | Eliminate fasteners.  |
| 17 | Place any necessary fasteners away from obstructions.   |
| 18 | Deep channels should be sufficiently wide to provide access to fastening tools. No-channel is best. |
| 19 | Provide flats for uniform fastening and ease of fastening   |
| 20 | Proper spacing insures allowance for a fastening tool   |

(Otto & Wood, 2001)

### **2.2.7 DFA methods**

Throughout the years, many DFA methods have been developed and implemented. Some are more effective than the others on some applications. DFA methods include (Geoffrey Boothroyd et al., 2002; Bralla, 1998; Stone, McAdams, & Kayyalethekkel, 2004; Whitney, 2004):

1. The Boothroyd and Dewhurst Method
2. The Hitachi Assemble Ability Evaluation Method
3. Lucas Hull DFA Method
4. The Westinghouse DFA Calculator
5. The Toyota Ergonomic Evaluation Method
6. Sony DFA Methods
7. Xerox Producibility Analysis

### **2.2.8 Boothroyd and Dewhurst Method**

One of the most widely recognized DFA methods was formulated by Boothroyd and Dewhurst. The DFA analysis focuses on redesigning an existing product through a two-step procedure applied to each part in the assembly. The first step questions each part to determine if it is necessary or is a candidate for elimination or combination with other parts in the assembly. The second step evaluates parts assembly in terms of ease of handling and insertion. The findings are then compared with synthetic data, before time and costs are accordingly generated for the assembly of each part (Appendix B and C) (Geoffrey Boothroyd et al., 2002).

Design efficiency (DFA index) rating can be calculated and used to compare different designs from these two steps. Higher DFA index indicates that a particular product is easier to assemble. The number of parts and assembly difficulties are two main factors that influence product assembly cost (Geoffrey Boothroyd et al., 2002). The DFA index of a product can be calculated by Equation 2.1 (Geoffrey Boothroyd, 2005).

$$DFA\ Index = \frac{\text{Theoretical number of parts} \times 3}{\text{Estimated total assembly time}} \quad 2.1$$

The number of parts that meets one of the criteria in Table 2.2 is theoretical number of parts. Parts that do not meet the requirements should be combined or eliminated. The DFA index is between 0 and 1 in Equation 2.1 but is usually reported in percentage (multiplying it by 100).

Table 2.2 Criteria for minimum number of parts

| Criteria | Requirement   |
|----------|---|
| 1        | During the normal operating mode of the product, the part moves relative to all other parts already assembled |
| 2        | The part must be of a different material or isolated from all other parts assembled                           |
| 3        | The part must be separate from all other assembled parts  |

The procedure for analyzing manually assembled products is summarized as follows:

- (1) Obtain the best information of the product or assembly through items such as engineering drawings, a prototype, or an existing product.
- (2) Disassemble the product and assign an identification number to each item as it is removed.
- (3) Reassemble the product. Add the part with the highest identification number to the work fixture and add the remaining parts one after another.
- (4) During assembly, complete a worksheet to compute the theoretical part number and assembly time (Appendix B and C).

Boothroyd and Peter Dewhurst computerised the assembly calculations and developed a version of the DFA method in 1981. Bogue (2012) reports several companies that have benefited from their use of DFA software.

### 2.2.9 DFA practices

Gauthier et al. (2000) analysed the low-volume production of highly engineered products subjected to DFA. They discussed two case studies through implementation of the Boothroyd Dewhurst DFA software. In the first case study, Fastrack Aerospace Product studied the items that increased the assembly time. DFA analysis was conducted on those items before the product was redesigned. The new design showed significant improvements in assembly operations over the baseline design. The improvements projected one third reduction in the assembly costs. The second case study involved an automotive turbocharger with the same method to compare with the findings of the Fastrack product. The total assembly time projected was 64% of the baseline design for Fastrack. Design changes halved the assembly time of the automotive turbocharger. These results show DFA is able to provide much-needed insights on assembly cost drivers for better revision efforts.

Kasai (2000) focused on applying DFA and DFE in life cycle assessment (LCA) for the Japanese automotive industry. The JAMA software was used to improve LCA but it was not effective enough because the software analysed only energy consumption and CO<sub>2</sub> emissions. To improve the results, the BDI (DFA) software was first implemented and then the DFE software. Results from the software are as summarized in Table 2.3.

Table 2.3 Example of DFE additional to DFA analysis

| Item to be calculated and evaluated                | Former model | New model, current, original design | New model, current, after improvement |
|--|--------------|-------------------------------------|---------------------------------------|
| DFA index  | 3.8          | 9 (improved by 55%)                 | 9 (improved by 82%)                   |
| DFA: total numbers of parts and assembly processes | 176          | 156 (improved by 11%)               | 141(improved by 20%)                  |
| DFA: assembly time, s                              | 1215         | 977 (improved by 20%)               | 840 (improved by 31%)                 |
| DFE: total environmental load index                | 5986         | 5560 (improved by 7%)               | 5538 (improved by 8%)                 |
| DFD: disassembly time, s                           | 1376         | 827 (improved by 40%)               | 601 (improved by 56%)                 |

(Kasai, 2000)

The results showed significant improvements in assembly and disassembly efficiency of the product design, but no information was given about the details to achieve these improvements.

An article by Choi et al. (2002) discusses the effectiveness of a virtual assembly software (DYNAMO) and its relation to BDI (DFA) software. DYNAMO helps designers find an acceptable assembly sequence but does not provide an optimum assembly sequence. The software checks the assembly collision and clearance violation. After it has checked the optimum assembly paths for collision, the assembly sequence is selected based on user experience. BDI (DFA) software does not give a graphical view of the assembly, so DYNAMO with 3D visualization can be combined with it. The combination improves the design evaluation process and further saves cost. This paper, however, does not detail the BDI (DFA) software's input and output.

Stone et al. (2004) presented a novel product architecture-based DFA method. In two case studies the efficiency of this new approach was compared with the well-known Boothroyd and Dewhurst DFA method. In the Boothroyd Dewhurst DFA method each part is first evaluated to determine whether it is necessary, can be eliminated, or can be combined with the other parts in an assembly. Then, handling, insertion, and other difficulties are considered to estimate the assembly process time. The product's architecture-based method is summarized in 5 steps as in Figure 2.3.

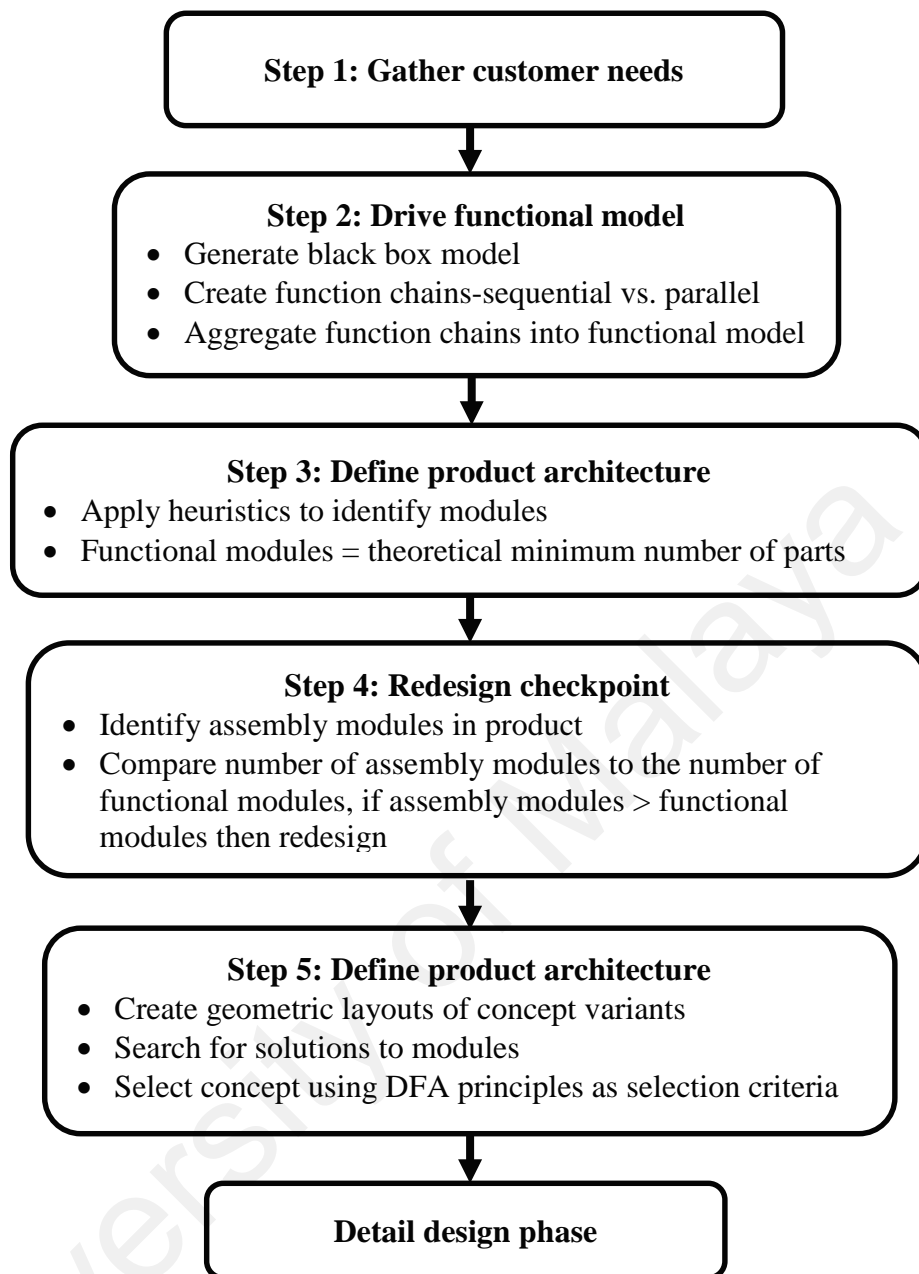

Figure 2.5 The product architecture-based approach to DFA  
(Stone et al., 2004)

Product architecture DFA method and Boothroyd Dewhurst DFA method are applied on two products for comparison, to show that conceptual DFA approach can reduce product part count as much as Boothroyd and Dewhurst DFA method. Conceptual DFA analysis also enables claims of design cycle savings because it only requires a functional model; collecting the product details is not necessary. Results from Boothroyd Dewhurst DFA method for heavy-duty stapler in the first case-study showed reduction to 15 parts from 29 parts of the original model, and to 89.17 seconds from 204.18 seconds of the

assembly time. Through product architecture-based method, the part count reduced from 29 to 11 and the assembly time was assumed to be 88.04 seconds. The assembly time of the original design was identical because it had been determined from Boothroyd Dewhurst manual assembly time estimations. In the second case–study, on an electric wok, fourteen parts were assumed to be eliminated. The assembly time improved from 233.48 seconds to 125.84 seconds through Boothroyd Dewhurst DFA method. In the new design approach, 20 parts were eliminated and 233.48 seconds of assembly time decreased to 91 seconds. The conclusion is that conceptual DFA is not a redesign method but it helps designers concurrently consider DFA guidelines early on in the design stage. The new method decreased more parts than did the Boothroyd Dewhurst DFA. This paper discusses the potential of these two methods in reducing parts, though the part reduction is theoretical and may not be achievable in a real product design through an architecture-based method.

Ease of assembly and ergonomic issues were considered by Mamat et al. (2009). The analyzed product was Proton's (automobile) front seats. Boothroyd Dewhurst DFA software was used to analyse the design efficiency. Software suggestions not only simplified the product but also helped the author eliminate some ergonomic difficulties. Yet another conclusion is that lifecycle considerations and difficulties should be considered earlier on in the design stage. There was neither any comparison between the new and old design nor the time saving ability of the software.

### **2.3 Design for Environment (Disassembly)**

LCA (life cycle assessment) refers to the input–output exchange processes between the environment and any given product throughout the phases of its life, from extraction and processing of the raw materials to the production, transportation, distribution, use, remanufacturing, recycling, and disposal processes (Gungor & Gupta, 1999; Vezzoli & Manzini, 2008).



If the specific phase of a product life focuses on minimizing environmental impact, it improves the product design from an environmental perspective through Designing for Environment (DFE). DFD is one aspect of DFE (Gungor & Gupta, 1999). It concentrates on easy disassembly of a product through easy and economical separation of its parts and materials. Designing the product for easy separation also facilitates maintenance, repairs, updating, and re-manufacturing (Vezzoli & Manzini, 2008).

### **2.3.1 Principles of DFD**

These are the general guidelines for improving disassembly. More details can be found in the Design for Environment Sustainability Handbook (Vezzoli & Manzini, 2008). Some of the guidelines are common in DFD and DFA (Chen, 2010; Scheuring, Bras, & Lee, 1994).

1. Minimizing the number of items in disassembly
2. Reducing the number of separate fasteners
3. Making the parts accessible in disassembly
4. Avoiding orientation changes during disassembly
5. Using simple standard tools in disassembly process
6. Using attachments that are reversible and easy to disassemble without making the joints unreliable
7. Minimizing the structures or components combined with different materials
8. Minimizing the use of hazardous substance
9. Designing products for reuse (through nondestructive separation methods)
10. Reducing the number of different materials
11. Avoiding non-compatible materials in the product structure
12. Selecting an efficient disassembly sequence

### **2.3.2 DFD evaluation methods**

- Hitachi Disassemble Ability Evaluation Method (Go, Wahab, Rahman, Ramli, & Azhari, 2011)
- Spread sheet-like chart (Kroll & Hanft, 1998)
- BDI & TNO (Gupta & Veerakamolmal, 1996; Harjula, Rapoza, Knight, & Boothroyd, 1996)
- AND/OR graph (Vinodh, Kumar, & Nachiappan, 2011)
- Disassembly Petri net (DPN) graph (Vinodh et al., 2011)
- Work Factor Method (Go et al., 2011)
- Genetic algorithm (Kongar & Gupta, 2006)

### **2.3.3 BDI & TNO analysis procedure**

The Boothroyd method estimates the disassembly time and cost for every part in the same way that the assembly time is calculated in Boothroyd and Dewhurst method (refer to past discussion). Environmental assessment is obtained in terms of a single figure indicator called MET points (Material cycles, Energy use, and Toxic emissions), developed by the TNO Industry Centre in Delft, the analysis tool a collaborative production with Boothroyd and Dewhurst Inc.. The best disassembly sequence can be selected according to the cost of disassembly and environmental impact (Harjula et al., 1996; W. Knight, 1999). The structure and procedure for the DFE analysis method is as shown in Figure 2.6.

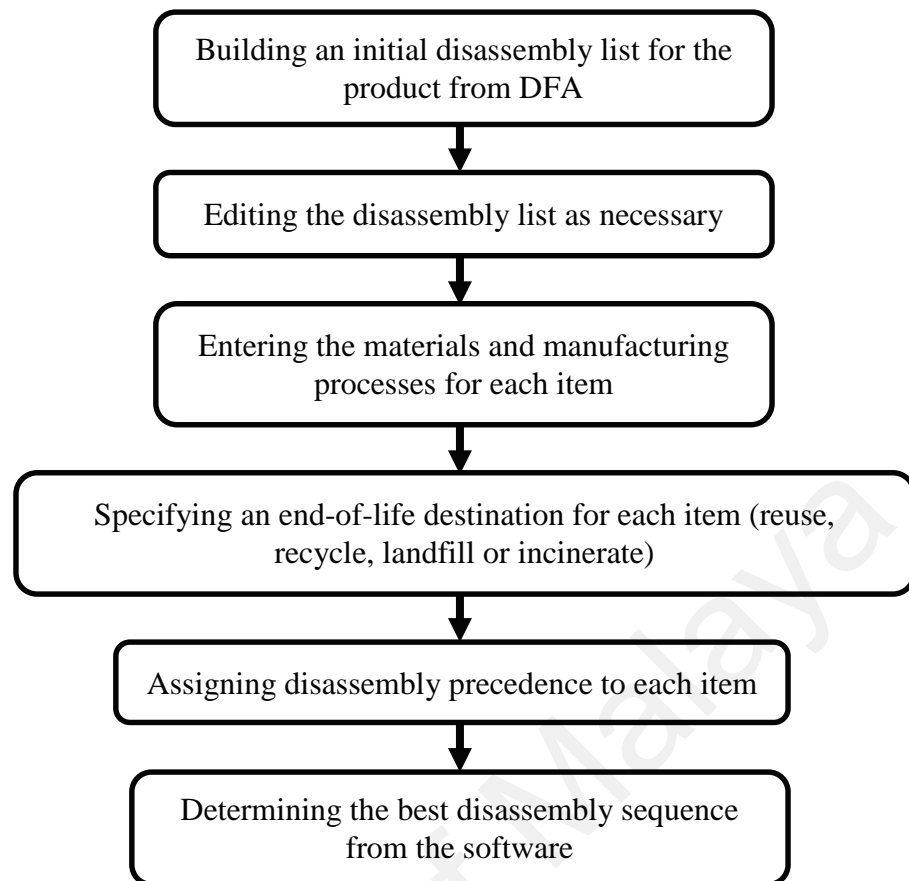

Figure 2.6 DFE analysis procedure  
(W. Knight, 1999)

#### 2.3.4 DFE (Disassembly) practices

Ehud Kroll et al. (1998) described an evaluation method for objectively quantifying the ease-of-disassembly of products. The method consists of a spreadsheet-like chart and corresponding catalog of rating difficulties for common manual disassembly tasks. Design effectiveness and estimated disassembly time were used to distinguish the effects of design changes on the overall process of disassembly. Possible areas for design improvements were identified through a summary of the evaluation results. The cost of disassembly was not studied.

Jialin Chen (2010) discussed the principles and general process of disassembly and considered a few suitable methods in developing the design. The disassembly of a TV set is discussed and analyzed in a case study. The disassembly methods for the different parts of a TV were investigated and explained step by step but the duration of each process was

not stated. Given, however, were the general methods and principles for improvement of disassembly efficiency regardless of the application to the TV set.

The study by Vinodh et al. (2011) presented the disassembly modeling of PS (phase selector) switch through component mating graph, directed graph, AND/OR graph, and DPN. Compare with other articles in this field, the economic benefits were also calculated and portrayed, giving the author a clear view of the magnitude of the gain developed by implementing the disassembly operation on a rotary switch. The advantages and drawbacks of all the modeling approaches were also discussed. The disassembly was planned on a reverse assembly approach. The disassembly leveling focused on generating feasible disassembly sequence. The disassembly precedence matrix and the final disassembly tree were reported and compared.

## **2.4 Summary**

This chapter focused on background information on DFA and DFD, their benefits, guidelines, and methods. Boothroyd and Dewhurst method has been explained as being one of the oldest and most widely used among DFA and DFD methods. Use of DFA and DFD has been shown to save time and costs throughout various industries.

## **CHAPTER 3**

### **METHODOLOGY**

As mentioned, the Boothroyd and Dewhurst Method is one of the oldest and most reliable methods for assembly analysis. In this dissertation, the DFA software version 9.3 (by BDI) was used for its analysis and implementation.

For disassembly, the DFE software version 1 (by BDI & TNO's) was implemented, to determine the financial effects of a product design in its end-of-life disassembly. The product's initial and end-of-life environmental effects were investigated. The software uses a method suggested by the TNO Product Centre of the Delft University of Technology for environmental assessment, which takes into account the effects of Materials, Energy and Toxicity (MET) on the environment.

DFM Concurrent Costing V2.2 was used to estimate the cost of manufacturing and producing the parts quickly, because item costs cannot easily be provided for this product. The components costs were used to compare the costs of the old and new designs in DFA and DFE software. The software products are located at the industrial lab of the University of Malaya Mechanical Engineering Department.

The main procedure followed in this study is as given in Figure 3.1. The brake lamp of an automotive product (Poroton Waja car) was analysed by the DFA software (see Figure 3.2) to estimate the assembly and operation times and cost of each part. From the software output and redesign suggestions, parts that could be optimized or eliminated were distinguished. The best way to implement the improvements were presented before the product was redesigned and optimized. The redesigned product (through DFA) was then examined by DFE software (see Figure 3.3) to estimate the disassembly time and cost of each part. The potential improvements were highlighted before the possible optimizations were applied. For better understanding of the dimensions and to compare

the old with the new design, modelling and sketching of the parts were done by Pro-Engineer software.

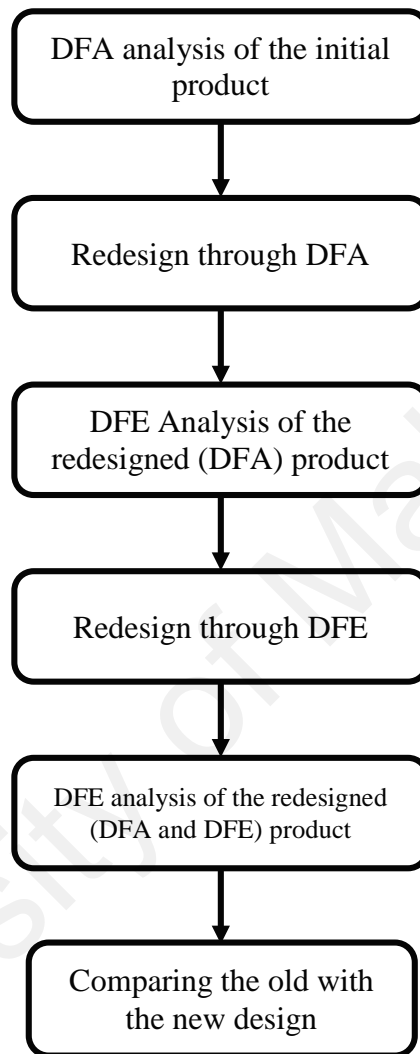

Figure 3.1 The general scheme of the method

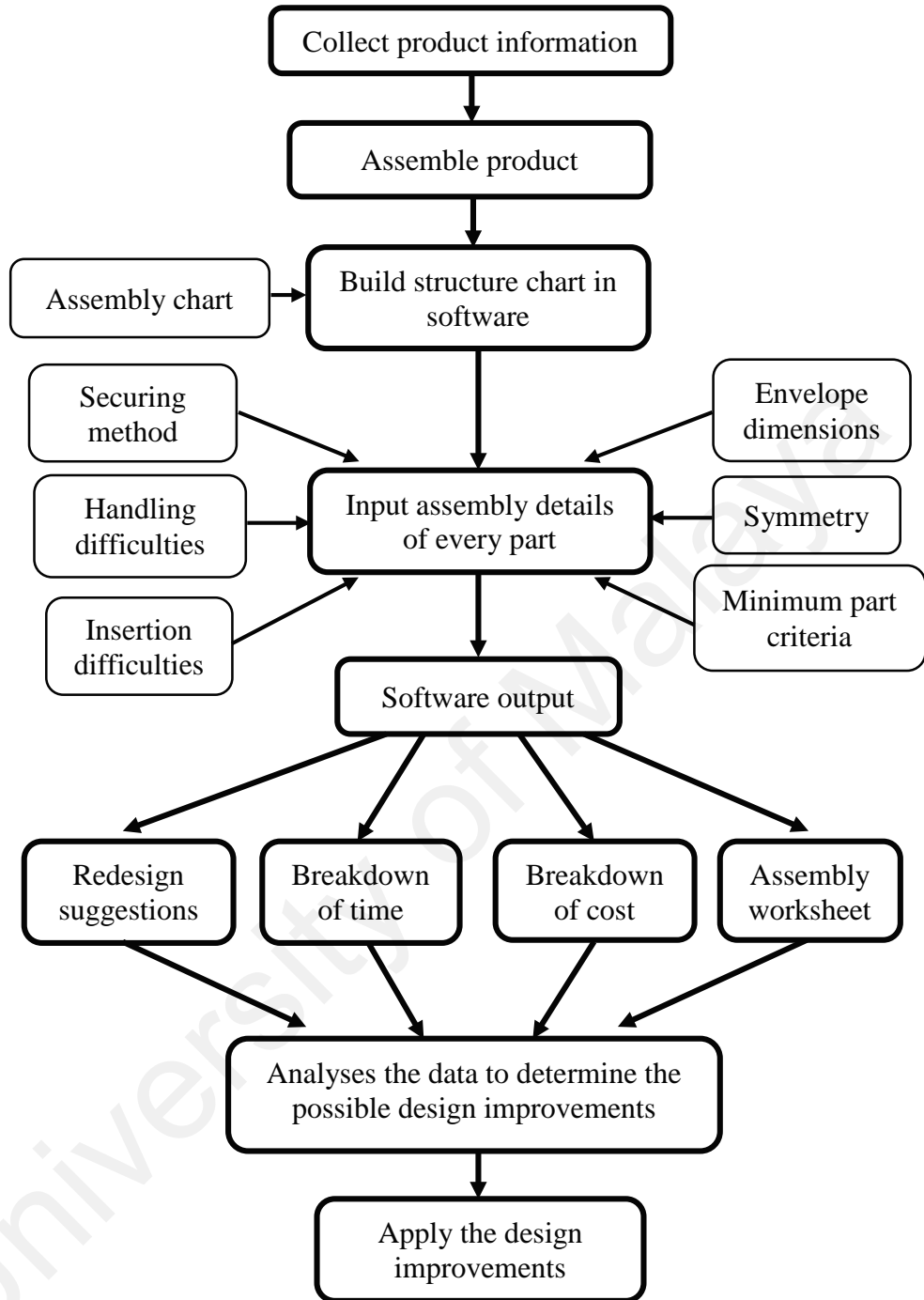

Figure 3.2 DFA methodology flow chart

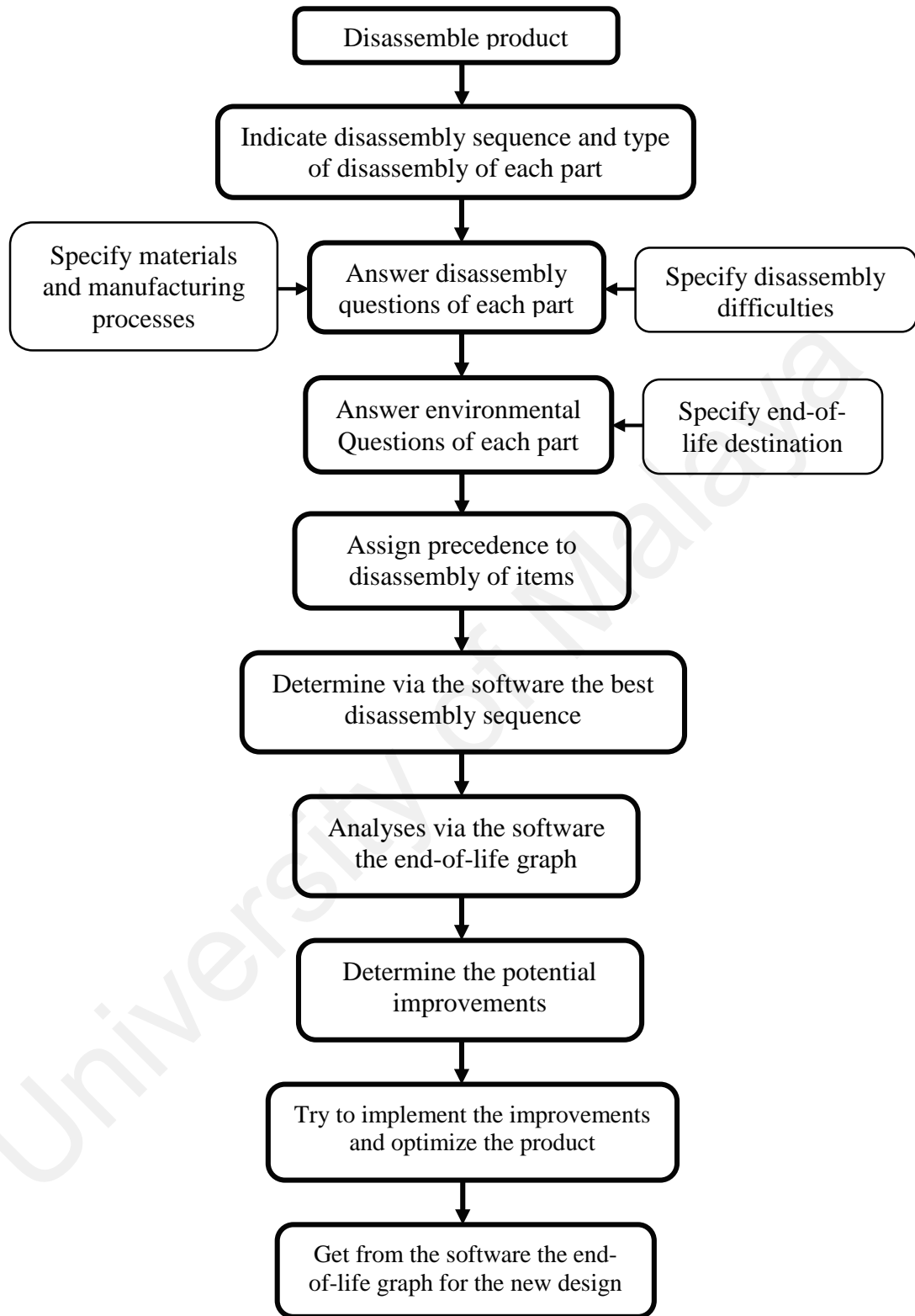

Figure 3.3 DFE methodology flow chart



### 3.1 Design overview:

Table 3.1 shows the list of components and the materials used to produce tail lamps. Assembly sequences with subassemblies of components are summarized in Figure 3.4. Assembly sequence diagram shows the total overview of the design in a step-by-step fashion and this diagram is used to build the structure chart for DFA method.

According to the table below product consisted of 23 parts with 3 subassemblies and 8 different types of materials. There are eleven different types of components in this product, weighing 1.79 kg in total.

Table 3.1 Parts specification

| Part Number | Part Name              | Material                   | Quantity |
|-------------|------------------------|----------------------------|----------|
| 1-1-1       | Light shell            | ABS                        | 1        |
| 1-1-5       | Light cover            | Polycarbonate              | 1        |
| 1-3-3       | Electric circuit       | Galvanized steel           | 1        |
| 1-3-2       | Copper connectors      | Copper                     | 6        |
| 1-3-1       | Plastic base           | Polypropylene              | 1        |
| 1-3-10-3    | Metallic clip          | Stainless steel            | 1        |
| 1-3-1       | Plastic board          | Polypropylene              | 1        |
| 1-1-2       | Bolt                   | Low Carbon Steel           | 3        |
| 1-3-7       | White bulb (12V-1.5W)  | -                          | 3        |
| 1-3-8       | Orange bulb (12V-1.5W) | -                          | 1        |
| 1-3-10-2    | Rubber washer          | EPDM                       | 1        |
| 1-4         | Rubber seal 1          | EPDM                       | 1        |
| 1-6         | Rubber seal 2          | EPDM                       | 1        |
| 1-7         | Harness connector      | Average bulk thermoplastic | 1        |
|             | Total                  |                            | 23       |

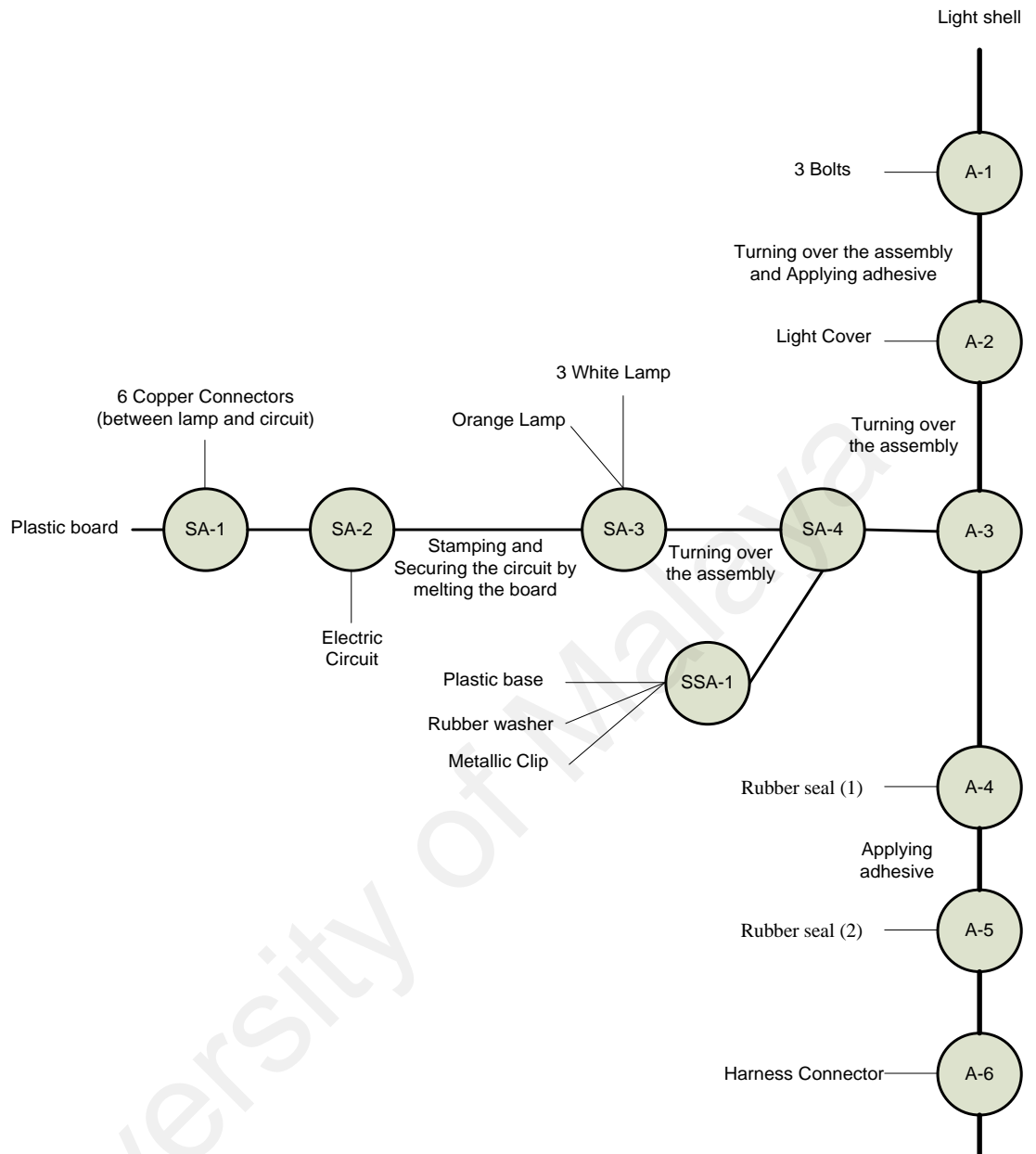

Figure 3.4 Assembly Chart (initial design)

### 3.2 Details of the DFA software panels

The software panels include Definition, Securing Method, Minimum Part Criteria, Envelop Dimensions, Symmetry, Handling Difficulties, Insertion Difficulties, Labor Time, and Manufacturing Data. A window is provided to input the Structural, Assembly Difficulties, and Manufacturing Details of all the components as Appendix E. Information on the different sections of the panels is provided in the Design for Assembly V9.3 User Guide, but is briefly given in this section.

### **3.2.1 Minimum-part criteria**

At the Minimum-Part Criteria tab a user must specify the purpose of the individual items by classifying the item as either theoretically necessary or a candidate for elimination. According to the Boothroyd and Dewhurst method the only parts theoretically required are items that:

1. Have to move relative to the rest of the assembly.
2. Must be made from a different material.
3. Must be separate for reasons of assembly or repair.
4. Act as a base part (one per product)

The minimum-part count is the sum of the number of all the parts that fall into one of these four categories. Any other item not included in the group is considered a candidate for elimination. If we define a well-designed product to be one that needs all the parts it has, it typically would have three times the number of parts predicted by the minimum-part count.

### **3.2.2 Envelope dimensions**

In the envelope dimensions tab, a user chooses the item shape - cylindrical or rectangular. A cylindrical item has as input variables its diameter and height whereas a rectangular item has length, width, and height. If an item is extremely small (or extremely big), the software decides that the item is difficult to handle and/or assemble; it thus includes extra time for assembling the item.

### **3.2.3 Symmetry**

Users must specify the symmetries of an item because parts that are symmetrical are easier to align and insert correctly.

### **3.2.4 Handling difficulties**

Through this tab a user can identify items that are difficult to handle (an item might be: flexible, easy to tangle, heavy, or too small to handle). The software adds additional handling/insertion time into the assembly-time calculations.

### **3.2.5 Insertion difficulties**

This tab provides options for the software to factor in the extra time required to insert difficult items. Threading a screw into a hole whose view or access is obstructed, for example, would take an extra long time.

### **3.2.6 Securing method**

Through this tab a user can choose how an item is secured to the assembly. The software uses industry data to estimate the time required to perform the securing operation. If the item is threaded, there are options to choose the number of revolutions required and the method used (hand screwed vs. screwdriver vs. electric screwdriver).

The design specifications required for all the components are gathered and summarized as follows. The information will be used as input to the DFA software.

### **3.2.7 Assembly**

By filling in the information for each mechanical part, the leftmost column of the software becomes populated in displaying a list of all the components making up the product. This list can be configured to display or hide specific components according to their type or tracking status. This tab is where a user can enumerate additional operations such as reorientation of the assembly, application of glue, and wiring of cables; all to provide even more accurate details on the assembly sequence. The DFA software provides time and cost estimates for these operations.

### 3.3 Details of the components for the DFA software

The DFA software collects the mentioned information on each separate item. In this section details of each part is collected and summarized in different tables. This information used as the input of the software.

#### 3.3.1 Light shell

The function of this part is to reflect light from the bulbs and provide illumination. The interior surface should be reflective so is coated with aluminum. Lightweight and having high thermal resistance and high electrical resistance are its main features.

Table 3.2 Specifications for a light shell

|                               |        |                |
|-------------------------------|--------|----------------|
| <b>Part number</b>            |        | 1-1-1          |
| <b>Repeat count</b>           |        | 1              |
| <b>Securing Method</b>        |        | Secured later  |
| <b>Minimum part criteria</b>  |        | Base Part      |
| <b>Shape</b>                  |        | non-rotational |
| <b>Dimensions</b>             | Length | 400 mm         |
|                               | Width  | 220 mm         |
|                               | Height | 110 mm         |
| <b>Alpha Symmetry</b>         |        | One way        |
| <b>Beta Symmetry</b>          |        | One way        |
| <b>Handling difficulties</b>  |        | -              |
| <b>Insertion difficulties</b> |        | -              |
| <b>Item cost</b>              |        | RM 11.06       |
| <b>Weight per item</b>        |        | 0.71 kg        |

#### 3.3.2 Bolts

This part secures the lamp to the back of the car. Bolts should have a high tensile strength to make the assembly durable.

Table 3.3 Specifications for the bolts

|   |        |            |
|---|--------|------------|
| <b>Part number</b>                      |        | 1-1-2      |
| <b>Repeat count</b>                     |        | 3          |
| <b>Securing Method</b>                  |        | Push/Press |
| <b>Minimum part criteria</b>            |        | Material   |
| <b>Shape</b>                            |        | Rotational |
| <b>Dimensions</b>                       | Length | 15 mm      |
|   | Height | 30 mm      |
| <b>Alpha Symmetry</b>                   |        | One way    |
| <b>Beta Symmetry</b>                    |        | Any way    |
| <b>Handling\ Insertion difficulties</b> |        | -          |
| <b>Item cost</b>                        |        | RM 0.2     |
| <b>Weight per item</b>                  |        | 0.05 kg    |

### 3.3.3 Light cover

Light cover provides conspicuity for the light. It signals through three colors. Its main features are transparent, highly durable (to fluids and/or sunlight), and having high thermal resistance.

Table 3.4 Light-cover specifications

|                               |               |                |
|-------------------------------|---------------|----------------|
| <b>Part number</b>            |               | 1-1-5          |
| <b>Repeat count</b>           |               | 1              |
| <b>Securing Method</b>        |               | Secured later  |
| <b>Minimum part criteria</b>  |               | Material       |
| <b>Shape</b>                  |               | non-rotational |
| <b>Dimensions</b>             | <b>Length</b> | 350 mm         |
|                               | <b>Width</b>  | 200 mm         |
|                               | <b>Height</b> | 90 mm          |
| <b>Alpha Symmetry</b>         |               | One way        |
| <b>Beta Symmetry</b>          |               | One way        |
| <b>Handling difficulties</b>  |               | -              |
| <b>Insertion difficulties</b> |               | -              |
| <b>Item cost</b>              |               | RM 5.65        |
| <b>Weight per item</b>        |               | 0.21 kg        |

### 3.3.4 Rubber seal (1)

This seal is assembled on the edge of the light shell to tranquillize the contact between the light cover and the car body. The rubbers should be highly flexible (having a low flexural modulus) to satisfy the intended function.

Table 3.5 Rubber seal (1) specifications

|                               |               |                |
|-------------------------------|---------------|----------------|
| <b>Part number</b>            |               | 1-4            |
| <b>Repeat count</b>           |               | 1              |
| <b>Securing Method</b>        |               | Self-sticking  |
| <b>Minimum part criteria</b>  |               | Material       |
| <b>Shape</b>                  |               | non-rotational |
| <b>Dimensions</b>             | <b>Length</b> | 300 mm         |
|                               | <b>Width</b>  | 200 mm         |
|                               | <b>Height</b> | 5 mm           |
| <b>Alpha Symmetry</b>         |               | One way        |
| <b>Beta Symmetry</b>          |               | One way        |
| <b>Handling difficulties</b>  |               | -              |
| <b>Insertion difficulties</b> |               | Align          |
| <b>Item cost</b>              |               | RM 1           |
| <b>Weight per item</b>        |               | 0.01 g         |

### 3.3.5 Rubber seal (2)

This has the same function and properties as rubber seal (1) but has different dimensions.

Table 3.6 Rubber seal (2) specifications

|                               |               |                                |
|-------------------------------|---------------|--------------------------------|
| <b>Part number</b>            |               | 1-6                            |
| <b>Repeat count</b>           |               | 1                              |
| <b>Securing Method</b>        |               | Secured later (Apply adhesive) |
| <b>Minimum part criteria</b>  |               | Material                       |
| <b>Shape</b>                  |               | non-rotational                 |
| <b>Dimensions</b>             | <b>Length</b> | 340 mm                         |
|                               | <b>Width</b>  | 50 mm                          |
|                               | <b>Height</b> | 1 mm                           |
| <b>Alpha Symmetry</b>         |               | One way                        |
| <b>Beta Symmetry</b>          |               | One way                        |
| <b>Handling difficulties</b>  |               | -                              |
| <b>Insertion difficulties</b> |               | Align                          |
| <b>Item cost</b>              |               | RM 1                           |
| <b>Weight per item</b>        |               | 0.01 kg                        |

### 3.3.6 Plastic board

This is a base part on which the bulbs, electrical circuit, and copper connectors are assembled. Its main specifications include having high thermal resistance, high electrical resistance, and high flexibility (for snap fits).

Table 3.7 Plastic-board specifications

|                               |               |                |
|-------------------------------|---------------|----------------|
| <b>Part number</b>            |               | 1-3-1          |
| <b>Repeat count</b>           |               | 1              |
| <b>Securing Method</b>        |               | Secured later  |
| <b>Minimum part criteria</b>  |               | Base part      |
| <b>Shape</b>                  |               | Non-rotational |
| <b>Dimensions</b>             | <b>Length</b> | 198 mm         |
|                               | <b>Width</b>  | 140 mm         |
|                               | <b>Height</b> | 53 mm          |
| <b>Alpha Symmetry</b>         |               | One way        |
| <b>Beta Symmetry</b>          |               | One way        |
| <b>Handling difficulties</b>  |               | -              |
| <b>Insertion difficulties</b> |               | -              |
| <b>Item cost</b>              |               | RM 5.52        |
| <b>Weight per item</b>        |               | 0.09 kg        |

### 3.3.7 Copper connectors

Copper connectors make the electrical connection between the circuit and the bulbs reliable. They should have high electrical conductivity and high elasticity.

Table 3.8 Copper-connector specifications

|                               |               |               |
|-------------------------------|---------------|---------------|
| <b>Part number</b>            |               | 1-3-2         |
| <b>Repeat count</b>           |               | 6             |
| <b>Securing Method</b>        |               | Secured later |
| <b>Minimum part criteria</b>  |               | Material      |
| <b>Shape</b>                  |               | Rotational    |
| <b>Dimensions</b>             | <b>Length</b> | 20 mm         |
|                               | <b>Height</b> | 5 mm          |
| <b>Alpha Symmetry</b>         |               | One way       |
| <b>Beta Symmetry</b>          |               | One way       |
| <b>Handling difficulties</b>  |               | -             |
| <b>Insertion difficulties</b> |               | Align         |
| <b>Item cost</b>              |               | RM 0.5        |
| <b>Weight per item</b>        |               | 0.001 kg      |

### 3.3.8 Electrical circuit

This part makes all the electrical connections from the harness connector to the bulbs. Its main features include having high electrical conductivity and high corrosion resistance.

Table 3.9 Electrical-circuit specifications

|                               |               |                |
|-------------------------------|---------------|----------------|
| <b>Part number</b>            |               | 1-3-3          |
| <b>Repeat count</b>           |               | 1              |
| <b>Securing Method</b>        |               | Secured later  |
| <b>Minimum part criteria</b>  |               | Material       |
| <b>Shape</b>                  |               | Non-rotational |
| <b>Dimensions</b>             | <b>Length</b> | 230 mm         |
|                               | <b>Width</b>  | 150 mm         |
|                               | <b>Height</b> | 30 mm          |
| <b>Alpha Symmetry</b>         |               | One way        |
| <b>Beta Symmetry</b>          |               | One way        |
| <b>Handling difficulties</b>  |               | Nest tangle    |
| <b>Insertion difficulties</b> |               | Align          |
| <b>Item cost</b>              |               | RM 4.07        |
| <b>Weight per item</b>        |               | 0.13 kg        |



### 3.3.9 White bulbs

White bulbs serve as a lighting source for the brake and reverse signals.

Table 3.10 White-bulb specifications

|                               |                    |       |
|-------------------------------|--------------------|-------|
| <b>Part number</b>            | 1-3-7              |       |
| <b>Repeat count</b>           | 3                  |       |
| <b>Securing Method</b>        | Electrical-bayonet |       |
| <b>Minimum part criteria</b>  | Material           |       |
| <b>Shape</b>                  | Round              |       |
| <b>Dimensions</b>             | <b>Length</b>      | 45 mm |
|                               | <b>Height</b>      | 25 mm |
| <b>Alpha Symmetry</b>         | One way            |       |
| <b>Beta Symmetry</b>          | One way            |       |
| <b>Handling difficulties</b>  | -                  |       |
| <b>Insertion difficulties</b> | Align-Resist       |       |
| <b>Item cost</b>              | RM 3               |       |
| <b>Weight per item</b>        | 0.01 kg            |       |

### 3.3.10 Orange Bulb

Orange bulb provides a light source for the turn signal.

Table 3.11 Orange-bulb specifications

|                               |                    |       |
|-------------------------------|--------------------|-------|
| <b>Part number</b>            | 1-3-8              |       |
| <b>Repeat count</b>           | 1                  |       |
| <b>Securing Method</b>        | Electrical-bayonet |       |
| <b>Minimum part criteria</b>  | Material           |       |
| <b>Shape</b>                  | Rotational         |       |
| <b>Dimensions</b>             | <b>Length</b>      | 45 mm |
|                               | <b>Height</b>      | 25 mm |
| <b>Alpha Symmetry</b>         | One way            |       |
| <b>Beta Symmetry</b>          | One way            |       |
| <b>Handling difficulties</b>  | -                  |       |
| <b>Insertion difficulties</b> | Align-Resist       |       |
| <b>Item cost</b>              | RM 4               |       |
| <b>Weight per item</b>        | 0.01 kg            |       |

### 3.3.11 Plastic base

The function of the plastic base with metallic clip is to secure the connection between the harness connector and the electrical circuit. For assembly, the harness connector of the plastic base has a snap-fit feature and good flexibility, both important for the function.

Table 3.12 Plastic-base specifications

|                               |               |                |
|-------------------------------|---------------|----------------|
| <b>Part number</b>            |               | 1-3-10-1       |
| <b>Repeat count</b>           |               | 1              |
| <b>Securing Method</b>        |               | Secured later  |
| <b>Minimum part criteria</b>  |               | Other          |
| <b>Shape</b>                  |               | Non-rotational |
| <b>Dimensions</b>             | <b>Length</b> | 50 mm          |
|                               | <b>Width</b>  | 25 mm          |
|                               | <b>Height</b> | 30 mm          |
| <b>Alpha Symmetry</b>         |               | One way        |
| <b>Beta Symmetry</b>          |               | One way        |
| <b>Handling difficulties</b>  |               | -              |
| <b>Insertion difficulties</b> |               | -              |
| <b>Piece part cost</b>        |               | RM 0.52        |
| <b>Weight per item</b>        |               | 0.01 kg        |

### 3.3.12 Rubber washer

Washer is used for tight locating the harness inside the plastic base. Flexibility is the main feature.

Table 3.13 Washer Specifications

|                               |               |                |
|-------------------------------|---------------|----------------|
| <b>Part number</b>            |               | 1-3-10-2       |
| <b>Repeat count</b>           |               | 1              |
| <b>Securing Method</b>        |               | Secured later  |
| <b>Minimum part criteria</b>  |               | Other          |
| <b>Shape</b>                  |               | Non-rotational |
| <b>Dimensions</b>             | <b>Length</b> | 40 mm          |
|                               | <b>Width</b>  | 12 mm          |
|                               | <b>Height</b> | 3 mm           |
| <b>Alpha Symmetry</b>         |               | Any way        |
| <b>Beta Symmetry</b>          |               | Either way     |
| <b>Handling difficulties</b>  |               | Nest tangle    |
| <b>Insertion difficulties</b> |               | Access-Align   |
| <b>Piece part cost</b>        |               | RM 0.1         |
| <b>Weight per item</b>        |               | 0.001 kg       |

### 3.3.13 Metallic clip

Metallic clip secures the plastic base on the plastic board by snap-fitting. Its main specification is high elasticity in deflection.

Table 3.14 Metallic-clip specifications

|                               |                |       |
|-------------------------------|----------------|-------|
| <b>Part number</b>            | 1-3-10-3       |       |
| <b>Repeat count</b>           | 1              |       |
| <b>Securing Method</b>        | Snap           |       |
| <b>Minimum part criteria</b>  | Fastener       |       |
| <b>Shape</b>                  | non-rotational |       |
| <b>Dimensions</b>             | <b>Length</b>  | 45 mm |
|                               | <b>Width</b>   | 20 mm |
|                               | <b>Height</b>  | 2 mm  |
| <b>Alpha Symmetry</b>         | One way        |       |
| <b>Beta Symmetry</b>          | One way        |       |
| <b>Handling difficulties</b>  | Nest tangle    |       |
| <b>Insertion difficulties</b> | Resist         |       |
| <b>Piece part cost</b>        | RM 0.1         |       |
| <b>Weight per item</b>        | 0.001 kg       |       |

### 3.3.14 Harness connector

This component conducts electricity from the car to the electrical circuit. It should have a high corrosion resistance.

Table 3.15 Harness-connector specifications

|                               |                         |       |
|-------------------------------|-------------------------|-------|
| <b>Part number</b>            | 1-7                     |       |
| <b>Repeat count</b>           | 1                       |       |
| <b>Securing Method</b>        | Electric- Latch or Snap |       |
| <b>Minimum part criteria</b>  | Material                |       |
| <b>Shape</b>                  | non-rotational          |       |
| <b>Dimensions</b>             | <b>Length</b>           | 35 mm |
|                               | <b>Width</b>            | 25 mm |
|                               | <b>Height</b>           | 5 mm  |
| <b>Alpha Symmetry</b>         | One way                 |       |
| <b>Beta Symmetry</b>          | One way                 |       |
| <b>Handling difficulties</b>  | -                       |       |
| <b>Insertion difficulties</b> | access                  |       |
| <b>Piece part cost</b>        | RM 4                    |       |
| <b>Weight per item</b>        | 0.008 kg                |       |

### 3.4 The assembly process

Electrical connection fastener subassembly, as we can see in the picture below is composed of 1 plastic base, 1 metallic clip, and 1 rubber washer. The assembly direction for this component is as shown below (see Figure 3.7).

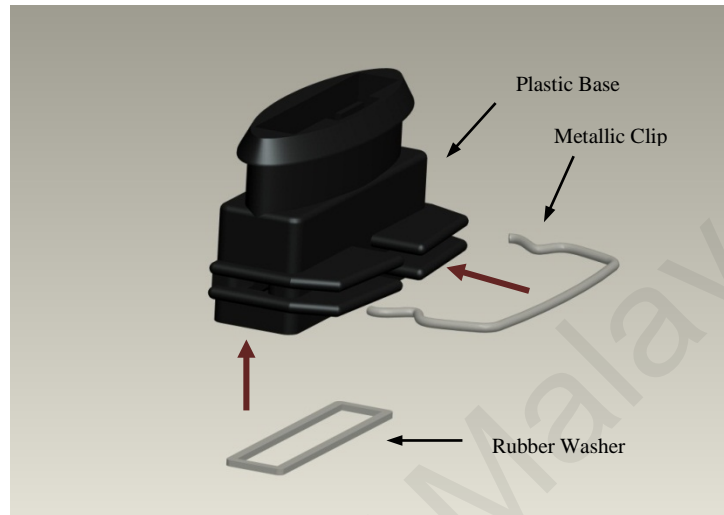

Figure 3.5 Subassembly of Electrical connection fastener

For subassembly of the bulbs and the electrical board the first 6 copper connectors are placed in particular holes on the board (see Figure 3.6).

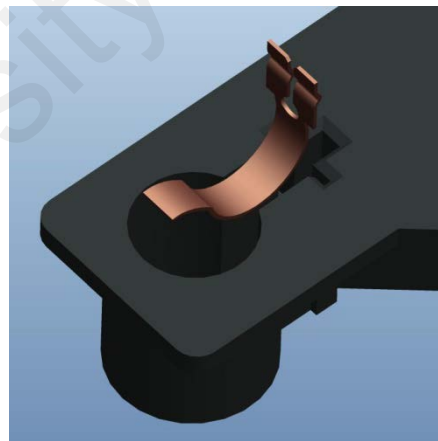

Figure 3.6 Assembly of the copper connector onto the board

The electrical circuit is assembled automatically as one part. It is stamped in specific locations during assembly, to cut the connections in between and make the electrical board functional. The cut separates that one part into 7 components. The electrical circuit is secured to the board by melting it to specific places (Figure 3.7) on the plastic board.

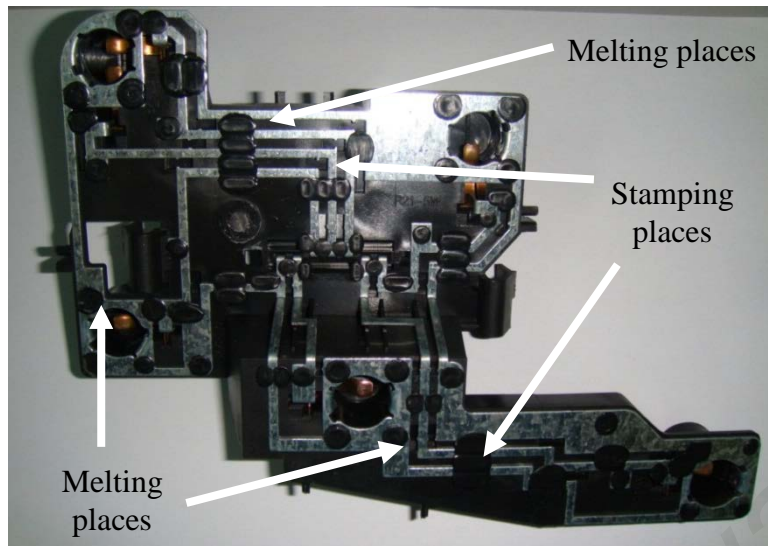

Figure 3.7 The stamping and melting places on the electrical board

In the next step the white and orange bulbs are assembled in the spaces indicated as in Figure 3.8.

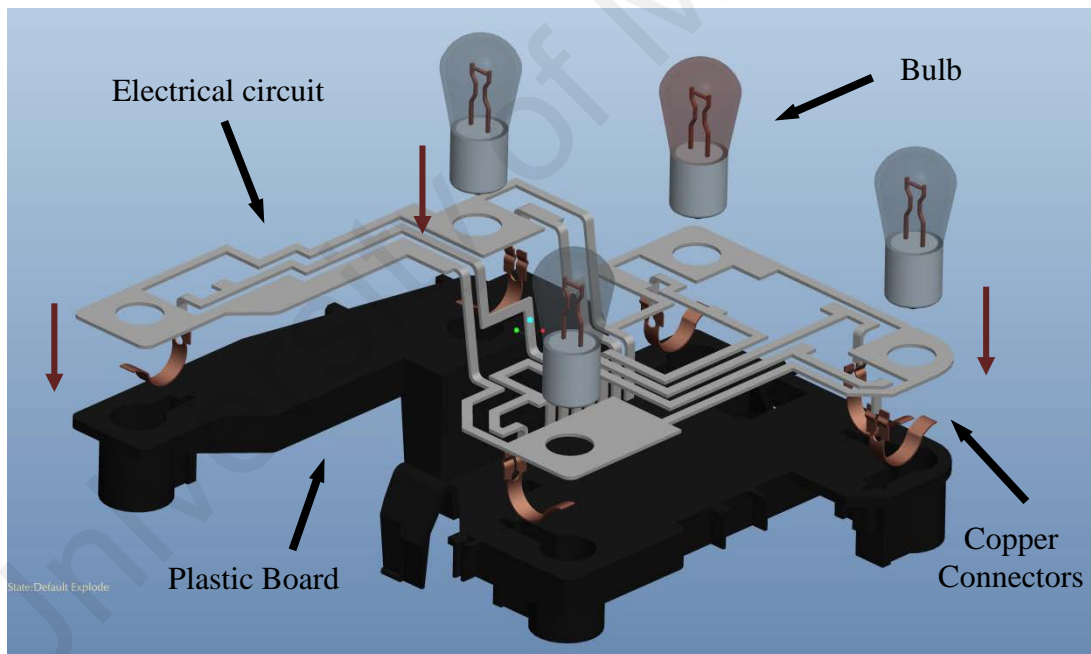

Figure 3.8 Exploded depiction of the bulbs and electrical board

After reorienting the assembly (see Figure 3.9), the parts from the electrical connection fastener subassembly are assembled onto the plastic board.

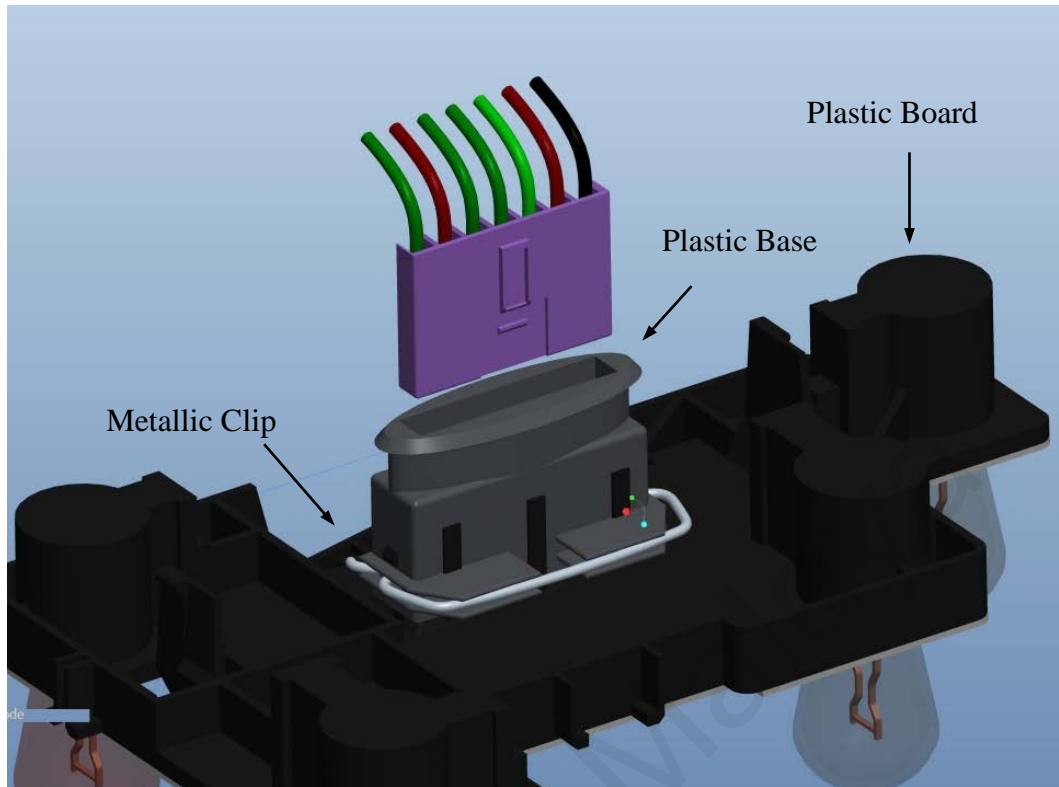

Figure 3.9 Assembly of the electrical-connection fastener to the electrical board

3 bolts, the assembled parts from the electrical-board subassembly, and the rubber seal are then assembled onto the backlight housing (Figure 3.12).

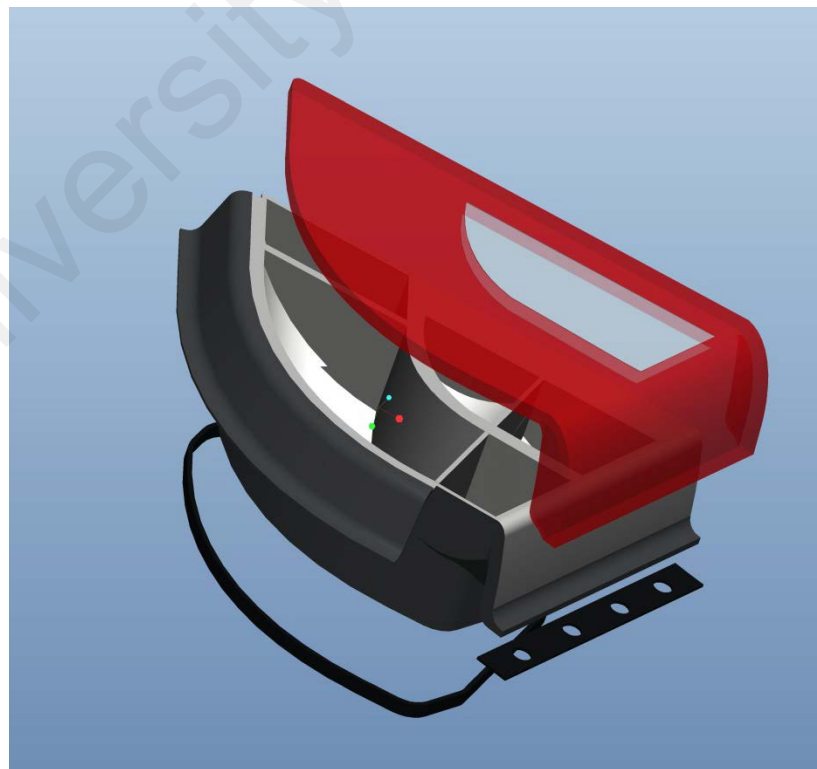

Figure 3.10 Light-shell subassembly, top view

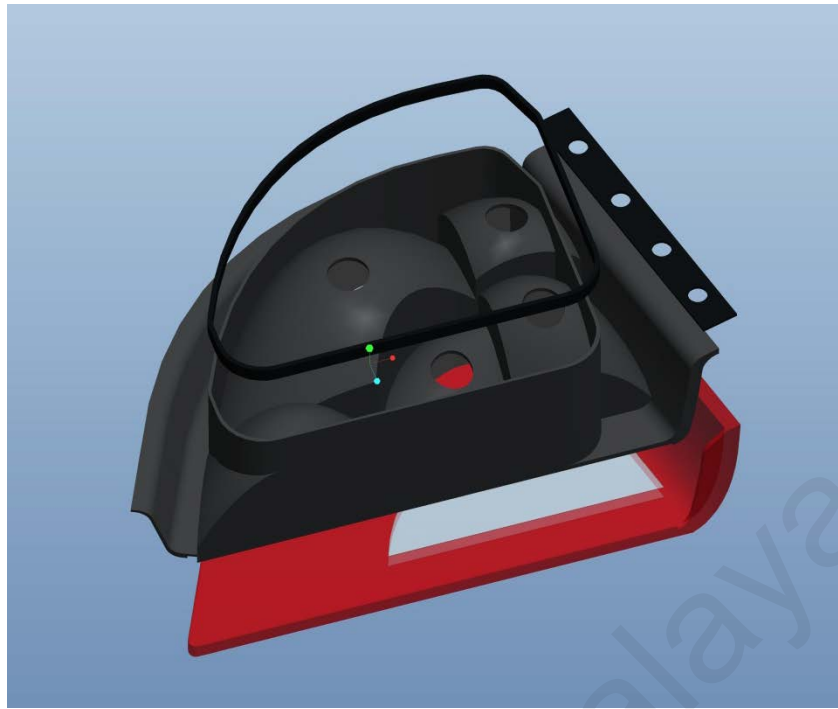

Figure 3.11 Light-shell subassembly, bottom view



Figure 3.12 Assembly of the electrical board onto the light

### 3.5 Details of the DFE software panels

General information on the product is first entered into the software through the Product Information window as below:

**Product Name:** REAR LIGHT  
**Manufacturer Name:** PROTON SDN BHD  
**Product life volume:** 1,000,000  
**Production life, years:** 10  
**Expected duration, years:** 12  
**Rest fraction disposal:** Landfill  
**Labor Rate, RM:** 70

Parts, operations, and subassemblies are added to the DFE worksheet in the order of disassembly. Disassembly sequence is the reverse of assembly sequence but some editing of the disassembly steps is still necessary. While adding the components the unfastening methods are also specified (see Figure 3.13) from Table 3.16.

| No. | Type | Name                           | Repeat count | Tool fetching time, s | Removal or operation time, s | Total removal time, s | Description              |
|-----|------|--------------------------------|--------------|-----------------------|------------------------------|-----------------------|--------------------------|
| 1   | SSub | Bulbs and electrical board     | 1            | 0.000                 | 3.200                        | 3.200                 | Snap fit unfasten/remove |
| 2   | SSub | Electrical connection fastener | 1            | 0.000                 | 3.200                        | 3.200                 | Snap fit unfasten/remove |
| 3   | Sub  | Bulbs                          | 4            | 0.000                 | 5.000                        | 20.000                | Push fit unfasten/remove |
| 4   | Part | Main Electrical Circuit        | 1            | 4.200                 | 21.800                       | 26.000                | Rivet unfasten/remove    |
| 5   | Part | Electrical Circuit             | 6            | 4.200                 | 8.200                        | 53.400                | Rivet unfasten/remove    |

Figure 3.13 Disassembly Worksheet Window

The DFE software has two panels for entering the specifications of the components for disassembly. The first panel has disassembly questions (Figure 3.14) whereas the second panel poses environmental questions (Figure 3.15). Disassembly questions determine the difficulties faced while dismantling the product, such as restricted view, obstructed access, etc. The software estimates from the data the disassembly time required for the components. Environmental questions specify the manufacturing processes, materials, and the end-of-life destination for the parts.

An initial disassembly list for the product was built through the DFD program. For each item, the materials and manufacturing processes used during manufacture were



entered. These were selected from drop down lists corresponding to categories in the materials and processes database. An 'end-of-life' destination for each item (reuse, recycle, landfill, or incinerate) specified and indicated if special waste treatment is required. For recycled materials a value is obtained from the materials database. A disassembly precedence is assigned to each item to indicate which ones must be removed immediately prior to another item when releasing it from the assembly. The program determines the best disassembly sequence. The results of the financial and environmental analysis of the product are summarized in a graph containing financial and environmental lines.



Figure 3.14 The disassembly-questions panel

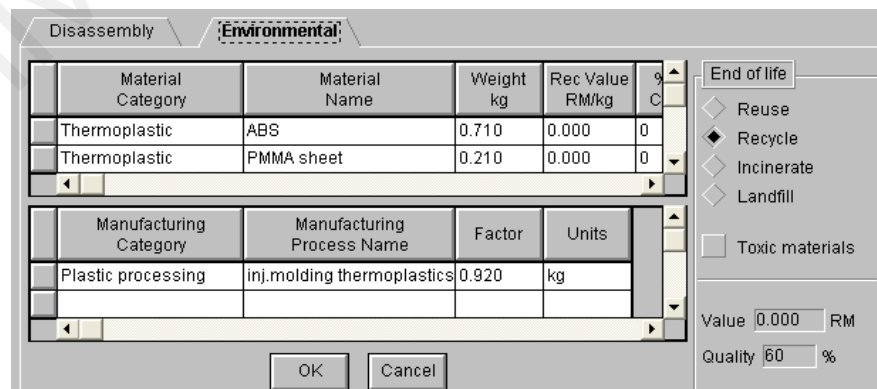

Figure 3.15 The environmental-questions panel

### 3.6 Details of the components for the DFE software

The disassembly specifications are gathered and summarized in Table 3.16, in a sequence that calls for parts that need to be disassembled at the end of its life. Disassembly of the electrical circuit is not a reverse of the assembly because in assembly it is one part but in disassembly it is 7 parts (1 main circuit and 6 electrical circuits). A reverse operation for the electrical circuit is considered as an unfastening of the rivet (because the software does not have any reverse operation for dismantling of the melted plastic joints). The disassembly information for the separately glued joints is as given in Table 3.20.

Table 3.16 Components disassembly specifications

| NO. | Name                           | Type                  | Reverse Operation  | Disassembly difficulties |
|-----|--------------------------------|-----------------------|--------------------|--------------------------|
| 1   | Bulbs and electrical board     | Set aside subassembly | Snap-fit unfasten  | -                        |
| 2   | Electrical connection fastener | Set aside subassembly | Snap-fit unfasten  | Restricted View          |
| 3   | Bulbs                          | Subassembly           | Remove             | -                        |
| 4   | Main Electrical Circuit        | Part                  | Rivet unfasten     | Severe obstruction       |
| 5   | Electrical Circuit             | Part                  | Rivet unfasten     | -                        |
| 6   | Copper Connector               | Part                  | Remove             | Obstructed access        |
| 7   | Plastic Board                  | Part                  | Remove             | -                        |
| 8   | Harness Connector              | Part                  | Snap-fit unfasten  | Obstructed access        |
| 9   | Metallic Clip                  | Part                  | Remove             | Not easy to unfasten     |
| 10  | Rubber Washer                  | Part                  | Remove             | -                        |
| 11  | Plastic Base                   | Part                  | Remove             | Not easy to unfasten     |
| 12  | Bolts                          | Part                  | Press-fit unfasten | Not easy to unfasten     |
| 13  | Rubber seal (1)                | Part                  | Remove             | -                        |
| 14  | Separate Glued Joint           | Operation             | Operation          | -                        |
| 15  | Rubber seal (2)                | Part                  | Remove             | -                        |
| 16  | Housing                        | Set aside subassembly | Remove             | -                        |
| 17  | Separate Glued Joint           | Operation             | Operation          | -                        |
| 18  | Light Cover                    | Part                  | Remove             | -                        |
| 19  | Light Shell                    | Part                  | Remove             | -                        |

The environmental-questions panel is available only for the parts and their subassembly; the set-aside assemblies and operations are not considered. The environmental specifications are categorized as Material Properties (see Table 3.17), Manufacturing Process (see Table 3.18), and End-of-Life considerations (see Table 3.19).

Table 3.17 The material properties

| Name                    | Material Category | Material Name              | Weight (kg) |
|-------------------------|-------------------|----------------------------|-------------|
| Bulbs                   | Cast Iron, Glass  | GG-15,Glass                | 0.01        |
| Main Electrical Circuit | Carbon Steel      | Steel Sheet                | 0.03        |
| Electrical Circuit      | Carbon Steel      | Steel Sheet                | 0.003       |
| Copper Connector        | Copper Alloy      | Copper                     | 0.001       |
| Plastic Board           | Thermoplastic     | PP                         | 0.09        |
| Harness Connector       | Thermoplastic     | Average Bulk Thermoplastic | 0.01        |
| Metallic Clip           | Stainless Steel   | X10CrNiS18 9               | 0.001       |
| Rubber Washer           | Rubber            | EPDM                       | 0.001       |
| Plastic Base            | Thermoplastic     | PP                         | 0.01        |
| Bolts                   | Carbon Steel      | 9SMnPb28                   | 0.05        |
| Rubber seal (1)         | Rubber            | EPDM                       | 0.01        |
| Rubber seal (2)         | Rubber            | EPDM                       | 0.01        |
| Light Cover             | Thermoplastic     | PC                         | 0.21        |
| Light Shell             | Thermoplastic     | ABS                        | 0.71        |

Table 3.18 The manufacturing processes

| Name                    | Manufacturing Process                    | Factor    |
|-------------------------|--|-----------|
| Bulbs                   | Cast Ferrous Metals, Blow Molding        | 0.001 kg  |
| Main Electrical Circuit | Laser cut steel                          | 174 sq.cm |
| Electrical Circuit      | Laser cut steel                          | 9.3 sq.cm |
| Copper Connector        | Pressing Copper                          | 0.001 kg  |
| Plastic Board           | Injection Molding PP                     | 0.090 kg  |
| Harness Connector       | Injection Molding Thermoplastics         | 0.010 kg  |
| Metallic Clip           | Cast Ferrous Metals                      | 0.001 kg  |
| Rubber Washer           | Injection Molding Thermoplastics         | 0.001 kg  |
| Plastic Base            | Injection Molding PP                     | 0.010 kg  |
| Bolts                   | Cast Ferrous Metals, Machining Cast Iron | 0.050 kg  |
| Rubber seal (1)         | Injection Molding Thermoplastics         | 0.010 kg  |
| Rubber seal (2)         | Injection Molding Thermoplastics         | 0.010 kg  |
| Light Cover             | Injection Molding Thermoplastics         | 0.210 kg  |
| Light Shell             | Injection Molding Thermoplastics         | 0.710 kg  |

Table 3.19 shows the end-of-life destination of each item: reuse, recycle, or landfill. Values for the parts chosen for reuse should also be specified. The recycling quality can be estimated from the recycling table given in the DFE user guide. Rubber seal (2) scores

80% recycling because it is mixed with glue. Aluminum coating on the light shell scores 40% on recycling quality. Because of its mixed colors, the light cover scores 70% on quality in recycling.

Table 3.19 End-of-life considerations

| Name                    | End of life | Price (RM) | Recycling Quality |
|-------------------------|-------------|------------|-------------------|
| Bulbs                   | Reuse       | 3.5        | -                 |
| Main Electrical Circuit | Recycle     | -          | 90 %              |
| Electrical Circuit      | Recycle     | -          | 90 %              |
| Copper Connector        | Reuse       | 0.52       | -                 |
| Plastic Board           | Recycle     | -          | 100 %             |
| Harness Connector       | Recycle     | -          | 90 %              |
| Metallic Clip           | Reuse       | 0.1        | -                 |
| Rubber Washer           | Reuse       | 0.1        | -                 |
| Plastic Base            | Recycle     | -          | 100 %             |
| Bolts                   | Recycle     | -          | 100 %             |
| Rubber seal (1)         | Recycle     | -          | 100 %             |
| Rubber seal (2)         | Recycle     | -          | 80 %              |
| Light Cover             | Recycle     | -          | 70 %              |
| Light Shell             | Recycle     | -          | 40 %              |

Table 3.20 Glued-joint specifications

| Operation                              | Number of repeats | Width of joint (mm) | Length of joint (mm) | Tool fetching time (s) |
|--|-------------------|---------------------|----------------------|------------------------|
| <b>Glued joint for Rubber seal (2)</b> | 1                 | 10                  | 10                   | 3                      |
| <b>Glued joint for light cover</b>     | 1                 | 120                 | 400                  | 3                      |

### 3.7 Summary

This chapter described the Boothroyd and Dewhurst method's selection to analyse the tail lamp as a case study. Assembly and disassembly overviews of the product were given in charts and diagrams. Details of every component (dimensions, handling difficulties, etc.) were specified and categorized. In the next chapter the data is used to analyse and redesign the product.

# CHAPTER 4

## RESULTS AND DISCUSSION

### 4.1 The structure chart of the original design

The structure charts was produced by the software from the Figure 3.4 Assembly Chart and the assembly process explained in a past chapter. Chart (a) defines the parts and operations precedence as they occur in the assembly procedure. Chart (b) shows parts represented by a red sign not meeting the criteria for separate parts. A yellow sign represents parts or operation that in the assembly process are insufficiently effective.

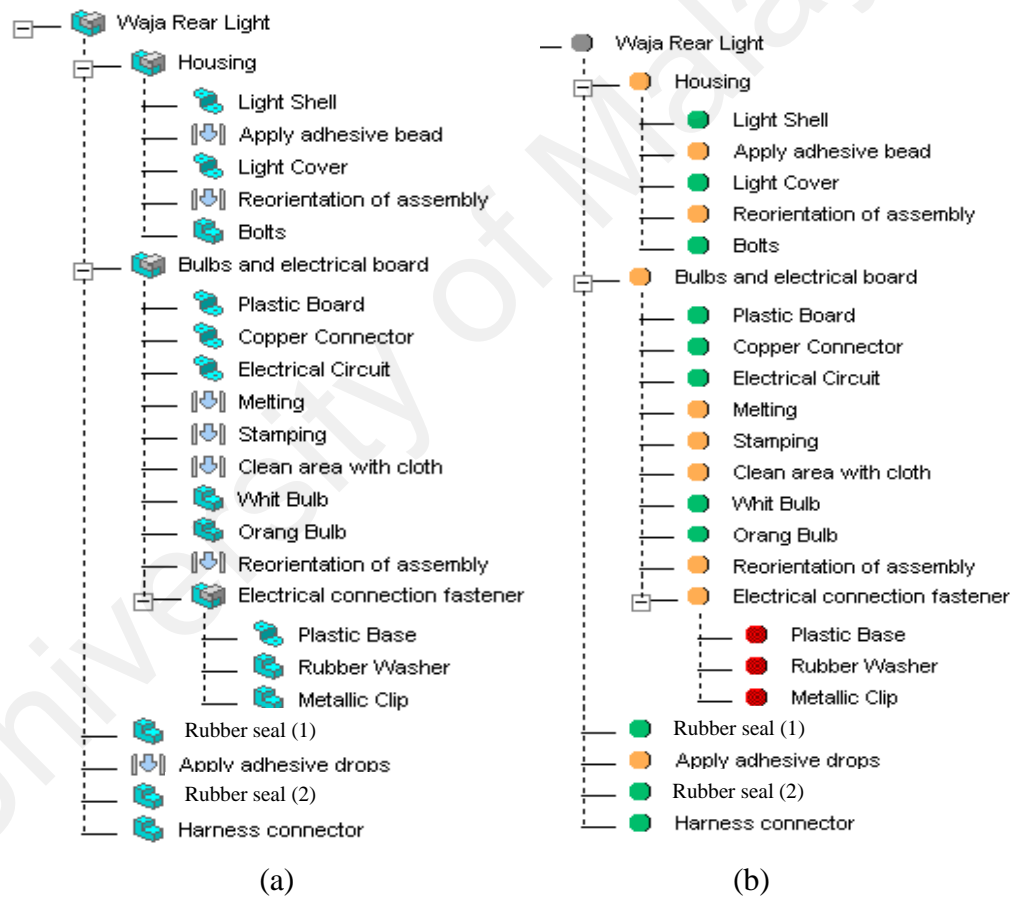

Figure 4.1(a) The structure chart; (b) The minimum-part criteria (initial design)

### 4.2 DFA analysis of the original design

By entering the DFA details for all the components from the previous chapter software calculates the assembly time in details for every part and operation based on the Boothroyd and Dewhurst method (Table 4.1).

Table 4.1 Assembly worksheet (initial design)

| No. | Name                                 | Handling time, (s) | Insertion/operation time (s) | Total labor time (s) | Labor cost(RM) |
|-----|--------------------------------------|--------------------|------------------------------|----------------------|----------------|
| 1   | Waja Rear Light                      |                    |                              |                      |                |
| 2   | Housing (sub)                        | 1.95               | 1.50                         | 3.45                 | 0.09           |
| 3   | Light Shell                          | 1.95               | 1.50                         | 3.45                 | 0.09           |
| 4   | Apply adhesive bead                  | -                  | 13.20                        | 13.20                | 0.33           |
| 5   | Light Cover                          | 1.95               | 1.50                         | 3.45                 | 0.09           |
| 6   | Reorientation of assembly            | -                  | 4.50                         | 4.50                 | 0.10           |
| 7   | Bolts                                | 1.50               | 5.00                         | 19.50                | 0.49           |
| 8   | Bulbs and electrical board (sub)     | 1.95               | 1.80                         | 3.75                 | 0.09           |
| 9   | Plastic Board                        | 1.95               | 1.50                         | 3.45                 | 0.09           |
| 10  | Copper Connector                     | 2.73               | 1.50                         | 25.38                | 0.64           |
| 11  | Electrical Circuit                   | 2.73               | 1.50                         | 4.23                 | 0.10           |
| 12  | Melting                              |                    | 20.00                        | 20.00                | 0.50           |
| 13  | Stamping                             |                    | 7.00                         | 7.00                 | 0.18           |
| 14  | Clean area with cloth                |                    | 5.42                         | 5.42                 | 0.14           |
| 15  | Whit Bulbs                           | 1.95               | 5.20                         | 21.45                | 0.54           |
| 16  | Orange Bulb                          | 1.95               | 5.20                         | 7.15                 | 0.18           |
| 17  | Reorientation of assembly            |                    | 3.00                         | 3.00                 | 0.08           |
| 18  | Electrical connection fastener (sub) | 1.95               | 1.80                         | 3.75                 | 0.09           |
| 19  | Plastic Base                         | 1.95               | 1.50                         | 3.45                 | 0.09           |
| 20  | Rubber Washer                        | 1.69               | 3.70                         | 5.39                 | 0.12           |
| 21  | Metallic Clip                        | 2.85               | 1.80                         | 4.65                 | 0.12           |
| 22  | Rubber seal (1)                      | 1.95               | 4.00                         | 5.95                 | 0.14           |
| 23  | Apply adhesive drops                 |                    | 4.00                         | 4.00                 | 0.10           |
| 24  | Rubber seal (2)                      | 2.51               | 1.50                         | 4.01                 | 0.10           |
| 25  | Harness Connector                    | 1.95               | 2.00                         | 3.95                 | 0.10           |
|     | <b>Totals for Waja Rear Light</b>    |                    |                              | <b>183.53</b>        | <b>4.59</b>    |

#### 4.2.1 Summary of the initial-design analysis

The initial design is summarized generally in Table 4.2, whereas the breakdown of costs is given by Table 4.3 and the breakdown of time by Table 4.4. Data from these tables were used to understand the possible areas of improvements for the rear light.

The rear light's DFA index (a measure of the assembly efficiency) is 30.5 % (the DFA index of a well-designed product should be around 30%), thus the rear light's DFA index indicates that the product already has an acceptable assembly procedure but there are still rooms for improvement.

Table 4.2 General Summary (initial design)

|  |           |
|--|-----------|
| <b>Product life volume</b>                   | 1,000,000 |
| <b>Number of entries (including repeats)</b> | 33        |
| <b>Number of different entries</b>           | 24        |
| <b>Theoretical minimum number of items</b>   | 19        |
| <b>DFA Index</b>                             | 30.5 %    |
| <b>Total weight, in kg</b>                   | 1.32      |
| <b>Total assembly labor time, in s</b>       | 183.53    |

Table 4.3 Breakdown of the costs (initial design)

|   |              |
|---|--------------|
| <b>Total assembly labor cost, in RM</b>                 | 4.59         |
| <b>Other operation cost per product, in RM</b>          | 0.25         |
| <b>Total manufacturing piece part cost, in RM</b>       | 48.10        |
| <b>Total cost per product without tooling, in RM</b>    | 52.95        |
| <b>Assembly tool or fixture cost per product, in RM</b> | 0.00         |
| <b>Manufacturing tooling cost per product, in RM</b>    | 1.08         |
| <b>Total cost per product, in RM</b>                    | <b>54.03</b> |

Table 4.4 Breakdown of the time (initial design)

| <b>Per Product data</b>                  | <b>Entries<br/>(including repeats)</b> | <b>Labor Time, s</b> |
|--|--|----------------------|
| Component parts                          | 23                                     | 115.46               |
| Subassemblies (partial or full analysis) | 3                                      | 10.95                |
| Standard and library operations          | 7                                      | 57.12                |
| <b>Totals</b>                            | <b>33</b>                              | <b>183.53</b>        |

The manual assembly of the product performed 10 times manually, with 150.1 s average assembly time (see Table 4.5). This appears to be more reasonable and consistent as compared with the one calculated on the Boothroyd method.

Table 4.5 Manual assembly times

| Actual assembly time (s) | Average assembly time (s) | DFA calculated operation time (s) |
|--------------------------|---------------------------|-----------------------------------|
| 144                      | 150.1                     | 183.53                            |
| 170                      |                           |                                   |
| 161                      |                           |                                   |
| 152                      |                           |                                   |
| 140                      |                           |                                   |
| 147                      |                           |                                   |
| 162                      |                           |                                   |
| 135                      |                           |                                   |
| 160                      |                           |                                   |
| 130                      |                           |                                   |

Figure 4.2 is a graph of Table 4.1 contents, showing which parts and operations use more costs in the assembly process. Copper connector, melting operation, white bulbs, and bolts are the high-costing parts and adhesive-bead a high-costing application, so they should be considered for combination or elimination. Figure 4.3 is a graph of Table 4.3 contents, illustrating the magnitude of the assembly costs of the analyzed product. The data will later be used to show how much the production costs had reduced throughout the DFA analysis. 43.40 s of assembly time was taken by the parts that did not meet any of the criteria for separate parts (Figure 4.4). Figure 4.1 (b) shows that plastic base, rubber washer, and metallic clip should be combined or eliminated to improve assembly.

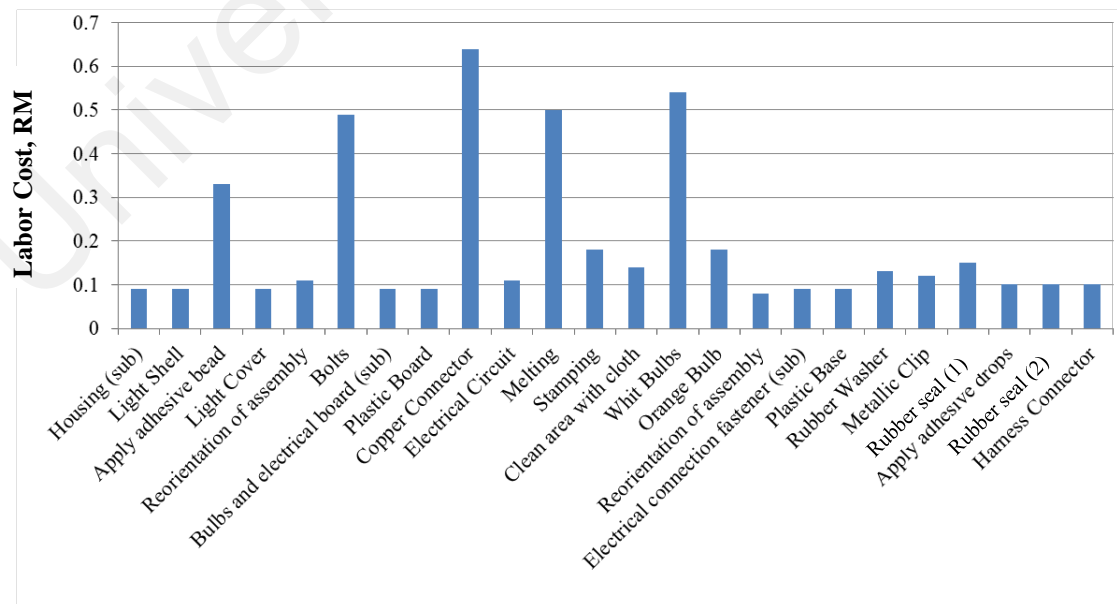

Figure 4.2 Labor cost per part and operation (initial design)



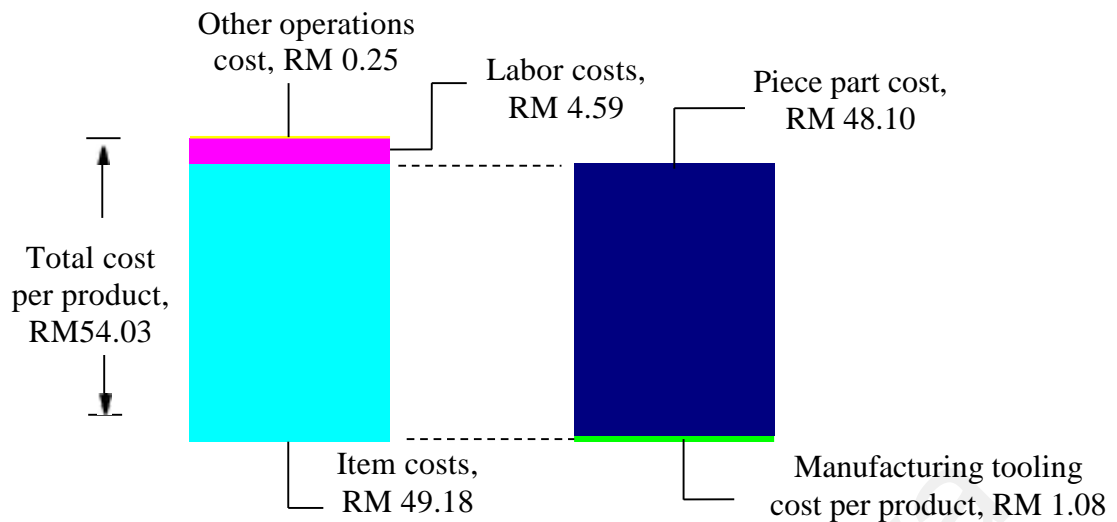

Figure 4.3 Breakdown of costs per product (initial design)

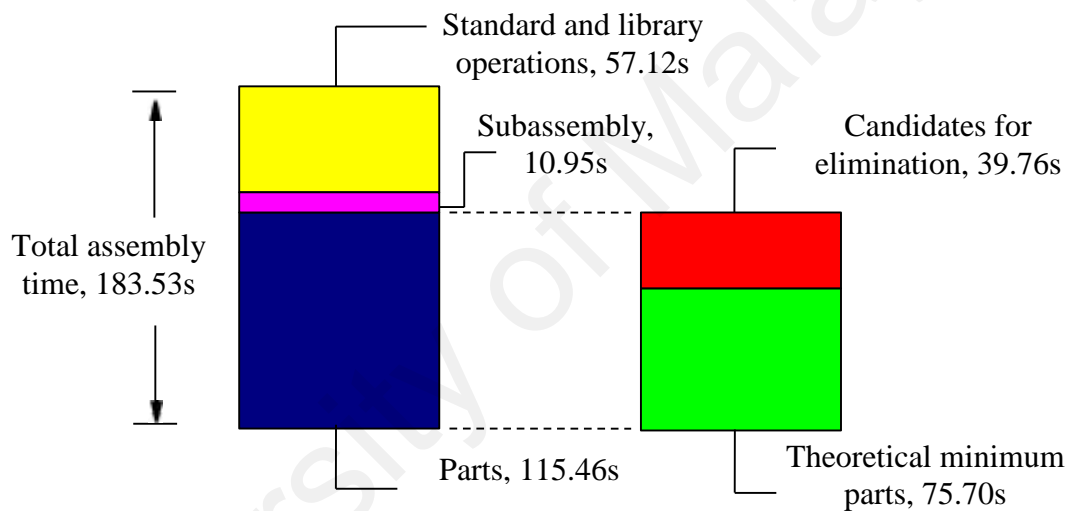

Figure 4.4 Breakdown of time per product (initial design)

#### 4.2.2 Guidelines from the DFA software

The user input allows the DFA software to enumerate items and operations that fit a generic set of guidelines for redesign and provide general recommendations for a possible redesign. Redesign suggestions are categorized and summarized for better understanding of the potential area of redesigns in an assembly process. Table 4.6 summarizes the components identifiable for elimination or combination and the appropriate assembly time savings. These parts did not fulfill the specifications for the theoretical minimum-part criteria. Operations in Table 4.7 should be reduced, improved, or eliminated as they do not add value to the product and yet contribute significantly to assembly time.

Table 4.6 Parts reduction

| Name             | Part number | Quantity | Time savings, s | Reduction (%) |
|------------------|-------------|----------|-----------------|---------------|
| Metallic Clip    | 1-3-10-3    | 1        | 4.65            | 2.53          |
| Copper Connector | 1-3-2       | 1        | 4.23            | 2.30          |
| Plastic Base     | 1-3-10-1    | 1        | 3.45            | 1.88          |
| Rubber washer    | 1-3-10-2    | 1        | 5.39            | 2.94          |
| <b>Total</b>     |             |          | <b>17.72</b>    | <b>9.65</b>   |

Table 4.7 Operation reduction

| Name                      | Part number | Quantity | Time savings, s | Reduction (%) |
|---------------------------|-------------|----------|-----------------|---------------|
| Apply adhesive drops      | 1-5         | 1        | 4.00            | 2.18          |
| Reorientation of assembly | 1-1-3       | 1        | 4.50            | 2.45          |
| Apply adhesive bead       | 1-1-4       | 1        | 13.20           | 7.19          |
| Stamping                  | 1-3-4       | 1        | 7.00            | 3.81          |
| Melting                   | 1-3-5       | 1        | 20.00           | 10.90         |
| Clean area with cloth     | 1-3-6       | 1        | 5.41            | 2.95          |
| Reorientation of assembly | 1-3-9       | 1        | 3.00            | 1.63          |
| <b>Total</b>              |             |          | <b>57.12</b>    | <b>31.12</b>  |

The rubber washer (see Table 4.8) should be redesigned to allow adequate access and unrestricted vision to allow placement or insertion.

Table 4.8 Insertion difficulties

| Name          | Part number | Quantity | Time savings, s | Reduction (%) |
|---------------|-------------|----------|-----------------|---------------|
| Rubber washer | 1-3-10-2    | 1        | 2.20            | 1.20          |

The individual assembly items listed in Table 4.9 nest or tangle. Redesign should be considered to eliminate or reduce their handling difficulties.

Table 4.9 Handling difficulty

| Name               | Part number | Quantity | Time savings, s | Reduction (%) |
|--------------------|-------------|----------|-----------------|---------------|
| Copper Connector   | 1-3-2       | 6        | 4.68            | 2.55          |
| Electrical Circuit | 1-3-3       | 1        | 0.78            | 0.43          |
| Metallic Clip      | 1-3-10-3    | 1        | 0.79            | 0.43          |
| <b>Total</b>       |             |          | <b>6.25</b>     | <b>3.41</b>   |

### 4.2.3 Implementing the redesign suggestions of the DFA software

Although useful, the DFA report is limited because the software understands parts as individual components only. The DFA software does not truly comprehend how different items attach to or interact with each other. As a result, the output of the DFA software can provide a good starting point for areas that designers can focus on to reduce assembly complexity. It can also produce costs data for analysis of design changes, but does not provide any meaningful suggestions on how to improve the design. To make improvements, engineers must understand how the product fits together and functions as a whole.

The redesign suggestions listed in Table 4.6 and illustrated by Figure 4.1 (b) show that eliminating the parts to secure the electrical connection is necessary. This part secures the connection. It has the same material as the plastic board so both can be combined with a harness connector. These modifications will cause elimination of the plastic base, rubber washer, metallic clip, and assembly reorientation. On the other hand, some changes have to be made to the plastic board and harness connector to eliminate those parts (Figure 4.5 and Figure 4.6).

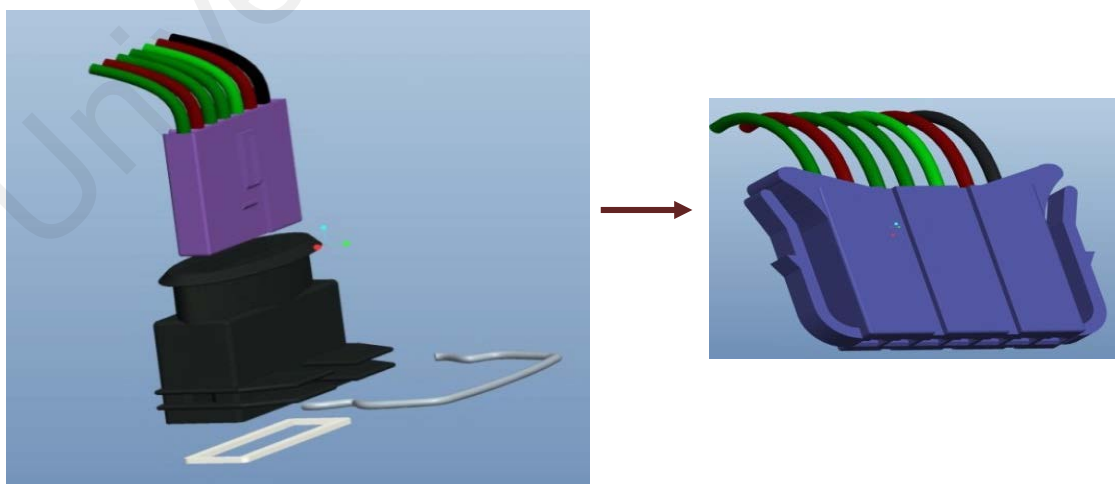

Figure 4.5 The redesigned of the plastic base, rubber washer, and metallic clip

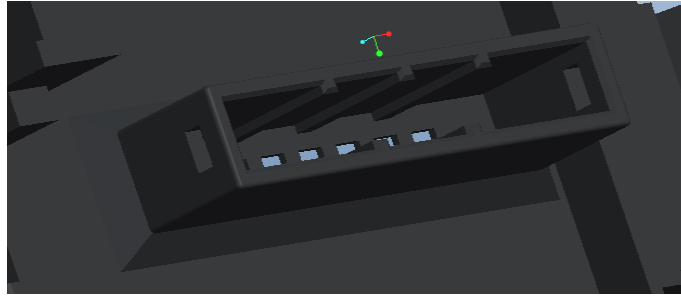

Figure 4.6 Back view of the redesigned plastic board

Instead of melting the plastic to secure the electrical circuit to the board, some adjustments can be made to eliminate melting and cleaning. Avoiding the melting operation has a major impact in disassembly of the electrical circuit, so it will be discussed in the next section. After the electrical circuit had been stamped, it will be transformed into one main circuit holding the bulbs in position and six narrow circuits connecting the copper connectors to the car's electrical system. The main circuit should be secured to the board so it won't be separated by forces from the bulb resistance. Designing ribs on the board and making holes with the same diameter as those of the ribs on the circuit is one way to secure it. To increase the main circuit's reliability, it can be bent around the edge of the board during stamping (see Figure 4.7). Securing the other six parts of the circuit can be done by placing the ribs and making a V-shaped cut at the circuit end where it is positioned on the plastic board holes (see Figure 4.8).

On the board there are five places for bulbs but only four were considered for the light shell. Changing the board shape reduces the manufacturing process cost as less material will be used for the product and fewer necessary copper connectors, too (five, from six). Designs of the plastic board and electrical circuit changed (Figure 4.9 and Figure 4.10) so the board and circuit became flat. The new design simplified and reduced the cost of the parts. The rubber seal (2) was redesigned such that it does not need glue to be joined to the light shell but will self-stick to the edge of the light shell, doing away with adhesive application. The copper connectors should have a different material from the circuit to increase reliability of the connection between the bulbs and the car's electrical system. A

combination of the parts is not feasible. If stamping is eliminated the electrical part should in assembly be considered as seven parts not one, thus not satisfying the main reduce-part-count purpose of the DFA method used. Eliminating the assembly reorientation from the housing subassembly is unreliable because the light cover is not rigid enough to be counted as the base part. The light cover must be glued to the light shell to ensure there is no way water or any external debris can enter the housing and consequently affect visibility of the light. The bolts cannot be consolidated with the light shell because of the high tensile strength that this part needs when it is assembled onto the car body. All thermoplastics have a lower tensile strength than carbon steel's so use of thermoplastic is not practicable. After all the redesign considerations, the new structure chart was established from Figure 4.13 and a DFA analysis was performed. The results are as given in the next section.

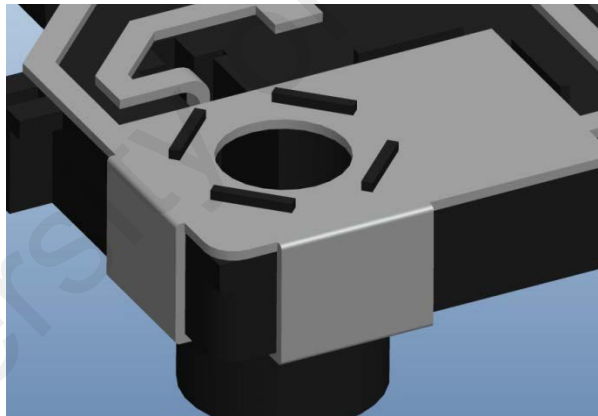

Figure 4.7 Securing the main circuit

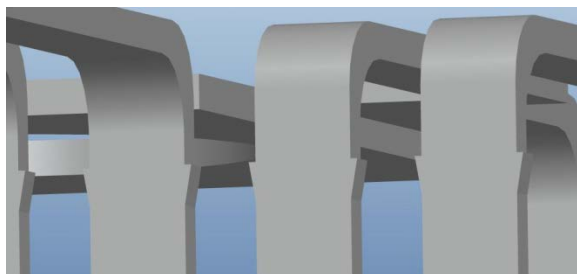

Figure 4.8 Securing the narrow circuits

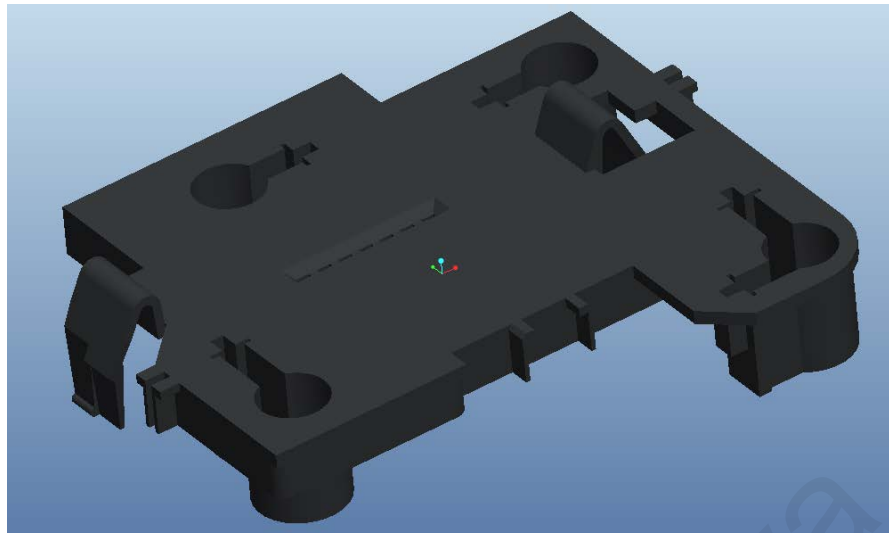

Figure 4.9 Plastic-board redesign

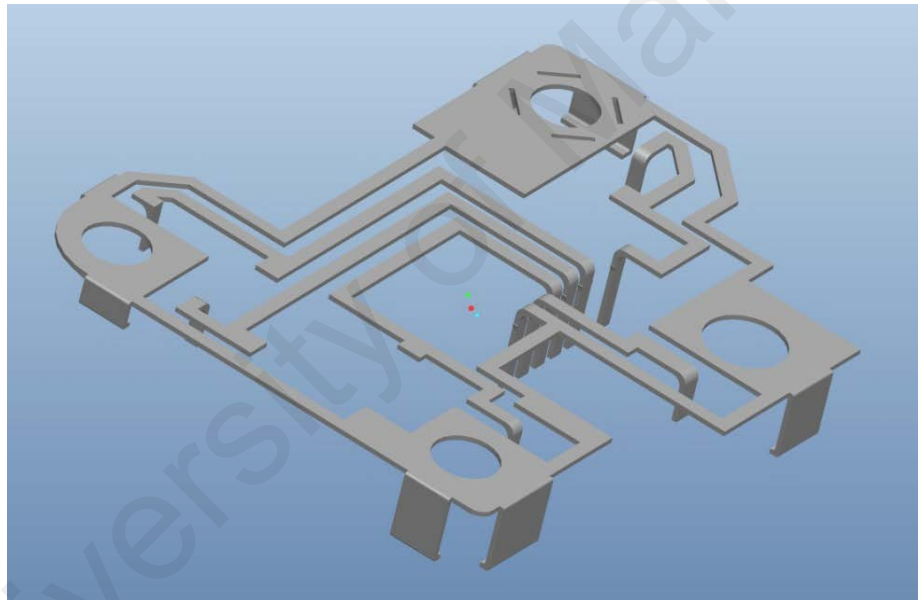

Figure 4.10 Electrical-circuit redesign

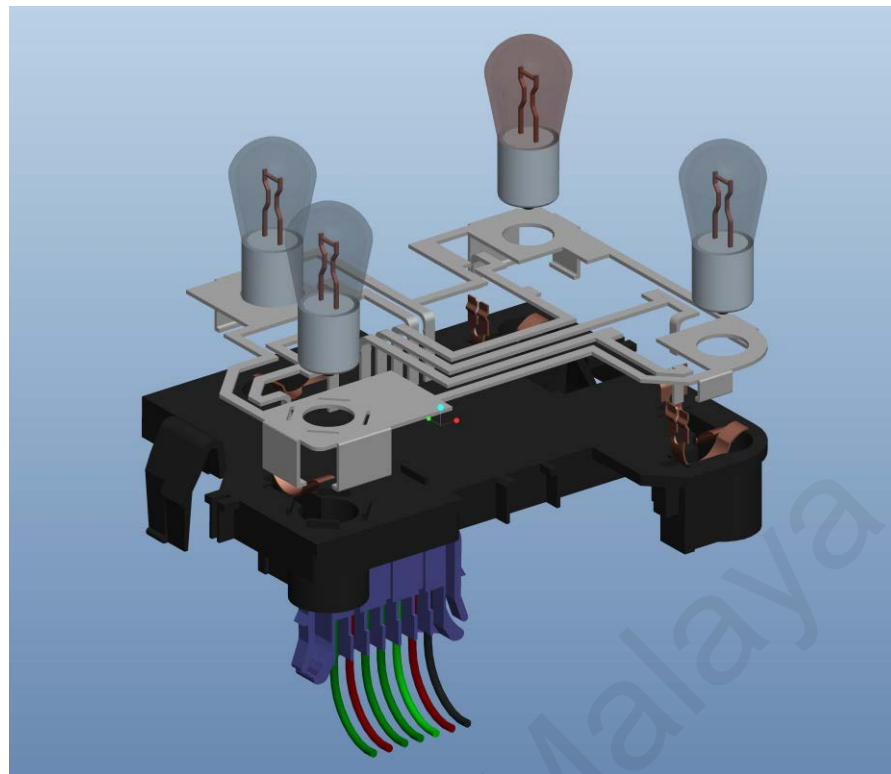

Figure 4.11 Assembly of the electrical-board components (redesign)



Figure 4.12 Assembly of the electrical board onto the light

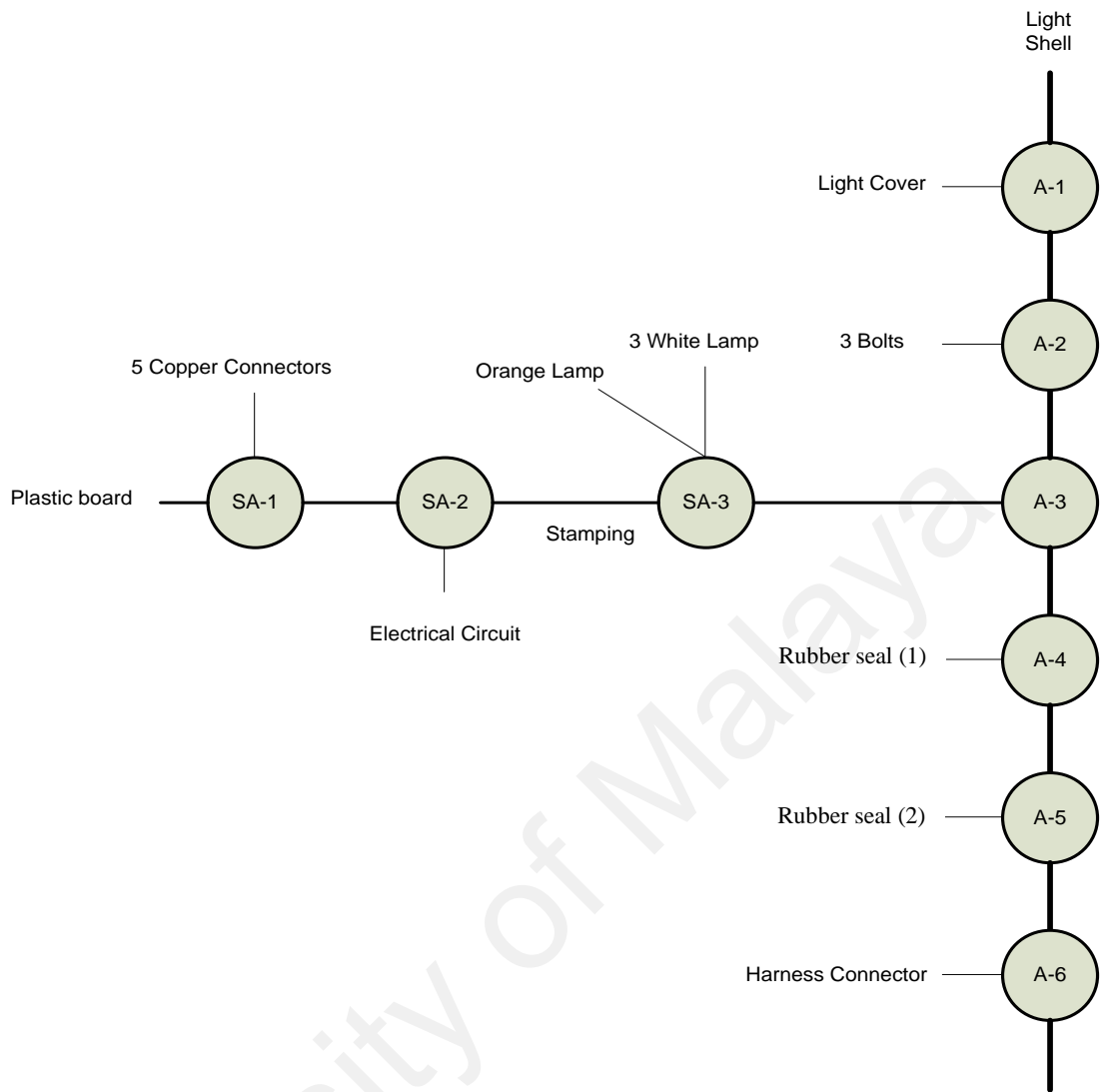

Figure 4.13 The redesign assembly chart



### 4.3 DFA analysis of the redesigned product

The new-structure chart (see Figure 4.14) shows that there is no candidates for part elimination (red label); also, most of the avoidable operations (yellow label) are excluded from assembly.

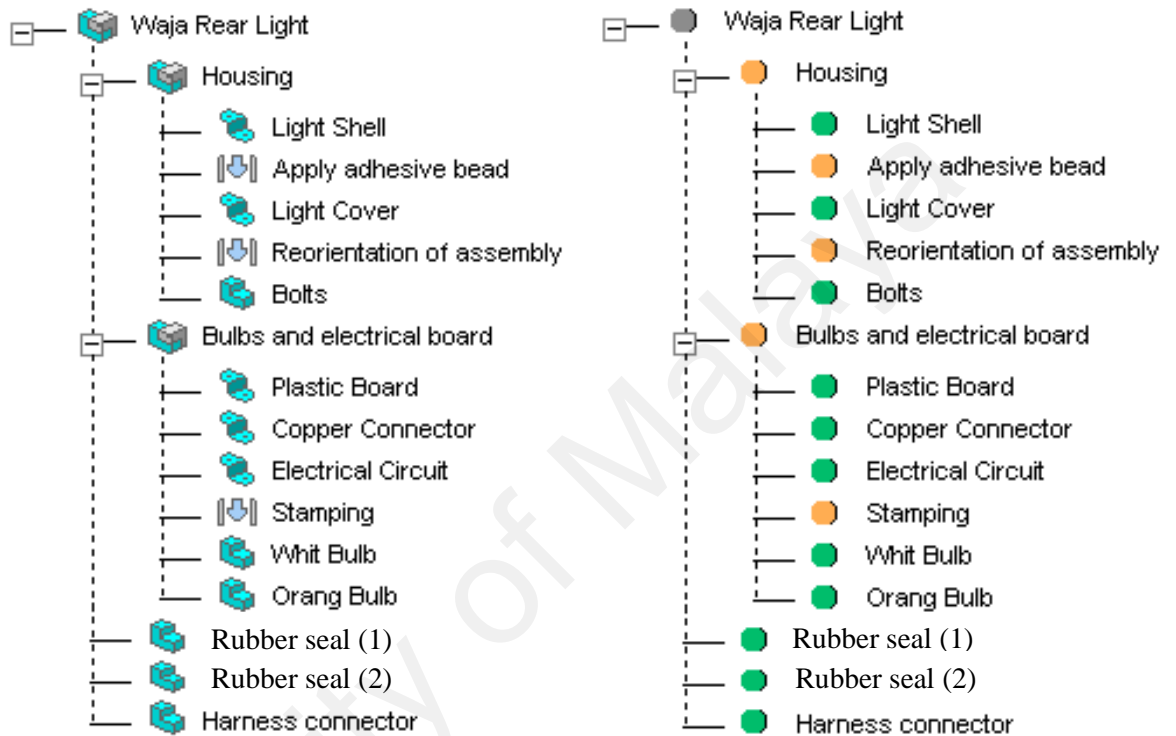

Figure 4.14 The redesign structure chart

#### 4.3.1 Summary of the DFA redesign analysis

With parts deleted and slight changes made to assembly difficulties, the new design specifications are entered and the software calculates the assembly time in detail for every part (Table 4.1).

Table 4.10 Assembly worksheet of the redesign

| No.       | Name                              | Handling time, (s) | Insertion/ operation time (s) | Total labor time (s) | Labor cost (RM) |
|-----------|-----------------------------------|--------------------|-------------------------------|----------------------|-----------------|
| 1         | Waja Rear Light                   |                    |                               |                      |                 |
| 2         | Housing (sub)                     | 1.95               | 1.50                          | 3.45                 | 0.09            |
| 3         | Light shell                       | 1.95               | 1.50                          | 3.45                 | 0.09            |
| 4         | Apply adhesive bead               |                    | 13.20                         | 13.20                | 0.33            |
| 5         | Light cover                       | 1.95               | 1.50                          | 3.45                 | 0.09            |
| 6         | Reorientation of assembly         |                    | 4.50                          | 4.50                 | 0.10            |
| 7         | Bolts                             | 1.50               | 5.00                          | 19.50                | 0.49            |
| 9         | Bulbs and electrical board (sub)  | 1.95               | 1.80                          | 3.75                 | 0.09            |
| 10        | Plastic board                     | 1.95               | 1.50                          | 3.45                 | 0.09            |
| 11        | Copper connector                  | 2.73               | 1.5                           | 21.15                | 0.53            |
| 12        | Electrical Circuit                | 1.95               | 1.50                          | 3.45                 | 0.09            |
| 13        | Stamping                          |                    | 5.00                          | 5.00                 | 0.12            |
| 15        | White bulbs                       | 1.95               | 5.20                          | 21.45                | 0.54            |
| 16        | Orange bulb                       | 1.95               | 5.20                          | 7.15                 | 0.18            |
| 18        | Rubber seal (1)                   | 1.95               | 4.00                          | 5.95                 | 0.15            |
| 19        | Rubber seal (2)                   | 2.51               | 4.00                          | 6.51                 | 0.16            |
| 20        | Harness connector                 | 1.95               | 1.80                          | 3.75                 | 0.09            |
| <b>21</b> | <b>Totals for Waja Rear Light</b> |                    |                               | <b>129.16</b>        | <b>3.23</b>     |

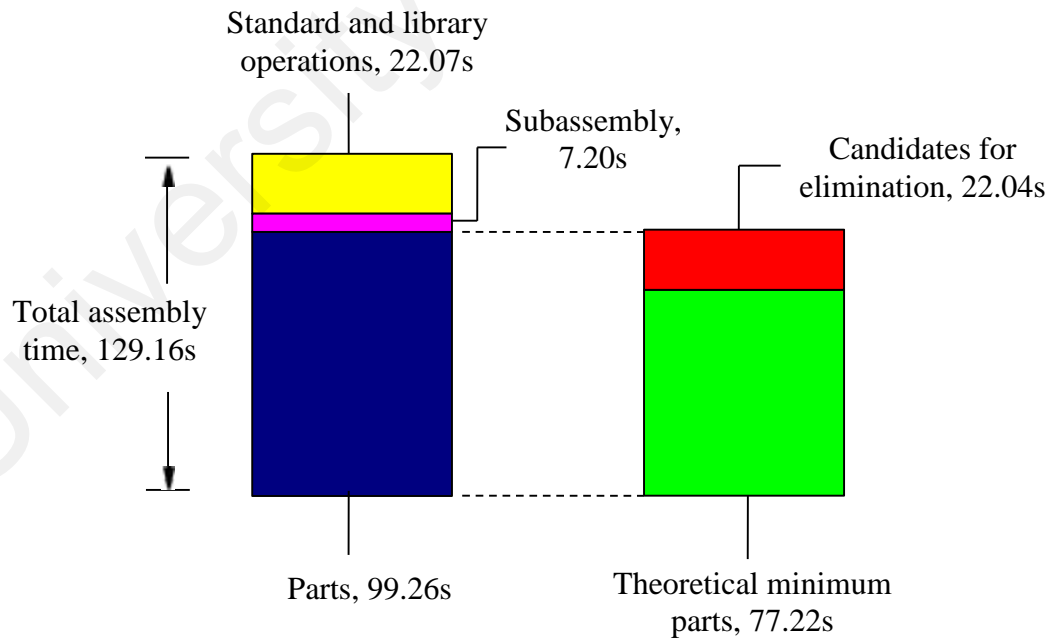

Figure 4.15 Breakdown of time per product (redesign)

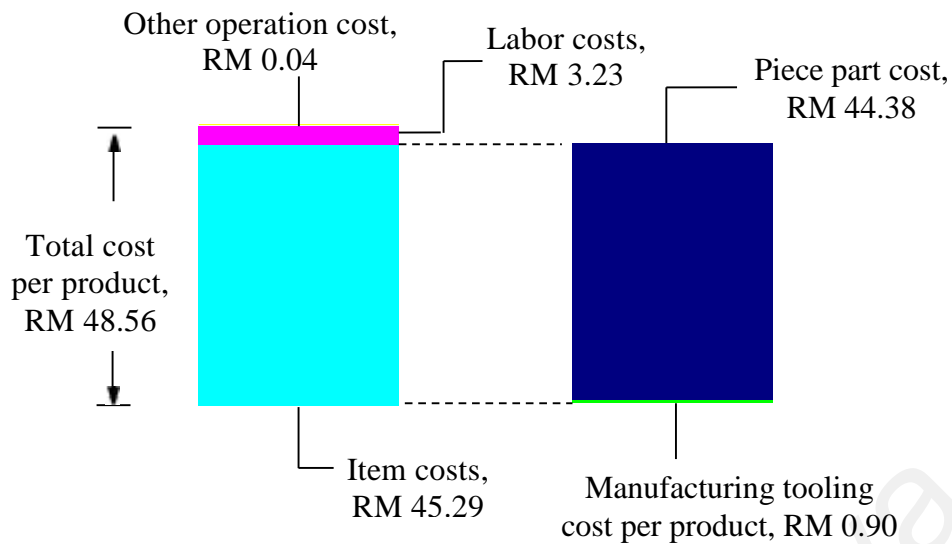

Figure 4.16 Breakdown of cost per product (redesign)

### 4.3.2 Comparing the initial and the redesigned product

The following tables and graphs compare the two designs for better realization of the design enhancements.

Table 4.11 General summary (comparison)

|  | <b>Initial Design</b> | <b>Redesign</b> |
|--|-----------------------|-----------------|
| <b>Product life volume</b>                   | 1,000,000             | 1,000,000       |
| <b>Number of entries (including repeats)</b> | 33                    | 24              |
| <b>Number of different entries</b>           | 24                    | 16              |
| <b>Theoretical minimum number of items</b>   | 19                    | 19              |
| <b>DFA Index</b>                             | 30.5 %                | 43.1 %          |
| <b>Total weight, in kg</b>                   | 1.32                  | 1.27            |
| <b>Total assembly labor time, in s</b>       | 183.53                | 129.16          |

Table 4.12 Comparing the costs breakdown

|   | <b>Initial Design</b> | <b>Redesign</b> |
|---|-----------------------|-----------------|
| <b>Total assembly labor cost, in RM</b>                 | 4.59                  | 3.23            |
| <b>Other operation cost per product, in RM</b>          | 0.25                  | 0.04            |
| <b>Total manufacturing piece part cost, in RM</b>       | 48.10                 | 44.38           |
| <b>Total cost per product without tooling, in RM</b>    | 52.95                 | 47.66           |
| <b>Assembly tool or fixture cost per product, in RM</b> | 0.00                  | 0.00            |
| <b>Manufacturing tooling cost per product, in RM</b>    | 1.08                  | 0.90            |
| <b>Total cost per product, in RM</b>                    | 54.03                 | 48.56           |

Table 4.13 Comparing the time breakdown

| Per Product data                      |  | Initial Design | Redesign      |
|---------------------------------------|--|----------------|---------------|
| <b>Entries</b><br>(including repeats) | <b>Component parts</b>                 | 23             | 19            |
|                                       | <b>Subassemblies</b>                   | 3              | 2             |
|                                       | <b>Standard and library operations</b> | 7              | 3             |
|                                       | <b>Total Entries</b>                   | <b>33</b>      | <b>24</b>     |
| <b>Labor Time, s</b>                  | <b>Component parts</b>                 | 115.46         | 99.26         |
|                                       | <b>Subassemblies</b>                   | 10.95          | 7.20          |
|                                       | <b>Standard and library operations</b> | 57.12          | 22.70         |
|                                       | <b>Total Assembly Time</b>             | <b>183.53</b>  | <b>129.16</b> |

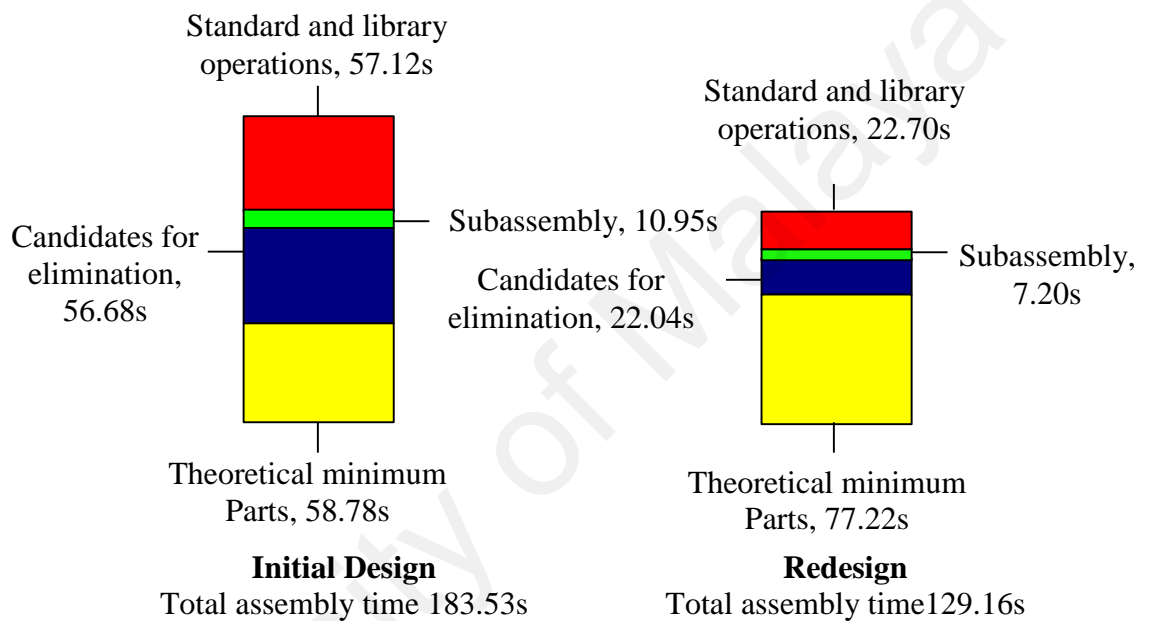

Figure 4.17 Comparing the time breakdown

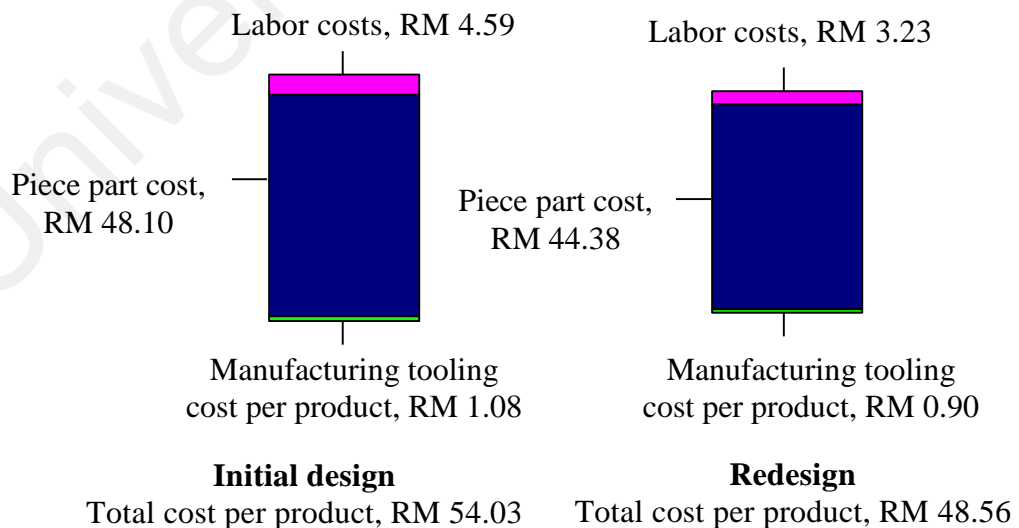

Figure 4.18 Comparing the costs breakdown

Compared with the initial design, the new design has 17% fewer parts and 27% fewer total assembly steps. Through the optimizations the assembly time reduced by 30%,

saving the company RM 5.47 in producing each light. The profit is thus worth RM 5,470,000 for the production volume total.

#### 4.4 DFE analysis

This section analyzes and discusses the design for environment and disassembly of the product. With DFE software, the financial effects of a product design's end of life disassembly is clarified. Also, the beginning and end of life environmental effects of the product design is examined. In doing so, items and materials that can be easily reused or recycled is selected and disassembly of the product is simplified.

##### 4.4.1 DFE analysis of the initial product

From the DFE details explained in the previous chapter software calculates the disassembly time, disassembly cost and MET point for each component as it is given in Table 4.14.

Table 4.14 Disassembly result of the initial design

| NO.          | Name                           | Removal or Operation time (s) | Total Removal Time (s) | Disassembly Cost (RM) |
|--------------|--------------------------------|-------------------------------|------------------------|-----------------------|
| 1            | Bulbs and electrical board     | 3.2                           | 3.2                    | 0.06                  |
| 2            | Electrical connection fastener | 3.2                           | 3.2                    | 0.06                  |
| 3            | Bulbs (4)                      | 5.0                           | 20.0                   | 0.39                  |
| 4            | Main electrical circuit (1)    | 21.8                          | 26                     | 0.51                  |
| 5            | Electrical circuit (6)         | 8.2                           | 53.4                   | 2.62                  |
| 6            | Copper connector (6)           | 4.8                           | 28.8                   | 0.56                  |
| 7            | Plastic board (1)              | 3.8                           | 3.8                    | 0.07                  |
| 8            | Harness connector (1)          | 3.9                           | 3.9                    | 0.08                  |
| 9            | Metallic clip (1)              | 5.7                           | 5.7                    | 0.07                  |
| 10           | Rubber washer (1)              | 3.8                           | 3.8                    | 0.09                  |
| 11           | Plastic base (1)               | 4.6                           | 8.8                    | 0.17                  |
| 12           | Bolts (3)                      | 9.3                           | 32.1                   | 0.62                  |
| 13           | Rubber seal 1 (1)              | 3.8                           | 3.8                    | 0.07                  |
| 14           | Separately-glued joint         | 3                             | 3.2                    | 0.06                  |
| 15           | Rubber seal 2 (1)              | 3.8                           | 3.8                    | 0.07                  |
| 16           | Housing (1)                    | 3.8                           | 3.8                    | 0.07                  |
| 17           | Separately-glued joint         | 120                           | 120                    | 2.33                  |
| 18           | Light cover (1)                | 3.8                           | 3.8                    | 0.27                  |
| 19           | Light shell (1)                | 3.8                           | 3.8                    | 0.07                  |
| <b>Total</b> |                                |                               | <b>334.9</b>           | <b>8.28</b>           |

The vertical axis on the left shows costs (below 0) or profits (above 0) in Figure 4.19. On the right the vertical axis belongs to the environmental effects in MET-points. The horizontal axis displays disassembly time, up to full disassembly (far right). Three types of results are displayed on this end-of-life graph:

- Financial line (blue curve): This shows the cumulative costs/revenues as disassembly proceeds. Each point on the graph corresponds to the removal of an item or a disassembly operation and shows the net cost or profit if disassembly stops then.
- MET points line (green curve): This shows the cumulative environmental effects. It is determined as the net effect of production and an item's end-of-life as disassembly proceeds.
- Effects of negative parts (red vertical bars): The individual item effect bars consist of the negative production effects of materials and manufacturing processes, together with the negative effects of the end-of-life recycling and disposal processes. Large bars indicate a greater priority for improvement of a particular part (through weight reduction or recycling, for example). They also indicate high environmental potential for reuse and recycling.

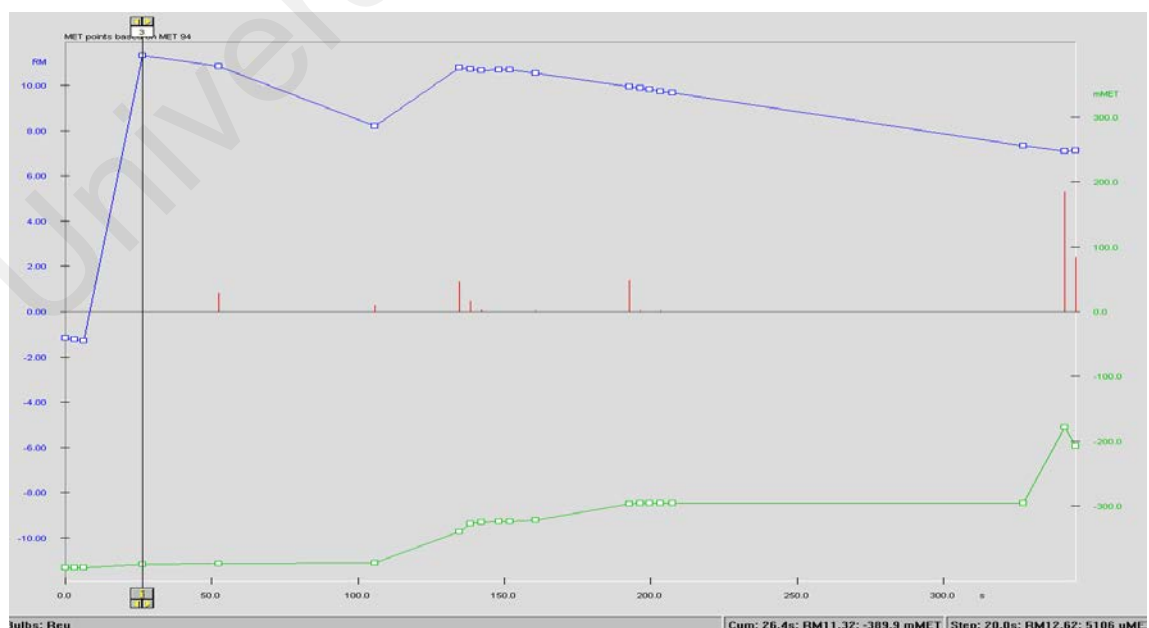

Figure 4.19 Disassembly results (initial product)

The suggestion is to stop disassembly when the highest rate of profit is achieved. For optimized disassembly this is achievable on item number 3 (the bulbs) after 35.9 s of disassembly, and the profit at this point is RM 11.36, with -388.9 MET. The product, though, still has a very low MET, which means it has a high environmental effect.

By optimizing the disassembly sequence (see Table 4.15) the assembly can cease after removing item number 5 (the rubber washer) and the disassembly time, profit, and MET are almost the same as before - not much improvement is done (Figure 4.20).

Table 4.15 Optimized disassembly sequence of the initial design

| Number | Name                           | Number | Name                   |
|--------|--------------------------------|--------|------------------------|
| 1      | Bulbs and electrical board     | 11     | Light cover (1)        |
| 2      | Bulbs (4)                      | 12     | Light shell (1)        |
| 3      | Electrical connection fastener | 13     | Plastic board (1)      |
| 4      | Metallic clip (1)              | 14     | Harness connector (1)  |
| 5      | Rubber washer (1)              | 15     | Plastic base (1)       |
| 6      | Main electrical circuit (1)    | 16     | Bolts (3)              |
| 7      | Electrical circuit (6)         | 17     | Rubber seal 1 (1)      |
| 8      | Copper connector (6)           | 18     | Separately-glued joint |
| 9      | Housing (1)                    | 19     | Rubber seal 2 (1)      |
| 10     | Separately-glued joint         |        |                        |

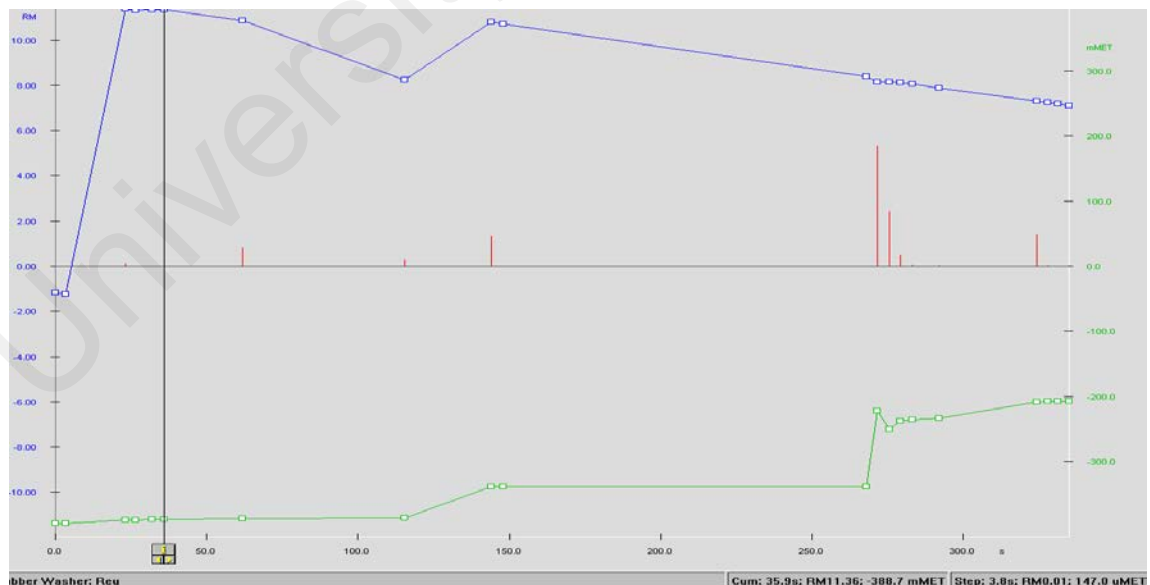

Figure 4.20 The optimized subassembly results of the initial product

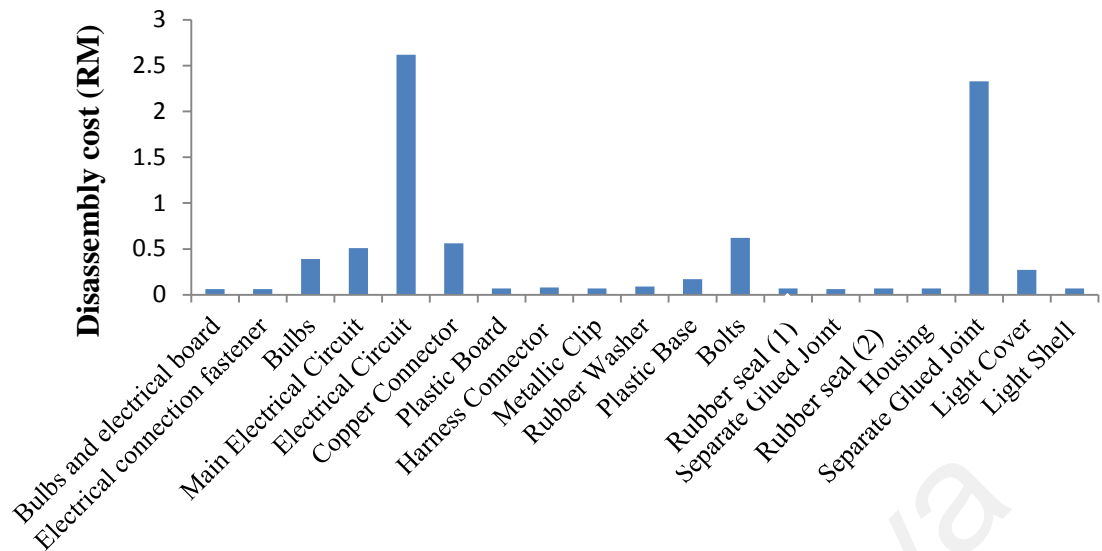

Figure 4.21 Disassembly Costs

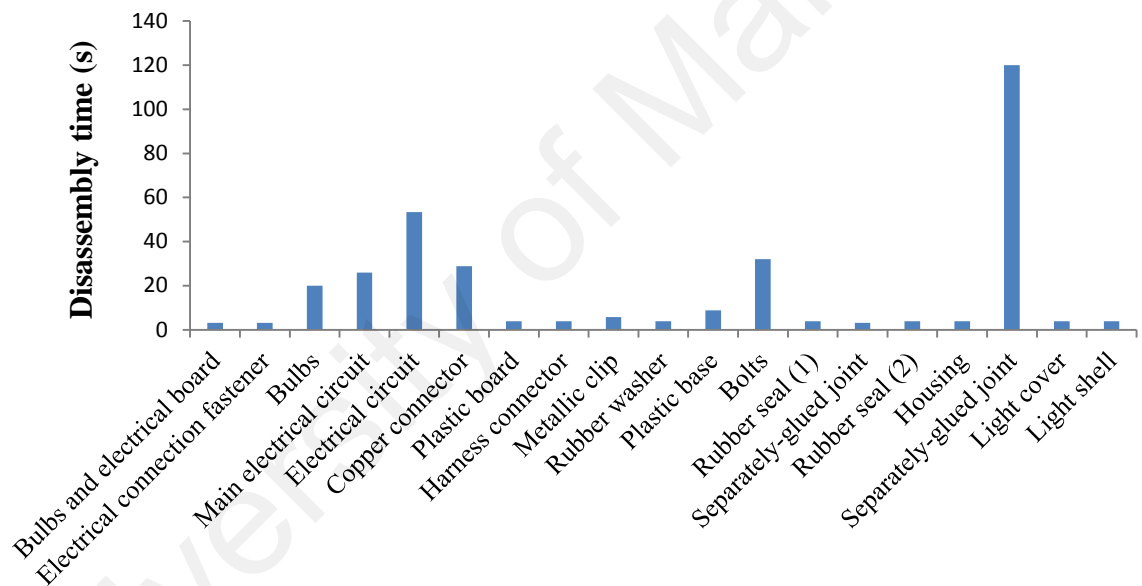

Figure 4.22 Disassembly Time

Figure 4.21 and Figure 4.22 show that removing the electric circuit and separating the glued joint of the light cover have a major effect on increasing disassembly time (electric circuit 16% and glued joint 36%) and cost (electric circuit 32% and glued joint 28%). From an environmental point of view, the green curve (Figure 4.19) is increased by removing most of the components except for the last item (the light shell). At this point the curve is dropping down and the environmental effect is increasing, indicating that disassembly of this part should change.



DFD improvements achieved through changes in assembly of the electrical circuit during the DFA analysis, so disassembly of this part is less difficult. Furthermore, the light-cover material changed from polycarbonate (which is incompatible with acrylonitrile butadiene styrene, i.e., ABS) to poly methyl methacrylate (PMMA) (see Appendix A). Because these two materials are compatible, they can be recycled together, and disassembly of the light cover off the light shell is unnecessary, so separating the glue joint, too, is unnecessary.

#### 4.4.2 DFE of the redesigned product

The design changes implemented and the new specifications for disassembly of the components can be found in Table 4.16.

Table 4.16 Disassembly specifications of the redesign

| NO. | Name                       | Type                  | Reverse Operation  | Disassembly difficulties                |
|-----|----------------------------|-----------------------|--------------------|---|
| 1   | Bulbs and electrical board | Set aside subassembly | Snap-fit unfasten  | -                                       |
| 2   | Bulbs (4)                  | Subassembly           | Push-fit unfasten  | -                                       |
| 3   | Main electrical circuit    | Part                  | Crimp unfasten     | Not easy to unfasten, Obstructed access |
| 4   | Electrical circuit (5)     | Part                  | Remove             | Not easy to unfasten                    |
| 5   | Copper connector (5)       | Part                  | Remove             | Obstructed access                       |
| 6   | Plastic board (1)          | Part                  | Remove             | -                                       |
| 7   | Harness connector (1)      | Part                  | Snap-fit unfasten  | -                                       |
| 8   | Bolts (3)                  | Part                  | Press-fit unfasten | Not easy to unfasten                    |
| 9   | Rubber seal 1 (1)          | Part                  | Remove             | -                                       |
| 10  | Rubber seal 2 (1)          | Part                  | Remove             | -                                       |
| 11  | Housing                    | Subassembly           | Remove             | -                                       |

Similar to the initial design software calculates the removal time and cost for each of the components (Table 4.17). Comparing the information from Table 4.14 and Table 4.17 shows that disassembly time decreased by 58% from 334.9 s to 140.1 s and disassembly cost reduced by 70% from RM 8.25 to RM 2.5. These improvements make the disassembly process desirable for the manufacturers as they can achieve a higher profit by spending less time, cost and effort.

Table 4.17 Disassembly result of the redesign

| NO. | Name                        | Removal or Operation time (s) | Total Removal Time (s) | Disassembly Cost (RM) |
|-----|-----------------------------|-------------------------------|------------------------|-----------------------|
| 1   | Bulbs and electrical board  | 3.2                           | 3.2                    | 0.06                  |
| 2   | Bulbs (4)                   | 5.0                           | 20.0                   | 0.39                  |
| 3   | Main electrical circuit (1) | 9.0                           | 13.2                   | 0.21                  |
| 4   | Electrical circuit (5)      | 5.7                           | 28.5                   | 0.37                  |
| 5   | Copper connector (5)        | 4.8                           | 24.0                   | 0.47                  |
| 6   | Plastic board (1)           | 3.8                           | 3.8                    | 0.07                  |
| 7   | Harness connector (1)       | 3.9                           | 3.9                    | 0.08                  |
| 8   | Bolts (3)                   | 9.3                           | 32.1                   | 0.62                  |
| 9   | Rubber seal 1 (1)           | 3.8                           | 3.8                    | 0.07                  |
| 10  | Rubber seal 2 (1)           | 3.8                           | 3.8                    | 0.07                  |
| 11  | Housing                     | 3.8                           | 3.8                    | 0.07                  |
|     | <b>Total</b>                |                               | <b>140.1</b>           | <b>2.50</b>           |

The point of maximum profit or minimum loss occurs after removing item number 6 (the plastic board) (see Figure 4.22). The disassembly time at that point was 92.7 s, the profit would be RM 17.7, the MET -319.8. Removal of all the components was likelier, reducing the profit slightly to RM 16.95 after 140.1 s of disassembling the product but the MET changed significantly to -214.5 (Figure 4.22).

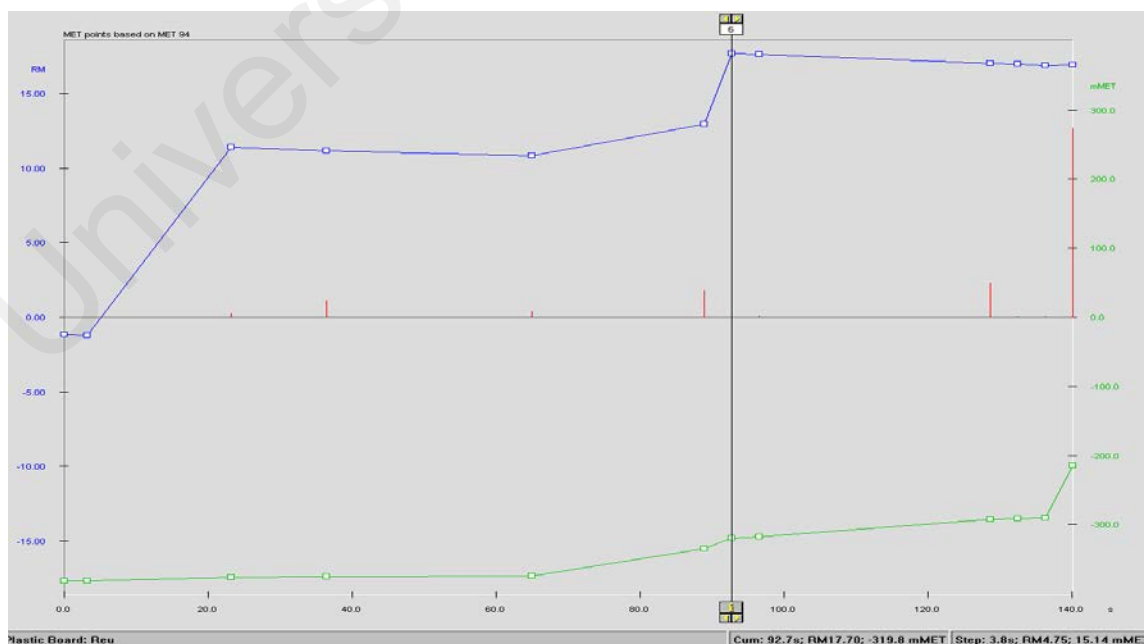

Figure 4.23 The disassembly result of the redesigned product

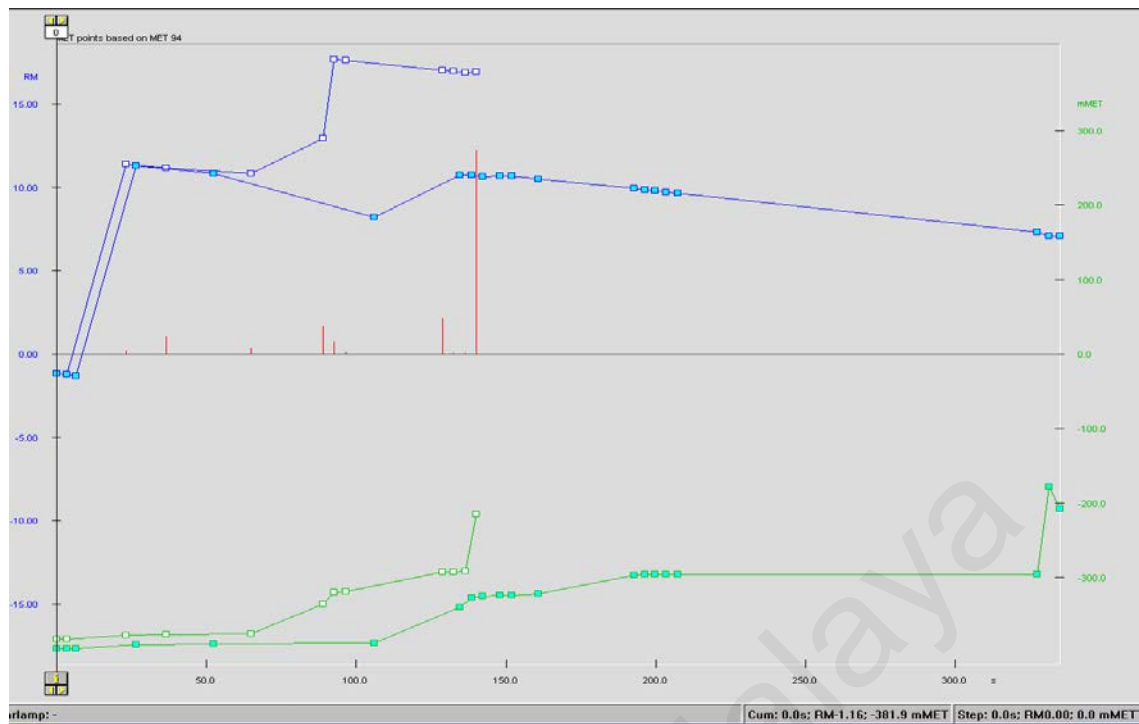

Figure 4.24 Comparing the disassembly results

Two designs were compared as the DFE point of view (see Figure 4.24). Through the new design company's gain is RM 14.25 from disassembly and reusing parts for each tail lamp that is produce. Considering the improvements from DFA and DFE analysis of product show the reduction of the unit cost from RM 54.03 to RM 34.11 by 37%. Total assembly and disassembly time of the product improved by 48% from 518.43 s to 269.26 s which means the half of the time is required to assemble and disassemble the product compare to the initial design. These data and justifications are based on the software analyses; those of an experimental design could differ, but still the analyses provide valid ideas on possible design improvements through DFA and DFE methods.

## 4.5 Summary

This chapter analyzed the product through DFA and DFD methods. Areas of improvements for assembly and disassembly were specified from the DFA and DFD results. Comparing the initial and the new design shows substantial achievements in cost reduction and benefit improvement through these methods.

## **CHAPTER 5**

### **CONCLUSION**

This chapter concludes the dissertation. Besides providing the conclusions it aims also to make recommendations according to the outcome of the work done and the objectives set at the beginning of the project.

The first objective was fulfilled through the analysis conducted in the introduction and literature review (Chapters 1 and 2). The literature review provided the whole picture of what DFA and DFD are. General DFA and DFD framework and guidelines were reviewed, followed by a specific review of the Boothroyd and Dewhurst method. The different approaches implemented to improve the product were also presented.

The second objective was achieved through the design analysis (chapter 3). A design optimization method was selected and discussed. The benchmarking tools (DFA and DFD) were implemented in a specific case study of tail-lamp design. Through the benchmarking, the assembly and disassembly issues and the potential improvements were specified and highlighted. The case study demonstrated that DFA and DFD could be used to study and examine the existing designs of the automotive industries and accordingly to develop new designs.

The third objective was accomplished in Chapter 4. The DFA and DFD redesign of the tail lamp was developed from the results of the Boothroyd and Dewhurst method. Through the process, important issues of the original design were identified and examined. Successful redesigning of the case study proves that DFA and DFD are useful tools helping designers solve assembly and disassembly problems, potentially and greatly benefiting product development.

## REFERENCES

- Abdullah, R., & Keshav Lall, M. (2003). Critical Elements of Supplier Development in the Malaysian Automobile Industry: Parts and Components Procurement and Supplier Development Practice at Proton. *Journal of International Development and Cooperation*, 9(2), 65-87.
- Bayoumi, A. M. E. (2000). *Current Advances in Mechanical Design and Production*. Paper presented at the the Seventh Cairo University International MDP Conference VII, Cairo-Egypt.
- Bogue, R. (2012). Design for manufacture and assembly: background, capabilities and applications. *Assembly Automation*, 32(2), 112-118.
- Bolz, R. W. (1977). *Production processes: the productivity handbook*: Industrial Press Inc.
- Boothroyd, G. (2005). *Assembly automation and product design* (Vol. 536): Cambridge Univ Press.
- Boothroyd, G., & Alting, L. (1992). Design for assembly and disassembly. *CIRP Annals-Manufacturing Technology*, 41(2), 625-636.
- Boothroyd, G., Dewhurst, P., & Knight, W. A. (2002). *Product Design for Manufacture and Assembly* (Vol. 58): CRC Press.
- Boothroyd, G., Dewhurst, P., & Knight, W. A. (2010). *Product Design for Manufacture and Assembly* (Vol. 74): CRC Press.
- Bralla, J. G. (1998). *Design for Manufacturability Handbook* (Second ed.). United States: McGraw-Hill.
- Cameron, D. L. (1995). Color-specificity to enhance identification of rear lights. *Perceptual and motor skills*, 80(3), 755-769.
- Chen, J. (2010). *A general study of design for disassembly for electronic products*. Paper presented at the Computer-Aided Industrial Design & Conceptual Design (CAIDCD), 2010 IEEE 11th International Conference.
- Choi, A. C. K., Chan, D. S. K., & Yuen, A. M. F. (2002). Application of Virtual Assembly Tools for Improving Product Design. *The International Journal of Advanced Manufacturing Technology*, 19(5), 377-383.

- Ciciulla, T. (2006). *How a Design for Manufacturing method is built up and why it is so profitable for a company* Paper presented at the Development of Modular Products Sweden
- Coma, O., Mascle, C., & Véron, P. (2003). Geometric and form feature recognition tools applied to a design for assembly methodology. *Computer-Aided Design*, 35(13), 1193-1210.
- De Lit, P., & Delchambre, A. (2003). *Integrated design of a product family and its assembly system*: Springer.
- Edwards, K. L. (2002). Towards more strategic product design for manufacture and assembly: priorities for concurrent engineering. *Materials & Design*, 23(7), 651-656.
- Gauthier, B., Dewhurst, P., & Japikse, D. (2000). *Application of Design for Manufacture and Assembly Methodologies to Complex Aerospace Products*. Paper presented at the 36th AIAA/ASME/SAE/ASEE Joint Propulsion Conference and Exhibit Huntsville, Alabama.
- Go, T. F., Wahab, D. A., Rahman, M. N. A., Ramli, R., & Azhari, C. H. (2011). Disassemblability of end-of-life vehicle: a critical review of evaluation methods *Journal of Cleaner Production*, 19(13), 1536-1546.
- Goubergen, D. V., & Vancauwenberghe, F. (2007). *Using Time Studies for Quantifying Waste and Improvement Opportunities in Work Methods*. Paper presented at the Industrial Engineering Research Conference, Belgium.
- Gungor, A., & Gupta, S. M. (1999). Issues in environmentally conscious manufacturing and product recovery: a survey. *Computers & Industrial Engineering*, 36(4), 811-853.
- Gupta, S. M., & Veerakamolmal, P. (1996). *Disassembly Of Products*. Boston: NIST Systems Integration for Manufacturing Application Program.
- Harjula, T., Rapoza, B., Knight, W. A., & Boothroyd, G. (1996). Design for Disassembly and the Environment. *CIRP Annals - Manufacturing Technology*, 45(1), 109-114.
- Huang, G., & Mak, K. (1998). A survey report on design for manufacture in the UK furniture manufacturing industry. *Integrated Manufacturing Systems*, 9(6), 383-387.
- Kasai, J. (2000). Experiences and thoughts about life cycle assessment in the automotive industry in Japan *The International Journal of Life Cycle Assessment*, 5(5), 313-316.
- Knight, W. (1999). *Product benchmarking using DFE analysis tools*. Paper presented at the Electronics and the Environment, 1999. ISEE -1999. Proceedings of the 1999 IEEE International Symposium.

- Knight, W., & Curtis, M. (1999). 'Design for Environment' software development. *Journal of Sustainable Product Design*, 36-44.
- Kongar, E., & Gupta, S. M. (2006). Disassembly sequencing using genetic algorithm. *The International Journal of Advanced Manufacturing Technology*, 30(5-6), 497-506.
- Kroll, E., & Hanft, T. A. (1998). Quantitative evaluation of product disassembly for recycling. *Research in Engineering Design*, 10(1), 1-14.
- Krumenauer, F., Matayoshi, C., Silva, I., Stipkovic Filho, M., & Batalha, G. (2008). Concurrent engineering and DFMA approaches on the development of automotive panels and doors. *Journal of Achievements in Materials and Manufacturing Engineering*, 31, 690-698.
- Kuo, T.-C., Huang, S. H., & Zhang, H.-C. (2001). Design for manufacture and design for 'X': concepts, applications, and perspectives. *Computers & Industrial Engineering*, 41(3), 241-260.
- Mamat, R., Wahab, D. A., & Abdullah, S. (2009). The Integration of CAD and Life Cycle Requirements in Automotive Seat Design. *European Journal of Scientific Research*, 31(1), 148-156.
- Mayyas, A., Qattawi, A., Omar, M., & Shan, D. (2012). Design for sustainability in automotive industry: A comprehensive review. *Renewable and Sustainable Energy Reviews*, 16(4), 1845-1862.
- McIntyre, S. E. (2008). Capturing attention to brake lamps. *Accident Analysis & Prevention*, 40(2), 691-696.
- Moore, D. W. (1999). Historical development and current effectiveness of rear lighting systems: The University of Michigan.
- Munro, S. (1998). *Design For Assembly/Manufacturability: winning the global manufacturing war by design*. Paper presented at the CSVA international conference, Michigan.
- Otto, K. N., & Wood, K. L. (2001). *Product Design*. New Jersey: Prentice Hall.
- Parker, M., & Group, P. (2010). DFMA can help manufacturers navigate today's economic turning point and successfully steer towards a new future. from <http://www.dfma.com/news/2010forum.htm>
- Pennino, T. P., & Potechin, J. (1993). Design for manufacture. *Spectrum, IEEE*, 30(9), 51-53. doi: 10.1109/6.275165
- Poli, C. (2001). *Design for manufacturing: a structured approach*: Butterworth-Heinemann.

- Scheuring, J. F., Bras, B., & Lee, K.-M. (1994). *Effects of design for disassembly on integrated disassembly and assembly processes*. Paper presented at the Computer Integrated Manufacturing and Automation Technology, 1994., Proceedings of the Fourth International Conference on.
- Stone, R. B., McAdams, D. A., & Kayyalethekkel, V. J. (2004). A product architecture-based conceptual DFA technique. *Design Studies*, 25(3), 301-325.
- Swift, K., & Booker, J. D. (2003). *Process Selection From design to manufacture* (Second ed.). Burlington MA: Butterworth-Heinemann.
- Ulrich, K. T. (2003). *Product design and development*: Tata McGraw-Hill Education.
- Vezzoli, C., & Manzini, E. (2008). *Design for Environmental Sustainability* (K. Pruul, Trans.). Milan, Italy: Springer.
- Vinodh, S., Kumar, R. P., & Nachiappan, N. (2011). Disassembly modeling, planning, and leveling for a cam-operated rotary switch assembly: a case study. *The International Journal of Advanced Manufacturing Technology*.
- Wad, P. (2004). Transforming Industrial Relations : the Case of the Malaysian Auto Industry. *Labor in Southeast Asia. Local processes in a globalised world*, RoutledgeCurzon, London, 235-264.
- Wang, G. G., & Shan, S. (2007). Review of metamodeling techniques in support of engineering design optimization. *Journal of Mechanical Design*, 129, 370.
- Whitney, D. E. (2004). *Mechanical assemblies: their design, manufacture, and role in product development*: Oxford university press New York.
- Xie, X. (2006). Design for manufacture and assembly. *Utah: Dept. of Mechanical*.
- Zandin, K. B. (2001). *Maynard's Industrial Engineering Handbook* (Fifth ed.): McGraw-Hill.



# APPENDIX A

Relative compatibility between polymers (Vezzoli & Manzini, 2008).

|      | ABS | EPDM | NBR | PA | PBT | PC | PE | PEEK | PES | PET | PMMA | POM | PP | PS | PVC | SAN | SBR |
|------|-----|------|-----|----|-----|----|----|------|-----|-----|------|-----|----|----|-----|-----|-----|
| ABS  | ABS | 5    |     | 4  | 4   | 3  | 5  | 6    | 6   | 5   | 1    |     | 5  | 5  | 2   | 1   | 3   |
| EPDM |     | EPDM | 5   | 5  | 5   | 5  | 4  | 6    | 6   | 5   | 4    |     |    | 5  | 5   | 5   | 5   |
| NBR  | 5   | 5    | NBR | 4  |     |    |    |      |     |     |      |     | 4  | 4  | 4   | 4   |     |
| PA   | 4   | 5    | 4   | PA | 5   | 5  | 5  | 6    | 6   | 4   | 5    |     | 5  | 5  | 6   | 5   | 4   |
| PBT  | 4   | 5    |     | 5  | PBT | 2  | 5  | 6    | 6   | 3   | 5    | 4   | 5  | 5  | 6   | 5   | 5   |
| PC   | 3   | 5    |     | 5  | 2   | PC | 5  | 6    | 4   | 2   | 2    | 5   | 5  | 5  | 6   |     | 5   |
| PE   | 5   | 4    |     |    | 5   | 5  | PE | 6    | 6   | 5   | 5    | 5   | 5  | 5  | 5   | 5   | 5   |
| PEEK | 6   | 6    | 6   | 6  | 6   | 6  | 6  | PEEK | 2   | 6   | 6    | 6   | 6  | 6  | 6   | 6   |     |
| PES  | 6   | 6    |     | 6  | 6   | 4  | 6  | 2    | PES | 5   | 6    | 6   | 6  | 6  | 6   | 6   |     |
| PET  | 5   | 5    |     | 4  | 3   | 2  | 5  | 6    | 5   | PET | 5    | 6   | 5  | 5  | 6   | 5   | 5   |
| PMMA | 1   | 4    |     | 5  | 5   | 2  | 5  | 6    | 6   | 5   | PMMA | 4   | 5  | 3  | 1   | 1   | 5   |
| POM  |     |      |     |    | 4   |    | 5  | 6    | 8   | 6   | 4    | POM |    |    | 5   |     |     |
| PP   | 5   |      | 4   | 5  | 5   | 5  | 5  | 6    | 8   | 6   | 5    |     | PP | 5  | 5   | 5   | 5   |
| PS   | 5   | 5    | 4   | 5  | 5   | 5  | 5  | 6    | 8   | 5   | 3    |     | 5  | PS | 5   | 5   |     |
| PVC  | 2   | 5    | 4   | 6  | 6   | 6  | 5  | 6    | 6   | 6   | 1    | 5   | 5  | 5  | PVC | 3   | 4   |
| SAN  | 1   | 5    | 4   | 5  | 5   |    | 5  | 6    | 6   | 5   | 1    |     | 5  | 5  | 3   | SAN | 4   |
| SBR  | 3   | 5    |     | 4  | 5   | 5  | 5  |      |     | 5   | 5    |     | 5  |    | 4   | 4   | SBR |

# APPENDIX B

Original classification system for the part features affecting manual handling time (Geoffrey Boothroyd, 2005).

MANUAL HANDLING—ESTIMATED TIMES (seconds)

Key:

ONE HAND

ONE HAND with GRASPING AIDS

TWO HANDS for MANIPULATION

TWO HANDS or assistance required for LARGE SIZE

|  |   | Parts are easy to grasp and manipulate            |   |                      |  |  | Parts present handling difficulties (1)  |   |                         |   |  |  |
|--|---|---|---|----------------------|--|--|--|---|-------------------------|---|--|--|
|  |   | Thickness >2 mm                                   |   | Thickness ≤2 mm      |  |  | Thickness >2 mm  |   | Thickness ≤2 mm         |   |  |  |
|  |   | Size >15 mm                                       | 6 mm ≤ size ≤15 mm                      | Size <6 mm           | Size >6 mm                             | Size ≤6 mm   | Size >15 mm  | 6 mm ≤ size ≤15 mm                      | Size <6 mm              | Size >6 mm  | Size ≤6 mm   |  |
|  |   | 0   | 1                                       | 2                    | 3                                      | 4  | 5  | 6                                       | 7                       | 8   | 9  |  |
| Parts can be grasped and manipulated by one hand without the aid of grasping tools       | $(\alpha + \beta) < 360^\circ$  | 0   | 1.13                                    | 1.43                 | 1.88                                   | 1.69   | 2.18   | 1.84                                    | 2.17                    | 2.65  | 2.98   |  |
|  | $360^\circ \leq (\alpha + \beta) < 540^\circ$   | 1   | 1.5                                     | 1.8                  | 2.25                                   | 2.06   | 2.55   | 2.25                                    | 2.57                    | 3.06  | 3.38   |  |
|  | $540^\circ \leq (\alpha + \beta) < 720^\circ$   | 2   | 1.8                                     | 2.1                  | 2.55                                   | 2.36   | 2.85   | 2.57                                    | 2.9                     | 3.38  | 3.7  |  |
|  | $(\alpha + \beta) = 720^\circ$  | 3   | 1.95                                    | 2.25                 | 2.7                                    | 2.51   | 3  | 2.73                                    | 3.06                    | 3.55  | 4  |  |
| Parts can be grasped and manipulated by one hand but only with the use of grasping tools | Parts need tweezers for grasping and manipulation   |   |   |                      |  |  |  |   |                         |   |  |  |
|  | Parts can be manipulated without optical magnification  |   |   |                      |  | Parts require optical magnification for manipulation |  |   |                         |   | Parts need standard tools other than tweezers                        | Parts need special tools for grasping and manipulation |
|  | Parts are easy to grasp and manipulate  |   | Parts present handling difficulties (1) |                      |  | Parts are easy to grasp and manipulate               |  | Parts present handling difficulties (1) |                         |   |  |  |
|  | Thickness >0.25 mm  | Thickness ≤0.25 mm                                | Thickness >0.25 mm                      | Thickness ≤0.25 mm   | Thickness >0.25 mm                     | Thickness ≤0.25 mm                                   | Thickness >0.25 mm   | Thickness ≤0.25 mm                      | Thickness >0.25 mm      | Thickness ≤0.25 mm                                | 8  | 9  |
|  | 0   | 1   | 2                                       | 3                    | 4                                      | 5  | 6  | 7                                       | 8                       | 9   | 7  | 7  |
|  | 4   | 3.6   | 6.85                                    | 4.35                 | 7.6                                    | 5.6  | 8.35   | 6.35                                    | 8.6                     | 7   | 7  |  |
|  | 5   | 4   | 7.25                                    | 4.75                 | 8                                      | 6  | 8.75   | 6.75                                    | 9                       | 8   | 8  |  |
|  | 6   | 4.8   | 8.05                                    | 5.55                 | 8.8                                    | 6.8  | 9.55   | 7.55                                    | 9.8                     | 8   | 9  |  |
|  | 7   | 5.1   | 8.35                                    | 5.85                 | 9.1                                    | 7.1  | 9.55   | 7.85                                    | 10.1                    | 9   | 10   |  |
|  | Parts severely nest or tangle or are flexible but can be grasped and lifted by one hand (with the use of grasping tools if necessary) (2) | Parts present no additional handling difficulties |   |                      |  |  | Parts present additional handling difficulties (e.g. sticky, delicate, slippery, etc.) (1) |   |                         |   |  |  |
| $\alpha \leq 180^\circ$  |   | $\alpha = 360^\circ$                              |   |                      | $\alpha \leq 180^\circ$                |  | $\alpha = 360^\circ$   |   |                         |   |  |  |
| Size >15 mm  |   | 6 mm ≤ size ≤15 mm                                | Size <6 mm                              | Size >6 mm           | Size ≤6 mm                             | Size >15 mm  | 6 mm ≤ size ≤15 mm   | Size <6 mm                              | Size >6 mm              | Size ≤6 mm  |  |  |
| 0  |   | 1   | 2                                       | 3                    | 4                                      | 5  | 6  | 7                                       | 8                       | 9   |  |  |
| 8  |   | 4.1   | 4.5                                     | 5.1                  | 5.6                                    | 6.75   | 5  | 5.25                                    | 5.85                    | 6.35  | 7  |  |
| Parts can be handled by one person without mechanical assistance                         |   |   |   |                      |  |  |  |   |                         |   |  |  |
| Parts do not severely nest or tangle and are not flexible                                |   |   |   |                      |  |  |  |   |                         |   |  |  |
| Part weight <10 lb   |   |   |   |                      | Parts are heavy (>10 lb)               |  |  |   |                         | Parts severely nest or tangle or are flexible (2) | Two persons or mechanical assistance required for parts manipulation |  |
| Parts are easy to grasp and manipulate   |   | Parts present other handling difficulties (1)     |   |                      | Parts are easy to grasp and manipulate |  | Parts present other handling difficulties (1)  |   |                         |   |  |  |
| $\alpha \leq 180^\circ$  |   | $\alpha = 360^\circ$                              | $\alpha \leq 180^\circ$                 | $\alpha = 360^\circ$ | $\alpha \leq 180^\circ$                | $\alpha = 360^\circ$                                 | $\alpha \leq 180^\circ$  | $\alpha = 360^\circ$                    | $\alpha \leq 180^\circ$ | $\alpha = 360^\circ$                              | 8  | 9  |
| 0  | 1   | 2   | 3                                       | 4                    | 5                                      | 6  | 7  | 8                                       | 9                       | 7   | 9  |  |
| 9  | 2   | 3   | 2                                       | 3                    | 3                                      | 4  | 4  | 5                                       | 7                       | 9   |  |  |

# APPENDIX C

Original classification system for the part features affecting insertion and fastening  
(Geoffrey Boothroyd, 2005).

MANUAL INSERTION-ESTIMATED TIMES (seconds)

| Key:   |  |   | Alter assembly no holding down required to maintain orientation and location (3)   |                             |   |                             | Holding down required during subsequent processes to maintain orientation at location (3) |                             |   |                             |   |   |   |  |                                |  |   |   |  |   |                            |  |                                |  |   |   |                            |                             |  |   |   |   |   |   |   |   |   |   |   |   |   |   |   |   |   |   |   |   |   |   |   |   |     |     |     |     |     |     |      |      |     |      |   |   |   |   |   |    |    |    |    |    |    |
|--|--|---|--|-----------------------------|---|-----------------------------|---|-----------------------------|---|-----------------------------|---|---|---|--|--------------------------------|--|---|---|--|---|----------------------------|--|--------------------------------|--|---|---|----------------------------|-----------------------------|--|---|---|---|---|---|---|---|---|---|---|---|---|---|---|---|---|---|---|---|---|---|---|---|-----|-----|-----|-----|-----|-----|------|------|-----|------|---|---|---|---|---|----|----|----|----|----|----|
|  |  |   | Easy to align and position during assembly (4)   |                             | Not easy to align or position during assembly |                             | Easy to align and position during assembly (4)  |                             | Not easy to align or position during assembly |                             |   |   |   |  |                                |  |   |   |  |   |                            |  |                                |  |   |   |                            |                             |  |   |   |   |   |   |   |   |   |   |   |   |   |   |   |   |   |   |   |   |   |   |   |   |     |     |     |     |     |     |      |      |     |      |   |   |   |   |   |    |    |    |    |    |    |
|  |  |   | No resistance to insertion   | Resistance to insertion (5) | No resistance to insertion                    | Resistance to insertion (5) | No resistance to insertion  | Resistance to insertion (5) | No resistance to insertion                    | Resistance to insertion (5) |   |   |   |  |                                |  |   |   |  |   |                            |  |                                |  |   |   |                            |                             |  |   |   |   |   |   |   |   |   |   |   |   |   |   |   |   |   |   |   |   |   |   |   |   |     |     |     |     |     |     |      |      |     |      |   |   |   |   |   |    |    |    |    |    |    |
| 0  |  |   | 1.5  | 2.5                         | 2.5   | 3.5                         | 5.5   | 6.5                         | 6.5   | 7.5                         |   |   |   |  |                                |  |   |   |  |   |                            |  |                                |  |   |   |                            |                             |  |   |   |   |   |   |   |   |   |   |   |   |   |   |   |   |   |   |   |   |   |   |   |   |     |     |     |     |     |     |      |      |     |      |   |   |   |   |   |    |    |    |    |    |    |
| 1  |  |   | 4  | 5                           | 5   | 6                           | 8   | 9                           | 9   | 10                          |   |   |   |  |                                |  |   |   |  |   |                            |  |                                |  |   |   |                            |                             |  |   |   |   |   |   |   |   |   |   |   |   |   |   |   |   |   |   |   |   |   |   |   |   |     |     |     |     |     |     |      |      |     |      |   |   |   |   |   |    |    |    |    |    |    |
| 2  |  |   | 5.5  | 6.5                         | 6.5   | 7.5                         | 9.5   | 10.5                        | 10.5  | 11.5                        |   |   |   |  |                                |  |   |   |  |   |                            |  |                                |  |   |   |                            |                             |  |   |   |   |   |   |   |   |   |   |   |   |   |   |   |   |   |   |   |   |   |   |   |   |     |     |     |     |     |     |      |      |     |      |   |   |   |   |   |    |    |    |    |    |    |
| Addition of any part (1) where neither the part itself nor any other part is finally secured immediately | Part and associated tool (including hands) can easily reach the desired location | Part and associated tool (including hands) cannot easily reach the desired location | <table border="1"> <thead> <tr> <th colspan="2">No screwing operation or plastic deformation immediately after insertion (map/press fits, circlips, spire nuts, etc.)</th> <th colspan="4">Plastic deformation immediately after insertion</th> <th colspan="2">Screw tightening immediately after insertion</th> </tr> <tr> <th rowspan="2">Easy to align and position with no resistance to insertion (4)</th> <th rowspan="2">Not easy to align or position during assembly (5)</th> <th colspan="2">Plastic bending or torsion</th> <th colspan="2">Rivetting or similar operation</th> <th rowspan="2">Easy to align and position with no torsional resistance (4)</th> <th rowspan="2">Not easy to align or position and/or torsional resistance (5)</th> </tr> <tr> <th>No resistance to insertion</th> <th>Resistance to insertion (5)</th> <th>Easy to align and position during assembly (4)</th> <th>Not easy to align or position during assembly</th> </tr> </thead> <tr> <td>0</td> <td>1</td> <td>2</td> <td>3</td> <td>4</td> <td>5</td> <td>6</td> <td>7</td> <td>8</td> <td>9</td> </tr> <tr> <td>3</td> <td>2</td> <td>5</td> <td>4</td> <td>5</td> <td>6</td> <td>7</td> <td>8</td> <td>9</td> <td>6</td> <td>8</td> </tr> <tr> <td>4</td> <td>4.5</td> <td>7.5</td> <td>6.5</td> <td>7.5</td> <td>8.5</td> <td>9.5</td> <td>10.5</td> <td>11.5</td> <td>8.5</td> <td>10.5</td> </tr> <tr> <td>5</td> <td>6</td> <td>9</td> <td>8</td> <td>9</td> <td>10</td> <td>11</td> <td>12</td> <td>13</td> <td>10</td> <td>12</td> </tr> </table> |                             |   |                             |   |                             |   |                             | No screwing operation or plastic deformation immediately after insertion (map/press fits, circlips, spire nuts, etc.) |   | Plastic deformation immediately after insertion |  |                                |  | Screw tightening immediately after insertion                |   | Easy to align and position with no resistance to insertion (4) | Not easy to align or position during assembly (5) | Plastic bending or torsion |  | Rivetting or similar operation |  | Easy to align and position with no torsional resistance (4) | Not easy to align or position and/or torsional resistance (5) | No resistance to insertion | Resistance to insertion (5) | Easy to align and position during assembly (4) | Not easy to align or position during assembly | 0 | 1 | 2 | 3 | 4 | 5 | 6 | 7 | 8 | 9 | 3 | 2 | 5 | 4 | 5 | 6 | 7 | 8 | 9 | 6 | 8 | 4 | 4.5 | 7.5 | 6.5 | 7.5 | 8.5 | 9.5 | 10.5 | 11.5 | 8.5 | 10.5 | 5 | 6 | 9 | 8 | 9 | 10 | 11 | 12 | 13 | 10 | 12 |
|  |  |   |  |                             |   |                             |   |                             |   |                             | No screwing operation or plastic deformation immediately after insertion (map/press fits, circlips, spire nuts, etc.) |   | Plastic deformation immediately after insertion |  |                                |  | Screw tightening immediately after insertion                |   |  |   |                            |  |                                |  |   |   |                            |                             |  |   |   |   |   |   |   |   |   |   |   |   |   |   |   |   |   |   |   |   |   |   |   |   |     |     |     |     |     |     |      |      |     |      |   |   |   |   |   |    |    |    |    |    |    |
|  |  |   |  |                             |   |                             |   |                             |   |                             | Easy to align and position with no resistance to insertion (4)  | Not easy to align or position during assembly (5) | Plastic bending or torsion                      |  | Rivetting or similar operation |  | Easy to align and position with no torsional resistance (4) | Not easy to align or position and/or torsional resistance (5) |  |   |                            |  |                                |  |   |   |                            |                             |  |   |   |   |   |   |   |   |   |   |   |   |   |   |   |   |   |   |   |   |   |   |   |   |     |     |     |     |     |     |      |      |     |      |   |   |   |   |   |    |    |    |    |    |    |
| No resistance to insertion   | Resistance to insertion (5)  | Easy to align and position during assembly (4)                                      | Not easy to align or position during assembly  |                             |   |                             |   |                             |   |                             |   |   |   |  |                                |  |   |   |  |   |                            |  |                                |  |   |   |                            |                             |  |   |   |   |   |   |   |   |   |   |   |   |   |   |   |   |   |   |   |   |   |   |   |   |     |     |     |     |     |     |      |      |     |      |   |   |   |   |   |    |    |    |    |    |    |
| 0  | 1  | 2   | 3  | 4                           | 5   | 6                           | 7   | 8                           | 9   |                             |   |   |   |  |                                |  |   |   |  |   |                            |  |                                |  |   |   |                            |                             |  |   |   |   |   |   |   |   |   |   |   |   |   |   |   |   |   |   |   |   |   |   |   |   |     |     |     |     |     |     |      |      |     |      |   |   |   |   |   |    |    |    |    |    |    |
| 3  | 2  | 5   | 4  | 5                           | 6   | 7                           | 8   | 9                           | 6   | 8                           |   |   |   |  |                                |  |   |   |  |   |                            |  |                                |  |   |   |                            |                             |  |   |   |   |   |   |   |   |   |   |   |   |   |   |   |   |   |   |   |   |   |   |   |   |     |     |     |     |     |     |      |      |     |      |   |   |   |   |   |    |    |    |    |    |    |
| 4  | 4.5  | 7.5   | 6.5  | 7.5                         | 8.5   | 9.5                         | 10.5  | 11.5                        | 8.5   | 10.5                        |   |   |   |  |                                |  |   |   |  |   |                            |  |                                |  |   |   |                            |                             |  |   |   |   |   |   |   |   |   |   |   |   |   |   |   |   |   |   |   |   |   |   |   |   |     |     |     |     |     |     |      |      |     |      |   |   |   |   |   |    |    |    |    |    |    |
| 5  | 6  | 9   | 8  | 9                           | 10  | 11                          | 12  | 13                          | 10  | 12                          |   |   |   |  |                                |  |   |   |  |   |                            |  |                                |  |   |   |                            |                             |  |   |   |   |   |   |   |   |   |   |   |   |   |   |   |   |   |   |   |   |   |   |   |   |     |     |     |     |     |     |      |      |     |      |   |   |   |   |   |    |    |    |    |    |    |
| 3  | 2  | 5   | 4  | 5                           | 6   | 7                           | 8   | 9                           | 6   | 8                           |   |   |   |  |                                |  |   |   |  |   |                            |  |                                |  |   |   |                            |                             |  |   |   |   |   |   |   |   |   |   |   |   |   |   |   |   |   |   |   |   |   |   |   |   |     |     |     |     |     |     |      |      |     |      |   |   |   |   |   |    |    |    |    |    |    |
| 4  | 4.5  | 7.5   | 6.5  | 7.5                         | 8.5   | 9.5                         | 10.5  | 11.5                        | 8.5   | 10.5                        |   |   |   |  |                                |  |   |   |  |   |                            |  |                                |  |   |   |                            |                             |  |   |   |   |   |   |   |   |   |   |   |   |   |   |   |   |   |   |   |   |   |   |   |   |     |     |     |     |     |     |      |      |     |      |   |   |   |   |   |    |    |    |    |    |    |
| 5  | 6  | 9   | 8  | 9                           | 10  | 11                          | 12  | 13                          | 10  | 12                          |   |   |   |  |                                |  |   |   |  |   |                            |  |                                |  |   |   |                            |                             |  |   |   |   |   |   |   |   |   |   |   |   |   |   |   |   |   |   |   |   |   |   |   |   |     |     |     |     |     |     |      |      |     |      |   |   |   |   |   |    |    |    |    |    |    |

| Key: | Mechanical fastening processes (part(s) already in place but not secured immediately after insertion) |                                |                                     | Non-mechanical fastening processes (part(s) already in place but not secured immediately after insertion) |  |                              | Non-fastening processes                       |   |    |
|------|---|--------------------------------|-------------------------------------|---|--|------------------------------|---|---|----|
|      | None or localized plastic deformation   |                                |                                     | Metallurgical processes   |  |                              | Other processes (e.g. liquid insertion, etc.) |   |    |
|      | Bending or similar processes  | Rivetting or similar processes | Screw tightening or other processes | Bulk plastic deformation (large proportion of parts plastically deformed during fastening)                | No additional material required (e.g. resistance, friction welding etc.) | Additional material required |   |   |    |
| 0    | 1   | 2                              | 3                                   | 4   | 5  | 6                            | 7   | 8 | 9  |
| 4    | 7   | 5                              | 12                                  | 7   | 8  | 12                           | 12  | 9 | 12 |

Part ADDED but NOT SECURED

Part SECURED IMMEDIATELY

SEPARATE OPERATION

Assembly processes where all solid parts are in place

## APPENDIX D

Picture of each part to show the dimensions.



Light shell



Light shell and bolts

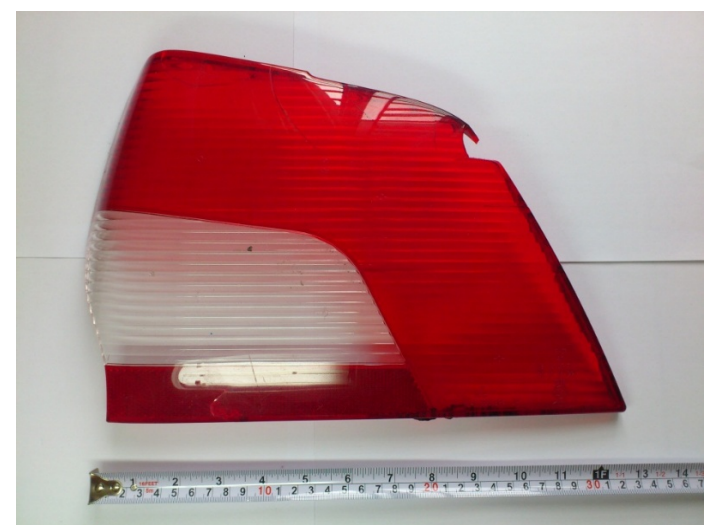

Light cover



Rubber seal (1)



Rubber seal (2)

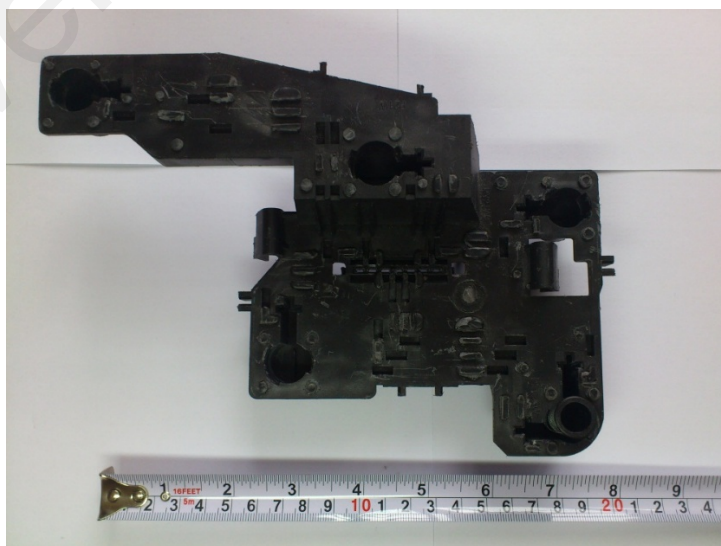

Plastic board



Copper connectors



Electrical circuit



White bulbs



Plastic base



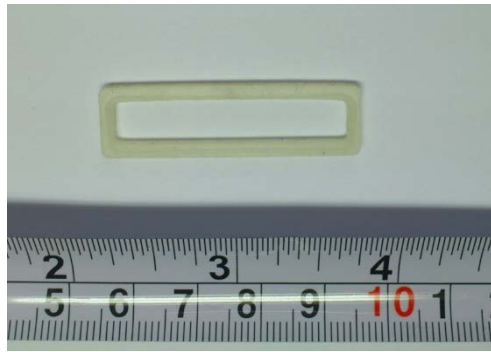

Washer



Metallic clip

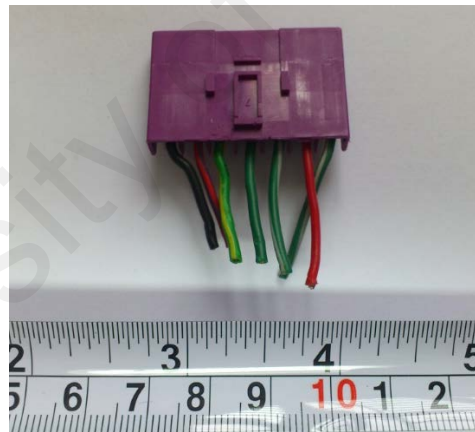

Harness connector

## APPENDIX E

The DFA software's part-characteristic window.

**Definition**

Name:

Part number:

Repeat count:

Item type:  part  sub-assembly

**Insertion difficulties**

view  access  align

resist  severe  holding down

regrasp  support weight  large depth

**Securing method**

secured later  thread  snap

push/press  rivet  self-stick

crimp  stake  electric

**Labor time**

Item fetching distance:

Item handling and fetching time, s: 1.95

Insertion/operation time, s: 1.50

**Minimum part criteria**

Item theoretically must be separate because of:

material  movement  assembly

base part

**Manufacturing data**

|                        | Item    | Product   |
|------------------------|---------|-----------|
| Piece part cost, RM    | 10.78   | 48.08     |
| Item cost per item, RM | 11.06   | 49.43     |
| Tooling investment, RM | 280,008 | 1,351,150 |
| Weight per item, kg    | 0.71    | 1.79      |

Material: ABS

Process: Injection molding

**Item is a candidate for elimination:**

fastener  connector  other

**Picture**

Scale to fit  Transparent

**Envelope dimensions, mm**

**Notes**

**Symmetry**

one way  either way  any way

one way  either way  any way

**Visit tracking**

not visited  partially visited  fully visited

**Handling difficulties**

nest tangle  severe tangle  flexible

difficult grasp  tweezers  grasp tools

bulky  two hands  two persons

swing crane  mobile crane  gantry crane

The DFA software panels