



6-1982

Activity Patterns, Movement Ecology, and Habitat Utilization of Black Bears in the Great Smoky Mountains National Park, Tennessee

Howard B. Quigley

University of Tennessee - Knoxville

Recommended Citation

Quigley, Howard B., "Activity Patterns, Movement Ecology, and Habitat Utilization of Black Bears in the Great Smoky Mountains National Park, Tennessee." Master's Thesis, University of Tennessee, 1982.
https://trace.tennessee.edu/utk_gradthes/2497

This Thesis is brought to you for free and open access by the Graduate School at Trace: Tennessee Research and Creative Exchange. It has been accepted for inclusion in Masters Theses by an authorized administrator of Trace: Tennessee Research and Creative Exchange. For more information, please contact trace@utk.edu.

To the Graduate Council:

I am submitting herewith a thesis written by Howard B. Quigley entitled "Activity Patterns, Movement Ecology, and Habitat Utilization of Black Bears in the Great Smoky Mountains National Park, Tennessee." I have examined the final electronic copy of this thesis for form and content and recommend that it be accepted in partial fulfillment of the requirements for the degree of Master of Science, with a major in Forestry.

Michael R. Pelton, Major Professor

We have read this thesis and recommend its acceptance:

James Byford, Ed Clebsch, Boyd Dearden

Accepted for the Council:

Dixie L. Thompson

Vice Provost and Dean of the Graduate School



(Original signatures are on file with official student records.)

To the Graduate Council:

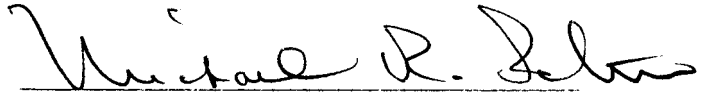
I am submitting herewith a thesis written by Howard B. Quigley entitled "Activity Patterns, Movement Ecology, and Habitat Utilization of Black Bears in the Great Smoky Mountains National Park, Tennessee." I have examined the final copy of this thesis for form and content and recommend that it be accepted in partial fulfillment of the requirements for the degree of Master of Science, with a major in Forestry, Wildlife and Fisheries.

Michael R. Pelton, Major Professor

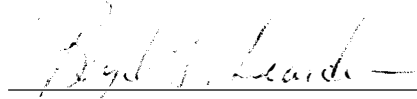
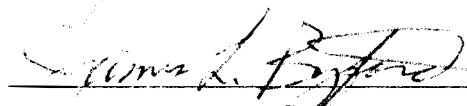
We have read this thesis
and recommend its acceptance:

Accepted for the Council:

Vice Chancellor
Graduate Studies and Research

ACTIVITY PATTERNS, MOVEMENT ECOLOGY, AND HABITAT UTILIZATION
OF BLACK BEARS IN THE GREAT SMOKY MOUNTAINS
NATIONAL PARK, TENNESSEE

A Thesis

Presented for the

Master of Science

Degree

The University of Tennessee, Knoxville

Howard B. Quigley

June 1982

000000

ACKNOWLEDGMENTS

I am especially grateful to my major professor, Dr. Michael R. Pelton, who made this research possible and provided assistance for the duration of the project. I would also like to thank Dr. James Byford, Dr. Ed Clebsch, and Dr. Boyd Dearden who served as my committee and contributed valuable comments on this manuscript. Dr. William L. Sanders provided insight and assistance in the statistical analyses herein.

Many people provided assistance with field operations, including Tom Burst, Tom Eagle, Dave Garshelis, Curtis Taylor, Danny Gray, Jeff King, and Tommy Smith. A sincere thanks to fellow graduate student John Eiler, whose friendship and support was much appreciated. This study was carried out in conjunction with that of Chuck Villarrubia, who generously provided his time, ideas, and cooperation and whose valued friendship will continue as a result of this project. And to Alan Rabinowitz, a sincere appreciation for being there when I could not.

A special thank you to my parents, whose unwavering support made the difficult times more tolerable and the good ones that much better.

Finally, a deep thanks to Caryn Rea who was always there with support and understanding.

This study was financed by McIntire-Stennis Project No. 27 of the Agricultural Experiment Station, Department of Forestry, Wildlife, and Fisheries, The University of Tennessee, Knoxville, and the Tennessee Wildlife Resources Agency.

ABSTRACT

Radio-collars were fitted on 22 black bears captured on a 155 km² study area in the northwest portion of the Great Smoky Mountains National Park, Tennessee, between June 1978 and December 1979.

Activity monitors in radio-collars indicated that bears exhibited crepuscular daily patterns of activity which were modified seasonally; activity was highest during the day in all seasons but night time activity was highest during fall. Most seasonal variation in diel patterns of activity are attributed to changes in foraging patterns. Monthly activity levels were lowest in the postdenning months of April and May and the predenning months of November and December; activity was highest in August and may be a reflection of the influences of breeding. Neither cloud cover nor precipitation affected activity but bears displayed depressed activity at high temperatures. Subadult and yearling females were the most active group overall; adult males were the least active group.

The convex polygon method was used to calculate home range sizes. The fact that home ranges of males (32.1 km²) were larger than those of females (5.2 km²) reflects the larger size of males and their instability in the population in the subadult and early adult years (<5 years). Larger home ranges in fall than spring/summer reflects increased feeding activity prior to denning.

Linear movements by 7 bears were termed extensive because they were large in relation to their normal home range. None of the 7 bears were over 5 years old; 6 of the 7 bears were male, 2 of the movements

terminated with the bear being shot. Six bears (28%) were located outside Park boundaries at some time during the study and neither roads nor reservoirs appeared to act as barriers to bear movement. Hourly travel rates were greatest between the hours of 0600 and 2200.

Analysis of habitat relationships with the computer based IMGRID system revealed that bears preferred areas where mast trees were abundant. Females showed stronger preference for areas of mast trees than males; adults showed stronger preference for areas of mast trees than subadults; and, seasonally, areas of mast trees were preferred during summer and fall. No overall preference for areas of heath abundance was found but females did exhibit preference for these areas. Bears avoided areas within 200m of roads but did not avoid the area around a trail. Females avoided roads more intensely than males; adults showed stronger avoidance of roads than subadults; and, seasonally, the strongest avoidance of roads was during fall. The results of analyses implicate the importance of experience and social organization in habitat utilization of bears.

Although IMGRID is a powerful tool for analysis of geographically based information, it appears that other methods will provide a more robust analysis of the dynamics of habitat utilization.

TABLE OF CONTENTS

CHAPTER	PAGE
I. INTRODUCTION.	1
II. STUDY AREA	5
III. MATERIALS AND METHODS	10
Capture and Handling.	10
Radio-Telemetry	11
Data Analysis	17
Home Range.	17
Movements	19
Activity Patterns	20
Habitat	21
IV. RESULTS AND DISCUSSION.	24
Assessment of Activity Monitor.	24
Factors Affecting Activity.	28
Seasonal and Hourly Effects	30
Effects of Weather on Activity.	41
Sex, Age, and Family Effects.	44
Home Range Analysis	47
Home Range Size	49
Notable Movements	58
Diel Movements	63
Habitat Utilization	67
Utilization of Mast Producing Overstory	67
Utilization of Heath Understory	81
Relationship of Bears to Roads.	93
Relationship to Elevation	106
IMGRID As a Habitat Analysis Tool	108
V. SUMMARY AND CONCLUSIONS	112
LITERATURE CITED.	116
APPENDICES.	124
A	125
B	126
C	127
D	132
E	133
F	135
VITA.	140

LIST OF TABLES

TABLE	PAGE
1. Forest types and their important tree species in the Great Smoky Mountains.	9
2. Analysis of variation in activity patterns of black bears in the GSMNP, Bunker Hill area, 1978-1979, with respect to time of year, time of day, differences among bears, and other interactions	29
3. Analysis of variation in activity patterns of black bears in the GSMNP, Bunker Hill area, 1978-1979, with respect to time of year, time of day, differences among bears, and weather factors.	31
4. Annual and seasonal home range sizes (km ²) for black bears in the GSMNP, 1978-1979.	51
5. Daily movement parameters of black bears in GSMNP, 1978-1979 (distance in kilometers).	64
6. Hourly movement parameters of black bears in GSMNP, 1978-1979 (km/hr)	65
7. Utilization of predicted mast overstory by 22 black bears in the GSMNP, 1978-1979.	68
8. Utilization of predicted mast overstory by 12 male black bears in the GSMNP, 1978-1979.	70
9. Utilization of predicted mast overstory by 10 female black bears in the GSMNP, 1978-1979.	71
10. Utilization of predicted mast overstory by 14 subadult black bears in the GSMNP, 1978-1979.	72
11. Utilization of predicted mast overstory by 14 adult black bears in the GSMNP, 1978-1979.	73
12. Utilization of predicted mast overstory in spring by 7 black bears in the GSMNP, 1978-1979.	74
13. Utilization of predicted mast overstory in September by 16 black bears in the GSMNP, 1978-1979	75
14. Utilization of predicted mast overstory in summer by 22 black bears in the GSMNP, 1978-1979.	76

TABLE	PAGE
15. Utilization of predicted mast overstory in fall by 14 black bears in the GSMNP, 1978-1979.	77
16. Utilization of predicted heath understory by 22 black bears in the GSMNP, 1978-1979.	83
17. Utilization of predicted heath understory by 12 male black bears in the GSMNP, 1978-1979.	85
18. Utilization of predicted heath understory by 10 female black bears in the GSMNP, 1978-1979.	86
19. Utilization of predicted heath understory by 14 subadult black bears in the GSMNP, 1978-1979.	87
20. Utilization of predicted heath understory by 14 adult black bears in the GSMNP, 1978-1979.	88
21. Utilization of predicted heath understory in spring by 7 black bears in the GSMNP, 1978-1979.	89
22. Utilization of predicted heath understory in summer by 22 black bears in the GSMNP, 1978-1979	90
23. Utilization of predicted heath understory in September by 16 black bears in the GSMNP, 1978-1979	91
24. Utilization of predicted heath understory in fall by 14 black bears in the GSMNP, 1978-1979.	92
25. Utilization of area within 200m of roads and trails by 22 black bears in the GSMNP, 1978-1979	95
26. Utilization of area within 200m of a limited public access road by 10 female black bears in the GSMNP, 1978-1979.	97
27. Utilization of area within 200m of a limited public access road by 10 male black bears in the GSMNP, 1978-1979.	98
28. Utilization of area within 200m of a limited public access road by 14 subadult black bears in the GSMNP, 1978-1979.	100
29. Utilization of area within 200m of a limited public access road by 14 adult black bears in the GSMNP, 1978-1979	101
30. Utilization of area within 200m of a limited public access road in spring by 7 black bears in the GSMNP, 1978-1979.	102

TABLE	PAGE
31. Utilization of area within 200m of a limited public access road in September by 16 black bears in the GSMNP, 1978-1979	103
32. Utilization of area within 200m of a limited public access road in fall by 14 black bears in the GSMNP, 1978-1979	104
33. Utilization of area within 200m of a limited public access road in summer by 22 black bears in the GSMNP, 1978-1979 . . .	105
34. Relative basal area (m^2/ha) of hard mast producing species by slope position, aspect, and convexity or concavity of topography for the Hannah Mountain area, GSMNP (Harmon 1981).	125
35. Percentage area of ground covered by deciduous and fleshy fruit producing ericads by slope position, aspect, and convexity or concavity of topography for the Hannah Mountain area, GSMNP (Harmon 1981)	126
36. Black bears captured in Bunker Hill study area, GSMNP, 1978-1979.	127
37. Annual home range estimates and normality statistics for 9 black bears using the bivariate elliptical model (Koepl et al. 1975)	132
38. Annual and seasonal home range sizes for 20 black bears in the GSMNP, 1978-1979.	133
39. Characteristics of the extensive movements displayed by 8 black bears in the GSMNP, 1978-1979.	135

LIST OF FIGURES

FIGURE	PAGE
1. The Bunker Hill study area in the Great Smoky Mountains National Park.	6
2. Duration of radio-tracking, trapping record, and fate of 22 bears in the Bunker Hill area, GSMNP, 1978-1979	25
3. Two measures of activity compared from diel tracking period during 1978-1979, Bunker Hill study area, GSMNP	26
4. Relationship between month and probability of activity for black bears in the GSMNP, 1978-1979.	32
5. Relationship of time of day to probability of activity for black bears, GSMNP, 1978-1979.	34
6. Seasonal differences in the daily activity pattern of black bears, GSMNP, 1978-1979.	36
7. Comparison of spring and summer daily activity patterns for the Bunker Hill area and the Bote Mountain area (Garshelis 1978), GSMNP, 1978-1979	40
8. Seasonal effects of temperature on activity patterns of black bears, GSMNP, 1978-1979.	42
9. Seasonal differences in activity among different sex and age groups and between females with and without cubs	46
10. Annual home ranges of 4 adult male black bears in the GSMNP, 1979.	55
11. Annual home ranges of 3 female black bears in the GSMNP, 1979	56
12. Home range overlap of 2 female black bears in the GSMNP, 1978-1979.	57
13. Extensive movements from the Bunker Hill study area, GSMNP, by bears 406 and 411, 1978.	60
14. Variation in use of elevation by 22 black bears in the GSMNP, 1978-1979	107

CHAPTER I

INTRODUCTION

In the southern Appalachian mountains black bears (Ursus americanus) have a varied status, ranging from almost complete protection in the Great Smoky Mountains National Park (GSMNP or Park) to total extirpation from private lands adjacent to the Park or national forests. Although the species is regarded as a prize game mammal, it is often hunted illegally both inside and out of protected areas, and shot on sight in the more settled communities of the region.

Studies on black bears were initiated in the GSMNP in 1970. During the 12 years since that date many techniques have been developed and/or refined that have enabled researchers to capture (Marcum 1974, Eagar 1977, Johnson and Pelton 1980a), handle (Eubanks et al. 1976, Beeman and Pelton 1978, Johnson and Pelton 1980b), and effectively monitor (Eubanks 1976, Beeman 1975, Garshelis 1978, Eagle 1979, Burst 1979) black bears. Utilizing these techniques, the present study attempted to focus on activity patterns, movements, and habitat utilization of black bears on a selected study area in the GSMNP.

The activity patterns of black bears as determined from telemetry vary greatly. Much of this variation is likely due to the varying influences of human pressure, food resources, and weather in different areas of North America; some of the variation is probably attributable to different methods of obtaining and interpreting data.

Descriptive measurements of mammal movements can take many forms. The 2 major divisions in these forms are (1) describing the area within which an animal moves or (2) describing linear movements. Almost all telemetry studies on black bears include an estimate of the area which the animal used (home range). Although comparison between studies is hampered by different methods of calculating home ranges, several generalizations can be gleaned from the results. Typically, male black bears used larger areas than female black bears (Eveland 1973, Kordek 1973, Matula 1974, Amstrup and Beechum 1976, Alt et al. 1976, Lindzey and Meslow 1977, Rogers 1977, Brown 1980, Garshelis and Pelton 1981, Novick 1982). The results of seasonal comparisons of home range vary from study to study. However, in general, if contrast were found within a study for home range size or if shifts in location of home range were exhibited, the food source was said to be responsible (Beeman 1975, Amstrup and Beechum 1976, Rogers 1977, Garshelis and Pelton 1981). Other influences on home range are also discussed by the above authors. Another common analysis of home range data is to examine the extent of overlap of home ranges. Implications are then made about black bear social organization (Kordek 1973, Amstrup and Beechum 1976, Rogers 1977, Lindzey and Meslow 1977, Garshelis 1978). Extensive conclusions were made from data on spacing of home ranges by Rogers (1977). Analysis of linear measurement of black bear movements with telemetry data has been less often undertaken than home range measurement and is generally very cursory in nature. When performed, the analysis is usually obtained from distances between consecutive daily locations; however, in some studies there have been

attempts to measure movements between hourly locations (Rogers 1977, Garshelis et al. in press).

Habitat utilization by black bears has been investigated in several studies using a variety of techniques. Usually, locational information on animals is equated to features of the land or vegetation which are found at or near the location. Jonkel and Cowan (1971) used relative trapping success as an index of bear use of different habitat types. McCollum (1973) and Kellyhouse (1980) used relative occurrence of bear sign in various habitat types to analyze habitat utilization. By far the most efficient means of obtaining locational information for habitat analysis is through radio-telemetry. This has been employed by Miller (1975), Amstrup and Beechum (1976), Rogers (1967, 1977), Lindzey and Meslow (1977), Landers (1979), Brown (1980), and Novick (1982). In all of the above studies, bear locations were analyzed in relation to habitat features measured on site or from maps (i.e. cover maps or United States Geological Survey maps). Other techniques for analysis of location data with habitat types are available, such as digitized habitat maps (Nichols and Warner 1972, Gilmer et al. 1973), LANDSAT imagery (Brabander and Barclay 1977), and computer techniques (Wilcott and Gates, 1977, Beeman 1977, Davis 1980, Exum 1981). Given the complexity of influences on black bear movements, it appears that habitat utilization is best analyzed by computer techniques because of the ability of computers to manipulate large amounts of data.

This study was planned as an extension of research on black bears in the GSMNP initiated in 1970 by The University of Tennessee,

Knoxville, Department of Forestry, Wildlife, and Fisheries. The present study was also an immediate expansion on work by Garshelis (1978) and was designed to be compared to research initiated simultaneously on Cherokee National Forest. The objectives of this study were:

1. To delineate patterns of daily, seasonal, and annual activity.
2. To document and measure characteristics of black bear movements.
3. To quantify the relationship of black bear locations to selected habitat features.

CHAPTER II

STUDY AREA

Research was conducted in the western edge of the Great Smoky Mountains National Park (GSMNP or Park) (Fig. 1). The area chosen is roughly bordered by the Tennessee-North Carolina line to the south, state highway 129 to the west, the Park border to the north, and the western edge of Cades Cove to the east, thus encompassing 155 km². The approximate center of the area is defined by the intersection of 35° 33' N latitude and 83° 56' W longitude in Blount County, Tennessee. The major drainages in the area are Panther Creek, Bible Creek, Parson Branch, and Abrams Creek. Park-maintained access to the area is limited to 12 km of unpaved road (Parson Branch Road) accessible to public traffic from April through October, 17 km of maintained trail (the Hannah Mountain Trail), and 5.5 km of unpaved road available only for foot travel by the public (Bunker Hill Road).

This particular section of the Park was chosen for 3 major reasons: (1) the area borders the edge of the Park so that information can be gained on movements of bears into and out of the Park; (2) the vegetation of the chosen area closely resembles that found outside of the Park, thus aiding the application of results found here to surrounding areas; (3) the topography and climatic influences are comparable to another study area established on adjacent national forest lands to the west for gathering simultaneous information on black bears for comparison.

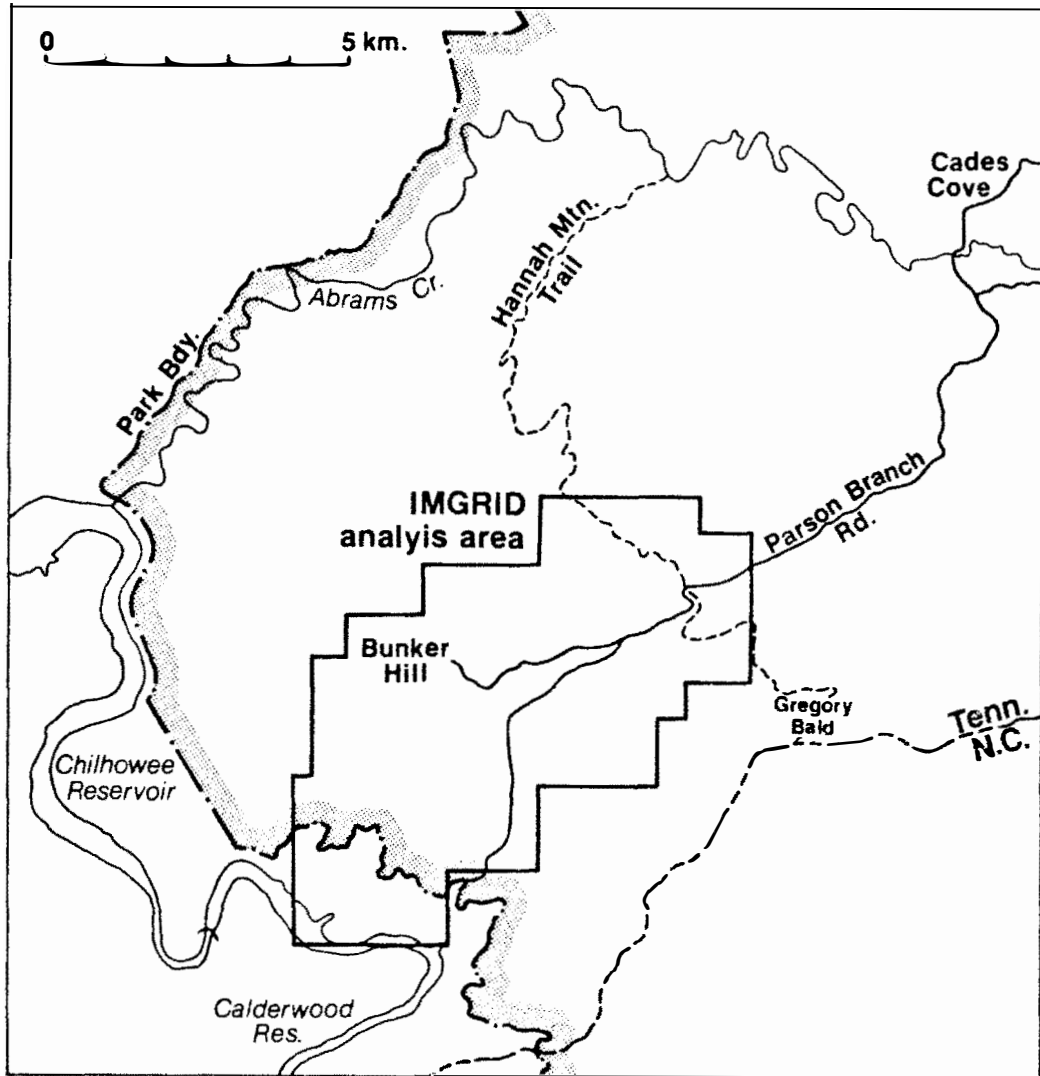

Figure 1. The Bunker Hill study area in the Great Smoky Mountains National Park. The approximate outline of the IMGRID analysis area is also shown.

The Great Smoky Mountains are part of the Unaka Mountain Range of the Blue Ridge Province in the southern division of the Appalachian Highlands (Fenneman 1938). The area is underlain by sandstones of the Ocoee Series, which date from the Precambrian Era (King et al. 1968). Soil types are of the Ramsey Association which exhibit medium to high acidity, low water storage capacity, and moderate fertility (Anonymous soil survey 1953). The topography of the area is characterized by a mosaic of sharp ridges and steep, V-shaped valleys cut by fast-flowing, rocky streams. Elevation ranges from 265m at Chilhowee Reservoir to 1508m at Gregory Bald.

The climate of the area is generally classified by Thornthwaite (1948) as mesothermal perhumid (warm-temperate rainforest). Locally, precipitation and temperature within the Great Smoky Mountains vary greatly with differences in elevation and aspect (Shanks 1954, Tanner 1963, Stephens 1969). The precipitation pattern is characterized by 2 maxima: one in late winter, originating from the west to east movement of continental fronts, the other in mid-summer, mainly of orographic origin. Average annual precipitation for the Park varies from 140 cm at lower elevations to over 220 cm at the highest elevations. Average annual temperature varies from 14°C at elevations below 450m to 8°C at elevations over 1900m, with a temperature gradient of 4°C per 1000m change in elevation. Except in rare drought years, precipitation exceeds evapotranspiration in all seasons (U.S. Dept. of Commerce 1972).

The highly variable elements of aspect, elevation, precipitation, and temperature, compounded by the relatively old geological

age of the Great Smoky Mountains has created a rich variety of flora. This includes over 1300 species of flowering plants, within which are 131 species of native trees (Stupka 1960). Both Shanks (1954) and Whittaker (1956) categorized 6 different forest types while Golden (1974) defined 20. The 6 types of Shanks are the most recognizable and most commonly used (Table 1). Of these 6 types, the 2 most common types on the study area are open oak/pine and closed oak; the spruce-fir type is absent from the area. Vaccinium spp. and Gaylussacia spp. are common understory inhabitants, sometimes forming continuous mats in the open oak/pine forest type. Rhododendron sp. is normally the dominant shrub on northern aspects and valley bottoms.

Fifty-nine species of mammals have been described for the GSMNP (Linzey and Linzey 1971). Black bears, white-tailed deer (Odocoileus virginianus), and European wild hogs (Sus scrofa) are the only large mammals occurring in the area. Black bears have no natural predator here and hunting, although it does exist, has been illegal since the establishment of the Park in 1932.

The study area may be subsequently referred to as the Bunker Hill area, after a prominent ridge central to research efforts in the area.

Table 1. Forest types and their important tree species in the Great Smoky Mountains.

Forest Type	Important Species
Cove hardwood	Yellow poplar Eastern hemlock Yellow buckeye Silverbell Beech (<u>Fagus grandifolia</u>) Yellow birch (<u>Betula allegheniensis</u>) Black cherry (<u>Prunus serotina</u>)
Hemlock	Eastern hemlock Yellow birch Silverbell Fraser magnolia (<u>Magnolia fraseri</u>)
Northern hardwood	Beech Sugar maple (<u>Acer saccharum</u>) Yellow buckeye Yellow birch
Closed oak	Chestnut oak (<u>Quercus prinus</u>) White oak (<u>Quercus alba</u>) Black oak (<u>Quercus velutina</u>) Northern red oak (<u>Quercus rubra</u>) Pignut hickory (<u>Carya glabra</u>) Mockernut hickory (<u>Carya tomentosa</u>) Sourwood (<u>Oxydendrum arboreum</u>)
Open oak and pine	Pitch pine (<u>Pinus rigida</u>) Scarlet oak (<u>Quercus coccinea</u>) Virginia pine (<u>Pinus virginiana</u>)
Spruce-fir	Red spruce (<u>Picea rubens</u>) Fraser fir (<u>Abies fraseri</u>)

Source: R. E. Shanks, 1954, Reference list of native plants in the Great Smoky Mountains, Botany Department, The University of Tennessee, Knoxville. (Mimeographed)

CHAPTER III

MATERIALS AND METHODS

Capture and Handling

Field work was begun in June 1978 and ended in December 1979. Traplines were established on Parson Branch Road, Bunker Hill Road, and the Hannah Mountain Trail in a small core area within the main study area boundaries (Fig. 1). This core area was chosen for its ease of mobility due to roads; high, accessible ridges for radio-tracking; and the prospect of more information on social aspects of bear movements through intensive trapping of a small area rather than widespread trapping of the entire study area. Prebaiting (Marcum 1974, Eagar, 1977, Johnson and Pelton 1980a) was undertaken to locate areas of bear use for trapping. Traplines were opened intermittently from June through September, 1978 and 1979, depending on equipment availability and the need for more study animals.

Black bears were trapped using Aldrich spring-activated foot snares (Aldrich Animal Trap Co., Clallam Bay, WA) as described by Marcum (1974) and Eagar (1977) or using modified culvert traps fabricated from 2 50-gallon oil drums, as described by Eiler (1981). One free-range capture was also made.

Bears were immobilized with an intramuscular injection of M-99 (Etorphine hydrochloride, D-M Pharmaceuticals, Rockville, MD) at the rate of 1 mg/45 kg of estimated body weight. Injections were administered using a jab stick (a syringe fitted to a plexi-glass

rod), a projectile syringe fired from a CO₂-charged pistol (CAP-CHUR, Palmer Chemical Co., Douglasville, GA), or a hand-held syringe. The method of injection depended on the capture method and the temperament of the animal. M50-50 (Diprenorphine, D-M Pharmaceuticals, Rockville, MD), intravenously injected with a hand-held syringe at the rate of 2 mg/45 kg estimated body weight, resulted in recovery of the animal within 3 minutes.

While immobilized, each animal was tagged, lip-tattooed, weighed, measured, sexed, examined for ectoparasites, and noted as to general body condition. A sample of blood was taken as described by Eubanks et al. (1976:29) and Beeman and Pelton (1978:127-129), a premolar was extracted, and reproductive condition was examined as described by Eiler (1981:12-13). All bears except 2 were fitted with radio-collars (Telonics, Mesa, AZ).

The first premolar was sectioned, prepared, and stained using techniques described by Eagle and Pelton (1978) and age was determined by the cementum-annuli technique described by Willey (1974). Bears were placed into 2 age classes: 4 years or older (adult), less than 4 years old (subadult).

Radio-Telemetry

Bears were either fitted with static collars which had life-expectancies of 2-3 years or, if they were young bears (1.5 years or less), they were fitted with break-away collars designed to fall off in 9 to 12 months due to deterioration of material in the collar (Telonics, Mesa, AZ). All collars transmitted in the 150-152 MHz range.

Two types of information were sought from radio-collared bears: activity and location. To obtain activity information each transmitter incorporated a reset motion sensor, commonly known as a mortality sensor (Telonics, Mesa, AZ). With this mechanism employed, the transmitter on a resting or immobile animal emits a signal with a base pulse rate, or inactive rate. (In this study 2 different base rates were used: 75 bpm, 40 bpm.) Movement by the animal caused the base pulse rate to change to an alternate, or active, mode. (In this study 2 different alternate modes were used: 100 bpm, 80 bpm.) The initial movement and any subsequent movement resets a timing mechanism on the alternate mode which keeps this mode operating for a programmed time period. The programmed time period for most transmitters in this study was 5 minutes. (Transmitters with 2-minute timers were experimented with in the later months of the study.) Thus, for a 5-minute timer, if an active animal became inactive and remained so for 5 minutes, the pulse rate automatically returned to the base mode.

Each time the signal from an animal was received in the field the signal mode was recorded as active or inactive. Due to the timing mechanism though, a bias may be interjected in favor of the active mode (i.e. an inactive animal has emitted 5 minutes of active signal before the signal gives a true indication of the situation, whereas an active animal will always produce a signal indicating so). To compensate for this overestimation of activity, a notation system was devised for the 5-minute reset monitors (Quigley et al. 1979). If the signal was initially heard in the active mode, or the signal changed from the inactive mode to the active mode while the researcher was

listening, the signal was given a second check 3-8 minutes later. If an active mode was still heard on the second check, the signal was recorded as such; if the signal had changed to inactive it was assumed that the animal's movement was only a temporary comfort movement and the signal was recorded as inactive. Schematically, the recording system appears as below:

<u>INITIAL MODE</u>	<u>SECOND CHECK</u>	<u>RECORDED (GROUPING)</u>
A - - - - -	A - - - - -	A(A)
I - - - - -	I - - - - -	I(B)
I-A - - - - -	A - - - - -	A(C)
A-I - - - - -	I - - - - -	I(D)
A - - - - -	I - - - - -	I(D)
I-A - - - - -	I - - - - -	I(D)

A = Active I = Inactive

Each time an activity recording was made in the field the following information was also recorded: time of day, date, temperature, weather conditions, cloud cover.

Locational information on radio-collared bears was obtained by triangulating azimuths obtained from known tracking points on the ground or by aerial locations from an airplane. Ground azimuths were determined by the loudest signal method (Springer 1979:928).

Over 50% of the azimuths obtained from the ground were taken from elevated 8-element antennas (Hy-Gain Electronics, Lincoln, NB); the remainder were obtained with a hand-held, 2-element, "H" antenna (Telonics, Mesa, AZ). The 8-element antenna exhibited a more precise directionality than the "H" type, plus, when elevated, the effective

"seeing" area of the antenna is increased while obstructions to the signal are decreased. Four of these larger antennas were placed on 9m masts at strategic points in the area; one was placed on top of a 30m fire tower located on Bunker Hill.

Locations obtained from the ground were made from the intersection of at least 2 azimuths. In most cases, 3 to 5 azimuths were taken on a single bear before a location was considered acceptable. Many locations utilized 7 to 9 azimuths. Azimuths that were considered aberrant were not used in determining locations. These readings were caused by obstructions between the animal and the researcher, refraction of the signal due to the high relief of the area, or movement of the animal. Effort was made to obtain the most direct signal from the animal that was possible and to reduce the time spent in transit between tracking points to minimize the effect that a moving animal can have on the accuracy of the location obtained. Movement to tracking points could usually be accomplished by vehicle. In another effort to assure accuracy and to increase efficiency, azimuths were roughly mapped in the field, the strength and stability of the signal were recorded, and the stability and accuracy of the azimuth were recorded.

Tests for accuracy were undertaken using transmitters in known locations. The tracking system of 8-element stations and hand-held "H" antennas easily placed the location within a circle with a diameter of 300m. Garshelis (1978) used a circle 300m in diameter to define locations in the mountainous areas of the GSMNP and Heezen

and Tester (1967) accepted error polygons of 240m in length with an automatic tracking system.

Aerial radio-tracking was accomplished from a Cessna 140, 170, or 172. An "H" antenna was placed on each of the 2 wing struts and connected through a switch box (Telonics, Mesa, AZ) in the cabin to the receiver. The switch box allowed the researcher to listen to both antennas at once or each antenna individually. To locate an animal using this system, transect lines were flown while listening to both antennas at once. When a signal was encountered, signals from each antenna were listened to individually; the animal was assumed to be to the side of the airplane from which the strongest signal was received. At the same time, it was noted whether the signal was increasing or decreasing in intensity (i.e. the animal was ahead or behind the airplane, respectively). When a decreasing signal intensity was heard, the airplane was turned to a perpendicular flight path to the side of highest intensity. This path was continued until a decreasing signal intensity was heard again and another perpendicular path to the strong side was begun. This procedure was continued until the signal was "boxed-in" to the desired accuracy of the location. The wing and antenna were also dipped to the determined location while the airplane circled to test the signal direction. The location was then placed on a United States Geological Survey (USGS) 1:24000 or 1:125000 scale map. Most locations took less than 8 minutes to establish from the air once the signal was encountered and were usually obtained from altitudes less than 200m above ground. Tests of accuracy with transmitters placed in the field indicated that the 300m diameter circle

used for ground-determined locations was also applicable to aerial locations. On 2 occasions general locations on wide-ranging bears were obtained from above cloud cover in mountainous regions by triangulating the position of the plane using air traffic beacons. A dual headphone jack that allowed the pilot and the researcher to monitor the signal at the same time reduced the time needed per location.

Attempts were made to locate each collared animal a minimum of 3 times per week. This could not be consistently accomplished due to the constraints of weather, available personnel, accessibility of the area in which a bear was located, and the number of animals being radio-tracked. The only way to keep track of wide-ranging animals was through the use of an airplane, but bad weather and the cost of air time limited such efforts. The most efficient system for locating radio-collared animals was for a researcher on the ground to locate the easily accessible animals and to tell the pilot by radio which animals needed to be located from the air. This system minimized ground and air time and always resulted in locations on all animals for that particular day. Periodically, diel sampling was carried out to determine hourly movement and activity patterns. This was accomplished with 2 8-element antennas, fitted with compass roses at the base, from which researchers took simultaneous hourly readings on available animals in the area for 24 continuous hours. Garshelis (1978) presents further discussion of radio-tracking techniques.

Each ground location was replotted under non-field conditions on USGS 1:24000 scale maps along with aerial locations. Using the Universal Transverse Mercator System (UTM), all radio-locations were given a 6-digit coordinate which corresponded to the 100m by 100m cell in which they fell (Strahler 1969:58-59, 625-627). A transparent grid overlay, with 1 ha (100m by 100m) UTM divisions, was aligned to grid north over the USGS maps for this procedure.

Data Analysis

Home range. Two techniques were used to estimate the area of an animal's home range [the area transversed by an individual in its normal activities of food gathering, mating, and caring for young (Burt 1943:351)]. The first technique, known as the bivariate or elliptical model, is a computer-based, probabilistic model described by Koepl et al. (1975). The 90% and 95% confidence (or probability) ellipses were calculated. Only annual ranges were determined with this technique for the purpose of comparison to other studies because it was felt that the sampling strategy produced highly variable scatters of point when broken down by season due to wide-ranging animals, low sample sizes, and inconsistent sampling intervals. The second method used for estimates of home range is termed the convex polygon or maximum area polygon method. For this calculation, the outermost points were connected in such a way that the angle to the inside of the polygon formed by any 3 consecutive points never exceeded 180°. The area was then calculated using point coordinates (Brinker 1969:248-250). In many cases, distinct clusters of points

were formed when a bear moved to a certain area and remained there for a period of days or weeks and then moved back to the original area and remained. Inclusion of the entire area between these distinct point clusters could lead to a gross over-estimation of the area of home range. For this reason, the 2 (or more) clusters were considered separately and the areas for each were calculated and added together. In some cases, these shifts in area of use by bears could be inferred as being caused by seasonal changes in food supply, and in other cases they could not. Because of this and the highly erratic nature of some movements, the method of tracing movements of activity centers to determine range shifts (Hayne 1949, Garshelis 1978:18) could not be justified. To account for travel area between 2 distinct clusters, a method for determining a corridor between 2 distinct clusters was devised. This corridor was defined by 4 points: the last location obtained in the origin area before the animal moved, the first location obtained in the new area, the last location obtained in the new area before the animal moved out, and the first location obtained in the original area after the animal returned. Locations obtained while the animal was in transit usually fell within the corridor boundaries, but if not, the edges of the corridor were defined by those points also. The corridor area was then calculated (not including area within the clusters) and added to the area of the clusters to determine annual or seasonal home ranges. Although subjective in nature, this corridor method provides for the area between clusters in a defined fashion when the inclusion of the total area between clusters could overestimate home range area or exclusion of any area between clusters

could lead to underestimation of home range area. The Mann-Whitney-Wilcoxon U Test (Sokal and Rohlf 1969:391-395) was used in determining differences in home range size ($P=0.05$). Home range overlap was determined with convex polygon estimates. For seasonal divisions of home range, spring was defined as den emergence through May, summer as June through September, and fall as October through den entrance (usually in December).

Movements. The following aspects of diel movement were analyzed: total daily movement (sum of distances between consecutive hourly locations), net daily movement (distance between the beginning point and the ending point in 24 hours of locations), daily range length (maximum distance between locations in a 24 hour period), and circuitry. Circuitry was calculated by dividing the total distance traveled in a period of 12 or more hours into the net movement for the same period. Thus, a value of 1 indicates straight line movement; a value of 0 indicates that the animal returned to the same location. Relatively stationary animals were not included in the analysis of circuitry (Garshelis et al. in press). The above movement parameters were tested for significance using the Mann-Whitney-Wilcoxon U Test ($P=0.05$).

Hourly rates of travel were calculated by dividing the total number of consecutive hourly locations into the distance traveled for that period. Diurnal (defined as 0600-2000 hours) rates of travel were only calculated from diel data when at least 8 hours of movements were recorded; nocturnal (defined as 2100-0500 hours) rates of travel were only calculated from diel data when at least 4 hours of movements

were recorded. All data on hourly movements were tested with the Mann-Whitney-Wilcoxon U Test ($P=0.05$). Seasonal divisions for movements analysis were the same as for home range analysis.

Activity patterns. The activity patterns of instrumented bears were analyzed in relation to information recorded simultaneously in the field for each activity reading (temperature, time of day, date, cloud cover, precipitation) and known information for each animal collected when the animal was trapped (sex, age, reproductive status). Presence or absence of cubs with females was determined from winter dens (Eiler 1981). For analysis, time of year was divided by month, seasons were divided as in home range analysis, time of day was divided by hour (on the half hour), temperature was divided by 3°C increments, and cloud cover was divided by 25% classes. Precipitation was defined as light rain, hard rain, snow, or no precipitation. When no precipitation was occurring, a precipitation history was also recorded and defined by 3 classes: (1) no rain in the last 24 hours, (2) rain within the last 24 hours, or (3) rain within the last 3 hours.

The influences and interactions of time of year, time of day, weather, sex, age, and presence of cubs on activity were tested with the least squares means analysis of variance procedure (SAS Institute 1979). This procedure was chosen because of its ability to partial out and measure the effect that each factor, or a combination of factors, has on activity. Thus, activity is reported as a probability under a given condition(s) rather than a percentage of activity

records for that condition(s). Orthogonal contrasts between least squares means were used to test sex, age, and family effects.

Habitat. The computer-based IMGRID (Information Management on a Grid Cell System) system (Sinton 1976), version 3.5 (Holmes and Jolly 1980), was used to evaluate the relationships of bear locations to habitat features. The system requires that all information be input on a grid cell base, each cell being coded for the particular feature(s) to be evaluated. For this study, the UTM coordinate system was used to divide the USGA 1:24000 scale base map into 100m by 100m cells as described earlier (p. 17). A 5300 cell area, which encompassed most bear locations, was chosen for coding of habitat features. These features were coded cell by cell from information available on the USGS base map using a transparent grid overlay. Since no detailed vegetation map for the area was available, a predictive model for overstory and understory composition was developed from vegetation plots analyzed in the study area by Harmon (1981) (Appendices A and B, respectively). The model uses 3 land features for prediction: position on slope, aspect, and whether the point is in ridge or valley type topography. Field tests of the model indicated that it was only sufficiently accurate when predicting very high or very low percentage cover of the desired types. Thus, bear locations were only tested for occurrence with high concentrations.

The following components were input for analysis by IMGRID:

1. Elevation (coded to the nearest 6m);
2. Water (permanent streams or reservoirs);

3. Man-made construction (i.e. powerlines, roads, trails);
4. Position on slope (lower 1/3, middle 1/3, upper 1/3 of the slope);
5. Aspect (N=315-345, E=45-135, S=135-240, W=240-315; unusual divisions are due to predictive model [Appendix A, B]);
6. Convex or concave topography (ridge or valley);
7. Bear locations (coded by age by sex by season; thus resulting in 24 different groupings; i.e. subadult female locations in fall).

The 2 predicted vegetation features were for hard mast (Quercus spp., Carya spp., Juglans spp., Fagus spp., and Aesculus spp.) and heath (Vaccinium spp. and Gaylussacia spp.).

Utilization of the various habitat features was determined with the 3 divisions of bear locations--age, sex, season--and by combining all locations together. Bear locations were tested for coincidence with habitat features in the same cell, except in the analysis of roads. In the latter case, proximity searches were done to find bear locations within a defined distance from the road or on the road. Seasons were divided in the following manner: spring = March-May, summer = June-August, fall = October-December. September was considered separately because it is normally the month of transition for bear diets from summer to fall type (Eagle 1979). It was felt that inclusion of September with summer or fall may lessen contrasts between the 2 seasons.

To determine differences in habitat utilization, except in the case of IMGRID-generated elevation data, chi-square goodness of

fit tests were used (Sokal and Rohlf 1969) ($P=0.10$). This was followed by Bonferroni tests (Neu et al. 1974) to determine which categories within the habitat component contributed most to the resultant chi-square statistic. A chi-square statistic was considered invalid if any expected cell frequency was less than 2. Duncan's multiple range test was used to test differences in elevation means ($P=0.05$).

CHAPTER IV

RESULTS AND DISCUSSION

A total of 1619 locations were obtained from June 1978 through December 1979 on 22 radio-collared bears (Appendix C, Fig. 2). These locations were considered in the analysis of home range estimates, movements, and habitat usage. A total of 5880 activity readings were obtained for analysis of activity patterns.

Assessment of Activity Monitor

The reset motion sensor was chosen for this project even though its use previous to this had been primarily for sensing mortality of animals rather than daily activity patterns. Several tests were performed to assess its reliability and function. Using consecutive hourly diel locations, a high correlation was found ($r=0.91$, $n=24$, $P<0.01$) between percentage activity determined by the reset monitor and mean distance moved for each hour of the day (Fig. 3). The above correlation existed despite the countering influence that was imposed due to the variation among bears and those affecting circadian patterns (Garshelis and Pelton 1981, this study, p. 29). Garshelis et al. (1982), using the same analysis, tested mean distance moved against percentage of activity as determined by tip-switch sensors and also found high correlations in both spring-summer ($r=0.88$, $P<0.001$) and fall ($r=0.69$, $P<0.001$). The higher correlation coefficient found in the Bunker Hill area may be an artifact of other influences on activity rather than superiority of the reset motion over the tip-switch

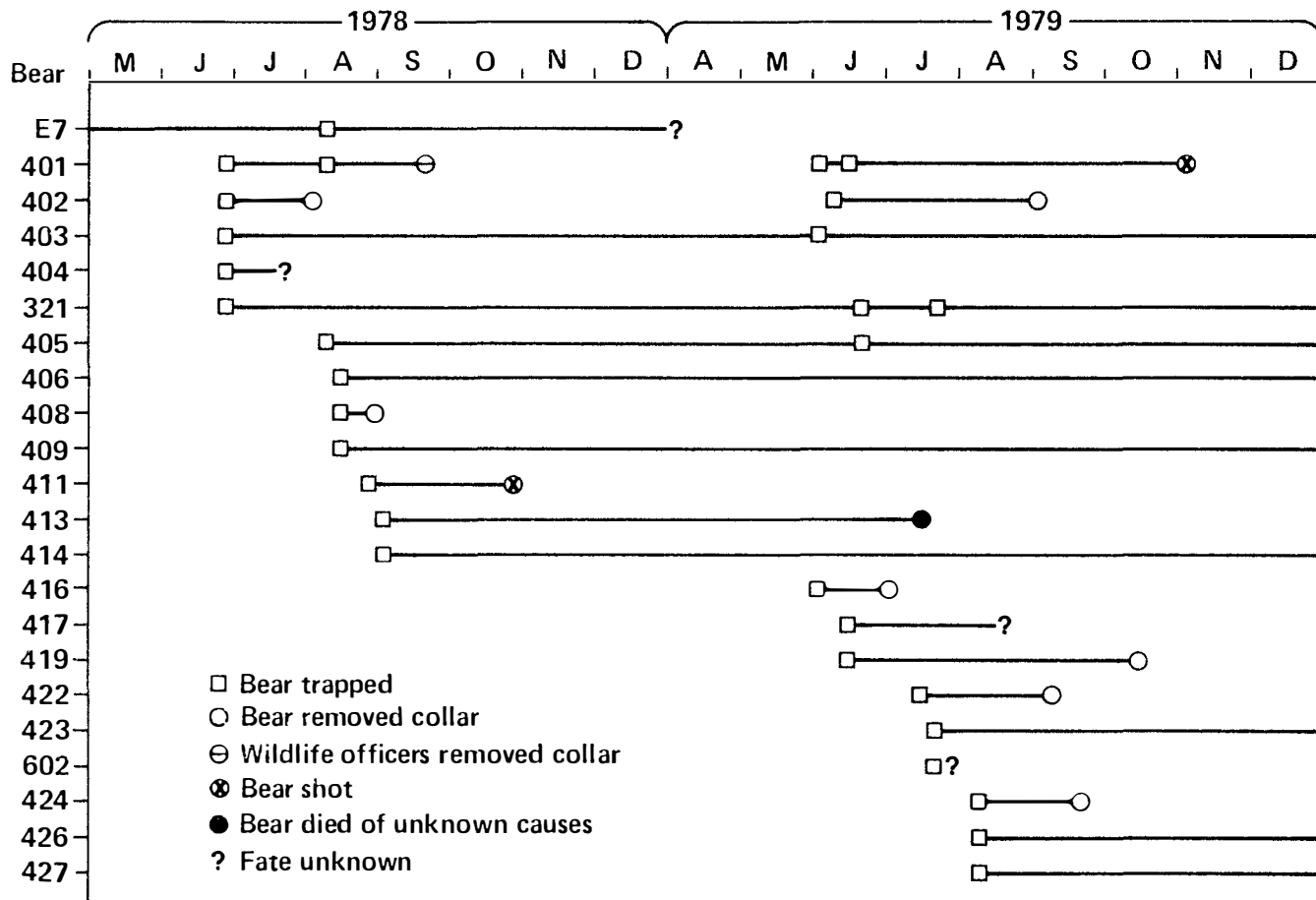

Figure 2. Duration of radio-tracking, trapping record, and fate of 22 bears in the Bunker Hill area, GSMNP, 1978-1979.

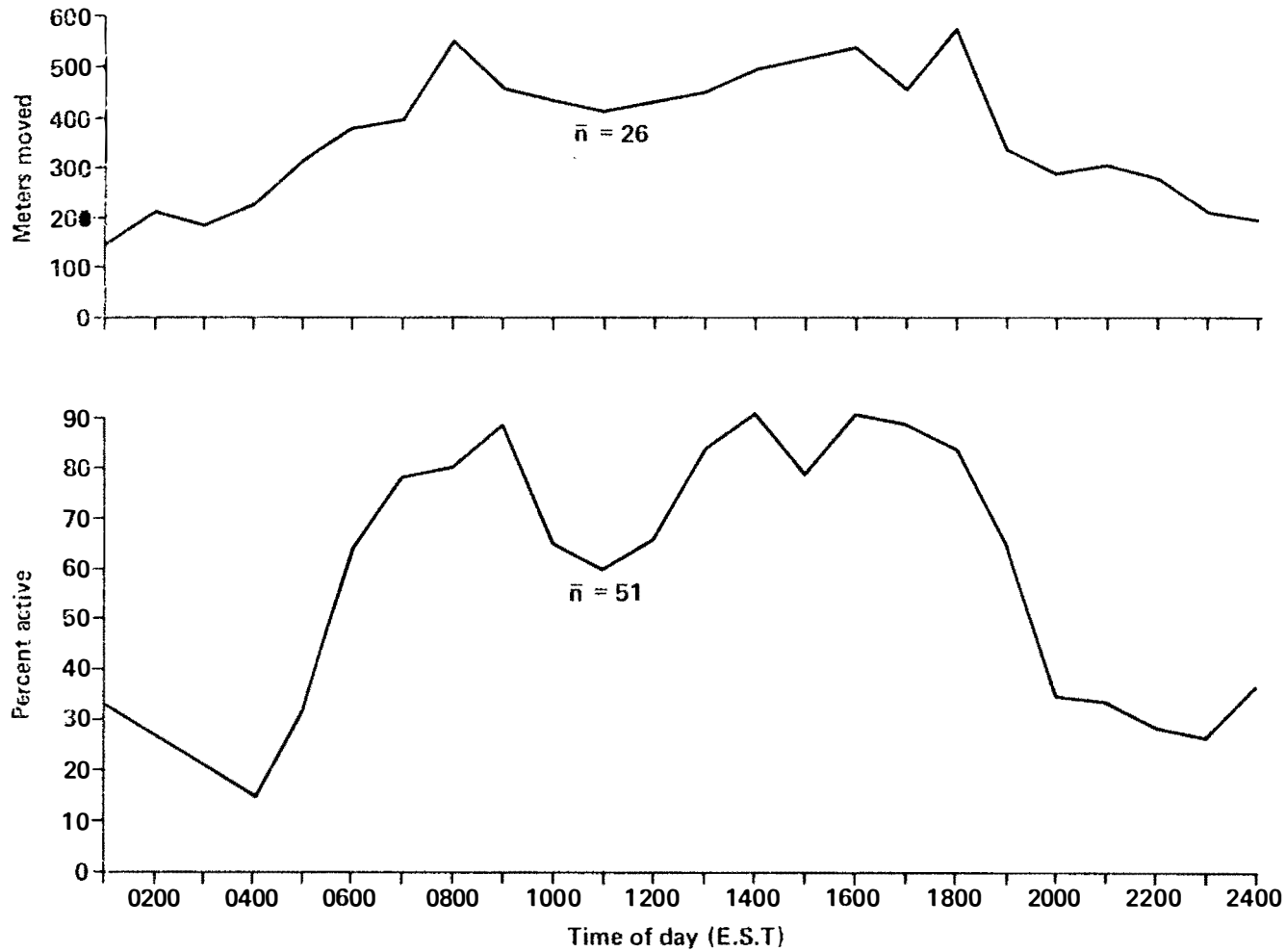

Figure 3. Two measures of activity compared from diel tracking period during 1978-1979, Bunker Hill study area, GSMNP. Upper curve represents mean distance moved per hour; lower curve represents percentage of activity recorded for the same hours. Mean sample size per point (\bar{n}) is given for each curve.

motion sensor. Although signal integrity was not recorded in this study, variations in the intensity of some inactive signals lead to an agreement with the conclusion by Lindzey and Meslow (1977) and Sunquist (1981) that use of this method may be biased toward activity.

The field recording system devised to compensate for the bias toward activity in the reset monitor created 4 groupings: group A-active; group B-inactive; group C-active with a change of mode; and group D-inactive with a change of mode. Groups C and D were tested in 2 ways to determine if they were more closely associated with group A (active) or group B (inactive). First, from diel tracking sessions, all observations were found in which 1 observer recorded a group D reading (n=75). In these cases, a second observer recorded a group A reading 34% of the time, a group B reading 42% of the time, a group C reading 5% of the time, and a group D reading 17% of the time. When a group C reading was recorded (n=29), a group A reading was recorded 21% of the time, a group B reading 62% of the time, a group C reading 3% of the time, and a group D reading 14% of the time. A significant association (sign test $P < 0.01$) for both group C and group D was found with group B (inactivity). Second, to further test this association, a comparison was made of mean distance moved when both observers recorded group A recordings ($\bar{X}=457m$), both recorded group B readings ($\bar{X}=242m$), and both recorded group D readings ($\bar{X}=238m$). (There were no cases in which both observers recorded group C readings.) Both of the above examinations indicate that groups C and D reflect inactivity of the animal and support the contention that the reset motion sensor overestimates activity. For these reasons,

readings from groups C and D were placed with group B readings for analysis, thus creating 2 groupings: active and inactive. These findings also indicate that a bias-compensating system for field recording of the reset monitor is justified, at least with reset timers of 5 minutes or more. In conclusion, the reset motion sensor was considered adequate for the needs of this project because (1) it compared favorably with mean distance moved per hour (Fig. 3), (2) signal integrity techniques appear less accurate, (3) only 1 observer is required, and (4) the reset monitor produces a relatively stable pulse (as compared to the tip-switch monitor) for quick, precise determination of azimuths.

Garshelis (1978) devised a system in which "head movement" was recorded for cases in which the changes of pulse rate from the tip-switch monitor fell between activity and inactivity cutoffs. Using the same testing as above, he concluded that head movement was more closely associated with inactivity than with activity, concluding that it was generated by "comfort movements" of "short duration" (1978:74). The recordings of readings from groups C and D in this study are probably indications of these same types of movements.

Factors Affecting Activity

Activity of bears was significantly influenced by the month of the year and the hour of the day along with the interactions of these 2 factors (Table 2). The individual variation in activity between bears themselves (Bear) and the variation in activity of individuals in relation to month and hour (Other interactions involving bear) also contributed a significant effect on levels of activity of

Table 2. Analysis of variation in activity patterns of black bears in the GSMNP, Bunker Hill area, 1978-1979, with respect to time of year, time of day, differences among bears, and other interactions.

Source of Variation	df	SS	MS	F
Total	5806	1290.2222		
Bear	19	80.6856 ^a	4.2466	18.7571 ^{b,d}
Month	8	56.4279 ^a	7.0535	31.1550 ^{b,d}
Season	2	40.6333 ^a	20.3166	89.7376 ^{b,d}
Hour	23	190.8636 ^a	8.2984	36.6537 ^{b,d}
Month x hour	148	63.1347 ^a	0.4266	1.8842 ^{b,d}
Season x hour	46	28.8372 ^a	0.6269	2.7690 ^{b,d}
Other interactions involving bear	1332	301.5214	0.2264	1.6795 ^{c,d}
Variation of observations within bear-month-hour	4276	576.1984	0.1348	

^a Partial sum of squares.

^b Tested against other interactions involving bear.

^c Tested against variation of observations within bear-month-hour.

^d $P < 0.05$

bears. The latter, residual contribution, may be due to the effects of sex, age, and family associations as suggested by Garshelis and Pelton (1980). Also, although the overall effect of the measured weather factors had a significant influence on levels of activity of bears, when broken down, only effects of temperature could be singled out as having a significant association (Table 3). Garshelis and Pelton (1980) reported similar results for bears in the GSMNP using the same techniques of analysis.

Seasonal and Hourly Effects

The monthly levels of activity of bears (Fig. 4) indicate that they were mostly inactive after den emergence, increasing to their highest level of activity during the summer months, then returning to low levels of activity before denning. Garshelis and Pelton (1980) found a very similar pattern for bears in the GSMNP. Johnson and Pelton (1979) documented decreasing pre-denning activity, an extreme low in the mid-denning period, and increasing post-denning activity. A combination of these studies thus produces an annual cyclic picture of activity of bears with high levels during summer, low levels during winter, and intermediate levels between the 2 which are either increasing (spring) or decreasing (fall). Amstrup and Beechum (1976) found that black bears in Idaho were less active in late fall and early spring than they were between June and October, suggesting this same pattern. In addition, studies in Pennsylvania (Alt et al. 1976), Washington (Lindzey and Meslow 1976), North Carolina (Hamilton 1978), and West Virginia (Brown 1980) displayed evidence for this annual

Table 3. Analysis of variation in activity patterns of black bears in the GSMNP, Bunker Hill area, 1978-1979, with respect to time of year, time of day, differences among bears, and weather factors.

Source of Variation	df	SS	MS	F
Total	3872	877.6081		
Bear	19	56.2427	2.9601	15.9145 ^a
Month	8	20.8273	2.6034	13.9968 ^a
Hour	23	84.1496	3.6587	19.6704 ^a
Weather	23	9.8154	0.4268	2.2946 ^a
Temperature	12	7.4966 ^b	0.6247	3.3586 ^a
Cloud cover	3	0.0437 ^b	0.0146	0.0785 ^{ns}
Precipitation	8	1.1192 ^b	0.1490	0.8011 ^{ns}
Residual	3799	706.5885	0.1860	

^a $P < 0.01$.

^b Partial sum of squares.

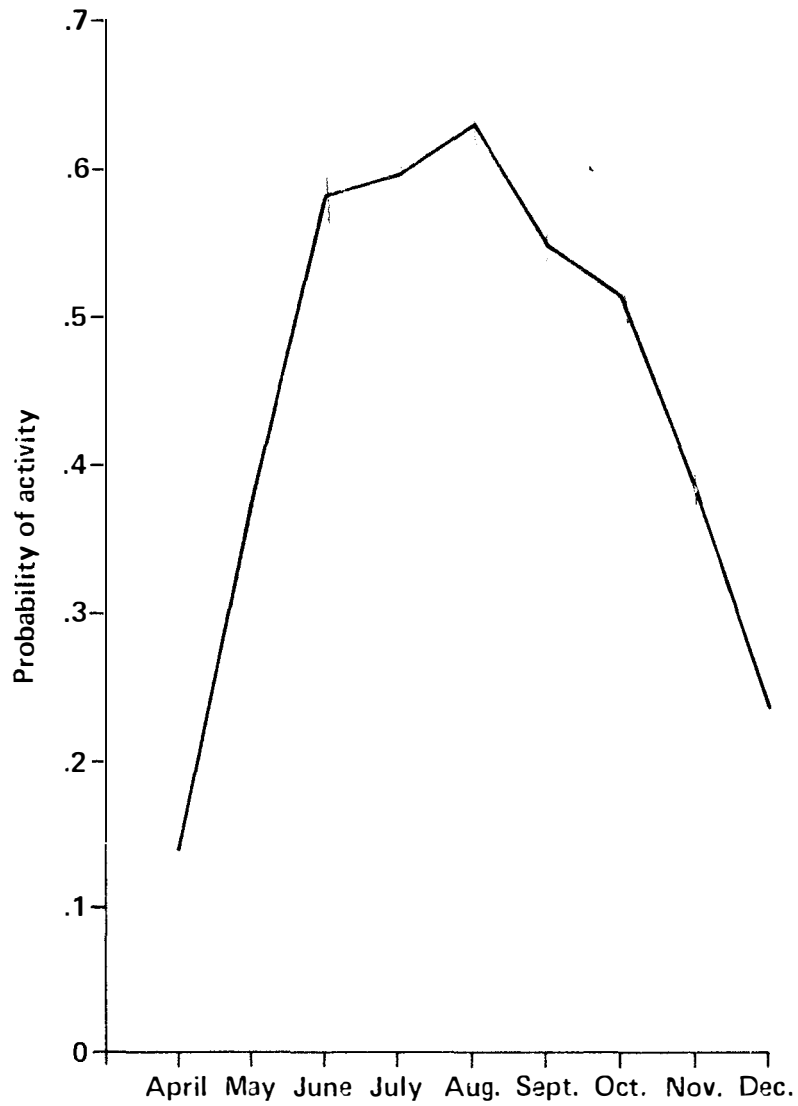

Figure 4. Relationship between month and probability of activity for black bears in the GSMNP, 1978-1979.

pattern. The monthly curve for activity of bears given by Garshelis and Pelton (1980) for the Bote Mountain area of the GSMNP has one distinct anomaly when compared to the pattern found in the Bunker Hill area (this study) of the GSMNP. Although bears during the summer months (June, July, August) exhibited the highest levels of activity in both cases, the bears of the Bote Mountain area exhibited their greatest activity in June, declining to August, whereas bears in the Bunker Hill area exhibited increased activity up to August, the highest level. It is possible that food changes played a part in this difference but good habits work by Eagle (1979) illustrates that major dietary changes for both areas occurred later in the year. A possible explanation is in the timing of breeding. Eiler (1981) found evidence that young females may breed later than adult females. Examination of trapping records for the Bunker Hill area and the Bote Mountain area revealed a significantly younger population of bears in the Bunker Hill area (5.7 vs 3.1 years mean age) and, consequently, a sample of younger bears was monitored using telemetry. Thus, this later activity peak may reflect increased activity due to unrest associated with estrus in females, causing higher activity on an individual basis and in the population as a whole. The mean distance moved per hour from diel radio-tracking in consecutive hours (p. 63) was highest for the late July and early August diels; this may be an artifact of breeding influences also.

The daily activity pattern averaged for the entire year shows that bears are mostly inactive during the night and mostly active during the day, with crepuscular peaks in activity (Fig. 5). The

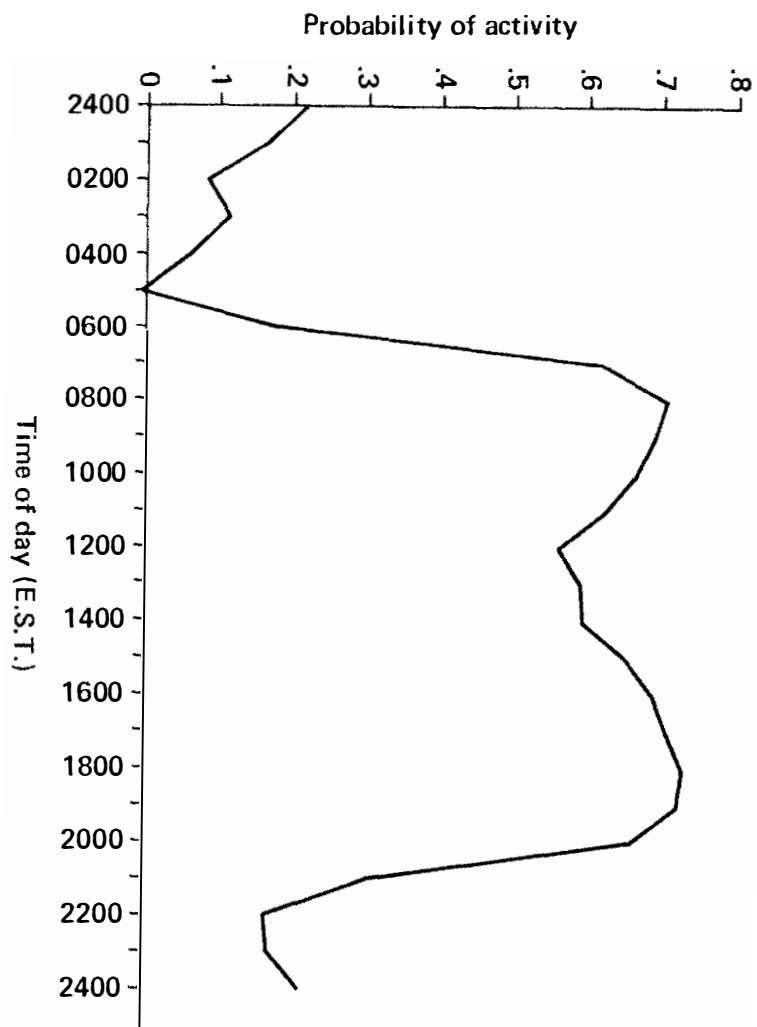

Figure 5. Relationship of time of day to probability of activity for black bears, GSMNP, 1978-1979.

crepuscular peaks at 0800 h and 1800 h in the curve were split by a depression which bottomed out at midday (1200). The lowest level of activity was in the 0500 h which actually gave a slightly negative probability of activity (-0.02). Diurnal and/or crepuscular activity patterns of bears have been reported for Washington (Poelker and Hartwell 1973, Lindzey and Meslow 1977), Idaho (Amstrup and Beecham 1976), and in the GSMNP in Tennessee (Eubanks 1976, Garshelis and Pelton 1980). Erickson (1965) reported a more nocturnal pattern of activity for black bears in Alaska as did Hamilton (1978) for North Carolina.

A further breakdown of the daily pattern is justified due to the significant effect which time of year had (month x hour, Table 2). The seasonal divisions (spring = April-May; summer = June-September; fall = October-December) were used to further analyze the effect of time of year. These divisions proved to contribute significantly to the variation found within month of the year (month, Table 2) and hour of the day (season x hour, Table 2).

The spring activity pattern of bears was the most crepuscular of the 3 seasons (Fig. 6). Spring was characterized by almost complete depression of activity by bears from 2200 h to 0500 h, except for a slight increase between 0200 h and 0400 h. The highest activity of bears was the 0700 h during spring--in fact, for any hour of any season--and initiated a 13 to 15 hour period of activity. After this initial extreme at 0700 h, the activity of bears fell to a mid-range (around 0.5) in which there was an equal probability of finding a bear active as there was in finding a bear inactive.

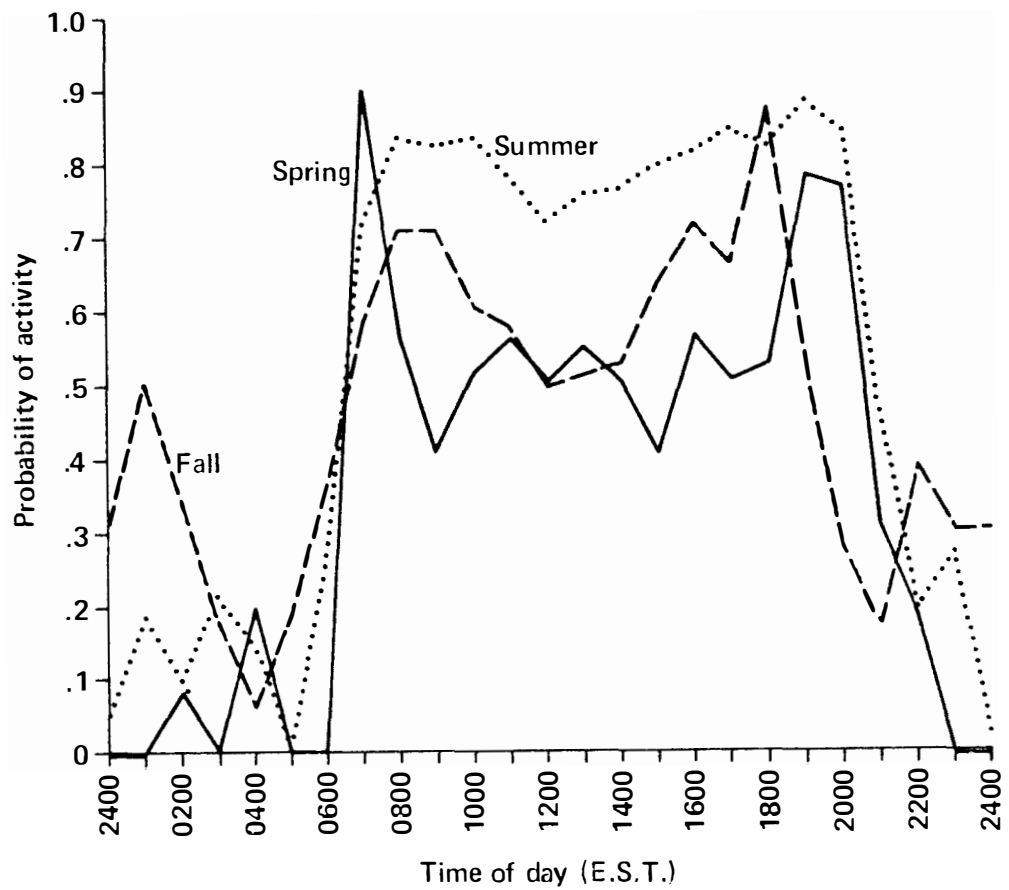

Figure 6. Seasonal differences in the daily activity pattern of black bears, GSMNP, 1978-1979.

The summer activity pattern of bears was characterized by a slightly higher level of activity in the late night/early morning period (0200-0600) than was found for spring (Fig. 6). The crepuscular pattern that was so obvious in spring was less evident during the summer. Two peaks were found in the "active" period (0700-2000 h) of approximately the same levels found for spring, but the depression between the peaks was only about 10% probability, as compared to the approximately 40% trough between the spring peaks.

The fall pattern appears to be a combination of characteristics from the spring and summer patterns (Fig. 6). The general level for the "inactive" period (2000-0600 h) was higher again, as was the tendency for the summer level over the spring level for this period; however, the "active" period shows a return to the crepuscular plan shown in spring.

The seasonal circadian activity patterns for this study (Fig. 6) follow, almost exactly, those found by Garshelis and Pelton (1980) for the Bote Mountain area of the GSMNP. Their explanations for the contrasts between the seasons rested almost exclusively in the food regime and foraging strategies. Their explanations are appropriate for this study also and are as follows: in spring, the highly crepuscular pattern is a result of utilizing mostly herbaceous material which is easily found, causes satiation quickly in the animal, but does not have high nutritive value. As a result, there are 2 brief feeding periods in which bears become satiated, but the low energy gain from these plants restricts activity in midday. In summer, the diet of berries is more dispersed but the high caloric value allows foraging

throughout the day. In addition, the caloric content provides for metabolic needs associated with the mating season and exploratory forays of young animals. The fall pattern is explained as an interaction of the patchier distribution of oaks (the main source of fall food), the added need of building fat stores for winter denning, and the physical size of acorns. As a result, the nocturnal-diurnal contrast is not as sharp as during other seasons since bears can still utilize acorns through tactile searching at night.

The above explanations provided by Garshelis and Pelton (1980) for the daily patterns of activity for the 3 seasons are completely acceptable for the Bunker Hill area of the GSMNP since the patterns are so similar between the 2 studies. In addition, the mating season (Eiler 1981) and food habits (Eagle 1979) are generally comparable between the 2 areas.

To test the explanations offered above, the specific differences in the food regimes of the Bote Mountain area and the Bunker Hill area were explored. These differences should be reflected by slight differences between activity patterns of the areas as a result of varying foraging strategies. The major difference between the food habits of bears in the Bunker Hill and Bote Mountain areas is in the extended time that berries are utilized in the former area (Eagle 1979). (Bunker Hill area = Hannah Mountain area in Eagle 1979). The differences in the topography and the availability of water in the 2 areas probably account for this difference. The Bote Mountain area is characterized by higher, sharper ridges than the Bunker Hill area and is generally higher in elevation. The Bote Mountain area receives

more rain due to the orographic rain patterns but receives less sun due to the generally more northerly aspect. The broader ridge-tops of the Bunker Hill area and their more southerly exposure probably contribute to earlier fruit ripening. In the valleys of the area, fruits would ripen later, thus producing a longer berry season. Spring data from Eagle (1979:35, 36) indicate that berries are a more consistently utilized food item year-to-year in the Bunker Hill area than are herbaceous material and grass. If the foraging behavior described by Garshelis and Pelton (1980) is exhibited, then the peaks and lows of the crepuscular pattern of bears utilizing herbs and grass should be dampened somewhat by the injection of more berries (and possibly squawroot which probably requires a foraging strategy more like that needed for berries than for herbs and grasses). (Squawroot was found in high concentration in Bunker Hill scats.) This is exactly what was found (Fig. 7). The spring peaks in activity of bears in the Bote Mountain area averaged over 100% probability of activity, whereas in the Bunker Hill area they averaged 89% probability of activity. The midday trough was also more distinct in the Bote Mountain area (about 38% probability of activity) than was the trough for the Bunker Hill area (about 48% probability of activity).

Fall food habits also display an extended use of berries in the Bunker Hill area (Eagle 1979). In fact, it was found that "bears in this section failed to change from the Summer to Early Fall pattern during either year" (1976, 1977) (Eagle 1979) while bears in all 5 other sections of the Park (including the Bote Mountain area) had already shifted from berries to tree-borne mast. Again, if the

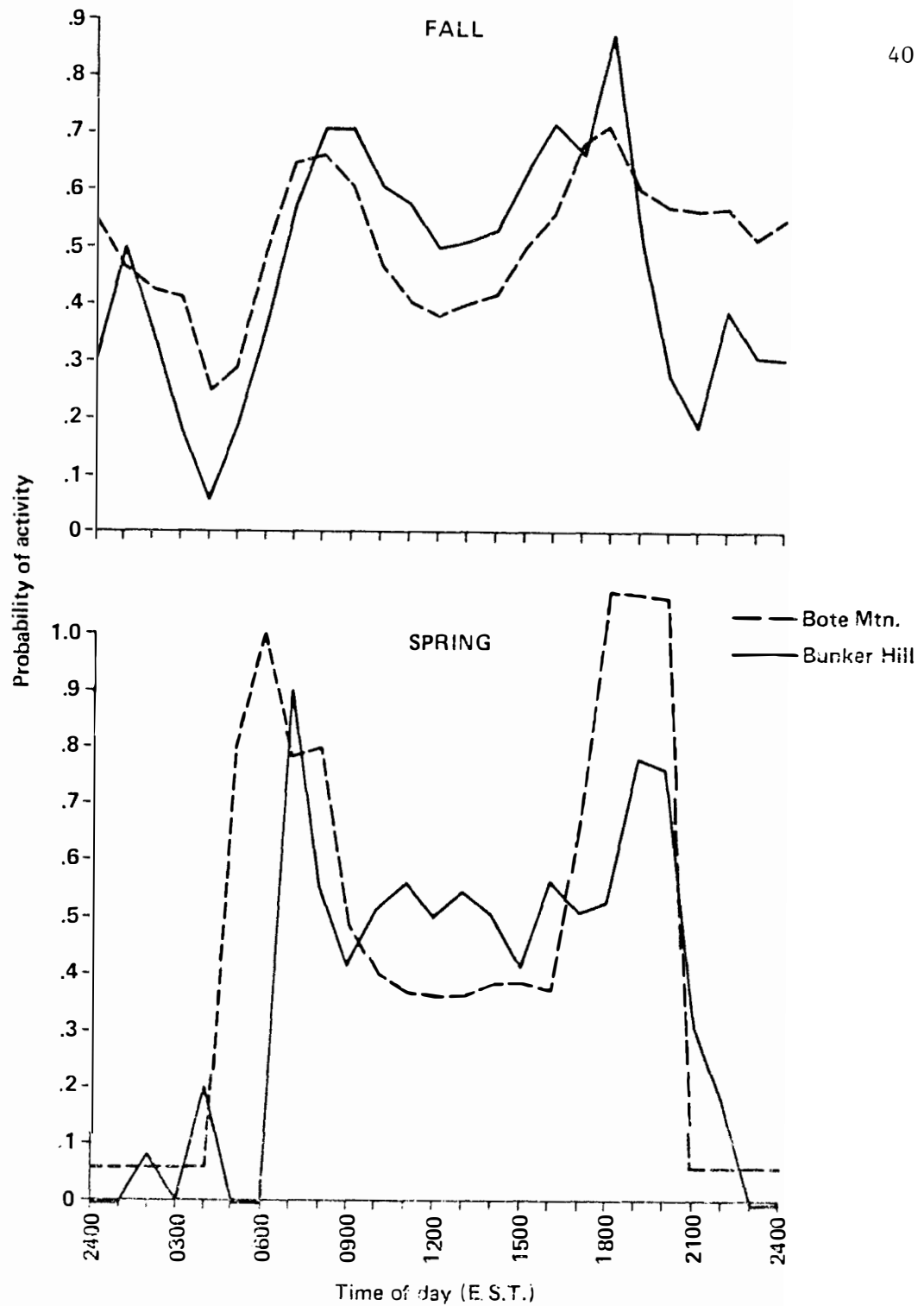

Figure 7. Comparison of spring and summer daily activity patterns for the Bunker Hill area and the Bote Mountain area (Garshelis 1978), GSNMP, 1978-1979.

foraging theories presented by Garshelis and Pelton (1980) hold true, the flattened circadian activity curve for fall in the Bunker Hill area should not be as distinct as in the Bote Mountain area because berry foraging is still an influence in the former. Once again, the predicted contrast is found: the Bunker Hill area shows a higher diurnal than nocturnal contrast in activity levels (Fig. 7). Therefore, the explanations for circadian patterns of activity of black bears during the 3 seasons given for the Bote Mountain area by Garshelis and Pelton (1980) are considered acceptable explanations for the patterns of activity of bears found in the present study, plus their findings also appear to be reinforced by these data found in the Bunker Hill area.

Effects of Weather on Activity

The effect of temperature contributed significantly to the level of activity of bears (Table 3, p. 31). An examination of seasonal temperature patterns is difficult to interpret (Fig. 8). On the upper ends of each seasonal curve, it appears that temperatures which have a depressing effect on activity vary with season: activity level declines above 19°C in the spring, above 22°C in the fall, and above 25°C in the summer. The lower ends of the seasonal curves are less easily interpreted. Summer exhibits the most consistent trend with a gently sloping positive correlation as temperature is increased from a low of 16°C (48% probability of activity) to the highest probability of activity (67%) at 25°C. In fall, the decreasing of temperatures from 19°C to 4°C has no significant correlation with activity. As suggested by Garshelis and Pelton (1980:17), increased

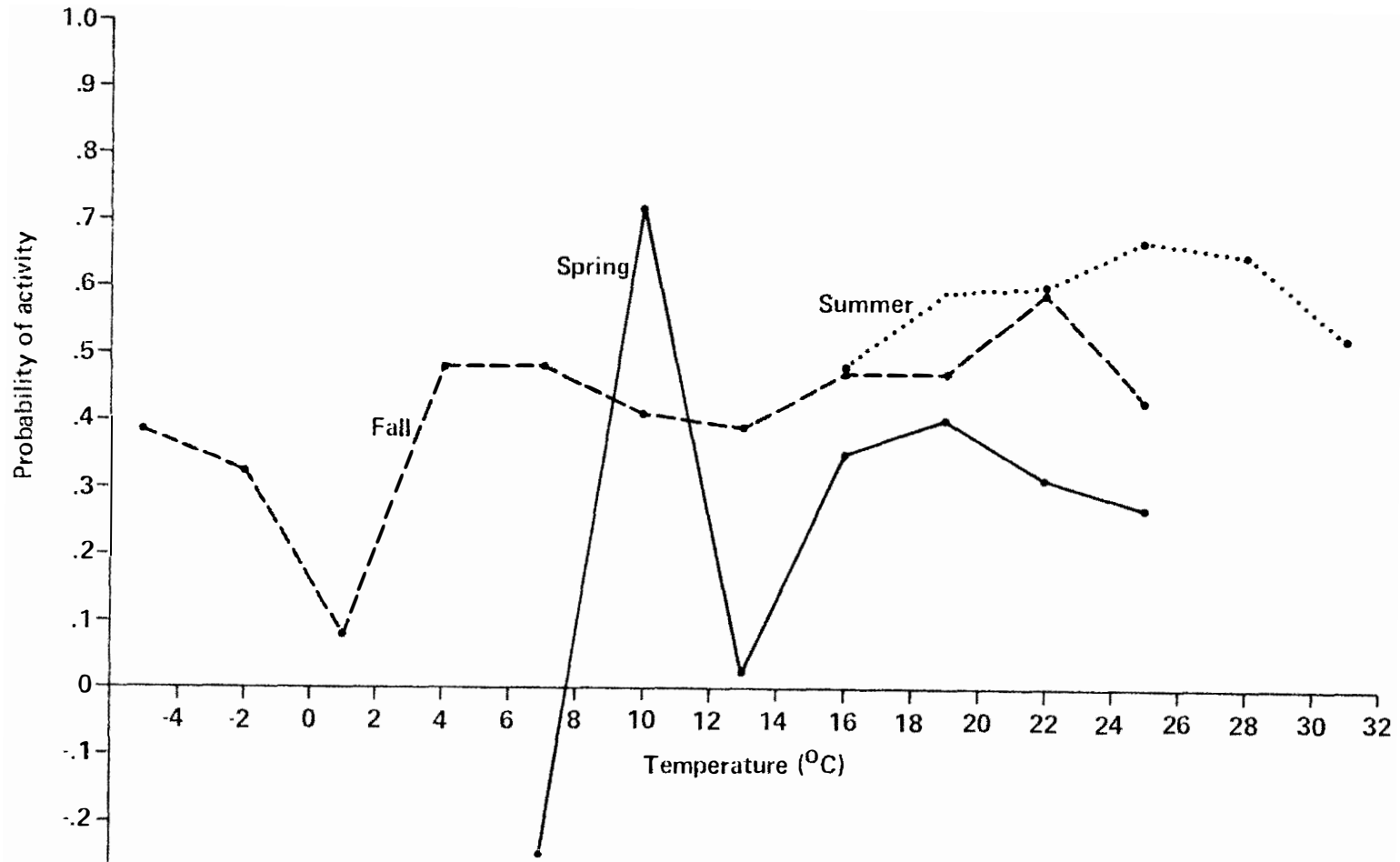

Figure 8. Seasonal effects of temperature on activity patterns of black bears, GSMNP, 1978-1979.

foraging in the fall may have a dampening effect on the influence of temperature just as it did on hour of the day. However, below 4°C, depressed activity of bears is found around freezing but below this point fall activity increases with decreasing temperature; this may be due to a larger percentage of males in the sample as females drop out of the sample by entering dens earlier (Johnson 1979). Since female black bears are less active than male black bears in the pre-denning period in the GSMNP (Johnson 1979:245), this increase in activity below freezing in the fall may reflect high percentages of males being sampled during the lower temperatures late in the year when most females are in dens. In spring, a positive correlation exists between activity of bears and temperature when including only the sample points of 7°C, 13°C, 16°C, and 19°C. The highly aberrant level at 10°C may be a result of sexual differences and sampling biases in the post-denning period (as were found for the pre-denning period) or sampling biases in relation to reproductive status. The extremely low activity of bears at 7°C in the spring (-0.26% probability of activity) may also reflect these biases or perhaps inadvertent sampling of denned bears.

Neither cloud cover nor precipitation had a significant effect on activity of bears in this study (Table 3, p. 31). The work by Garshelis and Pelton (1980) also found no significant effect from cloud cover but did find that precipitation explained a significant portion of the variation in activity. Brown (1980), comparing distance moved with weather conditions, could detect no significant influence of weather.

Sex, Age, and Family Effects

Five groupings were made using sex, age, and presence or absence of cubs: (1) adult males, (2) subadult and yearling males, (3) adult females without cubs (solitary), (4) adult females with cubs, and (5) subadult and yearling females. Overall tests of levels of activity of bears were performed. No significant difference was found between the activity of adult males and subadult and yearling males ($P=0.01$). Likewise, solitary females and females with cubs were not significantly different from each other ($P=0.01$), but they both had significantly higher levels of activity than either male group ($P<0.01$). Subadult and yearling females exhibited the highest overall activity--significantly higher than all 4 of the other groups ($P<0.01$).

Contrasting with the above, Garshelis and Pelton (1980:17) found that subadult and yearling males exhibited higher levels of activity than adult males. The lack of difference between the 2 male groups in the present study may be due to the small spread in years between the 2 age classes. The mean age for subadult and yearlings was 2.3 years; the mean for adults was 4.3 years. The oldest adult male was only 5 years--1 year into the adult age class. It could be that the age difference was not large enough between the classes to show a distinction in the activity behaviors. The reasons for other differences between these activity data and those of Garshelis and Pelton (1980) are not readily apparent. When the 5 groups are viewed in a hierarchy of levels of activity, the Bunker Hill study shows an almost total rearrangement from that found in the Bote Mountain area. The only obvious similarity is that subadult and yearling

females exhibit higher levels of activity than adult females. Problems in sampling may be responsible for placing subadult females as the overall highest group rather than adult females with cubs, as in Garshelis and Pelton (1980). This possibility exists because no subadult or yearling females were radio-tracked in the spring months and all bears exhibited lower levels of activity in spring than in fall. It is likely that, had there been a sufficient sample of subadult and yearling females from spring months, adult females with cubs would have displaced that group as the most active overall.

The 5 sex, age, and family groupings were also tested with respect to seasonal variation in levels of activity (Fig. 9). All available groups displayed increased activity from spring to summer and decreased activity from summer to fall; this would be expected given earlier results (p. 24). An interesting characteristic in the activity of adult females becomes visible with this seasonal breakdown. Although in the overall comparison females with cubs did not exhibit greater activity than solitary females ($P > 0.01$), activity of this group in fall was significantly greater ($P < 0.01$); this difference was not displayed in spring and summer. The greater activity of females with cubs is likely related to the presence of cubs, but several interacting factors are possible. (1) It is unclear whether black bear cubs are weaned by the fall months in the GSMNP but data from Eiler (1981:50) indicate that lactation continues through September and, most likely, at least partially into October. For this reason, greater activity could be related to nursing behavior and to foraging of the female to provide for herself and for milk

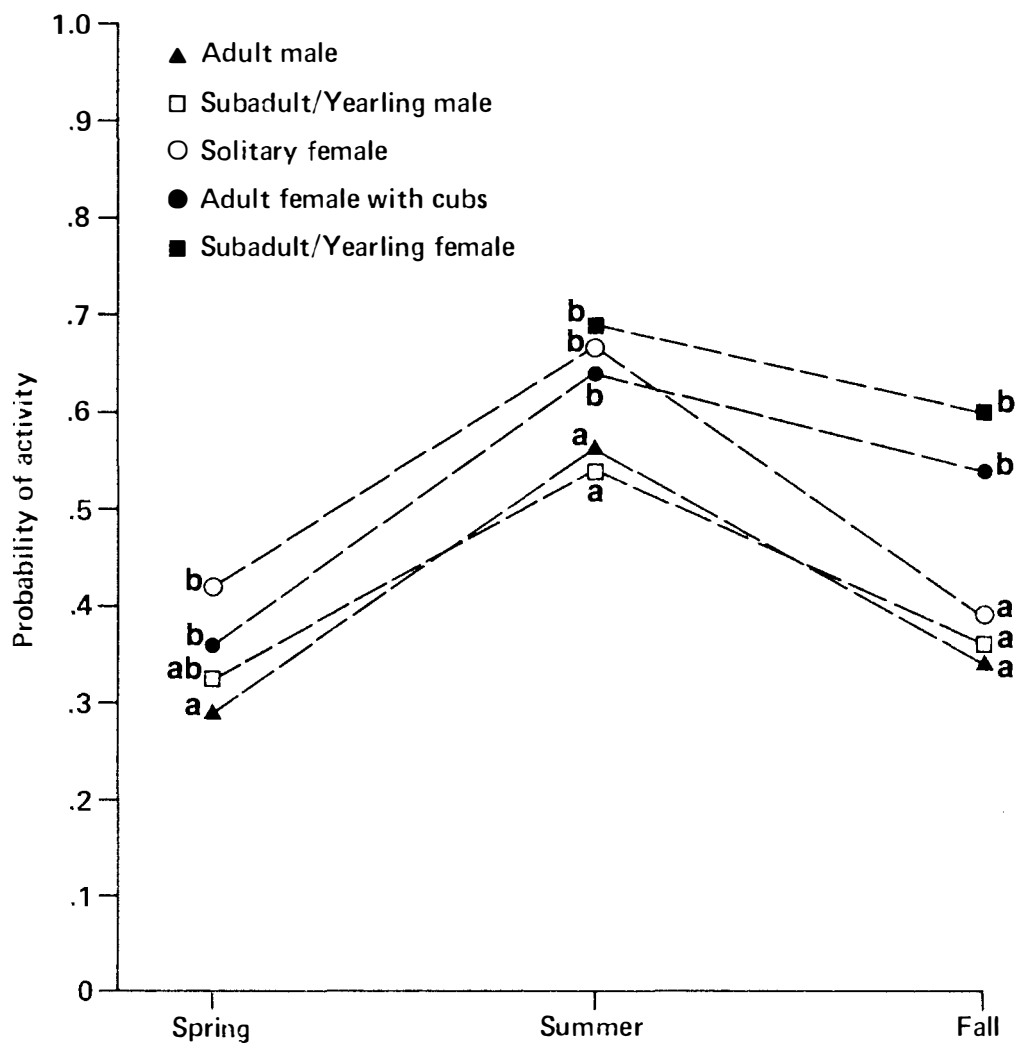

Figure 9. Seasonal differences in activity among different sex and age groups and between females with and without cubs. Different symbols denote differences at the 0.05 level.

production. (2) Since females with cubs lose weight from den emergence through mid-summer (Eiler 1981:62), added foraging may be needed to replace this loss and to add fat stores for denning. (3) The mere presence of cubs and the parental care that must be maintained, plus the added factors of physiological changes associated with the approach of the denning period (Nelson et al. 1973) and the change in food regime and diet (Eagle 1979, Beeman and Pelton 1980) may be responsible for the greater activity in fall of females with cubs. Garshelis and Pelton (1980:17) also found only a small decline in the activity of females with cubs from summer to fall.

Home Range Analysis

The bivariate elliptical method of home range calculation has some highly desirable characteristics but its practical application with data from this project was not acceptable. The point scatters of many of the locations of bears led to rejection of the estimate because the assumption of a bivariate normal distribution could not be met. These scatters of locations resulted from both wide-ranging movements of bears and the tendency for bears to remain in one small area for periods of time. This produced highly dispersed distributions and/or highly clumped distributions, respectively. In an attempt to bring the F values for skewness and kurtosis (numerical indices of deviations from the normal distribution) into acceptable levels (dropped from $P=0.05$ to $P=0.25$ during the process), points were eliminated from the analysis. First, using the method employed by Garshelis (1978:16), points less than 6 hours apart were dropped from analysis to meet the assumption of independence of each point. When

this did not result in an acceptable estimate, a visual assessment was made of the scatter; points were then dropped to adjust for skewness or kurtosis, or both. In most cases, the number of points dropped was unacceptable (sometimes over 50% of the total for a given bear) or the sample size fell below the level at which Koeppel et al. (1975) felt the model was reliable (20 points). Because of the above problem, convex polygon estimates of home range are used in this study. For the sake of comparison, elliptical estimates were computed for annual home ranges and the normality descriptions presented (Appendix D).

Two factors are probably responsible for the fact that data from this study were unsuitable for the bivariate home range model whereas the data obtained by Garshelis was suitable: the younger average age of the study population and more frequent aerial locating of bears in the Bunker Hill study. Erratic movements of younger bears resulted in unstable home ranges for these animals, whereas older bears exhibit more stable home ranges with more centralized movements. The resultant scatter of points from young bears does not seem conducive to the proper use of the bivariate model. For example, tracking success is a measure of how often radio contact is made with study animals when they are sought in their normal area of movement. The tracking success in the Garshelis (1978) study was 91%, extremely high when compared to other telemetry studies on large mammals. But when an animal was not found in the usual tracking area, aerial support could usually not be obtained for a search (pers. com., pers. obser.). Garshelis did eliminate 2 home ranges from analysis with the ellipse because they could not meet normality assumptions; aerial

support might have produced more unacceptable estimates. Although tracking success was not maintained for the Bunker Hill study, it would probably fall considerably below 91% (most likely in the 80-85% range). However, the basic difference is that, barring weather constraints, in the present study aerial searches were conducted on a regular basis or when an animal could not be found in its normal area. The result is that more, and larger, extensive movements of bears were recorded in the GSMNP than were recorded previously.

It is likely that the convex polygon method underestimates the home range sizes of bears. However, in many cases the bivariate elliptical model overestimates home range sizes (Jorgensen and Tanner 1963, Waldschmidt 1979) and has the additional problem of the normality assumption. It must be kept in mind that home ranges determined from the convex polygon method are probably estimates of the minimum area needed for bears. It should be noted also that travel routes between distinct areas are included in these polygon estimates, even when locations between them were not obtained (p. 17).

Home Range Size

Twenty-two individual bears were radio-collared during the 16 months of this study (excluding the winter denning period), resulting in a combined total of 46 calculated seasonal and annual home range estimates (Appendix E). The tracking period for some bears was not long enough for home ranges to be calculated due to premature loss of breakaway (or non-static) radio-collars, bear mortality, mid- to late-season trapping, and unexplained disappearances

(Fig. 1, p. 6). The following comparisons, made within this study and between this and other studies, are performed with home ranges determined by the convex polygon method.

Annual home ranges for males were significantly larger ($P < 0.05$) than those of females; the mean area occupied by males ($n=5$) and females ($n=6$) was 32.1 km^2 and 5.2 km^2 , respectively. All 3 seasonal comparisons also revealed significantly larger ($P < 0.05$) estimated home ranges for males than for females (Table 4). This sexual dimorphism with respect to home range size in black bears has been reported for black bears in Washington (Lindzey and Meslow 1977), Minnesota (Rogers 1977), West Virginia (Brown 1980), Pennsylvania (Alt et al. 1976, Alt et al. 1980), California (Novick 1982), and the GSMNP (Garshelis and Pelton 1981), regardless of the method used to calculate the area. One explanation for this seemingly universal characteristic is the sexual dimorphism of body size and weight in black bears. Due to the larger size, the male requires a higher food intake for metabolic maintenance than does the female. Harestad and Bunnell (1979) found that omnivores (including black bears) had the highest correlation ($r^2=0.75$) between home range size and body weight when compared with herbivores ($r^2=0.75$) and carnivores ($r^2=0.81$). Although empirical relationships do exist between home range size and body weight, the dynamics of home range, including size, are under the influence of several factors.

A full assessment of home range cannot be accomplished without understanding the influences of the available food regime and social interactions on bear movements. Amstrup and Beechum (1976), Rogers

Table 4. Annual and seasonal home range sizes (km²) for black bears in the CSMNP, 1978-1979.

Sex/Age Category	Spring Home Range			Spring/Summer Home Range			Fall Home Range			Annual Home Range		
	\bar{X}	Range	n	\bar{X}	Range	n	\bar{X}	Range	n	\bar{X}	Range	n
Subadult males	-	-	-	18.7	13.1-27.7	3	41.0	11.9-80.5	4	39.2	-	1
Adult males	3.6	0.9-6.3	2	14.0	5.3-28.8	5	14.9	11.0-19.3	3	30.4	14.4-46.8	4
Combined males	-	-	-	15.8	5.3-28.8	8	29.8	11.0-80.5	7	32.1	14.4-46.8	5
Subadult females	-	-	-	3.0	2.2-3.8	2	7.8	1.7-22.8	6	4.4	3.8-5.1	2
Adult females	1.2	0.9-1.6	2	2.7	2.0-3.8	4	4.7	1.9-9.4	4	5.5	2.7-10.8	4
Combined females	-	-	-	2.8	2.0-3.8	6	6.6	1.7-22.8	10	5.2	2.7-10.8	6

(1976, 1977), and Garshelis and Pelton (1981) present evidence of the effects that phenology, knowledge of food sources, and food concentrations can have on black bear movements. Phenological changes in the food regime can bring about changes in the amount of area a bear needs due to different foraging strategies required for different food sources (straight-line distances will be discussed under movements). A typical annual food cycle for bears in the GSMNP is generally characterized by usage of grasses and herbs in the spring, shrub-borne soft mast in the summer, and tree-borne hard mast in the fall, with interspersions of colonial insects, squaw root (Conopholis americana), and tree-borne soft mast (Prunus sp.) (Eagle 1979, Beeman and Pelton 1980). Eagle (1980) found that the shift from berries to hard mast in the Hannah Mountain area (within the area of this study) occurred during September. This change in the available food resource and the differences in the distribution of these resources appears to be reflected in the seasonal differences in home range size. Both males and females exhibited significantly larger ($P < 0.05$) home ranges in the fall than in the spring/summer (Table 4). Gaylussacia spp. and Vaccinium spp., the main berry-producing species in the area, are found in continuous, sometimes very dense, mats along ridge tops and on almost all southern exposures down through the upper 2/3 of the ridge (Harmon 1981, pers. obser.). In contrast, the hard mast producers (Quercus spp., Carya spp., Fagus sp.) are more widely dispersed in the area, although small, pocket concentrations of these species can be encountered (Harmon 1980, Garshelis and Pelton 1980, pers. observ.). Thus, bears foraging in

the summer can stay with the food resource almost constantly, while in the fall bears must travel more to find food. Trees producing hard mast were found in higher concentrations in the study area of Garshelis (1978) in the GSMNP and no difference in the sizes of spring/summer and fall home ranges was found within the sexes of bears of that study.

Learning should have important effects on an animal's ability to utilize food sources efficiently (amount of food found/distance moved). Thus, young animals, either through experimentation or transfer of information from the parent, are likely able to determine areas where the available foraging reward is highest, given the time of year.

If the above is true, one effect that can be expected is a reduction in home range size with time as the animal becomes acquainted with the dynamics of the food regime in the area. Of the 8 home ranges of bears in this study where 2 years of data are available, home ranges of 5 bears remained relatively stable and 3 displayed drastic, significant ($P < 0.05$) decreases in size with increase in age (Table 4). Social influences and yearly fluctuations in the food supply can also modify home range size, but this decrease was accompanied by weight increases expected in the early age classes (Eiler 1981) and the resultant increase in metabolic needs. It is interesting to note also that the mean annual home range size for subadult females is smaller than the mean annual home range size of adult females (Table 4). Although sample sizes are small, this may reflect the different social

influences on the sexes since subadult and adult males display little difference in mean annual home range size (Table 4).

Social relationships of cryptic species, such as black bears, are difficult to ascertain because direct observation of conspecific interactions in the wild is rare. Using radio-telemetry, some inferences can be made about how bears relate to each other spatially. Home range overlap was analyzed for the study area when sufficient information was available. Since all bears were not radio-collared in the area, a full assessment cannot be made, but some suggestions can be. In 1979, the only year with several annual home ranges available, extensive overlap was recorded for adult males, but very little for adult females (Fig. 10 and Fig. 11, respectively). Males averaged 50% overlap with other males; females averaged 11% overlap with other females. Rogers (1977) presented evidence that adult females were at least partially territorial in his study area, showing little tolerance for other females within their home ranges. Information from this study may be a reflection of a similar situation in the GSMNP. Another feature which Rogers found is that female offspring were able to establish home ranges within, or with a high degree of overlap of, their mother's home range. Garshelis (1978) presents evidence for this social organization in the GSMNP. The high degree of overlap (Fig. 12) and the age differences between bears E7 and 403 may be a consequence of this feature (E7 was 7 to 9 years old, 403 was 3 years old).

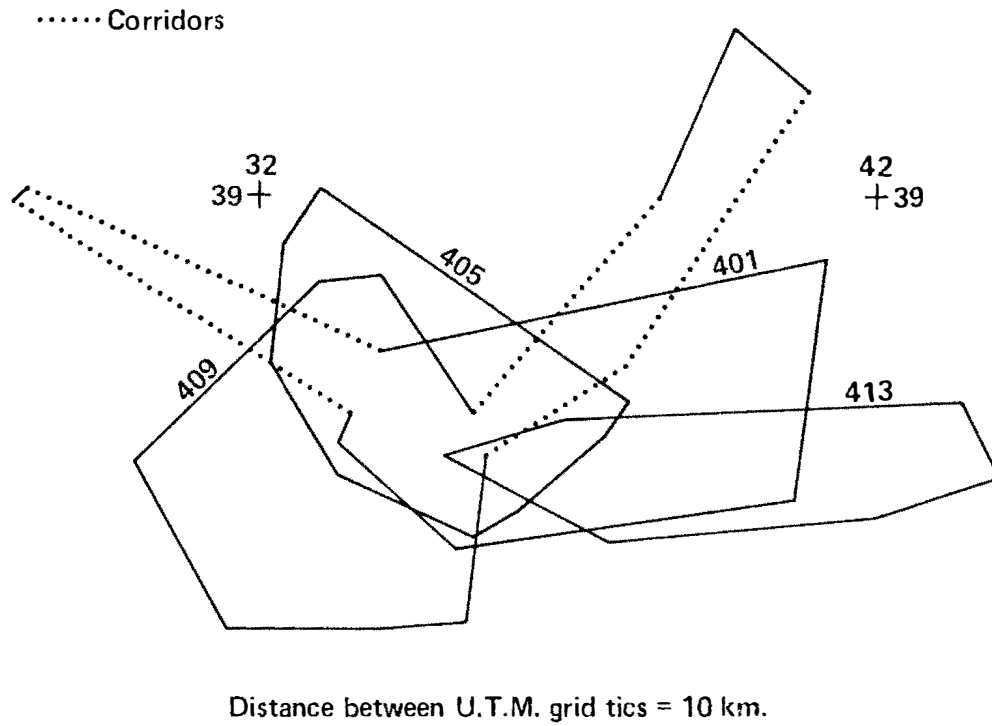
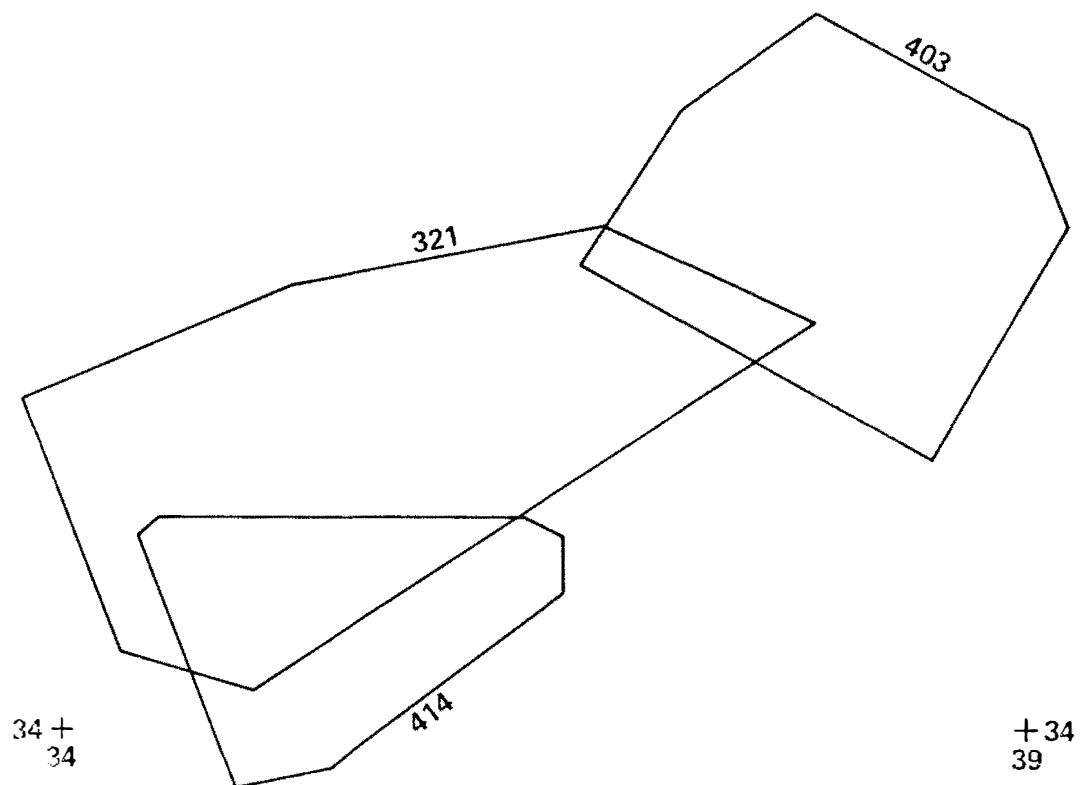

Figure 10. Annual home ranges of 4 adult male black bears in the GSMNP, 1979. Broken lines define corridors between widely separate areas of use.



Distance between U.T.M. grid tics = 5 km.

Figure 11. Annual home ranges of 3 female black bears in the CSMNP, 1979.

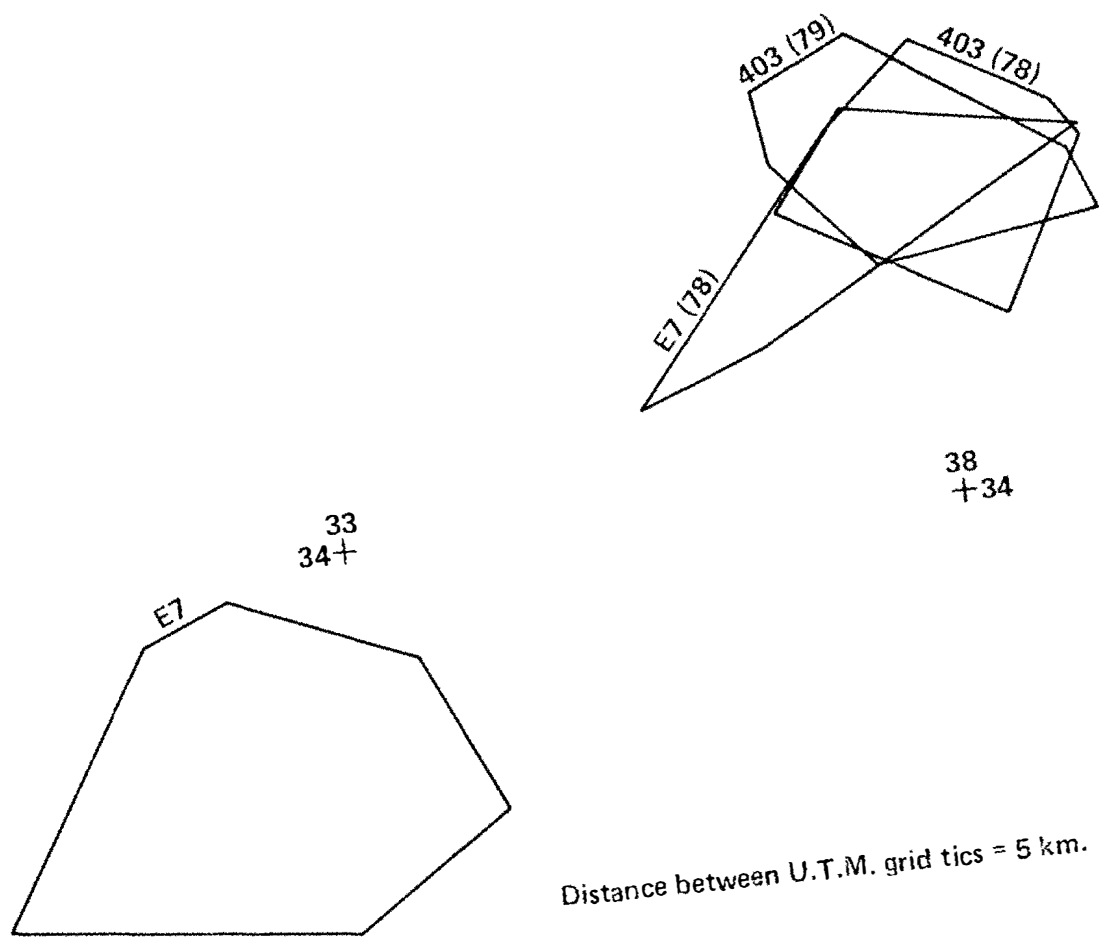

Figure 12. Home range overlap of 2 female black bears in the GSMNP, 1978-1979.

Notable Movements

As stated earlier, many large movements were recorded for the radio-collared bears in this study. Many of these movements are of interest from a land management point of view in relation to Park boundaries and hunting or they display interesting or unusual patterns. An extensive movement is defined as one in which a bear moved from its defined normal area at least a distance equal to the width of the normal area, or movements which showed little centralization over a large area; 7 bears made 8 such movements. None of the bears was over 5 years old (average age 3.1 years); 6 of the 7 were males. Two of the 8 movements terminated in the bear being shot to death, 1 legally, 1 illegally. All 8 movements occurred between 1 August and 8 December. Appendix F presents the information related to these 8 movements. The 3 largest movements are worthy of note.

Bear 401, a male, was first captured 28 June 1978. His following radio-locations were highly localized for July and early August of that year. The last radio location on 401 for 1978 was on 12 August; extensive aerial searches did not relocate the bear. On 24 September 401 was captured by state wildlife officers in Hartford, Tennessee, approximately 70 km east northeast of his normal range. The officers removed the radio-collar (which was still functioning) and transported 401 to Andrew Johnson Wildlife Management Area, approximately 25 km further from the study area, where he was released. On 6 June 1979, 401 was retrapped in the study area, thus displaying an example of homing over 90 km. The bear was recollared and routinely located in the study area through October of 1979. His October home range

was a relatively small 15 km². On 3 November, 401 was located from the air 8 km northwest of his 31 October location which was within his normal home range. On 5 November he was located near the 3 November location. On 7 November the collar was found in Chilhowee Reservoir. Reports from people in the area were that 401 was seen swimming the reservoir in the afternoon of 6 November, moving in the direction of the Park. Poachers trailed the bear with dogs and killed it shortly after it exited the water.

Bear 406, also a male, was captured on 13 August 1978, as a yearling. Between 18 November and 27 November he moved 10 km north, to the edge of the study area and the Park and back south to the North Carolina-Tennessee border. On 10 October he was located in Cherokee National Forest, 20 km southwest of his normal home range, where he remained through 9 November (Fig. 13). On 18 November he was located back in the study area and soon returned to his spring/summer home range where he dened.

Bear 411, also a male, was trapped 25 August 1978. On 1 September he was located in the study area but contact was lost on subsequent days until extensive aerial searches succeeded in locating him about 8 km west of Robbinsville, North Carolina, in the Snowbird Mountains, 26 km south of his previous location (Fig. 13). The last 3 locations on 411 document his return north and then back south, a straight-line distance of at least 25 km on each leg:

- (1) 18 October, located about 10 km west of Robbinsville,
- (2) 24 October, located near the southern end of Calderwood Lake, just outside of the

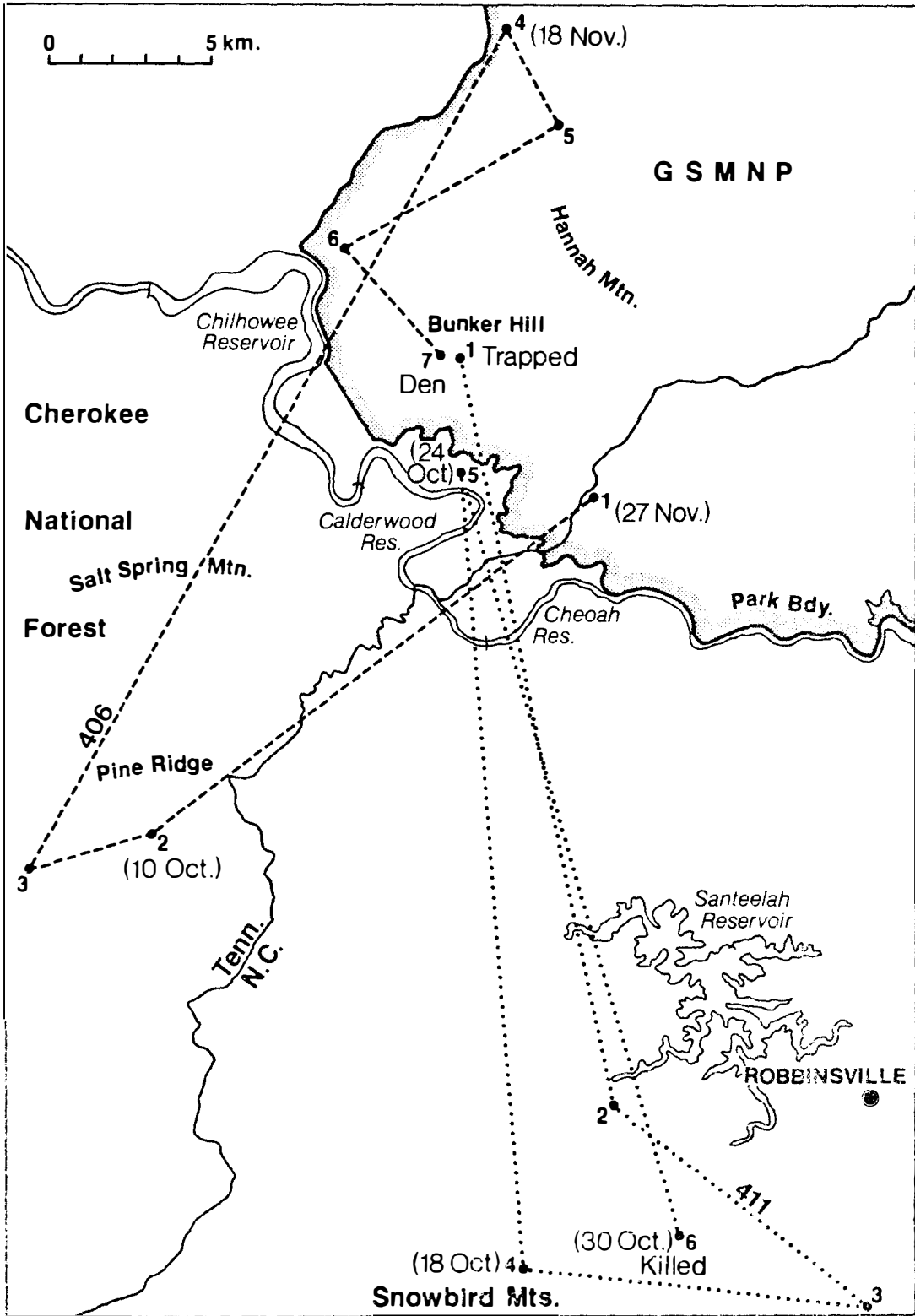

Figure 13. Extensive movements from the Bunker Hill study area, GSMNP, by bears 406 and 411, 1978.

Park, and (3) 30 October, killed in a legal hunt in the Snowbird Mountains.

Movements such as the ones described above are not unheard of in the GSMNP and are not unusual for black bears in general, but the reasons for them are far from fully understood. Tag returns by individuals and by state game agents in North Carolina and Tennessee have documented several extensive movements by wild black bears in the GSMNP, but few have been documented with telemetry. Garshelis (1978) documented at least 3 such extensive movements, 2 of which ended with the bear's death from hunters outside of the Park. Rogers (1977) reported many such extensive movements, several of which were called dispersal movements. Since the birth places of the bears in the Bunker Hill area were not known, it is unclear how their movements can be viewed in terms of dispersal. However, tracking success increased with time as bears reduced and centralized their movements, indicating the beginning of establishment of stable home ranges, it is likely that dispersal had already occurred with most individuals. Information on estrus presented by Eiler (1981) indicates that most mating activity by black bears in the GSMNP ceases by mid-August. Thus, the young age of these animals and the fact that reproductive pressures were small, if not non-existent, by the time these movements occurred, indicates that breeding influences are not likely the cause of these movements.

In view of the above, it appears that the food resource is responsible for the large movements but social pressures are also implied. Since these movements all were recorded in the late summer

or fall months, they could be a response to the patchier distribution of hard mast than berries; these extensive movements would be required in order to meet metabolic needs.

The lack of females with extensive movements also implicates social influences as a major cause of such movements. Rogers (1977) found that young female black bears were able to establish home ranges next to or overlapping their mother's home range, whereas males dispersed to establish home ranges in other areas. Garshelis (1978) also found evidence that this same organization was taking place in the GSMNP. Females would show much more cohesiveness to an established area than males.

In relation to Park borders, of the 21 back-country bears radio-tracked during this study, 5 males and 1 female (28%) were located outside the Park boundaries at some time. These bears moved from the Park to the outside lands at least 15 times during all months except December. The unpaved Parson Branch Road did not act as a boundary to bear movements and in fact, transected the home ranges of many bears. State highway 129 also did not appear to hamper bear movements; all bears that moved to the area outside the Park crossed the highway. Although the edge of Calderwood Reservoir acted as a small section of the border of the home range of 1 bear (E7), the locations of 5 other bears led to the conclusion that they swam reservoirs in the area a minimum of 8 times, indicating that water was not a barrier to movements.

Diel Movements

Diel movements of bears from this study were difficult to interpret because of problems with sampling. When diel radio-tracking was performed from stationary mast antennas, only the bears that were in the core of the study area could be monitored. This usually presented no problem in the summer because most animals were present there; but it was difficult to find enough animals in the core area during the fall months to make diel tracking worthwhile. As a result, sample sizes in the fall, especially for males, were small and interpretation of the results must be viewed with care. Also, because of the small sample sizes, significance tests were not performed on data from males in the fall.

The only significant difference ($P < 0.05$) between daily movement parameters (Table 5), tested over season and sex, was in circuitry. Males had significantly less circuitous travel routes than did females; this would be expected given the much larger home ranges of males. But other parameters (i.e. rates of travel) do not reflect greater movement of animals in the fall than in the spring/summer that would be expected given the larger fall home ranges. This is probably not reflected due to the sampling limitations as mentioned earlier; the bears that were not on long forays were apparently very sedentary.

No sex differences were noted in the comparison of hourly movements (Table 6) but overall travel rates for the "diurnal" hours (0600-2200) were significantly ($P < 0.05$) greater than those for "nocturnal" hours (2300-0500). The above was true for both

Table 5. Daily movement parameters of black bears in GSMNP, 1978-1979 (distance in kilometers).

Category	Total Daily Movement				Net Daily Movement			Circuitry			Daily Range Length			
	\bar{X}	S.D.	Max.	n	\bar{X}	S.D.	n	\bar{X}	S.D.	n	\bar{X}	S.D.	Range	n
<u>Spring/summer</u>														
Females	9.6	3.4	16.8	8	0.8	0.3	8	0.1	0.1	8	2.1	0.4	1.5-2.5	7
Males	8.8	4.0	14.2	9	1.4	1.4	9	0.2	0.2	9	2.1	1.2	0.8-5.1	11
Total	9.2	3.7	-	17	1.1	1.1	17	0.2	0.1	17	2.1	1.0	-	18
<u>Fall</u>														
Females	7.8	3.2	13.3	5	0.7	0.2	5	0.1	0.0	5	1.4	0.6	0.9-2.3	5
Males	5.0	2.3	6.3	2	0.6	0.2	2	0.1	0.0	2	0.9	0.3	0.7-1.1	2
Total	7.0	3.1	-	7	0.7	0.2	7	0.1	0.0	7	1.2	0.5	-	7

Table 6. Hourly movement parameters of black bears in GSMNP, 1978-1979 (km/hr).

Category	Mean Diurnal (0600-2200) Rate of Travel			Mean Nonturnal (2300-0500) Rate of Travel			Maximum Hourly Rate
	\bar{X}	(S.D.)	n	\bar{X}	(S.D.)	n	
<u>Spring/summer</u>							
Females	0.46	(0.16)	11	0.27	(0.09)	7	0.70
Males	0.46	(0.22)	11	0.21	(0.11)	10	0.59
Total	0.46	(0.19)	22	0.24	(0.11)	17	
<u>Fall</u>							
Females	0.43	(0.18)	5	0.27	(0.20)	6	0.56
Males	0.25	(0.12)	2	0.14	(0.06)	2	0.27
Total	0.37	(0.18)	7	0.24	(0.18)	8	

spring/summer and for fall seasons. This higher rate of movement of bears for the "active" period is expected given the activity pattern displayed by bears in this study (p. 35). The maximum hourly rate of travel recorded overall was 2.3 km, by a male (401), during daylight hours.

Garshelis et al. (in press) compared the daily and hourly movement parameters of black bears in the Bote Mountain area of the GSMNP to those of the present study. Comparisons during fall, again, are probably not justified due to small samples. However, most differences between the 2 areas occurred in spring/summer. Hourly rates of movement of bears for this season, both diurnal and nocturnal, plus total daily movements, were significantly greater ($P < 0.05$) in the Bunker Hill area than in the Bote Mountain area, for males and females; this may reflect the different age structures between the 2 areas or different food regimes. The mean age of radio-collared bears, and of the subpopulations in general, for the 2 areas were significantly different ($P < 0.05$); the Bunker Hill area had younger bears. Thus, the greater movements of bears in the Bunker Hill area may be a reflection of the instability in the younger age classes as they were establishing home ranges and becoming familiar with conspecifics and the food availability of those areas; older bears had likely established this familiarity and, thus, require less movement.

Habitat differences in the 2 areas may also produce differences in the rate of travel of bears due to different foraging strategies required. Garshelis et al. (1981) speculated that the contrasting

food regimes of the 2 areas, especially in the late spring and early summer, required the bears in the Bunker Hill area to travel longer distances. Citing food habits work by Eagle (1979), they pointed out that the herbaceous diet of the Bote Mountain bears likely required less movements by bears than the diet of berries (Vaccinium spp.) and squawroot found in the Bunker Hill area for spring/summer.

Habitat Utilization

From the total of 1619 locations obtained on 22 black bears, 1058 were coded into the IMGRID system for analysis of habitat utilization. The loss of 561 locations (35%) is due to locations outside the 5300 ha IMGRID coded area and to presence-or-absence coding which does not allow more than 1 location per cell (1 ha). The presence-or-absence coding system can also cause reduced sample sizes when sex, age, and season groups are combined to form new elements for analysis (i.e. subadult male locations combined with adult male locations = male locations). The coded bear locations were used to analyze utilization of predicted areas of hard mast producing overstory, predicted areas of soft mast understory (heath), use of areas in proximity of roads and trails, and elevational distribution.

Utilization of Mast Producing Overstory

The search using the predictive model for mast overstory (p. 21 and Appendix A) found that half of the 5300 ha was considered to be mast-producing (2650 ha). An overall chi-square analysis of the mast and non-mast areas revealed significant differential use by bears ($P < 0.01$, Table 7). The Bonferroni approach (Neu et al. 1974)

Table 7. Utilization of predicted mast overstory by 22 black bears in the GSMNP, 1978-1979.

Category	Total Area(ha)	Proportion of Total Area ^a	Locations in Category	Locations Expected in Category ^b	Proportion of Locations in Category	Confidence Interval ^c
Mast	2650	0.50	589	529	0.557	0.527 - 0.587
Non-Mast	2650	0.50	468	529	0.443	0.413 - 0.473
Total	5300		1057			

^a Proportion of total area represents expected bear locations as if bears occurred in each type in proportion to its availability.

^b Calculated by multiplying proportion of total area x total locations (i.e. 0.50 x 1047 = 529).

^c 90% simultaneous, 95% individual (Neu et al. 1974).

was used to determine the area and degree of differential use. Mast-producing areas were used more than expected by bears and non-mast-producing areas were used less than expected ($P=0.10$). To further test this differential use, sex, age, and seasonal breakdowns were tested.

Males were found to use areas of mast-producing trees in approximately the expected proportion ($P>0.10$), whereas females displayed a preference for these areas ($P<0.10$, Tables 8 and 9, respectively). Age was also found to be a significant influence on the differential use of the areas of mast-producing trees when sub-adult and adult groups were tested (chi-square, $P<0.01$, Tables 10 and 11, respectively). Both groups used the mast areas more than expected but adult bears had a stronger preference (Table 11) than did subadults (Table 10) who were only slightly into the significant range ($P=0.10$ simultaneous, $P=0.05$ individual). Over the 4 seasonal groups (spring, summer, September, fall) no differential use of mast areas by bears was found (chi-square, $P>0.10$). However, when tested individually, spring (Table 12) and September (Table 13) bear locations still displayed no significance ($P>0.10$) while both summer (Table 14) and fall (Table 15) bear locations displayed a marked preference for the areas of mast-producing trees ($P<0.10$), in approximately equal degree.

The sex difference in mast area utilization found in the Bunker Hill area is in contrast to that found by Garshelis and Pelton (1981) in the Bote Mountain area of the GSMNP. Whereas females displayed a preference for the mast areas in this study, in the Bote Mountain

Table 8. Utilization of predicted mast overstory by 12 male black bears in the GSMNP, 1978-1979.

Category	Total Area (ha)	Proportion of Total Area ^a	Locations in Category	Locations Expected in Category ^b	Proportion of Locations in Category	Confidence Interval ^c
Mast	2650	0.50	268	261	0.512	0.469 - 0.555
Non-Mast	2650	0.50	255	261	0.488	0.445 - 0.531
Total	5300		523			

^a Proportion of total area represents expected bear locations as if bears occurred in each type in proportion to its availability.

^b Calculated by multiplying proportion of total area x total locations (i.e. $0.50 \times 523 = 261$).

^c 90% simultaneous, 95% individual (Neu et al. 1974).

Table 9. Utilization of predicted mast overstory by 10 female black bears in the GSMNP, 1978-1979.

Category	Total Area (ha)	Proportion of Total Area ^d	Locations in Category	Locations Expected in Category ^b	Proportion of Locations in Category	Confidence Interval ^c
Mast	2650	0.50	373	306	0.609	0.570 - 0.648
Non-Mast	2650	0.50	239	306	0.391	0.352 - 0.430
Total	5300		612			

^d Proportion of total area represents expected bear locations as if bears occurred in each type in proportion to its availability.

^b Calculated by multiplying proportion of total area x total locations (i.e. $0.50 \times 612 = 306$).

^c 90% simultaneous, 95% individual (Neu et al. 1974).

Table 10. Utilization of predicted mast overstory by 14 subadult black bears in the CSMNP, 1978-1979.

Category	Total Area (ha)	Proportion of Total Area ^a	Locations in Category	Locations Expected in Category ^b	Proportion of Locations in Category	Confidence Interval ^c
Mast	2650	0.50	271	248	0.547	0.503 - 0.591
Non-Mast	2650	0.50	224	248	0.453	0.409 - 0.497
Total	5300		495			

^a Proportion of total area represents expected bear locations as if bears occurred in each type in proportion to its availability.

^b Calculated by multiplying proportion of total area x total locations (i.e. $0.50 \times 495 = 248$).

^c 90% simultaneous, 95% individual (Neu et al. 1974).

Table 11. Utilization of predicted mast overstory by 14 adult black bears in the GSMNP, 1978-1979.

Category	Total Area(ha.)	Proportion of Total Area ^a	Locations in Category	Locations Expected in Category ^b	Proportion of Locations in Category	Confidence Interval ^c
Mast	2650	0.50	359	316	0.568	0.529 - 0.607
Non-Mast	2650	0.50	273	316	0.432	0.393 - 0.471
Total	5300		632			

^a Proportion of total area represents expected bear locations as if bears occurred in each type in proportion to its availability.

^b Calculated by multiplying proportion of total area x total locations (i.e. $0.50 \times 632 = 316$).

^c 90% simultaneous, 95% individual (Neu et al. 1974).

Table 12. Utilization of predicted mast overstory in spring by 7 black bears in the GSMNP, 1978-1979.

Category	Total Area (ha)	Proportion of Total Area ^a	Locations in Category	Locations Expected in Category ^b	Proportion of Locations in Category	Confidence Interval ^c
Mast	2650	0.50	46	41	0.561	0.454 - 0.668
Non-Mast	2650	0.50	36	41	0.439	0.332 - 0.546
Total	5300		82			

^a Proportion of total area represents expected bear locations as if bears occurred in each type in proportion to its availability.

^b Calculated by multiplying proportion of total area x total locations (i.e. $0.50 \times 82 = 41$).

^c 90% simultaneous, 95% individual (Neu et al. 1974).

Table 13. Utilization of predicted mast overstory in September by 16 black bears in the GSMNP, 1978-1979.

Category	Total Area (ha)	Proportion of Total Area ^a	Locations in Category	Locations Expected in Category ^b	Proportion of Locations in Category	Confidence Interval ^c
Mast	2650	0.50	112	106	0.531	0.464 - 0.598
Non-Mast	2650	0.50	99	106	0.469	0.402 - 0.536
Total	5300		211			

^a Proportion of total area represents expected bear locations as if bears occurred in each type in proportion to its availability.

^b Calculated by multiplying proportion of total area x total locations (i.e. 0.50 x 211 = 106).

^c 90% simultaneous, 95% individual (Neu et al. 1974).

Table 14. Utilization of predicted mast overstory in summer by 22 black bears in the GSMNP, 1978-1979.

Category	Total Area (ha)	Proportion of Total Area ^a	Locations in Category	Locations Expected in Category ^b	Proportion of Locations in Category	Confidence Interval ^c
Mast	2650	0.50	264	233	0.567	0.522 - 0.612
Non-Mast	2650	0.50	202	233	0.433	0.388 - 0.478
Total	5300		466			

^a Proportion of total area represents expected bear locations as if bears occurred in each type in proportion to its availability.

^b Calculated by multiplying proportion of total area x total locations (i.e. 0.50 x 466 = 233).

^c 90% simultaneous, 95% individual (Neu et al. 1974).

Table 15. Utilization of predicted mast overstory in fall by 14 black bears in the GSMNP, 1978-1979.

Category	Total Area(ha)	Proportion of Total Area ^a	Locations in Category	Locations Expected in Category ^b	Proportion of Locations in Category	Confidence Interval ^c
Mast	1650	0.50	180	161	0.561	0.514 - 0.608
Non-Mast	2650	0.50	141	161	0.439	0.392 - 0.486
Total	5300		321			

^a Proportion of total area represents expected bear locations as if bears occurred in each type in proportion to its availability.

^b Calculated by multiplying proportion of total area x total locations (i.e. 0.50 x 321 = 161).

^c 90% simultaneous, 95% individual (Neu et al. 1974).

area it was found that males showed a stronger attraction to such mast areas than did females. Males shifted to areas of oak concentration while females usually shifted to a lesser degree. In the Bunker Hill area, large shifts by males were also common in the fall but these movements often took males outside the IMGRID area of analysis. Perhaps these outside locations were in areas of high mast concentration and if analyzed would reveal male attraction to oaks as well. But these outside movements exhibited no tendency toward a central area as was found with bears of the Bote Mountain area (Garshelis and Pelton 1981:918-119). Rather, the movements of males in the Bunker Hill area in the fall produced a dispersed pattern of locations with some clustering of points for short periods of time; analysis of the habitat in these areas was not undertaken.

The differences between sexes in the use of areas of mast trees in the Bunker Hill area may be due to social influences. If it is assumed that female offspring are able to establish home ranges within or overlapping the home range of their mother, while male offspring must disperse (p. 58), then young females may have a distinct advantage in familiarity with locations of sources of food. During the time that offspring travel with their mother (1-1 1/2 years) they not only learn what to eat but also the location of sources of food within the home range of the mother. When the offspring leave their mother, the female offspring are likely able to take immediate advantage of their knowledge of the area because they are able to utilize, at least partly, the area with which they are familiar. Males, on the other hand, must establish residence in a new area

socially, and must learn the dynamics of the food sources there. Thus, the foraging efficiency of males and resultant preferences for certain areas may not appear until the ages of 5 or 6 when they have dispersed, established a stable home range, and had sufficient time to encounter the variations in spatial concentrations of food sources.

In addition, Garshelis and Pelton (1981:918) found that heavier (likely dominant) males used areas of higher oak concentrations in the fall than did lighter (likely subordinate) males. The 3 heaviest males in their study were between 93 and 117 kg. In the Bunker Hill area only 1 male was known to have reached 90 kg and this bear removed its collar twice, was never radio-tracked for more than 3 months, and was never tracked during the fall months when the preference for mast type should be strongest. The other 2 large males of this study, 401 (82 kg) and 417 (86 kg), likewise were not radio-tracked for long periods (Fig. 1, p. 6). As a result, data on large males are inadequate to make conclusions about their use of mast tree areas or the effect that these larger males may have on utilization of mast tree areas by smaller males.

The higher degree of preference for areas of mast trees shown by adult bears over subadult bears may be a reflection of the dominance by larger and likely older bears suggested by Garshelis and Pelton (1981) since older bears tend to be heavier (Eiler 1981). However, this also may be interlaced with the effect of learned behavior. Increased age should result in increased experience with the variabilities in success of foraging in an established area. Increased experience should result in an increased preference for

areas where important food sources exist. This positive reinforcement was demonstrated by Herrstein (1971) with animals in experimental situations. Where black bears now exploit human foods, especially in national parks, it has been suggested that this is a learned behavior, rewarded by food, in which they have overcome innate fear of humans (Graber 1981, Eagar and Pelton 1978). Rogers (1977) found that female black bears with experience outside of their normal home range would move out to utilize these areas during years of food scarcity, resulting in higher reproductive success in these individuals. In the same study, it was found that older bears were less prone to nutrition-related mortality than younger bears, again possibly an example of the important role which experience and learning play in foraging success.

Seasonally, the preference found for the areas of mast trees in the fall (Table 15) is to be expected given that acorns are the major food item at this time. However, mast areas were also found to be preferred during the summer; this may be a result of the overlap of the mast and berry areas (berries being the major food in the summer). A comparison of the predictive model for mast (Appendix A) with that for heath (Appendix B) shows that 4 of the 9 combinations used to predict mast overstory were also used to predict heath understory. Thus, use of mast areas by bears during summer may reflect understory preference rather than overstory preference since acorn fall in eastern Tennessee normally does not begin until late August (Strickland 1972:16). Since acorns do not begin to fall until late August, one might expect to see a preference for the mast areas in September, but this was not found. In fact, although not significant

($P > 0.10$), in September mast areas were used with less frequency than their proportion of occurrence overall (Table 14); the protracted berry season (p. 38) may be responsible for this because, although acorns may be available in September and even offer nutritional superiority over berries (Eagle 1979), there may be little incentive to move to mast areas if berries continue to be abundant. The above is especially true if bears can utilize both sources in the same area (as found above in comparing the 2 predictive models). Alternate food sources may also complicate this picture. Although Eagle (1979) did not find grapes (Vitis spp.) to be a food item in the area in either year of his investigation (1976-1977) all 5 scats collected or observed during September 1978 in the Bunker Hill area contained over 80% grape fragments or pulp (pers. obser.). In years of grape abundance bears may switch from berries to grapes in the early fall before switching to acorns. Eiler (1981:73) also noted the abundance of wild grapes in 1978 and suggested that grapes may have a cushioning effect on black bears as an alternate food source in years of hard mast scarcity. Garshelis and Pelton (1981:919) found evidence that the abundance of black cherry (Prunus serotina) in a bear's spring/summer home range may delay movement to areas of oak abundance until cherries become scarce in October.

Utilization of Heath Understory

Berries of the genera Gaylussacia, Vaccinium, and Rubus were found to be the major summer food items of black bears in the GSMNP (Eagle 1979, Beeman and Pelton 1980). In the Bunker Hill area of

this study, Rubus sp. (blackberry) is of only minor importance in the diet of black bears, occurring in small, highly dispersed patches (pers. obser.). Eagle (1979) found that blackberries made up less than 5% of the summer diet in the Bunker Hill area (Hannah Mountain in Eagle 1979 = Bunker Hill area). On the other hand, Gaylussacia spp. (huckleberry) and Vaccinium spp. (blueberry) are found in abundance on the ridges of the Bunker Hill area. Eagle (1979) found that these 2 genera combined made up 65% or more of the summer diet of black bears in the area. The remainder of the summer diet was made up of small percentages (usually less than 5%) of grass and herbaceous material, squawroot, serviceberry (Amelanchier arborea), sassafras (Sassafras albidum), and insect and mammal remains. In addition, it was found that huckleberry and blueberry made up large proportions (17 to 52%) of the late spring and early fall diets of black bears in the Bunker Hill area. Therefore, areas of abundance of these 2 types of berries would be expected to be a major influence on where bears were located from late May through September.

The model for heath was used to predict areas of occurrence of the following species: Gaylussacia ursina, G. baccata, Vaccinium vacillans, V. hirsutum, and V. stamineum (Appendix B). The model was applied to the entire IMGRID study area (5300 ha) and found 1449 ha of heath (25% of 5300 ha). Overall, a chi-square test revealed no significant differential use by bears ($P > 0.50$) of heath or non-heath areas (Table 16). Sex, age, and seasonal breakdowns of bear locations were used to test for differential use that may be hidden in overall testing. No significant differential use of heath area was found

Table 16. Utilization of predicted heath understory by 22 black bears in the GSMNP, 1978-1979.

Category	Total Area (ha)	Proportion of Total Area ^a	Locations in Category	Locations Expected in Category ^b	Proportion of Locations in Category	Confidence Interval ^c
Mast	1449	0.273	303	289	0.286	0.259 - 0.313
Non-Heath	3851	0.727	755	769	0.714	0.687 - 0.741
Total	5300		1058			

^a Proportion of total area represents expected bear locations as if bears occurred in each type in proportion to its availability.

^b Calculated by multiplying proportion of total area x total locations (i.e. $0.273 \times 1058 = 289$).

^c 90% simultaneous, 95% individual (Neu et al. 1974).

($P > 0.10$) in any of the comparisons (Tables 16 through 24) except that of females (Table 18). Females displayed a preference for heath areas. This preference for heath by females and not by males may be a result of the same influences that brought about such differences in use of areas of mast trees (p. 78), i.e. familiarity with locations of food sources. The above adds strength to the idea that the adherence of females to areas generation to generation is an advantage over the situation for males, especially in the early years of life. The pattern, evidence, and ideas presented in the previous section on use of areas of mast trees are further strengthened by the following comparison of bear age groups in heath area utilization. Although the utilization of heath by subadults and adults (Tables 19 and 20, respectively) was not significant in either case ($P > 0.10$), adults displayed a higher degree of association to heath than subadults. Learning may also be implicated here as it was with the examination of usage by bears of areas of mast trees (p. 80).

Overall, though, the lack of preference for the heath type, in light of its importance as a good item, is worthy of note. Several factors could be involved. First, since breeding occurs during the summer, movements (and locations) may be related to factors other than foraging. Secondly, the diet of bears in the summer months is much more diversified than in the fall. Eagle (1979:40) found as many as 10 separate food items in the summer diet of black bears in the GSMNP. In contrast, a maximum of 5 items made up the fall diet. One item, oak, made up 83% of the fall diet in the Bunker Hill area (Eagle 1979:46). Therefore, with alternate food sources available

Table 17. Utilization of predicted heath understory by 12 male black bears in the GSMNP, 1978-1979.

Category	Total Area(ha)	Proportion of Total Area ^a	Locations in Category	Locations Expected in Category ^b	Proportion of Locations in Category	Confidence Interval ^c
Mast	1449	0.273	125	143	0.239	0.202 - 0.276
Non-Heath	3851	0.727	399	381	0.761	0.724 - 0.798
Total	5300		524			

^a Proportion of total area represents expected bear locations as if bears occurred in each type in proportion to its availability.

^b Calculated by multiplying proportion of total area x total locations (i.e. $0.273 \times 524 = 143$).

^c 90% simultaneous, 95% individual (Neu et al. 1974).

Table 18. Utilization of predicted heath understory by 10 female black bears in the GSMNP, 1978-1979.

Category	Total Area(ha)	Proportion of Total Area ^a	Locations in Category	Locations Expected in Category ^b	Proportion of Locations in Category	Confidence Interval ^c
Mast	1449	0.273	195	167	0.320	0.283 - 0.357
Non-Heath	3851	0.727	415	444	0.680	0.643 - 0.717
Total	5300		610			

^a Proportion of total area represents expected bear locations as if bears occurred in each type in proportion to its availability.

^b Calculated by multiplying proportion of total area x total locations (i.e. $0.273 \times 610 = 195$).

^c 90% simultaneous, 95% individual (Neu et al. 1974).

Table 19. Utilization of predicted heath understory by 14 subadult black bears in the GSMNP, 1978-1979.

Category	Total Area (ha)	Proportion of Total Area ^a	Locations in Category	Locations Expected in Category ^b	Proportion of Locations in Category	Confidence Interval ^c
Mast	1449	0.273	127	135	0.256	0.218 - 0.294
Non-Heath	3851	0.727	369	361	0.744	0.706 - 0.782
Total	5300		496			

^a Proportion of total area represents expected bear locations as if bears occurred in each type in proportion to its availability.

^b Calculated by multiplying proportion of total area x total locations (i.e. $0.273 \times 496 = 135$).

^c 90% simultaneous, 95% individual (Neu et al. 1974).

Table 20. Utilization of predicted heath understory by 14 adult black bears in the GSMNP, 1978-1979.

Category	Total Area(ha)	Proportion of Total Area ^a	Locations in Category	Locations Expected in Category ^b	Proportion of Locations in Category	Confidence Interval ^c
Heath	1449	0.273	190	173	0.300	0.264 - 0.336
Non-Heath	3851	0.727	444	461	0.700	0.664 - 0.736
Total	5300		634			

^a Proportion of total area represents expected bear locations as if bears occurred in each type in proportion to its availability.

^b Calculated by multiplying proportion of total area x total locations (i.e. 0.273 x 634 = 173).

^c 90% simultaneous, 95% individual (Neu et al. 1974).

Table 21. Utilization of predicted heath understory in spring by 7 black bears in the GSMNP, 1978-1979.

Category	Total Area(ha)	Proportion of Total Area ^a	Locations in Category	Locations Expected in Category ^b	Proportion of Locations in Category	Confidence Interval ^c
Mast	1449	0.273	17	22	0.207	0.119 - 0.295
Non-Heath	3851	0.727	65	60	0.793	0.705 - 0.881
Total	5300		82			

^a Proportion of total area represents expected bear locations as if bears occurred in each type in proportion to its availability.

^b Calculated by multiplying proportion of total area x total locations (i.e. $0.273 \times 82 = 22$).

^c 90% simultaneous, 95% individual (Neu et al. 1974).

Table 22. Utilization of predicted heath understory in summer by 22 black bears in the GSMNP, 1978-1979.

Category	Total Area(ha)	Proportion of Total Area ^a	Locations in Category	Locations Expected in Category ^b	Proportion of Locations in Category	Confidence Interval ^c
Mast	1449	0.273	121	127	0.260	0.220 - 0.300
Non-Heath	3851	0.727	345	339	0.740	0.700 - 0.780
Total	5300		466			

^a Proportion of total area represents expected bear locations as if bears occurred in each type in proportion to its availability.

^b Calculated by multiplying proportion of total area x total locations (i.e. 0.273 x 466 = 127).

^c 90% simultaneous, 95% individual (Neu et al. 1974).

Table 23. Utilization of predicted heath understory in September by 16 black bears in the GSMNP, 1978-1979.

Category	Total Area (ha)	Proportion of Total Area ^a	Locations in Category	Locations Expected in Category ^b	Proportion of Locations in Category	Confidence Interval ^c
Mast	1449	0.273	68	58	0.322	0.259 - 0.385
Non-heath	3851	0.727	143	153	0.678	0.615 - 0.741
Total	5300		211			

^a Proportion of total area represents expected bear locations as if bears occurred in each type in proportion to its availability.

^b Calculated by multiplying proportion of total area x total locations (i.e. $0.50 \times 211 = 58$).

^c 90% simultaneous, 95% individual (Neu et al. 1974).

Table 24. Utilization of predicted heath understory in fall by 14 black bears in the GSMNP, 1978-1979.

Category	Total Area (ha)	Proportion of Total Area ^a	Locations in Category	Locations Expected in Category ^b	Proportion of Locations in Category	Confidence Interval ^c
Mast	1449	0.273	97	82	0.324	0.271 - 0.377
Non-Heath	3851	0.727	202	217	0.676	0.623 - 0.729
Total	5300		299			

^a Proportion of total area represents expected bear locations as if bears occurred in each type in proportion to its availability.

^b Calculated by multiplying proportion of total area x total locations (i.e. $0.273 \times 299 = 82$).

^c 90% simultaneous, 95% individual (Neu et al. 1974).

it may not be as important to strictly adhere to heath areas for food in the summer as it is to adhere to mast areas in the fall.

Thirdly, the heath-predicting model may have faults. Of the 7 combinations of physical characteristics that predicted the highest percentage of ground cover by heath, only 5 were used in the analysis. The other 2 were dropped from analysis because field tests did not find them to be sufficiently accurate. More intensive field testing may not show this to be true.

Relationship of Bears to Roads

To test the effects of roads on bears, 2 types of roads in the IMGRID area were coded. The first is state highway 129 which forms the western boundary of the Park. Travel on this road can occur 24 hours a day, year round. This road will be termed a public access road. The second is Parson Branch Road; this is a gravel road only open to travel during the hours between sunrise and sunset from April through October. This road was termed a limited public access road. For comparison, Hannah Mountain Trail was added to the analysis to represent a feature of supposed light impact to bears. Hannah Mountain Trail is open solely to foot travel, year round. The area within approximately 200m of the roads and the trail was searched for bear locations and tested against the number of locations found outside of these corridors. Of the total 5300 ha IMGRID area, the public access road and its corridor made up 326 ha (6.2%), the limited access road and its corridor made up 419 ha (7.9%), while the trail and its corridor made up 484 ha (9.1%).

Overall, chi-square analysis indicated a significant relationship between the 3 categories and bear locations ($P < 0.001$, Table 25). The 3 were then tested ($P = 0.10$) for individual relationships to bear locations using the Bonferroni approach (Neu et al. 1974, Table 25). Both road types were found to be avoided ($P < 0.10$), the public access road to a higher degree than the limited public access road. Oddly, the trail actually exhibited an attractive influence ($P < 0.10$, i.e. more locations were found in the corridor surrounding the trail than were to be expected). The results indicate that bears not only avoid roads, but the degree to which they do so is directly correlated to the amount of traffic on the roads. This follows due to the fact that Parson Branch Road is a one-way road from which all vehicles must enter highway 129. Thus, the highway carries all Parson Branch Road traffic plus other traffic along the border of the Park. In West Virginia, both Miller (1975) and Brown (1980) also found that bears avoided areas near roads. Brown found this to be true even when testing the area out to 1 km from a road.

The apparent attraction of the trail is not likely to be a result of use by humans. In some national parks, including the GSMNP, bears utilize artificial food sources along trails and roads (Eagar and Pelton 1980, Graber 1981). This not only influences bear behavior (Eagar and Pelton 1980, Hastings 1981) but probably their distribution (Graber 1981:75). However, of the 5 sections of the GSMNP that were sampled in food habits work by Eagle (1979), the Hannah Mountain area was the only one in which no evidence was found for use of human foods by black bears. On 4 occasions, bears were sighted from Hannah

Table 25. Utilization of area within 200m of roads and trails by 22 black bears in the GSMNP, 1978-1979.

Category	Total Area(ha)	Proportion of Total Area ^a	Locations in Category	Locations Expected in Category ^b	Proportion of Locations in Category	Confidence Interval ^c
Public Access	326	0.062	16	66	0.015	0.007 - 0.023
Limited Public Access	419	0.079	54	84	0.051	0.037 - 0.065
Trail	484	0.091	136	96	0.129	0.107 - 0.151
Other	4071		831			
Total	5300		1057			

^a Proportion of total area represents expected bear locations as if bears occurred in each type in proportion to its availability.

^b Calculated by multiplying proportion of total area x total locations (i.e. 0.062 x 1057 = 66).

^c 90% simultaneous, 95% individual (Neu et al. 1974).

Mountain Trail during the course of field work in 1978 and 1979. Each time the bear ran directly away from the researcher. Reports of bear-human incidents are rare, if not absent, from the Hannah Mountain Trail. Thus, there is no evidence that bears in the Hannah Mountain or Bunker Hill area are anything other than a "wild" population, utilizing only natural foods. The reason for higher than expected bear use near the trail likely is related to the natural habitat of the area. IMCRID-generated maps of the Hannah Mountain area indicate not only a high concentration of predicted mast overstory, but also of heath understory. The maps revealed only moderate to low concentrations of the 2 vegetation types near either of the roads. It should be noted also that neither road occurred on a ridge top; Parson Branch Road traveled mainly in valley bottoms and highway 129 traveled the sides of ridges. The Hannah Mountain Trail was on a ridge top. In the southern Appalachians, game trails are common on ridge tops and maintained trails in the Park were likely developed from these game trails. Burst (1979) found that trees marked by black bears were most common on ridge tops.

The avoidance of roads by bears was further investigated using sex, age, and seasonal subdivisions. With these subdivisions the numbers became prohibitively low for analysis using the public access road. Therefore, the limited public access road was tested for sex, age, and seasonal variation in bear proximity. Any variations found with the limited public access road are probably present in relation to the public access road and perhaps intensified.

Females displayed higher avoidance of roads than did males (Tables 26 and 27, respectively). Although female avoidance was

Table 26. Utilization of area within 200m of a limited public access road by 10 female black bears in the GSMNP, 1978-1979.

Category	Total Area(ha)	Proportion of Total Area ^a	Locations in Category	Locations Expected in Category ^b	Proportion of Locations in Category	Confidence Interval ^c
Within 200m of road	419	0.079	24	48	0.039	0.024 - 0.054
More than 200m from road	4881	0.921	588	564	0.961	0.946 - 0.976
Total	5300		612			

^a Proportion of total area represents expected bear locations as if bears occurred in each type in proportion to its availability.

^b Calculated by multiplying proportion of total area x total locations (i.e. $0.079 \times 612 = 48$).

^c 90% simultaneous, 95% individual (Neu et al. 1974).

Table 27. Utilization of area within 200m of a limited public access road by 10 male black bears in the GSMNP, 1978-1979.

Category	Total Area(ha)	Proportion of Total Area ^a	Locations in Category	Locations Expected in Category ^b	Proportion of Locations in Category	Confidence Interval ^c
Within 200m of road	419	0.079	32	41	0.061	0.040 - 0.082
More than 200m from road	4881	0.921	491	482	0.939	0.918 - 0.960
Total	5300		523			

^a Proportion of total area represents expected bear locations as if bears occurred in each type in proportion to its availability.

^b Calculated by multiplying proportion of total area x total locations (i.e. 0.079 x 523 = 41).

^c 90% simultaneous, 95% individual (Neu et al. 1974).

significant ($P < 0.10$) and male avoidance was not ($P > 0.10$), males were a borderline case. Brown (1980) also tested sex differences in avoidance of roads. With a 1 km border area on either side of the roads, males showed a higher degree of avoidance than females; with a 0.5 km border area, the degree of avoidance was reversed (Brown 1980: 68-71). Overall, Brown found that males avoided roads more than females.

Although both subadults and adults were found less than expected within 200m of the road (Tables 28 and 29, respectively), adults avoided the area more intensely. Once again, as with the use of predicted mast (p. 69) and predicted heath (p. 83) areas, this age dimorphism may be the result of learned behavior. The more experiences with roads that a bear has, assuming they are negative experiences, the stronger will be its avoidance.

Seasonally, bears were found less than expected near roads in spring, September, and fall (all $P < 0.10$, Tables 30, 31, and 32, respectively) but they were found in these areas in approximately the same proportion as availability in summer ($P > 0.10$, Table 33). The results from spring should be viewed with caution because of the low number of observed locations ($n=2$). If vehicle traffic were directly responsible for the finding that bears avoid roads, then there is no reason why bears in the fall should exhibit the strongest avoidance (excluding spring); Parson Branch Road is closed to almost all traffic during November and December. However, traffic is especially high during the color change of deciduous trees in early fall. It is possible that after a relatively constant flow of traffic all summer,

Table 28. Utilization of area within 200m of a limited public access road by 14 subadult black bears in the GSMNP, 1978-1979.

Category	Total Area(ha)	Proportion of Total Area ^a	Locations in Category	Locations Expected in Category ^b	Proportion of Locations in Category	Confidence Interval ^c
Within 200m of road	419	0.079	26	39	0.052	0.032 - 0.072
More than 200m from road	4881	0.921	470	457	0.948	0.928 - 0.968
Total	5300		496			

^a Proportion of total area represents expected bear locations as if bears occurred in each type in proportion to its availability.

^b Calculated by multiplying proportion of total area x total locations (i.e. 0.079 x 496 = 39).

^c 90% simultaneous, 95% individual (Neu et al. 1974).

Table 29. Utilization of area within 200m of a limited public access road by 14 adult black bears in the GSMNP, 1978-1979.

Category	Total Area(ha)	Proportion of Total Area ^a	Locations in Category	Locations Expected in Category ^b	Proportion of Locations in Category	Confidence Interval ^c
Within 200m of road	419	0.079	29	50	0.046	0.030 - 0.062
More than 200m from road	4881	0.921	602	581	0.954	0.938 - 0.970
Total	5300		631			

^a Proportion of total area represents expected bear locations as if bears occurred in each type in proportion to its availability.

^b Calculated by multiplying proportion of total area x total locations (i.e. $0.079 \times 631 = 50$).

^c 90% simultaneous, 95% individual (Neu et al. 1974).

Table 30. Utilization of area within 200m of a limited public access road in spring by 7 black bears in the GSMNP, 1978-1979.

Category	Total Area(ha)	Proportion of Total Area ^a	Locations in Category	Locations Expected in Category ^b	Proportion of Locations in Category	Confidence Interval ^c
Within 200m of road	419	0.079	2	6	0.024	0.009 - 0.057
More than 200m from road	4881	0.921	80	76	0.976	0.943 - 1.009
Total	5300		82			

^a Proportion of total area represents expected bear locations as if bears occurred in each type in proportion to its availability.

^b Calculated by multiplying proportion of total area x total locations (i.e. $0.079 \times 82 = 6$).

^c 90% simultaneous, 95% individual (Neu et al. 1974).

Table 31. Utilization of area within 200m of a limited public access road in September by 16 black bears in the CSMNP, 1978-1979.

Category	Total Area(ha)	Proportion of Total Area ^a	Locations in Category	Locations Expected in Category ^b	Proportion of Locations in Category	Confidence Interval ^c
Within 200m of road	419	0.079	9	17	0.043	0.016 - 0.070
More than 200m from road	4881	0.921	202	194	0.957	0.930 - 0.984
Total	5300		211			

^a Proportion of total area represents expected bear locations as if bears occurred in each type in proportion to its availability.

^b Calculated by multiplying proportion of total area x total locations (i.e. 0.079 x 211 = 17).

^c 90% simultaneous, 95% individual (Neu et al. 1974).

Table 32. Utilization of area within 200m of a limited public access road in fall by 14 black bears in the GSMNP, 1978-1979.

Category	Total Area(ha)	Proportion of Total Area ^a	Locations in Category	Locations Expected in Category ^b	Proportion of Locations in Category	Confidence Interval ^c
Within 200m of road	419	0.079	10	24	0.034	0.013 - 0.055
More than 200m from road	4881	0.921	288	274	0.966	0.945 - 0.987
Total	5300		298			

^a Proportion of total area represents expected bear locations as if bears occurred in each type in proportion to its availability.

^b Calculated by multiplying proportion of total area x total locations (i.e. 0.079 x 298 = 24).

^c 90% simultaneous, 95% individual (Neu et al. 1974).

Table 33. Utilization of area within 200m of a limited public access road in summer by 22 black bears in the GSMNP, 1978-1979.

Category	Total Area(ha)	Proportion of Total Area ^a	Locations in Category	Locations Expected in Category ^b	Proportion of Locations in Category	Confidence Interval ^c
Within 200m of road	419	0.079	33	37	0.071	0.048 - 0.094
More than 200m from road	4881	0.921	433	429	0.929	0.906 - 0.952
Total	5300		466			

^a Proportion of total area represents expected bear locations as if bears occurred in each type in proportion to its availability.

^b Calculated by multiplying proportion of total area x total locations (i.e. 0.079 x 466 = 37).

^c 90% simultaneous, 95% individual (Neu et al. 1974).

followed by a brief period (2-4 weeks) of heavy traffic that the area around roads is avoided simply as a learned response. Hamilton (1978) also found that bears avoided roads in the fall during his study in North Carolina. In West Virginia, the month of most intense avoidance of roads by bears was October for both males and females (Brown 1980: 62, 63). Hunting pressure may also have been an influence in both of the aforementioned projects. Although hunting was illegal in the area of this study, it does occur and could have been an influence on bear avoidance of roads during fall. During the course of this study 1 bear was found shot to death within 100m of Parson Branch Road and 1 hunting party with dogs was caught on the road by Park personnel. It was not uncommon to find stray dogs in the area (normally those breeds used for bear hunting) from August through November.

Relationship to Elevation

Sex, age, and seasonal groupings were tested for differences in the use of elevation on the IMGRID analysis area. The mean elevation for males was significantly different than that for females ($P < 0.05$); males used lower elevations than females (Fig. 14). Garshelis (1978) found that males used lower elevations during the fall in the Bote Mountain area of the GSMNP, probably as a result of their utilizing prime oak areas. In a test for age differences, adults were found to use lower elevations than subadults ($P < 0.05$) in the Bunker Hill area.

Seasonally, no difference was found between the mean elevations used by bears in summer, September, and fall ($P > 0.05$); however, mean

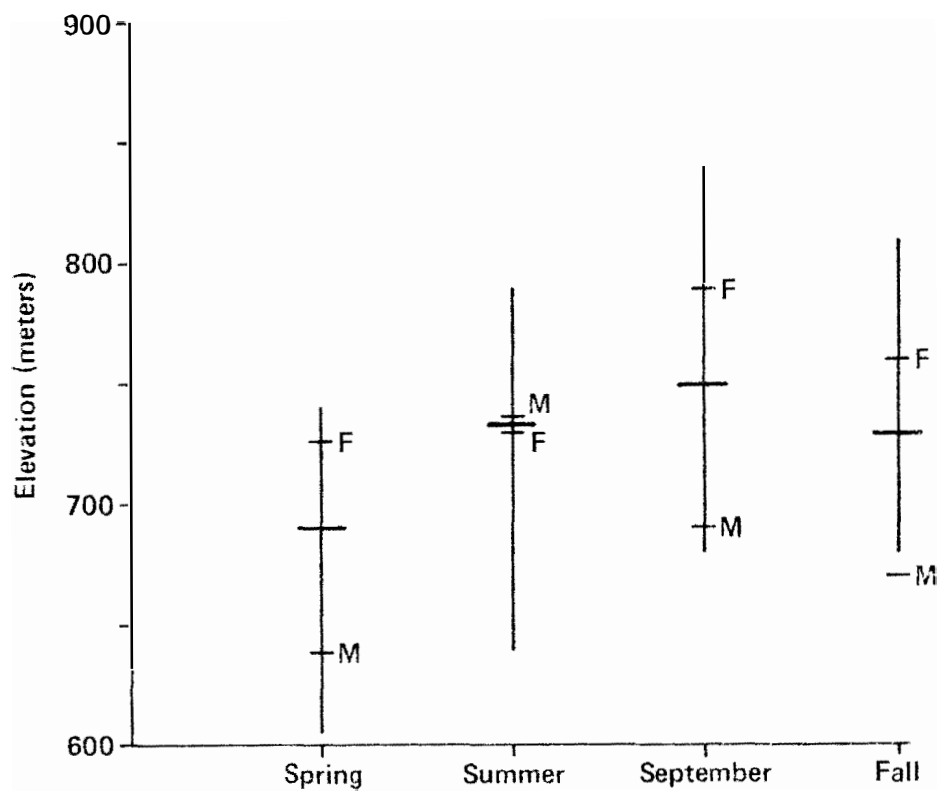

Figure 14. Variation in use of elevation by 22 black bears in the GSMNP, 1978-1979. Means and standard deviations shown for each season; male (M) and female (F) means shown for each season.

elevation in spring was significantly lower than all 3 others ($P < 0.05$). Beeman (1975) found no difference in the use of elevation by bears seasonally in the GSMNP. When the seasonal groups were broken down by sex, no difference was found between mean elevation used by males and females in the spring or summer ($P > 0.05$) but there was a significant difference between the 2 sexes in September and fall ($P < 0.05$); males were using lower elevations than females (Fig. 14). This is in agreement with the findings of Garshelis (1978:43) who discovered no sexual difference with respect to elevation in the summer, but males were at lower elevations during the fall. In the Bunker Hill area, the general food distribution is with summer berries in their highest concentrations on the upper portion of ridges and oak concentrations for fall foraging in the middle portion of ridges, with variations in both with exposure. Therefore, this lower elevation in fall for males could be equated with foraging for hard mast, as it was in the work by Garshelis (1978). However, no significance was found in the investigation of male association to mast type (p. 69). It is possible that some form of competitive exclusion by other larger bears may be to blame (p. 79).

INGRID As a Habitat Analysis Tool

INGRID has many features which make it desirable for use as a habitat analysis tool. First, the system is "user-oriented," in that it is designed with the user in mind so that previous knowledge of computers is not required in order to understand its ability and function. Second, the coded area can be added to or changed on a cell-by-cell basis or an area basis with the need for updating or

expansion. For instance, an entirely new area could be coded and meshed with the original area for analysis or a single cell may require a change in value to reflect a change in some feature within it. Third, analysis can take many forms depending on the particular information needed. Simple coincidence of features in the same cell can be determined. Searches can be carried out to determine concentrations of features. Recoding or value coding can even be done to test the coincidence of many features that may contain several types within them. These are only a few of the capabilities of the IMGRID system which were utilized in the process of analysis. There are other capabilities which were not utilized but which may be valuable in habitat analysis.

There are other aspects of the IMGRID system which must be taken into account because they may limit its function in certain situations. For one, the initial incoding of the area to be analyzed can be a very time consuming project. This will depend on the size of the area, the size of the cell chosen, the number of elements to be coded and the number of variations in each element which need to be distinctive. For example, in the Bunker Hill area, the "man-made construction" element was coded for the retrieval of information on 3 types of roads, a trail, powerline, and a house. The user must decide whether the cost in time and money for coding will be outweighed by the potential value of the final analysis and conclusions.

The most important limitation found from this study is in the weight that can be given to the results of the analysis, given that only frequencies of coincidence were generated. The movements of mammals are the result of dynamic interactions of many influences.

An animal reacts to a variety of social, biological, and physical inputs. This study was able to draw from information about activity patterns and movement measurements to make conclusions or theories about the results of habitat utilization, yet still only a minimum understanding can be gleaned. Because of this complicated picture, each link must carry as much weight as possible for analysis. In particular, habitat utilization analysis should be able to measure interactions of what may be important features to the animal rather than simple feature frequencies. For example, in the analysis of proximity of bears to roads and trails (p. 93), it was found that roads were avoided and the trail actually displayed an attractive influence. A closer look at the situation revealed that there were important concentrations of both mast and heath areas near the trail whereas the areas around the roads did not have as high a concentration of these 2 vegetation types essential to bears. A more powerful analysis of the situation would be one which could account for the influences of other features and still measure the influence of the feature in question. IMGRID, because of its versatility in analysis, can probably generate information which would be needed for an "interaction" type of analysis but coding and analysis would become very difficult, and perhaps impossible with situations more complicated than the one described above.

The needed approach for a fuller analysis appears to be one as used for activity data in this study (p. 20). For this purpose, it is possible that less incoding may be required because cells could be coded as needed for animal locations. For instance, if direct

coincidence of locations with habitat features and roads within 200m are to be analyzed, then each cell where a bear location fell would be coded for features within that cell and the presence or absence of roads within 200m. As such, time could be saved from coding of areas which bears did not use, plus the analysis would be more robust. In summary, IMGRID is a powerful, valuable tool but in the case of habitat utilization by animals it may not be able to produce results with as much credibility as other techniques.

CHAPTER V

SUMMARY AND CONCLUSIONS

1. Research was conducted in the northwest portion of the Great Smoky Mountains National Park (GSMNP or Park) from June 1978 through December 1979, to determine the activity patterns, home range dynamics, movements, and habitat utilization of black bears.

2. Twenty-four bears (10 females and 14 males) were trapped a total of 31 times over the study period. Twenty-two bears were fitted with radio-collars and periodically located for periods from 1 day to 15 months (not including the denning period). Activity monitors were present in all radio-collars.

3. Nine bears were tracked from capture until termination of the project; 7 bears removed their radio-collars; 1 bear was shot legally, 1 bear was shot illegally; 1 bear died of apparently natural causes; the fate of 4 bears is unknown.

4. A total of 5880 activity readings were used to determine how bear activity was affected by time of year, time of day, weather, age, sex, and reproductive status.

5. The reset motion sensor was found to be a reliable activity monitor for bears with probable advantages over other methods of determining activity through telemetry.

6. Monthly activity levels were lowest in the postdenning months of April and May and the predenning months of November and

December, while they were highest in August. The peak in August may be related to breeding.

7. The daily activity pattern was crepuscular throughout the year, although it varied seasonally probably due to changing foraging patterns.

8. Air temperature had a significant effect on levels of bear activity, causing depressed levels at high temperatures. The lowest temperatures generally produced the lowest activity levels for each season.

9. Neither cloud cover nor precipitation had a significant effect on the activity levels of bears.

10. Subadult and yearling females had the highest overall activity levels; adult males had the lowest overall activity level. Age was implicated as having a substantial effect on the activity level of bears although age variation within the study was small.

11. Barren females and females with cubs displayed different levels of activity for fall but not for spring or summer. This is likely due to increased foraging as a response to increased energy drain of cubs on the female and the approach of denning.

12. The convex polygon method was used to calculate seasonal and annual home ranges; 11 annual home ranges were calculated using the bivariate elliptical model (Koepl et al. 1975).

13. Estimated annual home ranges for males were larger than those of females; the mean area occupied by males and females was 32.1 km^2 and 5.2 km^2 , respectively. The difference is partially

explained by the larger body size of males and their need for greater food intake for metabolic maintenance.

14. Both males and females showed significantly larger mean estimated home ranges in fall than in spring/summer; contrasting foraging strategies of bears for the 2 seasons may be responsible.

15. Seven bears exhibited extensive movements outside of their normal home range. None of the bears was over 5 years old; 6 of the 7 were males; 2 of the movements terminated in the bear's death.

16. Hourly travel rates were significantly greater for "diurnal" hours (0600-2200) than for "nocturnal" hours (2300-0500).

17. No sexual difference was found in hourly movement parameters.

18. Males had significantly less circuitous travel routes than did females.

19. A total of 1058 bear locations were coded into the 5200 ha IMGRID analysis area along with physical land features for the purpose of acquiring habitat utilization information. Predictive models for shrub-borne soft mast and tree-borne hard mast were developed and field tested for accuracy. Bear locations were analyzed in relation to high yield hard mast areas, high yield soft mast areas, proximity to roads, and elevational distribution.

20. Overall, use of mast areas was significantly higher than expected.

21. Females preferred mast areas while males did not.

22. Adults preferred mast areas more than subadults.

23. No differential use of mast areas was found for bears in spring or September; differential use of mast areas was found for summer and fall.

24. Overall use of heath areas was no higher than expected.

25. There was no differential use of heath by sex, age, or season except that females preferred it.

26. Bears avoided areas around 2 types of roads but did not avoid areas around a trail.

27. Females avoided roads more intensely than males.

28. Adults avoided roads more than subadults.

29. Seasonally, roads were avoided most intensely during fall.

30. In the analyses of black bear use of mast areas, heath areas, and areas in the proximity of roads, the influences of learned responses, age, and social organization are implied throughout.

31. Overall, males used lower elevations than females.

32. No difference was found in elevational usage by bears between summer, September, and fall; spring elevational usage was significantly lower than all other seasons.

33. Although IMGRID is a powerful tool for analysis of geographically based information, other methods may provide a more complete analysis of habitat utilization by animals.

LITERATURE CITED

LITERATURE CITED

- Alt, G. L., F. W. Alt, and J. S. Lindzey. 1976. Home range and activity patterns of black bears in northeastern Pennsylvania. *Trans. N. E. Section Wildl. Soc.* 33: 45-56.
- _____, G. J. Matula, Jr., F. W. Alt, and J. S. Lindzey. 1980. Dynamics of home range and movements of adult black bears in northeastern Pennsylvania. *In Proc. 4th Intern. Conf. on Bear Res. and Manage.*, Kalispell, MT. 375 pp.
- Amstrup, S. C., and J. Beechum. 1976. Activity patterns of radio-collared black bears in Idaho. *J. Wildl. Manage.* 40: 340-348.
- Burt, W. H. 1943. Territoriality and home range concepts as applied to mammals. *J. Mammal.* 24: 346-352.
- Beeman, D. K., and M. R. Pelton. 1979. The effects of the immobilizing drugs phencyclidine hydrochloride and etorphine hydrochloride on blood parameters of black bears. *Proc. 4th Eastern Black Bear Workshop*, Greenville, ME. 409 pp.
- Beeman, L. E. 1975. Population characteristics, movements, and activities of the black bear (*Ursus americanus*) in the Great Smoky Mountains National Park. Ph.D. Dissertation, The University of Tennessee, Knoxville. 218 pp.
- _____, E. B. Rowland, C. E. Davis, and C. W. Smart. 1977. Computer-assisted resource management. Technical Note B21. Division of Forestry, Fish and Wildl. Develop., Tenn. Valley Auth., Norris, TN.
- _____, and M. R. Pelton. 1980. Seasonal foods and feeding ecology of black bears in the Smoky Mountains. *Proc. 4th Intern. Conf. on Bear Res. and Manage.*, Kalispell, MT. 375 pp.
- Brabander, J. J., and J. S. Burclay. 1977. A practical application of satellite imagery to wildlife habitat evaluation. *Proc. Annual Conf. S. E. Assoc. Fish and Wildl. Agencies* 31: 300-306.
- Brinher, R. C. 1969. Elementary surveying. International Textbook Co., Scranton, PA. 620 pp.
- Burst, T. L. 1979. An analysis of trees marked by black bears in the Great Smoky Mountains National Park. M.S. Thesis, The University of Tennessee, Knoxville. 80 pp.

- Davis, L. S. 1980. Strategy for building a location-specific multi-purpose information system for wildland management. *J. For.* 78: 402-408.
- Eagar, D. C. 1977. Radioisotope feces tagging as a population estimator of black bear (*Ursus americanus*) density in the Great Smoky Mountains National Park. M.S. Thesis. The University of Tennessee, Knoxville. 89 pp.
- Eagle, T. C. 1979. Foods of black bears in the Great Smoky Mountains National Park. M.S. Thesis. The University of Tennessee, Knoxville. 104 pp.
- _____, and M. R. Pelton. 1978. A tooth sectioning and simplified staining technique for aging black bears in the southeast. *Proc. East. Black Bear Workshop 4*: 92-98.
- Eiler, J. H. 1981. Reproductive biology of black bears in the Smoky Mountains of Tennessee. M.S. Thesis. The University of Tennessee, Knoxville. 128 pp.
- Erickson, A. W. 1965. The black bear in Alaska--its ecology and management. Alaska Dept. Fish and Game Restoration Proj. Rep. W-6-R-5. 19 pp.
- _____, A. W., and G. A. Petrides. 1964. Population structure, movements, and mortality of tagged black bears in Michigan. Pp. 46-67 in A. W. Erickson, J. Nellor, and G. A. Petrides. *The black bear in Michigan*. Michigan State University Res. Bull. 4.
- Eubanks, L. A. 1976. Movements and activities of black bear in the Great Smoky Mountains National Park. M.S. Thesis. The University of Tennessee, Knoxville. 83 pp.
- _____, J. C. Sparks, and M. R. Pelton. 1976. Selected chemical analysis of black bear serum. *J. Tenn. Acad. Sci.* 51: 29-31.
- Eveland, J. F. 1973. Population dynamics, movements, morphology and habitat characteristics of black bears in Pennsylvania. M.S. Thesis. The Pennsylvania State University, University Park. 157 pp.
- Exam, J. H. 1981. An assessment of a technique for computer-assisted habitat evaluation for bobwhite quail on Ames Plantation. M.S. Thesis. The University of Tennessee, Knoxville. 78 pp.
- Fenneman, N. M. 1938. *Physiography of eastern United States*. McGraw-Hill Book Co., New York and London. 714 pp.

- Garshelis, D. L. 1978. Movement ecology and activity behavior of black bears in the Great Smoky Mountains National Park. M.S. Thesis. The University of Tennessee, Knoxville. 117 pp.
- _____, and M. R. Pelton. 1980. Activity of black bears in the Great Smoky Mountains National Park. J. Mammal. 61: 8-19.
- _____, and M. R. Pelton. 1981. Movements of black bears in the Great Smoky Mountains National Park. J. Wildl. Manage. 45(4): 912-925.
- _____, H. B. Quigley, C. R. Villarrubia, and M. R. Pelton. 1981. Diel movements of black bears in the southern Appalachians. In Bears--Their biology and management. Proc. 5th Intern. Conf. on Bear Biology and Manage., Madison, WI (in press).
- Gilmer, D. S., S. E. Miller, and L. M. Cowardin. 1973. Analysis of radio-tracking data using digitized habitat maps. J. Wildl. Manage. 37: 404-409.
- Golden, M. S. 1974. Forest vegetation and site relationships in the central portion of the Great Smoky Mountains National Park. Ph.D. Dissertation. The University of Tennessee, Knoxville. 275 pp.
- Graber, D. M. 1981. Ecology and management of black bears in Yosemite National Park. Ph.D. Dissertation. University of California, Berkeley. 206 pp.
- Hamilton, R. J. 1978. Ecology of the black bear in southeastern North Carolina. M.S. Thesis. University of Georgia, Athens. 214 pp.
- Harestad, A. S., and F. L. Bunnell. 1979. Home range and body weight--a reevaluation. Ecol. 60(2): 389-401.
- Harmon, M. E. 1980. The influence of fire and site factors on vegetation pattern and process. A case study of the western portion of the Great Smoky Mountains National Park. M.S. Thesis. The University of Tennessee, Knoxville. 164 pp.
- Hastings, B. C., B. K. Gilbert, and D. L. Turner. 1981. Black bear behavior and human-bear relationships in Yosemite National Park. Tech. Rep. No. 2, Coop. Nat. Park Resources Study Unit, University of California at Davis. 42 pp.
- Hayne, D. W. 1949. Calculation of size of home range. J. Mammal. 30: 1-18.

- Heezen, K. L., and J. R. Tester. 1967. Evaluation of radio-tracking by triangulation with special reference to deer movements. *J. Wildl. Manage.* 31: 124-141.
- Holmes, D. D., and R. L. Jolly. 1980. IMGRID, version 3.5, user's manual. Tennessee Valley Authority, Norris. 508 pp.
- Herrstein, R. J. 1971. Quantitative hedonism. *J. Psychiatric Res.* 8: 399-412.
- Johnson, D. H. 1980. The comparison of usage and availability measurements for evaluating resource preference. *Ecology* 61(1): 67-71.
- Johnson, K. G., and M. R. Pelton. 1979. Denning behavior of black bears in the Great Smoky Mountains National Park. *Proc. Annual Conf. S. E. Fish and Wildl. Agencies* 33: 339-449.
- _____, and M. R. Pelton. 1980a. Prebaiting and snaring techniques for black bears. *Wildl. Soc. Bull.* 8: 46-54.
- _____, and M. R. Pelton. 1980b. Marking techniques for black bears. *Proc. Annual Conf. S.E. Assoc. Fish and Wildl. Agencies* (in press).
- Jonkel, C. J., and I. M. Cowan. 1971. The black bear in the spruce-fir forest. *Wildl. Monogr.* 27. 57 pp.
- Jorgensen, C. D., and W. W. Tanner. 1963. The application of the density probability function to determine the home ranges of *Uta stansburiana* and *Cnemidophorus tigris tigris*. *Herpetologica* 19(2): 105-115.
- Kellyhouse, D. G. 1980. Habitat utilization by black bears in northern California. Pp. 221-227 in C. J. Martinka and K. L. McArthur, eds., *Bears--Their biology and management*. U.S. Govt. Printing Office, Washington, D.C. 375 pp.
- King, R.B.N., and J. B. Hadley. 1968. Geology of the Great Smoky Mountains National Park. Tenn. and N.C. Geological Survey Prof. Paper 587, U.S. Govt. Printing Office, Washington, D.C. 23 pp.
- Koepl, J. W., N. A. Slade, and R. S. Hoffman. 1975. A bivariate home range model with possible application to ethnological data analysis. *J. Mammal.* 56: 81-90.
- Kordek, W. S. 1973. An investigation of the structure, stability, and movements of Pennsylvania black bears with particular emphasis on Pike County. M.S. Thesis. The Pennsylvania State University, University Park. 77 pp.

- Landers, J. L., R. J. Hamilton, A. S. Johnson, and R. L. Marchington. 1979. Foods and habitat of black bears in southeastern North Carolina. *J. Wildl. Manage.* 43: 143-153.
- Lindzey, F. G., and E. C. Meslow. 1976. Winter dormancy in black bears in southwestern Washington. *J. Wildl. Manage.* 40: 408-415.
- _____, and E. C. Meslow. 1977. Home range and habitat use by black bears in southwestern Washington. *J. Wildl. Manage.* 41: 413-425.
- Linzey, A. V., and D. N. Linzey. 1971. Mammals of the Great Smoky Mountains National Park. University of Tennessee Press, Knoxville. 114 pp.
- Marcum, L. C. 1974. An evaluation of radioactive feces tagging as a technique for determining population densities of the black bear (*Ursus americanus*) in the Great Smoky Mountains National Park. M.S. Thesis. The University of Tennessee, Knoxville. 95 pp.
- Matula, G. J., Jr., W. S. Kordeck, and J. S. Lindzey. 1974. Movements of black bear in Pennsylvania as determined by radio-tracking: A preliminary report. Pp. 130-137 in *Proc. 2nd Eastern Workshop of Black Bear Manage. and Res.*, Gatlinburg, TN.
- McCollum, M. T. 1973. Habitat utilization and movements of black bears in southwest Oregon. M.S. Thesis. Humbolt State University, Arcata, CA.
- Miller, T. O. 1975. Factors influencing black bear habitat selection on Cheat Mountain, West Virginia. M.S. Thesis. West Virginia University, Morgantown. 61 pp.
- Nelson, R. A., H. W. Wahner, J. D. Jones, R. D. Ellefson, and P. E. Zollman. 1973. Metabolism of bears before, during, and after winter sleep. *American J. Physiol.* 224: 491-496.
- Neu, C. W., C. R. Byers, and J. M. Peek. 1974. A technique for analysis of utilization-availability data. *J. Wildl. Manage.* 38: 541-545.
- Nicholls, T. H., and D. W. Warner. 1972. Barred owl habitat use as determined by radio-telemetry. *J. Wildl. Manage.* 36: 213-224.
- Novick, N. J., and G. R. Stewart. 1982. Home range and habitat preferences of black bears in the San Bernardino mountains of southern California. *Calif. Fish and Game* 67(4): 21-35.

- Poelker, R. J., and H. D. Hartwell. 1973. Black bear of Washington. Wash. State Game Dept. Biol. Bull. 14. 180 pp.
- Quigley, H. B., D. L. Garshelis, M. R. Pelton, C. I. Taylor, and C. R. Villarrubia. 1979. Use of telemetry monitors in activity studies. Pp. 48-56 in F. M. Long, ed., Proc. 2nd Intern. Conf., Wildl. Biotelemetry. Intern. Conf. Wildl. Biotelemetry, Laramie, WY. 259 pp.
- Rogers, L. L. 1976. Effects of mast and berry crop failures on survival, growth, and reproductive success of black bears. Trans. N. Amer. Wildl. Nat. Res. Conf. 41: 431-438.
- _____. 1977. Social relationships, movements, and population dynamics of black bears in northeastern Minnesota. Ph.D. Dissertation. University of Minnesota, Minneapolis. 194 pp.
- SAS Institute, Inc. 1979. SAS user's guide: SAS Institute. Gary, NC. 494 pp.
- Shanks, R. E. 1954. Reference list of native plants in the Great Smoky Mountains. Botany Dept., The University of Tennessee, Knoxville. 14 pp., mimeo.
- Sinton, D. F. 1976. An introduction to IMGRID: An information system for grid cell data structures. Dept. of Landscape Architecture. Harvard Graduate School of Design, Cambridge, MA. 70 pp.
- Soil Survey. 1953. Blount County. U.S. Dept. of Agric., The University of Tennessee, Knoxville Agric. Exp. Stn. and Tenn. Valley Auth. 119 pp.
- Sokal, R. R., and F. J. Rohlf. 1969. Biometry. W. H. Freeman and Co., San Francisco. 776 pp.
- Springer, J. T. 1979. Some sources of bias and sampling error in radio-triangulation. J. Wildl. Manage. 43: 926-935.
- Stephens, L. A. 1969. A comparison of climatic elements at four elevations in the Great Smoky Mountains. M.S. Thesis. The University of Tennessee, Knoxville. 119 pp.
- Strahler, A. N. 1969. Physical geography. John Wiley and Sons, Inc., New York. 733 pp.
- Strickland, M. D. 1972. Production of mast by selected species of oak (*Quercus* spp.) and its use by wildlife on the Tellico Management Area, Monroe County, Tenn. M.S. Thesis. The University of Tennessee, Knoxville. 63 pp.

- Stupka, A. 1960. Great Smoky Mountains National Park natural history handbook. No. 5. U.S. Govt. Printing Office, Washington, D.C. 75 pp.
- Sunquist, Melvin E. 1981. The social organization of tigers (Panthera tigris) in Royal Chitawan National Park, Nepal. Smithsonian Contr. to Zool. No. 336. Smithsonian Institution Press. 98 pp.
- _____, and G. C. Montgomery. 1973. Activity patterns and rates of movement of two-toed and three-toed sloths (Choloepus hoffmani and Bradypus infuscatus). J. Mammal. 54: 946-954.
- Tanner, J. T. 1963. Mountain temperatures in the southeastern and southwestern United States during late spring and early summer. J. Applied Meteor. 2: 473-483.
- Tate, J. T., and M. R. Pelton. 1980. Human-bear interactions in the Smoky Mountains: Focus on ursid aggression. In Proc. 5th Intern. Conf. on Bear Research and Manage., Madison, WI (in press).
- Thorntwaite, C. W. 1948. An approach toward a rational classification of climate. Geog. Rev. 38: 55-94.
- U.S. Department of Commerce. 1972. Climatology of the United States. Natl. Oceanic Atmos. Admin. Envir. Data Serv. Natl. Park Serv.: 20-40
- Waldschmidt, S. R. 1979. The effect of statistically based models on home range size estimate of Uta stansburiana. Am. Midl. Nat. 101: 236-240.
- Whittaker, R. H. 1956. Vegetation of the Great Smoky Mountains. Ecol. Monogr. 26: 1-80.
- Wilcott, J. C., and W. A. Gates. 1977. A review of existing geographic information systems and some recommendations for future systems. Proc. Symp. Classification, Inventory, and Analysis of Fish and Wildlife Habitat, Phoenix, AZ. 126 pp.
- Willey, C. H. 1974. Aging black bears from first premolar tooth sections. J. Wildl. Manage. 38: 97-100.

APPENDICES

APPENDIX A

Table 34. Relative basal area (m^2/ha) of hard mast producing species^a by slope position, aspect, and convexity or concavity of topography for the Hannah Mountain area, GSMNP (Harmon 1981).

Slope Position	Aspect		
	North	East/West ^b	South
<u>Concave shape</u>			
Upper 1/3	46 ^{c,d}	66 ^d	63 ^d
Middle 1/3	46 ^{c,d}	5	63 ^d
Lower 1/3	5	5	5
<u>Convex to flat shape</u>			
Upper 1/3	64 ^d	63 ^d	11
Middle 1/3	46 ^{c,d}	64 ^d	11
Lower 1/3	5	5	20

^a Includes Quercus sp., Carya sp., Juglans sp., Fagus sp., and Aesculus sp.

^b Similar values allowed combining of East and West values.

^c Only 23% of this value is Quercus sp., all others include at least 50% Quercus sp.

^d Only these values used in predictive model for high yield areas of hard mast.

APPENDIX B

Table 35. Percentage area of ground covered by deciduous and fleshy fruit producing ericads^a by slope position, aspect, and convexity or concavity of topography for the Hannah Mountain area, GSMNP (Harmon 1981).

Slope Position	Aspect		
	North	East/West ^b	South
<u>Concave shape</u>			
Upper 1/3	2	11	36 ^c
Middle 1/3	9	1	58 ^c
Lower 1/3	0	0	1
<u>Convex to flat shape</u>			
Upper 1/3	31 ^c	53 ^c	38 ^c
Middle 1/3	0	21	22
Lower 1/3	3	1	15

^a Includes Gaylussacia ursina, G. baccata, Vaccinium vacillans, V. hirsutum, V. stamineum.

^b Similar values allowed combining of East and West values.

^c Combinations used in predictive model for areas with high concentrations of shrub-borne soft mast.

APPENDIX C

Table 36. Black bears captured in Bunker Hill study area, GSMNP, 1978-1979.

Bear No.	Date	Sex	Age	Tattoo	Ear Tags	Weight (kg)	Trap Type	Comments
E7	13 August 1978	F	8	E7	L57	57	Culvert	In the company of 3 cubs; bear previously radio-collared in winter den, collar left on bear.
321	29 June 1978	F	3	None	LM97 RR321	43	Culvert	Radio-collar attached.
	22 June 1979		4	321		51	Snare	Refitted with new radio-collar
	20 July 1979				R0r421	48	Snare	Right ear tag changed.
401	28 June 1978	M	3	104	L0r401 RM401	47	Culvert	Radio-collar attached.
	12 August 1978					54	Culvert	Captured 24 September 1979 near Hartford, TN by state wildlife officers who removed radio-collar and transported bear to Andrew Johnson Wildlife Management Area.

Table 36 (continued).

Bear No.	Date	Sex	Age	Tattoo	Ear Tags	Weight (kg)	Trap Type	Comments
	6 June 1979		4			82	Culvert	Refitted with new radio-collar; illegally killed 6 November 1979.
402	29 June 1978	M	4	402	LM402 R0r402	79	Free-range	Bear darted while with bear 403 who was caught in a snare; radio-collar attached; bear removed collar 8 August 1978.
	18 June 1979		5			91	Snare	Radio-collar attached; bear removed collar 10 September 1979.
403	29 June 1978	F	3	403	LM403 R0r403	38	Snare	Radio-collar attached.
	6 June 1979		4			43		Refitted with new radio-collar
404	29 June 1978	F	3	404	LM404	48	Culvert	Radio-collar attached; never located after 15 July 1978, fate unknown.
405	12 August 1978	M	3	405	L0r405 RM405	39	Culvert	Radio-collar attached

Table 36 (continued).

Bear No.	Date	Sex	Age	Tattoo	Ear Tags	Weight (kg)	Trap Type	Comments
	22 June 1979		4			45	Culvert	Refitted with new radio-collar.
406	13 August 1978	M	1	406	LOr406 RM406	29	Culvert	Radio-collar attached.
407	17 August 1978	M	1	407	LOr407 RM407	19	Culvert	Radio-collar not attached.
408	17 August 1978	F	7	408	LM408 ROr408	52	Culvert	Radio-collar attached; bear removed collar prior to 1 September 1978
409	17 August 1978	M	3	409	LOr409 RM409	54	Culvert	Radio-collar attached.
410	25 August 1978	M	1	410	LOr410 RM410	26	Culvert	Radio-collar not attached.
	28 August 1978							Radio-collar not attached.
411	25 August 1978	M	2	411	LOr411 RM411	32	Culvert	Radio-collar attached; bear killed legally 30 October 1978 at Snowbird Mountain, North Carolina.

Table 36 (continued).

Bear No.	Date	Sex	Age	Tattoo	Ear Tags	Weight (kg)	Trap Type	Comments
413	1 Sept. 1978	M	4	413	LM413 ROr413	60	Culvert	Radio-collar attached; bear died of unknown causes between 11-18 July 1979.
414	5 Sept. 1978	F	3	414	LM414 ROr414	45	Culvert	Radio-collar attached.
416	2 June 1979	M	2	416	LOr416 RM416	34	Culvert	Breakaway radio-collar attached; bear removed collar within 3 weeks.
417	13 June 1979	M	4	417	LOr418 RM417	86	Snare	Radio-collar attached; signal not heard after 23 August 1979, unconfirmed reports that bear was illegally killed.
419	17 June 1979	M	1	419	LOr419 RM419	23	Snare	Breakaway radio-collar attached; bear removed collar between 17-20 October 1979.
422	15 July 1979	M	5	422	LOr422 RM422	70	Culvert	Breakaway radio-collar attached; bear removed collar between 4-12 September 1979.

Table 36 (continued).

Bear No.	Date	Sex	Age	Tattoo	Ear Tags	Weight (kg)	Trap Type	Comments
423	22 July 1979	F	2	423	LM423 ROr423	23	Snare	Breakaway radio-collar attached.
602	23 July 1979	M	4	602	LR602 R----	68	Culvert	Radio-collar attached; bear never radio-located, reported illegally killed inside Park (unconfirmed).
424	10 August 1979	F	7	424	LM424 ROr424	43	Snare	Breakaway radio-collar attached; lactating, assumed to be in the presence of cubs; bear removed collar between 20-22 Sept. 1979, cub tooth and claw marks on collar.
426	13 August 1979	F	2	426	LM426 ROr426	32	Snare	Breakaway radio-collar attached.
427	14 August 1979	F	2	427	LM427 ROr427	32	Snare	Breakaway radio-collar attached.

APPENDIX D

Table 37. Annual home range estimates and normality statistics for 9 black bears using the bivariate elliptical model (Koepl et al. 1975).

Bear		Number of Locations	Area of Ellipse (km ²)		Skewness		Kurtosis	
Number	Year		95%	90%	XG1/T	YG1/T	XG2/T	YG2/T
401	1979	101	28.4	21.7	-1.6/-6.7	-0.83/-3.5	7.9/16.7	3.6/6.5
403	1978	95	3.9	3.0	0.2/0.8	-0.5/-2.1	0.1/0.3	2.1/4.4
	1979	54	5.3	4.0	0.2/0.7	0.2/0.5	-0.8/-1.2	-0.6/-1.0
405	1979	115	17.6	13.4	-0.5/-2.3	-0.3/-1.2	2.0/4.6	2.7/6.0
406	1979	125	50.5	38.7	0.9/4.0	-0.3/-1.2	1.1/2.5	0.5/1.3
409	1979	65	70.8	53.6	1.9/6.5	0.1/0.4	4.3/7.5	-0.5/-0.9
413	1978-79	50	54.7	41.5	0.9/2.8	0.4/1.3	-0.2/-0.4	0.4/0.6
414	1979	103	4.1	3.6	0.9/3.8	-0.8/-3.5	1.6/3.4	-0.3/-0.6
E7	1978	70	52.4	40.0	-0.3/-0.9	-1.8/-6.3	-1.8/-3.2	8.8/15.7
321	1978	104	9.2	7.0	1.7/7.1	0.2/0.9	5.7/12.2	-0.1/-0.1
	1979	150	7.1	5.4	0.9/4.5	-0.4/-2.2	0.2/0.5	1.1/2.8

APPENDIX E

Table 38. Annual and seasonal home range sizes for 20 black bears in the GSMNP, 1978-1979

<u>Sex/Age Category</u> Bear Number	<u>Spring</u> <u>Home Range</u>		<u>Spring/Summer</u> <u>Home Range</u>		<u>Fall</u> <u>Home Range</u>		<u>Annual Home Range</u>			
	1978	1979	1978	1979	1978	1979	<u>Confidence ellipse</u>			Convex polygon
							90%	95%	(n)	
<u>Subadult males</u>										
401	-	-	13.1	-	-	-	-	-	-	-
405	-	-	-	-	11.9	-	-	-	-	-
406	-	-	-	15.3	80.5	24.9	38.7	50.5	(125)	39.2
409	-	-	-	-	46.9	-	-	-	-	-
419	-	-	-	27.7	-	-	-	-	-	-
<u>Adult males</u>										
401	-	-	-	14.0	-	11.0	21.7	28.4	(101)	29.6
402	-	-	-	13.5	-	-	-	-	-	-
405	-	0.9	-	5.3	-	14.4	13.4	17.6	(115)	14.4
409	-	6.3	-	8.7	-	19.3	53.6	70.8	(65)	46.8
413	-	-	-	28.8	11.0	-	41.5	54.7	(50)	30.7

Table 38 (continued).

Sex/Age Category Bear Number	Spring Home Range		Spring/Summer Home Range		Fall Home Range		Annual Home Range			
	1978	1979	1978	1979	1978	1979	Confidence ellipse			Convex polygon
							90%	95%	(n)	
Subadult females										
321	-	-	3.8	0	3.7	-	7.0	9.2	(104)	5.1
403	0	0	2.2	0	1.7	-	3.0	3.9	(95)	3.8
414	-	-	-	-	22.8	-	-	-	-	-
423	-	-	-	-	-	4.2	-	-	-	-
426	-	-	-	-	-	10.2	-	-	-	-
427	-	-	-	-	-	3.9	-	-	-	-
Adult females										
321	-	1.6	-	2.7	-	5.3	5.4	7.1	(150)	5.5
403	-	-	-	2.4	-	2.3	4.0	5.3	(54)	3.2
414	-	0.9	-	2.0	0	1.9	3.6	4.1	(103)	2.7
E7	-	-	3.8	-	9.4	-	40.0	52.4	(70)	10.8

APPENDIX F

Table 39. Characteristics of the extensive movements displayed by 8 black bears in the GSMNP, 1978-1979.

Bear No.	Sex	Age	Date	Distance from Previous Location	Description of Movement/Location
401	M	3	1979--9 August		Located on northwest side of Gregory Bald.
			12 August		Activity recording from same area.
			24 September	69 km	Captured in Hartford TN; released in Andrew Johnson Wildlife Management Area.
		4	1979--6 June	Approx. 90 km	Retrapped in study area.
			31 October		Located near Parson High Top, inside the study area.
			3-5 November		Located on west side of Chilhowee Reservoir, outside Park boundaries
		7 November		Radio-collar located in reservoir.	
405	M	3	1978--17 August		Located near Sam's Gap in study area.

Table 39 (continued).

Bear No.	Sex	Age	Date	Distance from Previous Location	Description of Movement/Location
			1978--17 August- 8 September	12 km	Over a period of 2-3 weeks, shifted to area near Shuckstack Mountain, on the North Carolina side of the Park, outside the study area.
			8 September- 1 October		Remained in area described above.
			9 October	12 km	Located back in study area.
406	M	1.5	1978--18 September		Located near Dalton Gap, in study area.
			27 September	10 km	Located near Sawmill Ridge/Abrams Creek, in study area.
			10 October	Approx. 20 km	Located in Cherokee National Forest to the west of the study area.
			9 November		Located in Cherokee National Forest.
			18 November	25 km	Located on Happy Valley Ridge in the Park, in the study area.

Table 39 (continued).

Bear No.	Sex	Age	Date	Distance from Previous Location	Description of Movement/Location
409	M	3	1978--1 September- 30 November		Approximately 50% of bear's locations were outside of the Park between Calderwood Reservoir and highway 129, outside of study area.
			1979--1-7 October		Located near Skunk Ridge, in study area.
			10 October	5-7 km	Located in northeast corner of study area.
			26 October	5-7 km	Returned to area near Skunk Ridge.
411	M	2	1978--1 September		Located near Bunker Hill, in study area.
			18 September	Approx. 26 km	Located in northeast slopes of Snowbird Mountain in North Carolina outside of the Park, approx. 8 km west of Robbinsville.
			18 October		Located in same general area as above.
			24 October	Approx. 24 km	Located near southern end of Calderwood Reservoir, outside of the Park.

Table 39 (continued).

Bear No.	Sex	Age	Date	Distance from Previous Location	Description of Movement/Location
(continued)			1978--30 October	Approx. 24 km	Killed legally in North Carolina, about 15 km west of Robbinsville.
414	F	2	1978--27 October		Located near Hickory Top, in study area.
			3 November	10 km	Located in North Carolina side of Park, near upper Creek, outside study area.
			11 November	4 km	Moved further from study area.
			1 December		Located in same area as above.
			8 December	14 km	Located back in study area.
422	M	5	1979-- July		Trapped and radio-tracked in study area.
			1 August- 24 September	5-10 km	Located intermittently in Cherokee National Forest, west of study area.
			4 September- 12 September	8-12 km	Collar removed by bear on Old Stewart Ridge near Santeetlah Creek, North Carolina, outside of study area.

Table 39 (continued)

Bear No.	Sex	Age	Date	Distance from Previous Location	Description of Movement/Location
E7	F	8	1978	5-7 km	A minimum of 3 times, moved from area near Sam's Gap to area between highway 129 and Calderwood Reservoir, outside of Park, with 3 cubs (Fig. 12, p. 57.

VITA

Howard B. Quigley, son of Donald and Ruth Quigley, was born in Oakland, California on March 7, 1952. He attended Skyline High School in Oakland, graduating in 1970. He attended Oregon State University in Corvallis, Oregon; Merrit Junior College in Oakland, California, and the University of California at Berkeley. He graduated from the University of California at Berkeley in 1980 with a Bachelor of Science degree in Conservation of Natural Resources. He began graduate school in 1977 in the Department of Forestry, Wildlife, and Fisheries at The University of Tennessee, Knoxville. He received his Master's degree in Wildlife and Fisheries Science in June 1982.