2002

Full Issue

Steven J. DeMaso

Texas Parks and Wildlife Department, Austin

William P. Kuvlesky Jr.

Texas A&M University, Kingsville

Fidel Hernandez

Texas A&M University, Kingsville

Michael E. Berger

Texas Parks and Wildlife Department, Austin

Follow this and additional works at: <https://trace.tennessee.edu/nqsp>

Recommended Citation

DeMaso, Steven J.; Kuvlesky, William P. Jr.; Hernandez, Fidel; and Berger, Michael E. (2002) "Full Issue," *National Quail Symposium Proceedings*: Vol. 5 , Article 57.

Available at: <https://trace.tennessee.edu/nqsp/vol5/iss1/57>

This Full Issue is brought to you for free and open access by Volunteer, Open Access, Library Journals (VOL Journals), published in partnership with The University of Tennessee (UT) University Libraries. This article has been accepted for inclusion in National Quail Symposium Proceedings by an authorized editor. For more information, please visit <https://trace.tennessee.edu/nqsp>.

Quail V: Proceedings of the Fifth National Quail Symposium



Edited by:

Stephen J. DeMaso, William P. Kuvlesky, Jr.,
Fidel Hernández, and Michael E. Berger

Published by:

Texas Parks and Wildlife Department
Austin, Texas, USA

Quail V: Proceedings of the Fifth National Quail Symposium

2002

DUNKARD

QUAIL V: PROCEEDINGS OF THE FIFTH NATIONAL QUAIL SYMPOSIUM

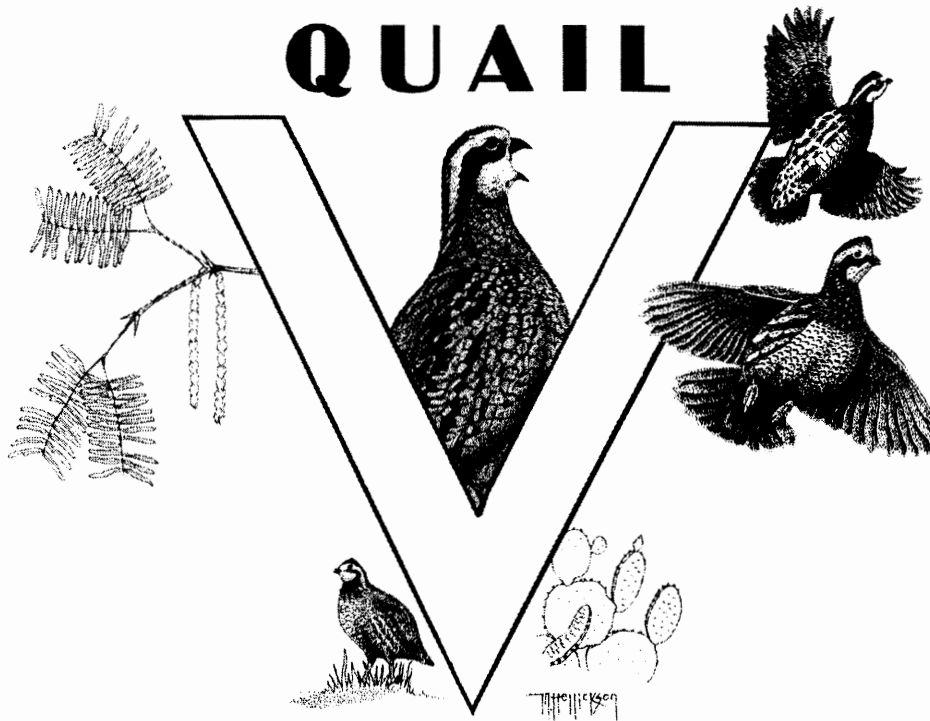

Edited by

**Stephen J. DeMaso, William P. Kuvlesky, Jr.,
Fidel Hernández, and Michael E. Berger**

Published by

**Texas Parks and Wildlife Department
Austin, Texas 78744, USA**

696
.627N38
2002

The Quail V logo, featuring northern bobwhites and south Texas bobwhite habitat features, was drawn by Dr. Mick Hellickson, Wildlife Biologist, King Ranch, Inc., Kingsville, Texas.

RECOMMENDED CITATION FORMATS

Entire volume:

DeMaso, S. J., W. P. Kuvlesky, Jr., F. Hernández, and M. E. Berger. eds. 2002. Quail V: Proceedings of the Fifth National Quail Symposium. Texas Parks and Wildlife Department, Austin, Texas.

For individual papers:

DeMaso, S. J., M. J. Peterson, J. R. Purvis, N. J. Silvy, and J. L. Cooke. 2002. A comparison of two quail abundance indices and their relationship to quail harvest in Texas. Proceedings of the National Quail Symposium 5:206–212.

ISBN: 1-891276-30-1

Published by:
Texas Parks and Wildlife Department
4200 Smith School Road
Austin, TX 78744-3291
www.tpwd.state.tx.us

QUAIL V: PROCEEDINGS OF THE FIFTH NATIONAL QUAIL SYMPOSIUM

Hosted by

Texas Parks and Wildlife Department

Caesar Kleberg Wildlife Research Institute

Texas A&M University—Kingsville

Texas Cooperative Extension

The Welder Wildlife Foundation

Texas Chapters of Quail Unlimited

South Texas Soil and Water Conservation District

23–27 January 2002

at the

Omni Bayfront Hotel
Corpus Christi, Texas

Funding for the Symposium Proceedings Provided By

**United States Department of Agriculture,
Natural Resources Conservation Service (NRCS),
Wildlife Habitat Management Institute
100 Webster Circle, Suite 3
Madison, MS 39110**

CONTENTS

Acknowledgments	ix
Preface	x
PLENARY SESSION	
Arizona Quail: Species in Jeopardy?	1
<i>Ron Engel-Wilson and William P. Kuvlesky, Jr.</i>	
Emerging Trends in Midwest Bobwhite Culture	8
<i>Thomas V. Dailey</i>	
Quail Management: Issues, Concerns, and Solutions for Public and Private Lands—A Southeastern Perspective	20
<i>L. Wes Burger</i>	
Rangewide Trends in Landuse and Northern Bobwhite Abundance: An Exploratory Analysis	35
<i>Markus J. Peterson, X. Ben Wu, and Paikho Rho</i>	
Keynote Address: Ideas, Landscapes, and Conservation's New Frontier	45
<i>Shane P. Mahoney</i>	
Banquet Remarks: Sustaining the 'Quail Wave' in the Southern Great Plains	48
<i>Dale Rollins</i>	
IMPACTS OF DEPREDAION ON QUAIL	
Coyotes: Friend or Foe of Northern Bobwhite in Southern Texas	57
<i>Scott E. Henke</i>	
Macrohabitat Composition Surrounding Successful and Depredated Northern Bobwhite Nests	61
<i>Eric L. Staller, William E. Palmer, and John P. Carroll</i>	
Bobcat Predation on Quail, Birds, and Mesomammals	65
<i>Michael E. Tewes, Jennifer M. Mock, and John H. Young</i>	
Effects of Field Borders and Mesomammal Reduction on Northern Bobwhite and Songbird Abundance on Three Farms in North Carolina (Oral Abstract)	71
<i>Peter T. Bromley, Shane D. Wellendorf, William E. Palmer, and Jeffery F. Marcus</i>	
Understanding the Relationship Between Northern Bobwhite Mortality and Raptor Migration in South Texas (Poster Abstract)	72
<i>Fernando R. Holschneider, Fidel Hernández, David Rios, and Juan D. Vasquez</i>	
Effects of Micro-Habitat, Macro-Habitat, and Predator Space-Use on Success of Northern Bobwhite Nests (Poster Abstract)	73
<i>Pat Stockett, Mark Smith, James Austin, Scott Szukaitis, Chrissie Henner, L. Wes Burger, Bruce Leopold, and Dave Godwin</i>	
PEN-REARED QUAIL	
Survival and Home Range Estimates of Pen-Raised Northern Bobwhites in Buffer Strip and Non-Buffer Strip Habitats	74
<i>Michael J. Oakley, Dixie L. Bounds, Theodore A. Mollet, and Edward C. Soutiere</i>	
Survival and Flight Characteristics of Captive-Reared and Wild Northern Bobwhites in South Texas	81
<i>Robert M. Perez, Don E. Wilson, and Karen D. Gruen</i>	

Survival and Habitat Use of Pen-Raised Northern Bobwhites at Camp Robinson Wildlife Demonstration Area, Arkansas (Poster Abstract)	86
<i>Matthew D. Lewis, Steven Fowler, Chris Kellner, and James C. Bednarz</i>	
WEATHER INFLUENCES ON QUAIL MANAGEMENT AND RESEARCH	
Effects of Hurricane Bret on Northern Bobwhite Survival in South Texas	87
<i>Fidel Hernández, Juan D. Vasquez, Fred C. Bryant, Andrew A. Radomski, and Ronnie Howard</i>	
Use of Weather Variables for Predicting Fall Covey Calling Rates of Northern Bobwhites	91
<i>Ted P. Seiler, Ronald D. Drobney, and Thomas V. Dailey</i>	
Weather and Age Ratios of Northern Bobwhites in South Texas	99
<i>Fred S. Guthery, Jeffery J. Lusk, David R. Synatzske, James Gallagher, Stephen J. DeMaso, Ronnie R. George, and Markus J. Peterson</i>	
Fine Scale Influence of Weather on Northern Bobwhite Abundance, Breeding Success, and Harvest in South Texas	106
<i>Robert M. Perez, James F. Gallagher, and Michael C. Frisbie</i>	
WESTERN QUAIL SPECIES	
Brood Season Habitat Selection by Montezuma Quail in Southeastern Arizona	111
<i>Kirby D. Bristow and Richard A. Ockenfels</i>	
Efficacy of Line Drives to Locate Montezuma Quail at Elephant Mountain Wildlife Management Area (Poster Abstract)	117
<i>Froylan Hernández, Louis A. Harveson, and Clay Brewer</i>	
HABITAT MANAGEMENT AND RELATED ISSUES	
The Impact of Invasive Exotic Grasses on Quail in the Southwestern United States	118
<i>William P. Kuvlesky, Jr., Timothy E. Fulbright, and Ron Engel-Wilson</i>	
Initial Effects of Prescribed Burning on Survival and Nesting Success of Northern Bobwhites in West-Central Texas	129
<i>Philip S. Carter, Dale Rollins, and Cody B. Scott</i>	
Does Habitat Management for Northern Bobwhites Benefit the Red Imported Fire Ant?	135
<i>A. R. Forbes, C. B. Dabbert, R. B. Mitchell, and J. M. Mueller</i>	
Winter Macro- and Microhabitat Use of Winter Roost Sites in Central Missouri	140
<i>Eliodora Chamberlain, Ronald D. Drobney, and Thomas V. Dailey</i>	
Characteristics of Four Agricultural Crops Established as Northern Bobwhite Brood Habitat	146
<i>Denise A. Maidens and John P. Carroll</i>	
Effects of Northern Bobwhite Habitat Management Practices on Red Imported Fire Ants	151
<i>Shaun Williamson, L. Wes Burger, Jr., Stephen Demarais, and Michael Chamberlain</i>	
Response of Vegetation Important to Northern Bobwhites Following Chemical and Mechanical Treatments (Oral Abstract)	156
<i>James R. Welch, K. V. Miller, and William E. Palmer</i>	
Winter Cover Height and Heat Loss: Is Taller Better? (Oral Abstract)	157
<i>Eliodora Chamberlain, Ronald D. Drobney, and Thomas V. Dailey</i>	
Northern Bobwhite Habitat Use in a Forest-Dominated System (Poster Abstract)	158
<i>Ira B. Parnell, III, Sara H. Schweitzer, Craig G. White, and Lynn A. Lewis</i>	

Northern Bobwhite Population Response to Intensive Mechanical Hardwood Clean-Up (Poster Abstract) . . .	159
<i>D. Clay Sisson, H. Lee Stribling, and Jerald F. Sholar</i>	
Northern Bobwhite Population Response to Intensive Modification of a Farm Landscape in Middle Georgia (Poster Abstract)	160
<i>D. Clay Sisson, H. Lee Stribling, and Steven D. Mitchell</i>	
LANDSCAPE SCALE HABITAT ISSUES	
Landscape-Scale Land-Cover Change and Long-Term Abundance of Scaled Quail and Northern Bobwhite in Texas	161
<i>Andrew S. Bridges, Markus J. Peterson, Nova J. Silvy, Fred E. Smeins, and X. Ben Wu</i>	
Movement Patterns of Resident and Relocated Northern Bobwhites in East Texas	168
<i>Xiangwen Liu, R. Montague Whiting, Jr., D. Scott Parsons, and Donald R. Dietz</i>	
Breeding Season Movements and Dispersal of Northern Bobwhites in Fragmented Habitats of Virginia . .	173
<i>Michael L. Fies, K. Marc Puckett, and Bonnie Larson-Brogdon</i>	
Habitat Selection of Northern Bobwhite in the Rio Grande Plains of Texas	180
<i>William P. Kuvlesky, Jr., Wendell G. Swank, and Nova J. Silvy</i>	
Contribution of CRP to Illinois Bobwhite Habitat at the Landscape Level (Poster Abstract)	190
<i>Whitney L. Weber and John L. Roseberry</i>	
Habitat Selection of Northern Bobwhite Coveys on Two Intensive Agricultural Landscapes in Eastern North Carolina (Poster Abstract)	191
<i>Shane D. Wellendorf, William E. Palmer, and Peter T. Bromley</i>	
QUAIL POPULATION DYNAMICS AND MONITORING	
Cyclicality in Northern Bobwhites: A Time-Analytic Review of the Evidence	192
<i>Wayne E. Thogmartin, John L. Roseberry, and Alan Woolf</i>	
Management Implications of Estimating Abundance of Quail Inhabiting Forest Environs in Mexico	201
<i>Jack C. Eitniear and John T. Baccus</i>	
A Comparison of Two Quail Abundance Indices and Their Relationship to Quail Harvest in Texas	206
<i>Stephen J. DeMaso, Markus J. Peterson, Jon R. Purvis, Nova J. Silvy, and Jerry L. Cooke</i>	
Hunting Success and Northern Bobwhite Density on Tall Timbers Research Station: 1970–2001	213
<i>William E. Palmer, Shane D. Wellendorf, Leonard A. Brennan, William R. Davidson, and Forest E. Kellogg</i>	
Factors Influencing Early Morning Covey Calling in Northern Bobwhites (Oral Abstract)	217
<i>Shane D. Wellendorf, William E. Palmer, and Peter T. Bromley</i>	
Improving Quail Management Through Statistical Modelling (Poster Abstract)	218
<i>Erynn M. Call, Ronald D. Drobney, and Thomas V. Dailey</i>	
Comparison of Methods to Capture Bobwhites During Summer (Poster Abstract)	219
<i>Shane D. Wellendorf, A. Vincent Carver, and William E. Palmer</i>	
Methods for Capturing, Marking, and Estimating Survival of Northern Bobwhite Chicks (Poster Abstract)	220
<i>Mark D. Smith, Adam D. Hammond, L. Wes Burger, William E. Palmer, A. Vince Carver, and Scott Szukaitis</i>	

QUAIL PHYSIOLOGY AND GENETICS

Relationship Among Plasma Triglycerides, Body Mass, and Reproduction of Northern Bobwhites 221
J. M. Mueller and C. B. Dabbert

Comparison of Northern Bobwhite Chick Fecal and Crop Analyses 225
Kristen Utz, John P. Carroll, and Steven J. Moreby

Using Microsatellite DNA to Understand Bobwhite Behavior and Population Structure (Poster Abstract) .. 229
Brant C. Faircloth, Kristine Oswald, William E. Palmer, John P. Carroll, L. Wes Burger, Koon Wah Fok, and Shane D. Wellendorf

PHILOSOPHIES RELATING TO QUAIL AND THEIR MANAGEMENT

A Decade of Progress, A Decade of Frustration 230
Leonard A. Brennan

Effects of Supplemental Feeding on Northern Bobwhite Populations in South Texas 233
Ted B. Doerr and Nova J. Silvy

The Effect of Quail Feeders on Northern Bobwhite Density in Western Oklahoma 241
Stephen J. DeMaso, Darrell Townsend, II, Scott A. Cox, Edward S. Parry, Robert L. Lochmiller, and Alan D. Peoples

The Bobwhite Quail Initiative: Restoring Georgia’s State Gamebird While Improving the Environment (Poster Abstract) 245
Chris Baumann, Bobby Bond, Joy Bornhoeft, John Carroll, Adam Hammond, Richard Hamrick, Walter Lane, Buck Marchinton, and Reggie Thackston

Closing Remarks: Pieces of the Puzzle, Circles in the Stream 246
Leonard A. Brennan

Award Recipients 250

Reviewers 252

Sponsors and Contributors 253

Committees 254

Order Form for Previous National Quail Symposium Proceedings bmii

ACKNOWLEDGMENTS

Many people provided assistance and encouragement, which helped to make the Fifth National Quail Symposium a success. The Texas Parks and Wildlife Department and the Caesar Kleberg Wildlife Research Institute provided financial support and allowed their respective staffs to prepare and conduct the Symposium.

Nena Chandler and Cynthia Ross provided editorial assistance during the preparation of the proceedings. Their help was and is very appreciated!

Bill Kuvlesky chaired the Local Arrangements Committee and handled most of the local arrangement details. Fidel Hernández handled the Poster Session, assisted with many of the local arrangement duties, and organized the field trip to the King Ranch.

Fred Bryant and Carolyn Appleton secured much of the funding for conducting the symposium. L. Pete Heard and the United States Department of Agriculture, Natural Resources Conservation Service, Wildlife

Habitat Management Institute provided financial support for publication of the proceedings.

Terry Blankenship and Lynn Drawe and the Welder Wildlife Foundation organized registration activities. Terry also provided assistance with the field trip to the King Ranch.

Dale Rollins and Ken Cearley organized the exhibitors and exhibit hall. Robert Perez solicited door prizes and raffle items for the symposium.

Mike Berger served as the copy editor and spent many early mornings reviewing manuscripts. I personally thank all who have helped with the Symposium and appreciate the opportunity to serve as Program Chairman and Editor of the Fifth National Quail Symposium.

*Steve DeMaso
Austin, TX*

PREFACE

Stephen J. DeMaso

Texas Parks and Wildlife Department, 4200 Smith School Road, Austin, TX 78744-3291

When I moved to Texas, I noticed a bumper sticker that said "I wasn't born here, but I got here as fast as I could." Although I don't feel exactly that way, I do feel similarly about quail country: "I wasn't born in quail country, but I got here as quick as I could." The more deeply I become involved in quail related issues, the more I contemplate what previous quail researchers and managers have thought and felt during previous decades as they addressed the status and plight of quail populations in North America. It is clear from their writing that they had concerns regarding habitat loss and declining populations, as we still do. In some ways, I feel helpless and inadequate regarding the current quail situation. Many agencies face similar problems, financial shortcomings, staff cutbacks, and the list could go on and on. However, just as in previous times, today's quail problems can't be fixed by just simply throwing money or people at them. Any serious attempt to address the quail decline at a state, regional, or national scale will logically require a systematic approach that addresses not only quail habitat, but all factors biotic and abiotic that affect that habitat. What challenges we have.

The proceedings of Quail V: Fifth National Quail Symposium is hopefully one of the many, and positive products that comes from the symposium held in Corpus Christi, Texas, 23–27 January 2002. The National Quail Symposia are meetings where researchers, managers, biologists, hunters, and quail enthusiasts come together to share current ideas on "hot topics" in the quail world and to discuss the direction of future quail research and management efforts. The first (1972) and second (1982) symposia were held in Stillwater, Oklahoma, the third (1992) was held in Kansas City, Missouri, and the fourth (1997) in Tallahassee, Florida.

I attended my first National Quail Symposium, at Quail III in Kansas City. We have come a long way since then. Since that time, we have expanded our body of knowledge about quail and their habitats—

based on both good and bad research. Previously, quail population "booms" were an artifact of man and his use of the land. However, times have changed and quail are now disappearing from much of their former range.

I believe that we have the knowledge to manage quail in many ecosystems. However, many of the management techniques used in vast areas of suitable quail habitat are not effective in the ever-changing, social, political, and financial world we live in today. To my knowledge, a viable quail population has never been restored in the world! Once they disappear, they seem to be lost forever. The landscape has changed. In the future, we will need to better understand the proximate causes of and the scale issues related to quail and the landscapes which they occur.

One hundred twenty-five authors provided 31 manuscripts for oral presentations, 4 abstracts for oral presentations, 3 manuscripts for poster presentations, and 13 abstracts for poster presentations. Authors and reviewers are to be complemented for their promptness and professionalism. All materials published in the proceedings have been held to the highest professional standards, and hopefully, with the proceedings of previous symposia, will serve as a valuable reference for biologists, managers, researchers, and students who have an interest in quail.

In closing, northern bobwhites have blessed me with many things. They have allowed me to achieve many of the professional goals that I set for myself when I began my wildlife career in 1984. They have brought me many new friends and colleagues. They have allowed me to work in 2 of the top quail states in the country. They have humbled me and my dogs. They have caused me to stop, ponder, and question current dogma. I sincerely hope that someday I can contribute to the stability, and hopefully abundant populations as partial repayment for what I have received from them.

ARIZONA QUAIL: SPECIES IN JEOPARDY?

Ron Engel-Wilson

Arizona Game & Fish Department, 2221 West Greenway Rd., Phoenix, AZ 85023-4312, USA

William P. Kuvlesky, Jr.

Caesar Kleberg Wildlife Research Institute, MSC 218, 700 University Blvd., Texas A&M University-Kingsville, Kingsville, TX 78363, USA

ABSTRACT

An overview of the 4 native species of quail in Arizona, their distribution, and habitats is presented. Possible threats to their long-term existence are explored. A discussion on harvest and hunters and the biological and political impacts hunters have in relation to quail distribution and abundance is presented. The concern with current management direction is addressed and recommendations made.

Citation: Engel-Wilson, R.W., and W.P. Kuvlesky, Jr. 2002. Arizona Quail: Species In Jeopardy? Pages 1–7 in S. J. DeMaso, W. P. Kuvlesky, Jr., F. Hernández, and M. E. Berger, eds. Quail V: Proceedings of the Fifth National Quail Symposium. Texas Parks and Wildlife Department, Austin, TX.

Key words: Arizona, Gambel's quail, habitat, management, masked bobwhite, Montezuma quail, scaled quail

INTRODUCTION

Arizona is blessed or cursed with a diversity of habitats and quail species. Quail are an important wildlife resource in Arizona. These birds are a source of recreation and enjoyment for thousands of consumptive and non-consumptive wildlife users and generate considerable economic benefits to local communities and to the State. Four species of Arizona quail (3 native and 1 introduced) are classified as game birds: Montezuma (*Cyrtonyx montezumae*), scaled (*Callipepla squamata*), Gambel's (*Callipepla gambelii*), and California (*Callipepla californica*). A fifth species, the masked bobwhite (*Colinus virginianus ridgwayi*) was extirpated at the turn of the century, and is now being reintroduced into southern Arizona by the United States Fish and Wildlife Service.

Gambel's Quail

The most widely distributed is the Gambel's quail. Gambel's quail are found in the deserts of Arizona, Colorado, Utah, New Mexico, Nevada, southern California, and northern Mexico (Gullion 1960). Bent (1932) thought birds occurring in Colorado were "exotics" (i.e., transplanted from California in the late 1900s) but other authors thought the birds were native (Mearns 1914, American Ornithologist Union 1957). The largest United States population of Gambel's quail occurs in Arizona. Of the 3 hunted quail, Gambel's is the most abundant in Arizona, found in a variety of habitats below 1,600 m elevation. It is strongly associated with arroyos, riparian areas, and habitats having a mesquite (*Prosopis velutina*) component. It also occurs in upland Sonoran desert, Mojave desert-scrub, scrub-invaded desert grassland, chaparral, oak woodland, Great Basin desert-scrub, and pinyon-juniper

communities (Brown 1989). Gambel's quail are also common in brushy or waste areas adjacent to agriculture (Bent 1932, Gullion 1960, Johnsgard 1973). Because the species is easily trapped, it has been introduced into a number of areas outside its native range. Most of the occupied range is either federal or state lease land open to hunters holding a valid Arizona hunting license.

Gambel's quail are an arid-land species that are endemic to hot and dry habitats like the Sonoran desert. The Sonoran desert is a shrub/succulent dominated ecosystem where fires are rare events. Therefore, beyond annual grasses and forbs that respond to an abundance of seasonal rainfall, the Sonoran desert lacks perennial bunchgrasses. Since Gambel's quail evolved in the Sonoran Desert, they require significantly more woody vegetation than do the other native quail species in Arizona. For example, Brown (1989) reports that unlike the other quail species, Gambel's quail roost in shrubs and mast makes up a greater percentage of their diet compared to the diets of scaled quail and masked bobwhites. Gambel's quail also do not require perennial bunchgrasses to nest successfully. Often Gambel's quail nests are simply a depression in the litter near the base of a shrub (Brown 1989). On the semi-arid grasslands of the Buenos Aires National Wildlife Refuge (BANWR) south of Tucson on the international border with Mexico, Gambel's quail preferred shrub-dominated grasslands, riparian areas and thickets (King 1998). Indeed, Gambel's quail were more shrub-tolerant than masked bobwhites or scaled quail, and it was evident that herbaceous cover was not as an important habitat variable for Gambel's quail as it was for the other two species (King 1998). Gambel's quail populations have probably increased on semi-arid grasslands in Arizona over the past century

in response to shrub invasions that have prevailed as result of overgrazing and the accompanying reduction of lightning-induced fires. They are the most adaptable of Arizona's 4 native quail species as evidenced by their ability to maintain self-sustaining populations in the rapidly developing suburban environments of Phoenix and Tucson.

Scaled Quail

The geographic range of scaled quail overlaps that of the Gambel's quail in Arizona. Scaled quail are found in western Texas, New Mexico, and eastern Arizona, south into Mexico. They also extend into southeastern Colorado, southwest Kansas, and the Texas and Oklahoma panhandles. Scaled quail have been transplanted in eastern and central Washington and eastern Nevada (Aldrich and Duvall 1955). In Arizona, scaled quail are primarily found in the southeastern portion of the state, with scattered populations along the Little Colorado River, from Springerville north to the Sanders-Chambers area (Brown 1989). The largest populations are found in the Sulphur Springs Valley, *badajadas* (the flat rolling hills at the bottom of western mountains) northeast of Oracle Junction, and the mountain foothills in the Altar Valley (Brown 1989). Populations north of the White Mountains, in eastern Arizona, may be a result of local introductions (Phillips et al. 1964). In Arizona, scaled quail inhabit desert grasslands at 1,060–1,400 m elevation (Brown 1989). Historically, scaled quail had a wider distribution in Arizona, but their range has contracted due to loss and alteration of grassland habitats (Rea 1973).

Unlike scaled quail in south Texas where habitats dominated by shrubs are preferred (Hammerquist-Wilson and Crawford 1987), scaled quail in Arizona prefer open grasslands. Brown (1989) stated that scaled quail prefer open semi-arid grasslands consisting of perennial bunchgrasses scattered with low shrubs and cacti. Similarly, (King 1998) reported that of the 3 quail species she studied on the BANWR, scaled quail seem to prefer open uplands dominated by perennial bunchgrasses with about 10% woody cover. In fact, open grasslands are so important to scaled quail that Brown (1989) stated that as woody cover invades grasslands, scaled quail begin to disappear and are gradually replaced by Gambel's quail.

Montezuma Quail

Montezuma quail are found primarily in Mexico. The northern most of 3 subspecies of Montezuma quail occurs in Arizona, New Mexico, and southwest Texas (Swarth 1909, Leopold and McCabe 1957). In Arizona, Montezuma quail occur primarily in the southeastern portion of the state, from the Baboquivari Mountains east to New Mexico, and from the Mexican border north to the Mogollon Rim (Swarth 1904, Bishop 1964). Montezuma quail occur over a wide range of elevations, between 1,219–2,743 m. They are primarily associated with evergreen Madrean pine-oak woodlands with a grassy under story (Leopold and McCabe 1957, Bishop 1964). Montezuma quail also

occur in riparian habitats, ponderosa pine forest, and rarely in sub-alpine forests and meadows. Montezuma quail can be found in semi-desert grasslands and pinyon-juniper woodlands following years of above-average summer precipitation. The range of Montezuma quail in Arizona has contracted since European settlement (Davis 1982).

In Arizona, Montezuma quail are primarily found in encinal oak woodlands with a grass understory (Bent 1932). Previous research (Leopold and McCabe 1957, Brown 1982) suggested that the grass understory provides food and cover. Stromberg (1990) found Montezuma quail in Arizona preferred south-facing slopes for night roosting. Also, during the day they preferred hillsides with oak trees together with intermediate under-story vegetation. Similarly, Albers and Gehlbach (1990) characterized Montezuma quail feeding habitat in Texas as Madrean oak woodland on dry slopes with a tall grass under-story. They found tall grass cover predicted locations of feeding sites more often on a grazed ranch where tall grass cover was patchy.

There is currently a lot of interest in the Montezuma quail. It is a bird that holds a lot of mystique for bird hunters with dogs because of its general tendency to hold very tight, it occurs in a limited area, and the scenery where it is hunted is terrific. We like to compare Montezuma quail hunting to dry fly fishing native trout in high mountain streams. You may not catch very many, oh but what a great time trying. The attitudes of serious Montezuma quail hunters are probably similar to those of dry fly purists. They long for the solitude, scenic grandeur, and the action at the end of gun or line.

California Quail

The last species that can be hunted is the California quail. These are the remnants of transplant attempts in the 1960s. A small population may remain on some private lands in northeastern Arizona. The season is open to allow for an individual to take a bird if they happen upon one.

Masked Bobwhite

The masked bobwhite quail is a federally-listed endangered species (Code of Federal Regulations 2000), though it is in fact, a subspecies of northern bobwhite. It was not discovered and described as a species until around the turn of the 19th century by which time ornithologists who encountered it thought it was almost extinct (Brown 1904). Masked bobwhites were finally extirpated from the United States a few years after 1900 (Brown 1989). Naturalists of the time, and quail biologists today, attribute its near extinction to habitat destruction from livestock overgrazing (United States Fish and Wildlife Service 1995, Kuvlesky et al. 2000). Its historic geographic range has always been small, extending from possibly as far south as Guaymas, Sonora, Mexico through the grasslands of north central Sonora up to the Altar and Santa Cruz Valleys in Arizona. Today the masked bobwhites

distribution is reduced to approximately 49,000 ha of Sonoran savanna grassland on the BANWR in south central Arizona and possibly 100,000 ha of private ranchland in northwestern Sonora, Mexico. The largest population of wild genetic stock occurs on Rancho Carrizo, a large cattle ranch near Benjamin Hill, Sonora. A second, and much smaller wild population occurs on Rancho Grande, approximately 10 km south of Rancho El Carrizo. The population inhabiting the BANWR was established from chicks produced by a captive population maintained by the Refuge that originated from wild birds trapped in Sonora during the late 1960s. Captively propagated chicks have been released on the BANWR on an annual basis since the late 1980s.

Biologists who have studied masked bobwhites believe that most populations frequent the floodplains, drainages of rivers, and creeks where deeper, more poorly drained soils permitted the growth of dense herbaceous vegetation. However, these habitats were also favored by cattle, which were introduced by the thousands to Sonora, Mexico and southeastern Arizona during the mid-to-late 1800s. Since cattle concentrated on floodplains for the abundant food and shade these areas typically provided, essential herbaceous cover was significantly reduced, if not entirely eliminated, by <20 to 30 years of unmanaged grazing (Kuvlesky et al. 2000). The decline of the masked bobwhite in the United States and Mexico during the late 1800s, and its extirpation from Arizona, seemed to coincide with increasing cattle numbers and the simultaneous loss of essential habitats. Specific information on masked bobwhite habitat requirements was unavailable until several research projects were conducted recently on the BANWR (Goodwin 1982, Simms 1989, King 1998) and in Sonora (Guthery et al. 2000, Guthery 2001). These studies indicated that masked bobwhites require a reasonably tall, diverse herbaceous community, as well as about 20–25% woody cover on semi-arid grasslands. Additionally, it was apparent that masked bobwhites were indeed sensitive to overgrazing.

Though accurate census information is unavailable, BANWR biologists estimate that no more than 2,000 masked bobwhites currently exist in both countries. Therefore, the masked bobwhite continues to be threatened with extinction, particularly wild populations in Sonora where their continued existence remains tied to the grazing management decisions of private landowners. If the wild Sonoran populations disappear, maintaining populations from captive-reared chick releases will be a real challenge.

MANAGEMENT NEEDS

Gambel's Quail

Gambel's quail populations are strongly influenced by climatic factors, primarily precipitation. Of the 3 quail species, the Gambel's most strongly typifies the "boom and bust" population cycle. MacGregor and Inlay (1951) found no development of female Gam-

bel's quail reproductive organs in the spring following a dry and cold winter. Swank and Gallizioli (1954) found that sharp annual differences in rainfall coincided with changes in Gambel's quail populations. They concluded that winter (Dec-Apr) rainfall was the primary factor limiting quail abundance. Campbell et al. (1973) also found Gambel's quail populations to be positively correlated with fall and winter rainfall amounts. Gambel's quail use water when available, but normally satisfy their needs with moisture contained in plant and insect foods (Vorhies 1928, Gorsuch 1934, Lowe 1955, Goodwin and Hungerford 1977). Availability of water sources is most important during the dry months of April–September (Goodwin and Hungerford 1977). Physiological studies have shown that Gambel's quail adjust kidney function to conserve water when water is scarce (Braun and Dantzler 1972, Williams et al. 1991).

Livestock grazing can also affect Gambel's quail populations. Early studies concluded that overgrazing had a deleterious effect on quail numbers (Gorsuch 1934, Griner et al. 1941, Kimball 1946). However, because they are not as dependent on herbaceous cover as other quail species that inhabit Arizona, Gambel's quail are probably more tolerant of grazing than masked bobwhites, scaled and Montezuma quail. The effects of hunting on Gambel's quail are generally considered compensatory for natural sources of mortality (Gallizioli 1965), and therefore not limiting. Quail harvests are strongly correlated with total October–March precipitation. As rainfall increases, so does the number of Gambel's and scaled quail harvested per hunter during the season. Record rainfall amounts for October–March during 1978, 1979, and 1980 were accompanied by high quail harvests. During the late 1980s, rainfall and quail harvests both declined.

Habitat conditions for all 3 quail species have changed to varying degrees, since the 1970s. Thousands of hectares of prime Gambel's quail habitat have been lost to suburban sprawl adjacent to major population centers (Phoenix and Tucson). As mentioned previously, Gambel's quail can persist in urban and suburban areas where native plant communities are partially retained. Such areas are almost always off-limits to quail hunting. Expansion of smaller towns and cities in southeastern Arizona has resulted in loss of habitat for scaled and Montezuma quail. Habitat changes on undeveloped public and private lands have likely occurred since the 1970s.

Scaled Quail

Grazing levels can affect scaled quail populations. Ligon (1937) reported scaled quail were negatively affected by excessive grazing in eastern New Mexico. He attributed grazing with widespread destruction of forbs, essential for scaled quail cover and food. Campbell et al. (1973) found scaled quail on moderately grazed New Mexico ranges with a variety of forb species for food and moderate amounts of brushy cover were more productive. Saiwana (1990) found moderate cattle grazing favored scaled quail food and cover

conditions in New Mexico. In Arizona, Bock and Bock (1988) also found more scaled quail on grazed sites compared with ungrazed sites. In south Texas, Campbell-Kissock et al. (1985) found quail were more abundant on high intensity, short duration pastures compared with pastures grazed year-long in drought conditions. Scaled quail evidently favored short duration pastures because these pastures had higher abundance of forbs and grass cover than pastures not included in the grazing system.

Medina (1988) found Lehmann lovegrass (*Eragrostis Lehmanniana*) was poor scaled quail habitat. He recommended burning and intensive grazing in habitats dominated by Lehmann lovegrass to reduce its cover and provide more foods for scaled quail. In other habitats, Bock and Bock (1988) found that fire had no effect on scaled quail numbers in a sacaton (*Sporobolus wrightii*) grassland in southeastern Arizona. Fall counts of scaled quail on burned and unburned grasslands were similar. Shrub density influences scaled quail habitat suitability. Homogenous grasslands without shrubs were unsuitable for scaled quail (Schemnitz 1961). Brown (1989) recommended thinning dense shrubs on ridges to improve habitat. Chaining large areas of bottomland in Texas was not recommended (Tharp 1971). In contrast, chaining a 10 km² desert area near Oracle Junction, Arizona, seemed to improve the habitat for scaled quail (J. Phelps, Arizona Game and Fish Department, personal communication) but there are no data to verify this. Griffing (1972) found quail on grasslands sprayed to control mesquite had heavier body weights than those on control areas. Earlier in the century, available surface water was thought important to quail survival (Grinnel 1927). In contrast, Snyder (1967) found that water was the least important of the 3 habitat requirements (food, water, cover). Campbell (1960) found that scaled quail used surface water especially in dry regions, but use was not great enough to justify the cost of guzzler construction. Similarly, supplemental feeding does not appear to be cost effective (Campbell 1959). However, Snyder (1967) recommended supplemental feeding on public lands to keep the birds available to hunters.

Montezuma Quail

Many authors suggested that some grazing levels decrease population numbers of Montezuma quail (Miller 1943, Leopold and McCabe 1957, Bishop 1964, Bishop and Hungerford 1965, Brown 1978, Brown 1982, Albers and Gehlbach 1990, Brennan 1993a), though direct mortality effects were never reported. Although the effects of grazing are not fully understood (Brennan 1993b), overgrazing can destroy key food sources, greatly reduces grass height that provides cover, and has coincided with severe declines and extirpations in some areas (Miller 1943, Leopold and McCabe 1957, Bishop 1964, Bishop and Hungerford 1965, Brown 1978, Brown 1982, Albers and Gehlbach 1990, Brennan 1993a). Brown (1978) reported that grazing did not limit production of food, but removal of >55% of available forage by weight

did nearly eliminate quail populations by removing their escape/hiding cover. Brown (1978) recommended grazing levels should not remove >35–40% of annual herbaceous production. Albers and Gehlbach (1990) confirmed this conclusion. They suggested when grazing removed 40–50% of the grass height within occupied range, Montezuma quail could not survive within the habitat.

Forest management practices are also important to Montezuma quail. Leopold and McCabe (1957) noted that in the pine-oak belt in Mexico, neither logging nor frequent fires eliminated Montezuma quail as long as fencerows, gullies, and roadsides remained undisturbed. The Coronado National Forest has established standards and guidelines for forest management in high-quality Montezuma quail habitat. These call for retention of uncut areas interspersed with openings <46 m wide, and maximum forage utilization by live-stock of 45% (by weight).

Masked Bobwhite

Masked bobwhite management largely involves improving and managing habitat because it is unlikely that this species will be removed from the federal endangered species list anytime in the near future, which means that legally hunting masked bobwhites is an unreasonable expectation. Nevertheless, masked bobwhite abundance could be increased if appropriate habitat management was implemented in Sonora, Mexico and the BANWR. Guthery et al. (2000) demonstrated that the habitat requirements of masked bobwhites and Texas bobwhites (*C. v. texanus*) were similar enough to justify using habitat management techniques that improve habitat for Texas bobwhites to improve habitats for masked bobwhites. Disking, chaining, and soil aerating were initiated on Rancho El Carrizo, Sonora during the early 1990s to improve masked bobwhite habitat with excellent results. Brush coverage was reduced on all of the areas mechanically manipulated and native grasses and forbs responded vigorously to the soil disturbance as soon as summer rains began. The United States Fish and Wildlife Service estimated that the mechanical operations improved almost 20,000 ha of masked bobwhite habitat on Rancho El Carrizo. Additionally, ranch owners improved almost 6,000 ha of habitat by installing a short duration grazing system, and by removing cattle or reducing stocking rates on important masked bobwhite pastures.

The mechanical methods used to improve masked bobwhite habitat on Rancho El Carrizo would no doubt improve masked bobwhite on the BANWR. However, it is unlikely that diskings, chaining or soil aerating will ever be conducted on the Refuge, because any type of action that disturbs the soil surface is prohibited on National Wildlife Refuges for fear of disturbing archaeological sites or destroying endangered species, particularly plants. Habitat improvement could be implemented after an area designated for management has been totally surveyed for archeological sites and endangered species, and then only after appropri-

ate protective measures are put in place. In reality then, mechanical habitat improvement will never be implemented on the BANWR because staff and funding shortages will not permit the necessary pre-treatment surveys to be completed. Prescribed fire and livestock prohibition will remain the only habitat improvement measures utilized on the BANWR.

FUTURE MANAGEMENT

Where can we go from here? First let us do a reality check. Gambel's quail population fluctuations are primarily driven by the amount of rainfall that occurs in their habitats from October to March each year. In Gambel's quail habitats lots of rain means more quail, little rain means fewer quail in the fall. If the hunting pressure is reduced on the population following the winter it does not rain, will the reduction in hunting pressure increase the number of birds the next year? In the long run, the reduction will probably not change anything. Do agencies need to adjust the season length and bag limit in poor years to reduce the number of birds harvested and the number of hunter days? No, average quail hunters are, by and large, self-regulating. If the season is not very good and the catch-per-unit effort is low, average hunters do not harvest very many birds per day and they do not hunt very many days. Serious and dedicated hunters may hunt the same number of days as they normally do, and their catch-per-unit-effort may be higher than that of the average hunters, but still lower than in good years.

The big difference between average hunters and serious hunters is their comments on the bag and seasons. The average hunter hunts 1 to 3 days/year and harvests between 0 and a limit. In years of high quail populations, they may hunt a few more days and may harvest a few more birds/day, but in general their quail harvest does not vary much year to year. Changing the season length or the bag limit does not affect the outcome of their trips to hunt quail, thus they seldom voice recommendations to change the bag or season limit. They have accepted the fact that weather is driving the quail populations, or they may not care. Serious or dedicated quail hunters have a different view of quail management. They truly believe that changing the bag limit or season lengths will improve their quail hunting experience. In reality what they want is the same thing that the dry fly fisherman wants to be in the wilderness alone, pitting their skill against a wily quarry. If they see another person, fishing or hunting or not, or even if they think someone has set foot in, heaven forbid, their secret spot, they consider their enjoyment compromised. If the season is shortened or the bag limit is reduced to make the season unattractive, the belief is that the average hunter will not go. This is only true if there is a drastic reduction in either bag limit or season length.

Cost, however, does reduce the number of individuals hunting. If an additional charge is required to hunt, some of the average hunters will not go, unless

the season is really good. This was observed when Arizona added a State Waterfowl Stamp requirement to hunt waterfowl. The number of individuals reporting hunting waterfowl dropped from 12,000 to 8,000 hunters, days/hunter, and birds/season/hunter increased, indicating that the average hunter was the one who stopped going. The total number of birds harvested did not change; they were just harvested by fewer hunters. There was no change on the impact to the population. There may have actually been a higher harvest. A similar result was observed when Arizona changed the fall turkey hunt from a general hunt to a permit hunt. Number of hunters was reduced by almost 50% yet the harvest remained unchanged. In both cases the net result was hunter recreation being provided was reduced.

Is this a good thing or a bad thing? It could be viewed in the political world as a bad thing. If these were voters that a political party was trying to get to vote as a block and the party leadership disenfranchised 25–50% of its party they would not stay in power very long. Today as agencies struggle to maintain hunter numbers and license sales, every effort should be made to provide as much hunter recreation as possible. If there is not a biological reason for reducing bag limits, shortening seasons or adding restrictions, we as researchers, managers, and quail hunters, should keep as many "voters" as possible on our side. We need individuals to be interested in the species and the sport. Hunters are our friends and we need them. They are powerful allies when we comment on forest management plans, land management plans, grazing allotment plans, housing developments, and other activities that reduce or affect suitability of thousands of hectares of quail habitat. Making statements that the proposed action will impact 90,000 quail hunters makes a bigger impression than the same statement using 45,000 quail hunters. The biggest threat to the future of quail hunting in the west, is the "Avid" quail hunter. We do not know what an "avid" quail is, and second if one looks at the definition of "avid" in the dictionary, it is not very pretty. An "avid" quail hunter could be considered greedy; in fact they might be "greedy to the point of gluttony." Avid equals greedy, and glutton equals a person with a remarkably great desire or capacity for something. Most of these individuals have good intentions, but what they want is to reduce the bag limit and shorten the season or charge additional fees to hunt quail; the end result is fewer quail hunters. In a period in hunting history when every hunter is important to the continued ability of hunters to enjoy the sport these individuals are trying to implement strategies that will reduce their numbers. Wildlife agencies should be very careful when catering to the desires of these individuals, especially if these individuals are making money from the recreation being provided by wildlife. If indeed wildlife is held in the public trust, one of the first questions asked before any restrictive management activity is implemented on hunters should be "Is there a biological benefit to the population or a negative consequence if not implemented?" If there is no positive biological reason to

implement and no negative consequence if not implemented, then the next question should be "If implemented will it reduce the number of hunters?" If the answer is yes, the management activity should not be implemented. P. J. Daugherty, Northern Arizona University, School of Forestry, has said that American hunters come from a long line of poachers and when we settled here we were adamant that the King would not control the take of wildlife. As resource managers we should be very careful not to allow kingdoms, fiefdoms, or even elite clubs to be given special treatment when it comes to hunting privileges. Whether or not populations of quail in Arizona are in jeopardy is not the issue. There will be quail here long after the entire state is a city. Maybe not as many species nor as widely distributed, but they will be here. What is in jeopardy is quail hunting. It could very well become the sport of the rich and the elite, managed by the guides and special interest groups.

ACKNOWLEDGMENTS

The authors would like to thank the following individuals for their assistance in the preparation of this manuscript: Steve Rosenstock, Vanessa Dickinson, Brian Wakeling, John Phelps, Richard Ockenfels, and Kirby Bristow. This is publication no. 02-101 of the Caesar Kleberg Wildlife Research Institute.

LITERATURE CITED

- Albers, R. P., and F. R. Gehlbach. 1990. Choice of feeding habitat by relict Montezuma quail in central Texas. *Wilson Bulletin* 102:300–308.
- Aldrich, J. W., and A. J. Duvall. 1955. Distribution of American gallinaceous game birds. United States Department of the Interior, Fish and Wildlife Service, Washington, D. C., Circular 34.
- American Ornithologist Union. 1957. The American ornithologist union checklist of North American birds. Allen Press Incorporated, Lawrence, Kansas.
- Bent, A. C. 1932. Life histories of North American gallinaceous birds. United States Natural History Museum, Bulletin 162.
- Bishop, R. A. 1964. The Mearns quail (*Cyrtonyx montezumae mearnsi*) in southern Arizona. Thesis. University of Arizona, Tucson.
- Bishop, R. A., and C. R. Hungerford. 1965. Seasonal food selection of Arizona Mearns quail. *Journal of Wildlife Management* 29:813–819.
- Bock, C. E., and J. H. Bock. 1988. Grassland birds in southeastern Arizona: impacts of fire, grazing, and alien vegetation. Pages 43–58 in *International Council on Bird Preservation. Technical Report 7*, Cambridge, England.
- Braun, E. J., and W. H. Dantzler. 1972. Function of mammalian-type and reptilian-type nephrons in kidney of desert quail. *American Journal of Physiology* 222:617–629.
- Brennan, L. A. 1993a. Strategic plan for quail management and research in the United States: introduction and background. *Proceedings of the National Quail Symposium* 3:160–169.
- Brennan, L. A. 1993b. Strategic plan for quail management and research in the United States: issues and strategies. *Proceedings of the National Quail Symposium* 3:170–182.
- Brown, D. E. 1989. Arizona game birds. University of Arizona Press, Tucson.
- Brown, H. 1904. Masked bobwhite (*Colinus ridgwayi*). *Auk* 21: 209–213.
- Brown, R. L. 1978. Statewide investigations: an ecological study of Mearns quail: a final report. Arizona Game and Fish Department, Phoenix.
- Brown, R. L. 1982. Effects of livestock grazing on Mearns quail in southeastern Arizona. *Journal of Range Management* 35: 727–732.
- Campbell, H. 1959. Experimental feeding of wild quail in New Mexico. *Southwestern Naturalist* 4:169–175.
- Campbell, H. 1960. Evaluation of gallinaceous guzzlers for quail in New Mexico. *Journal of Wildlife Management* 24:21–26.
- Campbell, H., D. K. Martin, P. E. Ferkovich, and B. K. Harris. 1973. Effects of hunting and some other environmental factors on scaled quail in New Mexico. *Wildlife Monograph* 34.
- Campbell-Kissock, L., L. H. Blankenship, and J. W. Stewart. 1985. Plant and animal foods of bobwhite and scaled quail in southwest Texas. *Southwestern Naturalist* 30:543–553.
- Code of Federal Regulations 2000. Code of Federal Regulations 2000. Title 50, Volume 1, Part 17.11.
- Davis, G. P., Jr. 1982. Man and wildlife in Arizona: the American exploration period, 1824–1865. N. B. Carmony and D. E. Brown, eds. Arizona Game and Fish Department, Phoenix.
- Gallizioli, S. 1965. Quail research in Arizona. Arizona Game and Fish Department, Phoenix.
- Goodwin, J. G. 1982. Habitat needs of masked bobwhite in Arizona. University of Arizona Contract Report to the United States Fish & Wildlife Service, Albuquerque, New Mexico.
- Goodwin, J. G., and C. R. Hungerford. 1977. Habitat use by native Gambel's and scaled quail and released masked bobwhite quail southern Arizona. Forest Service Research Paper. RM-197.
- Gorsuch, D. M. 1934. Life history of the Gambel quail in Arizona. *Biological Science Bulletin*, University of Arizona, Tucson.
- Griffing, J. P. 1972. Population characteristics and behavior of scaled quail in southeastern New Mexico. Thesis, New Mexico State University, Las Cruces.
- Griner, L., T. L. Kimball, and A. A. Nichol. 1941. Statewide wildlife management research project: Gambel's quail in Arizona. Arizona Game and Fish Department, Phoenix.
- Grinnel, J. 1927. A critical factor in the existence of southwestern game birds. *Science* 65:528–529.
- Gullion, G. W. 1960. The ecology of Gambel's quail in Nevada and the arid southwest. *Ecology* 41:518–536.
- Guthery, F. S., N. M. King, K. R. Nolte, W. P. Kuvlesky, Jr., S. DeStefano, S. A. Gall, and N. J. Silvy. 2000. Comparative habitat ecology of Texas and masked bobwhites. *Journal of Wildlife Management* 64:407–420.
- Guthery, F. S., N. M. King, K. R. Nolte, W. P. Kuvlesky, Jr., S. DeStefano, S. A. Gall, and N. J. Silvy. 2001. Multivariate perspectives on patch use by masked bobwhites. *Journal of Wildlife Management* 65:118–124.
- Hammerquist-Wilson, M., and J. A. Crawford. 1987. Habitat selection by Texas bobwhites and chestnut-bellied scaled quail in south Texas. *Journal of Wildlife Management* 51: 575–582.
- Johnsgard, P. A. 1973. Grouse and quails of North America. University of Nebraska Press, Lincoln, Nebraska.
- Kimball, T. L. 1946. 1946 midsummer survey to determine the current production of quail. Arizona Game and Fish Commission, Phoenix.
- King, N. M. 1998. Habitat use by endangered masked bobwhites and other quail on the Buenos Aires National Wildlife Refuge, Arizona. Thesis, University of Arizona, Tucson, Arizona.
- Kuvlesky, W. P., Jr., S. A. Gall, S. J. Dobrott, S. Tolley, F. S. Guthery, S. A. DeStefano, N. King, K. R. Nolte, N. J. Silvy, J. C. Lewis, G. Gee, G. Camou-Luders, and R. Engel-Wilson. 2000. The status of masked bobwhite recovery in the United States and Mexico. *Proceedings of the National Quail Symposium* 4:42–57.

ARIZONA QUAIL

7

- Leopold, A. S., and R. A. McCabe. 1957. Natural history of Montezuma quail in Mexico. *Condor* 59:3–26.
- Ligon, L. S. 1937. Tragedy of upland game birds throughout the west and southwest. *Transactions of the North American Wildlife Conference* 2:476–480.
- Lowe, C. H., Jr. 1955. Gambel quail and water supply on Tiburon Island, Sonora, Mexico. *Condor* 57:244.
- Macgregor, W., Jr., and M. Inlay. 1951. Observations on failure of Gambel quail to breed. *California Fish and Game* 37: 218–219.
- Mearns, E. A. 1914. Diagnosis of a new subspecies of Gambel's Quail from Colorado. *Proceedings of the Biological Society of Washington* 27:133.
- Medina, A. L. 1988. Diets of scaled quail in southern Arizona. *Journal of Wildlife Management* 52:753–757.
- Miller, L. 1943. Notes on Mearns quail. *Condor* 45:104–109.
- Phillips, A. R., J. T. Marshall, and G. Monson. 1964. *The birds of Arizona*. University of Arizona Press, Tucson.
- Rea, A. M. 1973. The scaled quail (*Callipepla squamata*) of the southwest: systematic and historical consideration. *Condor* 75:322–329.
- Saiwana, L. L. 1990. Range condition effects on scaled quail in southcentral New Mexico. Dissertation, New Mexico State University, Las Cruces.
- Schemnitz, S. D. 1961. Ecology of the scaled quail in the Oklahoma Panhandle. *Wildlife Monograph* 8.
- Simms, K. 1989. Home range, habitat use and movement of reintroduced masked bobwhites. Thesis, University of Arizona, Tucson.
- Snyder, W. D. 1967. Game bird surveys: experimental habitat improvement for scaled quail. Colorado Game, Fish, and Parks Department, Denver.
- Stromberg, M. R. 1990. Habitat, movements and roost characteristics of Montezuma quail in southeast Arizona. *Condor* 92:229–236.
- Swank, W. G., and S. Gallizioli. 1954. The influence of hunting and of rainfall upon Gambel's quail populations. *Transactions of the North American Wildlife Conference* 19:283–297.
- Swarth, H. S. 1904. Birds of the Huachuca Mountains, Arizona. *Pacific Coast Avifauna* 4:1–70.
- Swarth, H. S. 1909. Distribution and molt of the Mearns quail. *Condor* 11:39–43.
- Tharp, J. E. 1971. A study of scaled and bobwhite quail with special emphasis on habitat requirements and brush control. Thesis, Texas Tech University, Lubbock.
- United States Fish and Wildlife Service. 1995. Masked bobwhite (*Colinus virginianus ridgwayi*) recovery plan. United States Fish and Wildlife Service. Albuquerque, New Mexico.
- Vorhies, C. T. 1928. Do southwestern quail require water? *American Naturalist* 62:446–452.
- Williams, J. B., M. M. Pacelli, and E. J. Braun. 1991. The effect of water deprivation on renal function in conscious unrestrained Gambel's quail (*Callipepla gambelii*). *Physiological Zoology* 64:1200–1214.

EMERGING TRENDS IN MIDWEST BOBWHITE CULTURE

Thomas V. Dailey

Missouri Department of Conservation, 1110 South College Avenue, Columbia, MO 65201, USA

ABSTRACT

We begin the 21st century with the Midwestern northern bobwhite (*Colinus virginianus*) range reduced to a small portion of its historic distribution. This precipitous decline occurred largely during the last quarter of the 20th century, coincident with widespread intensive agricultural land use, unchecked natural plant succession, and frequent severe weather. Various bobwhite enthusiasts of the 1960s–1980s era including Klimstra, Dumke and Stanford had evaluated agricultural land use trends and predicted the near demise of bobwhites that we now lament. Alarmed upland bird hunters have repeatedly spurred policy makers and administrators into action. However, because bobwhites still are only an incidental product of modern agriculture, the potential for reversing declining population trends is limited. Moreover, as society and the wildlife profession become progressively less interested in consumptive uses of wildlife, the political will to appropriate agency resources for bobwhites *per se* is disappearing. Such a pattern has been seen in the Midwest where bobwhite conservation has become a marginal issue on the periphery of the species' range (e.g., Ia., Wis., Mich., Ont.). This paradigm shift is occurring in much of the bobwhite's historic range where habitat and bird populations remain at low levels. The result is that bobwhite culture as we know it (i.e., research, management, and hunting) will decline and be replaced by ecosystem conservation. At the state and national level (e.g., North American Bird Conservation Initiative, Conservation and Reinvestment Act), potential funding for restoration and management of savannas, prairies, agroecosystems, etc., can provide habitat for bobwhites. Bobwhite enthusiasts should embrace this change, and participate in the process to ensure that the needs of bobwhites are included. Importantly, our knowledge base for bobwhites is relatively strong and should bolster efforts to include needs of bobwhite in ecosystem management.

Citation: Dailey, T. V. 2002. Pages 8–19 in S. J. DeMaso, W. P. Kuvlesky, Jr., F. Hernández, and M. E. Berger, eds. Emerging trends in midwest bobwhite culture. Quail V: Proceedings of the Fifth National Quail Symposium. Texas Parks and Wildlife Department, Austin, TX.

Key words: abundance, access, agriculture, artificial propagation, attitude, biodiversity, *Colinus virginianus*, history, hunting, Midwest, *Phasianus colchicus*, ring-necked pheasant, socioeconomic, urban, wildlife profession

INTRODUCTION

“Perhaps it is time, indeed past time, to come to grips with some basic questions regarding the bobwhite's future” (Roseberry and Klimstra 1984:194). Fifteen years later, in remarks at Quail IV, John Roseberry (2000:244) reluctantly concluded that “. . . in the face of an ever-expanding human presence on the landscape, only a relatively few wildlife species will ultimately thrive, and the bobwhite will probably not be one of them.” Indeed, as we begin the 21st century the ill-health of bobwhite populations in the Midwest, especially toward the north, is even clearer. To better understand the future of bobwhite in the Midwest, I review trends in bobwhite abundance, bobwhite hunting and management, society, the wildlife profession, and agriculture. It appears there is potential for improvement in living conditions for bobwhites based on emerging, but complicated land use trends; however, the nature of professional bobwhite conservation will change as efforts on the species' behalf are absorbed into a larger, ecosystem approach to habitat restoration and management.

BOBWHITE CONSERVATION

Bobwhite Abundance

Bobwhite flourished in the Midwest following European settlement and the beginnings of agriculture.

Historical accounts in Wisconsin indicate a tremendous peak in the mid-1800s, followed by a long-term decline (Schorger 1944). Bobwhites were abundant and easy to catch in northern Missouri during this time, and men commonly herded large flocks into walk-in nets from horseback. The journal of attorney Alexander Slayback (1844) (paraphrased) reveals the catch: “Jan. 10th, Went Partridge hunting—caught 77; Jan. 11th, caught 41; Jan. 12th, Partridge hunting again—caught 91; Jan. 22nd, Went Partridge hunting—caught 103. Caught 28 at one drive. I have wasted several days hunting partridges lately but I think I will not waste much more time.” Such large catches made bobwhites popular for commercial trapping and shipment to the east coast. In Beloit, Wisconsin a shipment of 12 tons (ca. 55,000 birds) was reported in 1850 (reviewed by Kabat and Thompson 1963), and Nebraska trappers shipped 1 load of 18,700 bobwhite in 1875 (Nebraska Game and Fish Department 2001). This era of extreme exploitation did not last long, and during the late 19th century, and early 20th century depressed bobwhite abundance reduced hunting. For example, Wisconsin bobwhite hunting was discontinued during 1895–1931 (Kabat and Thompson 1963). Kozicky (1993:3) concluded that the great Midwest bobwhite peak of the 1800s “is a glamorous relic of the past, a relic we wish to fully understand but that we can only reproduce on a small scale.”

Population surveys by individual states since the

MIDWEST BOBWHITE CULTURE

Table 1. Long-term (1966–1999) population trends and relative abundance (mean birds/route) for northern bobwhite based on the North American Breeding Bird Survey (Sauer et al. 2000).

Region	Trend	P-value	Abundance
Illinois	-1.9	0.00	21.45
Indiana	-2.3	0.00	18.73
Iowa	-3.8	0.00	7.84
Kansas	-1.0	0.17	30.49
Michigan	-7.0	0.05	4.95
Missouri	-2.0	0.00	37.43
Nebraska	-1.1	0.27	8.82
Ohio	-6.2	0.00	10.62
Ontario	-19.2	0.05	1.67
Wisconsin	-1.0	0.41	1.67

1950's reveal wide annual fluctuations from drought, flooding, and severe winter weather, and a long-term downward trend. The most uniform survey for states in the Midwest is the North American Breeding Bird Survey. The long-term (1966–1999) trend is negative, with rates varying by latitude and longitude (Table 1). Northern-midwestern states (Mich. and Oh.) and Ontario, Canada showed the largest declines (-6.2 to -19.2%), and central-west states (Ind., Ill., Wis., Mo., Kans., Io., Nebr.) declined <3.9%.

Midwest bobwhite abundance reached its last notable peak in the late 1960s. This peak coincided with reduction in the Soil Bank Program (United States Department of Agriculture), which had peaked in 1961, but had dropped considerably by 1966 (Dahlgren 1988). Roseberry and Klimstra (1984:155) observed that the late 1960s peak was in phase with a 10-year cycle. Severe winter-weather in the late 1970s greatly reduced any potential large upswing cycle. For Illinois, Edwards (1972:180) proved to be prophetic in his evaluation of bobwhite abundance during 1955–1970: “my personal view is that we will never again see bobwhite as abundant in Illinois as they were in 1968 and 1969.” Indeed, by 1999 many Midwest states had recorded historic low bobwhite abundance (e.g., Mo., Dailey and Heidy 1999; Ind., McCreedy 2000).

The precipitous long-term decline during the last quarter of the 20th Century has been blamed on intensive agricultural land use (Klimstra 1982, Brady 1985, Roseberry and Sudkamp 1998). Modern agriculture provides few benefits to bobwhite with numerous negative aspects (e.g., large field size, monocultures, pesticides, less waste grain, overgrazing, pastures and hayfields dominated by exotic grasses). Intensive commodity production has been particularly egregious because the potential for bobwhite is negatively impacted in 2 ways. First, farm products that benefit bobwhite (e.g., grain, grass) are almost totally removed by efficient machinery and intensive harvest of grass. Second, the methods for producing the products (e.g., pesticides, fall plowing, double cropping, large field size) diminish overall living conditions for bobwhite. Depressed bobwhite abundance in the 1990s in some Midwest states also coincided with abnormally wet breeding seasons (e.g., massive flooding in Mo. and Mississippi River watersheds in 1993 and 1995).

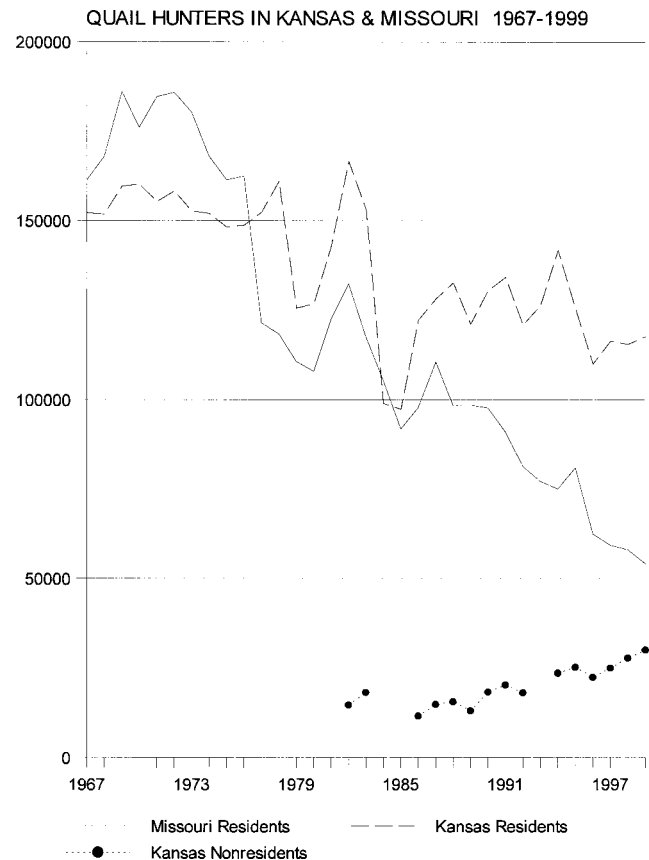

Fig. 1. Number of licensed quail hunters in Missouri and Kansas during 1967–1999. Missouri data from Missouri Department of Conservation files, Columbia, and Kansas data from Roger Applegate, Kansas Department of Wildlife and Parks, Emporia.

Hunting

Bobwhite harvest and the number of hunters varies widely across the Midwest. Ontario does not have a bobwhite hunting season and Michigan only recently reinstated its season. Annual harvest ranges from <3,000 (e.g., Wis. 1999 season, Dhuey 2000) to 1.3 million in Kansas during the 1999–2000 season (Roger Applegate, Kansas Department of Wildlife and Parks, personnel communication). The largest modern-day harvest occurred in Missouri during the 1969–70 season when 3.9 million bobwhite were harvested (Sheriff and Kulowiec 1996). Along with recent low harvest, hunter participation has been down, with the number of resident bobwhite hunters ranging from 890 in Wisconsin in 1999 (Dhuey 2000) to 117,600 in Kansas during 1999–2000 (Roger Applegate, Kansas Department of Wildlife and Parks, personnel communication); the next highest bobwhite hunter count is much lower, 52,500, in Missouri (Dailey and Heidy 2000). Kansas has the reputation as the best bobwhite hunting state in the Midwest, and attracted 30,000 non-resident bobwhite hunters in 1999 (Fig. 1). Bobwhite hunters come from many states to Kansas and the state might be attracting hunters that have abandoned their home states' bobwhite hunting. Although all Midwest states have lost bobwhite hunters since the 1960s, the downward trend in Kansas was shallower. The relative

strength of bobwhite hunting in Kansas is shown in Figure 3, in this case relative to a neighboring state, Missouri. The potential effect of these trends on future bobwhite conservation is discussed later in the paper.

Special Interest Groups

One index of interest in upland game birds is participation in special interest groups such as Quail Unlimited, Inc. (QU). Examination of the QU fiscal report for 1999–2000 reveals strong membership in the Midwest relative to the rest of the country (Quail Unlimited 2000). The top 10 states in membership include Kansas (ranked number 1), Missouri (5), Indiana (7), and Illinois (9). The majority of membership nationally is in eastern Kansas and western Missouri, with the major cities of Topeka, Wichita, and Kansas City boasting a membership of 1,324; this would rank as 4th on the state membership list with Kansas and Missouri removed. Whether these groups accurately represent the “voice” of bobwhite hunters is unknown. For example, in Missouri and Kansas in 1999, QU membership of <2,000 per state was <2.5% of the states’ resident bobwhite hunter populations.

Translocation and Artificial Propagation

“Have those of us in the wildlife management profession forgotten artificial propagation is a tool of wildlife management?” (Kozicky 1993:4). Midwest biologists have a rich history of manipulating game birds to meet hunter demand. Bobwhite managers typically use artificial propagation or translocation of wild birds because landscape isolation and severe winter weather have extirpated or greatly reduced populations. Large scale restoration via artificial propagation has been abandoned because it is expensive, ineffective, and ecologically indefensible (Roseberry et al. 1987). Restoration in localized areas via propagation or translocation remains viable (Roseberry et al. 1987, Griffith et al. 1989). High cost, and lack of success with translocation in Indiana (Brian R. Frawley, Michigan Department of Natural Resources, personnel communication) and West Virginia (Crum 1993), demonstrate the serious challenges of this management tool.

As bobwhites have become increasingly scarce, uses of propagated bobwhites for dog training, and private and commercial hunting have increased. Kozicky (1993), a longtime advocate of artificial propagation to meet recreational demand, argued for increased study of development of wild behavior in pen-raised bobwhites. However, businesses generally prefer to use ring-necked pheasants (*Phasianus colchicus*) and chukars (*Alectoris chukar*), and not bobwhites, because of the former species’ tendency to behave as single units, or in small groups of a few individuals. There are several advantages of hunting these alternative game birds. They are safer, with a typical hunt encounter involving only 1–2 targets in relatively predictable flight, versus a covey of bobwhite flying in many directions. For a dollar-conscious hunter, this behavior is also more attractive, reasoning that 10 pheasants flushed in separate events would provide more pre-

dictable recreation than a covey of 10 bobwhite flushing chaotically. From a marketing perspective, relative to bobwhite, these species offer an exciting hunt with the pheasants and/or chukar being colorful, noisy and larger targets. State natural resource agencies, likewise, could use similar criteria in selecting game birds for programs designed to recruit and/or retain hunters.

Pen-raised bobwhites are no longer used for hunting by state agencies in the Midwest, however, pen-raised pheasants are still being used for put-and-take hunts or to supplement wild populations prior to hunting seasons (e.g., Illinois Department of Natural Resources, Ohio Department of Natural Resources, Nebraska Game and Fish Department, Wisconsin Department of Natural Resources). In summary, it appears that Midwest game bird enthusiasts will be less reliant on propagated bobwhites than will be their southern counterparts, partly because of alternate, suitable game birds. Furthermore, as discussed later, as the influence of a decreasingly small hunter constituency wanes, the will to translocate wild bobwhites and/or to artificially propagate bobwhites will disappear.

Riding the Wave

At the turn of the 21st century bobwhite conservation has swelled once again with an abundance of research and conservation efforts. In 1997, John Roseberry (2000:243) described the roller-coaster that bobwhite conservation had been on since the 1920s and spoke favorably of the resurgence that began in 1992 at Quail III. There, in a strategic planning session, Lenny Brennan (1993:167) summarized the dismal state of bobwhite populations and called for a turn around: “The prognosis can be reversed if wildlife professionals and natural resource policymakers do a complete about-face and begin to make bobwhite management and research a priority.” Bobwhite conservation efforts have indeed turned around with a plethora of programs including experimental restoration in Georgia, Virginia and Missouri, creation of the Southeast Bobwhite Technical Committee as part of the Southeastern Association of Fish and Wildlife Agencies, and increased emphasis on research, in particular the establishment of 2 endowed chairs in bobwhite ecology in Oklahoma and Texas.

As we go about this business, it’s critical that we not operate in a vacuum. Experience from the periphery of the bobwhite’s range teaches us that we must be realistic about the challenges of a landscape unsuitable for bobwhite and of a people not interested in rectifying the situation. Moreover, the societal trend to disfavor consumptive use of wildlife indicates that the current resurgence could be relatively short-lived. On the bright side, society’s tendency to provide more support for conservation in general should benefit conservation of species such as bobwhite.

EMERGING TRENDS IN SOCIETY AND NATURAL RESOURCE MANAGEMENT

The nature of future bobwhite conservation will be determined by a complex of interrelated factors in-

cluding loss of rural populations and values, benefits to society of bobwhite hunting, behavior of bobwhite hunters, hunting participation, bobwhite abundance, ecological thought, etc.

A More Urbanized and Nonconsumptive Philosophy in Society

In the United States in 1990, about 190 million people lived in urban areas and 60 million lived in rural areas. During 1950–1990, urban populations nearly doubled and rural populations grew less rapid, resulting in a decline in the fraction of the population living in rural areas from about 33% to about 25% (The H. John Heinz III Center for Science, Economics and the Environment 1999).

In Missouri, the farm population declined 50% during 1970–1990 to 180,100 (Seipel et al. 1995). As the United States becomes less rural, the nature of attitudes toward hunting grows increasingly negative. In Illinois, 47% of survey respondents disapproved of state programs to maintain or increase game animals, and 79% of respondents 18–34 years old valued wildlife the same as pets and people (Mankin et al. 1999). A majority of survey respondents in Missouri (Missouri Department of Conservation 1996) and Illinois (Mankin et al. 1999) approved of hunting for food, but disapproved of hunting for “sport” or trophies. It’s unknown how bobwhite hunting might be viewed, although compared to deer hunting, the latter is more of a pursuit of food. Harvested bobwhites, on the other hand, provide a tiny fraction of the average hunter’s sustenance. For example, if we assume that the cooked meat of a bobwhite weighs 50 g, the average Missouri hunter (about 10 bobwhite bagged per season) consumes about a pound of bobwhite flesh annually. Bobwhite hunting is also at a disadvantage if society holds that hunting in general is not acceptable, except in rare situations, (e.g., when hunting benefits society). Deer harvest provides benefits to society by providing food and reducing damage to property and life. It’s doubtful the youth surveyed in Illinois would view bobwhite hunting as anything other than sport, (i.e., not a necessity of life).

Hunting is a declining part of American society, with urbanization, lack of time, negative societal attitudes, etc., contributing to the downward trend. The proportion of the United States population that hunts declined during 1955–1996 with a high of 11.2% in 1960 and a low of 7% in 1996 (United States Department of the Interior 1997: Table B-3 and page 30, respectively). Furthermore, hunters are a smaller proportion of the population of large cities, the places where media and political power are concentrated. In 1996, only 3% of residents in cities with populations >1 million hunted, 7% hunted from cities with populations of 250,000 to 999,999, 9% hunted from cities with 50,000 to 249,999, and 15% hunted from cities with <50,000 residents. In Illinois, 11% of urban and 29% of nonurban residents hunt or trap (Mankin et al. 1999). The status of hunting is better in some parts of the bobwhite’s range with 14% of west-north-central

residents (states of Mo., Kans., Ia., Minn., Neb., N.D., and S.D.) hunting, 8% of east-north-central (Wis., Mich., Ill., Ind., Oh.) and west-south-central (Okla., Ark., Tex., La.) hunting, 10% of east-south-central (Ky., Tenn., Miss., Ala.) and 6% of south Atlantic (Fla., Ga., S.C., N.C., W. Va., Va, Md.) hunting (United States Department of the Interior 1997:27).

Even more ominous for the future support of bobwhite conservation are the negative attitude and dwindling interest in hunting by American teens and young adults. For the United States population 16–17 years old, only 9% hunted in 1996 (United States Department of the Interior 1997:29). In the southeastern United States, Burger et al. (1999) found that the average age of bobwhite hunters was 38 years.

A particularly alarming aspect of the lack of young hunters is that university students, our future wildlife managers and researchers, increasingly do not hunt (Hodgdon 1999). In the Midwest, the University of Wisconsin-Madison, and the University of Missouri-Columbia, offer training in hunting in an attempt to familiarize students with this fundamental management tool. Mere familiarity with hunting, however, is not the traditional background of agency biologists. It is clear from my own experience with >70 temporary research assistants (minimum of Bachelors Degree) over the past 14 years that trained biologists that hunt are a minority. It is likely that future professionals will have less interest in game bird management and will not relate well to hunters.

Clearly, the balance of power in the United States is concentrated in the hands of people with relatively distant ties to consumptive use of natural resources. As trapping and hunting have been criticized over the past few decades, the first step taken by agencies, outdoor writers, hunting groups, etc., was to change hunter behavior using education (e.g., hunter safety instruction) to improve the perception of hunting. The degree of society’s tolerance for hunting, or game programs, is dependent on the taxa being hunted (people are more sensitive to death of mammals than birds), ethics, perception of fair chase, benefits to society, etc. Society has begun to eliminate the more objectionable aspects of consumptive recreation as evidenced by the loss, or near loss, of trapping, lion hunting or fox hunting in California, Colorado, Oregon, Washington, and Great Britain. These losses of professional jurisdiction over management demonstrate that game enthusiasts cannot take public support for granted. Burger (1988: 18) noted the precarious situation we are in: “While largely apathetic, nonhunters have the capacity to shift the balance of public sentiment in either direction, suddenly and overwhelmingly.” Unfortunately, bobwhite enthusiasts have recently shown a dark side when predators were illegally poisoned in the southeastern United States. At a minimum this has alerted the rest of society to the nature of bobwhite hunting and management. Research on predator control puts bobwhite conservation on a slippery slope, as noted in a discussion of predation by Leopold and Hurst (1994): “Therefore, most citizens will not appreciate the need to increase game bird abundance through predator con-

trol, instead assigning aesthetic and ecological, rather than recreational and utilitarian, values to wildlife.” Indeed, the perception of bobwhite hunters being greedy, at the expense of all fauna except bobwhites, could negatively affect major conservation initiatives beneficial to bobwhites, and it could ultimately doom the sport. With today’s conservation initiatives (e.g., Conservation Reserve Program [CRP], North American Bird Conservation Initiative, Conservation and Reinvestment Act [CARA]) involving a diverse coalition of interests (e.g., Sierra Club, Audubon Society), bobwhite conservationists have to be particularly sensitive to the views of society.

Environmentalism: Do Bobwhites Fit?

Other societal views, some originating in environmental concerns, have a potentially negative effect on the future of bobwhite habitat management. Askins (2001), in an article entitled, “Sustaining biological diversity in early successional communities: the challenge of managing unpopular habitats,” pointed out that society’s embrace of conservation of climax forest resulted in disdain for habitats manipulated by man, in this case early-successional forest stages created by logging. Bobwhite habitat management is seemingly unpopular, too, with long-held concepts of edge management for bobwhite being contrary to the ecological movement to avoid fragmented forests (Roseberry 1993). We have an example of such philosophy in Missouri, where unpopular habitats include hedgerows in grasslands. Hedgerows were created by farmers, and thus are viewed as “unnatural” in a landscape “intended” to have an open vista; further benefits of hedgerow removal are believed to be realized for area-sensitive grassland birds. In some cases, bobwhite hunters objected because of their experience finding bobwhite in these hedgerows; hedgerow removal could diminish habitat carrying capacity for bobwhite (Kabat and Thompson 1963, Roseberry and Klimstra 1984: 30). Regardless, lower value is being placed on tangible resources and constituents (i.e., bobwhite and bobwhite hunters), apparently in pursuit of something more “natural.” Bobwhite habitat management in general poses potential environmental risks. Management for early-successional habitats can impact the environment in several ways including burning of fossil fuels for cultivation, soil erosion from disturbance of ground, and air pollution from fire. Prescribed fire is the most sensitive issue, and societal tolerance for degradation of air quality will likely decline as human industrial activity increases and pressure on air quality intensifies. Existing restrictive regulations for air quality at the state and federal level have led to legislation protecting the right to use prescribed fire to perpetuate natural plant communities; Florida for example, has such a law.

Effects of a Diverse Constituency and Funding Base

During the last quarter of the 20th century support for conservation was broadened beyond traditional hunting and fishing fees to include sales taxes in Mis-

souri and Arkansas, automobile license plate revenue and tax check-offs in several states, and national initiatives such as CARA. Hunters and game-oriented resource professionals were delighted that all citizens were now supporting conservation programs. Indeed this is a good change providing funding for comprehensive natural resource programs and ultimately an improved environment. Also, during this period participation in conservation by nontraditional special interest groups grew tremendously with organizations such as National Audubon Society, Sierra Club, etc., becoming influential with local initiatives and national policy. The implications for game management of broadening agency funding and constituency bases were articulated by the Society for Animal Rights, Inc. (Favre and Olsen 1979): “If change of perspective is ever going to arrive at the game agencies, funding and political pressure are going to have to come from new sources. Only if these special interest agencies are forced into the political mainstream of social and financial debate will the broader issues be faced.”

Missouri: The New Paradigm in Midwest State Agencies

The effect on resource management of diversified funding and constituent bases can be seen from the experience of the Missouri Department Conservation (MDC) and its 25-year-old tax-supported program. Since 1977 MDC has received funding from a one-eighth of a cent sales tax. Of the typical annual budget of >\$130 million, about 25% is derived from hunting and fishing permits. Although hunters also pay the sales tax, their overall contribution is still small because only about 13% of Missourians hunt (United States Department of the Interior 1997, Table 50). This reversal in funding has broadened MDC’s emphasis from traditional constituents, primarily hunters and anglers, to more casual participants in outdoor activities. Simultaneous with this shift, ecosystem management was being espoused as the appropriate approach to conservation. Over the past decade MDC debated the relative merits of ecosystem and game management. Much of this debate focused on bobwhite management because intensive habitat management is expensive and unpopular in some circles. The fate of MDC’s bobwhite restoration was brought to the forefront in 2001 when a statewide comprehensive plan was devised. MDC’s internal administrative review revealed several of the key issues of those opposed to a bobwhite program. Foremost, some administrators argued that natural resource agencies should be engaged in ecosystem management, and not narrowly-focused programs for a single species. Bobwhite proponents countered that species-specific programs are conducted for rare and endangered animals; however, the goals of a game bird program are different because the aim of such programs is to achieve huntable numbers of animals, a population level higher than that required for population viability. Bobwhite advocates have also argued that the species could serve as a “poster-species” or icon, in efforts to affect improved wildlife

management on private lands; however, plan detractors remain unconvinced of the merit of a species plan. It is clear in Missouri that diminishing bobwhite hunter numbers (>160,000 annually in 1970s, 100,000 in 1980s, <50,000 in 2000) have influenced attitudes; one administrator commented that the agency should be less sensitive to bobwhite hunters because they represent a “declining interest group.” Similarly, for the Wisconsin Department of Natural Resources, Petersen et al. (2000) noted that although substantial resources had been committed to bobwhite management up to the 1980s, future funding was in doubt largely because the agency’s priorities are tied to harvest, and bobwhite harvest was in a seemingly permanent slump.

Kansas: The Traditional Paradigm in Midwest State Agencies

A stark contrast to Missouri’s system can be found next door in Kansas. Kansas and plains states to the north differ from their eastern counterparts in that they are largely rural in character and rely more on economic benefits generated from hunting, especially from nonresident hunters. Kansas Department of Wildlife and Parks (KDWP) is funded largely by hunting and fishing permit fees, and its Strategic Plan reflects that funding base: “In the 21st century, management of the state’s harvestable wildlife resources for consumptive recreation will continue to be a primary focus of the Department.” (Kansas Department of Wildlife and Parks 2000). Kansas Department of Wildlife and Parks is aggressively working to shore up its upland hunting tradition and to cultivate hunting via a hunter retention and recruitment program and by providing access to private land for hunting. The newly developed KDWP Hunter Recruitment and Retention program (*Kansas Hunting: Carry on the Tradition—Ensure the Future*) offers a comprehensive approach aimed at raising hunting participation to 15% of the state’s populace. However, the Missouri Department of Conservation’s mission statement reflects its diverse funding base and mentions hunting only in reference to the fact that its funding base no longer comes primarily from hunting licenses: “To provide opportunity for all citizens to use, enjoy, and learn about fish, forest, and wildlife resources.” (Missouri Department of Conservation 2000). Such differences have fostered a false impression among Missouri hunters that Kansas offers more to game bird hunters. Although MDC doesn’t offer as many programs targeted specifically at bobwhite hunters, the abundance of public hunting land in northern and western Missouri, and an aggressive private land management program, both made possible partly by the sales tax, provide substantial, but fewer tangible benefits to bobwhite hunters. Hunting success, measured as average daily bag (daily limit of 8), is nearly the same for Kansas (2.34 in 1980s, 2.19 in 1990s) and Missouri (2.32 in 1980s, 2.07 in 1990s).

Research Changes

The changing nature of bobwhite conservation, particularly research, was discussed at Quail III by

John Roseberry in a paper entitled “Bobwhite and the New Biology.” One important needed change recommended by Roseberry was less study of “site management skills and approaches” and more research on population ecology and the spatial structure of habitats (Roseberry 1993:17). Similarly, Guthery (1997:291) criticized the tendency for micromanagement of bobwhite and the redundancy of bobwhite research (“Numerous papers have dealt with management practices such as grazing, prescribed burning . . . and combinations of 2 or more of these practices.”) and called for testing of unifying principles he had conceived. By 2001, the rarity of bobwhite research in scholarly scientific journals (*Science*, *The Journal of Wildlife Management*, *Ecology*, etc.) and the plethora of unrepliated and descriptive studies in the Quail IV proceedings indicate that we are still largely stuck in the old paradigm of bobwhite conservation. That view was articulated at the first National Bobwhite Symposium by Komarek (1972:375): “Today in some circles, we seem to have lost the premise that the purpose of game research, particularly where it is financed by the sportsman’s dollar, is that these people who furnish the funds ‘naturally desire a practical outcome to the investigation.’ Thus it is heartening to me that in spite of the discussions now going on in those circles as to the merits of ‘pure’ game research versus management research, that at least in bobwhite management there is no such hiatus.” The roots of what Komarek refers to as ‘pure’ game research were from the Midwest and included the likes of Errington, Hamerstrom, Kabat, Thompson, Klimstra, and Roseberry. Long-term research such as practiced by these men did not come easy. In the 1940s, Pittman-Robertson funding for Paul Errington’s research was threatened and at the 13th North American Wildlife Conference, the role and nature of research was being debated. In support of Errington’s long-term studies, Aldo Leopold (1948:44) provided his perspective on the balance between applied and basic research: “Much of the confusion about wildlife research arises, I think, from a false premise as to its purpose. It is often assumed that its sole purpose is to produce bigger crops. I challenge whether this should be the sole purpose, or even the main purpose. I suspect that too much emphasis on bigger crops is the least likely way to get bigger crops.”

For state natural resource agencies, 21st century bobwhite research will increasingly be less about producing bigger crops of bobwhite, largely because the political will for such intensive management is disappearing. More importantly for bobwhite conservation, and ultimately for the fate of hunting, as populations of bobwhite become more fragmented, the need to understand population viability will spur basic research of population genetics, sink-source dynamics, exploitation by hunters and cyclic population phenomena (Roseberry 1993).

Ecosystem Management

So, if our traditional state bobwhite programs are dwindling, how will bobwhites figure in future agency

programs? They will be absorbed by ecosystem management. What should bobwhite enthusiasts do? Embrace ecosystem management, and participate in the process to ensure that needs of bobwhite are included.

Bobwhites have historically been a prominent part of only one national initiative, the United States Department of Agriculture Conservation Reserve Program. Bobwhite habitat requirements have been directly incorporated into the CRP. Beyond the CRP, the success of attempts to develop a national-level focus on bobwhites and upland game birds has largely been limited to planning and information transfer (e.g., North American Game Birds: Developing a Management and Research Agenda for the 21st Century; the Quail III Strategic Management Plan, Quail III/IV Symposia). Federal funding of these efforts was infinitesimal, totaling less than \$30,000. Unlike migratory wildlife, bobwhite conservation efforts are highly fragmented with little or no national focus or federal funding. Significant new opportunities for federal support of upland game bird initiatives now exist. To improve bobwhite conservation, the directors of the Southeastern Association of Fish and Wildlife Agencies (SEAFWA) created the Southeast Quail Study Group and called for formulation of a national quail plan (Northern Bobwhite Conservation Initiative, NBCI) for implementation within the North American Bird Conservation Initiative (NABCI), a program of the International Association of Fish and Wildlife Agencies (IAFWA). The NBCI is being developed by bobwhite biologists around the country under the direction of Ralph Dimmick, University of Tennessee. Northern bobwhites are considered a NABCI priority species within several Bird Conservation Regions (BCR) that occur in the Midwest (e.g., BCR 22-tall-grass prairie, BCR 24-central hardwood forest, BCR 19-central mixed grass prairie). Game bird enthusiasts also have a formal position in NABCI, the Resident Game Bird Working Group. Partners in Flight (under the authority of the IAFWA) considers northern bobwhite a priority species in most Midwestern ecological regions.

In order to ensure successful implementation of bobwhite conservation in the NABCI, bobwhite enthusiasts from all levels, public and private, need to increase their involvement at the local, state and regional level. Several states have already created plans to facilitate implementation of the NABCI. Importantly, we have an excellent understanding of bobwhite ecology compared to what's known for species of primary focus in some initiatives, (e.g., rare Henslow's sparrows in grasslands); this advantage should increase the chance of achieving effective habitat practices.

Numerous ecosystems, or natural plant communities, in the Midwest can provide habitat for bobwhites. The largest in area are the tall-grass prairies and oak-savannas. Midwestern tall-grass prairie and savanna ecosystems are a tiny fraction (<90%) of their historic range (Noss et al. 2001). The outstanding exception is the Flint Hills region of Kansas, which also happens to be a stronghold for bobwhites. Grasslands within the range of bobwhites in other Midwest states, however, exhibit extreme (99%) loss (Noss et al. 2001).

Oak savannas are typified by widely spaced trees and/or shrubs with a dominant understory of graminoids and forbs. Savannas are perpetuated by fire, and consequently species such as northern bobwhites that thrive in the early-successional habitats created by fire, benefit from savanna restoration (Callahan 1996). Savannas are one of the rarest plant communities in North America, with about 2% of the original 11 million presettlement hectares in the Midwest remaining (Nuzzo 1986). The amount of presettlement savanna varied widely among states, with tremendous potential for positive change for bobwhite in some cases. For example, Missouri's presettlement savannas covered about 15% of the state, or some 2.6 million ha; the current area is 2,024 ha (Mike Leahy, Missouri Department of Conservation, personnel communication). Interest in savanna restoration is increasing as evidenced by the publication of the Proceedings of the Midwest Oak Management Workshop, Eastern Illinois University, in 1991.

Natural plants and natural plant communities are being restored throughout the Midwest by numerous public agencies and private organizations. Efforts range from miles of narrow roadside plantings in Iowa to larger tracts, containing 2,000–4,000 ha, in Missouri, Illinois and Iowa. A plethora of community types exist (shortleaf pine woodlands, glades, etc.) that could provide habitat for bobwhites. The extent of restoration of natural communities could be limited by cost, amount of public land, willingness of private landowners to implement, air quality concerns regarding prescribed fire, etc.

AGRICULTURAL TRENDS

Given that agriculture will dominate land use in the Midwest in the 21st century, the importance of bobwhite conservation in agroecosystems cannot be overstated. John Roseberry, in concluding remarks at Quail IV (2000:244) posed the situation this way: "Given enough time, space, and opportunity, I think we have sufficient knowledge and skill to produce locally abundant bobwhite populations. To be a viable game species, however, it is not sufficient for bobwhite to be locally abundant. They must be reasonably abundant over relatively large portions of the landscape. The problem, of course, is that bobwhite biologists and managers do not control large portions of the landscape." The solution, Roseberry continued: "Finding ways to accommodate the needs of bobwhite in emerging agricultural and forestry programs will be challenging, but absolutely essential."

Midwest agriculture is extremely diverse with a plethora of influences including local, state, national, and international economies, the expanding human population, the culture of family farms, biotic and abiotic elements (e.g., global warming, disease, weeds) and environmental concerns of society. Although the potential for agricultural trends is relatively easy to identify, the nature of those trends, and the potential effect on bobwhite are very speculative. A guiding

idea for such evaluation is that as intensity of land use increases, quality of habitat for bobwhites declines.

Demographics

For bobwhite conservation to be successful on agricultural lands biologists must understand basic characteristics of rural landowners and the landscape. For example, in Missouri, demographic data have led biologists in rural northeast Missouri to hold landowner workshops >100 miles away in St. Louis. The abundance of absentee landowners necessitated such effort.

Study by Constance et al. (1996) of land ownership in Missouri provides an example of important demographics in Midwest agriculture. In the early 1990s in the Midwest, about 44% of all cropland was rented, and these rental acreages were concentrated in the most productive landscapes (e.g., riverbottoms). The majority of landlords were old (71% are ≥ 60 years old and 45% are ≥ 70 years old), and lived far from their land (54% live ≥ 50 miles from their farms). In Missouri and nationally, about 40% of rented noncorporate agricultural land is controlled by women, and 47% of these women are widowed, and typically elderly. Moreover, women own smaller tracts, and importantly rely more heavily on this income as a percentage of total income. The rental situation is further complicated by the fact that most landlords ($\geq 70\%$) leave farm decision-making to the renter.

Clearly, private land efforts must involve a team approach with researchers identifying the nature of land ownership and landscape physiogamy, and urban and rural biologists collaborating to reach all parties involved in management (owner, renter, government agencies, agribusiness, Non-governmental Organizations [NGOs], etc.). Timing is also critical, particularly for large-scale bobwhite restoration efforts. For example, chances of success are dependent on landowner willingness to cooperate; this in turn is affected by a plethora of factors, not the least of which is the person's discretionary income. Unlike government workers that have steady income, agricultural income is cyclical, with a deficiency in about 4 out of 10 years (Womack 2001).

Farm Size

Midwest farm size is changing with mid-size farms being replaced by larger and smaller tracts. The latter are often used for recreation, residence and agriculture, although only as a minor source of income. In Missouri, large farms dominate production with 4% of the farms producing 42% of the state's agricultural output; they do so on only 17% of the total farmland (Seipel et al. 1995:31). For the smaller farms, agriculture is a secondary consideration, and thus, wildlife might be able to compete better for a place in the management of these lands. In addition, because income of these landowners is supplemented by off-farm income, greater discretionary spending is possible, a potentially important prerequisite for habitat management. Also, the relatively small size of these land holdings should increase the heterogeneity of rural land-

scapes, providing more "edge" for bobwhites. Negative aspects for bobwhite conservation of these smaller land holdings increase with increasing density of landowners. These include urban landscaping (Burger 1988), pets, and reduced access for hunting. Work with conservation-minded landowners such as these is the bread-and-butter of wildlife management. The shift toward smaller land holdings could be stimulated by agricultural trends that make production on marginal lands uneconomical.

Marginal Agricultural Lands: Opportunity for Bobwhite Conservation?

Several trends have the potential to shift intensive agricultural production away from marginal (unprofitable) lands. Although such reduction in intensive land use could benefit bobwhites, the CRP demonstrates well that plant succession quickly renders such unmanaged lands unsuitable for bobwhite (Burger et al. 1990). The chances of these marginal lands being managed for bobwhite is not great because many of the landowners could lack the discretionary income, or time, necessary to manipulate plant communities. Relative to intensive agricultural land use, however, these marginal lands could provide opportunity for bobwhite management.

Some inherent land characteristics that contribute to profitability include plant growth capacity (soil fertility, moisture, etc.), and distance to suppliers and markets. Any one of these factors, or a combination, can affect profitability. Erosive, infertile lands with erratic rainfall that are far from suppliers and markets would be the most likely to be unprofitable and to go out of production. Other major forces, including technology and international economics, are also contributing to change in the profitability of America's rural lands.

Advocates of biotechnology argue that genetically engineered higher-yielding crops will reduce cultivation of marginal lands. Dennis Avery, director of the Hudson Institute's Center for Global Food Issues (Avery 2001), states that "If we are successful in 2020, the world will have free trade in farm products of all kinds, so that it can use its best land to produce the products for which each acre is best suited. As a result, we will meet the food demand of seven billion people—all more affluent by far than the average people of the year 2000—without taking any more land away from nature."

Marginal lands could be shifting out of production by the trend toward concentration of production in the hands of a few corporations. Monsanto's failed attempt to acquire American Home Products, Inc., is part of an ongoing strategy to create what's called a "dirt-to-dinner plate company" with control of what, when and where seeds are planted and harvested, and the manufacture and distribution of final products (ASI Global Landletter, Spring 1999). The model for this business approach is well established with poultry and pork. This could result in lands going out of production, either because landowners are unwilling to operate un-

der contract, or they are unable to compete with large corporations. There also is believed to be an advantage for vertically-integrated corporations to have ownership of large contiguous tracts, rather than scattered tracts, resulting in increased operating efficiency and fewer problems with neighboring landowners (ASI Global Landletter, Winter 2000). The net effect of increased corporate ownership on wildlife management is unclear, with both positive (e.g., marginal land out of production, corporations' sensitivity to environmentally-based public relations, large land area controlled by 1 manager) and negative aspects (decisions ultimately made by distant executive). Experts predict environmental concerns will play a "much bigger part" in future production decisions (ASI Global Landletter, Winter 2000), so biologists need to be aggressive with potential corporate cooperators.

Marginal lands could be driven out of the agribusiness mode by foreign competition. Free-trade advocates believe that reduced input costs and less costly environmental regulation will give foreign agricultural producers a competitive edge and result in less agriculture land use in the United States. Steven Blank, agricultural economist at the University of California-Davis, suggested that the United States get out of the farming business all together (Kirschenmann 2001). Although marginally profitable lands would be the most vulnerable to foreign competition, the best lands could also be affected by competition. Particularly pertinent to bobwhite conservation is the prediction that American farmers will move away from bulk commodities such as corn and soybeans (ASI Global Landletter, Winter 2000). Analysts figure that some of these crops could be replaced by specialty products, with large fields that once grew 1 or 2 crops now producing 10–15 different products. Further, these producers will work more closely with manufactures, customizing their acreage to meet specific demands. Although this scenario of diversification and small "field" size is grossly appealing to bobwhite enthusiasts, it wouldn't be surprising if such systems required a level of intense management that leaves little habitat for wildlife. Regardless of the development of such markets and land use, a net reduction in corn and soybean production has implications for bobwhite conservation, and a change to non-production or specialized production could bring new opportunity for bobwhite conservation.

The existing government-sponsored marginal land program, the CRP, has well-known significance to bobwhite enthusiasts in the Midwest (Burger et al. 1990). Because of the dominance of overly thick stands of grass in CRP fields, the potential for bobwhite will not be realized except where management (disking and/or prescribed fire) is conducted. The 2002 Farm Bill could provide another iteration of bobwhite-friendly change if policy makers agree to make the \$5/acre per year management a reimbursable cost instead of an upfront payment. At this rate, and assuming disking costs \$10/acre, the 3-year strip disking protocol recommended for CRP could result in a net economic gain for landowners. For numerous reasons (lack of

equipment and training, absentee ownership, lack of awareness and/or motivation, etc.), however, we cannot assume this will result in widespread management of CRP. Large-scale CRP management will require intensive efforts to promote the need, facilitate contracting, connect hunters with landowners, provide tax incentives, etc. Furthermore, as reviewed by Brady and Hamilton (1988), farmers have largely ignored wildlife components because of inadequate economic return. Access fees for hunting, whether paid by natural resource agencies (e.g., Kansas Department of Wildlife and Parks Walk In Hunting Access), commercial hunting operations, or individuals, could increase landowner motivation for CRP management.

Sustainable Agriculture

Sustainable agriculture, as defined by the United States Department of Agriculture (USDA), is "A system that is economically viable for farmers and ranchers, environmentally healthy, and supportive of local communities and rural areas" (USDA, North Central Region, Sustainable Agriculture Research and Education Program 2001). Proponents include the USDA, Congressional Rural Caucus, Iowa State University's Leopold Center, Jefferson Institute, American Farmland Trust, and a plethora of other university, state, and NGOs. Outside the USDA, proponents use a more diverse description of sustainable agriculture to include concepts such as spirituality, hope, harmony, "the earth as community" and social justice. Ikerd (1997), describes sustainable agriculture as farmer-oriented, with little relation to "agribusiness" and that it is known variously as practical farming, organic farming, small farmers, and alternative agriculture. Kirschenmann's (2001) vision for the farm of the future is that: "they will be more ecology driven, less technology dependent. Biodiversity will be the key to their economic and ecological resilience . . . more of the value of the agricultural enterprises will be retained on the farms and in local communities."

The fate of this movement, and potential implications for bobwhites are uncertain. The generalizations sound promising, harkening back to a day when bobwhites were valued on the farm for their consumption of insect pests, and land use was less intensive. I speculate that insight into effects of sustainable agriculture on bobwhites could be gained today by study of farmland areas owned by the Amish or Mennonites.

Biotechnology and World Food Demand

Wildlife experts agree that intensive agriculture provides little if any habitat for bobwhite and other farmland wildlife (Burger 1988, Roseberry 2000). Intensive agriculture has led to higher yields through hybridized seed, weed and pest control, multiple cropping, high inputs of fertilizer, continuous and management intensive grazing, etc. Theoretically, higher efficiency in crop, forage and animal production could result in greater production on the same or less area of land. However, higher yields and/or increased demand for food or fiber, could also stimulate use of

marginal lands and/or conversion of native plant communities to agricultural production. Some combination of these factors led to an increase of about 4.4 million hectares in cropland in the Midwest during 1945–1992 (The H. John Heinz III Center for Science, Economics and the Environment 1999), rendering the theory of conservation of land area via higher yields suspect.

Biotechnology figures heavily in the future of agriculture, with various implications for bobwhite. Early genetically modified organisms (GMOs) such as Roundup Ready Soybeans and Bt corn were designed to increase production. Theoretical benefits for bobwhites include lower use of insecticides where the GMO involves insect resistance, and lower use of herbicides where Roundup Ready products are used. The later could result in weedy field borders and non-production areas because of the need to perpetuate the genetic makeup of the population from which crops are being protected. For example, engineers of Bt corn have called for untreated refuge areas amongst fields of Bt corn so that the GMO's effectiveness lasts longer. Such refugia can potentially provide habitat for bobwhite in an agricultural setting otherwise cleansed of natural biota.

On the other hand, the effort in biotechnology to add value to agricultural products could result in marginal lands increasingly being used for production. As discussed above, this could be relatively hurtful for bobwhite. Within agriculture there are major expectations for GMOs adding value to agricultural products. Value is added using chemical, physical, and enzymatic methods to generate valuable foods, food additives, nutraceuticals, pharmaceuticals, and industrial products. As agricultural products become more valuable, the interest in production on marginal lands will increase, at least for landowners who own their land, and thus have lower fixed costs; otherwise, owners of the best agricultural land will still have a competitive advantage in an era of "value-added" products. Regardless of any effect on the amount of land in production, it's clear that increased value of an agricultural product leads producers to more zealously protect their crop, a scenario that probably leaves little room for the needs of wildlife.

All the above potential gains for bobwhite conservation can be wiped out by catastrophes released by biotechnology and/or by increased demand for food/fiber from a growing human population. Environmental risks associated with GMOs are uncertain despite recent media reports. Preliminary warnings of deleterious effects of Bt corn on monarch butterflies by Iowa State university researchers was followed by contradictory reports by both the researchers and the Environmental Protection Agency (EPA) (APHIS 2000). Based on differences between laboratory testing and field application, the EPA reported that data are insufficient to cause undue concern of widespread risks to Monarch butterflies. Recently in Missouri a rumor was circulating that bobwhites, deer, turkeys, etc., would not eat Roundup Ready soybeans. We could find no tests of effects of such beans on wildlife. Indeed, it might be difficult to test for such effects using standard

toxicology tests because many normal foods in great quantities create an adverse reaction (e.g., soybeans in tests on bobwhite, Robert J. Robel, Kansas State University, personnel communication).

In the 21st century demand for food/fiber will increase initially because of removal of restrictions on free trade, particularly China's potential admission to the World Trade Organization (FAPRI 2001). Further, the world population is predicted to increase from 6 billion today to 7 billion in 2020 (Avery 2001) placing tremendous demand on food production.

CONCLUSION

Faced by such formidable challenges to widespread quail restoration, quail enthusiasts must adopt new strategies if we are to be successful. For most, we must join mainstream ecological movements such as the North American Bird Conservation Initiative, and shed ecologically indefensible practices such as predator control and artificial propagation of game birds. Only time will tell if John Roseberry is a prophet in suggesting that "... in the face of an ever-expanding human presence on the landscape, only a relatively few wildlife species will ultimately thrive, and the bobwhite will probably not be one of them," or if the ever-evolving world society has room for a species such as bobwhite whose abundance has been so closely tied to agriculture.

LITERATURE CITED

- APHIS. 2000. Frequently asked questions: USDA and biotechnology. Animal and Plant Health Inspection Service, U.S. Department of Agriculture. Washington, D. C. (<http://www.aphis.usda.gov/biotechnology/faqs.html>)
- Askins, R. A. 2001. Sustaining biological diversity in early successional communities: the challenge of managing unpopular habitats. *Wildlife Society Bulletin* 29:407–412.
- ASI Global Landleter Spring 1999. Giant agribusiness mergers raise concern. Agricultural Services and Investments Global. Lucerne, Switzerland. (<http://www.asiglobal.com>)
- ASI Global Landleter Winter 2000. The future of agriculture: looking ahead in the new millennium. Agricultural Services and Investments Global. Lucerne, Switzerland. (<http://www.asiglobal.com>)
- Avery, D. T. 2001. Hudson's perspectives on international policy. Hudson Institute 1999 Annual Report. Indianapolis. (<http://www.hudson.org/futurist/i-globalfood.htm>)
- Brady, S. J. 1985. Important soil conservation techniques that benefit wildlife. Pages 55–62 in *Technologies to benefit agriculture and wildlife: workshop proceedings*. United States Congress, Office of Technological Assessment, OTA-BP-F-34, Washington, D.C.
- Brady, S. J., and R. Hamilton. 1988. Wildlife opportunities within federal agricultural programs. Pages 95–109 in D. L. Hallett, W. R. Edwards, and G. V. Burger, eds. *Pheasants: symptoms of wildlife problems on agricultural lands*. North Central Section of The Wildlife Society, Bloomington, Indiana.
- Brennan, L. A. 1993. Strategic plan for quail management and research in the United States: issues and strategies. *Proceedings of the National Quail Symposium* 3:170–171.
- Burger, G. V. 1988. 100 years of ringnecks: an historical perspective on pheasants in North America. Pages 1–26 in D. L. Hallett, W. R. Edwards, and G. V. Burger, eds. *Pheasants:*

- symptoms of wildlife problems on agricultural lands. North Central Section of The Wildlife Society, Bloomington, Indiana.
- Burger, L. W., Jr., E. W. Kurzejeski, T. V. Dailey, and M. R. Ryan. 1990. Structural characteristics of vegetation in CRP fields in northern Missouri and their suitability as bobwhite habitat. Transactions of the North American Wildlife and Natural Resource Conference 55:74–83.
- Burger, L. W., Jr., D. A. Miller, and R. I. Southwick. 1999. Economic impact of northern bobwhite hunting in the southeastern United States. Wildlife Society Bulletin 27:1010–1018.
- Callahan, T. R. 1996. Avian community structure within restored oak-savanna and unburned oak-woodland in Missouri. Thesis. University of Missouri, Columbia.
- Constance, D. H., J. Stanford Rikoon, and J. C. Ma. 1996. Landlord involvement in environmental decision-making on rented Missouri cropland: pesticide use and water quality issues. Rural Sociology 61:577–605.
- Crum, J. M. 1993. Translocation of wild-trapped bobwhite quail in West Virginia: a 3-year pilot study. Final Report, Work Plan 7, Job 7-1, P-R Project W-48-R, West Virginia Division of Natural Resources.
- Dahlgren, R. B. 1988. Distribution and abundance of the ring-necked pheasant in North America. Pages 29–43 in D. L. Hallett, W. R. Edwards, and G. V. Burger, eds. Pheasants: symptoms of wildlife problems on agricultural lands. North Central Section of The Wildlife Society, Bloomington, Indiana.
- Dailey, T. V., and V. L. Heidy. 1999. Wildlife harvest and population status report—northern bobwhite quail—1999. Missouri Department of Conservation, Jefferson City.
- Dailey, T. V., and V. L. Heidy. 2000. Wildlife harvest and population status report—northern bobwhite quail—2000. Missouri Department of Conservation, Jefferson City.
- Dhuey, B. 2000. Small game harvest: 1999–2000. Wisconsin Department of Natural Resources, Madison.
- Edwards, W. R. 1972. Quail, land use, and weather in Illinois, 1956–70. Proceedings of the National Bobwhite Symposium 1:174–183.
- FAPRI. 2001. Easing of diplomatic tension with China gives U.S. farmers hope for increased trade. News, FAPRI Analysis, College of Agriculture, Food and Natural Resources, University of Missouri-Columbia. (<http://cafnr.missouri.edu/news/2001/0401/FAPRI.html>)
- Favre, D. S., and G. Olsen. 1979. Surplus population: a fallacious basis for sport hunting. International Society for Animal Rights, Inc. Clarks Summit, Pennsylvania.
- Griffith, B., J. M. Scott, J. W. Carpenter, and C. Reed. 1989. Translocation as a species conservation tool: status and strategy. Science 245:477–480.
- Guthery, F. S. 1997. A philosophy of habitat management for northern bobwhites. Journal of Wildlife Management 61: 291–301.
- Hodgdon, H. H. 1999. Fish and wildlife management in the new millennium: perspective from The Wildlife Society. Proceedings of the Annual Conference of the Southeast Association of Fish and Wildlife Agencies 53:8–14.
- Ikerd, J. 1997. New hope for the future of farming. Social Science Unit, University of Missouri-Columbia. (<http://www.ssu.missouri.edu/faculty/jikerd/papers/newhope.html>)
- Kabat, C., and D. R. Thompson. 1963. Wisconsin quail, 1834–1962: population dynamics and habitat management. Wisconsin Conservation Department Technical Bulletin 30. Madison.
- Kansas Department of Wildlife and Parks. 2000. Strategic Plan 1997–2001. Pratt. (<http://www.kdwp.state.ks.us/about/plan.html>)
- Kirschenmann, F. 2001. Agriculture's uncertain future: unfortunate demise or timely opportunity? The Leopold Center for Sustainable Agriculture. Iowa State University, Ames. (<http://www.ag.iastate.edu/centers/leopold/pubinfo/papers/speeches/agfuture.html>)
- Klimstra, W. D. 1982. Bobwhite quail and changing land use. Proceedings of the National Quail Symposium 2:1–5.
- Komarek, E. V. 1972. Summation of the national bobwhite symposium. Proceedings of the National Bobwhite Symposium 1:372–367.
- Kozicky, E. L. 1993. The history of quail management with comments on pen-rearing. Proceedings of the National Quail Symposium 3:1–7.
- Leopold, A. 1948. Why and how research? Transactions North American Wildlife and Natural Resource Conference 13: 44–48.
- Leopold, B. D., and G. A. Hurst. 1994. Experimental designs for assessing impacts of predators on gamebird populations. Transactions North American Wildlife and Natural Resource Conference 59:477–487.
- Mankin, P. C., R. E. Warner, and W. L. Anderson. 1999. Wildlife and the Illinois public: a benchmark study of attitudes and perceptions. Wildlife Society Bulletin 27:465–472.
- McCreedy, C. D. 2000. Breeding populations of northern bobwhites, 2000. Indiana Division of Wildlife, Fish and Wildlife Management and Research Notes. Indiana Department of Natural Resources. Indianapolis. (<http://www.in.gov/dnr/fishwild/notes/quail.html>)
- Missouri Department of Conservation. 2000. Missouri Department of Conservation Strategic Plan. Jefferson City.
- Nebraska Game and Fish Department. 2001. The bobwhite quail in Nebraska. Lincoln. (<http://ngp.ngpc.state.ne.us/wildlife/quail.html>)
- Noss, R. F., E. T. LaRoe III, and J. M. Scott. 2001. Endangered ecosystems of the United States: a preliminary assessment of loss and degradation. USGS Biological Resources. (<http://biology.usgs.gov/pubs/ecosys.html>)
- Nuzzo, V. A. 1986. Extent and status of Midwest oak savanna: presettlement and 1985. Natural Areas Journal 6:6–36.
- Petersen, L. R., R. T. Dumke, and B. F. Duerksen. 2000. Habitat management for northern bobwhites in Wisconsin: a long-term assessment. Proceedings of the National Quail Symposium 4:16–25.
- Quail Unlimited, Inc. 2000. State membership ranking. Annual Report. Edgefield, South Carolina.
- Roseberry, J. L. 1993. Bobwhite and the “new” biology. Proceedings of the National Quail Symposium 3:16–20.
- Roseberry, J. L. 2000. Concluding remarks: the research perspective. Proceedings of the National Quail Symposium 4: 243–245.
- Roseberry, J. L., and W. D. Klimstra. 1984. Population ecology of the bobwhite. Southern Illinois University Press, Carbondale.
- Roseberry, J. L., and S. D. Sudkamp. 1998. Assessing the suitability of landscapes for northern bobwhite. Journal of Wildlife Management 62:895–902.
- Roseberry, J. L., D. Ellsworth, and W. D. Klimstra. 1987. Comparative post-release behavior and survival of wild, semi-wild, and game farm bobwhites. Wildlife Society Bulletin 15:449–455.
- Sauer, J. R., J. E. Hines, I. Thomas, J. Fallon, and G. Gough. 2000. The North American breeding bird survey, results and analysis 1966–1999. Version 98.1. United States Geological Survey, Patuxent Wildlife Research Center, Laurel, Maryland.
- Schorger, A. W. 1944. The quail in early Wisconsin. Transactions of the Wisconsin Academy of Science, Arts, and Letters. 36:77–103.
- Seipel, M., J. S. Rikoon, D. Hobbs, J. B. Bullock, and D. R. Gordon. 1995. The social and economic organization of Missouri agriculture, 1964–1992. Missouri Agricultural Experiment Station Special Report 486, University of Missouri-Columbia.
- Sheriff, S. L., and T. G. Kulowiec. 1996. Small game harvest

MIDWEST BOBWHITE CULTURE

19

- survey, 1994–95. Performance Report. W-13-R-50. Missouri Department of Conservation, Jefferson City.
- Slayback, A. L. 1844. Journal of Alexander L. Slayback, Attorney. Shelbyville, Missouri.
- The H. John Heinz III Center for Science, Economics and the Environment. 1999. Designing a report on the state of the nation's ecosystems. Report Brief, October 1999. Washington, D.C. (<http://www.us-ecosystems.org>)
- United States Department of Agriculture, North Central Region, Sustainable Agriculture Research and Education Program. 2001. (<http://www.sare.org/ncrsare/>)
- United States Department of the Interior. 1997. 1996 national survey of fishing, hunting, and wildlife-associated recreation. National Overview. United States Government Printing Office, Washington, D. C.
- Womack, A. 2001. FAPRI leader looks at congressional action on farm bill reform; doesn't view with alarm. News, College of Agriculture, Food and Natural Resources, University of Missouri-Columbia. (<http://cafnr.missouri.edu/news/2001/0301/womack.html>)

QUAIL MANAGEMENT: ISSUES, CONCERNS, AND SOLUTIONS FOR PUBLIC AND PRIVATE LANDS—A SOUTHEASTERN PERSPECTIVE

L. Wes Burger

Box 9690, Department of Wildlife & Fisheries, Mississippi State University, Mississippi State, MS 39762, USA

ABSTRACT

In the Southeastern United States, Breeding Bird Surveys that bobwhite populations have been declining at 3.8%/year over the last 3 decades. Declines have been attributed the cumulative effects of large-scale deterioration of quail habitat quality associated with advanced succession, intensive monoculture farming, and intensive timber management. Additional factors such as changing role of predation, expansion of red imported fire ants, and metapopulation processes may exacerbate declines. Declining bobwhite hunter participation, changing public values, and realignment of conservation emphases have diminished the emphasis on bobwhite management nationally. However, within the Southeast 3 states, Virginia, Georgia, and North Carolina, have developed targeted private lands initiatives to enhance local and regional bobwhite habitats and populations. Additional opportunities exist for enhancing regional populations through broad avian conservation initiatives such as the North American Bird Conservation Initiative and Partners in Flight. Potential benefits from these regional efforts will be accrued only if greater value and emphases are placed on conservation of early successional habitats. As anthropogenic activities and natural successional processes influence regional usable space for bobwhite in the Southeast, established paradigms regarding relationships among predation, harvest, habitat management, and population dynamics may no longer be germane. Restoration of local and regional bobwhite populations will require a much greater understanding of bobwhite population processes at a mechanistic level across local and regional spatial scales.

Citation: L. Wes Burger. 2001. Quail management: issues, concerns, and solutions for public and private lands—a southeastern perspective. Pages 20–34 in S. J. DeMaso, W. P. Kuvlesky, Jr., F. Hernández, and M. E. Berger, eds. Quail V: Proceedings of the Fifth National Quail Symposium, Texas Parks and Wildlife Department, Austin, TX.

Key words: *Colinus virginianus*, land use, northern bobwhite, Southeast, trends

POPULATION TRENDS

With few exceptions, northern bobwhite (*Colinus virginianus*) populations have declined over most of the range during the last 3 decades (Sauer et al. 2000). State agency harvest trends (Burger et al. 1999), Christmas Bird Counts (Brennan 1991), and North American Breeding Bird Surveys (BBS) all show similar declining trends. From 1966 through the present, the BBS conducted by the United States Geological Survey, Patuxent Environmental Science Center, provides the most consistent range-wide measure of bobwhite relative abundance and population trends. In the southeastern United States (United States Fish and Wildlife Service, Region 4), the BBS indicates a 3.8%/year decline from 1966–1999 (Sauer et al. 2000). The rate of decline is apparently increasing; BBS for the southeastern United States from 1966–1979 indicates a 1.7%/year decline, whereas those from 1980–1999 show a 5.3%/year decline (Sauer et al. 2000). During the period 1966–1979, 4 of 11 southeastern states exhibited significant declining trends, whereas from 1980–1999 11 of 11 states were declining (Table 1). Such a dramatic decline in a ubiquitously distributed species is of additional concern because of the loss of recreational opportunity and associated economic impacts on local economies (Burger et al. 1999). As bobwhite populations have declined, harvest of bobwhite in 10 southeastern states (Ala., Fla., Ga., Ky., La., Miss., N.C., S.C., Tenn., Va.) declined from an esti-

mated 17.1 million birds in 1970 to 3.5 million in 1995. The rate of decline in hunter numbers from 1980–1995 (–6.9%/year, Burger et al. 1999) exceeds the rate of bobwhite population decline (–4.8%/year) during the same period (Sauer et al. 2000), reflecting a reduction in hunter participation. As northern bobwhite populations continue to decline this pattern will continue. Reductions in bobwhite hunter populations represents a loss of a key constituency group needed for habitat management advocacy.

Although declining bobwhite populations have been attributed to a variety of factors including coyotes, nest predators, fire ants, pesticides, and avian predators, the primary cause has been the cumulative effects of large-scale deterioration of bobwhite habitat quality associated with advanced succession (Roseberry et al. 1979, Fies et al. 1992), intensive monoculture farming (Vance 1976, Exum et al. 1982, Roseberry 1993), and intensive timber management (Brennan 1991). In the terms of Guthery (1997), this is a range-wide reduction in useable space. Specific factors that have contributed to population declines vary regionally. In agricultural systems, farming practices have changed from diverse rotational cropping of row crops, small grains, hay, and legumes to intensive monocultural production of cotton, corn, soybeans, and rice. In intensively cultivated regions, lack of suitable grassy cover for nesting, weedy areas for brood rearing, and woody fencerows for winter and escape cover has re-

QUAIL STATUS IN THE SOUTHEAST

Table 1. Northern bobwhite population trends in the southeastern United States as indexed by Breeding Bird Surveys, 1966–1999^a.

State	1966–1999			1966–1979			1980–1999		
	Trend	<i>P</i>	<i>n</i>	Trend	<i>P</i>	<i>n</i>	Trend	<i>P</i>	<i>n</i>
Alabama	−4.2	0.00	89	−1.2	0.10	42	−6.2	0.00	88
Arkansas	−3.2	0.00	33	0.5	0.49	29	−5.3	0.00	33
Florida	−3.4	0.00	74	−1.5	0.22	34	−4.4	0.00	70
Georgia	−4.3	0.00	67	−1.9	0.17	54	−5.4	0.00	66
Kentucky	−2.5	0.00	46	−3.6	0.00	38	−2.8	0.00	41
Louisiana	−4.8	0.00	49	−1.7	0.13	24	−4.8	0.00	43
Mississippi	−3.5	0.00	34	−0.9	0.42	27	−4.9	0.01	32
North Carolina	−4.5	0.00	65	−3.4	0.00	29	−6.5	0.00	58
South Carolina	−4.7	0.00	29	−2.8	0.00	20	−5.6	0.00	25
Tennessee	−3.6	0.00	44	−1.6	0.00	41	−5.5	0.00	44
Virginia	−4.1	0.00	55	−2.4	0.00	43	−5.6	0.00	48
Southeast Region ^b	−3.8	0.00	530	−1.7	0.00	338	−5.3	0.00	500

^a Trend estimates from Sauer et al. (2000).

^b U.S. Fish & Wildlife Service Region 4, includes: Alabama, Arkansas, Florida, Georgia, Kentucky, Louisiana, Mississippi, North Carolina, South Carolina, Tennessee.

duced the overall capability of the land to support bobwhite (Kabat and Thompson 1963). In forested regions of the southeast, reduction in extent and frequency of fire (Brennan et al. 1998), increasing forest coverage, loss of small agricultural fields to natural succession and reforestation, expansion of densely planted pine plantations, and increasing use of total vegetation control in clearcuts and regeneration stands have reduced availability of grassy and weedy areas required for nesting, foraging, and brood-rearing (Fies et al. 1992). Modern land use practices which strive to maximize food, fiber, and forest products have the net effect of simplifying the landscape. This reduction in landscape complexity, or heterogeneity, has simply reduced the proportion of the landscape in usable space for bobwhite (Guthery 1997), and the population size which a given location is able to support.

LAND USE PATTERNS

In the southeastern United States, bobwhite are inextricably linked to early successional ground cover communities, although in other regions, they might occupy mid- to late-successional habitats (Spears et al. 1993). These communities may occur as spatially static patches in annually disturbed systems such as agricultural landscapes or as spatially and temporally dynamic patches created by timber thinning, clear cutting, and site preparation in forested systems. In forested systems, early successional communities occur as ephemeral patches, coming into existence following timber harvest, persisting for a brief (2–5 years) period, then lost through natural succession. Early successional *ground cover* might occur, and be perpetually maintained, by intermediate disturbance (e.g., fire) in an otherwise climax forest ecosystem such as pine/grassland. Declining populations are not unique to bobwhite, but rather reflect the alteration of an entire ecosystem characterized by region-wide loss of early successional plant communities and associated fauna (Church et al. 1993). Factors contributing to declines in early successional species are complex and cumulative, attributable to the changing manner in which

we as a society use our natural resources. Loss of early successional communities and reduction in landscape heterogeneity associated with large scale, intensive, and monocultural production of agricultural and forest products is likely the direct causes of region-wide population declines of these species.

Agricultural Landscapes

Throughout the southeastern United States, privately-owned, rural, agricultural and forested lands constitute 79% of the total land base and provide important wildlife habitats. The Southeastern landscape is forest dominated, in 1997 being comprised of 48.3% forest, 14.2% rowcrops, 11.4% pasture, 1% rangeland, 1% Conservation Reserve Program (CRP), and 3.5% other rural uses (United States Department of Agriculture 2000). Land use practices throughout the Southeast have changed dramatically during the previous 5 decades. These changes have included farm consolidation, replacement of native communities with exotic or offsite monocultures, and conversion of agricultural lands to urban uses and forest. Based on the United States Department of Agriculture–Natural Resources Conservation Service, Natural Resources Inventory (USDA-NRCS, NRI) survey of 12 Southeastern states (Ala., Ark., Fla., Ga, Ky., La., Miss., N.C., S.C., Tenn., Va., W.Va.), from 1982–1997, 4.7% of the rural land base (3.9% of total surface acres) was lost to urbanization or other uses (USDA-NRCS, NRI <http://www.nhq.nrcs.usda.gov/NRI/1997/>). Twenty percent of cropland (3.6 % of total landbase), 5.8% of pasture (0.7% total landbase), and 29% of range land (0.4% of total landbase) in these southeastern states were converted to other uses, while forested acres remained relatively stable (0.8% loss of forested acres, 0.4% of total landbase).

Simultaneously, more intensive management of remaining habitats has reduced the quality of these lands for wildlife. From 1950–1990 mean farm size doubled and the number of farms declined by nearly 60 percent. Specialized, high input, monocultural agriculture, increased field size, and elimination of idle areas have

reduced the quality of agricultural lands for bobwhite. Introduction of exotic forage grasses, and increased grazing intensity have reduced the availability and quality of early successional habitats in agricultural landscapes. From 1982–1992, cattle numbers increased by more than 25% and cattle/100 acres increased by 34%. Much of the existing range and pasture has been planted to non-native forage grasses such as tall fescue, bermuda grass, and bahia grass. Simultaneously, reduction in the use of fire has degraded the quality of remaining grasslands (Brennan et al. 1998).

Implementation of federal farm programs, such as the CRP, in the Southeast has had a significant effect on land use changes as well. Following CRP signup 22 almost 2.8 million acres were enrolled in CRP in 12 southeastern states (Ala., Ark., Fla., Ga, Ky., La., Miss., N.C., S.C., Tenn., Va., W.Va.). Conservation practices (CP) CP1 (cool-season grasses), CP2 (native warm-season grasses), CP3 (trees), CP4 (wildlife habitat), CP10 (existing grass), CP11 (existing trees), CP21 (filter strips), and CP22 (riparian buffers) collectively accounted for 97.6% of all enrolled acres. In contrast to the Midwest where grass establishment was the predominant conservation practice, tree planting (CP3 and CP11) was the most commonly selected CP in the Southeast, accounting for 61.9% of total enrolled acres. Current enrollment in tree planting practices is approximately equitably distributed between newly established stands (<15 years of age, 43.7%) and reenrolled stands (52.2% >10 years of age). The most commonly established tree species was loblolly pine, although a longleaf pine National Conservation Priority Area (CPA) was established beginning with signup 18. The longleaf pine CPA included parts of 9 southeastern states and provided special incentives (increased EBI and exemption from HEL requirements) for establishment of longleaf pine on eligible cropland. Through the 22nd signup, 168,541 acres of longleaf have been enrolled in this CPA. Grass cover practices account for 33.1% of current enrollment in the Southeast, and field border practices (CP21, CP22) account for 2.6% of enrolled acres. The distribution of enrollment between grass and tree practices differed substantially among southeastern states. Georgia and Florida enrolled almost exclusively trees (92.3%), whereas Kentucky, Tennessee, and West Virginia enrolled predominantly grasses (90.9, 85.9, 80.9%, respectively). As a result of strong involvement by state wildlife agencies, native warm-season grasses were more widely adopted in Virginia (9.5% of enrolled acres) and Kentucky (7.0% of enrolled acres), but < 1% were implemented in other states (e.g., Fla. 0.1%, Miss. 0.2%). Field border practices (CP21 and CP22) were extensively used in Kentucky (5.6% of enrolled acres), North Carolina (12.3% of enrolled acres), and South Carolina (11.1% of enrolled acres), but seldom used in Florida (0.1%), Georgia (0.3), or Louisiana (0.3%). Thus, CRP in the Southeast is quite different from that in other regions and tremendous variation exists among southeastern states as a result of differing land use and conservation goals and potentials. The net ef-

fect of the CRP in the Southeast was the conversion of agricultural lands to forest or forage grasses resulting in a long-term loss of potential habitat.

Forested Landscapes

Although forested acreage in the Southeast has been relatively stable during the past 2 decades, forest composition and quality have changed (Trani et al. 2001), reducing habitat quality for many wildlife populations. In general, there has been a conversion of longleaf pine to fast-growing slash and loblolly. The longleaf pine community once stretched from Texas to Virginia (Frost 1993) and was the dominant upland ecosystem across much of the southeastern coastal plain, covering more than 60% of uplands and 40% of the entire region (Noss et al. 1995). Today, less than 2% of the historic longleaf remains (Noss et al. 1995). Increasing human populations combined with increasing per capita consumption of paper products have contributed to a continuously expanding demand for pulpwood. Southern pulpwood production increased more than 4-fold from 1953–1993 and will likely continue to increase in the foreseeable future (Johnson 1996). In a 1995 survey of 7 Midsouth states (Ala., Ark., La., Miss., Okla., Tex., and Tenn.), most (67%) of 40,000,000 ha of timberland was in non-industrial private ownership (Rosson 1995). An increasing proportion of this timberland (16%) is artificially regenerated stands (plantations), mostly loblolly pine. Most (55%) plantation acreage in the Midsouth occurs on industrial forest lands with 39% on non-industrial private lands and 7% under public ownership (Rosson 1995). In the Coastal South, 32% of all timberland was in the seedling/sapling stage (Trani et al. 2001) but a substantial proportion (55%) of plantation acreage was in the seedling-sapling size-class. Thus, pine plantations will likely constitute an increasing component of the southern landscape and a significant proportion of early successional habitats. In the Gulf coastal plain, intensive plantation management has influenced both forest composition and age distribution (Trani et al. 2001). Use of genetically selected fast-growing seedlings and herbicidal competition control speed the time from planting to canopy closure, potentially reducing the window of early successional opportunity in reforested pine plantations.

Southern pine ecosystems are fire dependent. Fire has been one of the primary abiotic processes that has shaped the biota of the southern forest landscape (Brennan et al. 1998). The frequency and intensity of fire determines the composition and structure of pine forests in this region, particularly the degree of hardwood component in the mid- and understory. Presence and dominance of hardwood midstory canopy strongly influences herbaceous ground cover, and hence bobwhite habitat. Fire exclusion over the last 50 years, attributable to landscape fragmentation, intentional fire suppression, and declining application of prescribed fire (Brennan et al. 1998), has resulted in changes in forest ecosystems, including loss of herbaceous ground cover and expansion of forest land within former open

habitats (White and Wilds 1998, Trani et al. 2001). The impact of fire exclusion on bobwhite habitat and populations in the Southeast cannot be overemphasized. Dramatic reductions in fire frequency in southern landscapes has resulted in decline and loss of numerous fire-adapted species, including northern bobwhite (Brennan et al. 1998). Fire exclusion in pyric southern pine systems is perhaps the greatest habitat problem facing bobwhite in the Southeast.

PUBLIC PERCEPTIONS

Tom Dailey (*this volume*) thoroughly documents the changing characteristics and attitudes of our “increasingly urbanized and nonconsumptive society.” Despite trends in urbanization we see an ever increasing, but superficial sense of environmental awareness. With this new awareness comes increasing public expectations for resource stewardship. Changing public expectations are expressed through regulatory action, consumer pressure, and evolving priorities of legislation and governmental programs. Although conservation of natural systems and resources has broad public support, it seems that the public does not equally value all systems. Studies of public perception of forest landscapes indicate that, generally, aesthetic preference increases with forest stand age (summarized in Askins 2001). Furthermore, as Askins (2001) acknowledges, the history of extensive forest clearing in the eastern United States has resulted in tree planting and forest protection becoming synonymous with conservation. Although many of these forests have regenerated, public perceptions of conservation remain linked with a single-minded focus on climax forest systems. Thus a “not so subtle” conservation bias against early successional systems seems evident. Despite the fact that nearly 80% of the perilously endangered ecosystems in eastern North America are disturbance-maintained systems (Noss et al. 1995, Askin 2001, Thompson and DeGraaf 2001) conservation of early successional systems has not received high priority. Askins (2001) suggests that a barrier to sustaining and restoring these systems is a perception that they are uninteresting or unappealing and their maintenance often requires “removing trees to favor vegetation associated with human disturbance.” These perceptions of conservation, coupled with a misinformed attitude that simply “letting nature take its course” (Hunter et al. 2001) will restore or maintain “natural” systems have resulted in little conservation attention focused on disturbance-maintained systems. In the southeastern United States, bobwhite are inextricably linked to disturbance-maintained systems. Insofar as many natural disturbance processes have been permanently disrupted, human intervention with premeditated disturbance regimes (management) is essential for restoration and maintenance of the communities to which bobwhite are adapted. Even among natural resource professionals, creation of early successional systems through disturbance regimes deemed “unnatural” meets with sub-

stantial resistance. This is illustrated in opposition by many ornithologists to mechanical or herbicidal removal of hardwoods from fire excluded pine systems, even when accomplished for the purposes of red-cockaded woodpecker management. Within a recent special section in *The Wildlife Society Bulletin*, dedicated to maintenance of early successional systems, Hunter et al. (2001) acknowledged that direct management intervention *may* be justified, but “restoration should not be at the expense of developing future old-growth conditions in many areas where mid-successional stands now dominate.” Bobwhite are indeed associated with unpopular systems (Askins 2001).

Historical land use patterns accidentally produced such abundant populations over broad areas. As Roseberry (1993) noted, bobwhite habitat can be affected by too much disturbance, or not enough disturbance. This is the paradox facing bobwhite populations in the Southeast. Essential plant communities, appropriately interspersed, have been lost in both agricultural and forested systems because of too much and not enough disturbance, respectively. Bobwhite are no longer an accidental by product of broadly applied land use regimes. In modern landscapes restoration of bobwhite populations requires premeditated creation and maintenance of essential habitats on a spatially broad extent. In modern southeastern landscapes, locally abundant populations can be produced, but only through intensive management over extensive areas. In the Southeast, this has produced a dichotomous situation in which bobwhite persist at low densities over large portions of the range with high density populations only occurring on primarily private land where wealthy landowners allocate substantial resources to produce huntable populations.

The common goal of species conservation is to maintain viable populations. In contrast, to be a viable game species, bobwhite must be reasonably abundant over large portions of the landscape (Roseberry 2000). Increasingly, within the professional conservation community, management objectives for bobwhite populations sufficiently abundant to produce moderate levels of sustainable harvest are viewed with disdain. Expanded funding bases, changing constituencies, broader conservation objectives, and ecosystem management philosophies have led conservation agencies in the Midwest to question the legitimacy of management regimes developed around production of sustainable harvest of a focal species (Dailey *this volume*). Although increasingly common in northeastern and midwestern states, and evident in conservation forums such as *The Wildlife Society listserve*, this emerging paradigm has largely not yet reached Southeastern Fish and Wildlife Agencies. Most southeastern fish and wildlife agencies are still funded primarily by license fees, and hunters and fishermen remain a key constituency. Although participation in bobwhite hunting has declined throughout the Southeast (Burger et al. 1999), northern bobwhite remain a high profile species for many resource management agencies. This is illustrated in several state level initiatives targeting bobwhite habitat management on private lands.

PROACTIVE INITIATIVES

To address creation and maintenance of bobwhite habitat, 3 Southeastern states (Va., Ga., and N.C.) have developed specific programs that provide technical and financial assistance to private landowners interested in enhancing bobwhite habitat. These programs differ in their spatial extent, level of support, and specific practices subsidized.

Virginia

In 1996, Virginia Department of Game and Inland Fisheries (VDGIF) developed the Virginia Bobwhite Quail Plan. This plan identified specific changes that have occurred in pasture, rowcrop, and forest management practices that have contributed to declining bobwhite populations. These problems included: a) increased reliance on cool season forages for livestock forages; b) decreased use of prescribed burning; c) increased acreage of dense pine plantations; d) trends toward "cleaner" farming; e) lack of consideration for wildlife in USDA farm programs; f) unrealized opportunities to improve utility right-of-ways for bobwhites; g) lack of areas which demonstrate good quail habitat; h) lack of knowledge on availability of quail habitat and effects of landscape changes; i) lack of understanding of predation impacts on quail in fragmented habitats; j) impacts of changing pine forestry practices; k) impacts of pesticides on quail; and l) impacts of releasing pen-reared quail on wild quail populations (Capel et al. 1996). The Virginia plan developed specific strategies to address each of these problems. This plan included components to establish demonstration sites, provide technical assistance, and cost share to facilitate implementation of bobwhite habitat management. Five years after the initial implementation of this plan, VDGIF has documented a number of tangible products produced through the program. In an effort to increase information transfer VDGIF has produced 5 excellent technical bulletins addressing bobwhite habitat requirements, pine management, brood habitat management, and wildlife plantings and hosted 59 workshops attended by >3000 people. The Virginia Bobwhite Plan targeted habitat enhancement on private lands in 9 counties in the Piedmont and Tidewater regions. To implement this plan, VDGIF hired a dedicated biologist and reallocated substantial time of a second biologist to program delivery. This plan provided cost share funding for adding field borders to agricultural fields, idling land, converting fescue to native warm-season grasses, and adding wildlife plants to field buffers. These practices and cost shares were delivered through the Best Management Practices Program of the Department of Conservation and Recreation and Soil & Water Conservation Districts. A total of \$272,000 was invested in cost shared agricultural practices in 3 of the 5 years and an additional \$90,000 in prescribed burning cost share in 4 of 5 years. During 1996–2001, the Virginia Bobwhite Plan established 103 demonstration areas and cost shared 3,510 acres of habitat improvement on more than 400 landowners.

The Virginia Bobwhite Plan did not provide for a specific evaluation of the efficacy of habitat management practices in increasing local bobwhite populations.

Georgia

In 1999, the Georgia Department of Natural Resources implemented the Georgia Bobwhite Quail Initiative (BQI). The BQI is a comprehensive program that provides technical assistance and cost share to enhance bobwhite habitat on private lands in Georgia. The BQI is primarily directed at providing nesting and brood rearing habitats in 3 focus areas comprised of 20 counties in central Georgia. Within focus areas, Wildlife Resource Division (WRD) biologists provide cooperators with detailed technical assistance on bobwhite habitat management. Cooperators may receive incentive payments for establishment and maintenance of specific types of early successional habitats. Habitat management plans are developed for all interested landowners and incentive payments are allocated on a competitive basis. To be eligible for incentive payments potential cooperator's property must be located in 1 of the focus counties, must be at least 50 contiguous acres, must include commercial rowcrop agriculture, must be enrolled in the CRP longleaf Pine Conservation Priority Area, or in the Piedmont Physiographic Province and must be a pine forest not currently under intensive management for quail. Habitat management plans are competitively ranked for funding and plans containing multiple habitat practices receive higher rankings and increased chances for funding. Incentive contracts are for 3 years and are renewable annually based on cooperator performance. Specific cost-shared practices include herbaceous field borders, hedgerows, fallow patches and center pivot corners, pine forest openings, linear practices, prescribed burning in thinned pine forests, and conservation tillage. Funding is distributed annually contingent upon successful implementation of habitat practices and approval by WRD biologists. Funds are delivered through the local Soil and Water Conservation Commissions. During 1999 and 2000, WRD biologists provided technical assistance for 98 cooperators managing 203,466 acres. Cooperators enrolled 2,716 acres in cost-shared practices at a total cost of \$258,775 in incentive payments. Prescribed burning, field borders, and center pivot corners were the most commonly adopted practices. To deliver this program, Georgia Department of Natural Resources-WRD hired 6 wildlife biologists with exclusive responsibilities associated with the BQI. The Wildlife Resources Division is evaluating the efficacy of the BQI through a cooperative research project with University of Georgia. The goals of this project are to monitor baseline populations before and after initiation of BQI practices and compare treated and untreated farms. Fall covey density is being used as a response variable in an observational study that compares bobwhite abundance on lands enrolled in the BQI and neighboring farms not enrolled in the program. Both grid census methods and single-observer point counts are being used to index

fall abundance. All fields enrolled in the BQI will be monitored with one of these monitoring protocols. Initial results indicate a positive bobwhite response on 75% of BQI enrolled properties (R. Thackston, Georgia Department of Natural Resources, personal communication).

North Carolina

The North Carolina Wildlife Resources Commission has developed a new private lands initiative named CURE (Cooperative Upland habitat Restoration and Enhancement) to create and maintain early successional upland habitats for the benefit of northern bobwhite and associated early successional species. This program is targeted at those areas in North Carolina where existing land use and other habitat conditions provide the greatest potential for successful habitat restoration and enhancement. Funding and technical assistance will be concentrated in focal areas where combinations of agricultural, pasture, woodland, and shrubland exist in proportions that indicate overall suitability as small game habitat. Suitable habitat was identified from a habitat suitability model based on resampled and reclassified 1993–95 LANDSAT TM data. Three focal areas have been identified, 2 in the coastal plain and 1 in the Piedmont region. Within these focal areas, technical assistance and incentives will be available for landowners or landowner cooperatives that wish to implement habitat management on at least 5000 acres for a minimum of 5 years. Once enrolled in a cooperative, landowners will be eligible for technical assistance for management plan development and financial assistance for land rental, vegetation control and management, forest management, and fencing. North Carolina Wildlife Resources Commission proposes to allocate 7.5 full-time positions at a cost of nearly \$500,000/year to program delivery. Additionally, \$150,000/year will be allocated for practice cost-sharing. Bobwhite response to management regimes will be evaluated annually with a 50% sample of all potential habitat within participating landowner cooperatives using the fall covey call index.

Regional Initiatives

In addition to state-level initiatives, bobwhite populations could benefit from several regional and national initiatives. A Southeast Quail Technical Committee has been formed under the auspices of the directors of the Southeastern Association of Fish and Wildlife Agencies and charged with developing a national plan for restoration of bobwhite populations within the context of the North American Bird Conservation Initiative (NABCI). Ralph Dimmick is spearheading development of this plan, called the Northern Bobwhite Conservation Initiative (NBCI), with assistance from biologists around the region. The NBCI has set ambitious goals of stabilizing population declines within 5 years and restoring regional populations to 1980 levels within 20 years. Under the NABCI, the Southeastern Coastal Plain is designated as Bird Conservation Region (BCR) 27. This region comprises

39% of the land area of 10 southeastern states and provides perhaps the greatest opportunity for bobwhite restoration in the Southeast. Bobwhite is a priority species within BCR 27. Strategies identified in the NBCI were developed under the assumption that the availability of grasslands suitable for nesting and brood rearing limit bobwhite populations in agricultural and forest lands within BCR 27. The NBCI provides specific habitat acreage goals for each BCR and landscape type (crop, pasture, forest lands, etc). Under this plan, population objectives would be achieved primarily through conversion of crops to native grasslands, implementation of field borders and riparian corridors, conversion of exotic cool-season pastures to native warm-season grasses, reestablishment of longleaf, and enhancement of forest ground cover through prescribed burning, thinning, and improved site preparation.

In addition to the NABCI, Partners in Flight (PIF) has developed regional bird conservation plans (BCP). The 2 primary PIF physiographic regions in the southeastern United States are the East Gulf Coastal Plain (EGCP) and the South Atlantic Coastal Plain (SACP). Under the PIF conservation prioritization process, bobwhite are listed as a category I (highest priority) species in the EGCP and occur in 4 of the 7 priority habitat associations (longleaf pine/slash pine, loblolly pine/shortleaf pine, early successional habitats, grasslands and pastures). In the SACP region, bobwhite are listed as category IIa species (moderate priority) and occur in 3 of 8 priority habitat associations (early successional shrub-scrub, grasslands and associated habitats, and southern pine). Many of the primary habitat objectives proposed in the both the SACP and EGCP BCP would benefit regional bobwhite populations. Specific examples from the SACP include: retain and restore 1.3 million acres of native warm season grass habitats and associated long leaf pine, provide at least 300,000 acres of 5-year idle lands, 300,000 acres of annual communities, and 600,000 acres of 10–20-year idle lands, and increase long leaf pine acreage from 1.5 to 2.2 million acres, and improve herbaceous ground cover conditions favoring native grass communities. The SACP BCP specifically identifies the northern bobwhite as an extremely important species helping to drive habitat restoration efforts in this region. Many of the suggested habitat objectives for grassland and shrub-scrub are specifically to restore bobwhite populations in accordance with the NBCI, but will benefit other vulnerable grassland species.

As conservation funding bases expand and constituencies diversify, ecosystem management will increasingly be the philosophical framework under which public conservation programs are developed and delivered. As such, bobwhite conservation efforts framed in the context of restoration of early successional communities, disturbance-maintained systems, and pine grasslands will have the greatest probability of being widely adopted and implemented. Efforts such as the NABCI, NBCI, and PIF-BCP provide a vehicle for regional restoration of bobwhite and associated species. However, maximum benefits from re-

gional conservation planning will only be accrued through collaboration among quail ecologists, avian ecologists, and conservation biologists. We must be plugged in to broader conservation initiatives.

CHANGING PARADIGMS

As anthropogenic activities and natural successional processes influence regional usable space for bobwhite in the Southeast, established paradigms regarding relationships among predation, harvest, habitat management, and population dynamics may no longer be germane (Robel 1993, Roseberry 1993, Hurst et al. 1994). On both public and private lands throughout the Southeast, bobwhite populations, and the biologists who would manage them, face a myriad of circumstances that challenge prevailing paradigms.

Predation

Among the most controversial challenges is the poorly understood interactions between predator communities and bobwhite populations in modern landscapes. Under the influence of Errington's teaching and in an effort to maintain a public focus on habitat management, several generations of biologists have confidently promoted the enduring paradigm that "predation has no effect on bobwhite populations." However, the role of predation in limiting avian populations has received substantial attention in recent years (Hurst et al. 1996, Rollins and Carroll 2001, Jimenez and Conover 2001, Nelson 2001). Increasingly, the ecological community is recognizing that, contrary to historical paradigms, predation may limit recruitment and abundance of some species in modern landscapes (Cote and Sutherland 1995). Rollins and Carroll (2001) suggest that *how* predators interact with quail populations may be affected by changes in habitat, predator populations, predator community composition, and search efficiency. In modern landscapes, declining bobwhite populations may face increasing predator populations in a habitat matrix that increasingly favors the predator. Populations of some mesomammalian nest predators are apparently increasing throughout the Midwest and Southeastern United States (Lovell et al. 1998, Hubbard et al. 1999). Similarly, primary avian predators of adults may be increasing. During the period 1980–1999, BBS indicates increasing population trends for sharp-shinned hawk (18.1%/year), Cooper's hawk (13.8%/year), and red-tailed hawk (2.1%/year) (Sauer et al. 2000). In this changing context, previous assumptions about the impacts of predation on bobwhite demographics needs to be reevaluated (Hurst et al. 1994, Rollins and Carroll 2001).

Most published studies on bobwhite demographics have simply quantified the presumptive causes and rates of mortality of adults, chicks, and eggs. In recent years, a few researchers have begun to study the patterns and processes of predation and bobwhite populations in the South. Researchers have employed motion-sensitive cameras (Fies and Puckett 2000) and in-

frared video cameras (Staller 2001, Staller et al. 2001) to document patterns and rates of nest depredation by specific nest predators. An interesting outcome of this camera research is a renewed appreciation for the role of snakes in nest depredation. Stoddard (1931) recognized that certain snakes, including rat snakes, coachwhips, and king snakes were important nest predators. So much so, that he advocated control methods that today would be considered ethically repugnant and illegal. The general hunting public and wildlife managers tend to focus on the more visible mammalian predators such as skunk, raccoon, and opossum; however, these camera studies demonstrate that snakes are typically the most frequent nest predator (40–50% of depredations) and other species such as armadillos, that were previously ignored, might be as important as raccoons and other mesomammals (Staller 2001, Staller et al. *this volume*). Despite this progress, there needs to be a greater collective effort to understand the process of predation as it relates to habitat use and demographic parameters of bobwhites.

The term "predator context" has been used to describe the predator community at a given location in time and space (B. Palmer, Tall Timbers Research Station, personal communication). Just like weather and vegetation, predator communities change in space and time, we have just failed to measure these changes. Failure to characterize the predator context in which demographic studies have been conducted has limited our ability to understand habitat quality and population processes (Leopold and Hurst 1994). Relevant questions that have not been asked include "How does the abundance and composition of a predator community affect bobwhite demographics (survival, reproductive success, and population growth), population processes, and population trajectories?" and "How do weather, vegetation, and landscape structure alter the nature of these relationships?" That is, we need to understand the process of predation, rather than considering predation in terms of individual events or simply cause-specific mortality rates (Leopold and Hurst 1994). Research in progress on the relations of indices of predator abundance and bobwhite demographics across multiple sites throughout the Southeast is demonstrating correlations among demographic parameters and predator abundance (B. Palmer, Tall Timbers Research Station and L. W. Burger, Mississippi State University, unpublished data). If predators affect the demographic processes that lead to higher or lower densities of bobwhite then how can we judge habitat "quality" without understanding predator context.

Van Horne (1983) suggested that habitat quality is best understood through the demographic measures of success (e.g., rates of survival and reproduction). Guthery (1997) framed habitat quality in a binary context (usable space) where a specific point in space and time is either usable or not. Usable space is cover that provides essential resources compatible with the behavioral, physical, and physiological adaptations of bobwhite (Guthery et al. 2000). The usable space hypothesis states that bobwhite abundance on an area is proportional to functional space-time available on that

area. Guthery (1997) argued that, after controlling for the frequency and severity of catastrophic weather events, a general constant of proportionality might describe the relationship between abundance and usable space-time throughout the range. It follows from this that habitat quality, and therefore mean fitness, are the same wherever populations persist (Guthery et al. 2000). Guthery (1997) referred to this as “operational constancy.”

Southeastern state resource management agencies are coming under increasing pressure from stakeholders to liberalize wildlife codes to facilitate increased opportunities for predator management. These calls for enhanced flexibility in predation management go contrary to prevailing public sentiment that increasing harvestable surplus is not a legitimate justification for lethal control of predators. Renewed emphasis on predation management as a viable, even essential, tool for bobwhite management is based on the premise that reductions in predator abundance or efficacy would enhance demographic parameters such as nest success and survival. But Guthery et al. (2000) suggest that for bobwhite, because of this operational constancy in mean demographics, it is not feasible to increase “demographic capacity” or stabilize populations with management practices designed to increase survival or production (Guthery et al. 2000). This is in contrast to empirical observations by Cote and Sutherland (1997) and Tapper et al. (1996) that, for gray partridge and other ground nesting birds, selective reduction in abundance of important nest predators can increase nest success, recruitment, fall densities, and in some cases breeding densities. Predator removal, or habitat modification that alters use of the landscape by predators, changes the predator context. What is not yet understood is how predator context affects usable space and demographic capacity in a landscape. By analogy, Forrester et al. (1998) clearly demonstrate that, in the arid southwest, operative temperature alters the distribution of usable space for bobwhite during portions of the year. Vegetation mitigates the effects of ambient temperature and solar radiation, influencing the distribution of habitable (standard operative temperature within the thermal neutral zone or at least below the upper critical temperature) in the landscape. A given distribution of vegetation produces a different distribution of usable space under different thermal and radiant conditions. Similarly, predator context might alter the distribution of habitat space. Research has not adequately addressed how the abundance and types of predators affect the suitability of a given location to quail. In the context of usable space, the quantity of usable space through time might vary in relation to extant predator community. More specifically, a point in space (i.e., foraging location) that is usable in the absence of a particular predator, may be unusable in the presence of abundant populations of that predator. Throughout the ecological literature it has been demonstrated for numerous other species that optimal foraging strategies and habitat use differ in the presence and absence of efficient predators. Thus, we cannot understand habitat use and optimal habitat composition

in the absence of information on the abundance and composition of the predator community.

Beyond simply affecting quantity of usable space, the predator context may influence the nature of density-dependent demographic processes. Guthery et al. (2000) suggested that the reason it is not feasible to “. . . increase demographic capacity or stabilize populations with management that increases production or survival” is that “. . . density-dependent processes would mediate against a survival-production approach to augmentation of demographic capacity.” However, working on gray partridge, Potts (1986) suggested that predator management (altering the predator context) altered the nature of the density dependent relationship between partridge density and mortality rates. Rollins and Carroll (2001) suggested that predator removal might suppress the predator-mediated density-dependent mortality of adults and nests leading to higher rates of recruitment at a given density than would be predicted by the density-dependent reproduction relationship (Roseberry and Klimstra 1984). Thus, if altering the predator context alters the functional nature of the density-dependent relationship, a survival-production approach to enhancement of demographic capacity might work. Further theoretical and empirical research is needed to understand relationships among predator context, usable space, and demographic capacity. Integration of predator monitoring into ongoing demographic studies of bobwhite would provide a first step in this direction. A large, replicated, manipulative, multi-institutional study in Georgia is currently investigating relationships among predator density and bobwhite demographics (B. Palmer, Tall Timbers Research Station; personal communication; J. Carroll, University of Georgia; personal communication; C. Sisson, Auburn University, personal communication). Empirical and theoretical work directed at understanding relationships among vegetation structure, landscape structure, and vulnerability to avian and mammalian predators would provide additional insight. Approaches such as Guthery’s “cone of vulnerability” and the multi-resolution methodology in Stockett et al. (2001) illustrate promising avenues of investigation.

Management responses to mitigate the effects of predation on prey species include modifying the predator community, providing alternative prey, habitat modification, and manipulation of patch and landscape characteristics (Jimenez and Conover 2001). Although direct manipulation of predator communities has been shown to enhance productivity of some prey species (Cote and Sutherland 1997) public acceptance depends on the specific objectives of removal efforts (Messmer et al. 1999). Rollins and Carroll (2001) suggested an integrated pest management (IPM) approach to predation management involving establishment of “economic thresholds” of predation damage and application of non-lethal and lethal means of predation management. They suggested that non-lethal means (e.g., habitat manipulation) are the first line of defense. Fleske and Klaas (1991) and Herkert (1994) suggest that abundance and composition of a local predator community might be manipulated by removing den

sites and nesting and perching structures. For example, if the availability of suitable den sites in prairie and agricultural landscapes limits raccoon distribution and abundance (Stains 1956) or the distribution of foraging activity and space use (Mech et al. 1966, Rabinowitz and Pelton 1986), identification and selective removal of these features might provide a non-lethal means of managing predation in an IPM context. Similarly, if the abundance of midstory and mature hardwoods in a pine ecosystem influences predator abundance or efficiency, thinning or hardwood removal might enhance bobwhite survival or reproductive success. The efficacy of these non-lethal strategies should be experimentally investigated. Ongoing research projects in Florida (B. Palmer, Tall Timbers Research Station, personal communication) and Georgia (C. Sisson, Auburn University, personal communication) are investigating the effects of hardwood removal in a pine ecosystem on predator abundance and bobwhite demographics. Current research on Ames Plantation in Tennessee is investigating effects of manipulating landscape structure and composition on bobwhite demographics. All 3 of these studies show initial demographic increases in response to altering habitat structure.

Bobwhites occupy a wide variety of habitats across their range. By far most of these ecosystems have been dramatically altered by humans with resulting changes to abiotic (soils, weather, water) and biotic (disease, predators, vegetation) factors. Each of these factors has been identified as important in population regulation of game birds. The issue of predation and bobwhite populations is emotionally and politically charged. An unsavory history of predator extirpation associated with game bird management and recent incidents of illegal and unethical predator control on some southeastern quail plantations has cast a dark cloud on any discussion of predation management. Dailey (*this volume*) suggests that predator control puts quail conservation on a "slippery slope" and that the perception of quail enthusiasts as being indifferent to ecological values of other fauna could hamper regional conservation initiatives beneficial to bobwhite, and ultimately "doom" the sport. However, sensitivity to public perceptions and acceptance of broader conservation objectives, while laudable, should not be an excuse for failure to conduct the best possible research to understand the ecological processes at work in modern landscapes.

Fire Ants

Although bobwhite population declines are most often attributed to habitat loss, Allen et al. (1995) implicated the red imported fire ant (RIFA, *Solenopsis invicta*) as an additional factor that might contribute to declining bobwhite populations in the southeastern United States. Some studies have de-emphasized effects of fire ants on bobwhite populations (Johnson 1961, Komerak 1980, Brennan 1993). Brennan (1993) argues that only habitat availability limits bobwhite populations in the Southeast and RIFA are relatively

unimportant. Brennan (1993) cites high density populations on managed properties as evidence that bobwhite throughout the southeast respond to intensive habitat management and can be maintained even in the presence of RIFA. Yet Allen et al. (1995), Pederson et al. (1996), Giuliano et al. (1996) and Mueller et al. (1999) provide substantial experimental evidence that RIFA can negatively affect bobwhite populations under some circumstances. Effects of RIFA on bobwhite and other native animals are greatest in the presence of polygyne colonies (Porter and Savignano 1990, Lofgren 1986, and Allen et al. 1995). Polygyne colonies have multiple fertile queens, exhibit less territoriality, and consequently occur in very dense concentrations (300–2000 mounds/ha; Glancey and Lofgren 1988, Porter et al. 1988, and Lofgren and Williams 1984).

Red imported fire ants can affect bobwhite populations through direct and indirect effects on chicks. Allen et al. (1995) proposed 3 mechanisms by which RIFA may affect bobwhite populations: 1) depredation on pipping chicks, 2) indirect effects on invertebrate food resources of chicks, and 3) direct effects (pathological and mortality) of RIFA stings. Red imported fire ants can directly affect bobwhite populations through predation on pipping chicks (Johnson 1961). Johnson (1961) reported that fire ants may cause 6–12% mortality of pipping chicks. In a study of 440 bobwhite nests in Georgia (L. W. Burger, Mississippi State University, unpublished data), RIFA were responsible for 9.6% of all nest failures. Fire ants destroyed nests by attacking pipping chicks, constructing mounds over the nest cup, and invading the nest during incubation, causing abandonment. Loss to RIFA varied annually from 0 to 14.3% of all nest failures. Exposure to RIFA can reduce survival and weight gain of chicks (Giuliano et al. 1996). Giuliano et al. (1996) reported that exposure to RIFA stings reduced survival and body mass of 4-day-old bobwhite chicks. Moreover, RIFA may alter time and energy budgets of chicks, affecting weight gain and survival (Pederson et al. 1996). Red imported fire ants may reduce foraging efficiency of bobwhite chicks by simplifying invertebrate communities through competition and predation (Fillman and Sterling 1983, Porter et al. 1988, and Porter and Savignano 1990). In a manipulative field experiment, Mueller et al. (1999) demonstrated that RIFA abundance in the vicinity of the nest influenced survival of free-ranging, wild bobwhite chicks to 21 days.

Biologists, operating under the assumption that bobwhite populations are limited by habitat, frequently prescribe management practices that create early successional plant communities through disturbance (discing and prescribed fire). However, land management practices that disturb soil and vegetation and create early successional habitats, might actually increase RIFA abundance and associated negative effects (Allen et al. 1998). Red imported fire ants prefer the open and semi-open vegetation structure characteristic of early successional plant communities (Porter and Tschinkel 1987). Disturbance promotes RIFA coloni-

zation in 2 ways: 1) by opening canopy or dense herbaceous layers allowing light penetration, and 2) by removal of competitive native ant species. Native ants generally do not colonize as rapidly or exhibit the rapid population growth of the RIFA (Tschinkel 1993, Allen et al. 1998). Williamson et al. (*this volume*) demonstrate that management practices commonly prescribed to enhance bobwhite habitat (discing and fire) can have the unintended consequence of increasing RIFA abundance or activity in areas of high infestation, creating a management conundrum. Maintenance of early successional habitats is essential for bobwhite, yet in areas of high RIFA infestations, these practices can be expected to increase local abundance of RIFA, which could result in associated negative impacts on bobwhite population performance (Allen et al. 1995, Giuliano et al. 1996, Mueller et al. 1999).

Consistent with Brennan's (1993) argument, high density bobwhite populations can clearly be maintained in the presence of RIFA populations. However, actual population consequences of RIFA to bobwhite in the southeastern United States are unknown, but potentially significant. Range expansion and population growth of RIFA may exacerbate bobwhite population declines. Ironically, the very management practices we would prescribe to enhance bobwhite habitat may increase local RIFA populations. To this point, most of the RIFA/bobwhite research has been conducted in Texas. Throughout the remainder of the Southeast, the crucial experiments have not been conducted to quantify the magnitude and mechanisms by which expanding RIFA populations might affect bobwhite population processes. Additional research is needed to experimentally document the effects of RIFA on bobwhite demographics throughout the Southeast.

Harvest

The effect of harvest on bobwhite populations is an issue of prominent theoretical and applied interest to the natural resource profession and society. Bobwhite populations are a renewable resource that provide nutritional, economic, recreational, and aesthetic benefits (Burger et al. 1999). Compensatory mortality and density dependent reproduction have been proposed as mechanisms that buffer harvest mortality. Traditional harvest management for small game species, like bobwhite, assumes that more animals are produced than can survive. It is presumed that, up to a point, this "doomed surplus" can be harvested without affecting standing densities (Errington 1934). Relative stability of hunted bobwhite populations and small differences in breeding densities between hunted and unhunted populations have been cited as evidence that hunting minimally affects abundance (Errington and Hamerstrom 1935, Marsden and Baskett 1958, Baumgartner 1944, Vance and Ellis 1972). However, despite decades of research, theoretical and empirical aspects of harvest theory remains poorly understood for bobwhite (Roseberry and Klimstra 1984, Robertson and Rosenberg 1988) and fundamental hypotheses

regarding mechanisms of compensation remain untested (Caughley 1985).

For bobwhite populations to persist under sustained harvest, corresponding reductions in natural mortality or increases in reproductive rate must occur to compensate for harvest losses (Kautz 1990). Various models have been proposed to describe the relationships among harvest, mortality, reproduction, and density. At one extreme is the completely compensatory model, whereby harvest less than some threshold level does not increase seasonal or annual mortality of the harvested population (Anderson and Burnham 1976, Kautz 1990). The other extreme is the completely additive model which suggests that any level of harvest mortality is in addition to natural mortality and reduces annual survival correspondingly (Anderson and Burnham 1976, Kautz 1990). Intermediate to these extremes is the partial compensation model, whereby harvest at any level reduces the breeding density below its unharvested level; however, remaining individuals have enhanced survival and reproductive success and the population achieves a potential rate of increase greater than that of an unharvested population (Caughley 1985). It is this annual increase, or growth increment, that is harvested (Roseberry and Klimstra 1984, Caughley 1985, Robertson and Rosenberg 1988). The complete compensation and partial compensation models assume that reductions in natural mortality and increases in fecundity occur through density-dependent mechanisms. The completely additive model assumes that survival and reproductive success are independent of density.

For bobwhite, the complete-compensation harvest model is unrealistic and provides an inadequate basis for scientific harvest management of game bird populations (Roseberry and Klimstra 1984, Potts 1986, Pollock et al. 1989). A prediction of this model is that harvested populations will experience similar fall-spring mortality rates as unharvested populations. Guthery et al. (2000), citing 7 published and unpublished studies of hunted and unhunted populations, conclude that empirical evidence does not support this prediction because harvested populations generally experience fall-spring mortality rates nearly double that of unhunted populations. Studies in Illinois (Roseberry and Klimstra 1984) and Florida (Pollock et al. 1989) suggest that, for bobwhite, harvest mortality falls closer to the additive than compensatory end of the continuum. Furthermore, the timing of harvest influences the degree of additivity (Roseberry and Klimstra 1984, Pollock et al. 1989). For harvest mortality to be compensated for by a density-dependent reduction in natural mortality, the harvest must precede the period of highest natural mortality. The later in the season the harvest occurs, the less opportunity for compensation and the greater the additive nature of harvest mortality (Roseberry and Klimstra 1984).

The only mechanisms by which harvest mortality may be compensated for are density-dependent mortality, density-dependent reproduction and/or density-dependent emigration/immigration (Potts 1986, Robertson and Rosenberg 1988, Kautz 1990).

The extent to which hunting mortality is compensated for by a reduction in natural mortality is central to an understanding of the effects of harvest on populations (Roseberry and Klimstra 1984, Caughley 1985). Because the relationships among survival, breeding density, and reproduction are complex, estimates of annual survival alone may be misleading (Burger et al. 1998). As noted by Roseberry and Klimstra (1984), the relationship between hunting and natural mortality prior to the breeding season is the central issue. Therefore, the seasonal timing and nature of mortality is critical to evaluating the potential additive nature of harvest mortality. However, additive harvest mortality during the fall-spring period does not preclude compensation through density-dependent reproduction (Guthery et al. 2000). Density dependent reproduction might occur through variation in any 1 or a combination of the components of reproductive success (Burger et al. 1995).

Although experimental studies of the effects of harvest on bobwhite populations have not been conducted, Guthery et al. (2000) modeled bobwhite population viability for northern and southern populations subject to harvest and weather catastrophes (winter and summer). Given the set of assumptions underlying their model, in the absence of harvest the demographic capacity required for 95% probability of persistence for 100 years was approximately 100 for summer catastrophes, 500 for winter catastrophes and 800 for both summer and winter catastrophes. Demographic capacity required for population sustainability under summer catastrophes and harvest (assuming harvest completely additive) was 140 at 10% harvest, 450 at 20% harvest, and 700 at 30% harvest. They reported that a demographic capacity in excess of 10,000 would be required to sustain populations under a 40% harvest and summer catastrophes. Populations subject to winter catastrophes required a demographic capacity of 80 at 10% harvest, 100 at 20% harvest, and 400 at 30 or 40% harvest. Populations were unsustainable at 50% harvest rate. An important outcome of this model is that southern populations are less vulnerable to extinction under no harvest, but northern populations are less vulnerable to extinction in the presence of harvest (Guthery et al. 2000). Furthermore, southern populations required larger demographic capacities for persistence at all harvest rates. They demonstrate that northern and southern populations respond differently to harvest and these differences should be considered in developing appropriate harvest regimes across latitudinal gradients (Guthery et al. 2000). The strength of this modeling exercise is that it realistically incorporates known demographic processes such as density dependence and allows testing of the effects of various extraneous events such as weather catastrophes and harvest. Furthermore, it demonstrates the effect of demographic capacity on population persistence and when coupled with estimates of density or usable space (Guthery 1997) provides an approach for biologists to estimate minimum size landscapes required for self-sustaining populations. The clear relationships among demographic capacity, harvest rate, and popu-

lation persistence point out the difficulties in developing sustainable harvest regimes for bobwhite populations inhabiting fragmented landscapes. Populations inhabiting small or isolated habitat fragments (such as those throughout much of the Southeast) will be more vulnerable to extinction and harvest may increase probability of extinction (Guthery et al. 2000).

In recent decades, numerous Southeastern state resource management agencies, charged with setting and enforcing harvest regulations, have struggled with establishing a harvest framework that permits maximum recreational opportunity while at the same time minimizing additive harvest mortality in already declining populations. The principle approach has been to shorten season length by reducing late season (Feb) hunting opportunities. In outeastern states, warm temperatures and activity of venomous snakes limit hunting opportunity in November and December. Thus, January and February have traditionally provided most of the bobwhite hunting opportunity. Reductions in February hunting opportunities, although they might be biologically defensible, run contrary to long-term southern hunting tradition and may contribute to further attrition of bobwhite hunting enthusiasts (Burger et al. 1999). State agency biologists and conservation commissions find themselves in a quandary as they attempt to balance opportunity with sustainability. However, these decisions on harvest framework are more often made on the basis of tradition, economics, or political ramifications as opposed to biological sustainability. As our profession faces the 21st century there is an increasing need to understand the mechanics of bobwhite harvest management to support both harvest recommendations and management practices with defensible population performance data (Murphy and Noon 1991, Nudds and Morrison 1991, Burger et al. 1994). Experimental approaches such as those advocated by Burger et al. (1994) and modeling approaches demonstrated by Guthery et al. (2000) provide tools to acquire information needed for science-based management.

Metapopulation Processes

As early successional patches become more isolated and more ephemeral in duration, previously panmictic populations may become disjunct and local populations formerly interconnected by some level of gene flow may become isolated. In the face of diminishing habitat quantity and widely distributed habitat patches, isolated bobwhite populations may be more vulnerable to demographic and regional stochastic processes (random, regionally correlated catastrophic events such as weather) that increase the probability of local population extinctions, reduce recolonization rates, and contribute to regional population declines (Roseberry 1993). In an essay entitled "Bobwhite and the New Biology," Roseberry (1993) recognized that "The viability of local populations depends not only on their own attributes, but also on certain spatial and temporal characteristics of neighboring patches and resident populations (i.e., the metapopulation)." As

early as 1984, Roseberry and Klimstra (1984) questioned whether populations that occupy remnant patches of remaining habitat might be at greater risk because of their isolation. Roseberry (1993) recognized that the structure of landscapes and the movements of individuals among populations likely influenced local and regional population stability. They called for quail biologists to incorporate elements of landscape ecology into their thinking and plan and implement management regimes at a broader spatial scale. Yet nearly a decade later, relatively few real advances in modeling bobwhite population processes at landscape scales have occurred (although see Guthery et al. 2000).

In modern landscapes, regional persistence of bobwhite populations are surely subject to metapopulation processes. A metapopulation is a regional set of local populations persisting in a balance between local extinction and recolonization (Levins 1969, 1970). When a regional population functions as a metapopulation, regional persistence depends critically upon parameters affecting extinction and colonization rates, rates and patterns of interpatch migration, and propagule establishment probabilities. Does metapopulation theory "fit" bobwhites? Early successional species in general may fit the metapopulation model because early successional communities are ephemeral by nature and often exist in a dynamic mosaic landscape (Harrison 1991). In these systems, habitat dynamics drive the dynamics of early successional wildlife species. Through natural plant succession, every population is subject to extinction and the competing processes of disturbance and succession govern colonization and extinction. If a species does not perfectly track its shifting habitat, it will show metapopulation attributes, such as absence from suitable habitats and vulnerability to regional collapse (Harrison 1991). Although metapopulation theory is well developed and has been applied to the conservation of numerous other species (Hanski and Gilpin 1991), as yet, the relevance of metapopulation principles to regional bobwhite population dynamics has not been investigated. This is, in part, because some of the critical parameters required to model metapopulation processes (e.g., dispersal rates and distances, colonization and extinction rates) have not been estimated for bobwhite (although see Fies et al. *this volume*).

During the first half of the 20th century, the southeastern landscape was characterized by a heterogeneous mosaic containing ubiquitously distributed and interconnected patches of early successional habitats. In such a landscape context (or in modern landscape with vast contiguous habitat), the metapopulation nature of bobwhite populations would not be apparent. In modern landscapes, the metapopulation nature of regional bobwhite populations may be more apparent. Some predictions that follow from the theory include: 1) as early successional patches are lost through changing management practices or fire exclusion, remnant patches become increasingly smaller and more isolated leading to reduced colonization and increased risk of regional decline; 2) regionally correlated, stochastic environmental events (drought, global warm-

ing, increasing regional predator populations, etc.) increase the risk of metapopulation extinction; 3) bobwhite may be missing from systems of small or isolated, but otherwise suitable habitat, and 4) vulnerability to regional collapse. Site-specific habitat management has been and will continue to remain the core strategy for bobwhite recovery efforts. However, it has been recognized that the success of a local management program is scale-dependent. That is, a given level of management intensity is more efficacious when conducted on a larger scale.

Guthery et al. (2000) demonstrate that viability (probability of population persistence) of a local population increases with increasing demographic capacity and that minimum viable population size varies under different types of environmental catastrophes. They illustrate application of their model to determine minimum quantity of usable space required for local population persistence. However, their model does not incorporate interactions among local populations (immigration/emigration). To address regional population persistence, biologists and managers must address the problem from a regional or landscape perspective and recognize that the viability of local populations is affected not only by local demographics, but also by interactions with surrounding populations (Fies et al. *this volume*). To adequately understand these regional processes, we must employ more sophisticated, spatially explicit population models. Application of these models requires robust quantitative characterization of the distribution of habitat patches across the landscape. Habitat models, both theoretical (Guthery 1997) and empirical (Roseberry and Sudkamp 1998, Schairer et al. 1999), have been developed to characterize habitat quality at various spatial scales and these models may provide a starting point for development of spatially explicit population models. Spatially explicit population models link habitat models with population models that incorporate habitat specific population parameter estimates. To incorporate stochasticity, we must have empirical estimates of key population parameters and the probability distributions from which they are drawn and know how these demographic parameters vary among habitat patches or in relation to relative habitat quality. Additionally, we must better understand bobwhite dispersal, colonization, and extinction processes. Despite the substantial progress in modeling habitat quality and population viability illustrated in Guthery (1997) and Guthery et al. (2000), we have yet to integrate habitat, population, and movement/dispersal models in comprehensive, spatially explicit population models that characterize regional population processes.

CONCLUSION

As human populations, per capita consumption of resources, and technological capabilities in agriculture and forestry continue to expand, the regional availability of suitable habitats and subsequently bobwhite populations will continue to decline. Changing de-

mographic patterns and public values and declining hunter participation will contribute to a declining constituency that values bobwhite and the habitats to which they are adapted. State level initiatives may be successful in enhancing local populations; however, regional conservation efforts may provide the greatest opportunities for restoration. These efforts will benefit regional bobwhite populations only if early successional habitats are valued by the public and conservation community. Management of remnant bobwhite populations in modern, highly fragmented and simplified landscapes will require a new and more comprehensive understanding of the effects of predation, harvest, and landscape structure on population processes. Acquisition of this knowledge will not just require more research, but a different kind of research, one more rigorous, creative, quantitative, and mechanistic.

LITERATURE CITED

- Allen, C. R., S. Demarais, and R. S. Lutz. 1994. Red imported fire ant impact on wildlife: an overview. *The Texas Journal of Science* 46:51–59.
- Allen, C. R., R. S. Lutz, and S. Demarais. 1993. What about fire ants and northern bobwhites? *Wildlife Society Bulletin* 21: 349–351.
- Allen, C. R., R. S. Lutz, and S. Demarais. 1995. Red imported fire ant impacts on northern bobwhite populations. *Ecological Applications* 5:632–638.
- Allen, C. R., R. S. Lutz, and S. Demarais. 1998. Ecological Effects of the Invasive Nonindigenous Ant, *Solenopsis invicta*, on Native Vertebrates: The Wheels on the Bus. *Transactions of the North American Wildlife and Natural Resource Conference*. 63:56–65.
- Anderson, D. R., and K. P. Burnham. 1976. Population ecology of the mallard: VI. The effect of exploitation on survival. *Resource Publication* 128. United States Fish and Wildlife Service.
- Askins, R. A. 2001. Sustaining biological diversity in early successional communities: the challenge of managing unpopular habitats. *Wildlife Society Bulletin* 29:407–412.
- Baumgartner, F. M. 1944. Bobwhite quail populations on hunted vs. protected areas. *Journal of Wildlife Management* 8:259–260.
- Brennan, L. A. 1991. How can we reverse the northern bobwhite decline? *Wildlife Society Bulletin* 19:544–555.
- Brennan, L. A. 1993. Fire ants and northern bobwhites: a real problem or a red herring? *Wildlife Society Bulletin* 21:351–355.
- Brennan, L.A., R. T. Engstrom, W. E. Palmer, S. M. Hermann, G. A. Hurst, L. W. Burger, and C. L. Hardy. 1998. Whither wildlife without fire? *Transactions North American Wildlife and Natural Resources Conference* 63:1–11.
- Burger, L. W., Jr., E. W. Kurzejeski, L. D. Vangilder, T. V. Dailey, and J. H. Shultz. 1994. Effects of harvest on population dynamics of upland birds: are bobwhite the model? *Transactions North American Wildlife and Natural Resources Conference* 59:466–476.
- Burger, L. W., Jr., D. A. Miller, R. I. Southwick. 1999. Economic impact of northern bobwhite hunting in the southeastern United States. *Wildlife Society Bulletin*. 27:1010–1018.
- Burger, L. W., Jr., M. R. Ryan, T. V. Dailey, and E. W. Kurzejeski. 1995. Reproductive strategies, success, and mating systems of northern bobwhite in northern Missouri. *Journal of Wildlife Management*. 59:417–426.
- Capel, S. W., M. L. Fies, I. L. Kenyon, P. D. Keyser, and P. K. Moore. 1996. Virginia bobwhite quail management plan. Virginia Department of Game and Inland Fisheries Wildlife Information Publication No. 96-1.
- Carter, M.F., W. C. Hunter, D. N. Pashley, and K. V. Rosenberg. 2000. Setting conservation priorities for land birds in the United States: the Partners in Flight approach. *Auk* 117: 541–548.
- Caughley, G. 1985. Harvesting of wildlife: past, present, and future. Pages 3–14 in S. L. Beasom and S. F. Roberson, eds. *Game Harvest Management*. Caesar Kleberg Wildlife Research Institute, Kingsville, Texas.
- Church, K. E., J. R. Sauer, and S. Droege. 1993. Population trends of quails in North America. *Proceedings of the National Quail Symposium* 3:44–54.
- Cote, I. M., and W. J. Sutherland. 1997. The effectiveness of removing predators to protect bird populations. *Conservation Biology* 11:395–405.
- Errington, P. L. 1934. Vulnerability of bobwhite populations to predation. *Ecology* 15:110–127.
- Errington, P. L., and F. N. Hamerstrom, Jr. 1935. Bobwhite winter survival on experimentally shot and unshot areas. *Iowa State College Journal Science* 9:625–639.
- Exum, J. H., R. W. Dimmick, and B. L. Deardon. 1982. Land use and bobwhite populations in an agricultural system in west Tennessee. *Proceedings of the National Quail Symposium* 2:6–12.
- Fies, M. L., I. L. Kenyon, and J. V. Gwynn. 1992. Effects of changing land use patterns on bobwhite quail habitat in Virginia. *Virginia Journal of Science* 23:143–155.
- Fies, M. L., and K. M. Puckett. 2000. Depredation patterns of northern bobwhite nest predators in Virginia. *Proceedings of the National Quail Symposium* 4:96–102.
- Fillman, D. A., and W. L. Sterling. 1983. Killing power of the red imported fire ant (Hym.: Formicidae): a key predator of the boll weevil (Col.: Curculionidae). *Entomophaga* 28: 339–344.
- Fleske, J. P., and E. E. Klaas. 1991. Dabbling duck recruitment in relation to habitat and predators at Union Slough national Wildlife Refuge, Iowa. *United State Fish and Wildlife Service, Fish and Wildlife Technical Report* 32.
- Forrester, N. D., F. S. Guthery, S. D. Kopp, W. E. Cohen. 1998. Operative temperature reduces habitat space for northern bobwhite. *Journal of Wildlife Management* 62:1506–1511.
- Frost, C. C. 1993. Four centuries of changing landscape patterns in the longleaf pine ecosystem. *Tall Timbers Fire Ecology Conference Proceedings*. 18:17–43.
- Giuliano, W. M., C. R. Allen, R. S. Lutz, and S. Demarais. 1996. Effects of red imported fire ants on northern bobwhite chicks. *Journal of Wildlife Management* 60:309–313.
- Guthery, F. S. 1997. A philosophy of habitat management for northern bobwhite. *Journal of Wildlife Management* 61: 291–301.
- Guthery, F. S., M. J. Peterson, and R. R. George. 2000. Viability of northern bobwhite populations. *Journal of Wildlife Management* 64:646–662.
- Hanski, H., and M. Gilpin. 1991. Metapopulation dynamics: brief history and conceptual domain. *Biological Journal of the Linnean Society* 42:3–16.
- Harrison, S. 1991. Local extinction in a metapopulation context: An empirical evaluation. *Biological Journal of the Linnean Society* 42:73–88.
- Herkert, J. R. 1994. The effects of habitat fragmentation on Midwestern grassland bird communities. *Ecological Applications* 4:461–471.
- Hubbard, M. W., D. L. Garner, and E. E. Klaas. 1999. Factors influencing wild turkey hen survival in southcentral Iowa. *Journal of Wildlife Management*. 63:731–738.
- Hunter, W. C., D. A. Buehler, R. A. Canterbury, J. L. Confer, and P. B. Hamel. 2001. Conservation of disturbance-dependent birds in eastern North America. *Wildlife Society Bulletin* 29:440–455.
- Hurst, G. A., L. W. Burger, Jr., and B. D. Leopold. 1996. Predation and galliforms: an old issue revisited. *Transactions*

- of the North American Wildlife and Natural resources Conference 61:61–66.
- Jimenez, J. E., and M. R. Conover. 2001. Ecological approaches to reduce predation on ground-nesting gamebirds and their nests. *Wildlife Society Bulletin* 29:62–69.
- Johnson, A. S. 1961. Antagonistic relationships between ants and wildlife with special reference to imported fire ants and bobwhite quail in the Southeast. Proceedings of the Annual Conference of the Southeastern Association of Game and Fish Commissioners 15:88–107.
- Johnson, T. G. 1996. Trends in Southern pulpwood production, 1953–1993. Resource Bulletin SRS-3, Asheville, North Carolina: United States Department of Agriculture, Forest Service, Southern Research Station.
- Kabat, C., and D. R. Thompson. 1963. Wisconsin quail, 1834–1962: population dynamics and habitat management. Wisconsin Conservation Department Technical Bulletin 30. Madison.
- Kautz, J. E. 1990. Testing for compensatory responses to removals from wildlife populations. *Transactions of the North American Wildlife and Natural resources Conference* 55: 527–533.
- Komerack, E. V. 1980. Comments on the fire ant problem. *Proceedings of Tall Timbers Ecological Animal Control Habitat Management* 7:1–8.
- Leopold, B. D., and G. A. Hurst. 1994. Experimental designs for assessing the impacts of predators on gamebird populations. *Transactions of the North American Wildlife and Natural Resources Conference* 59:477–487.
- Levins, R. 1969. Some demographic and genetic consequences of environmental heterogeneity for biological control. *Bulletin of the Entomological Society of America* 15:237–240.
- Levins, R. 1970. Extinction. Pages 77–107 in M. Gerstenhaber ed. *Some Mathematical Problems in Biology*, American Mathematical Society, Providence, Rhode Island.
- Lofgren, C. S. 1986. The economic importance and control of imported fire ants in the United States. Pages 227–256 in S. B. Vinson, ed. *Economic impact and control of social insects*. Praeger Publishers, New York, New York.
- Lofgren, C. S., and D. F. Williams. 1984. Reinfestation rates of red imported fire ants following toxic bait treatments. *Proceedings of the 1984 Imported Fire Ant Conference* 112–119.
- Lovell, C. D., Leopold, B. D., and Shropshire, C. C. 1998. Trends in Mississippi predator populations. *Wildlife Society Bulletin* 26:552–556.
- Marsden, H. M., and T. S. Baskett. 1958. Annual mortality in a banded bobwhite population. *Journal of Wildlife Management* 22:414–419.
- Mech, L. D., J. R. Tester, and D. W. Warner. 1966. Fall daytime resting habits of raccoons as determined by telemetry. *Journal of Mammalogy* 47:450–466.
- Messmer, T. A., M. W. Brunson, D. Reiter, and D. G. Hewitt. 1999. United States public attitudes regarding predators and their management to enhance avian recruitment. *Wildlife Society Bulletin* 27:75–85.
- Mueller, J. M., C. B. Dabbert, S. Demarais, and A. R. Forbes. 1999. Northern bobwhite chick mortality caused by red imported fire ants. *Journal of Wildlife Management* 63:1291–1298.
- Murphy, D. D., and B. D. Noon. 1991. Coping with uncertainty in wildlife biology. *Journal of Wildlife Management* 55: 773–782.
- Nelson, H. K. 2001. Impact of predation on avian recruitment: an introduction. *Wildlife Society Bulletin* 29:2–5.
- Noss, R. F., E. T. LaRoe III, and J. M. Scott. 1995. Endangered ecosystems of the United States: a preliminary assessment of loss and degradation. United States Department of Interior. National Biological Service, Biological Report 28.
- Nudds, T. D., and M. M. Morrison. 1991. Ten years after “Reliable Knowledge”: Are we gaining? *Journal of Wildlife Management* 55:757–760.
- Pederson, E. K., W. E. Grant, and M. T. Longnecker. 1996. Effects of red imported fire ants on newly hatched northern bobwhite. *Journal of Wildlife Management* 60:164–169.
- Pollock, K., C. T. Moore, W. R. Davidson, F. E. Kellogg, and G. L. Doster. 1989. Survival rates of bobwhite quail based on band recovery analysis. *Journal of Wildlife Management* 53:1–6.
- Porter S. D., and D. A. Savignano. 1990. Invasion of polygyne fire ants decimates native ants and disrupts arthropod community. *Ecology* 71:2095–2106.
- Porter S. D., and W. R. Tschinkel. 1987. Foraging in *Solenopsis invicta* (Hymenoptera: Formicidae): effects of weather and season. *Environmental Entomology* 16:802–808.
- Porter S. D., B. Van Eimeren, and L. E. Gilbert. 1988. Invasion of red imported fire ants (Hymenoptera: Formicidae): microgeography of competitive replacement. *Annals of the Entomological Society of America* 81:913–918.
- Potts, G. R. 1986. *The partridge: Pesticides, predation, and conservation*. Collins, London.
- Rabinowitz, A. R., and M. R. Pelton. 1986. Day-bed use by raccoons. *Journal of Mammalogy* 67: 766–769.
- Robel, R. J. 1993. Symposium wrap-up: What is missing? *Proceedings of the National Quail Symposium* 3:156–158.
- Robertson, P. A., and A. A. Rosenberg. 1988. Harvesting gamebirds. Pages 177–201 in P. J. Hudson and M. R. W. Rands, eds. *Ecology and management of game birds*. Blackwell Scientific Publishing, Ltd. Oxford.
- Rollins, D., and J. P. Carroll. 2001. Impacts of predation on northern bobwhite and scaled quail. *Wildlife Society Bulletin* 29:39–51.
- Roseberry, J. L. 1993. Bobwhite and the “new” biology. *Proceedings of the National Quail Symposium* 3:16–20.
- Roseberry, J. L. 2000. Concluding remarks: the research perspective. *Proceedings of the National Quail Symposium* 4: 243–245.
- Roseberry, J. L., and W. D. Klimstra. 1984. Population ecology of the bobwhite. Southern Illinois University Press, Carbondale.
- Roseberry, B. G. Peterjohn, and W. D. Klimstra. 1979. Dynamics of an unexploited bobwhite population in deteriorating habitat. *Journal of Wildlife Management* 43:306–315.
- Roseberry, J. L., and S. D. Sudkamp. 1998. Assessing the suitability of landscapes for northern bobwhite. *Journal of Wildlife Management* 62:895–902.
- Rosson, J. F., Jr. 1995. *Forest plantations in the Midsouth, USA*. Resource Paper SO-290. New Orleans, Louisiana. United States Department of Agriculture, Forest Service, Southern Forest Experiment Station.
- Sauer, J. R., J. E. Hines, I. Thomas, J. Fallon, and G. Gough. 2000. *The North American Breeding Bird Survey, Results and Analysis 1966–1999*. Version 98.1, United States-Geological Survey, Patuxent Wildlife Research Center, Laurel, Maryland.
- Schairer, G. L., R. H. Wynne, M. L. Fies, and S. D. Klopfer. 1999. Predicting landscape quality for northern bobwhite from classified Landsat imagery. *Proceedings of the Southeastern Association of Fish and Wildlife Agencies* 53:243–256.
- Spears, G. S., F. S. Guthery, S. M. Rice, S. J., DeMaso, and B. Zaiglin. 1993. Optimum seral stage for Northern Bobwhites as influenced by site productivity 57:805–811.
- Stains, H. J. 1956. *The raccoon in Kansas: natural history, management and economic importance*. University of Kansas Museum of Natural History and State Biological Survey. Publication 10.
- Staller, E. L. 2001. Identifying predators and nest fates of northern bobwhite nests using miniature video cameras. Thesis. University of Georgia, Athens.
- Stoddard, H. L. 1931. *The bobwhite quail: its habits, preservation, and increase*. Charles Scribner’s Sons, New York.
- Tapper, S. C., G. R. Potts, and M. H. Brockless. 1996. The effect of an experimental reduction in predation pressure on the

- breeding success and population density of grey partridges *Perdix perdix*. *Journal of Applied Ecology*. 33:965–978.
- Thompson, F. R., III, and R. M. DeGraaf. 2001. Conservation approaches for woody early successional communities in the eastern United States. *Wildlife Society Bulletin* 29:483–494.
- Trani, M. K., R. T. Brooks, T. L. Schmidt, V. A. Rudis, and C. M. Gabbard. 2001. Patterns and trends of early successional forests in the eastern United State. *Wildlife Society Bulletin* 29:413–424.
- Tschinkel, W. R. 1988. Distribution of the fire ants *Solenopsis invicta* and *S. geminata* (Hymenoptera: Formicidae) in northern Florida in relation to habitat and disturbance. *Annals of the Entomological Society of America* 81:76–81.
- United States Department of Agriculture, Natural Resources Conservation Service-National Resources Inventory. 1999. <http://www.nhq.nrcs.usda.gov/NRI/1997/>. Revised 12/1999.
- Van Horne, B. 1983. Density as a misleading indicator of habitat quality. *Journal of Wildlife Management* 47:893–901.
- Vance, D. R. 1976. Changes in land-use and wildlife populations in southeastern Illinois. *Wildlife Society Bulletin* 4:11–15.
- Vance, D. R., and J. A. Ellis. 1972. Bobwhite populations and hunting on Illinois public hunting areas. *Proceedings of the National Quail Symposium* 1:165–173.
- White, P. S., and S. P. Wilds. 1998. Regional trends of biological resources: Southeast. Pages 253–314 in M. J. Mac, P. A. Opler, C. E. Puckett Haecker, and P. D. Doran, eds. *Status and trends of the nations biological resources*. Volume I. United State Department of Interior Geological Survey, Reston, Virginia.

RANGEWIDE TRENDS IN LANDUSE AND NORTHERN BOBWHITE ABUNDANCE: AN EXPLORATORY ANALYSIS

Markus J. Peterson

Department of Wildlife and Fisheries Sciences and George Bush School of Government and Public Service, Texas A&M University, College Station, TX 77843-2258, USA

X. Ben Wu

Department of Rangeland Ecology and Management, Texas A&M University, College Station, TX 77843-2126, USA

Paikho Rho

Department of Rangeland Ecology and Management, Texas A&M University, College Station, TX 77843-2126, USA

ABSTRACT

Biologists generally assume that habitat loss, fragmentation, and conversion resulting from changes in landuse are primarily responsible for the nearly rangewide declines in northern bobwhite (*Colinus virginianus*) abundance noted since at least 1990. Few data-based analyses have addressed this relationship at broad spatial scales. We used data on northern bobwhite abundance from the North American Breeding Bird Survey (BBS; 1966–1999) and county-level landuse from the U.S. Census of Agriculture (COA; 1978, 1987, 1997) to evaluate how 9 landuse variables related to northern bobwhite abundance at the rangewide spatial scale. We also explored the relationship between cropland cover and northern bobwhite abundance by state, physiographic region, and using a moving window approach. Although northern bobwhite abundance typically decreased at the rangewide spatial scale, trends in abundance varied considerably spatially, either exhibiting no trend or increasing in many western and northern portions of this species' range. While both spatial and temporal patterns in landuse were obvious, there were no clear univariate or multivariate relationships among these variables and bobwhite abundance that could be applied universally across this species' range. The relationship between cropland cover and northern bobwhite abundance based on physiographic regions was more interpretable than that based on political boundaries (states). When data were used to define spatial patterns between cropland cover and northern bobwhite abundance, spatially consistent and temporally persistent patterns were obtained. We suggest that further research using moving windows of various dimensions, including landuse variables in addition to cropland, and adding several more decades of bobwhite and landuse data is an essential aspect of formulating defensible, spatially explicit strategies for northern bobwhite conservation and management.

Citation: Peterson, M. J., X. B. Wu, and P. Rho. 2002. Rangewide trends in landuse and northern bobwhite abundance: an exploratory analysis. Pages 35–44 in S. J. DeMaso, W. P. Kuvlesky, Jr., F. Hernández, and M. E. Berger, eds. Quail V: Proceedings of the Fifth National Quail Symposium. Texas Parks and Wildlife Department, Austin, TX.

Key words: abundance, *Colinus virginianus*, habitat, landscape, landuse, northern bobwhite, spatial scale, trends

INTRODUCTION

During the last few years, most authors of scientific articles addressing northern bobwhite biology attempted to justify their research by citing articles published since 1990 that quantified long-term, broad scale declines in northern bobwhite abundance. These studies relied primarily on either Christmas Bird Count (Brennan 1991) or BBS data (Droege and Sauer 1990, Church et al. 1993, Brady et al. 1998). Three issues are important for conceptualizing the current concern with declines in northern bobwhite abundance. First, eminent quail biologists have lamented long-term, broad-scale declines in northern bobwhite abundance for at least 70 years. For example, Leopold (1931:26), Errington and Hamerstrom (1936:382), and Lehmann (1937:8) all argued that state- and subcontinent-wide declines in bobwhite abundance began somewhere between 1875 and 1905. Similarly, Stoddard (1931:xxi) justified his mammoth study of northern bobwhites because “difficulty is now being experienced in maintaining these birds in numbers in many parts of their

range.” Probably the only substantive difference between historical and recent concerns regarding the demise of the northern bobwhite is that studies published since 1990 are better quantified. Second, apparently many authors assume, since northern bobwhite abundance is declining in numerous areas, that any and all bobwhite data are now more critically needed than previously—even if these data have little if anything to do with population dynamics or trends in abundance. Lastly, it is generally assumed that habitat loss, fragmentation, and conversion resulting from changes in landuse are primarily responsible for declines in northern bobwhite abundance (Brennan 1991, 1993; Church and Taylor 1992, Brady et al. 1998). Unfortunately, although hundreds of articles have evaluated how northern bobwhites use habitat at the scale of pastures, few data-based analyses have addressed how trends in bobwhite abundance vary with changes in landuse and landcover (Lee and Brennan 1994), particularly at the physiographic region to rangewide spatial scales.

Brady et al. (1993) attempted to address part of this deficiency by identifying landuse characteristics

Table 1. Correlations between northern bobwhite abundance (5-year means centered on 1978, 1987, and 1997) from North American Breeding bird survey data (Sauer et al. 2000) and landuse variables^a from the Census of Agriculture (USDA-NASS 2000) calculated using 100,000 randomly selected points from the interpolated surfaces.

	1978		1987		1997	
	<i>r</i>	<i>P</i>	<i>r</i>	<i>P</i>	<i>r</i>	<i>P</i>
Average farm size	0.05838	<0.0001	0.15105	<0.0001	-0.03639	<0.001
Cropland cover	-0.21904	<0.0001	-0.06675	<0.0001	0.19904	<0.001
Rangeland cover	0.20916	<0.0001	0.36566	<0.0001	0.29108	<0.001
Woodland cover	0.12962	<0.0001	-0.01635	<0.0001	-0.13722	<0.001
CRP/WRP land cover			0.07212	<0.0001	0.28441	<0.001
Positive crop cover ^b	0.01316	0.8811	0.09435	<0.0001	0.40259	<0.001
Negative crop cover ^c	-0.33351	<0.0001	-0.19062	<0.0001	-0.03969	<0.001
Other crop cover ^d	-0.07499	<0.0001	-0.06994	<0.0001	-0.00608	0.0607
Cotton cover	0.21202	<0.0001	0.28432	<0.0001	0.13466	<0.001

^a All landuse variables are percent cover, except average farm size.

^b Sorghum, rice, wheat, oats, barley (5 items).

^c Cotton, hay-alfalfa, corn for grain or seed, corn for silage or green chop (4 items).

^d Sunflower seed, soybeans, peanuts, dry edible beans, tobacco, potatoes, sugar beets, sugar cane, pineapples, vegetables, and land in orchards (11 items).

correlated with differing northern bobwhite abundances at the statewide spatial scale in Kansas. They used data from the U.S. Department of Agriculture's COA and National Resources Inventory for Kansas counties where bobwhites were counted during a single rural mail carrier survey conducted in 1982, and BBS data for 1974, 1978, 1982, and 1987. Because there was no long-term trend in bobwhite abundance between 1967 and 1988 in Kansas, the authors could not address how changes in landuse might influence long-term trends in quail abundance. Similarly, they found no correlation between short-term trends in agricultural landuse and northern bobwhite abundance between 1974 and 1987. They did, however, delineate several landuse characteristics associated with the presence and absence of northern bobwhites and relative bobwhite density. Similarly, Roseberry and Sudkamp (1998) used classified satellite imagery (1991–95), county-level bobwhite harvest (1989–93), and BBS (1993–96) data to assess landscape suitability for northern bobwhites in Illinois. Their model was able to identify and map landscapes that were potentially suitable for bobwhites. Again, they did not address how long-term changes in landscape characteristics might influence trends in bobwhite abundance.

In an attempt to explain how northern bobwhite abundance varied by landuse at the rangewide spatial scale, as well as explore possible explanations for long-term trends in bobwhite abundance, Brady et al. (1998) used northern bobwhite abundance data from the BBS (1970–94) and landuse data from the National Resources Inventory (1972, 1982, 1992). The landuse data were evaluated at 2 spatial scales within a nested hierarchy: 10 Land Resource Regions and 86, multi-county Major Land Resource Areas (10,000–285,000 ha). Using correlative approaches, they found that for any given year, bobwhite abundance was positively associated with the percent of rangeland and certain crops, while negatively associated with percent land in urban areas, forest, and certain other crops. When bobwhite abundance among years for given physiographic regions was considered, 10 landuse and 6 spatial variables were correlated with trends in northern bob-

white abundance. Interestingly, the models could account for only 35 to 52% of the spatial and temporal variation in bobwhite abundance.

Although Brady et al. (1993), Roseberry and Sudkamp (1998), and Brady et al. (1998) all demonstrated that landuse and landscape characteristics were associated with the relative abundance of northern bobwhites at broad spatial scales, only Brady et al. (1998) attempted to address how changes in landscapes might be associated with long-term trends in northern bobwhite abundance. They suggested that, because their models accounted for only a limited amount of the variation in bobwhite abundance among years, that more detailed analyses, possibly relying on vegetative composition or successional stage, might be warranted. An alternative approach relates to the spatial scale at which data were collected. Because the landuse data utilized by Brady et al. (1998), for example, were collected at much broader spatial scales than were the bobwhite data, it is possible that considerable landuse information was lost that could help one better understand trends in northern bobwhite abundance. Similarly, because National Resources Inventory data were available for only 1982, 1987, and 1992, the timeframe addressed was rather limited.

In this exploratory analysis, we used northern bobwhite abundance data from the BBS (Sauer et al. 2000) and county-level landuse data from the United States Department of Agriculture's COA (USDA-NASS 2000) for 1978, 1987, and 1997 to better elucidate how changes in landuse are related to long-term trends in northern bobwhite abundance at the rangewide spatial scale in the United States. Additionally, we evaluated the relationship between cropland cover and northern bobwhite abundance by state, physiographic region, and using a moving window approach to illustrate how more detailed, spatially explicit analyses could help us better understand trends in bobwhite abundance.

METHODS

Databases and Data Preparation

Northern bobwhite abundance data were obtained from the BBS (Sauer et al. 2000) and used to develop

NORTHERN BOBWHITE TRENDS AND LANDUSE

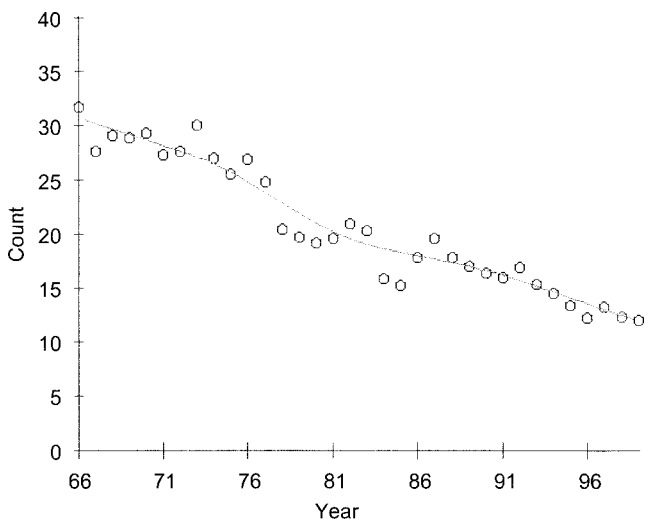

Fig. 1. Rangewide trend in northern bobwhite abundance based on North American Breeding Bird Survey data, 1966–1999 (Sauer et al. 2000).

interpolated abundance maps over northern bobwhite range for 1978, 1987, and 1997. These years were chosen because COA (USDA-NASS 2000) landuse data were available for these years. Given the high temporal variability of northern bobwhite abundance and because we were interested in long-term trends in abundance, a 5-year mean value centered on each of these years was generated for all routes surveyed in ≥ 3 of

the 5 years. These route data then were used to generate ArcView grids of the northern bobwhite abundance (2×2 -km² resolution) using the first power inverse distance weighted (IDW) interpolation method in ArcView Spatial Analyst (ESRI 1998).

County-level landuse statistics were extracted from the Censuses of Agriculture (USDA-NASS 2000) taken in 1978, 1987, and 1997 for cropland, rangeland, woodland, and CRP/WRP cover, as well as average farm size. These years were chosen for this exploratory analysis because previous censuses were not available electronically. These variables were interpolated over northern bobwhite range to generate 2×2 -km² grids using the same method described above.

Because, as expected, there was a high degree of spatial autocorrelation among values in the interpolated grids, 100,000 grid cells were randomly selected within northern bobwhite range and used to generate new grids for each of the abundance and landuse variables. The spatial autocorrelation, as measured by Moran's I, decreased from ~ 1 (near perfect positive autocorrelation) to ~ 0.1 (little autocorrelation) for the sampled grids containing only those 100,000 cells. These randomly sampled grids were used for all subsequent analyses.

Analyses

To explore the relationships among northern bobwhite abundance and individual landuse variables, we

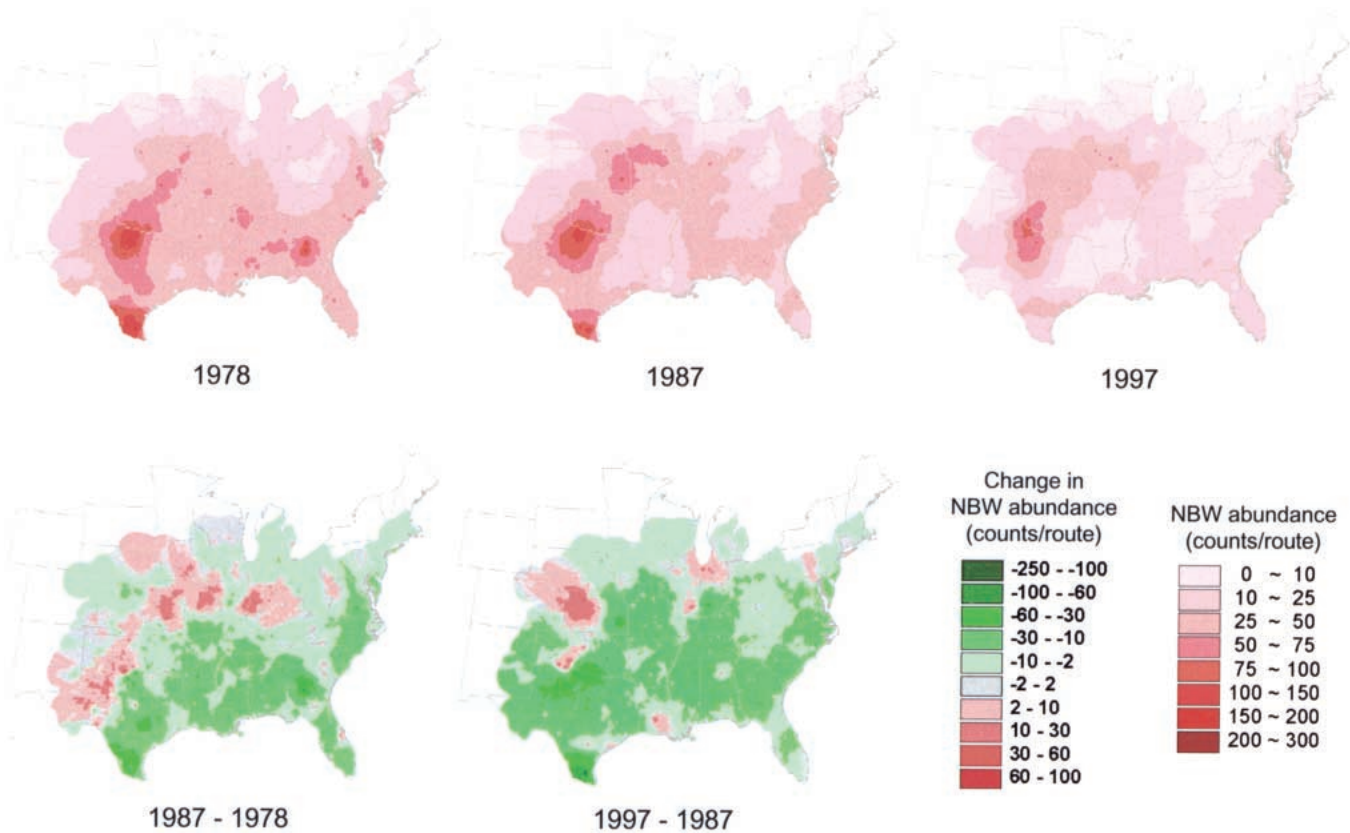

Fig. 2. Interpolated northern bobwhite population index based on the 5-year mean from the North American Breeding Bird Survey (Sauer et al. 2000) centered around (A) 1978, (B) 1987, and (C) 1997, and its changes from (D) 1978 to 1987, and (E) 1987 to 1997.

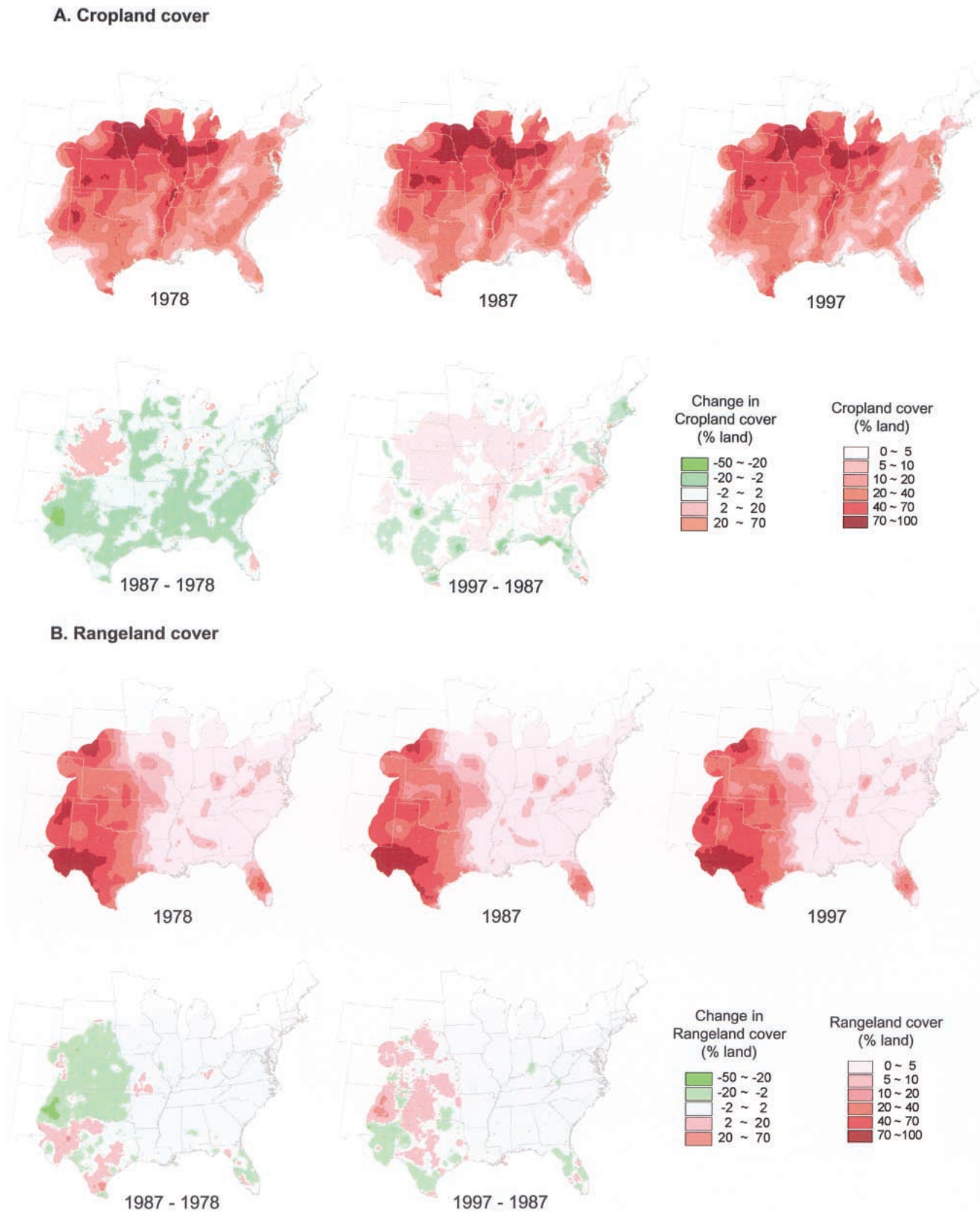
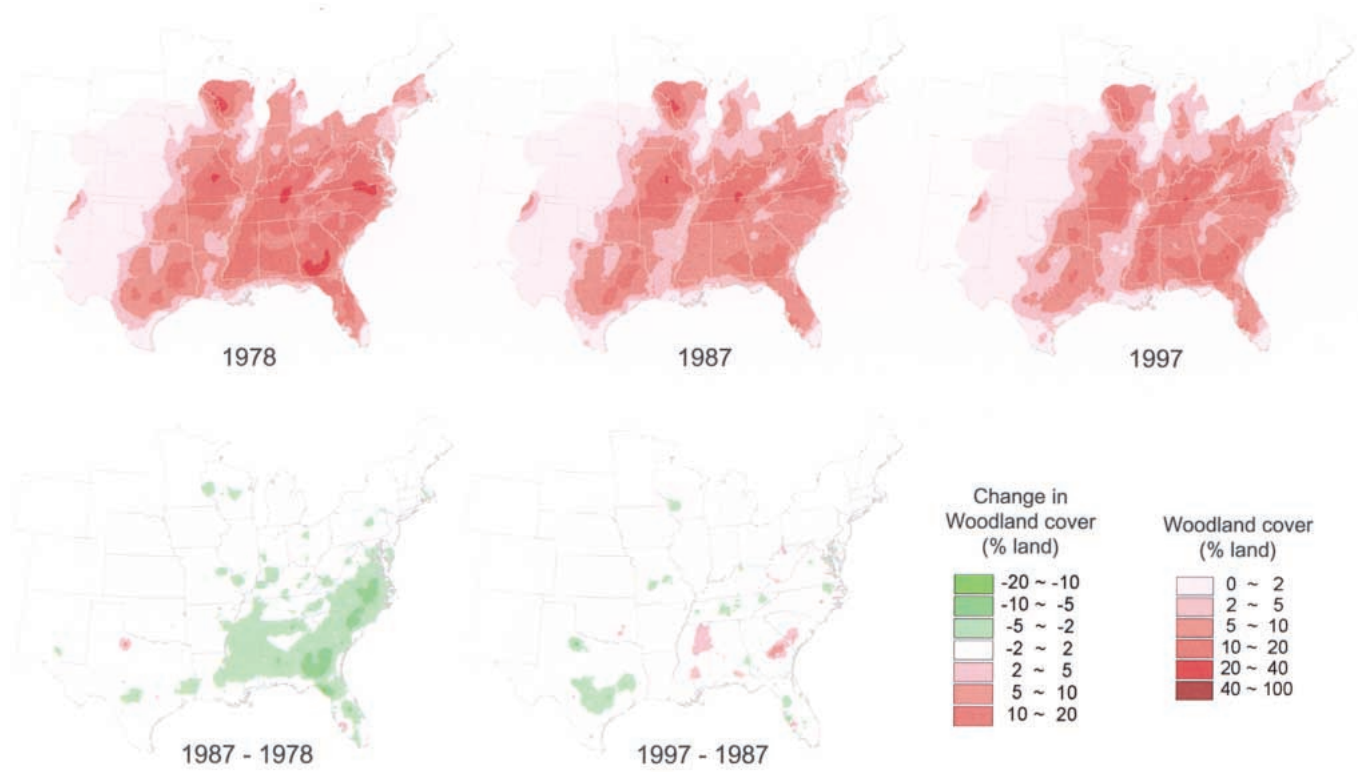

Fig. 3. Spatial interpolations of (A) cropland, (B) rangeland, (C) woodland, and (D) CRP/WRP cover, as well as (E) mean farm size in 1978, 1987, and 1997 within the northern bobwhite range based on county-level data from the Census of Agriculture (USDA-NASS 2000).

NORTHERN BOBWHITE TRENDS AND LANDUSE

C. Woodland cover



D. CRP/WRP cover

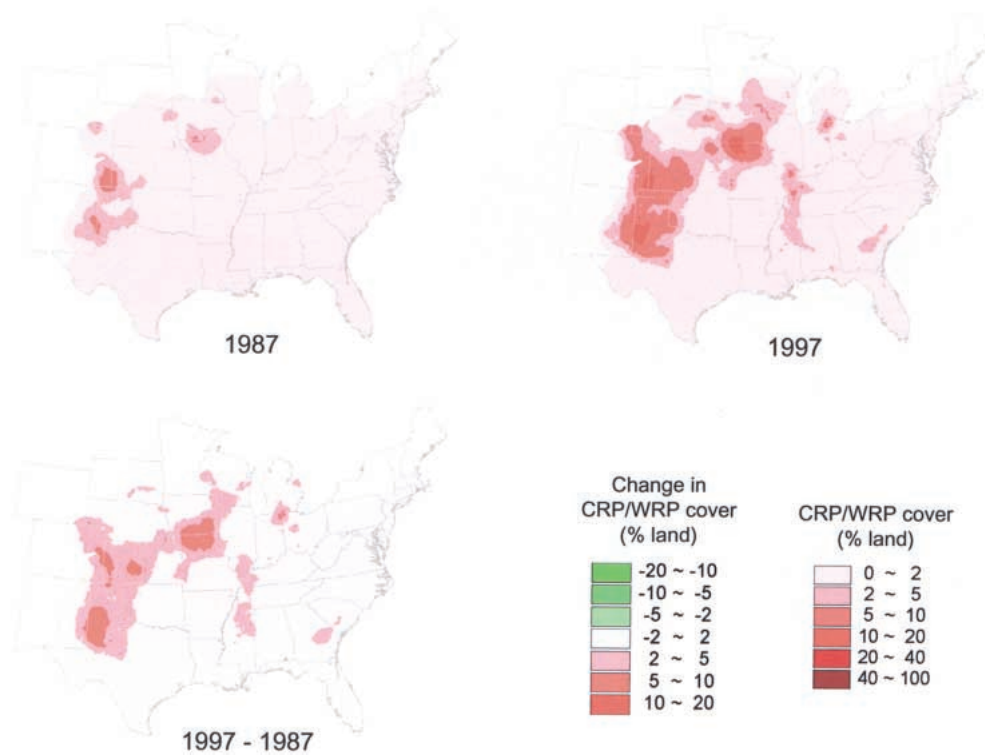

Fig. 3. Continued.

E. Average Farm Size

Fig. 3. Continued.

calculated Pearson's correlation coefficients (SAS Institute 1989) between northern bobwhite abundance and each landuse variable listed earlier for 1978, 1987 and 1997 using the randomly sampled grids. We also categorized crops as positive, negative, other, and cotton, based on how these crops commonly are perceived by quail biologists (see Table 1 for definitions). Because it is possible that relationships among landuse variables and northern bobwhite abundance are multivariate or additive rather than univariate, we used multivariate approaches to screen for possible multivariate effects of landuse on northern bobwhite abundance. First, we regressed northern bobwhite abundance against the landuse variables using stepwise regression (SAS Institute 1989). We also conducted principal factor analysis for the landuse variables, and then regressed northern bobwhite abundance against the factor scores we obtained (SAS Institute 1989).

Because spatial/regional variations in the northern bobwhite-landuse relationship might prevent crisp, rangewide relationships between northern bobwhite abundance and landuse, we also evaluated the relationship between northern bobwhite abundance and cropland cover in 1978, 1987, and 1997 by state, physiographic region, and using a moving window approach as examples of how more detailed, spatially explicit analyses might clarify these relationships. It was beyond the scope of this study to evaluate numerous landuse variables. Cropland cover was chosen for this exercise because it generally is thought to be

critically important to northern bobwhite populations (Brady et al. 1993, Brady et al. 1998, Roseberry and Sudkamp 1998). We calculated a Pearson's correlation coefficient between northern bobwhite abundance and cropland cover for each state and physiographic region using the randomly sampled cells within each state and physiographic region, respectively, for all 3 time periods. For the moving window analysis, 400×400-km² windows were defined and moved systematically across northern bobwhite range in 80-km steps. For each window with ≥80% of its area within northern bobwhite range, a Pearson's correlation coefficient between northern bobwhite abundance and cropland cover was calculated based on the randomly sampled cells that fell within the moving window for each of the 3 time periods. An ArcView script was developed for defining and evaluating the moving windows and calculating the correlation coefficients between selected variables for each window. There was a total of 465 qualified 400×400-km² moving windows with 80-km steps within northern bobwhite range. This approach effectively resulted in an 80×80-km² grid over northern bobwhite range.

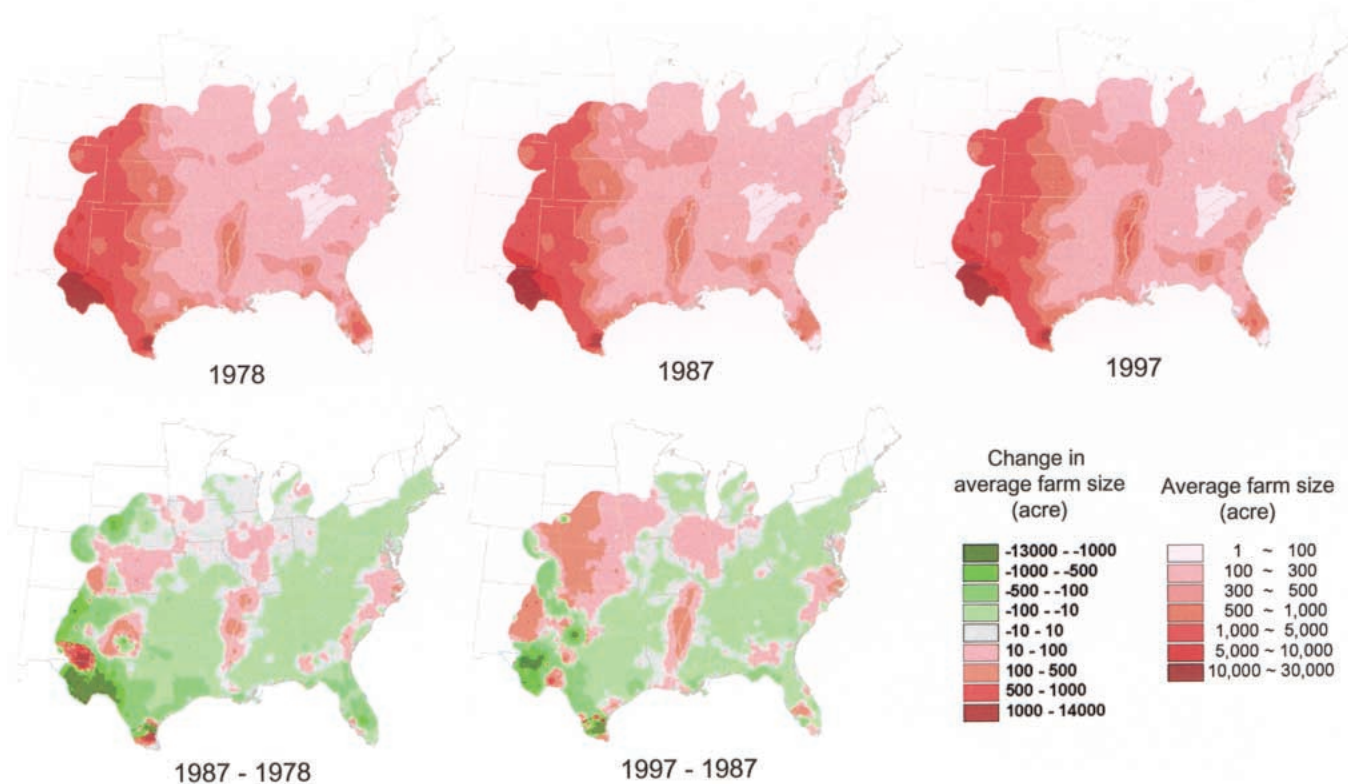
RESULTS

When the entire range of the northern bobwhite addressed by the BBS was considered, abundance declined since the late 1960s (Fig. 1). Trends in bobwhite

abundance, however, varied considerably spatially, either exhibiting no trend or increasing in many western and northern portions of this species' range, particularly between 1978 and 1987 (Fig. 2).

Cropland cover (Fig. 3A) increased dramatically between 1978 and 1987 in most of Nebraska and Kansas, probably at the expense of rangeland (Fig. 3B), and continued to increase between 1987 and 1997. Losses of cropland cover occurred over this entire period in much of Tennessee, Texas, eastern South Carolina, and the coastal bend of Florida. Where changes in cropland cover were observed in most of the remaining northern bobwhite range, they were typified by decreases from 1978 to 1987, and increases from 1987 to 1997. Some of the losses in rangeland cover (Fig. 3B) that occurred in most of Nebraska, Kansas, Oklahoma, and the Texas Panhandle between 1978 to 1987, reversed from 1987 to 1997. Conversely, rangeland gains occurring in west and south Texas during 1978 to 1987, became losses between 1987 to 1997. In general, rangeland was lost over much of Florida during these 2 decades. Woodland cover (Fig. 3C) was lost over most of the southeastern United States between 1978 and 1987. From 1987 to 1997, however, these losses largely were terminated, and increased woodland cover was seen in parts of Mississippi and along the South Carolina-Georgia border. Between 1987 and 1997, most increases in CRP/WRP coverage (Fig. 3D) extended from west Texas, through western Kansas, into southern Iowa and northern Missouri. From 1978 through 1997, average farm/ranch size (Fig. 3E) increased over much of the Mississippi valley, from coastal southern Virginia through southwestern Georgia, and in Kansas, but decreased during this period in much of southwestern Texas. Interestingly, portions of Nebraska, eastern New Mexico, and Florida that experienced marked decreases in the average farm/range size between 1978 and 1987, saw dramatic increases from 1987 to 1997. The converse was the case along the southeastern corner of New Mexico and part of far south Texas.

While there were obvious spatial and temporal patterns in the landuse variables we considered (Fig. 3A–E), there were no clear relationships among any of these variables and northern bobwhite abundance that could universally be applied across this species' range (Table 1). Interestingly, associations between northern bobwhite abundance and the crops considered negative or positive were not consistent across the 3 time periods. Further, cotton cover and northern bobwhite abundance were positively, though weakly, related. The results were no more convincing when we used multivariate approaches to regress northern bobwhite abundance against the landuse variables and main factors resulting from factor analysis ($r^2 = 0.23$ – 0.32 and 0.08 – 0.15 , respectively). Clearly, no single landuse variable or group of variables we evaluated can account for northern bobwhite abundance patterns across this species' range.

Because the state-based assessment of the relationship between cropland cover and northern bobwhite abundance was biologically arbitrary, it was potential-

ly misleading ecologically (Fig. 4A). In Texas, for instance, this analysis suggested that cropland cover had little to do with northern bobwhite populations—an unreasonable conclusion. The assessment based on physiographic regions appeared more appropriate (Fig. 4B). For example, our analysis found a strong positive relationship between cropland cover and northern bobwhite abundance in the Edwards Plateau of Texas, a region typified by rangeland (Fig. 3B; Hatch et al. 1990), as had earlier field surveys (Reid et al. 1979). Analysis based on physiographic regions, while more useful than the statewide summary, still misrepresented the spatial patterns inherent in the relationship between northern bobwhite abundance and cropland cover. For example, if physiographic regions are the spatial unit of interest, one is led to believe that there was a markedly negative relationship between cropland cover and northern bobwhite abundance in the southwestern extreme of this species' range during the 5-year periods centered on 1978 and 1987, that suddenly became strongly positive during the 5-year period bracketing 1997 (Fig. 4B). Again, this is unreasonable. The moving window approach was unique in that it provided spatially consistent and temporally persistent patterns (Fig. 4C). For these reasons, the results of the moving window analysis are much more conducive to the development of sound, broadly applicable ecological interpretations of the cropland cover–northern bobwhite relationship that can serve as the basis for defensible management recommendations.

DISCUSSION

There is no question that determining why northern bobwhite abundance has declined over vast areas (Figs. 1–2) is important to hunters, bird watchers, and biologists alike. For various reasons, most quail biologists have studied northern bobwhites at the pasture spatial scale. Such efforts, while excellent for some purposes, are unlikely to explain why northern bobwhite abundance has declined at the physiographic region or continental spatial scales—far too few pastures can be evaluated.

Fluctuations in northern bobwhite abundance among years have long been recognized (Stoddard 1931:339–347, Rosene 1969:194–197, Schwartz 1974, Snyder 1978, Roseberry and Klimstra 1984: 151–191) and are particularly noticeable in semiarid areas such as western Texas (Peterson and Perez 2000, Peterson 2001). In semiarid regions at least, these fluctuations can largely be explained by weather (Bridges et al. 2001; Lusk et al. 2001, Under Review). The fact that weather can explain fluctuations in northern bobwhite abundance among years, however, does not necessarily imply that it is responsible for observed long-term trends in bobwhite numbers (Figs. 1–2). For this to have been the case, significant climatic changes, such as global warming (Guthery et al. 2000a), would have had to have occurred since the early 1970s.

If global warming, or other climate changes, are not solely responsible for long-term trends in northern

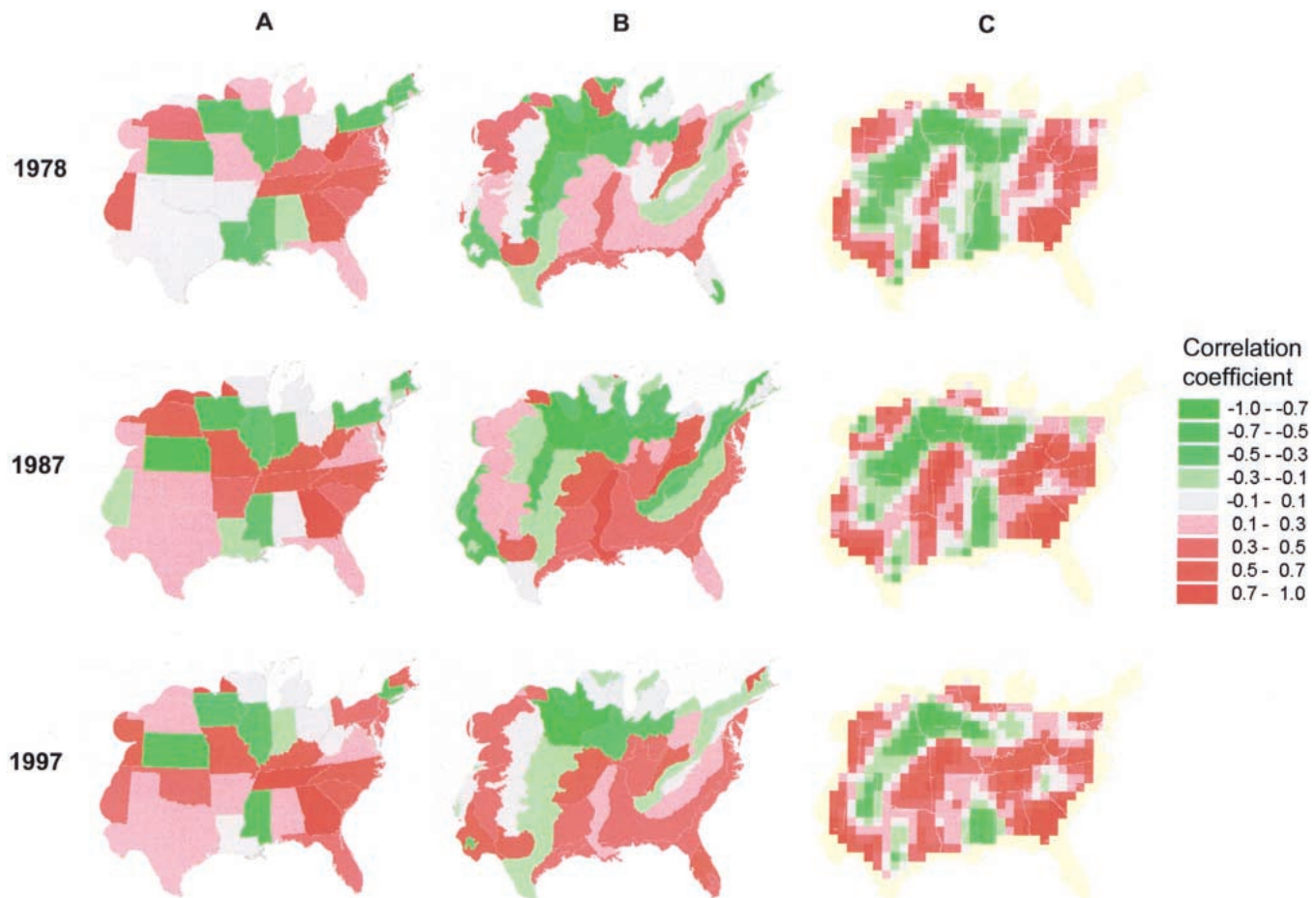

Fig. 4. Correlation between the 5-year mean number of northern bobwhites observed during the North American Breeding Bird Survey (Sauer et al. 2000) centered around 1978, 1987, and 1997 and cropland cover by (A) state, (B) physiographic region, and (C) 400×400-km² moving windows (displayed as an 80×80-km² grid) from the county-level Census of Agriculture (USDA-NASS 2000) data, based on 100,000 randomly selected data points from the interpolated data.

bobwhite abundance, then human-influenced habitat changes are likely involved (Brennan 1991, 1993; Church and Taylor 1992, Brady et al. 1998). While the relationship between northern bobwhite abundance and various landuses have been evaluated at broad spatial scales in certain locales (Brady et al. 1993; Roseberry and Sudkamp 1998; Lusk et al. 2001, Under Review), few studies have addressed the entire range of this species (but see Brady et al. 1998). In our attempt to address this deficiently, we found that none of the univariate or multivariate landuse-based explanations for trends in northern bobwhite abundance that we evaluated could appropriately be applied across this species' range (Table 1). It certainly is possible, however, that fluctuations in bobwhite abundance might respond in a strongly nonlinear fashion to ≥ 1 landuse variable (Lusk et al. 2001, Under Review), or that threshold-based state transitions occurred. These possibilities warrant further investigation.

It also was apparent that dramatic spatial and temporal variation in landuse typified northern bobwhite range in the United States (Fig. 3A–E). Quail biologists probably have suspected this for many years. For example, quail managers commonly argue that ranch fragmentation in much of Texas contributed to declin-

ing quail abundance, while their colleagues east of the Appalachians, from Virginia through Georgia, often argue that increasingly clean farming occurring on larger and larger farms was the problem. Both groups may be correct (Fig. 3E). Because of the spatial and temporal variation in landuse (Fig. 3A–E), as well as quail abundance (Fig. 2), it seems obvious that both spatially and temporally explicit analyses, covering vast areas, will be required to explain the trends in northern bobwhite abundance illustrated in Figure 2.

Although our failure to delineate a single, universal landuse-based explanation for trends in northern bobwhite abundance is inconvenient for managers, it should not be surprising. For example, even when only the western portion of northern bobwhite range was considered, bobwhite population dynamics still varied dramatically by latitude (Guthery et al 2000b). Similarly, while it might be fair to say that the northern bobwhite is an early successional species in forested areas of the southeastern United States, this certainly is not the case in the rangelands of Texas and Oklahoma. Guthery (1999) maintained that viable populations of northern bobwhites could exist under a wide variety of habitat configurations, but that boundaries existed affecting whether space could be used by

bobwhites—thus affecting abundance. Again, spatially explicit, regional variations in the northern bobwhite-landscape relationship are likely an important reason for the lack of a simple, all encompassing relationship among landuse and bobwhite abundance.

It also should not be surprising that the state-based assessment of the relationship between cropland cover and northern bobwhite abundance (Fig. 4A) was not particularly useful. After all, political boundaries are largely arbitrary as far as northern bobwhites are concerned. While assessments based on physiographic regions (Fig. 4B) were much more functional, they still misrepresented the spatial pattern inherent in the relationship between cropland cover and northern bobwhite abundance in many regions. Two possible explanations for this fact come to mind. First, perhaps the classification of physiographic regions was not sufficiently fine to represent natural ecological divisions pertinent to northern bobwhites. Second, although the physiographic regions might be fair representations of the natural divisions of major ecosystems, the functions of these ecosystems as northern bobwhite habitat unquestionably have been modified, sometimes severely, by human activities. This could lead to altered spatial patterns of habitat distribution (Guthery 1999) that are driven by both biophysical and anthropogenic processes as well as their interactions.

The spatially consistent and temporally persistent patterns obtained by allowing data to define the spatial patterns associated with cropland cover and northern bobwhite abundance (Fig. 4C) suggests that scientifically sound, broadly applicable ecological interpretations of this relationship are possible. For example, Roseberry and Sudkamp (1998), Lusk et al. (2001), and Lusk et al. (Under Review) found optimal levels of cultivation for northern bobwhites to be between 30 and 65% across Illinois, 40–50% in western Oklahoma, and ~20% in 6 western physiographic regions of Texas, respectively. Thus, because the optimal level of cultivation for northern bobwhites varies spatially, data-driven, spatially explicit analyses should be able to reliably explain why such patterns persist over time.

The patterns illustrated in Figure 4C may well reflect the combined influence of multiple factors, not simply cropland cover. The existence of these patterns, however, should help biologists determine which landuse variables most influence northern bobwhite abundance in a spatially explicit fashion, and how changes in these factors influences northern bobwhite populations in different areas of this species' range. Evaluating other landuse variables, such as those listed in Table 1, using a moving window approach and various sized moving windows, would be excellent initial steps. This same general approach also could be used to evaluate the relationship between northern bobwhite abundance and individual crops, human density, or other factors of interest. Further, since many biologists maintained that northern bobwhite abundance has been declining for at least 100 years (Leopold 1931:26, Stoddard 1931:xxi, Errington and Hamerstrom 1936:382, Lehmann 1937:8), longer-term bobwhite and lan-

duse data also should be employed. We contend that such analyses are essential to formulating defensible, spatial explicit strategies for northern bobwhite conservation and management designed to maximize the amount of habitat space available through time (Guthery 1997), thus allowing bobwhites to take advantage of their genetically derived ability to make use of diverse habitats (Guthery 1999).

SUMMARY AND IMPLICATIONS

Although northern bobwhite abundance typically decreased at the rangewide spatial scale (1966–99; Fig. 1), trends in abundance varied considerably spatially (Fig. 2), either exhibiting little trend or increasing in certain western and northern portions of this species' range. While both spatial and temporal patterns in landuse were obvious and intriguing (Fig. 3), there were no clear univariate or multivariate relationships among these variables and northern bobwhite abundance that could appropriately be applied across this species' range (Table 1). In other words, we found no data supporting a single landuse-based "rule of thumb" that could universally explain long-term trends in northern bobwhite abundance across this species' range.

Our exploration of the relationship between cropland cover and northern bobwhite abundance at various spatial scales was revealing. First, using political boundaries, such as state lines, to explain ecological phenomena is likely to be misleading at best (Fig. 4A). Political boundaries typically have little relevance to northern bobwhite populations. Although assessments based on physiographic regions were much more useful (Fig. 4B), they still sometimes misrepresented the spatial pattern inherent in the relationship between cropland cover and northern bobwhite abundance in several regions. Perhaps physiographic regions were not sufficiently fine to represent natural ecological divisions pertinent to northern bobwhites, or the spatial patterns of habitat was altered by anthropogenic activities and their interactions with biophysical processes. Lastly, our moving window approach, which allowed data to define the spatial patterns associated with cropland cover and northern bobwhite abundance, was unique in that it provided spatially consistent and temporally persistent patterns (Fig. 4C). These consistent, yet persistent patterns suggest that scientifically sound, broadly applicable ecological interpretations of the cropland cover-northern bobwhite relationship are possible.

Scientifically defensible, spatially explicit management plans for northern bobwhites are badly needed. While the spatially consistent, yet temporally persistent patterns between cropland cover and northern bobwhite abundance (Fig. 4C) suggest that landscape-based explanations for relative quail abundances should be possible, these patterns may well reflect the combined influence of multiple factors (Fig. 3B–E), not simply cropland cover. For this reason, we suggest that moving windows-based analyses, exploring multiple window dimensions, be used to evaluate the ef-

fects and scaling of numerous landuse variables thought to be important to northern bobwhites. Further, many biologists' perception that northern bobwhite abundance began declining in the early 1970s is likely a function of when the BBS began. For this reason, future analyses should start much earlier by either taking advantage of COA data not available electronically (or other long-term landuse data), and northern bobwhite abundance surveys beginning prior to the BBS. Analyses of this type are essential to formulating defensible, spatially explicit strategies for northern bobwhite conservation and management designed to maximize the amount of habitat space available through time across this species' range.

ACKNOWLEDGMENTS

The Institute for Science, Technology, and Public Policy in the George Bush School of Government and Public Service, the Texas Agricultural Experiment Station, and Texas A&M University supported this project.

LITERATURE CITED

- Brady, S. J., C. H. Flather, and K. E. Church. 1998. Range-wide declines of northern bobwhite (*Colinus virginianus*): land use patterns and population trends. *Gibier Faune Sauvage* 15:413–431.
- Brady, S. J., C. H. Flather, K. E. Church, and E. W. Schenck. 1993. Correlates of northern bobwhite distribution and abundance with land-use characteristics in Kansas. *National Quail Symposium Proceedings* 3:115–125.
- Brennan, L. A. 1991. How can we reverse the northern bobwhite population decline? *Wildlife Society Bulletin* 19:544–555.
- Brennan, L. A. 1993. Strategic plan for quail management and research in the United States: Introduction and background. *Proceedings of the National Quail Symposium* 3:160–169.
- Bridges, A. S., M. J. Peterson, N. J. Silvy, F. E. Smeins, and X. Ben Wu. 2001. Differential influence of weather on regional quail abundance in Texas. *Journal of Wildlife Management* 65:10–18.
- Church, K. E., J. R. Sauer, and S. Droege. 1993. Population trends of quails in North America. *Proceedings of the National Quail Symposium* 3:44–54.
- Church, K. E., and J. S. Taylor. 1992. Management and research of northern bobwhite (*Colinus virginianus*) in North America: an Overview. *Gibier Faune Sauvage* 9:787–796.
- Droege, S., and J. R. Sauer. 1990. Northern bobwhite, gray partridge, and ring-necked pheasant population trends (1966–1988) from the North American Breeding Bird Survey. Pages 2–20 in K. E. Church, R. E. Warner, and S. J. Brady, eds. *Perdix V: gray partridge and ring-necked pheasant workshop*. Kansas Department of Wildlife and Parks, Emporia.
- Errington, P. L., and F. N. Hamerstrom, Jr. 1936. The northern bob-white's winter territory. *Iowa State College of Agriculture and Mechanical Arts Research Bulletin* 201:305–443.
- ESRI (Environmental Systems Research Institute). 1998. Working with ArcView Spatial Analyst. Environmental Systems Research Institute (ESRI), Inc. Redlands, California.
- Guthery, F. S. 1997. A philosophy of habitat management for northern bobwhites. *Journal of Wildlife Management* 61:291–301.
- Guthery, F. S. 1999. Slack in the configuration of habitat patches for northern bobwhites. *Journal of Wildlife Management* 63:245–250.
- Guthery, F. S., N. D. Forrester, K. R. Nolte, W. E. Cohen, and W. P. Kuvlesky, Jr. 2000a. Potential effects of global warming on quail populations. *Proceedings of the National Quail Symposium* 4:198–204.
- Guthery, F. S., M. J. Peterson, and R. R. George. 2000b. Viability of northern bobwhite populations. *Journal of Wildlife Management* 64:646–662.
- Hatch, S. L., K. N. Gandhi, and L. E. Brown. 1990. Checklist of the vascular plants of Texas. Texas Agricultural Experiment Station Publication MP-1655, Texas A&M University System, College Station.
- Lee, J. M., and L. A. Brennan. 1994. Changes in northern bobwhite habitat and populations in a southern Mississippi wildlife management area: 1955–1992. *Proceedings of the Annual Conference, Southeastern Association of Fish and Wildlife Agencies* 48:201–207.
- Lehmann, V. W. 1937. Increase quail by improving their habitat. Texas Game, Fish and Oyster Commission, Austin, Texas.
- Leopold, A. 1931. Report on a game survey of the north central states. Democrat Printing Company, Madison, Wisconsin.
- Lusk, J. J., F. S. Guthery, and S. J. DeMaso. 2001. A neural network model for predicting bobwhite quail abundance in the Rolling Red Plains of Oklahoma. Pages: In press in J. M. Scott, P. J. Heglund, M. Morrison, M. Raphael, J. Hauler, and B. Wall, editors. *Predicting species occurrences: issues of scale and accuracy*. Island Press, Covello, California.
- Lusk, J. J., F. S. Guthery, R. R. George, M. J. Peterson, and S. J. DeMaso. Bobwhite abundance in relation to weather and land use. *Journal of Wildlife Management* 66:Under Review.
- Peterson, M. J. 2001. Northern bobwhite and scaled quail abundance and hunting regulation: a Texas example. *Journal of Wildlife Management* 65:828–837.
- Peterson, M. J., and R. M. Perez. 2000. Is quail hunting self regulatory?: northern bobwhite and scaled quail abundance and quail hunting in Texas. *Proceedings of the National Quail Symposium* 4:85–91.
- Reid, R. R., C. E. Grue, and N. J. Silvy. 1979. Competition between bobwhite and scaled quail for habitat in Texas. *Proceedings of the Annual Conference, Southeastern Association of Fish and Wildlife Agencies* 33:146–153.
- Roseberry, J. L., and W. D. Klimstra. 1984. Population ecology of the bobwhite. Southern Illinois University Press, Carbondale.
- Roseberry, J. L., and S. D. Sudkamp. 1998. Assessing the suitability of landscapes for northern bobwhite. *Journal of Wildlife Management* 62:895–902.
- Rosene, W. 1969. The bobwhite quail: its life and management. Rutgers University Press, New Brunswick, New Jersey.
- SAS Institute. 1989. SAS/STAT user's guide, version 6. Fourth Edition. Gary, North Carolina.
- Sauer, J. R., J. E. Hines, I. Thomas, J. Fallon, and G. Gough. 2000. The North American Breeding Bird Survey, results and analysis 1966–1999. Version 98.1, USGS Patuxent Wildlife Research Center, Laurel, Maryland. (<http://www.mbr-pwrc.usgs.gov/bbs/bbs.html>)
- Schwartz, C. C. 1974. Analysis of survey data collected on bobwhite in Iowa. *Journal of Wildlife Management* 38:674–678.
- Snyder, W. D. 1978. The bobwhite in eastern Colorado. Technical Publication No. 32. Colorado Division of Wildlife, Fort Collins.
- Stoddard, H. L. 1931. The bobwhite quail: its habits, preservation and increase. Charles Scribner's Sons, New York, New York.
- USDA-NASS (U.S. Department of Agriculture, National Agricultural Statistics Service). 2000. 1997 Census of Agriculture. USDA National Agricultural Statistics Service, Washington, D.C. (<http://www.nass.usda.gov/census/>)

IDEAS, LANDSCAPES, AND CONSERVATION'S NEW FRONTIER

Shane P. Mahoney

P. O. Box 22033, St. John's, Newfoundland, A1C 6L2, Canada

Citation: Mahoney, S. P. 2002. Ideas, landscapes, and conservation's new frontier. Pages 45–47 in S. J. DeMaso, W. P. Kuvlesky, Jr., F. Hernández, and M. E. Berger, eds. Quail V: Proceedings of the Fifth National Quail Symposium, Texas Parks and Wildlife Department, Austin, TX.

As the new century stretches before us, we in the conservation profession are challenged by an unfor-giving array of problems, the most prodigious of which is the explosion of human populations. This en-tirely natural phenomenon, buried within the genomic engines of our kind and harnessed to our rapacious greed for land, threatens all other living creatures and indeed the ecological fabric our tiny, limited planet. As the human hoard launches itself against the finite dynamics of nature, changes of profound complexity flirt with our juvenile wisdoms to create milieus of tension and crisis. While conservation efforts of great integrity and scope marshal the best we in this profes-sion have to offer, the reality is that far too seldom do we attain the conceptual summits where ultimate un-derstandings are sequestered. There are many reasons for this, not the least of which is the ever-quickening diminishment of natural diversity. Like laborers emp-tying deserts with spoons, we appear preordained to starting afresh as earlier progress is destroyed or new crises created.

To forestall a sense of disempowerment and to en-sure the efforts we make result in maximal benefit to conservation are, I think, concerns for us all. We need to understand that we are making a difference and that our efforts to sustain nature simultaneously assist in sustaining traditions and activities we see as valuable. For many of us (and this may seem anti-thetical to the popular mythology of biologists as misfits) our deep concern for wild creatures is coupled with a profound appreciation of human societies that have traditionally relied on them, and a desire to preserve the lifestyles and appropriate natural conditions that will enable continuance of these cultures. In this sense at least, we encompass the human species within the natural com-munity in an ecological way, identifying as for any other population its specific ecological requirements, while simultaneously struggling with the impact it (we), like all species, are having on the lands we use.

In this context historical reflections are profoundly important. They provide the perspective of both the direction and pace of change. Furthermore they map the journeys of ideas, providing our only true un-derstanding of how social, intellectual, and environmental landscapes coalesce to influence the progress and ma-turation of thought as well as the effectiveness of con-servation programs. Historical perspectives rescue us from the hypnosis of myopia as well as from the crip-pling effects of feeling overwhelmed. They are our

transcendental selves in fact, allowing us to live though a time before birth, giving us experience that time would otherwise have denied us, and providing us with a wisdom beyond our years. All current efforts in conservation were effected in a time previous and are affected yet by their formative years. Thus an un-derstanding of how ecological and societal situations have changed, and why, is crucial to evaluating our current problems and designing our current solutions.

Furthermore, our best efforts in any one field of endeavor, whether research, stewardship, or any other, can only be successful if they are integrated within a conservation framework that has all components work-ing. Deciding on what this framework is and un-derstanding its integrated functioning can only be achieved through conceptual thinking. This requires a determined retreat from the hurly-burly of our collec-tive muledom and a journey to reflective thought. While this was throughout intellectual history consid-ered the essential ingredient for advancement of ideas, the womb of creativity and cradle of civilization both, it has most unfortunately become what I term the “last great extravagance of our times.” It cannot be pur-chased, only afforded; thus its rarity in our culture. It is seldom considered a valuable enough entity to even enter our job descriptions, let alone our work roster. The isolated plateaus of peace required for such in-cubations are considered holiday resorts it appears, and thus unaffordable at any price. As a consequence we run the risk of working as ants gathering leaves but hoping to build a forest.

Today, in addition to the perusal of ideas and the historicity of their progress and clash, we are, more than any time before, challenged to identify the con-servation model we believe can deliver nature and its surrounding and supporting human traditions into the next generations and beyond. The challenge has sur-mounted that of preceding times because we have ar-rived at an interlude in the earth's natural history which lays before us the prospect of an extinction cat-aclysm of staggering proportions and unprecedented pace. This is a time demanding the best and most dex-terous of our abilities, the greatest vision and scope, and the most coordinated societal approach to conservation we can engender. We urgently require an unobstructed view of the new frontier, and a strategy cleared of con-fusion and inefficiencies. We must coordinate the con-servation corps as never before. But to do so we must decide what the crucial linkages and components are.

I suggest 2 arresting questions in this regard:

1. What societal groups and processes must be integrated to effect the conservation of nature?
2. What world view most appropriately determines man's role within and for nature?

The first question is a pragmatic one whose answer will determine our conservation *tactics*; the second is a philosophical one, and its answer delves at the heart of society's current debate over hunting and fishing, and other extractive or utilitarian life style models. This second is a philosophical query whose answer will decide our *strategy*. Clearly if man is seen as rightfully integrating with nature as a moral utilitarian, a sustainable user and personally motivated conservationist, then one approach to natural populations and landscapes will be endorsed. If man's role is a voyeuristic one where interactions with other species must disallow lethal interactions of any kind then a very different approach, with different priorities and agendas, will be appropriate. Currently we have groups working with commitment and talent towards both strategies. I ask us all: how long can we afford this?

In North America we are the inheritors of a landscape abounding in wildlife and with still, by world standards, large expanses of clean and productive natural land. While not exclusively so, this legacy is primarily the result of a small group of dedicated leaders from the political and social elite of the late 1800s and a legion of hunter-conservationists who collectively inspired and enacted a social movement for conservation that had as its basis a utilitarian philosophy that predated the modern notions of sustainable use by a century! In what can only be termed a revolution, men like President Theodore Roosevelt, George Bird Grinnell, and Gifford Pinchot in the United States, and somewhat later, Prime Minister Sir Wilfred Laurier and Gordon Hewitt, in Canada, founded a program of conservation that destroyed the myth of limitlessness in nature, and stood firm against the centuries-old slaughter of wildlife for any price.

While this first great tremor for conservation launched wildlife refuges and reserves, National Parks, National Forests, and effective legislation and enforcement, it was clear by the 1930s that this was not sufficient. Continuing declines in some wildlife populations, as well as over abundances and habitat deterioration for others pointed to a deficit of knowledge and the requirements for training of a highly specialized force to manage wildlife populations, not just protect them. Again hunter-naturalists figured prominently and a new knowledge tide was set in motion. Men like Aldo Leopold and "Ding" Darling helped guide the rise of the wildlife management profession, and imaginative funding mechanisms based on the willingness of hunters to pay directly for conservation helped unite this second great revolution in the 1930s with the first of some fifty years earlier. The tactics of law, money and knowledge were clearly linked in these first revolutions to a utilitarian based philosophy, the demarcated strategy of which was to provide wildlife and land in sufficient abundance to maintain not only populations, but also the hunting and fishing traditions

which required these. This North American model of wildlife conservation and management is arguably the most successful and mature in the world.

It is not without its problems however and some 50 years (again) after the second revolution we find ourselves groping once more. In strange ironies we see the disproportionate successes of the model, once rare species such as deer and turkey reaching overabundance status on landscapes where simultaneously others teeter on the abyss of extinction. Traditions once taken for granted, such as hunting, trapping and fishing, are ever more sequestered, constrained by shifting societal attitudes, land use practices, and urbanite emigrations to rural landscapes without rural cultures. Declining financial resources from hunting and fishing licenses, coupled with gradually emergent new sources of less directed funds have shifted the balance of influence within wildlife agencies and programs to some extent, and both the agencies and their headwater universities have begun to spawn new breeds of professionals whose identity and focus no longer reflect the traditional rural cultures of yesterday. Political elites are forever showing their broad range of adaptability as well, and reflect like sundials the times in which we live.

Humming within this model we see the crucial components of conservation as we have defined it, components that furnish the chassis upon which our vast array of programs depend. The principal members of this group are the public (amongst which hunters still figure prominently as supporters), academia, the body politic, professional agencies and organizations, and conservation groups. As the supporting infrastructure, all these components must work in a coordinated way if we are to realize the continued success in wildlife and freshwater fish conservation and management that we have achieved, and redress the failures and shortcomings we must acknowledge. One of our increasing problems I believe has been our specialized focus on separate components and the absence of a coordinated conceptual approach which targets several components at once and tracks simultaneously the response of others.

This is where the third revolution resides, in articulating new multifaceted approaches to influencing the conservation corps in a systemic attack. Our suggested anti-biotic administrations may no longer be effective, if what is at stake is a personality that believes there is no illness to be confronted, or one that sees the problem as entirely different from our diagnosis. To give one example of what I mean, many agencies are focusing on questions of hunter retention and recruitment, but when I ask the simple question of how many hunters do we want, I get vague answers or a clear silence. This suggests that asking how the political and academic communities, and the non-hunting and anti-hunting publics are to be approached on this issue is a useless exercise. Who, I ask, sees this as a problem, and why? Indeed where are we going to put these additional hunters? Wouldn't their presence necessitate an affiliated strategy for land acquisition or access? Is this possible?

I realize that the situations will differ depending

upon where in North America you are referencing, but certainly the answers to such questions are crucial in defining our conservation strategy and determining what issue we are to focus upon and how. Imagine if society doesn't think we have a problem in this regard at all. Why should academia respond? Why should politicians deal with it? Why indeed should agencies care? Well, the reality is they should all care and respond if hunting is relevant and valuable to society in a conservation sense or otherwise. Ah! But is hunting valuable and relevant? That is the basic question, and yet how much effort have we spent on trying to resolve this highly philosophical problem? Probably very little, because such pursuits are not deemed essential to our jobs. Well in fact they are critical, because depending upon the answer, we ought to make completely different decisions as to how much effort to expend in preserving hunting. That, in turn, will depend on how we tackle the components of the conservation corps.

Our goal, it seems to me, ought to be clear enough. We desire a sustaining and sustainable natural world. Leaving definitions aside, we must acknowledge that this cannot be achieved if the general public and our political leadership are not in general agreement with each other, and with the conclusions of our best teachers and experts as to the nature and scope of the problems we face. All of us know that multiple components are involved at every level of the conservation equation. Let us take research as an example. Detailed knowledge of one component of a species' ecology is obviously insufficient for its management and protection. The intriguing association of quail productivity, rainfall, "sub-clover," and phytoestrogens is certainly an elaborate hypothesis, but of course even its definitive extraction could not effectively reverse the declines that have occurred. It is but one piece of an elaborate puzzle.

Landscape level changes associated with industrial forestry and agriculture and the suppression of the "great regenerator," fire, have presented a different America to quail, seemingly not one to their liking. Thus any recovery across their former range of abundance must involve political, social, and economic re-evaluations. Furthermore, as quail have declined and turkeys and deer exploded, new constituencies have arisen. For the recalcitrant quail, money has become a formidable elixir, money to be invested in burnings and plantings, and money to secure your personal access to them. Quail have moved along the spectrum towards European style hunting and management, once abundant and available to every man, now rarer and harder to obtain. Support for quail conservation has undoubtedly undergone a personality shift.

In the quail scenario we see an exemplar of the maelstrom that now evinces the third revolution in American conservation. Once the great hope, knowledge is clearly not sufficient to protect wildlife resources. It is essential; but our great realization must be that it is insufficient. Understanding must be coupled with opportunity if it is to play its role, and opportunity is determined by the conservation corps I

have earlier referred to. Politics, agencies, public opinion, academia, and conservation organizations must all bring their best capacities to bear if the challenges facing quail, and all of the continent's resources, are to be met and overcome.

But our challenge doesn't end there. We must decide which world view we are to espouse, the "wise use" model of the founders of our conservation system, or the protectionist ideal where man foregoes all lethal interactions with the rest of animate creation. What is our fundamental motivation for quail preservation, and why do supportive constituencies exist at all? And which of these constituencies will fight for these little birds long enough to sustain their presence in our natural communities. We must face this debate head on, and recognize that it is *the* fundamental decision for conservation, not only for quail, but for all wildlife the world over. The human population roars and its echo will decide the fate of this planet. Some guiding philosophy must unite us in the fight to preserve the wondrous world of nature. Its diminishment is the loss of beauty and truth and the one mirror by which humanity may understand and honestly judge itself.

In North America we have had great achievements in conservation. We have restored species on the brink of extinction, safeguarded large predators, and launched a complex and versatile superstructure to work for wildlife that is the envy of the world. But no system reigns forever and we are witnessing major challenges that must be addressed. Our system of "wise use" and free and democratic access to wildlife is under assault, from without and within. At the same time that traditional activities such as hunting and fishing are coming under attack from groups opposed, changes within these cultures are worrying even the proponents who see a drift towards elitism and exclusivity and a return to the practice of viewing wild creatures as commodities. While the philosophical collisions between those genuinely opposed to lethal interactions with nature and those in favor is a healthful sign of the relevance of these activities, the slide towards commercializing wildlife is a direct and grievous assault on all who have worked for and benefited from the great North American model. It will deliver us, if unchecked, bereft of supportive constituencies, and nature will lose.

And so it is our fate, those of us who work for the conservation of nature, to be embroiled in debates that run the full range of human discussion, from the most pragmatic to the most philosophical. Running through the challenges of quail conservation and recovery are the haunting shadows of passenger pigeons flying in their multitudes and slaughtered in their billions. So too the nearly lost but wonderfully rescued flash of wood ducks in the morning light. Never easy, never certain, the road we travel is arduous and unending, marvelous and honorable. We must choose our philosophical ground and recognize that only by connecting the elements of conservation in a coordinated parade can we achieve our goals. Our ideas have traveled a long and complex landscape, but they have truly arrived at a new frontier.

SUSTAINING THE 'QUAIL WAVE' IN THE SOUTHERN GREAT PLAINS

Dale Rollins

Department of Wildlife and Fisheries Sciences and Texas Agricultural Extension Service, Texas A&M University, San Angelo, Texas 76901-9714, USA

ABSTRACT

The southern Great Plains (i.e., Texas and Oklahoma) historically affords some of the best, and currently most stable, northern bobwhite (*Colinus virginianus*) populations anywhere. However, bobwhite populations have declined in recent years over much of this area, especially east of the 98th meridian. Two subsets of the southern plains, the Rolling Plains (parts of northwestern Texas, western Oklahoma, and western Kansas) and the Rio Grande Plains (south Texas) offer the most expansive, contemporary northern bobwhite habitat throughout its range. Bobwhite habitat in the southern plains is affected primarily by rainfall and rangeland management for livestock. Range management practices (brush control, grazing management) can be prescribed to benefit bobwhite habitat, but a large part of potential bobwhite range in the southern plains suffers from overgrazing and excessive brush control. Farm Bill policies (e.g., Conservation Reserve Program) have had a major impact on dryland agriculture in this region, but their impacts on bobwhites have been only marginally positive (if at all) to date. Income generated from quail hunting in this region currently rivals or exceeds that generated from cattle grazing leases. Accordingly, more landowners are beginning to temper traditional land management goals, and incorporate more quail-friendly practices (i.e., "brush sculpting" and reducing stocking rates). Educational efforts aimed at landowners should strive to implement existing knowledge and develop informed decision-makers. The current demand for quail hunting affords an excellent opportunity to promote, and adopt, management practices that will hopefully sustain the heritage of quail hunting in this region of the bobwhite's range for future generations.

Citation: Rollins, D. 2002. Sustaining the 'quail wave' in the southern Great Plains. Pages 48–56 in S. J. DeMaso, W. P. Kuvlesky, Jr., F. Hernández, and M. E. Berger, eds. Quail V: Proceedings of the Fifth National Quail Symposium. Texas Parks and Wildlife Department, Austin, TX.

Key words: *Callipepla squamata*, *Colinus virginianus*, education, fragmentation, Great Plains, habitat, management, northern bobwhite, quail decline, scaled quail, Texas

INTRODUCTION

When I read Brennan's (1991) dire predictions about the future of northern bobwhite populations in the southeastern United States, I dismissed the idea as a chicken little strategy (i.e., the sky is falling) to generate dollars for research efforts. After all, quail populations (bobwhite and scaled quail [*Callipepla squamata*]) and quail hunting were very good in my parts of the Rolling Plains in west Texas. A quail "boom" had occurred in 1987 and a smaller one in 1992; things were good on the "western front."

But Brennan's (1991) fatalistic forecast planted seeds of uncertainty that eroded my complacency. Enough so, that I decided to attend Quail IV at Tallahassee, Florida. The conference served as a wake-up call for me. Quail biologists from one southeastern state after another lamented the decline of quail in their respective states over the last 30 years. The mood was a somber one. One speaker remarked how the "quail wave" had run its course in his state; changes in land use (e.g., intensive agricultural systems, intensive timber production) have caused a dramatic decline over most of the bobwhite's historic range in the southeastern United States.

About 1992, I also realized something, possibly a disease epizootic, had caused a dramatic, and as far as I'm concerned inexplicable, decline in scaled quail throughout the Rolling Plains of Texas and south-

western Oklahoma (Rollins 2000a). Now my false sense of invincibility relative to both bobwhites and scaled quail had been shaken. Not since have I taken them for granted. I returned to west Texas resolved to rally the troops. Since 1992, I have had the opportunity to be involved with various research and educational efforts aimed at understanding, and hopefully mitigating, the decline of bobwhites and scaled quail in west Texas.

I will examine quail management issues operating in the southern Great Plains, and especially in the Rolling Plains of northwest Texas and the South Texas Plains. Over the last 30 years, these 2 regions of Texas have been the most productive areas for bobwhites in Texas (Texas Parks and Wildlife 2000).

QUAIL TRENDS

Trend lines of bobwhite and scaled quail abundance as estimated by the Breeding Bird Survey (BBS; Sauer et al. 2000) have decreased in both regions (Fig. 1), especially since 1980 (Table 1). Bobwhite declines have been less drastic in the Rolling Plains (identified as Rolling Red Plains by BBS) than in the South Texas Plains (referred to as South Texas Brushlands in BBS). However, bobwhite and scaled quail trends in these areas can be difficult to assess in the short term (<10-year period), as both species exhibit irruptive popula-

SUSTAINING QUAIL IN THE SOUTHERN PLAINS

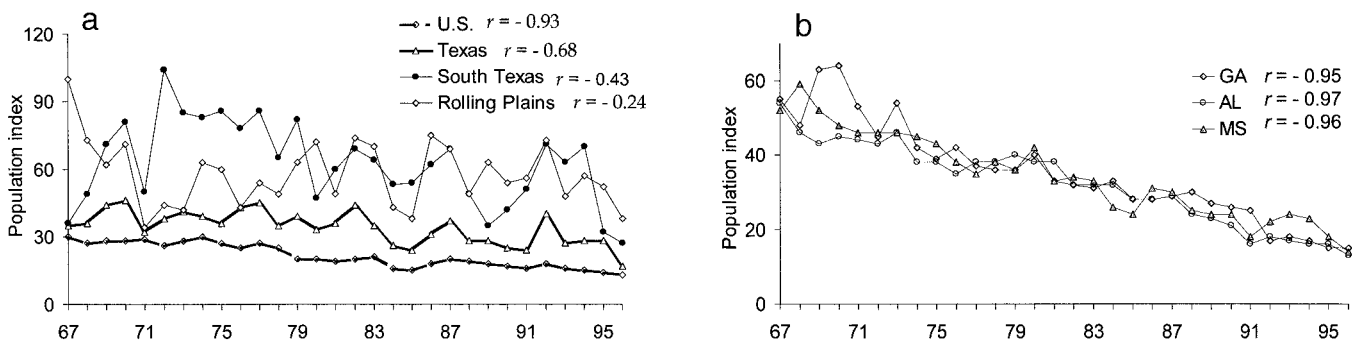

Fig. 1. Northern bobwhite abundance in selected ecological regions in Texas (1a), and in 3 states throughout the southeastern United States (1b), 1966–98. Data obtained from Breeding Bird Survey (Sauer et al. 2000). Ecological regions defined by Gould (1975).

tion growth in the Rolling Plains (Jackson 1962, Rolins 1999a, 2000a) and the South Texas Plains (Peterson and Perez 2000).

Across the state, bobwhite abundance in Texas declined an average of 4.9% annually from 1980–2000 according to BBS, while scaled quail abundance declined 2.2% annually during the same time period (Sauer et al. 2000). Regional declines have been more pronounced (e.g., scaled quail declined 8.1% annually in the Rolling Plains from 1980–2000 according to BBS). Roadside counts by Texas Parks and Wildlife Department (TPWD) have documented significant de-

clines in some regions (e.g., Pineywoods, Gulf Prairies and Marshes) (Peterson and Perez 2000), but did not document a decline statewide (Peterson and Perez 2000). The most notable declines have been east of the 98th meridian, in the Cross Timbers and Prairies, Blackland Prairies, Pineywoods, Edwards Plateau, Post Oak Savannah, and Gulf Prairies and Marshes ecological regions (Texas Parks and Wildlife Department 2000). Roadside counts for bobwhites in the Cross Timbers, Edwards Plateau, and Gulf Prairies and Marshes ecological regions were below their long-term means 6 of the last 7 years. Counts in 2000 were the

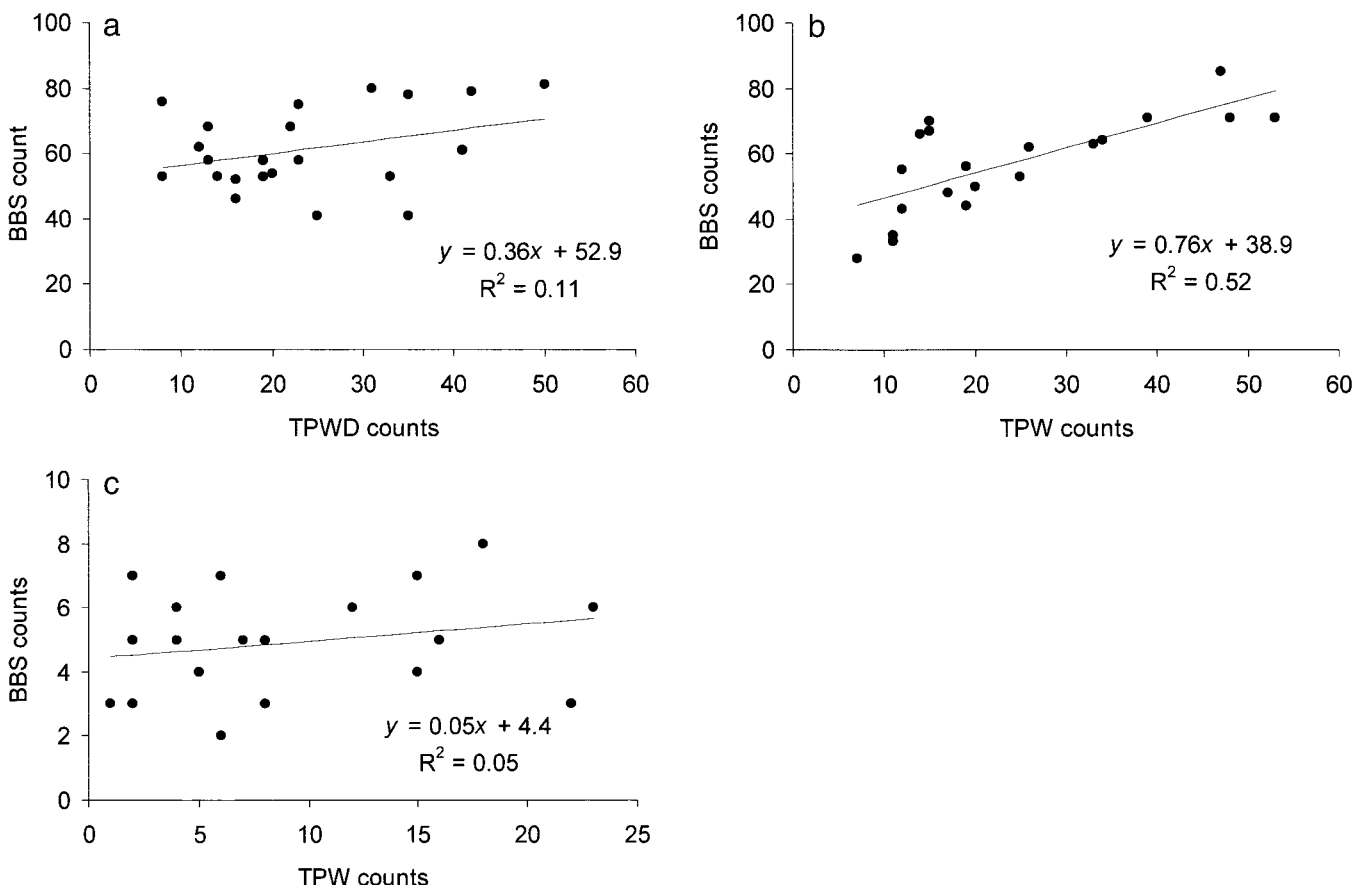

Fig. 2. Correlation of Texas Parks and Wildlife Department roadside quail counts (x-axis) with Breeding Bird Survey counts (y-axis) for 2 ecological regions in Texas. Figures 2a and 2b are for Rolling Plains and South Texas Plains, respectively; 2c is for scaled quail in the South Texas Plains.

Table 1. Northern bobwhite and scaled quail trends in various parts of the Southern Great Plains as estimated by Breeding Bird Survey (Sauer et al. 2000).

Species State/Region	1966–2000			1966–79			1980–2000		
	Trend	<i>P</i>	<i>n</i>	Trend	<i>P</i>	<i>n</i>	Trend	<i>P</i>	<i>n</i>
Northern bobwhite									
Kansas	-1.0	0.17	37	-1.3	0.36	34	-0.4	0.79	37
Oklahoma	-0.9	0.06	61	-0.4	0.56	33	-2.5	0.00	60
Texas	-2.4	0.00	166	3.3	0.00	97	-4.9	0.00	158
Rolling Plains	0.3	0.73	24	2.7	0.28	7	-2.8	0.02	23
South Texas	-1.9	0.00	30	-0.4	0.56	33	-4.1	0.00	29
Scaled quail									
Texas	-3.7	0.00	67	-2.4	0.04	39	-2.2	0.20	59
Rolling Plains	-5.5	0.00	13	2.6	0.90	7	-8.3	0.01	10
South Texas	-3.5	0.02	18	-5.2	0.13	11	0.0	0.99	15

lowest on record for those 3 regions (Texas Parks and Wildlife Department 2000).

Roadside counts (typically conducted in Aug) were significantly correlated with BBS counts (typically conducted in May–Jun) for bobwhites in south Texas ($r = 0.72$, 19 *df*, $P = 0.002$), but not for the Rolling Plains ($r = 0.33$, 19 *df*, $P = 0.14$; Fig. 2). Roadside counts were not correlated with BBS data for scaled quail in the South Texas Plains ($r = 0.22$, 19 *df*, $P = 0.34$).

HUNTER TRENDS

A sample ($n = 250$) of Quail Unlimited (QU) members who resided in Texas were surveyed during the fall of 2000 (D. Rollins, unpublished data) to assess their hunting activities, expenditures, and other information related to quail hunting during the 1999–2000 season. The response rate was 47%. The average QU member in Texas is a white, middle-aged, male. Most (85%) are college graduates with 42% having achieved some post-graduate education. They are affluent (42% reported household incomes $> \$125,000$). Residence was split among rural communities (26%), small cities ($< 100,000$ people) (31%), medium-sized cities (100,000–250,000 people) (28%), and large cities ($> 500,000$ people) (15%). They spent a considerable amount of money ($\bar{x} = \$10,354$ in 1999), with major expenses listed for leases, equipment, and dog-related. The bulk of those expenditures (65%) were made in the destination county. The statistics cited are probably not representative of all quail hunters in Texas.

Most (80%) respondents hunted quail during the 1999–2000 hunting season. Of those who hunted, the mean number of days hunted was 15.3 days in 1999, down 29% from an average of 19.7 days in 1990. Hunters bagged a mean of 3.6 bobwhites/hunting day. Based on the expenses cited here, the average quail bagged cost the hunter \$207. That equates to a quail value of \$1.15/g (\$34.50/oz), or \$1,215/kg (\$552/lb)! A sizeable number (19%) of those surveyed indicated they had purchased property within the last 10 years for quail hunting.

Most (87%) Texas QU members believed that

quail numbers had declined on the properties they had hunted over the last 10 years. A few reported an increase (7%) or no change (6%) in quail populations. When asked “what are the most important factors affecting quail populations in the counties where you hunt,” the most frequently cited factors were weather (78%), land use changes (48%), predators (42%), overgrazing (39%), and fire ants (33%). At least 10 other factors were reported less frequently.

Relevant TPWD statistics indicated a 49% decline in quail hunters from 1981 to 1999 (Texas Parks and Wildlife Department 1999). Quail hunting participation (i.e., quail hunter days) dropped 39% during the same time period. No economic expenditure data are available for nonresident quail hunters, but the expenditures likely approach or exceed those incurred by resident quail hunters. Nonresident quail hunters increased 462% from 1981–98.

FACTORS AFFECTING QUAIL

Abiotic

Weather.—The influence of precipitation on quail in semiarid ranges is well documented (Campbell et al. 1973, Giuliano and Lutz 1993, Bridges et al. 2000), but how it influences quail populations is not (Rollins 1999a). Hanselka and Guthery (1991) estimated that annual precipitation accounted for 40% of the annual variability observed in bobwhite populations in south Texas. Irruptions appear to be related indirectly to rainfall, possibly through some plant-related stimulus (e.g., nutrition). Various theories have examined Vitamin A (Lehmann 1953), phytoestrogens (Cain et al. 1987, Delehanty 2000), phosphorus in the diet (Cain et al. 1982), effects of drought stress on breeding physiology (Koerth and Guthery 1991), and more indirect effects through habitat change (Rollins 1999b), or some related aspect (insect availability; Roseberry and Klimstra 1984:112).

An alternate hypothesis is that precipitation increases nesting cover across the landscape (i.e., “usable space”) (Guthery 1997), and subsequently may increase nesting success by complicating the predators’ search efficiency (Rollins 1999b). Quail irrup-

tions in the Rolling Plains ecoregion of Texas are characterized by landscapes dominated by common broomweed (*Xanthocephalum dracunculoides*) (Jackson 1962, Rollins 1999a). Dense canopies of common broomweed tend to “insulate” quail from predators (avian and mammalian) and hence increase “usable space.”

Jackson (1962) characterized bobwhite irruptions in the Rolling Plains of Texas as an interaction among drought, livestock grazing practices, plant succession, and periodic episodes of heavy rains. Jackson’s (1962) explanation of the situation may be described as a 5-step process.

1. A drought of several years, coupled with livestock overgrazing, depletes much of the habitat, hence most of the bobwhite population.
2. A year of average rainfall promotes secondary succession on the bared soils, resulting in expanses of annual forbs (e.g., doveweed [*Croton* spp.], buffalobur [*Solanum rostratum*]) useful as food to quail. The habitat is “functional [but] unstable.” The nutritional situation is good and the predator population has lagged during the dry years. Bobwhites undergo a “lateral” increase and occupy sites across the landscape.
3. A year of excessive rainfall breaks the drought. The landscape is now covered with a dense canopy of common broomweed which provides excellent winter ground cover, yet is open at ground level for easy travel by quail. “Now the range is all bobwhite habitat as regards cover” (Jackson 1962). The quail population increase is rapid (i.e., a “vertical” increase).
4. A year of normal rainfall follows with good moisture carryover from the previous year. The bobwhite population explodes and occupies all marginal habitats (even roadsides). Meanwhile plant succession has advanced to a stage less desirable to bobwhites (mostly grasses) and the quail population is left “out on a limb,” and probably competing for food with an irruptive rodent population.
5. The bobwhite population crashes if food or cover fails before spring. Dry years set in and continue. Conditions revert again to phase 1.

“Water harvesting” (i.e., contour ripping and installing “spreader” dams) has been promoted recently for increasing herbaceous biomass, species diversity, and arthropod biomass (R. J. Buntyn, Texas Agricultural Experiment Station, unpublished data). Study areas near Ft. Stockton, Texas where such practices had been applied, along with conservative stocking rates, exhibited high (>70%) hatch rates for scaled quail during a 2-year study.

Habitat Fragmentation.—Habitat fragmentation is commonly cited as a chronic agent in the decline of bobwhites (Klimstra 1982, Brennan 1991). Urbanization and land fragmentation are especially acute in the eastern half of Texas (Wilkins et al. 2000), and these trends are coincidental with declining quail abundance in those areas. However, Peterson et al. (*this volume*) could not identify consistent trends or identify land use

relationships that described bobwhite abundance across its geographic range.

Global Warming.—Quail populations have declined coincidentally with global warming (Guthery et al. 2000). These authors outlined mechanisms (e.g., reduced length of the laying season) that may depress quail reproduction. Global warming could also exacerbate the negative impacts of habitat fragmentation, habitat loss, and overgrazing.

Biotic

Predation.—Rollins and Carroll (2001) provided an overview of the impacts of predation on bobwhite and scaled quail. Although quail have adaptations for coping with high predation rates (e.g., reneating, large clutches), populations in some areas may be suppressed by predation. Changes in land use, management practices, and predator communities interact to depress quail populations over much of the bobwhite range. Recent changes in land use may have made quail more vulnerable to predation (Hurst et al. 1996, Rollins 1999b). Additional studies are needed to assess the role of predation and predation management in light of these landscape-level changes.

Comparing earlier studies (Stoddard 1931:188, Jackson 1952) to more contemporary studies (Frost 1999) suggests that changes have also occurred within populations and communities of various predators that are often implicated in the decline of quail populations. The increasing popularity of feeding deer (*Odocoileus virginianus*) over much of Texas may be 1 factor predisposing greater raccoon (*Procyon lotor*) abundance (Cooper and Ginnett 2000). Such temporal changes in predator populations may be important, especially in light of landscape changes that may make quail more vulnerable to predation (Rollins 1999b).

Fire Ants.—In the southeastern half of Texas, fire ants (*Solenopsis* spp.) have probably received more attention than any other invasive agent for their role (real or perceived) in the demise of quail in that region. A divergence of opinions exists about the absolute importance of fire ants as a mortality factor for bobwhites (Brennan 1993a, Allen et al. 1995, Mueller et al. 1999). Some of these differences may stem from different species of fire ants involved. Earlier studies (Travis 1938) were conducted before the importation of the red imported fire ant (*S. invicta*) which typically occurs at greater mound densities, and is more aggressive than native fire ants (Vinson and Sorenson 1986). Several studies in the Coastal Prairie region of Texas (Allen et al. 1995, Giuliano et al. 1996, Mueller et al. 1999) have identified causal mechanisms resulting in greater chick mortality in areas with high densities of red imported fire ant.

Hunting.—Quail hunting is typically considered to be self regulatory. Hunters spend fewer days afield and have lower success in “poor” years and conversely in “good” years (Peterson and Perez 2000). Peterson and Perez (2000) analyzed bobwhite and scaled quail harvest data in Texas and generally found support for the self-regulating hypothesis. The average Texas quail

hunter in their data set hunted between 2.5–3.0 days regardless of quail abundance. However, a subset of the quail hunter population in Texas (QU members) hunted an average of 15 days in 1999 (D. Rollins, unpublished data).

Quail biologists have argued for at least a decade about the degree to which hunting at various times in the season is additive or compensatory (Roseberry 1979, Brennan and Jacobson 1992). Experiments designed to determine the effect of harvest timing and intensity on the subsequent breeding capital of bobwhites are needed (Brennan 1991, Peterson and Perez 2000).

Two situations in Texas underscore the need for a better understanding of harvest management at finer spatial scales than that practiced by state wildlife agencies. First, the low number of public hunting areas which are heavily hunted, and are likely to field even more hunting pressure (unless changes are made to reduce hunter access) as quail numbers decline in areas farther east. Second, the escalation of land values for quail hunting (i.e., the price of private quail hunting leases) may increase hunting pressure, even during “poor” years (Peterson and Perez 2000).

Landowners in Texas often argue the current season length (about 115 days; usually early Nov through late Feb) is too long, and they believe the TPWD Commission should decrease the season length and/or bag limit. However, Peterson (1999) suggested that minor regulatory changes in season length or bag limit would be inconsequential in terms of reversing declining quail populations. The TPWD’s philosophy is to maximize hunter opportunity (i.e., set a long season) and let individual landowners establish more conservative guidelines as they deem appropriate for their individual properties.

If bobwhite abundance continues to decline in Texas, I predict that the latter third of the season will be curtailed. And I question how long quail seasons will remain open in the eastern third of the state where bobwhite abundance is acutely low. Can hunting mortality be anything less than additive in such locally declining populations?

HABITAT CHANGE

Obvious Trends

Habitat loss in Texas occurs as a result of introduced pastures (e.g., bermudagrass [*Cynodon dactylon*], old world bluestems [*Bothriochloa* spp.]), large-scale brush control, overgrazing, urbanization, and in eastern portions of the state, timber production. Population growth along the Interstate 35 corridor (especially) is having dramatic impacts on former quail habitat (Wilkins et al. 2000). The fragmented habitats that are now the rule east of the 98th meridian bode poorly for bobwhites in Texas, just as they have for much of the southeastern United States.

Historically, the 2 most pervasive practices that have affected quail habitat in the Rolling Plains and South Texas Plains are brush control and overgrazing.

The title of Guthery’s (1986) book, “Beef, Brush, and Bobwhites,” underscored the importance of grazing and brush management for bobwhites in south Texas. Brush and grazing management can be an asset or liability for quail managers.

In my opinion, the ultimate habitat problem in the classical quail country along the eastern Rolling Plains (i.e., east of a line from Abilene to Vernon) is overgrazing. Overgrazing changes the composition (i.e., species diversity) and the structure (fewer tall bunchgrasses) of the vegetation. The novice quail manager sees such sites as awash with good food-producing plants (e.g., western ragweed [*Ambrosia psilostachya*] and doveweed), but food is rarely the limiting factor for bobwhites in this region (Guthery 2000:68).

Quail managers often promote grazing to manipulate plant succession (Guthery 1986:36). But optimal bobwhite habitat in more arid regions calls for higher seral stages than more mesic environs (Spears et al. 1993). The need for heavier stocking to provide adequate bare ground is rarely a problem west of the 98th meridian. Good grazing management that promotes higher successional species is recommended for quail range in most of west and south Texas.

Although the value of a quail hunting lease can equal or surpass the value of a grazing lease in the Rolling Plains and South Texas Plains (D. Rollins, unpublished data), cattle are still king on most quail range in Texas. Much of the quail range suffers from “subsistence ranching,” where high stocking rates and continuous grazing are common. Increasingly, such heavy grazing is exacerbated by federal farm programs (e.g., drought disaster feed programs) that allow high stocking rates to be maintained during drought.

However, attitudes are changing, especially as more ranches are purchased with the goal of increasing quail populations. The importance of quail hunting as a factor driving real estate values in Texas is noncontroversial. Within the last decade, 19% of Texas QU members had purchased property for the primary purpose of hunting quail. If such trends continue, and I believe they will only escalate over the next 10 years, there will be growing interest in the idea of “prescribed grazing,” (i.e., grazing for the purpose of attaining specific habitat management goals) and “undergrazing” (i.e., conservative stocking rates).

Large-scale brush clearing is detrimental to quail habitat. However, the judicious use of brush control can be an excellent tool for managing quail habitats (Guthery 1986:23, Guthery and Rollins 1997). Adoption of a “Brush Sculptor” philosophy (Rollins et al. 1997) (i.e., the planned, selective control of brush to enhance wildlife habitat) is becoming popular throughout west and south Texas. I predict that attention to wildlife habitat needs will indeed shape the present generation of brush contractors and landowners.

Another concern is the increasing attention given to brush control as a means for enhancing watershed yield. During the last 2 legislative sessions, some \$23 million was appropriated for landowners in certain west Texas watersheds to clear brush for the purpose of increasing water yield to rivers and reservoirs. Con-

flicts arise when trying to maximize water goals while sustaining adequate wildlife habitat (Rollins 2000b). Thurow et al. (1997) estimated that >95% of the brush from a given area would need to be removed before substantial increases in water yield could be expected. These thresholds typically exceed the minimum woody cover requirements for bobwhites in this region.

While too much brush control can limit quail habitat, it should be noted that increased density of mesquite (*Prosopis glandulosa*) and junipers (*Juniperus* spp.) can reduce habitat potential for quail. Some sites have simply become too dense with brush to provide usable space for bobwhite and scaled quail. In such areas, the judicious use of appropriate brush control (i.e., brush sculpting) can be an effective tool for habitat managers.

Cryptic Trends

Habitat fragmentation harms quail populations by forcing quail to live in ever smaller parcels of suitable habitat. Accordingly, fragmentation facilitates the quail's enemies (e.g., mesomammals) involved in nest depredation (Rollins and Carroll 2001). Guthery's (1997) "usable space" hypothesis predicts that quail populations are better served by an abundance of habitat ("quantity") than by improving the "quality" of smaller patches. Jackson's (1962) depiction of broomweed in quail irruptions is an example of a periodic pulse in usable space.

I believe that suitable nesting cover is perhaps the single most limiting factor across Texas. My students have used simulated nests to study hatch rates relative to various management practices. Hatch rates tend to be >50% when the number of suitable bunchgrass clumps (e.g., *Schizachyrium scoparium*, *Hilaria mutica*) exceeds about 650/ha (Slater et al. 2001). The manager's goal should be to enhance nesting cover across the landscape, and not just in small "islands" (e.g., 2 ha) of nesting habitat. Lower stocking rates and timely deferments from grazing can be used to improve the availability of good nesting cover.

When discussing cryptic habitat loss, I often cite the Hippocratic oath (i.e., first do no harm) as an axiom for quail managers. Hippocratic management includes those practices that would at first glance appear benign to quail, but may ultimately be liabilities. Examples include (1) the proliferation of deer feeders in Texas, which concentrate egg-eating mesomammals (Cooper and Ginnett 2000, Rollins and Carroll 2001); (2) the proliferation of farm ponds which may fragment prairie landscapes and enhance their habitability by raccoons (Rollins 1999b); and (3) government-subsidized livestock feeding programs during droughts which postpone (or preclude) de-stocking procedures, and ultimately range recovery.

Disease.—Disease is usually dismissed as an issue in wild bobwhite management. However, Rollins (2000a) provided anecdotal evidence that disease may have been involved in the drastic decline of scaled quail across the Rolling Plains in 1988. Scaled quail populations have remained at low levels since that

time. The playa lakes region (High Plains of Texas) harbors ≥ 3 million waterfowl during the winter months, and is occasionally subjected to epizootics of avian cholera.

Another potential disease problem is aflatoxicosis from contaminated "deer" corn. A 1998 study (N. Wilkins, Texas A&M University, unpublished data) found that 44% of the deer corn purchased at various locations ($n = 52$) across Texas contained >20 ppb of aflatoxin, the recommended maximum for consumption by poultry. An estimated 300 million pounds of deer corn were fed in Texas during 1998.

Sociological/Political

"Deermania".—While bobwhites have historically been "charismatic avifauna," the decline of bobwhites over the eastern half of Texas ensures that the "Baby Boomer" generation of Texans (i.e., those born between 1945–55) may be the last to become familiar with the "poor-bob-white" song. A generation of Texas quail hunters and pointing dogs has been replaced with one fascinated by deer feeders and compound bows (especially in east and central Texas). Quail hunter numbers in Texas decreased by 49% from 1981 to 1999 (Texas Parks and Wildlife Department 1999, Adams and Causey 2000). Similarly, quail hunter numbers in Oklahoma decreased 73% from 1967 to 1996 (Crews and DeMaso 2000). Political attention and budget priorities within state wildlife agencies ultimately track user participation rates. Conceivably the demand for deer hunting and management may become pervasive in state wildlife agencies, perhaps ultimately to the atrophy of quail management (Brennan 1993b). Has such a cervid-weighted priority evolved in both Oklahoma and Texas over the last 20 years? One former TPWD Commissioner relayed to me that during his 6-year term on the Commission in the early 1990s, discussion of quail totaled less than a couple of hours. Recent attention to the plight of quail has renewed interest in the species, and may increase research and management efforts directed at quail (Brennan 1999).

Lack of Focus/Coordination.—In many respects, we in the southern plains have been slow to recognize (or admit) that quail populations are in trouble. Some argue whether the "decline" is real, and if so, in which ecological regions populations have declined, and whether such declines are "ecological destiny." Brennan (1999) lamented that quail biologists in the southeastern United States may be "bucking the sun" (i.e., fighting an uphill battle) in attempting to restore bobwhite abundance in that region. Strategic plans like that developed by the Southeast Quail Study Group, and various state quail initiatives (e.g., Georgia and Virginia), are evidence that the battle will continue to be waged.

Quail research in Oklahoma and Texas has been largely disjointed over the last 20 years (or longer). Universities involved with quail research during this period have included major players (Texas A&M [including Texas A&M—Kingsville], Texas Tech Uni-

versity, and Oklahoma State University), smaller universities (e.g., Stephen F. Austin University, Southwest Texas State University), state wildlife agencies (TPWD and Oklahoma Department of Wildlife Conservation), and privately-funded entities (e.g., Caesar Kleberg Wildlife Research Institute, Welder Wildlife Foundation, Samuel Roberts Noble Foundation). Funding mechanisms (i.e., competitive proposals) have tended to isolate, rather than consolidate, research efforts.

STEPS IN THE RIGHT DIRECTION

Research Efforts

Texas would be well served to study the structure and function of the Southeast Quail Study Group, and clone a state version. The size and ecological diversity of the state, plus its strategic importance in the future of wild bobwhites, and economic impact from quail-related recreation suggest that such coordination is overdue. The recent appropriation of a "Quail Decline Initiative" (QDI) in May 2001 provided some seed money to initiate such a planning effort. The recent establishment of endowed quail chairs at Oklahoma State University and the Caesar Kleberg Wildlife Research Institute reflects a growing research interest in quail, and will hopefully provide leadership in developing a more focused, regional, long-range strategic plan. Such efforts need to be replicated at various locations across the state, and conducted for longer time periods than are presently done. A secure funding base for such long-term research interests is needed, and one that could be promoted with full funding of the proposed QDI.

Outreach

Brennan (1991, 1999) identified extension outreach programs as a key component in the effort to reverse the decline of quail. Over the last 10 years, my primary contributions to quail management have been outreach efforts. These include efforts aimed at landowners, game managers, youth, and the general public.

Adult Education.—The increasing importance of quail and quail hunting to the Texas economy has permitted me to spend considerable efforts aimed at landowner education (e.g., field days and workshops). In 1998, I initiated daylong workshops called "Quail Appreciation Days" (QUADs) that focus on appreciating (i.e., judging with heightened awareness) the importance of quail (economic and ecological) and their habitat needs. To date 30 QUADs have been conducted across the western half of Texas. Pre- and post-tests are used to measure information transfer, and post-test scores typically double. Subsequent follow-up analyses are needed to determine how much of the technology learned is applied, and results in sustaining or increasing bobwhite abundance. Efforts are in place in various counties to implement a series of quail estimation indices (e.g., whistle counts, simulated nest surveys) to monitor management effects over time.

Another adult education program was "W.I.L.D. about Quail" (Wildlife Intensive Leadership Development). This program involves a series of 3 ongoing, 2-day workshops to train and equip participants as "master volunteers" who will then help promote quail conservation in their local communities.

Over the years I've had the opportunity to develop productive relationships with various media. Currently, I write weekly or monthly columns for outlets that target ranchers (Livestock Weekly), farmers (Texas Farmer-Stockman), and hunters (Quail Unlimited Magazine). This network is beneficial in (1) delivering timely information targeted for various stakeholders, and (2) cultivating support for quail-related conservation efforts (e.g., QDI). The Internet affords special opportunities, and several excellent web sites provide technical and lay information about quail management.

Youth Education.—Perhaps my most notable contribution to quail management, and certainly my most personally rewarding accomplishment, has been the inception, and success, of the Bobwhite Brigade (Rollins et al. 2000). Initiated in 1993, this week-long "boot camp" on quail management and leadership development has trained ≥ 500 youth (ages 14–17). Students are encouraged to return to their home communities and conduct awareness-level educational programs on quail conservation. To date, $\geq 3,000$ such programs have been conducted. The Bobwhite Brigade has since been replicated in 2 other regions of Texas, and in ≥ 5 other states.

EPILOGUE

The next 10 years promise to be especially exciting, and anxious, times for quail managers in the southern Great Plains. If (as) bobwhite abundance continues to decline in more eastern ranges, the demand for wild bobwhite hunting will undoubtedly sustain, and likely increase, the appetite for those interested in improving quail habitat in Oklahoma and Texas.

I believe that very soon we will see acknowledgment that the quail "tail" is wagging the livestock "dog" as the primary motivation for rangeland ownership in northwest and south Texas, and perhaps western Oklahoma. I am excited about the current hunger for information and technical assistance among both "traditional" ranchers and absentee landowners who purchase properties for recreational use.

I am cautiously optimistic that an "early diagnosis" of the quail decline in the southern plains will permit and promote appropriate therapeutic management. Certainly we can glean much from successes and failures on the research, outreach, and political fronts from our colleagues in the southeastern United States. Efforts will require the coordination and support of state game agencies, universities, landowners, conservation organizations, and an increasingly apathetic public. My optimism is tempered, however, by the rapidly growing population in Texas. As such, the challenge in Texas will be the same as points farther east: how to keep bobwhites on an increasingly fragmented landscape.

If we fail, I for one will lament the plenary session for the next national quail symposium to be held in Texas. I fear the theme will be “what used to be,” and the opening presentation will be “all’s quiet on the western front.” Let us not become complacent lest the quail wave may play itself out on the plains of west Texas.

ACKNOWLEDGMENTS

P. S. Carter, S. C. Slater, F. Hernández, J. Frost, R. J. Buntyn, and E. K. Lyons were graduate students involved in various projects that helped shape my thoughts on quail management. K. A. Cearley and a number of county extension agents have been instrumental in conducting extension programs. The numerous volunteers and cadets associated with the Bobwhite Brigade have been a source of inspiration, as have my bird dogs Suzie and Doc. K. A. Cearley, P. Melton, G. T. Miller, R. Cantu, C. Richardson, and M. Wagner provided helpful review comments.

LITERATURE CITED

- Adams, C. E., and L. A. Causey. 2000. The future of hunting in Texas. Department of Wildlife and Fisheries Sciences, Texas A&M University, College Station.
- Allen, C. R., S. Demarais, and R. L. Lutz. 1995. Red imported fire ants impacts on northern bobwhite populations. *Ecological Applications* 5:632–638.
- Brennan, L. A. 1991. How can we reverse the northern bobwhite population decline? *Wildlife Society Bulletin* 19:544–555.
- Brennan, L. A. 1993a. Fire ants and northern bobwhites: a real problem or a red herring? *Wildlife Society Bulletin* 21:351–355.
- Brennan, L. A. 1993b. Strategic plan for quail management and research in the United States. *Proceedings of the National Quail Symposium* 3:160–169.
- Brennan, L. A. 1999. Current status of the northern bobwhite. Pages 53–58 in K.A. Cearley, ed. *Preserving Texas’ Quail Heritage into the 21st Century*. Texas Agricultural Extension Service, San Angelo.
- Brennan, L. A., and H. A. Jacobson. 1992. Northern bobwhite (*Colinus virginianus*) hunter use of public wildlife areas: the need for proactive management. *Gibier Faune Sauvage* 9:847–858.
- Bridges, A. S., M. J. Peterson, N. J. Silvy, F. E. Smeins, and X. Ben Wu. 2000. Differential effects of weather on regional quail abundance in Texas. *Journal of Wildlife Management* 65:10–18.
- Cain, J. R., S. L. Beasom, L. O. Rowland, and L. D. Rowe. 1982. The effects of varying dietary phosphorus on breeding bobwhites. *Journal of Wildlife Management* 46:1061–1065.
- Cain, J. R., R. J. Lien, and S. L. Beasom. 1987. Phytoestrogen effects on reproductive performance of scaled quail. *Journal of Wildlife Management* 51:198–201.
- Campbell, H., D. K. Martin, P. E. Ferkovich, and B. K. Harris. 1973. Effects of hunting and some other environmental factors on scaled quail in New Mexico. *Wildlife Monograph* 34.
- Cooper, S. M., and T. F. Ginnett. 2000. Potential effects of supplemental feeding of deer on nest predation. *Wildlife Society Bulletin* 28:660–666.
- Crews, A. K., and S. J. DeMaso. 2000. Demographics of quail hunters in Oklahoma. *Proceedings of the National Quail Symposium* 4:219–225.
- Delehanty, D. 2000. Reproductive effort of female mountain quail induced by dietary xanthophyll. *Proceedings of the National Quail Symposium* 4:125.
- Frost, J. 1999. An evaluation of short-term mesomammal control on nesting success and survival of northern bobwhites in west-central Texas. Thesis. Angelo State University, San Angelo, Texas.
- Gould, F. W. 1975. Texas plants: a checklist and ecological summary. Third edition. Texas Agricultural Experiment Station Publication MP-585. Texas A&M University, College Station.
- Giuliano, W. M., and R. S. Lutz. 1993. Quail and rain: what’s the relationship? *Proceedings of the National Quail Symposium* 3:64–68.
- Giuliano, W. M., C. R. Allen, R. S. Lutz, and S. Demarais. 1996. Effects of red imported fire ants on northern bobwhite chicks. *Journal of Wildlife Management* 60:309–313.
- Guthery, F. S. 1986. Beef, brush and bobwhites: quail management in cattle country. Golden Banner Press, Corpus Christi, Texas.
- Guthery, F. S. 1997. A philosophy of habitat management for northern bobwhites. *Journal of Wildlife Management* 61:291–301.
- Guthery, F. S. 2000. On bobwhites. Texas A&M University Press, College Station.
- Guthery, F. S., and D. Rollins. 1997. Sculpting brush for upland game birds. Pages 68–72 in K.A. Cearley, ed. *Preserving Texas’ Quail Heritage into the 21st Century*. Texas Agricultural Extension Service, San Angelo.
- Guthery, F. S., N. D. Forrester, K. R. Nolte, W. E. Cohen, and W. P. Kuvlesky, Jr. 2000. Potential effects of global warming in quail populations. *Proceedings of the National Quail Symposium* 4:198–204.
- Hanselka, C. W., and F. S. Guthery. 1991. Bobwhite quail management in south Texas. Publication B-5005. Texas Agricultural Extension Service. Texas A&M University, College Station.
- Hurst, G. A., L. W. Burger, and B. D. Leopold. 1996. Predation and galliforme recruitment: an old issue revisited. *Transactions North American Wildlife and Natural Resources Conference* 61:62–76.
- Jackson, A. S. 1952. The bobwhite quail in relation to land management in the western Cross Timbers. Federal Aid Project 18-R. Final report. Texas Game, Fish and Oyster Commission, Austin.
- Jackson, A. S. 1962. A pattern to population oscillations of the bobwhite quail in the lower plains grazing ranges of northwest Texas. *Proceedings Southeastern Association Game and Fish Commissioners* 16:120–126.
- Klimstra, W. D. 1982. Bobwhite quail and changing land use. *Proceedings of the National Quail Symposium* 2:1–5.
- Koerth, N. E., and F. S. Guthery. 1991. Water restriction effects on northern bobwhite reproduction. *Journal of Wildlife Management* 55:132–137.
- Lehmann, V. W. 1953. Bobwhite populations and Vitamin A. *Transactions North American Wildlife Conference* 18:199–246.
- Lehmann, V. W. 1984. Bobwhites in the Rio Grande Plain of Texas. Texas A&M University Press, College Station.
- Mueller, J. M., C. B. Dabbert, S. Demarais, and A. R. Forbes. 1999. Northern bobwhite chick mortality caused by red imported fire ants. *Journal of Wildlife Management* 63:1291–1298.
- Peterson, M. J. 1999. Northern bobwhite and scaled quail abundance and harvest regulations in Texas. Page 44 in K.A. Cearley, ed. *Preserving Texas’ Quail Heritage into the 21st Century*. Texas Agricultural Extension Service, San Angelo.
- Peterson, M. J., and R. Perez. 2000. Is quail hunting self regulatory? Northern bobwhite and scaled quail abundance and quail hunting in Texas. *Proceedings of the National Quail Symposium* 4:85–91.
- Rollins, D. 1999a. A pattern to quail irruptions in the Rolling

- Plains of Texas. Pages 33–36 in K.A. Cearley, ed. Preserving Texas' Quail Heritage into the 21st Century. Texas Agricultural Extension Service, San Angelo.
- Rollins, D. 1999b. Is there a place for predator control in quail management? Pages 45–48 in K.A. Cearley, ed. Preserving Texas' Quail Heritage into the 21st Century. Texas Agricultural Extension Service, San Angelo.
- Rollins, D. 2000a. Status, ecology and management of scaled quail in west Texas. Proceedings of the National Quail Symposium 4:165–172.
- Rollins, D. 2000b. Integrating wildlife concerns into brush management designed for watershed enhancement. Pages 38–47 in J. L. Cearley and D. Rollins, eds. Brush, water and wildlife: a compendium of our knowledge. Texas Agricultural Extension Service, San Angelo.
- Rollins, D., D. N. Ueckert, and C. G. Brown, eds. 1997. Brush sculptors. Symposium proceedings. Texas Agricultural Extension Service, San Angelo.
- Rollins, D., D. W. Steinbach, and C. G. Brown. 2000. The Bobwhite Brigade: an innovative approach to wildlife extension education. Proceedings of the National Quail Symposium 4:227–231.
- Rollins, D., and J. C. Carroll. 2001. Predation impacts on northern bobwhite and scaled quail. Wildlife Society Bulletin 29: 39–51.
- Roseberry, J. L. 1979. Bobwhite population responses to exploitation: real and simulated. Journal of Wildlife Management 43:285–305.
- Roseberry, J. L. and W. D. Klimstra. 1984. Population ecology of the bobwhite. Southern Illinois University Press, Carbondale, Illinois.
- Sauer, J. R., J. E. Hines, I. Thomas, J. Fallon, and G. Gough. 2000. The North American Breeding Bird Survey, Results and Analysis 1966–1999. Version 98.1, United States Geological Survey, Patuxent Wildlife Research Center, Laurel, Maryland.
- Slater, S. C., D. Rollins, R. C. Dowler, and C. B. Scott. 2001. *Opuntia*: a prickly paradigm for quail managers in west Texas. Wildlife Society Bulletin 29:713–719.
- Spears, G. S., F. S. Guthery, S. M. Rice, S. J. DeMaso, and B. Zaiglin. 1993. Optimum seral stage for northern bobwhites as influenced by site productivity. Journal of Wildlife Management 57:805–811.
- Stoddard, H. L. 1931. The bobwhite quail: its habits, preservation and increase. Charles Scribner's Sons, New York, New York.
- Texas Parks and Wildlife Department. 1999. Small game harvest survey results 1981–82 thru 1998–99. Texas Parks and Wildlife Department, Austin.
- Texas Parks and Wildlife Department. 2000. Quail forecast 2000–2001. <http://www.tpwd.state.tx.us/hunt/regs/quail/>
- Thurow, T. L., A. P. Thurow, C. A. Taylor, Jr., J. R. Conner, and M. Garriga. 1997. Environmental and economic tradeoffs associated with vegetation management on the Edwards Plateau. Pages 3–10 in C. A. Taylor, Jr., ed. Proceedings Juniper Symposium. Texas A&M Research and Extension Center Publication 97-1. San Angelo.
- Travis, B. V. 1938. The fire ant (*Solenopsis* spp.) as a pest for quail. Journal of Economic Entomology 31:649–652.
- Vinson, S. B., and A. A. Sorenson. 1986. Imported fire ants: life history and impact. Texas Department of Agriculture, Austin.
- Wilkins, N., R. D. Brown, R. J. Conner, J. Engle, C. Gilliland, A. Hays, R. D. Slack, and D. W. Steinbach. 2000. Fragmented lands: changing land ownership in Texas. Publication MKT-3443. Texas Agricultural Extension Service, College Station.

COYOTES: FRIEND OR FOE OF NORTHERN BOBWHITE IN SOUTHERN TEXAS

Scott E. Henke

Caesar Kleberg Wildlife Research Institute, Texas A&M University-Kingsville, Kingsville, TX 78363, USA

ABSTRACT

Food habits of 407 coyotes (*Canis latrans*), intermittently collected in southern Texas from March 1994 to January 1997, were determined from coyote stomachs. Mammalian prey was the most prevalent diet item as calculated by frequency of occurrence and aggregate percent methods, followed by insects, vegetation, birds, and reptiles. The remains of northern bobwhite (*Colinus virginianus*) or their eggs were found in only 12 coyote stomachs, which constituted <1% of the coyote diet as calculated by the aggregate percent method. Northern bobwhite appear to be an incidental prey item for coyotes in southern Texas. Therefore, coyote removal programs designed to lessen quail depredation appear unwarranted.

Citation: Henke, S. E. 2002. Coyotes: Friend or foe of northern bobwhite in southern Texas. Pages 57–60 in S. J. DeMaso, W. P. Kuvlesky, Jr., F. Hernández, and M. E. Berger, eds. Quail V: Proceedings of the Fifth National Quail Symposium. Texas Parks and Wildlife Department, Austin, TX.

Key words: *Canis latrans*, *Colinus virginianus*, coyote, depredation, food habits, northern bobwhite, Texas

INTRODUCTION

Northern bobwhite populations have been declining throughout most of their range and there is concern that bobwhites could be extirpated in the southeastern United States by 2005 (Brennan 1991). Depredation has been reported as the major source of mortality for bobwhites at every life stage (Rollins and Carroll 2001). Coyotes are typically listed among the common predators of bobwhite and their eggs (Beasom 1974, Lehmann 1984:190, Guthery 1995, Hernández et al. 1997, Rollins and Carroll 2001, Wallace 2001).

Coyotes are opportunistic and generalist predators (MacCracken and Hansen 1987) and their diet often differs widely from one area to another (Bekoff 1977). In an extensive literature review of diet across 17 western states, coyote diets averaged 33% lagomorph, 25% carrion, 18% rodent, and 13.5% domestic livestock (Sperry 1941). However, Lehmann (1946) reported that 37% ($n = 14$) of the coyote diet during spring and summer in southern Texas consisted of bobwhites and their eggs. Lehmann (1946) concluded that coyotes were the primary predator of bobwhite nests in southern Texas; however, his sample sizes were too small to generate little confidence in that conclusion.

My objective was to report coyote food habits from a large sample ($n = 407$) of coyotes collected in southern Texas. The coyotes used for this report were collected for other research projects.

STUDY AREAS

Coyotes were collected on 7 ranches in southern Texas, which included the Santa Gertrudis Division of the King Ranch (Kleberg Co.), the Callaghan Ranch (Webb Co.), La Mesa Ranch (Webb Co.), Heard Ranch

(Webb Co.), Duval Ranch (Duval Co.), Cameron Ranch (La Salle Co.), and La Campana Ranch (McMullen Co.). All collection areas consisted of privately owned rangeland used primarily for cattle and oil production.

Mean annual rainfall for southern Texas is 40–90 cm, increasing from west to east. Temperatures range from 8° C in January to 38° C in July. During the collection period the area experienced average rainfall and temperatures, with 1995 being slightly wetter than average and 1996 being dryer than average (http://climate.tamu.edu/bclimate-DQ/station_sel/station_nameA.html).

Originally the region supported a grassland-savannah climax community (Fulbright 2001), but grazing, suppression of fire, and other factors have resulted in plant communities dominated by dense stands of honey mesquite (*Prosopis glandulosa*), blackbrush (*Acacia rigidula*), Texas prickly pear (*Opuntia lindheimeri*), whitebrush (*Aloysia lycioides*), and spiny hackberry (*Celtis pallida*). Potential prey items for coyotes on the study areas included white-tailed deer (*Odocoileus virginianus*), javelina (*Tayassu tajacu*), raccoon (*Procyon lotor*), striped skunk (*Mephitis mephitis*), opossum (*Didelphis virginiana*), armadillo (*Dasyurus novemcinctus*), eastern cottontail (*Sylvilagus floridanus*), black-tailed jackrabbit (*Lepus californicus*), eastern woodrat (*Neotoma floridanus*), hispid cottontail rat (*Sigmodon hispidus*), hispid pocket mouse (*Chaetodipus hispidus*), Ord's kangaroo rat (*Dipodomys ordii*), fulvous harvest mouse (*Reithrodontomys fulvescens*), deer mouse (*Peromyscus maniculatus*), white-footed mouse (*Peromyscus leucopus*), domestic cattle (*Bos* sp.), northern bobwhite, greater roadrunner (*Geococcyx californianus*), prickly pear fruit, mesquite beans, and a variety of songbirds, reptiles, and insects.

Table 1. Percent of coyote stomachs (i.e., frequency of occurrence) that contained the diet item, analyzed from coyotes collected in southern Texas during 1994–1997.

Diet item ¹	Collection date				Total (n = 407)
	Mar 1994 (n = 200)	Jul 1995 (n = 98)	Oct 1997 (n = 42)	Jan 1997 (n = 67)	
Rodent	41.5 ²	9.2	9.5	41.8	30.5
Lagomorph	32.0	14.3	11.9	34.3	26.0
Insect	0.0	59.2	45.2	0.0	18.9
Vegetation	8.0	37.8	28.6	0.0	16.0
Misc. bird (Bobwhites)	3.0 (3.0)	7.1 (3.1)	11.9 (2.4)	9.0 (3.0)	5.9 (2.9)
Livestock	1.5	6.1	4.8	10.4	4.4
Misc. reptile	0.0	7.1	19.0	0.0	3.7
Misc. mammal	0.5	6.1	4.8	3.0	2.7
White-tailed deer	0.0	8.2	0.0	0.0	2.0
Empty	15.5	10.2	14.3	13.4	13.8
Mean no. of diet items/stomach	1.0	1.6	1.5	1.1	1.2

¹ Common diet items found in coyote stomachs consisted of Ord's kangaroo rats, cotton rats, woodrats, hispid pocket mice, black-tailed jackrabbits, eastern cottontails, grasshoppers and beetles within the Families Locustidae and Carabidae, respectively, mesquite beans, prickly pear fruit, Texas persimmons, agarito barberries, acorns, livestock, northern bobwhites, roadrunners, sandhill cranes, ravens, skunks, armadillos, 6-lined racers, and bullsnakes.

² Proportion of stomachs that contained the diet item as calculated from the number of stomachs that contained the diet item/number of stomachs examined.

METHODS

Coyotes were collected by aerial and ground hunting during March 1994, July 1995, January 1997, and October 1997. Coyotes were field necropsied, their stomachs excised and kept on wet ice until they could be frozen at -23°C .

In the laboratory, each stomach was thawed and the contents were emptied into a shallow pan for examination. Stomach samples were analyzed by both the frequency of occurrence method (Andelt 1985) and the percent occurrence method (Chamrad and Box 1964). In short, frequency of occurrence was calculated as the proportion of stomachs that contained a particular food item. The overall frequency of occurrence can sum to $>100\%$ because coyote stomachs often contain multiple prey items. Percent occurrence was determined using a 100-point frame (Chamrad and Box 1964, Johnson and Hansen 1977). Food items from each sample (one sample = contents of one stomach) were spread onto the frame and 100 random points were selected. Each food item that lay on or closest to each of the 100 random points was identified. Reference samples of available foods from the study areas were used to identify individual food items. Hair was identified to species following Stains (1958) and seeds were identified according to Martin and Barkley (1961).

Due to differential digestibility of food items, coyote food habits are reported by the percent occurrence and frequency of occurrence methods. This is because the importance of common but highly digestible foods (e.g., grasshoppers) often are underestimated in the diet by percent occurrence method alone. Frequency of occurrence data are expressed as the proportion of coyote stomachs that contained a particular food item. Data for percent occurrence is expressed as an aggregate percent due to stomachs of varying weights (Litvaitis et al. 1994). An analysis of seasonal effects on coyote food habits was not performed because of po-

tential confounding effects; seasonal coyote collection did not occur during the same year (i.e., year effects) and specimens were not consistently collected from each ranch each season (i.e., area effects).

RESULTS

Four hundred and seven coyote stomachs were analyzed, of which 56 were empty (Table 1). The number of stomachs analyzed from each collection period was 200, 98, 67, and 42 for March 1994, July 1995, January 1997, and October 1997, respectively.

Mammalian prey, insects, and vegetation comprised nearly 96% of the diet of coyotes from southern Texas. Expressing the diet by the aggregate percent method, lagomorphs (26.6%) and rodents (26.2%) comprised the majority of the diet of coyotes, followed by insects (16.3%), vegetation (11.6%), white-tailed deer fawns (6.7%), livestock (6.3%), miscellaneous birds (3.4%), miscellaneous mammals (1.8%), and miscellaneous reptiles (1.1%). Of the miscellaneous birds, northern bobwhites and their eggs comprised only 0.9% of the coyote diet by the aggregate percent method. Only 12 of the 407 coyote stomachs contained northern bobwhite or their eggs (Table 1).

Black-tailed jackrabbits and eastern cottontail rabbits comprised the lagomorph category, while Ord's kangaroo rats, cotton rats, woodrats, and hispid pocket mice were the most common rodent species identified. Grasshoppers and beetles in the Families Locustidae and Carabidae, respectively, were the common insects found in the stomachs. Mesquite beans, prickly pear fruit, Texas persimmon (*Diospyros texana*), agarito barberry (*Berberis trifoliolata*), and acorns (*Quercus* sp.) comprised the majority of plant material eaten by coyotes. Livestock (i.e., cattle) remains as carrion in coyote stomachs could not be distinguished from live-killed animals. Bird species found in coyote stomachs were northern bobwhites, roadrunners, sandhill cranes

(*Grus canadensis*), and ravens (*Corvus cryptoleucus*). The miscellaneous mammal group consisted of skunk and armadillo, while the miscellaneous reptiles were 6-lined racers (*Cnemidophorus sexlineatus*) and a bullsnake (*Pituophis melanoleucus*).

DISCUSSION

Northern bobwhites were not a major prey item of coyotes in southern Texas. These findings are consistent with numerous other reports of coyote food habits throughout the United States. Evidence of bobwhite depredation was found in 1.4% of 770 coyote stomachs in Missouri (Korschgen 1957), 2.0% of 168 stomachs in Arkansas (Gipson 1974), 0.2% by volume in 514 scats from Texas (Meinzer et al. 1975), and 0.6% of 311 stomachs and scats from Mississippi and Alabama (Wooding et al. 1984). In other studies where diet items were placed in broader categories than in this paper, birds constituted only 1% of the coyote diet in 6,354 scats from southern Texas (Andelt et al. 1987), 2.4% of the diet in 1,042 scats from California (Barrett 1983), 2.5% of the diet in 831 scats from Idaho (Johnson and Hansen 1979), and 2.0% of prey found in 208 scats from South Dakota (MacCracken and Uresk 1984).

The obvious question is why the seemingly disparate results between Lehmann's (1946) research and more recent studies? I believe the answer was given by Guthery (1995) who stated that Lehmann's (1946) results were biased because of inappropriate statistical procedures. In addition, Lehmann (1946) reported results from a small sample size and relied on circumstantial evidence to determine the species of nest predator. Hernández et al. (1997) demonstrated that the *modus operandi* of nest predators is too similar between several species to confidently distinguish one predator from another based only on nest debris and egg shell fragments.

Often, predator control is suggested as a means to increase production and survival of northern bobwhites (Lehmann 1984:190–196, Reynolds and Tapper 1996, Rollins 1999). However, the results of this study provide evidence that such practices against coyotes will not increase bobwhite populations. Although coyotes may occasionally eat bobwhites or their eggs, there is no evidence that such levels of predation negatively influence the population dynamics of northern bobwhites.

In fact, it is possible that coyotes may inadvertently aid northern bobwhites by reducing the numbers of more serious quail predators. Removal of coyotes can cause a phenomenon known as mesopredator release (Henke and Bryant 1999); an increase in the abundance of smaller-sized (i.e., meso) predators such as raccoons, skunks, badgers (*Taxidea taxus*), gray foxes (*Urocyon cinereoargenteus*), and bobcats (*Lynx rufus*) with the removal of a dominant predator. Henke and Bryant (1999) demonstrated an increase in mesopredator abundance after just 1 year of a seasonal coyote removal program. In at least 1 instance meso-

predators were considered more efficient nest predators of northern bobwhites than coyotes (Hernández et al. 1997). Sovada et al. (1995) reported that coyote removal led to a greater abundance of red foxes (*Vulpes vulpes*), which resulted in a greater loss of waterfowl production in the Prairie Pothole region. The possibility of a greater loss of bobwhite production to mesopredators could exist in southern Texas with the implementation of coyote removal. Therefore the benefit of coyotes to bobwhites may actually outweigh the occasional loss of birds to coyotes by depredation.

ACKNOWLEDGMENTS

I thank the Texas Department of Health and the Texas Wildlife Damage Management Services for personnel to assist with coyote collections, and S. C. Farry, C. L. Kerr, and M. Perez for assistance in coyote collection and necropsy. Thanks also are extended to P. Robertson, S. DeMaso, and W. Kuvlesky for comments on an earlier draft of this manuscript. This is publication no. 02-104 of the Caesar Kleberg Wildlife Research Institute.

LITERATURE CITED

- Andelt, W. F. 1985. Behavioral ecology of coyotes in south Texas. Wildlife Monographs 94.
- Andelt, W. F., J. G. Kie, F. F. Knowlton, and K. Cardwell. 1987. Variation in coyote diets associated with season and successional changes in vegetation. Journal of Wildlife Management 51:273–277.
- Barrett, R. H. 1983. Food habits of coyotes, *Canis latrans*, in eastern Tehama County, California. California Fish and Game 69:184–196.
- Beasom, S. L. 1974. Intensive short-term predator removal as a game management tool. Transactions of the North American Wildlife and Natural Resources Conference 39:230–240.
- Bekoff, M. 1977. The coyote, *Canis latrans*. Mammalian Species 79:1–9.
- Brennan, L. A. 1991. How can we reverse the northern bobwhite population decline? Wildlife Society Bulletin 19:544–555.
- Chamrad, A. D., and T. W. Box. 1964. A point frame for sampling rumen contents. Journal of Wildlife Management 28:473–477.
- Fulbright, T. E. 2001. Human-induced vegetation changes in the Tamaulipan scrub of La Frontera. Pages 166–175 in G. L. Webster and C. J. Bahre, eds. Changing plant life of La Frontera. University of New Mexico Press, Albuquerque.
- Gipson, P. S. 1974. Food habits of coyotes in Arkansas. Journal of Wildlife Management 38:848–853.
- Guthery, F. S. 1995. Coyotes and upland gamebirds. Pages 104–107 in D. Rollins, C. Richardson, T. Blankenship, K. Canon, and S. E. Henke, eds. Coyotes in the southwest: a compendium of our knowledge. Texas Parks and Wildlife Department, Austin.
- Henke, S. E., and F. C. Bryant. 1999. Effect of coyote removal on the faunal community in western Texas. Journal of Wildlife Management 63:1066–1081.
- Hernández, F., D. Rollins, and R. Cantu. 1997. Evaluating evidence to identify ground-nest predators in west Texas. Wildlife Society Bulletin 25:826–831.
- Johnson, M. K., and R. M. Hansen. 1977. Comparison of point frame and hand separation of coyote scats. Journal of Wildlife Management 41:319–320.
- Johnson, M. K., and R. M. Hansen. 1979. Coyote food habits

- on the Idaho National Engineering Laboratory. *Journal of Wildlife Management* 43:951–956.
- Korschgen, L. J. 1957. Food habits of the coyote in Missouri. *Journal of Wildlife Management* 21:424–435.
- Lehmann, V. W. 1946. Bobwhite quail reproduction in southwestern Texas. *Journal of Wildlife Management* 10:111–123.
- Lehmann, V. W. 1984. Bobwhites in the Rio Grande Plain of Texas. Texas A&M University Press, College Station.
- Litvaitis, J. A., K. Titus, and E. M. Anderson. 1994. Measuring vertebrate use of terrestrial habitats and foods. Pages 254–274 in T. A. Bookhout, ed. *Research and management techniques for wildlife and habitats*. The Wildlife Society, Bethesda, Maryland.
- MacCracken, J. G., and D. W. Uresk. 1984. Coyote foods in the Black Hills, South Dakota. *Journal of Wildlife Management* 48:1420–1423.
- MacCracken, J. G., and R. M. Hansen. 1987. Coyote feeding strategies in southeastern Idaho: optimal foraging by an opportunistic predator? *Journal of Wildlife Management* 51:278–285.
- Martin, A. C., and W. D. Barkley. 1961. *Seed identification manual*. University of California Press, Berkeley and Los Angeles.
- Meinzer, W. P., D. N. Ueckert, and J. T. Flinders. 1975. Food niche of coyotes in the Rolling Plains of Texas. *Journal of Range Management* 28:22–27.
- Reynolds, J. C., and S. C. Tapper. 1996. Control of mammalian predators in game management and conservation. *Mammalian Review* 26:127–156.
- Rollins, D. 1999. Is there a place for predator control in quail management? Pages 45–48 in K. A. Cearley, editor. *Preserving Texas' quail heritage into the 21st century*. Texas Agriculture Extension Service, Abilene, Texas.
- Rollins, D., and J. P. Carroll. 2001. Impacts of predation on quail. Pages 84–101 in T. F. Ginnett and S. E. Henke, eds. *The role of predator control as a tool in game management*. Texas Agricultural Extension Service, San Angelo, Texas.
- Sovada, M. A., A. B. Sargeant, and J. W. Grier. 1995. Differential effects of coyotes and red foxes on duck nest success. *Journal of Wildlife Management* 59:1–9.
- Sperry, C. C. 1941. Food habits of the coyote. United States Department of Interior, Fish & Wildlife Service Research Bulletin 4, Washington, D. C.
- Stains, H. J. 1958. Field key to guard hair of middle western furbearers. *Journal of Wildlife Management* 22:95–97.
- Wallace M. C. 2001. Turkey, quail, and predators in the Rolling Plains, Texas. Pages 139–143 in T. F. Ginnett and S. E. Henke, eds. *The role of predator control as a tool in game management*. Texas Agricultural Extension Service, San Angelo, Texas.
- Wooding, J. B., E. P. Hill, and P. W. Sumner. 1984. Coyote food habits in Mississippi and Alabama. *Proceedings of the Southeastern Association of Fish and Wildlife Agencies* 38:126–133.

MACROHABITAT COMPOSITION SURROUNDING SUCCESSFUL AND DEPREDATED NORTHERN BOBWHITE NESTS

Eric L. Staller¹

Daniel B. Warnell School of Forest Resources, University of Georgia, Athens, GA 30605, USA

William E. Palmer

Tall Timbers Research Station, 13093 Henry Beadel Drive, Tallahassee, FL 32312, USA

John P. Carroll

Daniel B. Warnell School of Forest Resources, University of Georgia, Athens, GA 30605, USA

ABSTRACT

Relationships among macrohabitat and depredation of northern bobwhite (*Colinus virginianus*) nests are poorly understood. Yet, macrohabitat composition may influence the nest predator community and, therefore, the vulnerability of northern bobwhite nests to depredation. We determined if macrohabitat composition surrounding bobwhite nests influenced nest placement, nest success, and which predators were responsible for depredating nests. We characterized macrohabitats at 2 scales, 8 and 16 ha, by surrounding both bobwhite nests, and an equal number of random locations, with a circular buffer. Random points were placed within the area used by bobwhites on our study area. We then determined the acreage of each macrohabitat category within each circular buffer to determine the macrohabitat composition. Macrohabitat categories included hardwood forested drains, upland pine forests burned in March of the same calendar year, upland pine forests burned in March of the previous calendar year, and fields. We documented nest predators using infrared video cameras placed at the nest site. We monitored 104 bobwhite nests on Tall Timbers Research Station (TTRS) during 1999 and 2000. Size of the circular buffer around nests did not qualitatively affect results. Area (ha) of upland pine forests and fields were similar at depredated nests, hatched nests, and random locations. However, there was an average of 81% and 56% more area of hardwood drain in the circular buffers associated with random locations than at successful and depredated nests, respectively. Area of upland pine forests and fields were similar for nests depredated by raccoon (*Procyon lotor*), armadillo (*Dasypus novemcinctus*) and snake (*Elaphus* spp.). However, there was an average of 6.1 and 3.3 times more area of hardwood drain surrounding nests that were depredated by snakes relative to nests depredated by raccoons and armadillos, respectively. While our sample sizes were low, bobwhites exhibited a tendency to place nests in landscapes with less hardwood drain than were generally available on the study area. Macrohabitat surrounding nests influenced the type of nest predator to depredate nests. To minimize depredation of bobwhite nests by snakes, we suggest nesting cover should be developed away from drain edges.

Citation: Staller, E. L., W. E. Palmer, and J. P. Carroll. 2002. Macrohabitat composition surrounding successful and depredated northern bobwhite quail nests. Pages 61–64 in S. J. DeMaso, W. P. Kuvlesky, Jr., F. Hernández, and M. E. Berger, eds. Quail V: Proceedings of the Fifth National Quail Symposium. Texas Parks and Wildlife Department, Austin, TX.

Key words: *Colinus virginianus*, macrohabitat, nest predators, nesting success, northern bobwhite, Tall Timbers Research Station, video

INTRODUCTION

Since the 1960s bobwhite populations in the Southeast have declined by 70% (Brennan 1991, Church et al. 1993). Year-round habitat needs of bobwhites have been well documented (Brennan 1999). However, bobwhite-nest predator interactions and the effects of nesting macrohabitat composition on the vulnerability of nest location to depredation needs further research (Rollins and Carroll 2001).

Nest depredation may limit bobwhite densities (Errington and Stoddard 1938) as in other game birds (Newton 1998:247). In many bird species, depredation is the major cause of egg and chick losses, commonly accounting for around half of all nesting attempts and more than 80% of all nest failures (Nice 1937, Lack 1954, Ricklefs 1969, Martin 1991). The effect of ma-

crohabitat composition on nest vulnerability and depredation rates is poorly understood. Yet, suitability of a nest site for bobwhites may depend on macrohabitat composition. Despite years of locating bobwhite nests using telemetry, identification of nest predators at depredated nests has been problematic and likely inaccurate (Fies and Puckett 1999, Larviere 1999, Pietz and Granfors 2000). With the advent of infrared, continuous video cameras, accurate identification of predators is now possible (Staller 2001).

Using this new technology, we compared macrohabitat composition surrounding nest sites to determine if certain macrohabitats predisposed nests to depredation by different nest predators. We also compared macrohabitats surrounding bobwhite nests to random locations to assess if bobwhites were selecting for particular macrohabitats on our study area. We hoped that this information would provide ideas for reducing nest depredation through habitat management.

¹ Current address: Tall Timbers Research Station, 13093 Henry Beadel Drive, Tallahassee, FL 32312

METHODS

Study Site

Tall Timbers Research Station is located in the Red Hills region of the Gulf Coastal Plain in Florida and Georgia. Tall Timbers Research Station is approximately 1,568 ha in size, and is dominated by short leaf (*Pinus echinata*) and loblolly pine (*P. taeda*). Intermixed throughout the study site are narrow hardwood drains and large hammocks (27.5% of the area). Fields (7.9% of area), 0.4–1.2 ha in size, are maintained with annual disking. Early fall bobwhite densities, based on fall covey call counts, were about 1.8 and 2.2 birds/ha, during 1999 and 2000, respectively. Management for TTRS consists of prescribed burning, mowing, roller chopping, and disking. Mammalian predators have not been removed since 1990.

Camera System Design

The video camera system consisted of a model N9C2 Fieldcam™ LRTV Microcam™ with a 3.7 mm wide-angle lens and a 6 array LED at 950 nm (Furman Diversified Inc. 2912 Bayport Blvd. Seabrook, TX 77586). Natural sunlight, as well as an auxiliary 36-array LED infrared illumination system at 950 nm, provided light for 24-hour surveillance. The Fieldcam™ and illumination system was supported on a camouflaged articulating arm clamped to a wooden stake, and was connected to a VHS time-lapse video recorder that recorded 20 fields per second. A Tote™ LCD 410 field and setup monitor allowed technicians to view the nest while setting up the system. A 225-reserve capacity Marine Source™ deep cycle battery powered the entire system.

Data Collection

Land cover maps were created from aerial imagery and GPS using Arc View. Macrohabitat categories included pine forests burned in March of the same calendar year (hereafter, burned pine), pine forests burned in March of the previous calendar year (hereafter, unburned pine), hardwood forested drains (hereafter, drain), fields, roads, wetlands, and manicured areas. Edges of drains were mapped using GPS.

Approximately 100 bobwhites were captured January–April, 1999–2000, on an 1,100 ha area of TTRS using “walk in” funnel-traps (Smith et al. 1981), baited with cracked corn. We classified bobwhites by sex and age, banded, and weighed them, and released them at the capture site. Trapping, handling and marking procedures were consistent with the guidelines in the American Ornithologists’ Union Report of Committee on Use of Wild Birds in Research (American Ornithologists’ Union 1988), and those of the University of Georgia, Institutional Animal Care and Use Committee, permit # A34337-01. A sample of birds ≥ 150 g were fitted with 6.4–6.9 g necklace radio transmitters (American Wildlife Enterprises, 493 Beaver Lake Rd. Tallahassee, FL 32312).

To locate nests, bobwhites were located daily us-

ing telemetry homing techniques (White and Garrott 1990). Telemetry equipment consisted of a 3-element, directional, hand-held, yagi antenna and portable receivers. When nests were located, we plotted the location on a land cover map, and monitored nest fates using 6 and 13 infrared surveillance cameras in 1999 and 2000 field seasons, respectively.

Cameras were set approximately 1.5 m from bobwhite nests when the incubating adult was away from the nest. We attempted to minimize modifying vegetation near the nest location. Thirty meters of cable connected the camera to the VHS-recording unit. All cables were laid flat on the ground and did not cross a likely predator travel route (e.g., firebreak, field edge, or road). The camera arm, lens, and recording unit were completely camouflaged in order to conceal the equipment. During the 2000 field season, we checked the incubating bobwhite every 1–2 hours after placing the camera at the nest site. If the bobwhite was in the near vicinity, but had not resumed incubation within 4–6 hours the camera was moved farther from the nest and set at an angle to the entrance to minimize disturbance to the incubating bobwhite. Every 24-hours a technician retrieved the previous day’s tape, and replaced the battery. The last 2 minutes of the VHS-tapes were viewed daily to ensure the camera had not been moved by weather or animal contact. All tapes were ultimately reviewed to gather pertinent data.

Data Analysis

Nests were categorized as hatched or depredated. We did not include nests that were depredated by ≥ 1 predator in our analysis. We also limited our comparisons to nests depredated by raccoons, armadillos, and snakes because of small sample sizes associated with the other depredating species.

Random locations were generated in Arc View using a random points theme that placed the points on the study area map. Nest locations were digitized onto our study area map. Habitat categories included in the analysis were burned and unburned pines, drains, and fields.

At random and nest locations, we added 8-ha and 16-ha circular buffers. Buffer size was based on the home ranges of bobwhites at our study site. Macrohabitat categories and macrohabitat compositions were determined using a clip polygon theme in Arc View. Mean area (ha) and 95% confidence intervals of each macrohabitat category were calculated for each nest and random location. Due to low sample sizes, we presented area means and an approximate 95% confidence intervals ($2 \times SE$) in graphical format rather than applying parametric statistics.

RESULTS

We monitored the outcome of 30 bobwhite nests on TTRS during 1999. The 30 events consisted of: 10 hatches (33.3%), 14 depredations (46.7%), and 6 nest abandonments (20%). The 14 depredations consisted of 12 documented depredations and 2 unrecorded depredations due to camera failure.

NESTING HABITAT AND PREDATORS

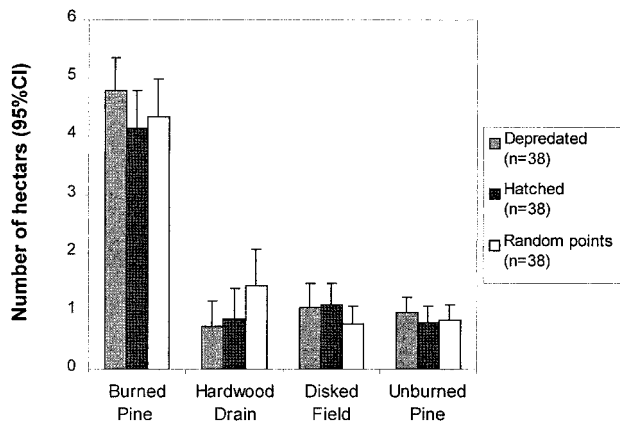

Fig. 1. Mean hectares and 95% CI for 8-ha areas around depredated bobwhite nests, hatched bobwhite nests, and random points on Tall Timbers Research Station, Leon County, Florida during 1999 and 2000.

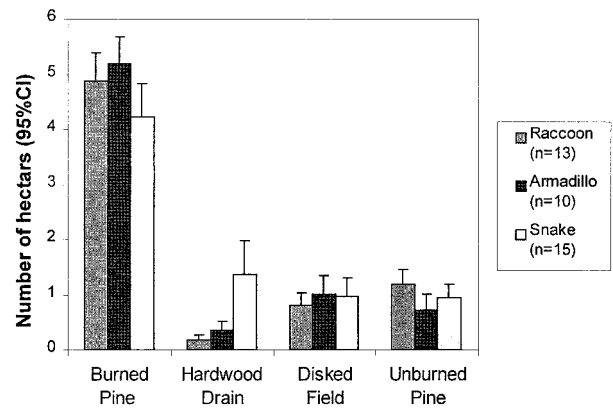

Fig. 3. Mean hectares and 95% CI for 8-ha areas around raccoon, armadillo, and snake depredated bobwhite nests on Tall Timbers Research Station, Leon County, Florida during 1999 and 2000.

During 2000, we monitored the outcome of 74 bobwhite nests at TTRS. We documented 74 events, including 41 hatches (55.4%), 31 depredations (41.9%), and 2 nest abandonments (2.7%).

Predator Identification

Individual predators were identified to species (mammals) or genus (snakes) on 58 occasions at 45 depredated nests during the 1999-00 field seasons. Thirty-eight of the 45 depredated nests were depredated by one predator, including; 15 rat snake, 13 raccoon, and 10 armadillo depredations. These 38 depredations were used to compare macrohabitat composition.

Habitat Characteristics

There was no qualitative difference between macrohabitat compositions of areas surrounding nests at the 8-ha and 16-ha scales. Therefore, results for each buffer size were averaged for presentation in text. At the 8-ha and 16-ha scales, proportions of burned pine, unburned pine, and fields were similar for depredated nests, hatched nests, and for random locations (Figs.

1, 2). However, random locations had an average of 81% and 56% more drain than hatched and depredated nests, respectively.

At the 8-ha and 16-ha scales, areas of burned pine, unburned pine, and fields were similar for bobwhite nests depredated by raccoons and armadillos, although nests depredated by snakes were surrounded by slightly less area of burned pine (Figs. 3, 4). Nests depredated by snakes were surrounded by 6.1 and 3.3 times more area of drain compared to nests depredated by raccoons and armadillos, respectively. Relative to amount of drain surrounding all nests, nests depredated by raccoons, armadillos and snakes were surrounded by 0.3, 0.5, and 1.6 times the amount of drain, respectively. Relative to the amount of drain surrounding random locations, nests depredated by raccoons, armadillos, and snakes were surrounded by 0.2, 0.3, and 1.0 times the amount of drain, respectively.

DISCUSSION

While our sample size was low, our data suggest that bobwhites selected nesting landscapes with less

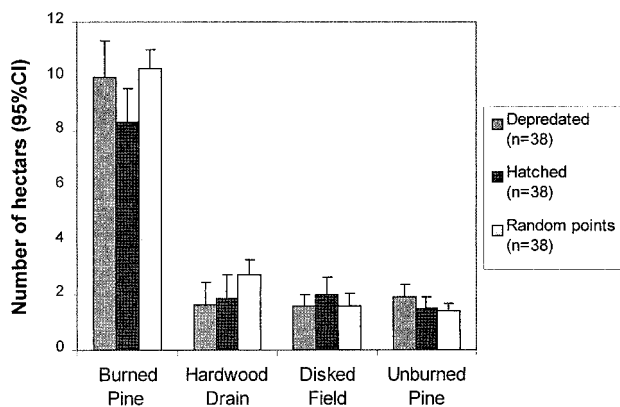

Fig. 2. Mean hectares and 95% CI for 16-ha areas around depredated bobwhite nests, hatched bobwhite nests, and random points on Tall Timbers Research Station, Leon County, Florida during 1999 and 2000.

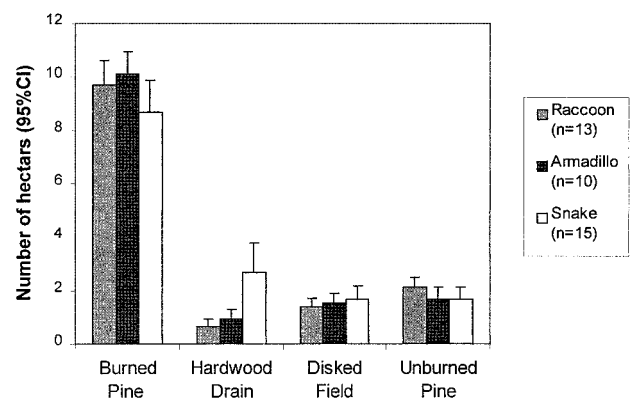

Fig. 4. Mean hectares and 95% CI for 16-ha areas around raccoon, armadillo, and snake depredated bobwhite nests on Tall Timbers Research Station, Leon County, Florida during 1999 and 2000.

drain than generally available on the study area. Although not suspected to be the case, our data may be biased if a greater proportion of nests located near or in drains were depredated during the laying period than nests located in upland sites. This is because incubation of a nest by a radiomarked bobwhite was necessary for us to find nests. Therefore, the apparent distribution of nests on TTRS may have been a function of depredation and macrohabitat composition, rather than the latter alone.

Differences in macrohabitat composition among hatched and depredated nests, and all nests and random locations, were minor. This suggests bobwhites on TTRS were not selecting nesting areas based on specific macrohabitat compositions, but were selecting nesting areas in proportion to the available macrohabitat categories. Microhabitat composition of the ground story likely predominates in the selection of a nest site by a bobwhite (Taylor et al. 1999). On TTRS, suitable ground cover vegetation for bobwhite nesting existed regardless of the macrohabitat composition. Another reason for the minor differences found between macrohabitat composition from nest and random locations was because random locations were based on sampled bobwhite nests, second order selection had likely already occurred (Johnson 1980).

Lack of differences between macrohabitat composition of depredated and hatched nests suggests that, overall, success of a nest was not greatly influenced by macrohabitat composition. This is reasonable, given that the nest predators in our study area have relatively generalist habitat needs and diets. One exception to the lack of differences in macrohabitat composition between nests was the apparent differences between macrohabitat composition surrounding nests depredated by snakes versus armadillos and raccoons. Nests depredated by snakes had more drain than other predators and all nest sites. This suggests that gray rat snakes were either more successful at finding bobwhite nests associated with drains, or that mammals foraged more in the upland pine forests and gray rat snakes foraged more in upland pine forests near drains. In Mississippi, Burger and Richardson (1999) found that gray rat snakes preferred upland hardwood patches in an upland pine matrix, which supports the idea that on TTRS gray rat snakes foraged near drains. From 1997–1999, most invasive hardwoods were removed from upland pine areas, suggesting that TTRS may have reduced the rat snake habitat in the uplands, and hence they were associated more with hardwoods in drains.

CONCLUSION

Our results are preliminary, however we suggest managers create nesting habitat away from hardwood drains running through upland pine forests. On our study area, this would be possible by maintaining more of an annual forb community along drains by annual burning, rather than burning on a 2 or 3 year cycle (Taylor et al. 1999). Reduction of hardwood pockets in upland pine forests may also reduce nest depreda-

tions by snakes. However, given the complexities of predator interactions with bobwhites, larger sample sizes and macrohabitat composition on other nest predator species is needed to provide reasoned habitat management recommendations to reduce nest depredation.

ACKNOWLEDGMENT

We thank D. Butler for his bloody good data collection.

LITERATURE CITED

- American Ornithologists' Union. 1988. Report of committee on use of wild birds in research. *Auk* 105 (Supplemental 1:1–41).
- Brennan L. A. 1991. How can we reverse the northern Bobwhite population decline? *Wildlife Society Bulletin* 19:544–555.
- Brennan L. A. 1999. Northern bobwhite *Colinus virginianus*. *The Birds of North America*, No. 397, A. Poole and F. Gill, eds. The Academy of Natural Sciences, Washington D. C., and the American Ornithologists' Union, Philadelphia, Pennsylvania.
- Burger, L. W., and D. Richardson. 1999. Spatial ecology of gray rat snakes in red-cockaded woodpecker clusters in east-central Mississippi. Final project report, Project number E-1, Segment 12, Mississippi Department of Wildlife, Fisheries and Parks, Starkville.
- Church, K. E., J. R. Sauer, and S. Droge. 1993. Population trends of quail in North America. *Proceedings of the National Quail Symposium* 3:44–64.
- Errington, P. L., and H. L. Stoddard. 1938. Modifications in predation theory suggested by ecological studies of the bobwhite quail. *Transactions of the North American Wildlife Conference* 3:736–740.
- Fies, M. L., and K. M. Puckett. 1999. Depredation patterns of northern bobwhite nest predators in Virginia. *Proceedings of the National Quail Symposium* 4:96–102.
- Johnson, D. H. 1980. The comparison of usage and availability measurements for evaluating resource preference. *Ecology* 61:65–71.
- Lack, D. 1954. *The natural regulation of animal numbers*. Oxford University Press, Oxford, United Kingdom.
- Lariviere, S. 1999. Reasons why predators cannot be inferred from nest remains. *Condor* 101:718–721.
- Martin, T. E. 1991. Food limitation in terrestrial breedingbird populations: is that all there is? *Proceedings of the International Ornithology Congress* 20:1595–1602.
- Newton, I. 1998. *Population limitation in birds*. Academic Press Limited, San Diego, California.
- Nice, M. M. 1937. Studies in the life history of the song sparrow. Part 1. *Transactions of the Linnean Society* 4:1–247.
- Pietz, P. J., and D. A. Granfors. 2000. Identifying predators and fates of grassland passerine nests using miniature video cameras. *Journal of Wildlife Management* 64:71–87.
- Ricklefs R. E. 1969. An analysis of nestling mortality in birds. *Smithsonian Contributions of Zoology* 9:1–48.
- Rollins, D., and J. P. Carroll. 2001. Impacts of predation on northern bobwhite and scaled quail. *Wildlife Society Bulletin* 29:33–38.
- Smith, H. D., F. A. Stormer, and R. D. Godfrey, Jr. 1981. A collapsible quail trap. Research Note RM-400. Rocky Mountain Forest and Range Experiment Station, Fort Collins, Colorado.
- Staller, E. L. 2001. Identifying predators and nest fates of northern bobwhite nests using miniature video cameras. Thesis. University of Georgia, Athens.
- Taylor, J. S., K. E. Church, and D. H. Rusch. 1999. Microhabitat selection by nesting and brood-rearing northern bobwhite in Kansas. *Journal of Wildlife Management* 63:686–694.
- White, C. G. and R. A. Garrott. 1990. *Analysis of radio-tracking data*. Academic Press, San Diego, California.

BOBCAT PREDATION ON QUAIL, BIRDS, AND MESOMAMMALS

Michael E. Tewes

Caesar Kleberg Wildlife Research Institute, MSC 218, Texas A&M University, Kingsville, TX 78363, USA

Jennifer M. Mock

Caesar Kleberg Wildlife Research Institute, MSC 218, Texas A&M University, Kingsville, TX 78363, USA

John H. Young

Texas Parks and Wildlife Department, Wildlife Diversity Program, 3000 IH 35 South, Suite 100, Austin, TX 78704, USA

ABSTRACT

We reviewed 54 scientific articles about bobcat (*Lynx rufus*) food habits to determine the occurrence of quail, birds, and mesopredators including red (*Vulpes vulpes*) and gray fox (*Urocyon cinereoargenteus*), raccoon (*Procyon lotor*), skunk (*Mephitis* spp.), and opossum (*Didelphis virginianus*). Quail (*Colinus virginianus*, *Cyrtonyx montezumae*, *Callipepla squamata*, *C. gambelii*, *C. californica*, *Oreortyx pictus*) were found in 9 diet studies and constituted >3% of the bobcat diet in only 2 of 54 studies. Birds occurred in 47 studies, but were also a minor dietary component in most studies. Although mesopredators were represented as bobcat prey in 33 of 47 studies, their percent occurrence within bobcat diets was low and showed regional patterns of occurrence. Bobcats are a minor quail predator, but felid effects on mesopredators and secondary impacts on quail need to be studied.

Citation: M. E. Tewes, J. M. Mock, and J. H. Young. 2002. Bobcat predation on quail, birds, and mesomammals. Pages 65–70 in S. J. DeMaso, W. P. Kuvlesky, Jr., F. Hernández, and M. E. Berger, eds. Quail V: Proceedings of the Fifth National Quail Symposium. Texas Parks and Wildlife Department, Austin, TX.

Key words: bobcat, California quail, *Callipepla californica*, *C. gambelii*, *C. squamata*, *Colinus virginianus*, *Cyrtonyx montezumae*, depredation, diet, food habits, Gamble's quail, *Lynx rufus*, mesomammal, mesopredator, Montezuma quail, mountain quail, northern bobwhite, *Oreortyx pictus*, scaled quail

INTRODUCTION

The role of bobcat depredation on quail is often debated by hunters, wildlife managers, and state agency personnel. Although researchers have studied predators of specific quail populations, a particular quail species was often the research focus while a variety of predators were monitored (Burger et al. 1995, Taylor et al. 2000). Food habit studies focusing on particular predators have often been overlooked by quail researchers and managers. One reason is this information is spread among a variety of literature sources and under titles exclusive of quail. Consequently, quail managers, biologists, and researchers are unaware of these sources that focus on bobcat diets.

Our paper extensively reviews literature about the food habits and foraging ecology of bobcats in North America to determine the relative importance of quail in bobcat diets. The presence of birds in bobcat diets was recorded because some studies failed to identify avian species. Also, the relative use of avian prey relative to mammalian prey is important to understanding bobcat diets and potential for depredation of quail.

Bobcats and other predators (i.e., skunks, raccoons, opossums, and red and gray foxes) in each locale form predator complexes that can have unpredictable and difficult to assess impacts on quail and other bird populations. Bobcats are predators on other

mesopredators within their communities, and the reduction of bobcat populations with predator control or fur harvest may have an indirect effect on the population sizes and distributions of potentially more serious quail predators. Consequently, we gathered information on the presence of known mesopredators in the diets of bobcats.

METHODS

We reviewed studies examining bobcat food habits in various locations over North America. Most of the studies were conducted in the United States, although a few occurred in Canada or Mexico.

Sources for 'data mining' and information collection of bobcat food habits included journal articles, conference proceedings, books, theses, and dissertations. A Microsoft Excel spreadsheet was developed to organize selected dietary information, including the presence of quail, birds, and mesopredators.

Additional information gathered from each source included study location, dominant habitat or plant community, and method used. Method was recorded as analysis of 1) scats, 2) gastrointestinal tracts (stomach, intestine, and colon), 3) caches or carcasses, and 4) visual observation of depredation events. Sometimes multiple methods (e.g., scat and stomach anal-

Table 1. Selected prey items reported in bobcat diet studies from North American between 1939–2000. Results are reported as maximum percent occurrence for each prey type unless otherwise noted.

Reference	State	Method	N	Quail distr. ¹	Quail Grouse	Other birds	Opos- sum	Rac- coon	Porcu- pine	Skunk spp.	Red fox	Gray fox	Comments
NORTHEAST													
Fox & Fox 1982	WV	Stomach	172	P ²	—	3.5	5.9	5.2	1.2	—	—	—	—
Litvaitis, Clark & Hunt 1986	ME	Intestines	170	A ³	—	—	33.3	—	—	15.4	—	0.6	—
Manville 1958	MI	Stomach & intestines	8	A	—	—	—	—	—	P	—	—	—
Litvaitis, Stevens, & Mautz 1984	NH	Intestines	388	I ⁴	—	—	P	—	—	P	—	—	—
Mills 1984	CAN	Scat	47	A	—	—	8.5	—	—	—	—	—	Nova Scotia, Canada
Parker & Smith 1983	CAN	Stomach	70	A	—	1.4	4.3	—	—	2.9	1.4	—	—
Litvaitis, Major, & Sherburne 1986	CAN	Stomach	377	A	—	7.0	7.0	—	—	—	—	—	Cape Breton Isl., N.S.
Pollack 1951	ME	Scat	308	A	—	—	13.3	—	—	2.8	—	—	—
	N. Eng.	Stomach & intestines	208	I	—	1.4	3.4	—	—	18.3	—	—	—
		Scat	250	I	—	2.0	1.6	—	—	6.8	—	—	—
Rollings 1945	ME	Stomach	50	A	—	1.0	1.0	—	—	10.0	1.0	—	Frequency of occurrence
Westfall 1956	ME	Intestines	88	A	—	6.8	6.8	—	—	11.4	2.3	—	—
Hamilton & Hunter 1939	VT	Stomach	140	A	—	5.5	1.0	—	—	7.1	4.4	0.8	Percentage by bulk
McCord 1974	MA	Scat	43	P	—	—	<5.0	—	Tr ⁵	—	—	—	—
Major & Sherburne 1987	ME	Scat	109	A	—	—	15.0	—	—	—	—	—	—
Dibello et al. 1990	ME	Scat	452	A	—	—	8.5	—	P	P	—	—	—
Litvaitis & Harrison 1989	ME	Scat	346	A	—	—	9.7	—	P	P	—	—	—
Litvaitis et al. 1984	NH	Intestines	388	I	—	—	P	—	P	P	—	—	—
Litvaitis, Sherburne, & Bissonette 1986	ME	Scat	452	A	—	—	13.3	—	—	2.8	—	—	Percent frequency
Berg 1979	ME	Stomach	73	A	—	—	P	—	—	12.0	—	—	—
SOUTHEAST													
Kitchings & Story 1979	TN	Scat	31	P	—	—	14.0	5.0	—	—	—	—	Percent frequency occurrence
Miller & Speake 1978	AL	Stomach	136	P	—	—	11.1	5.9	0.7	—	—	—	—
		Intestines	137	P	—	—	8.0	5.1	—	—	—	—	—
		Scat	218	P	0.9	—	13.8	5.5	—	—	—	—	—
Story et al. 1982	TN	Scat	176	P	—	—	13.1	20.0	9.0	—	—	—	Percent frequency of occurrence
Progulskie 1955	VA	Scat	124	P	—	—	16.9	3.8	—	—	—	—	—
	Appalach	Scat, stomach & intes-											
		tines	233	P	—	—	6.9	6.5	2.1	—	1.3	0.9	Frequency occurrence
Kight 1962	SC	Scat	317	P	2.6	—	11.0	0.8	0.4	—	—	—	—
Buttrey 1979	TN	Stomach, intestines & scat	48	P	—	—	12.2	—	—	—	—	—	—
Maehr & Brady 1986	FL	Stomach	413	P	6.0	—	55.0	7.0	4.0	—	—	—	Frequency
Wassmer et al. 1988	FL	Scat	146	P	1.4	—	17.2	3.4	1.4	—	—	—	—
CENTRAL PLAINS													
Beasom & Moore 1977	TX	Stomach	125	P	6.0	—	32.0	—	—	—	—	—	—
Fritts & Sealander 1978	AR	Stomach	150	P	1.0	—	7.0	9.0	5.0	—	4.0	1.0	—
Leopold & Krausman 1986	TX	Scat	344	P	—	—	P	—	—	—	—	—	—
Blankenship 2000	TX	Scat	653	P	0.2	—	32.8	—	0.3	—	—	—	Grouped birds and eggs
Litvaitis 1981	OK	Scat	40	P	—	—	27.5	—	—	—	—	—	—
Mahan 1980	NE	Stomach	57	P	1.8	—	8.8	—	—	1.8	—	—	—
Rolley 1985	OK	Stomach	549	P	—	—	13.0	P	—	—	—	—	Percentage of total prey
Rolley & Warde 1985	OK	Stomach	145	P	—	—	11.0	P	—	—	—	—	—
Lehmann 1984	TX	Stomach	—	P	—	—	Tr	—	—	—	—	—	—
Trevor et al. 1989	ND	Stomach	74	A	—	—	6.9	—	—	1.4	1.4	—	—

BOBCAT PREY SPECIES

67

Table 1. continued.

Reference	State	Method	N	Quail distr. ¹	Quail Grouse	Other birds	Opos- sum	Rac- coon	Porcu- pine	Skunk spp.	Red fox	Gray fox	Comments
SOUTHWEST													
Anderson 1987	CO	Visual obs.	—	I	—	C	—	—	—	—	—	—	Snow cache
Gashwiler et al. 1960	UT & NV	Stomach	53	I	—	5.7	—	—	3.8	—	—	—	
		Scat & intestines	81	I	—	2.5	—	—	—	—	—	—	
Jones & Smith 1979	AZ	Scat	176	I	—	12.0	—	—	—	2.0	—	—	
Delibes & Hiraldo 1987	Mexico	Scat	540	P	—	1.9	—	—	—	0.2	—	—	
NORTHWEST													
Bailey 1972	ID	Scat	55	I	P	~22.0	—	—	—	—	—	—	Primarily sage grouse
Bailey 1979	ID	Stomach	233	I	—	6.0	—	—	—	—	—	—	Percent frequency occurrence
Brittill et al. 1979	WA	Stomach	76	I	—	5.2	—	—	—	—	—	—	Percent frequency
Knick et al. 1984	W	Stomach	324	I	—	6.0	—	—	—	—	—	—	
Koehler & Hornocker 1989	ID	Scat	160	I	—	12.0	—	—	—	—	—	—	Percent frequency
Nussbaum & Maser 1975	OR Coast Range	Scat	143	P	—	0.7	—	—	—	—	—	—	
	OR Cascade Range	Scat	34	P	—	2.9	—	—	—	—	—	—	
Towell 1982	OR	Stomach & intestines	98	P	1.0	12.0	—	—	6.0	—	—	—	

¹ Quail Distr.—Distribution of quail species (*Colinus virginianus*, *Cyrtornyx montezumae*, *Callipepla squamata*, *C. gambelii*, *C. californica*, *Oreortyx pictus*) based on Brennan 1999 for *C. virginianus* and National Geographic Society (1987) for other species.

² P—Indicates presence.

³ A—Indicates quail are absent from the study area.

⁴ I—Indicates sporadic/inconsistent quail distribution within state or study area.

⁵ Tr—Indicates item found in trace quantities.

ysis) were used within the same study. We determined sample sizes for each study and each method of analysis.

Percent occurrence within bobcat diets was determined for most studies for quail, birds, and mesopredators. We noted the absence of quail distribution with those study sites where bobcat food habit studies occurred.

RESULTS

We examined 54 scientific sources for information on bobcat food habits. This survey included 38 journal articles, 10 symposia proceedings, 3 dissertations, 1 thesis, 1 book chapter, and 1 technical report. Only articles which yielded results from individual studies were used. Previous literature summaries often failed to provide the specific information that we required, and they were not used in the data summaries.

Lagomorphs and rodents were dominant constituents of bobcat diets. Forty-seven studies found either quail, birds, or mesopredators in bobcat diets (Table 1), whereas 7 studies found none of these elements. Dietary studies lacking quail, birds, and mesopredators included Marston (1942), Dill (1947), Cook (1971), Beale and Smith (1973), Litvaitis et al. (1982), Litvaitis et al. (1986b), and Koehler and Hornocker (1991).

The following methods were used in the 47 studies: 18 used scats alone, 22 used both stomachs and intestinal analyses, 6 used stomachs and scats, and 1 used observations of caches, carcasses and predation events.

Of the 35 bobcat diet studies that occurred within known or presumed quail distributions, 9 (25.7%) studies identified quail remains. Four of these studies were conducted in the southeast, 4 in the central plains, and 1 in the northwest. Percent occurrence of quail in the bobcat diets of these studies was consistently low (Table 1).

Birds were identified in 46 (85.2%) of the studies (Table 1) and percent occurrence of this group was usually <10%. Grouse were found in 11 (20.4%) of 47 studies.

Percent occurrence of medium-sized mammalian predators was usually <20% in bobcat diets (Table 1). Opossums occurred in 7 of 8 studies from the southeast and 3 of 10 studies from the central plains (Table 1). Opossums were absent from bobcat diets in the southwest, northwest, and only occurred in 1 of 18 studies from the northeast. Raccoons occurred in 11 of 47 studies, with 6 of these from the southeast. Porcupines (*Erethizon dorsatum*) were most commonly found in bobcat diets from the northeast (14 of 18 studies). Eleven of the 47 studies identified skunk (*Mephitis* spp.) remains.

DISCUSSION

Numerous studies have summarized the prey consumed by bobcats through most of their range (Mc-

Cord and Cardoza 1982, Anderson 1987, Rolley 1987, Lariviere and Walton 1997). The dominance of lagomorphs and rodents in their diets has been previously demonstrated (McCord and Cardoza 1982, Anderson 1987, Rolley 1987, Lariviere and Walton 1997), and observed again during this literature survey. However, the primary purpose of this effort was to evaluate the occurrence of less common elements in bobcat diets. Although each method (e.g., scat versus stomach analysis) has problems and biases, we were able to identify emerging patterns regarding quail, birds, and mesopredators.

Quail occurred in >3% of bobcat scat and gastrointestinal samples in only 2 of 54 studies. Beasom and Moore (1977) found 6% occurrence of northern bobwhite in bobcat stomachs during 1971 and 4% occurrence in 1972. Maehr and Brady (1986) found 6% frequency of occurrence of northern bobwhite in bobcat stomachs analyzed. Thus, quail were generally absent from bobcat diets or represented a low percentage when present. Comparing quail distribution with location of the bobcat diet studies was useful in developing a better assessment of quail presence in bobcat food habits. Bobcat diet studies occurring outside the presumed quail distribution would not detect quail as a diet component.

Birds as a group were found in 87% of the bobcat diets, but the avian component was always considerably less than the lagomorph or rodent components. The literature survey by Lariviere and Walton (1997) concluded that Galliformes were the most important taxa of birds consumed by bobcats, but Passeriformes, Strigiformes, Gruiformes, Accipetridae, and Anatidae were also consumed (Fritts and Sealander 1978, Maehr and Brady 1986, Anderson 1987). The appearance of grouse in bobcat diets was noted for studies from the northeast and northwest. Bird egg remains were sometimes found in bobcat scats but generally not identified to species (Jones and Smith 1979).

Bobcats are primarily nocturnal predators with crepuscular, bimodal peaks of activity (Buie et al. 1979, Miller and Speake 1979) and reduced midday activity (Buie et al. 1979, Witmer and DeCalesta 1986). In contrast, quail and most bird species are active during diurnal periods. This incongruence in activity periods is probably a major explanation for the infrequency of birds, particularly quail, in bobcat diets. Because bobcats rely primarily on visual and auditory senses for hunting and less on olfactory senses, the likelihood of bobcat-quail encounters are reduced at night.

The occurrence of mesopredators in bobcat diets was also low. However, opossums, raccoons, foxes, and skunks were occasionally encountered. The population densities of mesopredators are usually lower than those of lagomorphs and rodents, and the removal of a few individual predators by bobcats may have relatively greater impacts on the density of mesopredators than smaller mammals.

The interactions of multiple, sympatric predators on one another and their prey form a complex system which has the potential to affect quail as well as other

prey. For example, striped skunks (*Mephitis mephitis*), opossums, and raccoons can be important predators of adult quail and quail eggs (Brennan 1999, Fies and Puckett 2000). These predators are themselves prey for bobcats, coyotes, and mountain lions whose actions may effect the impact on quail and other small prey. Such a complex system is difficult to study and often requires long time periods and considerable resources to obtain reliable data (Blankenship 2000). Although bobcat depredation on quail is a direct trophic link, bobcat predation on mesopredators may have subtle and indirect consequences for quail populations.

The relative role of mammalian and avian predators on quail varies depending on the location of the study, characteristics of predator communities, and habitat attributes (Burger et al. 1995, Taylor et al. 2000). Our understanding of the complex interplay of predator communities upon their prey is very limited. For example, interference competition between coyotes (*Canis latrans*) and bobcats has been suspected with coyotes dominant over bobcats (Litvaitis and Harrison 1989). Coyotes have been documented to kill bobcats (Litvaitis and Harrison 1989, Knick 1990). Removal of selected predators (e.g., coyotes) may result in the release of other predators (e.g., foxes, skunks, raccoons, and opossums) (Henke and Bryant 1999) with unintended depredation consequences. It is possible that the intensive removal of bobcats may allow rodents and lagomorphs to increase, thereby attracting other predators which may result in more depredation on quail and their nests. However, even if bobcats and other predators consumed a higher percentage of quail, it would not necessarily mean that such depredation had a negative effect on the ultimate size of the quail population. Other factors (e.g., habitat quantity and quality) may represent a dominant or limiting effect.

ACKNOWLEDGMENTS

This is publication no. 02-106 of the Caesar Kleberg Wildlife Research Institute.

LITERATURE CITED

- Anderson, E. M. 1987. Bobcat predation on a red-tailed hawk. *Southwestern Naturalist* 32:149-150.
- Bailey, T. N. 1972. Ecology of bobcats with special reference to social organization. Dissertation, University of Idaho, Moscow.
- Bailey, T. N. 1979. Den ecology, population parameters and diet of eastern Idaho bobcats. Bobcat Research Conference Proceedings: current research on biology and management of *Lynx rufus*. National Wildlife Federation, Scientific and Technical Series 6, Front Royal, Virginia.
- Beale, D. M., and A. D. Smith. 1973. Mortality of pronghorn antelope fawns in western Utah. *Journal of Wildlife Management* 37:343-352.
- Beasom, S. L., and R. A. Moore. 1977. Bobcat food habit response to a change in prey abundance. *Southwestern Naturalist* 21:451-457.
- Berg, W. E. 1979. Ecology of bobcats in northern Minnesota. Bobcat Research Conference Proceedings: current research on biology and management of *Lynx rufus*. National Wild-

- life Federation, Scientific and Technical Series 6, Front Royal, Virginia.
- Blankenship, T. L. 2000. Ecological response of bobcats to fluctuating prey populations on the Welder Wildlife Foundation Refuge. Dissertation, Texas A&M University and Texas A&M University-Kingsville, College Station and Kingsville.
- Brennan, L. A. 1999. Northern bobwhite (*Colinus virginianus*). Pages 1–4 in A. Poole and F. Gill, eds. The birds of North America No. 397, Philadelphia, Pennsylvania.
- Brittall, J. D., S. J. Sweeney, and S. T. Knick. 1979. Washington bobcats: diet, population dynamics and movement. Bobcat Research Conference Proceedings: current research on biology and management of *Lynx rufus*. National Wildlife Federation, Scientific and Technical Series 6, Front Royal, Virginia.
- Buie, D. E., T. T. Fendley, and H. McNab. 1979. Fall and winter home ranges of adult bobcats on the Savannah River Plant, South Carolina. Proceedings of the Bobcat Research Conference, National Wildlife Federation, Scientific and Technical Series 6, Front Royal, Virginia.
- Burger, L. W., Jr., T. V. Dailey, E. W. Kurzejeski, and M. R. Ryan. 1995. Survival and cause-specific mortality of northern bobwhite in Missouri. *Journal of Wildlife Management* 59:401–410.
- Buttrey, G. W. 1979. Food habits and distribution of the bobcat, *Lynx rufus rufus* (Schreber), on the Catoosa Wildlife Management Area. Bobcat Research Conference Proceedings: current research on biology and management of *Lynx rufus*. National Wildlife Federation, Scientific and Technical Series 6, Front Royal, Virginia.
- Cook, R. S., M. White, D. O. Trainer, and W. C. Glazener. 1971. Mortality of young white-tailed deer fawns in south Texas. *Journal of Wildlife Management* 35:47–56.
- Delibes, M., and F. Hiraldo. 1987. Food habits of the bobcat in two habitats of the southern Chihuahuan Desert. *Southwestern Naturalist* 32:457–461.
- Dibello, F. J., S. M. Arthur, and W. B. Krohn. 1990. Food habits of sympatric coyotes, *Canis latrans*, red foxes, *Vulpes vulpes*, and bobcats, *Lynx rufus*, in Maine. *Canadian Field-Naturalist* 104:403–408.
- Dill, H. H. 1947. Bobcat preys on deer. *Journal of Mammalogy* 28:63.
- Fies, M. L., and K. M. Puckett. 2000. Depredation patterns of northern bobwhite nest predators in Virginia. Proceedings of the National Quail Symposium 4:96–102.
- Fox, L. B., and J. S. Fox. 1982. Population characteristics and food habits of bobcats in West Virginia. Proceedings of the Annual Conference of the Southeastern Association of Fish and Wildlife Agencies 36:671–677.
- Fritts, S. H., and J. A. Sealander. 1978. Diets of bobcats in Arkansas with special reference to age and sex differences. *Journal of Wildlife Management* 42:533–539.
- Gashwiler, J. S., W. L. Robinette, and O. W. Morris. 1960. Foods of bobcats in Utah and eastern Nevada. *Journal of Wildlife Management* 24:226–229.
- Hamilton, W. J., Jr., and R. P. Hunter. 1939. Fall and winter habits of Vermont bobcats. *Journal of Wildlife Management* 3:99–103.
- Henke, S. E., and F. C. Bryant. 1999. Effect of coyote removal on the faunal community in western Texas. *Journal of Wildlife Management* 63:1066–1081.
- Jones, J. H., and N. S. Smith. 1979. Bobcat density and prey selection in central Arizona. *Journal of Wildlife Management* 43:666–672.
- Kight, J. 1962. An ecological study of the bobcat, *Lynx rufus* (Schreber), in west-central South Carolina. Thesis, University of Georgia, Athens.
- Kitchings, J. T., and J. D. Story. 1979. Home range and diet of bobcats in eastern Tennessee. Bobcat Research Conference Proceedings: current research on biology and management of *Lynx rufus*. National Wildlife Federation, Scientific and Technical Series 6, Front Royal, Virginia.
- Knick, S. T. 1990. Ecology of bobcats relative to exploitation and a prey decline in southeastern Idaho. *Wildlife Monographs* 108.
- Knick, S. T., S. J. Sweeney, J. R. Alldredge, and J. D. Brittall. 1984. Autumn and winter food habits of bobcats in Washington State. *Great Basin Naturalist* 44:70–74.
- Koehler, G. M., and M. G. Hornocker. 1989. Influences of seasons on bobcats in Idaho. *Journal of Wildlife Management* 53:197–202.
- Koehler, G. M., and M. G. Hornocker. 1991. Seasonal resource use among mountain lions, bobcats, and coyotes. *Journal of Mammalogy* 72:391–396.
- Lariviere, S., and L. R. Walton. 1997. *Lynx rufus*. *Mammalian Species* 563:1–8.
- Lehmann, V. W. 1984. Bobwhites in the Rio Grande Plain of Texas. Texas A&M University Press, College Station.
- Leopold, B. D., and P. R. Krausman. 1986. Diets of 3 predators in Big Bend National Park. *Journal of Wildlife Management* 50:290–295.
- Litvaitis, J. A. 1981. A comparison of coyote and bobcat food habits in the Wichita Mountains, Oklahoma. Proceedings of Oklahoma Academy of Science 61:81–82.
- Litvaitis, J. A., J. A. Sherburne, M. O'Donoghue, and D. May. 1982. Cannibalism by a free-ranging bobcat, *Felis rufus*. *Canadian Field-Naturalist* 96:476–477.
- Litvaitis, J. A., C. L. Stevens, and W. W. Mautz. 1984. Age, sex, and weight of bobcats in relation to winter diet. *Journal of Wildlife Management* 48:632–635.
- Litvaitis, J. A., A. G. Clark, and J. H. Hunt. 1986a. Prey selection and fat deposits of bobcats (*Felis rufus*) during autumn and winter in Maine. *Journal of Mammalogy* 67:389–392.
- Litvaitis, J. A., J. T. Major, and J. A. Sherburne. 1986b. Status report: bobcat movements in relation to snowshoe hare density. Page 375 in S.D. Miller, and D. D. Everett, eds. *Cats of the world: biology, conservation, and management*. National Wildlife Federation, Washington D.C.
- Litvaitis, J. A., J. A. Sherburne, and J. A. Bissonette. 1986c. Bobcat habitat use and home range size in relation to prey density. *Journal of Wildlife Management* 50:110–117.
- Litvaitis, J. A., and D. J. Harrison. 1989. Bobcat-coyote niche relationships during a period of coyote population increase. *Canadian Journal of Zoology* 67:1180–1186.
- Maehr, D. S., and J. R. Brady. 1986. Food habits of bobcats in Florida. *Journal of Mammalogy* 67:133–138.
- Mahan, C. J. 1980. Winter food habits of Nebraska bobcats (*Felis rufus*). *Prairie Naturalist* 12:59–63.
- Major, J. T., and J. A. Sherburne. 1987. Interspecific relationships of coyotes, bobcats, and red foxes in western Maine. *Journal of Wildlife Management* 51:1987.
- Manville, R. H. 1958. Odd items in bobcat stomachs. *Journal of Mammalogy* 39:439.
- Marston, M. A. 1942. Winter relations of bobcats to white-tailed deer in Maine. *Journal of Wildlife Management* 6:328–337.
- McCord, C. M. 1974. Selection of winter habitat by bobcats (*Lynx rufus*) on the Quabbin Reservation, Massachusetts. *Journal of Mammalogy* 55:428–437.
- McCord, C. M., and J. E. Cardoza. 1982. Bobcat and lynx: *Felis rufus* and *F. lynx*. Pages 728–768 in J. A. Chapman, and G. A. Feldhamer, eds. *Wild Mammals of North America: biology, management, and economics*. Johns Hopkins University Press, Baltimore, Maryland.
- Miller, S. D., and D. W. Speake. 1978. Prey utilization by bobcats on quail plantations in southern Alabama. Proceedings of the Annual Conference of the Southeastern Association of Fish and Wildlife Agencies 32:100–111.
- Miller, S. D., and D. W. Speake. 1979. Demography and home range of bobcat in south Alabama. Proceedings of the Bobcat Research Conference. National Wildlife Federation Scientific and Technical Series 6, Front Royal, Virginia, USA.

- Mills, J. K. 1984. Food habits of bobcats, *Lynx rufus*, in Nova Scotia. *Canadian Field-Naturalist* 98:50–51.
- National Geographic Society. 1987. Field guide to the birds of North America. The National Geographic Society, Washington, D.C.
- Nussbaum, R. A., and C. Maser. 1975. Food habits of the bobcat, *Lynx rufus*, in the Coast and Cascade ranges of western Oregon in relation to present management policies. *Northwest Science* 49:261–266.
- Parker, G. R., and G. E. J. Smith. 1983. Sex- and age-specific reproductive and physical parameters of the bobcat (*Lynx rufus*) on Cape Breton Island, Nova Scotia. *Canadian Journal of Zoology* 61:1771–1782.
- Pollack, E. M. 1951. Food habits of the bobcat in the New England states. *Journal of Wildlife Management* 15:209–213.
- Progulske, D. R. 1955. Game animals utilized as food by the bobcat in the Southern Appalachians. *Journal of Wildlife Management* 19:249–253.
- Rolley, R. E. 1985. Dynamics of a harvested bobcat population in Oklahoma. *Journal of Wildlife Management* 49:283–292.
- Rolley, R. E. 1987. Bobcat. Pages 671–681 in M. Novak, J. A. Baker, M. E. Obbard, and B. Malloch, eds. *Wild furbearer management and conservation in North America*. Ministry of Natural Resources, Ontario, Canada.
- Rolley, R. E., and W. D. Warde. 1985. Bobcat habitat use in southeastern Oklahoma. *Journal of Wildlife Management* 49:913–920.
- Rollings, C. T. 1945. Habits, foods and parasites of the bobcat in Minnesota. *Journal of Wildlife Management* 9:131–145.
- Story, J. D., W. J. Galbraith, and J. T. Kitchings. 1982. Food habits of bobcats in eastern Tennessee. *Journal of Tennessee Academy of Science* 57:29–32.
- Taylor, J. D., II, L. W. Burger, Jr., S. W. Manley, and L. A. Brennan. 2000. Seasonal survival and cause-specific mortality of northern bobwhite in Mississippi. *Proceedings of the National Quail Symposium* 4:103–107.
- Toweill, D. E. 1982. Winter foods of eastern Oregon bobcats. *Northwest Science* 56:310–315.
- Trevor, J. T., R. W. Seabloom, and S. H. Allen. 1989. Food habits in relation to sex and age of bobcats from southwestern North Dakota. *Prairie Naturalist* 21:163–168.
- Wassmer, D. A., D. D. Guenther, and J. N. Layne. 1988. Ecology of the bobcat in south-central Florida. *Bulletin of the Florida State Museum, Biological Sciences* 33:159–228.
- Westfall, C. Z. 1956. Foods eaten by bobcats in Maine. *Journal of Wildlife Management* 20:199–200.
- Witmer, G. W., and D. S. DeCalesta. 1986. Resource use by unexploited sympatric bobcats and coyotes in Oregon. *Canadian Journal of Zoology* 64:2333–2338.

EFFECTS OF FIELD BORDERS AND MESOMAMMAL REDUCTION ON NORTHERN BOBWHITE AND SONGBIRD ABUNDANCE ON THREE FARMS IN NORTH CAROLINA

Peter T. Bromley

Fisheries and Wildlife Sciences Program, North Carolina State University, Raleigh, North Carolina, 27695-7646, USA

Shane D. Wellendorf¹

Fisheries and Wildlife Sciences Program, North Carolina State University, Raleigh, North Carolina, 27695-7646, USA

William E. Palmer

Tall Timbers Research Station, 13093 Henry Beadel Dr., Tallahassee, FL 32312, USA

Jeffery F. Marcus²

Fisheries and Wildlife Sciences Program, North Carolina State University, Raleigh, North Carolina, 27695-7646, USA

ABSTRACT

Lack of early nesting habitat may be limiting population levels of northern bobwhites (*Colinus virginianus*) and early successional songbirds on agricultural landscapes. Alternatively, detrimental effects of mesomammal predators on nesting success and survivorship of bobwhites may be causal at low densities. Previous research has documented increased use of agricultural areas by bobwhites on farms with field borders, but bobwhites had low nesting success in these areas. No replicated studies in the southeast United States have been conducted investigating the effects of field borders and mesomammal predator reduction on bobwhite and songbird abundance. We conducted a 3-year study on farms in Hyde, Tyrrell, and Wilson counties, North Carolina using a 2×2 factorial treatment combinations and a blocked study design. On each study area, 4, 200-ha farm blocks were randomly assigned 1 of 4 treatments. Treatments included: (1) 5–10 m fallow vegetation borders on all disked field edges, (2) removal of mesomammal nest predators (raccoons (*Procyon lotor*), opossums (*Didelphis virginianus*), and foxes (*Urocyon cinereoargenteus* and *Vulpes vulpes*)) between January through June of each year, (3) a combination of field borders and predator reduction, or (4) neither treatment. In 1997–99, we measured fall abundance of bobwhite coveys on farm blocks using morning covey call surveys and summer abundance of songbirds using variable radius point counts. Field borders were established in 1996 in Hyde and Wilson counties and 1997 in the Tyrrell county study area. Number of mesomammal predators annually removed from farm blocks averaged 42 (SE = 3.5) and was similar between study areas and years. Field border farm blocks had consistently more coveys heard than non-border farm blocks ($F_{1,2} = 216.0$, $P < 0.004$). However, there were no differences in the number of coveys heard between predator reduction and non-reduction farms ($F_{1,2} = 10.4$, $P = 0.084$). Farms with both field border and predator reduction had more coveys heard compared to other farm blocks ($F_{1,2} = 43.3$, $P < 0.0223$). Summer bobwhite abundance was greater on field border areas ($F_{1,6} = 5.93$, $P < 0.051$). No other differences in songbird abundance were detected between field border and non-border farms. In 1997, songbird nest density was estimated in field border and non-border farms on the Wilson County study area. Field border farms had higher nest density, particularly for field sparrows (*Spizella pusilla*) and common yellowthroats (*Geothlypis trichas*), and had greater nesting bird diversity. Field borders were a practical technique to increase bobwhite abundance on small farm blocks. Increases in bobwhite abundance associated with predator reduction on small farms with field border would not be economically feasible in most circumstances.

Citation: Bromley, P. T., S. D. Wellendorf, W. E. Palmer, and J. F. Marcus. 2002. Effects of field borders and mesomammal reduction on northern bobwhite and songbird abundance on three farms in North Carolina. Page 71 in S. J. DeMaso, W. P. Kuvlesky, Jr., F. Hernández, and M. E. Berger, eds. Quail V: Proceedings of the Fifth National Quail Symposium. Texas Parks and Wildlife Department, Austin, TX.

¹ Present address: Tall Timbers Research Station, 13093 Henry Beadel Dr., Tallahassee, FL 32312

² Present address: 202 Natural Resources Hall, University of Nebraska, Lincoln, NE 68583-0819

UNDERSTANDING THE RELATIONSHIP BETWEEN NORTHERN BOBWHITE MORTALITY AND RAPTOR MIGRATION IN SOUTH TEXAS

Fernando R. Holschneider

Caesar Kleberg Wildlife Research Institute, Texas A&M University-Kingsville, Kingsville, TX 78363, USA

Fidel Hernández

Caesar Kleberg Wildlife Research Institute, Texas A&M University-Kingsville, Kingsville, TX 78363, USA

David Rios

Caesar Kleberg Wildlife Research Institute, Texas A&M University-Kingsville, Kingsville, TX 78363, USA

Juan D. Vasquez

Caesar Kleberg Wildlife Research Institute, Texas A&M University-Kingsville, Kingsville, TX 78363, USA

ABSTRACT

The fall and spring migration routes of numerous raptor species converge in the Rio Grande Plains ecoregion of Texas resulting in a high seasonal diversity and abundance of raptors. Raptors are believed to be an important source of mortality for northern bobwhite (*Colinus virginianus*). Because of the economic importance of bobwhites and the high concentration of raptors in south Texas, we investigated the relationship between bobwhite mortality and raptor abundance. Our objectives were to document raptor diversity and abundance, correlate bobwhite mortality with raptor abundance, and correlate ambient temperature with raptor abundance. We monitored radiomarked bobwhites ($n = 164$) biweekly during September–February 2000–01 in Brooks County, Texas. We conducted raptor surveys bimonthly during October–February 2000–01 between 1100 and 1500 hours along a 24-km road. We documented a total of 96 bobwhite mortalities. Raptors accounted for 16 % of the mortalities, with 43% by mammals, 13% unknown predator, and 28% hunter. We observed a total of 310 raptors, representing 15 identified species. Red-tailed hawk (*Buteo jamaicensis*) and white-tailed hawk (*Buteo albicaudatus*) comprised a large percentage (38%) of the raptors observed. A weak correlation ($r = -0.11$) existed between raptor abundance and total bobwhite mortality. A stronger correlation ($r = 0.86$) existed between Accipiter abundance and raptor depredation of bobwhites. We detected a relatively strong negative correlation ($r = -0.65$) between raptor abundance and ambient temperature. Our limited data suggest that general raptor abundance may not be a strong indicator of actual bobwhite mortality, and that it may be erroneous to infer that a high abundance of raptors results in a high mortality of bobwhites. Understanding the relationship between bobwhite and raptors will involve determining species-specific migration timing and numbers.

Citation: Holschneider, F. R., F. Hernández, D. Rios, and J. D. Vasquez. 2002. Understanding the relationship between northern bobwhite mortality and raptor migrations in south Texas. Page 72 in S. J. DeMaso, W. P. Kuvlesky, Jr., F. Hernández, and M. E. Berger, eds. Quail V: Proceedings of the Fifth National Quail Symposium, Texas Parks and Wildlife Department, Austin, TX.

EFFECTS OF MICRO-HABITAT, MACRO-HABITAT, AND PREDATOR SPACE-USE ON SUCCESS OF NORTHERN BOBWHITE NESTS

Pat Stockett

Department of Wildlife & Fisheries, Box 9690, Mississippi State University, Mississippi State, MS 39762, USA

Mark Smith

Department of Wildlife & Fisheries, Box 9690, Mississippi State University, Mississippi State, MS 39762, USA

James Austin

Department of Wildlife & Fisheries, Box 9690, Mississippi State University, Mississippi State, MS 39762, USA

Scott Szukaitis

Department of Wildlife & Fisheries, Box 9690, Mississippi State University, Mississippi State, MS 39762, USA

Chrissie Henner

Department of Wildlife & Fisheries, Box 9690, Mississippi State University, Mississippi State, MS 39762, USA

L. Wes Burger

Department of Wildlife & Fisheries, Box 9690, Mississippi State University, Mississippi State, MS 39762, USA

Bruce Leopold

Department of Wildlife & Fisheries, Box 9690, Mississippi State University, Mississippi State, MS 39762, USA

Dave Godwin

Mississippi Department of Wildlife, Fisheries, and Parks, Box 9690, Mississippi State, MS 39762, USA

ABSTRACT

Northern bobwhite (*Colinus virginianus*) exhibit high reproductive potential allowing populations to rapidly respond to newly created habitat and recover from high annual mortality. However, they experience low individual nest success, ranging from 16–50%. Survival of nests, particularly first nests, is an important demographic parameter that influences overall population performance and participation in alternative reproductive strategies such as renesting, double-clutching, and male-incubation. As bobwhite populations continue to decline, old paradigms regarding the relationships among habitat characteristics, predator abundance, and bobwhite productivity are being reexamined. A new emerging paradigm hypothesizes that habitat structure, landscape context, and predator context interact in a complex manner to influence fate of individual nests. Vegetation characteristics at nest sites, and components of bobwhite nesting habitat have been described, but few studies have shown relationships between vegetation characteristics and nest success. In contrast, several studies have demonstrated relationships between landscape structure and nest success, and ongoing research in the southeastern United States is demonstrating relationships between predator context and productivity. Although numerous studies have estimated nest success, no study has simultaneously examined effects of vegetation structure, landscape structure, and predator context on survival of bobwhite nests. We use incubated nests ($n = 104$) of radiomarked bobwhite on a managed area in east-central Mississippi from 1996–00 to examine effects of micro-habitat, macro-habitat, and predator space-use on nest survival. At each nest we characterized microhabitat by measuring vegetation height, density (Robel Visual Obstruction Reading), grass canopy coverage, forb canopy coverage, litter coverage, litter depth, and % bare ground. Within 50-, 200-, and 400-m concentric circles around nest sites we characterized landscape context using measures of patch richness, patch diversity, and interspersed/juxtaposition indices, and habitat specific measures of patch density, patch shape index, edge density, and % of landscape. We used year-specific harmonic mean utilization distributions of radiomarked raccoons to construct cumulative raccoon utilization distributions to measure intensity of space use by an important bobwhite nest predator. We used logistic regression on nest fate (hatched/failed) to develop predictive models of nest success as a function of micro-habitat, macro-habitat, and predator space-use. We constructed a set of candidate models that hypothesized nest fate as a function of micro-habitat, macro-habitat, predator space-use, micro and macro habitat, microhabitat and predator space use, macrohabitat and predator space use, and a global model that included all 3 groups of predictor variables. We used information theoretic approaches for model selection and inference.

Citation: Stockett, P., M. Smith, J. Austin, S. Szukaitis, C. Henner, L. W. Burger, B. Leopold, and D. Godwin. 2002. Effects of micro-habitat, macro-habitat, and predator space-use on success of northern bobwhite nests. Page 73 in S. J. DeMaso, W. P. Kuvlesky, Jr., F. Hernández, and M. E. Berger, eds. Quail V: Proceedings of the Fifth National Quail Symposium, Texas Parks and Wildlife Department, Austin, TX.

SURVIVAL AND HOME RANGE ESTIMATES OF PEN-RAISED NORTHERN BOBWHITES IN BUFFER STRIP AND NON-BUFFER STRIP HABITATS

Michael J. Oakley

Maryland Cooperative Fish & Wildlife Research Unit, Biological Resources Division, United States Geological Survey, University of Maryland Eastern Shore, 1120 Trigg Hall, Princess Anne, MD 21853, USA

Dixie L. Bounds

Maryland Cooperative Fish & Wildlife Research Unit, Biological Resources Division, United States Geological Survey, University of Maryland Eastern Shore, 1120 Trigg Hall, Princess Anne, MD 21853, USA

Theodore A. Mollett

Department of Agriculture, University of Maryland Eastern Shore, 1121 Trigg Hall, Princess Anne, MD 21853, USA

Edward C. Soutiere

Tudor Farms Inc., 3675 Decoursey Bridge Road, Cambridge, MD 21613, USA

ABSTRACT

We investigated the effect of agricultural buffer strips on survival and home range estimates of pen-raised northern bobwhites (*Colinus virginianus*) at Tudor Farms on the Eastern Shore of Maryland. In September 2000 we released groups of bobwhites into 9 buffer strip (treatment) areas and 9 non-buffer strip (control) areas among 11 agricultural farms. Each group consisted of 4 radiomarked bobwhites and 26 non-radiomarked bobwhites. To maintain contact with the established coveys, additional radiomarked bobwhites ($n = 177$) were introduced into the coveys as radiomarked birds died. Survival for bobwhites released in buffer strip areas was lower ($P < 0.001$) than survival in non-buffer strip areas. None of the radiomarked bobwhites released in the buffer strip areas survived past 27 weeks, whereas 11% of radiomarked bobwhites in non-buffer strip areas survived to 27 weeks and 1 bird survived to 41 weeks. Predation was the primary mortality factor (88%), followed by unknown causes (7%), stress (2%), hunting (2%), and road kill (1%). Mean fall and winter home range (95% minimum convex polygon) for 21 bobwhite coveys was 24.2 ± 3.5 ha, ranging from 1.7 to 65.8 ha. Home range areas of bobwhite coveys in buffer strips ($n = 12$, $\bar{x} = 15.0 \pm 2.7$ ha) was significantly smaller ($P = 0.002$) than non-buffer strip coveys ($n = 9$, $\bar{x} = 36.4 \pm 4.9$ ha). We conclude that the smaller home ranges in buffer strip areas seem to indicate better habitat quality; however, high mortality rates of pen-raised bobwhites limited our ability to confirm this.

Citation: Oakley, M. J., D. L. Bounds, T. A. Mollett, and E. C. Soutiere. 2002. Survival and home range estimates of pen-raised northern bobwhites in buffer strip and non-buffer strip habitats. Pages 74–80 in S. J. DeMaso, W. P. Kuvlesky, Jr., F. Hernández, and M. E. Berger, eds. Quail V: Proceedings of the Fifth National Quail Symposium. Texas Parks and Wildlife Department, Austin, TX.

Key words: buffer strips, *Colinus virginianus*, habitat analysis, home range, Maryland, mortality, northern bobwhite, radiotelemetry, survival

INTRODUCTION

Nationwide, northern bobwhite populations have declined at an estimated rate of 2.4% per year (Church et al. 1993). Bobwhite populations have experienced excessive declines in Maryland and throughout the southeast (Brennan 1991, Church et al. 1993, Maryland Department of Natural Resources 1999). Maryland's estimated annual bobwhite harvest has declined an estimated 95% from 1975 to 1997 (Maryland Department of Natural Resources 1999). Several possible factors may explain why bobwhite populations have declined, including modernization of agricultural practices (Minser and Dimmick 1988, Burger et al. 1990, Brennan 1991), predators (Mueller 1989, DeVos and Mueller 1993, Rollins and Carroll 2001, Fies et al. In Press), and weather (Speake and Haugen 1960, Speake 1990, Bridges et al. 2001).

Researchers have suggested that habitat improvements may reverse the population decline of bobwhites (Stoddard 1931:359, Rosene 1969:224, Brennan 1991). Historically, agricultural fields were small with considerable edge habitats (hedgerows and fence lines). However, modernization of agriculture has led to an increase in farm field size and removal of edges (Langer 1985), which reduced the amount of habitat available for bobwhites (Brennan 1991). One type of habitat improvement is buffer strips, also called filter strips, conservation buffers, or transitional bands. Establishment of buffer strips is a practical, economical, and effective technique for managing northern bobwhite habitat (Puckett et al. 2000). Recently, federal farm programs, such as the Conservation Reserve Program (CRP), have compensated private landowners for providing buffer strip habitat (Isaacs and Howell

1988). In addition, the United States Department of Agriculture has developed a National Conservation Buffer Initiative with the goal of establishing 2 million miles of buffer habitat by the year 2002.

Researchers have studied the effects of buffer strips on wildlife, particularly bobwhites. For example, Rosene (1969:286) found that buffer strips between forests and planted crops produced more food and cover for bobwhites. Buffer strips provided bobwhites with nesting cover and insects in summer, and seeds in winter (Rosene 1969:289). Stinnett and Klebenow (1986) found California quail (*Callipepla californica*) preferred buffer strip habitats to other habitats throughout the year. Puckett et al. (2000) reported buffer strip drainage ditches received more use than non-buffer strip ditches in North Carolina.

Given the dramatic declines in bobwhite populations, some managers have used pen-raised bobwhites to augment wild populations. Pen-raised bobwhites are hatched and reared in captivity and later released into the wild. The release of pen-raised bobwhites to augment wild populations is generally considered unjustified by biologists (Beuchner 1950, DeVos and Mueller 1989, DeVos and Speake 1995, Fies et al. In Press); however, it is often accepted as a common management technique to facilitate a greater harvest (DeVos et al. 1991, Mueller et al. 1997). Only recently have the interactions of released bobwhites on native bobwhite populations been evaluated. Some researchers have found no difference in habitat use (DeVos and Speake 1993) and home range (DeVos and Speake 1993, Mueller et al. 1997) between pen-raised and wild bobwhites.

We estimated survival and home range for pen-raised northern bobwhites in habitat with buffer strips (treatment) and without buffer strips (control). The use of buffer strips by pen-raised bobwhites and the effect they have on survival is unknown. Therefore, we tested the null hypothesis that bobwhite survival and home range would be the same on study areas with and without buffer strips.

STUDY AREA

Our study area consisted of 11 farming units; 4 farms (Collins, Merrill, Sandhill, and Storr) had buffer strips, 5 farms (Lowe, McCollister, Mowbray, Fork Neck, and Willey) had no buffer strips, and 2 farms (Cephas and Walnut Hill) had areas with and without buffer strips. All farming units were on Tudor Farms or adjacent farms leased by Tudor Farms. Tudor Farms is about 3,900 ha and is a private game and wildlife management area located in Dorchester County on the Eastern Shore of Maryland. The management area consists of 1,608 ha of wetlands, 1,301 ha of forests and forested wetlands, 567 ha of agriculture and upland wildlife cover, and 421 ha of fresh and tidal water.

Tudor Farms has developed and annually maintains about 48.6 ha of buffer strips. The buffer strips are designated areas of planted vegetation established between croplands and forests to provide additional

wildlife habitat. This area buffers about 11.5 linear km of agricultural edge. Buffer strip widths averaged 36 m (range: 30–41 m). Mowed paths 4.6 m wide were maintained throughout the year at the immediate edge between the woods and buffer for 71% of the total linear buffered edge. Use of these paths by all-terrain vehicles, automobiles, and agricultural equipment was common on about one-third of all buffer strips with mowed paths. Prescribed burning was conducted in portions of the buffer strips annually.

Tudor Farms buffer strips were planted with a mixture of warm-season grasses, which included big bluestem (*Andropogon gerardii*), little bluestem (*Schizachyrium scoparium*), Indiangrass (*Sorghastrum nutans*), switchgrass (*Panicum virgatum*), and lovegrass (*Eragrostis* spp.). Shrubs in the buffer strips included bicolor lespedeza (*Lespedeza bicolor*), thunberg lespedeza (*L. thunbergii*), sericea lespedeza (*L. cuneata*), autumn olive (*Elaeagnus umbellata*), baccharis bush (*Baccharis halimifolia*), and bayberry (*Myrica cerifera*). Crops planted in the buffer strips included sorghum, and trailing soybeans. Few areas in the buffer strip contained invasive native vegetation. Most common annual grass and forbs were blackberry (*Rubus* spp.), goldenrod (*Solidago* spp.), ragweed (*Ambrosia* spp.), aster (*Aster* spp.), foxtail grass (*Setaria* spp.), broomsedge (*Andropogon glomeratus*), and barnyard grass (*Digitaria* spp.).

The non-buffer strip areas were fields of annually harvested agricultural crops adjacent to mixed pine and hardwood forested edge habitats. Agricultural practices on both buffer and non-buffer strip areas were typical of modern farming methods. No-till and tilled corn, soybeans, wheat, barley, and sorghum were cultivated on the area. Drainage ditches (0–3 m) were within and around some agricultural fields.

METHODS

Field Procedures

The wild bobwhite population at Tudor Farms was not sufficient to mark an adequate sample to research. Wild bobwhites did occur, however, at Tudor Farms at unknown densities. Therefore, we used pen-raised bobwhites to evaluate buffer and non-buffer strip habitats. Day-old bobwhite chicks from a Pennsylvania hatchery were raised in an indoor–outdoor holding facility in Cambridge, Maryland. When the chicks were 13 weeks old, they were released at Tudor Farms, 11.3 km from the holding facility.

We established an Anchor Covey Release System (Haaland 1996) at 18 release sites, 9 in treatment and 9 in control areas. Each release system contained a camouflaged shelter, a feeder tube (filled with wheat and sorghum), and a call box set on a nearby tree. A water tube was not provided because water was readily available in adjacent habitats. An adult male bobwhite was placed in the call box to encourage bobwhites to return to the release area. Release systems were established and maintained in good cover on the edge of forests adjacent to fields or within the buffer strips for

2 weeks. After 2 weeks, the call bird was removed from the call box and the Anchor Covey Release System was no longer maintained. All release sites were at least 520 m apart to minimize intermixing among release groups.

Initially, we radiomarked 72 pen-raised bobwhites with 6.8 g necklace transmitters (American Wildlife Enterprises, Monticello, Florida). All radiomarked bobwhites weighed >138 g, in accordance with the University of Maryland Institutional Animal Care and Use Committee guidelines (transmitter must not weigh >5% of an animal's total body weight). After all bobwhites were radiomarked, they were transported to Tudor Farms and released in a flight pen. Bobwhites were kept in the pen 8 days before release to allow for acclimation to the transmitter. Each transmitter was equipped with a mortality indicator.

The 72 radiomarked bobwhites were divided into 18 release groups. Each group consisted of 30 individuals, of which 4 bobwhites were radiomarked and 26 were not radiomarked. All released bobwhites ($n = 540$) were banded with uniquely numbered leg bands. In August 2000, 9 groups were released in treatment areas with buffer strips and 9 groups released in control areas without buffer strips. We began locating the bobwhites 24 hours after the release.

After release, the bobwhites appeared to form coveys, which were individually recognized according to daily social interactions and group movements. We defined a covey as a group of bobwhites >2 individuals. Each covey represented a single sample for home range estimates. Coveys were located 2–5 times per week, using a random sample of daily activity periods. Each covey was located ≥ 1 time per week for each AM period (pre-sunrise–1100 hours), mid-day period (1100–1400 hours), and PM period (1400 hours–post-sunset). We used the homing method (Mech 1983) to locate each marked covey, or approached the covey to within about 5 m if visual observations were not possible.

We identified the cause of mortality based on evidence at the transmitter recovery site, damage to transmitter, and criteria suggested by Dumke and Pils (1973). The causes of mortality were recorded as predation (avian, mammalian, reptilian), hunting, road kill, stress, or unknown. Because of high mortality rates, we radiomarked an additional 177 bobwhites from September 2000 to January 2001 to maintain locations for all coveys.

When mortality occurred and ≤ 2 radiomarked bobwhites remained in a covey, we reintroduced bobwhites in 1 of 3 ways. First, pen-raised bobwhites in the flight pen were radiomarked and given ≥ 24 hours to acclimate to the transmitter. These bobwhites were carried to the location of the deficient covey, and 1–3 radiomarked bobwhites were released into the existing covey. Second, we located a covey deficient of radiomarked bobwhites and used a net to capture unmarked birds. We marked and released bobwhites in the locations they were captured. Third, we used a modified Stoddard funnel trap (Stoddard 1931:442), to trap coveys in a predetermined, prebaited location

commonly used by the target covey. All trapped individuals were marked and released at the location where they were trapped.

Data Analysis

We estimated survival for bobwhites using the Kaplan-Meier staggered entry design (Kaplan and Meier 1958, Pollock et al. 1989). The staggered entry design allowed us to include additional bobwhites throughout the study, and to eliminate bobwhites that emigrated out of the treatment or control areas in which they were released. Survival was estimated in treatment and control areas. Log-rank tests were used to compare survival between bobwhites released in treatment and control areas (Pollock et al. 1989).

The computer program HOME RANGE (Samuel et al. 1985) run from ArcView geographic information system (GIS) (ESRI 1989) was used to estimate 95% minimum convex polygon (MCP) home range sizes. We developed home range estimates using data collected for the individual radiomarked bobwhites with the greatest number of survival days in each covey. We considered statistical tests to be significant at $P \leq 0.05$.

RESULTS

Although we planned to release 72 radiomarked bobwhites, 1 radio transmitter failed. Therefore, 36 bobwhites were released in treatment areas and 35 in control areas. We found that survival was greater in non-buffer strip areas than in buffer strip areas ($P < 0.001$) for the originally released bobwhites. Of the originally released bobwhites, the longest a bobwhite survived in the buffer strip areas was 26 weeks compared to 35 weeks in the non-buffer strip areas.

Because of the high mortalities of the originally released bobwhites, we released additional birds (Sep 2000–Jan 2001) for a total of 249 radiomarked bobwhites. We monitored 119 bobwhites released in buffer strips and 103 released in non-buffer strips. The remaining bobwhites ($n = 27$) moved from one treatment type to another (i.e., treatment to control or vice versa) and were censored from the data set. Log-ranked tests indicated survival was greater ($P < 0.001$) for the originally released bobwhites in non-buffer strip areas than buffer strip areas (Fig 1). We also found the survival for all quail released in non-buffer strip areas was greater ($P < 0.005$) than in buffer strip areas (Fig 2). For all bobwhites released in non-buffer strips, the longest survival was 41 weeks, while the longest survival in buffer strip areas was 27 weeks.

Predators were the primary cause of mortality (88%), followed by other causes including unknown causes (7%), stress (2%), hunting (2%), and road kill (1%) (Fig.3). Predation accounted for 97% of the mortalities in buffer strip areas and 78% in non-buffer strip areas. Avian predators were responsible for most mortalities in buffered (42%) and non-buffered (41%) areas. Mammalian predation accounted for 27% and 12% of mortalities in buffered and non-buffered areas,

SURVIVAL AND HOME RANGE OF PEN-RAISED BOBWHITES

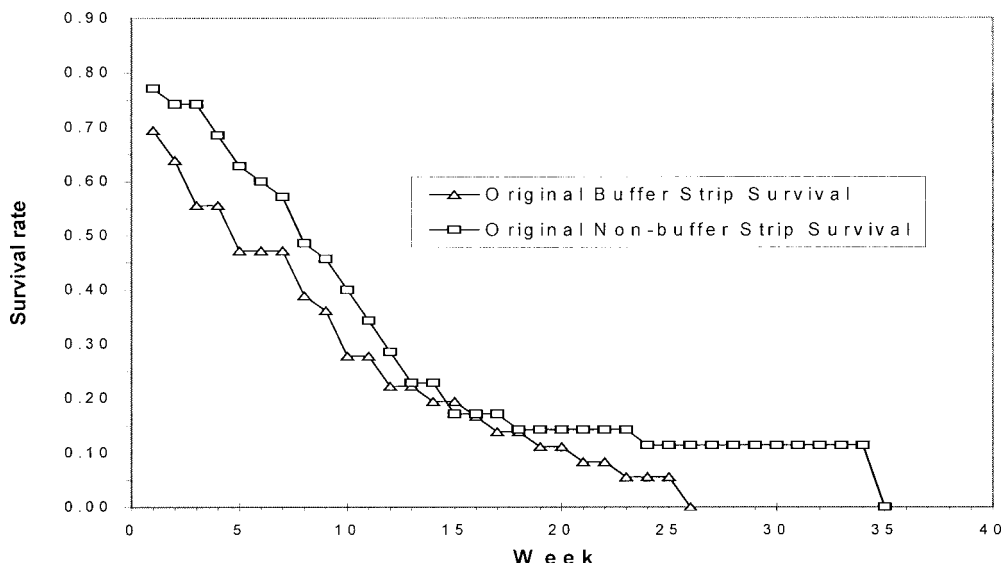

Fig. 1. Weekly survival rates of original pen-raised northern bobwhites released in buffer strip and non-buffer strip areas on Tudor Farms in Dorchester County, Maryland, Sep 2000 to Apr 2001.

respectively. While unknown predation accounted for 26% in buffered areas and 25% in non-buffered areas.

After the release, some groups of bobwhites divided into 2 or more coveys. We identified 27 coveys throughout the study period. Six coveys were eliminated from the home range analysis because they were released in a treatment area and later moved into a control area or vice versa. We estimated home range areas for 12 coveys that remained in treatment areas and 9 coveys in control areas (Table 1). Estimated home range areas for bobwhite coveys ranged from 1.7 ha to 65.8 ha ($\bar{x} = 24.2 \pm 3.5$ ha). The estimated home range of buffer strip coveys ($\bar{x} = 15.0 \pm 2.7$ ha) was smaller ($P = 0.002$) than non-buffer strip coveys ($\bar{x} = 36.4 \pm 4.9$ ha).

DISCUSSION

The survival of our original release of pen-raised bobwhites was higher than what Fies et al. (In Press) reported in Virginia. Fies et al. (In Press) reported that all radiomarked pen-raised bobwhites died within 9 days after release in Virginia. Other researchers reported higher survival rates for pen-raised bobwhites. In Alabama, DeVos and Speake (1995) reported 18% survival of pen-raised bobwhites after 22 weeks. In South Carolina, Mueller et al. (1997) found pen-raised bobwhite survival was 55% in 12 weeks. In Alabama, DeVos and Speake (1993) reported 20% of pen-raised bobwhites survived to April. None of the radiomarked bobwhites from our original release in buffer strip ar-

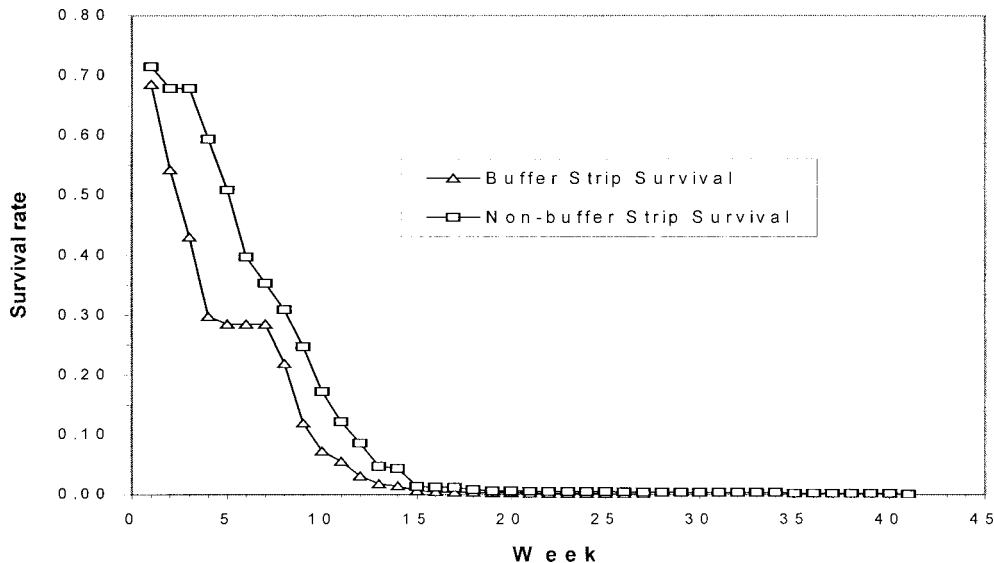

Fig. 2. Weekly survival rates of all pen-raised northern bobwhites released in buffer strip and non-buffer strip areas on Tudor Farms in Dorchester County, Maryland, from Sep 2000 to Apr 2001.

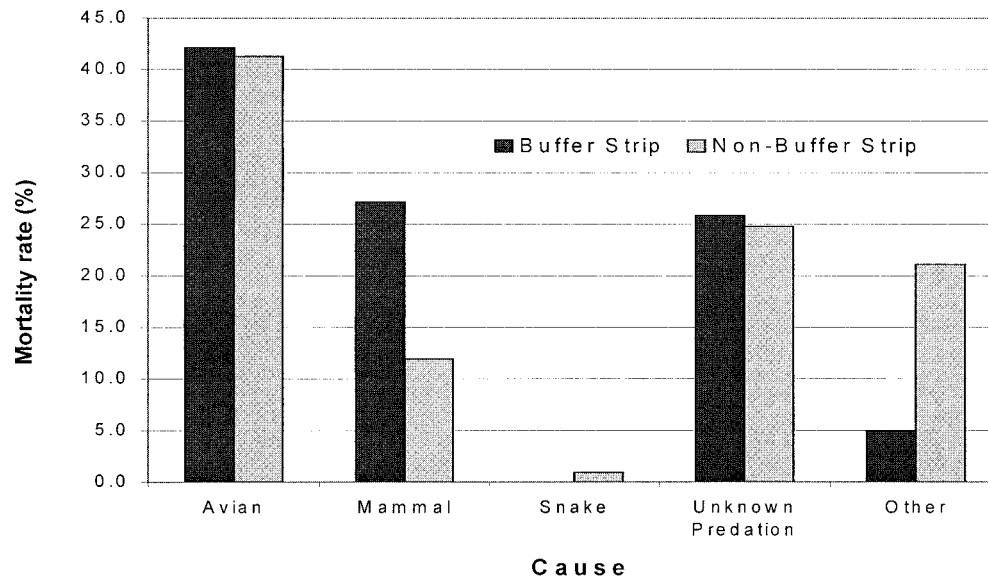

Fig. 3. Predation rates compared to other causes of mortality for pen-raised northern bobwhites in buffer strip and non-buffer strip areas at Tudor Farms in Dorchester County, Maryland, from Sep 2000 to Apr 2001.

eas survived to April, while 11% of the bobwhites in non-buffer strip areas survived to April.

The low bobwhite survival in buffer strip areas may indicate these areas lacked adequate cover for protection from predators. Predation affected bobwhite survival in both buffered and non-buffered areas. Our personal observations were consistent with those of Sisson et al. (2000) who observed many species of bobwhite predators, especially hawks and owls, were attracted to release sites to prey on released birds. Bryan and Best (1991) found that most bird species, in Iowa, preferred the habitat in buffer strips. Bryan and

Best (1991) reported total bird abundance was three times higher in buffer strips than in field plots. With an increase in the availability of prey, predators may respond with greater efficiency in their search effort for prey in buffer strip areas and less effort in non-buffer strip areas.

We found the main cause of predation was similar to those of DeVos and Speake (1995) in Alabama, and Mueller et al. (1997) in South Carolina, which indicated avian predators were the most common of the known causes of mortality to pen-raised bobwhites. However, Mueller (1984) found 68% of all predations on pen-raised bobwhites in the spring were attributed to mammalian predators, 18% to avian predators, and 14% to unknown predators. The release of other pen-raised birds such as ring-necked pheasant (*Phasianus colchicus*), and gray partridge (*Perdix perdix*) in managed areas may augment the concentration of bobwhite predators in buffer strip areas. In addition, the mowed roads maintained between the buffer and forests at the treatment locations may have caused bobwhites to be more exposed to avian predators as they traveled from the buffer to forest habitats.

The small home range sizes we found in buffer strip areas may be an indication that bobwhites did not need to move as far to acquire the food and cover resources as did bobwhites in the non-buffered areas. For example, in our study the minimum home range size of 1.7 ha was in a buffer strip area and the maximum home range size of 65.8 ha was in a covey in a non-buffered area. Overall, our average MCP home range size (24 ha) was somewhat larger than those reported in other studies (Dixon et al. 1996, Mueller et al. 1997). Dixon et al. (1996) reported a mean home range size of 11.1 ha, while Mueller et al. (1997) reported a larger mean home range size of 17.2 ha. Wild bobwhite coveys in North Carolina had mean home range sizes of 28 ha in buffer strip areas and 89 ha in non-buffer strip areas (Puckett et al. 2000). Our mean

Table 1. Minimum convex polygon (MCP) home range estimates of pen-raised northern bobwhite coveys in buffer strip and non-buffer strip areas at Tudor Farms in Dorchester County, Maryland, from Sep 2000 to Apr 2001.

Treatment type	Coveys	95% MCP (hectares)	Number of locations	Survival days	
Buffer Strip	Cephas—4	1.75	41	66	
	Sandhill—4	3.89	8	17	
	Sandhill—3	5.95	18	48	
	Cephas—3	10.01	128	167	
	Sandhill—2	13.41	54	119	
	Walnut Hill—5	13.70	25	48	
	Sandhill—1	13.75	140	163	
	Walnut Hill—1	16.69	109	86	
	Storr—1	19.94	49	81	
	Cephas—1	23.31	38	79	
	Collins—1	24.96	92	176	
	Collins—2	32.87	65	155	
	Non-buffer Strip	Fork Neck—2	15.27	43	51
		McCollister—1	23.81	53	89
Lowe—2		27.55	115	205	
Mowbray—1		30.45	36	102	
Mowbray—2		34.00	21	70	
Walnut Hill—3		40.55	121	228	
Lowe—1		44.69	104	99	
Walnut Hill—2		45.17	125	193	
McCollister—2		65.78	81	78	

home range size in buffer strip areas and non-buffer strip areas was 15 ha and 36 ha, respectively.

In addition, the timing of agricultural crop harvest may also have affected home range size. Covey movements were larger prior to crop harvest than after crop harvest. The presence of standing crops seemed to provide coveys greater protection in their daily movements. The larger range in movements could be due to reduced pressure from predators. These movements could also be imitating bobwhites during the "fall shuffle" when family groups of wild bobwhites disperse.

Although covey home ranges were significantly larger in non-buffered areas, the larger range of movement in these areas did not result in a higher mortality rate, as reported in the literature. This may indicate that predators were not as aggressively searching for prey in the non-buffer strip areas as they were in the buffer strip areas.

From these data, we suggest that the presence of buffer strips did not improve survival of pen-raised bobwhites at Tudor Farms. This data, however may indicate that buffer strips may provide suitable habitat due to the smaller home range size of coveys in buffer strips compared to those in non-buffer strips. We suggest that buffer strips did not provide adequate protection from predators. Although pen-raised bobwhites may not adequately represent wild bobwhite survival, our results may support the need to test the effects of buffer strips on wild bobwhite survival.

ACKNOWLEDGMENTS

We thank Tudor Farms Inc. for funding the study, and C. Lewis for her dedicated fieldwork and technical assistance. We thank A. Bradshaw who raised the bobwhites and provided technical assistance, and M. Airyey, A. Jolicouer, and B. Lowe for their technical assistance. We appreciate cooperation of landowners who allowed us access to their property. We also thank M. Tome and J. Wiley for review of this manuscript.

LITERATURE CITED

- Beuchner, H. K. 1950. An evaluation of restocking with pen-reared bobwhite. *Journal of Wildlife Management* 14:363–377.
- Brennan, L. A. 1991. How can we reverse the northern bobwhite population decline? *Wildlife Society Bulletin* 19:544–555.
- Bridges, A. S., M. J. Peterson, N. J. Silvy, F. E. Smeins, and X. B. Wu. 2001. Differential influence of weather on regional quail abundance in Texas. *Journal of Wildlife Management* 65:10–18.
- Bryan, G. G., and L. B. Best. 1991. Bird abundance and species richness in grassed waterways in Iowa rowcrop fields. *American Midland Naturalist* 126:90–102.
- Burger, L. W., E. Kurzejeski, T. Dailey, and M. Ryan. 1990. Structural characteristics of vegetation in CRP fields in northern Missouri and their suitability as bobwhite habitat. *Transactions of the North American Wildlife and Natural Resources Conference* 55:74–83.
- Church, K. E., J. R. Sauer, and S. Droege. 1993. Population trends of quails in North America. *Proceedings of the National Quail Symposium* 3:44–54.
- DeVos, T., and B. S. Mueller. 1989. Relocating wild quail coveys: a pilot study. Pages 57–59 in C. Kyser, J. L. Landers, and B. S. Mueller, eds. *Proceedings of the Tall Timbers Game Bird Seminar*, Tallahassee, Florida.
- DeVos, T., and B. S. Mueller. 1993. Reproductive ecology of northern bobwhite in North Florida. *Proceedings of the National Quail Symposium* 3:83–90.
- DeVos, T., D. C. Sisson, and L. Brennan. 1991. Ecological impacts. Pages 27–30 in J. L. Landers, L. P. Simoneaux, and D. C. Sisson, editors. *The effects of released, pen-raised bobwhites on wild bird populations*. Tall Timbers, Inc., and The Southeastern Cooperative Wildlife Disease Study, August 16–17. Tallahassee, Florida.
- DeVos, T., and D. W. Speake. 1993. Pen-raised quail: use and abuse. Pages 35–38 in D. Sisson and A. Bruce, eds. *Proceedings of the Tall Timbers Game Bird Seminar*, Tallahassee, Florida.
- DeVos, T., and D. W. Speake. 1995. Effects of releasing pen-raised northern bobwhite quail on survival rates of wild populations of northern bobwhites. *Wildlife Society Bulletin* 23:267–273.
- Dixon, K. R., M. A. Horner, S. R. Anderson, W. D. Henriques, D. Durham, and R. J. Kendall. 1996. Northern bobwhite habitat use and survival on a South Carolina plantation during winter. *Wildlife Society Bulletin* 24:627–635.
- Dumke, R. T., and C. M. Pils. 1973. Mortality of radio-tagged pheasants on the Waterloo Wildlife Area. *Technical Bulletin Number 72*. Department of Natural Resources. Madison, Wisconsin.
- ESRI, Inc. 1989. *ARC/VIEW Version 3.2 Environmental Systems Research Institute*. Redlands, California.
- Fies, M. L., J. E. Fischer, and D. E. Steffen. 2000. Survival of game farm, F1-Wild progeny, and wild-relocated northern bobwhites using two release methods. *Proceedings of the Annual Conference of the Southeastern Association Fish and Wildlife Agencies* 54:IN PRESS.
- Haaland, R. 1996. Putting quail back into quail hunting. *Quail Unlimited Magazine* 15:78–80.
- Isaacs, B., and D. Howell. 1988. Opportunities for enhancing wildlife benefits through the Conservation Reserve Program. *Transactions of the North American Wildlife and Natural Resource Conference* 53:222–231.
- Kaplan, E. L., and P. Meier. 1958. Nonparametric estimation from incomplete observations. *Journal of American Statistical Association* 53:457–481.
- Langer, L. L. 1985. An economic perspective on the effects of federal conservation policies on wildlife habitat. *Transactions of the North American Wildlife and Natural Resources Conference*. 50:200–209.
- Maryland Department of Natural Resources. 1999. *Game Report: annual report 1998–1999*. Maryland Department of Natural Resources. Annapolis, Maryland.
- Mech, L. D. 1983. *Handbook of animal radio-tracking*. University of Minnesota Press, Minneapolis.
- Minser, W., and R. Dimmick. 1988. Bobwhite quail use of no-till versus conventionally planted crops in western Tennessee. *Journal of Soil and Water* 43:270–272.
- Mueller, B. S. 1984. Final Report: an evaluation of releasing pen-raised quail in the fall and spring. *Quail Unlimited Magazine* 2:6–8.
- Mueller, B. S. 1989. The effects of hawks and owls on bobwhite quail. *Quail Unlimited Magazine* 8(3):8–12.
- Mueller, B. S., L. Robinette, and J. Wilson. 1997. Progress report number 2: a study to determine the impacts of pen-raised bobwhites on native quail populations. Clemson University, Clemson, South Carolina.
- Pollock, A. H., S. R. Winterstein, C. M. Bunck, and P. D. Curtis. 1989. Survival analysis in telemetry studies: the staggered entry design. *Journal of Wildlife Management* 53:7–15.
- Puckett, K. M., W. E. Palmer, P. T. Bromley, J. R. Anderson,

- and T. L. Sharpe. 2000. Effects of filter strips on habitat use and home range of northern bobwhites on Alligator River National Wildlife Refuge. *Proceedings of the National Quail Symposium* 4:26–31.
- Rollins, D., and J. P. Carroll. 2001. Impacts of predation on northern bobwhite quail and scaled quail. *Wildlife Society Bulletin* 29:39–51.
- Rosene, W. 1969. *The bobwhite quail: its life and management*. Rutgers University Press. New Brunswick, New Jersey.
- Samuel, M. D., D. J. Pierce, E. O. Garton, L. J. Nelson, and K. R. Dixon. 1985. User's manual for program Home Range. *Forestry and Wildlife Range Experimental Station Technical Report 15* (revised). University of Idaho, Moscow.
- Sisson, D. C., D. W. Speake, and H. L. Stribling. 2000. Survival of northern bobwhites on areas with and without liberated bobwhites. *Proceedings of the National Quail Symposium* 4:92–94.
- Speake, D. W. 1990. Factors regulating bobwhite populations in Alabama. Pages 26–29 *in* C. Kyser, J. L. Landers, and B. S. Mueller, eds. *Proceedings of the Tall Timbers Game Bird Seminar*, Tallahassee, Florida.
- Speake, D. W. and A. O. Haugen. 1960. Quail reproduction and weather in Alabama. *Proceedings of the Annual Conference of the Southeastern Association of Fish and Wildlife Agencies* 14:85–97.
- Stinnett, D., and D. Klebenow. 1986. Habitat use of irrigated lands by California quail in Nevada. *Journal of Wildlife Management* 50:368–372.
- Stoddard, H. L. 1931. *The bobwhite quail: its habits, preservation, and increase*. Charles Scribner's Sons, New York.

SURVIVAL AND FLIGHT CHARACTERISTICS OF CAPTIVE-REARED AND WILD NORTHERN BOBWHITE IN SOUTHERN TEXAS

Robert M. Perez

Texas Parks and Wildlife Department, P.O. Box 1081, La Vernia, TX 78121, USA

Don E. Wilson¹, Retired

Texas Parks and Wildlife Department, 4200 Smith School Road, Austin, TX 78744-3292, USA

Karen D. Gruen²

Texas Parks and Wildlife Department, 4200 Smith School Road, Austin, TX 78744-3292, USA

Abstract

Introductions of captive-reared northern bobwhite (*Colinus virginianus*) to bolster native populations have been largely unsuccessful. We compared the survival and flight characteristics of game-farm ($n = 46$), first-generation (F_1) ($n = 48$), wild translocated ($n = 45$), and wild native ($n = 50$) northern bobwhites. In November 1993, all birds were radio-collared, leg banded, sexed, and aged. Birds were then released on a study area in Brooks County, Texas in groups of about 15, 1 bird at a time. Upon release, the direction of departure, speed, and time required to reach cover were recorded. The mean flight speed and distance flown for wild bobwhites was significantly greater ($P < 0.01$) than captive-reared bobwhites. Wild native, wild translocated, and F_1 groups were non-randomly distributed in direction of departure at release site ($P < 0.01$). Survival of wild groups was significantly higher than captive-raised groups ($P < 0.05$). The major cause of mortality in all groups was mammalian depredation. Fifteen F_1 quail and 1 game-farm quail integrated into wild coveys. Our results re-confirm the inability of game-farm and first-generation northern bobwhites to survive in the wild, and we offer flight speed as one potential causal factor.

Citation: Perez, R. M., D. E. Wilson, and K. D. Gruen. 2002. Survival and flight characteristics of captive-reared and wild northern bobwhite in South Texas. Pages 81–85 in S. J. DeMaso, W. P. Kuvleky, Jr., and F. Hernández, and M. E. Berger, eds. Quail V: Proceedings of the Fifth National Quail Symposium. Texas Parks and Wildlife Department, Austin, TX.

Key words: *Colinus virginianus*, direction of departure, first generation, flight speed, northern bobwhite, south Texas, survival

INTRODUCTION

Since the early 1900s, captive-reared upland gamebirds have been used in numerous stocking attempts in North America. Unfortunately, these birds typically failed to survive in the wild (Buechner 1950, Robertson and Rosenberg 1988, Kennamer et al 1992). Although there has been some limited success using first-generation birds bred from wild stock or crosses between wild and captive-reared birds, survival was substantially lower than that of released wild birds (Johnsgard 1973, Prince 1988, Robertson and Rosenberg 1988). As a result, large numbers of birds must be released over time. For example, a population of ring necked pheasants (*Phasianus colchicus*) was established in the upper Gulf Coast of Texas using approximately 17,000 hybrid pheasants (wild-trapped \times pen-reared) released from 1968 through 1980 (Mabie 1980). However, Backs (1982) and Roseberry et al. (1987) found that first-generation, captive-reared northern bobwhite (hereafter bobwhite), released into the wild were unable to survive and reproduce. We found no reports of successful stocking attempts which

resulted in a viable population using first generation bobwhites.

Long term breeding of captive animals can lead to loss of vigor, reduced viability, growth rate, and fertility (Seal 1977). Some biologists hypothesize that stockings of captive-reared birds fail more often than those using wild birds because of genetic differences (Nestler and Studholme 1945). Hatchery propagation led to decreased genetic fitness in Hawaiian geese (Berger 1977) and has been cited as a potential reason for the failure of stocking attempts of many species (Griffith et al. 1989). However, Ellsworth et al. (1988) were unable to detect genetic differences between game-farm, wild, and first-generation bobwhites. At any rate, genetic differences are not the only factors influencing survival of stocked birds.

The breeding, rearing, transport, and release of captive-reared birds are multi-variate processes, and failure at any step could result in decreased survival of released birds (Dees 1994). Commonly observed reasons for such failures include lack of predator avoidance behavior, inability to recognize natural foods, and imprinting on humans (Waggerman 1968, Klimstra and Scott 1973, Berger 1977, Welty and Baptista 1988). Additionally, decreased flight speed, poor

¹ Present address: 2023 FM 1966, Maxwell, TX 78656

² Present address: 4700 Wren Wood Dr., Columbia, MO 65202

utilization of escape cover, and social hierarchy differences could decrease survival. Kassinis and Guthery (1996) examined flight behavior of wild bobwhites and reported flights averaging 31 km/hr and 47 m. These values reflect optimum adaptations to habitat structure via natural selection pressure. Because it is difficult to determine whether certain behavioral traits are learned or innate, developing husbandry techniques to increase survival is difficult.

To address this problem, we tested the following hypotheses: (1) flight speed, distance, and direction of departure at time of release for captive-reared groups of bobwhite are slower, shorter, and more varied than wild coveys; (2) survival of first generation bobwhites reared under special husbandry conditions is greater than survival of game-farm bobwhites; and (3) wild translocated and wild resident bobwhites have higher survival than both first-generation and game-farm bobwhites.

STUDY AREA

Bobwhites were released on a 202-ha pasture on a private cattle ranch located in Brooks County in the Rio Grande Plains ecological region of Texas (Gould 1975). The area was actively grazed and burned in a rotational system. Soils were moderately well drained loamy fine sand with <1% slope. Annual mean maximum and minimum temperatures for the area were 28.9° and 15.6° C, respectively and mean annual precipitation was 65.4 cm (United States Department of Agriculture 1993). The major vegetative association on the study site was a mesquite-granjeno parks (McMahan et al. 1984). Percent brush coverage varied from 5 to 10%. Predominant brush species were mesquite (*Prosopis glandulosa*), granjeno (*Celtis pallida*), and prickly pear (*Opuntia* spp), with some huisache (*Acacia farnesianna*). Surrounding pastures had 60–80% brush coverage. At the time of release, there was abundant winter bobwhite forage, including partridge pea (*Cassia fasciculata*), giant croton (*Croton* sp.), ragweed (*Ambrosia* spp.), and other forbs.

METHODS AND MATERIALS

Husbandry

We collected ninety pairs of wild bobwhite using baited funnel traps (Stoddard 1931:442) in Brooks County, Texas, during September and October 1992. All birds were individually marked with aluminum leg bands and taken to the Southwest Texas State University hatchery in Hays County, Texas. These birds were then acclimated by over-wintering, allowed to breed, and eggs were collected, stored, and incubated using standard husbandry techniques (Dees 1994). However, from the time of hatch to release, human contact was kept to a minimum to avoid imprinting. Hatchery personnel wearing a dark coat moved chicks from the incubator to brood rooms under low blue light conditions. Food and water were provided automatically. At 8-weeks of age, chicks were allowed access to 3.6 ×

2.4 × 28.3 m flight pens, which were protected from disturbance by a visual barrier. From this point until release, birds interacted with humans once every few days when water and food supplies were replenished (Dees 1993).

Data Collection and Analysis

We used northern bobwhite in 4 groups of 50 as follows: (1) captive-reared first generation birds (F₁) produced from wild parents, (2) captive-reared birds (GF) from a commercial game-bird farm, (3) resident wild birds (WR) trapped on the study area, and (4) translocated wild birds trapped approximately 35 km from the study site (WT). The age and sex of each bird was determined. All birds were then fitted with uniquely numbered aluminum leg bands and 6 g neck-lace radio transmitters (Holohil Systems Ltd., model RI-2B). First-generation birds were collected from the flight pens before sunrise on 9 November 1993, placed in groups of 15 in standard cardboard quail shipping cartons, immediately transported to the study area, and released. Game-farm birds were delivered from a game bird breeder in Henderson, Texas, transported to the study area, and released on the same date. Resident wild birds were trapped and released at the trap site on 8 November 1993. Translocated birds were trapped from 10–12 November 1993 on a ranch located about 35 km from the study site. All birds were released on the study area in groups of about 15, 1 bird at a time. Birds within groups were kept out of visual, but not auditory, contact with the bird being released. Flight speed, time required to reach cover, and direction of departure were determined for each bird.

Flight speed was recorded with a Doppler radar gun. Time of flight was recorded with a stopwatch. Speed and time were used to estimate distance flown. Differences in speed and distance flown, by age, sex, and group were determined using ANOVA (SAS 1989). Direction was recorded as clockface vectors. The first bird released from each unit was assigned the direction of 90° and subsequent birds were recorded in 30° sectors (91–120°, 121–150°, etc.). To determine whether the departure direction was significantly non-random, we analyzed the data with a circular distribution statistic or *V test* at the *P* < 0.01 level (Zar 1984) as follows:

$$V = R \cos(\bar{a} - u_0)$$

Where *R* = mean vector length, \bar{a} = mean angle, and *u*₀ = predicted mean angle. Length (*R*) is a measure of concentration and varies from 0 (data are too dispersed to describe a mean direction) to 1.0 (data are all concentrated in the same direction).

Telonics receivers (model TR-2) and scanners (model TS-1) were used to locate each bird daily for the first 15 weeks of the study. Thereafter, birds were located twice weekly. Whenever possible, the cause of death was determined by field signs left at the kill site, bird remains, and post-mortem transmitter condition (DeVos and Speake 1995). Monitoring ended after 21 weeks (3 April 1994). A chi-squared goodness of fit

SURVIVAL AND FLIGHT CHARACTERISTICS OF BOBWHITES

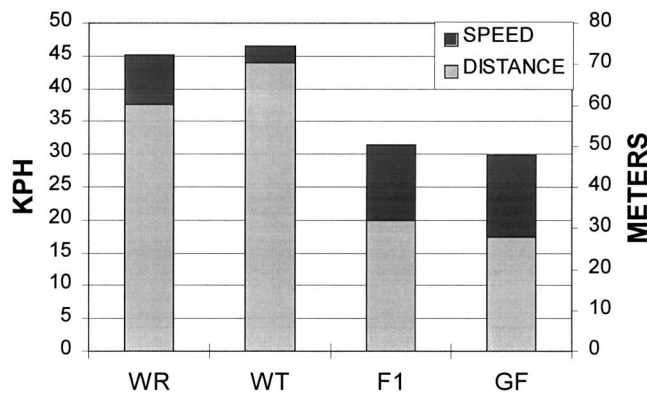

Fig. 1. Mean flight speeds and mean distances flown for wild resident (WR), wild translocated (WT), first-generation (F₁), and game-farm (GF) groups of northern bobwhite released in Brooks County, Texas, 1993.

test (Zar 1984) was used to compare avian and mammalian mortality among groups. The LIFETEST procedure in SAS (1989) was used to analyze survival among groups at the $P < 0.01$ level. Birds with transmitter failure or birds harvested by hunters were included in the analysis as right-censored data (SAS 1989). Differences between groups were tested using log-rank tests. The ranked data were used to create 2 by 2 contingency tables, which were compared using an approximate Chi-square test statistic (Zar 1984, Pollock et al. 1989). The comparison-wise error rate was set at 0.008 so that the experiment wise error rate would be 0.05.

RESULTS

Flight Characteristics

We found differences in flight speed ($F = 33.28$, 3 df, $P = 0.0001$) and distance flown ($F = 22.90$, 3 df, $P = 0.0001$) by group, but no differences by age or sex. The mean flight speeds (km/hr) for WR (45.2 ± 0.8) and WT (46.5 ± 0.8) groups were significantly greater ($P = 0.0001$) than flight speeds of F₁ (31.4 ± 0.9) and GF (29.9 ± 1.2) groups (Fig. 1). The mean distances flown (m) by WR (60.3 ± 4.2) and WT (70.4 ± 4.2) were significantly farther ($P = 0.0001$) than distances flown by F₁ (31.8 ± 4.6) and GF (27.8 ± 5.8) groups (Fig. 1). There were no differences in flight speed or distance flown between F₁ and GF groups or between WR and WT groups. Wild resident ($u_{0.01, 43} = 6.704$, $P < 0.0005$), WT ($u_{0.01, 48} = 4.745$, $P < 0.0005$), and F₁ ($u_{0.01, 42} = 3.714$, $P < 0.0005$) groups were non-randomly distributed in direction of departure, while GF birds were randomly distributed ($u_{0.01, 21} = 2.197$, $P > 0.01$). Resident bobwhite flew in the expected mean direction more frequently than all other groups (Table 1), and had the greatest mean vector length ($r = 0.741$) when compared to WT ($r = 0.534$), F₁ ($r = 0.360$), and GF ($r = 0.374$) groups (Fig. 2).

Table 1. Frequency of direction of departure relative to the first bird released from coveys of wild resident (WR), wild translocated (WT), first-generation F₁, and game-farm (GF) northern bobwhite quail in Brooks County, Texas, 1993.

a _i (deg) ^a	WR		WT		F ₁		GF	
	f _i ^b	Relative f _i	f _i	Relative f _i	f _i	Relative f _i	f _i	Relative f _i
0–30	1	0.02	0	0.00	6	0.14	3	0.14
31–60	4	0.09	11	0.23	6	0.14	3	0.14
61–90	29	0.67	12	0.25	12	0.29	5	0.24
91–120	2	0.05	7	0.15	3	0.07	1	0.05
121–150	2	0.05	3	0.06	1	0.02	2	0.10
151–180	0	0.00	6	0.13	1	0.02	0	0.00
181–210	0	0.00	6	0.13	6	0.14	1	0.05
211–240	2	0.05	0	0.00	1	0.02	1	0.05
241–270	0	0.00	2	0.04	0	0.00	2	0.10
271–300	0	0.00	1	0.02	3	0.07	0	0.00
301–330	3	0.07	0	0.00	1	0.02	1	0.05
331–360	0	0.00	0	0.00	2	0.05	2	0.10
n	43		48		42		21	

^a Angle.

^b Observed frequency of a_i.

Survival

Game-farm and F₁ quail reached 50% mortality in 9 and 10 days, respectively. Wild resident and WT birds reached a 50% loss in 72 and 47 days, respectively (Fig. 3). Survival at 12 weeks was similar between WR ($\hat{S} = 0.305$) and WT ($\hat{S} = 0.242$) groups, and was also similar between F₁ ($\hat{S} = 0.054$) and GF ($\hat{S} = 0.000$) groups. At the end of the monitoring period there were no surviving birds ($\hat{S} = 0.000$). We documented significant differences in survival among

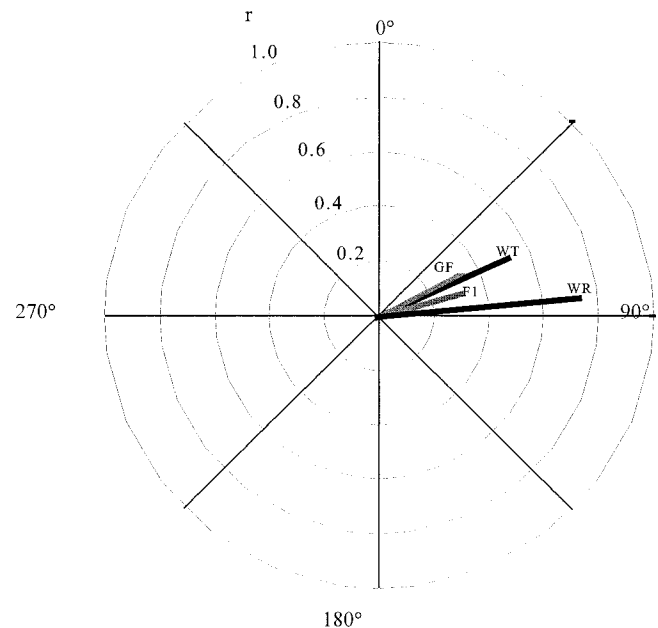

Fig. 2. Diagram of the mean direction (deg) of departure for wild resident (WR), wild translocated (WT), first-generation (F₁), and game-farm (GF) groups of northern bobwhite released in Brooks County, Texas, 1993. Length (r) is a measure of concentration and varies from 0 (data are too dispersed to describe a mean direction) to 1.0 (data are all concentrated in the same direction).

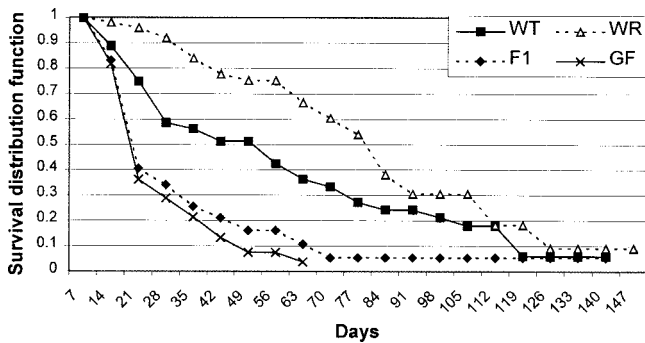

Fig. 3. Plot of the estimated survival distribution function vs. in days for wild resident (WR), wild translocated (WT), first-generation (F_1), and game-farm (GF) groups of northern bobwhite released in Brooks County, Texas, 1993.

groups ($\chi^2 = 64.118$, 3 df, $P = 0.0001$) (Fig. 3). Game-farm and F_1 birds had a significantly lower survival than wild groups at ($\chi^2 = 15.079$, 1 df, $P < 0.001$) and ($\chi^2 = 7.085$, 1 df, $P < 0.008$) respectively. There was no significant difference in survival between WR and WT ($\chi^2 = 5.038$, 1 df, $P > 0.03$) or F_1 and GF groups ($\chi^2 = 0.639$, 1 df, $P > 0.25$). However, cause of death was dependent on type of bobwhite group ($\chi^2 = 11.61$, 3 df, $P = 0.008$). Mammalian depredation was the leading cause of death in all groups. Game-farm birds experienced more avian depredation (26.1%) than WR (16%), WT (9%), and F_1 (4.3%) groups. Hunters harvested 28.9% of the resident birds and 16% of the translocated birds (Table 2). Most harvest took place after captive-reared groups had reached 50% mortality.

DISCUSSION

The mean flight speeds we recorded for WR (45 km/hr) and WT (46 km/hr) groups of northern bobwhite were consistent with the findings of Sooter (45 km/hr, 1947), but inconsistent with mean speed (31 km/hr) reported by Kassinis and Guthery (1996). The flight speeds of captive-reared GF and F_1 groups were significantly slower than wild groups in support of our initial hypothesis. Although game-farm and F_1 birds had similar mean flight speed, there were observable differences in flight characteristics. Twenty-nine percent of the game-farm birds walked away from the point of release, while only 8.5% of F_1 birds walked away. One F_1 quail was pursued by a great horned owl (*Bubo virginianus*) immediately after its release. This individual bird flew as fast (48.3 km/hr) as wild bobwhite before it escaped into heavy cover.

Upon initial release WT, WR and F_1 units were non-randomly distributed in their direction of departure while GF groups were randomly distributed. These results are inconsistent with our hypothesis that both captive-reared groups would be non-randomly distributed. However, it is important to note that at a $P < 0.05$ level GF birds would also be non-randomly distributed. Additionally, F_1 and GF birds had mean vector lengths (R) 50% less concentrated in direction than WR birds and 30–33% less concentrated than WT

Table 2. Causes of mortality (%) for wild resident (WR), wild translocated (WT), first-generation (F_1), and game-farm (GF) northern bobwhite released in Brooks County, Texas, 1993.

Source	WR	WT	F_1	GF
Avian	17	9	4.3	26.3
Mammalian	39.6	60.4	74	61.9
Starvation/Dehydration	0	0	6.5	0
Collar came off	10.4	4.6	6.5	2.3
Unknown	4	10	8.7	9.5
Shot	29	16	0	0
Total	100	100	100	100

birds. Although not statistically significant, WT birds did not fly as consistently in the same direction as WR birds. Translocated birds were released in groups composed of birds caught at separate trap sites. These units were not natural coveys and this could be one possible explanation for differences in direction of departure between wild groups. Our results suggest that native coveys used auditory cues to fly in similar directions and distances at time of release.

Despite efforts to reduce the effects of imprinting, our hypothesis that F_1 birds would have greater survival than GF birds was not supported. There was no difference in survival between F_1 and GF groups. However, WR and WT birds had greater survival than both captive-reared groups, consistent with our third hypothesis and with the results of Roseberry et al. (1987) in Illinois.

Other observational information includes behavioral traits of captive-reared birds and integration of these birds into wild coveys. Game-farm birds showed little fear of humans, rarely flushing or not flushing very far. Avian predators took more GF birds (28%) than any other group. They were frequently found at the same daily location, usually under a mature mesquite, which may have improved avian predator efficiency. First-generation birds were consumed just as quickly, but changed their location more frequently and did not have as much avian depredation (4.3%). Fifteen F_1 birds and 1 game-farm bird integrated into wild coveys. Integrated F_1 birds flushed easily, and flew as fast as wild birds, while the game-farm bird did not fly, but instead ran in the direction of the flush. Integrated birds survived longer than groups containing no wild birds. Wild resident bobwhites remained in their release groups; wild translocated quail dispersed and then integrated into wild coveys resident to the site.

The breeding, rearing, transport, and release of captive-reared birds are multi-variate processes in which a multitude of factors influence the development of behavior. From the moment an egg is placed in a hatchery it is subject to different conditions than those in the wild. Temperature, humidity and other environmental stimuli are regulated artificially in breeding facilities and are certainly not identical to natural incubation. Some researchers have found evidence that differing levels of prenatal auditory (hen contentment calls) and visual stimulation (light patterns) interfered with the emergence of species typical patterns of post-

natal development of incubator-reared bobwhite (Lickliter 1994, Sleigh and Lickliter 1996). It is unknown if prenatal stimuli at breeding facilities affect captive-reared birds any differently than the stimuli wild birds experience. We suspect that, once hatched, chicks in brood rooms and flight pens imprint on each other instead of a cock or hen, and their surroundings do not simulate native habitats. Klimstra and Scott (1973) found substantial differences between the diets of released captive-reared and wild bobwhite. They suspected that captive-reared birds might fail to recognize natural food items after their initial release. Bobwhites are highly social birds that communicate through numerous vocalizations and body language. These mechanisms have been developed over time as adaptations to the natural environment. Bobwhite depend on these vocalizations to facilitate breeding, predator avoidance and social hierarchy (Guthery 2000:5). It is unlikely that these mechanisms can be fully developed in flight pens. Although F_1 birds were subject to depredation by snakes, raccoons, and dogs, and harassment by birds of prey, their ability to avoid predators in the wild was not better than game-farm birds. Our findings reconfirm the inability of captive-reared first-generation northern bobwhite to survive in the wild and we offer flight speed as one potential causal factor.

LITERATURE CITED

- Backs, S. E. 1982. An evaluation of releasing first generation (F_1) bobwhite quail produced from wild stock. Bulletin Number 14, Indiana Department of Natural Resources, Indianapolis.
- Berger, A. J. 1977. Fitness of offspring from captive populations. Pages 315–320 in S. A. Temple, ed. *Endangered birds; management techniques for preserving threatened species*. University of Wisconsin Press, Madison.
- Buechner, H. K. 1950. An evaluation of restocking with pen-reared bobwhites. *Journal of Wildlife Management* 14:363–377.
- Dees, K. W. 1994. Productivity of wild northern bobwhite quail under a 17-hour light regime. Thesis. Southwest Texas State University, San Marcos.
- Dees, K. W. 1993. Development of hatchery techniques to produce wild bobwhite quail. Contract # 373-0505, Final report submitted to Texas Parks and Wildlife Department.
- DeVos, T. A., and D. W. Speake. Effects of releasing pen-raised northern bobwhites on survival of wild populations of northern bobwhites. *Wildlife Society Bulletin* 23:267–273.
- Ellsworth, D. L., J. L. Roseberry, and W. D. Klimstra. 1988. Biochemical genetics of wild, semi-wild, and game farm northern bobwhites. *Journal of Wildlife Management* 52:138–144.
- Gould, F. W. 1975. Texas plants—a checklist and ecological summary. Texas A&M University, Texas Agricultural Experimental Station, College Station.
- Griffith, B., J. M. Scott, J. W. Carpenter, and C. Reed. 1989. Translocations of captive-reared terrestrial vertebrates, 1973–1986. *Endangered Species Update* 8:10–12.
- Guthery, F. S. 2000. On bobwhites. Texas A&M University Press, College Station.
- Johnsgard, P. A. 1973. Grouse and quails of North America. University of Nebraska Press, Lincoln.
- Kassinis, N. I., and F. S. Guthery. 1996. Flight behavior of northern bobwhites. *Journal of Wildlife Management* 60:581–585.
- Kenamer, J. E., R. Breneman, and M. Kenamer. 1992. History pages 6–17 in J.G. Dickson, ed. *The wild turkey biology and management*. Stackpole Books, Harrisburg, Pennsylvania.
- Klimstra, W. D., and T. G. Scott. 1973. Adaptation of pen-reared bobwhites to foods in a natural environment. *Journal of Wildlife Management* 37:492–494.
- Lickliter, R. 1994. Prenatal visual experience alters postnatal sensory dominance hierarchy in bobwhite quail chicks. *Infant Behavior and Development* 17:185–193.
- Mabie, D. W. 1980. Introduction of the ring-necked pheasant to the Texas Gulf Coast. *Proceedings of the Southeastern Association of Fish and Wildlife Agencies* 35:249–255.
- McMahan, C. A., R. G. Frye, and K. L. Brown. 1984. The vegetative types of Texas including cropland. P-R Project W-107-R, Texas Parks and Wildlife Department, Austin.
- Nestler, R. B., and A. T. Studholme. 1945 The future of pen-reared quail in post-war restocking programs. *Pennsylvania Game News* 16:26–27.
- Pollock, K. H., S. R. Wintorstein, C. M. Bunck, and P. D. Curtis. 1989. Survival analysis in telemetry studies: the staggered entry design. *Journal of Wildlife Management* 53:7–15.
- Prince, H. H., P. Squib, and G. L. Belyea. 1988. Sichuans, pheasants of the future?—learning from past release programs. Pages 291–305 in D.L. Hallet, W.R. Edwards, and G.V. Burger, eds. *Pheasants: Symptoms of Wildlife Problems on Agricultural Lands*. North Central Section of The Wildlife Society, Bloomington, Indiana.
- Robertson, P. A., and A. A. Rosenberg. 1988. Harvesting gamebirds. pages 177–201 in P. J. Hudson and M. R. W. Rands eds. *Ecology and Management of Gamebirds*. BSP Professional Books, Palo Alto, California.
- Roseberry J. L., D. L. Ellsworth, and W. D. Klimstra. 1987. Comparative post-release behavior and survival of wild, semi-wild, and game farm bobwhites. *Wildlife Society Bulletin* 15:449–455.
- SAS Institute Inc. 1989. SAS/STAT user's, version 6, fourth edition, SAS Institute Inc., Cary, North Carolina.
- Seal, U. S. 1977. The Noah's ark problem: multi-generation management of wild species in captivity. Pages 303–314 in S. A. Temple, ed. *Endangered birds; management techniques for preserving threatened species*. University of Wisconsin Press, Madison.
- Sleigh, M. J., and R. L. Lickliter. 1996. Augmented prenatal auditory stimulation alters postnatal perception, arousal, and survival in bobwhite quail chicks. *Developmental Psychobiology* 30:201–212.
- Sooter, C. A. 1947. Flight of some south Texas birds. *Wilson Bulletin* 59:174–175.
- Stoddard, H. L., Sr. 1931. The bobwhite quail—its habits, preservation and increase. Charles Scribner's Sons, New York.
- United States Department of Agriculture. 1993. Soil survey of Brooks County, Texas.
- Waggenerman, G. L. 1968. Imprinting in the bobwhite quail. M.S. thesis. Oklahoma State University, Stillwater.
- Welty J. C., and L. Baptista. 1988. *The life of Birds*. Saunders College Publishing, San Francisco, California.
- Zar, J. H. 1984. *Biostatistical analysis*. Prentice Hall, New Jersey.

SURVIVAL AND HABITAT USE OF PEN-RAISED NORTHERN BOBWHITES AT CAMP ROBINSON WILDLIFE DEMONSTRATION AREA, ARKANSAS

Matthew D. Lewis

Biology Department, Arkansas Tech University, Russellville, AR 72801, USA

Steven Fowler

Department of Biological Sciences, Arkansas State University, State University, AR 72467, USA

Chris Kellner

Biology Department, Arkansas Tech University, Russellville, AR 72801, USA

James C. Bednarz

Department of Biological Sciences, Arkansas State University, State University, AR 72467, USA

ABSTRACT

Post-release survival of pen-reared northern bobwhite (*Colinus virginianus*) is often extremely low. Although predation is usually assumed to cause low survival rates, very little detailed research has been conducted into cause-specific mortality of pen-reared bobwhites in natural settings. Further, little is known about habitat selection by pen-reared bobwhites, and the relationship between habitat and survival. We report results based on 110 radiomarked bobwhites out of 2500 banded and released at Camp Robinson Wildlife Demonstration Area in Arkansas. Birds were released at 125 sites in coveys of 20 birds per site. Release sites were ranked based on habitat quality. In addition, habitat analyses were conducted over each individual's area of activity. In March 2001, when monitoring of birds ended, 6 birds remained alive. Mortality agents included avian predators (51%, $n = 49$), mammalian predators (36%, $n = 35$) and unknown predators (13%, $n = 12$). Other causes of mortality included radio collars (5%, $n = 5$) and apparent heat stress (3%, $n = 3$). Most mortality occurred within 1 month of release (66%, $n = 73$). Overall mean survival was 36.4 ± 4.3 days. We found no significant difference in length of survival among birds released at good, medium, or poor sites ($P = 0.97$). Regardless of release site, birds were located most often in shrub cover (50%, $n = 388$ locations) while the second most common habitat used was herbaceous cover (29%, $n = 230$ locations). During callback trapping in May 2001, we recaptured 14 bobwhites that were banded and released in August of 2000, and 6 wild birds, suggesting that pen-reared birds actually outnumbered wild birds.

Citation: Lewis, M. D., S. Fowler, C. Kellner, and J. C. Bednarz. 2002. Survival and habitat use of pen-reared northern bobwhite at Camp Robinson Wildlife Demonstration Area, Arkansas. Page 86 in S. J. DeMaso, W. P. Kuvlesky, Jr., F. Hernández, and M. E. Berger, eds. Quail V: Proceedings of the Fifth National Quail Symposium, Texas Parks and Wildlife Department, Austin, TX.

EFFECTS OF HURRICANE BRET ON NORTHERN BOBWHITE SURVIVAL IN SOUTH TEXAS

Fidel Hernández

Caesar Kleberg Wildlife Research Institute, Texas A&M University-Kingsville, Kingsville, TX 78363, USA

Juan D. Vasquez

Caesar Kleberg Wildlife Research Institute, Texas A&M University-Kingsville, Kingsville, TX 78363, USA

Fred C. Bryant

Caesar Kleberg Wildlife Research Institute, Texas A&M University-Kingsville, Kingsville, TX 78363, USA

Andrew A. Radomski¹

Caesar Kleberg Wildlife Research Institute, Texas A&M University-Kingsville, Kingsville, TX 78363, USA

Ronnie Howard

San Tomas Hunting Camp, Box 94, Encino, TX 78353, USA

ABSTRACT

The impacts of intense storms such as hurricanes on wildlife rarely are documented. We had the opportunity to monitor the impact of Hurricane Bret on northern bobwhite (*Colinus virginianus*) survival and reproduction in Brooks County, Texas. On 22 August 1999, Hurricane Bret struck our study area, which received >45 cm of rain and experienced wind gusts >160 km/h. We documented the survival of bobwhite adults ($n = 82$), broods ($n = 15$), and nests ($n = 4$) via radiotelemetry before and after the hurricane. Only 11 (13%) adult bobwhites were killed, with 4 killed directly from exposure to the hurricane. Broods experienced higher mortality, with 7 (47%) broods killed during the hurricane. Six of the 7 dead broods were <1 week old. Sizes of the 8 surviving broods were reduced from a mean brood size of about 11 chicks prior to the hurricane to a mean size of 4 after the hurricane ($P = 0.01$). Of the 4 nests monitored, 3 were depredated and eggs in 1 nest hatched the weekend of the storm. Hurricanes may negatively impact the survival of young (i.e., <2 weeks old) bobwhite broods.

Citation: Hernández, F., J. D. Vasquez, F. C. Bryant, A. A. Radomski, and R. Howard. 2002. Effects of Hurricane Bret on survival of northern bobwhite in south Texas. Pages 87–90 in S. J. DeMaso, W. P. Kuvlesky, Jr., F. Hernández, and M. E. Berger, eds. Quail V: Proceedings of the Fifth National Quail Symposium, Texas Parks and Wildlife Department, Austin, TX.

Key words: *Colinus virginianus*, hurricane, Hurricane Bret, mortality, northern bobwhite, survival, weather

INTRODUCTION

Natural disasters such as hurricanes are unpredictable, devastating phenomena. Hurricanes can generate winds >200 km/hr and torrential rain at a rate of 10 cm/hr. While their impact on physical structures (e.g., buildings, trees, etc.) may be readily assessed, the effects of hurricanes on wildlife remain obscure and relatively unknown. A few studies have reported the impacts of hurricanes on wildlife, namely wild turkeys (*Meleagris gallopavo*; Baumann et al. 1996) and white-tailed deer (*Odocoileus virginianus*; Labisky et al. 1999). However, to our knowledge, the effects of hurricanes on northern bobwhites have never been reported.

Hurricane Bret made landfall on the southern coast of Texas at Kennedy County on 22 August 1999 (Na-

tional Weather Service, Corpus Christi, Texas). The hurricane was classified as a Category 4 on the Saffir-Simpson Scale with peak winds of 224 km/hr. The hurricane deposited approximately 64 cm of rain in some coastal locations, but weakened as it moved westward over land.

The eye of Hurricane Bret passed over Brooks County where a radiotelemetry study on bobwhite population ecology has been ongoing since August 1998. We report the effects of Hurricane Bret on bobwhite survival based on our radiomarked population of bobwhites.

STUDY AREA

The study area is within the Rio Grande Plains ecoregion of Texas (Gould 1975). The vegetation for the ecoregion is characterized as a South Texas mixed-brush community (Scifres 1980:30). Vegetation specific to the study area consists predominantly of honey mesquite (*Prosopis glandulosa*), huisache (*Acacia*

¹ Present address: United States Department of Agriculture—Agricultural Research Services, H.K. Dupree Stuttgart National Aquaculture Research Center, P.O. Box 860, 2955 Hwy. 130E, Stuttgart, AR 72160

smallii), granjeno (*Celtis pallida*), live oak (*Quercus virginiana*), and pricklypear cactus (*Opuntia lindheimeri*). Predominant forbs include croton (*Croton* spp.), sunflower (*Helianthus annuus*), dayflower (*Commelina erecta*), and partridge pea (*Chamaecrista fasciculata*). Predominant grasses include little bluestem (*Schizachyrium scoparium*), paspalum (*Paspalum* spp.), three awn (*Aristida* spp.), gulf cordgrass (*Spartina spartinae*), King Ranch bluestem (*Bothriochloa ischaemum*), Kleberg bluestem (*Dichanthium annulatum*), sandbur (*Cenchrus incertus*), red lovegrass (*Eragrostis secundiflora*), and buffelgrass (*Pennisetum ciliare*).

Climatic conditions are classified as semi-arid, subhumid and are characterized by a high rate of evaporation (National Cooperative Soil Survey 1987). The months of May and October receive the greatest amount of precipitation (8.6–10.4 cm), and the mean annual rainfall is 57.7 cm. The 30-year mean temperature is 22° C (range 15.2–28.8° C). January is the coldest month (mean 12.2° C), and August is the hottest month (mean 29.4° C).

METHODS

We captured bobwhites using standard funnel traps and night netting during spring and summer 1999 in Brooks County, Texas. Bobwhites weighing over 150 g were fitted with a 6–7 g neck-loop radio transmitter and an aluminum leg band. We monitored bobwhites using radiotelemetry at least twice weekly during spring (Mar–Apr) and thrice weekly during the nesting season (May–Aug). This allowed timely inspections of bobwhite mortalities, nest locations, and nest fate.

On the evening of 22 August 1999, Hurricane Bret moved inland, passing through Kennedy County into Brooks County. Adult bobwhites and broods were monitored prior to the hurricane on 21 August 1999. Once the hurricane had passed, we resumed monitoring on 24 August.

We compared the number of nests found during May–October of 1999 (hurricane data) with 2000 (no hurricane) to evaluate the influence of Hurricane Bret on length of the nesting season. We evaluated the effect of added moisture generated by Hurricane Bret on weather by comparing the Modified Palmer Drought Severity Index (PMDI) for these months between years. Palmer indices (Palmer 1965) use precipitation, temperature, Thornthwaite's (1948) evapotranspiration index, runoff, soil recharge, and average regional weather conditions to quantify departures from normal weather conditions. The values for PMDI can range from ≥ 4.0 (extreme wetness) to ≤ -4.0 (extreme drought). Near normal values range from about 1.50 to -1.50 . Weather data were obtained from the National Oceanic and Atmospheric Administration's (NOAA) National Climate Data Center (<http://www.ncdc.noaa.gov>).

Because of our low sample size (<100 radio-marked bobwhites), we emphasize descriptive statistics. However, we used paired *t*-tests (Ott 1992) to analyze the change in brood size before and after the

hurricane. We used Kruskal-Wallis one-way analysis of variance by ranks test (Daniel 1987) to compare brood age in days with brood fate. Statistical results are stated as ($x \pm SD$). We considered results significant at $\alpha = 0.05$.

RESULTS

Hurricane Bret moved over our study area during the late evening hours of 22 August 1999 depositing >45 cm of rain and producing wind gusts >160 km/hr. Because South Texas rangeland is relatively flat (i.e., elevation ranging about 0–300 m above sea level), this resulted in large expanses of rangeland inundated >24 cm deep. During the hurricane, we were monitoring a total of 82 adult bobwhites, 15 broods, and 4 active nests being incubated.

Adult bobwhites were not severely impacted by the storm. Eleven (13%) adult bobwhites were killed. Of these 11, 4 bobwhites were killed directly from exposure to the hurricane, apparently by drowning. We found these 4 bobwhites intact, floating in standing water. The remains of the other 7 bobwhites suggested they had been depredated (i.e., body not intact but rather dismembered). However, we are unsure if the 7 depredated bobwhites were killed by the hurricane and subsequently scavenged by predators.

Broods suffered a higher mortality than adults, with 7 (47%) broods killed during the hurricane. There was no difference in age between surviving broods (11.8 ± 7.8 days) and dead broods (6.3 ± 4.7 days; $P = 0.19$). However, 6 of the 7 broods that died were <1 week old. The 8 surviving broods experienced a 64% reduction in size. Brood size differed before (11.2 ± 2.2 chicks) and after (4.2 ± 3.1 chicks) the hurricane ($P = 0.01$).

Three of the 4 nests were depredated sometime during the hurricane (21–23 August 1999). The eggs of the remaining nest hatched between 21 and 23 August 1999. These chicks were the youngest brood being monitored and did not survive the hurricane. We found the brood on a small "island" (<30 cm in diameter) at the base of a mesquite tree that was surrounded by water over 25 cm deep. Brood remains suggested a raptor kill because only 8 sets of chick wings and 2 sets of adult leg bones were found. This was typical of an avian kill, as the carcasses had clipped wings and bones stripped of the muscle. Because the chicks were 1–2 days old during the hurricane and thus not capable of flying, it is likely that this brood sought refuge on this small island as the water level rose, thereby facilitating depredation. The juxtaposition in which other dead broods were found after Hurricane Bret is noteworthy. Dead broods usually were found drowned in standing water, with the attending adult dead <30 cm away from the brood.

Prior to the hurricane, we found 128 nests during April–August 1999 (pre-hurricane) and 7 nests during September–October 1999 (post-hurricane; Table 1). The eggs of the last nest hatched on 21 October 1999. During 2000, we found 39 nests during April–August

HURRICANE BRET AND BOBWHITE SURVIVAL

Table 1. Comparison of number of bobwhite nests found via radiomarked bobwhites and cumulative percentage of total nests during 1999 ($n = 217$ bobwhites) and 2000 ($n = 172$ bobwhites), Brooks County, Texas. Hurricane Bret moved across Brooks County on 22 August 1999.

Month	Year			
	1999		2000	
	<i>n</i>	Cumulative %	<i>n</i>	Cumulative %
April	19	14.1	0	0.0
May	27	34.1	14	35.9
June	31	57.0	16	76.9
July	27	77.0	8	97.4
August	24	94.8	1	100.0
September	2	96.3	0	—
October	5	100.0	0	—
Total	135	—	39	—

and 0 nests during September–October. The eggs of the last nest hatched 10 August 2000. Modified Palmer Drought Severity Index was higher (i.e., more moist conditions) during 1999 compared to 2000 (Fig. 1).

DISCUSSION

Our limited data suggest that Hurricane Bret did not severely impact adult bobwhite survival, whereas broods experienced lower survival. However, the impact of Hurricane Bret on bobwhite recruitment may have been minimal due to the timing of the hurricane relative to bobwhite nesting chronology.

Peak nesting season for south Texas bobwhites is May–July (Lehmann 1984:84–89). More than 50% of the nest production in our study area occurred during April–June 1999 based on radiomarked bobwhites. These first broods may represent about 52–73% of the fall age ratio (juveniles/adult; Guthery and Kuvlesky 1998). Because bobwhite chicks can withstand the elements at approximately 5 weeks of age (Stoddard 1931), most of the 1999 broods probably were old enough (i.e., 5–15 weeks) to survive the storm. Any broods lost to Hurricane Bret may represent only a small proportion of the overall bobwhite production.

One potential benefit of hurricanes is that the added moisture may help to extend the nesting season in south Texas. Bobwhite populations can exhibit extreme variations in productivity which have been correlated with patterns and amounts of precipitation and weather (Lehmann 1984, Guthery et al. 1988, Bridges et al. 2001). Guthery et al. (1988) reported a 2-month decrease in effective breeding season in the drier western Rio Grande Plains of Texas as compared to the more mesic eastern Rio Grande Plains. They stated that the virtual cessation of laying activity in the western Rio Grande Plains during the hottest, driest months of summer (Jul–Aug) probably reflected an adaptive response of bobwhites to the harsh conditions for laying and chick survival. Our limited data (i.e., nesting data and Modified Palmer Drought Index) indicate that the moisture and subsequent improved range conditions resulting from Hurricane Bret may have extended the nesting season during 1999 as compared to 2000.

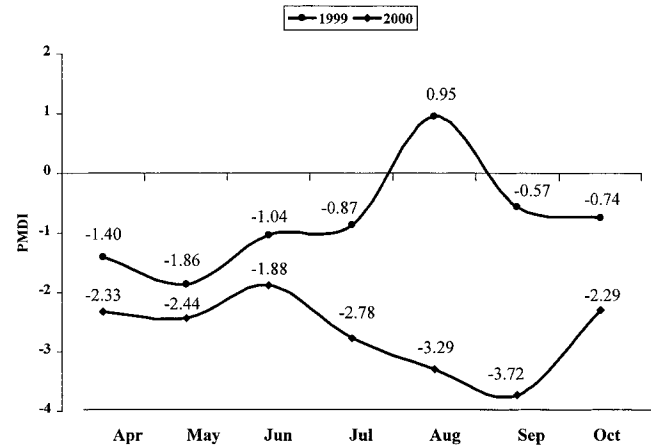

Fig. 1. Comparison of Modified Palmer Drought Severity Index (PMDI) between 1999 and 2000 during bobwhite nesting season, Brooks County, Texas. Hurricane Bret moved across Brooks County on 22 August 1999.

However, because we found drastically more nests during April–August 1999 as compared to 2000, the effects of Hurricane Bret on late nesting season (Sep–Oct) are likely confounded with other factors (e.g., heat, body condition, etc.).

We acknowledge that our low sample size and narrow scope limits our study. However, we believe our study provides insightful information on a relatively unknown subject.

ACKNOWLEDGMENTS

We wish to acknowledge the Texas State Council, South Texas, Houston, and East Texas Chapters of Quail Unlimited for supporting the South Texas Quail Research Project. We also extend our sincerest gratitude to King Ranch Inc., the Richard M. Kleberg, Jr. Center for Quail Research, the Robert J. Kleberg, Jr. and Helen C. Kleberg Foundation, Freeport-McMoran Inc., the George and Mary Josephine Hamman Foundation, the Amy Shelton McNutt Charitable Trust, the V. H. McNutt Memorial Foundation, the William A. and Madeline Welder Smith Foundation, the Bob and Vivian Smith Foundation, and all the private contributors for their generous support of our bobwhite research efforts. This is publication no. 02-105 of the Caesar Kleberg Wildlife Research Institute.

LITERATURE CITED

- Baumann, D. P., Jr., W. E. Mahan, and W. E. Rhodes. 1996. Effects of Hurricane Hugo on the Francis Marion National Forest wild turkey population. *Proceedings of the National Wild Turkey Symposium* 7:55–60.
- Bridges, A. S., M. J. Peterson, N. J. Silvy, F. E. Smeins, and X. B. Wu. 2001. Differential influence of weather on regional quail abundance in Texas. *Journal of Wildlife Management* 65:10–18.
- Daniel, W. W. 1987. *Biostatistics: a foundation for analysis in the health sciences*. Fourth edition. John Wiley and Sons, New York, New York.
- Gould, F. W. 1975. *Texas plants: a checklist and ecological sum-*

- mary. Texas Agricultural Experiment Station Bulletin 1183, College Station, Texas.
- Guthery, F. S., N. E. Koerth, and D. S. Smith. 1988. Reproduction of northern bobwhites in semiarid environments. *Journal of Wildlife Management* 52:144–149.
- Guthery, F. S., and W. P. Kuvlesky, Jr. 1998. The effect of multiple-brooding on age ratios of quail. *Journal of Wildlife Management* 62:540–549.
- Labisky, R. F., K. E. Miller, and C. S. Hartless. 1999. Effect of Hurricane Andrew on survival and movements of white-tailed deer in the Everglades. *Journal of Wildlife Management* 63:872–879.
- Lehmann, V. W. 1984. Bobwhites in the Rio Grande Plains of Texas. Texas A&M University Press, College Station, Texas.
- National Cooperative Soil Survey. 1987. Soil survey of Brooks County, Texas. United States Department of Agriculture, Washington, D.C.
- Ott, R. L. 1992. An introduction to statistical methods and data analysis. Fourth edition. Duxbury Press, Belmont, California.
- Palmer, W. C. 1965. Meteorological drought. Weather Bureau Research Paper Number 45, United States Department of Commerce, Washington, D.C.
- Scifres, C. J. 1980. Brush management: principles and practices for Texas and the Southwest. Texas A&M University Press, College Station, Texas.
- Stoddard, H. L. 1931. The bobwhite quail: its habits, preservation and increase. Charles Scribner's Sons, New York, New York.
- Thorntwaite, C. W. 1948. An approach toward a rational classification of climate. *Geographical Review* 38:55–94.

USE OF WEATHER VARIABLES FOR PREDICTING FALL COVEY CALLING RATES OF NORTHERN BOBWHITES

Ted P. Seiler

Department of Fisheries and Wildlife Sciences, University of Missouri-Columbia, 302 Anheuser-Busch Natural Resources Bldg., Columbia, MO 65211-7240, USA

Ronald D. Drobney

United States Geological Survey, Missouri Cooperative Fish and Wildlife Research Unit, 302 Anheuser-Busch Natural Resources Bldg., Columbia, MO 65211-7240, USA

Thomas V. Dailey

Missouri Department of Conservation, 1110 South College Avenue, Columbia, MO 65201, USA

ABSTRACT

A newly developed technique for estimating fall northern bobwhite (*Colinus virginianus*) density is currently being employed in parts of the United States. One aspect of this technique involves predicting morning covey calling rates (i.e., the proportion of coveys that call on a given morning). We monitored 60 radiomarked coveys, a total of 229 covey observations, to determine whether or not each covey called. Calling rates were evaluated in relation to date, year, area, temperature, relative humidity, barometric pressure, barometric status, cloud coverage, and wind speed. We used logistic regression to test 9 *a priori* models as predictive models of bobwhite covey calling behavior. Models were compared using Akaike information criteria (AICc) values to determine the relative importance of 6 different variables (wind speed, date, temperature, cloud coverage, barometric pressure, and relative humidity). An exploratory analysis was then conducted to find the best predictive model using the best subsets model selection procedure. Standard errors of the coefficients in the best models were calculated using a traditional bootstrapping technique. We found an overall calling rate of 78%. Wind speed and date were the most influential of the 6 variables used in *a priori* model tests. Nine of the 19 exploratory models fit the data reasonably well. The best model included area and wind speed as independent variables, and was a better model than the best *a priori* model. There was a difference in calling rates between areas, and as a consequence, we recommend caution in application of our models to new areas.

Citation: Seiler, T. P., R. D. Drobney, and T. V. Dailey. 2002. Use of weather variables for predicting fall covey calling rates of northern bobwhites. Pages 91–98 in S. J. DeMaso, W. P. Kuvlesky, Jr., F. Hernández, and M. E. Berger, eds. Quail V: Proceedings of the Fifth National Quail Symposium. Texas Parks and Wildlife Department, Austin, TX.

Key words: calling rate, *Colinus virginianus*, covey calls, density estimation, Missouri, northern bobwhite, weather

INTRODUCTION

Various methods have been evaluated for counting bobwhites during the fall season, including covey mapping, mark-recapture techniques, drive counts (Dimmick et al. 1982, Janvrin et al. 1991), and distance sampling (Guthrey 1988). These methods have unique biases and are often imprecise or unreliable. Norton et al. (1961) evaluated several papers and determined summer whistling cock counts did not provide reliable indices of fall populations. Distance sampling has been found to be a poor estimator of bobwhite populations when density is low (Kuvlesky et al. 1989). Drive counts can be reasonable estimators of bobwhite density (Dimmick et al. 1982, Janvrin et al. 1991) but are logistically difficult because of large labor requirements. Mark-recapture techniques have biases and assumptions which often are not met. Each of the above methods is labor and time intensive, and as a consequence, biologists and managers do not have a reliable and cost-effective technique to estimate northern bobwhite abundance during the fall season.

Fall covey calls provide another potential method for counting bobwhites (Guthrey 1986). Bobwhites form coveys beginning in fall and these coveys vocalize through winter. By determining the proportion of coveys that call and estimating average covey size, it should be possible to estimate bobwhite abundance by counting the number of coveys heard on an area. DeMaso et al. (1992) found that covey calls provided a poor density estimate when using a single observer and an unknown sampling area. Recent research indicates the morning covey call count method, which involves counting calling coveys on a known area, has potential as a density estimator (Wellendorf 2000). This method is currently being used in the southeastern United States and parts of Missouri.

To estimate bobwhite density using the covey call count technique, it is necessary to estimate the proportion of coveys that call (or calling rate) on the mornings data are collected. This paper focuses on predicting the proportion of coveys that call on a given morning.

The morning covey calling rate is defined as the

proportion of coveys from which at least 1 bird calls on a given morning. This calling rate is not constant over time (W. E. Palmer, Tall Timbers Research Station, personal communication), and we hypothesize that environmental factors, such as time of year and weather, influence this variation. No previous literature was found showing correlation of fall covey calling with environmental factors, but several papers exist relating courtship whistles from males in the summer with weather variables. Hansen and Guthrey (2001) reported whistling activity detected by observers decreased as temperature, light intensity, and wind speed increased, and increased as humidity increased. Robbins (1981) found a positive correlation between number of bobwhite whistles detected and temperature, and a negative relationship with cloud coverage. Robel et al. (1969) found significant correlation between the number of whistles heard and temperature, relative humidity, wind velocity, and date, but noted little effect from changes in barometric pressure and light intensity. Bennett (1951) reported a significant effect of temperature on bobwhite whistling behavior, while Elder (1956) reported no effect of temperature. These papers present conflicting results and none identifies whether environmental variables affect bobwhite calling behavior, or if calling activity is only altered as perceived by observers.

Using radiotelemetry, we positioned observers within hearing distance of a known covey location and observed the calling activity of that particular covey. We measured weather variables during the calling period, and built logistic regression models to determine the relationships of those variables to covey calling behavior. An exploratory model was also built in an attempt to find the best predictive model for use with the morning covey call count population estimation technique.

METHODS AND STUDY AREAS

Study Areas

The data were collected on Reform and Whetstone Creek Conservation Areas in Callaway County, Missouri. The Whetstone Creek Conservation Area study area (WCCA) has a gently rolling terrain and contains approximately 500 ha of upland habitat consisting of about 20% forest and 80% open fields. The area is intensively managed for small game, including northern bobwhites. Management practices include row cropping, discing, and burning. Reform Conservation Area (RCA) is owned by Union Electric Company and managed by the Missouri Department of Conservation. The RCA study area is approximately 500 ha, about 30% wooded and 70% open, and consists of grazed pastures, crop fields, and woody draws.

Fall Covey Call Data

Radiomarked coveys were monitored during the fall to determine whether or not each covey called (≥ 1 bird called) on each morning they were observed.

Sampling was conducted from October through mid-November 1999, and mid-September through mid-November 2000. Radiomarked coveys (≥ 2 bobwhites, at least 1 being radiomarked) were randomly selected for monitoring without replacement. Once all radiomarked coveys had been monitored, they were re-randomized and sampled again. We added new radiomarked coveys after all coveys already scheduled for sampling had been monitored. If 2 coveys chosen for sampling were within 1 km of each other, the covey chosen second was sampled the following day to insure independent data. Observers began listening ≥ 40 minutes prior to sunrise, and all covey calls were recorded until 10 minutes after the last covey call was detected, or sunrise, whichever came first.

Observers stood about 50 m from each chosen covey. Coveys located < 20 m or > 150 m from the observer were not used in the analysis. We assume 100% detection, and no observer influence on calling behavior of coveys > 20 m and < 150 m from the observer. We attempted to observe morning covey calling activity 7 days/week, weather permitting. We did not collect data during rain or during wind speeds > 33 kmph. Because only 1 to 5 birds in most coveys were radiomarked, we assume radio transmitters did not affect calling behavior of coveys. We also made the assumption that individual coveys do not inherently call at different rates.

Independent Variables

Weather variables were collected at the Prairie Fork Creek Conservation Area Weather Station each day at the hour closest to sunrise. This weather station was located about mid way between the most distant points on WCCA and RCA. All study areas were < 16 km from the weather station, so variation in weather variables from the data collected should have been minimal.

The variables collected at the weather station included wind speed (kph), temperature ($^{\circ}\text{C}$), relative humidity (%), and barometric pressure (mb Hg at sea level). Barometric status was computed by determining the trend in barometric pressure from the previous 3 hours. Percent cloud cover was estimated by each observer at sunrise and averaged to the nearest 20% to obtain a single estimate of cloud cover for each morning.

Other variables used in the analysis included date, year, and area. We categorized date into 9 weekly periods (hereafter referred to as week) to insure we had enough observations in each period to allow maximum variation in calling rates. Year was included in the analysis because the fall of 1999 was unusually warm and dry, whereas the fall of 2000 was relatively normal for central Missouri. Area was included because environmental factors may have varying influences on different areas.

Statistical Analysis

Univariate Analysis.—The response variable (call) was plotted on a graph with each independent variable

separately and visually inspected for trends. If a non-linear trend was detected, the variable was transformed from its linear form to a form that fit the data better, and tested using least squares from a univariate logistic regression.

A Wilcoxon 2-sample test (Snedecor & Cochran 1989) with significance at $\alpha = 0.05$ was performed on each independent variable with the response variable. The Wilcoxon test was used instead of a t-test because some of the variables could have had non-normal distributions. These univariate tests were performed to get a preliminary idea of the relationships between the independent variables and the dependent variable (call). Even if a variable did not show significance, it was used in the models because there was potential for significant interactions with other variables.

Logistic Regression.—Previous researchers (Bennitt 1951, Robel et al. 1969, Robbins 1981, Hansen and Guthrey 2001) reported 6 variables (temperature, relative humidity, wind speed, percent cloud cover, barometric pressure, and date) that influence male whistling during summer. We developed 9 *a priori* models using these 6 variables. Our models were analyzed using logistic regression in program SAS (SAS Institute Incorporated, 1989), with “called” or “did not call” as the binary response variable. For each *a priori* model, AICc (Akaike Information Criteria for small samples) values were calculated:

$$\text{AICc} = -2\log_e(l(\hat{O})) + 2K + 2K(K + 1)/(n - K - 1)$$

where $\log_e(l(\hat{O}))$ is the value of the log-likelihood given the data, and K is the number of parameters in the model (Burnham and Anderson 1998). These models were then ranked based on their ΔAIC values (Burnham and Anderson 1998):

$$\Delta\text{AIC} = \text{AICc}_i - \min \text{AICc}$$

where AICc_i = the AICc value for that model and $\min \text{AICc}$ = the lowest AICc value from all models. A model with a lower ΔAIC value is considered a better model.

Previous research results were not used verbatim as our models because of strong contradictions among the reported results. Instead, our models were built with only 1 variable difference between models to allow the maximum number of direct comparisons between variables. Each variable can be compared to 4 other variables using our models. The number of occasions 1 variable provided a better model than another variable was counted and used to rank the variable’s relative importance as influencing factors in fall covey calling behavior.

Exploratory Analysis.—After ranking the relative importance of the 6 variables used in *a priori* models, week, wind, temperature, relative humidity, percent cloud cover, barometric pressure, barometric status, year, and area were all used in a best subsets model selection procedure to pick the best models (Hosmer and Lemsho 1989). The variables year, barometric status, and area were not included, or were not significant in previous literature (Bennitt 1951, Robel et al. 1969, Robbins 1981, Hansen and Guthrey 2001), but

we thought they may affect calling, so we tested these variables in our exploratory analysis. These models were run in SAS and AICc and ΔAIC values were calculated for each model (Burnham and Anderson 1998). The continuous main effects variables in each model were tested for interaction effects by adding the interaction terms to the model 1 at a time (Hosmer and Lemsho 1989). Interaction terms that were significant in the models were retained in the final model. Each variable was removed, 1 at a time from each model to determine if the models improved without a particular variable (Hosmer and Lemsho 1989). If a model improved, the variable was left out. Akaike weights (W) were calculated for all models with ΔAIC values ≤ 2 to determine the probability that each particular model was the best of the tested models (Burnham and Anderson 1998):

$$W_i = \exp(-\frac{1}{2}\Delta\text{AIC}_i) / \sum \exp(-\frac{1}{2}\Delta\text{AIC}_i)$$

The best *a priori* model was compared with the best model from the exploratory procedure. The exploratory model was expected to perform better than the *a priori* model because we had little information to use when building the *a priori* models due to a lack of literature on fall morning covey calling behavior.

No validation was performed on our models because we did not want to reduce the sample size used to build the models. Instead, a traditional bootstrap was used to determine how much the models would change when built with a slightly different data set, in other words, to determine the stability of the models. Observations were randomly chosen with replacement, from the original data set of 229 observations to develop a new data set. The new data set was used to rebuild the model being tested and the intercept and coefficients were saved to a table. This process was repeated 500 times for each model with ΔAIC value ≤ 2 . The tables containing the bootstrapped intercepts and coefficients were used to determine the standard error around the intercept and coefficients for each model (Efron and Tibshirani 1986).

RESULTS

Univariate Analysis

A total of 229 observations was collected from 60 coveys in 83 days of data collection. Each covey was monitored 1–10 times, 3.8 being the mean. The covey being observed called 182 times and did not call 47 times. During our study, coveys initiated calling between 9 and 48 minutes before sunrise. More observations were obtained on WCCA (169) than on RCA (60), partly because we were able to trap more coveys on WCCA.

Calling rates were 70.0% ($\pm 0.76\%$) on RCA, 82.8% ($\pm 0.22\%$) on WCCA (Fig. 1), and the overall mean was 79.5%. On average, the calling rate on both areas was about 6% higher in 1999 than in 2000, however, there was considerable variation in the calling rate both years (Fig. 2).

A graph of calling by week shows a slight curve

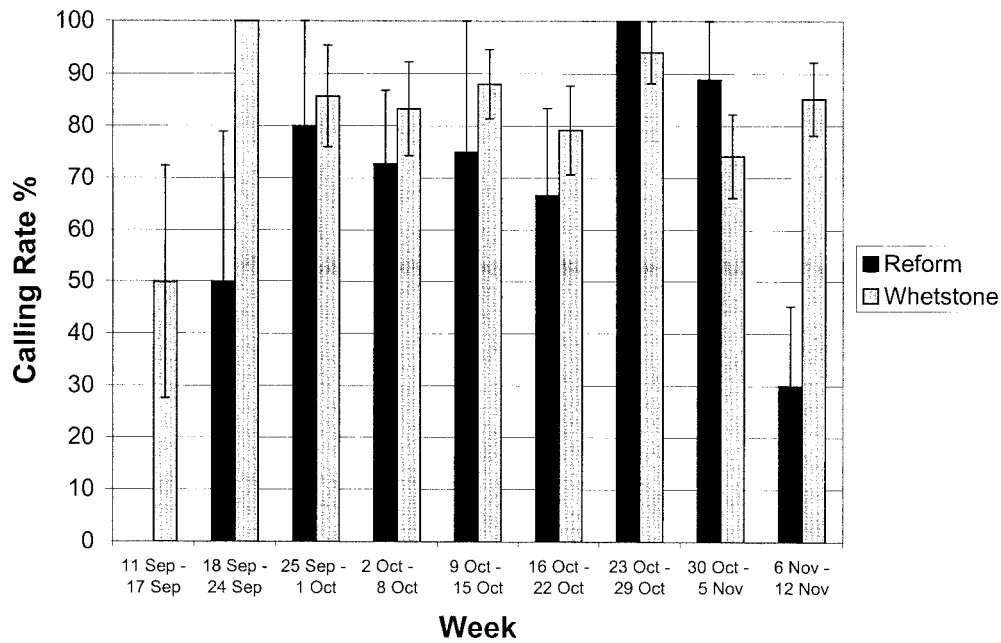

Fig. 1. Weekly morning covey calling rates (± 1 standard error) of northern bobwhite on RCA and WCCA for combined years 1999 and 2000. The calling rate is the proportion of coveys heard calling. No data were collected on RCA during the first week.

in the data (Fig. 3), therefore, week was transformed into a quadratic variable which best fit the data. In all further data analysis, week was used in its quadratic form. The peak calling period was 23–29 October with a calling rate of 96%. The period with the lowest calling rate (50%) occurred during 11–17 September.

Graphs of calling rate by wind speed and by area showed minor linear trends. Calling rate differed by area according to the Wilcoxon test ($P = 0.035$). Mean wind speed differed for calling and non-calling coveys (Table 1), although it was not significant ($P = 0.249$).

No other variables were significant in the univariate analysis.

Logistic Regression

None of the overall *a priori* models was a significant predictor of morning covey calls. For these models, AICc values ranged from 235.3 to 239.7, and the intercept only model was 234.5. The Δ AIC values ranged from 0 to 4.36 (Table 2).

Comparisons of the different models showed that

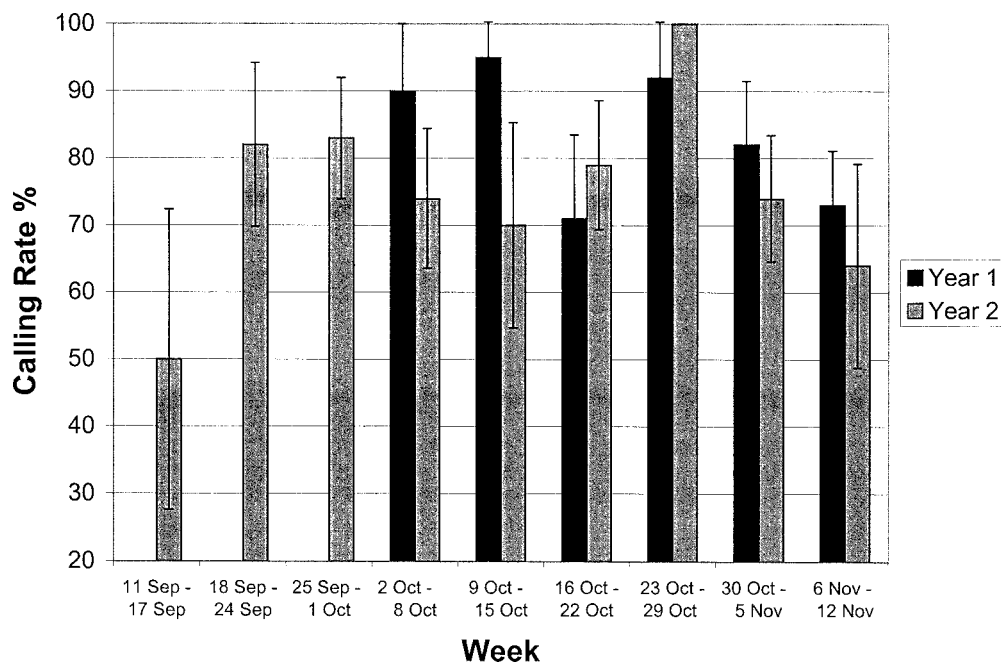

Fig. 2. Central Missouri weekly morning covey calling rates (± 1 standard error) of northern bobwhite during 1999 and 2000. In 1999, no data were collected during the first 3 weeks. The calling rate is the proportion of coveys heard calling.

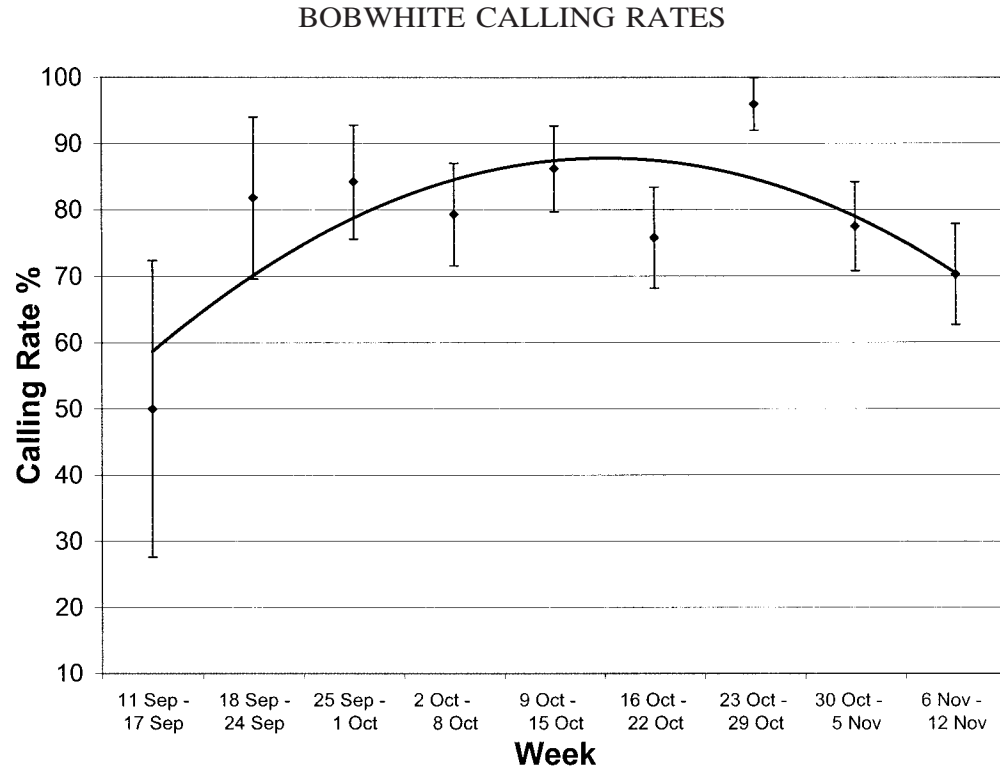

Fig. 3. Weekly morning covey calling rates (± 1 standard error) of northern bobwhite in central Missouri during 1999 and 2000 combined. The calling rate is the proportion of coveys heard calling.

wind speed was the most influential of the 6 variables included in the *a priori* models. Week was the second most influential variable, followed by percent cloud cover for predicting calling behavior. No difference was apparent between the other variables (temperature, relative humidity, and barometric pressure) in their effect on calling behavior. The top 4 models included week and wind, reinforcing the importance of these 2 variables relative to the others.

Exploratory Analysis

The exploratory models had AICc values ranging from 229.5 to 239.5, and the intercept only model was 234.5. Nine of the 19 models were reasonable according to their Δ AIC scores (Table 3). When variables were removed from the models 1 at a time, models did not improve. None of the *a priori* models was better than the best exploratory model.

A model with only area as an explanatory variable provided a good model. No other variables alone provided a model as good as area, indicating area was the most influential variable on covey calling behavior

(Table 3). Wind speed, week, and year were also influential variables. All models with some or all of these variables were good models, as long as area was included (Table 3). The addition of other variables into the model did not improve predictive power. When the variable area was removed from any of the models, it lost predictive power.

Area and wind speed were the explanatory variables in the best model, and the second best model used area and week (Table 3). The fact that area and wind provide a better model than area and week supports our findings from the *a priori* models that wind speed had greater influence on covey calling behavior than week.

The model weights show that the best model has a 16.7% probability of actually being the best model, whereas the second best model had 14.6% probability of being the best model (Table 3). Because several of the models share a similar probability of being the best, it would be best to treat them as equally likely models and use a model averaging technique when predicting covey calling rates.

Table 1. Mean values (\pm SE) of continuous variables considered for inclusion in logistic regression models comparing observations when northern bobwhite coveys called ($n = 182$) and observations when coveys did not call ($n = 47$) in central Missouri during 1999 and 2000.

Variable	Calling		Non-calling		Range	
	\bar{x}	SE	\bar{x}	SE	Min	Max
Wind Speed (kmph)	2.53	0.20	3.30	0.46	0.6	12.4
Percent Cloud Cover	31.16	2.73	35.65	5.93	0.0	100.0
Temperature ($^{\circ}$ C)	8.86	0.43	8.52	1.03	-2.9	22.1
Relative Humidity	93.01	0.88	93.34	1.66	50.0	100.0
Barometric Pressure (mb Hg)	1020.7	0.39	1020.7	0.86	1007.0	1036.0

Table 2. Ranking of *a priori* logistic regression models predicting northern bobwhite morning covey calls in central Missouri during 1999 and 2000. Each variable is included in 6 or 7 of the 9 models considered.

No.	Model	P-value	AICc	ΔAIC
1	43.850 + 0.754 * Week - 0.067 * Week ² - 0.136 * Wind - 0.004 * Cloud - 0.043 * Baropres	0.190	235.3	0.000
2	23.866 + 0.715 * Week - 0.064 * Week ² - 0.153 * Wind + 0.011 * Temp - 0.024 * Baropres	0.211	235.6	0.322
3	0.373 + 0.627 * Week - 0.057 * Week ² - 0.162 * Wind + 0.016 * Temp - 0.009 * Relhum	0.216	235.7	0.378
4	32.548 + 0.667 * Week - 0.060 * Week ² - 0.162 * Wind - 0.007 * Relhum - 0.031 * Baropres	0.224	235.8	0.488
5	2.567 - 0.186 * Wind + 0.014 * Temp - 0.016 * Relhum - 0.003 * Cloud	0.333	236.1	0.772
6	25.398 - 0.186 * Wind + 0.015 * Relhum - 0.003 * Cloud + 0.022 * Baropres	0.380	236.5	1.159
7	28.912 + 0.721 * Week - 0.064 * Week ² + 0.013 * Temp - 0.009 * Relhum + 0.004 * Cloud + 0.028 * Baropres	0.321	236.7	1.415
8	-0.641 + 0.754 * Week - 0.068 * Week ² + 0.013 * Temp - 0.002 * Relhum - 0.005 * Cloud	0.357	237.2	1.938
9	-2.340 + 0.009 * Temp - 0.005 * Relhum - 0.004 * Cloud + 0.004 * Baropres	0.911	239.7	4.361

* Week - Week² = the quadratic for week (1-9), Wind = wind speed (kmph), Cloud = % cloud cover, Baropres = barometric pressure (mb Hg), Temp = temperature (°C), Relhum = % relative humidity.

The standard errors around the intercepts and coefficients of our models determined from bootstrapping were small (Table 3), indicating none of our models varied greatly when a slightly different data set was used to build them.

DISCUSSION

Relative Importance of Variables

Comparisons with previous literature are not valid because of differences in survey methods. The previous researchers (Bennitt 1951, Robel et al. 1969, Robbins 1981, Hansen and Guthrey 2001) were working with male courtship whistling in the summer. Our study monitored morning covey calls in the fall, and the effects of weather variables may be completely different during these 2 time periods. Additionally, previous research (Bennitt 1951, Robel et al. 1969, Robbins 1981, Hansen and Guthrey 2001) studied the number of calls heard by observers, whereas our study evaluated the presence or absence of calling activity of individual bobwhite coveys. Some of the weather variables measured may affect the ability of observers

to hear morning covey calls, while not affecting the bobwhite calling behavior.

W. E. Palmer (Tall Timbers Research Station, personal communication) has been studying fall morning covey calls in the southeast United States and found that date was an influential variable on their study areas. Our results showing significant influence of week on covey calling activity concur with Palmer's findings.

Extrapolation to New Areas

The area effect we observed on bobwhite calling might be due to a variety of differences between areas. One potential difference is bobwhite density, which was suggested by W. E. Palmer (Tall Timbers Research Station, personal communication) as one of the most important variables influencing covey calling. Because we wanted a model for use with a density estimation technique, it was not practical to include bobwhite density in the model, therefore we did not measure bobwhite density on our areas. We were, however, able to trap and radiomark 43% more coveys on WCCA than on RCA with equal trapping effort, and this great-

Table 3. The 9 best (of 19) logistic regression models that explained the effects of weather variables on morning covey calling rate of northern bobwhite in central Missouri during 1999 and 2000. All models are designed to predict the probability that a covey will call.

No.	Model	P-value	-2log _e (1(Ö))	AICc	Weight
1	1.1013(0.0149) + 0.7483(0.0163) * Area - 0.1495(0.0040) * Wind	0.029	225.416	229.468	0.167
2	-0.7930(0.0503) + 0.7398(0.0191) * Week - 0.0681(0.0017) * Week ² + 0.7715(0.0165) * Area	0.032	223.637	229.742	0.146
3	1.3606(0.0184) - 0.4214(0.0167) * Year + 0.7553(0.0166) * Area - 0.1572(0.0041) * Wind	0.035	223.893	229.998	0.128
4	-0.4006(0.0481) + 0.6518(0.0172) * Week - 0.0600(0.0015) * Week ² + 0.7830(0.0162) * Area - 0.1175(0.0039) * Wind	0.033	221.976	230.151	0.119
5	0.8473(0.0126) + 0.727(0.0155) * Area	0.040	228.246	230.263	0.112
6	-0.2985(0.0502) + 0.6848(0.0179) * Week - 0.0660(0.0016) * Week ² + 0.7805(0.0169) * Area - 0.4261(0.0175) * Year	0.038	222.309	230.484	0.101
7	0.1585(0.0557) + 0.5794(0.0188) * Week - 0.0564(0.0017) * Week ² + 0.7913(0.0181) * Area - 0.1233(0.0043) * Wind - 0.4468(0.0178) * Year	0.036	220.526	230.790	0.086
8	1.0684(0.0175) + 0.7319(0.0165) * Area - 0.3778(0.0162) * Year	0.065	227.000	231.052	0.076
9	-1.2667(0.0677) + 0.7051(0.0192) * Week - 0.0634(0.0017) * Week ² + 0.7777(0.0163) * Area - 0.1417(0.0042) * Wind + 0.0154(0.0009) * Temp	0.044	221.098	231.362	0.065

* Week - Week² = the quadratic for categorized weeks (1-9), Wind = wind speed (kmph), Cloud = % cloud cover, Baropres = barometric pressure (mb Hg), Status = barometric status (0 = falling, 1 = stable, 2 = rising), Temp = temperature (°C), Relhum = % relative humidity, Area = 0 (RCA) or 1 (WCCA), Year = 0 (1999) or 1 (2000).

er trapping success may be an indicator of higher bobwhite density on WCCA.

Regardless of the cause(s) of variation between areas, the importance of area as a variable in our study will make extrapolation of our models to new areas difficult. It may be necessary to build a new model for each new area prior to conducting the covey-call-count-density-estimation technique.

We recommend further research on WCCA and RCA to determine if the area effects remain constant over a period of years. More research on these 2 areas would also help determine the extent of annual fluctuations in calling rates. If calling rates fluctuate widely between years, the value of the covey call count technique as a tool for determining annual population trends would be considerably lower.

During our study all sampling was conducted in the hour before sunrise, and we had few days with wind speeds >8 kmph at that time of the day (Table 1). If we had encountered more days with high winds, wind speed may have been a more influential variable. Although we found no significant influence of other weather variables on covey calling behavior, potential effects of these variables may be apparent at more extreme levels. Therefore, our model's usefulness may be limited to days with similar weather conditions to those we encountered. We are confident, however, that these conditions are common during autumn, and our model could be used if data were collected under similar conditions.

Confidence in the Models

The usefulness of our models is questionable because none had an AICc value much lower than that of the intercept only model. Therefore, density estimates obtained by using our models may not be better than simply using the mean calling rate. Bootstrapping showed that models had little variability when rebuilt with a slightly different data set, but this stability may not be due to good predictive ability. It is possible that bobwhite calling rates do not vary greatly across the range of conditions we sampled, thereby causing the models to be stable, even though they have little predictive ability.

CONCLUSIONS

In conclusion, area, week, wind speed, and year were factors affecting bobwhite covey calling rates on our study areas. It appears that none of these variables had a strong influence on calling behavior over the range of weather conditions that we experienced. Our data indicate bobwhite calling rates varied little under normal weather conditions, which would render the mean calling rate as useful as a predictive model.

When using the morning covey call count, we recommend conducting all sampling in weather similar to conditions encountered during our study, and during the last 3 weeks in October (Julian dates 282–302). During this time, calling rates were at their highest (81.0% on RCA and 86.4% on WCCA), which lead

to minimum variation between areas. Attempting to compare call counts obtained from different areas is not advisable until the calling rate of each area is known.

Additional research is planned on RCA over the next 2 years. The data collected will be used to validate our models and to determine the importance of annual fluctuations in covey calling rates. Until further research has been conducted, we recommend using caution when interpreting data from morning covey call counts using our models.

ACKNOWLEDGMENTS

We thank M. Wallendorf for reviewing this manuscript. We thank J. Millspaugh and S. Sheriff for their help with statistical analysis. A. Akyuz helped in obtaining the weather data. We also thank R. Byrd and all of our other field assistants who were tireless in their efforts to collect the data. This is a contribution from the Missouri Cooperative Fish and Wildlife Research Unit (Missouri Department of Conservation, University of Missouri, United States Geological Survey and Wildlife Management Institute Cooperating). The Prairie Fork Trust Fund and Quail Unlimited also provided funding. The Missouri Department of Conservation allowed us access to our study areas.

LITERATURE CITED

- Bennitt, R. 1951. Some aspects of Missouri quail and quail hunting, 1938–1948. Missouri Conservation Commission Technical Bulletin Number 2.
- Burnham, K. P., and D. R. Anderson. 1998. Model selection and inference: a practical information-theoretic approach. Springer Verlag Inc. New York, New York.
- DeMaso, S. J., F. S. Guthrey, G. S. Spears, and S. M. Rice. 1992. Morning covey calls as an index of northern bobwhite density. *Wildlife Society Bulletin* 20:94–101.
- Dimmick, R. W., F. E. Kellog, and G. L. Doster. 1982. Estimating bobwhite population size by direct counts and the Lincoln index. *Proceedings of the National Quail Symposium* 2:13–18.
- Efron, B., and R. Tibshirani. 1986. Bootstrap methods for standard errors, confidence intervals, and other measures of statistical accuracy. *Statistical Science* 1:54–77.
- Elder, J. B. 1956. Analysis of whistling patterns in the eastern bobwhite, *Colinus v. virginianus* L. *Proceedings of the Iowa Academy of Science* 63:639–651.
- Guthrey, F. S. 1986. Beef, brush, and bobwhites-quail management in cattle country. Ceasar Kleberg Wildlife Research Institute Press, Texas A&I University, Kingsville.
- Guthrey, F. S. 1988. Line transect sampling of bobwhite density on rangeland: evaluation and recommendations. *Wildlife Society Bulletin* 16:193–203.
- Hansen, H. M., and F. S. Guthrey. 2001. Calling behavior of bobwhite males and the call-count index. *Wildlife Society Bulletin* 29:145–152.
- Hosmer D. W., and S. Lemshow. 1989. Applied logistic regression. John Wiley & Sons, New York, New York.
- Janvrin, J. A., E. P. Wiggers, and T. V. Dailey. 1991. Evaluation of drive counts for estimating northern bobwhite densities. *Wildlife Society Bulletin* 19:475–481.
- Kuvlesky, W. P., Jr., B. H. Koerth, and N. J. Silvy. 1989. Problems of estimating northern bobwhite populations at low density. *Proceedings of the Annual Conference of the*

- Southeast Association of Fish and Wildlife Agencies. 43: 260–267.
- Norton, H. W., T. G. Scott, W. R. Hanson, and W. D. Klimstra. 1961. Whistling-cock indices and bobwhite populations in autumn. *Journal of Wildlife Management* 25:398–403.
- Robbins, C. S. 1981. Bird activity levels related to weather. Ralph, C. J. and J. M. Scott, eds. *Studies in Avian Biology* 6:301–310.
- Robel, R. J., D. J. Dick, and G. F. Krause. 1969. Regression coefficients used to adjust bobwhite quail whistle count data. *Journal of Wildlife Management* 33:662–668.
- SAS Institute Incorporated. 1989. SAS users manual/statistics, Version 6. SAS Institute, Incorporated. Cary, North Carolina.
- Snedecor G. W., and W. G. Cochran. 1989. *Statistical Methods*. Iowa State University Press, Ames.
- Wellendorf, S. D. 2000. Factors influencing early morning covey calling in northern bobwhites. Thesis. North Carolina State University, Raleigh.

WEATHER AND AGE RATIOS OF NORTHERN BOBWHITES IN SOUTH TEXAS

Fred S. Guthery

Department of Forestry, Oklahoma State University, Stillwater, OK 74078, USA

Jeffrey J. Lusk

Department of Forestry, Oklahoma State University, Stillwater, OK 74078, USA

David R. Synatzske

Texas Parks and Wildlife Department, Artesia Wells, TX 78001, USA

James Gallagher

Texas Parks and Wildlife Department, Artesia Wells, TX 78001, USA

Stephen J. DeMaso

Texas Parks and Wildlife Department, 4200 Smith School Road, Austin, TX 78744, USA

Ronnie R. George

Texas Parks and Wildlife Department, 4200 Smith School Road, Austin, TX 78744, USA

Markus J. Peterson¹

Texas Parks and Wildlife Department, 4200 Smith School Road, Austin, TX 78744, USA

ABSTRACT

Understanding the effects of weather on quail reproduction in semiarid environments requires simultaneous consideration of temperature and precipitation data. Therefore, we used neural modeling to assess the interactive effects of summer (Jun–Aug) temperatures (monthly means of daily maxima) and seasonal precipitation (totals) on age ratios (juvenile/adult) of northern bobwhites (*Colinus virginianus*) in south Texas based on data collected during 1940–97 ($n = 35$, 23 years missing). Age ratios increased with June temperature. Ratios were insensitive to mean maximum daily temperature in July up to 36 °C, when they began to decline rapidly. Ratios were insensitive to August temperatures. Ratios increased in an asymptotic manner with fall (Sep–Nov), spring (Mar–May), and summer precipitation, and were least sensitive to fall precipitation and most sensitive to spring precipitation. Based on our analysis, temperature and precipitation influenced bobwhite production in a complex, nonlinear manner that seemed to contain thresholds and asymptotes. Low temperatures can ameliorate the negative effects of drought, and high temperatures can suppress the positive effects of precipitation. The apparent asymptotic effect of precipitation, given temperature, illustrates that assumed linearity between precipitation and production may lead to errors of interpretation and expectation for production in a particular year.

Citation: Guthery, F. S., J. J. Lusk, D. R. Synatzske, J. Gallagher, S. J. DeMaso, R. R. George, and M. J. Peterson. 2002. Weather and age ratios of northern bobwhites in south Texas. Pages 99–105 in S. J. DeMaso, W. P. Kuvlesky, Jr., F. Hernández, and M. E. Berger, eds. Quail V: Proceedings of the Fifth National Quail Symposium. Texas Parks and Wildlife Department, Austin, TX.

Key words: age ratio, *Colinus virginianus*, neural modeling, northern bobwhite, precipitation, production, reproduction, temperature, Texas, weather

INTRODUCTION

Annual and seasonal variation in precipitation explains a good deal of the variation in production and abundance of quails in semiarid environments. Kiel (1976) observed that age ratios, an index of production, were a linear function of May–July precipitation in southern Texas. Likewise, precipitation explains a

portion of the variation in productivity of scaled quail (*Callipepla squamata*; Campbell et al. 1973), California quail (*C. californica*; Francis 1970); Gambel's quail (*C. gambelii*; Swank and Gallizioli 1954), and Montezuma quail (*Cyrtonyx montezumae*; Brown 1979).

The suppressing effects of high temperatures on reproduction of bobwhites and other quails also are well established, at least in a correlative sense (Leopold 1933, Robinson and Baker 1955, Reid and Goodrum 1960, Speake and Haugen 1960, Stanford 1972). Guthery et al. (2001) provided evidence that annual

¹ Present address: Department of Wildlife and Fisheries Sciences and George Bush School of Government and Public Service, Texas A&M University, College Station, TX 77843

variation in heat loads in the Rio Grande Plains was sufficient to explain boom-bust population behavior of bobwhites in this region. Guthery et al. (2000*b*) hypothesized that global warming could reduce the percentage of hens that attempts to lay, the length of the laying season, and the number of nesting attempts; these reductions would be expected to suppress annual production.

Recently, researchers have addressed the combined effects of temperature and precipitation on production. Heffelfinger et al. (1999) determined that for Gambel's quail in Arizona, the effects of temperature and precipitation were interactive. For example, cooler temperatures could reverse the effects of low rainfall, and hotter temperatures could reverse the effects of high rainfall. Bridges et al. (2001) found that the Modified Palmer Drought Severity Index was a stronger correlate of bobwhite populations than raw precipitation in the South Texas Plains. The Palmer Index incorporates temperature, among other variables, into a precipitation-related variable.

Our objective was to further explore the interactive effects of seasonal precipitation and summer temperatures on bobwhite age ratios in a semiarid environment (South Texas Plains). We used age ratio records collected over a 58-year period and modeled these ratios based on summer temperature maxima (means) and seasonal precipitation. This effort served to place at risk the findings of Heffelfinger et al. (1999). We also developed probability distributions for the weather variables used in modeling so the likelihood of model output could be interpreted.

METHODS

The age ratio (juveniles/adult) data came from Lehmann (1984:133; 1940–1972) and records from the Chaparral Wildlife Management Area (1973–1997; Dimmit and LaSalle counties) operated by Texas Parks and Wildlife Department. Based on large samples ($\leq 18,534$), Lehmann's data before 1970 probably came from regional wing collections and were listed only as "South Texas quail." For 1970–1972, his records were from Kiel (1976). All records (Lehmann, Chaparral Area) were based on harvested bobwhites. We deleted 2 outliers (>4 SDs from the mean). With missing values in some years, the data set contained 41 age ratios obtained during 1940–1997.

We used weather records (Earthinfo, Inc., Boulder, Colorado, USA) from Falfurrias and Carrizo Springs, Texas, because these 2 stations had long-term data sets that were complete relative to other potential data sources. To obtain weather data for age ratio modeling, we used weather records from Falfurrias unless records for a particular year were missing, in which case we used records from Carrizo Springs. In some years weather records were missing from both stations. The resulting data set consisted of 35 observations with 32 weather records based on Falfurrias data and 3 on Carrizo Springs data. Variables used in modeling age ratios included mean maximum daily temperatures in

June, July, and August, and total precipitation in fall (Sep–Nov of preceding year), winter (Dec–Feb), spring (Mar–May), and summer (Jun–Aug).

We used neural modeling with back propagation of errors (Smith 1996) to develop multivariate models of the age ratio as a function of weather variables. Neural modeling is a powerful, nonparametric method of describing functional relationships. We modeled using commercial software (Neural Connections, SPSS Inc., Chicago, Illinois, USA). The model selected consisted of 7 input nodes (the weather variables), 2 hidden nodes or processing elements, and 1 output node (age ratio). We modeled on 5 randomly drawn subsets of the data (80% of data) to subjectively determine whether modeling on different portions of the data set resulted in similar projected relationships between age ratio and weather variables. Because the projections were generally similar, we report results from the model that yielded the smoothest functional relationships. This model was generated (trained) with 80% of the data, randomly drawn, and tested with the remaining 20% of the data. We generated artificial data and modeled on these data to understand how the age ratio changed with changes in an independent variable. We held other variables constant at their means within the age ratio dataset when modeling the effects of a given independent variable.

We developed beta distributions with parameters estimated by the method of matching moments (Evans et al. 1993) to describe weather features from the Falfurrias station. We used the beta distribution because of its flexibility and simplicity (2 parameters) and because this distribution has served as the basis for stochastic modeling of bobwhite dynamics (Guthery et al. 2000*a*). The probability distributions presented here could be used in the Guthery et al. (2000*a*) model. The weather data were collected over 1908–1997 with 11 years missing ($n = 79$). An outlier for fall precipitation was removed, resulting in $n = 78$ for that season. Also, the beta distribution failed to adequately describe June temperature records, so we used the normal distribution for this month.

RESULTS

The linear correlation between observed age ratios and those predicted by the neural model was $r = 0.77$ ($n = 28$) for the training data and $r = 0.55$ ($n = 7$) for the validation data. When the model was applied using mean values for all weather variables, it predicted an age ratio of 2.21 juveniles/adult, which compared with the mean estimated from the data of 2.45 ± 0.29 (SE) juveniles/adult. These results indicated the neural model identified relationships in the data, but that a large percentage of variation in the data remained unexplained.

The simulated relationships between the age ratio and temperature and precipitation variables were developed on the same x - y scales (Figs. 1 and 2) so that sensitivity of age ratio to a variable could be estimated by the ranges of predictions (larger range, more sen-

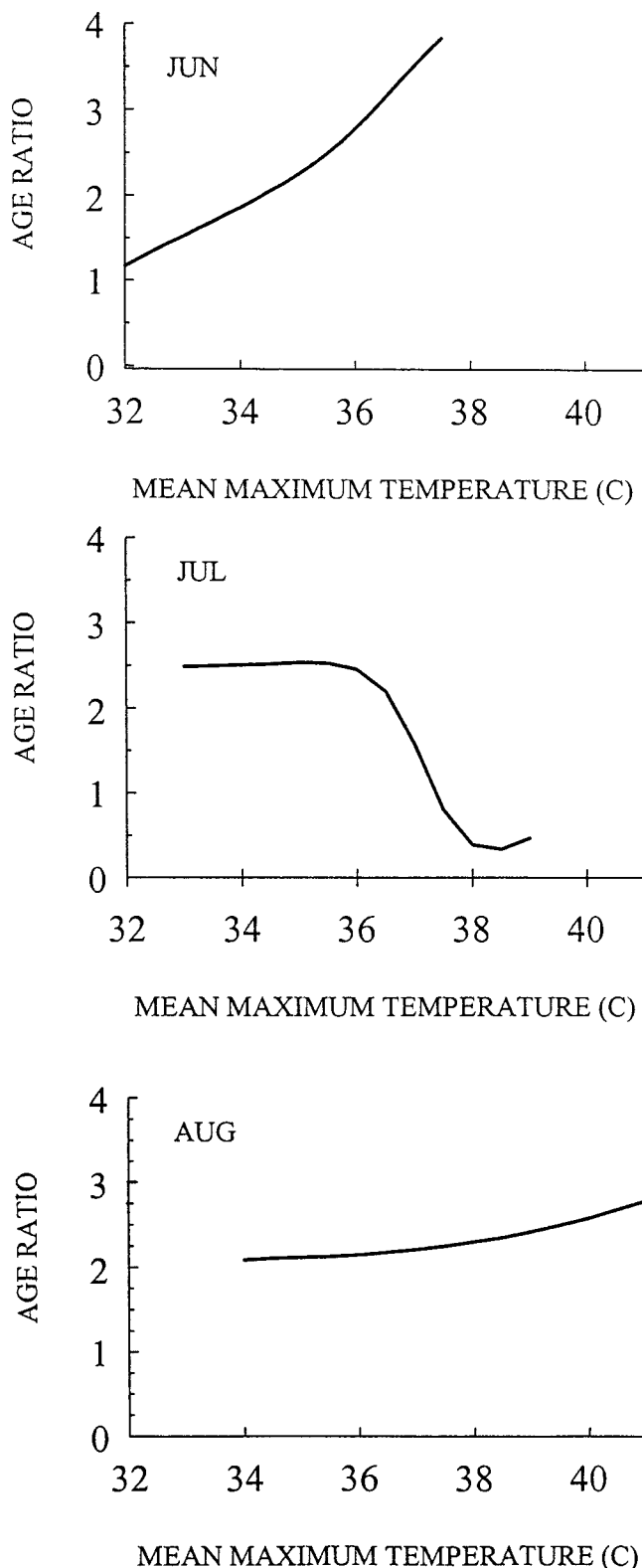

Fig. 1. Neural model predictions of northern bobwhite age ratios in south Texas as a function of mean maximum temperatures in June, July, and August during 1940–1997 (23 years missing). The predictions were generated for any 1 variable by holding values for other variables constant at their means in the dataset. Independent variables included mean maximum temperatures and precipitation (mm) for winter, spring, summer, and fall.

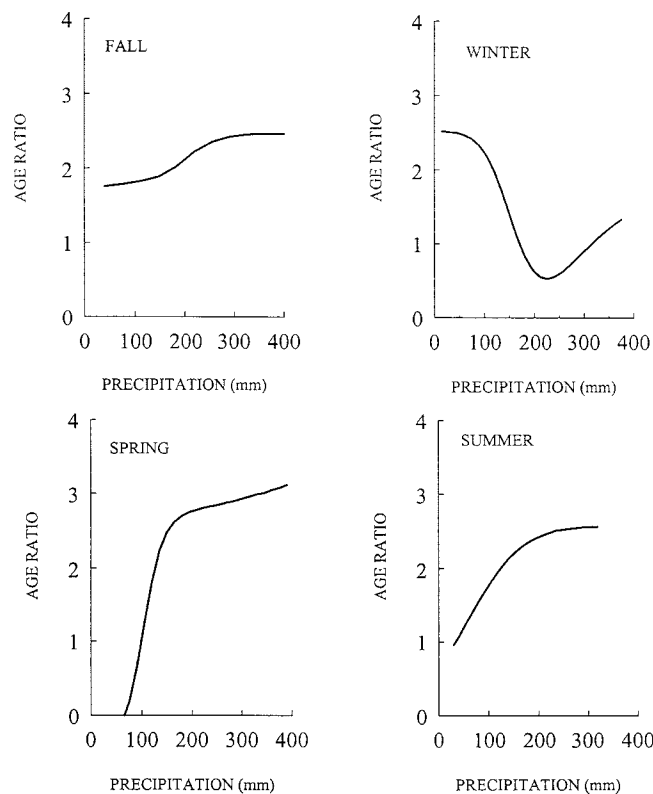

Fig. 2. Neural model predictions of northern bobwhite age ratios in south Texas as a function of total seasonal precipitation during 1940–1997 (23 years missing). The predictions were generated for any 1 variable by holding values for other variables constant at their means in the dataset. Independent variables included mean maximum temperature in June, July, and August and precipitation for winter, spring, summer, and fall.

sitivity). With other variables held constant at their means, the age ratio increased with June maximum temperatures within the range of observed values (32–38 °C). For July temperatures, however, the ratio was insensitive to temperature up to a threshold of about 36 °C, at which point productivity seemed to collapse. There was a weak tendency for the age ratio to increase with August temperatures, but the ratio was insensitive to August temperatures in comparison with June and July temperatures.

The relationships between seasonal precipitation and the age ratio revealed a common pattern for fall, spring, and summer precipitation: the age ratio increased curvilinearly and monotonically with precipitation and the ratio was somewhat insensitive to higher quantities of precipitation (Fig. 2). In other words, the rate of increase in the age ratio decelerated with increasing amounts of precipitation, resulting in an approximate asymptote for fall and summer precipitation. The modeled response to winter precipitation was a complex, curvilinear effect with high predicted ratios at low and high amounts of winter precipitation and the low predicted ratio at intermediate amounts. The age ratio appeared to be least sensitive to fall precipitation and most sensitive to spring precipitation.

Because the age ratio seemed sensitive to July temperatures and spring precipitation, we plotted mod-

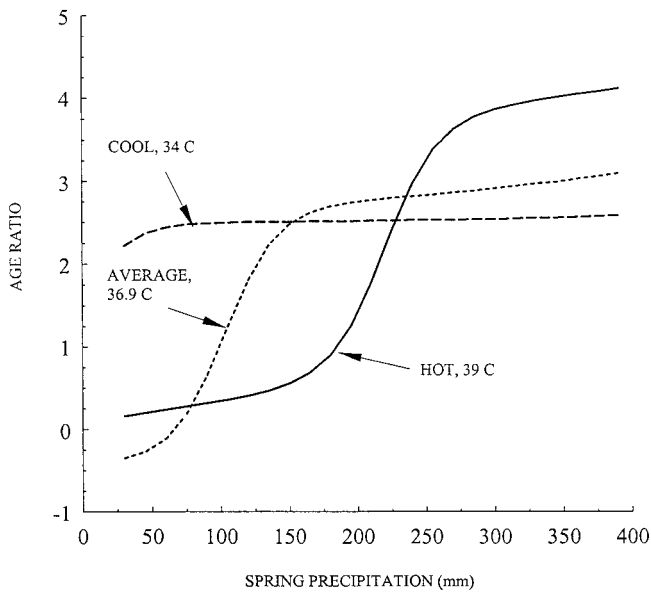

Fig. 3. Neural model predictions of northern bobwhite age ratios in south Texas as a function of spring precipitation and July temperatures (mean maximums, °C) during 1940–1997 (23 years missing). The predictions were generated by holding mean maximum temperatures in June and August and total precipitation in winter, summer, and fall constant at their means in the dataset.

el predictions at 3 arbitrary July temperatures as a function of spring precipitation (Fig. 3). This is a method of perceiving different portions of a multidimensional response surface in 2 dimensions; the remaining variables were held constant at their means. During cool Julys, the age ratio was insensitive to the amount of spring precipitation and tended to be above average. The ratio increased in a logistic fashion when mean maximum temperatures in July were average. At spring precipitation values exceeding 150 mm, the age ratio was somewhat insensitive (increased at a slow rate) to increasing precipitation. A similar, logistic-like effect was estimated for hot Julys, but peak production occurred at about 275 mm (10.8 inches) of spring precipitation and then stabilized.

The results given above need to be interpreted in the context of the probabilities associated with weather events that may inhibit or foster production as indexed with an age ratio. For example, even if cool temperatures in July could override the effects of low spring rainfall (Fig. 3), such temperatures would occur with low probability (Fig. 4). Mean maximum July temperatures below 34 °C were estimated to occur in 3 of every 100 years, whereas means below 35 °C were estimated to occur in 15 of every 100 years. Consider also the high age ratios predicted for hot Julys with high amounts of spring precipitation (Fig. 3). July temperatures equaling or exceeding 39 °C with spring rainfall exceeding 300 mm (11.8 inches) were estimated to occur in 2 of every 1,000 years, if spring rainfall is independent of July temperatures. This expected frequency is based on the product of probabilities from the July temperature (Fig. 4) and spring precipitation (Fig. 5) probability distributions.

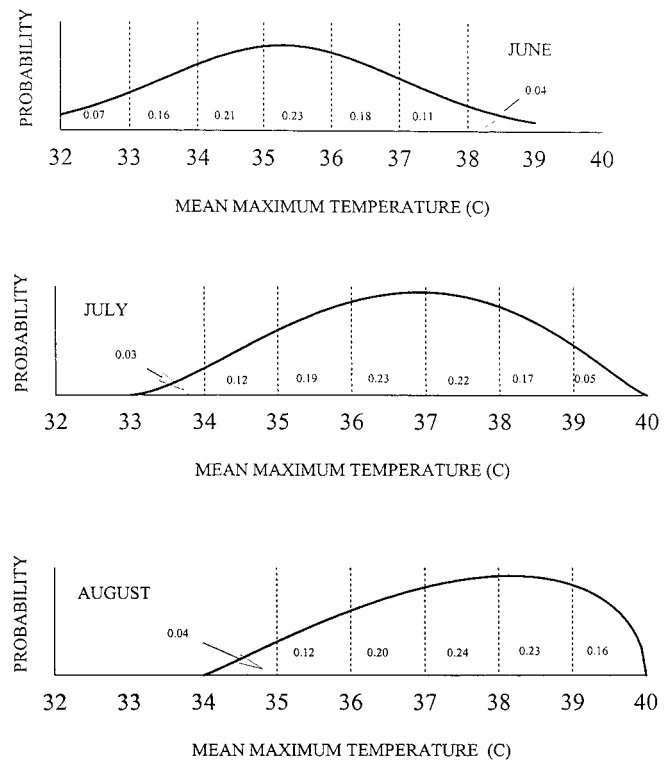

Fig. 4. Estimated probability distributions for mean maximum temperatures in south Texas for June, July ($\alpha = 2.5880$, $\beta = 2.2470$), and August ($\alpha = 2.1145$, $\beta = 1.4954$) during 1908–1997 (11 years missing; Falfurrias station). Numbers under the curves give approximate probabilities that mean maximum temperatures fall within the indicated range. June temperatures were modeled under the normal distribution ($\bar{x} = 35.3$, $SD = 1.77$) because of a poor fit to the beta distribution; probabilities reflect the normal distribution truncated to the range of observed temperature values.

DISCUSSION

Throughout this manuscript we have discussed the age ratio as an index of production. We acknowledge that it may be an ambiguous index because an age ratio is a complex function of 9 demographic variables and 1 function (Guthery and Kuvlesky 1998). This complexity means that there are many demographic and time-based processes that may lead to the same age ratio. Other indices of production, such as the percentage of juveniles in a population or percent summer gain, are equally ambiguous. This statement is true because age ratio, percent juveniles, and percent summer gain are mathematically related such that any one can be derived from any other (Guthery 2002). Converting the age ratio or percent juveniles to percent summer gain requires knowledge of breeding-season survival of adults. Otherwise, all of the production indices discussed above depend on the same driving variables. So any commonly applied index of production contains the same ambiguity because all are tautologically equivalent.

Weather (temperature, precipitation) alters age ratios through effects on demographic variables such as the probability of nest success, proportion of hens that lays, number of nesting attempts per hen, clutch size,

BOBWHITE AGE RATIOS

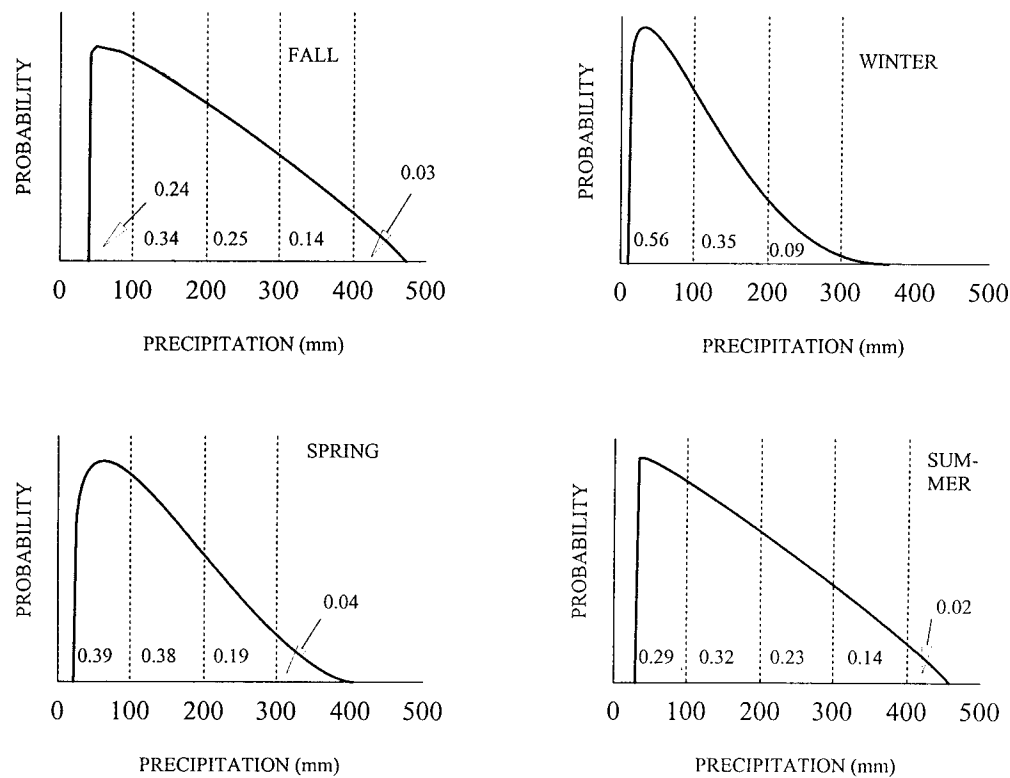

Fig. 5. Estimated beta distributions for seasonal precipitation in south Texas for fall ($\alpha = 1.0342$, $\beta = 1.9060$), winter ($\alpha = 1.1467$, $\beta = 3.3001$), spring ($\alpha = 1.1944$, $\beta = 2.6173$), and summer ($\alpha = 1.0161$, $\beta = 1.9073$) during 1908–1997 (11 years missing; Falfurrias station). Numbers under the curves give approximate probabilities that precipitation falls within the indicated range.

length of the laying season, seasonal distribution of nest initiation, and survival of adults and juveniles, among others. Our modeling effort was an attempt to synthesize weather influences on the complex demographic and dynamic influence leading to an age ratio. The effort necessarily required simplification that resulted in some level of mismatch between the variables used in modeling and the reality of the field. For example, we assumed data from the Falfurrias station reflected conditions for the region of inference. Also, modeling an age ratio on means (temperatures) and totals (precipitation) fails to account for the frequency, pattern, and intensity of weather events. A given mean maximum temperature might or might not be associated with intense heat waves, and a particular total for precipitation might or might not have accrued from a deluge. Because of the complexity of an age ratio per se and variation quashed by modeling on means and totals, the neural model predictions were associated with considerable uncertainty. The model performed with at best moderate predictive power (explained 59% of variation in training data, 29% in validation data).

A model with the specified level of performance should be viewed with skepticism, especially since it was developed with a relatively small sample ($n = 35$). However, such a model may contain useful information if it is consistent with known weather-related processes affecting quail production. Also, such a model, given empirical support, may be informative if it sug-

gests patterns or processes that have gone undiscovered in previous work.

Certain aspects of the model predictions were consistent with published results. Our analysis identified spring precipitation as a key variable influencing age ratios, as did Kiel's (1976) work in the same region. In contrast to Kiel (1976), however, our analysis suggested an asymptotic effect of spring precipitation, whereas his findings were linear over age ratios ranging from 0.6 to 7.0 (we would have eliminated the higher age ratio as an outlier). The asymptotic effect seems more realistic, biologically, than the linear effect. Theoretically, the age ratio is an asymptotic function of the number of nesting attempts (Guthery and Kuvlesky 1998), and the number of attempts in any breeding season is time-limited. This would lead to the expectation, if precipitation lengthens the breeding season and thus increases the potential number of nesting attempts, that production could be an asymptotic function of precipitation.

Our results were consistent with the findings of Heffelfinger et al. (1999) concerning weather effects on age ratios of Gambel's quail in Arizona. They reported that mid-winter (Dec–Jan) precipitation was more influential than early-winter (Oct–Nov) or late winter (Feb–Mar) precipitation. Although we found spring rainfall to be more important than rainfall in other seasons, the Arizona and south Texas results were consistent if timing of rainfall is placed in phenological context. Gambel's quail in Arizona start nest-

ing before bobwhites in south Texas; the common property between studies was the importance of rainfall associated with the beginning or early portions of the nesting season. Heffelfinger et al. (1999) reported declining age ratios with increasing July temperatures, regardless of the quantity of rainfall. On the contrary, we observed a threshold effect of July temperature at a given rainfall (Fig. 1). However, the results were consistent in that higher July temperatures were associated with lower predicted age ratios in each study.

The threshold effect of July temperatures and other results were consistent with known aspects of the thermal biology of bobwhites. Heat stress, as evidenced by gular flutter, appears at a temperature of about 35 °C in quails (Henderson 1971, Spiers et al. 1983). The model predicted a collapse in production at a mean maximum temperature of about 36 °C in July (Fig. 1). A possible process leading to a collapse in production at temperatures near 35 °C is reproductive quiescence associated with heat stress. In contradiction, however, the model predicted increasing age ratios with increasing June maxima beyond the threshold value. These results were enigmatic. The age ratio essentially failed to respond to August temperature maxima, which may merely indicate most production has completed before August. We recognize that bobwhites may lay during any month in south Texas (Lehmann 1984:84) but this occurrence does not preclude a strong seasonal peak in reproduction effort (Guthery et al. 1988). Based on data presented in Guthery et al. (1988), the breeding effort essentially collapses by July in the western Rio Grande Plains and is in strong decline in the eastern Rio Grande Plains. Data from the Chaparral Area were reflective of the western Rio Grande Plains.

Rainfall in semiarid environments generally benefits birds and, with the exception of winter precipitation, this generalization held for bobwhite age ratios in south Texas (Fig. 2). We can speculate that winters with more precipitation are colder, leading to energy stress that inhibits early season production. Indeed, Koerth and Guthery (1988) reported that body fat levels of bobwhites in April were negatively correlated with total precipitation the preceding February for the south Texas region. This conjecture would be consistent with declining age ratios with increasing winter precipitation up to about 225 mm (8.9 inches). However, we cannot explain why predicted production would increase as rainfall increased above 225 mm. The result may simply represent an anomaly in the dataset.

We have tried to identify the deficiencies in the data set we analyzed and readers should keep these deficiencies in mind as we conclude with some generalizations. We observe, first, that quail production in semiarid environments appears to respond to both temperature and precipitation. It is conceivable, based on empirical data (Heffelfinger et al. 1999, this study), that lower temperatures can ameliorate the negative effects of drought on production. Moreover, higher temperatures can suppress the positive effects of precipitation. The weather-quail production system seems to be nonlinear with thresholds and asymptotes. Ob-

viously, nonlinearity renders linear outlooks on the weather-production relation incomplete and, in certain domains of inference, inaccurate. For example, if the production response to precipitation is approximately asymptotic (Fig. 2), then there are precipitation levels that invoke a null response in quail productivity. There is a tendency for human beings to linearize and simplify, which likely will lead to false expectations of bobwhite population performance in the system we studied.

MANAGEMENT IMPLICATIONS

The weather is beyond management control. However, knowledge of the nature and strength of weather influences on bobwhite demography assists managers in placing proper perspectives on practices aimed at enhancing the reproduction performance of quail in semiarid environments such as south Texas. Weather variables may explain at least half, and perhaps more, of the variation in bobwhite age ratios in south Texas (Kiel 1976, this study). Adding random variation associated with depredation events (nest, chick, adults) and other limiting factors to the variation explained by weather leaves little room for variation explained by habitat management practices. Moreover, the power of weather suggests that such practices should be aimed primarily at ameliorating the negative reproduction effects of low rainfall in association with high temperatures. Management for positive thermal effects involves preservation of adequate amounts of herbaceous and woody cover to reduce heat loads near the ground and provide thermal refugia (Guthery et al. 2001). In the absence of prohibitively costly measures such as widespread sprinkler irrigation, it is likely that management never will be able to fully reverse the effects of weather on reproduction because the habitat structure to which quail are adapted renders them vulnerable to thermal insult.

ACKNOWLEDGMENTS

The Game Bird Research Fund and Bollenbach Endowment, Oklahoma State University, and the Texas Parks and Wildlife Department supported this study. This manuscript is approved for publication by the Oklahoma Agricultural Experiment Station.

LITERATURE CITED

- Bridges, A. S., M. J. Peterson, N. J. Silvy, F. E. Smeins, and X. B. Wu. 2001. Differential influence of weather on regional quail abundance in Texas. *Journal of Wildlife Management* 65:10–18.
- Brown, D. E. 1979. Factors influencing reproductive success and population densities of Montezuma quail. *Journal of Wildlife Management* 43:522–526.
- Campbell, H., D. K. Martin, P. E. Ferkovich, and B. K. Harris. 1973. Effects of hunting and some other environmental factors on scaled quail in New Mexico. *Wildlife Monographs* 34.
- Evans, M., N. Hastings, and B. Peacock. 1993. *Statistical distributions*. John Wiley & Sons, New York, New York.

- Francis, W. J. 1970. The influence of weather on population fluctuations in California quail. *Journal of Wildlife Management* 34:249–266.
- Guthery, F. S. 2002. The technology of bobwhite management—theory behind the practice. Iowa State University Press, Ames.
- Guthery, F. S., C. L. Land, and B. W. Hall. 2001. Heat loads on reproducing bobwhites in the semiarid subtropics. *Journal of Wildlife Management* 65:111–117.
- Guthery, F. S., M. J. Peterson, and R. R. George. 2000a. Viability of northern bobwhite populations. *Journal of Wildlife Management* 64:646–662.
- Guthery, F. S., N. D. Forrester, K. R. Nolte, W. E. Cohen, and W. P. Kuvlesky, Jr. 2000b. Potential effects of global warming on quail populations. *Proceedings of the National Quail Symposium* 4:198–204.
- Guthery, F. S., N. E. Koerth, and D. S. Smith. 1988. Reproduction of northern bobwhites in semiarid environments. *Journal of Wildlife Management* 52:144–149.
- Guthery, F. S., and W. P. Kuvlesky, Jr. 1998. The effect of multiple-brooding on age ratios of quail. *Journal of Wildlife Management* 62:540–549.
- Heffelfinger, J. R., F. S. Guthery, R. J. Olding, C. L. Cochran, Jr., and C. M. McMullen. 1999. Influence of precipitation timing and summer temperatures on reproduction of Gambel's quail. *Journal of Wildlife Management* 63:154–161.
- Henderson, C. W. 1971. Comparative temperature and moisture responses in Gambel and scaled quail. *Condor* 73:430–436.
- Kiel, W. H. 1976. Bobwhite quail population characteristics and management implications in south Texas. *Transactions of the North American Wildlife and Natural Resources Conference* 41:407–420.
- Koerth, N. E., and F. S. Guthery. 1988. Relationships between prior rainfall and current body fat for northern bobwhites in South Texas. *Texas Journal of Agriculture and Natural Resources* 2:10–12.
- Lehmann, V. W. 1984. Bobwhites in the Rio Grande Plain of Texas. Texas A&M University Press, College Station.
- Leopold, A. 1933. Game management. Charles Scribner's Sons, New York, New York.
- Reid, V. H., and P. D. Goodrum. 1960. Bobwhite quail: a product of longleaf pine forests. *Transactions of the North American Wildlife Conference* 25:241–252.
- Robinson, T. S., and R. H. Baker. 1955. Climate and bobwhite quail in Kansas—1951–1954. *Transactions of the Kansas Academy of Science* 58:353–359.
- Smith, M. 1996. Neural networks for statistical modeling. International Thomson Computer Press, Boston, Massachusetts.
- Speake, D. W., and A. O. Haugen. 1960. Quail reproduction and weather in Alabama. *Proceedings of the Southeastern Association of Fish and Wildlife Agencies* 14:85–97.
- Spiers, D. E., T. Adams, and R. K. Ringer. 1983. Temperature regulation in adult quail (*Colinus virginianus*) during acute thermal stress. *Comparative Biochemistry and Physiology* 74A:369–373.
- Stanford, J. A. 1972. Bobwhite quail population dynamics: relationships of weather, nesting, production patterns, fall population characteristics, and harvest in Missouri quail. *Proceedings of the National Bobwhite Quail Symposium* 1: 115–139.
- Swank, W. G., and S. Gallizioli. 1954. The influence of hunting and of rainfall upon Gambel's quail populations. *Transactions of the North American Wildlife Conference* 19:283–297.

FINE SCALE INFLUENCE OF WEATHER ON NORTHERN BOBWHITE ABUNDANCE, BREEDING SUCCESS, AND HARVEST IN SOUTH TEXAS

Robert M. Perez

Texas Parks and Wildlife Department, La Vernia, TX 78121, USA

James F. Gallagher

Texas Parks and Wildlife Department, Artesia Wells, TX 78001, USA

Michael C. Frisbie

Texas Parks and Wildlife Department, San Marcos, TX 78121, USA

ABSTRACT

Weather plays a substantial role in annual changes in populations of northern bobwhite (*Colinus virginianus*) within and among ecological regions. Few studies have tested this relationship within the confines of specific sites. We examined the fine scale influence of annual (12-month), seasonal (6-month), and monthly Modified Palmer Drought Severity Indices (PMDI) and raw precipitation on abundance, breeding success, and harvest of northern bobwhites on 2 sites in south Texas. We used 18 years (1984–01) of roadside census, juvenile:adult ratios, and harvest records from the Chaparral Wildlife Management Area (CWMA) in La Salle County and 15 years (1984–99) of juvenile:adult ratios and harvest records from a private property in Brooks County (BCP) to examine relationships and trends with weather variables. Bobwhite abundance was correlated ($r \geq 0.50$, $P \leq 0.035$) with 12- and 6-month sums of precipitation and PMDI. Breeding success was correlated ($r \geq 0.53$, $P \leq 0.023$) with 12-month precipitation for both sites and was correlated ($r = 0.53$, $P = 0.040$) with 6-month precipitation for BCP only. Harvest variables for CWMA were correlated ($r \geq 0.54$, $P \leq 0.022$) with 12- and 6-month PMDI, while BCP harvest/ha was correlated ($r = 0.54$, $P = 0.027$) with the 12-month precipitation sum. Monthly correlates with precipitation increased from spring to summer until July when they became negatively related to rainfall on both sites. Monthly PMDI correlates became increasingly important from spring through summer including July. Our findings account for at least part of the annual variation in northern bobwhite abundance in south Texas and provide information useful in understanding of the influence of weather at fine spatial scales.

Citation: Perez, R. M., J. F. Gallagher, and M. C. Frisbie. 2002. Fine scale influence of weather on northern bobwhite abundance, breeding success, and harvest. Pages 106–110 in S. J. DeMaso, W. P. Kuvleky, Jr., F. Hernández, and M. E. Berger, eds. Quail V: Proceedings of the Fifth National Quail Symposium. Texas Parks and Wildlife Department, Austin, TX.

Key words: abundance, breeding success, *Colinus virginianus*, harvest, Modified Palmer Drought Severity Index, northern bobwhite, precipitation, south Texas, weather

INTRODUCTION

Climate and weather have a major effect on bird populations. Weather dictates the growth of plants and the foods they produce (Welty and Baptista 1988). The growth stage of shrubs and grasses and the amount of food available throughout any given year affects the population dynamics of ground nesting birds (McMillan 1964, Roseberry and Klimstra 1984:128, Giuliano et al. 1996). The relationship between weather variables and populations has been examined for many gallinaceous species (Peterson and Silvy 1994, Sheaffer and Maleki 1996, Roberts and Porter 1998). Heffelfinger et al. (1999) found that reproductive failure was associated with low rainfall (0–6.3 cm) in October–March and high mean daily temperatures (32.2°–35.0° C) during the brooding season (Jun–Jul) for Gambel's quail (*Callipepla gambelii*). Conversely, ample seasonal rainfall and soil moisture have been positively correlated with the reproductive success of California quail (*C. californica*; McMillan 1964, Francis 1970,

Botsford et al. 1988). Abundance, breeding success, and harvest have also been correlated with weather variables for northern bobwhite and scaled quail (*C. squamata*). These relationships are more apparent in semiarid environments than mesic clines (Cambell 1968, Rice et al. 1993, Bridges et al. 2001, Guthery et al. 2001).

Of the 6 ecological regions examined in Texas by Bridges et al. (2001), the strongest correlation ($r = 0.90$) between the Modified Palmer Drought Severity Index (PMDI) and bobwhite abundance was in the Rio Grande Plains, while raw precipitation for the same region was positively correlated but to a lesser degree ($r = 0.64$). The PMDI takes into consideration a suite of weather variables and was designed to better represent real-time conditions and transitional periods (Heddinghaus and Sabol 1991). For these reasons, Bridges et al. (2001) suggested that PMDI correlates may be more closely associated with changes in quail abundance than single weather variables at the landscape and ecological-region level. Few studies have

tested these relationships within the confines of specific sites (Francis 1970). Furthermore, fine scale research may illuminate relationships, which are not apparent at larger scales, and may provide information helpful in understanding annual variation in bobwhite populations at the local level.

The objective of this study was to assess the relationship between weather and bobwhite populations at a fine spatial scale (i.e., ranch-level). Annual, seasonal, and monthly raw precipitation and PMDI values for 2 south Texas study sites were correlated with bobwhite abundance, breeding success, and harvest to test the following hypotheses: 1) annual PMDI from the nearest weather station is correlated more strongly with abundance, breeding success, and harvest than raw precipitation alone; 2) seasonal (Sep–Nov and Apr–Jun) PMDI from the nearest weather station is correlated more strongly with abundance, breeding success, and harvest than raw precipitation for the same time period; and 3) Monthly raw precipitation and PMDI values exhibit similar trends when correlated with abundance, breeding success, and harvest.

METHODS

Study Areas

Two areas were selected within the Rio Grande Plains ecological region of Texas (Gould 1975): the CWMA and the BCP. The CWMA encompasses 6,151 ha in Dimmit and La Salle Counties, Texas, approximately 32 km south-southwest of Cotulla, Texas. The Duval fine sandy loam and Dilley very fine sandy loam soils that predominate on the CWMA support very diverse plant communities. The major vegetative associations present are mesquite-granjeno (*Prosopis glandulosa-Celtis pallida*) parks and mesquite-blackbrush (*Acacia rigidula*) brush (McMahan et al. 1984). Introduced perennial grasses (Lehmann lovegrass [*Eragrostis lehmanniana*] and buffelgrass [*Cenchrus ciliaris*]) were seeded by previous owners or have invaded and presently constitute the majority of the herbaceous biomass found on the CWMA. Native grasses such as plains lovegrass (*Eragrostis intermedia*), plains bristlegrass (*Setaria macrostachya*), and tanglehead (*Heteropogon contortus*) have been reduced as a result of past overgrazing by livestock. The landscape is dominated by mesquite, various acacias (*Acacia* spp.), cacti (*Opuntia* spp.) and other chaparral species. Topography is gently rolling, with elevation ranging from 143 m to 187 m above sea level.

The BCP has ranged in size over the course of this study from 9,700 to 13,760 ha, but has remained at 13,760 ha since 1988. This site is predominately fine sandy soils and is entirely within the mesquite-granjeno parks vegetative association (McMahan et al. 1984). Common native grasses include brownseed paspalum (*Paspalum plicatulum*), Pan American balsam-scale (*Elyonurus tripsacoides*), purple three-awn (*Aristida purpurea*), hooded windmillgrass (*Chloris cucullata*), and lovegrasses (*Eragrostis* spp.) Introduced grasses are present, but not dominant. Topography is

flat with a 0 to 3% slope and elevations between 12 to 20 m above sea level.

Long hot summers and short mild winters characterize the climate for this region. In La Salle County, mean winter temperature is 12.7° C with a mean minimum of 6.7° C, and mean summer temperature is 29.4° C with a mean maximum of 36.1° C. The two areas typify the majority of South Texas with over 60% of both sites having been subjected historically to mechanical treatment to reduce brush. Woody vegetation dominates the landscape because of a variety of factors, but the primary causes are probably historic overgrazing by livestock and the suppression of natural fires. Coverage of woody plants varies from <30% canopy coverage, usually found on undisturbed sites, to >90% canopy coverage on drainages and areas that have been mechanically manipulated. Previous and present mineral exploration has resulted in several oil or natural gas well sites and numerous seismic and pipeline clearings. Water is well distributed on both areas and mean annual precipitation for CWMA and BCP is 55.4 and 65.4 cm, respectively.

Data Collection and Analysis

Rainfall data for CWMA are for the period January 1982–January 2001, whereas BCP data are for the period January 1984–December 1999. All raw precipitation data were collected from rain gauges located on site.

Annual and seasonal PMDI data used for CWMA are from NOAA station 4109, located west of Freer, Texas in northeast Webb County, approximately 72 km from the CWMA, and from NOAA station 4110 for BCP, located near San Manuel, Texas in northern Hidalgo County, approximately 64 km from BCP. Drought index data for both areas cover the period September 1982–January 2001.

Survey data were available only from CWMA and represent bobwhite observed/km along two 16.1 km survey routes on CWMA for the period 1983–2000. Counts were conducted 4–8 times per year, from mid-July through mid-October, and results were averaged.

We used harvest records to obtain juvenile:adult ratios as an index of breeding success and as an index of abundance expressed as the total bobwhite harvest for a given season. Additional harvest data collected from the BCP include the number of birds harvested divided by number of hectares hunted. Additional harvest parameters collected from the CWMA include the mean hunter bag for bobwhites across the whole season (total bobwhite harvest/number of hunters participating).

We assumed that harvest indices are related directly to bobwhite abundance; however, the relationship is not necessarily proportional. The CWMA is part of a public hunting system where hunting pressure is largely unregulated, whereas BCP is a commercial hunting camp and adjusts annual harvest to reach a target spring breeding density of 60% of the estimated fall bobwhite population. For the period 1983 through 2000 mean annual bobwhite harvests for CWMA and

Table 1. Correlations between annual (Sep–Aug) sums of raw precipitation (Precip) and the Modified Palmer Drought Severity Index (PMDI) and northern bobwhite abundance (Bobwhite/km), breeding success (Juv:adult), annual total harvest (Harvest), mean harvest per hunter (Bag), and harvest per hectare (Harvest/ha) for the Chaparral Wildlife Management Area (CWMA), La Salle county, Texas, 1982–01 and a private ranch (BCP), Brooks county, Texas, 1984–99.

Variable	Raw precip				PMDI			
	CWMA		BCP		CWMA		BCP	
	<i>r</i>	<i>P</i>	<i>r</i>	<i>P</i>	<i>r</i>	<i>P</i>	<i>r</i>	<i>P</i>
Juv:adult	0.53	0.023	0.72	0.003	0.15	0.566	0.25	0.313
Harvest	0.44	0.066	0.48	0.058	0.54	0.022	0.30	0.220
Bag	0.42	0.083			0.58	0.011		
Bobwhite/km	0.50	0.035			0.51	0.031		
Harvest/ha			0.54	0.027			0.42	0.086

BCP were 1,839 (min = 30, max = 11,219) and 3,356 (min = 471, max = 7,712) respectively, and mean annual hunter days for the same time period were 1,396 (min = 212, max = 3,796) and 448 (min = 152, max = 680), respectively.

We plotted abundance and harvest variables against raw precipitation data and PMDI data. We then visually inspected plots for non-linearities, in particular, anything that would suggest a threshold effect. All variables were tested for normality using the Lilliefors test (Wilkinson 1990). Because most variables were significantly non-normal, we used Spearman Rank Correlations to examine the relationship between abundance, breeding success, and harvest with raw precipitation and PMDI. We calculated relationships for the sum of the 12-month period (Sep–Aug) preceding each hunting season, the fall (Sep–Nov) and breeding season (Apr–Jun) time periods (6-month sum) and single month values. Tests were considered significant at the $P < 0.05$ level.

RESULTS

Abundance

Correlations with CWMA census were essentially the same for raw precipitation ($r = 0.50$ [$P = 0.035$]) and PMDI ($r = 0.51$, $P = 0.031$) for the 12-month sum (Table 1). Bobwhite abundance was also correlated with 6-month precipitation ($r = 0.58$, $P = 0.013$), and 6-month PMDI ($r = 0.58$, $P = 0.012$, Table 2). Monthly raw precipitation values were correlated with bobwhite abundance for May ($r = 0.55$, $P = 0.018$) and June ($r = 0.63$, $P = 0.005$, Fig. 1). Monthly PMDI

values were correlated ($r \geq 0.49$) during 3 months (May–Jul) with the strongest correlation coming in July ($r = 0.56$, $P = 0.017$, Fig. 2).

Breeding Success

Age ratio was correlated ($r \geq 0.53$) with 12-month and 6-month raw precipitation for BCP and was correlated ($r = 0.53$) only with 12-month precipitation for CWMA (Tables 1–2). February was the only monthly raw precipitation value correlated ($r = 0.53$, $P = 0.025$) with age ratio, and August was the only monthly PMDI value correlated ($r = 0.49$, $P = 0.040$) for CWMA (Figs. 1 and 2). There were no monthly precipitation values correlated with BCP age ratio, but August and June BCP PMDI values were correlated ($r = 0.54$, $P = 0.021$; and $r = 0.46$, $P = 0.050$, respectively) with age ratio (Fig. 2).

Harvest

Annual harvest and bag were correlated ($r \geq 0.54$) with 12- and 6-month PMDI for CWMA (Tables 1–2). Bobwhite harvest/ha was correlated ($r = 0.54$, $P = 0.027$) with 12-month raw precipitation for BCP (Table 1).

June was the only monthly raw precipitation value correlated ($r = 0.47$, $P = 0.047$) with annual harvest for CWMA and May was the only precipitation value correlated ($r = 0.51$, $P = 0.042$) for BCP (Fig. 1). The only monthly PMDI value correlated ($r = 0.52$, $P = 0.027$) with annual harvest was August for BCP (Fig. 2).

May was the only monthly raw precipitation value

Table 2. Correlations between seasonal (Sep–Nov and Apr–Jun) sums of raw precipitation (Precip) and the Modified Palmer Drought Severity Index (PMDI) and northern bobwhite abundance (Bobwhite/km), breeding success (Juv:adult), annual total harvest (Harvest), mean harvest per hunter (Bag), and harvest per hectare (Harvest/ha) for the Chaparral Wildlife Management Area (CWMA), La Salle county, Texas, 1982–01 and a private ranch (BCP), Brooks county, Texas, 1984–99.

Variable	Raw precip				PMDI			
	CWMA		BCP		CWMA		BCP	
	<i>r</i>	<i>P</i>	<i>r</i>	<i>P</i>	<i>r</i>	<i>P</i>	<i>r</i>	<i>P</i>
Juv:adult	0.30	0.230	0.53	0.040	0.07	0.795	0.14	0.569
Harvest	0.46	0.057	0.44	0.095	0.57	0.013	0.20	0.433
Bag	0.40	0.105			0.61	0.007		
Bobwhite/km	0.58	0.013			0.58	0.012		
Harvest/ha			0.50	0.057			0.27	0.288

WEATHER AND BOBWHITES

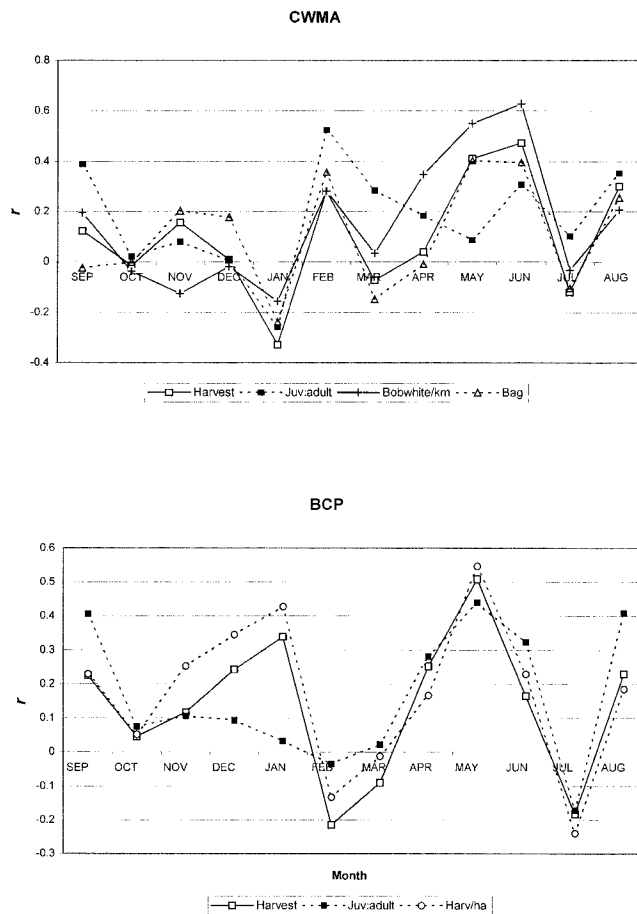

Fig. 1. Correlations between monthly raw precipitation for 12 months preceding hunting seasons (Sep–Aug) and northern bobwhite annual total harvest (harvest), breeding success (Juv:adult), abundance (Bobwhite/km) and mean harvest per hunter (bag) for the Chaparral Wildlife Management Area (CWMA), La Salle county, Texas, 1982–01 and for a private ranch (BCP) in Brooks county, Texas 1984–99. Note: birds harvested/ha were only estimated on the BCP and abundance was estimated only on the CWMA.

correlated ($r = 0.56$, $P = 0.026$) with bobwhite harvest/ha for BCP. However, monthly PMDI values were correlated ($r \geq 0.49$) during 3 months (Jun–Aug) with the strongest correlation coming in August ($r = 0.62$, $P = 0.006$, Fig. 2).

DISCUSSION

Drought index data used for the purpose of this study were taken from the nearest NOAA weather station. Data collected at these stations certainly differs to some degree from weather conditions on site. If the weather stations were actually located on the study sites the PMDI may have accounted for more variability. We did not test variables against a regional PMDI index because the purpose of this study was to examine fine scale trends and relationships.

Annual roadside counts were only conducted at the CWMA. This index of abundance was correlated with the 12- and 6-month sums of raw precipitation and PMDI; however, there was little difference be-

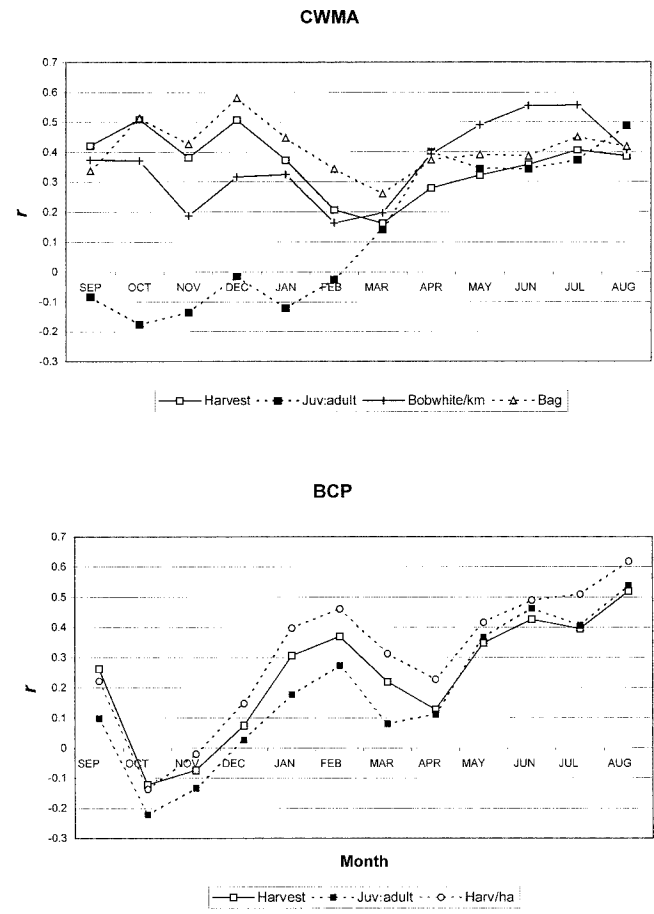

Fig. 2. Correlations between monthly Modified Palmer Drought Indices (PMDI) for 12 months preceding hunting seasons (Sep–Aug) and northern bobwhite annual total harvest (harvest), breeding success (Juv:adult), abundance (Bobwhite/km) and mean harvest per hunter (bag) for the Chaparral Wildlife Management Area (CWMA), La Salle county Texas, 1982–01 and for a private ranch (BCP) in Brooks county, Texas 1984–99. Note: birds harvested/ha were only estimated on the BCP and abundance was estimated only on the CWMA.

tween PMDI and precipitation for both time periods. These findings do not support the hypothesis that PMDI accounts for more variability in abundance than raw precipitation alone at finer scales and contrasts the findings of Bridges et al. (2001) at coarser scales.

The 12- and 6-month sums of raw precipitation were more strongly correlated with breeding success than PMDI sums for both study sites. This does not support the hypothesis that the PMDI accounts for more variation in age ratios than raw precipitation alone. The complexity of factors influencing this index leads us to believe that bobwhite reproductive efforts are influenced by weather differently from indices of abundance. Precipitation can only partially account for the variation in the breeding success of bobwhites. Other factors such as high summer temperatures could directly and negatively affect re-nesting attempts, reproductive condition, juvenile survival, and available thermal space (Guthery et al. 2001, Heffelfinger et al. 1999, Forrester et al. 1998). Although PMDI incorporates several weather variables including tempera-

ture, our results did not show a significant correlation with age ratio. At fine scales, other factors including degree of grazing pressure, amount of ground disturbance, and habitat management practices may also influence breeding success.

The CWMA harvest variables were correlated more strongly with annual and seasonal sums of PMDI than with raw precipitation sums. These findings are consistent with our hypothesis that PMDI accounts for more variation in harvest as an index of abundance than precipitation alone at fine scales. However, BCP harvest variables were conversely related and were inconsistent with the same hypothesis, but that may be the product of uneven hunter effort. Harvest at the CWMA was through a public hunting system and was regulated only by the number of days the area was open to quail hunters (mean annual hunter days = 1,396). Conversely, harvest at the BCP was regulated to reach a target spring bobwhite breeding density. The number of outings per season varied greatly from year to year and did not necessarily reflect the availability of birds (mean annual hunter days = 448). In other words, hunter effort was notably different between sites. For this reason we expected differences in correlations with weather variables between sites. We have more confidence in the CWMA harvest variables because consistent annual hunter effort may be related more closely to abundance.

Trends in monthly precipitation correlates were similar for both sites. With the exception of CWMA age ratio, rainfall became increasingly important from spring through summer until July where correlations became negative (Fig. 1). Precipitation has been shown to have direct and detrimental effects on young birds (Welty and Baptista 1988, Healy and Nenko 1985). Furthermore, Rosene (1969:145) suspected that heavy rainfall during the nesting and brooding season could greatly reduce bobwhite recruitment. Although our results do not provide definitive evidence that large amounts of July rainfall negatively influence bobwhite production, we feel that July precipitation and bobwhite production warrants further investigation.

Monthly PMDI values did not demonstrate this relationship with July (Fig. 2). Instead, PMDI became increasingly important from spring through summer including July. This does not support our hypothesis that monthly raw precipitation and PMDI values are correlated similarly with abundance, breeding success, and harvest.

In conclusion, at fine scales raw precipitation accounted for more variation in bobwhite census, and age ratio than PMDI, whereas PMDI accounted for more variation in harvest variables only at the public hunting area, CWMA. Our findings provide information useful in understanding of the influence of weather on annual variation of bobwhite populations in South Texas.

ACKNOWLEDGMENTS

We thank Texas Parks and Wildlife Department staff at the CWMA for collecting and providing rainfall, quail abundance and breeding success data. We

also thank Ronnie Howard for his time and technical advice.

LITERATURE CITED

- Botsford, L. W., T. C. Wainwright, J. T. Smith, S. Mastrup, and D. F. Lott. 1988. Population dynamics of California quail related to meteorological conditions. *Journal of Wildlife Management* 52:469–477.
- Bridges, A. S., M. J. Peterson, N. J. Silvy, F. E. Smeins, and X. Ben Wu. 2001. Differential influence of weather on regional quail abundance in Texas. *Journal of Wildlife Management* 65:10–18.
- Campbell, H. 1968. Seasonal precipitation and scaled quail in eastern New Mexico. *Journal of Wildlife Management* 32:641–644.
- Forrester, N. D., F. S. Guthery, S.D. Kopp, and W. E. Cohen. 1998. Operative temperature reduces habitat space for northern bobwhites. *Journal of Wildlife Management* 62:1506–1511.
- Francis, W. J. 1970. Influence of weather on population fluctuations in California quail. *Journal of Wildlife Management* 34:249–266.
- Giuliano, W. M., R. S. Lutz, and R. Patino. 1996. Reproductive responses of adult female northern bobwhite and scaled quail to nutritional stress. *Journal of Wildlife Management* 60:302–309.
- Gould, F. W. 1975. Texas plants—a checklist and ecological summary. Texas A&M University, Texas Agricultural Experimental Station, College Station.
- Guthery, F. S., C. L. Land, and B.W. Hall. 2001. Heat loads on reproducing bobwhites in the semiarid subtropics. *Journal of Wildlife Management* 65:111–117.
- Healy, W. M., and E. S. Nenko. 1985. Effect of weather on wild turkey poults survival. *Proceedings of the National Wild Turkey Symposium* 5:91–101.
- Heddinghaus, T. R., and P. Sabol. 1991. A review of the Palmer Drought Severity Index and where do we go from here? Seventh Conference on Applied Climatology. American Meteorological Society, Boston, Massachusetts.
- Heffelfinger, J. R., F. S. Guthery, R. J. Olding, C. L. Cochran, Jr., and C. M. McMullen. 1999. Influence of precipitation timing and summer temperatures on reproduction of Gambel's quail. *Journal of Wildlife Management* 63:154–161.
- McMahan, C. A., R. G. Frye, and K. L. Brown. 1984. The vegetative types of Texas including cropland. P-R Project W-107-R, Texas Parks and Wildlife Department, Austin.
- McMillan, I. I. 1964. Annual population changes in California quail. *Journal of Wildlife Management* 28:702–711.
- Peterson, M. J., and N. J. Silvy. 1994. Spring precipitation and fluctuations in water's prairie chicken numbers: hypothesis revisited. *Journal of Wildlife Management* 58:222–229.
- Rice, S. M., F. S. Guthery, G. S. Spears, S. J. DeMaso, and B. H. Koerth. 1993. A precipitation based model for northern bobwhites on semiarid rangeland. *Journal of Wildlife Management* 57:92–102.
- Roberts, S. D., and W. F. Porter. 1998. Influence of temperature and precipitation on survival of wild turkey poults. *Journal of Wildlife Management* 62:1499–1505.
- Roseberry, J. L., and W.D. Klimstra. 1984. Population ecology of the bobwhite. Southern Illinois University Press, Carbondale, Illinois.
- Rosene, W. 1969. The bobwhite quail: its life and management. Rutgers University Press, New Brunswick, New Jersey.
- Sheaffer, S. E., and R. A. Malecki. 1996. Predicting breeding success of Atlantic coast population Canada geese from meteorological variables. *Journal of Wildlife Management* 60:882–890.
- Welty J. C., and L. Baptista. 1988. The life of birds. Saunders College Publishing, San Francisco, California.
- Wilkinson, L. 1990. SYSTAT: The system for statistics. SYSTAT, Inc. Evanston, Illinois.

BROOD SEASON HABITAT SELECTION BY MONTEZUMA QUAIL IN SOUTHEASTERN ARIZONA

Kirby D. Bristow

Arizona Game and Fish Department, 2221 W. Greenway Rd., Phoenix, AZ 85023, USA

Richard A. Ockenfels

Arizona Game and Fish Department, 2221 W. Greenway Rd., Phoenix, AZ 85023, USA

ABSTRACT

Habitat conditions during brood season can affect Montezuma quail (*Cyrtonyx montezumae*) population levels in Arizona, and land use practices can affect these habitat conditions. General habitat affinities of Montezuma quail are known, however, information on specific habitat selection patterns is limited. We investigated seasonal habitat selection by Montezuma quail in the foothills of the Huachuca and Santa Rita mountains in southeastern Arizona. We used pointing dogs to locate quail during brood seasons (Aug–Oct) of 1998 and 1999. We measured habitat components at 60 flush sites and 60 associated (<100 m) random plots. Compared to random plots, quail used areas with higher grass and forb species richness, and more trees ($P < 0.10$). Low level (≤ 50 cm) visual obstruction, usually associated with bunchgrass cover, was greater ($P < 0.10$) at flush sites than at random plots. Optimum brood season habitat for Montezuma quail should contain ≥ 6 species of forbs/0.01 ha, tree canopy cover between 10 and 50%, and grass canopy cover between 50 and 85% with a minimum average height of 25cm. Maintaining these habitat characteristics could minimize negative impacts of land-use practices on Montezuma quail.

Citation: Bristow, K. D., and R. A. Ockenfels. 2002. Brood season habitat selection by montezuma quail in southeastern Arizona. Pages 111–116 in S. J. DeMaso, W. P. Kuvlesky, Jr., F. Hernández, and M. E. Berger, eds. Quail V: Proceedings of the Fifth National Quail Symposium. Texas Parks and Wildlife Department, Austin, TX.

Key words: Arizona, *Cyrtonyx montezumae*, grazing, habitat selection, livestock, Madrean evergreen woodland, Montezuma quail

INTRODUCTION

Montezuma quail population levels are affected by seasonal precipitation patterns and land-use practices that impact habitat conditions (Brown 1979). Habitat conditions during brood season are important to survival of young quail and can have a great impact on population levels (Stanford 1972). Brown (1978) considered survival more important than productivity in determining Montezuma quail population levels. General habitat affinities of Montezuma quail have been described (Wallmo 1954, Leopold and McCabe 1957, Bishop 1964, Brown 1978), however, brood season habitat selection has not been studied.

Montezuma quail populations are affected by climatic and habitat conditions prior to and during brood season. Montezuma quail feed primarily on subterranean bulbs and tubers (Bishop and Hungerford 1965), and seem dependent on perennial bunchgrasses for hiding and thermal cover (Brown 1979, Brown 1982). Most of these perennial bunchgrasses, and forbs that Montezuma quail consume, are dependent upon summer precipitation. Summer rains usually begin in July, coincidental with onset of Montezuma quail nesting. Brown (1979) found a positive correlation between summer rainfall amounts and percent young harvested during subsequent hunting seasons.

Reduction of grass cover by livestock grazing is considered an important factor affecting distribution and abundance of Montezuma quail (Leopold and McCabe 1957, Bishop 1964, Brown 1978, Brown

1982). Limited livestock grazing can increase availability of food for Montezuma quail, but excessive removal of grass cover could eliminate quail from an area (Brown 1982). Brown (1982) considered available grass cover during spring the most important factor affecting Montezuma quail survival and reproduction in grazed areas, however, the relative importance of grass cover during brood season is unknown.

Because most grasses that provide cover for Montezuma quail grow in summer, cover availability should be greater during brood season (Aug–Oct), which occurs after the summer growing season. Some studies have indicated that Montezuma quail habitat selection is less affected by grass cover in ungrazed than in grazed areas (Albers and Gelbach 1990, Stromberg 1990). Although Brown (1982) found Montezuma quail were absent from heavily grazed but otherwise suitable areas, Stromberg (1990) found quail in ungrazed habitats used areas with less understory cover than randomly selected sites. This suggests that a range of cover is important to Montezuma quail.

Relative importance of specific habitat factors, and their impacts on brood season habitat selection are unclear. Information on preferred vegetative characteristics is necessary for managing land to protect or enhance Montezuma quail habitat. Some authors have described the general habitat associations of Montezuma quail (Leopold and McCabe 1957, Bishop 1964, Brown 1978), however, only Stromberg (1990) attempted to relate habitat characteristics quail use to the

range of available habitat characteristics. We quantified brood season habitat selection and contrasted habitats used in grazed and ungrazed areas. Our goal was to provide data to help land managers better design management strategies that will maintain or enhance Montezuma quail habitat.

METHODS

Study Area

We conducted our study in the foothills of the Santa Rita and Huachuca mountains, Santa Cruz County in southeastern Arizona. The area is composed primarily of Madrean evergreen woodlands interspersed with semi-desert grasslands (Brown 1994a). We concentrated efforts within Madrean evergreen woodlands, considered typical Montezuma quail habitat (Brown 1982). These woodlands were dominated by various live oaks, including Mexican blue (*Quercus oblongifolia*), Emory (*Q. emoryi*), and Arizona white oak (*Q. arizonica*) (Brown 1994a). Alligator juniper (*Juniperus deppeana*) mimosa, (*Mimosa* spp.), manzanita (*Arctostaphylos* spp.), and mesquite (*Prosopis juliflora*) were found in more xeric locations (Brown 1994a). Trees and shrubs dominated north-facing slopes, whereas perennial bunchgrasses (*Aristida* spp., *Bouteloua* spp., *Eragrostis* spp., and *Trichachne* spp.) dominated south-facing slopes and flats (Brown 1994b). Riparian areas contained mixtures of cottonwood (*Populus fremontii*), willow (*Salix* spp.), and sycamore (*Platanus wrightii*) (Minckley and Brown 1994).

Topography consisted of rolling hills broken by numerous small canyons, and elevation ranged between 1,200–1,500 m. Mean annual precipitation was 37.2 cm and bimodally distributed, with peaks in winter and late summer. Seasonal temperatures averaged 10.4° and 24.2° C for summer and winter, respectively (Sellers et al. 1985).

We collected data in 2 subunits. The Research Ranch Sanctuary of The National Audubon Society in the foothills of the Huachuca Mountains represented an ungrazed subunit. The Research Ranch (TRR), managed in cooperation with United States Bureau of Land Management and United States Forest Service (USFS), had been protected from grazing since 1968 (Brady et al. 1989). The USFS Coronado National Forest managed the grazed subunit, in the foothills of the Santa Rita Mountains. Recreation and cattle grazing were major land uses within Coronado National Forest (CNF) subunit. The CNF used recommendations from Brown (1982) to manage livestock grazing to protect Montezuma quail habitat. Range conditions within CNF varied from overused to lightly used, with some pastures being temporarily deferred from grazing.

Habitat Measurements

We used pointing dogs to locate Montezuma quail between 31 August and 29 October 1998 and 1999.

We avoided sampling each covey more than once per season, however, because we did not have telemetered birds we could not be certain that all flush sites represented independent coveys. We estimated number of males, females, and total covey size at flush sites. We centered habitat component measurements at the approximate center of a flush site. We recorded date, time of day, study area subunit, and used a Global Positioning System unit (GPS) to obtain Universal Transverse Mercator (UTM) coordinates for each site.

At flush site centers, we described landform and substrate of flush sites by classifying terrain type, and measuring aspect of slope and soil compaction. We assigned each site a terrain category based upon position on a slope. Terrain categories were ridge top, upper half of ridge, lower half of ridge, or drainage bottom. We measured slope aspect with a compass and assigned each site an aspect category, of north (316–0°, and 0–45°), east (46–135°), south (136–225°), or west (226–315°). We measured soil compaction (tons/m²) with a penetrometer at 1-m intervals along 2 perpendicular, 6-m transects that intersected at their midpoints on the site. We averaged the 12 readings as an estimate of soil compaction at the site.

At flush sites, we estimated vegetation species composition within a 100-m² circular plot (radius = 5.6 m) by counting the number of grass, forb, shrub, and tree species. We measured distance (m) to and diameter (DBH = diameter cm at 1.2 m high) of the nearest tree (>2 m tall). We also recorded distance to nearest shrub (>0.3 m tall). We estimated percent canopy cover within a 25-m radius circle using 4 perpendicular transects that intersected on flush site centers. This method yielded 100 points oriented in 4 directions at 1-m intervals. We used a random numbers table (Zar 1984) to orient the first transect line, and subsequent lines were oriented by increasing 90° from the previous line. At each 1-m point, we recorded all vegetation that could provide canopy cover for a quail (>10 cm high). We classified canopy cover as grass, forb, shrub, or tree. We calculated percent canopy cover as total number of hits within each class.

We measured vertical structure around flush sites by estimating visual obstruction using a 50-cm² visibility board with a 5-cm grid. Thus, the board had 10 height classes, each with 10 intersections. We centered the board vertically on the flush site and counted number of intersections visible, from a 1-m height, within each height class from a distance of 4 m, similar to Thomson (1975). We took measurements oriented along the 4 transect lines, then averaged values for each height class. We also recorded maximum height of 50% obstruction as the height category at which the mean number of visible intersections was ≤5.0 (i.e., visual obstruction ≥50%).

Random Plots

We measured the same habitat variables in the same manner at flush sites and associated (<100 m) random plots. We located random plots by travelling a random number of paces (0–100), in a random di-

MONTEZUMA QUAIL BROOD HABITAT

Table 1. Means (\pm SD) of habitat variables at Montezuma quail flush sites ($n = 29$) and associated random plots ($n = 29$) in the foothills of the Huachuca Mountains, southeastern Arizona, Aug–Oct 1998 and 1999.

Variable	Flush	Random	P^a
Soil compactness (tons/m ²)	19.2 \pm 10.5	23.1 \pm 11.7	0.184
Grass species richness	5.3 \pm 14	4.1 \pm 1.5	0.003
Forb species richness	6.1 \pm 1.3	4.3 \pm 1.5	<0.001
Tree species richness	0.5 \pm 0.5	0.3 \pm 1.5	0.186
Shrub species richness	1.2 \pm 1.0	1.6 \pm 1.3	0.136
Distance to nearest tree (m)	10.3 \pm 11.3	16.3 \pm 14.3	0.079
DBH of nearest tree (cm)	12.5 \pm 8.7	10.3 \pm 7.3	0.305
Distance to nearest shrub (m)	6.4 \pm 9.7	4.3 \pm 4.5	0.290
Percent grass canopy cover	73.3 \pm 10.8	65.6 \pm 16.5	0.040
Percent forb canopy cover	19.7 \pm 11.5	15.6 \pm 9.6	0.142
Percent tree canopy cover	21.1 \pm 14.3	10.4 \pm 10.1	0.002
Percent shrub canopy cover	7.3 \pm 10.1	10.7 \pm 12.5	0.262
Maximum 50% obstruction (cm) ^b	26.2 \pm 12.4	16.9 \pm 13.7	0.009

^a Differences determined by 2 sample *t*-tests.

^b Average maximum height at which the visual obstruction $\geq 50\%$.

rection (0–360°), from each flush site. We used a random numbers table to determine random direction and number of paces (Zar 1984). Transect lines at plots were oriented in the same random direction as the associated flush site.

Statistical Analysis

Using data collected at TRR (ungrazed subunit), we compared habitat measurements from quail flush sites with habitat measurements collected at random plots to determine factors that influenced habitat selection. To determine if the grazing program administered by the USFS on CNF impacted Montezuma quail habitat use, we compared flush site habitat measurements between study area subunits. To describe habitat preferences of Montezuma quail over a range of habitats, we pooled data collected at flush sites from both study area subunits and calculated means (\pm SD) of habitat variables that differed between flush sites and random plots at TRR.

We realized that we performed multiple tests of variables with a potential lack of independence, and the experimentwise error rate could have been high. However, because this study was designed to provide improved guidelines for habitat management of Montezuma quail, and relatively little is known about their habitat selection patterns, we accepted Type I errors as preferable to Type II errors. Therefore, to minimize potential for Type II errors, we chose not to apply Bonferroni corrections to α levels. We considered differences to be statistically significant if $P \leq 0.10$.

We used 2 sample *t*-tests for all continuous data sets (Zar 1984). For categorical data on TRR, we calculated Bonferroni confidence intervals for habitat parameters at flush sites (Neu et al. 1974, Byers et al. 1984). If availability, as determined from random plots, differed from use, we calculated a Jacobs' *D* selectivity index (Jacobs 1974) to determine magnitude of selection.

RESULTS

We located 60 coveys of Montezuma quail during brood seasons of 1998 ($n = 30$) and 1999 ($n = 30$).

Based on distribution of flush sites and the average brood season home-range size of Montezuma quail coveys calculated by Stromberg (1990), we were confident that we sampled ≥ 21 coveys each year. We located equal numbers of flush sites on both study areas in 1998, and located 16 coveys on CNF and 14 coveys on TRR in 1999. We found 97% of the coveys in September (40%) and October (57%). Locating coveys in August was difficult due to higher daily temperatures that made it difficult to effectively and safely use dogs to locate Montezuma quail.

We flushed 520 birds; most ($\geq 55\%$) coveys were male female pairs with their broods. However, as the brood season progressed into October, it became difficult to discern adult quail from young of the year. We estimated 74% of birds found were young of the year. Mean covey size was 8.7 birds/covey, and 82% of the coveys contained broods. Brood sizes ranged from 1 to 16, with a mean of 6.6. We were able to classify 80% of adult birds encountered as male or female. We were able to classify activity of 60% of coveys found. We classified 57% of the coveys as feeding, 2% roosting, and 1% travelling.

Habitat Measurements

At TRR, species richness was greater at flush sites for grasses and forbs than at random plots ($P \geq 0.10$) (Table 1); species richness for trees and shrubs did not differ between flush sites and random plots. Flush site centers were closer to trees than were centers of random plots, but DBH of the closest trees were not different between flush sites and random plots (Table 1). Percent canopy cover characteristics differed between flush sites and random plots. Flush sites had more grass and tree canopy than did random plots (Table 1).

Both methods we used to measure visual obstruction indicated that Montezuma quail used areas with more vertical cover than that found at random plots. Maximum heights at which 50% of the visibility board was fully obstructed from view were higher at flush sites than at random plots (Table 1). Visual obstruction was greater at flush sites for all 10 height levels of the visibility board than that seen at random plots ($P \leq 0.027$) (Fig. 1).

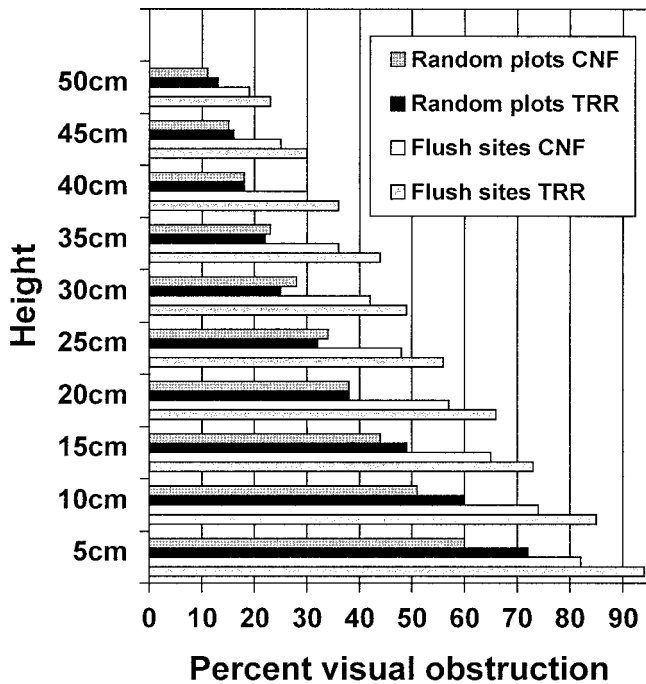

Fig. 1. Mean visual obstruction by height class determined by visibility board readings taken at Montezuma quail flush sites at the Research Ranch (TRR, $n = 29$) and Coronado National Forest (CNF, $n = 31$) study area subunits, compared to associated random plots ($n = 60$), in the Huachuca and Santa Rita mountains, southeastern Arizona, 1998 and 1999. All differences significant ($P \leq 0.10$) according to 2 sample t -tests.

Montezuma quail at CNF used sites that were closer to trees and had higher tree canopy cover than at TRR. Whereas flush sites at TRR had higher grass canopy cover. All other habitat variables were similar for flush sites at different study area subunits (Table 2).

Montezuma quail flush sites on TRR and CNF ($n = 60$) contained a mean of 6.4 (± 2.3) species of forbs/0.01 ha, mean tree canopy cover of 31.8% (± 20.3) and mean grass canopy cover of 67.2% (± 16.2). Mean maximum heights at which $\geq 50\%$ of the visibility board was obstructed was 24.8 cm (± 13.7) for all flush sites.

DISCUSSION

We found that vegetation richness and cover affected habitat selection of Montezuma quail within

Madrean evergreen woodlands, during the brood season. Flush site characteristics were different from random plots for half of the habitat variables we measured. Our specific findings during brood season were similar to earlier general descriptions of year-round habitat use patterns (Leopold and McCabe 1957, Bishop 1964, Brown 1978, Stromberg 1990).

The most marked difference between flush sites and random plots was in the amount of visual obstruction and cover. Most perennial bunch grasses that provide cover for Montezuma quail are summer growing species, and are at their greatest densities and heights during brood season (Stromberg 1990). Despite increased availability of grass cover during brood season throughout the study area, flush sites had greater percent canopy cover of grass and greater visual obstruction than randomly available. Possible explanations for this selection include predator avoidance and feeding strategies.

Montezuma quail are typically associated with dense grass cover (Leopold and McCabe 1957, Bishop 1964, Brown 1978, Brown 1982). However, some studies have found that Montezuma quail habitat selection is less affected by grass cover in ungrazed areas (Albers and Gelbach 1990, Stromberg 1990). Stromberg (1990) found that Montezuma quail on TRR used areas with less understory cover than randomly selected sites. Although flush sites at CNF had less grass canopy cover than at TRR, amount of visual obstruction at flush site centers was consistent between grazed and ungrazed areas. Thus, Montezuma quail were still able to find suitable cover in areas with moderate grazing pressure. This evidence tends to support Stromberg's (1990) contention that protection from grazing increased availability of cover beyond requirements of the species.

Raptor depredation is the greatest source of natural mortality for Montezuma quail (Bishop 1964, Stromberg 1990). The primary predator avoidance strategy of Montezuma quail is to remain motionless, relying on cryptic coloration to avoid detection (Leopold and McCabe 1957). This behavior can only be effective when there is sufficient cover to hide birds. Brown (1982) found that Montezuma quail were absent from otherwise suitable habitat where available grass biomass had been reduced by more than 55% of annual production. He speculated that reduced cover exposed birds to increased threat of predation and made these areas uninhabitable.

Table 2. Means (\pm SD) of important habitat variables at Montezuma quail flush sites collected on The Research Ranch (TRR, $n = 29$) and Coronado National Forest (CNF, $n = 31$) study area subunits in the foothills of the Huachuca and Santa Rita mountains, southeastern Arizona, Aug–Oct 1998 and 1999.

Variable	TRR	CNF	P^a
Grass species richness	5.3 \pm 1.4	5.7 \pm 1.4	0.214
Forb species richness	6.1 \pm 1.3	6.7 \pm 3.0	0.325
Distance to nearest tree (m)	10.3 \pm 11.3	5.0 \pm 4.4	0.024
Percent grass canopy cover	73.3 \pm 10.8	61.4 \pm 18.4	0.003
Percent tree canopy cover	21.1 \pm 14.3	41.8 \pm 20.1	<0.001
Maximum 50% obstruction (cm) ^b	26.2 \pm 12.4	23.5 \pm 15.0	0.456

^a Differences determined by 2 sample t -tests.

^b Average maximum height at which the visual obstruction $\geq 50\%$.

We found that flush sites in grazed areas had higher tree canopy and lower grass canopy than in ungrazed areas. We might speculate that Montezuma quail are compensating for reduced grass cover availability in grazed areas by selecting sites with more tree cover. However, since differences in grass and tree canopy cover between study area subunits were consistent for random plots as well as flush sites, we feel that these habitat use patterns simply reflected availability.

We found that visual obstruction was important at each height level ≤ 50 cm. However, differences in visual obstruction between flush and random points decreased with increasing height and would probably be insignificant at levels reaching maximum heights of native bunch grasses. Based on average grass canopy and visual obstruction at flush sites, optimum brood season Montezuma quail habitat should contain 50–85% grass canopy in a mosaic of heights between 10 and 40 cm. Minimum average grass heights should be >25 cm to adequately protect broods and adults from ground predators. Higher grass cover may be necessary to reduce the threat of aerial predators.

Although grass species richness was greater at flush site than random plots, this may be a function of grass densities, as areas with higher grass densities often have increased diversity (Brady et al. 1989). This may also be related to diet. Bishop and Hungerford (1965) found that insects composed nearly 50% of the volume of Montezuma quail crops during brood season. Areas with greater vegetational diversity would likely have greater insect diversity and density. This may be especially important for young chicks, which are more dependent upon insects than are adults (Bishop and Hungerford 1965).

Vegetation at flush sites was typical of that found on more mesic north-facing slopes of our study area. Most accounts of Montezuma quail consider oak trees to be indicators of their habitat (Leopold and McCabe 1957, Bishop 1964, Brown 1978, Stromberg 1990). However, Bishop and Hungerford (1965) found that mast from various species of oaks were important in Montezuma quail diets only during spring. Montezuma quail populations also exist in mesquite grassland habitats that contain few oaks. Selection for proximity to trees and greater tree canopy, therefore, may be more related to microclimate conditions or predator avoidance rather than to mast availability.

Forb richness was greater at flush sites than random plots. This is probably a function of dietary requirements of Montezuma quail. Holdermann and Holdermann (1997) found that Montezuma quail in New Mexico were associated with yellow nutsedge (*Cyperus esculentes*) and Gray's woodsorrel (*Oxalis grayi*), and that these plants were associated with relatively mesic deep loamy soils, where forb diversity was high. Yellow nutsedge and Gray's woodsorrel composed a substantial portion of Montezuma quail diets in Arizona (Bishop and Hungerford 1965), and their habitat selection may be largely affected by habitat requirements of these plants.

In summary, habitat selection of Montezuma quail

is likely affected by dietary and security requirements. Brown (1982) found heavily grazed areas devoid of birds, presumably due to lack of cover, although those areas had higher food availability for Montezuma quail. We found that visual obstruction was important relative to habitat selection, yet other factors, such as proximity to trees, tree canopy, and vegetational diversity may be more related to microclimate and diet. Although our study did not look at relative densities or productivity of populations in different habitats, habitat quality typically influences population viability. Future Montezuma quail research should focus on relative bird densities and nesting success under different habitat conditions, especially with respect to availability of cover and specific food resources.

ACKNOWLEDGMENTS

We wish to thank Bill Brannan of the Research Ranch Sanctuary of The National Audubon Society for providing access and logistic support during our field efforts. Neil Lawson assisted in study site selection and pointing dog training. Kevin Barnes, Laurel Kagen-Wiley, and Mike Pruss assisted with field data collection. Brian Wakeling and Mike Rabe assisted in study design and statistical analysis. Jim deVos, Steve Germaine, Ron Olding, and Steve Rosenstock provided valuable editorial comments that improved the final version of this manuscript.

LITERATURE CITED

- Albers, R. P., and F. R. Gelbach. 1990. Choices of feeding habitat by relict Montezuma quail in central Texas. *Wilson Bulletin* 102:300–308.
- Bishop, R. A. 1964. The Mearns' quail (*Cyrtonyx montezumae mearnsi*) in southern Arizona. Thesis. University of Arizona, Tucson.
- Bishop, R. A., and C. R. Hungerford. 1965. Seasonal food selection of Arizona Mearns Quail. *Journal of Wildlife Management* 29:813–819.
- Brady, W. W., M. R. Stromberg, E. F. Aldon, C. D. Bonham, and S. H. Henry. 1989. Response of a semidesert grassland to 16 years of rest from grazing. *Journal of Range Management* 42:284–288.
- Brown, D. E. 1979. Factors influencing the reproductive success and population densities in Montezuma quail. *Journal of Wildlife Management* 43:522–526.
- Brown, D. E. 1994a. Warm-temperate forests and woodlands. Pages 58–78 in D. E. Brown, ed. *Biotic communities: southwestern United States and northwestern Mexico*. University of Utah Press, Salt Lake City.
- Brown, D. E. 1994b. Grasslands. Pages 107–142 in D. E. Brown, ed. *Biotic communities: southwestern United States and northwestern Mexico*. University of Utah Press, Salt Lake City.
- Brown, R. L. 1978. An ecological study of Mearns' quail. Arizona Game and Fish Department Federal Aid in Wildlife Restoration final report, Project W-78-R-22, Phoenix.
- Brown, R. L. 1982. Effects of livestock grazing on Mearns quail in southeastern Arizona. *Journal of Range Management* 35:727–732.
- Byers, C. R., R. K. Steinhorst, and P. R. Krausman. 1984. Clarification of a technique for analysis of utilization-availability data. *Journal of Wildlife Management* 48:1050–1053.
- Holdermann, D., and R. Holdermann. 1997. Distribution, phe-

- nology, ecological relationships, and below ground biomass of *Cyperus esculentus* and *Oxalis grayi* in relation to Montezuma quail at the Fort Stanton Special Management area. New Mexico Department of Game and Fish Resources, Report #95-516-49, Santa Fe.
- Jacobs, J. 1974. Quantitative measurements of food selection. *Oecologia* 14:413-417.
- Leopold, A. S., and R. A. McCabe. 1957. Natural history of the Montezuma quail in Mexico. *Condor* 59:3-26
- Minckley, W. L., and D. E. Brown. 1994. Wetlands. Pages 223-268 in D.E. Brown, ed. *Biotic communities: southwestern United States and northwestern Mexico*. University of Utah Press, Salt Lake City.
- Neu, C. W., C. R. Byers, and J. M. Peek. 1974. A technique for analysis of utilization- availability data. *Journal of Wildlife Management* 38:541-545.
- Sellers, W. D., R. H. Hill, and M. Sanderson-Rae. 1985. *Arizona Climate: the first hundred years*. University of Arizona Press, Tucson.
- Stanford, J. A. 1972. Bobwhite quail population dynamics: relationships of weather, nesting, production patterns, fall population characteristics, and harvest in Missouri quail. *Proceedings of the National Quail Symposium* 1:115-139.
- Stromberg, M. R. 1990. Habitat, movements and roost characteristics of Montezuma Quail in southeastern Arizona. *Condor* 45:57-65.
- Thomson, W. R. 1975. A photographic technique to quantify lateral cover density. *Journal of the South African Wildlife Management Association* 5:75-78.
- Wallmo, O. C. 1954. Nesting of Mearns Quail in southeastern Arizona. *Condor* 56:125-128.
- Zar, J. H. 1984. *Biostatistical analysis*, Third Edition. Prentice-Hall, Englewood Cliffs, New Jersey.

EFFICACY OF LINE DRIVES TO LOCATE MONTEZUMA QUAIL AT ELEPHANT MOUNTAIN WILDLIFE MANAGEMENT AREA

Froylan Hernández

Department of Natural Resource Management, Sul Ross State University, Alpine, TX 79832, USA

Louis A. Harveson

Department of Natural Resource Management, Sul Ross State University, Alpine, TX 79832, USA

Clay Brewer

Elephant Mountain Wildlife Management Area, Texas Parks and Wildlife Department, Alpine, TX 79832, USA

ABSTRACT

There is little information on the status of Montezuma quail (*Cyrtonyx montezumae*) in Texas. Most of the literature that does exist is either outdated or from out-of-state sources (i.e., New Mexico and Arizona). We initiated a pilot study to document and update general life history information of Montezuma quail at Elephant Mountain Wildlife Management Area, Brewster County, Texas in March 2000. To establish the study area, we used sign of recent Montezuma quail use (i.e., diggings) to document areas of use, resulting in a 114-ha area on top of Elephant Mountain proper. This study plot subsequently was sampled by the 3 line drives consisting of 17, 12, or 10 observers/line. The observers walked abreast of each other towards a designated point, covering the entire width (600 m) of the sample area. Two line drives were conducted in December 2000 (17- and 12-observer lines) and 1 in March 2001 (10-observer line). All line drives were conducted in the morning between 0900–1200 hrs. Average distances between observers for the 17-, 12-, and 10-observer lines were 35, 50, and 60 m, respectively. The average speed for all 3 line drives was 2.5 km/hr. Only the 17-observer line drive detected quail. Two coveys were flushed, 1 of 4 birds (1 M and 3 F) and 1 of 5 birds (2 M and 3 F). The birds only flushed if the observer was <1 m from them. One possible reason for the low detection of quail may be their defense strategy, which is to crouch down and lay motionless. Based on these limited data, we infer that to increase the probability of effectively locating Montezuma quail, the distance between observers must be < 35 m and the number of observers increased. Line drives with few observers and large spacing between observers may not be a suitable technique to locate Montezuma quail.

Citation: Hernandez, F., L. A. Harveson, and C. Brewer. Efficacy of line drives to locate Montezuma quail at elephant mountain wildlife management area. Page 117 in S. J. DeMaso, W. P. Kuvlesky, Jr., F. Hernández, and M. E. Berger, eds. Quail V: Proceedings of the Fifth National Quail Symposium, Texas Parks and Wildlife Department, Austin, TX.

THE IMPACT OF INVASIVE EXOTIC GRASSES ON QUAIL IN THE SOUTHWESTERN UNITED STATES

William P. Kuvlesky, Jr.

Caesar Kleberg Wildlife Research Institute, MSC 218, 700 University Blvd., Texas A&M University-Kingsville, Kingsville, TX 78363, USA

Timothy E. Fulbright

Caesar Kleberg Wildlife Research Institute, MSC 218, 700 University Blvd., Texas A&M University-Kingsville, Kingsville, TX 78363, USA

Ron Engel-Wilson

Arizona Game & Fish Department, 2221 West Greenway Rd., Phoenix, AZ 85023-4312, USA

ABSTRACT

Five native quail species inhabit arid and semi-arid ecosystems in the southwestern United States. One species is endangered, one species is declining throughout its historic range, another species is declining in portions of its historic range, and the other two species may be beginning to decline in selected portions of their respective ranges. A number of factors have been implicated for these declines, though habitat loss is frequently cited as the most common factor associated with southwestern quail declines. Exotic species invasions in the United States represent a significant economic and biological threat to the United States. Many exotic organisms introduced to the United States are threatening entire ecosystems, replacing native species and even threatening other native species with extinction. Numerous exotic grasses are invading arid and semi-arid ecosystems in the Southwest. Most exotic grasses were intentionally introduced for erosion control and to provide forage for livestock. Cattlemen sometimes favor exotic grasses in spite of their impacts to native biodiversity. The impacts of exotic grasses on vegetative communities are discussed, as well as their potential impacts on the five native quail species that inhabit the southwestern United States. Exotic grass eradication and control are also discussed, as well as introducing exotic grass pest management into existing land management programs. Research designed to determine the impacts of exotic grass invasions on quail and their habitat is recommended.

Citation: Kuvlesky, W. P., Jr., T. E. Fulbright, R. Engel-Wilson. 2002. The impact of invasive exotic grasses on quail in the southwestern United States. Pages 118–128 in S. J. DeMaso, W. P. Kuvlesky, Jr., F. Hernández, and M. E. Berger, eds. Quail V: The Fifth National Quail Symposium. Texas Parks and Wildlife Department, Austin, TX.

Key words: *Callipepla gambelii*, *C. squamata*, *Colinus virginianus*, *C. v. ridgwayi*, *Cyrtonyx montezumae*, eradication, exotic grass, forb, Gambel's quail habitat, insect, management, Masked bobwhite, Montezuma quail, native vegetation, northern bobwhite, research, scaled quail, southwest

INTRODUCTION

Quail are an important component of ecosystems they inhabit throughout southwestern North America. Recently, quail were one of the most abundant terrestrial nonmigratory bird species that inhabited arid and semi-arid ecosystems in this area. Five species of quail are native to southwestern North America, and one species has been introduced. The northern bobwhite (*Colinus virginianus*) has the widest geographic distribution, because it occurs throughout most of Texas and northern Mexico, however it is absent in the arid regions of west Texas and the western Panhandle of the state (Lehmann 1984:7). Masked bobwhites (*C. virginianus ridgwayi*), an endangered subspecies of the northern bobwhite, inhabit a restricted range in southeastern Arizona and northwestern Sonora, Mexico (United States Fish & Wildlife Service 1995). Scaled quail (*Callipepla squamata*) occur in semi-arid to arid regions of south and west Texas, northern Mexico, and throughout arid and semi-arid regions of New Mexico and southeastern Arizona (Brown 1989). Gambel's

quail (*C. gambelii*) occur in portions of West Texas and New Mexico and throughout most of the arid and semi-arid regions of Arizona (Brown 1989). Montezuma quail (*Cyrtornyx montezumae*) inhabit select grassland and oak savanna habitats in west Texas, northern Mexico, southwestern New Mexico and southeastern Arizona (Brown 1989). California quail (*C. californicus*), the only species not native to the southwestern United States, were introduced to a small area in eastern Arizona (Brown 1989).

Quail were fairly common residents of a variety of arid and semi-arid habitats in southwestern North America and occupied an important functional niche wherever they were found. Because quail are capable of responding very rapidly to an improvement in habitat conditions by producing large numbers of young, they can become very abundant locally in a short period of time (Stoddard 1931:102, Rosene 1969:65). Quail are an important prey species to many mammalian and avian predators (Lehmann 1984:265, Hurst et al. 1996). Today, quail are not only of ecological importance to the ecosystems they inhabit. They are

also of aesthetic and economic value to humans. Indeed, hunting is an important tradition in many southeastern states that has existed for more than a century (Stoddard 1931:435). Many southern plantations exist today solely for the purpose of maintaining a viable quail population that is hunted in the traditional southern manner which includes the use of mule-drawn wagons, gaited horses, and well-trained bird dogs. Quail hunting is also of economic importance in portions of Texas (Lehmann 1984, Guthery 1986) and Oklahoma, and to a lesser extent, in Arizona and New Mexico (Brown 1989). Hunters funnel millions of dollars annually into numerous rural southwestern communities for hunting leases, guided hunts, lodging, food, and ammunition. Healthy quail populations, particularly bobwhites, therefore offer a financial boon to tens of thousands of people.

Because quail are so important to the livelihood of so many people, and they are of aesthetic importance to both consumptive and nonconsumptive users, the current continental decline of quail populations (Brennan 1991, Church et al. 1993) has aroused considerable alarm among quail biologists, hunters, bird-watchers and people in local communities where quail are an important stimulus to business. Recent quail declines have been attributed to numerous phenomena. Loss of habitat as been cited frequently as one of the primary reasons quail populations have declined (Brennan 1991, Church et al. 1993) and rangeland and forest degradation has largely been responsible for the declines of western quail populations (Brown 1989, Kuvlesky et al. 2000, Engel-Wilson and Kuvlesky *this volume*). In addition to habitat destruction, Guthery et al (2000) suggested that slight temperature increases due to global warming could be rendering some portions of current bobwhite ranges uninhabitable because maximum summer temperatures now exceed the physiological thermal limits of bobwhites. Increased rates of mesomammalian predation has also been suggested as stimulating quail declines, particularly in the Southeast (Hurst et al. 1996). Unfortunately, one factor alone is almost certainly not the reason for the continued decline of quail populations in North America. Instead, Hurst et al. (1996) suggest that declining quail and wild turkey (*Meleagris gallopavo*) populations in the southeast are probably the result of a combination of factors, such as the interaction of habitat losses and increased vulnerability to predators, operating within and across landscapes on a regional scale of resolution.

Another perspective has been offered by Guthery (1997) when he argued that the recent decline of quail populations is in reality a spatial/temporal issue. He claims that given sufficient useable space, quail populations should be able to maintain themselves at self-sustainable levels. Loss of habitat, increasing temperatures, and increased predator populations simply represent factors that decrease useable space for quail populations. If Guthery's assessment of quail declines is accurate, then anything that reduces useable space-time represents a threat to quail populations. It is conceivable that exotic grass infestations and lack of bare ground due to the prevalence of sod-forming grasses

impact usable space during at least portions of the quail year. Usable space could be reduced during early summer if insect abundance is low in exotic grass pastures because insects comprise a substantial portion of the diets of nesting hens and young broods during April–July. Conversely, exotic grass plantations may increase useable space in regions where grass cover is limited if these areas provide correct habitat structure. Abundant speculation exists regarding the exotic grass/quail issue because few scientific facts are currently known. We postulate that exotic grasses render space unusable by quail. The conversion of millions of hectares of native rangeland in Texas, New Mexico, Arizona and northern Mexico to exotic grass plantations is a serious threat that has been largely ignored. The primary objectives of this paper are to first review the current state of our knowledge regarding the impacts of exotic grass invasions on quail populations in the southwestern United States, and then provide suggestions for future research projects regarding the exotic grass/quail issue.

EXOTIC GRASSES IN THE SOUTHWEST

Exotic flora and fauna have become a major threat to the natural resources of the United States over the past 50 years. Exotic species, also known as invasive, alien, foreign, introduced, nonnative and/or nonindigenous species, are plants and animals that have been introduced into an environment in which they have not evolved and usually have no enemies to limit their reproduction and expansion into new habitats (Westbrooks 1998). Pimm and Gilpin (1989) and Randall (1996) recently ranked exotic species invasions, behind habitat loss as the second greatest threat to endangered species in the United States. However, exotic plant invasions often represent habitat loss so the invasion of exotic species may be an even greater threat than previously realized (Wilcove et al. 1998). Between one half (Wilcove et al. 1998) and two thirds (Westbrooks 1998) of the endangered species in North America and Hawaii are threatened by exotic species.

Introduced plants alone threaten many ecosystems throughout North America. Like most of the United States, exotic plants have also become naturalized in the southwestern United States and have, to varying degrees, simplified native vegetative communities throughout this region. A number of exotic grass species were introduced to the southwestern United States by livestock producers and federal and state agricultural agencies, to curb erosion and provide forage for livestock (Bahre 1991, Roundy and Biedenbender 1996). Buffelgrass (*Cenchrus ciliaris*), Kleberg bluestem (*Dicanthium annulatum*), King Ranch bluestem (*Bothriochloa ischaemum*), Lehmann lovegrass (*Eragrostis lehmanniana*), and Boers lovegrass (*E. curvula* var. *conferta*) represent some of the more common exotic African grass species introduced to the southwest. The majority of these grasses have naturalized and have been enormously successful in expanding their ranges. Typically exotic grasses become established on

disturbed sites such as highway right-of-ways, oil and gas pipelines, and drilling sites, and then aggressively invade additional areas by modifying the environment in a manner that favors their establishment. For instance, buffelgrass, Lehmann lovegrass and cheatgrass (*Bromus tectorum*), modify natural fire cycles by increasing the periodicity of fires which creates better growing conditions for plant, and in this manner exotic grasses invades more acreage. Consequently, exotic grass invasions in the Southwest are likely occurring at a rate far more rapid than people realize and most ecologists have no idea what impact this invasion is having on the native flora and fauna. Nevertheless, the few studies that have been conducted elsewhere indicate that invasive exotic plants negatively impact native wildlife populations.

IMPACTS OF EXOTIC GRASSES ON PLANT COMMUNITIES

Many exotic plants form dense monocultures that reduce species diversity, and inhibit survival and re-establishment of native species (D'Antonio et al. 1998, Christian and Wilson 1999, Brown and Rice 2000), many of which may be important plants for insects and for producing seeds eaten by quail. Many exotic plant species are highly competitive and are able to out compete natives for nutrients, water, and light. Allelopathy is another mechanism by which exotic grasses inhibit establishment of other plant species. Buffelgrass and Kleberg bluestem inhibit seed germination of Illinois bundleflower (*Desmanthus illinoensis*) and partridgepea (*Cassia fasciculata*), 2 forbs that produce seeds important as food for quail (Nurdin and Fulbright 1990). Planting extensive stands of these exotic grasses could be extremely detrimental to quail food plants, particularly if other native forb species are equally susceptible to germination inhibition.

Soil nutrient availability is reduced by stands of exotic plants. Soils under stands of crested wheatgrass (*Agropyron cristatum*) have lower available nitrogen, total nitrogen, and carbon than soils under stands of native prairie grasses that established abandoned agricultural fields (Christian and Wilson 1999). Similarly, pastures seeded to monocultures of crested wheatgrass or Russian wildrye (*Elymus junceus*) are lower in organic matter and nitrate than native mixed prairie (Dormaar et al. 1995). The reduction in soil nutrients caused by exotic grasses may inhibit efforts to replace exotics with native plants to improve habitat for quail and may lower overall ecosystem productivity.

Soil characteristics may influence susceptibility of an area to invasion by exotics. Many invasive exotic species colonize disturbed sites characterized by high levels of nitrogen. Exotic plant abundance in Australia is positively correlated with soil phosphorus, whereas native plant abundance is negatively correlated with decreased soil phosphorus (Morgan 1998). Perennial exotic grasses of high biomass depended on high soil nutrient levels for successful establishment in the Australian study.

Certain plant communities or vegetation types are more vulnerable to invasion of exotics than others (Larson et al. 2001). Riparian zones are particularly at risk (Stohlgren et al. 1998). Communities with higher functional group richness may be slightly more resistant to invasion by exotics (Symstad 2000).

Invasion and establishment of non-native plants is often facilitated or increased by soil disturbance (Parker et al. 1993, Morgan 1998). Mowing allows the invasion of exotic plant species in tallgrass prairie (Gibson et al. 1993). Different soil disturbances may not be equivalent in the degree to which exotic plants invade following the disturbance (Kotanen 1997). Different types of disturbances have different effects on native plants. Certain disturbances were more favorable to exotics than to native plants, but none were effective in preventing occupancy by exotics. Roadside planting of exotics increases the invasion of exotics into adjacent grasslands (Tyser and Worley 1992).

Soil disturbance is widely used by wildlife managers to increase the abundance of early-successional herbaceous plants that produce seeds or herbage eaten by quail (Robel et al. 1996). Rather than improving habitat for quail, disking may increase the invasion of exotic plants. In southern Texas, canopy cover of buffelgrass was 7 times greater on soils disked 5 years earlier than on undisturbed soils (T. E. Fulbright, unpublished data). More frequent disking may intensify the invasion of exotic plants. Russian thistle (*Salsola kali*) was absent on undisturbed soils. One year after the final disking treatment, soils disked annually for 5 years supported a 40% canopy cover of Russian thistle compared to only 13% on soils disked only once.

The effects of livestock grazing on invasion by exotic plants are variable. Grazing has little effect on spread of exotic plants in Rocky Mountain grasslands (Stohlgren et al. 1999). Lehmann lovegrass invades semiarid grassland in the absence of cattle grazing, but higher grazing intensities increase relative abundance of the grass (McClaran and Anable 1992).

Although disturbance may exacerbate the spread of exotic plants, disturbance is not a prerequisite for invasion (Symstad 2000, Larson et al. 2001). Crawley (1987) suggested that all communities are susceptible to invasion if the introduced species has superior competitive or demographic traits. Five of 6 abundant exotic plant species in Theodore Roosevelt National Park have distributions unrelated to disturbance (Larson et al. 2001).

Exotic plant invasions clearly alter the ecological processes of the native plant communities that are invaded. Some alterations are subtle while others are more obvious. Perhaps the most striking negative effect that exotic grass invasions may impose on native plant communities is reduction of soil nutrients. Native forb and grass diversity and abundance declines as invaded soils become impoverished. The negative effects may cascade and eventually include reduced insect and bird biodiversity and abundance as reported by Bock et al. (1986) for an invaded southeastern Arizona

QUAIL AND EXOTIC GRASSES

121

grassland. It would appear that exotic grass invasions result in simplified ecological communities.

QUAIL POPULATIONS AND EXOTIC GRASSES

Each of the 4 native quail species that inhabit the southwestern United States, have specific habitat requirements. Some of these habitat requirements are specific to each species, while other requirements appear to be universally shared among species. Forbs for example, are essential dietary items for masked bobwhites (Brown 1989, United States Fish & Wildlife Service 1995), scaled quail (Schemnitz 1961, Medina 1988), Gambel's quail (Brown 1989), northern bobwhites (Lehmann 1984:188, Guthery 1986:145), and to a lesser extent Montezuma quail (Leopold and McCabe 1957, Brown 1989). Similarly, habitats that support a diverse and abundant invertebrate community are important to all four quail species because insects are essential food items of young chicks, as well as adults for at least portions of the year (Schemnitz 1961, Lehmann 1984:192, Guthery 1986:147, Brown 1989). Additionally, herbaceous habitats that provide adequate nesting, escape, thermal and brooding cover are important to each quail species (Schemnitz 1961, Brown 1989, King 1998, Guthery et al. 2000), except Gambel's quail relative to their nesting requirements, because Gambel's quail nests are often nothing more than a depression in the shade of a shrub (Brown 1989). Therefore, exotic grass invasions could negatively impact southwestern quail populations if invasions limit one or more of the habitat attributes required by quail to fulfill their specific life history requirements. However, it is also possible that the presence of exotic grasses benefit quail populations by providing a habitat attribute that was limited or missing prior to exotic grass invasions.

Unfortunately, few studies have been conducted to determine how exotic grasses specifically impact quail populations, and the few studies that have been completed were done in the Southeast and Midwest and offer mixed results. For example, Burger et al. (1990), and Burger (1993) believed that Conservation Reserve Program (CRP) fields consisting of the exotic grass tall fescue (*Festuca arundinacea*) and red clover (*Trifolium pratense*) established in northern Missouri provided habitat conditions suitable for northern bobwhite production. However, Barnes et al. (1995), concluded that tall fescue fields in Kentucky provided poor bobwhite habitats. Washburn et al. (1999) advocated improving areas dominated by tall fescue in Kentucky by killing the plant and replacing it with native grasses, because native plants provided better habitat conditions for bobwhites. Clearly additional research is needed to quantify the specific impacts of exotic grass invasions on quail populations throughout the country, but particularly in the Southwest where almost none of this type of research has been conducted.

In the absence of relevant research results, we will discuss the potential impacts of exotic grass invasions

on southwestern quail populations based on what we know about important habitat requirements for each species. More importantly, we will relate some of the plant community alterations that result from exotic grass invasions identified in the previous section, to the availability and abundance of important quail habitat attributes in areas that have been invaded.

MASKED BOBWHITES

Masked bobwhites are the least studied of the 4 species of quail native to the Southwest. Therefore, their life history is not well documented. The few research projects completed, indicate that masked bobwhite life history is similar to that of bobwhites in south Texas (Simms 1989, King 1998, Guthery et al. 2000). Nevertheless, the habitat needs of masked bobwhites remained very obscure until recently. This dearth of information prompted biologists from the United States Fish & Wildlife Service (USFWS) to assume for years that Lehmann lovegrass on and around the Buenos Aires National Wildlife Refuge (BANWR) in the Altar Valley south of Tucson, and buffelgrass in northcentral Sonora, Mexico were detrimental to masked bobwhite recovery efforts (Kuvlesky et al. 2000). Based on meager, mostly anecdotal observations, it was assumed that diverse stands of native grasses provided better habitat than exotic grass stands. However, recent research indicated that masked bobwhites inhabiting BANWR were equally as likely to be found in stands of Lehmann lovegrass as in stands of native grass (King 1998). Though no scientific proof currently exists, exotic grass stands may provide essential cover to masked bobwhites during periods of drought. For example, Sonoran and USFWS biologists monitoring masked bobwhite populations on Rancho El Carrizo, Sonora, Mexico during a severe drought in the mid-1990s noted that most masked bobwhite observations occurred in buffelgrass, because cattle had consumed virtually all of the native grasses leaving buffelgrass as the only herbaceous cover available (Kuvlesky et al. 2000). During another drought in 1998, while masked bobwhites were being located for translocation to BANWR, every covey found was utilizing the cover provided by buffelgrass, again because it was the only herbaceous cover available (Kuvlesky et al. 2000).

However, during drought when masked bobwhites used pastures where buffelgrass was the dominant herbaceous feature, prairie acacia (*Acacia angustissima*) seeds, a favorite masked bobwhite food (United States Fish & Wildlife Service 1995), appeared to be abundant. When droughts ended and native grass and forb populations recovered, quail began utilizing areas dominated by native vegetation, though continued use of buffelgrass remained evident. Buffelgrass and Lehmann lovegrass may serve as important herbaceous cover for masked bobwhites, particularly when native herbaceous cover is limited. The superior structural and species diversity of native grass stands probably offer more food advantages, and possibly cover ad-

vantages, than stands of exotic grass. It is possible that masked bobwhites would have used, or even preferred native grass cover on Rancho El Carrizo during drought had it not been preferentially removed by cattle. Also, as mentioned previously in this paper, forb populations generally decline as exotic grass invade native plant communities, and this situation cannot be good for masked bobwhites because an important source of food is less available. Another important food, invertebrates, could also be negatively impacted by exotic grass invasions in the Southwest, though research conducted by Burger (1993) in a more mesic area of Missouri indicated that diverse and abundant invertebrate fauna inhabited tall fescue fields that included red clover. Nevertheless, in the arid southwest insect diversity and abundance is likely lower in exotic grass plantations (Bock et al. 1986) than native grass stands because legumes and forbs that attract insects are suppressed by exotic grass infestations (Medina 1988). Native plant communities likely provide better habitat conditions than exotic grass plantations because herbaceous species and structural diversity is probably superior, and these characteristics yield better cover and food conditions for quail. Masked bobwhites obviously use exotic grass, however it is probably useful only as cover. Unless food-producing plants like prairie acacia occur in exotic grass plantations, food supplies are probably limited forcing masked bobwhites to fulfill their nutritional requirements elsewhere. For example, King (1998) found that masked bobwhites displayed no preference for native grass stands over Lehmann lovegrass stands. She did note that masked bobwhite coveys found in Lehmann lovegrass were never far from extensive stands of native grasses suggesting that native grasses were important to masked bobwhites.

SCALED QUAIL

In addition to masked bobwhites, King (1998) also studied scaled and Gambel's quail on the BANWR, and much of this work was later summarized by Guthery et al. (2001). Like masked bobwhites, scaled and Gambel's quail did not prefer native grass. Instead, scaled quail preferred upland habitats with 10–15% woody cover, and on the BANWR, the dominant herbaceous species on these uplands was Lehmann lovegrass. Brown (1989) also noted that scaled quail in Arizona preferred level, semi-arid grasslands interspersed with short shrubs and cacti. He did not mention Lehmann lovegrass, stating only that grasslands favored by scaled quail consist of perennial bunchgrasses. Medina (1988) however, reported that scaled quail in Arizona were less abundant in stands of Lehmann lovegrass and more abundant in open areas with low perennial grass cover and high forb cover. Washes and other disturbed sites that were characterized by low perennial grass cover and high forb cover were frequented by scaled quail. His food habit data revealed that scaled quail consumed proportionally more forb seeds than any other plant item, and that bristle-

grass (*Setaria grisebachii*) seeds were the dominant grass component of diets. Insects were important foods during the summer, and on an annual basis ranked third behind forbs and grass seeds. Lehmann lovegrass appeared to be an unimportant food item. Schemnitz (1961) noted similar habitat preferences in the Oklahoma Panhandle. He reported that during his study in the mid-1950s, scaled quail thrived on the low-successional habitat conditions provided by the livestock and grain crop agricultural production typical on the shortgrass prairie at the time. Forbs and insects, which made up most of quail diets were abundant. When Schemnitz (1993) visited his former study site during the early 1990s he reported that scaled quail populations had declined and he attributed this decline to the prevalence of modern farming and CRP fields that consisted of dense stands of perennial grasses which provided scaled quail with some cover, but little food. Other studies have also indicated that scaled quail avoid areas of dense vegetation in favor of habitats with more diverse species composition and structure (Goodwin and Hungerford 1977, Campbell-Kissock 1985).

Perennial grasses, including Lehmann lovegrass, therefore may offer some cover value to scaled quail populations, but if Lehmann lovegrass offers little food and quail are supposed to avoid dense stands of Lehmann lovegrass, why do scaled quail appear to frequent uplands on the BANWR dominated by this exotic plant? Medina (1988) probably provided a clue when he stated that scaled quail preferred washes and other disturbed sites on his Arizona study area. The BANWR, and many other federal, state and private lands inhabited by scaled quail in Arizona, has numerous dirt roads, and dry washes located within its boundaries that represent frequently disturbed areas. Moreover, thousands of rodent excavations as well as hundreds of headcuts created by sheet and rill erosion provide numerous additional frequently disturbed sites where forbs are abundant. Scaled quail that inhabit extensive uplands dominated by Lehmann lovegrass may be able to exist on these areas because of numerous disturbed sites that provide a reliable source of seeds and greens. Invertebrates may also be more abundant on these sites than in Lehmann lovegrass stands. Scaled quail probably tolerate exotic grass plantations if a sufficient number of disturbed areas are present to support forb and insect populations. However, extensive exotic grass plantations that lack disturbed sites are unlikely to be used by scaled quail.

GAMBEL'S QUAIL

Unlike scaled quail, Gambel's quail require habitat with more woody cover (Guthery et al. 2001). Gambel's quail not only consume more mast than scaled quail or bobwhites, they also roost in bushy shrubs and small trees (Brown 1989). Overgrazing in the Southwest generally favors the development of shrublands (Burgess 1995) which benefits Gambel's quail over scaled quail and masked bobwhites because both spe-

cies are less tolerant of the conversion of grasslands to shrublands (Brown 1989). Gambel's quail are an arid-land species that have successfully adapted to the Sonoran Desert in Arizona, where perennial grasses are infrequent (Brown 1989). However, they are also the most abundant quail species on semi-arid grasslands that are at higher elevations within and around the Sonoran Desert. Gambel's quail are also extremely adaptable, a behavioral trait that permits them to successfully occupy large urban areas like Phoenix and Tucson. Since, numerous exotic shrub species are propagated in these urban habitats frequented by Gambel's quail it is likely that they have adapted to the presence of these plants and use them as roosting habitat and escape cover.

The adaptability of Gambel's quail permit them to occupy virtually every vegetation cover type on the Sonora savanna grasslands that make-up the BANWR, and they are the most abundant quail species in most cover types on the Refuge (Kuvlesky unpublished data). During annual winter quail surveys, BANWR Biologists observed more Gambel's quail on uplands dominated by Lehmann lovegrass than scaled quail. Gambel's quail were also the most abundant species on Rancho El Carrizo, Sonora, Mexico, and were as likely to be located in buffelgrass pastures as pastures dominated by native grasses. Large expanses of Lehmann lovegrass and buffelgrass likely impact Gambel's quail populations less than other quail species because sufficient shrub cover is present and bare disturbed areas have abundant forb populations, Gambel's quail seem able to maintain self-sustainable numbers where exotic grasses are the dominant grass species. It is possible that Lehmann lovegrass and buffelgrass enhance Gambel's quail habitat on semi-arid grasslands by providing an additional source of cover. Nevertheless, where exotic grasses suppress forbs and insect populations, Gambel's quail populations may be reduced.

Another exotic grass species however, may pose a genuine threat to Sonoran Desert ecosystems and the Gambel's quail populations that occupy areas that are being invaded. Red brome (*Bromus rubens*) probably first appeared in California from the Mediterranean region of Eurasia several decades ago where it became naturalized and then rapidly began invading semi-arid and arid ecosystems at an alarming pace (James 1995). Like cheatgrass (*Bromus tectorum*) in the Great Basin deserts and buffelgrass in Sonora, Mexico, red brome is a fire adapted species that modifies natural fire cycles in a manner that continually perpetuates invasion of additional acreage (D'Antonio and Vitousek 1992). The abundant fine fuel loads produced by red brome increase fire frequencies in invaded areas which results in the suppression of shrubs. Red brome invasion of the Sonoran Desert is a serious concern because shrubs and succulents are the dominant vegetation types of this desert. Native herbaceous vegetation consists almost entirely of desert annuals that are ephemeral in that these species must have winter precipitation to complete their life cycles. Consequently, because fine fuels are largely absent during summer thunderstorms,

lightening-caused fires are rare in the Sonoran Desert, and lack of fire facilitates the continued dominance of shrubs and succulents. However, saguaros (*Carnegiea gigantea*), mesquite (*Prosopis glandulosa*), and ironwood (*Olneya tesota*) populations gradually decline with the increased fire frequency that accompanies red brome invasions of the Sonoran Desert. It seems likely then, that Gambel's quail populations will decline in areas invaded by red brome in response to the gradual disappearance of the native Sonoran Desert shrubs which are critical to quail survival (Engel-Wilson unpublished data). If red brome invasion of the Sonoran Desert continues unabated, the future status of Gambel's quail may begin to resemble the current status of bobwhites in the Southeast.

MONTEZUMA QUAIL

Like the masked bobwhite, Montezuma quail have not been studied to any great extent by quail biologists. Therefore, nothing has been done to quantify the impacts of exotic grass invasions on this species. Montezuma quail typically occupy Mandrean oak (*Quercus* sp.) woodlands at elevations >1200 m though they use semi-arid grasslands slightly below this elevation during certain times of the year (Brown 1989). Like masked bobwhites, Montezuma quail require substantial herbaceous cover to survive. Brown (1982) described optimal habitat as consisting of 30% tree crown cover and 70% grass cover. Native warm season, perennial bunchgrasses represent preferred herbaceous cover. Brown (1989) does not mention exotic grass species as being important to Montezuma quail. Instead he states that bunchgrass species composition varies with locality and site though preferred herbaceous habitats consist of tall native species, such as sideoats grama (*Bouteloua curtipendula*), cane beardgrass, (*Bothriochloa barbinodis*), wolftail (*Lycurus setosus*), green sprangletop (*Leptochloa dubia*), and Texas bluestem (*Andropogon* spp.). Montezuma quail also use sites consisting of shorter species such as blue grama (*B. gracilis*), hairy grama (*B. hirsuta*), and three-awns (*Aristida* spp.), though these habitats are less desirable than those composed of taller grasses. Montezuma quail food habits do not include grasses other than the seeds of paspalums (Brown 1989). The bulbs of wood sorrels (*Oxalis* spp.) and bulbs and tubers of flat sedges (*Cyperus esculentus*, *C. rusbyi*) are the predominate foods consumed during October–June (Leopold and McCabe 1957, Bishop and Hungerford 1965). Acorns are important foods when they are available and insects, particularly beetles (Coleoptera), are important to both adults and chicks during the nesting and brood-rearing season of late summer and early fall (Brown 1989).

Given what is known about the life history and habitat requirements of Montezuma quail, exotic grass invasions apparently result in habitat loss. A diversity of tall bunchgrasses, abundant oxlals bulbs and sedge tubers, as well as abundant and diverse insect populations are required to maintain viable Montezuma

quail populations. Since exotic grass infestations reduce native grass and forb diversity, we speculate that Montezuma quail populations decline in response to exotic grass invasions.

NORTHERN BOBWHITE

A substantial amount of research has been conducted on northern bobwhites throughout the species range in Texas and Oklahoma because bobwhites are popular among hunters and private landowners (Guthery 1986:251, Brown 1999). Quail biologists have ample information available to them to effectively implement brush management, grazing management, and hunting management programs that benefit northern bobwhite populations in the Southwest. It is odd, that few researchers have examined the impacts of exotic grass invasions on bobwhites when hundreds of thousands of hectares of exotic grass exist in Texas alone. Perhaps bobwhite researchers have avoided broaching the subject with private landowners, because many cattlemen believe that exotic grasses, especially buffelgrass, are good livestock forage. However, it would be in the best interests of many ranchers who derive income from quail hunting to know if exotic grass invasions are detrimental to bobwhite populations inhabiting their properties. Despite this logic, exotic grass/quail research has been neglected for northern bobwhites in the Southwest.

A few notable quail biologists with years of experience working with quail in south Texas, developed opinions regarding the impacts of exotic grasses on quail populations. For instance, Lehmann (1984:287) advocated restoring rangelands to high quality perennial bunchgrasses and legumes in order to increase bobwhite densities in south Texas. He furthermore stated that management activities that promote large expanses of buffelgrass, Kleberg bluestem or any other nonfood-bearing exotic species should be avoided if increasing quail numbers is a management goal. Guthery's (Oklahoma State University, Stillwater, personal communication) extensive research on northern bobwhites in south Texas lead him to believe that it was unreasonable to assume that exotic grass invasions were universally negative for bobwhite populations inhabiting southwestern rangelands. For example, he observed that King Ranch bluestem infestations and invasions provided poor quail habitat conditions throughout south Texas. Conversely, he noted that in one instance, quail surveys on ranch infested with buffelgrass produce estimates of 5 birds/ha (Guthery and Koerth 1992) which is a high density for south Texas. Precipitation was average to above average during the beginning and middle of the study, which suggests that native foods were probably adequate. Moreover, quail feeders and waterers were established on the study site at a density of 1 feeder/9 ha and 1 waterer/8 ha. Thus, bobwhites had ample food and water available to them otherwise a density of 5 birds/ha could not have been produced or sustained. Habitat quality on the study site was considered high, indicating that forbs were avail-

able to quail and thus were probably not a limiting factor. Clearly buffelgrass infestations on this ranch did not completely suppress forb populations. Nevertheless, given what is known about the impacts of exotic grass invasions on forb abundance, it is possible that forb numbers were considerably higher on the ranch prior to buffelgrass invasion. Pre-buffelgrass forb abundance may seem irrelevant from a quail management perspective because post-buffelgrass forb abundance was sufficient to support a density of 5 birds/ha. However, during drought, forb abundance in buffelgrass pastures may be much lower than in a comparable pasture composed of native grasses, thereby reducing the quality of buffelgrass habitat to bobwhites.

Guthery's research in south Texas indicated to him that one should not generalize about the impacts of exotic grass invasions on bobwhite populations (personal communication). Though Lehmann (1984:287) believed that exotic grass represented poor quail habitat, this belief was based largely on several decades of observation, which, though valuable, is not an alternative to good science. Similarly, Guthery and Koerth (1992) did not design their research to quantify the impacts of buffelgrass invasions on bobwhite populations. Their research was simply conducted on a ranch over a period of time when quail were abundant on their buffelgrass study sites. They never suggested that buffelgrass provided either good or bad habitat conditions for bobwhites. Instead we speculated that bobwhite populations were not significantly impacted by buffelgrass during their study. Unfortunately, speculation like anecdotal observation, does not prove or disprove anything. The truth is, like masked bobwhites, scaled quail, Gambel's quail, and Montezuma quail, we really do not know what impacts, if any, exotic grass invasions have on northern bobwhite populations.

RESEARCH AND MANAGEMENT NEEDS

The recent work of Burger et al. (1990), Burger (1993), Barnes et al. (1995), and Washburn et al. (1999, 2000) in the Midwest and Southeast represents almost all of the published research that addresses the impacts of exotic grasses on quail. Significantly more research needs to be conducted in a variety of ecoregions in North America to assess the impacts of exotic grass invasions on quail populations. The research of Bock et al. (1986) indicated that exotic grass invasions resulted in lower avian diversity in southeastern Arizona, and Schemnitz (1993) believed that exotic grass species planted to CRP fields in the Oklahoma Panhandle have negatively impacted scaled quail habitat conditions. Additionally, numerous anecdotal observations by other quail biologists working throughout the southwest suggests that exotic grass invasions may prove harmful to quail populations. Nonetheless, little scientific evidence presently exists implicating exotic

grass invasions as a legitimate threat to quail populations of the southwest.

Clearly, a logical beginning is to determine if a problem exists! Coarse-scale, retrospective analyses of trends in quail abundance could be correlated to trends in exotic grass invasions across regional landscapes to determine if scaled quail population declines in south-eastern Arizona for example, are related to increasing exotic grass dominance of grassland landscapes. Similar retrospective studies could be done in south Texas for bobwhites and buffelgrass, in the Sonoran Desert for Gambel's quail and red brome, and in northcentral Sonora, Mexico and the BANWR of Arizona for masked bobwhites and buffelgrass and Lehmann lovegrass, respectively. In addition to retrospective studies, Geographic Information Systems could be used in conjunction with landscape-scale quail and vegetation data collected today to determine if quail abundance is impacted by landscapes dominated by exotic grasses. One would simply need reasonably accurate Global Positioning Systems, reliable four-wheel drive vehicles, access to a regional landscape and sufficient help to conduct quail surveys and regional assessment of the impacts of exotic grass on quail abundance could be accomplished.

If it can be established that quail numbers are lower on landscapes dominated by exotic grasses compared to quail numbers on landscapes dominated by native grasses, then research designed to determine the specific mechanisms responsible for lower quail numbers can be initiated. Incorporated in such a research project would be studies that illuminate the life history of the exotic grasses of interest so that potential vulnerabilities of the exotic plant could be identified, and then possibly exploited in an effort to reduce the negative impacts of the exotic grass on quail populations. For example, Biedenbender et al. (1995) knew that Lehmann lovegrass seed germination is enhanced by red light and fluctuating diurnal temperatures so they exploited these aspects of Lehmann lovegrass life history in an effort to suppress seedling germination. They succeeded in suppressing seedling expression in favor of native grass seedlings in southeastern Arizona by altering light, temperature and moisture relations in seedbed environments via a combination of spring glyphosate and June mowing treatments. Biedenbender et al. (1995) did not discuss how quail might benefit from the results of their work, however, suppression of Lehmann lovegrass in favor of native vegetation would benefit masked bobwhite and scaled quail populations if the observations of King (1998), Guthery et al. (2000), and Schemnitz (1963) are correct.

In addition to the work of Biedenbender et al. (1995), other researchers have demonstrated a direct relationship between suppressing exotic grass populations and improving quail habitat. Barnes et al. (1995) determined that tall fescue provided poor habitat conditions for quail, then Washburn et al. (1999, 2000) determined that a combination of seasonal herbicide application and prescribed burning significantly reduced tall fescue density on treated fields in favor of native grasses that enhanced bobwhite habitat condi-

tions. The results of these research projects are encouraging, because they indicate that tall fescue and Lehmann lovegrass populations can be reduced in Kentucky and Arizona, respectively.

There are however complications associated with exotic grass suppression that need to be considered on a species specific and site-by-site basis. For instance, methodology developed to slow or stop Lehmann lovegrass invasions in Arizona, may not succeed in Texas where climatic and edaphic factors are markedly different. Similarly, techniques that increase tall fescue mortality may have no impact on buffelgrass or red brome. Another problem associated with attempting to improve quail habitat conditions by reducing exotic grass populations concerns replacing the exotic grass with vegetation that is favored by quail. Presumably grasses and forbs native to the treated site would be the preferred post-treatment cover crop, however often native seedbanks have diminished or no longer exist on treated sites, because of sheet and rill erosion. Consequently, if a native cover crop is desired, seed must be purchased from commercial sources, and commercial sources of native herbaceous species endemic to specific locales are extremely limited in the Southwest and often impossible to acquire. Most often available native grass seed stocks are cultivated great distances from treatment sites where native grass seeding is desired, and attempts to establish native grass stands from commercially produced seeds sometimes yields poor results (Roundy and Biedenbender 1995).

Despite these challenges, successfully rehabilitating exotic grass infestations to improve quail habitat in the Southwest could be achieved if it is deemed a problem, and quail conservation is a priority among private and public land stewards. Clearly, additional research devoted to studying specific exotic grass species in specific locales will be required. However, before these research projects are initiated, important realities associated with exotic grasses in the Southwest need to be understood by everyone advocating exotic grass suppression. First, certain exotic grass species are perceived as important livestock forage by many livestock producers. As mentioned earlier in this paper, hundreds of thousands of hectares of a variety of exotic grass species have been established in the Southwest over the past 50 years by ranchers, as well as federal and state agencies to provide reliable forage for cattle. Ranchers in south Texas and northern Mexico in particular, continue to seed thousands of hectares of buffelgrass annually. Livestock producers are unlikely to advocate exotic suppression. So exotic suppression will have to be implemented on areas where exotic grass is viewed as a pest. Federal land managers of National Wildlife Refuges and National Parks are required to implement management activities that restore native flora and fauna, so Federal Refuge and Parks represent areas where exotic grass suppression research would likely be welcome. Exotic grass suppression would also be welcome on properties owned by private conservation organizations, such as the Nature Conservancy and the National Audubon Society, because these organizations are very interested in na-

tive flora and fauna conservation and restoration. Also, many ranchers actively promote exotic grass establishment, however, there are some private landowners who would prefer to manage for native vegetation for commercial and aesthetic reasons. These individuals may believe that native vegetation provides better habitat for bobwhites, and because quail are a valuable commodity in Texas, for example, some ranchers may be interested in initiating exotic grass suppression if they know that quail will benefit. Therefore, it is important to focus research efforts on lands where exotic species are regarded as pests and where suppression is desired.

The other important reality regarding exotic grass suppression is to understand very clearly that eradicating established exotics that are resilient aggressive invaders is impossible. Eradicating many naturalized exotic species, and perhaps even controlling them, are unrealistic expectations. Once established, non-native plants are extremely difficult to remove, since they are often subject to less pressure from competition or predation than native species (Palmer et al. 1997). Removal of exotic grasses by hand resulted in an increase in native shrubs in Hawaii (D'Antonio et al. 1998). Hand removal is impractical over large areas, and few economically feasible methods of biologically, chemically, or mechanically removing exotics are available. Rice blast (*Pyricularia grisea*) is pathogenic to buffelgrass. However, the fungus may also affect agricultural crops, thus its use as a biological control agent may not be advisable (Tix 2000).

Nevertheless, Heady (1999) believed that it may be possible to reduce populations of some exotic plant species, but he also believed it highly unlikely that elimination could be achieved once exotic vegetation becomes naturalized and firmly established. He noted that on a worldwide basis, efforts to eradicate alien invaders have generally failed. Furthermore Heady (1999) recognized that weed management, where the objective is partial or reasonable economic control, requires carefully designed research programs more than the selection and application of pesticides. Adopting a management philosophy is probably the most realistic approach to effectively deal with exotic grass infestations and invasions. Many private landowners in south Texas have implemented an integrated natural resource management program on their properties which integrates livestock, water, brush, and wildlife management in a manner that maximizes the economic potential of the natural resources on their properties. Because bobwhites are important commodities to many of these landowners they often manage livestock and brush in a manner that enhances quail production. If these landowners learn that exotic grass invasions could pose a threat to quail populations, they may be very responsive to cooperating in research projects designed to determine if, and how exotic grasses negatively impact quail populations. Similarly, these landowners may also be very receptive to incorporating exotic grass management into their integrated natural resource management programs, especially if exotic grass management benefits quail populations. Designating a series of pastures as exotic grass management

units and then focusing suppression activities on a different management unit each year would be an organized and economical way of managing exotic grass invasions on a ranch. Monitoring quail responses to exotic grass management activities could also be accomplished quite easily by establishing whistle counts surveys throughout management units, and then conducting quail surveys on an annual basis.

CONCLUSIONS

Thousands of exotic species have been introduced to the United States during the past century and numerous species that have successfully naturalized portions of North America are threatening the native biodiversity of the ecosystems that they currently occupy. Invasions of exotic plants modify microclimatic and edaphic features of native vegetative communities in a manner that creates progressively better conditions for the exotic plant invading the native system, thereby perpetuating invasion. An important consequence of exotic grass invasions appears to be the simplification of native biodiversity of the ecosystem being invaded. Exotic grass invasions are currently occurring on thousands of hectares of rangeland in the southwestern United States and little research has been conducted to determine how these invasions are impacting wildlife populations inhabiting these rangeland ecosystems. The meager work that has been done indicates that exotic grass invasions have a negative impact on the plant and animal communities that are being invaded. Bird communities in particular, may be impoverished as a result of exotic grass invasions because these invasions typically reduce herbaceous structural diversity, which not only reduces niche diversity, but also probably reduces forb and insect diversity.

Like northern bobwhite populations throughout most of their historic distribution, populations of most of the 5 native southwestern quail species are also declining in at least portions of their range. Scaled quail and Montezuma quail populations continue to decline throughout Texas, New Mexico, and Arizona. Masked bobwhites remain endangered in Arizona despite annual supplementation of captive-reared chicks to an introduced population. What is even more disturbing is that Gambel's quail and northern bobwhite populations that have been at least stable for decades in Arizona and south Texas, respectively, have recently exhibited indications that population declines are underway. These declines have largely been attributed to habitat loss due to overgrazing, increased agricultural crop production, and urban development. However, quail populations could also be losing useable habitat space to exotic grass invasions. Few studies have been conducted addressing the exotic grass/quail issue, and most of those that have been completed were conducted in the midwest or southeast and yielded mixed results. Nevertheless, recent grassland community studies indicate that essential quail habitat features could be negatively impacted by exotic grass invasions. Concern that exotic grass invasions could neg-

actively impact quail populations is therefore justified, until scientific evidence proves otherwise. Clearly a need exists to experimentally quantify the impacts of exotic grass invasions on quail populations in the southwest. Until research projects specifically designed to evaluate the impacts of exotic grass on quail populations are implemented, we will remain ignorant regarding the exotic grass invasion/quail issue.

ACKNOWLEDGMENTS

This is publication no. 02-102 of the Caesar Kleberg Wildlife Research Institute.

LITERATURE CITED

- Bahre, C. J. 1991. A legacy of change: historic impact on vegetation in the Arizona borderlands. University of Arizona Press, Tucson, Arizona.
- Barnes, T. G., L. A. Madison, J. D. Sole, and M. J. Lacki. 1995. An assessment of habitat quality for northern bobwhites in tall fescue-dominated fields. *Wildlife Society Bulletin* 23: 231–237.
- Biedenbender, S. H., B. A. Roundy, and L. Abbott. 1995. Replacing Lehmann lovegrass with native grass. Page 52–56 in B. A. Roundy, E. D. Durant, J. S. Haley, D. K. Mann, eds. Proceedings: wildland shrub and arid land restoration symposium. General Technical Report INT-GTR-315. United States Department of Agriculture, Forest Service, Intermountain Research Station, Provo, Utah.
- Bishop, R. A., and C. R. Hungerford. 1965. Seasonal food selection of Arizona Mearns's quail. *Journal of Wildlife Management* 29:813–819.
- Bock, C. E., J. H. Bock, K. L. Jepson, and J. C. Ortega. 1986. Ecological effects of planting African lovegrasses in Arizona. *National Geographic Research* 2:456–463.
- Brennan, L. A. 1991. How can we reverse the northern bobwhite population decline? *Wildlife Society Bulletin* 19:544–555.
- Brown, C. S., and K. J. Rice. 2000. The mark of Zorro: effects of the annual grass *Vulpia myuros* on California native perennial grass. *Restoration Ecology* 8:10–17.
- Brown, D. E. 1982. Effects of livestock grazing on Mearns quail in southeastern Arizona. *Journal of Range Management* 35: 727–732.
- Brown, D. E. 1989. Arizona gamebirds. University of Arizona Press, Tucson.
- Brown, T. 1999. Demand for quail hunting in Texas. Pages 146–150 in K. A. Cearley, ed. Preserving Texas's quail heritage into the 21st century. Texas Agricultural Extension Service, Texas A&M University, College Station, Texas.
- Burger, L. W., Jr., E. W. Kurzjeski, T. V. Dailey, and M. R. Ryan. 1990. Structural characteristics of vegetation in CRP fields in northern Missouri and their suitability as bobwhite habitat. *Transactions of the North American Wildlife and Natural Resource Conference* 55:74–83.
- Burger, L. 1993. Relative invertebrate abundance and biomass in conservation reserve planting in northern Missouri. Proceedings of the National Quail Symposium 3:102–108.
- Burgess, T. L. 1995. Desert grassland, mixed shrub savanna, shrub steppe or semidesert scrub? The dilemma of coexisting growth forms. Pages 31–67 in M. P. McClaran and T. R. Van Devender, eds. The desert grassland. University of Arizona Press, Tucson.
- Campbell-Kissock, L. H. Blankenship, and J. W. Stewart. 1985. Plant and animal foods of bobwhite and scaled quail in southwest Texas. *Southwest Naturalist* 30:543–553.
- Christian, J. M., and S. D. Wilson. 1999. Long-term ecosystem impacts of an introduced grass in the northern Great Plains. *Ecology* 80:2397–2407.
- Church, K. E., J. R. Sauer, and S. Droege. 1993. Population trends of quails in North America. Proceedings of the National Quail Symposium 3:44–54.
- Crawley, M. J. 1987. What makes a community invulnerable? Pages 429–453 in A. J. Gray, M. J. Crawley, and P. J. Edwards eds. Colonization, succession, and stability. Blackwell Scientific Publications, Oxford.
- D'Antonio, C. M., and P. M. Vitousek. 1992. Biological invasions by exotic grasses: the grass/fire cycle and global change. *Annual Review of Ecology and Systematics* 23:63–87.
- D'Antonio, C. M., R. F. Hughes, M. Michelle, D. Hitchcock, and P. M. Vitousek. 1998. The response of native species to removal of invasive exotic grasses in seasonally dry Hawaiian woodland. *Journal of Vegetation Science* 9:699–712.
- Dormaar, J. F., M. A. Naeth, W. D. Willms, and D. S. Chanasyk. 1995. Effect of native prairie, crested wheatgrass (*Agropyron cristatum* (L.) Gaertn.) and Russian wildrye (*Elymus junceus* Fisch.) on soil chemical properties. *Journal of Range Management* 48:258–263.
- Gibson, D. J., T. R. Seastedt, and J. M. Briggs. 1993. Management practices in tallgrass prairie: large- and small-scale experimental effects on species composition. *Journal of Applied Ecology* 30:247–255.
- Goodwin, J. G., Jr., and C. R. Hungerford. 1977. Habitat use by native Gambels and scaled quail and released masked bobwhite quail in southern Arizona. United States Forest Service Research Paper, RM-197. Fort Collins, Colorado.
- Guthery, F. S. 1986. Beef, brush and bobwhites: quail management in cattle country. Golden Banner Press, Corpus Christi, Texas.
- Guthery, F. S., and N. E. Koerth. 1992. Substandard water intake and inhibition of bobwhite reproduction during drought. *Journal of Wildlife Management* 56:760–768.
- Guthery, F. S. 1997. A philosophy for habitat management for northern bobwhites. *Journal of Wildlife Management* 61: 291–301.
- Guthery, F. S., N. D. Forrester, K. R. Nolte, W. E. Cohen, and W. P. Kuvlesky, Jr. 2000. Potential effects of global warming on quail populations. Population trends of quails in North America. Proceedings of the National Quail Symposium 4:198–204.
- Guthery, F. S., N. M. King, K. R. Nolte, W. P. Kuvlesky, Jr., S. DeStefano, S. A. Gall, and N. J. Silvy. 2001. Comparative habitat ecology of masked bobwhites, scaled and Gambel's quail in southern Arizona. *Journal of Wildlife Management* 65:IN PRESS.
- Heady, H. F. 1999. Perspectives on rangeland ecology and management. *Rangelands* 21:23–32.
- Hurst, G. A., L. W. Burger, and B. D. Leopold. 1996. Predation and galliforme recruitment: an old issue revisited. *Transactions of the North American Wildlife and Natural Resource Conference* 61:62–76.
- James, D. 1995. The threat of exotic grasses to the biodiversity of semiarid ecosystems. *Aridlands Newsletter*. 37:1–3.
- King, N. M. 1998. Habitat use by endangered masked bobwhites and other quail on the Buenos Aires National Wildlife Refuge, Arizona. Thesis. University of Arizona, Tucson.
- Klose, N. 1950. America's crop heritage: the history of foreign plant introduction by the federal government. Iowa State University Press, Ames.
- Kotaniemi, P. M. 1997. Effects of experimental soil disturbance on revegetation by natives and exotics in coastal California meadows. *Journal of Applied Ecology* 34:631–644.
- Kuvlesky, W. P., Jr., S. A. Gall, S. J. Dobrott, S. Tolley, F. S. Guthery, S. A. DeStefano, N. King, K. R. Nolte, N. J. Silvy, J. C. Lewis, G. Gee, G. Camou-Luders, and R. Engel-Wilson. 2000. The status of masked bobwhite recovery in the United States and Mexico. Proceedings of the National Quail Symposium 4:42–57.
- Larson, D. L., P. J. Anderson, and W. Newton. 2001. Alien plant invasion in mixed-grass prairie: effects of vegetation type

- and anthropogenic disturbance. *Ecological Applications* 11: 128–141.
- Lehmann, V. W. 1984. Bobwhite in the Rio Grande Plains of Texas. Texas A&M University Press, College Station.
- Leopold, A. S., and R. A. McCabe. 1957. Natural history of the Montezuma quail in Mexico. *Condor* 59:3–26.
- McClaran, M. P., and M. E. Anable. 1992. Spread of introduced Lehmann lovegrass along a grazing intensity gradient. *Journal of Applied Ecology* 29:92–98.
- Medina, A. L. 1988. Diets of scaled quail in southern Arizona. *Journal of Wildlife Management* 52:753–757.
- Morgan, J. W. 1998. Patterns of invasion of an urban remnant of a species-rich grassland in southeastern Australia by non-native plant species. *Journal of Vegetation Science* 9:181–190.
- Nurdin, and T. E. Fulbright. 1990. Germination of 2 legumes in leachate from introduced grasses. *Journal of Range Management* 43:466–467.
- Palmer, M. A., R. F. Ambrose, and N. L. Poff. 1997. Ecological theory and community restoration ecology. *Restoration Ecology* 5:291–300.
- Parker, I. M., Mertens, S. K., and Schemske, D. W. 1993. Distribution of seven native and two exotic plants in a tallgrass prairie in southeastern Wisconsin: the importance of human disturbance. *American Midland Naturalist* 130:43–55.
- Pimm, S., and M. Gilpin. 1989. Theoretical issues in conservation biology. Pages 287–305 in J. Roughgarden, R. May and S. Leven, eds. *Perspectives on ecological theory*. Princeton University Press, Princeton, New Jersey.
- Randall, J. 1996. Weed control for the conservation of biological diversity. *Weed Technology*. 10:370–383.
- Robel, R. J., B. L. Henning, K. W. Johnson, K. E. Kemp, and K. E. Church. 1996. Effects of seasonal disking on seed production and invertebrate biomass. *Southwest Naturalist* 41:403–408.
- Rosene, W. 1969. *The bobwhite quail: its life and management*. Rutgers University Press, New Brunswick, New Jersey.
- Roundy, B. A., and S. H. Biedenbender. 1995. Revegetation in the desert grassland. Pages 265–303 in M. P. McClaran and T. R. Van Devender, eds. *The desert grassland*. University of Arizona Press, Tucson.
- Schemnitz, S.D. 1961. Ecology of the scaled quail in the Oklahoma panhandle. *Wildlife Monograph* Number 8.
- Schemnitz, S. D. 1993. Scaled quail habitats revisited—Oklahoma Panhandle. *Proceedings of the National Quail Symposium* 4:143–147.
- Simms, K. 1989. Home range, habitat use and movement of reintroduced masked bobwhite. Thesis. University of Arizona, Tucson.
- Stoddard, H. L. 1931. *The bobwhite quail: its habits, preservation and increase*. Charles Scribner's Sons Publishers, New York, New York.
- Stohlgren, T. J., L. D. Schell, and B. V. Heuvel. 1999. How grazing and soil quality affect native and exotic plant diversity in Rocky Mountain grassland. *Ecological Applications* 9:45–64.
- Symstad, A. J. 2000. A test of the effects of functional group richness and composition on grassland invisibility. *Ecology* 81:99–109.
- Tix, D. 2000. *Cenchrus ciliaris* invasion and control in southwestern U.S. grasslands and shrublands. *Restoration and Reclamation Review* 6:1.
- Tyser, R. W., and C. A. Worley. 1992. Alien flora in grasslands adjacent to road and trail corridors in Glacier National Park, Montana (U.S.A.). *Conservation Biology* 6:253–262.
- United States Congressional Office of Technology Assessment. 1993. *Harmful non-indigenous species in the United States*. OTA-F-565. Government Printing Office, Washington, D.C.
- United States Fish and Wildlife Service. 1995. *Masked bobwhite (Colinus virginianus ridgwayi) recovery plan*. United States Fish & Wildlife Service, Albuquerque, New Mexico.
- Washburn, B. E., T. G. Barnes, J. D. Sole, and R. Hines. 1999. Eradicating tall fescue using glyphosate followed by cool-season grass seedings. *Proceedings of the Annual Conference of the Southeastern Fish and Wildlife Agencies*. 53: 123–130.
- Washburn, B. E., T. G. Barnes, and J. D. Sole. 2000. Improving northern bobwhite habitat by converting tall fescue fields to native warm season grasses. *Wildlife Society Bulletin* 28: 97–104.
- Westbrooks, R. 1998. *Invasive plants, changing the landscape of America: fact book*. Federal Interagency Committee for the Management of Noxious and Exotic Weeds (FICMNEW). Washington, D.C.
- White, L. D., and D. Wolfe. 1985. Nutritional value of common buffelgrass. Pages 13–24 in *Buffelgrass: adaptation, management and forage quality*. Symposium Proceedings, Texas Agricultural Experiment Station Report. MP-1575, Texas A&M University, College Station.
- Wilcove, D. S. 1998. Quantifying threats to imperiled species in the United States. *BioScience* 48: 214–222.
- Williamson, M. 1996. *Biological invasions*. Chapman & Hall, New York, New York.

INITIAL EFFECTS OF PRESCRIBED BURNING ON SURVIVAL AND NESTING SUCCESS OF NORTHERN BOBWHITES IN WEST-CENTRAL TEXAS

Philip S. Carter¹

Department of Agriculture, Angelo State University, San Angelo, TX 76909, USA

Dale Rollins

Department of Wildlife and Fisheries Sciences, Texas A&M University, San Angelo, TX 76901, USA

Cody B. Scott

Department of Agriculture, Angelo State University, San Angelo, TX 76909, USA

ABSTRACT

Fire is often prescribed for managing habitat for northern bobwhites (*Colinus virginianus*) in the southeastern United States, yet little is known about its use as a tool in more xeric portions of the species' range. This study was conducted from 1994 to 1995 on 3 sites in the northern Edwards Plateau ecoregion of Texas to monitor immediate post-burn effects on bobwhite ecology. Each site included a burned pasture paired with an unburned control. We radiomarked ≥ 50 bobwhites (25/pasture) at each study site with neck-loop transmitters just prior to burning and monitored their survival and nesting habits for 6 months post-burn. Survival was similar ($P > 0.05$) between burned and unburned areas. Predation was the leading cause of mortality, with mammals and raptors accounting for 68% and 31% of the predation, respectively. Nest initiation and success were low for both treatments. Nest sites occurred mostly in association with prickly pear cactus (*Opuntia* spp.). Our results suggest that relatively "cool" prescribed burns had few short-term effects on bobwhite survival in west-central Texas. However, reductions in cacti density and cover that often occur post-burn, especially if followed by an application of herbicide (i.e., picloram), may reduce the number of potential nesting sites for bobwhites.

Citation: Carter, P. S., D. Rollins, and C. B. Scott. 2002. Initial effects of prescribed burning on survival and nesting success of northern bobwhite in west-central Texas. Pages 129–134 in S. J. DeMaso, W. F. Kuvlesky, Jr., F. Hernández, and M. E. Berger. eds. Quail V: Proceedings of the Fifth National Quail Symposium. Texas Parks and Wildlife Department, Austin, TX.

Key words: burning, cacti, *Colinus virginianus*, mortality, nesting, northern bobwhite, prickly pear, range management, telemetry, Texas

INTRODUCTION

Prescribed burning is a tool to improve northern bobwhite (*Colinus virginianus*) habitat throughout the southeastern United States. Additionally, fire has become an important tool for managing rangelands throughout the Great Plains (Wright and Bailey 1982: 91). Burning is a relatively inexpensive technique for increasing forage availability for livestock and wildlife while controlling less desirable species like juniper (*Juniperus* spp.) and cacti (*Opuntia* spp.) (White and Hanselka 1989).

The impacts of burning on bobwhite habitat are unclear. Late winter burning improves bobwhite habitat in southern pine forests (Stoddard 1931:402, Speake 1967, Rosene 1969:293) and in the midwest (Ellis et al. 1969, Seitz and Landers 1972). Conversely, there is some evidence that bobwhites prefer to nest in unburned locations with adequate perennial bunchgrass cover (Rosene 1969:198, Dimmick 1971). Because the western range of bobwhites is more xeric (<40 cm annual precipitation in west Texas versus >120 cm in Florida), the impacts of fire on bobwhite

habitat may be less beneficial. Good nesting habitat typically consists of bunchgrasses that are several years old with a large overhead canopy (e.g., little bluestem [*Schizachyrium scoparium*]) (Lehmann 1984: 81, Townsend et al. 2001); fire typically consumes such vegetation.

Predators are the major causes of bobwhite mortality and nest failure (Stoddard 1931:187, Hurst et al. 1996, Rollins and Carroll 2001). Rollins and Carroll (2001) reported an average hatch rate of 28% across the range of published studies of bobwhites; mesomammals (e.g., *Procyon lotor*, *Mephitis mephitis*) commonly depredate quail nests (Hernández et al. 1997). Raptors are also major predators of juvenile and adult bobwhites (Stoddard 1931:211, Mueller 1988). In northern Florida, raptors (primarily accipiters) were responsible for 60% of the annual predation of bobwhites (DeVos 1985). Almost 50% of the annual bobwhite mortality on the Tall Timbers Research Station in Florida occurs in February through April when raptors are localized in the region.

Prescribed burning may increase the vulnerability of bobwhites to predators (especially raptors) via reductions in escape cover (Mueller and Atkinson 1985; Guthery 2000:69). Likewise, the reduction of peren-

¹ Present address is USDA Natural Resource Conservation Service, Plains, TX 79355

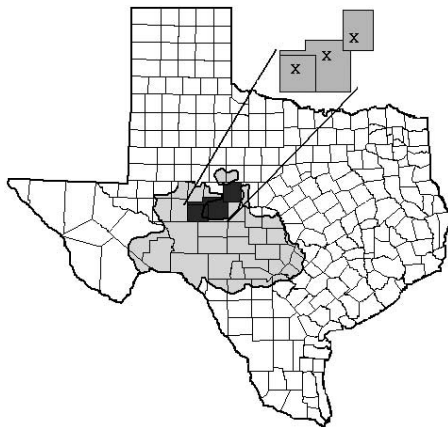

Fig. 1. Study sites located in (left to right in inset) Irion, Tom Green, and Runnels counties, Texas. Each county is located on the northwestern edge of the Edwards Plateau ecoregion. Approximate study location within each county indicated by an "X".

nial bunchgrasses and prickly pear may reduce nesting success (Slater et al. 2001). Accordingly, we designed a study to (1) monitor post-burn survival and cause-specific mortality of bobwhites and (2) monitor nest site selection and nesting success on burned versus unburned sites in west-central Texas.

METHODS

Study Areas

We conducted our study during 1994–95 on 3 sites in the northern Edwards Plateau ecoregion of Texas in Irion, Tom Green, and Runnels counties (Fig. 1). Each study site consisted of a burned and unburned pasture located within 5 km of each other. Vegetation, soil type, and precipitation were similar within a particular study site, but varied somewhat across the 3 sites.

Site 1 was located in Irion County about 32 km west of San Angelo, Texas on the Funk Ranch. Average annual precipitation is 46 cm. Understory vegetation consisted primarily of cacti, three-awns (*Aristida* spp.), tobosa (*Hilaria mutica*), curlymesquite (*H. belangeri*) and buffalograss (*Buchloe dactyloides*). Overstory consisted of a mix of several small trees and shrubs, primarily mesquite (*Prosopis glandulosa*) and redberry juniper (*Juniperus pinchotii*). The burned site included 60 ha that was surrounded by the unburned site. Unburned areas were grazed with cattle, sheep, and goats at a heavy stocking rate (approximately 10 ha/animal unit [AU]). Predator control was conducted on this site for ranch management purposes (i.e., protection of sheep and goats). Predator species targeted for control were foxes (*Vulpes vulpes* and *Urocyon cinereoargenteus*), bobcat (*Lynx rufus*), and raccoon.

Site 2 was located on the north shore of O.C. Fisher Reservoir on the Angelo State University Management, Instruction, and Research (MIR) Center about 15 km northwest of San Angelo. Mean annual precipitation is 52 cm. Understory vegetation consisted of cacti, Texas wintergrass (*Stipa leucotricha*), Johnsongrass (*Sorghum halepense*), sideoats grama (*Bouteloua*

curtipendula), and threeawns. Overstory vegetation was primarily dominated by mesquite. The burned area consisted of 60 ha and the unburned area was several pastures surrounding the burn but at least 1.6 km from the burn. Unburned areas were grazed with cattle, sheep, and goats at moderate stocking rates (approximately 15 ha/AU).

Site 3 was located 8 km east of Bronte, Texas on the Tidwell and Rocking Horse Ranches. Average annual precipitation is 56 cm. Dominant understory vegetation consisted of Texas wintergrass, sideoats grama, threeawns, and cacti. The dominant overstory vegetation was mesquite. The burned pasture was 284 ha, whereas the adjacent unburned area was 130 ha.

Burn dates were 27 January 1994, 27 February 1994, and 13 January 1995 for sites 1–3, respectively. Burns were conducted under prescriptions according to Natural Resource Conservation Service guidelines (United States Department of Agriculture 1988). Fine fuel loads were estimated at 2,500, 4,000, and 3,500 kg/ha for sites 1–3, respectively. Fuel continuity was greatest at Site 2, and similar between sites 1 and 3. Headfires were ignited between 1300 and 1600 hours. Weather conditions (relative humidity, air speed, ambient temperature) varied across the 3 burns. Weather conditions (i.e., lower humidity, higher wind speeds) resulted in a "hotter" burn at site 2. Higher humidity prevailed at site 1, with site 3 being intermediate.

Data Collection

We trapped bobwhites with standard Stoddard funnel-type traps (Day et al. 1980), 1–14 days prior to each burn. After capture, we fitted bobwhites with neck-loop radio telemeters weighing <6 g (Wildlife Materials, Inc.TM, Carbondale, Illinois, USA). We monitored bobwhite movements and survival thrice weekly prior to the burn, continuously throughout the burn, and immediately thereafter for 4–6 hours (Curtis et al. 1988). Post-burn monitoring occurred thrice weekly through May or until nest incubation was initiated. We then monitored bobwhites twice weekly for the remainder of the study (September of the burn year).

Cause-specific mortality was determined by examining the collar and other physical evidence at the kill site. We assumed a bobwhite was dead or incubating a nest when no fluctuation in the bird's daily location was detected. We classified the cause of mortality by inspecting kill sites. The main difference between a mammal and raptor kill is that a raptor leaves the bones and wings intact while mammals leave nothing but feathers (S. Cox, Oklahoma Department Wildlife Conservation, personal communication). The telemeter may also be used as evidence. A mammal leaves indentations on the softer parts of the telemeter, whereas a raptor typically leaves crimped marks on the antenna or the antenna is curled.

We inspected nest sites when incubation was suspected. When we located the nest, we placed an additional telemeter nearby to aid us in finding the nest in the absence of the incubating quail. We character-

BOBWHITE RESPONSE TO PRESCRIBED BURNING IN TEXAS

131

Table 1. Sex and number of bobwhites radiomarked at 3 sites in west-central Texas, 1994–95.

Site	County	1994		1995	
		Males	Females	Males	Females
1	Irion	0	59		
2	Tom Green	21	35		
3	Runnels			45	51

ized nesting microhabitat relative to vegetative cover, number of eggs, and nest status when the hen was found to be away from the nest.

Data Analysis

We compared survivorship curves using the Kaplan-Meier survival estimator (Kaplan and Meier 1958) using the program STAGKAM (Kulowiec 1989), with the staggered entry approach (Pollock et al. 1989a). Survival distributions were compared using log-rank chi-square tests (Burger et al. 1991). We assumed that birds were sampled randomly and that trapping, handling, and radiomarking did not affect survival probability (Heisey and Fuller 1985, Burger et al. 1995) or cause-specific mortality agents. Bobwhites that died or were lost within 7 days of marking were excluded from the study (Kurzejeski et al. 1987, Pollock et al. 1989a,b). Bobwhites that were lost due to dispersal or radio failure were deemed “censored” (Pollock et al. 1989a). We used censored birds for survival probabilities up until the day the signal was lost, but they were not considered mortalities (Burger et al. 1995).

RESULTS

Capture Success

We radiomarked 211 bobwhites across the 3 study sites (Table 1). Fifty-nine females were radiomarked at site 1: 28 from the burned plot and 31 from the unburned plot. Fifty-six birds were marked at site 2: 29 from the burned plot and 27 from unburned sites. Both females and males were marked at site 2 because of limited success of trapping females. The sample from the burned plot consisted of 15 females and 12 males, whereas the unburned plot included 20 females and 9 males. Site 3 included 57 (30 females, 27 males) on the burned plot and 39 (21 females, 18 males) on the unburned plot. Bobwhites on the burned area at site 3 were radiomarked during 2 separate trappings. Thirty-eight quail were radiomarked during January and 16 more during February. The additional collaring period was needed because a large number of the original birds died or were censored early in the study.

Survival

Across all 3 sites, 30 (14.2%) of the quail were excluded from the analysis because they did not survive or were censored within 7 days of radiomarking (Fig. 2). Twenty five (11.8%) of the remaining 181 quail were censored because of radio failure and 25

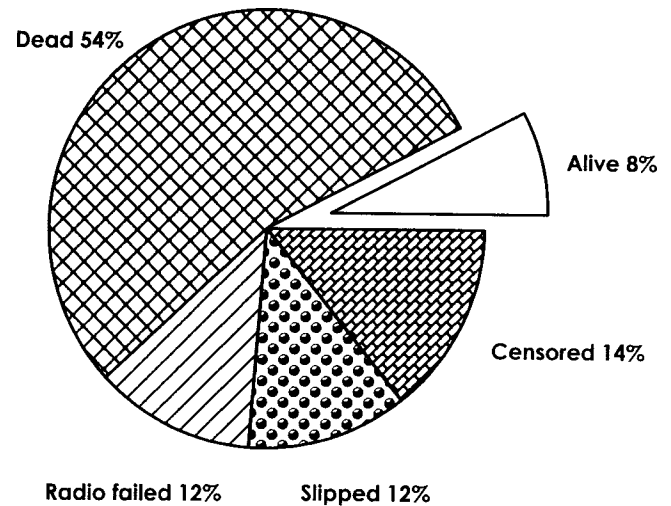

Fig. 2. Fates of radiomarked bobwhites at 3 study sites in west-central Texas, 1994–95.

(11.8%) slipped their transmitters. Seventeen (8.1%) quail survived throughout the study, leaving 114 (54.0%) that were killed.

Survival did not differ between treatments ($P = 0.72$), among sites ($P = 0.38$), or between age classes ($P = 0.82$). We accepted the null hypothesis that survival rates were similar between burned and unburned areas. Females lived longer ($P < 0.05$) than males across all sites. Females lived an average of 72.2 ± 7.7 days, whereas males lived 48.7 ± 7.7 days. Radiomarked birds lived an average of 69.5 ± 7.5 days on site 1, 67.9 ± 7.7 days on site 2, and 55.3 ± 7.1 days on site 3.

No radiomarked bobwhites were killed directly as a result of the fire itself. Birds avoided the advancing flames by either moving ahead of, or flying over, the headfire.

Predation was the primary cause of post-burn mortality, accounting for 93 (82% of the total) deaths (Fig. 3). Mammals were credited with 63 deaths (55%), raptors with 29 deaths (25%), and snakes with 1 death. Seventeen (15%) radiomarked bobwhites died from unknown causes and 4 (4%) died from exposure immediately following a hail storm.

Nesting Ecology

Of the 58 radiomarked bobwhites (44 females and 14 males) alive at the onset of nesting (i.e., 1 May), 19 females incubated a total of 21 nests from May through September. Thirteen nests were located in unburned areas and 8 in burned areas ($P = 0.25$). The null hypothesis of equal nesting in burned and unburned sites was accepted. Nesting success was similar on burned and unburned sites. Eight nests were successful, 9 were abandoned, and 4 were depredated.

Bobwhites chose 3 microhabitats for nesting: grass, brush-grass, and cacti associations (Table 2). Overall, 5 birds nested in grass, 4 in brush-grass, and 12 in cacti associations. On burned sites, 7 nests were in cacti associations and 1 in brush-grass. On un-

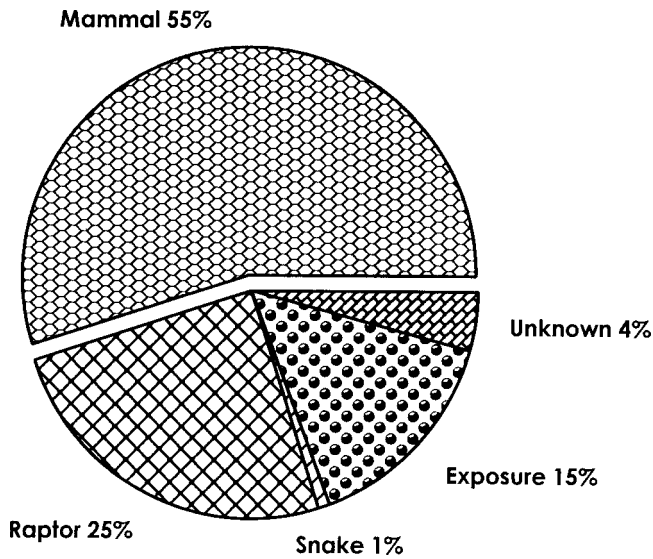

Fig. 3. Cause-specific mortality of radiomarked bobwhites from 3 study sites in west-central Texas, 1994–95.

burned sites, 5 nests were in grass, 5 in cacti associations, and 3 in brush–grass. Vegetation type chosen for nesting site did not affect nest success ($P > 0.05$).

DISCUSSION

Survival

Similar survival rates of radiomarked bobwhites between burned and unburned sites suggested that prescribed burning had no effect on short-term survival rates under the conditions of this study. Northern harriers (*Circus cyaneus*) were observed flying over burned areas on several occasions during the burns, but no radiomarked quail were killed during, or immediately after, burning. Raptor predation on bobwhites has been documented during and immediately following burning in south Texas (Tewes 1984) and in northern Florida (Mueller and Atkinson 1985).

Mean survival rate from March–August in this study was 64.2 days, slightly lower than the mean of 70.7 days reported by Hernández (1999) in Shackelford County, Texas (about 150 km northeast of our study sites). His study sites in Shackelford County would generally be considered superior bobwhite habitat relative to our study sites (i.e., greater abundance of nesting cover and lighter stocking rates).

Predation was the major cause of death during this study, in concurrence with other studies of bobwhite mortality (Stoddard 1931:203, DeVos 1985, Mueller 1988, Burger et al. 1995, Hernández 1999, Rollins and Carroll 2001). Raptors are reported as the most serious predator of bobwhites in the southeastern United States (DeVos 1985, Mueller 1988), but mammals were responsible for most of the predation in this study (68%). We believe that gray foxes and feral cats were the primary mammalian predators, although red foxes, skunks, raccoons, bobcats, and ringtails (*Bassariscus astutus*) may have contributed to predation losses. Gray foxes would sometimes leave scat at kill sites

Table 2. Nesting location and nest fate of 21 bobwhite nests on burned versus unburned sites in west-central Texas, 1994–95.

Site	Treatment	Nest Location ^a	Microhabitat	Fate
1	Unburned	Unburned	Cacti/grass	Abandoned
	Unburned	Unburned	Cacti/grass	Depredated
	Unburned	Unburned	Brush/grass	Hatched
	Unburned	Unburned	Brush/grass	Hatched
2	Burned	Unburned	Grass	Hatched
	Unburned	Unburned	Brush/grass	Abandoned
	Unburned	Burned	Cacti/grass	Abandoned
	Unburned	Unburned	Grass	Abandoned
	Burned	Unburned	Grass	Abandoned
	Burned	Unburned	Grass	Depredated
3	Burned	Burned	Brush/grass	Abandoned
	Unburned	Unburned	Cacti/grass	Abandoned
	Unburned	Unburned	Cacti/grass	Hatched
	Burned	Burned	Cacti/grass	Hatched
	Burned	Burned	Cacti/grass	Hatched
	Burned	Burned	Cacti/grass	Hatched
	Burned	Burned	Cacti/grass	Hatched
	Burned	Burned	Cacti/grass	Depredated

^a Some locations were from burned areas but quail nested in the unburned “islands” of vegetation left by the mosaic burn pattern.

and feral cats were observed occasionally near trap sites.

Northern harriers and red-tailed hawks (*Buteo jamaicensis*) were probably responsible for most of the kills by raptors during this study. Jackson (1947) identified northern harriers as a major predator during winter months on bobwhites in the Rolling Plains of Texas. Cooper’s (*Accipiter cooperi*) and sharp-shinned hawks (*A. striatus*) may have also been responsible for some predation, but they were rarely observed at the study sites. Both Cooper’s and sharp-shinned hawks are known to be secretive, suggesting visual observation may not accurately represent their abundance. However, accipiter populations have increased across their range in the last 20 years (Sauer et al. 2000).

Radiomarking probably affects the short-term behavior and survival of bobwhites (Mueller 1986). Short-term mortality rates may be accelerated by radiomarking. However, Mueller et al. (1988) compared the mortality of radiomarked and unmarked bobwhites in northern Florida and found that high mortality rates occurred 40–45 days post marking, but mortality rates of unmarked bobwhites were similar.

Similar to Burger et al. (1995), we documented higher male mortality during the mating season. Burger et al. (1995) attributed higher male mortality during the breeding season to increased vulnerability of males to predators while displaying. Male bobwhites typically perch in an open area (e.g., a fencepost), while calling and may be increasing their vulnerability to predators, especially raptors. Raptors most noted for predation on bobwhites (i.e., accipiters and northern harriers) are winter residents in west Texas, and typically absent during the bobwhite breeding season in this area. Hernández (1999) reported similar survival for male and female bobwhites ($\bar{x} = 72.2$ and 71.2 days, respectively) during the summer breeding period in Shackelford County, Texas.

The scale and intensity of the burns in this study may have minimized any potentially adverse impacts on survival. The best test of our hypothesis called for each treatment to burn uniformly to reduce any potential "island effects." However, such was not the case, as considerable patches of vegetation (herbaceous, cacti, and woody) remained following our burns. Such islands of unburned vegetation within burned areas may provide adequate refuges for bobwhites (Mueller et al. 1988). Post-burn monitoring of radiomarked bobwhites during this study supported the use of islands as refuge areas; radiomarked birds tended to be localized near areas that did not burn. If no "islands" were available, bobwhites moved off the burned area. The resulting mosaic burn patterns, particularly on site 1, may explain the lack of difference in survival among burned and unburned areas. Mosaic burns are the rule when burning rangelands in west Texas due to discontinuous fuel loads. Such "patchy" burns are desirable for quail (Guthery 1986:30).

Nesting Ecology

The importance of prickly pear as nesting habitat for bobwhites has not been documented prior to this study. In south Texas, Lehmann (1984:81) found only 1 of 189 bobwhite nests located in prickly pear. We observed 12 of 21 nests situated in cacti the summer immediately following burning. Carter (San Angelo State University, San Angelo, Texas, unpublished data) found that 8 of 12 scaled quail (*Callipepla squamata*) from study site 1 also nested in prickly pear.

In semi-arid regions with limited nesting cover, prickly pear may be more important in bobwhite nesting ecology than described previously. In a subsequent study in west Texas, Slater et al. (2001) placed simulated nests in either cacti-grass associations or grass alone, and found greater nest survival for nests in prickly pear at sites that provided <690 potential bunchgrass nesting clumps/ha. Hernández (1999) also confirmed the relative importance of prickly pear as a nesting substrate in Shackelford County, Texas. He reported that 30% of bobwhite nests were in prickly pear even on sites that had an abundance of traditional nesting substrate (>618 little bluestem plants/ha). Bobwhite nests situated in prickly pear had a hatch rate of 58% (14 of 24 hatched) but only 38% of nests in grass hatched (18 of 57 hatched).

MANAGEMENT IMPLICATIONS

Prescribed burning is often used to increase available forage species for livestock and simultaneously suppress undesirable species like prickly pear. For optimal prickly pear control, a prescribed burn is followed by herbicide application (e.g., picloram) that usually kills >95% of the cacti present (Ueckert et al. 1988). Landowners interested in maintaining quail nesting habitat should consider use of cactus for quail nesting sites in the semiarid Southwest. Burning could be used without the follow-up picloram application to reduce prickly pear by 20 to 50%, or herbicides could

be applied in a mosaic pattern to leave some cactus for nesting sites. Additional studies are needed to define optimum prickly pear and bunchgrass densities for increasing bobwhite nest survival.

ACKNOWLEDGMENTS

Partial funding for this project was provided by the Texas Council of Quail Unlimited and the University of Texas-Surface Interests. The United States Army Corps of Engineers, J. Funk, Jr., J. Tidwell, W. Hohmann, and F. Price granted access rights to their properties during the study. J. Hooten, S. Edmonson, R. Dusek, and C. McCown provided logistical support. T. Maxwell, R. Dowler, and W. Schacht provided reviews of previous drafts.

LITERATURE CITED

- Burger, L. W., Jr., M. R. Ryan, D. P. Jones, and A. P. Wywiolowski. 1991. Radio transmitters bias estimation movements and survival. *Journal of Wildlife Management* 55:693-697.
- Burger, L. W., Jr., T. V. Dailey, E. W. Kurzejeski, and M. R. Ryan. 1995. Seasonal and annual survival and cause-specific mortality of northern bobwhite in Missouri. *Journal of Wildlife Management* 59:401-410.
- Curtis, P. D., B. S. Mueller, P. D. Doerr, and C. F. Robinette. 1988. Seasonal survival of radio-marked northern bobwhite quail from hunted and non-hunted populations. *Biotelemetry X: International Radio-telemetry Symposium* 10:263-275.
- Day, G. I., S. D. Schemnitz, and R. D. Taber. 1980. Capturing and marking wild animals. Pages 61-88 in S.D. Schemnitz (ed.) *Wildlife Management Techniques Manual*. The Wildlife Society, Washington, D.C.
- DeVos, T. 1985. Predation and the bobwhite quail. *Quail Unlimited* 4:16-17.
- Dimmick, R. W. 1971. The influence of controlled burning on nesting patterns of bobwhite quail in west Tennessee. *Proceedings of the Annual Conference of Southeastern Association of Fish and Wildlife Agencies* 25:149-155.
- Ellis, J. A., W. P. Edwards, and K. D. Thomas. 1969. Responses of bobwhites to management in Illinois. *Journal of Wildlife Management* 33:749-762.
- Guthery, F. S. 1986. Beef, brush, and bobwhites: quail management in cattle country. Golden Banner Press. Corpus Christi, Texas.
- Guthery, F. S. 2000. *On bobwhites*. Texas A&M University Press, College Station.
- Heisey, D. M., and T. K. Fuller. 1985. Evaluation of survival and cause-specific mortality rates using telemetry data. *Journal of Wildlife Management* 49:668-674.
- Hernández, F. 1999. The value of prickly pear cactus as nesting cover for northern bobwhite. Dissertation. Texas A&M University, College Station and Kingsville.
- Hernández, F., D. Rollins, and R. Cantu. 1997. Evaluating evidence to identify ground-nest predators in west Texas. *Wildlife Society Bulletin* 25:826-831.
- Hurst, G. A., L. W. Burger, Jr., and B. D. Leopold. 1996. Predation and galliforme recruitment: an old issue revisited. *Transactions North American Wildlife and Natural Resources Conference* 61:62-76.
- Jackson, A. S. 1947. A bobwhite quail irruption in northwest Texas lower plains terminated by predation. *Transactions North American Wildlife and Natural Resources Conference* 12:511-519.
- Kaplan, E. L., and P. Meir. 1958. Nonparametric estimation from

- incomplete observations. *Journal American Statisticians Association* 53:457–481.
- Kulowiec, T. 1989. SAS program for conducting log-rank tests of survival distributions from two trials analyzed using the Kaplan-Meier estimator program, STAGKAM. Missouri Department of Conservation, Columbia.
- Kurzejeski, E. W., L. D. Vangiler, and J. B. Lewis. 1987. Survival of wild turkey hens in northern Missouri. *Journal of Wildlife Management* 51:188–193.
- Lehmann, V. W. 1984. Bobwhites in the Rio Grande Plain of Texas. Texas A&M University Press, College Station.
- Mueller, B. S. 1986. Do radio tags have an effect on quail mortality? *Tall Timbers Report* 7:3–4.
- Mueller, B. S. 1988. Raptor effects on bobwhite quail. *Proceedings Southeast Raptor Management Symposium*, Blacksburg, Virginia.
- Mueller, B. S., and J. Atkinson. 1985. First year report: post-fire mortality study. *Proceedings Tall Timbers Game Bird Seminar*, Tall Timbers Research Station, Tallahassee, Florida.
- Mueller, B. S., J. B. Atkinson, Jr., and T. DeVos. 1988. Mortality of radio-tagged and unmarked northern bobwhite quail. *Proceedings 10th International Symposium on Biotelemetry*, Fayetteville, Arkansas.
- Pollock, C. M., S. R. Winterstein, and P. D. Curtis. 1989a. Survival analysis in telemetry studies: the staggered entry approach. *Journal of Wildlife Management* 53:7–14.
- Pollock, C. M., S. R. Winterstein, and M. J. Conroy. 1989b. Estimation and analysis of survival distributions for radio-tagged animals. *Biometrics* 45:99–109.
- Rollins, D., and J. P. Carroll. 2001. Predation impacts on northern bobwhite and scaled quail. *Wildlife Society Bulletin* 29:39–51.
- Rosene, W. 1969. *The bobwhite quail: its life and management*. Rutgers University Press, New Brunswick, New Jersey.
- Sauer, J. R., J. E. Hines, I. Thomas, J. Fallon, and G. Gough. 2000. *The North American Breeding Bird Survey, Results and Analysis 1966–1999*. Version 98.1, United States Geological Service, Patuxent Wildlife Research Center, Laurel, Maryland.
- Seitz, W. K., and R. Q. Landers. 1972. Controlled burning in relation to bobwhite quail populations on a southern Iowa public hunting area. *Iowa State Journal of Research* 47:149–165.
- Slater, S.C., D. Rollins, R. C. Dowler, and C. B. Scott. 2001. *Opuntia*: a prickly paradigm for quail managers in west Texas. *Wildlife Society Bulletin* 29:713–719.
- Speake, D. W. 1967. Effects of controlled burning on bobwhite quail populations and habitat on an experimental area in the Alabama Piedmont. *Proceedings of the Annual Conference of Southeastern Association of Fish and Wildlife Agencies* 20:19–32.
- Stoddard, H. L. 1931. *The bobwhite quail: its habits, preservation and increase*. Charles Scribner's Sons, New York.
- Tewes, M. E. 1984. Opportunistic feeding by white-tailed hawks at prescribed burns. *Wilson Bulletin* 96:135–136.
- Townsend, D. E., II, R. E. Masters, R. L. Lochmiller, D. M. Leslie, Jr., S. J. DeMaso, and A. D. Peoples. 2001. Characteristics of nest sites of northern bobwhites in western Oklahoma. *Journal of Range Management* 54:260–264.
- Ueckert, D. N., J. L. Peterson, R. L. Potter, J. D. Whipple, and M. W. Wagner. 1988. Managing pricklypear with herbicides and fire. Pages 10–15 *in* *Research Reports, Sheep and Goat, Wool and Mohair*. Texas Agricultural Experiment Station, San Angelo.
- United States Department of Agriculture. 1988. Standards and specifications for prescribed burning, Texas–Area 9. Natural Resources Conservation Service, Field Office Technical Guide Set IV, Washington, D.C.
- White, L. D., and C. W. Hanselka. 1989. Prescribed range burning in Texas. *Texas Agricultural Extension Service Bulletin* B-1310. College Station.
- Wright, H. A., and A. W. Bailey. 1982. *Fire ecology: United States and southern Canada*. John Wiley & Sons, New York.

DOES HABITAT MANAGEMENT FOR NORTHERN BOBWHITES BENEFIT THE RED IMPORTED FIRE ANT?

A. R. Forbes

Department of Range, Wildlife, and Fisheries Management, Texas Tech University, Lubbock, TX 79409-2125, USA

C. B. Dabbert

Department of Range, Wildlife, and Fisheries Management, Texas Tech University, Lubbock, TX 79409-2125, USA

R. B. Mitchell

Department of Range, Wildlife, and Fisheries Management, Texas Tech University, Lubbock, TX 79409-2125, USA

J. M. Mueller¹

Department of Range, Wildlife, and Fisheries Management, Texas Tech University, Lubbock, TX 79409-2125, USA

ABSTRACT

Red imported fire ants (*Solenopsis invicta*) have caused damage to agricultural, economic, and wildlife resources since their accidental introduction. Previous studies have suggested that red imported fire ant (RIFA) mound densities are positively correlated to habitats maintained through disturbance. Prescribed burning and disking are two techniques commonly used to disturb portions of the landscape to maintain early successional habitats for northern bobwhite (*Colinus virginianus*). We tested the hypothesis that prescribed burning and disking would increase RIFA mound densities. This study was conducted in Refugio County, Texas in the Texas Coastal Prairie on Loamy Prairie range sites. Red imported fire ant mound densities were different between years ($F = 5.05$, $df = 2$, $P = 0.0148$). However, burning and disking had no impact ($F = 0.22$, $df = 2$, $P = 0.8044$) on RIFA mound densities. Initially high RIFA mound densities in our study area coupled with the territoriality of predominantly monogyne (single-queen) colonies may have limited increases in RIFA mound density in response to treatments on these study sites.

Citation: Forbes, A. R., C. B. Dabbert, R. B. Mitchell, and J. M. Mueller. 2002. Does habitat management for northern bobwhite benefit the red imported fire ant? Pages 135–140 in S. J. DeMaso, W. P. Kuvlesky, Jr., F. Hernández, and M. E. Berger, eds. Quail V: Proceedings of the Fifth National Quail Symposium. Texas Parks and Wildlife Department, Austin, TX.

Key words: biological control, burning, *Colinus virginianus*, disking northern bobwhite, red imported fire ants, *Solenopsis invicta*

INTRODUCTION

The red imported fire ant has become a significant ecological, economic, and human health concern in the United States since its accidental introduction in the late 1930s at the port of Mobile, Alabama. Red imported fire ants are predicted to eventually occupy more than 25% of the United States (Vinson and Sorenson 1986). Their negative impact on agricultural and economic resources is well documented (Adams et al. 1976, 1977, 1983, 1988, Brinkley 1989). Red imported fire ants also have a detrimental impact on our wildlife resources (Ridlehuber 1982, Sikes and Arnold 1986, Lockley 1995, Allen et al. 1997).

Predominantly terrestrial species, such as northern bobwhites are particularly susceptible to impacts of RIFA. Northern bobwhite populations in 15 Texas counties were negatively correlated with years of RIFA infestation (Allen et al. 1995). Red imported fire ants reduced survival of northern bobwhite chicks to 3 weeks of age by 38% in the Texas Coastal Prairie (Mueller et al. 1999).

Red imported fire ant populations can be significantly reduced using broadcast applications of insecticide baits such as Amdro® (American Cyanamid, Wayne, New Jersey). However, this treatment is not economically feasible for many landowners, particularly those with larger tracts of land (Drees 1998). Until an economically feasible method to control RIFA over large areas is available, we must attempt to slow the invasion of RIFA and prevent increases in population densities on currently colonized areas. Therefore, it is important that we examine whether current land management practices are benefiting RIFA populations, and thus possibly degrading habitat for northern bobwhites and other wildlife species.

Disking and prescribed burning are often used to enhance habitat for early successional wildlife species such as northern bobwhites. Disking breaks up most dense grasses and, to a lesser extent, shrubs. Forb growth is stimulated, which provides food for northern bobwhite (Buckner and Landers 1979, Webb and Guthery 1983). Invertebrate biomass, an important protein source for northern bobwhite chicks, increases in response to disking (Robel et al. 1996). Additionally, disking creates travel lanes through thick cover

¹ Present address: Department of Biology, Sul Ross State University, Box C-64, Alpine, TX 79832

and provides edge between grasses and bare ground, which is beneficial to nesting hens (Guthery 1986:71).

Prescribed burning is one of the least expensive habitat manipulation techniques used to manage habitat for northern bobwhites (Guthery 1986:75). In Texas, prescribed fire application costs between \$7 and \$18 per ha on juniper-infested rangeland (Mitchell et al. 2000). Fire favors many species of forbs, which are preferred northern bobwhite foods (Hansmire et al. 1988, Masters et al. 1995). Burning also encourages the growth of grasses such as *Panicum* spp. and *Paspalum* spp. (Wright and Bailey 1982:58). These grasses provide winter food and to a lesser extent, cover for northern bobwhites (Lehmann 1984:81). Formerly avoided as a management practice, prescribed burning is becoming an accepted and valuable tool for wildlife habitat enhancement.

While both disking and burning improve habitat quality for early successional wildlife species, they may also make habitat more suitable for RIFA. Red imported fire ant mound density has been positively correlated with habitats maintained via disturbance (Tschinkel 1988, Stiles and Jones 1998). Consequently, management practices used to benefit early successional species may increase RIFA and lessen or even negate the desired benefits of habitat manipulations. We tested the hypothesis that prescribed burning and disking would increase RIFA mound densities in the Texas Coastal Prairie.

METHODS

Study Area

Our study was conducted in Refugio County, Texas. Climate is subtropical, with dry, mild winters, and hot, humid summers (Guckian 1988). Average annual precipitation is 97 cm, with 60% typically occurring between April and September (Guckian 1988). Soils are moderately deep to deep, loamy soils on nearly level uplands of the Faddin (Abruptic Argiaquolls) and Wyick (Typic Albaqualfs) series (Guckian 1988). The range site is loamy prairie, with a climax vegetation dominated by grasses including little bluestem (*Andropogon scoparius*), sideoats grama (*Bouteloua curtipendula*), and various *Paspalum* species. Dominant forbs include partridgepea (*Cassia fasciculata*) and various Croton (*Croton* spp.) species. This vegetation is typical Texas Coastal Prairie (Gould 1975), although honey mesquite (*Prosopis glandulosa*) and huisache (*Acacia smallii*) have invaded some areas.

Experimental Design

This study utilized a completely randomized design, with 3 treatments (prescribed burning, disking, and control) and 5 replicates. The experimental units were 150 × 150 m plots of Texas Coastal Prairie infested with RIFA. Other consistent characteristics across plots were sandy loam soils, adequate fine fuel load, and continuous fine fuel to carry prescribed fires uniformly across the plots. Each plot received 1 of the

following randomly chosen treatments: prescribed burning, disking, or control. A 7-m disked strip was installed on the perimeter of plots to serve as firebreaks for plots where prescribed burns were conducted. Each experimental unit was bordered by a 7-m disked strip to minimize possible variation associated with the firebreaks.

Application of Treatments

Habitat treatments were applied after pre-treatment RIFA mound censuses were conducted. Each treatment was randomly assigned to 5 plots. Prescribed burns were conducted on 2 March 1998 using the strip head-fire ignition technique (Wright and Bailey 1982:426). Fine fuel loads on the burned areas ranged from 2340 to 3170 kg/ha. Fire intensity was low, with ambient air temperatures of 21–24°C, relative humidities of 32–42%, and light winds (4–10 km/h). Disking treatments were applied with 1 pass of a 7-m wide disk pulled behind a tractor. Eight strips were disked on each plot in a parallel fashion, covering approximately 40% of the plot. Disking was conducted the last week of February and the first week of March 1998.

RIFA Sampling

Within each plot, a 100 × 100 m core area was delineated in the middle of each treatment area. We estimated RIFA mound densities before burning and disking in January–February 1998 within the core areas using distance sampling (Buckland et al. 1993, Forbes et al. 2000). Nine, 100-m transects were sampled within each core area. The first transect was randomly placed 5 to 15 m from a randomly chosen side of the core area. The remaining 8 transects were set parallel to the previous transect at 10-m intervals. Each transect was evaluated by 2 observers, and all RIFA mounds detected within a 5-m perpendicular distance from the transect line were recorded. Red imported fire ant mound densities were calculated using the program DISTANCE (Laake et al. 1996, Forbes et al. 2000). After burning and disking, RIFA mound densities were estimated in June–July 1998, and May–June 1999 using the same method.

To determine whether RIFA colonies within the sampling area were monogyne (single queen) or polygyne (multiple queens), RIFA workers from a total of 100 randomly chosen mounds were collected within the core areas before treatment. Approximately 50 workers were collected from each mound. Head capsule widths were measured on 15 randomly selected workers from each mound. Red imported fire ant mounds were classified as monogyne or polygyne based upon the guidelines established by Greenberg et al. (1985).

Data Analysis

Red imported fire ant mound density data were analyzed using a repeated measures analysis of variance (ANOVA) with Statistical Analysis Systems (SAS) software (SAS 1985). Data were log-trans-

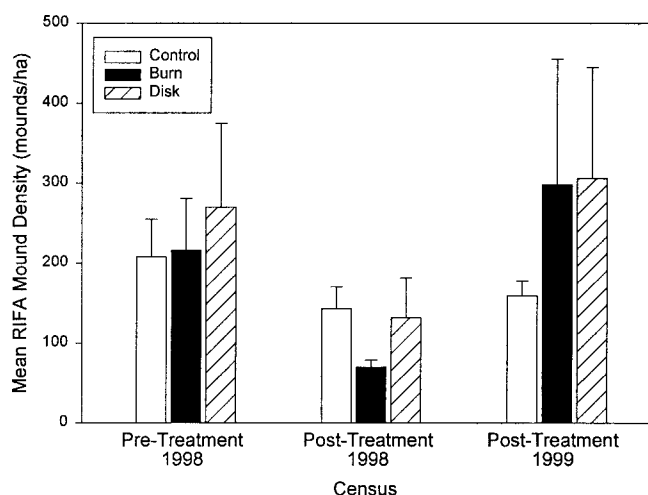

Fig. 1. Mean RIFA mound densities (\pm SE) within treatments in Refugio County, Texas in 1998 and 1999.

formed to satisfy assumptions of normality, homogeneous variances, and sphericity. However, results of ANOVA on log-transformed data were not different from that of non-transformed data. Therefore, results are presented using actual RIFA mound densities, as results are more easily interpreted. Differences in percentage of polygyne colonies among treatments were analyzed using a one-way ANOVA. Linear regression was used to determine the relationship between percentage of polygyne colonies and RIFA mound density (SAS 1985). Significance was assessed at $\alpha = 0.05$. Means are reported as ± 1 SE.

RESULTS AND DISCUSSION

Red imported fire ant mound densities were extremely variable throughout treatments, ranging from 46.3 mounds/ha to 893.0 mounds/ha over the 2 years of the study (Fig. 1). Red imported fire ant mound densities were different between years ($F = 5.05$, $df = 2$, $P = 0.0148$), but not among treatments ($F = 0.22$, $df = 2$, $P = 0.8044$). Temporal differences are likely explained by the extreme difference in precipitation in the 3 months leading up to and including the month during which RIFA mounds were censused (Fig. 2). Precipitation was similar to the long-term mean during pre-treatment counts in 1998 and post-treatment counts in 1999, but extreme drought conditions were prevalent during the post-treatment counts in 1998 (National Oceanic and Atmospheric Administration 1998, 1999). This likely caused RIFA to move deeper into the soil as water content declined near the surface (Lofgren et al. 1975), making smaller RIFA mounds more difficult to detect, resulting in lower mound density estimates.

One possible explanation for the lack of RIFA response (i.e., changes in RIFA mound densities) to treatments relates to whether mounds were predominantly monogyne or polygyne. Porter et al. (1991) estimated that polygyny occurs at a rate of approximately 54% in Texas. Red imported fire ant mounds sam-

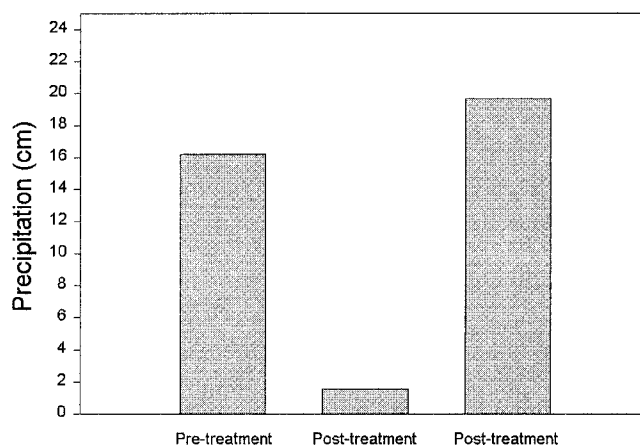

Fig. 2. Three month precipitation totals prior to RIFA mound surveys in Refugio County, Texas in 1998 and 1999.

pled within plots on this study were $32 \pm 7\%$ polygyne, and percent polygyny did not differ among treatments ($F = 0.407$, $df = 2$, $P = 0.6750$). Mean RIFA mound density estimates prior to treatment application were 231.37 ± 41.37 mounds/ha, which is very close to the maximum density at which monogyne colonies will occur (Vinson and Sorenson 1986, Porter and Tschinkel 1988, Porter et al. 1992). Red imported fire ant mound densities in previous studies which have linked RIFA populations to disturbance were conducted in areas where mound densities were as low as 8.8 mounds/ha (Tschinkel 1988, Stiles and Jones 1998). In the current study, RIFA mound densities were already close to the maximum density for monogyne colonies. Consequently, application of treatments may not have increased RIFA mound densities because RIFA mounds were already near the maximum densities permitted by their territorial behavior. Red imported fire ant mound densities in 1999, 1 year after treatment applications, were related (*a posteriori*; $R^2 = 0.8392$, $P < 0.0001$) to percent occurrence of polygyny (Fig. 3). Responses of RIFA colonies to habitat treatments in areas where mounds are

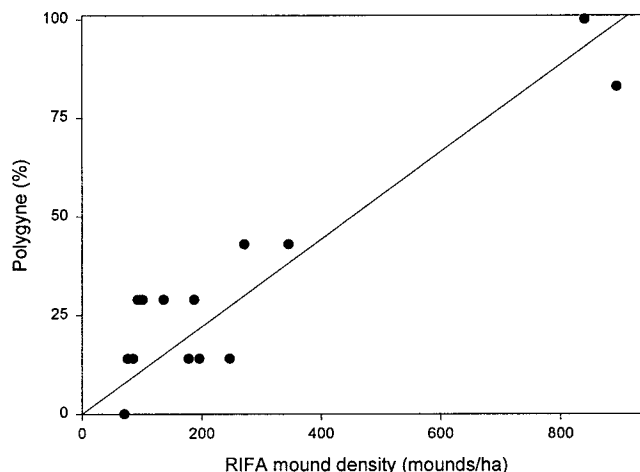

Fig. 3. Linear regression of RIFA mound densities against % occurrence of polygyny within sampling areas in Refugio County, Texas in 1998 and 1999 ($R^2 = 0.8392$, $P < 0.0001$).

predominantly polygyne may differ, due to their decreased territoriality.

CONCLUSION

This study examined the effects of burning and disking on RIFA populations in the Texas Coastal Prairie. Red imported fire ants occupy many different habitats throughout the southeastern and Gulf Coast regions of the United States. The effects of burning and disking (and/or other habitat management techniques) on RIFA populations is largely unknown in these other habitats. In many instances, eradication of RIFA is biologically and economically unfeasible. Although this study indicates prescribed burning and disking do not increase the mound densities of predominantly monogyne colonies of RIFA in the Texas Coastal Prairie, it is important to determine that wildlife management practices in other regions are not causing conditions to become more favorable for RIFA, and thus less favorable for wildlife.

ACKNOWLEDGMENTS

Research was funded by the Texas Imported Fire Ant Research and Management Plan. Special thanks go to the J. F. Welder Heirs for allowing us to conduct this experiment on their property. Authors also wish to thank the Dr. Leon Bromberg Charitable Trust Fund for support, Dr. D. Wester for assistance in statistical analyses and W. Brown, J. Medina, B. Meyer, C. Pleasant, B. Racher, and J. Wrinkle for field assistance. Contribution number T-9-951 of the College of Agricultural Sciences and Natural Resources, and Technical Paper 13 of the Texas Tech University Fire Ecology Center.

LITERATURE CITED

- Adams, C. T., W. A. Banks, and C. S. Lofgren. 1988. Red imported fire ant (Hymenoptera: Formicidae): correlation of ant density with damage to two cultivars of potatoes (*Solanum tuberosum* L.). *Journal of Economic Entomology* 81:905–909.
- Adams, C. T., W. A. Banks, C. S. Lofgren, B. J. Smittle, and D. P. Harlan. 1983. Impact of the red imported fire ant, *Solenopsis invicta* (Hymenoptera: Formicidae), on the growth and yield of soybeans. *Journal of Economic Entomology* 76:1129–1132.
- Adams, C. T., J. K. Plumely, W. A. Banks, and C. S. Lofgren. 1977. Impact of the red imported fire ant, *Solenopsis invicta* Buren, on the harvest of soybeans in North Carolina. *Journal of the Entomological Society of America* 93:150–152.
- Adams, C. T., J. K. Plumely, C. S. Lofgren, and W. A. Banks. 1976. Economic importance of the red imported fire ant, *Solenopsis invicta* Buren. Preliminary investigations of impact on soybean harvest. *Journal of the Georgia Entomological Society* 11:165–169.
- Allen, C. R., R. S. Lutz, and S. Demarais. 1995. Red imported fire ant impacts on northern bobwhite populations. *Ecological Applications* 5:632–638.
- Allen, C. R., S. Demarais, and R. S. Lutz. 1997. Effects of red imported fire ants on white-tailed deer fawns. *Journal of Wildlife Management* 61:911–916.
- Brinkley, C. K. 1989. Economic impact of the red imported fire ant, *Solenopsis invicta* Buren, in Texas. Thesis. Texas Tech University, Lubbock.
- Buckland, S. T., D. R. Anderson, K. P. Burnham, and J. L. Laake. 1993. Distance sampling: estimating abundance of biological populations. Chapman & Hall, New York, New York.
- Buckner, J. L., and J. L. Landers. 1979. Fire and disking effects on herbaceous food plants and seed supplies. *Journal of Wildlife Management* 43:807–811.
- Drees, B. M. 1998. Managing red imported fire ants in wildlife areas. Fire Ant Plan Fact Sheet #006, Texas A&M Agricultural Extension Service, College Station.
- Forbes, A. R., J. M. Mueller, R. B. Mitchell, C. B. Dabbert, and D. B. Wester. 2000. Accuracy of red imported fire ant mound density estimates. *Southwestern Entomologist* 25:109–112.
- Gould, F. W. 1975. The grasses of Texas. Texas A&M University Press, College Station.
- Greenberg, L. D., J. C. Fletcher, and S. B. Vinson. 1985. Differences in worker size and mound distribution in monogynous and polygynous colonies of the fire ant *Solenopsis invicta* Buren. *Journal of the Kansas Entomological Society* 58:9–18.
- Guckian, W. J. 1988. Soil survey of Refugio County, Texas. United States Department of Agriculture, Soil Conservation Service, Washington, D.C.
- Guthery, F. S. 1986. Beef, brush, and bobwhites: quail management in cattle country. Golden Banner Press, Inc., Corpus Christi, Texas.
- Hansmire, J. A., D. L. Drawe, D. B. Wester, and C. M. Britton. 1988. Effect of winter burns on forbs and grasses of the Texas coastal prairie. *Southwestern Naturalist* 33:333–338.
- Laake, J. L., S. T. Buckland, D. R. Anderson, and K. P. Burnham. 1996. DISTANCE User's Guide. Version 2.2. Colorado Cooperative Fish & Wildlife Research Unit, Colorado State University, Fort Collins.
- Lehmann, V. W. 1984. Bobwhites in the Rio Grande Plain of Texas. Texas A&M University Press, College Station.
- Lockley, T. C. 1995. Effect of imported fire ant predation on a population of the least tern—an endangered species. *Southwestern Entomologist* 20:517–519.
- Lofgren, C. S., W. A. Banks, and B. M. Glancey. 1975. Biology and control of imported fire ants. *Annual Review of Entomology* 20:1–30.
- Masters, R., M. Stewart, T. Bidwell, and J. Sparks. 1995. Wildlife Management Notes, No. 2. Bob-White Quail. Oklahoma Cooperative Extension Service, Stillwater.
- Mitchell, R., C. Britton, B. Racher, E. Fish, and E. Atkinson. 2000. Prescribed fire costs on juniper-infested rangeland. *Rangelands* 22:7–10.
- Mueller, J. M., C. B. Dabbert, S. Demarais, and A. R. Forbes. 1999. Northern bobwhite chick mortality caused by red imported fire ants. *Journal of Wildlife Management* 63:1291–1298.
- National Oceanic and Atmospheric Administration. 1998. Climatological data annual summary: Texas. National Climatic Data Center, Asheville, North Carolina.
- National Oceanic and Atmospheric Administration. 1999. Climatological data annual summary: Texas. National Climatic Data Center, Asheville, North Carolina.
- Porter, S. D., A. Bhatkar, R. Mulder, S. B. Vinson, and D. J. Clair. 1991. Distribution and density of polygyne fire ants (Hymenoptera: Formicidae) in Texas. *Journal of Economic Entomology* 84:866–874.
- Porter, S. D., H. G. Fowler, and W. P. MacKay. 1992. Fire ant mound densities in the United States and Brazil (Hymenoptera: Formicidae). *Journal of Economic Entomology* 85:1154–1161.
- Porter, S. D., and W. R. Tschinkel. 1987. Foraging in *Solenopsis invicta* (Hymenoptera: Formicidae): effects of weather and season. *Environmental Entomology* 16:802–808.

BOBWHITE HABITAT MANAGEMENT AND FIRE ANTS

139

- Ridlehuber, K. T. 1982. Fire ant predation on wood duck ducklings and pipped eggs. *Southwestern Naturalist* 27:222.
- Robel, R. J., B. L. Henning, K. W. Johnson, K. E. Kemp, and K. E. Church. 1996. Effects of seasonal disking on seed production and invertebrate biomass. *Southwestern Naturalist* 41:403–408.
- SAS Inst. Inc. 1985. SAS/SAT guide for personal computers, Version 6 ed., Cary, North Carolina.
- Sikes, P. J., and K. A. Arnold. 1986. Red imported fire ant (*Solenopsis invicta*) predation on cliff swallow (*Hirundo pyr-rhonota*) nestlings in east-central Texas. *Southwestern Naturalist* 31:105–106.
- Stiles, J. H., and R. H. Jones. 1998. Distribution of the red imported fire ant, *Solenopsis invicta*, in road and powerline habitats. *Landscape Ecology* 13:335–346.
- Tschinkel, W. R. 1988. Distribution of fire ants *Solenopsis invicta* and *S. geminata* (Hymenoptera: Formicidae) in northern Florida in relation to habitat and disturbance. *Annals of the Entomological Society of America* 81:76–81.
- Vinson, S. B., and A. A. Sorenson. 1986. Imported fire ants: life history and impact. Texas Department of Agriculture, Austin.
- Webb, W. M., and F. S. Guthery. 1983. Response of wildlife food plants to spring disking of mesquite rangeland in Northwest Texas. *Journal of Range Management* 36:351–353.
- Wright, H. A., and A. W. Bailey. 1982. *Fire Ecology: United States and Southern Canada*. John Wiley & Sons. New York, New York.

WINTER MACRO- AND MICROHABITAT USE OF WINTER ROOST SITES IN CENTRAL MISSOURI

Eliodora Chamberlain

Department of Fisheries and Wildlife Sciences, 302 Anheuser-Busch Natural Resources Building, University of Missouri, Columbia, MO 65211-7240, USA

Ronald D. Drobney

U.S. Geological Survey, Missouri Cooperative Fish and Wildlife Research Unit, 302 Anheuser-Busch Natural Resources Building, University of Missouri, Columbia, MO 65211-7240, USA

Thomas V. Dailey

Missouri Department of Conservation, 1110 South College Avenue, Columbia, MO 65201, USA

ABSTRACT

Northern bobwhite (*Colinus virginianus*) managers and biologists have expressed concern regarding the apparent decline of northern bobwhite populations throughout the United States. The decline has been attributed to habitat loss; however, the decline may be the result of multiple factors. Several studies concluded that reproduction was not a limiting factor, and recommended that investigations of winter habitat use at the microhabitat level are needed. In our study, we used data from 166 roost sites obtained from 194 radiomarked bobwhites to analyze winter macrohabitat use and microhabitat characteristics of roosts selected by bobwhites in central Missouri. At the macrohabitat level, bobwhites showed a preference for early successional vegetation (ESV), native warm-season grass (NWSG), and old (idle) fields. Most roost locations (51.2%) were in old fields, in ESV (23%), and NWSG (17%). For all 3 habitat types (old fields, ESV, NWSG), litter at the roost site was higher ($P < 0.05$) than the surrounding vegetation. In the 2 most preferred habitat types, visual obstruction reading (VOR) and maximum vegetation height were higher ($P < 0.05$) than the surrounding vegetation. In NWSG and old fields, litter depth was significantly higher ($P < 0.05$) than the surrounding vegetation. Habitat management of winter cover in central Missouri will benefit from the maintenance of dense ground litter (>65%), tall vegetation (>91 cm), VOR (29 cm), and litter depth about 1.5 cm in ESV, NWSG, and old fields.

Citation: Chamberlain, E., R. D. Drobney, and T. V. Dailey. 2002. Winter macro- and microhabitat use in central Missouri. Pages 140–145 in S. J. DeMaso, W. P. Kuvlesky, Jr., F. Hernández, and M. E. Berger, eds. Quail V: Proceedings of the Fifth National Quail Symposium. Texas Parks and Wildlife Department, Austin, TX.

Key words: *Colinus virginianus*, macrohabitat, microhabitat, Missouri, northern bobwhite, winter habitat

INTRODUCTION

The abundance of northern bobwhites has declined in North America at a rate of 2.4% per year, and continues to decline (Robbins et al. 1986, Droege and Sauer 1990, Brennan 1991, Church et al. 1993). Bobwhite populations in Missouri have shown similarly declines (Dailey and Truitt 1998). The decline has been attributed to habitat loss and degradation (Dixon et al. 1996). Efforts to restore bobwhite populations have emphasized the need to understand seasonal habitat needs (Burger et al. 1994).

During the 1930's Errington and Hamerstrom (1936) and Stoddard (1931:45) conducted the first winter habitat studies of northern bobwhites. These studies were descriptive, but stimulated additional research on bobwhite winter ecology. Klimstra and Ziccardi (1963) were the first to describe bobwhite winter habitat selection by analyzing roost-site microhabitat characteristics. In Illinois farmland, bobwhites selected winter roost-sites with a mean vegetation height of 59 cm and a density of 181 stems/m². In the Oklahoma tallgrass prairie, bobwhites selected roosts with a max-

imum height of 68 cm and a density of 136 stems/m² (Wiseman and Lewis 1981). In Missouri farmland, bobwhite winter roosts were characterized as 27% forb cover and 23% bare ground (Burger et al. 1994).

The objective of this study was to determine macro- and microhabitat use of bobwhite winter roost-sites in Saline County, Missouri. We also developed roosting habitat models for old fields, ESV, and NWSG.

METHODS

Study Area

The study was conducted at the Blind Pony Conservation Area (BPCA) in Saline County, Missouri. Blind Pony Conservation Area is managed for northern bobwhites with habitat management focused on early successional stage vegetation. The plant diversity on BPCA provided an opportunity for bobwhites to select among a wide range of cover densities and habitat types. Blind Pony Conservation Area contains many small fields separated by relatively small patches of woody cover. Stands of NWSG were distributed

throughout the area. Native warm-season grass stands were vegetated by Indian grass (*Sorghastrum* spp.), big bluestem (*Andropogon gerardii*), little bluestem (*Andropogon scoparius*), and switchgrass (*Panicum virgatum*). Woody vegetation consisted of oak trees (*Quercus* spp.), multiflora rose (*Rosa multiflora*), red cedar (*Juniperus virginiana*), and blackberry (*Rubus* spp.). Cropland is common with corn, soybean, wheat/lespedeza (*Lespedeza* spp.). Three to 6 m of crop field borders are unharvested. Food plots containing millet were interspersed among old fields and stands of NWSG.

We used Roseberry and Klimstra's (1984:13–15) criteria for defining old fields (idle) as 2 to 3-year old tracts dominated by perennial vegetation, and characterized by increasing amounts of woody vegetation and decreasing annual species such as ragweed (*Ambrosia* spp.). On the study area, old fields consisted of goldenrod (*Solidago* spp.), smartweed (*Polygonum* spp.), asters (*Aster* spp.), oak saplings, red cedar (*Juniperus virginiana*), maple (*Acer* spp.), and hickory (*Carya* spp.). Early successional fields were dominated by annuals such as ragweed, lespedeza, foxtail (*Setaria* spp.), dropseed (*Sporobolus* spp.), and millet (Roseberry and Klimstra 1984:13–15, 31). Cool-season grasses (CSG) consisted of crabgrass (*Digitaria* spp.), brome (*Bromus* spp.), and fescue (*Festuca* spp.).

Covey Locations

The study of roost site selection and habitat characteristics was conducted from January through March 1995–96. We randomly selected 3–5 radiomarked bobwhites each day from a population of 194 radiomarked bobwhites on the BPCA (11–16 coveys). From 0300 until 1 hour before sunrise, we determined the location of each covey. The general area was flagged, so we could find roost fecal piles at daylight. We recorded ambient temperature (minimum/maximum), snow depth, soil temperature, precipitation (presence/absence), wind speed (measured with hand-held wind gauge), and wind direction about 15 m from the estimated covey location. If the ground was frozen, we recorded soil temperature as 0° C. During daylight searches for roosts, we identified the previous night's roost from the freshest fecal pile (e.g., containing no frost).

Vegetation Measurements

To determine whether microhabitat characteristics of roosts differed from that of surrounding vegetation, we measured the microhabitat characteristics of 4 randomly selected points in the field containing each roost. The random sites were chosen by placing a grid scaled at 15-m intervals over an aerial photograph of the roost fields, and randomly selected 4 sites.

We measured VOR using the method described by Robel et al. (1970). A Daubenmire frame was used to measure percent canopy cover (CC), maximum vegetation height (MH), percent basal cover of the vegetation (BC), percent bare ground (BG), percent snow cover (SC), snow depth (SD), percent litter cover (LC),

and litter depth (LD)(Daubenmire 1959). We estimated LD by averaging 5 random measurements within the Daubenmire frame. The same procedure was used to estimate SD.

Statistical Analyses

Macrohabitat Use and Preference.—Using PC ArcView and ARC/INFO, we developed a land use/land cover spatial data layer for the BPCA. We used this data layer to quantify the extent of land cover types in ha. Supporting information, including roads, streams, and section lines were used as location references for establishing the boundaries of the study area.

Relative preference indices were calculated as described by Taylor and Guthery (1980), Wiseman and Lewis (1981), Byers et al. (1984), and Anderson and Gutzwiller (1994). Indices indicate habitat preference ranging from highly preferred (+10) to avoidance (–10). We estimated habitat availability as the proportion of the study area covered by each habitat type, defined by the dominant vegetation (Thompson and Fritzell 1988, Janvrin 1991, Anderson and Gutzwiller 1994). Relative use of habitat types was determined by the proportion of telemetry locations recorded in each habitat type.

Microhabitat Use.—To assess the influence of microhabitat variables on roost site selection, we used stepwise logistic regression (SAS Institute 1990) to determine how independent variables relate to microhabitat selection across a range of low ambient temperatures. We selected 9 independent variables a priori that we predicted might be related to bobwhite microhabitat selection. Each habitat type was modeled separately, and the analysis progressed by introducing 1 independent variable at a time. The probability rejection level was 0.10 to determine the best model.

We used multivariate analysis to detect differences ($P < 0.05$) in microhabitat variables between roost and random sites. The mean of the 4 random sites was compared with the corresponding characteristics of the roost site.

RESULTS

From January through March 1995–96, we measured 166 roost sites from 194 radiomarked bobwhites. Individual bobwhite coveys did not use the same roost more than once. During the study, daily minimum ambient temperatures ranged from –20° to 13° C, and recorded wind velocities did not exceed 13 m/sec.

Macrohabitat Use and Preference

Bobwhites roosted in old fields more than any other habitat type. Old fields accounted for 51% of roost sites, compared to 24% in ESV, and 17% in NWSG (Table 1). Despite the high intensity of use of old fields, relative-use data indicated that bobwhites preferred ESV and NWSG to old fields (Table 2). Woody vegetation, agricultural fields, and CSG were used in-

Table 1. Percentage and number of northern bobwhite roost sites in 6 types of vegetation on Blind Pony Conservation Area, Saline County, Missouri, Jan–Mar, 1995–96.

Habitat type	1995	1996	Total
*Old fields	47% (22)	53% (63)	51% (85)
*ESV ^a	26% (12)	23% (27)	23% (39)
*NWSG ^b	19% (9)	16% (19)	17% (28)
Woody vegetation	6% (3)	4% (5)	5% (8)
Crop fields	2% (1)	3% (4)	3% (5)
Cool-season grass	0% (0)	1% (1)	1% (1)
Total number of roosts	47	119	166

* The 3 vegetation types used for all statistical analyses.

^a ESV represents early successional vegetation.

^b NWSG represents native warm-season grass.

frequently, and accounted for a combined total <10% of the roost sites (Table 1).

Microhabitat Characteristics

Roost Sites vs. Random Sites.—We analyzed roost microhabitat characteristics for each habitat type, and there were several influential microhabitat variables. Using the SWLR procedure, the probability (p) of an old field site being a bobwhite roost was:

$$\ln(p/1 - p) = -0.52 - 0.006CC + 0.28LD - 0.02BC.$$

The probability of a site being a roost site in ESV was:

$$\ln(p/1 - p) = -3.5 + 0.04VOR + 0.02MH + 0.03BG.$$

In NWSG, the probability (p) of a site being a bobwhite roost was:

$$\ln(p/1 - p) = -3.36 + 0.01MH + 0.02LC \text{ (Table 3).}$$

We compared roost and random site characteristics to determine if roosts differed from the surrounding field. Old field roosts had a lower CC (37%), BC (31%) and SC (14%) than the random sites ($P < 0.05$). Litter depth (1.65 cm) and LC (79%) were higher ($P < 0.05$) at roosts (Table 4). Roosts in early successional vegetation had higher VOR (21 cm), MH (94 cm), LC (65%) and BG (13%) than random sites ($P < 0.05$). Snow depth (0.40 cm) and snow cover (19%) were lower ($P < 0.05$) at roost sites (Table 5). Roosts in NWSG had higher VOR (29 cm), MH (106 cm), LD (1.44 cm) and LC (67%) than random sites ($P < 0.05$) (Table 6).

DISCUSSION

Although there was a greater proportion of old fields on BPCA, bobwhites roosted in ESV 4 times more often than expected based upon the proportional availability of this cover type, and used old fields and NWSG at almost twice their proportional availability. Preference for ESV supports the findings of studies conducted in Illinois (Klimstra and Ziccardi 1963) and Missouri (Burger et al. 1994). The high relative use ranking of NWSG on our study area seems consistent with the findings of a study conducted in Oklahoma

Table 2. Relative preference of northern bobwhite roosts in 6 types of vegetation on Blind Pony Conservation Area, Saline County, Missouri, Jan–Mar, 1995–96.

Habitat type	Proportion available	Proportion used	Relative preference
Old fields	0.290	0.510	2.86
ESV ^a	0.060	0.240	5.78
NWSG ^b	0.090	0.170	3.12
Woody vegetation	0.210	0.050	-10.00
Crop fields	0.120	0.030	-5.85
Cool-season grass	0.240	0.006	-9.50

^a ESV represents early successional vegetation.

^b NWSG represents native warm-season grass.

(Wiseman and Lewis 1981), that showed high numbers of roosts in native grasslands.

Tonkovich and Stauffer (1993) attributed the preference of bobwhite for ESV and NWSG to the availability of high energy seeds such as lespedeza, ragweed, milo, and millet. We believe the greater availability of such seeds in close proximity to roost sites may augment bobwhite overwinter survival by reducing the amount of time spent foraging; therefore increasing foraging efficiency and reducing exposure to predators.

Our study results indicate that although northern bobwhites utilize a variety of habitat types for roosting, microhabitat characteristics of selected winter roosts differ significantly from that of the surrounding vegetation. Of the 9 microhabitat variables measured, LC was the only variable that differed from the random sites for all 3 habitat types. This finding is not in accordance with other studies (Klimstra and Ziccardi 1963, Burger et al. 1994), which found that bobwhites utilized roosts with little to no litter accumulation. The difference between our LC results and others could be attributed to litter availability resulting from different management practices. At BPCA, NWSG stands were burned on a 3–5 year rotation, and haying was limited. Litter biomass has been found to decrease immediately following a burn, and then increase as the time since

Table 3. Stepwise logistic regression predicting the occurrence of northern bobwhite winter roosts in old fields, early successional vegetation, and native warm-season grass on Blind Pony Conservation Area, Saline County, Missouri, Jan–Mar 1995–1996.

Habitat type	Coefficient	Odds ratio	χ^2	P
Old fields	-0.515 ^a			
Canopy cover	-0.006	0.994	2.758	0.009
Litter depth	0.282	1.326	4.721	0.030
Basal cover	-0.017	0.983	6.789	0.009
Early successional vegetation	-3.500 ^a			
VOR ^b	0.037	1.037	5.558	0.018
Maximum height	0.016	1.016	6.040	0.014
Bare ground	0.026	1.027	2.768	0.096
Native warm-season grass	-3.358 ^a			
Maximum height	0.010	1.010	3.481	0.062
Litter cover	0.019	1.020	7.922	0.005

^a Intercept for the linear portion of the logistic regression equation.

^b VOR represents visual obstruction reading.

BOBWHITE WINTER HABITAT

Table 4. Microhabitat characteristics of northern bobwhite roosts and random sites in old fields on Blind Pony Conservation Area, Saline County, Missouri, Jan–Mar, 1995–96. Values displayed are least squares mean \pm least squares standard error (SE).

Microhabitat variables	Roost sites (<i>n</i> = 87)		Random sites (<i>n</i> = 313)		<i>P</i>
	\bar{x}	SE	\bar{x}	SE	
VOR ^a (cm)	16.04	0.87	16.19	0.34	0.3911
Maximum height (cm)	91.35	3.81	83.90	1.03	0.0698
Canopy cover (%)	37.13	3.11	52.89	0.85	*0.0001
Litter depth (cm)	1.65	0.07	1.44	0.02	*0.0070
Percent cover of litter (%)	78.77	2.28	67.60	0.63	*0.0001
Percent basal cover (%)	30.80	1.93	41.33	0.64	*0.0001
Percent bare ground (%)	7.64	0.99	5.97	0.34	0.1267
Snow depth (cm)	0.86	0.24	0.68	0.02	0.4620
Percent snow cover (%)	14.44	1.40	19.25	0.36	*0.0004

^a VOR represents visual obstruction reading.

* Denotes significant difference.

the burn progresses (Gibson 1988). Litter also accumulates rapidly with planting age. Four to 6 years after planting, litter accumulation leveled off at 70% (Burger et al. 1994).

In ESV and NWSG, bobwhites utilized roosts characterized by tall vegetation (94 and 106 cm, respectively), which was taller than the surrounding vegetation. Roosts in Illinois had a mean vegetation height of 59 cm (Klimstra and Ziccardi 1963), which is considerably lower than the mean vegetation height used by bobwhites on the BPCA. In northeast Oklahoma, roosts were characterized by an average height of 68 cm (Wiseman and Lewis 1981). The differences in vegetation characteristics of roosts might be attributed to study site differences in plant species composition, differences in winter severity among regions, and differences resulting from differences in methodology.

Our study described winter roost characteristics at macro- and microhabitat levels. Several of the significant microhabitat variables (LC, LD, MH, VOR) may contribute to the thermal value of winter roosts. For example, tall vegetation reduces convective heat loss to the environment, where dense litter cover and depth minimizes conductive heat loss to the soil (Geiger 1965:297–308, Kendeigh 1969, Campbell and Norman 1998:72). Vegetation height and density not only min-

imize wind velocity at the level of the roost, but perhaps more importantly, reduces the loss of long-wave radiation (Geiger 1965:284–287, 290–293, 297–308; Campbell and Norman 1998:231). During the day, vegetative cover absorbs both the counter-radiation of the sky and terrestrial radiation rising from the ground. At night, the amount of radiation absorbed during the day is lost; however, the rate at which it is lost depends upon vegetation height and CC (Geiger 1965:297–308, 362; Campbell and Norman 1998:247–276). Although the microhabitat characteristics of selected roost sites appear to be related to their favorable thermal characteristics, more research is needed to determine the specific relationships between bobwhite thermostatic energy demands and winter.

Other ecological components such as depredation and food availability must also be considered when examining bobwhite winter habitat selection and survival. Depredation is the most apparent proximate cause of fall-spring bobwhite mortality in Missouri. Burger (1993) reported that mammalian depredation (21.6%) and avian depredation (25.2%) were the primary causes of bobwhite mortality in Missouri (Burger 1993). Therefore, bobwhite habitat selection is probably attributed to other factors, such as cover characteristics that reduce the risk of depredation. Ultimately,

Table 5. Microhabitat characteristics of northern bobwhite roosts and random sites in early successional vegetation on Blind Pony Conservation Area, Saline County, Missouri, Jan–Mar, 1995–96. Values displayed are least squares mean \pm least squares standard error (SE).

Microhabitat variables	Roost sites (<i>n</i> = 39)		Random sites (<i>n</i> = 140)		<i>P</i>
	\bar{x}	SE	\bar{x}	SE	
VOR ^a (cm)	21.44	1.57	13.45	0.48	*0.0001
Maximum height (cm)	94.40	4.45	71.89	1.41	*0.0001
Canopy cover (%)	65.09	3.94	62.49	1.16	0.2673
Litter depth (cm)	1.00	0.11	1.06	0.03	0.5033
Percent cover of litter (%)	65.26	3.46	55.10	0.95	*0.0198
Percent basal cover (%)	31.13	2.94	35.53	0.99	0.1415
Percent bare ground (%)	12.81	1.71	7.70	0.53	*0.0083
Snow depth (cm)	0.39	0.17	1.13	0.03	*0.0008
Percent snow cover (%)	19.43	2.53	28.40	0.68	*0.0018

^a VOR represents visual obstruction reading.

* Denotes significant difference.

Table 6. Microhabitat characteristics of northern bobwhite roosts and random sites in native warm-season grass on Blind Pony Conservation Area, Saline County, Missouri, Jan–Mar, 1995–96. Values displayed are least squares mean \pm least squares standard error (SE).

Microhabitat variables	Roost sites (n = 28)		Random sites (n = 97)		P
	\bar{x}	SE	\bar{x}	SE	
VOR ^a (cm)	28.98	2.54	22.73	0.92	*0.0203
Maximum height (cm)	105.69	5.60	90.99	1.91	*0.0236
Canopy cover (%)	63.60	4.59	76.91	1.35	0.2445
Litter depth (cm)	1.44	0.11	1.02	0.04	*0.0017
Percent cover of litter (%)	67.48	4.20	43.02	1.23	*0.0001
Percent basal cover (%)	36.96	3.86	45.26	1.40	0.0586
Percent bare ground (%)	9.91	2.20	8.34	0.68	0.5169
Snow depth (cm)	0.56	0.48	1.25	0.13	0.2358
Percent snow cover (%)	20.20	3.16	23.43	0.93	0.1484

^a VOR represents visual obstruction reading.

* Denotes significant difference.

winter habitat selection is likely the result of multiple factors, and bobwhites probably select winter habitats that maximize bioenergetic advantages and predator avoidance, optimize distance from nearby coveys, and increase accessibility to food resources (Roseberry and Klimstra 1984:23–35). These characteristics of winter habitat collectively enhance the potential winter survival of northern bobwhites.

ACKNOWLEDGMENTS

Financial support for the project was funded by the Chancellor's Gus T. Ridgel Fellowship, George Washington Carver Fellowship, Missouri Department of Conservation Scholarship-Internship, Quail Unlimited in Missouri, and Pheasants Forever in Missouri. This is a contribution from the Missouri Cooperative Fish and Wildlife Research Unit (Missouri Department of Conservation, University of Missouri, United States Geological Survey, and Wildlife Management Institute cooperating). We are grateful to Delia M. Garcia for editing this manuscript.

LITERATURE CITED

- Anderson, S. H., and K. J. Gutzwiller. 1994. Habitat evaluation methods. Pages 592–606 in T. A. Bookhout, ed. *Research and management techniques for wildlife and habitats*. Allen Press Incorporated, Lawrence, Kansas.
- Brennan, L. A. 1991. How can we reverse the northern bobwhite population decline. *Wildlife Society Bulletin* 19:544–555.
- Burger, L. W., Jr. 1993. Bobwhite survival and reproductive ecology. Dissertation. University of Missouri, Columbia.
- Burger, L. W., Jr., M. R. Ryan, E. W. Kurzejeski, and T. V. Dailey. 1994. Factors affecting the habitat value of CRP lands for northern bobwhite in northern Missouri. *Proceedings of the NCT-163 Post Conservation Reserve Program Land Use Conference*. Denver, Colorado.
- Byers, C. R., R. K. Steinhorst, and P. R. Krausman. 1984. Clarification of a technique for analysis of utilization-availability data. *Journal of Wildlife Management* 48:1050–1053.
- Campbell G. S., and J. M. Norman. 1998. *An Introduction to Environmental Biophysics*. Springer-Verlag, New York, New York.
- Church, K. E., J. R. Sauer, and S. Droege. 1993. Population trends of quails in North America. *Proceedings of the National Quail Symposium* 3:44–54.
- Dailey, T. V., and V. L. Truitt. 1998. Annual bobwhite quail population and hunter surveys. Performance Report. Missouri Federal Aid Project Number W-13-R-52.
- Daubenmire, R. K. 1959. A canopy coverage method of vegetational analysis. *Northeast Scientist* 43:43–64.
- Dixon, K. R., M. A. Horner, S. R. Anderson, W. D. Henriques, D. Durham, and R. J. Kendall. 1996. Northern bobwhite habitat use and survival on a South Carolina plantation during winter. *Wildlife Society Bulletin* 24:627–635.
- Droege, S., and J. R. Sauer. 1990. Northern bobwhite, gray partridge, and ring-necked pheasant populations trends (1966–1988) from the North American Breeding Bird Survey. Pages 2–20 in K. E. Church, R. E. Warner, and S. J. Brady, eds. *Perdix V: Gray partridge and ring-necked pheasant workshop*. Kansas Department of Wildlife and Parks, Emporia.
- Errington, P. L., and F. N. Hamerstrom, Jr. 1936. The northern bobwhite's winter territory. *Iowa Agricultural Experimental Station. Research Bulletin* 201:301–443.
- Geiger, R. 1950. *The climate near the ground*. Harvard University Press. Cambridge, Massachusetts.
- Gibson, D. J. 1988. Regeneration and fluctuation of tallgrass prairie vegetation in response to burning frequency. *Bulletin Torrey Botanical Club* 115:1–12.
- Janvrin, J. A. 1991. Movements of northern bobwhites in response to hunting pressure and evaluation of drive counts for estimating quail densities. Thesis. University of Missouri, Columbia.
- Kendeigh, S. C. 1969. Energy responses of birds to their thermal environments. *Wilson Bulletin* 81:45–449.
- Klimstra, W. D., and V. C. Ziccardi. 1963. Night-roosting habitat of bobwhites. *Journal of Wildlife Management* 27:202–214.
- Robbins, C. S., D. Bystrak, and P. H. Geissler. 1986. The breeding bird survey: its first fifteen years, 1965–1979. United States Fish and Wildlife Service Resource Publication 157.
- Robel, R. J., J. N. Briggs, A. D. Dayton, and L. C. Hulbert. 1970. Relationships between visual obstruction measurements and weight of grassland vegetation. *Journal of Range Management* 23:295–297.
- Roseberry, J. L., and W. D. Klimstra. 1984. *Population ecology of the bobwhite*. Southern Illinois University Press, Carbondale.
- SAS Institute, Inc. 1990. *SAS Procedures Guide-Version 6*. Third edition. Cary, North Carolina.
- Stoddard, H. L. 1931. *The bobwhite quail: its habits, preservation, and increase*. Charles Scribner's Sons, New York, New York.

BOBWHITE WINTER HABITAT

145

- Taylor, M. A., and F. S. Guthery. 1980. Fall-winter movements, ranges, and habitat use of lesser prairie chickens. *Journal of Wildlife Management* 44:521–524.
- Thompson, F. R., and E. K. Fritzell. 1988. Ruffed grouse winter roost sites preference and influences on energy demands. *Journal of Wildlife Management* 52:454–460.
- Tonkovich, M. J., and D. F. Stauffer. 1993. Evaluating micro-habitat selection by northern bobwhite in Virginia. *Proceedings of the Annual Conference of Southeastern Association of Fish and Wildlife Agencies* 47:257–267.
- Wiseman, D. S., and D. C. Lewis. 1981. Bobwhite use of habitat in tallgrass rangeland. *Wildlife Society Bulletin* 9:248–255.

CHARACTERISTICS OF FOUR AGRICULTURAL CROPS ESTABLISHED AS NORTHERN BOBWHITE BROOD HABITAT

Denise A. Maidens

D. B. Warnell School of Forest Resources, University of Georgia, Athens, GA 30602, USA

John P. Carroll

D. B. Warnell School of Forest Resources, University of Georgia, Athens, GA 30602, USA

ABSTRACT

Small plots of agricultural crops are often planted in the Southeast for northern bobwhite (*Colinus virginianus*) management. Often these are viewed as primarily winter habitat, and assumed to provide summer habitat. We evaluated the macroinvertebrate and vegetative structure of millet, sorghum, wheat, and soybean plots on a cotton farm to assess their value as bobwhite brood habitat. During June and July 1999 and June, July, and August 2000, we studied 5 blocks, each planted with all 4 agricultural crops. We measured invertebrate abundance along a 15-meter transect in each plot using vacuum sampling and height/density of vegetation. Visual obstruction readings (VOR) were highest in millet and sorghum, followed by wheat and then soybean ($P < 0.001$). Macroinvertebrate numbers differed among cover types ($P < 0.001$), but macroinvertebrate weights did not ($P = 0.14$). Among important Orders, Coleoptera, Hemiptera, Diptera, and Homoptera were found in greater numbers in millet. Numbers of Hymenoptera did not differ among crops. In most cases, millet yielded the highest biomass and numbers of macroinvertebrates, followed by sorghum. Soybeans and wheat had fewer macroinvertebrates among the crops studied. On our study area it appears that millet provides the best brood habitat, although sorghum appears to provide a second useful crop. Thus, among these crops we recommend use of millet plots as brood habitat for northern bobwhite chicks.

Citation: Maidens, D. A., and J. P. Carroll. 2002. Characteristics of four agricultural crops established as northern bobwhite brood habitat. Pages 146–150 in S. J. DeMaso, W. P. Kuvlesky, Jr., F. Hernández, and M. E. Berger, eds. Quail V: Proceedings of the Fifth National Quail Symposium. Texas Parks and Wildlife Department, Austin, TX.

Key words: agriculture, brood habitat, *Colinus virginianus*, Georgia, insects, macroinvertebrates, millet, northern bobwhite, sorghum, soybean, wheat

INTRODUCTION

Decline of northern bobwhite populations has mirrored the decline of small non-commercial farms (Klimstra 1982). These areas provided hedgerows and borders that made quality brood habitat. Brood habitat is important because the early stages of development of bobwhites are most vulnerable to malnutrition and predation; at this stage, peak mortality occurs (Stoddard 1931, Hurst 1972).

Vegetative cover is an important aspect of brood habitat because it protects chicks from avian predators (Brennan et al. 1996). Availability and abundance of macroinvertebrates, however, are the vital features of quality brood habitat (Rosene 1969, Hurst 1972, DeVos et al. 1992, Guthery 2000). For the first 6 weeks, chicks feed on >80% macroinvertebrates (Handley 1931, Landers and Mueller 1986) to provide the large amount of protein necessary for rapid growth (Nestler et al. 1942, Nestler et al. 1945, Rosene 1969). Immune system problems may result when protein requirements are not met (Lochmiller et al. 1993), and longer foraging times increase the risk of predation (Palmer 1995).

Macroinvertebrates are fundamental to bobwhite chick survival; furthermore, the right types of macroinvertebrates are crucial, because bobwhites are selective about what they will eat (Handley 1931, Jack-

son et al. 1987). Field borders and plots used as brood habitat must have the proper assemblages of macroinvertebrates. Among those noted as preferred are: beetles (Coleoptera), leafhoppers (Hemiptera: Cicadellidae), true bugs (Hemiptera: Homoptera), spiders (Arachnida), grasshoppers and crickets (Orthoptera), ants (Hymenoptera: Formicidae), various larvae, snails (Mollusca: Gastropoda), and flies (Diptera) (Handley 1931, Hurst 1972, Healey et al. 1985, Jackson et al. 1987, Guthery 2000). Brood habitat, and the selection of specific macroinvertebrate foods by bobwhites, has not been well studied in agricultural ecosystems (J. Carroll, personal communication, Jackson et al. 1987). Legumes have been found to produce large macroinvertebrate populations (Stoddard 1963, Webb 1963, Jackson et al. 1987), but research is lacking for other agricultural crops in the Southeast. Our objective was to determine previously established row crops, including millet, sorghum, soybeans, and wheat, as bobwhite brood habitat in terms of macroinvertebrate assemblages and cover quality.

STUDY AREA

The Wolf Creek farm is a 900-ha private farm in Turner County, located on the Upper Coastal Plain of Georgia. The site contains both farmland and forested

areas. The farmland consists of cotton and peanut fields, whereas the unfarmed portion is mostly loblolly pine (*Pinus taeda*) and longleaf pine (*Pinus palustris*), and bottomland hardwoods. Much of the farmland contains sandy soils and some of the fields receive center pivot irrigation. This area was established in 1997 as a demonstration and research area combining agriculture and bobwhite management practices; at the time of the study, about 90 small blocks of agricultural crops were established throughout the farm.

METHODS

We studied plots of millet, sorghum, soybean, and wheat that had been previously established as brood habitat using conventional tillage. These blocks generally had lower chemical inputs than normal crop fields and thereby tended to be “weedy.” Using a randomized block design, we studied 5 sets of fields. Each field contained 1 plot of each of the 4 crop types. Although field and plot sized varied, fields were roughly 0.5 ha. Each field was divided into strips of the 4 crops.

Macroinvertebrates and vegetation were assessed during 2 seasons in 1999 (12 July 1999, “middle”; 2 August 1999, “late”) and 3 seasons in 2000 (6 June 2000, “early”; 1 July 2000, “middle”; and 27 July 2000, “late”). To assess vegetative cover, we measured VOR to the nearest dm in each cardinal direction at a random location within each plot with a Robel pole (Robel et al. 1970). A random 15-m transect was sampled in each plot with a D-Vac™ vacuum sampler (D-Vac Co., Ventura, CA) (Dietrick et al. 1959, Dietrick 1961). Robel pole readings and vacuum sampling were taken near where human-imprinted chick trials had taken place the previous day, allowing for direct comparisons to the chick study. Macroinvertebrates were euthanized in bags containing ethyl acetate, then frozen and transported to the laboratory. Macroinvertebrate content of each field was separated from the vegetation, identified to order and family, sorted, and counted. Length and width measures of each macroinvertebrate were taken to acquire an estimate of their weights, using previously published formulas (Palmer 1995). We divided macroinvertebrates into the following categories for analyses: Coleoptera, Diptera, Hemiptera, Homoptera, Hymenoptera, Lepidoptera, and miscellaneous. We chose order classifications to include macroinvertebrates traditionally believed important to bobwhites, with “miscellaneous” including those which are not. Future studies may reveal which of these orders are most important for bobwhite chicks.

We used a randomized block analysis of variance (ANOVA) to test for variability in the mean weight and number of different macroinvertebrates collected in each field type by year and season, and to assess the mean VOR in each field type by season and year. Linear regression was used to test the relationships between VOR and weight and amount of macroinvertebrates collected with the vacuum sampler in each crop.

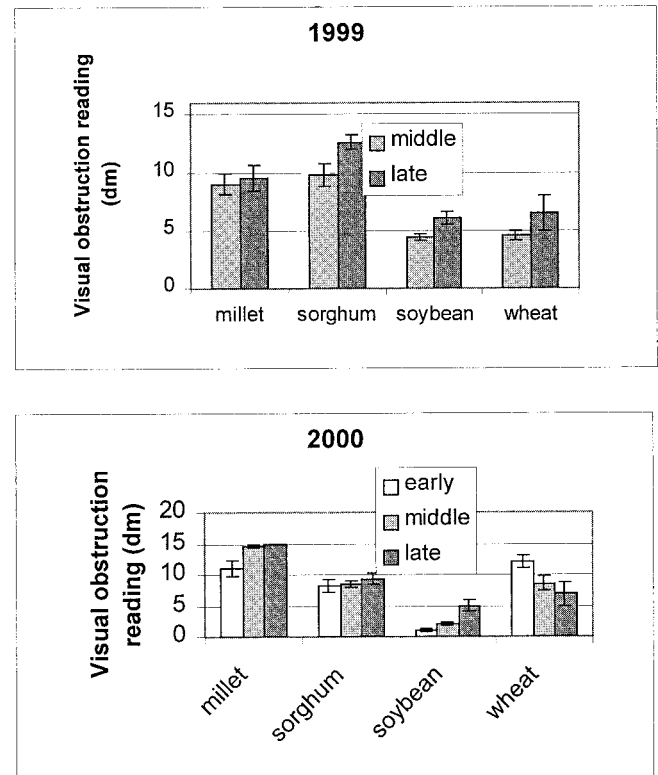

Fig. 1. Mean (\pm SE) visual obstruction readings ($n = 100$) taken in 4 different agricultural crops on Wolf Creek Farm, Turner County, Georgia, 1999 and 2000.

RESULTS

Vegetation Density

Mean VOR differed among the 4 field types ($F = 36.79, 7,92 \text{ df}, P < 0.001$), for 1999 ($F = 29.77, 7,32 \text{ df}, P < 0.0001$, and for 2000 ($F = 42.90, 7,52 \text{ df}, P < 0.0001$) (Fig. 1). In general, millet and sorghum had higher mean VORs, followed by wheat and soybean. This was true of 1999, when VOR differed among the 4 field types for both middle ($F = 21.75, 7,12 \text{ df}, P < 0.0001$) and late seasons ($F = 18.06, 7,12 \text{ df}, P = 0.0002$). In 2000, mean VOR differed among the 4 field types for early ($F = 25.94, 7,12 \text{ df}, P < 0.0001$), middle ($F = 61.13, 7,12 \text{ df}, P < 0.001$), and late seasons ($F = 12.09, 7,12 \text{ df}, P < 0.0006$). Again, millet had higher mean VOR, this time followed by sorghum, wheat, and soybeans (Fig. 1).

Macroinvertebrate Weights

Total weights of macroinvertebrates did not differ among crop types (Table 1). Among orders of invertebrates, there were differences among crop types. Sorghum and millet contained the heaviest amounts of Coleoptera, with soybean following, and very small amounts in wheat ($F = 3.59, 7,72 \text{ df}, P = 0.02$). Total weight of Diptera differed among the 4 crop types, with millet ranking highest, sorghum and wheat intermediate, and soybean last ($F = 3.05, 7,72 \text{ df}, P = 0.03$). Millet had greater weight of Hemiptera than the other crops ($F = 10.57, 7,72 \text{ df}, P < 0.001$). Total

Table 1. Total weight (\pm SE) of macroinvertebrates sampled with a vacuum sampler in 4 different agricultural crops on Wolf Creek Farm, Turner County, Georgia, 1999 and 2000.

Order Species	\bar{X}	SE	<i>F</i>	<i>df</i>	<i>P</i>
Pooled			5.68	7, 72	0.15
millet	0.75	0.22			
sorghum	0.83	0.31			
soybean	0.37	0.30			
wheat	0.14	0.05			
Coleoptera			3.59	7, 72	0.02
millet	0.03	0.009			
sorghum	0.02	0.007			
soybean	0.002	0.001			
wheat	0.008	0.002			
Diptera			3.05	7, 72	0.03
millet	0.02	0.008			
sorghum	0.005	0.002			
soybean	0.001	0.0008			
wheat	0.004	0.002			
Hemiptera			10.57	7, 72	<0.001
millet	0.15	0.04			
sorghum	0.03	0.008			
soybean	0.01	0.007			
wheat	0.02	0.007			
Homoptera			1.78	7, 72	0.16
millet	0.28	0.12			
sorghum	0.28	0.18			
soybean	0.01	0.004			
wheat	0.05	0.03			
Hymenoptera			6.63	7, 72	0.0005
millet	0.14	0.05			
sorghum	0.81	0.18			
soybean	0.04	0.01			
wheat	0.07	0.22			
Lepidoptera			0.79	7, 72	0.51
millet	0.004	0.003			
sorghum	0.02	0.007			
soybean	0.004	0.003			
wheat	0.01	0.12			
Miscellaneous			1.14	7, 72	0.34
millet	0.21	0.15			
sorghum	0.08	0.04			
soybean	0.02	0.006			
wheat	0.06	0.03			

Table 2. Total number of macroinvertebrates sampled with a vacuum sampler in 4 different agricultural crops on Wolf Creek Farm, Turner County, Georgia, 1999 and 2000.

Order Species	\bar{X}	SE	<i>F</i>	<i>df</i>	<i>P</i>
Pooled			22.95	7, 71	<0.001
millet	138.2	21.66			
sorghum	49.50	9.83			
soybean	15.0	2.95			
wheat	21.10	3.93			
Coleoptera			6.96	7, 72	0.004
millet	4.20	1.00			
sorghum	2.55	0.73			
soybean	0.35	0.13			
wheat	1.00	0.31			
Diptera			4.60	7, 72	0.005
millet	20.85	7.61			
sorghum	5.40	1.73			
soybean	2.70	0.96			
wheat	4.00	1.25			
Hemiptera			14.53	7, 72	<0.001
millet	66.15	14.82			
sorghum	11.45	3.72			
soybean	5.60	1.96			
wheat	4.65	1.61			
Homoptera			10.04	7, 72	<0.001
millet	28.35	5.09			
sorghum	19.85	5.31			
soybean	2.60	0.65			
wheat	5.70	1.59			
Hymenoptera			1.57	7, 72	0.20
millet	8.60	4.75			
sorghum	6.35	2.12			
soybean	1.70	0.52			
wheat	2.45	0.56			
Lepidoptera			2.07	7, 72	0.11
millet	0.30	0.15			
sorghum	0.95	0.46			
soybean	0.15	0.11			
wheat	0.20	0.16			
Miscellaneous			1.35	7, 72	0.27
millet	4.21	1.52			
sorghum	3.00	0.76			
soybean	1.50	0.34			
wheat	4.00	1.21			

weight of Hymenoptera differed among the 4 crop types ($F = 6.63$, 7,72 *df*, $P = 0.005$), with most Hymenoptera found in sorghum. Total weight of Homoptera, Lepidoptera, and miscellaneous did not vary among the 4 crop types.

Macroinvertebrate Counts

Total number of macroinvertebrates sampled with the vacuum sampler differed among the 4 crop types ($F = 22.95$, 7,71 *df*, $P < 0.001$) (Table 2). Throughout the study, millet consistently yielded higher numbers of macroinvertebrates, with sorghum intermediate, and soybean and wheat last.

Among orders of invertebrates, there were differences among crop types (Table 2). The most Coleoptera were found in millet, followed by sorghum, wheat, and soybean ($F = 6.96$, 7,72 *df*, $P = 0.0004$). Diptera counts varied among the 4 crop types, with the most found in millet, followed by sorghum, soybean, and

wheat ($F = 4.60$, 7,72 *df*, $P = 0.005$). Millet contained more Hemiptera than any of the other crop types ($F = 14.53$, 7,72 *df*, $P < 0.0001$). Millet contained the most Homoptera, followed by sorghum, wheat, and soybean ($F = 10.04$, 7,72 *df*, $P < 0.0001$). Hymenoptera, Lepidoptera, and miscellaneous counts did not differ among the 4 crop types.

Vegetation Density and Vacuum Sampling

Weight of macroinvertebrates collected with a vacuum sampler was unrelated to VOR in all 4 crops (Table 3). Number of macroinvertebrates collected with a D-Vac vacuum sampler was unrelated to VOR in millet, sorghum, and soybean (Table 4). Number of macroinvertebrates was related to VOR in wheat ($F = 6.96$, $P = 0.02$, $R^2 = 0.28$).

AGRICULTURAL CROPS AS BROOD HABITAT

Table 3. Test results comparing visual obstruction reading and total weight of macroinvertebrates sampled with a vacuum sampler in 4 different agricultural crops on Wolf Creek Farm, Turner County, Georgia, 1999 and 2000.

Species	F	df	P	R ²	Equation
Overall					
millet	0.43	18	0.52	0.02	$y = -1.7408 + 0.25456x$
sorghum	5.39	18	0.03	0.23	
soybean	0.05	18	0.83	0.003	
wheat	0.39	18	0.54	0.02	

Table 4. Comparisons of visual obstruction reading and total number of macroinvertebrates sampled with a vacuum sampler in 4 different agricultural crops on Wolf Creek Farm, Turner County, Georgia, 1999 and 2000.

Species	F	df	P	R ²	Equation
Overall					
millet	3.36	18	0.08	0.16	$y = 41.1978 - 2.41391x$
sorghum	0.03	18	0.87	0.002	
soybean	0.17	17	0.69	0.01	
wheat	6.96	18	0.02	0.28	

DISCUSSION

Biologists have developed many techniques to assess habitat quality. As macroinvertebrates are the key feature in bobwhite brood habitat (Rosene 1969, Hurst 1972, DeVos et al. 1992, Guthery 2000), macroinvertebrate sampling should be the focus of brood habitat assessment. Various methods of sampling invertebrates include sweep-nets, drop cloths, funnels, sticky traps, and other methods (Byerly et al. 1978, Nuessly and Sterling 1984, Schotzko and O'Keefe 1986, Cooper and Whitmore 1990, Mommertz et al. 1996). Comparisons among methods have been inconsistent. It has been cautioned by some that sweepnet and vacuum sampling may overestimate insect abundance, and furthermore that vacuum sampling estimates are generally higher than those of sweepnets (Race 1960, Byerly et al. 1978); other studies have shown vacuum sampling more accurate in predictive power and estimates of population density than sweepnets (Ellington et al. 1984). Other studies show no differences among drop-net, sweep net, or vacuum sampling (Schotzko and O'Keefe 1986, Gillespie and Kemp 1996). Vacuum sampling, however, yields good abundance estimates (Ellington et al. 1984), is appropriate for foliage macroinvertebrates, and has been used in a variety of agricultural settings (Cooper and Whitmore 1990), including sampling of bobwhite brood habitat. When selecting a macroinvertebrate sampling method, it is important to consider the foraging method of the species in question (Cooper and Whitmore 1990). Because chicks forage along the ground and at low heights of vegetation, vacuum sampling is most appropriate.

Other studies have used a vacuum sampler to test the suitability of different habitats as brood habitat, but research is lacking for comparing agricultural crops in general. In a comparison of organic and conventional farms, sampling revealed no difference between farms, but more insect biomass was found in wheat, oats, clover, and clover/oat plots than in corn, soybeans, and alfalfa (Whitmore 1982). Using a vacuum sampler, conventionally tilled soybeans have been shown inferior in invertebrate abundance to Conservation Reserve Program (CRP) plantings (Burger et al. 1993), and greater invertebrate biomass has been found in disked plots compared to undisked plots (Manley et al. 1994). However, old fields, fertilized old fields, and fertilized Kobe lespedeza fields showed no difference in density and biomass of invertebrates (Jackson et al. 1987). Using sweep nets, fescue fields have been found not to contain sufficient biomass of insects to support bobwhite broods

(Barnes et al. 1995). In comparing various combinations of treatments of brood habitat plots including mowing, chopping, burning, and use of herbicides, vacuum sampling did not reveal any differences (Welch 2000), although differences had previously been found on burned vs. unburned plots using both sweep nets and vacuum sampling (Hurst 1972).

Utilizing vacuum sampling, we found differences among our plots. Millet appeared most suitable as brood habitat, followed by sorghum, due to the large number of macroinvertebrates. In comparison, wheat and soybean were poor brood habitat. In terms of weight, there were no differences until the macroinvertebrates were sorted by Order. In most cases, millet ranked highest, with sorghum second; again, wheat and soybean were poor. In terms of macroinvertebrate numbers, millet generally had the most, followed by sorghum, soybean, and wheat. The same was true when the samples were sorted by order.

Using similar methods to compare various CRP plantings and conventionally tilled soybeans, Burger et al. (1993) consistently ranked red clover highest in comparison to all other plantings. We found higher biomass and number of macroinvertebrates in our millet plots than Burger et al. (1993) did in their red clover plots. Our sorghum plots did not contain as many macroinvertebrates as their clover plots, but had more than their other CRP plantings. Our wheat plots were comparable in biomass to their lowest ranked planting, soybeans. Their CRP plantings were dominated in terms of biomass by Homoptera, Hemiptera, and when present, Orthoptera; by number, Homoptera and Diptera were dominant. In contrast, we found Hymenoptera, Homoptera, and miscellaneous to account for the majority of biomass in our samples, whereas Hemiptera and Homoptera dominated in numbers. However, it must be cautioned that in both studies, annual differences in abundance were apparent. Regional differences may also be present, as we found higher macroinvertebrate biomass and numbers in our soybean plots.

Because millet also ranked highest in VOR and sorghum ranked second, this suggests that millet would be the most preferential crop for bobwhite brood habitat, and sorghum would be a good second choice. Soybean and wheat provide little benefit of macroinvertebrates or cover in comparison. Because legumes have been found to be a good producer of invertebrates, both historically and in recent research (Burger et al. 1993), we would suggest that including legumes within or nearby might increase invertebrate production.

ACKNOWLEDGMENTS

Funding was provided by the University of Georgia D. B. Warnell School of Forest Resources, McIntyre-Stennis Project GEO-0100-MS, The University of Georgia College of Agricultural and Environmental Sciences, the United States Department of Agriculture Natural Resources Conservation Service, Central Georgia Soil and Water Conservation District, Quail Unlimited, and Monsanto, Inc. Mr. L. O. Peebles provided logistical support, the study site, and housing. Randy Hudson initiated the management project, and Mike Beggs planted and maintained all the wildlife plantings on the farm and helped with chick trials. We thank Dr. Bob Cooper for statistical advice. We thank Richard Franklin, Elena Goldberg, Stephanie Hudson, Justin Sloan, Kristen Utz, and Heather Venter, who assisted with field work. Use of bobwhite chicks was approved by the University of Georgia Institutional Animal Use and Care Committee (Animal Use Permit #A34337-01).

LITERATURE CITED

- Barnes, T. G., L. A. Madison, J. D. Sole, and M. J. Lacki. 1995. An assessment of habitat quality for northern bobwhite in tall fescue-dominated fields. *Wildlife Society Bulletin* 23: 231–237.
- Brennan, L. A., J. M. Lee, R. S. Fuller, S. M. Manley, L. W. Burger, and G. A. Hurst. 1996. Of bugs and birds: the importance of macroinvertebrate foods for bobwhites. *Quail Unlimited Magazine* 15:12–17.
- Burger, L. W. Jr., E. W. Kurzejeski, T. V. Dailey, and M. R. Ryan. 1993. Relative invertebrate abundance and biomass in Conservation Reserve Program plantings in northern Missouri. *Proceedings of the National Quail Symposium* 3:102–108.
- Byerly, K. F., A. P. Gutierrez, R. E. Jones, and R. K. Luck. 1978. A comparison of sampling methods for some arthropod populations in cotton. *Hilgardia* 46:257–282.
- Cooper, R. J., and R. C. Whitmore. 1990. Arthropod sampling methods in ornithology. *Studies in Avian Biology* 13:29–37.
- DeVos, T., and B. S. Mueller. 1993. Reproductive ecology of northern bobwhite in north Florida. *Proceedings of the National Quail Symposium* 3:83–90.
- Dietrick, E. J., C. B. Cowan, Jr., W. C. Watkins, Jr., D. D. Lindgren, and R. I. Ridgeway. 1959. A new method for sampling arthropods using a suction collection machine and modified Berlese funnel separator. *Journal of Economic Entomology* 52:1085–1091.
- Dietrick, E. J. 1961. An improved backpack motor fan for suction sampling of insect populations. *Journal of Economic Entomology* 54:394–395.
- Ellington, J., K. Kiser, G. Ferguson, and M. Cardenas. 1984. A comparison of sweep-net, absolute, and Insectivac sampling methods in cotton ecosystems. *Journal of Economic Entomology* 77:599–605.
- Gillespie, R. L., and W. P. Kemp. 1996. Sampling method assessment and quantification of temporal shifts in densities of grasshopper species (Orthoptera:Acrididae) between winter wheat, *Triticum aestivum*, and adjacent rangeland. *Environmental Entomology* 25:559–569.
- Guthery, F. S. 2000. On bobwhites. Texas A&M University Press, College Station.
- Handley, C. O. 1931. Food of the young. Pages 159–164 in H. L. Stoddard. *The bobwhite quail: its habits, preservation, and increase*. Charles Scribner's Sons, New York.
- Healey, W. M. 1985. Turkey poult feeding activity, invertebrate abundance, and vegetation structure. *Journal of Wildlife Management* 49:466–472.
- Hurst, G. A. 1972. Macroinvertebrates and bobwhite quail brood habitat management. *Proceedings of the National Bobwhite Symposium* 1:65–82.
- Jackson, J. R., G. A. Hurst, and E. A. Gluesing. 1987. Abundance and selection of invertebrates by northern bobwhite chicks. *Proceedings of Annual Conference of Southeastern Association of Fish and Wildlife Agencies* 41:303–310.
- Klimstra, W. D. 1982. Bobwhite quail and changing land use. *Proceedings of the National Quail Symposium* 2:1–5.
- Landers, J. L., and B. S. Mueller. 1986. Bobwhite quail management: a habitat approach. Tall Timbers Research Station. Miscellaneous Publication Number 6. Tallahassee, Florida.
- Lochmiller, R. L., M. R. Vestey, and J. C. Boren. 1993. Relationships between protein nutritional status and immunocompetence in northern bobwhite chicks. *Auk* 110:503–510.
- Manley, S. W., R. S. Fuller, J. M. Lee, and L. A. Brennan. 1994. Arthropod response to strip disking in old fields managed for northern bobwhites. *Proceedings of the Annual Conference of the Southeastern Association of Fish and Wildlife Agencies* 48:227–235.
- Mommertz, S., C. Schauer, N. Kosteres, A. Lang, and J. Filser. 1996. A comparison of D-Vac suction, fenced and unfenced pitfall traps sampling of epigeal arthropods in agroecosystems. *Annals of Zoologica Fennici* 33:117–124.
- Nestler, R. B., L. M. Llewellyn, and M. J. Rensberger. 1945. Comparison of animal and plant proteins for young pen-reared bobwhite quail. *Journal of Wildlife Management* 9: 274–279.
- Nestler, R. B., W. W. Bailey, and H. E. McClure. 1942. Protein requirements of bobwhite quail chicks for survival, growth, and efficiency of feed utilization. *Journal of Wildlife Management* 6:185–193.
- Nuessly, G. S., and W. L. Sterling. 1984. Comparison of D-Vac and modified drop cloth methods for sampling arthropods in cotton. *The Southeastern Entomologist* 9:95–103.
- Palmer, W. E. 1995. Effects of modern pesticides and farming systems in northern bobwhite quail brood ecology. Dissertation. North Carolina State University, Raleigh.
- Race, S. R. 1960. A comparison of two sampling techniques for Lygus bugs and stink bugs on cotton. *Journal of Economic Entomology* 53:689–90.
- Robel, R. J., J. Briggs, A. D. Dayton, and L. C. Hulbert. 1970. Relationships between visual obstruction measurements and weight of grassland vegetation. *Journal of Range Management* 23:295–297.
- Rosene, W. 1969. *The bobwhite quail: its life and management*. Rutgers University Press, New Brunswick, New Jersey.
- Schotzko, D. J., and L. E. O'Keefe. 1986. Comparison of sweep net, D-Vac, and absolute sampling for *Lygus hesperus* (Heteroptera: Miridae) in lentils. *Journal of Economic Entomology* 79:224–228.
- Stoddard, H. L. 1931. *The bobwhite quail: its habitats, preservation, and increase*. Charles Scribner's Sons, New York, New York.
- Stoddard, H. L. 1963. Maintenance and increase of the eastern wild turkey on private lands of the coastal plain of the deep southeast. *Bulletin Number 3*, Tall Timbers Research Station, Tallahassee, Florida.
- Webb, L. G. 1963. Utilization of domestic crops by deer and wild turkeys with notes on macroinvertebrates inhabiting crops. *Proceedings Annual Conference of the Southeast Association of Game and Fisheries Commissions*. 17:92–100.
- Welch, J. R. 2000. Evaluation of chemical and mechanical treatments to enhance southeastern pine forest habitat for northern bobwhite. Thesis. University of Georgia, Athens.
- Whitmore, R. W. 1982. Insect biomass in agronomic crops as food for ring-necked pheasant chicks (*Phasianus colchicus* L.). Dissertation. University of Nebraska, Lincoln.

EFFECTS OF NORTHERN BOBWHITE HABITAT MANAGEMENT PRACTICES ON RED IMPORTED FIRE ANTS

Shaun Williamson

Box 9690, Mississippi State University, Mississippi State, MS 39762, USA

L. Wes Burger, Jr.

Box 9690, Mississippi State University, Mississippi State, MS 39762, USA

Stephen Demarais

Box 9690, Mississippi State University, Mississippi State, MS 39762, USA

Michael Chamberlain¹

Box 9690, Mississippi State University, Mississippi State, MS 39762, USA

Abstract

Management practices that create early successional plant communities through disturbance (discing and prescribed fire) often are prescribed for restoration of declining northern bobwhite (*Colinus virginianus*) populations. Because disturbance may facilitate invasion of exotic flora and fauna such as red imported fire ants (RIFA, *Solenopsis invicta*), we hypothesized that habitat management practices commonly used to enhance bobwhite habitat might have the unintended consequence of increasing local abundance of RIFA. During 1999, we tested effects of 4 treatments (spring discing, spring prescribed burning, spring mowing, and no management), in a randomized complete block design ($n = 10$) on RIFA abundance in Conservation Reserve Program (CRP) fields in central Mississippi. We surveyed RIFA abundance using 3 measures: 1) mound density, 2) a population index based on worker ant and brood estimates, and 3) foraging activity as indexed by attraction to protein bait cups. During May 1999, mound density ($P = 0.0136$) and population index ($P = 0.0078$) differed among treatments, with abundance values greatest in plots treated with fire, and lowest in disced plots. The index of foraging activity did not differ among treatments ($P = 0.6637$). During October 1999, mound density ($P = 0.0334$) and population index ($P = 0.0451$) differed among treatments with abundance values greatest in plots receiving fire and disc treatments, and lowest abundance in control plots. The index of foraging activity did not differ among treatments ($P = 0.9079$). Disturbance tools such as prescribed fire and discing are essential to maintain plant communities to which bobwhite are adapted; however, they may have the unintended consequence of facilitating invasion of RIFA and increasing local RIFA populations.

Citation: Williamson, S., L. W. Burger, S. Demarais, and M. Chamberlain. 2002. Effects of northern bobwhite habitat management practices on red imported fire ants. Pages 151–155 in S. J. DeMaso, W. P. Kuvlesky, Jr., F. Hernández, and M. E. Berger, eds. Quail V: Proceedings of the Fifth National Quail Symposium. Texas Parks and Wildlife Department, Austin, TX.

Key words: *Colinus virginianus*, discing, fire ant, habitat management, northern bobwhite, prescribed burning, *Solenopsis invicta*

INTRODUCTION

During the last 3 decades, northern bobwhite populations have declined rangewide, and the decline has been particularly steep in the southeast (Brennan 1991, Sauer et al. 1997). The decline has been attributed to large-scale deterioration of bobwhite habitat quality through advanced natural succession, monoculture farming, and intensive timber management (Exum et al. 1982, Brennan 1991). Furthermore, Allen et al. (1995) implicated the RIFA as an additional factor that might contribute to declining bobwhite populations in the southeastern United States.

Effects of RIFA on bobwhite populations have been a contentious issue in the scientific literature (Allen et al. 1993, Brennan 1993). Some studies have de-emphasized effects of fire ants on bobwhite popula-

tions (Johnson 1961, Komerack 1980, Brennan 1993). Yet Allen et al. (1995), Pederson et al. (1996), Mueller et al. (1999), and Giuliano et al. (1996) presented compelling evidence that RIFA can negatively affect bobwhite populations under some circumstances. Red imported fire ants can affect bobwhite populations through direct and indirect effects on chicks. Red imported fire ants can directly affect bobwhite populations through predation on pipping chicks (Johnson 1961). Exposure to RIFA can reduce survival and weight gain of chicks (Giuliano et al. 1996). Moreover, RIFA may alter time and energy budgets of chicks, affecting weight gain and survival (Pederson et al. 1996). Red imported fire ants may reduce foraging efficiency of bobwhite chicks by simplifying invertebrate communities through competition and depredation (Fillman and Sterling 1983, Porter et al. 1988, and Porter and Savignano 1990). Mueller et al. (1999) demonstrated that RIFA abundance in the vicinity of the nest influenced survival of bobwhite chicks to an age of 21 days.

¹ Present address: School of Forestry, Wildlife, and Fisheries, Louisiana State University, Baton Rouge, LA 70803

Effects of RIFA on bobwhite and other native animals, including arthropods and vertebrates, are greatest in the presence of polygyne colonies (Lofgren 1986, Porter and Savignano 1990, and Allen et al. 1995). Polygyne colonies have multiple fertile queens, exhibit less territoriality, and consequently occur in very dense concentrations (300–2000 mounds/ha) (Glancey and Lofgren 1988, Porter et al. 1988, and Lofgren and Williams 1984). In contrast, monogyne colonies exhibit territoriality and generally stabilize at densities of 40–80 mounds/ha (Vinson and Sorensen 1986, Porter and Tschinkel 1987).

Red imported fire ants prefer the open and semi-open vegetation structure characteristic of early successional plant communities (Porter and Tschinkel 1987). Anthropogenic activities often create and maintain disturbance-dependent ecosystems (Banks et al. 1985), potentially facilitating colonization by RIFA. Disturbance promotes RIFA colonization in 2 ways: 1) by opening canopy or dense herbaceous layers allowing light penetration, and 2) by removal of competitive native ant species. Native ants generally do not colonize as rapidly or exhibit the rapid population growth of the RIFA (Tschinkel 1993, Allen et al. 1998).

Management practices commonly prescribed to enhance bobwhite habitat, such as disking and fire, create and maintain early successional characteristics and may have the unintended consequence of increasing RIFA abundance or activity. Although RIFA are known to inhabit early successional plant communities, potential effects of bobwhite habitat management practices on RIFA have not been investigated. Therefore, we tested the null hypothesis that disking, prescribed fire, and mowing did not affect indices of RIFA abundance and foraging activity during 1999 in central Mississippi.

METHODS

This research was conducted on Cameron Plantation, a 4,048-ha private property in Madison County, Mississippi. Cameron Plantation is characterized by a mostly flat topography with 0–12% slopes. The predominate soil type is Loring silt loam, with minor occurrence of Calloway and Grenada silt loams (Scott 1984). These soils are moderately well drained and contain a fragipan. Soil pH is strongly acidic to very strongly acidic (Scott 1984). Vegetative communities on Cameron Plantation include mature bottomland hardwood, mixed pine/hardwood, and pine forests, CRP fields enrolled as CP10 (existing grass) and CP3 (pine trees), and agricultural fields planted to soybeans or corn. Red imported fire ant populations were estimated on Cameron Plantation and adjacent properties during May 1998 by complete census of mounds in 35 randomly located, 0.10-ha circular plots (Lofgren and Williams 1984 and Allen et al. 1995). Mean RIFA mound density was 395 (SE = 38.01) mounds/ha and mean population index was estimated following the methodology of Lofgren and Williams (1984) at 581 (SE = 52.17).

Table 1. Population index used to assess relative abundance of red-imported fire ants (RIFA) on Cameron Plantation, Mississippi, 1999.

Estimated No. of Worker Ants	Mound Index	
	Worker Brood Absent	Worker Brood Present
<100	1	6
100 to 1000	2	7
1000 to 10,000	3	8
10,000 to 50,000	4	9
>50,000	5	10

We established treatment blocks (n = 10) in March 1999 on 10 grass CRP fields with similar soil and vegetative characteristics distributed throughout the property. Grass stands in these fields had previously been maintained by annual mowing and were dominated by broomsedge (*Andropogon virginianus*). Treatment blocks had not been burned or disced for ≥ 3 years prior to the initiation of the study. All treatment blocks consisted of Loring soils (Scott 1984). Each block was divided into 4, 30m \times 50m plots. Each plot was randomly assigned a treatment: burning, mowing, disking, or no treatment. Prescribed burn plots were burned 2–4 March 1999. Burn plots were encircled by a 2-m wide, disced fire break. Disking was performed on 2 March 1999 for all selected plots. Plots assigned a mowing treatment were bush-hogged to a height of 10 cm on 10 March 1999. We separated plots by a 10-m wide, non-treated buffer to minimize residual effects of treatments on adjacent plots.

Treatment plots were sampled for RIFA during 2 periods: 19–20 May 1999 and 21–23 October 1999. Only 6 blocks were sampled in October due to inadvertent destruction of 4 plots by land management activities. We used a complete count of mounds and the population index method as modified by Lofgren and Williams (1984) to index fire ant abundance within treatment plots. Mound surveys were conducted by a careful, systematic search throughout each 0.15-ha plot by a team of 5 trained observers. Observers positioned themselves 3 m apart and followed a 50-m transect, recording all active mounds to their right between themselves and the next observer allowing the team to cover the entire plot in 2 passes. To assess presence and relative abundance of RIFA in all mounds, we used a shovel to dig down to soil moisture where ants would be, if present (Mueller et al. 1999). Active mounds received a score based on estimated number of worker ants present, and the presence of worker brood (all mounds possessed worker brood). The population index was then calculated for each plot using the following equation:

$$\text{Population index (PI)} = s_6 \times 5 + s_7 \times 10 + s_8 \times 15 + s_9 \times 20 + s_{10} \times 25$$

where s was the number of mounds, with brood, within a given size class (estimated number of ants). The weighting factor increased with mound size (Table 1; Lofgren and Williams 1984). A foraging index was used in conjunction with mound counts to index fire

FIRE ANT RESPONSE TO DISTURBANCE

Table 2. Mean mound density of red-imported fire ants, population index, and foraging index for 0.15-ha plots treated with fire, discing, mowing, and no treatment during May and October, 1999, Cameron Plantation, Madison County, Mississippi.

Month	Treatment	Mounds/plot		RIFA Index		Foraging Index	
		\bar{x}	SE	\bar{x}	SE	\bar{x}	SE
May	BURN	45.10 A	7.09	556.00 A	262.43	42.40 A	8.44
	MOW	42.40 AB	8.79	529.00 A	117.41	35.10 A	7.86
	CONTROL	30.30 BC	4.33	402.50 AB	37.52	39.40 A	8.24
	DISC	24.00 C	3.729	274.5 B	44.12	34.10 A	6.16
October		M^b		M^b		$-^a$	SE
	BURN	53.0 A		633.5 A		49.17 A	21.90
	DISC	50.5 A		546.5 A		52.50 A	12.74
	MOW	45.5 AB		530.0 AB		60.83 A	24.76
	CONTROL	37.5 B		433.5 B		46.50 A	17.19

^a Means within the same season with same letter are not significantly different, LSD $P < 0.05$.

^b During the October sampling season, medians reported for total mound density and population index. Mean ranks compared using Fisher's LSD $P < 0.05$.

ant foraging activity in each treatment. Foraging RIFA were sampled using 21, 30-ml baitcups containing approximately 1 g of protein bait (hot dog) (Porter and Tschinkel 1987, Mueller et al. 1999). Bait cups were distributed on a 10m \times 30m grid in the center of each plot with 5 m spacing between cups. We left baits exposed for 30 minutes, then capped (Summerlin et al. 1977) and froze them at -20°C (Mueller et al. 1999). Specimens in each cup identified as RIFA were counted and recorded.

We tested effects of disturbance treatments on mound density and RIFA index using a randomized complete block analysis of variance (ANOVA) within each sampling interval. The assumption of normality was tested using the Shapiro-Wilk's test for each sampling procedure and interval (SAS Institute Inc. 1989). Within each interval and sampling technique, we tested for homogeneity of variance using Levene's test (Snedecor and Cochran 1980). If the data did not meet the normality assumption, we used a Friedman 2-way analysis of variance on ranks (Daniel 1978). Following a significant F test, we used Fisher's LSD ($\alpha = 0.05$) for multiple comparisons among treatments (Peterson 1985). All analyses were conducted in SAS version 6.12 (SAS Institute Inc. 1989).

RESULTS

During the May sampling interval, residuals were normally distributed for total mound density ($W = 0.983$, $P = 0.878$), population index ($W = 0.963$, $P = 0.305$), and foraging index ($W = 0.978$, $P = 0.616$). Similarly, we observed homogeneity of variance across treatments for total mound density ($F_{3,36} = 0.71$, $P = 0.519$), population index ($F_{3,36} = 0.66$, $P = 0.582$), and foraging index ($F_{3,36} = 1.55$, $P = 0.218$). We observed block effects for the total count ($F_{9,27} = 3.87$, $P = 0.003$), population index ($F_{9,27} = 4.00$, $P = 0.002$) and foraging index ($F_{9,27} = 5.54$, $P < 0.001$), suggesting significance among block variation. Total mound count ($F_{3,27} = 4.28$, $P = 0.014$) and population index ($F_{3,27} = 4.87$, $P = 0.008$) differed among treatments, whereas foraging index did not differ among treatments ($F_{3,27} = 0.53$, $P = 0.664$). During May,

prescribe burned plots had more mounds than control or disced treatments ($P < 0.05$), but did not differ from mowed ($P > 0.05$; Table 2). Mowed plots had greater mound density than disced plots, but did not differ from fire or control. Mound density in disced treatments did not differ from control. Red imported fire ant population index exhibited an identical rank order with minor differences in mean separation. Prescribe burned and mowed plots had a higher population index than disced plots ($P < 0.05$), but did not differ from control plots ($P > 0.05$). Population index in control plots did not differ from disced ($P > 0.05$). Foraging index did not differ among treatments; however, rank ordering of means differed only slightly from that of total mound count and population index (Table 2).

During the October sampling interval residuals for total mound density ($W = 0.852$, $P = 0.002$) and population index ($W = 0.879$, $P = 0.007$) deviated from normality. Levene's test suggested a tendency toward lack of homogeneity of variance for both total mound density ($F_{3,20} = 2.47$, $P = 0.092$) and population index ($F_{3,20} = 2.55$, $P = 0.085$). Therefore, for these 2 metrics, we used Friedman's non-parametric 2-way analysis of variance on ranks to test for differences between treatments. October foraging index exhibited normal residuals ($W = 0.950$, $P = 0.272$) and homogeneity of variance ($F_{3,20} = 0.81$, $P = 0.505$). Total mound count ($F_{3,20} = 3.50$, $P = 0.034$) and population index ($F_{3,20} = 3.21$, $P = 0.045$) differed among treatments, but the foraging index did not ($F_{3,15} = 0.18$, $P = 0.908$). Pairwise comparisons yielded an identical pattern for total mound count and population index during October. Median values for fire, discing, and mowing did not differ, but fire and discing exhibited greater mound density and population index than controls. Mowing did not differ from the control (Table 2).

DISCUSSION

All management practices affected RIFA abundance, as indexed by mound counts and population indices, relative to undisturbed plots. However, the direction and magnitude of response varied among prac-

tices and over time. During the brief interval between implementation of the treatments and measurement of spring mound density (2 months), RIFA populations increased in response to prescribed fire. Burning reduces litter accumulation, increases sunlight reaching ground, releases nutrients, and stimulates growth of new vegetative material, all of which might improve the foraging environment and food resources for RIFA. In contrast, discing initially reduced RIFA density. Discing might temporarily destroy mounds and foraging tunnels causing short-term dispersal and apparent reduction in local mound density and foraging activity.

The October census provided insight into how RIFA react to disturbance over time. Seven months after disturbances, the pattern of RIFA abundance among treatments differed from that observed in May. During October, total mound count and population index methods suggested that RIFA were most abundant in the prescribed fire treatment, followed by the disced, mowed, and control treatments. All sampling methods suggested that there was a lag time of response to discing disturbance. Discing may have initially disrupted mounds, but by October, the early successional plant communities created by discing had facilitated a positive RIFA response. Similar to prescribed fire, discing reduces litter accumulation, increases bare ground, and stimulates germination of annual grasses and forbs, thereby potentially enhancing foraging environment and food resources for RIFA.

We indexed RIFA response to disturbance regimes using mound density, RIFA population index, and bait cup visitations. Presumably, all 3 metrics index RIFA relative abundance and should reveal similar patterns in population response to habitat management practices. However, at the spatial scale and RIFA population levels of our study, only mound density and population index indicated a RIFA response to habitat alteration. Killion and Grant (1993) reported that measures of RIFA abundance or activity are scale dependent, and that mound density and foraging activity as measured by bait cups may be uncorrelated across a range of spatial scales. We theorize that as mound density increases, foraging activity at bait cups may be asymptotic, such that beyond some threshold, further increases in mound density result in relatively minor or no further increase in foraging activity. Killion and Grant (1993) suggested that mound density or pit trap captures provide a better index to abundance than bait cup visitations.

Regional bobwhite population declines have most frequently been attributed to reductions in landscape heterogeneity and loss of early successional communities. However, increasingly compelling evidence suggests that RIFA can negatively impact bobwhite survival and reproductive success (Allen et al. 1995, Giuliano et al. 1996, Pederson et al. 1996, Mueller et al. 1999) and might exacerbate population declines in some areas. Biologists, operating under the assumption that bobwhite populations are limited by habitat, frequently prescribe management practices that create early successional plant communities through inter-

mediate disturbance (discing and prescribed burning). However, land management practices that disturb soil and vegetation and create early successional habitats, might actually increase RIFA abundance and associated negative effects (Allen et al. 1998). Although correlative associations between disturbance and RIFA have been previously reported (Tschinkel 1988, Allen et al. 1998), no studies have explicitly examined RIFA response to the types of management regimes prescribed for bobwhite habitat enhancement.

Allen et al. (1995) suggested that threats to bobwhite by RIFA were greatest in areas with high infestation. Negative impacts of RIFA on bobwhite have been reported at mean mound densities of 205 mounds/ha (Allen et al. 1995) and 290 mounds/ha (Mueller et al. 1999). Estimated RIFA mound density on our central Mississippi study area in 1999 was 395 mounds/ha (SE = 38.0), considerably higher than levels reported to negatively impact bobwhites (Allen et al. 1995, Mueller et al. 1999). Consequently RIFA populations on our study site are within the range at which negative population consequences might exist for bobwhites.

Red imported fire ants occur in both monogyne and polygyne infestations. Polygyne fire ants exhibit less intraspecific territoriality, and thus may occur at extremely high densities increasing negative impacts on native arthropods and vertebrates (Porter et al. 1991, Allen et al. 1994, Allen et al. 1995, Allen et al. 1998, Mueller et al. 1999). We did not confirm polygyny by floating mounds to identify multiple queens, or dissecting queens to determine if insemination had occurred (Allen et al. 1995). However, polygyne infestations are characterized by extremely high colony densities (Allen et al. 1998). Because monogyne colonies normally do not exceed 99 mounds/ha (Lofgren and Williams 1984, Porter and Tschinkel 1987, Porter et al. 1988, and Allen et al. 1995) and observed densities for all blocks on our study site exceeded 200 mounds/ha, we presumed that colonies were polygyne.

CONCLUSION

Overall, our study provides empirical, experimental evidence that land management practices leading to soil and vegetation disturbance increase infestation by RIFA. More specifically, the 2 habitat management regimes (discing and burning) most frequently prescribed to enhance bobwhite habitat quality increased RIFA mound density and population index. This creates a management conundrum. Maintenance of early successional habitats is essential for bobwhite, yet in areas of high RIFA infestations, these practices can be expected to increase local abundance of RIFA, which could result in associated negative impacts on bobwhite population performance (Allen et al. 1995, Giuliano et al. 1996, Mueller et al. 1999). We acknowledge that this study examined only short-term effects of disturbance practices. Additional research addressing long-term effects of sustained management regimes on RIFA abundance and colonization is needed.

LITERATURE CITED

- Allen, C. R., S. Demarais, and R. S. Lutz. 1994. Red imported fire ant impact on wildlife: an overview. *Texas Journal of Science* 46:51–59.
- Allen, C. R., R. S. Lutz, and S. Demarais. 1993. What about fire ants and northern bobwhites? *Wildlife Society Bulletin* 21: 349–351.
- Allen, C. R., R. S. Lutz, and S. Demarais. 1995. Red imported fire ant impacts on northern bobwhite populations. *Ecological Applications* 5:632–638.
- Allen, C. R., R. S. Lutz, and S. Demarais. 1998. Ecological effects of the invasive nonindigenous Ant, *Solenopsis invicta*, on native vertebrates: the wheels on the bus. *Transactions of the North American Wildlife and Natural Resource Conference* 63:56–65.
- Banks, W. A., D. P. Jouvenaz, D. P. Wojcik, and C. S. Lofgren. 1985. Observations on fire ants, *Solenopsis spp.* in Mato Grosso, Brazil. *Sociobiology* 11:143–152.
- Brennan, L. A. 1991. How can we reverse the northern bobwhite decline? *Wildlife Society Bulletin* 19:544–555.
- Brennan, L. A. 1993. Fire ants and northern bobwhites: a real problem or a red herring? *Wildlife Society Bulletin* 21:351–355.
- Daniel, W. W. 1978. *Applied non-parametric statistics*. Houghton Mifflin, Boston, Massachusetts.
- Exum, J. H., R. W. Dimmick, and B. L. Deardon. 1982. Land use and bobwhite populations in an agricultural system in west Tennessee. *Proceedings of the National Quail Symposium* 2:6–12.
- Fillman, D. A., and W. L. Sterling. 1983. Killing power of the red imported fire ant (Hym.: Formicidae): a key predator of the boll weevil (Col.: Curculionidae). *Entomophaga* 28: 339–344.
- Giuliano, W. M., C. R. Allen, R. S. Lutz, and S. Demarais. 1996. Effects of red imported fire ants on northern bobwhite chicks. *Journal of Wildlife Management* 60:309–313.
- Glancy, B. M., and C. S. Lofgren. 1988. Adoption of newly mated queens: a mechanism for proliferation and perpetuation of polygynous red imported fire ants, *Solenopsis invicta* Buren. *Florida Entomologist* 71:581–587.
- Johnson, A. S. 1961. Antagonistic relationships between ants and wildlife with special reference to imported fire ants and bobwhite quail in the Southeast. *Proceedings of the Annual Conference of the Southeastern Association of Game and Fish Commissioners* 15:88–107.
- Killion, M. J., and W. E. Grant. 1993. Scale effects in assessing the impact of imported fire ants on small mammals. *Southwestern Naturalist* 38:393–396.
- Komerack, E. V. 1980. Comments on the fire ant problem. *Proceedings of Tall Timbers Ecological Animal Control Habitat Management* 7:1–8.
- Lofgren, C. S. 1986. The economic importance and control of imported fire ants in the United States. Pages 227–256 in S. B. Vinson, ed. *Economic impact and control of social insects*. Praeger Publishers, New York.
- Lofgren, C. S., and D. F. Williams. 1984. Reinfestation rates of red imported fire ants following toxic bait treatments. *Proceedings of the 1984 Imported Fire Ant Conference* 112–119.
- Mueller, J. M., C. B. Dabbert, S. Demarais, and A. R. Forbes. 1999. Northern bobwhite chick mortality caused by red imported fire ants. *Journal of Wildlife Management* 63:1291–1298.
- Pederson, E. K., W. E. Grant, and M. T. Longnecker. 1996. Effects of red imported fire ants on newly hatched northern bobwhite. *Journal of Wildlife Management* 60:164–169.
- Petersen, R. G. 1985. *Design and analysis of experiments*. Marcel Dekker, New York.
- Porter S. D., A. Bhatkar, R. Mulder, S. B. Vinson, and D. J. Clair. 1991. Distribution and density of polygyne fire ants (Hymenoptera: Formicidae) in Texas. *Journal of Economic Entomology* 84:866–874.
- Porter S. D., and D. A. Savignano. 1990. Invasion of polygyne fire ants decimates native ants and disrupts arthropod community. *Ecology* 71:2095–2106.
- Porter S. D., and W. R. Tschinkel. 1987. Foraging in *Solenopsis invicta* (Hymenoptera: Formicidae): effects of weather and season. *Environmental Entomology* 16:802–808.
- Porter S. D., B. Van Eimeren, and L. E. Gilbert. 1988. Invasion of red imported fire ants (Hymenoptera: Formicidae): microgeography of competitive replacement. *Annals of the Entomological Society of America* 81:913–918.
- SAS Institute. 1989. *SAS/STAT user's guide*, version 6.12 Fourth edition. SAS Institute, Cary, North Carolina.
- Sauer, J. R., J. E. Hines, G. Gough, I. Thomas, and B. G. Peterjohn. 1997. *The North American Breeding Bird Survey Results and Analysis*. Version 96.4. Patuxent Wildlife Research Center, Laurel, Maryland.
- Scott, F. T. 1984. *Soil Survey of Madison County, Mississippi*. United States Government Printing Office, Washington, D.C.
- Snedecor, G. W., and W. G. Cochran. 1980. *Statistical methods*: Seventh edition. Iowa State University Press, Ames.
- Summerlin, J. W., A. C. F. Hung, and S. B. Vinson. 1977. Residues in nontarget ants, species simplification following aerial application of mirex. *Environmental Entomology* 6: 193–197.
- Tschinkel, W. R. 1988. Distribution of the fire ants *Solenopsis invicta* and *S. geminata* (Hymenoptera: Formicidae) in northern Florida in relation to habitat and disturbance. *Annals of the Entomological Society of America* 81:76–81.
- Tschinkel, W. R. 1993. The fire ant (*Solenopsis invicta*): still unvanquished. Pages 121–136 in B. N. McKnight, ed., *Biological Pollution: The control and impact of invasive exotic species*. Indiana Academy of Science, Indianapolis.
- Vinson, S. B., and A. A. Sorensen. 1986. *Imported fire ants: life history and impact*. Texas Department of Agriculture, Austin.

RESPONSE OF VEGETATION IMPORTANT TO NORTHERN BOBWHITES FOLLOWING CHEMICAL AND MECHANICAL TREATMENTS

James R. Welch¹

Warnell School of Forest Resources, University of Georgia, Athens, GA 30602-2152, USA

K. V. Miller

Warnell School of Forest Resources, University of Georgia, Athens, GA 30602-2152, USA

William E. Palmer

Tall Timbers Research Station, 13093 Henry Beadel Dr., Tallahassee, FL 32312, USA

ABSTRACT

Populations of northern bobwhite (*Colinus virginianus*) have declined since the early 1900s due to large-scale land use changes and habitat destruction. In southern pine stands land managers have used a variety of treatments to control hardwood encroachment, a major contributing factor to the loss of optimal quail habitat. We compared the use of the herbicide Arsenal® (imazapyr) and traditional mechanical treatments with and without fire to control hardwood stem encroachment on 2 study areas. On Tall Timbers Research Station, hardwood stem density decreased on herbicide and herbicide + burn plots, but increased on all mechanically treated plots between years. Herbicide and herbicide + burn plots resulted in a >3-fold increase in forb coverage between years, whereas mechanically treated plots did not increase forb coverage. On Foshalee Plantation, hardwood stem density decreased and forb coverage increased between years on chemically treated plots. A one-time application of Arsenal can control hardwood encroachment in pine forests and stimulate herbaceous species growth. Following treatment, vegetative communities likely can be maintained for prolonged periods by using traditional, less expensive, methods of management such as prescribed fire.

Citation: Welch, J. R., K. V. Miller, and W. E. Palmer. 2002. Response of vegetation important to northern bobwhites following chemical and mechanical treatments. Page 156 in S. J. DeMaso, W. P. Kuvlesky, Jr., F. Hernández, and M. E. Berger, eds. Quail V: Proceedings of the Fifth National Quail Symposium. Texas Parks and Wildlife Department, Austin, TX.

¹ Present address: Fish and Wildlife Department, Oregon State University, Corvallis, OR 97331

WINTER COVER HEIGHT AND HEAT LOSS: IS TALLER BETTER?

Eliodora Chamberlain

Department of Fisheries and Wildlife Sciences, 302 Anheuser-Busch Natural Resources Building, University of Missouri, Columbia, Missouri 65211-7240, USA

Ronald D. Drobney

U.S. Geological Survey, Missouri Cooperative Fish and Wildlife Research Unit, 302 Anheuser-Busch Natural Resources Building, University of Missouri, Columbia, Missouri 65211-7240, USA

Thomas V. Dailey

Missouri Department of Conservation, 1110 South College Avenue, Columbia, Missouri 65201, USA

ABSTRACT

Previous studies have demonstrated that roost site selection affects energy requirements for thermoregulation in several avian species; however, the influence of microhabitat characteristics on heat loss has not been evaluated for northern bobwhites (*Colinus virginianus*). One frequently measured microhabitat feature that is commonly thought to influence the thermal characteristics of avian ground roost sites is cover height. We simultaneously measured thermoregulatory energy expenditure of bobwhites across a range of low ambient temperatures (-24° to 14° C) in 3 cover heights (0 cm, 46 cm, 124 cm) using 3 heated taxidermic mounts. Predicted metabolic rates (PMR) were derived on the basis of power consumption of the taxidermic mounts. Predicted metabolic rate for each vegetation height was linearly related to ambient temperature, and decreased significantly ($P < 0.05$) as temperature increased. Contrary to our predictions, PMR did not differ ($P = 0.769$) among the 3 vegetation heights across a range of environmental conditions. These findings suggest that under the conditions occurring during our field measurements, thermoregulatory energy requirements of bobwhites are essentially independent of vegetation height at the roost, and primarily are a function of conductive rather than convective heat loss.

Citation: Chamberlain, E., R. D. Drobney, and T. V. Dailey. 2002. Winter cover height and heat loss: is taller better? Page 157 in S. J. DeMaso, W. P. Kuvlesky, Jr., F. Hernández, and M. E. Berger, eds. Quail V: Proceedings of the Fifth National Quail Symposium. Texas Parks and Wildlife Department, Austin, TX.

NORTHERN BOBWHITE HABITAT USE IN A FOREST-DOMINATED SYSTEM

Ira B. Parnell, III¹

Daniel B. Warnell School of Forest Resources, University of Georgia, Athens, GA 30602, USA

Sara H. Schweitzer

Daniel B. Warnell School of Forest Resources, University of Georgia, Athens, GA 30602, USA

Craig G. White

Daniel B. Warnell School of Forest Resources, University of Georgia, Athens, GA 30602, USA

Lynn A. Lewis

Southeastern Cooperative Wildlife Disease Study, University of Georgia, Athens, GA 30602, USA

ABSTRACT

Changes in land use that reduce habitat availability and quality for northern bobwhites (*Colinus virginianus*) are thought to be the major cause of bobwhite population decline in the Southeast. Increased conversion of open habitats to densely stocked pine plantations has contributed to habitat loss. We examined bobwhite habitat use in the Upper Coastal Plain of Georgia, a landscape dominated by forests and agriculture. The purposes of this study were to monitor habitat selection by bobwhites in this forest and agriculture system and to determine what role pine plantations, including those established as a conservation practice of the Conservation Reserve Program, have within bobwhite's selection of habitat types. To date little research has been conducted to determine bobwhite habitat selection within this forest and agriculture dominated system. Many bobwhite research studies have been undertaken on intensively managed lands in the southeastern United States. Many landowners and land managers may not have the resources necessary to manage their lands exclusively for bobwhites. This study was conducted on lands where landowners had multiple objectives in mind, such as agriculture, timber, and wildlife. We determined home range sizes and habitat selection of 55 radiomarked bobwhites during 1997–2000. Selection of habitats by radiomarked bobwhites supported our hypotheses that they would prefer early-successional habitats within the forest-dominated study area. Selected habitats included fallow fields and open-canopy planted pines whereas agricultural areas and closed-canopy planted pines were avoided. Thinning to create open-canopy planted pine stands will benefit bobwhites by providing additional early successional habitat. Bobwhites selected open canopy planted pine and fallow field habitats in preference to closed-canopy planted pine and agricultural areas. Our results suggest that managing fallow fields and open canopy planted pine habitat for bobwhites will provide preferred habitat within this landscape and is feasible for the average landowner.

Citation: Parnell, I. B., III, S. H. Schweitzer, C. G. White, and L. A. Lewis. 2002. Northern bobwhite habitat use in a forest dominated system. Page 158 in S. J. DeMaso, W. P. Kuvlesky, Jr., F. Hernández, and M. E. Berger, eds. Quail V: Proceedings of the Fifth National Quail Symposium. Texas Parks and Wildlife Department, Austin, TX.

¹ Present address: Georgia Department of Natural Resources, Wildlife Resources Division, Albany, GA 31706

NORTHERN BOBWHITE POPULATION RESPONSE TO INTENSIVE MECHANICAL HARDWOOD CLEAN-UP

D. Clay Sisson

Albany Quail Project, c/o Pineland Plantation, Rt.1, Box 115, Newton, GA 31770, USA

H. Lee Stribling

School of Forestry and Wildlife Sciences, Auburn University, AL 36849, USA

Jerald F. Sholar

Albany Quail Project, c/o Pineland Plantation, Rt.1, Box 115, Newton, GA 31770, USA

ABSTRACT

Habitat degradation for northern bobwhite (*Colinus virginianus*) has occurred in many fire-maintained pine forests of the southeastern Coastal Plain due to encroachment of undesirable hardwoods over time. This is especially true for old-field lands where the highly combustible native groundcover has been eliminated. A management technique gaining in popularity recently is the removal of these hardwoods to improve habitat conditions for bobwhites. We used radio-telemetry and plantation hunting records to measure population parameters and hunting success on 1 such property before, during, and after an intensive mechanical hardwood "clean-up." An 800-acre hunting course on Nilo Plantation near Albany, Georgia was the study area for this project and is a site where we have maintained a continuous year-round sample of radiomarked bobwhites since fall 1993, that now cumulatively totals >500. These telemetry studies have revealed that bobwhite survival and reproductive output were declining and had reached low points the year prior to the initiation of hardwood clean-up. The clean-up operation consisted of mechanical felling of most mature hardwood in the pine uplands, followed by piling with root rakes, and then burning the piles. Kaplan-Meier survival estimates prior to the clean-up were Spring-Fall (15%), Fall-Spring (37%), and annual (6%). Cause specific mortality from avian depredation for the 2 Fall-Spring periods prior to clean-up averaged 35%. Broods produced per hen alive on 15 April was 0.42. During the 2 years since clean-up was completed, survival estimates have increased 2- to 5-fold now averaging: Spring-Fall (44%), Fall-Spring (73%), and annual (34%). Broods produced per hen alive on 15 April has almost doubled to 0.72. Cause-specific mortality from avian depredation during Fall-Spring has averaged only 6%. Plantation hunting success on this course had declined to a 20-year low of 3.2 coveys/hour but has since shown an almost 3-fold increase to a record high of 9.4 coveys/hour. This intensive hardwood clean-up has certainly improved the quality of the habitat on this site. We believe it also altered the predator context there by making the environment less suitable to the bobwhite's natural enemies which contributed to the increased survival and reproductive output.

Citation: Sisson, D. C., H. L. Stribling, and J. F. Sholar. 2002. Northern bobwhite population response to intensive mechanical hardwood clean-up. Page 159 in S. J. DeMaso, W. P. Kuvlesky, Jr., F. Hernández, and M. E. Berger, eds. Quail V: Proceedings of the Fifth National Quail Symposium, Texas Parks and Wildlife Department, Austin, TX.

NORTHERN BOBWHITE POPULATION RESPONSE TO INTENSIVE MODIFICATION OF A FARM LANDSCAPE IN MIDDLE GEORGIA

D. Clay Sisson

Albany Quail Project, c/o Pineland Plantation, Rt.1, Box 115, Newton, GA 31770, USA

H. Lee Stribling

School of Forestry and Wildlife Sciences, Auburn University, AL 36849, USA

Steven D. Mitchell

Albany Quail Project, c/o Whitehall Plantation, 2396 Eloise Holmes Rd., Montrose, GA 31065, USA

ABSTRACT

Region wide population declines of northern bobwhite (*Colinus virginianus*) are well documented and believed to be primarily associated with landscape level changes in land use patterns across the southeast. While these declines have not occurred in the traditional "plantation belt" of southwestern Georgia, they are certainly evident throughout much of the rest of the state. In an effort to test the effectiveness of intensive bobwhite management techniques outside their traditional area, we used radio-telemetry, GIS, replicated whistling cock counts, and a fall covey census to monitor population response on one such typical middle Georgia farming landscape that is being intensively modified to benefit quail. Whitehall Plantation is a 3,734-ha farm in Laurens and Bleckley counties, Georgia whose history mirrors that of most of middle Georgia as well as much of the southeast. After many years of high populations and good quail hunting through the 1970s, most of the old fencerows were cleaned up to make way for bigger farm equipment. This was followed by a population decline throughout the 1980s that was made worse when the property was cleaned up even more to make way for center-pivot irrigation. The early 1990s marked a low point in the quail population with the landowners records showing only 10 coveys on the 567-ha core study area (1 bird/4 ha). The property at this point was made up of approximately 55% crop fields, 40% unmanaged woodlands, and 5% houses/pasture/ponds. Efforts to rebuild the population began in 1995 when all the dry land crop acreage was planted into longleaf pines, 15-m borders were developed around all the irrigated crop fields, and no-till farming practices were initiated. These efforts intensified in 1998 when the Albany Quail Project became associated with the property. At this time, all the agricultural fields were divided up with 15-m terraces, fall disking for brood range was initiated, and all the woodland acreage was silviculturally treated as needed. The goal was to make as much of the uncultivated acreage as possible usable space for quail. This has resulted in a landscape that is now 22% agriculture, 21% managed woodlands, 21% planted longleaf, 12% hedgerows and old fields, 10% mature hardwoods, 9% houses/pasture/pond, and 5% fallow land. In addition to these landscape modifications and habitat improvements, a year-round supplemental feeding and nest predator trapping program were initiated. Response to these efforts has been dramatic. Replicated whistling cock counts in June have increased 191% and a fall covey count census now shows approximately 45 coveys on this same 567-ha (1 bird/ha), a 400% increase. Year-round monitoring of a cumulative total of 440 radiomarked birds began in fall 1998 and has provided insights into the mechanisms behind this population response. A majority of the winter covey ranges, nest sites, and brood ranges are in planted longleaf, managed woodlands, or field borders/hedgerows, all habitats that did not exist five years ago. Kaplan-Meier survival estimates for Fall-Spring (58%), Spring-Fall (36%), and annual (21%) are well above those reported for similar southeastern landscapes and rival those of the intensively managed woodland hunting plantations farther south. Landowner satisfaction is high, as his perception is that his quail population and hunting success are as good now as they have been in his lifetime.

Citation: Sisson, D. C., H. L. Stribling, and S. D. Mitchell. 2002. Northern bobwhite population response to intensive modification of a farm landscape in middle Georgia. Page 160 in S. J. DeMaso, W. P. Kuvlesky, Jr., F. Hernández, and M. E. Berger, eds. Quail V: Proceedings of the Fifth National Quail Symposium, Texas Parks and Wildlife Department, Austin, TX.

LANDSCAPE-SCALE LAND-COVER CHANGE AND LONG-TERM ABUNDANCE OF SCALED QUAIL AND NORTHERN BOBWHITE IN TEXAS

Andrew S. Bridges¹

Department of Wildlife and Fisheries Sciences, Texas A&M University, College Station, TX 77843-2258, USA

Markus J. Peterson²

Texas Parks and Wildlife Department, 210 Nagle Hall, College Station, TX 77843-2258, USA

Nova J. Silvy

Department of Wildlife and Fisheries Sciences, Texas A&M University, College Station, TX 77843-2258, USA

Fred E. Smeins

Department of Rangeland Ecology and Management, Texas A&M University, College Station, TX 77843-2126, USA

X. Ben Wu

Department of Rangeland Ecology and Management, Texas A&M University, College Station, TX 77843-2126, USA

ABSTRACT

Between 1978 and 1998, scaled quail (*Callipepla squamata*) abundance in the Rolling Plains ecological region declined ($r_s = -0.85$, $P < 0.001$), while no trend ($P = 0.74$) was exhibited in the South Texas Plains. Northern bobwhites (*Colinus virginianus*) exhibited no trend ($P > 0.10$) in either ecological region. Changes in land-cover between 1976 and 1998 indicated a loss of Savannah and Shrubland and an increase in Parkland cover types in the Rolling Plains. In the South Texas Plains, Woodland and Brush/Shrubland decreased between 1976 and 1998, whereas Brush/Shrub Parkland and Parkland increased. We examined land-cover change as a possible component in the scaled quail decline in the Rolling Plains. Loss of the Shrubland cover type may explain the decline of scaled quail in the Rolling Plains. Our results further suggest intraspecific spatial usability boundaries. These boundaries differed by species, with scaled quail associated with dense structure near the ground, whereas northern bobwhite were less abundant in areas dominated by scattered shrubs and trees, and large expanses of short, close-canopy cover types. A method is proposed for quickly obtaining data on land-cover changes on time.

Citation: Bridges, A. S., M. J. Peterson, N. J. Silvy, F. E. Smeins, and X. B. Wu. 2002. Landscape-scale land-cover change and long-term abundance of scaled quail and northern bobwhite in Texas. Pages 161–167 in S. J. DeMaso, W. P. Kuvlesky, Jr., F. Hernández, and M. E. Berger, eds. Quail V: Proceedings of the Fifth National Quail Symposium. Texas Parks and Wildlife Department, Austin, TX.

Key words: *Callipepla squamata*, *Colinus virginianus*, habitat, land-cover, northern bobwhite, regional abundance, scaled quail, Texas

INTRODUCTION

Populations of scaled quail and northern bobwhites have declined over the majority of their respective ranges during at least the last few decades (Brennan 1991, Church et al. 1993, Brady et al. 1998). In Texas, analysis of 21 years (1978–98) of quail abundance surveys conducted by Texas Parks and Wildlife (TPW) indicated both scaled quail and northern bobwhite abundance declined in multiple physiographic regions (Bridges 1999, Peterson 2001). In the Rolling

Plains ecological region of Texas (Gould 1975), scaled quail abundance declined (Fig. 1), while no trend was exhibited for northern bobwhites (Fig. 2). In the South Texas Plains, no trend was exhibited for scaled quail or northern bobwhites. The short-term fluctuations in these surveys were weather related (Bridges et al. 2001).

Rollins (1996) listed brush encroachment as a possible cause of declining scaled quail abundance in Texas. Wilson and Crawford (1987) found scaled quail in southern Texas preferred sparser shrub cover than did northern bobwhites, while Reid et al. (1993) found scaled quail used both scattered shrub and thick shrub areas. In the Rolling Plains and South Texas Plains ecological regions, Reid (1977) found whistle-counts of northern bobwhites were negatively correlated with cropland and positively correlated with woody land-cover types. Reid et al. (1979) noted that in 3 of the

¹ Present address: Department of Fisheries and Wildlife Sciences, Virginia Polytechnic Institute and State University, Blacksburg, VA 24060-0321

² Present address: Department of Wildlife and Fisheries Sciences and the Center for Public Leadership Studies, George Bush School of Government and Public Service, Texas A&M University, College Station, TX 77843-2258

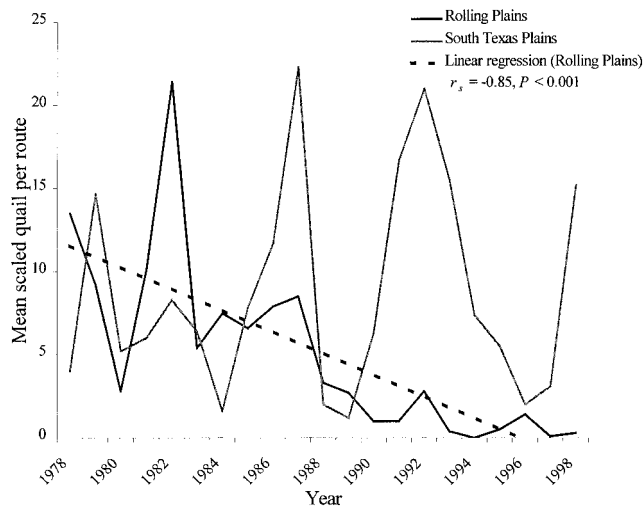

Fig. 1. Mean abundance of scaled quail per census route in the Rolling Plains and South Texas Plains ecological regions of Texas, 1978–98.

4 ecological areas (South Texas Plains, Edwards Plateau, Rolling Plains, and High Plains) of Texas where both species occurred, each species selected different habitats during the breeding season. In the fourth area, the High Plains, habitat use overlapped. The lack of adequate cover in the High Plains (76% cropland) suggested there was direct competition for habitat during the breeding season in this physiographic region.

Guthery (1997, 1999) proposed that northern bobwhites could sustain populations under a wide variety of habitat configurations, but thresholds exist after which usable space, and accordingly abundance would be affected. If a similar relationship between scaled quail and habitat exists, it might explain observed declines in abundance in the Rolling Plains of Texas.

For our study, we chose to look at quail populations in the South Texas Plains and the Rolling Plains of Texas. Northern bobwhite and scaled quail are more numerous (representing optimal habitat for both species) in the South Texas Plains than in any other ecological region of Texas (Bridges 1999). We chose the Rolling Plains because this is the only region in Texas where scaled quail are declining (representing unsuitable habitat for scaled quail).

The objectives of our study were to (1) evaluate changes in landscape-scale land-cover characteristics in the Rolling Plains and South Texas Plains ecological regions of Texas, (2) determine whether differential landscape-scale land-cover changes could have contributed to population trends of quail in the Rolling Plains and South Texas Plains of Texas, and (3) evaluate a vehicle-based method of land-cover classification for quantifying change.

METHODS

Land-cover surveys were conducted along TPW quail roadside census routes in the Rolling Plains and South Texas Plains ecological regions of Texas. The Rolling Plains is about 9,700,000 ha of the Great

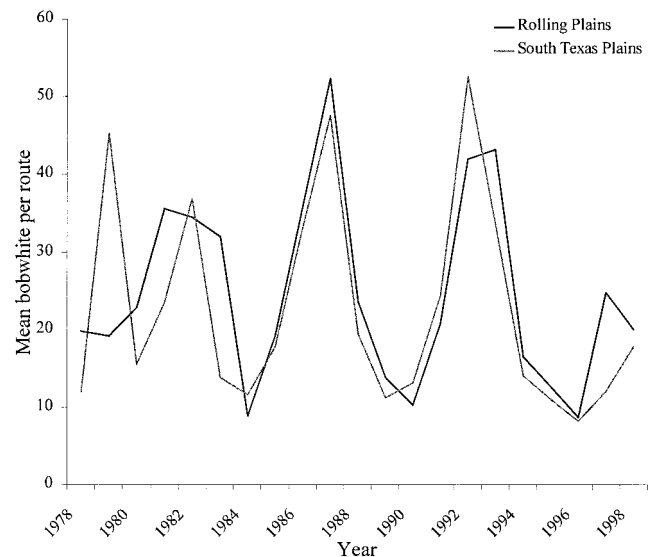

Fig. 2. Mean abundance of northern bobwhite per census route in the Rolling Plains and South Texas Plains ecological regions of Texas, 1978–98.

Plains extending south into Texas (Gould 1975:13). It is rolling terrain, primarily used as rangeland with some cropland, and ranges from 240 to 910 m in elevation. Annual precipitation ranges from 55 to 75 cm with peaks in mid spring and late summer. The South Texas Plains is approximately 8,000,000 ha of flat to gently rolling hills (Gould 1975:12). It is largely rangeland with some cropland and has an elevation varying from sea level to 300 m. Annual precipitation is 40 to 90 cm annually with peaks in late spring and late summer.

We used a 21-year (1978–98) quail abundance data set compiled by TPW. Biologists for TPW ran a series of 32.2-km census routes randomly placed throughout Texas (Peterson and Perez 2000). Routes were run annually during the first 2 weeks of August. Observations began either 1 hour before sunset or at sunrise. Observers drove at 32 km/hr and recorded quail species, total number seen (separated into singles, pairs, and coveys), and approximate age of quail at 1.6-km intervals.

The Rolling Plains and South Texas Plains ecological regions represented the western edge of the northern bobwhite's range and the eastern edge of the scaled quail's range in Texas (Reid 1977). On some routes in these regions, only 1 quail species was recorded from 1978–98. Therefore, all routes in these ecological regions might not represent suitable habitat for both quail species. If a quail species had never been recorded on a given route since its inception, that route was not considered habitat for that species and was excluded when calculating annual mean abundance per route for that species. To insure that biologically significant fluctuations (100% changes) in mean abundance could be detected from the data set, a power analysis (MINITAB 1998) was conducted revealing that doublings in mean abundance (100% change) between years could be detected in both ecological re-

LANDSCAPE CHANGES AND QUAIL ABUNDANCE

Table 1. Descriptions of land-cover classes used in 1976 (Reid 1977) and 1998 land-cover surveys.

Land-cover class	Description
Barren	Areas with <25% ground cover.
Urban	Cities or towns; areas dominated by human dwellings including the fences, shrub rows, windbreaks, and roads associated with their presence.
Cropland	Cultivated cover or row crops used for food and/or fiber for man or domestic animals.
Pasture and fields	Areas dominated by grasses and/or forbs with <10% canopy cover of trees (single or multi-stemmed woody plants >3 m in height) and/or shrubs (single or multi-stemmed woody plants <3 m in height).
Shrub savannah	Pastures or fields with widely scattered shrubs covering 10–25% of the ground.
Shrub parkland	Pastures or fields with 25–75% canopy cover of shrubs, usually in clusters.
Shrubland	Evenly spaced shrubs covering $\geq 75\%$ of the ground.
Brush parkland	Impenetrable clusters of shrubs covering 25–75% of the ground.
Brushland	A continuous, impenetrable cover of shrubs over $\geq 75\%$ of the ground.
Tree savannah	Pastures or fields with widely scattered trees covering 10–25% of the ground.
Tree parkland	Pastures or fields with open or closed clusters of trees covering 25–75% of the ground.
Woodland	Evenly spaced trees (excluding managed fruit and nut trees), >3 but <10 m in height, covering $\geq 75\%$ of the ground without understory.
Orchard	Managed, open stand of evenly spaced fruit or nut trees.
Forest	Trees >10 m in height, covering $\geq 75\%$ of the ground and usually with an understory, except in managed monocultures.

gions at the ≥ 0.80 probability level ($\alpha = 0.05$; Bridges 1999).

Land-cover surveys were run during the first 2 weeks of August 1998. August was chosen to coincide with TPW survey timing. Surveys were run along TPW quail routes. For the Rolling and South Texas Plains, respectively, 35 and 27 routes were run. Exact route locations and maps were obtained from TPW. To evaluate changes in land-cover, a vehicle-based classification system developed by Grue (1977) and Reid (1977) was employed. One observer drove and read the odometer while a second observer evaluated and recorded land-cover types to approximately 0.8 km on both sides of the route (Table 1). Where more than 1 cover type was present within 0.8 km of the route, the cover type closest to the road was recorded.

Proportionate land-cover data from 1998 for the Rolling Plains and South Texas Plains were compared with land-cover data from the 1976 survey (Reid 1977). Routes run in 1998 generally overlapped with those run in 1976, but additional routes had been added by 1998 and all routes were 8 km longer than in 1976. Although routes were not identical, we considered both the 1976 and 1998 surveys to be sufficient

to represent landscape-scale quail habitat at the time they were run.

Only major land-cover types (covering >2% of land) were used for further analysis. Because of the similarity of “brush” and “shrub” land-cover classes (as defined by Reid 1977), these classes were lumped by percentage of canopy closure into “Brush/Shrubland” and “Brush/Shrub Parkland” for further analyses.

Raw data collected in 1976 (Reid 1977) were not available, so detailed comparisons between individual routes were not possible. To analyze proportional data at the ecological region scale, Bonferroni confidence intervals ($\alpha = 0.05$) were constructed around major land-cover proportions for 1998 data. Means from 1976 were compared with this interval to determine whether significant changes in major land-cover types occurred between 1976 and 1998 surveys. Within the South Texas Plains ecological region, where scaled quail remained abundant between 1978 and 1998, routes were divided by those having a majority (defined as >1:1 ratio) of scaled quail versus northern bobwhite. This could not be done in the Rolling Plains because of the virtual extirpation of scaled quail from this region.

A modified version of the Bonferroni confidence intervals (Neu et al. 1974, Byers et al. 1984) was used to evaluate differences in land-cover. Sample size (n) was calculated by adding the total numbers of different habitat types recorded per route. For example, if 4 different habitat types occurred on the first route and 6 occurred on the second, then $n = 10$ for these 2 routes. Johnson (1999) recommended confidence intervals as an alternative to traditional hypothesis testing for wildlife studies. Cherry (1998) listed problems with using Bonferroni confidence intervals as *post hoc* tests for Chi-square analyses, arguing that if associated assumptions were met, confidence intervals were valid without Chi-square analysis. Additionally, sampling based on repeated locations of individual animals or repeated sightings of animals not known to be different might not strictly adhere to independence assumptions. The violation of the independence assumption, however, is routinely done in the literature (Neu et al. 1974, Byers et al. 1984). We considered the total number of different habitat types per route no less independent than multiple locations from 1 animal or repeated sightings of animals not known to be different.

Major land-cover types (barren, grain cropland, non-grain cropland, pasture, shrub savannah, brush/shrub parkland, brush/shrubland, savannah, parkland, woodland, and urban) significantly ($P < 0.05$) correlated with northern bobwhite and scaled quail abundance observed along transects during 1998 were identified from a matrix of product-moment correlation coefficients. Because so few scaled quail were observed in the Rolling Plains during 1998, we used the mean number of scaled quail seen during the period 1996–98 for correlation analyses of land-cover types and scaled quail in this ecological region. We assumed the major land-cover types seen along transects during 1998 had not changed significantly during this period.

Table 2. Bonferroni confidence intervals for proportions of major land-cover types adjacent to quail routes in the Rolling Plains ecological region of Texas in 1976 and 1998.

Land-cover type	Expected proportion (1976) P_o	Actual proportion (1998) P_i	% Change	Bonferroni intervals P_i
Cropland	0.339	0.297	-12.4	$0.217 \leq P \leq 0.377$
Pasture	0.208	0.203	-2.4	$0.132 \leq P \leq 0.273$
Shrub Savannah	0.139	0.049	-64.7	$0.011 \leq P \leq 0.087$ -
Brush/Shrub Parkland	0.038	0.117	207.9	$0.061 \leq P \leq 0.173$ +
Brush/Shrubland	0.042	0.020	-52.4	$0.000 \leq P \leq 0.044$
Savannah	0.104	0.022	-78.8	$0.000 \leq P \leq 0.047$ -
Parkland	0.059	0.188	218.6	$0.119 \leq P \leq 0.256$ +
Woodland	0.063	0.095	50.8	$0.043 \leq P \leq 0.146$

+ Indicates proportional increase in land-cover type at 0.05 significance level.

- Indicates proportional decrease in land-cover type at 0.05 significance level.

RESULTS

Land-cover Type Changes

In the Rolling Plains, Savannah (78.8%) and Shrub Savannah (64.7%) decreased between 1976 and 1998 (Table 2). Conversely, Parkland (218.6%) and Brush/Shrub Parkland (207.9%) increased during this period. Additionally, Brush/Shrubland (52.4%) decreased (nearly significant) in the Rolling Plains. In the South Texas Plains, Woodland (45.0%) and Brush/Shrubland (28.6%) decreased between 1976 and 1998 (Table 3). Brush/Shrub Parkland (256.4%) and Parkland (122.4%; nearly significant) increased and all other classes showed no significant change.

Ecological Region Differences

More Cropland (14.9%) and less Brush/Shrubland (-24.0%) existed in the Rolling Plains than in the South Texas Plains in 1998 (Table 4). On the 5 routes in the South Texas Plains dominated by scaled quail between 1978 and 1998, less cropland (-15.2%) and more Brush/Shrubland (33.8%) existed than on routes dominated by northern bobwhite in 1998 (Table 5).

Quail/Land-cover Type Relationships

During 1998, in the Rolling Plains, northern bobwhite numbers were positively correlated with Parkland ($r = 0.391$; $P = 0.020$), whereas scaled quail

abundance was negatively correlated ($r = -0.370$; $P = 0.029$) with Grain Crops, positively correlated ($r = 0.391$; $P = 0.021$) with Savannah, and were positively correlated ($r = 0.287$) with Brush/Shrubland (although not significantly; $P = 0.095$). In the South Texas Plains, however, northern bobwhite abundance was positively correlated ($r = 0.419$; $P = 0.042$) with Pastureland and scaled quail numbers were positively correlated ($r = 0.453$; $P = 0.026$) with Brush/Shrubland. Although not significant ($P = 0.108$), northern bobwhite numbers were negatively correlated ($r = -0.337$) with Brush/Shrubland.

DISCUSSION

Changes in land-cover in the Rolling Plains between 1976 and 1998 indicated a loss of Savannah, Shrub Savannah, and Brush/Shrubland cover types, and a >200% increase in Parkland and Brush/Shrub Parkland cover types. In light of declines in scaled quail abundance in the Rolling Plains, it appears that scaled quail prefer areas of scattered shrubs and trees (nesting areas) and areas of thick shrubs (escape cover). This also is supported by their positive correlation with Savannah and Brush/Shrubland in the Rolling Plains. However, in 1998, the percentages of Shrub Savannah and Savannah land-cover types were higher in the Rolling Plains than in the South Texas Plains, where scaled quail populations were stable. It appears

Table 3. Bonferroni confidence intervals for proportions of major land-cover types adjacent to quail routes in the South Texas Plains ecological region of Texas in 1976 and 1998.

Land-cover type	Expected proportion (1976) P_o	Actual proportion (1998) P_i	% Change	Bonferroni intervals P_i
Cropland	0.193	0.148	-23.3	$0.080 \leq P \leq 0.216$
Pasture	0.117	0.123	5.1	$0.060 \leq P \leq 0.185$
Shrub Savannah	0.029	0.037	27.6	$0.001 \leq P \leq 0.073$
Brush/Shrub Parkland	0.055	0.196	256.4	$0.120 \leq P \leq 0.272$ +
Brush/Shrubland	0.364	0.260	-28.6	$0.175 \leq P \leq 0.344$ -
Savannah	0.035	0.023	-34.3	$0.000 \leq P \leq 0.052$
Parkland	0.049	0.109	122.4	$0.0492 \leq P \leq 0.169$
Woodland	0.160	0.088	-45.0	$0.027 \leq P \leq 0.132$ -

+ Indicates proportional increase in land-cover type at 0.05 significance level.

- Indicates proportional decrease in land-cover type at 0.05 significance level.

LANDSCAPE CHANGES AND QUAIL ABUNDANCE

Table 4. Bonferroni confidence intervals for proportions of major land-cover types adjacent to quail routes in the Rolling Plains and South Texas Plains ecological regions of Texas in 1998. RP = Rolling Plains and STP = South Texas Plains.

Land-cover type	Rolling Plains	South Texas Plains	%Difference (RP-STP)	
Cropland	0.217 $\leq P \leq$ 0.377	0.080 $\leq P \leq$ 0.216	14.90%	RP > STP
Pasture	0.132 $\leq P \leq$ 0.273	0.060 $\leq P \leq$ 0.185	8.02%	
Shrub Savannah	0.011 $\leq P \leq$ 0.087	0.001 $\leq P \leq$ 0.073	1.26%	
Brush/Shrub Parkland	0.061 $\leq P \leq$ 0.173	0.120 $\leq P \leq$ 0.272	-7.89%	
Brush/Shrubland	0.000 $\leq P \leq$ 0.044	0.175 $\leq P \leq$ 0.344	-23.98%	RP < STP
Savannah	0.000 $\leq P \leq$ 0.047	0.000 $\leq P \leq$ 0.052	-0.14%	
Parkland	0.119 $\leq P \leq$ 0.256	0.049 $\leq P \leq$ 0.169	7.87%	
Woodland	0.043 $\leq P \leq$ 0.146	0.028 $\leq P \leq$ 0.132	1.47%	

RP > STP Indicates proportionally more land-cover on the Rolling Plains at 0.05 significance level.

RP < STP Indicates proportionally less land-cover on the Rolling Plains at 0.05 significance level.

that nest sites are not limiting in the Rolling Plains. This was not true for escape cover (Brush/Shrubland), which comprised only 2.0% of total land-cover in the Rolling Plains and 26.0% of total cover in the South Texas Plains. The 52.4% decline of this cover type, from 4.2 to 2.0% of the total area of the Rolling Plains, may be below the lower threshold of this cover type required by scaled quail, thus precipitating the decline observed in the Rolling Plains. Furthermore, and contradicting Wilson and Crawford (1987), scaled quail were found in greater proportional abundance on routes in the South Texas Plains with more dense woody land-cover than on routes with less woody land-cover. This is further illustrated by the positive and negative correlations between Brush/Shrubland and scaled quail and northern bobwhite abundance, respectively, in the South Texas Plains. Because northern bobwhites were associated with Parkland cover types (Parkland increased over 200%) in the Rolling Plains, their populations remained stable. Apparently, the increase in Parkland was above the threshold required by northern bobwhite for this cover type.

Scaled quail and northern bobwhites do not have identical land-cover requirements (Schemnitz 1964, Reid et al. 1979, Wilson and Crawford 1987). Thus, differential trends in scaled quail and northern bobwhite abundance within the Rolling Plains should not be surprising. Campbell et al. (1973) found that a dense understory of forbs and shrubs was not optimal scaled quail habitat. Brown (1989:145) advocated clearing dense brush on hilltops to improve scaled quail habitat. Schemnitz (1964) found scaled quail pre-

ferred less dense cover than northern bobwhites. Wilson and Crawford (1987) also found that scaled quail preferred relatively sparser shrub cover than did northern bobwhites, suggesting that moderate densities of woody land-cover might adversely affect scaled quail while not harming northern bobwhites. However, Reid et al. (1979) noted scaled quail selected shorter shrub types with more closed canopies, whereas northern bobwhites were located in more open, taller, and diverse types.

Our results suggest both quail species have maximum and minimum limits (habitat boundaries) in their habitat preferences. Guthery (1997) argued that usable space was limiting for northern bobwhites. Although distance to woody mottes limited habitat usability in Guthery's (1999) northern bobwhite model, he did suggest a second boundary after which woody land-cover could become too dense and availability of herbaceous land-cover might be limiting. It appears the discrepancies in cover-type use found by various investigators can be explained by the concept of both a lower and upper boundary of canopy closure for both northern bobwhites and scaled quail. However, these boundaries apparently differ by species, with scaled quail preferring dense structure near the ground (scattered shrubs and/or trees that allow dense grass or forb understory or dense shrubs that produce a dense understory). Such habitat is produced by Shrub Savannahs, Savannahs, and Brush/Shrublands, all of which were correlated with scaled quail numbers in our study. Northern bobwhites prefer (correlated in our study) Shrub Parkland, Parkland, and Woodland types

Table 5. Bonferroni confidence intervals for proportions of major land-cover types adjacent to quail routes in South Texas Plains ecological region in 1998 dominated by either scaled quail or bobwhite from 1978 to 1998. Scaled = scaled quail and Bob = northern bobwhite.

Land-cover type	>50% Scaled quail	>50% Bobwhite	%Difference (RP-STP)	
Cropland	0.000 $\leq P \leq$ 0.0964	0.0965 $\leq P \leq$ 0.259	15.21%	Scaled < Bob
Pasture	0.000 $\leq P \leq$ 0.147	0.066 $\leq P \leq$ 0.214	9.12%	
Shrub Savannah	0.000 $\leq P \leq$ 0.110	0.000 $\leq P \leq$ 0.078	0.66%	
Brush/Shrub Parkland	0.026 $\leq P \leq$ 0.399	0.108 $\leq P \leq$ 0.275	-2.05%	
Brush/Shrubland	0.306 $\leq P \leq$ 0.760	0.111 $\leq P \leq$ 0.279	-33.84%	Scaled > Bob
Savannah	0.000 $\leq P \leq$ 0.059	0.000 $\leq P \leq$ 0.059	1.46%	
Parkland	0.000 $\leq P \leq$ 0.156	0.053 $\leq P \leq$ 0.192	6.89%	
Woodland	0.000 $\leq P \leq$ 0.196	0.023 $\leq P \leq$ 0.138	0.47%	

Scaled > Bob Indicates proportionally more land-cover on scaled quail routes at 0.05 significance level.

Scaled < Bob Indicates proportionally less land-cover on scaled quail routes at 0.05 significance level.

(where shrubs or trees are clumped, with understory being open) and open grass or forbs types nearby. Northern bobwhites appear to avoid totally open areas with only scattered shrubs and trees and large expanses of short, close-canopy cover types.

Cropland (negatively correlated with scaled quail abundance) was more prevalent on the Rolling Plains than on the South Texas Plains in 1998, providing support for the hypothesis that changes in agricultural practices such as "clean farming" might be detrimental to scaled quail (Schemnitz 1993; Brady et al. 1998). Scaled quail also were found in greater proportional abundance on routes with less cropland in the South Texas Plains in 1998. The decline in scaled quail abundance in the Rolling Plains also supports this hypothesis, while the lack of long-term trend in northern bobwhite abundance does not. However, scaled quail were more abundant on routes with significantly less cropland than those dominated by northern bobwhites in the South Texas Plains, indicating that cropland in 1998 might not be suitable habitat for scaled quail.

MANAGEMENT IMPLICATIONS

Our study suggests that quail habitat boundaries are species specific and non-linear. If this is the case, efforts should be made to understand spatial-temporal habitat parameters and boundaries for regional populations of individual quail species. After establishing these boundaries, management efforts should focus on maximizing spatial-temporal usability (Guthery 1999). Our study also illustrates a method for quickly documenting land-cover changes and the potential importance of such changes for managing wildlife. Capel et al. (1993) listed the development of inventory and monitoring systems for quail habitat as a needed component of strategies designed to reverse quail declines. While not a substitute for remote sensing analysis, methods similar to ours might provide a convenient and inexpensive alternative for evaluating land-cover changes. After baseline land-cover surveys of road censuses have been conducted, the periodic re-running of the surveys, easily conducted in conjunction with wildlife abundance surveys, could allow for quick and inexpensive evaluation of land-cover change. If further investigation is necessary, survey results also might provide valuable ground-truthing data for remote sensing analysis.

ACKNOWLEDGMENTS

We would like to thank TPW, the Welder Wildlife Foundation (contribution #562), and Texas A&M University for providing support for this project. We would like to thank all TPW biologists who compiled the data analyzed. We thank Wesley Newman for assisting in the 1998 land-cover survey, Mike Frisbie for aiding in data processing, and James Matis for statistical advice. Finally, we thank Rob Reid and Chris Grue for collecting the 1976 data and developing the

technique used to classify land-cover along these routes.

LITERATURE CITED

- Brady, S. J., C. H. Flather, and K. E. Church. 1998. Range-wide declines of northern bobwhite (*Colinus virginianus*): land use patterns and population trends. *Gibier Faune Sauvage* 15:413–431.
- Brennan, L. A. 1991. How can we reverse the bobwhite population decline? *Wildlife Society Bulletin* 19:544–555.
- Bridges, A. S. 1999. Abundance of northern bobwhite and scaled quail in Texas: influence of weather and land-cover change. Thesis, Texas A&M University, College Station.
- Bridges, A. S., M. J. Peterson, N. J. Silvy, F. E. Smeins, and X. B. Wu. 2001. Differential influence of weather on regional quail abundance in Texas. *Journal of Wildlife Management* 65:10–18.
- Brown, D. E. 1989. *Arizona game birds*. University of Arizona Press and Arizona Game and Fish Department, Tucson.
- Byers, C. R., R. K. Steinhorst, and P. R. Krausman. 1984. Clarification of a technique for analysis of utilization-availability data. *Journal of Wildlife Management* 48:1050–1053.
- Campbell, H., D. K. Martin, P. E. Ferkovich, and B. K. Harris. 1973. Effects of hunting and some other environmental factors on scaled quail in New Mexico. *Wildlife Monographs* 34.
- Capel, S., J. A. Crawford, R. J. Robel, L. W. Burger, Jr., and N. W. Sotherton. 1993. Agricultural practices and pesticides. *Proceedings of the National Quail Symposium* 3:172–173.
- Cherry, S. 1998. Statistical tests in publications of The Wildlife Society. *Wildlife Society Bulletin* 26:947–953.
- Church, K. E., J. R. Sauer, and S. Droege. 1993. Population trends in quails in North America. *Proceedings of the National Quail Symposium* 3:44–55.
- Gould, F. W. 1975. Texas plants—a checklist and ecological summary. Texas A&M University, Agricultural Experiment Station, College Station.
- Grue, C. E. 1977. Classification, inventory, analysis, and evaluation of the breeding habitat of the mourning dove (*Zenaidura macroura*) in Texas. Dissertation. Texas A&M University, College Station.
- Guthery, F. S. 1997. A philosophy of habitat management for northern bobwhites. *Journal of Wildlife Management* 61:291–301.
- Guthery, F. S. 1999. Slack in the configuration of habitat patches for northern bobwhites. *Journal of Wildlife Management* 63:245–250.
- Johnson, D. H. 1999. The insignificance of statistical significance testing. *Journal of Wildlife Management* 63:763–772.
- MINITAB. 1998. Release 12 for Windows. Minitab Inc., State College, Pennsylvania.
- Neu, C. W., C. R. Byers, and J. M. Peek. 1974. A technique for analysis of habitat utilization-availability data. *Journal of Wildlife Management* 38:541–545.
- Peterson, M. J. 2001. Northern bobwhite and scaled quail abundance and hunting regulation: a Texas example. *Journal of Wildlife Management* 65:IN PRESS.
- Peterson, M. J., and R. M. Perez. 2000. Is quail hunting self regulatory? Northern bobwhite and scaled quail abundances and quail hunting in Texas. *Proceedings of the National Quail Symposium* 4:85–91.
- Reid, R. R. 1977. Correlation of habitat parameters with whistle-count densities of bobwhite (*Colinus virginianus*) and scaled quail (*Callipepla squamata*) in Texas. Thesis, Texas A&M University, College Station.
- Reid, R. R., C. E. Grue, and N. J. Silvy. 1979. Competition between bobwhite and scaled quail for habitat in Texas.

LANDSCAPE CHANGES AND QUAIL ABUNDANCE

167

- Proceedings of the Annual Conference of the Southeastern Association of Fish and Wildlife Agencies 33:146–153.
- Reid, R. R., C. E. Grue, and N. J. Silvy. 1993. Habitat requirements of breeding scaled quail in Texas. Proceedings of the National Quail Symposium 3:137–142.
- Rollins, D. 1996. Ecology and management of blue quail in Texas. Proceedings of the Texas Quail Short Course 2:93–103.
- Schemnitz, S. D. 1964. Comparative ecology of bobwhite and scaled quail in the Oklahoma panhandle. American Midland Naturalist 71:429–433.
- Schemnitz, S. D. 1993. Scaled quail habitats revisited—Oklahoma panhandle. Proceedings of the National Quail Symposium 3:143–147.
- Wilson, M. H., and J. A. Crawford. 1987. Habitat selection by Texas bobwhites and chestnut-bellied scaled quail in south Texas. Journal of Wildlife Management 51:575–582.

MOVEMENT PATTERNS OF RESIDENT AND RELOCATED NORTHERN BOBWHITES IN EAST TEXAS

Xiangwen Liu¹

Arthur Temple College of Forestry, Stephen F. Austin State University, Nacogdoches, TX 75962, USA

R. Montague Whiting, Jr.

Arthur Temple College of Forestry, Stephen F. Austin State University, Nacogdoches, TX 75962, USA

D. Scott Parsons¹

Arthur Temple College of Forestry, Stephen F. Austin State University, Nacogdoches, TX 75962, USA

Donald R. Dietz

Temple-Inland Forest Products Corporation, Lufkin, TX 75904, USA

ABSTRACT

We compared home range sizes and movement patterns of resident and relocated northern bobwhites (*Colinus virginianus*) on an area managed specifically for the species in the Pineywoods of east Texas. During the winters of 1990–1992, 155 south Texas, 136 east Texas, and 139 resident bobwhites were radiomarked, released, and thereafter regularly located. Bird locations were plotted on a digitized map, and home range sizes and movement patterns of each group of birds were estimated. Resident bobwhites moved longer daily distances in March and had larger home ranges during the nesting season (May–Jul) than relocated birds ($P \leq 0.05$). Conversely, no differences were detected among groups in mean of daily distances moved in April or dispersal during the breeding season (Mar–Jun) ($P > 0.05$). Annual dispersal distances ($\bar{x} = 1.43$ km) of birds that survived into November were similar among groups ($P > 0.05$). Managers that elect to relocate northern bobwhites should consider doing so in the fall and only into habitats of ample size.

Citation: Liu, X, R. M. Whiting, Jr., D. S. Parsons, and D. R. Dietz. 2002. Movement patterns of resident and relocated northern bobwhites in eastern Texas. Pages 168–172 in S. J. DeMaso, W. P. Kuvlesky, Jr., F. Hernández, and M. E. Berger, eds. Quail V: Proceedings of the Fifth National Quail Symposium. Texas Parks and Wildlife Department, Austin, TX.

Key words: *Colinus virginianus*, movement patterns, northern bobwhite, relocation, Texas, transplant

INTRODUCTION

Historically, bobwhites were present but probably not abundant in east Texas before Europeans arrived. However, early farming and land-use practices favored the species, and populations flourished (Lay 1965). Prior to World War II, east Texas was known for its bobwhite hunting. After World War II, land use practices changed and serious population declines occurred (Lay 1965). By 1987, bobwhite numbers in east Texas were so low that the Texas Parks and Wildlife Department discontinued bobwhite survey routes.

In the late 1980's, Temple-Inland Forest Products Corporation made the commitment to intensively manage a 563-ha area for bobwhites on the South Boggy Slough Hunting and Fishing Club in east Texas. The general objective of the project was to re-establish bobwhites on the area through habitat improvement and relocation of wild-trapped birds. After initial habitat improvement, wild bobwhites were trapped in east and south Texas and released on the area, which had a small remnant population. The corporation also funded a study that examined and compared habitat preferences

(Liu et al. 1996), survival (Liu et al. 2000), and reproduction (Nedbal et al. 1997, Parsons et al. 2000b) of the resident and relocated bobwhites. This paper reports movement patterns of the 3 groups of bobwhites.

METHODS

The study area was in Trinity County, which is in the Pineywoods Ecological Region of east Texas. Climate in this area is hot and humid, with precipitation ranging 90–150 cm/year (Gould 1975:2). The study area was dominated by upland stands of loblolly (*Pinus taeda*) and shortleaf (*P. echinata*) pines. Hardwoods, primarily sweetgum (*Liquidambar styraciflua*), oaks (*Quercus* spp.), and hickorys (*Carya* spp.) occurred along the small drainages (Liu 1995). Basal areas in these 50–60 year-old pine and mixed pine-hardwood stands ranged 21–28 m²/ha. Two 10-ha pine plantations, each 5 years old, were on the north end of the area and, as the result of a tornado, a 101-ha portion of the study area was clearcut, site prepared, and replanted in spring, 1989. Also, there were about 10 km of pipeline rights-of-ways and 40 km of roads within the area.

¹ Present address: Texas Parks and Wildlife Department, 4200 Smith School Road, Austin, TX 78744-3291

MOVEMENTS OF RELOCATED BOBWHITES

Habitat modifications were initiated in February 1989. Basal area of merchantable trees was reduced to 9–14 m²/ha using crown and/or low thinnings. Approximately 20% of the study area was converted into food plots. Cover blocks, both natural and planted, occupied 30% of the area. The study area was initially burned with a prescribed fire in 1989 and was burned again in both 1991 and 1992. Cover blocks, food plots, and young pine plantations were protected during the prescribed burns (Parsons et al. 2000a).

In February and March 1990, 50 bobwhites (*C. v. texanus*) from Kenedy County, in south Texas, and 31 from Houston County, which is north of and adjacent to Trinity County, were captured, banded, radiomarked, and released on the study area. Thirteen of the estimated 20 resident birds were captured, banded, radiomarked, and released at the point of capture; both groups of birds captured in east Texas were of the *C. v. mexicanus* subspecies (Johnsgard 1973). In winter 1991, 50 south Texas, 50 east Texas, and 69 resident (i.e., birds hatched and reared on the study area) bobwhites were radiomarked and released. Likewise, in winter 1992, 55, 55, and 57 south Texas, east Texas, and resident bobwhites, respectively, were radiomarked and released on the study area.

During the 3-year study, attempts were made to locate each bird ≥ 5 days/week during the late winter, spring, summer, and early fall; numbers of locations were reduced to 2 or 3 days/week during the deer season. Radiomarked birds were tracked until they died, the transmitter failed, or the project ended. Throughout the study, radiomarked birds were recaptured and transmitters replaced as necessary. Searches were conducted daily for missing birds.

In 1990, bird locations were plotted on existing copies of aerial photos of the study area. However, a set of new aerial photos was taken in 1991 and a digitized study area map was made from these photos. A grid system, with each cell representing a 100 \times 100 m area, was imposed on the map. Daily locations of the birds were plotted on the gridded map in 1991 and 1992, and the aerial photos were used to help determine the precise locations of the birds on the map. To minimize plotting error, each person locating bobwhites was given intensive training pertaining to the use of the map and aerial photos and recognition of landmarks.

In order to error test the radio-locating and location-plotting systems, 36 locations were randomly selected in the study area. A transmitter was placed at each location, at approximately the height of a bobwhite, by a person who was not a radio-tracker. Each tracker then independently located these transmitters as if they were birds, including plotting the locations on the gridded map. Actual locations of the transmitters were plotted on the map thereafter. The distances between estimated locations and the actual locations were measured using a Geographic Information System (GIS) (ESRI 1993). Analyses of variance were performed on these data to determine any accuracy differences among trackers. There was no statistical difference among the trackers, therefore the data were

pooled for all trackers and the error rates were then estimated (Liu et al. 1996).

March home range sizes, nesting-season home range sizes, means of distances moved daily, breeding-season dispersal distances, and annual dispersal distances were compared among the 3 groups of bobwhites. For these analyses, only birds that were initially radiomarked each year were included (i.e., birds that joined the population after late February were excluded).

March home range was selected because it was before covey break-up, but after relocated birds had time to become acclimated to the study area. The nesting-season home range included all radio locations of a bird during May, June, and July. The mean of distances moved daily by a bird was the average of all distance measurements between radio locations on consecutive days in a month. Breeding-season dispersal distance was the distance between the release site of a bird and the radio location farthest from that site during June. June was selected because by then the spring shuffle was completed and most birds had settled into the breeding-season routine. Annual dispersal distances were calculated for birds surviving into November. These values were obtained for each bird by measuring the distance from the release site to the most distant radio location recorded during the year.

In order to obtain March or nesting-season home range of a bird, digitized radio locations were used to define a polygon and the area of the polygon (excluding obvious outliers) was calculated using the GIS. The process of measuring home range was made interactive by an ARC Macro Language (AML) program (Liu 1995:121) and the measurements were automatically written into the original information (INFO) files.

Movement data were obtained using the GIS. In order to determine the distance a bird dispersed from its release site, a map of the release sites was digitized. Breeding-season dispersal was obtained by calculating the distances between the bird's release site and each of its daily locations in June. These distances were then compared and the greatest distance was obtained. The mean of distances moved daily during each month was calculated using a similar routine. During each month, the first location of a bird was selected and then the location successive to the first was selected. These 2 locations were tested for consecutiveness in dates and, if they were consecutive, the distance between them was calculated. Next, the location successive to the second was selected and the test and measuring process repeated. This process continued until distances between all consecutive locations of the bird in the month were measured. The total of the distance measurements was divided by the number of measurements to produce the monthly average. These processes were customized by an AML program (Liu 1995:124) and the results were also output to the original INFO files.

Two statistical analysis procedures were used to analyze home range and movement data. March home range sizes, nesting-season home range sizes, breed-

Table 1. Results of multivariate analyses of variance of home range sizes and movements among resident, east Texas relocated, and south Texas relocated bobwhites on the South Boggy Slough study area, Trinity County, Texas, 1990–1992. Means with the same letter within rows do not differ ($P > 0.05$).

Variable	South Boggy residents ($n = 35$)		East Texas relocated ($n = 56$)		South Texas relocated ($n = 41$)		P-value
	\bar{x}	SE	\bar{x}	SE	\bar{x}	SE	
March home range (ha)	10.5a	10.0	5.5b	4.3	6.1b	5.3	0.002
Nesting-season home range (ha)	61.9a	30.1	46.9b	27.1	42.6b	29.8	0.011
Breeding-season dispersion (km)	1.4	0.7	1.2	0.6	1.1	0.7	0.127
Mean distance moved daily in March (m)	182.0a	98.0	123.0b	58.0	134.0b	73.0	0.001
Mean distance moved daily in April (m)	195.0	158.0	209.0	186.0	151.0	82.0	0.178

ing-season dispersal distances, and means of distances moved daily during March and April were compared among groups using MANOVA. When differences were detected among groups, Duncan's multiple range tests were performed to further identify the differences.

After April, the numbers of birds rapidly decreased, thus missing values increased. This resulted in the whole record for many birds being rejected by the analysis procedure. Therefore, the means of distances moved daily were not compared among groups for the remainder of the year. However, these means were compared among months within each group using ANOVA, and if appropriate, Duncan's multiple range tests. For similar reasons, annual dispersal distances were not compared in the MANOVA procedure, but in separate ANOVA and Duncan's multiple range tests. The SAS system (SAS Institute 1988) was used for statistical analyses. The alpha levels for all statistical tests were set *a priori* at 0.05.

RESULTS AND DISCUSSION

The mean March home range size of South Boggy residents was larger than those of either east Texas or south Texas relocated birds. Likewise, South Boggy residents had larger nesting-season home ranges than either east Texas or south Texas relocated bobwhites ($P < 0.05$). Conversely, there was no difference among the 3 groups in breeding-season dispersal ($P > 0.05$), which was between the time of release and the end of June (Table 1).

Corresponding to the differences in March home range sizes, the means of distances moved daily in March were also different. Both east Texas and south Texas relocated bobwhites had shorter daily movements in March than did South Boggy residents; the differences were not significant in April (Table 1).

The monthly means of distances moved daily ranged 60 to 299 m; the means were lowest in November, but the sample sizes were also the smallest during that month. Among months, the differences were not significant for either the South Boggy residents or south Texas relocated birds. However, the east Texas relocated bobwhites had significantly longer daily movements in May than in March. For each group,

the mean distance that the birds moved daily peaked in May, and the maximum variation (i.e., standard error) occurred in either April or May (Fig. 1). For South Boggy residents and south Texas relocated birds, the standard error values increased in April, reached the maximum in May, and then declined. For east Texas relocated birds, the standard error values were somewhat higher in April than in May. Regardless, it is noteworthy that the standard error values for the month with the highest variation in daily movements was much greater for South Boggy residents than for east Texas or south Texas relocated birds (Fig. 1).

Changes in means of distances moved daily coincided with the breeding season. During fall and winter, bobwhites are in coveys. In early stages of the breeding season, males start whistling, seeking females, and the coveys break up (Rosene 1969:98). During this period, often called the spring shuffle, the birds move extensively. In this study, the spring shuffle began in April and continued into May. After this period of extensive movement, most birds were with mates, hence daily moving distances and variations in these distances were reduced (Fig. 1).

The fact that the South Boggy residents differed from the other 2 groups in average distances moved daily during March and in March home range size suggests that the relocation process had a profound influence on movement behavior of relocated birds during the initial period after relocation. Obviously, the relocated birds were not familiar with the area into which they had been introduced and this may have reduced their movements.

Lack of differences in daily distances moved in April seemingly suggests that the relocated birds had become acclimated to the study area by then. This probably was not the case, however. The impending breeding season probably had more of an impact on the birds' movements than did the lack of familiarity with the study area.

During April and May, birds from all 3 groups often made long-distance movements, seeking a mate. However, movements by South Boggy residents were longer than those of either relocated group during both months. Although the values were smaller, the same was true for June. Finally, the nesting season (May–Jul) home range size of South Boggy residents was

MOVEMENTS OF RELOCATED BOBWHITES

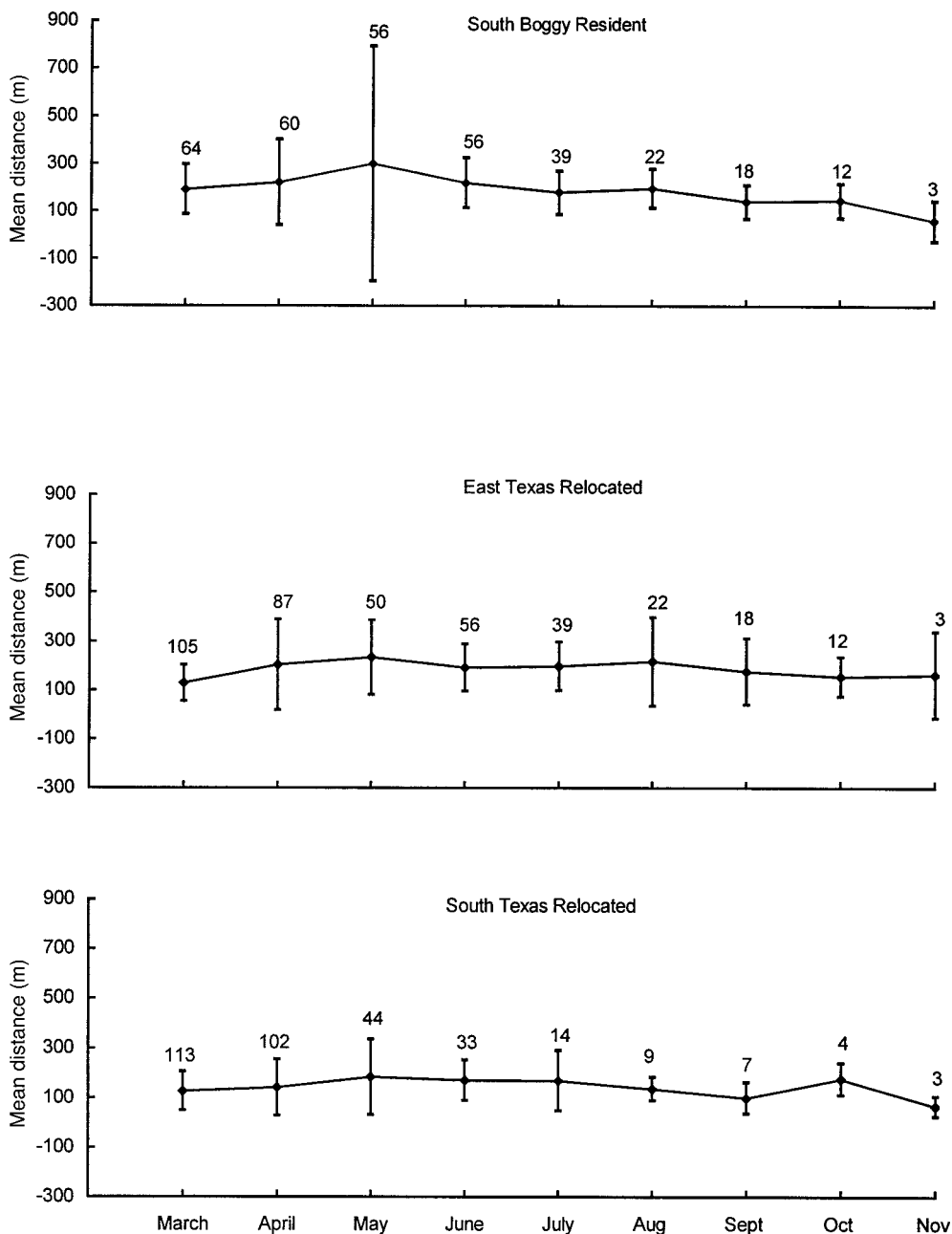

Fig. 1. Monthly means and standard errors of distances moved daily by resident, east Texas relocated, and south Texas relocated bobwhites on the South Boggy Slough study area, Trinity County, Texas, 1990–1992. Numbers presented are sample sizes.

significantly larger than those of the relocated birds (Table 1). These findings indicate that movements of relocated birds were restrained at least through June, or for at least 4 months. If the birds had been relocated in the fall, the impact of the process might have been clearer.

Impact of the relocation process on movement behavior lessened with time and had disappeared by late fall. Among the 3 groups, annual dispersal distances of birds that survived through the breeding seasons into November showed no significant differences ($P = 0.88$). The mean dispersal distance for resident birds was 1.5 km (SD = 0.6 km); for east Texas and south Texas groups, mean dispersal distances were about the same, 1.4 km (SD = 0.5 and 0.4 km, respectively).

MANAGEMENT IMPLICATIONS

Wildlife managers who find it necessary to relocate wild northern bobwhites into habitat created for the species should consider the timing of relocation and size of the modified habitat. Our data indicate that it takes at least 4 months for relocated birds to become familiar with their surroundings, even if the birds are from a similar habitat type. This suggests that relocations should take place in fall rather than winter. Unfortunately, relocation in the fall subjects the birds to a longer period of potential depredation prior to the breeding season than does winter relocation.

Although the annual dispersal distance of the birds averaged 1.4–1.5 km, many birds dispersed much far-

ther than that. However, most of these birds either died or their signals were lost before November, thus they were excluded from that analysis. The greatest known distance was 3.8 km, made by a male South Boggy resident in 1991. It should be pointed out that at least 50 birds dispersed ≥ 2.5 km (Liu 1995:100). This suggests that if a designated relocation area is less than 5.0 km in diameter, at least 10% of the relocated birds may move out of the area, even if all birds are released at its center. This percentage is probably an underestimate because some missing birds in this study probably moved farther than that.

ACKNOWLEDGMENTS

R. M. Capps, H. B. Clark, S. L. Cook, S. D. Cottrell, B. G. Eichler, K. E. C. Flannery, C. D. Foster, B. S. Mueller, and R. D. Stanley aided in data collection and tabulation. T. B. Jordan provided editorial assistance. The project was funded by Temple-Inland Forest Products Corporation and otherwise supported by the Arthur Temple College of Forestry at Stephen F. Austin State University.

LITERATURE CITED

- ESRI. 1993. ARC/INFO user's guide. Environmental Systems Research Institute, Inc., 380 New York Street, Redlands, California.
- Gould, F. W. 1975. Texas plants: a checklist and ecological summary. Texas Agriculture Experiment Station, Texas A&M University, College Station.
- Johnsgard, P. A. 1973. Grouse and quails of North America. University of Nebraska Press, Lincoln.
- Lay, D. W. 1965. Quail management handbook for east Texas (revised). Bulletin No. 34, Texas Parks and Wildlife Department, Austin.
- Liu, X. 1995. Survival, movements, and habitat selection of relocated and resident northern bobwhite in east Texas. Dissertation, Stephen F. Austin State University, Nacogdoches, Texas.
- Liu, X., R. M. Whiting, Jr., B. S. Mueller, D. S. Parsons, and D. R. Dietz. 1996. Habitat preferences of relocated and resident northern bobwhite in east Texas. Proceedings of the Annual Conference of the Southeastern Association of Fish and Wildlife Agencies 50:632–643.
- Liu, X., R. M. Whiting, Jr., B. S. Mueller, D. S. Parsons, and D. R. Dietz. 2000. Survival and causes of mortality of relocated and resident northern bobwhites in east Texas. Proceedings of the National Quail Symposium 4:119–124.
- Nedbal, M. A., R. H. Honeycutt, S. G. Evans, R. M. Whiting, Jr., and D. R. Dietz. 1997. Northern bobwhite restocking in east Texas: a genetic assessment. Journal of Wildlife Management 61:854–863.
- Parsons, D. S., R. M. Whiting, Jr., X. Liu, and D. R. Dietz. 2000a. Food plot use by juvenile northern bobwhites in east Texas. Proceedings of the National Quail Symposium 4:71–74.
- Parsons, D. S., R. M. Whiting, Jr., X. Liu, B. S. Mueller, and S. L. Cook. 2000b. Reproduction of relocated and resident northern bobwhites in east Texas. Proceedings of the National Quail Symposium 4:132–136.
- Rosene, W., Jr. 1969. The bobwhite quail: its life and management. Rutgers University Press, New Brunswick, New Jersey.
- SAS Institute. 1988. SAS/STAT user's guide, release 6.03 edition. SAS Institute, Inc., Cary, North Carolina.

BREEDING SEASON MOVEMENTS AND DISPERSAL OF NORTHERN BOBWHITES IN FRAGMENTED HABITATS OF VIRGINIA

Michael L. Fies

Virginia Department of Game and Inland Fisheries, P.O. Box 996, Verona, VA 24482, USA

K. Marc Puckett

Virginia Department of Game and Inland Fisheries, HC6, Box 46, Farmville, VA 23901, USA

Bonnie Larson-Brogdon

Virginia Department of Game and Inland Fisheries, P.O. Box 996, Verona, VA 24482, USA

ABSTRACT

To better understand dispersal patterns of northern bobwhites (*Colinus virginianus*) in fragmented habitats, we measured breeding season movements of 198 radiomarked bobwhites in central and eastern Virginia during 1994–1996. Mean distance between arithmetic centers of winter (1 Feb–15 Apr) and early breeding season (16 Apr–30 Jun) activity areas was $1,194 \pm 137$ m. Distance between centers of winter and late breeding season (1 Jul–15 Sep) activity areas averaged $1,644 \pm 209$ m and was greater for juveniles than adults ($P = 0.04$). Maximum distances moved between winter and breeding season locations (early, late, and combined) was also greater for juveniles than adults ($P \leq 0.05$). Forty-nine of 198 (25%) bobwhites dispersed more than 2 km. A greater proportion of juveniles (28%) than adults (10%) dispersed >2 km. Juvenile males were more likely to disperse than any other sex/age group ($P = 0.02$). Adult males were least likely to disperse ($P < 0.01$). We suggest that breeding season movements of bobwhites may be greater in fragmented landscapes than in areas with large blocks of suitable habitat. We recommend that researchers utilize dispersal information to help define the spatial distribution of habitat patches necessary to perpetuate bobwhite populations at a regional level.

Citation: Fies, M. L., K. M. Puckett, and B. Larson-Brogdon. 2002. Breeding season movements and dispersal of northern bobwhites in fragmented habitats of Virginia. Pages 173–179 in S. J. DeMaso, W. P. Kuvlesky, Jr., F. Hernández, and M. E. Berger, eds. Quail V: Proceedings of the Fifth National Quail Symposium. Texas Parks and Wildlife Department, Austin, TX.

Key words: breeding season, *Colinus virginianus*, dispersal, habitat fragmentation, metapopulations, movements, northern bobwhite, Virginia

INTRODUCTION

Knowledge of dispersal and movement patterns is essential for understanding the population dynamics of wildlife species, particularly those associated with fragmented habitats. Unfortunately, empirical data needed to characterize dispersal patterns are usually lacking (Walters 2000). In fragmented landscapes, immigration from productive populations is necessary to ensure the persistence of declining populations. Martin et al. (2000) describes this process as “dispersal rescue,” whereby populations that experience poor reproduction or high mortality can escape extinction by immigration of other individuals from within the metapopulation system. The metapopulation persists if the recolonization rate of individual patches exceeds their rate of extinction (McCullough 1996:2).

Metapopulation theory appears relevant to northern bobwhite populations, since bobwhites are one of the least mobile gallinaceous species (Leopold 1933:77) and frequently occupy fragmented landscapes. However, efforts to develop a spatially explicit metapopulation model have been hampered by a lack of information on northern bobwhite dispersal patterns

and colonization rates. While some studies suggest that bobwhites are sedentary (Stoddard 1931:182, Errington 1933, Smith et al. 1982), others show them to be capable of travelling significant distances (Duck 1943, Kabat and Thompson 1963, Lehmann 1984:119). Even in these studies, however, documented movements >1.6 km were uncommon.

Prior to widespread use of radiotelemetry, estimates of northern bobwhite dispersal distances were likely biased because they were based on relocations of banded birds. Bobwhites dispersing the farthest distances, particularly those leaving defined study areas, were least likely to be detected, resulting in conservative estimates (Koenig et al. 1996). Even recent telemetry studies frequently do not provide reliable dispersal information, because birds leaving the study area are often censored from analyses. Also, many telemetry studies have been on areas intensively managed for bobwhites, where inter-patch connectivity is high and dispersal distances are likely lower than in unmanaged landscapes (Urban 1972). In our study, we measured breeding season movements and dispersal of northern bobwhites in fragmented habitats of Virginia without study area boundary constraints.

METHODS

Study Area

We conducted our study in fragmented agricultural landscapes of Amelia and James City counties, Virginia. Amelia County is located approximately 40 km southwest of Richmond in the Piedmont region of southcentral Virginia; James City County is located in the Coastal Plain region of southeastern Virginia, near Williamsburg. Both study areas were 10–15% cropland and 60–75% woodland. Common crops were corn, soybeans, wheat, and alfalfa. Pastureland was more abundant in Amelia County, consisting primarily of grazed or hayed fields of tall fescue (*Festuca arundinacea*). Woodland habitats in both counties were usually mixtures of mature hardwoods (*Quercus* spp., *Liriodendron tulipifera*, *Acer* spp.) and pine (*Pinus taeda*, *P. virginiana*). Cutovers of recently planted loblolly pine were distributed throughout both study areas. Although we never measured the level of habitat fragmentation on our study areas, northern bobwhites typically occupied small patches of suitable cover within a matrix of mostly unsuitable habitat types. For this reason, we considered the habitat on both study areas to be fragmented.

Field Procedures

We captured northern bobwhites from February through April during 1994 to 1996 in modified funnel entrance cage traps (Stoddard 1931: 442–445) baited with cracked corn. All captured bobwhites were aged, sexed, weighed, and leg-banded. Each bird was equipped with a necklace radio transmitter (Advanced Telemetry Systems Inc., Isanti, MN and American Wildlife Enterprises, Monticello, FL) that weighed about 6 g and contained a 12-hour mortality sensor. Bobwhites trapped in the morning were released within 4 hours at their capture site; birds trapped in the late afternoon were held overnight and released the next morning.

We monitored radiomarked bobwhites daily to determine survival. If radio contact was lost for more than 2 days, we used vehicles to systematically search the area within approximately 5 km of the bird's last known location. When vehicle searches failed, we used fixed-wing aircraft to search an area at least 20 km from the last known coordinates.

Beginning 1 May through 15 September, we attempted to locate each bird once/week by flushing or closely approaching them (<50 m). Prior to that time (1 Feb to 30 Apr), the precise location of each bird was determined only periodically, as time permitted. These locations were plotted on aerial photos or recorded using a global positioning system (GPS) unit. Locations collected with GPS units were differentially corrected to remove selective availability error and believed to be within 35 m of their true geographic position 95% of the time (Dussault et al. 2001). All locations were later entered into a computerized geographic information system using ArcView® software

(Environmental Systems Research Institute, Inc., Redlands, California).

Data Analysis

We analyzed northern bobwhite movement patterns by measuring the distance (m) between arithmetic centers of seasonal activity areas defined by clusters of locations within selected time intervals. We chose the arithmetic center (versus the center of a harmonic mean or kernel home range) because it was simple to calculate, could be estimated from fewer data points, and has been used by others to measure the distance between seasonal point clusters (Garrott et al. 1987). We also measured the maximum distance (m) between points within and among these clusters. The animal movement extension (Hooge and Eichenlaub 1997) designed for ArcView® was used to perform these calculations.

Seasons were defined as winter (1 Feb to 15 Apr), early breeding season (16 Apr to 30 Jun), and late breeding season (1 Jul to 15 Sep). Since coveys were beginning to break up in early April, bobwhites trapped between 1 April and 15 April were excluded from analysis unless they were trapped with 2 or more other birds. Birds that died prior to 1 May were also excluded. Breeding seasons were separated into early and late periods coinciding with peak hatch periods known to occur in Virginia during June and July (Fies, unpublished data). Mortality locations were excluded from analysis, since predators may have transported carcasses from their original kill sites.

Most studies suggest that movements within a bobwhite's winter range rarely exceed 1 km (Lehmann 1946, Murphy and Basket 1952, Lewis 1954, Agee 1957). We classified a bird as a disperser if the maximum straight-line distance between any single winter and breeding season location was greater than 2 km, twice the maximum winter home range diameter (Townsend et al. 2001). Bobwhites that never moved more than 2 km from any winter location were classified as non-dispersers.

We tested for differences among mean seasonal movement distances using analysis of variance (PROC GLM; SAS Institute 1989) with sex and age as the main effects. We used Chi-square procedures to test for overall differences between proportions of bobwhites that dispersed by sex and age class. A Z-test was used to compare proportions of bobwhites that dispersed by combined sex and age classes.

RESULTS

We placed radio transmitters on 424 northern bobwhites captured on 30 farms during 1994–1996. Of these, 198 bobwhites provided data that could be included in the analyses (captured before 15 Apr and survived past 1 May). During the study period, the area in which we monitored bobwhites was approximately 520 km² in Amelia County and 300 km² in James City County.

MOVEMENT AND DISPERSAL OF BOBWHITES

Table 1. Mean distance (m) between arithmetic centers of seasonal activity areas of radiomarked northern bobwhites monitored in Amelia and James City counties, Virginia, 1994–1996.

Sex	Age	Winter ^a –Early Breeding Season ^b			Winter–Late Breeding Season ^c			Winter–Combined Breeding Season ^d			Early–Late Breeding Season		
		<i>n</i>	\bar{x}	SE	<i>n</i>	\bar{x}	SE	<i>n</i>	\bar{x}	SE	<i>n</i>	\bar{x}	SE
Female	Juvenile	71	1015	195	50	1898	402	42	1234	310	42	674	146
	Adult	13	794	238	8	744	335	8	729	287	8	582	218
	Pooled	84	981	169	58	1739	353	50	1153	265	50	659	127
Male	Juvenile	78	1645	267	51	1816	322	49	1747	337	49	449	66
	Adult	26	526	98	18	854	176	18	685	141	18	489	90
	Pooled	104	1365	207	69	1565	247	67	1462	255	67	460	54
Pooled	Juvenile	149	1345	169	101	1857	256	91	1510	231	91	553	77
	Adult	39	615	103	26	820	156	26	699	129	26	517	90
	Pooled	188	1194	137	127	1644	209	117	1330	185	117	545	63

^a 1 Feb–15 Apr^b 16 Apr–30 Jun^c 1 Jul–15 Sep^d 16 Apr–15 Sep

Movement Distance

Distance between centers of seasonal activity areas.—Mean distance between the arithmetic centers of winter and early breeding season (WEB) activity areas was $1,194 \pm 137$ m (range 30–11,988 m) (Table 1). Mean WEB did not differ significantly ($F_{1,181} = 0.42$, $P = 0.515$) between males ($1,365 \pm 207$ m) and females (981 ± 169 m). Mean WEB appeared to be higher for juveniles ($1,345 \pm 169$ m) than adults (615 ± 103 m), but this difference was not significant ($F_{1,181} = 3.49$, $P = 0.063$) at the $P \leq 0.05$ level.

Bobwhites appeared to move farther from their winter activity areas as the breeding season progressed. Distance between the centers of winter and late breeding season (WLB) activity areas averaged $1,644 \pm 209$ m (range 39–13,532 m). Mean WLB did not differ by sex ($F_{1,120} = 0.34$, $P = 0.559$), but was significantly higher ($F_{1,120} = 4.29$, $P = 0.041$) for juvenile ($1,857 \pm 256$ m) than adult (820 ± 156 m) bobwhites. Distance between centers of the early and late breeding season activity areas averaged 545 ± 63 m (range 7–4,247 m) and did not differ by sex ($F_{1,110} = 0.35$, $P = 0.556$) or age ($F_{1,110} = 0.21$, $P = 0.651$).

Of the birds with locations in both the early and

late breeding seasons ($n = 117$), the mean distance between the centers of winter and combined breeding season activity areas (WCB) was $1,330 \pm 185$ m (range 43–11,718 m). We found no difference in mean WCB between sexes ($F_{1,110} = 0.98$, $P = 0.324$). Mean WCB appeared to be greater for juvenile bobwhites ($1,510 \pm 231$ m) than adults (699 ± 129 m). This difference approached statistical significance ($F_{1,110} = 3.33$, $P = 0.071$), but was not different at the $P \leq 0.05$ level.

Maximum movement distances.—The maximum distance that bobwhites moved between winter and early breeding seasons (MWEB) averaged $1,528 \pm 141$ m (range 39–12,054 m) (Table 2). Mean MWEB did not differ by sex ($F_{1,181} = 0.48$, $P = 0.488$), but was greater ($F_{1,181} = 3.85$, $P = 0.051$) for juvenile birds ($1,684 \pm 174$ m) than adults (929 ± 109 m). Mean maximum distance between winter and late breeding season (MWLB) locations was $1,842 \pm 210$ m (range 72–13,540 m). Mean MWLB was similar ($F_{1,120} = 0.35$, $F = 0.553$) for males ($1,753 \pm 249$ m) and females ($1,948 \pm 353$ m), but was greater ($F_{1,120} = 4.95$, $P = 0.028$) for juveniles ($2,070 \pm 256$ m) than adults (958 ± 155 m). The maximum distance

Table 2. Mean maximum distance (m) between seasonal locations of radiomarked northern bobwhites monitored in Amelia and James City counties, Virginia, 1994–1996.

Sex	Age	Winter ^a –Early Breeding Season ^b			Winter–Late Breeding Season ^c			Winter–Combined Breeding Season ^d			Early–Late Breeding Season		
		<i>n</i>	\bar{x}	SE	<i>n</i>	\bar{x}	SE	<i>n</i>	\bar{x}	SE	<i>n</i>	\bar{x}	SE
Female	Juvenile	71	1393	216	50	2116	402	42	1844	353	42	1286	218
	Adult	13	1055	220	8	900	326	8	1025	310	8	983	257
	Pooled	84	1341	186	58	1948	353	50	1713	303	50	1238	187
Male	Juvenile	78	1949	266	51	2025	323	49	2218	339	49	1091	128
	Adult	26	865	123	18	984	177	18	1164	167	18	1004	141
	Pooled	104	1678	206	69	1753	249	67	1935	257	67	1068	100
Pooled	Juvenile	149	1684	174	101	2070	256	91	2046	244	91	1181	121
	Adult	39	928	109	26	958	155	26	1121	147	26	998	123
	Pooled	188	1528	141	127	1842	210	117	1840	196	117	1141	98

^a 1 Feb–15 Apr^b 16 Apr–30 Jun^c 1 Jul–15 Sep^d 16 Apr–15 Sep

Table 3. Mean maximum distance (m) between locations within breeding seasons for radiomarked northern bobwhites monitored in Amelia and James City counties, Virginia, 1994–1996.

Sex	Age	Early Breeding Season ^a			Late Breeding Season ^b			Combined Breeding Season ^c		
		<i>n</i>	\bar{x}	SE	<i>n</i>	\bar{x}	SE	<i>n</i>	\bar{x}	SE
Female	Juvenile	61	924	137	41	674	151	42	1321	216
	Adult	11	621	171	7	323	72	8	1000	266
	Pooled	72	878	120	48	623	131	50	1269	187
Male	Juvenile	65	797	89	44	552	66	49	1146	129
	Adult	24	778	119	13	461	62	18	1047	144
	Pooled	89	792	72	57	531	53	67	1119	101
Pooled	Juvenile	126	859	81	85	611	80	91	1226	121
	Adult	35	729	97	20	413	49	26	1032	126
	Pooled	161	830	67	105	573	66	117	1183	98

^a 16 Apr–30 Jun^b 1 Jul–15 Sep^c 16 Apr–15 Sep

between winter and combined breeding season locations (MWCB) averaged $1,840 \pm 196$ m (range 43–11,718 m). Mean MWCB of male ($1,935 \pm 257$ m) and female ($1,713 \pm 303$ m) bobwhites did not differ ($F_{1,110} = 1.16$, $P = 0.283$), but was greater ($F_{1,110} = 4.78$, $P = 0.031$) for juveniles ($2,046 \pm 244$ m) than adults ($1,121 \pm 147$ m).

Maximum movement distances were generally greater between than within breeding seasons. The maximum distance between early and late breeding season locations (MEBLB) averaged $1,141 \pm 98$ m (range 81–6,584 m) and did not differ by sex ($F_{1,110} = 0.03$, $P = 0.860$) or age ($F_{1,110} = 1.69$, $P = 0.196$). In contrast, the maximum distance between locations within the early breeding season (MEB) was 830 ± 67 m (range 58–5,155 m) (Table 3). Mean MEB also did not differ by sex ($F_{1,154} = 0.19$, $P = 0.662$) or age ($F_{1,154} = 1.78$, $P = 0.184$). Mean maximum distance between late breeding season (MLB) locations was 573.0 ± 66 m (range 19–6,092 m). We observed no significant difference in mean MLB distance between males and females ($F_{1,98} = 0.08$, $P = 0.782$), or juveniles and adults ($F_{1,98} = 1.87$, $P = 0.175$). Maximum distance between locations during the combined breeding season averaged $1,183 \pm 98$ m (range 81–6,583 m),

and also did not differ by sex ($F_{1,110} = 0.08$, $P = 0.776$) or age ($F_{1,110} = 1.93$, $P = 0.167$).

Dispersal

Forty-nine of 198 (24.7%) bobwhites were classified as dispersers (maximum distance between winter and breeding season locations greater than 2 km) (Table 4). We observed no difference ($\chi^2 = 0.64$, 1 df, $P = 0.800$) in the proportion of dispersing male (25.5%) and female (23.9%) bobwhites. However, juvenile birds were almost 3 times more likely to disperse than adult birds ($\chi^2 = 5.48$, 1 df, $P = 0.019$). Forty-five of 159 (28.3%) juvenile bobwhites dispersed, compared to only 4 of 39 (10.3%) adults.

The proportion of bobwhites dispersing varied by combination of sex and age ($\chi^2 = 8.72$, 3 df, $P = 0.033$). More juvenile males dispersed (32.5%) than any other sex/age group ($Z = 2.08$, $P = 0.019$). In contrast, only 1 of 26 (3.9%) adult male bobwhites dispersed. Adult males were significantly less likely to disperse than other sex/age group ($Z = 2.65$, $P = 0.004$). There was no difference in the proportion of juvenile and adult females that dispersed ($Z = 0.076$, $P = 0.470$).

DISCUSSION

Spring dispersal is likely an innate behavioral characteristic that enables bobwhites to expand and replenish their range by colonizing newly created or depleted habitats (Howard 1960). Immigration of individuals from productive populations into areas with declining populations is vital for metapopulation stability, particularly in fragmented landscapes. The relative sensitivity of some avian species, including bobwhites, to habitat fragmentation is very likely dependent upon their propensity to disperse (Walters 1998). Innate dispersal also promotes gene flow between populations and reduces inbreeding.

Unfortunately, accurate estimates of bobwhite dispersal distance are lacking in the current literature. As Lehmann (1946) acknowledged, most early bobwhite movement studies were measures of the “travels of

Table 4. Proportion of radiomarked northern bobwhites with a maximum distance between winter (1 Feb–15 Apr) and breeding season (16 Apr–15 Sep) locations <2 km (non-dispersers) or ≥ 2 km (dispersers) in Amelia and James City counties, Virginia, 1994–1996.

Sex	Age	<i>n</i>	Maximum Distance Moved			
			<2 km		≥ 2 km	
			%	SE	%	SE
Female	Juvenile	79	76.0	4.8	24.0	4.8
	Adult	13	76.9	12.2	23.1	12.2
	Pooled	92	76.1	4.5	23.9	4.5
Male	Juvenile	80	67.5	5.3	32.5	5.3
	Adult	26	96.1	3.9	3.9	3.9
	Pooled	106	74.5	4.3	25.5	4.3
Pooled	Juvenile	159	71.7	3.6	28.3	3.6
	Adult	39	89.7	4.9	10.3	4.9
	Pooled	198	75.3	3.1	24.7	3.1

sedentary birds," because the probability of detecting long distance movements was low. For example, Murphy and Baskett (1952) reported that 93% of Missouri bobwhites dispersed <1.2 km from their winter range during the spring. Several years later, Lewis (1954) found that 88% of banded quail dispersed <1.2 km on the same study area. In both of these studies, however, recovery of banded birds that moved long distances was mostly accidental. As a result, the proportion of birds moving long distances was likely underestimated.

Although comparable data are lacking, northern bobwhites in our study dispersed greater distances than those reported by most other researchers. In Florida, the average distance between successive year captures of 710 bobwhites trapped during winter was only 228 m (Smith et al. 1982). Simpson (1976) reported similar annual movements for bobwhites in Georgia; 96% of banded birds were recaptured within 800 m of their previous year winter capture site. In both these studies, however, bobwhites were not trapped during the breeding season. Movements of banded birds that dispersed farther distances during the spring and summer, then moved back towards their original capture sites the following winter, would have been undetected. In a more comparable study conducted in North Carolina, mean distance between first capture site and first nest of radiomarked bobwhites was 340 m and 1,460 m on areas with and without field borders, respectively (Puckett et al. 1995). However, most bobwhites that dispersed off the study areas were censored from analyses, likely biasing overall dispersal distance estimates.

Several researchers reported dispersal distances greater than those we observed. In Wisconsin, the average distance moved by bobwhites from winter through mid-July was 2.1 km (Kabat and Thompson 1963), compared to 1.8 km during a similar time period in our study. Rosene (1969:99–100) hypothesized that bobwhites moved shorter distances in the southern portion of their range, presumably because satisfactory nesting cover was closer to winter ranges. Recent research in Oklahoma (Townsend et al. 2001), however, does not support this theory. In their study, 42% of radiomarked bobwhites moved more than 2 km from their winter capture sites during the breeding season. Although the authors did not report the average distance from winter to spring for all bobwhites monitored, we presume that this distance was greater than we observed, since only 25% of the birds in our study dispersed more than 2 km.

For most avian species, females are the predominant dispersers, choosing mates that have defended territories with the best resources (Clark et al. 1997). Female-biased dispersal has been reported for some gallinaceous species, including ruffed grouse (*Bonasa umbellus*) (Small and Rusch 1989). In our study, we found no evidence that female bobwhites dispersed longer distances than males. We also observed no difference in the proportion of male and female bobwhites dispersing more than 2 km. Contrary to the idea of female-biased dispersal, most researchers suggest

that male bobwhites move longer distances than females (Hood 1955, Loveless 1958, Kabat and Thompson 1963, Smith et al. 1982). Others report no difference in movements between sexes (Stoddard 1931: 176, Simpson 1976). Since bobwhites are polygamous (Curtis et al. 1993), generally non-territorial, and exhibit a highly flexible mating system (Burger et al. 1995), female-biased dispersal would likely offer little ecological advantage to this species.

Although data are lacking for bobwhites, juveniles of most avian species disperse greater distances than adults, possibly avoiding inbreeding (Howard 1960). This premise is consistent with our observation that juvenile bobwhites moved longer distances from their winter range and were more likely to disperse >2 km than adult birds. In particular, juvenile males were more likely to disperse than any other sex/age group. Smith et al. (1982) also reported that juveniles moved longer distances and were more likely to make extensive movements than adult bobwhites. In Illinois, the home range of unmated males (presumably subadults) was almost twice as large as mated males during the late spring and summer months (Urban 1972). Others have also suggested that the birds most likely to disperse unusually long distances are unmated males (Loveless 1958).

Our observation that adult males were less likely to disperse than other birds has not been previously reported in the literature. Most likely, adult males were able to find mates more successfully than juvenile males and did not find it necessary to disperse in search of a mate. Adult females may have been more likely to disperse than adult males as they searched for suitable nest sites, particularly after a failed incubation attempt. We observed several long distance movements by hens following nest failure; this phenomenon has also been documented by others (Urban 1972).

The maximum distance moved by an individual bobwhite in our study was 13.5 km (a juvenile female). Only 4 other birds (3 juvenile males, 1 juvenile female) moved more than 10 km. Other researchers have documented long distance movements of 6.4–8.0 km in Wisconsin (Kabat and Thompson 1963), 8.2 km in Indiana (Hoekstra and Kirkpatrick 1972), 11.3 km in Georgia (Stoddard 1931:176), and 15.3 km in Florida (Loveless 1958). Unusually long distance movements of 40 km (Townsend et al. 2001), 41.8 km (Davison, in Duck 1943), and 59.5 km (DeMaso et al. 1997) have been reported in Oklahoma, and 38.6 km (Jackson 1969:66), 104.6 km (Kiel 1976), and 164.1 km (Green 1966) in Texas. Such long distance movements, however, are generally considered to be rare dispersal events.

Results of this and several other studies suggest that bobwhites may disperse greater distances in fragmented habitats. Loveless (1958) and Smith et al. (1982) reported little mobility on areas managed specifically for quail, while Kabat and Thompson (1963) noted larger movements in landscapes consisting of mostly marginal habitat. It seems likely that bobwhite dispersal distance increases as inter-patch connectivity decreases.

We propose that northern bobwhite populations in the fragmented agricultural landscapes of Virginia fit many of the criteria of traditional metapopulation structure. Although not measured, we observed local extinction and subsequent recolonization of isolated patches in the areas we studied. While bobwhites are known to be capable of dispersing long distances, their probability of successfully locating a suitable habitat patch is almost certainly affected by the spatial distribution of these areas. Theoretically, bobwhites could have difficulty locating and subsequently colonizing a habitat patch if the distance between patches exceeds their normal dispersal distance (Weins 1996:59). If bobwhites are to persist in fragmented landscapes, managers must define the spatial characteristics of large areas and maintain suitable habitats within a yet-to-be-defined critical dispersal distance. Spatially explicit population models that incorporate measures of population performance (survival and reproductive success) and measures of dispersal distance and colonization rates are needed to further define these optimal landscape-level habitat characteristics.

Although site-specific management will remain an important component of future bobwhite recovery efforts, it seems clear that managers will need to address the problem of declining populations from a regional or landscape perspective. The viability of local bobwhite populations is affected not only by their own reproduction and survival characteristics, but also by interactions with neighboring populations. Public wildlife agencies with limited resources may need to prioritize their future site-level management efforts in areas where the overall landscape matrix is most suitable for bobwhites. Roseberry and Sudkamp (1998) and Schairer et al. (1999) have suggested using Landsat imagery and geographic information systems to identify these priority areas. Modern managers will need to incorporate traditional habitat management prescriptions with these emerging technologies (Roseberry 1993). Additional information regarding bobwhite dispersal behavior will be useful in improving our ability to make "real world" management decisions within a theoretical metapopulation context.

ACKNOWLEDGMENTS

We gratefully acknowledge the dedicated field assistance of wildlife technicians M. Barbour, A. Bell, R. Bondurant, D. Cervenak, D. Henneman, B. Johnson, V. Lester, K. Stigall, and S. Summers. Numerous Virginia Department of Game and Inland Fisheries personnel, including G. Askins, S. Capel, I. Kenyon, P. Keyser, P. Moore, E. Stinson, R. Turney, M. Walls, P. West, and others assisted with trapping and radio-telemetry fieldwork. We also appreciate the cooperation of many landowners who gave us permission to trap and monitor bobwhites on their farms. Primary funding was provided by the Virginia Department of Game and Inland Fisheries and the Federal Aid in Wildlife Restoration Program, Project WE-99-R. We are also very grateful for additional funds provided by several Virginia Chapters of Quail Unlimited.

LITERATURE CITED

- Agee, C. P. 1957. The fall shuffle in central Missouri bobwhites. *Journal of Wildlife Management* 21:329–335.
- Burger, L. W., Jr., M. R. Ryan, T. V. Dailey, and E. W. Kurzeski. 1995. Reproductive strategies, success, and mating systems of northern bobwhite in Mississippi. *Journal of Wildlife Management* 59:417–426.
- Clark, A. L., B. Saether, and E. Roskaft. 1997. Sex biases in avian dispersal: a reappraisal. *Oikos* 79:429–438.
- Curtis, P. D., B. S. Mueller, P. D. Doerr, C. F. Robinette, and T. DeVos. 1993. Potential polygamous breeding behavior in northern bobwhite. *Proceedings of the National Quail Symposium* 3:55–63.
- DeMaso, S. J., S. A. Cox, and S. E. Parry. 1997. The Packsaddle bobwhite mortality study: a final 5-year progress report. Unpublished report, Oklahoma Department of Wildlife Conservation, Oklahoma City.
- Duck, L. G. 1943. Seasonal movements of bobwhite quail in northwestern Oklahoma. *Journal of Wildlife Management* 7:365–368.
- Dussault, C., R. Courtois, J. Ouellet, and J. Huot. 2001. Influence of satellite geometry and differential correction on GPS location accuracy. *Wildlife Society Bulletin* 29:171–179.
- Errington, P. L. 1933. Mobility of the northern bobwhite as indicated by banding returns. *Bird Banding* 4:1–8.
- Garrott, R. A., G. C. White, R. M. Bartmann, L. H. Carpenter, and A. W. Alldredge. 1987. Movements of female mule deer in northwest Colorado. *Journal of Wildlife Management* 51:634–643.
- Green, H. 1966. Dynamics of bobwhite quail in the west Texas rolling plains: population turnover. Progress Report, Project W-88-R-5. Texas Parks and Wildlife Department, Austin.
- Hoekstra, T. W., and C. M. Kirkpatrick. 1972. The bobwhite quail of Crane Naval Ammunition Depot, Indiana—25 years of protection and plant succession. *Proceedings of the National Quail Symposium* 1:184–194.
- Hood, M. R. 1955. Mississippi quail investigation. *Proceedings of the Southeastern Association of Game and Fish Commissioners* 9:157–163.
- Hooge, P. N., and B. Eichenlaub. 1997. Animal movement extension to ArcView. Version 1.1. Alaska Biological Science Center, United States Geological Survey, Anchorage.
- Howard, W. E. 1960. Innate and environmental dispersal of individual vertebrates. *American Midland Naturalist* 63:152–161.
- Jackson, A. S. 1969. Quail management handbook for west Texas rolling plains. Texas Parks and Wildlife Department Bulletin 48, Austin.
- Kabat, C. and D. R. Thompson. 1963. Wisconsin quail, 1834–1962, population dynamics and habitat management. Wisconsin Conservation Department Technical Bulletin 30, Madison.
- Kiel, W. H. 1976. Bobwhite quail population characteristics and management implications in south Texas. *Transactions of the North American Wildlife Conference* 41:407–420.
- Koenig, W. D., D. Van Vuren, and P. N. Hooge. 1996. Detectability, philopatry and the distribution of dispersal distances in vertebrates. *Trends in Ecology and Evolution* 11:514–517.
- Lehmann, V. W. 1946. Mobility of bobwhite quail in southwestern Texas. *Journal of Wildlife Management* 10:124–137.
- Lehmann, V. W. 1984. Bobwhites in the Rio Grande Plain of Texas. Texas A&M University Press, College Station.
- Leopold, A. 1933. Game management. Charles Scribner's Sons, New York, New York.
- Lewis, J. B. 1954. Further studies of bobwhite mobility in central Missouri. *Journal of Wildlife Management* 18:414–416.
- Loveless, C. M. 1958. The mobility and composition of bobwhite quail populations in south Florida. *Florida Game and*

MOVEMENT AND DISPERSAL OF BOBWHITES

179

- Fresh Water Fish Commission Technical Bulletin 4, Tallahassee.
- Martin, K., P. B. Stacey, and C. E. Braun. 2000. Recruitment, dispersal, and demographic rescue in spatially-structured white-tailed ptarmigan populations. *Condor* 102:503–516.
- McCullough, D. R. 1996. Introduction. Pages 1–10 in D. R. McCullough, ed. *Metapopulations and wildlife conservation*. Island Press, Washington, D. C.
- Murphy, D. A., and T. S. Baskett. 1952. Bobwhite mobility in central Missouri. *Journal of Wildlife Management* 16:498–510.
- Puckett, K. M., W. E. Palmer, P. T. Bromley, J. R. Anderson, Jr., and T. L. Sharpe. 1995. Bobwhite nesting ecology and modern agriculture: a management experiment. *Proceedings of the Annual Conference of the Southeastern Association of Fish and Wildlife Agencies* 49:505–515.
- Roseberry, J. L. 1993. Bobwhite and the “new” biology. *Proceedings of the National Quail Symposium* 3:16–20.
- Roseberry, J. L., and S. D. Sudkamp. 1998. Assessing the suitability of landscapes for northern bobwhite. *Journal of Wildlife Management* 62: 895–902.
- Rosene, W. 1969. *The bobwhite quail, its life and management*. Rutgers University Press, New Brunswick, New Jersey.
- SAS Institute, Inc. 1989. *SAS/STAT® User’s Guide*, Version 6, Fourth Edition, Volume 2, Cary, North Carolina.
- Schairer, G. L., R. H. Wynne, M. L. Fies, and S. D. Klopfer. 1999. Predicting landscape quality from classified Landsat imagery. *Proceedings of the Annual Conference of the Southeastern Association of Fish and Wildlife Agencies* 53: 243–256.
- Simpson, R. C. 1976. Certain aspects of the bobwhite quail’s life history and population dynamics in southwest Georgia. Georgia Department of Natural Resources Technical Bulletin WL1, Atlanta.
- Small, R. J., and D. H. Rusch. 1989. The natal dispersal of ruffed grouse. *Auk* 106:72–79.
- Smith, G. F., F. E. Kellogg, D. L. Doster, and E. E. Provost. 1982. A 10-year study of bobwhite quail movement patterns. *Proceedings of the National Quail Symposium* 2:35–44.
- Stoddard, H. L. 1931. *The bobwhite quail: its habits, preservation and increase*. Charles Scribner’s Sons, New York, New York.
- Townsend, D. E., Jr., R. L. Lochmiller, D. M. Leslie, Jr., S. J. DeMaso, S. A. Cox, and A. D. Peoples. 2001. Fitness costs and benefits associated with long distance dispersal in northern bobwhites (*Colinus virginianus*). Unpublished manuscript, Oklahoma State University, Stillwater.
- Urban, D. 1972. Aspects of bobwhite quail mobility during spring through fall months. *Proceedings of the National Quail Symposium* 1:194–199.
- Walters, J. R. 1998. The ecological basis of avian sensitivity to habitat fragmentation. Pages 181–192 in J. M. Marzluff and R. Sallabanks, eds. *Avian conservation*. Island Press, Washington, D.C.
- Walters, J. R. 2000. Dispersal behavior: an ornithological frontier. *Condor* 102:479–481.
- Weins, J. A. 1996. Wildlife in patchy environments: metapopulations, mosaics, and management. Pages 53–84 in D. R. McCullough, ed. *Metapopulations and wildlife conservation*. Island Press, Washington, D.C.

HABITAT SELECTION OF NORTHERN BOBWHITE IN THE RIO GRANDE PLAINS OF TEXAS

William P. Kuvlesky, Jr.¹

Department of Wildlife and Fisheries Sciences, Texas A&M University, College Station, TX 77843-2258, USA

Wendell G. Swank²

Department of Wildlife and Fisheries Sciences, Texas A&M University, College Station, TX 77843-2258, USA

Nova J. Silvy

Department of Wildlife and Fisheries Sciences, Texas A&M University, College Station, TX 77843-2258, USA

ABSTRACT

From June 1987 through September 1988, we determined habitat selection by northern bobwhites (*Colinus virginianus*) in the Rio Grande Plains of south Texas. Habitat components were evaluated at a large scale (100-m circular plots) and fine scale (8-m circular plots) levels of resolution at radiomarked bobwhite locations and at random sites. Data was collected during summer 1987, fall-winter 1987–88, and spring-early summer 1988. On both scales of resolution, during each season, bobwhites were found in more patchier areas than were available. Distance to roads was the only important large scale habitat variable identified. Forbs appeared to be the most important fine scale habitat variable. Grass, shrubs, and bare ground were also identified as important habitat variables. Important fine-scale and large-scale habitat variables were not correlated with one another. Therefore, it is important to examine habitat variables at different scales when studying habitat use by northern bobwhites.

Citation: Kuvlesky, W. P., Jr., W. G. Swank, and N. J. Silvy. 2002. Habitat selection of northern bobwhite in the Rio Grande Plains of Texas. Pages 180–189 in S. J. DeMaso, W. P. Kuvlesky, Jr., F. Hernández, and M. E. Berger, eds. Quail V: The Fifth National Quail Symposium. Texas Parks and Wildlife Department, Austin, TX.

Key words: northern bobwhite, *Colinus virginianus*, habitat, habitat interspersions, scale, Texas

INTRODUCTION

Northern bobwhites are an important natural resource in the Rio Grande Plains of Texas (Lehmann 1984:5), and numerous landowners are interested in optimizing the economic return on quail hunting (Guthery 1986: 212). Understanding the specific habitat requirements of bobwhites, and how various brush management techniques and grazing systems affect vegetative succession, bobwhite habitat selection and population dynamics are important in implementing a successful bobwhite management plan.

Habitat variables such as nesting and brooding cover (native bunchgrasses), thermal cover (shrubs) and food (forbs and mast) are important to bobwhites (Stoddard 1931:132, Rosene 1969:165, Lehmann 1984:212, Guthery 1986:78, and Wilkins 1987). Reid (1977) and Reid et al. (1979) found a relationship between northern bobwhite abundance and habitat interspersions on a large scale of resolution. Often overlooked, however, is the interspersions of habitat variables at a finer scale of resolution. For example, Beecher (1942:40) noted that abundance of forbs in a meadow together with grass, and sedges must be con-

sidered an interspersions of habitat types. Since northern bobwhites are terrestrial and have low mobility, the interspersions of fine scale habitat variables would be important to northern bobwhites.

The primary objective of our study was to determine which large scale and fine scale habitat variables were important to bobwhites. A second objective was to determine if there was a relationship between large scale and fine scale habitat variables selected by northern bobwhites. We consider the results of this study a preliminary analysis of spatial data collected for the senior author's Ph.D. dissertation. Many of the spatial analysis techniques currently used to quantify the spatial relationships of habitat variables on large and fine scales of resolution did not exist when the analyses was conducted for these data over a decade ago. Consequently, we anticipate applying some of the new spatial statistical techniques to the data to better quantify the preliminary results reported in this paper.

METHODS

Study Area

The study was conducted from May 1987–September 1988 at the La Copita Research Area, a 1,093-ha ranch, owned and operated by the Texas Cooperative Extension Service, in Jim Wells County, Texas. The ranch is located between the South Texas Plains

¹ Present address: Caesar Kleberg Wildlife Research Institute, Texas A&M University-Kingsville, Kingsville, TX 78363

² Present address: 2326 South Quail Road, Cottonwood, AZ 86326-7015

and Gulf Prairies and Marshes ecological regions (Gould 1975).

The climate at La Copita is subtropical with a mean annual temperature of 22.2° C and a growing season of about 300 days/year (Loomis 1989). Mean annual precipitation was 71.5 cm (Loomis 1989), and was bimodally distributed with peaks occurring during April–June and August–September. Predominant up-land range sites were sandy loams and gray sandy loams, while drainages were primarily claypan prairie and clay loam range sites (Walsh 1985).

Walsh (1985) classified the overall vegetation type at La Copita as Tamaulipan thorn-scrub woodland and Scanlan (1988) described the landscape as consisting of shrub clusters dispersed with grassy interstitial areas. The dominant woody species was mesquite (*Prosopis glandulosa*). Dominant herbaceous species were panicums (*Panicum* spp.), tridens (*Tridens* spp.), grama grasses (*Bouteloua* spp.), Texas bristlegrass (*Setaria texana*) and orange zexmenia (*Zexmenia hispida*) (Scanlan 1988).

Procedures

The study was not replicated on other property in the surrounding area nor were replicates established on La Copita. The research should therefore be considered a descriptive study of bobwhite habitat use on a large and fine scale of resolution.

Radio Telemetry

Telemetry was used to determine areas used by northern bobwhites in the field. Bobwhites were captured with funnel traps (Stoddard 1931:443) baited with grain sorghum at permanent trap locations, established at an approximate density of 1/9 ha (Wilkins 1987:12). All bobwhites captured were aged (Petrides and Nestler 1943), sexed, banded, and radiomarked with poncho transmitters. Trap location, date, and climatic conditions for each capture incident were recorded. An effort was made to maintain 10–12 bobwhites (equal sex ratio) fitted with transmitters at all times. Radiomarked birds were located once each day for 3 consecutive days. Monitoring sessions were conducted during mornings, afternoons, and evenings during the 3-day period to minimize temporal biases. Directional bearings were taken from permanently established stations and these data were entered into a computer program (D. Martin, unpublished manuscript) to calculate the geometric center of an error polygon, which represented a bobwhite's location (Mech 1983). Date, time, and climatological data were recorded for each telemetry location.

Landscape-scale Measurements

Large-scale measurements from randomly selected bobwhite telemetry locations were sampled during spring, summer and fall-winter seasons. Large-scale patch measurements were obtained from a 1987 aerial photo (2.5 cm: 230 m) of the research area (United States Department of Agriculture, Natural Resource

Conservation Service). To qualify for sampling, a location had to have an error polygon <0.5 ha (Wilkins 1987). The geometric centers of the error polygons representing bobwhite locations were plotted on the photo and served as the mid-point of an imaginary circle. Patch measurements were then estimated along 4 sampling transects extending 100-m in cardinal directions originating from the mid-point. For comparative purposes, a 1,000 × 1,000-m grid overlay was placed on the photo of the research area and 25 random points (center of grid) were located. Patches at random points were measured in a manner identical to bobwhite locations.

From the aerial photo, patch types were classified as brushy areas, openings, or roads. The patch encompassing the mid-point of the circle was designated as the origin patch from which patch measurements for each sampling transect began. The length of each consecutive discrete patch type starting with the length of the origin patch, was then measured along the entire length of each sampling transect (Fig. 1). However, because our objective was to quantify habitat interspersions we believed we needed information regarding the spatial relationships of discrete patch types. Consequently, in addition to measuring the length of each patch type along a sampling line, we also noted the type of patch that immediately followed the origin patch, was defined as the boundary patch. The measured patch was then labeled according to its classification and the identity of its boundary patch (Fig. 1). For example, if a bobwhite or random point was located in an opening on the aerial photo, this opening would represent the first patch type to be linearly measured on the sampling line. The opening would be the origin patch. If the next consecutive patch that immediately followed the opening was a brushy patch, then it would be referred to as the boundary patch. The origin patch would then be labeled an opening-brush patch (OB) based on the classification of the patch measured (opening) and the identity of the boundary patch next encountered along the sampling line (brushy patch) (Fig. 1). The boundary patch (brushy patch) would then become the next patch measured until another boundary patch type, which might have been a road, ended the brushy patch. The second patch would then be labeled a brush-road patch (BR).

Six discrete large scale patch combinations could theoretically be measured (m) along a sampling transect; opening-brush (OB), opening-road (the width of a road) (OR), brush-opening (BO), brush-road (BR), road-opening (RO), and road-brush (RB) (Table 1). In addition to measuring the linear extent (m) of a patch and knowing the identity of its boundary patch, we believed that knowing the distance between patches of the same class, would help quantify patch interspersions. Therefore, we also calculated the nearest neighbor distance between patches of the same classification (Fig. 1). For example, we calculated the distance from an opening (OB patch) to the next nearest consecutive opening (OR) patch on the sampling transect. We started this process with the first opening patch (OB), and then repeated the process for every opening patch en-

Large Scale Habitat Variables

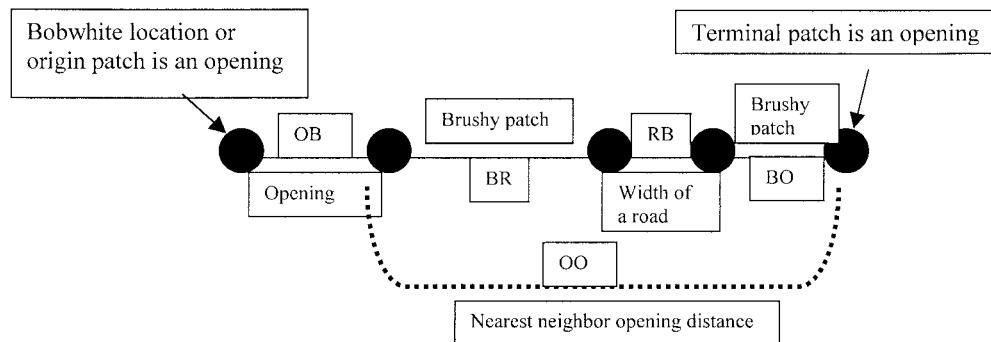

Fine Scale Habitat Variables

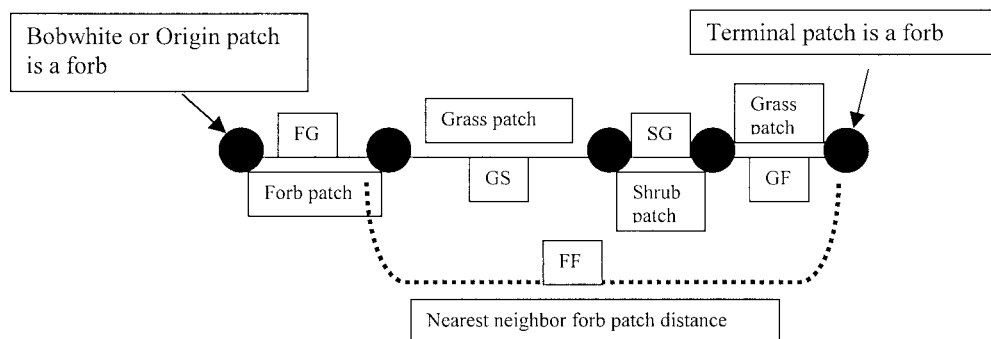

Fig. 1. Methodology used to label patches, measure length of patches and distance between a patch and the next consecutive patch of the same type along sampling line at the La Copita Research Area, 1987–88. (OB = opening ended by a brushy patch, BR = brushy patch ended by the width of a road, RB = road ended by a brushy patch, OO = distance from one opening to the nearest consecutive opening on sampling transect, FG = forb patch ended by a grass patch, GS = grass patch ended by a shrub patch, SG = shrub patch ended by a grass patch, GF = grass patch ended by a forb patch, FF = distance from one forb patch to the nearest consecutive forb patch on sampling transect).

countered along the sampling transect. Measurements were calculated for the distance between nearest neighbor open-open (OO), brush-brush (BB), and road-road (RR) patches.

Fine-scale Measurements

Fine scale measurements were also obtained from bobwhite telemetry sites located in the field. Locations were categorized as spring, summer, or fall-winter periods. Random points were chosen from a 100×100 -m grid of the research area. Each telemetry location or random point represented the geometric center of an error polygon or selected random grid, respectively. At each telemetry point, a circular area of about 0.2 ha was established. Fine scale cover type distances were estimated in 1-cm increments using a range pole

extended to 8 m (radius of a 0.2-ha circle) in the cardinal directions from the center of the plot.

Fine scale patch classes were forb, grass, shrub and bare ground. Patch classes were divided into 12 discrete patch type combinations following the same protocol described for the large scale patches (Fig. 1). Individual patch types measured were: bare ground-shrub (BS), bare ground-forb (BF), bare ground-grass (BG), shrub-bare ground (SB), shrub-forb (SF), shrub-grass (SG), forb-bare ground (FB), forb-shrub (FS), forb-grass (FG), grass-forb (GF), grass-shrub (GF), and grass-bare ground (GB) (Table 1). Telemetry and random points were located in the field, and an origin patch representing the telemetry or random location, was designated from which sampling transects were marked in the cardinal directions. Like the large scale

BOBWHITE HABITAT SELECTION

Table 1. Patch classification protocol for landscape-scale and fine-scale habitat variables from summer 1987–summer 1988, La Copita Research Area, Jim Wells County, Texas.

Patch classification	Boundary patch	Patch acronym
	Large-scale	
Opening	Brush patch	OB
Opening	Road*	OR
Opening**	Opening	OO
Brush patch	Opening	BO
Brush patch	Road	BR
Brush patch**	Brush patch	BB
Road	Opening	RO
Road	Brush patch	RB
Road**	Road	RR
	Fine-scale	
Forb	Grass	FG
Forb	Bare ground	BG
Forb	Shrub	FS
Forb**	Forb	FF
Bare ground	Shrub	BS
Bare ground	Forb	BF
Bare ground	Grass	BG
Bare ground**	Bare ground	BB
Shrub	Bare ground	SB
Shrub	Forb	SF
Shrub	Grass	SG
Shrub**	Shrub	SS
Grass	Forb	GF
Grass	Bare ground	GB
Grass	Shrub	GS
Grass**	Grass	GG

* Width of road is considered the patch.

** Distance from a patch class to the nearest consecutive identical patch class along sampling transect.

patches, fine scale patches were labeled based on the patch class (forb, grass, etc.) measured and the boundary patch, which represented a different patch class, that immediately proceeded it (Fig. 1). Therefore, if the origin patch was a forb and the next consecutive patch along the sampling transect was a grass patch, then the origin patch would be labeled a forb-grass (FG) patch. The length of the grass boundary patch was then measured to where the next different patch class (its boundary patch) terminated it, and this second patch was perhaps labeled a grass-bare ground patch (GB). This process was repeated until the end of the sampling transect was reached. Moreover, for all shrub patches measured on the sampling line, the height (cm) for the respective shrub were recorded.

We also calculated the nearest neighbor distance between patches of the same classification (Fig. 1). For example, we calculated the distance from a forb patch (FG) to the next nearest consecutive forb patch (FG, FB, FS) patch on the sampling transect. We started this process with the first forb patch, and then repeated the process for every forb patch encountered along the sampling transect. Measurements were calculated for the distance between nearest neighbor forb-forb (FF), grass-grass (GG), bare ground-bare ground (BB) and shrub-shrub (SS) patches.

Linear canopy coverage (cm) and shrub height (cm) were recorded for all woody species occurring in a plot that had at least a portion of the canopy covering

a line. In addition, percent coverage of forbs, grass, bare ground, and litter were determined for each plot, as were forb and grass heights (cm). The number of forb and grass species occurring within a plot were estimated providing an index of species diversity. A total of 28 fine scale habitat variables were measured.

Statistical Analyses

Large-scale data collected for individual habitat variables measured from transects radiating in the 4 cardinal directions from each point were pooled and considered 1 sample. For both telemetry locations and random points, all samples were summed and a mean was calculated on a seasonal basis for each variable. Telemetry and random variable means were subjected to a one-way analysis of variance to determine seasonal differences. Variables were considered significantly different at $P < 0.05$. The Student-Newman-Keuls multiple comparison procedure was used to isolate specific seasonal differences if ANOVA indicated that significant seasonal differences existed. Since cover percentages and herbaceous height and diversity were estimated for the entire plot and were not sampled, these components were excluded from the analysis of variance.

Chi-square analyses were used to determine if habitat variables at telemetry locations differed from random locations each season (Ott 1988:219). Mann-Whitney tests (Conover 1980) were used to determine differences in mean percentages of bare ground, forbs, grass, and litter between telemetry and random locations. Herbaceous diversity and height data did not represent number of patches and were excluded from Chi-square analysis. Data from bobwhite locations were considered “observed” values, while those from random points were considered “expected” values.

Fine-scale and large scale habitat variables that differed between telemetry and random locations were selected based on the seasonal consistency of their significance. Spearman rank-order-correlation coefficients were then calculated to determine the strength of the relationship between the fine-scale components (dependent variable) and the large scale components (independent variable).

RESULTS

Large-Scale

Analysis from the aerial photo revealed seasonal differences in the distance between habitat variables at telemetry sites (Table 2). Brush-opening patches were largest and distances between openings were longest during the first summer and then decreased from season to season thereafter. A similar pattern was evident for road-opening patches and distances between brush-brush patches, although the decreases were not significant from fall-winter 1987–88 to spring-early summer 1988.

The number of opening-brush and brush-opening patches were lowest during summer 1987, then in-

Table 2. Mean distance between patches (m) of landscape-scale habitat variables from summer 1987–summer 1988, La Copita Research Area, Jim Wells County, Texas.

Habitat variable Season	Telemetry locations		Random locations	
	\bar{x}	<i>n</i>	\bar{x}	<i>n</i>
Brush-brush				
Summer 1987	19.3 A ^a	44	12.8 A	23
Fall-winter 1987–88	14.7 B	55	10.8 A	28
Summer 1988	12.5 B	56	12.6 A	22
Brush-opening				
Summer 1987	9.3 A	44	5.4 A	23
Fall-winter 1987–88	7.6 B	55	5.3 A	28
Summer 1988	5.3 C	56	6.1 A	22
Brush-road				
Summer 1987	7.2 A	17	7.2 A	9
Fall-winter 1987–88	5.9 A	24	6.5 A	12
Summer 1988	7.0 A	29	10.1 A	11
Opening-opening				
Summer 1987	24.0 A	45	25.6 A	26
Fall-winter 1987–88	14.4 B	55	16.9 A	30
Summer 1988	11.9 C	56	20.2 A	24
Opening-brush				
Summer 1987	6.4 A	44	6.3 A	23
Fall-winter 1987–88	6.9 A	55	5.6 A	28
Summer 1988	6.2 A	56	6.2 A	22
Opening-road				
Summer 1987	5.8 A	22	7.5 A	8
Fall-winter 1987–88	7.1 A	25	5.7 A	9
Summer 1988	6.7 A	28	5.3 A	6
Road-road				
Summer 1987	41.9 A	37	56.2 A	13
Fall-winter 1987–88	50.0 A	40	48.1 A	17
Summer 1988	44.7 A	41	56.5 A	15
Road-brush				
Summer 1987	3.3 A	46	2.2 A	26
Fall-winter 1987–88	2.1 A	55	1.7 A	30
Summer 1988	2.1 A	56	4.3 A	24
Road-opening				
Summer 1987	20.5 A	22	16.7 A	6
Fall-winter 1987–88	5.9 ^b B	29	17.4 ^b A	12
Summer 1988	4.5 B	32	10.2 A	8

^a Means within a column sharing a letter are not significantly ($P > 0.05$) different.

^b Means within rows are significantly ($P < 0.05$) different.

creased each season throughout the study (Table 3). The number of opening-opening and brush-brush patches exhibited an identical pattern. The general pattern as the study progressed revealed patch sizes decreased, while the number of patches increased.

Fine Scale

Telemetry Locations.—At telemetry locations, the distance between habitat variables had significant seasonal differences (Table 4). Patch dimensions were larger for bare ground-shrub, bare ground-forb, bare ground-grass, forb-shrub, forb-grass, and grass-bare ground, patches during summer 1987 than in fall-winter 1987–88 and spring-early summer 1988. Grass-forb patches during summer 1987 were larger than fall-winter patches and these were larger than grass-forb patches in spring-early summer 1988. Similarly, summer

Table 3. Mean number of patches of landscape-scale habitat variables observed from summer 1987–summer 1988, La Copita Research Area, Jim Wells County, Texas.

Habitat variable Season	Telemetry locations		Random locations	
	\bar{x}	<i>n</i>	\bar{x}	<i>n</i>
Brush-brush				
Summer 1987	22.6 A ^a	46	27.9 A	26
Fall-winter 1987–88	27.0 B	55	33.5 A	30
Summer 1988	34.1 C	56	31.7 A	24
Brush-opening				
Summer 1987	20.5 A	46	28.9 A	26
Fall-winter 1987–88	24.5 B	55	30.9 A	30
Summer 1988	31.2 C	56	26.2 A	24
Brush-road				
Summer 1987	0.4 A	46	0.4 A	26
Fall-winter 1987–88	0.6 A	55	0.7 A	30
Summer 1988	0.7 A	56	0.8 A	24
Opening-opening				
Summer 1987	24.0 A	46	39.9 A	26
Fall-winter 1987–88	27.9 B	55	39.9 A	30
Summer 1988	35.6 C	56	39.0 A	24
Opening-brush				
Summer 1987	20.9 A	46	25.8 A	26
Fall-winter 1987–88	25.0 B	55	30.9 A	30
Summer 1988	32.8 C	56	28.7 A	24
Opening-road				
Summer 1987	0.9 A	46	0.4 A	26
Fall-winter 1987–88	0.7 A	55	0.3 A	30
Summer 1988	1.0 A	56	0.3 A	24
Road-road				
Summer 1987	1.1 A	46	0.8 A	26
Fall-winter 1987–88	1.4 A	55	1.3 A	30
Summer 1988	1.7 A	56	1.1 A	24
Road-brush				
Summer 1987	0.4 A	46	0.4 A	26
Fall-winter 1987–88	0.5 A	55	0.7 A	30
Summer 1988	0.6 A	56	0.6 A	24
Road-opening				
Summer 1987	0.7 A	46	0.3 A	26
Fall-winter 1987–88	0.8 A	55	0.5 A	30
Summer 1988	1.1 A	56	0.4 A	24

^a Means within a column sharing a letter are not significantly ($P > 0.05$) different.

1987 shrub-grass patches were larger than those of fall-winter 1987–88 and spring-early summer 1988. During spring-early summer 1988, forb-bare ground and grass-bare ground patches were larger than during the previous 2 seasons. Distances between bare ground patches were greater during summer 1987 than the following fall-winter 1987–88 and spring-early summer 1988. However, forb patches were farther apart during spring-early summer 1988 than the previous summer, which were farther apart than fall-winter 1987–88.

Beginning in the summer 1988, percent bare ground, and forb coverage declined from season to season, while percent grass coverage declined from summer to fall and then remained unchanged. The reverse was true for percent litter coverage, which increased every season over the course of the study. Grass heights remained similar from summer 1987 through fall-winter 1987–88 then, decreased during

BOBWHITE HABITAT SELECTION

Table 4. Mean distance between patches (cm), linear canopy coverage (cm), height (cm), and diversity (# species) for fine-scale habitat variables from summer 1987–summer 1988, La Copita Research Area, Jim Wells County, Texas.

Habitat variable Season	Telemetry locations		Random locations	
	\bar{x}	<i>n</i>	\bar{x}	<i>n</i>
Bare ground-bare ground				
Summer 1987	54.6 A ^a	45	48.4 A	27
Fall-winter 1987–88	40.5 ^b B	57	57.9 ^b A	30
Summer 1988	46.0 B	61	47.3 A	24
Bare ground-forb				
Summer 1987	15.3 A	44	7.7 A	30
Fall-winter 1987–88	9.3 B	57	6.2 B	22
Summer 1988	6.3 B	59	17.7 B	27
Bare ground-grass				
Summer 1987	25.8 A	45	17.7 A	27
Fall-winter 1987–88	12.1 B	57	12.0 B	30
Summer 1988	7.2 B	61	6.9 B	24
Bare ground-shrub				
Summer 1987	13.4 A	35	20.6 A	20
Fall-winter 1987–88	8.1 B	46	8.0 B	25
Summer 1988	8.0 B	58	8.4 B	19
Forb-bare ground				
Summer 1987	27.0 A	45	35.7 A	25
Fall-winter 1987–88	24.9 ^b A	57	40.3 ^b A	30
Summer 1988	38.2 ^b B	59	54.7 ^b A	24
Forb-forb				
Summer 1987	100.9 ^b A	45	135.5 ^b A	8
Fall-winter 1987–88	62.7 ^b B	57	125.1 ^b A	9
Summer 1988	145.4 ^b C	59	178.7 ^b A	6
Forb-grass				
Summer 1987	23.9 A	44	16.1 A	21
Fall-winter 1987–88	14.9 B	55	17.8 A	26
Summer 1988	10.3 B	43	11.9 A	13
Forb-shrub				
Summer 1987	21.1 ^b A	12	41.6 ^b A	7
Fall-winter 1987–88	6.8 B	13	6.9 A	7
Summer 1988	6.0 B	8	5.0 A	1
Grass-bare ground				
Summer 1987	27.3 A	45	26.7 A	27
Fall-winter 1987–88	24.4 ^b A	57	37.4 ^b A	30
Summer 1988	34.4 B	61	36.9 A	24
Grass-forb				
Summer 1987	16.9 A	43	11.7 A	23
Fall-winter 1987–88	10.2 B	56	8.8 A	25
Summer 1988	7.6 C	46	8.8 A	18
Grass-grass				
Summer 1987	78.0 A	45	71.8 A	27
Fall-winter 1987–88	63.3 A	57	71.0 A	30
Summer 1988	71.1 ^b A	61	94.6 ^b A	24
Grass-shrub				
Summer 1987	38.2 ^b A	18	25.2 ^b A	12
Fall-winter 1987–88	7.8 A	18	9.6 A	9
Summer 1988	17.5 A	14	12.2 A	6
Shrub-bare ground				
Summer 1987	41.7 A	35	48.1 A	20
Fall-winter 1987–88	43.2 ^b A	45	70.6 ^b A	27
Summer 1988	59.6 A	56	49.8 A	19
Shrub-forb				
Summer 1987	18.5 ^b A	10	31.0 ^b A	8
Fall-winter 1987–88	13.6 ^b A	16	39.5 ^b A	8
Summer 1988	21.2 A	9	26.7 A	3

Table 4. Continued.

Habitat variable Season	Telemetry locations		Random locations	
	\bar{x}	<i>n</i>	\bar{x}	<i>n</i>
Shrub-grass				
Summer 1987	21.9 A	18	21.1 A	9
Fall-winter 1987–88	16.3 AB	16	18.6 A	9
Summer 1988	10.9 B	15	10.8 A	6
Shrub-shrub				
Summer 1987	310.7 A	36	308.3 A	20
Fall-winter 1987–88	340.5 ^b A	49	245.5 ^b A	27
Summer 1988	278.1 ^b A	59	339.4 ^b A	19
Percent bare ground				
Summer 1987	23.9 A	45	19.9 A	25
Fall-winter 1987–88	32.0 ^b B	57	24.2 ^b A	30
Summer 1988	39.9 ^b C	61	46.9 ^b B	23
Percent forbs				
Summer 1987	30.6 A	43	30.3 A	23
Fall-winter 1987–88	25.2 ^b B	57	12.3 ^b B	30
Summer 1988	15.5 C	59	14.5 B	22
Percent grass				
Summer 1987	40.2 A	45	44.4 A	26
Fall-winter 1987–88	31.1 B	57	38.5 A	30
Summer 1988	29.2 B	61	23.1 B	23
Percent litter				
Summer 1987	6.9 A	41	10.4 A	20
Fall-winter 1987–88	12.0 ^b B	55	25.2 ^b B	30
Summer 1988	16.2 C	60	16.3 AB	22
Forb diversity				
Summer 1987	6.0 A	42	5.6 A	21
Fall-winter 1987–88	8.6 B	57	5.1 A	30
Summer 1988	7.7 B	61	5.7 A	23
Grass diversity				
Summer 1987	3.2 A	42	3.8 A	22
Fall-winter 1987–88	2.7 A	57	2.8 A	30
Summer 1988	2.7 A	61	2.9 A	23
Forb height				
Summer 1987	26.5 A	44	32.7 A	25
Fall-winter 1987–88	8.5 B	56	10.4 B	30
Summer 1988	9.0 B	59	13.2 B	21
Grass height				
Summer 1987	23.8 A	45	33.5 A	26
Fall-winter 1987–88	22.5 ^b A	57	36.4 ^b A	30
Summer 1988	13.9 B	60	21.7 B	21
Woody height line				
Summer 1987	118.6 A	36	118.9 A	21
Fall-winter 1987–88	104.9 A	49	115.4 A	27
Summer 1988	89.7 ^b A	59	60.6 ^b A	19
Woody height plot				
Summer 1987	126.6 ^b A	21	226.0 ^b A	22
Fall-winter 1987–88	163.3 ^b B	49	202.5 ^b A	27
Summer 1988	152.7 B	60	156.0 A	19
Woody canopy line				
Summer 1987	98.3 A	18	98.9 A	22
Fall-winter 1987–88	24.0 ^b B	16	10.6 ^b B	27
Summer 1988	12.2 B	15	17.0 B	19
Woody canopy plot				
Summer 1987	292.3 ^b A	30	229.6 ^b A	18
Fall-winter 1987–88	204.5 ^b B	49	341.1 ^b B	27
Summer 1988	199.7 B	60	175.6 A	19

^a Means within a column sharing a letter are not significantly ($P > 0.05$) different.

^b Means within rows are significantly ($P < 0.05$) different.

Table 5. Mean number of patches of fine-scale habitat variables observed from summer 1987–summer 1988, La Copita Research Area, Jim Wells County, Texas.

Habitat variable Season	Telemetry locations		Random locations	
	\bar{x}	<i>n</i>	\bar{x}	<i>n</i>
Bare ground-bare ground				
Summer 1987	62.3	A ^a 45	72.2	A 27
Fall-winter 1987–88	84.3 ^b	B 57	63.2	A 30
Summer 1988	76.0	C 62	77.5	A 24
Bare ground-forb				
Summer 1987	23.0	A 45	21.0	A 27
Fall-winter 1987–88	39.5 ^b	B 57	18.1	A 30
Summer 1988	21.1	A 62	16.9	A 24
Bare ground-grass				
Summer 1987	34.7	A 45	44.6	A 27
Fall-winter 1987–88	39.4	A 57	38.5	A 30
Summer 1988	50.3	B 62	52.3	A 24
Bare ground-shrub				
Summer 1987	2.2	A 45	3.9	A 27
Fall-winter 1987–88	3.0	A 57	4.9	A 30
Summer 1988	4.7	B 62	4.0	A 24
Forb-bare ground				
Summer 1987	22.9	A 45	21.4	A 27
Fall-winter 1987–88	40.0 ^b	B 57	18.7	A 30
Summer 1988	21.4	A 62	18.6	A 24
Forb-forb				
Summer 1987	35.4 ^b	A 45	27.44	A 27
Fall-winter 1987–88	54.6 ^b	B 57	24.9	A 30
Summer 1988	25.1	C 62	178.7	A 24
Forb-grass				
Summer 1987	10.7 ^b	A 45	5.3	A 27
Fall-winter 1987–88	12.8 ^b	A 57	6.5	A 30
Summer 1988	2.28	B 62	1.83	B 24
Forb-shrub				
Summer 1987	0.24 ^b	A 45	0.26	A 27
Fall-winter 1987–88	0.32	A 57	0.27	A 30
Summer 1988	0.15	A 62	0.04	A 24
Grass-bare ground				
Summer 1987	34.2	A 45	44.0	A 27
Fall-winter 1987–88	39.5	A 57	37.5	A 30
Summer 1988	50.0	B 62	51.8	A 24
Grass-forb				
Summer 1987	11.1 ^b	A 45	5.2	A 27
Fall-winter 1987–88	13.6 ^b	A 57	6.4	A 30
Summer 1988	2.5	B 62	2.2	B 24
Grass-shrub				
Summer 1987	0.50	A 45	0.52	A 27
Fall-winter 1987–88	0.42	A 57	0.40	A 30
Summer 1988	0.30	A 62	0.38	A 24
Grass-grass				
Summer 1987	47.8	A 45	51.6	A 27
Fall-winter 1987–88	53.6	A 57	47.7	A 30
Summer 1988	51.8	A 62	54.9	A 24
Shrub-bare ground				
Summer 1987	2.0	A 45	4.0	A 27
Fall-winter 1987–88	3.1 ^b	A 57	4.9	A 30
Summer 1988	4.4	B 62	4.0	A 24
Shrub-forb				
Summer 1987	2.9 ^b	A 45	0.30	A 27
Fall-winter 1987–88	0.30	A 57	0.37	A 30
Summer 1988	0.16	A 62	0.13	A 24

Table 5. Continued.

Habitat variable Season	Telemetry locations		Random locations	
	\bar{x}	<i>n</i>	\bar{x}	<i>n</i>
Shrub-grass				
Summer 1987	0.58	A 45	0.37	A 27
Fall-winter 1987–88	0.39	A 57	0.43	A 30
Summer 1988	0.29	A 62	0.29	A 24
Shrub-shrub				
Summer 1987	3.1	A 45	4.7	A 27
Fall-winter 1987–88	3.8	A 57	5.8	A 30
Summer 1988	4.9	B 62	3.9	A 24

^a Means within a column sharing a letter are not significantly ($P > 0.05$) different.

^b Means within rows are significantly ($P < 0.05$) different.

spring-early summer 1988, whereas forb heights decreased between summer 1987 and fall-winter 1987–88 remaining unchanged thereafter. Forb diversity increased from summer 1987 to fall-winter 1987–88 where it remained the same for the rest of the study.

Shrub heights within the plots increased between the first summer and the following fall-winter season. Woody canopy cover along sampling lines and those within plots decreased over the same period. Woody height and canopy cover then remained unchanged through spring-early summer 1988.

At telemetry locations, the number of patches differed by season (Table 5). Numbers of bare ground-shrub, bare ground-grass, shrub-bare ground, and grass-bare ground patches were comparable during summer 1987 and fall-winter 1988, but increased during spring-early summer 1988. Similarly, the mean number of patches for all woody species variables were higher in spring-early summer, than the previous 2 seasons. In addition, more shrubs with greater heights were recorded within plots during fall-winter 1987–88 than in summer 1987. Quantities of bare ground-forb, forb-bare ground, forb-grass and grass-forb patches, were higher during fall-winter 1988–89 than in either of the other 2 seasons, which were similar.

Random Locations.—At random points, distance between patches had significant seasonal differences (Table 4). Distance between bare ground-shrub, bare ground-forb, and brush-grass patches were larger during summer 1987 than during fall-winter 1987–88 and spring-early summer 1988. The percent of bare ground did not change significantly from summer 1987 through winter 1988, but increased during spring-early summer 1988. However, percent forb cover and height were highest during the first summer, then declined during fall-winter 1987–88. Grass cover and height followed the same pattern, except decreases in coverage were not significant until spring-early summer 1988. Less ground litter was encountered during summer 1987 than what was found the following fall-winter. Woody canopy cover along the sampling lines decreased between summer 1987 and fall-winter 1987–88, although woody canopy within plots displayed the reverse pattern.

At random points, the number of forb-grass and grass-forb patches were similar between summer 1987 and fall-winter 1987–88, but declined during spring-early summer 1988 (Table 5). The number and height of shrubs within plots increased noticeably from season to season throughout the term of study. Seasonal differences in fine-scale mean patch sizes and numbers followed a pattern similar to that exhibited at the landscape scale. Patch sizes tended to decrease seasonally, while patch numbers correspondingly increased.

Telemetry vs. Random Locations

Large Scale.—Large scale patch dimensions did not differ significantly between telemetry and random points during summer 1987 and spring-early summer 1988 (Table 2). However, road-opening distance at telemetry sites were smaller than at random sites during fall-winter 1987–88. Similarly, there were no differences in patch numbers at telemetry locations and random points during fall-winter 1987–88 and spring-early summer 1988 (Table 3). Fewer opening-opening distances were recorded at telemetry locations than at random sites during summer 1987.

Fine scale.—During summer 1987, fine-scale habitat variables at 45 telemetry locations and 27 random points were sampled and differences were found for 8 habitat variables (Table 4). Telemetry locations contained smaller shrub-forb and forb-shrub patches, as well as shorter distances between forb-forb patches. Conversely, grass-shrub patches were larger. The heights of woody species within telemetry plots were shorter than those in random plots, but had more extensive canopies. More forb-grass and grass-forb patches were found in telemetry plots than were in random plots, as were the number of woody species (Table 5). Percent coverage of bare ground, forbs, grass, and litter were similar for both telemetry and random plots (Table 4).

During fall and winter 1987–88, 11 habitat variables differed between telemetry and random locations (Table 4). Telemetry plots had smaller shrub-bare ground, shrub-forb, forb-bare ground, and grass-bare ground patches, shorter grass heights, as well as shorter distances between bare ground-bare ground, and forb-forb patches. The distance between shrub patches was greater at telemetry locations than at random locations. Also, shrubs were smaller within telemetry plots, had more extensive canopies along the sampling lines, but had less extensive canopies within the sampling plots than shrubs found in random plots. Patch numbers were greater for bare ground-forb, forb-bare ground, forb-grass, and grass-forb patches at bobwhite locations than at randomly sampled plots (Table 5). In addition, more shrub-shrub and forb-forb patch distances were recorded at telemetry plots. A significant lack of cover and a higher percentage of forbs occurred in telemetry plots than in random plots, but less litter was found in telemetry plots (Table 4).

During spring and early summer 1988, 5 habitat variables differed between telemetry and random locations (Table 4). Patches of forb-bare ground were

smaller and the distance between forb-forb, grass-grass, and shrub-shrub patches, was shorter at telemetry locations. Shrubs occurring along the sampling lines were taller, while shrub canopies in the plots were more extensive at telemetry plots than at random plots. No significant differences in patch numbers were apparent between telemetry and random sites (Table 5). However, fewer bare ground-grass patches occurred at telemetry sites than at random sites. Forb, grass, and litter coverage were similar at both sites.

Field/Aerial Photo Relationships

The only habitat variable measured in the field that differed substantially between telemetry and random sites during all 3 seasons was forb-forb distance (Table 4). A smaller road-opening distance at telemetry locations during fall-winter was the only significant habitat variable measured on the aerial photo (Table 2). Correlation analysis revealed no relationship ($r = -0.23$, $P = 0.2301$, $n = 16$) between forb-forb and road-opening distances.

Patch numbers of forb-forb and grass-forb patches at telemetry sites were larger than at random sites during summer 1987 and fall-winter 1987–88 (Table 5). Fewer opening-opening measurements at telemetry locations during summer 1987 was the only significant habitat variable from analysis of the aerial photo (Table 3). No correlation was found between forb-grass and opening-opening ($r = 0.02$, $P = 0.8939$, $n = 16$) and grass-forb and opening-opening patch numbers ($r = 0.10$, $P = 0.5299$, $n = 16$). The results of these correlation analyses indicated there was essentially no relationship between important habitat variables measured from the aerial photo and from the field.

DISCUSSION

Results of this study indicated habitat interspersion was an important variable associated with areas preferred by northern bobwhites. Patterns of interspersion were evident in habitats used by northern bobwhites during each of the 3 seasons.

Seasonal differences in patch size and abundance were apparent for a number of habitat variables. Some of these differences were evident solely at telemetry locations, while others were similar at telemetry and random locations. Differences that occurred only at telemetry locations presumably reflect habitat preference.

Large-Scale Measurements

Since the only seasonal differences were at telemetry locations and no seasonal differences were evident at random sites, it is likely that changes in habitat variables represented shifts in quail habitat preferences. Northern bobwhites exhibited a tendency to select habitats that were composed of increasingly smaller, though more numerous patches, that were closer together from one season to the next.

From summer 1987 through fall-winter and into

spring-early summer 1998, brush-opening and road-opening distances decreased, while the number of brush-opening patches increased. Similarly, opening-brush patch size remained unchanged throughout the year, while patch numbers increased to their highest level during spring-early summer. In addition, distances between open patches and distances between brush patches decreased, while the number of opening-opening and brush-brush patches increased during the same period. Northern bobwhites, thus exhibited a tendency to select habitats that were composed of smaller, more numerous patches that were closer together as the study progressed.

Bobwhites seemed to prefer roads near openings during fall and winter. However, it would be inappropriate to conclude that this variable was more important than others on an annual basis. What appeared to be important were the number and the spatial distribution of openings, brush, and roads.

Fine-Scale Measurements

Several-habitat variables measured followed similar seasonal patterns of change at both telemetry and random locations indicating that whatever external factor(s) was responsible, it influenced the study area similarly. After 2 years of above average precipitation, a drought began during late summer 1987, and with the exception of a few centimeters of rain in November, persisted through the duration of the study (D. McKown, unpublished data). The significant seasonal disparities observed were at least partially attributable to this lack of rainfall.

Habitat variables that differed seasonally at telemetry locations were probably seasonally preferred by northern bobwhites. Bobwhites apparently selected habitats where forb patches were clumped and had higher forb coverage than found at random locations, indicating bobwhites were selecting habitat partially on the basis of percent-forb coverage. Wilkins (1987:53) also noted that bobwhites sought areas with high-forb coverage and diversity when herbaceous cover and diversity were limited during fall and winter.

Bobwhites selected areas with more grass in summer than during fall and winter. This was probably in response to nest-site selection. Wilkins (1987:51) also reported less grass use by bobwhites during fall and winter.

Percent bare ground and litter increased throughout the study at both telemetry and random locations indicating that these variables were probably not being selected by bobwhites. However, despite the increase in litter, there was less dead plant material at telemetry locations than at random sites, suggesting quail selected for areas with less litter. In addition, the distance between patches of bare ground decreased at telemetry sites from summer to fall-winter. These trends indicated that, although bare ground cover and litter accumulations increased, bobwhites selected areas with smaller, more numerous bare ground patches with lower percent litter cover during fall and winter. In addition to high forb and low grass coverage, areas with a

substantial number of small bare ground patches resulting in high bare ground coverage were preferred by bobwhites during fall-winter. Wilkins (1987:50) also reported that bobwhites were associated with habitats with higher percentages of bare-ground coverage during this same period.

Bobwhites also preferred taller shrubs with less extensive canopies during fall/winter than during spring and summer. In addition, the number of shrubs at telemetry locations increased from summer to fall-winter, offering coveys more shrubs in which they could take refuge. This suggested that as the herbaceous habitat conditions continued to deteriorate in response to the drought, bobwhites moved into areas with higher shrub densities.

Habitat Interspersion

Few large scale variables appeared to be important to bobwhites. Areas with more roads and fewer openings were apparent in bobwhite habitat during fall-winter 1987–88 and summer 1987, respectively.

During each season of this study, habitat interspersion at the fine-scale of resolution was greater at telemetry locations than at random sites as determined from field aerial photograph data. Generally, patch sizes were smaller and more numerous, and patches were closer together in habitats at telemetry locations than at random sites. Patterns of habitat interspersion influenced bobwhite habitat selection.

Seasonal differences in numbers of habitat variables comprising the interspersion matrix were evident throughout the study. During fall-winter 1988–89, 10 patch dimension and 6 patch number variables were important to bobwhites. During summer 1987, 6 dimension and 3 patch number variables were important. Only four patch dimension variables differed significantly from random locations during spring-early summer 1988. Bobwhites were grouped in coveys during the fall and winter, making it possible that a greater diversity of habitats were necessary to fulfill the daily needs of a covey. This would seem to be particularly important during stressful periods, such as when bobwhites were experiencing food shortages and had to compete for a scarce resource. Such an event may have been occurring over winter. However, as the drought increased in severity through winter and into spring, food should have become even more limiting. Yet the number of important variables within the interspersion matrix decreased. The most plausible explanation is that coveys were breaking up and pairs were beginning to select reproductive areas.

Although each individual habitat variable may have served a useful purpose, what seemed most important in determining bobwhite use of habitats was the interspersion of roads, brush, and openings at the large scale. Interspersion of forbs, grass, shrubs, and bare ground at the fine scale of resolution seemed more important to bobwhites than a specific patch size or number of patches. In bobwhite habitat, patches were smaller, numbers of patches were greater, and patches were in closer proximity to one another than at random

sites. As the year progressed and the drought increased in severity, patch sizes decreased, patch numbers increased, and patches were closer together. Selecting patchy habitats provides bobwhites with certain obvious advantages. For example, areas where essential habitat patches are in close proximity to one another minimizes the amount of movement required for a bird to fulfill its daily and seasonal requirements. Scott and Klimstra (1954:261) noted that by moving less, bobwhites reduced risks of exposure to predators. Another advantage of minimizing movement is that bobwhites are able to conserve more energy. Roseberry and Klimstra (1984:33) believed that during severe winter weather, the proximity of food and cover required less movement of bobwhites and resulted in a more favorable net energy balance. Also, south Texas summers are hot and as a result quail often expend a significant amount of energy in an attempt to maintain cooler body temperatures. Consequently, the reduction in movement afforded by patchy habitats may provide bobwhites with bioenergetic advantages.

CONCLUSIONS

The results of this study suggested that interspersed fine scale habitats used by bobwhites consisted of patches that were smaller, more numerous, and closer together than those of random locations. Bobwhite habitats had more patches, at both the large and fine scales during each of the 3 seasons studied. In addition, as the study progressed and the drought increased in severity, patches in bobwhite habitats grew smaller, more numerous and closer to one another.

Distance to roads seemed to be the most important large scale habitat variable associated with bobwhite habitat. Roads might have served as foraging areas as well as a means for bobwhites to move to various areas of their range.

Forb, grass, bare ground and shrub patches were identified as important fine scale habitat components. Distance between forb patches was the most important fine scale variable at telemetry locations each season. Forbs, along with grasses and shrubs provided food and cover for bobwhites while bare ground enhanced foraging activity and movement.

Relationships between significant large scale and fine scale variables were not apparent. As a result, it would be inadvisable to examine an aerial photo and conclude the area had adequate bobwhite habitat without conducting field studies.

ACKNOWLEDGMENTS

This is publication no. 02-103 of the Caesar Kleberg Wildlife Research Institute.

LITERATURE CITED

- Beecher, W. J. 1942. Nesting birds and the vegetation substrate. Chicago Ornithological Society, Chicago, Illinois.
- Conover, W. J. 1980. Practical nonparametric statistics. John Wiley & Sons Inc., New York, New York.
- Gould, F. W. 1975. Texas plants, a check list and ecological summary. Texas Agricultural Experiment Station, Texas A&M University, College Station.
- Guthery, F. S. 1986. Beef, brush and bobwhites: quail management in cattle country. Golden Banner Press, Inc., Corpus Christi, Texas.
- Lehmann, V. W. 1984. Bobwhites in the Rio Grande Plains of Texas. Texas A&M University Press, College Station.
- Loomis, L. E. 1989. Influence of heterogeneous subsoil development on vegetation patterns in a subtropical savanna parkland. Dissertation. Texas A&M University, College Station.
- Mech, L. D. 1983. Handbook of animal radio-tracking. University of Minnesota Press, Minneapolis.
- Ott, L. 1988. An introduction to statistical methods and data analysis. Third edition, PWS-Kent Publishing Company, Boston, Massachusetts.
- Petrides, G. A., and R. B. Nestler. 1943. Age determination in juvenile bobwhite quail. American Midland Naturalist. 30: 774-782.
- Reid, R. R. 1977. Correlation of habitat parameters with whistle-count densities of bobwhite (*Colinus virginianus*) and scaled quail (*Callipepla squamata*) in Texas. Thesis. Texas A&M University, College Station.
- Reid, R. R., C. E. Grue, and N. J. Silvy. 1979. Competition between bobwhite and scaled quail for habitat in Texas. Proceedings of the Annual Conference of the Southeastern Association of Fish and Wildlife Agencies 33:146-153.
- Roseberry, J. L., and W. D. Klimstra. 1984. Population ecology of the bobwhite. Southern Illinois University Press, Carbondale.
- Rosene, W., Jr. 1969. The bobwhite quail, its life and management. Rutgers University Press, New Brunswick, New Jersey.
- Scanlan, J. C. 1988. Spatial and temporal vegetation patterns in a subtropical *Prosopis* savanna woodland, Texas. Dissertation. Texas A&M University, College Station.
- Scott, T. G., and W. D. Klimstra. 1954. Report on a visit to quail management areas in southeastern United States. Illinois Wildlife 9:5-9.
- Stoddard, H. L. 1931. The bobwhite quail: its habits, preservation and increase. Charles Scribner's Sons, New York, New York.
- Walsh, P. B. 1985. Habitat use and population fluctuations of white-tailed deer at La Copita Research Area, Jim Wells County, Texas. Thesis. Texas A&M University, College Station.
- Wilkins, R. N. 1987. Influence of grazing management on population attributes, habitats and habitat selection of bobwhites in south Texas. Thesis. Texas A&M University, College Station.

CONTRIBUTION OF CRP TO ILLINOIS BOBWHITE HABITAT AT THE LANDSCAPE LEVEL

Whitney L. Weber

Cooperative Wildlife Research Laboratory, Southern Illinois University at Carbondale, Carbondale, IL 62901, USA

John L. Roseberry

Cooperative Wildlife Research Laboratory, Southern Illinois University at Carbondale, Carbondale, IL 62901, USA

ABSTRACT

Northern bobwhite (*Colinus virginianus*) population declines in the midwest have been attributed to habitat degradation and loss due mainly to intensified agricultural land use and farming practices. Thus, there was initial optimism that the Conservation Reserve Program (CRP) would benefit bobwhites by converting cropland to semi-permanent grassland. However, CRP apparently has not positively impacted regional or statewide population trends in Illinois. Deficiencies at both site and landscape level may be involved. To address the latter issue, we mapped the location of each individual CRP field (>8,800) in 11 representative counties within the bobwhite range in Illinois. We then analyzed their spatial relationship to other land cover and bobwhite habitat using Geographic Information Systems and a statewide digital land cover map based on classified satellite imagery. Existing bobwhite habitat and CRP fields tended to be spatially correlated because both are largely confined to moderately rolling terrain as opposed to very hilly or very flat areas. Nevertheless, almost 25% of all existing CRP acreage within our 11 study counties occurred in landscapes with insufficient woody edge to support high bobwhite populations. Furthermore, CRP did not always provide the habitat component most limiting for bobwhites.

Citation: Weber, W. L., and J. L. Roseberry. 2002. Contribution of CRP to Illinois bobwhite habitat at the landscape level. Page 190 in S. J. DeMaso, W. P. Kuvlesky, Jr., F. Hernández, and M. E. Berger, eds. Quail V: Proceedings of the Fifth National Quail Symposium, Texas Parks and Wildlife Department, Austin, TX.

HABITAT SELECTION OF NORTHERN BOBWHITE COVEYS ON TWO INTENSIVE AGRICULTURAL LANDSCAPES IN EASTERN NORTH CAROLINA

Shane D. Wellendorf

Fisheries and Wildlife Sciences Program, North Carolina State University, Raleigh, NC 27695-7646, USA

William E. Palmer

Tall Timbers Research Station, 13093 Henry Beadel Dr., Tallahassee, FL 32312, USA

Peter T. Bromley

Fisheries and Wildlife Sciences Program, North Carolina State University, Raleigh, NC 27695-7646, USA

Abstract

Little information is available for home range size and habitat use of northern bobwhites (*Colinus virginianus*) on modern agricultural landscapes in autumn. Therefore, we monitored radiomarked bobwhite coveys from September–December 1998 on farms in Wilson and Tyrrell counties, North Carolina. The Tyrrell County farm was a 6084-ha area recently developed for commercial production of corn and soybeans. Dispersed throughout crop areas were forested and fallow blocks at differing stages of succession. The Wilson County farms had small fields ($\bar{x} = 1.8$ ha, $SE = 0.12$) planted in cotton, soybeans, corn, and tobacco and were surrounded by mixed pine and hardwood blocks of differing ages. Mean home range size at the Tyrrell County farm was 33.2 ha (range 4.5–128.5 ha) ($n = 10$). The two largest home ranges, 70.7 and 128.6 ha, were disproportionately large due to large movements from harvested crop fields to permanent forested cover. Covey home ranges were not established at random ($\lambda = 0.124$; $\chi^2_4 = 20.18$; $P < 0.001$). Road and canal edges were selected significantly more than any other habitat followed in rank by soybean fields, corn fields, forested, and fallow blocks. Road and canal edges provided necessary cover for moving between habitat types, especially from forested and fallow blocks to crop fields. Within home ranges, coveys did not allocate their time at random ($\lambda = 0.336$; $\chi^2_4 = 10.89$; $P < 0.05$). Habitats were ranked in the order of forested blocks, fallow areas, soybean fields, road and canal edges, and corn fields, but no significant differences were found between habitats. In Wilson County, average covey home range was 17.4 ha (Range: 4.9–37.6 ha) ($n = 11$). Coveys did not establish their home range at random ($\lambda = 0.407$; $\chi^2_2 = 9.87$; $P < 0.05$), selecting forested blocks over crop fields ($T_g = 3.02$, $P < 0.012$). Within home ranges coveys did not allocate their time at random ($\lambda = 0.1319$; $\chi^2_5 = 22.28$; $P < 0.001$), utilizing primarily forested blocks followed by cotton fields, soybean fields, corn fields, and other areas. On both study areas, forested and fallow blocks were the only source of cover to spend time in after crop harvest. Covey use within forested and fallow blocks was concentrated along edges of crop fields, leaving large portions of this habitat type unused. Forested and fallow blocks were primarily used as loafing cover in between feeding periods in adjacent crop fields.

Citation: Wellendorf, S. D., W. E. Palmer, and P. T. Bromley. 2002. Habitat selection of northern bobwhite coveys on two intensive agricultural landscapes in eastern North Carolina. Page 191 in S. J. DeMaso, W. P. Kuvlesky, Jr., F. Hernández, and M. E. Berger, eds. Quail V: Proceedings of the Fifth National Quail Symposium, Texas Parks and Wildlife Department, Austin, TX.

CYCLICITY IN NORTHERN BOBWHITES: A TIME-ANALYTIC REVIEW OF THE EVIDENCE

Wayne E. Thogmartin

Cooperative Wildlife Research Laboratory and Department of Zoology, Southern Illinois University, Mail Code 6504, Carbondale, IL 62901-6504, USA

John L. Roseberry

Cooperative Wildlife Research Laboratory, Southern Illinois University, Mail Code 6504, Carbondale, IL 62901-6504, USA

Alan Woolf

Cooperative Wildlife Research Laboratory, Southern Illinois University, Mail Code 6504, Carbondale, IL 62901-6504, USA

ABSTRACT

Cyclical behavior in wildlife populations, including northern bobwhite (*Colinus virginianus*), has long fascinated human observers. However, studies examining cyclicity of bobwhite abundance have yielded contradictory results. We reviewed evidence for periodic fluctuation in bobwhite abundance by studying 73 long-term time series. Our aim was to discern with time-series techniques whether cyclicity occurred in bobwhite abundance. We elucidated the frequency of occurrence, geographical distribution, and potential mechanisms responsible for cyclicity. Approximately one-half ($n = 37$) of the populations examined demonstrated cyclical behavior, with a period varying between 4 and 17 yrs. True cycles, consistent, significant fluctuations in abundance, were rare, occurring in only 3 time series. The predominant form of periodicity was of the phase-forgetting quasi-cycle type ($n = 34$). This phase-forgetting may have contributed to previous contradictory findings of cyclicity in this species. We reason cyclicity in bobwhite populations is caused by aperiodic environmental perturbations interacting with density-dependence. Cyclic bobwhite populations occupied the northern and western portion of the species' range, where stochastic weather events regularly negatively influence bobwhite population dynamics. Bobwhite populations were non-cyclic in the relatively consistent climate of the southeastern United States, however, habitat fragmentation rather than climate may have contributed to the absence of cyclicity in this region.

Citation: Thogmartin, W. E., J. L. Roseberry, and A. Woolf. 2002. Cyclicity in northern bobwhite: a time-analytic review of the evidence. Pages 192–200 in S. J. DeMaso, W. P. Kuvlesky, Jr., F. Hernández, and M. E. Berger, eds. Quail V: Proceedings of the Fifth National Quail Symposium. Texas Parks and Wildlife Department, Austin, TX.

Key words: California quail, *Callipepla californica*, *Colinus virginianus*, density dependence, environmental forcing, northern bobwhite, periodicity, phase-forgetting quasi-cycles

INTRODUCTION

Northern bobwhite abundance is highly variable between years over much of the species' range (Stoddard 1931:339–347, Rosene 1969:194–197, Schwartz 1974, Peterson and Perez 2000), with populations fluctuating as much as 70% or more around the long-term mean (Roseberry and Klimstra 1984:122). Throughout much of the quail range these fluctuations appear primarily due to differences in overwinter mortality (Scott 1937, Mosby and Overton 1950, Kozicky and Hendrickson 1952, Kabat and Thompson 1963, Stanford 1972) and subsequent reproductive success (Parmalee 1955, Robinson 1957, Speake and Haugen 1960, Schemnitz 1964, Lehmann 1984, Forrester et al. 1998).

Roseberry and Klimstra (1984) suggested the increasing phase in bobwhite population fluctuations was generally gradual and steady in their southern Illinois study of bobwhite population dynamics. Declines, however, took 1 of 2 paths, either tumbling sharply in 1 year or declining at a rate similar to the increases occurring over a span of 3–4 years. Williams (1963)

found similar results for California quail (*Callipepla californica*). Such gradual change is indicative of serial correlation (temporal autocorrelation) in abundance.

Roseberry and Klimstra (1984:151–191) indicated these correlated fluctuations contributed to cyclic patterns in abundance. A cycle may be defined as a fluctuation having period, timing, and amplitude (Wing 1955). Mathematically, for animals to cycle, a time series $\{y(t)\}$ is periodic if there exists a period of length T such that:

$$y(t + T) = y(t)$$

(Lindström et al. 1997). Unlike the 10-year cycles of northern grouse (Tetraonidae; Keith 1963), Preno and Labisky (1971) believed bobwhites cycled on a 5-year basis ($T = 5$), whereas Roseberry and Klimstra (1984) thought it was 8–10 yrs. Wing (1955) believed bobwhites cycled on ~4-year period (either 3.8, 4.2, or 4.4 yrs), as did Williams (1963) for California quail ($T = 4$). Other authors reported no evidence of cyclicity in their study population (e.g., Errington 1957, Brennan et al. 2000).

NORTHERN BOBWHITE CYCLICITY

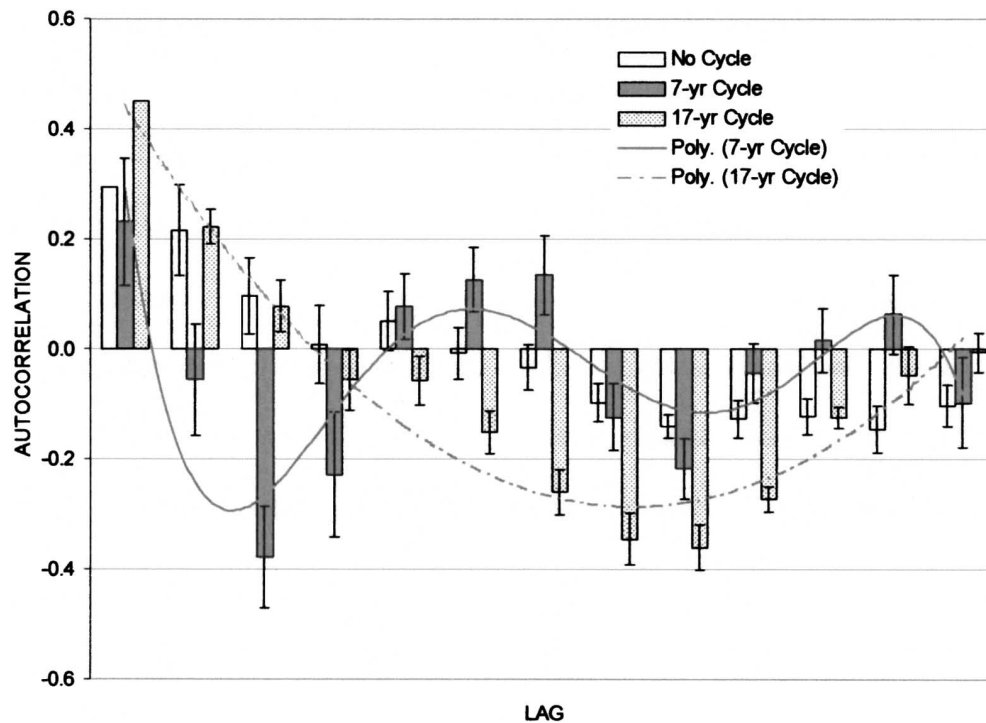

Fig. 1. Autocorrelation functions for 7-year cycle, 17-year cycle, and non-cyclic northern bobwhite populations in Illinois, as determined by route-level counts from the North American Breeding Bird Survey. Autocorrelation function significant at $r = 0.346$; correlations at lags ≥ 8 are tentative due to decreased sample size.

Recognizing patterns in population abundance is a precondition for uncovering mechanisms responsible for producing them (Lindström et al. 1997) and, as Edwards (1972) suggested, if wildlife managers can begin to predict these fluctuations (i.e., their direction and strength) management actions will be more effective. For instance, if the cyclic aspect of a population's dynamics suggest a downward turn in the population in the near future, management will not needlessly over-react knowing that a natural upturn will follow shortly thereafter.

We examined whether temporal patterns of variability in bobwhite abundance in Illinois were periodic. In addition, we reviewed published data testing cyclicity in bobwhites, as well as other long-term data sets amenable to analysis. Our purpose was to elucidate the frequency of occurrence, geographical distribution, and potential mechanisms responsible for cyclicity.

METHODS

Time series analysis follows 2 general approaches (Box and Jenkins 1970). One approach, the frequency domain, examines dominant periodicities or cyclical patterns in a time series. Conversely, time-domain analysis examines the structural pattern of a time series, analyzing the values of a process directly. Combining both approaches is often useful in gleaning a better understanding of the data series. While we conducted frequency-domain analyses (e.g., spectral analysis), we confined final analyses to the time domain

due to the subjective nature of period determination by frequency-domain analyses coupled with the shortness of many time series.

We examined several sources of long-term abundance data. We examined route- and state-summarized North American Breeding Bird Survey (NABBS) data for Illinois. These data were available for 26 routes, for 1967–1998 ($n = 32$ years), primarily through the west-central and southern portions of the state. We also (re-) examined cyclicity in data provided by Wing (1937:326; $n = 19$ and 24 yrs), Errington (1957:289; $n = 18$ and 18 yrs), Kabat and Thompson (1963:21; $n = 23$ and 25 yrs), Williams (1963; $n = 12, 13,$ and 13 yrs), Rosene (1969:381; $n = 10$ yrs), Mitchell (1979:11; $n = 34$ yrs), Roseberry and Klimstra (1984:73; $n = 26$ and 26 yrs), and Brennan et al. (2000; $n = 39, 53,$ and 91 yrs). The Kabat and Thompson (1963) data set contained Errington's data, plus an additional 4 years of spring and 8 years of autumn counts. The Williams (1963) data were counts of California quail introduced to New Zealand. We also examined Illinois fall harvest ($n = 24$ yrs) and Christmas Bird Counts ($n = 41$ yrs) for evidence of periodicity. The third data set examined was annual NABBS counts from 29 eastern states (not including Ill.; 1967 or 1968–2000, range = 33–34 yrs). In total, we examined 73 time series of varying length (range = 10–91 yrs), occurring throughout the species range. Since population dynamics relate to multiplicative processes (Williamson 1971), all abundance indices were log-transformed ($\log[\text{ABUNDANCE} + 1]$) to stabilize variances (Sen and Srivastava 1990).

Table 1. Cyclic patterns in quail. T is period of cycle, PFQC is phase-forgetting quasi-cycle.

Data Set	Location	Type	Season	Time Series Length	T	Cyclic Pattern
Wing (1937)	Oh.	Census	Winter	1908–1931	14?	PFQC
Wing (1937)	Pa.	unknown ^a	unknown ^a	1915–1933	14?	PFQC
Errington (1957)	Wis.	Census	Spring	1930–1947	8	PFQC
Errington (1957)	Wis.	Census	Autumn	1929–1946	8–9	PFQC
Kabat and Thompson (1963)	Wis.	Census	Spring	1929–1951	8	PFQC
Kabat and Thompson (1963)	Wis.	Census	Autumn	1929–1955	8	PFQC
Rosene (1969)	S.C.	Census	Autumn ^b	1957–1967	5	PFQC
Mitchell (1979)	Neb.	Mail-Carrier	Summer	1945–1978		Noncyclic
Roseberry and Klimstra (1984)	Ill.	Census	Spring	1954–1979	8–9	PFQC
Roseberry and Klimstra (1984)	Ill.	Census	Autumn	1954–1979	8	Definitely Cyclic
Brennan et al. (2000)	Ga.	Coveys Flushed, Plantation "C"	Autumn	1960–1997		Noncyclic
Brennan et al. (2000)	Ga.	Coveys Flushed, Plantation "D"	Autumn	1938–1990		Noncyclic
Brennan et al. (2000)	Ga.	Coveys Flushed, Plantation "E"	Autumn	1906–1996		Noncyclic
Harvest	Ill.	Harvest	Autumn/Winter	1975–1998		Noncyclic
Christmas Bird Counts	Ill.	Counts	Winter	1967–2000		Noncyclic

^a Author did not indicate season or census type.

^b Estimate made at start of hunting season, in fall.

For NABBS time series of routes with gaps in the data, we averaged the neighboring data values when the gap was 1 year. Time series with gaps ≥ 2 years were excluded. Routes were also excluded when the time series possessed ≥ 3 , 1-year gaps or ≥ 3 years with zero counts. To insure a lengthy period for analysis, only routes extending ≥ 20 years were included. Because we were interested in periodic fluctuations within time-series, we removed long-term trends by fitting 1st- and 2nd-order polynomial and LOESS regressions. The method for removing the long term trend is vital and we were conservative in our application, always choosing the less aggressive option (i.e., erring on the side of non-stationarity rather than removing too much variation due to trend).

Detection of temporal autocorrelation for each time series (i.e., correlation within a single time series) was accomplished with lagged scatter plots, autocorrelation function (ACF) plots, and partial autocorrelation function (PACF) plots (Brockwell and Davis 1987). Cyclicity of the time series was assessed by identifying recurring peaks and valleys in the ACFs. Evidence for true cyclicity occurred when multiple lags exceeded Bartlett's line, a significance level derived from convergence of sample correlation coefficients to the normal distribution (Lindström et al. 1997). Weaker evidence for cyclicity (Nisbet and Gurney 1982), was suggested when recurring patterns were observed but the lagged autocorrelations were

not significant. These non-significant recurring patterns are described as quasi-cycles; when the periodic pattern recurs with regularity and similar (though non-significant) intensity at each peak and valley, this quasi-cycle is labeled phase-remembering. When the intensity declines with lag distance, the quasi-cycle is phase-forgetting. Time series with non-significant lags or no obvious patterns in either the ACF or PACF plots were identified as random.

The theoretical ACF and PACF equals zero at all lags for an independently and identically distributed (i.e., random) sequence. But, when conducting hypothesis tests at $\alpha = 0.05$ across an independent set of such series, 5% of samples would be expected to reject the null when in fact the null is true (Type I error). To demonstrate the degree of difference between the 73 bobwhite time series we drew 73 random time series. We examined ACFs for cyclic patterning in the random time series and then compared the bobwhite time series with the random time series by a 2-sample test for equality of proportions. The proportions tested were the proportion of cyclic or quasi-cyclic series in each time series group. We applied Yates' continuity correction to our test calculation.

To discern whether cyclicity was due to exogenous or endogenous factors we examined partial autocorrelation plots. Following Turchin (1990), we identified whether a population exhibited direct- or delayed-density dependence. Direct density dependence was iden-

Fig. 2. Autocorrelation functions for published time series of northern bobwhite abundance (A, Wing 1937; B, Errington 1957; C, Kabat and Thompson 1963; D, Rosene 1969; E, Williams 1963; F, Roseberry and Klimstra 1984; G, Mitchell 1979; H, annual Illinois harvest and Christmas Bird Counts; I, 3 data sets from Brennan et al. 2000). All plots represent northern bobwhite abundance except for Williams (1963), which are for California Quail. The horizontal dashed lines are Bartlett's line of significance; correlations exceeding this line are significant. Tentative lags located to the right of the vertical line. Refer to Table 1 for details.

NORTHERN BOBWHITE CYCLICITY

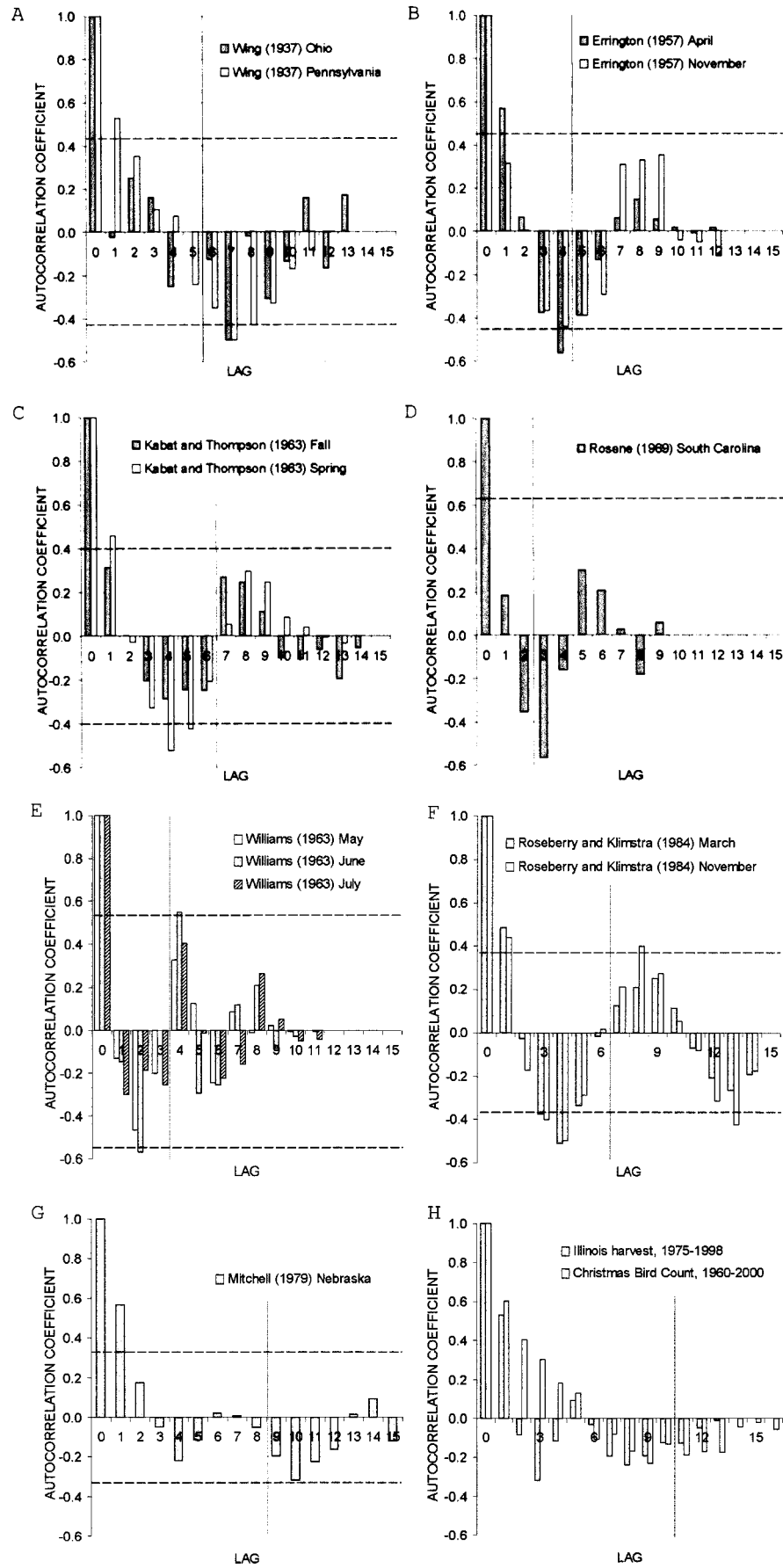

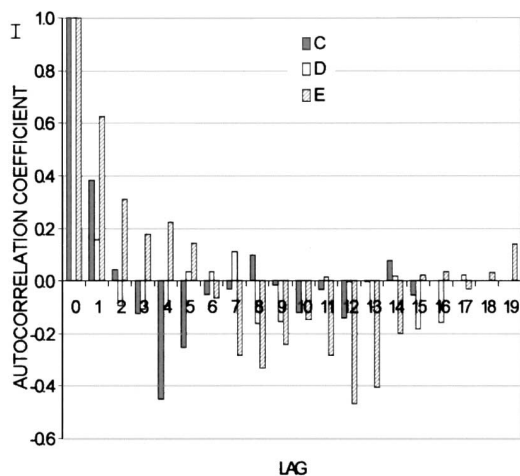

Fig. 2. Continued.

tified by a negative correlation between counts in year t and year $t-1$, whereas delayed density dependence was a negative correlation between year t and year $t-x$, where $x > 1$.

RESULTS

Illinois Data

At the time-scale we investigated ($n = 21-25$ yrs), examination of ACFs indicated periodicity in 18 of the 26 Illinois NABBS time series. None of the autocorrelations, however, exceeded Bartlett's band and, thus, no time series exhibited true cyclicity. Rather, the periodic patterns were quasi-cyclic.

The NABBS time series appeared to be grouped in 2 levels of quasi-periodicity (Fig. 1), 1 centered around a period of 7 years ($\bar{x}_T = 6.7 \pm 0.2$, $n = 6$), the other around a period of 17 years ($\bar{x}_T = 16.6 \pm 0.4$, $n = 10$). One other time series appeared to possess a period $T = 11$, whereas another time series was suggestive of periodicity $T > 20$.

Published Data Sets

Nine of 15 time series exhibited cyclical patterns (including data for the California quail), 8 of which were of the phase-forgetting quasi-cycle type (Fig. 2A-F). Periods varied considerably between 5 and 14 years (median = 8 yrs). The single instance of a definitively cycling time series ($T = 8$) was the autumn census for quail in southern Illinois (Fig. 2F; Roseberry and Klimstra 1984). Nebraska mail carrier observations, annual Illinois harvest, Christmas Bird Counts in Illinois, and coveys flushed/hour on 3 south Georgia plantations did not exhibit cyclicity (Fig. 2G-I).

Other North American Breeding Bird Survey Data Sets

Bobwhite populations as indexed by NABBS counts exhibited some form of cyclical patterning in a third of the states. Two states, Kansas and Kentucky,

possessed truly cyclic bobwhite populations (Fig. 3A). Kansas bobwhite cycled with a period of ~ 5.5 years, whereas bobwhite in Kentucky cycled on an 11-year period. Ten of the 27 remaining populations exhibited phase-forgetting quasi-cycles, similar to those of Ohio and Texas (Fig. 3B). As with the published data sets, periods varied considerably between 4 and 12 years (median = 6 yrs). Fifteen states, including Louisiana and Mississippi (Fig. 3C), exhibited little apparent periodicity.

There was a geographical gradient in cyclicity, as only northern and western populations exhibited regular variation in their abundance (Fig. 4). Based on state-level NABBS data, bobwhite in the southeastern United States demonstrated little propensity to cycle.

Comparison with Random Time Series

Fifteen of 73 time series possessed what we deemed quasi-cycles. The proportion of observed cycles ($P = 0.507$) versus expected cycles (as drawn from the random series, $P = 0.205$) was substantially greater ($\chi^2_1 = 50.6$, $P < 0.0001$). The random time series also differed from the bobwhite series in that none of the random time series exhibited true cyclicity and only 2 of the 15 random quasi-cycles were phase-forgetting, unlike the bobwhite quasi-cycles in which all were phase-forgetting.

Density Dependence

Partial autocorrelation function plots indicated delayed density dependence was not uncommon in bobwhite population dynamics though there were no instances of immediate density dependence. Seven of 18 (39%) published data sets ($\bar{x}_{lag} (\pm SE) = 4.7 \pm 1.0$), 10 of 25 (40%) Illinois NABBS routes ($\bar{x}_{lag} = 3.8 \pm 0.7$), and 9 of 30 (30%) state-level NABBS counts (including Illinois; $\bar{x}_{lag} = 4.0 \pm 1.1$) exhibited significant negative lags. Density dependence across all significant data sets was most common at lag 2 with a few significant lags as far out as 11 and 12 (grand $\bar{x}_{lag} = 4.1 \pm 0.5$). After accounting for deterministic trends in abundance, a significant lag at lag 2 indicated a steady-state population governed by density dependence increased or decreased for ≤ 2 successive years.

DISCUSSION

Approximately one-half of the time series we examined indicated cyclical behavior in bobwhite abundance, the predominant form of which was the phase-forgetting quasi-cycle. Only 3 of 73 (4%) time series exhibited truly significant periodicity. True cyclicity is a common phenomenon in boreal species such as various grouse (Keith 1963, Watson and Moss 1979, Williams 1985, Lindén 1988), hares (*Lepus* spp.; Sinclair et al. 1993), lynx (*Lynx lynx*; Keith 1963), and small mammals (Finerty 1980, Lindén 1988, Steen et al. 1990).

In quail, the evidence for cyclicity has been contradictory, both in the published literature and in the

NORTHERN BOBWHITE CYCLICITY

197

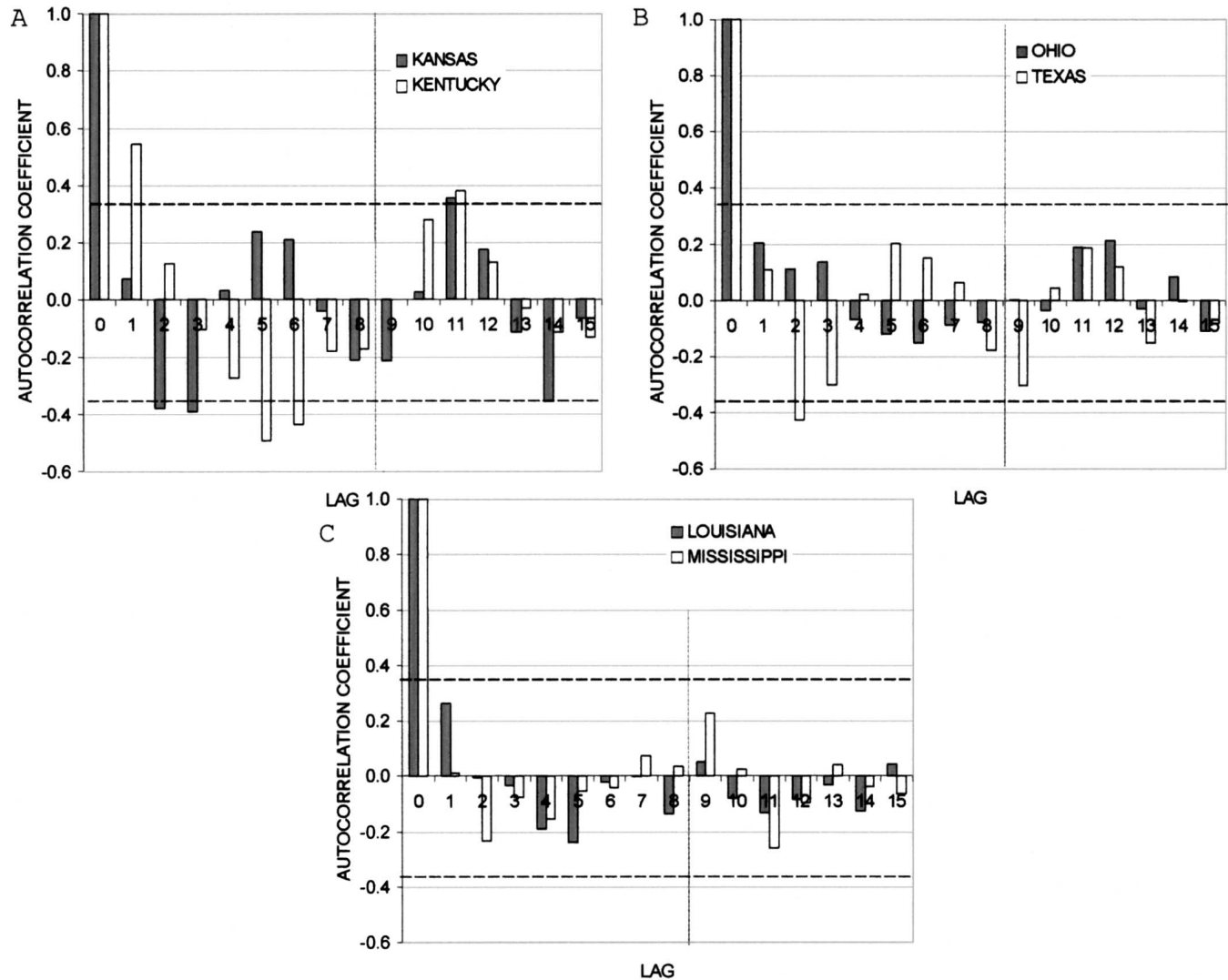

Fig. 3. Autocorrelation functions for cycling (Kans. and Ky.), quasi-cycling (Oh. and Tex.), and non-cycling (La. and Miss.) northern bobwhite populations, as determined from state-level counts of the North American Breeding Bird Survey. Autocorrelation function significant at $r = 0.336$; correlations at lags >8 are tentative due to decreased sample size.

data we analyzed. A solution for this seemingly contradictory behavior may lay in the geographical location and context of the population (Moss and Watson: In Press). Within similar latitudes, tetraonid species, for instance, exhibit both cyclic and non-cyclic dynamics (Moss and Watson: In Press). In small mammals and other taxa a biogeographical gradient occurs from north to south in amplitude and degree of cyclicality in population fluctuations (Dymond 1947, Lindén 1988, Bjørnstad et al. 1995, Turchin and Hanski 1997, Lambin et al. 2000). Because of this latitudinal gradient, true cyclicality is less common in non-boreal species.

Our analyses suggested most, but not all, of the northern and midwestern bobwhite populations exhibited periodicity in abundance. In contrast, populations in the southeastern United States exhibited no evidence for cyclicality.

In addition to latitudinal gradient, scale of analysis may be important in whether cycles are found when they exist (Moss and Watson: In Press). Watson et al.

(1998) found adjacent populations of rock ptarmigan (*Lagopus mutus*) in Scotland exhibited 6- and 10-year cycles. In bobwhite, route-level spring call counts and Roseberry and Klimstra's (1984) survey results indicated cyclicality in local population dynamics whereas regional-scale fall harvest and winter counts in Illinois did not. We believe neither fall harvest nor winter count data demonstrated cyclicality because the underlying cyclic patterns were obscured by averaging dynamics across different populations. When we examined time series of individual routes in Illinois rather than the mean state-wide NABBS, we discovered bobwhite commonly cycled at varying intervals, 17 years in central Illinois and 7 years in southern Illinois; the mean condition across routes obscured this pattern.

Similar north-to-south declines in period length were documented for voles and grouse (Moss and Watson: In Press). Angelstam et al. (1985) found voles cycled with a period of 5 years in northern Scandinavia, 3–4 years in central Scandinavia, and not at all in

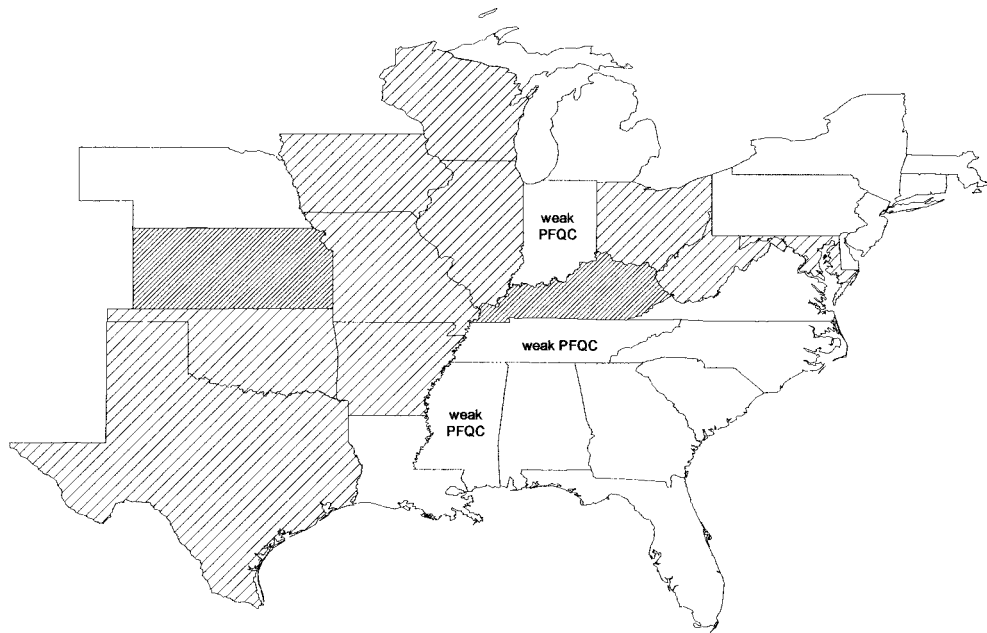

Fig. 4. Geographical gradient in the occurrence of cyclicity of northern Bobwhite as determined by North American Breeding Bird Survey data from 1967–2000 for states shown. Dark hatching indicates states where true cyclicity occurred in bobwhite abundance and light hatching indicates where bobwhite populations exhibited quasi-cyclicity. Bobwhite populations in states without hatching did not exhibit periodicity in abundance.

southern Scandinavia, whereas red grouse (*Lagopus lagopus*) cycled with periods of 7–8 years in Scotland and 4–5 years in England (Moss and Watson:In Press). Moss and Watson (In Press) suggested “regularities in weather patterns, possibly acting via plant growth, [may] entrain unstable populations to their periods.”

When cyclicity was evident in bobwhite it was generally of the phase-forgetting quasi-cycle type (PFQC; Nisbet and Gurney 1982, Turchin and Taylor 1992). Turchin and Taylor (1992) indicated deterministic population dynamics exhibiting either dampened oscillations around a stable point equilibrium, limit cycles, or “weak” chaos were sufficient to cause phase-forgetting quasi-cycles. We found that while some Illinois populations did exhibit the necessary chaotic dynamics to create phase-forgetting quasi-cycles, the number of populations that did so was small (~1%) and temporally inconsistent, and therefore an unlikely cause of cyclicity (Thogmartin 2001). So, how else may such complex patterns develop?

In a review of the causes of cyclicity, Kendall et al. (1999) indicated cycles may be caused by 1) direct and delayed-density dependence, 2) consumer-resource interactions such as predator-prey and host-pathogen, and 3) periodic environmental variation. Roseberry and Klimstra (1984) believed the cyclicity they observed was due to environmental forcings coupled with density dependence. Roseberry and Klimstra (1984) did not observe phase-forgetting, and thus their explanation was in line with Nisbet and Gurney’s (1982) periodically driven quasi-cycle. This phase-remembering pattern occurs in a deterministically stable system driven by periodic external fluctuations. They believed the periodic behavior of lunar illumination

and relatively evenly-spaced severe winter weather contributed to create cyclicity in their population.

Our analyses indicated, however, that the predominant cyclic pattern across the range of the species is phase-forgetting rather than phase-remembering. There are 3 recognized causes of phase-forgetting (Nisbet and Gurney 1982). Phase-forgetting quasi-cycles may be produced in a stable, underdamped system perturbed by either 1) demographic stochasticity (endogenous resonant quasi-cycle) or 2) aperiodic external fluctuations (exogenous resonant quasi-cycles). When the system is not stable, 3) environmental stochasticity may also promulgate PFQCs (perturbed limit cycles).

The question then is, which of the 3 causes of phase-forgetting likely explains bobwhite population dynamics? Inferring which of these processes may explain the observed PFQCs is difficult, as any or all of them may. If we can identify the bobwhite populations that we analyzed as stable or unstable, the problem becomes simpler. Stability, as Nisbet and Gurney (1982:11) defined it, is the long-term persistence of a population. By that definition, the various populations we examined were stable, if not stationary, narrowing our focus to endogenous and exogenous sources for cyclicity. Given that demographic stochasticity is most important only at small population sizes, our most parsimonious choice then becomes cyclicity due to external fluctuations. Kaitala et al. (1996) indicated occasional random perturbations reducing reproductive success may cause cyclicity in a population under delayed density-dependence. Delayed-density dependence was a common, though not universal phenomenon, in the northern and western states where cyclicity was evident. The random perturbations in these

states were likely stochastic climate extremes such as prolonged drought or extensive snowfall (Bridges et al. 2001, Thogmartin 2001). Therefore, we propose that cycles in bobwhite are likely due to the interaction of delayed density dependence and environmental perturbations. Given this proposed linkage between environmental perturbation and cyclicity in bobwhite dynamics, we might expect similar dynamics in western quail species (*Callipepla*) experiencing extremes in precipitation or temperature beyond the mean condition.

SUMMARY AND IMPLICATIONS

We established the frequency of occurrence, the geographical location, and potential mechanisms responsible for cyclicity in bobwhite. Two questions derive from these results. First, why did some northern and western populations cycle when others did not, and second, why do the periods differ between locations for those populations that do cycle?

Sixteen of the Illinois NABBS time series we examined were non-cyclic. If it is true that bobwhite populations generally unperturbed by climatic extremes, as in the southeastern United States, do not possess the necessary impetus for cyclic dynamics, then these 16 routes in Illinois may index populations buffered from climatic excess. Lack of cyclicity may also be due to a remaining degree of non-stationarity not removed by the detrending technique that we implemented.

Turchin and Taylor (1992) indicated non-stationarity may occur when there exists a lack of density dependence, externally driven periodic changes occur in the long-term mean abundance, or, if environmental change occurs on a time scale comparable to the length of the time series (≥ 25 yrs, in this case). Populations in the southeastern states, where bobwhite are experiencing their greatest decline, generally did not exhibit density dependence. When dynamics of bobwhite populations are not density dependent, populations may “randomly walk” away from the initial density, and thus do not possess a mean abundance around which to fluctuate (Turchin and Taylor 1992). This random walk is possible for bobwhite if abundance is constrained by factors other than conspecifics. Moss et al. (1996), for instance, were able to experimentally prevent population cycling in red grouse by increasing harvest when the population was on the upswing. By this rationale, bobwhite populations failing to exhibit cyclic patterns may be over-hunted during periods when the populations should be increasing.

Alternatively, non-stationarity in abundance may be due to fragmentation of habitat. Absence of cyclicity in snowshoe hares, tetraonids, and small rodents has been associated with fragmented habitat (Moss and Watson: In Press). This absence was attributed to increased mortality by generalist predators in these altered habitats and to increased dispersal into habitat where mortality exceeds reproduction (i.e., sinks). Fragmentation and loss of habitat is the primary cause associated with the decline of bobwhite indicating this

may be a more plausible hypothesis for lack of cyclic activity (Brennan 1991).

A multiplicity of processes integrating across temporal and spatial scales likely contributes to geographic differences in period length. One such source of variation is global climate patterns. For instance, El Niño Southern Oscillation events occur irregularly at intervals of 2–7 years, with the average about once every 3–4 years, whereas North Atlantic Oscillation events fluctuate on interannual and interdecadal time scales (Hurrell et al. 2001). In the midwestern United States, these global climate processes influence, for instance, seasonal temperature and precipitation, as well as corn production (Mauget and Upchurch 1999, Hurrell et al. 2001); Thogmartin (2001) showed with multivariate autoregressions that long-term bobwhite abundance in Illinois was associated with these climate processes. Both of these climatological phenomena, as well as other environmental processes, may interact to varying degrees across the bobwhite range to yield location-specific perturbations to demographic processes, causing cyclicity of varying period and strength.

ACKNOWLEDGMENTS

This study was funded through the Federal Aid in Wildlife Restoration program (Project W-106-R, Upland/Wildlife Habitat Project), the Cooperative Wildlife Research Laboratory at Southern Illinois University, Carbondale, and the Division of Wildlife Resources, Illinois Department of Natural Resources, cooperating. L. A. Brennan provided data for analysis.

LITERATURE CITED

- Angelstam, P., E. Lindstrom, and P. Widen. 1985. Synchronous short-term population fluctuations of some birds and mammals in Fennoscandia—occurrence and distribution. *Holarctic Ecology* 8:285–298.
- Bjørnstad, O. N., W. Falck, and N. C. Stenseth. 1995. A geographical gradient in small rodent density fluctuations: a statistical modelling approach. *Proceeding of the Royal Society, Biological Sciences* 262:127–133.
- Box, G. E. P., and G. M. Jenkins. 1970. *Time series analysis: forecasting and control*. Holden-Day, San Francisco, California.
- Brennan, L. A. 1991. How can we reverse the northern bobwhite decline? *Wildlife Society Bulletin* 19:544–555.
- Brennan, L. A., J. M. Lee, and R. S. Fuller. 2000. Long-term trends of northern bobwhite populations and hunting success on private shooting plantations in northern Florida and southern Georgia. *Proceedings of the National Quail Symposium* 4:75–77.
- Bridges, A. S., M. J. Peterson, N. J. Silvy, F. E. Smeins, and X. B. Wu. 2001. Differential influence of weather on regional quail abundance in Texas. *Journal of Wildlife Management* 65:10–18.
- Brockwell, P. J., and R. A. Davis. 1987. *Time series: theory and methods*. Springer-Verlag, New York, New York.
- Dymond, J. R. 1947. Fluctuations in animal populations with special reference to those of Canada. *Transactions of the Royal Society of Canada* 41:1–34.
- Edwards, W. R. 1972. Quail, land use, and weather in Illinois, 1956–1970. *Proceedings of the National Quail Symposium* 1:174–183.
- Errington, P. L. 1957. Of population cycles and unknowns. *Cold*

- Spring Harbor Symposia on Quantitative Biology 22:287–300.
- Finerty, J. P. 1980. The population ecology of cycles in small mammals. Yale University Press, New Haven, Connecticut.
- Forrester, N. D., F. S. Guthery, S. D. Kopp, and W. E. Cohen. 1998. Operative temperature reduces habitat space for northern bobwhites. *Journal of Wildlife Management* 62: 1506–1511.
- Hurrell, J. W., Y. Kushnir, and M. Visbeck. 2001. Climate: the North Atlantic Oscillation. *Science* 291:603–604.
- Kabat, C., and D. R. Thompson. 1963. Wisconsin quail, 1834–1962: population dynamics and habitat management. Technical Bulletin 30. Wisconsin Conservation Department, Madison.
- Kaitala, V., E. Ranta, and J. Lindström. 1996. Cyclic population dynamics and random perturbations. *Journal of Animal Ecology* 65:249–251.
- Keith, L. B. 1963. Wildlife's ten-year cycle. University of Wisconsin Press, Madison.
- Kendall, B. E., C. J. Briggs, W. W. Murdoch, P. Turchin, S. P. Ellner, E. McCauley, R. M. Nisbet, and S. N. Woods. 1999. Why do populations cycle? A synthesis of statistical and mechanistic modeling approaches. *Ecology* 80:1789–1805.
- Kozicky, E. L., and G. O. Hendrickson. 1952. Fluctuations in bob-white populations, Decatur County, Iowa. *Iowa State College Journal of Science* 20:97–104.
- Lambin, X., S. J. Petty, and J. L. MacKinnon. 2000. Cyclic dynamics in field vole populations and generalist predation. *Journal of Animal Ecology* 69:106–118.
- Lehmann, V. W. 1984. Bobwhites in the Rio Grande Plain of Texas. Texas A&M University Press, College Station.
- Lindén, H. 1988. Latitudinal gradients in predator-prey interactions, cyclicity and synchronism in voles and small game populations. *Oikos* 52:341–349.
- Lindström, J., H. Kokko, and E. Ranta. 1997. Detecting periodicity in short and noisy time series data. *Oikos* 78:406–410.
- Mauget, S. A., and D. R. Upchurch. 1999. El Niño and La Niña related climate and agricultural impacts over the continental United States. United States Department of Agriculture, Agricultural Research Service, Technical Bulletin 2. (<http://www.csrl.ars.usda.gov/wewc/enso&ag/techrpt2.pdf>)
- Mitchell, J. 1979. Surveys and management of bobwhite quail. Work Plan H-78, Pittman-Robertson Project W-15-R-35, Nebraska Game and Parks Commission, Lincoln.
- Mosby, H. S., and W. S. Overton. 1950. Fluctuations in the quail population on the Virginia Polytechnic Institute farms. *Transactions of the North American Wildlife Conference* 15:347–353.
- Moss, R., A. Watson, and R. Parr. 1996. Experimental prevention of a population cycle in red grouse. *Ecology* 77:1512–1530.
- Moss, R., and A. Watson. In Press. Population cycles in birds of the grouse family (Tetraonidae). *Advances in Ecological Research*.
- Nisbet, R. M., and W. S. C. Gurney. 1982. Modelling fluctuating populations. John Wiley and Sons, Chichester, New York.
- Parmalee, P. W. 1955. Some factors affecting nesting success of the bobwhite quail in east-central Texas. *American Midland Naturalist* 53:45–55.
- Peterson, M. J., and R. M. Perez. 2000. Is quail hunting self-regulatory? Northern bobwhite and scaled quail abundance and quail hunting in Texas. *Proceedings of the National Quail Symposium* 4:85–91.
- Preno, W. L., and R. F. Labisky. 1971. Abundance and harvest of doves, pheasants, bobwhites, squirrels, and cottontails in Illinois, 1956–1969. Illinois Department of Conservation Technical Bulletin 4, Springfield.
- Robinson, T. S. 1957. Climate and bobwhites in Kansas in 1956. *Transactions of the Kansas Academy of Science* 60:283–287.
- Roseberry, J. L., and W. D. Klimstra. 1984. Population ecology of the bobwhite. Southern Illinois University Press, Carbondale.
- Rosene, W. 1969. The bobwhite quail: its life and management. Rutgers University Press, New Brunswick, New Jersey.
- Schemnitz, S. D. 1964. Comparative ecology of bobwhite and scaled quail in the Oklahoma panhandle. *American Midland Naturalist* 71:429–433.
- Schwartz, C. C. 1974. Analysis of survey data collected on bobwhite in Iowa. *Journal of Wildlife Management* 38:674–678.
- Scott, T. G. 1937. Snow-killing of the bob-white. *Wilson Bulletin* 49:21–27.
- Sen, A., and M. Srivastava. 1990. Regression analysis: theory, methods, and applications. Springer, Berlin, Germany.
- Sinclair, A. R. E., J. M. Gosline, G. Holdsworth, C. J. Krebs, S. Boutin, J. N. M. Smith, R. Boonstra, and M. Dale. 1993. Can the solar cycle and climate synchronize the snowshoe hare cycle in Canada? Evidence from tree rings and ice cores. *American Naturalist* 141:173–198.
- Speake, D. W., and A. O. Haugen. 1960. Quail reproduction and weather in Alabama. *Proceedings of the Annual Conference of the Southeastern Association of Game and Fish Commissioners* 14:85–97.
- Stanford, J. A. 1972. Bobwhite quail population dynamics: relationships of weather, nesting, production patterns, fall population characteristics, and harvest in Missouri quail. *Proceedings of the National Quail Symposium* 1:115–139.
- Steen, H., N. G. Yoccoz, and R. A. Ims. 1990. Predators and small rodent cycles: an analysis of a 79-year time series of small rodent population fluctuations. *Oikos* 59:115–120.
- Stoddard, H. L. 1931. The bobwhite quail: its habits, preservation, and increase. Charles Scribner's Sons, New York, New York.
- Thogmartin, W. E. 2001. Spatial and temporal dynamics of northern bobwhite in Illinois. Dissertation. Southern Illinois University, Carbondale.
- Turchin, P. 1990. Rarity of density dependence or population regulation with lags? *Nature* 344:660–663.
- Turchin, P., and I. Hanski. 1997. An empirically based model for latitudinal gradient in vole population dynamics. *American Naturalist* 149:842–874.
- Turchin, P., and A. D. Taylor. 1992. Complex dynamics in ecological time series. *Ecology* 73:289–305.
- Watson, A., and R. Moss. 1979. Population cycles in the Tetraonidae. *Ornis Fennica* 56:87–109.
- Williams, G. R. 1963. A four-year population cycle in California quail, *Lophortyx californicus* (Shaw) in the south island of New Zealand. *Journal of Animal Ecology* 32:441–459.
- Williams, J. 1985. Statistical analysis of fluctuations in red grouse bag data. *Oecologia* 65:269–272.
- Williamson, M. 1971. The analysis of biological populations. Edward Arnold, London, United Kingdom.
- Wing, L. W. 1937. Further studies of wildlife cycles. *Transactions of the North American Wildlife Conference* 2:326–345.
- Wing, L. W. 1955. Latitudinal slippage of bob-white, hairy woodpecker, and downy woodpecker cycles. *Journal of Cycle Research* 4:3–31.

MANAGEMENT IMPLICATIONS OF ESTIMATING ABUNDANCE OF QUAIL SPECIES INHABITING FOREST ENVIRONS IN MEXICO

Jack C. Eitnienar

Center for the Study of Tropical Birds, Inc., 218 Conway Drive, San Antonio, TX 78209-1716, USA

John T. Baccus

Wildlife Management Program, Department of Biology, Southwest Texas State University, San Marcos, TX 78666, USA

ABSTRACT

Estimating abundance of forest quail in Mexico offers unique challenges to wildlife managers. Unlike quail inhabiting grassland, forest quail are often cryptic, live in inaccessible mountainous areas, and unpredictably respond to playback census techniques. During 1996–1999, we estimated abundance of singing quail (*Dactylortyx thoracicus*) and bearded wood quail (*Dendrortyx barbatus*) in northeast Mexico. Singing quail were visually counted at El Cielo Biosphere Reserve, Tamaulipas, along 14 transects varying in length from 1,400 to 5,000 m. Because of the cryptic nature of bearded wood quail, visual counts proved unsuccessful in estimating abundance. Therefore, a tape recording of their chorus call was used to determine presence. Vocalizing wood quail were documented at 10 stations on a single 1,000 m transect near Coatepec, Veracruz. Because of the varied habitat types in the area total population estimates were not estimated. Only the numbers present along our transect are reported. Estimates of abundance of singing quail were obtained due to the homogenous habitat. Density estimates from Ejido Lazaro Cardenas for singing quail were 56 quail/45.4 ha (1 quail/0.8 ha). Density estimates for La Cueva were 30 quail/15.9 ha (1 quail/0.53 ha). The management of these quail species presents a substantial challenge for biologists, because of the difficulty in obtaining population estimates. The number of wood quail estimated by each responding individual to the chorus call and possible seasonal elevation shifts of singing quail should be considered when estimates of abundance are used to set harvest regulations.

Citation: Eitnienar, J. C. and J. T. Baccus. 2002. Management implications of estimating abundance of quail species inhabiting forest environs in Mexico. Pages 201–205 in S. J. DeMaso, W. P. Kulesky, Jr., F. Hernández, and M. E. Berger eds. Quail V: Proceedings of the Fifth National Quail Symposium. Texas Parks and Wildlife Department, Austin, Texas.

Key Words: abundance, bearded wood quail, *Dactylortyx thoracicus*, *Dendrortyx barbatus*, estimating numbers, Mexico, playback, singing quail, strip

INTRODUCTION

In economic terms, species with economic value receive more monies that can be devoted to enhancing their long-term survival than species without economic value. Such economic value can be consumptive as with hunting or non-consumptive as with ecotourism. For most gamebirds in North America, consumptive strategies apply to their use as a game species (i.e., hunting). Many species of New World quail inhabiting mountainous and tropical forests of Mexico, Central and South America are in desperate need of conservation and management (Leopold 1959). Fostering value and developing management plans are necessary to prevent species extirpation (Collar et al. 1992, Mexico 1994, Carroll and Hoogesteijn 1995, McGowan et al. 1995, Carroll and Eitnienar 2000, Fuller et al. 2000). Information on population status and habitat use is an obvious precursor to the development of a sustainable management strategy. This is especially relevant if the management protocol involves harvest quotas. Such information is lacking for most tropical quail species. While the literature is replete with studies on grassland quail of North America, few, if any, propose methods for the obtaining population and demographic data

and/or the development of management strategies for tropical quail species. This paper addresses the lack of such information and focuses on our studies conducted from 1996–1999 on the status of singing quail and bearded wood quail (Eitnienar et al. In Press) in north-eastern Mexico.

METHODS

Singing Quail

The study site was located in the El Cielo Biosphere Reserve in southwestern Tamaulipas immediately south of the Tropic of Cancer between 22°48' and 23°30' north latitude and 99°00' and 99°30' west longitude. The reserve covers 10,000 ha with altitudes ranging from 200–1,600 m and is within the Sierra de Cucharas at the eastern slope of the Sierra Madre Oriental. The vegetation has been described as a mixture of tropical and temperate species (Rzedowski 1983). During 9–10 November 1996, our staff conducted a brief verbal survey of residents in ejidos San Jose, Lazaro Cardenas, Joya de Manantiales, and Alta Cima about their knowledge of singing quail. As a result of the surveys, two areas were chosen for research sites.

These included, Ejido Larzaro Cardenas (9 transects), and La Cueva (5 transects). Transect length ranged from 1,400 to 5,000 m (Eitniear et al. 1997). The location of the 2 areas was separated by 16 km to prevent quail movement between the 2 areas. The abundance of singing quail was obtained using line transect methodology (Roseberry 1982, Ralph et al. 1993) during 1997 (24 Jun–5 Jul, 21–30 Jul, 21 Sep–5 Oct). Transects were walked by an observer and quail were recorded, if they were within 10 m of the transect line. Results were compared to singing quail numbers recorded during the El Cielo Audubon Christmas bird count (CBC) published annually in *American Birds*, an annual publication of the National Audubon Society.

Bearded Wood Quail

The playback technique was tested at a site near Coatepec, Veracruz (19°28'51" N, 96°58'50" W). Because bearded wood quail are considered an elusive and secretive species (Johnsgard 1981, Howell and Webb 1995), the study site was located with assistance from local bird trappers (Aguilar 1991, Eitniear et al. 2000). The elevation of the site ranged from 1,219 to 1,376 m above sea level in an area with shaded coffee groves, cloud forest, secondary growth forest, grasslands, and tree fern associations (Rzedowski 1983). A detailed species account of the floral composition of these associations is in Garcia et al. (1993).

A line transect with 10 listening stations (Fig. 3) separated by 100 m, was established using a pedometer. A 3-minute, endless-looped tape was made of the species chorus call (Hardy and Raitt 1997). This call follows the species alarm call and is similar in function to the separation call emitted by the northern bobwhite (*Colinus virginianus*) and Venezuelan wood quail (*Odontophorus columbianus*, Bailey 1978, Carroll and Hoogenstein 1995, Pedro Mota, personal communication).

For the period 20 July 1995 to 2 April 1996, except March, surveys were conducted each month. At each station the tape was played (Marantz PMD 201 cassette player, with 1,165 kh, 25 w 8 ohm Otto speaker) 3 times for 30 seconds followed by 30 seconds of listening. Responses were recorded with respect to direction and estimated distance. All surveys were conducted between 0600 and 1000 hr.

RESULTS

Singing quail

The estimated abundance of singing quail (adults, juvenile and young) observed during 3 surveys on the 14 transects are presented in Fig 1. Survey results of Ejido Lazaro Cardenas showed a quail density of 56 quail/45.4 ha (1 quail/0.8 ha) and La Cueva 30 quail/15.9 ha (1 quail/0.53 ha).

Bearded Wood Quail

Seventeen surveys had positive responses at 8 of the 10 stations. The number of responses varied by

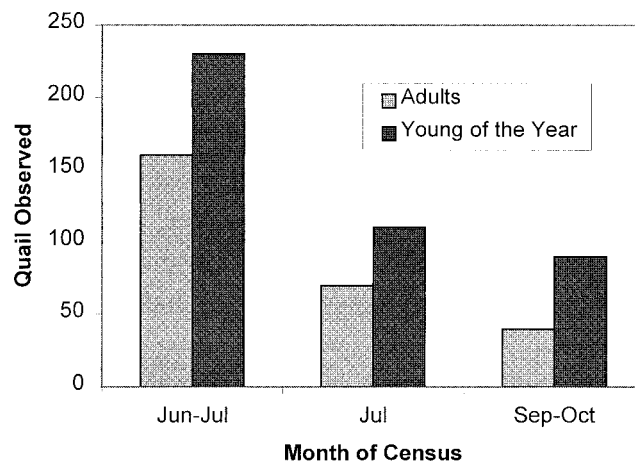

Fig 1. Total number adults and young of the year of singing quail observed in Ejido Lazaro Cardenas (transects 1–9) and La Cueva (transects 1–5) during surveys in El Cielo Biosphere Reserve, Tamaulipas, Jun–Oct 1997.

station and month (Figs. 3 and 4). We recorded 35 responses at 170 individual points (20.6% response rate). The greatest number of responses (51.4%) occurred at station 3, the only station in a cloud forest habitat. The second highest response rate (22.8%) was at station 4 in a shaded coffee grove habitat. Based on responses by this species, tree fern, grassland, coffee grove, and secondary growth forest are less suitable habitats than cloud forest for the bearded wood quail at this site.

The total number of responses varied by month. When the data are normalized (number of responses/number of stations surveyed), the response rates for October and November were greatest (Fig. 4). Response rates diminished substantially from November to April. No responses were heard in January.

DISCUSSION

Singing Quail

The total population and abundance of adult singing quail decreased throughout the summer. We speculate that the species exhibits latitudinal migration moving to lower elevations during cooler months. A preliminary survey conducted on 15 December observed zero birds. Another survey conducted on 03 March 2000 observed 2 individuals. This theory, however, requires additional study. According to Audubon Christmas Bird Count (CBC) data (1972–1996), the abundance of singing quail in El Cielo has steadily increased (Fig. 2). The increase in singing quail at this site is possibly related to the termination of timber harvesting in the early 1970s, resulting in vegetative succession towards a mature forest community. Dense canopy forest environments, which produce a heavy leaf litter layer, are the preferred habitat of singing quail, because they primarily forage in leaf litter (Leopold 1959, Warner and Harrell 1957, Arriaga 1988). In contrast to our density estimates, Harrell (1951) found a density of 1 quail/5.4 ha at El Cielo. Harrell

QUAIL ABUNDANCE IN MEXICO

203

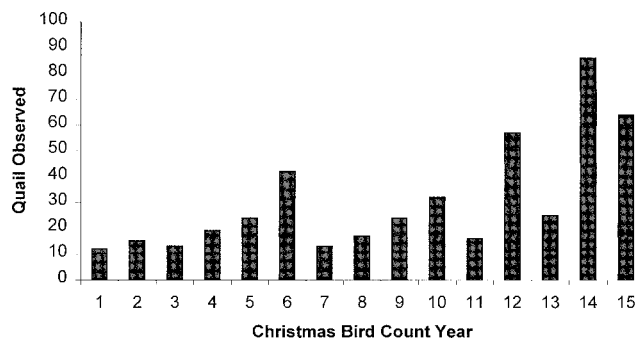

Fig. 2. Singing quail recorded during annual El Cielo CBC from 1972–96. See American Birds (1973) for count site description.

(1951) conducted his study in 1950 when logging activities were ongoing in the El Cielo region. A possible explanation for the abundance of singing quail observed in December (1972–78, 1989–96 CBC counts) may be due to the size and composition of the count circle which includes lowland riverside gallery forest and deciduous forest (American Birds 1973) that likely contain higher invertebrate populations during the winter.

Bearded Wood Quail

The advantages of using recorded calls to locate rare, secretive, or unevenly distributed birds have been compared to the stop-listen methods (Braun et al. 1973, Johnson et al. 1981, Marion et al. 1981, Parker 1991). Bohl (1956) played the species “community” call to locate chukar partridge (*Alectoris graeca*). The results of our study are similar to his findings. Determining population status in addition to establishing the presence or absence of a species requires more knowledge of the species social behavior than currently documented for species of tropical quail. Often, only 1 or 2 individuals in a small group of 2 to 7 birds would respond to played calls. The responding birds are likely adult males, although we could not be certain because the species is not sexually dichromatic. Females and subadults may constitute individuals not responding (McDonald and Winnett-Murray 1989). Further fieldwork is needed to determine how many birds are represented by 1 response. It is not known why the species responded poorly to the recorded calls during January and February. There was no response on a survey conducted in March 1997 (Sergio Aguilar-Rodriguez, personal communication). Differential response rates may be due to changes in social behavior associated with onset of the breeding season (Levy et al. 1966). Stirling and Bendell (1966) concluded that playback of a recorded call resulted in a 4-fold increase in effectiveness in surveying blue grouse (*Dendragapus obscurus*). While we did not compare this technique to the “Walk, look and listen” technique, our results indicate that it is a useful method to determine presence or absence of bearded wood quail in an area from April through December. The technique needs further development but these results suggest that call-playback surveys undertaken from July to De-

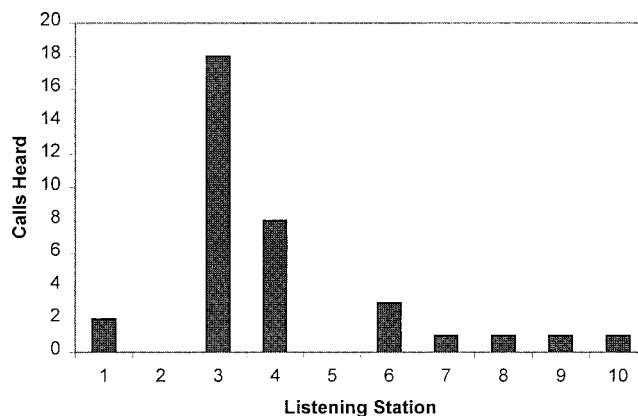

Fig. 3. Number of responding bearded wood quail to call-playbacks of conspecific chorus calls at 10 listening stations in Coatepec, Veracruz, Mexico, from Jul 1995–Apr 1996. Station composition; 1,2,7,8 Shade Coffee with varying amounts of secondary growth, 3 same as previous stations with cloud forest as southern border, stations 9,10 secondary forest with tree ferns.

cember could provide rapid presence-absence data. Better population estimates and habitat assessment of this species will require additional research.

MANAGEMENT IMPLICATIONS

Gamebird conservation initiatives supported through the sale of hunting licenses and stamps have enhanced habitat and benefited game and nongame bird species. Additionally, through the monitoring of gamebird populations, as is required to establish harvest regulations, the viability of populations is enhanced. Robust amounts of published literature on the life history, ecology, and numerous tested population monitoring techniques support the success of such management programs in temperate regions. In tropical regions, standard wildlife monitoring techniques are often less effective to study avifauna. Nevertheless, our results indicate that population status, while often limited to presence or absence, is obtainable for 2 species of tropical quail. However, social situations and seasonal movements differ from the breeding and non-

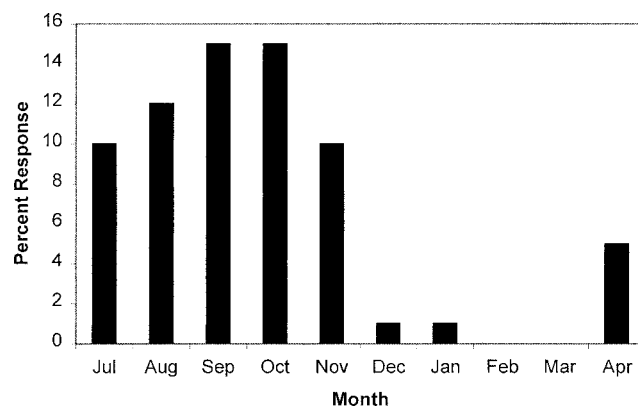

Fig. 4. Percent responses of bearded wood quail to call-playbacks of conspecific chorus calls by month when normalized (number of responses/number of listening stations surveyed).

breeding season considerations of temperate regions (Eitniear et al. 1997). Considering our initial investigations with tropical quail we suggest that game species managers in tropical countries consider the following questions in determining quail management strategies.

1. Opportunities for immigration. Is the managed population within a fragmented landscape?
2. Knowledge of the species life history. Does the species breed sporadically over a long period? Will harvest periods realistically follow periods of reproductive inactivity?
3. Population data. Can population estimates be obtained or is presence/absence data only available? If the latter, a more conservative harvest quota should be considered.
4. Physical/financial resources. Are human and financial resources available to monitor population status throughout the year?
5. Is the managing agency able to establish partnerships with hunting groups, academic institutions, and nongovernmental organizations to aid in the collection of population status data?

ACKNOWLEDGMENTS

Field data on quail would not be possible without the field assistance of Sergio H. Aquila-R. (Veracruz) and Alvaro Aragon T. (Tamaulipas). John P. Carroll, chair, WPA/Birdlife/SSC Partridge, Quail and Francolin Specialist Group assisted in securing financial support and provided significant guidance for both quail projects. Financial support was received from the World Pheasant Association-International, IUCN-SSC/Birdlife/WPA Partridge, Quail, and Francolin Specialist Group, Prince Bernhard Nature Trust, Panlitet Fentener van Vlissingen Foundation, World Nature Association, Wildlife Preservation Trust International and a Southwest Texas State University faculty research grant to John T. Baccus. Field studies were conducted under permit No. DOQ 550-4627/96 from Secretaria de Medio Ambiente, Recursos Naturales y Pesca-Mexico.

LITERATURE CITED

- American Birds. 1973. Gomez Farias Count. 27:537-538
- Aquilar, S. H. 1991. El comercio de aves silvestres vivas en Xalapa, Veracruz, Mexico. *La Ciencia y el Hombre* 7:47-61.
- Arriaga, L. 1988. Gap dynamics of a tropical cloud forest in northeastern Mexico. *Biotropica* 20:178-184.
- Bailey, K. 1978. The structure and variation of the separation call of the bobwhite quail (*Colinus virginianus*, *Odontophorinae*). *Animal Behavior* 26:296-303.
- Bohl, W. H. 1956. Experiments in locating wild chukar partridges by use of recorded calls. *Journal of Wildlife Management* 20:83-85.
- Braun, C. E., R. K. Schmidt, and G. E. Rogers. 1973. Census of Colorado White-tailed Ptarmigan with tape-recorded calls. *Journal of Wildlife Management* 37:90-93.
- Carroll, J. P., and J. C. Eitniear. 2000. Quails in Mexico: needs and opportunities. *Proceedings of the National Quail Symposium* 4:191-193.
- Carroll, J. P., and A. Hoogesteijn. 1995. Observations of the Venezuelan wood-quail at Rancho Grande, Henri Pittier Park, Venezuela. Pages 67-72 in D. Jenkins, ed. *Annual Review. WPA 1993/1994*. World Pheasant Association, Reading, United Kingdom.
- Carroll, J. P., K. E. Church, and M. G. Kelsey. 1995. Status and conservation of neotropical quails. *Proceedings International Wildlife Management Congress* 1:658-661.
- Collar, N. J., L. P. Gonzaga, N. Krabbe, A. Madrono Nieto, L. G. Naranjo, T. A. Parker III, and D. C. Wege. 1992. *Threatened birds of the Americas: the ICBP/IUCN Red Data book*. International Council for Bird Preservation. Cambridge, United Kingdom
- Eitniear, J. C., S. R. Aquilar, J. T. Baccus., and J. P. Carroll. In Press. Surveying endangered bearded wood-partridges using playback of a recorded call. *Vida Silvestre Neotropical*.
- Eitniear, J. C., S. R. Aquilar, V. Gonzalez, R. R. Pedraza, and J. T. Baccus. 2000. New records of bearded Wood-partridge, *DENDRORTYX BARBATUS*, (AVES: PHASIANIDAE) in Mexico. *Southwestern Naturalist* 45:238-241.
- Eitniear, J. C., V. Gonzalez, A. Aragon T., and J. T. Baccus. 1997. Quail research in El Cielo and Sierra Gorda biosphere reserves, Mexico. Pages 87-92 in *Memoria VII Simposium internacional de fauna silvestre*. Universidad Autonoma de Tamaulipas, Ciudad Victoria, Tamaulipas, Mexico.
- Fuller, R. A., Carroll, J. P., and McGowan, P. J. K. (eds). 2000. Partridges, quails, francolins, snowcocks, guineafowl, and turkeys. Status survey and conservation action plan 2000-2004. WPA/Birdlife/SSC Partridge, quail, and francolin specialist group. IUCN, Gland, Switzerland and Cambridge, United Kingdom, World Pheasant Association, Reading, United Kingdom.
- Garcia H. M. C., E. Lopez-Flores, M. S. Ramirez, and H. R. Oliva. 1993. Diagnostico ambiental de la subcuenca del Rio Metlac, Veracruz, Mexico. *Pronatura*, A. C. Cordoba, Veracruz.
- Hardy, J. W., and R. J. Raitt. 1997. *Voices of the New World quails*. Ara Records, Gainesville, Florida.
- Harrell B. E. 1951. *The birds of Rancho del Cielo an ecological investigation in the oak-sweet gum forest of Tamaulipas, Mexico*. Unpublished Thesis, University of Minnesota.
- Howell, S. N. G., and S. Webb. 1995. *A guide to the birds of Mexico and northern Central America*. Oxford University Press, Oxford, United Kingdom.
- Johnsgard, P. A. 1981. *Grouse and quails of North America*. University of Nebraska Press, Lincoln.
- Johnson, R. R., B. T. Brown, L. T. Haight, and J. M. Simon. 1981. Playback recordings as a special avian census technique. *Studies Avian Biology* 6:68-71.
- Leopold, A. S. 1959. *Wildlife in Mexico: the gamebirds and mammals*. University of California Press, Berkely.
- Levy, S. H., J. J. Levy, and R. A. Bishop. 1966. Use of tape-recorded female quail calls during the breeding season. *Journal of Wildlife Management* 30:426-428.
- Marion, W. R., T. E. O'meara, and D. S. Maehr. 1981. Use of playback recordings in sampling elusive and secretive birds. *Studies in Avian Biology* 6:81-85.
- McDonald, D., and K. Winnett-Murray. 1989. First reported nests of the Blackbreasted Wood-quail, *Odontophorus leucolaemus*. *Condor* 91:985-986.
- McGowan, P. J. K., S. D. Dowell, J. P. Carroll, and N. J. Aebischer. 1995. Partridges, quails, francolins, snowcocks and guineafowl; status survey and conservation action plan 1995-1999. IUCN and World Pheasant Association, Reading, United Kingdom.
- Mexico. 1994. Norma Oficial Mexicana NOM-059-ECOL-1994, 16 Mayo de 1994. que determina las especies y subespecies de flora y fauna silvestres terrestres y acuaticas en peligro de extincion, amenazadas, rara y las sujetas a proteccion

QUAIL ABUNDANCE IN MEXICO

205

- especial, y que establece especificaciones para su proteccion. *Diario Oficial de la Federacion*: 16:2-60.
- Parker, T. A. 1991. On the use of tape recorders in avifaunal surveys. *Auk* 108:443-444
- Ralph, C. J., G. R. Geupel, P. Pyle, T. E. Martin, and D. F. DeSante. 1993. Handbook of field methods for monitoring landbirds. General Technical Report PSW-GTR-144, United States Department of Agriculture, Forest Service, Pacific Southwest research Station, Albany, California. .
- Roseberry, J. L. 1982. Bobwhite. Pages 68-70 in D. E. Davis, ed. Handbook of census methods for terrestrial vertebrates. CRC Press, Inc., Boca Raton, Florida.
- Rzedowski, J. 1983. *Vegetacion de Mexico*. 2nd edition. Editorial Limusa, S. A. Mexico.
- Stirling, D. F. and J. F. Bendell. 1966. Census of Blue Grouse with recorded calls of the female. *Journal of Wildlife Management* 30:184-187.
- Warner, D. W., and B. E. Harrell. 1957. The systematics and biology of the singing quail, *Dactylortyx thoracicus*. *Wilson Bulletin* 69:122-147.

A COMPARISON OF TWO QUAIL ABUNDANCE INDICES AND THEIR RELATIONSHIP TO QUAIL HARVEST IN TEXAS

Stephen J. DeMaso

Texas Parks and Wildlife Department, 4200 Smith School Road, Austin, TX 78744, USA

Markus J. Peterson

Department of Wildlife and Fisheries Sciences, Texas A&M University, College Station, TX 77843, USA

Jon R. Purvis

Texas Parks and Wildlife Department, 4200 Smith School Road, Austin, TX 78744, USA

Nova J. Silvy

Department of Wildlife and Fisheries Sciences, Texas A&M University, College Station, TX 77843, USA

Jerry L. Cooke

Texas Parks and Wildlife Department, 4200 Smith School Road, Austin, TX 78744, USA

ABSTRACT

Surveys are used to monitor status and trends of animal populations. However, different surveys may give conflicting results for the same species and population being surveyed. Therefore, we compared results of the North American Breeding Bird Survey (BBS) and Texas Parks and Wildlife (TPW) roadside counts for scaled quail (*Callipepla squamata*) and northern bobwhite (*Colinus virginianus*) in Texas. Surveys were compared on both an ecoregion and statewide basis. The BBS and TPW surveys gave similar trends for bobwhites and scaled quail for 5 of 8, and 3 of 5 ecoregions, respectively. Survey trends differed at the statewide scale for both species. We compared estimated statewide harvest as an independent index of quail population status in Texas with results from both surveys. The TPW roadside survey was more closely related to estimated statewide harvest for northern bobwhites ($R^2 = 0.86$, $P = \leq 0.001$) and scaled quail ($R^2 = 0.75$, $P = \leq 0.0001$) than the BBS survey ($R^2 = 0.60$, $P = 0.001$; and $R^2 = 0.35$, $P = < 0.0001$, respectively). Survey methods, sampling frameworks, and issues of scale are important variables to consider when interpreting survey results. The BBS provides useful data on quail populations at a multi-state or national scale. However, most state wildlife agencies require surveys that provide information at finer spatial scales.

Citation: DeMaso, S. J., M. J. Peterson, J. R. Purvis, N. J. Silvy, and J. L. Cooke. 2002. A comparison of two quail abundance indices and their relationship to quail harvest in Texas. Pages 206–212 in S. J. DeMaso, W. P. Kuvlesky, Jr., F. Hernández, and M. E. Berger, eds. Quail V: Proceedings of the Fifth National Quail Symposium. Texas Parks and Wildlife, Austin, TX.

Key words: Breeding Bird Survey, *Callipepla squamata*, *Colinus virginianus*, index, northern bobwhite, roadside survey, scaled quail, Texas

INTRODUCTION

Most state wildlife agencies use surveys to monitor wildlife populations. Such surveys are biologically necessary and sometimes legally required to determine trends of game species abundance in many states. Various state wildlife agencies have used male-whistle counts (Bennitt 1951, Reeves 1954, Rosene 1957, Brown et al. 1978), roadside surveys (Peterson and Perez 2000), and morning covey-call counts (Davis 1979:57–58, Roseberry 1982, Guthery 1986:138–141, DeMaso et al. 1992) to monitor northern bobwhite populations.

Since the early 1990s, BBS data have been used to describe quail population trends at statewide, regional, and national scales in North America (Church et al. 1993, Capel et al. 1995). Different surveys, how-

ever, may give conflicting results for the same populations being surveyed. This could result from differences in survey methodologies, data analysis, the scale at which surveys were conducted, or the scale at which survey results were extrapolated as well as erroneous interpretation of survey data and subjective biases of the interpreters.

Our primary objective was to compare the BBS and TPW quail survey in Texas and determine which survey was more closely related to estimated statewide quail harvest. We hypothesized that both surveys would give similar results at the ecoregion and statewide spatial scales. We then discuss some of the problems and conflicting results that may arise from improperly defining survey objectives, scale issues, sample sizes, and the time frame when surveys are conducted.

METHODS

Breeding Bird Survey

The BBS is an avian-survey program initiated in 1966 to monitor the status and trends of breeding bird populations across North America (Sauer et al. 1999). Started in Maryland and Delaware, this survey now covers the continental United States and Canada. Currently, the BBS is coordinated by the United States Geological Service's Patuxent Wildlife Research Center and the Canadian Wildlife Service.

The BBS has about 4,100 permanent, active routes of which approximately 3,000 are surveyed annually in early summer. Each route is 39.4 km (24.5 mile) long, with 3-minute point counts conducted at 0.8 km (0.5 mile) intervals for a total of 50 point count stops/route. All birds heard or seen within a 0.4 km (0.25 mile) radius of each stop are recorded. Surveys begin 30 minutes before sunrise and normally require 4–5 hours for completion. Sky condition, wind speed, and temperature also are recorded at the beginning and end of each survey. Over 2,500 skilled amateur birders and professional biologists participate in the program each year. See Droege (1990) for more detail regarding the BBS.

All BBS data were obtained from the BBS web site (<http://www.mp2-pwrc.usgs.gov/bbs/>). Data from the BBS, both at the ecoregion and statewide spatial scales, are presented as the mean number of quail seen or heard/route.

TPW Quail Roadside Survey

Since 1978, quail population trends in Texas have been monitored using randomly selected 32.2-km (20-mile) roadside-survey lines [see Perez (1996) for the development of this technique and its application]. Currently, 158 survey lines are located in the Gulf Prairies, Cross Timbers, Edwards Plateau, High Plains, Rolling Plains, South Texas Plains, and Trans Pecos ecological areas (Gould 1975). Surveys in the Blackland Prairies and Pineywoods were discontinued in 1988 because of a budget cut. We report all data at the ecoregion scale, even if the number of years when surveys were conducted is not equal. Data reported at the statewide scale only contain surveys that have an equal, complete time series.

Routes are sampled once each August by TPW biologists, either at sunrise (E to W) or 1 hour prior to local sunset (W to E; Peterson and Perez 2000). Survey routes are driven at 32.2 km/hr (20 miles/hr) and all quail observed are recorded by species for each 1.6-km (1 mile) interval. The number of chicks/brood and approximate Size of broods also is recorded. Data for the index, both at the ecoregion and statewide scale, are presented as the mean number of quail observed/route.

Quail Harvest

Quail harvest estimates for Texas were determined for 1981–83 and 1986–99 as part of the annual Small

Game Harvest Survey conducted by TPW (Texas Parks and Wildlife Department 2000). This survey was mailed to 15,000 randomly-selected individuals holding a Texas hunting license (Peterson and Perez 2000). Survey questions included the species hunted, total number harvested, number of days spent hunting, and the Texas county where the person hunted the species most often. Non-respondents were mailed a second and third notice for an overall mean response of about 56.6%.

Analysis of Survey and Harvest Data

Northern bobwhite and scaled quail trends were determined by graphing BBS and TPW data by year for the 8 ecoregions having bobwhites and the 5 ecoregions where scaled quail occur. The Blackland Prairies and Pineywoods ecoregions did not have TPW survey data since 1988. However, we used all available data in our trend analysis. Trends also were determined statewide for both species.

Linear regression analysis was used to determine if slopes of trend lines were different from 0.0 (i.e., trends were increasing, decreasing, or stable). This and all subsequent statistical tests with a $P \leq 0.05$ were considered significantly different. Ninety-five percent confidence intervals were calculated for each slope to determine differences between survey types (if confidence intervals overlapped, we considered there was no significant difference). Annual percent change in quail abundance was calculated as the percent change from the first data point (1978) to the last data point (1999) in the time period, based on the regression equation for that survey type, divided by the number of years in the time interval. However, caution should be used when interpreting results from ecoregions where sample sizes are small. We compared estimates of statewide harvest from 1986–99 for bobwhites and scaled quail with estimates obtained from BBS and TPW surveys. We considered the statewide harvest data as an independent index of population status for each species. We graphed survey type (independent variable) and estimated statewide harvest (dependent variable), then conducted regression analysis to determine which survey had the strongest relationship with estimated statewide harvest (i.e., the population status).

RESULTS

The BBS and TPW survey gave similar trends for bobwhites in 5 of 8 ecoregions (Table 1, Fig. 1). The surveys also gave similar trends in 3 of 5 ecoregions for scaled quail (Table 1, Fig. 2). The statewide trends, however, differed between the surveys for both quail species (Table 1, Fig. 3)

Slopes of regression lines using BBS data were equal to 0.0 in 2 of 8 ecoregions for bobwhites, and 2 of 5 ecoregions for scaled quail (Table 2). Slopes using TPW data differed from 0.0 in 3 of 8 ecoregions for bobwhites and 3 of 5 ecoregions for scaled quail (Ta-

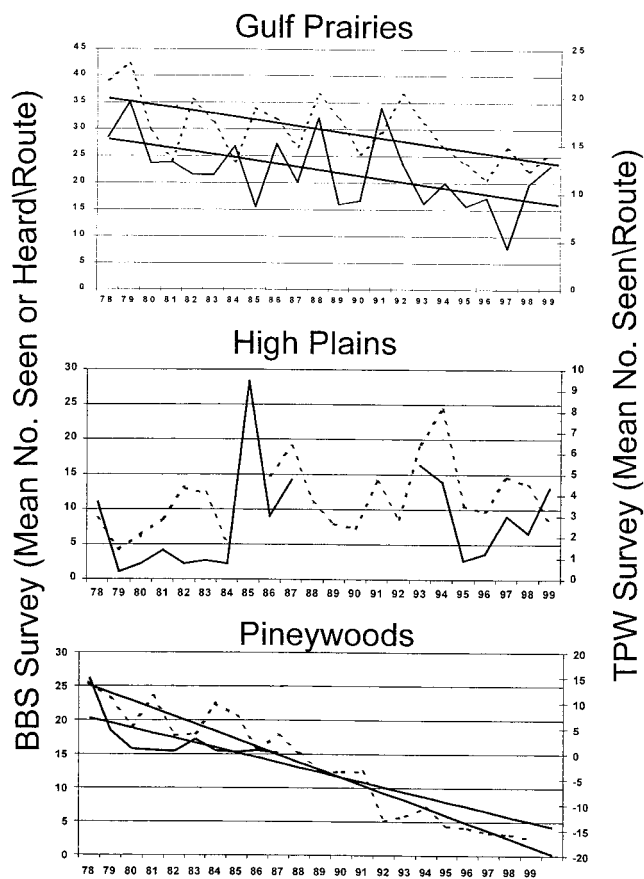
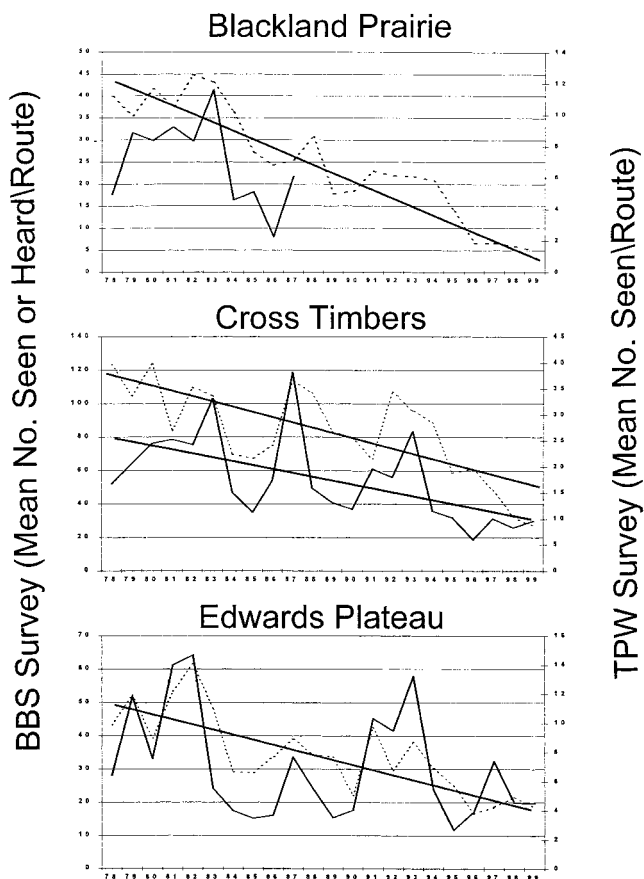

Fig. 1. Comparison of North American Breeding Bird Survey (dashed line) and Texas Parks and Wildlife roadside survey (solid line) of northern bobwhite abundance trends in Texas, by ecoregion. Trend line indicates the slope is different ($P < 0.05$) from 0.0.

Fig. 1. Continued.

ble 2). Statewide slopes differed between surveys for both quail species (Table 2).

Slopes for bobwhite trends differed between survey types in the Blackland Prairies, Cross Timbers, Edwards Plateau, South Texas Plains, and statewide (Table 3). No differences were found between surveys for scaled quail at the ecoregion or statewide scale (Table 3).

Correlation coefficients ranged between 0.22 and 0.73 for bobwhites among ecoregions, and the statewide coefficient was 0.36 (Table 4). Scaled quail correlation coefficients ranged from 0.17 to 0.64 among the ecoregions, and was 0.63 at the statewide level (Table 4). Survey types were positively correlated for both northern bobwhites and scaled quail (Table 4), but the BBS provided a more negative trend.

Annual percent change for bobwhites within ecoregions, based on BBS counts ranged from -4.3% to 1.6% (Table 5). Seven of the 8 ecoregions indicate annual declines. Similarly, TPW counts indicate annual declines in most ecoregions (Table 5). Annual percent change for scaled quail was similar among ecoregions, between survey types (Table 5).

The TPW roadside survey was more related to estimated statewide harvest for northern bobwhites ($R^2 = 0.86$, $P = < 0.0001$) and scaled quail ($R^2 = 0.75$, P

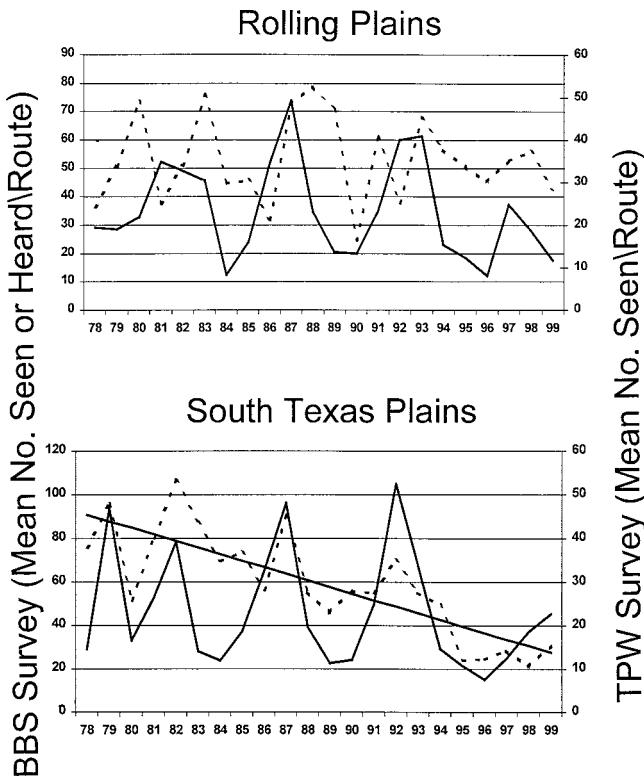

Fig. 1. Continued.

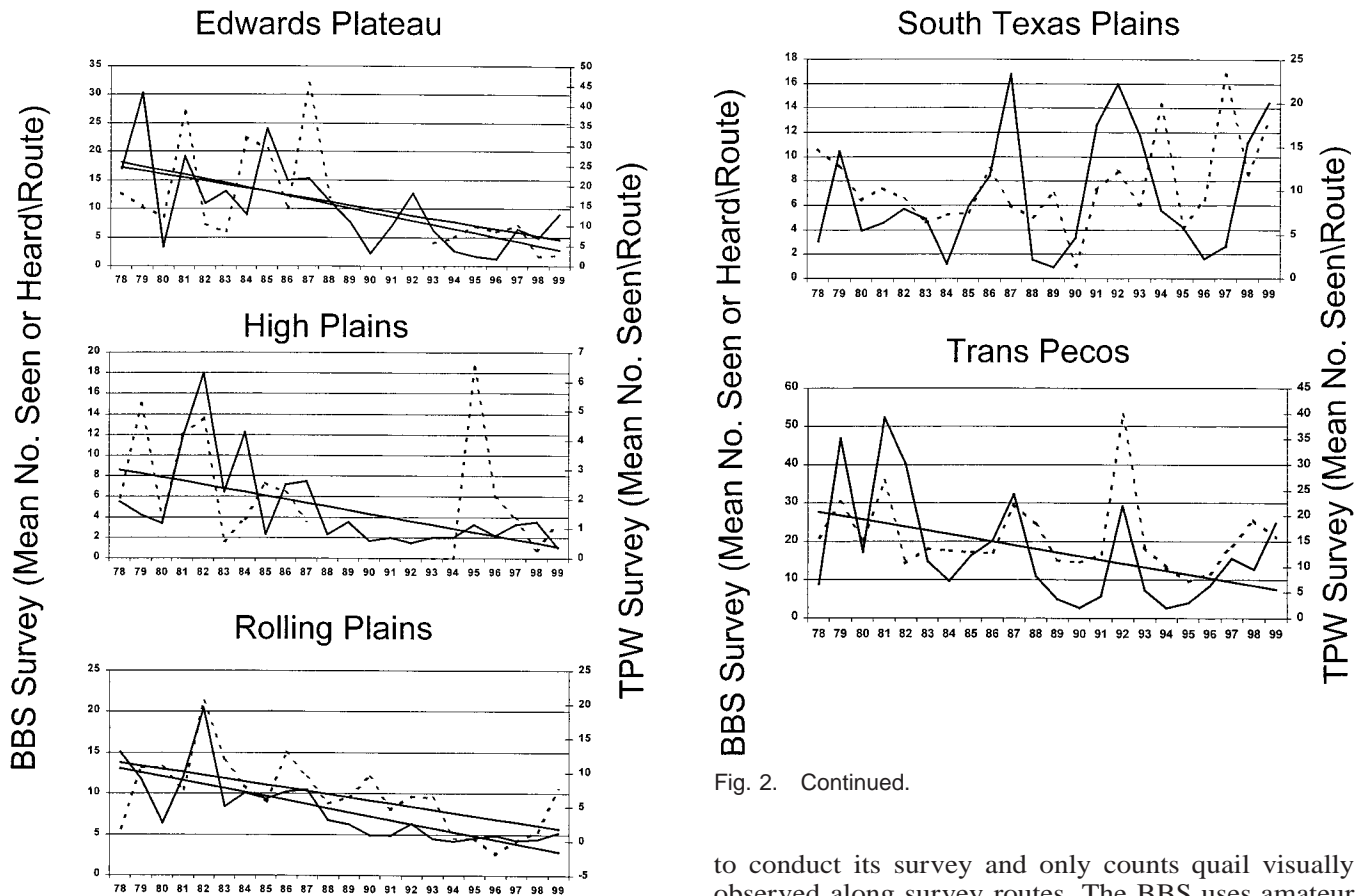

Fig. 2. Comparison of North American Breeding Bird Survey (dashed line) and Texas Parks and Wildlife roadside survey (solid line) of scaled quail abundance trends in Texas, by ecoregion, 1978–99. Trend line indicates the slope is different ($P < 0.05$) from 0.0.

Fig. 2. Continued.

= <0.0001) than was the BBS survey ($R^2 = 0.60$, $P = 0.0012$; and $R^2 = 0.35$, $P = 0.0197$, respectively) (Fig. 4).

DISCUSSION

Sauer et al. (1994) compared mourning dove (*Zenaidura macroura*) call-count surveys and the BBS and found that population estimates differed between surveys in 11 of 48 states and these differences were probably the result of the BBS having smaller ecoregion and statewide sample sizes. We found no other literature that reported comparisons of BBS counts with a similar population index for any other upland game bird species. We found that the BBS and TPW survey gave similar trends for most ecoregions, but differed at the statewide scale in Texas. Similar to many other states, parts of Texas have increasing, stable, and decreasing quail populations. However, regardless of which survey is used, quail numbers are declining if Texas is considered as a whole.

When making comparisons between surveys, it is important to understand differences in survey methodology that could influence survey results. For example, TPW uses wildlife biologists and technicians

to conduct its survey and only counts quail visually observed along survey routes. The BBS uses amateur birders and professionals to conduct surveys and all species of birds seen or heard at stops are recorded. Observer experience and the density of bird species occurring only at stops could bias BBS counts.

Another important difference between surveys is that not all BBS routes are surveyed annually. Depending on the availability of volunteers, sample sizes within an ecoregion may differ annually, and sometimes are quite small.

Table 1. Quail population trends in Texas from the North American Breeding Bird Survey (BBS) and Texas Parks and Wildlife (TPW) quail roadside survey, 1978–99.

Species	BBS	TPW
Northern Bobwhite		
Blackland Prairie	Decreasing	Stable
Cross Timbers	Decreasing	Decreasing
Edwards Plateau	Decreasing	Stable
Gulf Prairies	Decreasing	Decreasing
High Plains	Stable	Stable
Pineywoods	Decreasing	Decreasing
Rolling Plains	Stable	Stable
South Texas Plains	Decreasing	Stable
Statewide	Decreasing	Stable
Scaled Quail		
Edwards Plateau	Decreasing	Decreasing
High Plains	Decreasing	Stable
Rolling Plains	Decreasing	Decreasing
South Texas Plains	Stable	Stable
Trans Pecos	Stable	Decreasing
Statewide	Stable	Decreasing

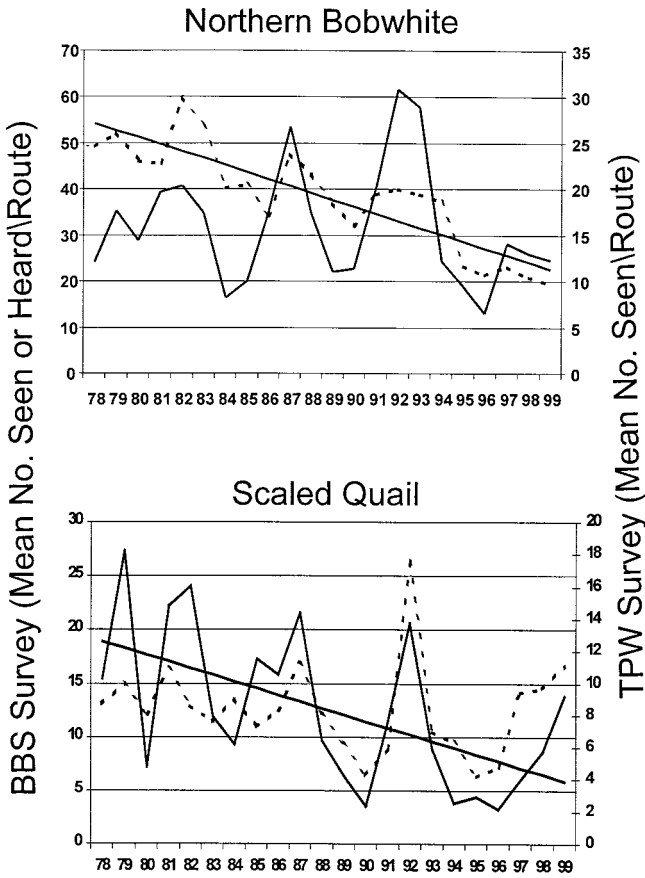

Fig. 3. Statewide comparison of North American Breeding Bird Survey (dashed line) and Texas Parks and Wildlife roadside survey (solid line) of northern bobwhite and scaled quail abundance trends in Texas, by ecoregion, 1978–99. Trend line indicates the slope is different ($P < 0.05$) from 0.0.

Table 2. P -values for t -test testing if slopes are equal to 0.0 for quail trends estimated from the North American Breeding Bird Survey (BBS) and Texas Parks and Wildlife (TPW) quail roadside survey, 1978–99.

Species	BBS	TPW
Northern Bobwhite		
Blackland Prairie	0.0001	0.2294
Cross Timbers	0.0001	0.0076
Edwards Plateau	0.0001	0.1233
Gulf Prairies	0.0052	0.0199
High Plains	0.4307	0.4262
Pineywoods	0.0001	0.0429
Rolling Plains	0.9330	0.3478
South Texas Plains	0.0001	0.3194
Statewide	0.0001	0.6928
Scaled Quail		
Edwards Plateau	0.0381	0.0017
High Plains	0.0186	0.2266
Rolling Plains	0.0045	0.0001
South Texas Plains	0.1789	0.2969
Trans Pecos	0.5042	0.0431
Statewide	0.6900	0.0072

Table 3. Ninety-five percent confidence intervals for slopes of regression lines for quail trends in Texas, by species, ecoregion, and survey type, 1978–99.

Species	BBS		TPW	
	Lower	Upper	Lower	Upper
Northern Bobwhite				
Blackland Prairie	-2.12	-1.50	-0.96	0.19
Cross Timbers	-4.39	-1.86	-1.18	-0.24
Edwards Plateau	-1.98	-0.94	-0.43	0.04
Gulf Prairies	-0.84	-0.19	-0.50	-0.06
High Plains	-0.26	0.61	-0.10	0.23
Pineywoods	-1.28	-0.99	-1.76	-0.18
Rolling Plains	-1.08	0.99	-1.12	0.38
South Texas Plains	-4.00	-2.03	-1.34	0.42
Statewide	-1.90	-1.13	-0.50	0.33
Scaled Quail				
Edwards Plateau	-1.12	-0.08	-1.60	-0.48
High Plains	-0.63	-0.08	-0.21	0.05
Rolling Plains	-0.62	-0.15	-0.80	-0.36
South Texas Plains	-0.07	0.39	-0.21	0.71
Trans Pecos	-0.86	0.42	-1.37	-0.07
Statewide	-0.36	0.23	-0.68	-0.14

Another difference between the 2 surveys is that they each use different regional boundaries within a state. We used the ecoregions delineated by Gould (1975), whereas BBS uses the regions described by Bailey (1978). These different systems do not overlap exactly. A better comparison would have been to choose regional boundaries *a priori*, then place survey routes for each survey type in the appropriate region.

The season when surveys are conducted also could affect results. The BBS is conducted at the beginning of the quail's breeding season; at a time when quail populations are at their lowest. The TPW survey is conducted in August following the majority of quail reproduction in Texas, when quail numbers are at their highest. Therefore, the BBS does not address annual

Table 4. Regression slope, R^2 , and Pearson correlation coefficient (r) for the North American Breeding Bird Survey (BBS) counts and Texas Parks and Wildlife (TPW) quail roadside counts, by quail species and ecoregion, Texas, 1978–99.

Species	BBS		TPW		r
	Slope	R^2	Slope	R^2	
Bobwhite					
Blackland Prairie	-1.81	0.86	-0.38	0.07	0.70
Cross Timbers	-3.12	0.52	-0.71	0.27	0.67
Edwards Plateau	-1.46	0.59	-0.19	0.07	0.73
Gulf Prairies	-0.52	0.30	-0.28	0.21	0.48
High Plains	0.18	0.03	0.07	<0.01	0.68
Pineywoods	-1.13	0.92	-0.97	0.35	0.61
Rolling Plains	-0.04	0.04	-0.37	<0.01	0.22
South Texas Plains	-3.01	0.63	-0.46	<0.01	0.58
Statewide	-1.51	0.74	-0.09	<0.01	0.36
Scaled Quail					
Edwards Plateau	-0.60	0.20	-1.04	0.36	0.50
High Plains	-0.36	0.21	-0.08	0.04	0.29
Rolling Plains	-0.39	0.31	-0.58	0.55	0.64
South Texas Plains	0.16	0.04	0.25	<0.01	0.17
Trans Pecos	-0.22	0.05	-0.72	0.15	0.60
Statewide	-0.06	<0.01	-0.41	0.28	0.63

QUAIL ABUNDANCE INDICES IN TEXAS

Table 5. Annual percent change in quail abundance from the North American Breeding Bird Survey (BBS) and Texas Parks and Wildlife (TPW) quail survey, 1978–99. Annual percent change calculated as percent change from first data point to last data point in the time period, based on the regression equation for that survey, divided by the number of years in the time period.

Species Ecoregion	BBS	TPW
Bobwhite		
Blackland Prairie	-3.92	-4.05
Cross Timbers	-2.56	-2.71
Edwards Plateau	-2.80	-1.96
Gulf Prairies	-1.43	-1.73
High Plains	1.61	3.84
Pineywoods	-4.29	-12.97
Rolling Plains	-0.09	-1.31
South Texas Plains	-3.15	-1.58
Statewide	-2.65	-0.46
Scaled Quail		
Edwards Plateau	-3.33	-3.82
High Plains	-3.85	-2.50
Rolling Plains	-2.75	-5.10
South Texas Plains	2.66	3.44
Trans Pecos	-0.89	-3.30
Statewide	-0.43	-3.05

production. Reproductive data are needed to aid state agencies in setting the fall hunting season.

The number of survey routes sampled also affects survey results. The TPW survey has about 150 survey routes statewide for northern bobwhites. The BBS has increased the number of routes in Texas, but averaged about 75 for the last 6 years. TPW routes for scaled quail in Texas ranged between 80 and 90. The BBS survey has less than 40 routes for scaled quail. Small sample sizes can increase variability associated with results.

Scale also is an important consideration when using surveys. Survey methodology needs to address the scale at which survey data will be extrapolated. The TPW survey was designed to be able to give information at ecoregion and statewide spatial scales. The BBS was designed for state, cross-state regions, and national scales. Most state wildlife agencies, however, need surveys that provide information at finer scales. Knowing the population status of a particular species within a given part of the state is an important aspect of conducting the states' business, providing hunting season forecasts, and setting hunting regulations.

CONCLUSIONS

The BBS was designed to represent bird populations at statewide, cross-state, regional, national, and multi-national spatial scales. Most state wildlife agencies, however, need surveys that provide information at finer scales, such as the ecoregion level, in order to track population trends, inform the regulatory process, and provide hunting season forecasts. Knowing the population status of a particular species within a given part of the state is an important part of managing quail populations, providing accurate information to the

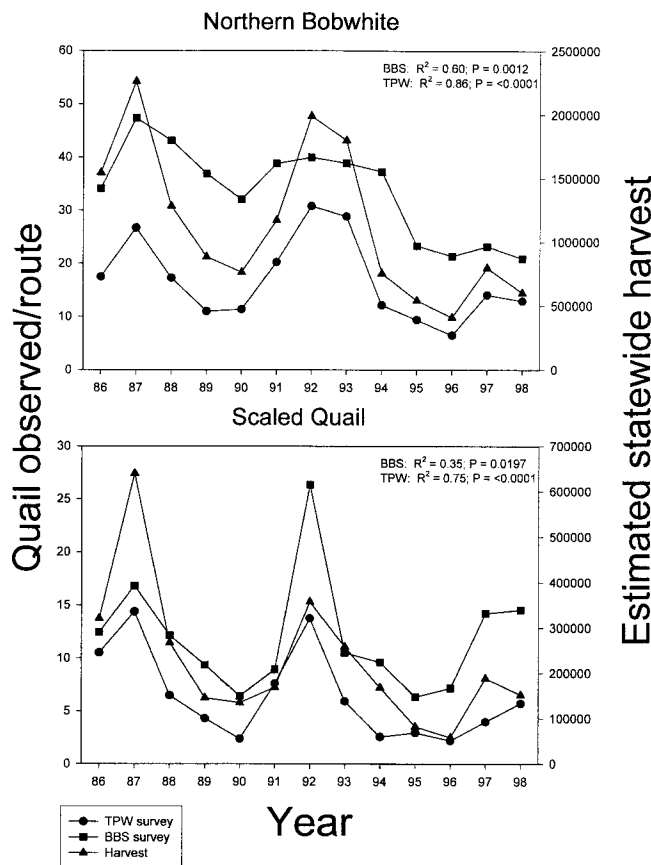

Fig. 4. Relationship between statewide North American Breeding Bird Survey, Texas Parks and Wildlife roadside survey, and estimated statewide harvest for northern bobwhites and scaled quail in Texas, 1986–99.

public, and responding to inquiries by other agencies. Therefore, the TPW production and harvest surveys should be continued in order to acquire these data.

The availability of data on the Internet may make it tempting to use the most accessible data (BBS), rather than the data collected at the appropriate scale to address a particular question. Therefore, we must be cognizant of the limitations of different surveys and strive to use the most appropriate survey to address a particular question.

ACKNOWLEDGMENTS

Mike Berger, Steve Cordts, Gary Graham, Ron George, Dave Morrison, and Jay Roberson reviewed an early draft of this manuscript. The Texas Parks and Wildlife, Wildlife Division's Headquarters Research Fund, provided financial support for this work.

LITERATURE CITED

Bailey, R. G. 1978. Description of the ecoregions of the United States. United States Forest Service, Department of Agriculture, Ogden, Utah.
 Bennett, R. 1951. Some aspects of Missouri quail and quail hunting, 1938–1948. Missouri Conservation Committee Technical Bulletin 2.

- Brown, D. E., C. I. Cochran, and T. E. Waddell. 1978. Using call-counts to predict hunting success for scaled quail. *Journal of Wildlife Management* 42:281–287.
- Capel, S., B. Carmichael, M. Gudlin, and D. Long. 1995. Wildlife habitat needs assessment, southeast region. *Transactions of the North American Wildlife and Natural Resources Conference* 60:288–299.
- Church, K. E., J. R. Sauer, and S. Droege. 1993. Population trends of quails in North America. *Proceedings of the National Quail Symposium* 3:44–54.
- Davis, B. D. 1979. Effects of brush control on quail populations. Federal Aid Service Number 19. Texas Parks and Wildlife Department, Austin.
- DeMaso, S. J., F. S. Guthery, G. S. Spears, and S. M. Rice. 1992. Morning covey calls as an index of northern bobwhite density. *Wildlife Society Bulletin* 20:94–101.
- Droege, S. 1990. The North American breeding bird survey. Pages 1–4 in J. R. Sauer and S. Droege, eds. *Survey designs and statistical methods for the estimation of avian population trends*. United States Fish and Wildlife Service, Biological Report 90(1).
- Gould, F. W. 1975. Texas plants: a checklist and ecological summary. Texas A&M University, Agricultural Experiment Station, College Station. MP-585/Revision.
- Guthery, F. S. 1986. Beef, brush, and bobwhites: quail management in cattle country. Caesar Kleberg Wildlife Research Institute Press, Kingsville, Texas.
- Perez, R. M. 1996. Small game research and surveys: quail harvest regulations. Texas Parks and Wildlife Department, Performance Report W-126-R-4, Job No. 5, Austin.
- Peterson, M. J. and R. M. Perez. 2000. Is quail hunting self-regulatory? Northern bobwhite and scaled quail abundance and quail hunting in Texas. *Proceedings of the National Quail Symposium* 4:85–91.
- Reeves, M. C. 1954. Bobwhite quail investigation. Final Report, P-R Project W-2-R, Indiana Department of Conservation, Division of Fish and Game, Indianapolis.
- Roseberry, J. L. 1982. Bobwhite. Pages 68–70 in D. E. Davis, ed. *Handbook of census methods for terrestrial vertebrates*. CRC Press, Incorporated, Boca Raton, Florida.
- Rosene, W., Jr. 1957. A summer whistling cock count of bobwhite quail as an index to wintering populations. *Journal of Wildlife Management* 21:152–158.
- Sauer, J. R., D. D. Dolton, and S. Droege. 1994. Mourning dove population trend estimates from call-count and North American breeding bird surveys. *Journal of Wildlife Management* 58:506–515.
- Sauer, J. R., J. E. Hines, I. Thomas, J. Fallon, and G. Gough. 1999. The North American breeding bird survey, results and analysis, 1966–1998. Version 98.1, United States Geological Service Patuxent Wildlife Research Center, Laurel, Maryland.
- Texas Parks and Wildlife Department. 2000. Small game harvest survey results 1981–1982 thru 1999–2000. Texas Parks and Wildlife, Austin.

HUNTING SUCCESS AND NORTHERN BOBWHITE DENSITY ON TALL TIMBERS RESEARCH STATION: 1970–2001

William E. Palmer

Tall Timbers Research Station, 13093 Henry Beadel Drive, Tallahassee, FL 32312, USA

Shane D. Wellendorf

Tall Timbers Research Station, 13093 Henry Beadel Drive, Tallahassee, FL 32312, USA

Leonard A. Brennan¹

Tall Timbers Research Station, 13093 Henry Beadel Drive, Tallahassee, FL 32312, USA

William R. Davidson

Southeastern Cooperative Wildlife Disease Study, College of Veterinary Medicine, University of Georgia, Athens, GA 30602, USA

Forest E. Kellogg²

Southeastern Cooperative Wildlife Disease Study, College of Veterinary Medicine, University of Georgia, Athens, GA 30602, USA

ABSTRACT

Hunting success, defined as number of coveys found/hr of hunting, has been used as an index of population size of northern bobwhites (*Colinus virginianus*). However, the relationship between hunting success and bobwhite density has not been documented on individual study areas. We related estimates of bobwhite density on a 445-ha section of Tall Timbers Research Station (TTRS) to the number of coveys flushed/hr of hunting, 1970–2001. To estimate density of bobwhites, we captured bobwhites in baited-funnel traps for a 2–3 week period and recaptured 15–20% of banded birds by systematically hunting the study area using pointing bird dogs. Bobwhite population sizes, calculated using a bias-corrected Peterson estimate, were converted to densities because of changes in study area size over time. Annual density estimates and hunting success ranged from 0.7–4.8 bobwhites/ha and 0.5–2.9 covey finds/hr over the study period, respectively. We assessed the variance in bobwhite abundance explained by year and hunting success using multiple linear regression. There was a significant positive relationship between covey finds/hr and bobwhite density ($t_{25} = 9.070$, $P = <0.0001$). Covey finds/hr explained the greatest amount of variation ($r^2 = 0.77$) in density. Our data suggest that if hunting procedures are standardized over time, hunting success may be used to index bobwhite abundance, and potentially provide crude estimates of population density.

Citation: Palmer, W. E., S. D. Wellendorf, L. A. Brennan, W. R. Davidson, and F. E. Kellogg. 2002. Hunting success and northern bobwhite density on Tall Timbers Research Station: 1970–2001. Pages 213–216 in S. J. DeMaso, W. P. Kuvlesky, Jr., F. Hernández, and M. E. Berger, eds. Quail V: Proceedings of the Fifth National Quail Symposium. Texas Parks and Wildlife Department, Austin, TX.

Key words: *Colinus virginianus*, Florida, hunting success, northern bobwhite, population density, population trends, Tall Timbers Research Station

INTRODUCTION

Records of hunting success are commonly maintained for private and public hunting areas (Vance and Ellis 1972, Brennan and Jacobson 1992, Brennan et al. 1997). Biologists have used this information, summarized as number of covey observations/unit of hunting effort, to index abundance of bobwhites (Rosene 1969, Brennan et al. 1997) and other game birds (Tap-

per 1992). This information may be the only available long-term index of game bird populations on certain areas (Church et al. 1993). In the Red Hills of northern Florida and southern Georgia, plantation owners maintain detailed records of hunting success, some of which span nearly 100 years (Brennan et al. 2000). While statewide indices of bobwhite abundance have been linked to statewide harvests (Schwartz 1974, Peterson and Perez 2000), the value of using hunting success as an index of bobwhite abundance on a managed area has not been assessed. Therefore, we estimated bobwhite abundance on TTRS and determined if hunting success was a useful index of bobwhite abundance from 1970–2001.

¹ Present address: Ceasar Kleberg Wildlife Research Institute, Texas A&M University, MSC218, Kingsville, TX 78363

² Present address: North American Timberlands Inc., 585 Research Drive, Suite A, Athens, GA 30605-2761

STUDY AREA

From 1970–1997 we used a 445-ha portion of TTRS located in Leon County, Florida, to estimate bobwhite density and hunting success. During this period, the study area was divided into 2 sections, 1 north and 1 south of County Road 12. Because these areas were sometimes managed differently, and quail densities were thought to differ in some years, we analyzed data collected on each sub-section as well as on the overall area. After 1997, the study area was increased to a single 805 ha and was composed of upland pine forests (65%), hardwood forested hammocks and drains (21%), and fields (14%). Over the course of the study, prescribed fire was used annually to maintain open upland pine forests. Fields were either planted in crops, annually disked, or left fallow for multiple years. Kellogg et al. (1972) and DeVos and Mueller (1993) provide additional descriptions of the study area.

METHODS

During 1970–93, personnel at the Southeastern Cooperative Wildlife Disease Study, University of Georgia, coordinated this research project in cooperation with TTRS personnel. After 1993, TTRS personnel coordinated and conducted study activities.

Population Estimates

From 1970–01, annual bobwhite population estimates were calculated using a bias-corrected Petersen estimate (Chapman 1951; O'Brien et al. 1985, Lancia et al. 1994). Bobwhites were captured using funnel traps baited with grain, marked with numbered leg bands, and released at the capture site (Kellogg et al. 1972). Trap density was approximately 1 trap/2 ha across the entire study area. Trapping started in mid-to late-January and continued until approximately 40 to 60% of the recaptured bobwhites were banded, typically taking 2–3 weeks. Within 1 week after trapping, a second sample was collected by systematically hunting the study area. The study area was divided into 12 hunting courses. Each course was thoroughly covered by 1 hunting party (composed of 1–4 hunters and their bird dogs) until all courses were hunted. Hunters were asked to harvest 2 bobwhites from each covey, however, this rule was not in effect prior to 1975. This process was repeated until 10–25% of marked bobwhites were recovered by shooting. Between 1990 and 1994, harvest rates were 10% on the south area and 25% on the north area. Typically, the shooting sample required 2–3 weeks to complete. To estimate population size, we assumed that the population was closed, marked and unmarked bobwhites had equal capture probabilities within sampling periods, capture probabilities between capture periods were independent, and bands were not lost (Smith et al. 1982, O'Brien et al. 1985). Population estimates were converted to relative densities because study area size increased after 1997.

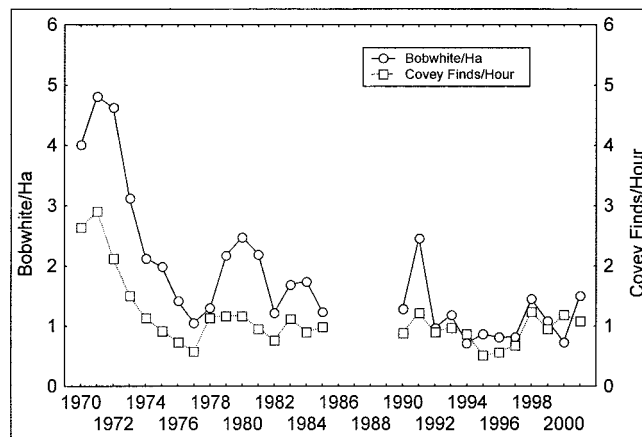

Fig. 1. Northern bobwhite density and number of hunter covey finds/hour on Tall Timbers Research Station, Florida, 1970–01.

Hunting Activity

Hunting for bobwhites on TTRS was limited to the 2–3 week period associated with recapture of banded bobwhites. Hunting methods remained consistent during each year of the study. However, personnel and dogs varied from year-to-year. Hunters walked their assigned hunting course and located coveys using pointing dogs. Hunters recorded the beginning and ending time of hunts and the number of coveys flushed. Each covey observed was considered a located covey, whether or not bobwhites were harvested. Hunting success was defined as the number of coveys flushed/hr of hunting. Hunting success for each course was averaged to determine an annual mean number of coveys flushed/hr.

Data Analysis

We assessed the relationship between bobwhite density and coveys flushed/hr using multiple linear regression (StatSoft 1996). We regressed year and coveys flushed/hr on bobwhite density. Data collected from 1986 to 1989 were not included in the analyses for the south side and the entire area because bobwhites were banded only on the north area. We used the coefficient of partial determination (r^2) to examine variation accounted for by each independent variable in our model. Residuals were tested for normality and serial correlation. Year was included in the model because error terms were serially correlated ($\rho = 0.38$) when it was not included in the model. Regression models assume error terms are independent ($\rho = 0$), normal random variables. Serial correlation of error terms ($\rho > 0$) is a common problem encountered with time series data that causes variance of error terms and regression coefficients to be underestimated (Neter et al. 1985). Serial correlation is often caused by omission of one or more key independent variables (Neter et al. 1985).

RESULTS

We banded an average of 472 bobwhites (range 127–1,139) each year between 1970–01. Population

HUNTING SUCCESS AND BOBWHITE DENSITY

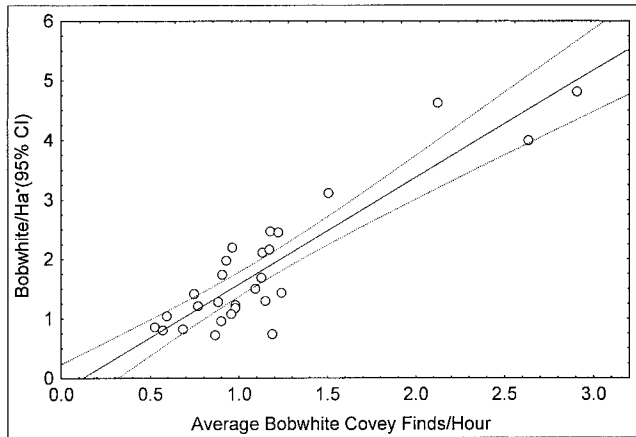

Fig. 2. Relationship between northern bobwhite density and covey finds/hour of hunting on Tall Timbers Research Station, Florida.

size and the number of coveys flushed/hr ranged from 0.7–4.8 bobwhites/ha and 0.5–2.9 coveys flushed/hr, 1970–85 and 1990–01 (Fig. 1).

Number of hunts/year averaged 45.5 (SE = 2.8). Each hunt averaged 2.3 hr (SE = 0.07). Average number of hunts/hunting course was 4.4 (SE = 0.16). Mean number of dogs used per hunting party was 2.2 (SE = 0.06). Average number of different coveys flushed/hr was 1.1 (SE = 0.1).

The overall regression of year and hunting success on density was significant ($F_{2,25} = 93.2$, $R^2 = 0.88$, $P < 0.001$). Residuals were normally distributed ($X^2 = 0.71$, $df = 1$, $P = 0.40$), were not serially correlated ($\rho = 0.02$), and were not correlated with observed density estimates ($r = 0.38$, $t_{26} = 1.87$, $P = 0.07$). Across all years, bobwhite densities were greater on the north area (1.9 quail/ha, SD = 1.35) than the south area (1.6 quail/ha, SD = 0.94), but this difference was not statistically significant ($t = 1.5$, $df = 24$, $P = 0.14$). Bobwhite densities on the north and south areas were correlated ($r = 0.75$, $P < 0.001$). The regression of year and hunting success on density was also significant for the north area ($R^2 = 0.79$, $P < 0.001$) and the south area ($R^2 = 0.70$, $P < 0.001$).

For the overall regression, the coefficient of partial determination indicated year was negatively related to density ($r^2 = 0.39$, $t_{25} = -4.0$, $P < 0.001$). Coefficient of partial determination for covey flushes/hr of hunting indicated it was positively related to bobwhite density ($r^2 = 0.77$, $t_{25} = 9.070$, $P < 0.001$) (Fig. 2).

DISCUSSION

Hunting success was strongly related to bobwhite density on TTRS. Several factors associated with this study may have facilitated the observed relationship between hunting success and density. For example, standardization of hunting, a short hunting season, and relatively constant habitat conditions that were conducive to flushing coveys all remained relatively constant from year-to-year.

For hunting success to be a suitable index of abun-

dance, the probability of observing a covey while hunting needs to remain relatively constant from year-to-year. Over the course of this study, ground cover vegetation on TTRS was maintained by use of prescribed fire and mowing. Therefore, habitat conditions over the duration of this study were conducive to flushing coveys on all portions of the study area. In a similar habitat type, Sisson et al. (2000) found that the probability of finding a covey was relatively consistent from year-to-year using pointing dogs (range 40–60%). Therefore, with standardized hunting methods, number of coveys flushed/hr of hunting should be a reasonable index of bobwhite population density. Our study suggests that on managed bobwhite plantations, hunting success is a reasonable index of bobwhite density.

A second important factor of this study was that yearly hunting occurred during a relatively short period of time. Therefore, avoidance behavior of bobwhites to hunters may not have been as severe as on a heavily hunted study area (Radomski and Guthery 2000). Hunting intensity on TTRS remained low among years such that most coveys probably interacted with hunters < 5 times/season. However, despite low hunting effort, coveys on TTRS tended to run or flush wild as hunters approached, similar to behavior observed by Sisson et al. (2000). There is little evidence that covey avoidance behavior should bias indexing bobwhite populations using hunter success. However, this factor should be considered on heavily hunted management areas, especially if hunting pressure is increasing and hunting success is declining (Brennan and Jacobson 1992). Therefore, we suggest that to avoid covey avoidance behaviors biasing indices, managers consider using only an early portion of a hunting season (e.g., first 14 days) to assess hunter success, rather than an entire season.

We assumed that hunters did not use previous knowledge of bobwhite capture sites to influence hunting behavior. If hunters choose areas to hunt based on previous experience gained from capturing quail, relationships between bobwhite density and hunting success could simply be an artifact of our study design. To avoid this potential bias, we strictly enforced that hunters completely covered their assigned area. However, as with most managed hunting areas, hunters were likely to be familiar with covey locations because of past hunting experience. But, because habitat was well distributed over each hunting course, it was more likely that hunters simply hunted the area they were assigned. Overall, we believe this assumption was reasonable and that the relationship between hunter success and bobwhite density was probably not an artifact of hunter knowledge of covey locations.

We assumed that the Petersen estimator provided an unbiased estimate of bobwhite abundance on TTRS. O'Brien et al. (1985) concluded that methods used during this study met assumptions for the Petersen estimator, except possibly the assumption of equal catchability for individual quail (aggregation behavior and trapping methodology precludes meeting this assumption). Because the methods used to mark and recapture

bobwhites were independent, potential bias created by trap response or capture heterogeneity was minimized (O'Brien et al. 1985). However, variance estimates may be negatively biased because lack of capture probability independence is a function of aggregation behavior of bobwhites that exist as coveys throughout the winter.

MANAGEMENT IMPLICATIONS

Information to index long-term trends of non-migratory species can be difficult to obtain (Church et al. 1993). To assess bobwhite abundance, private and public bobwhite managers commonly collect hunting success information (Brennan and Jacobson 1992, Brennan et al. 2000, Fies 2001) because it is relatively easy to collect. Further, biologists and managers may be wary of not collecting data that have been collected for many years and may prove useful in the future. We suggest that number of coveys flushed/hr of hunting may be an useful index of bobwhite population size for management areas if: (1) habitat conditions are relatively constant over time, (2) hunting success is measured at similar times each year, and (3) hunting methods and pressure are relatively constant or standardized. Managers should recognize that changes in hunting methods and habitat conditions over time could influence the annual probability of hunters flushing a covey, which could reduce the explanatory value of this index. If habitat conditions change over time such that the probability of hunters flushing coveys has likely changed, then using covey flushes/hr to index bobwhite populations may be ill advised.

ACKNOWLEDGMENTS

We would like to thank V. Carver, C. Croft, T. DeVos, G. Doster, R. Fuller, L. Green, M. Hartman, J. Lee, S. Manley, B. Mueller, and D. Sisson for their assistance in data collection. C. Croft coordinated data entry.

LITERATURE CITED

- Brennan, L. A., and H. A. Jacobson. 1992. Northern bobwhite (*Colinus virginianus*) hunter use of public wildlife areas: the need for proactive management. *Gibier Faune Sauvage* 9:847–858.
- Brennan, L. A., W. Rosene, B. D. Leopold, and G. A. Hurst. 1997. Northern bobwhite population trends at Groton Plantation, South Carolina: 1957–1990. Miscellaneous Publication No. 10. Tall Timbers Research Station, Tallahassee, Florida.
- Brennan, L. A., J. M. Lee, and R. S. Fuller. 2000. Long-term trends of northern bobwhite populations and hunting success on private shooting plantations in northern Florida and southern Georgia. *Proceedings of the National Quail Symposium* 4:75–77.
- Chapman, D. G. 1951. Some properties of the hypergeometric distribution with applications to zoological sample censuses. *University of California Publication of Statistics* 1:131–160.
- Church, K. E., J. R. Sauer, and S. Droege. 1993. Population trends of quails in North America. *Proceedings of the National Quail Symposium* 3:44–54.
- DeVos, T., and B. S. Mueller. 1993. Reproductive ecology of northern bobwhite in north Florida. *Proceedings of the National Quail Symposium* 3:102–108.
- Fies, M. L. 2001. 2000–2001 quail hunter cooperators survey. *Wildlife Resource Bulletin* 01-4. Virginia Department of Game & Inland Fisheries, Richmond.
- Kellogg, F. E., G. L. Doster, E. V. Komarek, Sr., and R. Komarek. 1972. The one quail per acre myth. *Proceedings of the National Bobwhite Quail Symposium Proceedings* 1: 15–20.
- Lancia, R. A., J. D. Nichols, and K. H. Pollock. 1994. Estimating the number of animals in wildlife populations. Pages 215–253 in T. A. Bookhout, ed. *Research and management techniques for wildlife and habitats*. Fifth ed. The Wildlife Society, Bethesda, Maryland.
- Neter, J., W. Wasserman, and M. H. Kutner. 1985. *Applied linear statistical models*. Second edition. R. D. Irwin, Inc. Homewood, Illinois.
- O'Brien, T. G., K. H. Pollock, W. R. Davidson, and F. E. Kellogg. 1985. A comparison of capture-recapture with capture-removal for quail populations. *Journal of Wildlife Management* 49:1062–1066.
- Peterson, M. J., and R. M. Perez. 2000. Is quail hunting self-regulatory? Northern bobwhite and scaled quail abundance and quail hunting in Texas. *Proceedings of the National Quail Symposium* 4:85–92.
- Radomski, A. A., and F. S. Guthery. 2000. Theory of the hunter-covey interface. *Proceedings of the National Quail Symposium* 4:78–81.
- Rosene, W. 1969. *The bobwhite quail; its life and management*. Rutgers University Press, New Brunswick, New Jersey.
- Schwartz, C. C. 1974. Analysis of survey data collected on bobwhite in Iowa. *Journal of Wildlife Management* 38:674–678.
- Sisson, D. C., H. L. Stribling, and D. W. Speake. 2000. Efficiency of pointing dogs in locating northern bobwhite coveys. *Proceedings of the National Quail Symposium* 4:109.
- Smith, G. F., F. E. Kellogg, G. L. Doster, and E. E. Provost. 1982. A 10-year study of bobwhite quail movement patterns. *Proceedings of the National Quail Symposium* 2:35–43.
- StatSoft. 1996. *STATISTICA for Windows*. StatSoft, Inc., Tulsa, Oklahoma.
- Tapper, S. 1992. *Game heritage: an ecological review from shooting and gamekeeping records*. The Game Conservancy, Ltd. Fordingbridge, Hampshire, United Kingdom.
- Vance, D. R., and Ellis, J. A. 1972. Bobwhite populations and hunting on Illinois public hunting areas. *Proceedings of the National Bobwhite Quail Symposium* 1:165–174.

FACTORS INFLUENCING EARLY MORNING COVEY CALLING IN NORTHERN BOBWHITES

Shane D. Wellendorf¹

Fisheries and Wildlife Sciences Program, North Carolina State University, Raleigh, NC, 27695-7646, USA

William E. Palmer

Tall Timbers Research Station, 13093 Henry Beadel Dr., Tallahassee, FL 32312, USA

Peter T. Bromley

Fisheries and Wildlife Sciences Program, North Carolina State University, Raleigh, NC, 27695-7646, USA

ABSTRACT

Data from early morning covey calling may be useful for measuring abundance of northern bobwhite (*Colinus virginianus*). However, critical assumptions about detection rates, survey timing, and seasonality effects have not been tested. Additionally, the effects of weather and covey density on call rates are unknown. We quantified call rates of 219 radiomarked coveys at 5 sites in 1998 and 2 sites in 1997 and 1999 to monitor calling behavior of bobwhite coveys. First calls for coveys ($n = 442$) occurred on average 23.4 (SE = 0.5) min before sunrise and averaged 31.4 ± 1.9 calls/covey. Few first calls (13%) occurred after 15 min before sunrise. Across sites, call rates averaged 58% (SE = 2.0) ($n = 763$). Call rates were most variable during September and December biweekly periods and least variable during late October and early November biweekly periods. We developed 15 logistic regression models from data collected in 1998 for predicting the probability of a covey to call. Selected best models were chosen using the Akaike information criterion modified for overdispersion and small sample size. The selected best model included number of adjacent calling coveys, wind speed, cloud cover, and barometric pressure change. Parameter estimates for number of adjacent calling coveys had an odds ratio of 1.4; the 95% CI did not contain 0. A less parsimonious model, which also included biweekly period and interaction terms, was equally as likely (QAIC_c = 0.32) as the selected model. The 16–31 October biweekly period had an odds ratio of 1.8; conditional 95% CI not containing 0. A *post hoc* analysis was conducted using the same candidate model list, but we replaced number of adjacent calling coveys with deviations of the number of adjacent calling coveys from site means. Results were similar to the previous analysis with the same selected best model, but model fit was improved. Selected best models were tested using observations collected in 1999 from 2 of the 5 sites monitored in 1998. Predicted call rates were relatively precise (observed call rate-predicted call rate <0.10) for biweekly periods associated with peak call rates, but call rates were less precise (range 0.12–0.27) for other biweekly periods. Constancy of call rates suggests that at bobwhite densities we observed (0.75 and 5 bobwhites/ha), covey call surveys have potential to index fall populations of bobwhites with reasonable accuracy.

Citation: Wellendorf, S. D., W. E. Palmer, and P. T. Bromley. 2002. Factors influencing early morning covey calling in northern bobwhites. Page 217 in S. J. DeMaso, W. P. Kuvlesky, Jr., F. Hernández, and M. E. Berger, eds. Quail V: Proceedings of the Fifth National Quail Symposium. Texas Parks and Wildlife Department, Austin, TX.

¹ Present address: Tall Timbers Research Station, 13093 Henry Beadel Dr., Tallahassee, FL 32312

IMPROVING QUAIL MANAGEMENT THROUGH STATISTICAL MODELLING

Erynn M. Call

Department of Fisheries and Wildlife Sciences–Missouri Cooperative Fish and Wildlife Research Unit, 303G ABNR Bldg., University of Missouri-Columbia, Columbia, MO 65211, USA

Ronald D. Drobney

Department of Fisheries and Wildlife Sciences–Missouri Cooperative Fish and Wildlife Research Unit, 302 ABNR Bldg., University of Missouri-Columbia, Columbia, MO 65211, USA

Thomas V. Dailey

Missouri Department of Conservation, 1110 South College Avenue, Columbia, MO 65201, USA

ABSTRACT

Northern bobwhite (*Colinus virginianus*) populations have been declining since the 1960s. Anthropogenic influences, particularly farming, are suspected to be 1 of the most significant contributors to loss of landscape diversity and thus the present scarcity of bobwhites. Because of habitat degradation on private lands, management on public areas is critical to sustain populations. To understand the efficacy of management efforts, information relating survival and nest success to habitat characteristics within intensively managed areas is needed. Within Missouri, management is currently based upon data collected from poor habitat on private agricultural land in northeast Missouri. Population dynamics within agricultural habitat are not necessarily relevant to intensively managed areas. Our research was conducted on 3 conservation areas that focus on bobwhite management. This poster will present population data that will eventually be incorporated into a model identifying factors that affect bobwhite reproduction and survival. Data were derived from radiomarked birds that were located 6 days/week to document survival. We monitored incubating birds until nest termination to determine nest success. The probability of surviving to the end of the first field season (1 May–30 Sep 2000) was 0.021 (SE = 0.08, $n = 95$). At the end of the first field season, 6 birds survived, 55 died, 12 slipped the radio collar, and 22 were censored due to disappearance of the radio signal (unknown fate). Overall nest survival during the 22-day incubation period was 54.8%. Results of this research will provide managers insight into the effects of habitat manipulations on bobwhite populations.

Citation: Call, E. M., R. D. Drobney, and T. V. Dailey. Improving quail management through statistical modelling. Page 218 in S. J. DeMaso, W. P. Kuvlesky, Jr., F. Hernández, and M. E. Berger, eds. Quail V: Proceedings of the Fifth National Quail Symposium, Texas Parks and Wildlife Department, Austin, TX.

COMPARISON OF METHODS TO CAPTURE BOBWHITES DURING SUMMER

Shane D. Wellendorf

Fisheries and Wildlife Sciences Program, North Carolina State University, Raleigh, NC 27695-7646, USA

A. Vincent Carver

Tall Timbers Research Station, 13093 Henry Beadel Dr., Tallahassee, FL 32312, USA

William E. Palmer

Tall Timbers Research Station, 13093 Henry Beadel Dr., Tallahassee, FL 32312, USA

ABSTRACT

Live-capturing northern bobwhites (*Colinus virginianus*) using baited funnel traps during summer often is inefficient. Previous methods to attract wild bobwhites to a trap site have included bait (typically cracked corn), or use of a pen-raised female bobwhite inside the trap. It has been suggested that playing electronic recordings of the bobwhite's "koi-lee" call at the trap site may improve trap success, but this idea has never been tested. Therefore, in July 1999, we collected trapping data from farms in Wilson County, North Carolina and Tall Timbers Research Station (TTRS) in Leon County, Florida. Trap sites were randomly assigned each day with 1 of 4 treatments including bait only, bait with electronic calling (bait and call), pen-raised female bobwhite (hen), or a hen with electronic calling (hen and call). Traps were set starting at sunrise and were checked after sunset. We captured 87 males, 10 females, and 3 immature bobwhites in 500 trap nights. At TTRS, number of bobwhites caught per 10 trap nights was 0.5 for bait, 0.2 for bait and call, 4.2 for hen, and 4.4 for hen and call. At Wilson, number of bobwhites caught per 10 trap nights was 1.0 for bait, 0.4 for bait and call, 1.3 for hen, and 3.3 for hen and call. Trap success for the hen only and hen and call treatments varied between sites. At TTRS, use of hens greatly improved capture success compared to using bait, but little difference was observed between hen only and hen and call treatments. Conversely, at Wilson, hen only and bait only treatments had similar capture success, but the hen and call treatment was 2.5 times more successful over the other treatments. Electronic calling appeared to have attracted bobwhites to the trap vicinity and the hen appeared to encourage bobwhites to enter the trap. This circumstance was especially evident at Wilson where the overall bobwhite abundance was low and the distribution was unequal across the landscape. We recommend using pen-raised female bobwhite and electronic calling to maximize trap success during the bobwhite breeding season on areas with low to moderate bobwhite densities.

Citation: Wellendorf, S. D., A. V. Carver, and W. E. Palmer. 2002. Comparison of methods to capture bobwhites during summer. Page 219 in S. J. DeMaso, W. P. Kuvlesky, Jr., F. Hernández, and M. E. Berger, eds. Quail V: Proceedings of the Fifth National Quail Symposium, Texas Parks and Wildlife Department, Austin, TX.

METHODS FOR CAPTURING, MARKING, AND ESTIMATING SURVIVAL OF NORTHERN BOBWHITE CHICKS

Mark D. Smith

Department of Wildlife and Fisheries, Mississippi State University, Box 9690, Mississippi State, MS 39762, USA

Adam D. Hammond

Department of Wildlife and Fisheries, Mississippi State University, Box 9690, Mississippi State, MS 39762, USA

L. Wes Burger

Department of Wildlife and Fisheries, Mississippi State University, Box 9690, Mississippi State, MS 39762, USA

William E. Palmer

Tall Timbers Research Station, 13093 Henry Beadel Drive, Tallahassee, FL 32312, USA

A. Vince Carver

Tall Timbers Research Station, 13093 Henry Beadel Drive, Tallahassee, FL 32312, USA

Scott Szukaitis

Department of Wildlife and Fisheries, Mississippi State University, Box 9690, Mississippi State, MS 39762, USA

ABSTRACT

Lack of techniques to capture, mark, and observe chicks from hatch to fall has hindered our ability to understand this critical life stage of northern bobwhite (*Colinus virginianus*) and other galliforms. We present 2 methods for capturing wild, free-ranging northern bobwhite chicks associated with a radiomarked adult and demonstrate application of capture-recapture estimators. Both capture techniques involve monitoring radiomarked adults, locating nests, determining date of hatch, and then locating roosting adults with broods prior to sunrise during the pre-flight period (1–12 days post-hatch). The first technique involves erecting a temporary circular fence around the roosting radio-marked bird and brood, securing the edges with dirt, and systematically clearing all vegetation and ground debris until chicks are captured. The second technique involves placing a temporary fence in a “V” formation with a small mesh funnel trap placed at the apex. Birds are then “corralled” into the funnel trap. We used both methods during the breeding seasons of 1997–99. Overall, we captured 762 chicks from 137 broods. Of 131 capture attempts using the ring method, 18.3% (n = 24) were complete failures, 13.7% (n = 18) resulted in partial capture, whereas 68% (n = 89) resulted in complete capture. Using the funnel method, 22.2% (n = 2) of attempts were complete failures, 22.2% (n = 2) resulted in partial captures, and 55.6% (n = 5) resulted in complete brood capture. Captured chicks can be permanently and uniquely marked using monel patagial wing bands. We demonstrate application of capture-recapture models in program MARK to estimate chick survival from hatch to recruitment in the fall population (Oct 1).

Citation: Smith, M. D., A. D. Hammond, L. W. Burger, W. E. Palmer, A. V. Carver, and S. Szukaitis. 2002. Methods for capturing, marking, and estimating survival of northern bobwhite chicks. Page 220 in S. J. DeMaso, W. P. Kuvlesky, Jr., F. Hernández, and M. E. Berger, eds. Quail V: Proceedings of the Fifth National Quail Symposium, Texas Parks and Wildlife Department, Austin, TX.

RELATIONSHIP AMONG PLASMA TRIGLYCERIDES, BODY MASS, AND REPRODUCTION OF NORTHERN BOBWHITES

J. M. Mueller¹

Department of Range, Wildlife, and Fisheries Management, Texas Tech University, Lubbock, TX 79409-2125, USA

C. B. Dabbert

Department of Range, Wildlife, and Fisheries Management, Texas Tech University, Lubbock, TX 79409-2125, USA

ABSTRACT

The earliest potential initiation of northern bobwhite (*Colinus virginianus*) reproduction is limited by photoperiod. Secondary factors such as lipid reserves, diet, and stress often limit the beginning of northern bobwhite reproduction, potentially reducing reproductive success and causing a shorter reproductive season. We measured late winter body masses and plasma triglycerides of wild northern bobwhites and subsequent reproductive timing and effort in 1997 and 1998 on the coastal prairie of Texas. Using body mass and plasma triglyceride levels as indices of body fat, we tested the hypothesis that the onset of reproduction and first clutch size was influenced by late winter lipid reserves. Northern bobwhite plasma triglycerides were higher ($P < 0.001$) and more variable ($P = 0.019$) in 1998, and nesting began 15 ± 1.6 days ($\chi \pm SE$) earlier than in 1997. However, within each year, no combination of body mass and triglycerides was associated with timing of nesting or size of first clutch ($P > 0.1$). In addition, body masses were not correlated with plasma triglycerides ($P > 0.1$). Our findings suggest that individual plasma triglyceride levels and body mass are unsuitable variables for assessing within-population differences in reproductive timing. However, mean plasma triglycerides for a population may be useful for assessing differences in reproductive timing among years and locations. The relationship between triglycerides and hormones directly affecting gonadal recrudescence, such as luteinizing hormone (LH) and prolactin, is uncertain for wild northern bobwhites. Thus, future studies should assess causes and patterns of change in these hormones.

Citation: Mueller J. M., and C. B. Dabbert. 2002. Relationship among plasma triglycerides, body mass, and reproduction of northern bobwhites. Pages 221–224 in S. J. DeMaso, W. P. Kuvlesky, Jr., F. Hernández, and M. E. Berger, eds. Quail V: Proceedings of the Fifth National Quail Symposium. Texas Parks and Wildlife Department, Austin, TX.

Key words: body mass, *Colinus virginianus*, northern bobwhite, reproduction, triglycerides

INTRODUCTION

The initiation of reproduction in birds is controlled by the endocrine system (Bahr and Johnson 1991). Photoperiod has an overriding influence on reproduction in many species, including northern bobwhite (Kirkpatrick and Leopold 1952), by regulating hypothalamic secretions of follicle stimulating hormone (FSH) and LH (Farner and Follett 1979, Carey 1996). After minimum photoperiod is available to birds, secondary factors may influence hormone levels and determine when individuals begin to reproduce. Physiological condition, diet, and stress are 3 interrelated secondary factors influencing northern bobwhite reproduction. For example, water deprivation in northern bobwhites decreases serum progesterone, delays or prevents egg production, decreases clutch size, and causes smaller eggs (Cain and Lien 1985, Koerth and Guthery 1991, Giuliano et al. 1995). Insufficient dietary energy increases serum corticosterone and decreases northern bobwhite egg production (Giuliano et al. 1996). Lower body mass in late winter may delay the onset of egg laying in pheasants (*Phasianus colchicus*), probably due to levels of stress and reproductive hormones (Gates and Woehler 1968). Physiolog-

ical condition, diet, and stress are probably strongly correlated among wild birds at any particular time and place because these factors are largely dependent on environmental conditions. However, differences in condition, diet, and stress within a population may explain within-year variability in the timing of reproduction and reproductive effort.

Late winter lipid reserves probably influence future reproduction (Gates and Woehler 1968), although lipid reserves are less important to reproduction of grouses and presumably other galliforms as compared to waterfowl (Thomas 1988). Lipid reserves could increase size of the first clutch by allowing a female to maintain and recruit more follicles for ovulation, largely through the action of FSH (Carey 1996). Lipid reserves are correlated with northern bobwhite body masses during winter (Robel 1972, Frawley et al. 1999), and with both body masses and plasma triglycerides when measured in other avians (Bacon et al. 1989, Dabbert et al. 1997). Thus, late winter body masses and plasma triglycerides may explain within-year variability of reproductive timing and first clutch sizes. We tested the hypothesis that the onset of reproduction and first clutch size of northern bobwhites was influenced by late winter lipid reserves, using body masses and plasma triglyceride levels as indices of body fat.

¹ Present address: Department of Biology, Sul Ross State University, Box C-64, Alpine, TX 79832

METHODS

Female northern bobwhites were captured from 1 February through 23 April in 1997 and 1998 primarily with walk-in funnel traps (Smith et al. 1981) baited with milo. All hens were weighed, marked with an aluminum legband (National Band and Tag Co., Newport, Kentucky), radiomarked (American Wildlife Enterprises, Montacello, Florida), bled, and released. Each hen was bled by pricking the ulnar or brachial vein with a 25-gauge needle and collecting blood into heparinized capillary tubes. Capillary tubes were sealed with clay, transported to a field lab, and centrifuged. Tubes were then scored with a diamond-tipped pen and broken immediately above the white blood cell layer. Plasma was pipetted into cryovials, frozen initially at -20°C and then -84°C , and shipped on dry ice to a commercial laboratory (Veterinary Associates Laboratory, Edmond, Oklahoma) for measurement of triglycerides using a Technicon RA-1000[®] clinical chemistry analyzer (Bayer Corporation, Pittsburgh, Pennsylvania). Hemolytic and lipemic samples were discarded due to potential measurement errors (Alleman 1990).

From late April until mid-July, most radiomarked hens were located at least once every other day to find nests. Each bird was approached on foot until it flushed or moved away, was observed, or had been circled by the researcher, indicating that it might be on a nest. Two sets of stake flags were placed at a distance of 5 and 10 m from the nest, oriented so that each set was aligned with the nest. The position of the nest could be determined on subsequent visits by sighting down both sets of stake flags and determining the point where the 2 lines intersected. This marking method was used so that predators investigating the stake flags were not drawn directly to the nest. Hens were never intentionally flushed from nests and rarely flushed inadvertently. To confirm the nest location and clutch size, the nest site was checked at times when the hen might be away from the nest feeding. When the nest was unoccupied, the number of eggs was recorded. The date that eggs in a nest began to be incubated was estimated by averaging the last date that a hen was not found on a nest and the first date that a hen was found incubating eggs on a nest. The date that nesting began was estimated by subtracting the number of eggs in a nest from the estimated date that incubation of eggs began.

Data Analysis

The value of late-winter body mass and plasma triglycerides as predictors of first clutch size and date of first nest initiation was assessed using multiple linear regression. Body masses and plasma triglycerides were recorded from birds captured 6–16 February 1997 and 4 February–7 March 1998. Records for 5 nests initiated >30 days after the earliest nests each year were censored because it was suspected that the initial nests for these birds were not detected. First nests would probably not have been detected if they

Table 1. First clutch sizes, dates of nest initiation, late winter body masses (g), and plasma triglyceride levels (mg/dL) of northern bobwhites in 1997 ($n = 17$) and 1998 ($n = 23$), Refugio County, Texas.

Variable	1997		1998	
	\bar{x}	SE	\bar{x}	SE
First clutch size	15.7	0.3	15.2	0.4
Date of nest initiation	3 May	1.9	18 April	1.4
Body mass	167.7	2.6	161.1	1.9
Plasma triglyceride	122.2	9.6	250.1	21.0

were depredated before incubation began or if the male incubated the eggs.

Residuals were tested for normality using the Shapiro–Wilk test (Shapiro and Wilk 1965). Homoscedasticity and linearity were assessed by examining plots of residual and predicted values. Analyses were conducted using SPSS for Windows, release 6.0 (Norušis 1993). Statistical significance was determined with $\alpha = 0.05$. Means are reported ± 1 SE.

RESULTS

Body masses, plasma triglyceride levels, dates of nest initiation, and sizes of first clutches were obtained for 17 northern bobwhite hens in 1997 and 23 in 1998 (Table 1). Northern bobwhites began nesting 15 ± 1.6 days earlier in 1998 ($t_{38} = 6.70$, $P < 0.001$). Clutch sizes did not differ between years ($t_{38} = 0.86$, $P = 0.394$). The mean and variance of plasma triglycerides were higher in 1998 (mean: t-test for unequal variances, $t_{30} = -5.53$, $P < 0.001$; variance: Levene's [1960] test, $F_{1,38} = 5.99$, $P = 0.019$). Body masses were lower in 1998 (t-test for equal variances, $t_{38} = 2.09$, $P = 0.043$). Plasma triglycerides were not correlated with body mass either year (1997: $R^2 = 0.01$, $F_{1,15} = 0.20$, $P = 0.660$; 1998: $R^2 = 0.12$, $F_{1,21} = 2.87$, $P = 0.105$; Fig. 1).

Tests for relationships among variables were conducted separately for each year because birds began reproducing earlier in 1998. No combination of body mass and triglycerides successfully predicted date of nest initiation or first clutch size (Table 2). Assumptions of normality and homoscedasticity were violated for analyses of clutch size in 1998 due to a clutch of 22 eggs. The analysis was repeated with this record removed with identical results.

DISCUSSION

Late winter body mass and plasma triglycerides were not related to date of nest initiation or first clutch size either year. This contradicts patterns found in turkeys (*Meleagris gallopavo*) (Badyaev et al. 1996), where body mass in February–March and nest initiation date were the best predictors of clutch size of first nests. However, in the turkey study (Badyaev et al. 1996), the partial r for female body mass was 0.10. Thus, turkey body mass accounted for only an additional 1% of the variation in clutch sizes given the

BOBWHITE REPRODUCTION AND BODY CONDITION

223

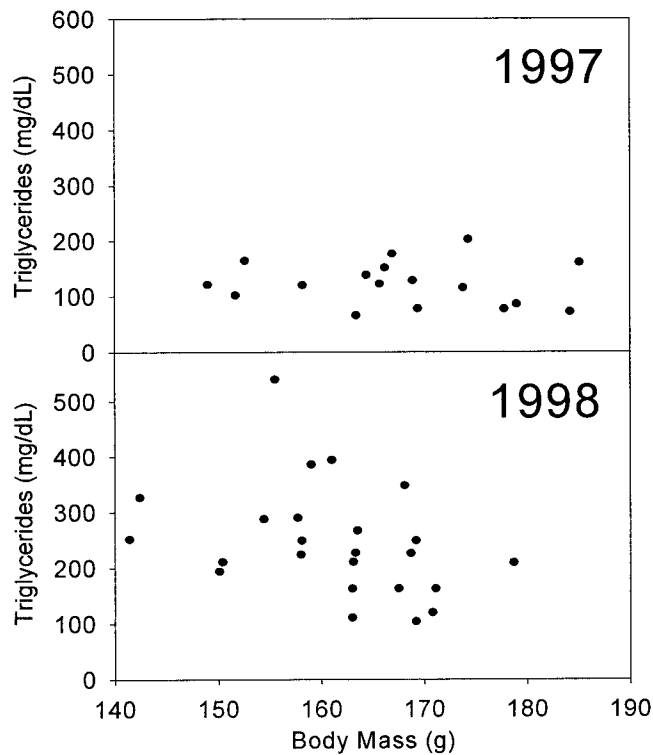

Fig. 1. Lack of linear relation between plasma triglycerides and body mass of northern bobwhites in 1997 and 1998, Refugio County, Texas (1997: $R^2 = 0 = 0.01$, $F_{1,15} = 0.20$, $P = 0.660$; 1998: $R^2 = 0.12$, $F_{1,21} = 2.87$, $P = 0.105$).

other variable in their model. If body mass influenced clutch size this weakly in our study, we could not have detected it. Both studies support earlier conclusions that galliform reproduction relies very little on lipid reserves (Thomas 1988).

In 1997, plasma triglyceride levels from our study were similar to winter plasma triglyceride levels reported for northern bobwhites housed in outdoor pens and fed a commercial gamebird feed *ad libitum* (Hill and Murray 1987). However, triglyceride levels in 1998 were twice as high and twice as variable. We examined the relationship between sampling date and plasma triglycerides in 1998 to determine if our sampling interval extended into the beginning of the breeding season when triglycerides increase 3- to 6-fold (Hill and Murray 1987). If this occurred, we predicted that plasma triglycerides would increase during the 31-day sampling interval in 1998. However, we found no linear relationship between plasma triglycerides and sampling date ($F_{1,21} = 0.5$, $P = 0.507$). We suspected that differences in sampling locations also may have caused the observed annual differences. In 1997, 13 of 17 samples were obtained from birds captured within a 1-km radius. In 1998, samples were obtained from 8 locations separated by >2 km, and the largest number of samples from any single location was 7. To test whether the differences in the means and variability of plasma triglycerides were due to location, we compared the samples collected in 1997 from a single location with 4 samples collected from that location in 1998. Surprisingly, the means and

Table 2. R^2 and significance of late winter body mass (BM) and plasma triglycerides (TRIG) as predictors of first clutch size and date of nest initiation for northern bobwhites in Refugio County, Texas, 1997.

Dependent variable	Year	Independent variables	R^2	P
First clutch size	1997	BM + TRIG	0.19	0.235
		BM	0.12	0.172
		TRIG	0.09	0.249
	1998	BM + TRIG	0.03	0.752
		BM	0.00	0.970
Date of nest initiation	1997	TRIG	0.03	0.466
		BM + TRIG	0.03	0.794
		BM	0.02	0.582
	1998	TRIG	0.02	0.634
		BM + TRIG	0.08	0.414
		BM	0.03	0.463
		TRIG	0.03	0.435

trends for 1997 and 1998 of plasma triglyceride levels and body masses from this single location were nearly identical to that of all locations. Thus, we do not know why triglyceride levels were so much greater and variable in 1998.

Higher plasma triglycerides in 1998 were associated with earlier reproduction. However, we found no relationship between individual plasma triglyceride levels and date of reproduction. We suspect that northern bobwhites in our study were differentially affected by numerous extrinsic factors, such as differences in diet caused by habitat quality and disturbance by predators. In addition, some extrinsic factors probably affected all of the birds to nearly the same extent within a given year; these effects would include winter severity and precipitation. Our results suggest that plasma triglycerides may be useful as an indicator of population trends in timing of reproduction, but not for predicting reproductive timing of individuals.

Body mass and plasma triglycerides were not positively related (Fig. 1). In fact, the pattern in 1998, though not statistically significant, was a negative relationship. These results indicate a need for a better understanding of how body mass, plasma triglycerides, and body fat vary among wild birds subjected to stressful late winter conditions. In addition, better information is needed on the timing of changes in these variables as photoperiod increases to levels that can stimulate gonadal recrudescence.

CONCLUSION

Our ability to predict northern bobwhite production is hampered by an incomplete understanding of the factors controlling reproductive timing and effort. Earlier nesting of galliforms is advantageous due to lower nest predation, higher hatchability, and greater potential for renesting (Lehmann 1946, Klimstra and Roseberry 1975, Guthery et al. 1988, Badyaev et al. 1996). Photoperiod limits the potential reproductive period in northern bobwhites (Kirkpatrick and Leopold 1952), but secondary factors such as lipid reserves, diet, and stress can constrain the realized reproductive

period (Gates and Woehler 1968; Cain and Lien 1985; Koerth and Guthery 1991; Giuliano et al. 1995, 1996). Our findings indicate that plasma triglycerides and body masses may be useful for comparing populations among years and locations, but these variables do not explain within-population variation in reproductive timing and effort. Future research on reproduction of northern bobwhites should measure hormones more closely linked to gonadal recrudescence and ovulation and inhibitory effects of stress hormones such as corticosterone. Research on reproduction of wild northern bobwhite can build on the excellent foundation of recent laboratory studies that measured reproductive and stress hormones (Cain and Lien 1985; Giuliano et al. 1995, 1996).

ACKNOWLEDGMENTS

Research was funded by the Texas Imported Fire Ant Research and Management Plan. Special thanks go to the J. F. Welder Heirs for allowing us to conduct this experiment on their property.

LITERATURE CITED

- Alleman, A. R. 1990. The effects of hemolysis and lipemia on serum biochemical constituents. *Veterinary Medicine* 85: 1272–1284.
- Bacon, W. L., K. E. Nestor, and E. C. Naber. 1989. Prediction of carcass composition of turkeys by blood lipids. *Poultry Science* 68:1282–1288.
- Badyaev, A. V., T. E. Martin, and W. J. Etges. 1996. Habitat sampling and habitat selection by female wild turkeys: ecological correlates and reproductive consequences. *Auk* 113: 636–646.
- Bahr, J. M., and P. A. Johnson. 1991. Reproduction in poultry. Pages 555–575 in P. T. Cupps, ed. *Reproduction in domestic animals*. Fourth edition. Harcourt Brace Jovanovich, San Diego, California.
- Cain, J. R., and R. J. Lien. 1985. A model for drought inhibition of bobwhite quail (*Colinus virginianus*) reproductive systems. *Comparative Biochemistry and Physiology* 82A:925–930.
- Carey, C. 1996. Female reproductive energetics. Pages 324–374 in C. Carey, ed. *Avian energetics and nutritional ecology*. Chapman & Hall, New York, New York.
- Dabbert, C. B., T. E. Martin, and K. C. Powell. 1997. Use of body measurements and serum metabolites to estimate the nutritional status of mallards wintering in the Mississippi Alluvial Valley, USA. *Journal of Wildlife Diseases* 33:57–63.
- Farner, D. S., and B. K. Follett. 1979. Reproductive periodicity in birds. Pages 829–872 in E. J. W. Barrington, ed. *Hormones and evolution*. Volume 2. Academic Press, New York, New York.
- Frawley, B. J., D. A. Osborne, H. P. Weeks, Jr., L. W. Burger, Jr., and T. V. Dailey. 1999. Use of total body electrical conductivity to predict northern bobwhite lipid mass. *Journal of Wildlife Management* 63:695–704.
- Gates, J. M., and E. E. Woehler. 1968. Winter weight loss related to subsequent weights and reproduction in penned pheasant hens. *Journal of Wildlife Management* 32:234–247.
- Giuliano, W. M., R. S. Lutz, and R. Patiño. 1995. A simulated insect diet as a water source for quail: effects on body mass and reproduction. *Comparative Biochemistry and Physiology* 111A:299–302.
- Giuliano, W. M., R. S. Lutz, and R. Patiño. 1996. Reproductive responses of adult female northern bobwhite and scaled quail to nutritional stress. *Journal of Wildlife Management* 60:302–309.
- Guthery, F. S., N. E. Koerth, and D. S. Smith. 1988. Reproduction of northern bobwhites in semiarid environments. *Journal of Wildlife Management* 52:144–149.
- Hill, E. C., and H. C. Murray. 1987. Seasonal variation in diagnostic enzymes and biochemical constituents of captive northern bobwhites and passerines. *Comparative Biochemistry and Physiology* 87B:933–940.
- Kirkpatrick, C. M., and A. C. Leopold. 1952. The role of darkness in sexual activity of the quail. *Science* 116:280–281.
- Klimstra, W. D., and J. L. Roseberry. 1975. Nesting ecology of the bobwhite in southern Illinois. *Wildlife Monographs* 41.
- Koerth, N. E., and F. S. Guthery. 1991. Water restriction effects on northern bobwhite reproduction. *Journal of Wildlife Management* 55:132–137.
- Lehmann, V. W. 1946. Bobwhite quail reproduction on southwestern Texas. *Journal of Wildlife Management* 10:111–123.
- Levene, H. 1960. Robust tests for equality of variances. Pages 278–292 in I. Olkin, ed. *Contributions to probability and statistics*. Stanford University Press, Palo Alto, California.
- Norušis, M. J. 1993. *SPSS® for Windows: base system user's guide*. Release 6.0. SPSS, Chicago, Illinois.
- Robel, R. J. 1972. Body fat content of bobwhites in relation to food plantings in Kansas. *Proceedings of the National Quail Symposium* 1:139–149.
- Shapiro, S. S., and M. B. Wilk. 1965. An analysis of variance test for normality (complete samples). *Biometrika* 52:591–611.
- Smith, H. D., F. A. Stormer, and R. D. Godfrey, Jr. 1981. A collapsible quail trap. United States Forest Service Research Note RM-400.
- Thomas, V. G. 1988. Body conditions, ovarian hierarchies, and their relation to egg formation in Anseriform and Galliform species. Pages 353–363 in H. Oullet, ed. *Acta XIX Congressus Internationalis Ornithologici*. University of Ottawa Press, Ottawa, Canada.

COMPARISON OF NORTHERN BOBWHITE CHICK FECAL AND CROP ANALYSES

Kristen Utz

Daniel B. Warnell School of Forest Resources, University of Georgia, Athens, GA 30602, USA

John P. Carroll

Daniel B. Warnell School of Forest Resources, University of Georgia, Athens, GA 30602, USA

Stephen J. Moreby

The Game Conservancy Trust, Fordingbridge, Hampshire, SP6 1EF, United Kingdom

ABSTRACT

Impacts of modern agriculture on gamebird brood ecology have been studied in a number of species. One common factor cited has been the decline in available invertebrate food available to foraging chicks. In the United Kingdom, assessment of chick diet has been accomplished mainly through fecal analysis of wild chicks, whereas in North America crop analysis of human-imprinted chicks has become a commonly applied technique. We compared results of both techniques on groups of human-imprinted northern bobwhite (*Colinus virginianus*) chicks to determine if these different techniques provide similar results. Chicks were allowed to forage in groups of 6–8 in cotton fields with various cover crops. We euthanized half the chicks for crop analysis and isolated the other half of the chicks for 12 hours to collect feces. We found a positive relationship between total number of invertebrates/chick in crops and feces ($P = 0.01$, $R^2 = 0.51$). However, among important chick-food Orders the relationship varied greatly: Coleoptera ($P = 0.10$, $R^2 = 0.34$), Homoptera ($P < 0.001$, $R^2 = 0.41$), and Hymenoptera ($P = 0.81$, $R^2 = 0.05$). Our results suggest that there is a positive relationship between the 2 techniques, but that composition of the diet relative to what foods might be available in a particular site could be biased. We suggest more detailed research on technique development and standardization of techniques for assessing this important component of bobwhite life history.

Citation: Utz, K., J. P. Carroll, and S. J. Moreby. 2001. Comparison of northern bobwhite chick crop and fecal analyses. Pages 225–228 in S. J. DeMaso, W. P. Kuvlesky, Jr., F. Hernández, M. E. Berger, eds. Quail V: Proceedings of the Fifth National Quail Symposium, Texas Parks and Wildlife Department, Austin, TX.

Key words: brood habitat, chicks, *Colinus virginianus*, fecal analysis, Georgia, insects, northern bobwhite

INTRODUCTION

Gamebird biologists have developed a number of techniques to assess quality of brood habitat. For several species, especially those inhabiting agricultural ecosystems, a primary consideration has been to assess the importance of the invertebrate community to provide food resources. In northern bobwhites, it has been demonstrated in numerous studies that there is a significant link between invertebrate numbers and composition, and chick ecology (Handley 1931, Hurst 1972, Potts 1986, Jackson et al. 1987, Sotherton and Moreby 1992, DeVos and Mueller 1993, Palmer 1995).

Numerous techniques have been used over the years to assess numbers and types of invertebrates available to gamebird chicks in the field. Insect sampling techniques commonly employed include vacuum samplers (e.g., D-Vac systems), pit-fall trapping, and sweep-netting (Hurst 1972, Burger et al. 1993). Biologists have also employed more direct measures using data derived directly from chicks, including gut and fecal analysis (Moreby 1988, Palmer 1995). Human-imprinted chicks have also been employed to assess invertebrate availability (Kimmel and Healy 1987).

Some researchers using human-imprinted chicks have observed and identified foods consumed by chicks (Erpelding et al. 1987), whereas others have used esophageal stricture, and/or gut analysis (Palmer 1995). Palmer (1995) argued that mechanical sampling devices have limitations because even if they provide an unbiased sample of insects in a particular habitat they do not actually provide any estimate of those invertebrates available to or selected by gamebird chicks. Further, almost all other techniques that are applied commonly have untested assumptions and/or limitations in their application to gamebird management (Palmer 1995).

Use of quail chicks as the sampling tool offers the best opportunity for assessing habitat; however, this technique has logistical problems. For example, wild broods would provide the best opportunity to assess foods consumed, but sampling techniques require that this be done in an indirect way. Typically this has been done by sampling feces collected in the wild or by capturing wild chicks to extract crops and gizzards. Since wild chicks can be difficult to obtain, especially in ecosystems where biologists are trying to understand low population densities, the use of human-imprinted chicks has been viewed as a viable compro-

mise. Previous research done on wild broods using fecal analysis and human-imprinted quail using crops suggests that there is predictive value to both techniques (Sotherton and Moreby 1992, Palmer 1995).

As part of a research project investigating cotton cropping systems and quail brood habitat, we compared 2 commonly used techniques (crop and fecal analysis) to examine invertebrate abundance in brood habitat.

STUDY AREA

The study was conducted in the Upper Coastal Plain ecological region, in Jefferson and Johnson counties, Georgia. This region is dominated by row crop agriculture and pine plantations. Dominant crops were cotton, peanuts, and corn. Forests consisted of hardwoods and loblolly pines (*Pinus taeda*).

METHODS

Study Design

The study consisted of 2 duplicate fields (about 10 ha) with each field divided into 4 treatments. Treatments consisted of: 1) conventional tillage, where cotton is tilled with a standard pesticide regime, 2) conservation tillage type A, where fields are strip-tilled and winter wheat is used as a cover crop with a standard pesticide regime, 3) conservation tillage type B, where fields are strip-tilled and clover and winter wheat are used as cover crops with a standard pesticide regime, and 4) clover-strip tillage, where fields are strip-tilled and clover is used as a cover crop, but no insecticides and minimal herbicides are sprayed on the field. A randomized complete block design was used to reduce variation among the fields.

Imprinting

We imprinted the chicks following Palmer (1995). Imprinting was used to allow the quail chicks to establish a bond with the researcher. We could then allow chicks to forage in a habitat for controlled periods of time, thereby standardizing our sampling techniques.

Two-hundred fifty quail eggs for each trial were obtained from a private breeder and were mechanically incubated for 21–23 days. On the last 2 days before hatching, we whistled to them to begin the imprinting process. As they hatched, the chicks were allowed to dry and were then placed in a brooder where the temperature was maintained at 35°C. They were fed commercial chick starter. During the first 2 days after hatch the quail handler spent up to 15 hours per day establishing a bond with the chicks using whistling and imitating hen calls. Approximately 130 chicks were imprinted in June 2000, 100 in July 2000, and 170 in August 2000.

After imprinting, we allowed chicks to forage at least once in each cotton cropping system. This allowed the chicks to practice foraging at each crop type

Fig. 1. Relationship between invertebrates counted in the crops and feces of bobwhite groups ($n = 24$) foraged in cotton fields in Georgia during 2000. The solid line is the least squared regression of the data and dashed line represents a theoretical 1:1 relationship.

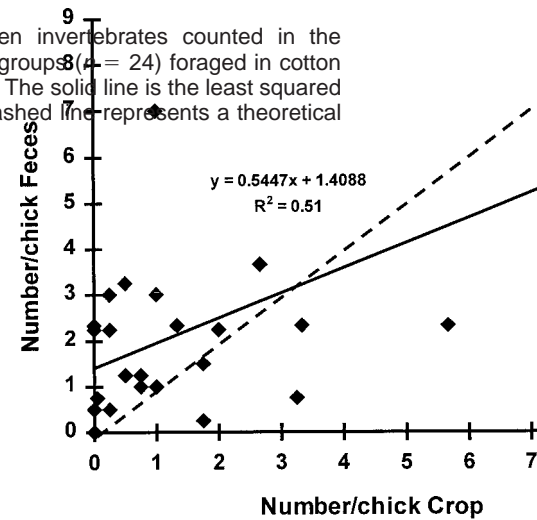

and to become familiar with the handler before the final trials. This was done for about 5 days.

Data Collection

Field trials occurred when the chicks were 8–10 days old. Feed was removed 12 hours before the field trials to ensure chicks were hungry. Groups of 6–8 chicks were allowed to forage simultaneously on each of the field types for 30 minutes. After foraging, half of the chicks were collected in boxes for fecal collection while the other half were sacrificed using a carbon dioxide chamber. Due to low hatch success, the sample size in July (100 chicks) was less than June (130 chicks) and August (170 chicks). Therefore, 6 chicks were used per group instead of 8. Chicks that were used for fecal collection were isolated in divided brooders. Feces were collected for 12 hours and placed in vials containing 70% ethanol. Insect contents were identified in the feces and were categorized to taxonomic Order. We counted insects in feces following Moreby (1988). Use of quail chicks in this study followed protocols approved by the University of Georgia (IACUC Animal Use Permit #A34337-01).

Data Analysis

We used regression analysis to assess the relationship and predictive ability of crop and fecal analysis.

RESULTS

We tested groups of chicks in a total of 24 trials (3 time periods and 2 blocks with 4 cover types in each block). In most cases there were 8 chicks in each group. Our results suggest a positive relationship in numbers of insects consumed between fecal and crop contents ($F = 7.88$, 22 df , $P = 0.01$, $R^2 = 0.51$) (Fig. 1).

BOBWHITE CHICK FECAL AND CROP ANALYSES

Fig. 2. Relationship between Coleoptera numbers counted in the crops and feces of bobwhite groups ($n = 24$) foraged in cotton fields in Georgia during 2000. The solid line is the least squared regression of the data and dashed line represents a theoretical 1:1 relationship.

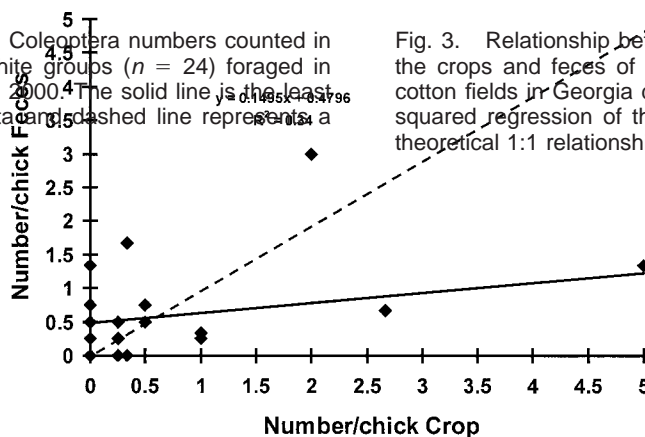
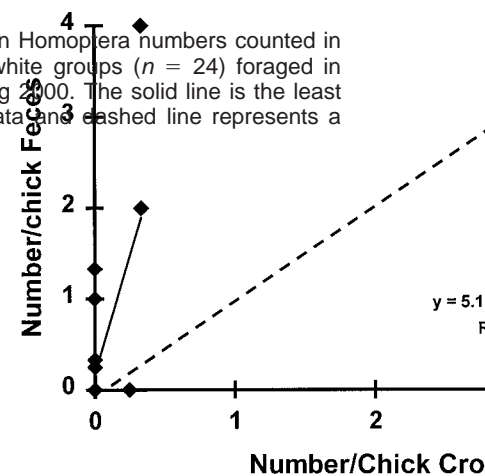

Fig. 3. Relationship between Homoptera numbers counted in the crops and feces of bobwhite groups ($n = 24$) foraged in cotton fields in Georgia during 2000. The solid line is the least squared regression of the data and dashed line represents a theoretical 1:1 relationship.



Among Orders comprising important chick foods, relationships between the two techniques were variable. Comparison of feces and crop in Order Coleoptera suggested a positive relationship ($F = 2.95, 22 df, P = 0.10, R^2 = 0.34$); however, the regression suggested that 5 insects would be detected in the crop for each one detected in the feces (Fig. 2). Comparison of crops and feces in Order Homoptera suggested a positive relationship ($F = 15.29, 22 df, P < 0.001, R^2 = 0.41$). For this Order, we were more likely to find insects in the feces rather than the crops (Fig. 3). In the Order Hymenoptera, we found no relationship between the numbers found in the crops and feces ($F = 0.0575, 22 df, P = 0.81, R^2 = 0.05$) (Fig. 4).

DISCUSSION

Our results suggest that the total numbers of insects per chick in the feces and crop were significantly correlated. This is an important finding because studying fecal contents alone would be a non-destructive means of studying brood habitat without having to sacrifice the chicks for gut samples. However, it is apparent from this comparison that insects available to and/or selected by quail could yield significantly different results depending on the technique chosen. For instance, the Order Coleoptera consists of beetles which contain hard shells and mouth parts. The easily identifiable parts that are difficult for a chick to digest allow easy identification in the feces. However, our results also suggest that these insects might be retained in the gut longer than the 12 hours we collected feces. Most of the insects in the Order Hymenoptera consumed by chicks in our study were ants (Formicidae). These have soft bodies and hard mouth-parts, therefore might pass very quickly through the gut, yet be easily identified. Therefore, both techniques have potential biases associated with the relative passage and digestion of various invertebrates. Other factors, such as behavioral and/or physiological characteristics of the chicks could affect results. For example, when forag-

ing chicks with empty crops, chicks might fill and pass crop contents faster than the 30 minutes used in this study. Ambient temperature during foraging periods for these animals with limited thermoregulatory ability might also impact food passage rates and levels of digestion.

A weakness in our experiment is the possibility that there were significant differences in types of invertebrates consumed by the subsamples of chicks used for each technique. This is difficult to test, but we found our chicks foraged in relatively tight groups and were randomly assigned to a sampling method. Therefore, we believe that there should be little bias in foods consumed among chicks within groups.

Fig. 4. Relationship between Hymenoptera counted in the crops and feces of bobwhite groups ($n = 24$) foraged in cotton fields in Georgia during 2000. The solid line is the least squared regression of the data and dashed line represents a theoretical 1:1 relationship.

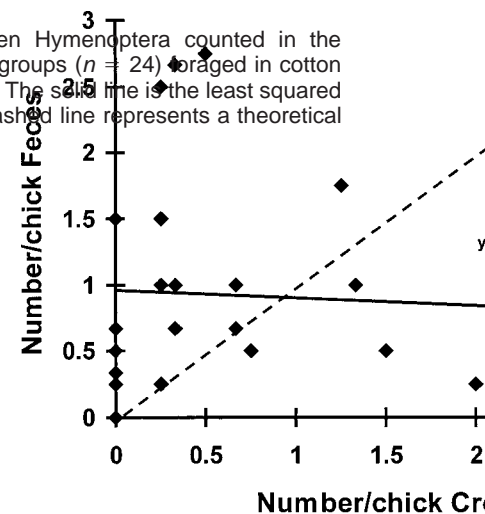

MANAGEMENT IMPLICATIONS

Our data suggest that 2 commonly employed techniques provide similar results when assessing total numbers of invertebrates consumed by bobwhite chicks. However, there were marked differences at the Order level. These results suggest that we need to investigate in more detail the assumptions we make with our invertebrate sampling techniques, especially those related to assessing habitat quality.

ACKNOWLEDGMENTS

Funding was provided by Quail Unlimited, Monsanto Corp., United States Department of Agriculture, Natural Resources Conservation Service, Central Georgia Soil and Water Conservation District, and the University of Georgia, Daniel B. Warnell School of Forest Resources, and McIntyre-Stennis Project GEO-0100-MS. We thank H. Venter, D. Maidens, R. Franklin, and M. Cooper for field assistance. Mr. A. Walker provided much logistical support. We thank T. Harrington and R. Hamrick for assistance with statistical analyses.

LITERATURE CITED

- Burger, L. W., Jr., E. W. Kurzejeski, T. V. Dailey, and M. R. Ryan. 1993. Relative invertebrate abundance and biomass in Conservation Reserve Program plantings in northern Missouri. *Proceedings of the National Quail Symposium* 3: 102–108.
- DeVos, T., and B. S. Mueller. 1993. Reproductive ecology of northern bobwhite in north Florida. *Proceedings of the National Quail Symposium* 3:92–101.
- Erpelding, R., R. O. Kimmel, and D. J. Lockman. 1987. Foods and feeding behavior of young gray partridge in Minnesota. Pages 17–30 *in* R. O. Kimmel, J. W. Schulz, and G. J. Mitchell, eds. *Perdix IV: Gray Partridge Workshop*. Minnesota Department of Natural Resources, Madelia.
- Handley, C. O. 1931. Food of the young. Pages 159–164 *in* H. L. Stoddard. *The bobwhite quail: its habits, preservation, and increase*. Charles Scribner's Sons, New York, New York.
- Hurst, G. A. 1972. Insects and bobwhite quail brood habitat management. *Proceedings of the National Quail Symposium* 1:65–82.
- Jackson, J. R., G. A. Hurst, and E. A. Gluesing. 1987. Abundance and selection of invertebrates by northern bobwhite chicks. *Proceedings of Annual Conference of Southeastern Association of Fish and Wildlife Agencies* 41:303–310.
- Kimmel, R. O., and W. M. Healy. 1987. Imprinting: a technique for wildlife research. Pages 39–52 *in* R. O. Kimmel, J. W. Schulz, and G. J. Mitchell, eds. *Perdix IV: Gray Partridge Workshop*. Minnesota Department of Natural Resources, Madelia.
- Moreby, S. J. 1988. An aid to identification of arthropod fragments in the feces of gamebird chicks (Galliformes) *Ibis* 130:519–526.
- Palmer, W. E. 1995. Effects of modern pesticides and farming systems on northern bobwhite quail ecology. Dissertation. North Carolina State University, Raleigh.
- Potts, G. R. 1986. *The partridge: pesticides, predation, and conservation*. Collins, London, United Kingdom.
- Sotherton, N. W., and S. J. Moreby. 1992. The importance of beneficial arthropods other than natural enemies in cereals. *Interpretation of Pesticide Effects on Beneficial Arthropods. Aspects of Applied Biology* 31:11–18.

USING MICROSATELLITE DNA TO UNDERSTAND BOBWHITE BEHAVIOR AND POPULATION STRUCTURE

Brant C. Faircloth

Daniel B. Warnell School of Forest Resources, University of Georgia, Athens, GA 30602, USA

Kristine Oswald

Department of Wildlife and Fisheries, Box 9690, Mississippi State University, Mississippi State, MS 39762, USA

William E. Palmer

Tall Timbers Research Station, 13093 Henry Beadel Dr., Tallahassee, FL 32312, USA

John P. Carroll

Daniel B. Warnell School of Forest Resources, University of Georgia, Athens, GA 30602, USA

L. Wes Burger

Department of Wildlife and Fisheries, Box 9690, Mississippi State University, Mississippi State, MS 39762, USA

Koon Wah Fok

Institute of Genetics, University of Nottingham, Queen's Medical Centre, Nottingham, NG7 2UH, United Kingdom

Shane D. Wellendorf

Tall Timbers Research Station, 13093 Henry Beadel Dr., Tallahassee, FL 32312 USA

ABSTRACT

Northern bobwhite (*Colinus virginianus*) have a flexible mating system with varying degrees of parental investment in offspring. Questions of relatedness of mates and the dynamics of covey membership have not been answered. It is not known how different patterns of mating systems impact productivity of bobwhite populations. In addition to behaviors, the genetic structure of bobwhite populations likely varies across landscapes, and may depend on the distribution and abundance of habitat types. These issues have critical conservation and management implications, such as the impact of habitat fragmentation on gene flow. Recent advances in molecular techniques provide an opportunity to investigate these questions through examination of small, repetitive, highly variable regions of DNA known as microsatellites. Microsatellites provide the fine-scale resolution needed to objectively understand certain population structures and reproductive strategies. Microsatellite analysis techniques have been used successfully to research relatedness and extra-pair paternity of a number of species. Therefore, we have begun to investigate the genetic basis for many northern bobwhite behaviors related to reproduction. Our primary objectives are to determine: (1) relatedness of individuals within coveys and groups over time, (2) relatedness between reproductive pairs relative to random pairings, (3) relatedness of chicks in broods, (4) rates of extra-pair fertilization, (5) rates of intra-specific nest parasitism, and (6) the relatedness of incubating birds to their eggs. To do so, we have developed a series of microsatellite markers for northern bobwhites. We radiomarked approximately 75% of bobwhites on our study area at Tall Timbers Research Station. We collected body feathers from adults and 1.5 mm patagial micro-biopsies from each chick (4 days old) found brooding with radiomarked adults for microsatellite analysis. We are determining relatedness and parentage, based on these microsatellite data, using programs RELATEDNESS and CERVUS. Additionally, we are testing our tissue collection techniques on a pen-reared population of bobwhites to determine the efficiency of DNA amplification via the polymerase chain reaction for 4 tissue collection techniques: patagial micro-biopsy, down and feather shaft, egg tooth, and egg membrane. Additionally, we are pairing pen-reared adult hens and males for different periods of time to determine the presence of sperm storage and test for evidence of sperm competition. Further, we are crossing individuals of known relatedness over several generations to test the accuracy of paternity inferences calculated by CERVUS with respect to bobwhite microsatellite data. Finally, by collecting feathers from hunter-killed bobwhites throughout the Red Hills and the southeast, we will compare the genetic structure of the bobwhite population(s) of the Red Hills, likely the last panmictic population in the southeast, to more isolated, declining populations. In our poster we present a detailed description of this research along with first year results.

Citation: Faircloth, B. C., K. Oswald, W. E. Palmer, J. P. Carroll, L. W. Burger, K. W. Fok, and S. D. Wellendorf. 2002. Using microsatellite DNA to understand bobwhite behavior and population structure. Page 229 in S. J. DeMaso, W. P. Kuvlesky, F. Hernández, and M. E. Berger, eds. Quail V: Proceedings of the Fifth National Quail Symposium, Texas Parks and Wildlife Department, Austin, TX.

A DECADE OF PROGRESS, A DECADE OF FRUSTRATION

Leonard A. Brennan

Caesar Kleberg Wildlife Research Institute, Texas A&M University, Kingsville, TX 78363-8202, USA

ABSTRACT

The past decade has seen tremendous research progress for the northern bobwhite (*Colinus virginianus*). Research conducted during the 1990s advanced our understanding of bobwhite breeding biology, habitat relationships, long-term population trends, and genetics, among other things. Technological advances allowed improvements in censusing techniques, tracking broods, assessing population status in relation to broad scale land use changes, and identifying nest predators. The 1990s also saw the development of a National Strategic Plan for Quail Management and Research, the emergence of the Southeast Quail Study Group, and a renewed interest in National Quail Symposia. Despite this recent renaissance in research and related activities, bobwhite population declines continued throughout much of the southeastern United States and elsewhere. There is a palpable level of frustration among quail hunters, resource agency managers, and other quail enthusiasts who feel that: (1) seemingly nothing is being done to reverse the bobwhite population decline, and (2) that the scientific community has not developed a meaningful or realistic research agenda. It is an amazing paradox that we have made great bobwhite research progress during the past decade, but virtually none of the new insights gained from research have been successfully applied, on the ground, to improve bobwhite numbers. I hypothesize that the disconnect between recent scientific advances, and management applications to reverse the bobwhite decline, is a function of numerous cultural and economic factors that will be difficult to overcome. These factors include: (1) broad scale land use trends that are hostile to the production and maintenance of wild bobwhite populations, (2) habitat management and maintenance costs that are beyond the reach of most resource agencies and individuals, and (3) lack of incentives to motivate individuals and organizations to tackle bobwhite management on a meaningful scale. Whether land use planning, land management policy, and/or market incentives can conspire to provide useable habitat space through time for bobwhites (and other quails) on a scale that will be sufficient to reverse widespread population declines, is one of the most vexing wildlife management problems for the next century.

Citation: Brennan, L. A. 2002. A decade of progress, a decade of frustration. Pages 230–232 in DeMaso, S. J., W. P. Kuvlesky, Jr., F. Hernández, and M. E. Berger, eds. Quail V: Proceedings of the Fifth National Quail Symposium. Texas Parks and Wildlife Department, Austin, TX.

Key words: *Colinus virginianus*, incentives, management, northern bobwhite, philosophy, research

INTRODUCTION

The purpose of this essay is to draw attention to a curious paradox in modern wildlife management. During the past decade, wildlife scientists and managers have developed a widespread, renewed interest in northern bobwhite ecology and management. Much of this renewed interest stems from ongoing, long-term bobwhite population declines that have occurred during the past 40–100 years (Kabat and Thompson 1963, Brennan 1991). However, despite a renewed interest in northern bobwhite research, virtually none of the new insights gained have been applied in a meaningful management context to reverse or restore bobwhite numbers. I hypothesize that there are a complex array of economic and cultural factors that are responsible for the bobwhite research progress and management frustration that we have witnessed during the 1990s.

RESEARCH PROGRESS

Thousands of scientific articles and commentaries have addressed aspects of northern bobwhite biology, ecology, and management during the past century (Scott 1985, Brennan 1999). The decade of the 1990s was a particularly productive period of research that revolutionized how we understand bobwhite breeding biology (Curtis 1993), model habitat relationships

(Guthery 1997, Guthery et al. 2000), interpret long-term population trends (Lee and Brennan 1994, Brennan et al. 2000; Thogmartin et al. *this volume*), and assess genetic relationships (White et al. 2000, Faircloth et al. *this volume*).

Advances in research techniques have led to improvements in censusing techniques (Wellendorf et al. *this volume*), marking and tracking broods (Carver et al. 1999, Smith et al. *this volume*) assessing population status in relation to broad scale land use trends (Guthery et al. 2001), and identifying nest predators (Staller et al. *this volume*).

While the application of radiotelemetry was responsible for considerable research progress, advances in other methodological, conceptual and philosophical approaches to quail research must also be given credit (Hernández et al. 2002). As wildlife and game bird scientists become more comfortable with contemporary approaches to modeling habitat and population dynamics, and using molecular tools to address quail population and sociological dynamics, new insights into this well-studied galliform will clearly be part of our future. We are gaining new, important knowledge about this species as it continues to decline and undergo local and regional extinctions over most of its native geographic range. As wildlife professionals, however, I can't help but think that we might be standing around playing our research fiddles while bobwhite

habitat disappears, much like Nero did when Rome burned.

MANAGEMENT FRUSTRATION

There is no question that agency resource managers and quail hunting enthusiasts are clearly frustrated at the continued downward trend in bobwhite numbers across most of the bird's range. Tales of woe from lack of quail hunting opportunities pervade conversations from the annual National Quail Unlimited conventions to the local county extension offices. While the magnitude and extent of this frustration has not been quantified, I believe that it is significant. Furthermore, I believe that we have a massive communication problem between quail research professionals and the quail hunting community. For example, from the perspective of a manager, Drew (2000:247) stated "... There is nothing new in quail research." This problem stems from the hunting community's frustration with declining quail numbers, and an inability to translate advances in quail research to increases in quail numbers.

Historical documents note that early in the 20th century quail were abundant and provided readily available hunting opportunities throughout the Midwest (Leopold 1931) and Southeast (Leopold 1929), whereas opportunities to hunt white-tailed deer (*Odocoileus virginianus*) and wild turkeys (*Meleagris gallopavo*) were scarce at that time. Today, the opposite is true, and this feeds the frustration. People have a hard time understanding why we have an embarrassment of deer and turkey riches, but few quail.

The lack of quail hunting opportunities has largely eliminated a cultural tradition whereby people of modest means could pursue this bird. The primary upland game hunting opportunities currently available on public lands are for doves, (*Zenaida* spp.) deer, and turkeys. Today, most quail hunting opportunities are available to only people who can own or lease relatively vast (500–2,500+ ha) tracts of land, and absorb land management costs that can range from \$50 to \$200/ha/year. During the 1950s Herbert Stoddard predicted that bobwhite hunting was on a track to become "Grand Opera,"—an expensive and rarified experience that would be available only to wealthy people with the means to afford it. Fifty years later, Stoddard's prediction is reality.

Despite the research progress of the past decade, little or none of this new information has been applied to efforts to restore or increase quail numbers. Over the years of reading most of the literature on quail, I have failed to find even 1 publication that documents the sustained recovery of a formerly extirpated population of quail, despite Herculean efforts in case of masked bobwhite (*C. v. ridgwayi*) restoration and recovery efforts (Kuvlesky et al. 2000). Furthermore, contemporary case histories which document localized increases of bobwhite populations in response to management are relatively rare, although they do exist (Brennan 1993, Palmer et al. *this volume*).

LACK OF INCENTIVES

The hypothesis that habitat loss from changing land use is responsible for the bobwhite decline is supported by observations and data from the private hunting plantations in the southeastern United States (Brennan et al. 2000), rangelands in south Texas, and portions of habitat the Midwest, where relatively large blocks of bobwhite habitat remain, and consistently support populations with densities that provide satisfying hunting opportunities.

In all 3 of the cases noted above, bobwhite habitat and wild populations of bobwhites are maintained either through intensive management (on Southeast Quail Plantations) or bobwhite-friendly land uses, such as moderately intensive cattle grazing (in South Texas and other parts of the Midwest). Where there is habitat (and useable habitat space) there are quail (Guthery 1997). When the prevailing land use trends are not favorable to quail, the birds disappear. This simple concept seems impossible for some people to grasp. Many people believe that it is more effective to increase quail by killing predators, planting food plots, or releasing pen-raised quail, than solving the habitat problem through management.

I have come to the conclusion, however, that people are reluctant to tackle efforts to recover, restore, and/or maintain bobwhite habitat through management, because such an undertaking is phenomenally expensive. There are few meaningful incentives to support such efforts.

The people who are owning, leasing, and managing bobwhite habitat on private lands are doing these things because they can afford them. Their incentive is the payoff of enjoying Grand Opera quail hunting at rates of >4 coveys per hour, regardless of the staggering costs. They do this because they can. It is perhaps the most expensive wildlife habitat management in the world.

Nonindustrial private landowners who have parcels ranging from 25–500 ha often face a set of circumstances that disallow them to conduct effective quail management, even if they wanted to do so. There are few economic, governmental, or societal incentives to support efforts by these people to implement prescribed fire, frequent disking, field borders, conservation headlands, and improve habitat for quail. In fact, the disincentives to not do these things are probably greater than the incentives available to encourage them. For example, consider potential or perceived liabilities from applying prescribed fire, despite the presence of right-to-burn legislation in many southeastern states. While weedy field borders may provide crucial winter habitat for bobwhites, they also are frowned upon by farmers, bankers, and county extension agents who worked to eradicate the cotton boll weevil. Stewardship Forest programs seldom seem to reward or encourage private land owners who are interested in single-tree selection and uneven-aged management silviculture systems that have potential to maintain quail habitat in southern pine forests.

Most incentive programs that have been promoted

to enhance wildlife habitat in the southeastern United States have either been hostile to bobwhites, such as the early Conservation Reserve Program (CRP) sign-ups that promoted cool-season fescue pastures, or high-density pine plantations. Other Farm Bill incentives, such as CRP contracts that allow seasonal disking for quail, or favor longleaf pine (*Pinus palustris*) seem like too little too late. Hopefully, I'm wrong.

OVERCOMING INERTIA AND MEETING THE CHALLENGE

Clearly, there is considerable inertia that is preventing progress with respect to reversing the bobwhite decline. As researchers, we have done a pretty good job at building a scientific foundation for quail habitat management in particular and quail habitat management in general. Unfortunately, numerous cultural and economic roadblocks are preventing this science from being translated into effective bobwhite management. Some of these roadblocks, and I argue most of the critical ones, will be impossible to remove without the presence of significant economic and cultural incentives to counter the widespread, continuing losses of quail habitat that are a function of changing land uses.

ACKNOWLEDGMENTS

The ideas presented in this paper developed over the past 20 years during my experiences with quail in California, Idaho, Mississippi, Florida, Texas and other states. Although these ideas developed from interactions with many colleagues, any errors of logic or accuracy are strictly my own.

LITERATURE CITED

- Brennan, L. A. 1991. How can we reverse the northern bobwhite population decline? *Wildlife Society Bulletin* 19:544–555.
- Brennan, L. A. 1993. Fire ants and northern bobwhites: a real problem or a red herring? *Wildlife Society Bulletin* 21:351–355.
- Brennan, L. A. 1999. Northern bobwhite (*Colinus virginianus*) *The Birds of North America*, No. 397. A. Poole and F. Gill, eds. *The Birds of North America*, Inc. Philadelphia, Pennsylvania.
- Brennan, L. A., J. M. Lee, and R. S. Fuller. 2000. Long-term trends of northern bobwhite populations and hunting success on private shooting plantations in northern Florida and southern Georgia. *Proceedings of the National Quail Symposium* 4:75–77.
- Carver, A. V., L. W. Burger, Jr., and L. A. Brennan. 1999. Passive integrated transponders and patagial tag markers for northern bobwhite chicks. *Journal of Wildlife Management* 63:162–166.
- Curtis, P. D., B. S. Mueller, P. D. Doerr, C. F. Robinette, and T. DeVos. 1993. Potential polygamous breeding behavior in northern bobwhite. *Proceedings of the National Quail Symposium* 3:55–63.
- Drew, H. 2000. Concluding remarks: the manager's perspective. *Proceedings of the National Quail Symposium* 4:246–247.
- Guthery, F. S. 1997. A philosophy of habitat management for northern bobwhites. *Journal of Wildlife Management* 61:291–301.
- Guthery, F. S., N. M. King, K. R. Nolte, W. P. Kuvlesky, Jr., S. DeStephano, S. A. Gall, and N. J. Silvy. 2000. Comparative habitat ecology of Texas and masked bobwhites. *Journal of Wildlife Management* 64:407–420.
- Guthery, F. S., M. C. Green, R. E. Masters, S. J. DeMaso, H. M. Wilson, and F. B. Steubing. 2001. Land cover and bobwhite abundance on Oklahoma farms and ranches. *Journal of Wildlife Management* 65:IN PRESS.
- Hernández, F., F. S. Guthery, and W. P. Kuvlesky, Jr. 2002. The legacy of bobwhite research in south Texas. *Journal of Wildlife Management* 66:IN PRESS.
- Kabat, C., and D. R. Thompson. 1963. Wisconsin quail, 1834–1962: population dynamics and habitat management. Wisconsin Conservation Department Technical Bulletin No. 30.
- Kuvlesky, W. P., Jr., S. A. Gall, S. J. Dobrott, S. Tolley, F. S. Guthery, S. A. DeStephano, N. King, K. R. Nolte, N. J. Silvy, J. C. Lewis, G. Gee, G. C. Luders, and R. Engel-Wilson. 2000. The status of masked bobwhite recovery in the United States and Mexico. *Proceedings of the National Quail Symposium* 4:42–57.
- Lee, J. M., and L. A. Brennan. 1994. Changes in northern bobwhite habitat and populations in a southern Mississippi wildlife management area: 1955–1992. *Proceedings of the Annual Conference of the Southeastern Association of Fish and Wildlife Agencies* 48:201–207.
- Leopold, A. 1929. Report on a game survey of Mississippi. Unpublished Report, Mississippi Department of Wildlife, Fisheries and Parks, Jackson.
- Leopold, A. 1931. Report on a game survey of the north central states. *Sporting Arms and Manufacturers' Institute*, Madison, Wisconsin.
- Scott, T. G. 1985. *Bobwhite thesaurus*. International Quail Foundation. Edgefield, South Carolina.
- White, S. L., K. R. Nolte, W. P. Kuvlesky, Jr., and F. S. Guthery. 2000. Comparative morphology and phylogenetic relatedness among bobwhites in the southern U.S. and Mexico. *Proceedings of the National Quail Symposium* 4:111–114.

EFFECTS OF SUPPLEMENTAL FEEDING ON NORTHERN BOBWHITE POPULATIONS IN SOUTH TEXAS

Ted B. Doerr¹

Department of Wildlife and Fisheries Sciences, Texas A&M University, College Station, TX 77843-2258, USA

Nova J. Silvy

Department of Wildlife and Fisheries Sciences, Texas A&M University, College Station, TX 77843-2258, USA

ABSTRACT

During 1985–87, the effects of supplemental feeding on northern bobwhite (*Colinus virginianus*) populations were studied on 4 paired sites, representing a cross-section of soils, vegetation, and hunting pressure in south Texas. Whole milo was provided from late fall–March. Feeding increased winter survival of birds on deep sand sites (225–245%), but not on red sandy loam or clay sites. Feeding did not improve reproductive success on any of the study sites. Most birds collected had milo in their crops and there was a tendency to find birds close to feeders more often than at random points. The study demonstrated that supplemental feeding can increase survival if food is limiting, however, data suggested feeding was not effective when habitat structure was inappropriate, or when food was not limiting.

Citation: Doerr, T. B., and N. J. Silvy. 2002. Effects of supplemental feeding on northern bobwhite populations in south Texas. Pages 233–240 in S. J. DeMaso, W. P. Kuvlesky, Jr., F. Hernández, and M. E. Berger, eds. Quail V: Proceedings of the Fifth National Quail Symposium. Texas Parks and Wildlife Department, Austin, TX.

Key words: *Colinus virginianus*, northern bobwhite, reproduction, supplemental feeding, survival, Texas

INTRODUCTION

Northern bobwhite management efforts are theoretically directed at limiting factors. It is difficult to determine the limiting factor or factors in specific situations, so management techniques have tended to be copied from other areas that have successful programs. Technique suitability is rarely evaluated for new situations. Feeding of a high-energy supplement in autumn–winter is 1 tool in northern bobwhite management that has gained acceptance in south Texas with little scientific evidence that it increased density by improving productivity, or survival.

Supplemental feeding of northern bobwhites has been tested in several areas. Frye (1954) found that Florida population densities increased with supplemental feeding when natural foods were limiting. Conversely, populations were not increased with the use of supplemental feed in Alabama (Keeler 1959). Robel et al. (1974) reported that birds having access to food plots had greater accumulated body fat compared to birds not having access to food plots during late winter in Kansas. Lehmann (1984:16, 276) suggested that northern bobwhite benefited from feeding in south Texas, but predators also were attracted to feeders. Guthery (1986:48–59) also suggested that supplemental feeding could benefit northern bobwhite reproduction and survival if habitat structure was of sufficient quality and the feeding program was correctly handled. DeMaso et al. (1998), working in Oklahoma, found

that supplemental feeding did not have an effect on annual mortality, but did affect the distribution of cause-specific northern bobwhite mortality. Townsend, et al. (1999) noted that winter weather in Oklahoma was not a predictor of use of feeders by northern bobwhite. In 2 of 3 years, they also found winter survival was greater on areas with supplemental feed compared with non-fed areas, however, the opposite was found for the third year.

Our objective was to monitor northern bobwhite responses to fall feeding of a high-energy supplement in south Texas. Specifically, we looked at the effects of supplemental feeding on northern bobwhite winter survival, winter–spring population age structure, fall–winter distribution, and predator activity at feeders.

STUDY AREAS

Eight study sites (260 ha each) were selected and paired; one of each pair was a treatment (feeding) site and the other was a control (non-fed) site. Three study-site pairs were in south Texas, 35 km south of Hebbronville centrally located in Jim Hogg County. A fourth study-site pair was in the Gulf Prairies and Marshes (Gould 1975) on the Welder Wildlife Foundation Refuge, about 18 km north of Sinton, in San Patricio County. Annual precipitation at the Welder location averaged about 80 cm. The south Texas areas received about 50 cm of rainfall annually.

Study-site pairs were selected based on geographic proximity and similarity of current and past grazing management, range condition classes (United States Department of Agriculture 1976), quail harvest rates,

¹ Present address: Los Alamos National Laboratory, 528 35th Street, Los Alamos, NM 87544

precipitation patterns, and vegetation types. Study sites were centrally located in pastures to reduce potential effects of northern bobwhite ingress and egress.

Vegetation, soil types, grazing pressure, and hunting activity were similar on study sites and the surrounding areas (Doerr 1988). Doerr (1988) noted that vegetation structure was similar on paired areas except for site III during fall 1986. The control site III was in better range condition compared to the fed site III. The increased grass cover on control site III accounted for a higher vertical screening (vegetation profile board; Nudds 1977). Site IV had significantly greater percent screening at all strata heights compared to the other sites (I, II, and III) (Doerr 1988). Site II had the lowest percent screening compared to the other sites.

Paired Sites I

The first paired sites were located on the H. C. Weil's Palangana Ranch in Jim Hogg County and a 0.3-km buffer of similar habitat separated sites. Soils were dominated by deep sands in the Nueces and Saritas soil series, although inclusions of sandy loam of the Delmita series comprised <20% of each study site. Mesquite (*Prosopis glandulosa*) mottes with brazil (*Condalia obtusifolia*), lime-prickly ash (*Zanthoxylum fagara*), lantana (*Lantana horrida*), and granjeno (*Celtis pallida*) were common woody species and comprised 10% of the vegetation cover of the study sites. Important herbaceous species associated with the mesquite mottes included ground cherry (*Physalis viscosa*), dichanthelium (*Dichanthelium* spp.), bristlegrass (*Setaria* spp.), and panicgrasses (*Panicum* spp.). Open areas (90% of sites) were dominated by perennial horsemint (*Monarda* spp.), milkpea (*Galactia* spp.), three-awn (*Aristida* spp.), thinseed paspalum (*Paspalum setaceum*), panicum, and seacoast bluestem (*Schizachyrium scoparium*). Other plants included partridgepea (*Cassia fasciculata*), cowpen daisy (*Verbesina enceloides*), and spurges (Euphorbiaceae).

Grazing management consisted of a cow-calf operation with year-long continuous grazing at 8 ha/animal unit (AU). This was changed to a 2-herd 3-pasture system at 10 ha/AU during the study. Northern bobwhite harvest rates were similar on both sites (about 20% of autumn densities) as was hunting pressure (about 20 hunter hours/site).

Paired Sites II

The second paired sites were on the A. Weil's Sombrero Ranch in Jim Hogg County. A 0.6-km buffer of similar habitat separated the sites. Soils were predominately sandy loams of the Delmita series, with inclusions of Nueces and Saritas soils. Woody vegetation consisted of catclaw acacia (*Acacia greggii*), brazil, granjeno, and mesquite. Brush composed 20% of the vegetation cover on the sites. Common grasses included three-awn, panicgrass, thinseed paspalum, seacoast bluestem, fringed signalgrass (*Brachiaria ciliatissima*), red lovegrass (*E. oxylepis*), hairy grama (*Bouteloua hirsuta*), and sideoats grama (*B. curtipendula*). Forbs included partridgepea, perennial horse-

mint, milkpea, cowpen daisy, croton, yellow wood-sorrel (*Oxalys dillenii*), tephrosia (*Tephrosia* spp.), senna (*Senna* spp.), pepperweed (*Lepidium* spp.), bladderpod (*Lesquerella* spp.), and flax (*Linum rigida*).

Grazing management, throughout the study, consisted of a cow-calf operation with year-long, continuous grazing at 8 ha/AU. Northern bobwhite harvest rates were <10% of autumn densities and hunting pressure was <15 hunter hours/site during the study.

Paired Sites III

The third paired sites were on the W. W. Jones' Alta Vista Ranch in Jim Hogg County. Soils were deep sands of the Nueces and Saritas soil series. This study area was not established until the second field season (autumn 1986 through winter 1987). Vegetation was similar to site I. The primary difference in vegetation composition between the 2 areas was that site III had a greater percent cover of seacoast bluestem, tanglehead (*Heteropogon contortus*), crinkleawn (*Trachypogon secundus*), and American balsamscale (*Elyonurus tripsacoides*).

Livestock management was a cow-calf operation with a year-long, continuous grazing system at 12 ha/AU. Northern bobwhite harvest rates were equal on the paired sites at 20–30% prior to the 1986–87 hunting season. Harvest during the 1986–87 season was about 19% on the control site and 37% on the fed site.

Paired Sites IV

The fourth paired sites were on the Welder Wildlife Foundation in San Patricio County and study sites were contiguous. Soil on this area was Victoria clay. Brush species included mesquite, agarito (*Berberis trifoliata*), huisache, hackberry (*Celtis* spp.), lime pricklyash, blackbrush (*A. rigidula*), granjeno, and Texas persimmon (*Diospyros texana*). Common grasses included gramagrasses, common bermudagrass (*Cynodon dactylon*), vine mesquite (*P. obtusum*), meadow dropseed (*Sporobolus asper*), Texas wintergrass (*Stipa leucotricha*), and tridens (*Tridens* spp.). Forbs included western ragweed (*Ambrosia psilostachya*), Leavenworth vetch (*Vicia leavenworthii*), upright prairie coneflower (*Ratibida columnaris*), frogfruit (*Phyla* spp.), yellow wood-sorrel, croton, bladderpod, pepperweed, mallows, and primrose (*Oenothera* spp.).

The sites were part of a cow-calf operation on a 3-month, 4-pasture, 3-herd, deferred-rotation system. The control area was moderately stocked (2.8 ha/AU) and the treated area was lightly stocked (5.7 ha/AU). Both sites were in good range condition. There was no hunting pressure on these sites.

METHODS

Feeders

Sixteen feeders were set in a 4 × 4 grid, 0.3 km apart on each fed site. Feeders also were 0.3 km from study site borders to reduce potential ingress-egress from the surrounding land. Initially, feeders consisted

of a 208-l plastic drum placed on a 1.2-mm plywood board, and wired between 2 metal fence posts. Six, 8-mm holes were drilled into the sides of each feeder about 6 cm above the bottom. These feeders were replaced prior to the 1986–87 field season with 19-l plastic buckets hung 2–4 cm above the soil surface from existing brush. Feeders hung from brush were less susceptible to loss of feed due to red harvester ants (*Pogonomyrmex barbatus*), and the large plastic drums were more difficult to fill than were the plastic buckets. Feed flow holes were drilled 2–3 cm above the bottom of the containers. Feeders were filled with 15 kg of whole milo and monitored twice weekly from 1 September 1985 through 31 March 1986 and from 25 November 1986 through 31 March 1987. Whole milo is a high carbohydrate (70–80%), low protein (12%), and low fat (1–4%) supplement (Nestler et al. 1944). The high carbohydrate content makes milo an excellent energy source. It provides 100% of minimum protein requirements of non-breeding adult northern bobwhites and 52% of breeding female northern bobwhite protein requirements (Nestler et al. 1944).

Population Attributes

Northern bobwhite population densities were estimated using line transects (Guthery 1987). Four, 1.2-km transects spaced at 0.3-km intervals were established on each study site. Between 20 and 45 km of transects were walked on each study site in the autumn and late winter through early spring (Mar) during the first or last 3 hours of daylight. Numbers of birds flushed, right-angle distance between transect line and each flush point, and transect length were estimated. Effective strip width, group size, and population density were calculated using a Kelker estimator (Gates 1979).

Trapping was conducted on sites I and II and the fed site III during both field seasons and on the unfed site III during the second field season. Sixteen to 32 traps were used on each site. Trap locations were pre-baited for 3–5 days. Trapping was conducted once a month from September through March the first field season and limited to a 15-day trap session in November and March the second field season. An effort was made to trap and mark 100 individual quail at each site during both years. Birds were banded with uniquely numbered aluminum leg bands supplied by Texas Parks and Wildlife. Age, sex, location, and date of capture of each individual were recorded. These data were used to determine age and sex ratios and an index of relative survival (numbers recaptured and/or harvested/number initially banded). Data also were used the second year to provide a second index of bird density on the study sites using a Schumacher-Eschmeyer (Schumacher and Eschmeyer 1943) estimator.

Crop Analysis

Crops of birds obtained from hunters at site III were examined for presence or absence of supplemental feed and native foods. We did not have access to

hunters at sites I and II. Date and time of collection were noted for each bird.

Observation Data

Feeders were visited 0.5 hour before to 2 hours after sunrise and 2 hours before sunset to 0.5 hour after sunset to determine if northern bobwhites or raptors were at or near feeders. A similar number of random points were visited on both treatments and served as controls. Feeders were visited 5 times/month and random points were visited 1–2 times/month from November through February. Presence or absence of northern bobwhites and raptors were recorded. The visual presence of northern bobwhites at feeders (within 30 m) was assumed to be an indicator of feed use by the birds.

Scent Stations

Terrestrial predator activity was monitored using modified scent stations (Linhart and Knowlton 1975). Eight scent stations spaced 0.3 km apart were operated for 2 consecutive nights on each study site. Each station consisted of a 2-m diameter, cleared circular area. Soil in the area was sifted and leveled. A scent capsule was staked in the center of the area. Carmine's Canine Lure was used as an attractant. Species and number of animals were recorded in the morning. These data were reported as animal visitations/night/station.

Statistical Analyses

Differences in grazing pressure, vegetation, soils, and hunting pressure between study sites preclude the use of statistical analysis to differentiate between treatment effects and experimental error when comparing treatment effects between study sites. Therefore, statistical analysis related to northern bobwhite and predator responses are descriptive.

A 95% confidence interval (Schumacher and Eschmeyer 1943, Chapman 1948) was used to detect differences in northern bobwhite densities between fed and control sites. Differences between northern bobwhite density estimates from trap data also were determined using 95% confidence intervals. Frequencies of bands returned were compared between paired study-sites using Chi-square tests.

Data related to northern bobwhite and raptor presence on fed and random points were pooled by month for each site and analyzed using Chi-square tests (Snedecor and Cochran 1967:250–252). Data related to presence of grain in crops were not pooled, and were analyzed using Chi-square tests.

RESULTS

Northern Bobwhite Population Attributes

Initial densities were similar on paired sites (Table 1). Northern bobwhite densities were greater on fed sites compared to control sites on deep sand study areas (sites I and III) during subsequent spring sample

Table 1. Seasonal densities of northern bobwhites (D = number/ha) and standard errors as affected by supplemental feeding on 4 south Texas study areas, 1985–87.

Area Treatment	Fall 1985		Winter 1985		Spring 1986		Fall 1986		Spring 1987	
	D ^a	SE	D	SE	D	SE	D	SE	D	SE
Site I										
control	1.49	0.36	0.77	0.25	0.30A	0.25	1.95	0.73	0.35A	0.45
fed	1.59	0.60	1.40	0.71	1.10B	0.35	2.31	0.81	1.10B	0.42
Site II										
control	1.92	0.61	2.54	0.71	1.85	0.78	2.05	0.29	0.95	0.38
fed	1.89	0.66	2.28	0.75	2.10	0.90	1.92	0.33	0.89	0.50
Site III										
control ^b					0.64	0.56	1.64	0.51	0.56	0.41
fed	1.79	0.62	0.70	0.38	1.11	0.49	2.56	0.53	0.69	0.56
Site IV										
control	0.25	0.85	0.20	0.92	0.25	0.87	0.52	0.74	0.36	0.93
fed	0.25	0.87	0.31	0.96	0.29	0.82	0.25	0.85	0.40	0.89

^a Densities followed by different letters in columns by study areas differ ($P < 0.05$).

^b Study site added spring 1986.

periods, but not in autumn 1986. Densities were not different on the fed sites II and IV compared to the respective control sites during subsequent sample periods. Fall 1986 population estimates based on trap data were supportive of estimates from transect data (Fig. 1). No marked northern bobwhites were observed or harvested off sites from which they were originally trapped.

Densities were greatest in the autumn and declined 50–76% during winter and early spring. The greatest population reductions were seen on sites I and III (Table 1). Population reductions ranging between 3 and 53% were seen on sites II and IV. Site IV on the Gulf Prairies and Marshes had the lowest population densities compared to all other study areas (Table 1). Northern bobwhite densities on the south Texas areas (sites I, II, and III) were at comparable levels in the autumn. Densities on site II were generally greater than those on the deep sand areas (sites I and III).

Winter survival was not greater on fed sites compared to paired control sites, except on site I (Tables 2 and 3). Survival, based on estimated densities, ranged between 17 and 97% (Table 2). Survival on the

fed site I was over twice the survival found on the control site. Survival based on band returns during the second field season yielded similar results. Band returns were similar between the control and fed sites II and returns on the fed site I were double those on the control area (Table 3).

Juvenile-to-adult ratios (Table 4), as a measure of reproductive success, were similar between paired fed and control sites, and varied between 1:1.7 and 1:2.6. Juvenile-to-adult-female ratios followed the same pattern, varying from 1:6.4 to 1:8.0.

Feed Usage

Percent of birds using supplemental feed varied by month and time of day. Between 45 and 70% of birds shot on fed areas during the second field season had supplement in the crops (Table 5). The percent of crops with supplement increased over time. A greater ($P < 0.05$) percent of northern bobwhite crops collected in the afternoon had some supplement present compared to bird crops collected in the morning during November and December 1987 (Table 6). The percent of crops with milo present was similar ($P > 0.25$) between morning and evening samples in January and February 1987. The percent of northern bobwhite crops having no food (native or supplement) was greater ($P < 0.05$) in morning compared to afternoon (Table 7).

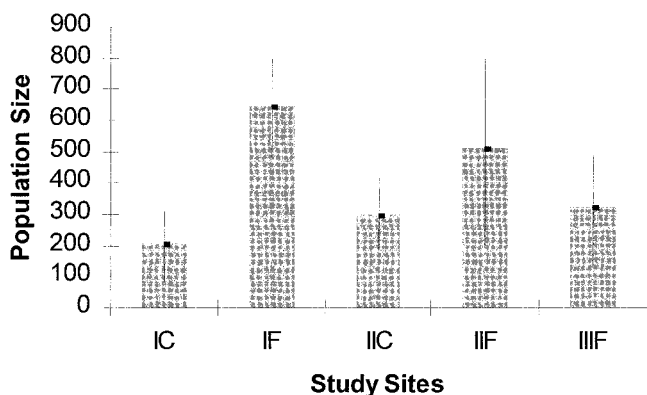

Fig. 1. Population estimates (Schumacher-Eschmeyer) of northern bobwhites and 95% confidence intervals on Site I with (IF) and without feeders (IC), Site II with (IIF) and without feeders (IIC), and Site III with feeders (IIIF).

Table 2. Percent northern bobwhite survival and increase on 3 south Texas study areas based on comparison of spring and fall population estimates from flush transect data, 1985–87.

Area	Treatment	Winter 1985 survival	% Spring to fall increase	Winter 1986 survival
Site I	Control	20.1	650.0	18.0
Site I	Fed	69.2	210.0	47.6
Site II	Control	72.8	110.8	46.3
Site II	Fed	92.1	91.4	46.4
Site III	Control ^a		256.3	34.2
Site III	Fed	62.0	230.6	27.0

^a Site not established until spring 1986.

SUPPLEMENTAL FEEDING AND BOBWHITES

Table 3. Indices of survival on 5 south Texas study sites based on band returns from birds banded in 1985–86 and re-trapped or harvested in 1986–87 and birds banded in fall 1986 and re-trapped in spring 1987.

Index	Site I		Site II		Site III
	Fed	Control	Fed	Control	Fed
Banded 1985	54	46	58	60	112
Re-trapped 1986–87	12B ^a	3A	6A	3A	9A
% bands re-trapped	22.2	6.5	10.3	5.0	8.0
Banded fall 1986	133	102	110	100	100
Re-trapped spring 1987	36B	16A	9A	8A	6A
% bands retrapped	27.1	15.7	7.3	9.0	6.0

^a Number followed by different letters in rows differ ($P < 0.10$).

The percent of times that birds were flushed near feeders (≤ 30 m) was greater compared to the percent of times birds were flushed at random locations on fed and control sites, except on site I (Table 8).

Predation

Indices of predator activity and depredation were similar between paired sites. Scent-station visitations ranged between 0.56 and 1.55 animals/station/night. Raptor sighting on transects averaged 0.21 birds/km on fed areas and 0.24 birds/km on control areas. There was no difference ($P < 0.05$) between the number of perched predators observed at feeders (21 of 2,500 observations) compared to observation points on control areas (2 of 500 observations).

DISCUSSION

If supplemental feeding was an effective tool in this study, then increases in northern bobwhite density on fed sites compared to unfed sites should be related to increased reproductive success or survival. If supplemental feeding did not increase population densities, then either food supply indices should be adequate or some other habitat factor should be documented as limiting the population.

Paired Site I

Density calculations showed about twice the density on the fed area compared to the control area. High use of supplemental feed by birds on the fed area and increased autumn-to-spring survival of birds on the fed site compared to the control site suggested that supplemental feeding increased population numbers. Similarly, the increased use (more northern bobwhites at

feeders) of supplemental feed over time, the increased use of supplemental feed during morning feeding periods over time, and the slight increase in the percent of birds with no food (native or supplemental) in crops indicated that native foods became limited as the winter progressed.

The similarity of northern bobwhite age ratios on the fed and control sites and the similarity or reduced spring-to-autumn population increase suggested that supplementing winter food supplies with a high energy-low protein ration did not improve reproductive success. Perrin (1965) hypothesized that a restricted food supply would delay egg laying and clutch size, and that early nest initiation would increase survival of young. Work by Dijkstra et al. (1982) on kestrels (*Falco tinnunculus*) and Kallander (1974) supported the hypothesis that laying date and clutch size were affected by increased food supply. Yom-Tov (1974) reported increased breeding success of carrion crows (*Corvus corone*) having access to supplemental feed compared to crows without access to supplemental feed. Similar findings were reported by Hogstedt (1981) regarding black-billed magpies (*Pica pica*) and by Pattee (1977) studying wild turkeys (*Meleagris gallopavo*). Wilbur et al. (1974) felt that supplemental feeding might have improved California condor (*Gymnogyps californius*) breeding success. These studies supplied a complete ration supplement. Also, the supplement was supplied during the breeding and brooding periods.

Guthery (1986:59) suggested that an appropriately executed feeding program could enhance breeding success of northern bobwhites. This type of program includes supplying a whole ration supplement throughout breeding and brooding. The supplement provided to northern bobwhites in our study was low in protein

Table 4. Age ratios (juveniles/adult) in autumn 1986 through spring 1987 based on trap data and harvest data on the south Texas study sites I, II, and III.

Age ratio	Site I		Site II		Site III	
	Control (125) ^a	Fed (263)	Control (131)	Fed (153)	Control (269) ^b	Fed (194)
J:A ^c	2.3	2.3	2.7	1.7	2.6	1.9
J:A female	7.3	7.4	7.4	8.0	6.7	6.4

^a Number of birds trapped.

^b Number of birds harvested.

^c J = juvenile and A = adult.

Table 5. Number (n) and percent (%) of crops with supplemental feed present and absent in November–February from fed site III, winter 1986–87.

Month	With feed ^a		Without feed	
	n^a	%	n	%
November	66AB	49	70	51
December	56A	46	67	54
January	281BC	59	196	41
February	26C	70	11	30

^a Number of crops with supplemental feed followed by different letters differ ($P < 0.05$).

Table 6. Number (*n*) and percent (%) of crops with supplemental feed present and absent from fed site III by time of day, winter 1986–87.

Period	Time of collection	Crops with feed ^a		Crops without feed	
		<i>n</i>	%	<i>n</i>	%
Nov–Dec	Morning	46A	37	78	63
	Evening	91B	60	62	40
Jan–Feb	Morning	147A	62	92	38
	Evening	160A	58	115	42

^a Number of crops with supplement feed followed by different letters during same date differ ($P < 0.05$).

and was available only during the beginning of the breeding season. A diet composed of whole milo does not meet minimum protein or phosphorous requirements of northern bobwhite (Nestler et al. 1944). Protein has been suggested as an important supplemental nutrient for improving northern bobwhite productivity (Guthery 1986:53). However, Wood et al. (1986) found that south Texas northern bobwhites were able to meet minimum reproductive protein requirements, but not minimum phosphorous requirements by using native foods. The study by Wood et al. (1986) was not designed to determine if native food supplies limited populations or nutrient plane. Their study only addressed whether existing northern bobwhites were able to meet nutrient requirements. The data strongly suggested that protein was not limiting, but that phosphorous may have been limiting. Therefore, the use of a whole-milo supplement in winter and early spring may not have met the necessary assumptions of supplying the appropriate nutrient at the appropriate time to improve reproduction.

Paired Site II

Northern bobwhite density, reproductive success, age ratios, and survival were not different between the fed and control sites. These population indices suggest that factors other than food may have limited population densities.

More conclusive evidence that food may not have been limiting on site II was the occurrence of birds at feeders. Birds were found more consistently at feeders compared to random locations on site II, but birds did not use feeders as consistently as birds on site I.

Paired Site III

Northern bobwhite density on the fed site was greater compared to density on the control site in spring 1986. It cannot be conclusively stated that feeding was the source of population differences and hence survival, during winter 1985, because pre-treatment data were unavailable.

Bird survival was similar between the fed and control site in winter 1986. This might be due to differential hunting pressure between the control and fed site. Harvest pressure (number of birds shot/estimated autumn population) was similar between the study sites in winter 1985, but in winter 1986 harvest pressure was 37% on the fed site, and 19% on the control

Table 7. Number (*n*) and percent (%) of crops having no native or supplemental feed present in mornings and evenings from fed site III, winter 1986–87.

Period	Time of collection	Crops with feed ^a		Crops without feed	
		<i>n</i>	%	<i>n</i>	%
Nov–Dec	Morning	38B	24	124	76
	Evening	10A	6	153	94
Jan–Feb	Morning	64B	21	239	79
	Evening	35A	11	275	89

^a Number of crops with feed followed by different letters differ ($P < 0.05$).

site. Number of hunter hours was nearly twice as high on the fed site compared to the control site in winter 1986. Nearly doubling hunting mortality on the fed site compared to the control site may have reduced overall winter survival in 1986. Hunting mortality may not be completely compensatory with other sources of mortality. Roseberry and Klimstra (1984:40) reported data from Illinois that hunting mortality was intermediate between being additive and compensatory. If hunting mortality during our study was additive, the larger harvest on the fed site decreased survival and contributed to the similarity in winter survival for the fed and control sites in 1986.

Paired Site IV

Northern bobwhite densities on the fed site were not different from densities on the control site. Food-producing forb densities and cover were generally greater than found on the other paired sites (Doerr 1988) suggesting that food production may not have been limiting. Also, the probability of locating birds at feeders compared to random locations was not different. The low bird densities on site IV compared to the other sites indicated that some component of the environment not measured by our study was restricting bird densities.

Site IV was surrounded by a coyote-resistant fence and few coyotes were present inside the study area.

Table 8. Number (*n*) and percent (%) of observations at feeder and random locations having northern bobwhite present and absent on 4 south Texas study areas, fall–winter 1985–86 and 1986–87.

Area	Treatment	Birds present ^a		Birds absent	
		<i>n</i>	%	<i>n</i>	%
Site I	Fed-feeder	109C	18.2	491	81.8
	Fed-random	4A	4.0	96	96.0
	Control	6A	3.0	194	97.0
Site II	Fed-feeder	66B	11.0	534	89.0
	Fed-random	8B	8.0	92	92.0
	Control	3A	1.5	197	98.5
Site III	Fed-feeder	128C	21.3	472	78.7
	Fed-random	5A	5.0	95	95.0
	Control	1A	1.0	99	99.0
Site IV	Fed-feeder	2A	2.0	98	98.0
	Fed-random	0A	0.0	100	100.0
	Control	0A	0.0	100	100.0

^a Different letters following number of visits with birds differ ($P < 0.10$).

Scent-station activity suggested that other mammalian predator activity was no greater compared to activity on Sites I, II, and III. Fewer raptors were observed on site IV compared to the other study areas. Therefore, depredation is discounted as an important reason for reduced populations on site IV.

Wilson (1984) felt that herbaceous vegetation on the Welder Wildlife Foundation Refuge was too thick for optimum northern bobwhite densities. Furthermore, Bareiss (1985) reported that a majority of random locations on the Welder Refuge were unsuitable for northern bobwhites. Doerr and Silvy (1987) also noted that habitat structure was limiting populations on site IV. Also Doerr and Silvy (1987) found that northern bobwhite densities on a study area adjacent to site IV were greater compared to densities on site IV. Moreover, they reported that herbaceous structure of the vegetation on adjacent sites was lower compared to structure on site IV. Doerr and Silvy (1987) concluded that a negative relationship existed between northern bobwhite densities and nest cover, and percent vegetation screening.

MANAGEMENT IMPLICATIONS

The variable population responses to supplemental feeding demonstrate that food supply is only 1 of several environmental factors in a complex system. Winter feeding of a high-energy supplement can improve survival if food is limiting. This study also demonstrated that feeding can increase the probability of locating birds. However, supplemental feeding cannot compensate for limitations in habitat structure or high hunting pressure. Therefore, management objectives and habitat status should be assessed prior to implementation of any feeding program.

Supplemental feeding with whole milo appears to increase survival of birds on deep sand range sites in south Texas. However, this increased survival did not result in increased densities the following fall.

Whole milo was not effective for increasing northern bobwhite density or survival on clay soils of the Gulf Coast Prairies and Marshes or on red sandy loams of south Texas. Plant communities on the Gulf Coast Prairies and Marshes are highly productive due to high soil fertility, length of growing season, and abundant rainfall. Northern bobwhites are closely related to lower successional stages. Therefore, maintaining lower successional stages over a portion of their range will probably be of greater benefit for northern bobwhites than simply supplying an additional food source. Supplemental feeding on red sandy loam range sites in south Texas may be more complex. Guthery (1986: 130) suggested that enhancing native foods and rejuvenating habitat structure may be synergistic. Therefore, manipulating both habitat structure and native feed on these range sites may be required to achieve a satisfactory northern bobwhite population response.

Whole milo supplied from winter through early spring did not increase reproductive success. If the objective of a feeding program is to improve reproduc-

tive success, then a total ration supplied through the breeding and brooding seasons may be more appropriate. Supplemental feeding did not improve reproductive success of bobwhites on any of the study sites. Young bobwhite chicks feed almost exclusively on insects (Roseberry and Klimstra 1984:87). Supplemental feeding does not produce more insects for chicks, therefore, one would not expect supplemental feeding to increase reproductive success if insects were limiting within an area. No matter how much supplemental feeding increases adult bobwhite survival and body condition, if insects are limiting, supplemental feeding will not increase bobwhite numbers for the fall hunt. Therefore, a fifth assumption that could be added to Doerr's (1988) list for bobwhite supplemental feeding; supplemental feeding should benefit all segments (young as well as adults) of the population.

Winter feeding appears to improve the consistency of locating birds on deep sand and red sandy loam range sites of south Texas. Feeding does not appear to improve opportunities for locating birds when populations are low. Also, feeding did not increase predator activity, nor was there a greater probability to see predators at feeders compared to locations without feeders. DeMaso et al. (1999) and Townsend et al. (1999) also noted that northern bobwhites using feeders were not predisposed to hunter harvest or predators.

No single management tool will produce consistent results with northern bobwhite populations because of the matrix of environmental factors that influence a population. Knowledge concerning the status of key environmental factors can improve predictions regarding the effects a management tool may have on a population. Doerr and Silvy (1987) felt that an understanding of northern bobwhite management objectives and knowledge of the status of the habitat and population were essential to gain benefits from a feeding operation. This study demonstrates that the effects of feeding on northern bobwhite populations are variable because of the confounding interactions of environmental factors. Variability in efficacy of supplemental feeding and the associated costs need to be considered and compared to potential risks and benefits of other management tools before managers implement such a program.

LITERATURE CITED

- Bareiss, L. J. 1985. Response of bobwhites to short duration and continuous grazing. Thesis, Texas Tech University, Lubbock.
- DeMaso, S. J., E. E. Parry, S. A. Cox, and A. D. Peoples. 1999. Cause-specific mortality of northern bobwhites on an area with quail feeders in western Oklahoma. Proceedings Annual Conference Southeastern Fish and Wildlife Agencies 52:359-366.
- Dijkstra, C., L. Vuursten, C. Daan, and D. Masman. 1982. Clutch size and laying data in the kestrel *Falco tinnunculus*: effect of supplementary food. Ibis 124:210-213.
- Doerr, T. B. 1988. Effects of supplemental feeding on northern bobwhite populations in south Texas. Dissertation, Texas A&M University, College Station.
- Doerr, T. B., and N. J. Silvy. 1987. Application of supplemental feeding for northern bobwhite management in south Texas.

- Pages 111–119 in L. D. White, T. R. Troxel, and J. M. Payne, eds. International Ranchers Roundup. Texas Agricultural Extension Service, Texas A&M University, College Station.
- Frye, O. E. 1954. Studies of automatic quail feeders in Florida. Transactions of the North American Wildlife Conference 19: 298–315.
- Gates, C. W. 1979. Line transects and related issues. Pages 71–154 in R. M. Cormack, G. P. Patil, and D. S. Robson, eds. Sampling biological populations. International Cooperative Publishing House, Fairland, Maryland.
- Gould, F. W. 1975. Texas plants: a checklist and ecological summary. Texas Agricultural Experiment Station, Texas A&M University, College Station.
- Guthery, F. S. 1986. Beef, brush, and bobwhites: quail management in cattle country. Caesar Kleberg Wildlife Research Institute Press, Kingsville, Texas.
- Hogstedt, G. 1981. Effect of additional food on reproductive success in the magpie (*Pica pica*). Journal of Animal Ecology 50:219–229.
- Kallander, H. 1974. Advancement of laying of great tits by the provision of food. Ibis 116:365–367.
- Keeler, J. E. 1959. Quail feeder study. Alabama Department of Conservation, Wildlife Restoration Project. W-32-R, Final Report. 1953–1957. Montgomery, Alabama.
- Lehmann, V. W. 1984. Bobwhites in the Rio Grande Plain of Texas. Texas A&M University Press, College Station.
- Linhart, S. B., and F. F. Knowlton. 1975. Determining the relative abundance of coyotes by scent station lines. Wildlife Society Bulletin 3:119–124.
- Nestler, R. B., W. W. Bailey, M. J. Rensberger, and M. Y. Benner. 1944. Protein requirements of breeding bobwhite quail. Journal of Wildlife Management 8:284–289.
- Nudds, T. D. 1977. Quantifying vegetative structure of wildlife cover. Wildlife Society Bulletin 5:113–117.
- Pattee, O. H. 1977. Effects of nutrition on wild turkey reproduction in south Texas. Dissertation, Texas A&M University, College Station.
- Perrins, C. M. 1965. Population fluctuations and clutch-size in the great tit (*Parus major* L.). Journal of Animal Ecology 34:601–647.
- Robel, R. J., R. M. Case, A. R. Bisset, and T. M. Clement, Jr. 1974. Energetics of food plots in bobwhite management. Journal of Wildlife Management 38:653–664.
- Roseberry, J. L., and W. D. Klimstra. 1984. Population ecology of the bobwhite. Southern Illinois University Press, Carbondale.
- Schumacher, F. X., and R. W. Eschmeyer. 1943. The estimate of fish populations in lakes and ponds. Journal of the Tennessee Academy of Science 18:228–249.
- Snedecor, G. W., and W. G. Cochran. 1967. Statistical methods. Iowa State University Press, Ames.
- Townsend, D. E., II, R. L. Lochmiller, S. J. DeMaso, D. M. Leslie, Jr., A. D. Peoples, S. A. Cox, and E. S. Parry. 1999. Using supplemental food and its influence on survival of northern bobwhite (*Colinus virginianus*). Wildlife Society Bulletin 27:1074–1081.
- United States Department of Agriculture. 1976. Soil Conservation Service national range handbook. Amendment No. 11.
- Wilbur, S. D., W. D. Carrier, and J. C. Burneman. 1974. Supplemental feeding program for California condors. Journal of Wildlife Management 38:342–346.
- Wilson, M. H. 1984. Comparative ecology of bobwhites and scaled quail in southern Texas. Dissertation, Oregon State University, Corvallis.
- Wood, K. N., F. S. Guthery, and N. E. Koerth. 1986. Spring-summer nutrition and condition of northern bobwhites in south Texas. Journal of Wildlife Management 50:84–88.
- Yom-Tov, Y. 1974. The effects of food and predation on breeding density and success, clutch size, laying date of the crow (*Corvus corone* L.). Journal of Animal Ecology 43:479–498.

THE EFFECT OF QUAIL FEEDERS ON NORTHERN BOBWHITE DENSITY IN WESTERN OKLAHOMA

Stephen J. DeMaso¹

Oklahoma Department of Wildlife Conservation, Oklahoma City, OK 73152, USA

Darrell Townsend, II

Department of Zoology, Oklahoma State University, Stillwater, OK 74078, USA

Scott A. Cox

Oklahoma Department of Wildlife Conservation, Cheyenne, OK 73628, USA

Edward S. Parry

Oklahoma Department of Wildlife Conservation, Fredrick, OK 73542, USA

Robert L. Lochmiller²

Department of Zoology, Oklahoma State University, Stillwater, OK 74078, USA

Alan D. Peoples

Oklahoma Department of Wildlife Conservation, Oklahoma City, OK 73152, USA

ABSTRACT

We investigated the effect of quail feeders on northern bobwhite (*Colinus virginianus*) covey size and density from 1 October 1991 to 1 October 1996 on the Packsaddle Wildlife Management Area (WMA) in western Oklahoma. Thirty-two quail feeders filled with milo were located near the center of every 8.1 ha on a 283.3-ha treatment area. An adjacent 283.3-ha control area contained no quail feeders. Line-transect methodology was used to seasonally determine covey size and density on each area. Transects were traversed on horseback during October and March of each year. Mean fall covey size was similar ($t = 0.19$, $df = 1$, $P = 0.8525$) between the control (14.0 ± 1.2 birds/covey) and treatment (14.2 ± 1.1 birds/covey) areas, pooled over years. Mean spring covey size was similar ($t = 10.18$, $df = 1$, $P = 0.9999$) between the control (9.4 ± 1.9 birds/covey) and treatment (6.6 ± 1.5 birds/covey) areas, pooled over years. Pooled over treatments, mean covey size was similar ($F = 1.30$, $df = 4$, $P = 0.2798$) among years, but differed ($F = 40.56$, $df = 1$, $P = 0.0001$) between spring (7.6 ± 1.2 birds/covey) and fall (14.1 ± 0.8 birds/covey). Mean bobwhite density, pooled over seasons and years was similar ($t = -3.55$, $df = 1$, $P = 0.9125$) between control (1.28 ± 0.43 birds/ha) and treatment (1.38 ± 0.44 birds/ha) areas. We concluded that quail feeders had no effect on mean covey size or density of bobwhite populations on our study area in western Oklahoma.

Citation: DeMaso, S. J., D. E. Townsend, II, S. A. Cox, E. S. Parry, R. L. Lochmiller, and A. D. Peoples. 2002. The effect of quail feeders on northern bobwhite density in western Oklahoma. Pages 241–244 in S. J. DeMaso, W. P. Kuvlesky, Jr., F. Hernández, and M. E. Berger, eds. Quail V: Proceedings of the Fifth National Quail Symposium, Texas Parks and Wildlife Department, Austin, TX.

Key words: *Colinus virginianus*, covey size, density, line transect, northern bobwhite, Oklahoma, quail feeders

INTRODUCTION

Supplemental feeding is a common management practice used to augment populations of northern bobwhites in Oklahoma and throughout their range (Frye 1954, Guthery 1986:48, Peoples 1992). Although this practice has gained wide acceptance, there is little scientific evidence indicating feeders increase density, productivity, or survival of bobwhite populations. Several studies have examined the effect of supplemental feeding on wild bobwhite populations (Frye 1954,

Keeler 1959, Robel 1979, Doerr 1988, Kane 1988, Peoples 1992), and those that have been conducted often provide conflicting results.

Frye (1954) reported that supplemental feeding increased bobwhite numbers in south Florida. Guthery (1997) used these data from Florida (Frye 1954), as well as from Alabama (Keeler 1959), Texas Rio Grande Plains (Doerr 1988, Guthery, unpubl. data), and the Texas Coastal Prairie (Doerr 1988, Kane 1988) to determine whether increased food supplies increase bobwhite density. Guthery (1997) concluded that food supplementation was a neutral management practice because bobwhites did not respond with an increase in density to supplemental feed.

Our objective was to determine if quail feeders are

¹ Present address: Texas Parks and Wildlife Department, 4200 Smith School Road, Austin, TX 78744-3291

² Deceased

Table 1. Number of flushing observations (n) used to estimate northern bobwhite mean covey size by season, treatment, year, and pooled over treatments and years on Packsaddle WMA, Ellis County, Oklahoma, 1991–96.

Year Season	Treatment						Pooled		
	Control			Feeder			n	\bar{x}	SE
	n	\bar{x}	SE	n	\bar{x}	SE			
1991									
Fall	25	15.5	1.28	22	14.0	1.76	47	14.8	1.06
1992									
Spring	7	10.0	1.31	9	9.8	1.75	16	9.9	1.11
Fall	13	17.8	0.96	16	15.6	0.75	29	16.6	0.62
1993									
Spring	4	10.8	2.25	2	5.5	0.50	6	9.0	1.81
Fall	14	9.9	1.81	16	14.3	0.52	30	12.3	0.96
1994									
Spring	4	13.0	1.22	6	5.3	1.89	10	8.4	1.72
Fall	13	14.9	0.79	10	12.3	2.00	23	13.8	0.99
1995									
Spring	2	4.0	1.00	3	4.3	2.40	5	4.2	1.36
Fall	20	12.8	1.36	19	12.7	1.31	39	12.7	0.93
1996									
Spring	3	4.7	1.86	16	5.8	1.03	19	5.6	0.90
Fall	10	12.1	1.45	15	15.9	1.44	25	14.4	1.09
1991–96									
Spring	20	9.4	0.97	36	6.6	0.77	56	7.6	0.63
Fall	95	14.0	0.60	98	14.2	0.58	198	14.1	0.42

a viable management alternative for increasing mean covey size and density of bobwhite populations in western Oklahoma.

STUDY AREA AND METHODS

Research was conducted on the Packsaddle WMA in southern Ellis County, Oklahoma. Cole et al. (1966) described the soils, ecological, and climatic conditions in this county. DeMaso et al. (1997) and Parry et al. (1997) provide details on the Packsaddle WMA study area.

The study area was divided into 2 areas, each 283.3 ha. Beginning 1 October 1991, 1 area was supplemented with milo *ad libitum* in gravity-flow feeders, distributed at about 1 feeder/8.1 ha (35 feeders total). The second area served as a control, and was separated from the feeder area by a 1.2-km wide buffer zone.

Bobwhite density was estimated using line-transect methodology (Burnham et al. 1980, Buckland et al. 1993). Four 800-m long transects were permanently established on each study area, 300 m apart, and oriented north-south. Transects were traversed on horseback repeatedly during the first and last 3 hours of daylight (Guthery 1988) until cumulative length ridden was 32 km/site per season. Each time a covey flushed, the number of birds and right-angle distance from the transect to the point where the covey flushed were recorded. Covey centers were determined at the point of first sighting for coveys that did not flush.

Line-transect data were used to estimate density using the computer program DISTANCE (Buckland et

al. 1993). We used the half-normal detection model because it best satisfied the model selection criteria while yielding reasonable density estimates (Buckland et al. 1993). However, within each site, the number of right-angle distance measurements fell below the recommended 40 observations (Burnham et al. 1980) and were considerably below the 100 observations recommended by Buckland et al. (1993). To increase sample size, the seasonal and annual estimates of $\hat{f}(0)$ based on pooled data were assumed applicable on all sites within a season and year; treatment densities were estimated using $\hat{f}(0)$ values, pooled over season and year.

We used the Student's *t*-test to test for differences in covey size and density between treatment and control populations. Analysis of variance tests were used to test for differences between seasons and among years for these demographic attributes. Because our study was not replicated in different areas, we will stress descriptive statistics. All estimates are reported as $\bar{x} \pm 1.96(\text{SE})$. All statistical tests were considered significant at $P < 0.05$.

RESULTS

Covey size

Mean fall covey size was similar ($t = 0.19$, $df = 1$, $P = 0.8525$) between the control (14.0 ± 0.60 birds/covey) and treatment (14.2 ± 0.58 birds/covey) areas (Table 1). Mean spring covey size was similar ($t = 10.18$, $df = 1$, $P = 0.9999$) between the control (9.4 ± 0.97 birds/covey) and treatment (6.6 ± 0.77 birds/

covey) areas (Table 1). Mean covey size was similar ($F = 1.30$, $df = 4$, $P = 0.2798$) among years, but differed ($F = 40.56$, $df = 1$, $P = 0.0001$) between spring (7.6 ± 0.63 birds/covey) and fall (14.1 ± 0.42 birds/covey) seasons (Table 1).

Bobwhite Density

Mean bobwhite density, pooled over seasons and years was similar ($t = -3.55$, $df = 1$, $P = 0.9125$) between the control (1.28 ± 0.43 birds/ha) and treatment (1.38 ± 0.44 birds/ha) areas.

DISCUSSION

Mean covey size did not differ between the control and treatment area among years. Our results were similar to the results from a quail feeder study in Alabama (Keeler 1959). To our knowledge, no other studies reported the effect of quail feeders on mean covey size.

Frye (1954) reported an increase in bobwhite numbers on an area with automatic quail feeders in south Florida. We found no difference in bobwhite density between the control and treatment study areas. Our results are consistent with studies in south Texas (Doerr 1988, Kane 1988, Guthery 1997) and in Alabama (Keeler 1959). Our results agree with the above results that food supplementation is a neutral management practice.

Four assumptions must be met in order for a supplemental feeding program for bobwhites to be successful (Doerr 1988). These assumptions include: 1) the native food supply is limiting bird numbers, 2) no other habitat parameter (i.e., nesting cover, brood-rearing cover, woody cover, etc.) restricts the population from increasing when supplemental food is provided, 3) birds will utilize supplemental feed, and 4) the birds will be healthier (have higher survival, be more productive, avoid predators better, etc.) when the food supply is improved (i.e., food supply is a component of fitness) (Doerr 1988). Also, a successful feeding program needs to benefit the entire population (e.g., adult birds, chicks, females, and males), not just one segment of that population (i.e., over winter survival of adult birds). On an annual basis, some of the above assumptions must not have been met on our native rangeland study sites in western Oklahoma.

Our results, and the results of other researchers, show that increasing food does not increase bobwhite covey size or density. However, supplemental feeding may be useful as a shooting preserve management tool. Feeders may concentrate birds into specific areas and change the distribution of cause-specific mortality of bobwhites on that area (DeMaso et al. 1998). Doerr (1988) found that of the birds collected in south Texas, there was a tendency to find birds close to feeders more often than at points without feeders. Data from Packsaddle WMA controlled hunts showed similar results early during the hunting season. However, good shooting preserve management techniques may not be good population management techniques. The majority of the quail hunting public has been confused for many

years on the differences between wildlife management and shooting preserve management.

MANAGEMENT IMPLICATIONS

On our study area in western Oklahoma, quail feeders did not increase bobwhite density. Therefore, we recommend managers should focus bobwhite management activities on habitat manipulation. Management activities such as prescribed burning, strip discing, and cattle grazing can be used to augment the late fall and winter supply of bobwhite food. Also, these techniques can increase insect availability (food) for bobwhites during the spring and summer.

ACKNOWLEDGMENTS

We thank G. Duffy, R. Hatcher, A. LaPierre, H. Namminga, M. O'Meilia, and M. Shaw for manuscript review. We thank technicians and contract personnel for assisting with data collection. Funding was a contribution of Federal Aid in Wildlife Restoration, Oklahoma Project W-82-R, the Grand National Quail Foundation, and Oklahoma Chapters of Quail Unlimited, Inc.

LITERATURE CITED

- Buckland, S. T., D. R. Anderson, K. P. Burnham, and J. L. Laake. 1993. Distance sampling: estimating abundance of biological populations. Chapman & Hall, London, United Kingdom.
- Burnham K. P., D. R. Anderson, and J. L. Laake. 1980. Estimation of density from line transect sampling of biological populations. Wildlife Monograph 72.
- Cole, E. L., A. J. Conradi, and C. E. Rhoads. 1966. Soil survey of Ellis County, Oklahoma. United States Soil Conservation Service, Washington, D.C.
- DeMaso, S. J., A. D. Peoples, S. A. Cox, and E. S. Parry. 1997. Survival of northern bobwhite chicks in western Oklahoma. *Journal of Wildlife Management* 61:846-853.
- DeMaso, S. J., E. S. Parry, S. A. Cox, and A. D. Peoples. 1998. Cause-specific mortality of northern bobwhites on an area with quail feeders in western Oklahoma. *Proceedings Annual Conference Southeast Association of Fish and Wildlife Agencies* 52:359-366.
- Doerr, T. B. 1988. Effects of supplemental feeding on northern bobwhite populations in south Texas. Dissertation, Texas A&M University, College Station.
- Frye, O. E., Jr. 1954. Studies of automatic quail feeders in Florida. *Transactions of the North American Wildlife and Natural Resources Conference* 19:298-319.
- Guthery, F. S. 1986. Beef, brush, and bobwhites: quail management in cattle county. Caesar Kleberg Wildlife Research Institute Press, Kingsville, Texas.
- Guthery, F. S. 1988. Line transect sampling of bobwhite densities on rangeland: evaluation and recommendations. *Wildlife Society Bulletin* 16:193-203.
- Guthery, F. S. 1997. A philosophy of habitat management for northern bobwhites. *Journal of Wildlife Management* 61: 291-301.
- Kane, A. H. 1988. Effects of management on bobwhite habitat and density in southern Texas. Thesis, Texas A&I University, Kingsville.
- Keeler, J. E. 1959. Quail feeder study. Alabama Department of Conservation, Montgomery.

- Parry, E. S., S. J. DeMaso, S. A. Cox, and A. D. Peoples. 1997. Recovery rates of banded vs. radiomarked northern bobwhites in western Oklahoma. Proceedings of the Annual Conference of Southeastern Association of Fish and Wildlife Agencies 51:342-351.
- Peoples, A. D. 1992. Production, utilization, and nutritional value of supplemental feed to northern bobwhites in western Oklahoma. Thesis, Oklahoma State University, Stillwater.
- Robel, R. J., A. R. Bisset, T. M. Clement, Jr., and A. D. Dayton. 1979. Metabolizable energy of important foods of bobwhites in Kansas. Journal of Wildlife Management 43:982-987.

THE BOBWHITE QUAIL INITIATIVE: RESTORING GEORGIA'S STATE GAMEBIRD WHILE IMPROVING THE ENVIRONMENT

Chris Baumann

Georgia Department of Natural Resources, Wildlife Division, East Dublin, GA, USA

Bobby Bond

Georgia Department of Natural Resources, Wildlife Division, East Dublin, GA, USA

Joy Bornhoeft

Georgia Department of Natural Resources, Wildlife Division, East Dublin, GA, USA

John Carroll

Daniel B. Warnell School of Forest Resources, University of Georgia, Athens, GA, USA

Adam Hammond

Georgia Department of Natural Resources, Wildlife Division, East Dublin, GA, USA

Richard Hamrick

Daniel B. Warnell School of Forest Resources, University of Georgia, Athens, GA, USA

Walter Lane

Georgia Department of Natural Resources, Wildlife Division, East Dublin, GA, USA

Buck Marchinton

Georgia Department of Natural Resources, Wildlife Division, East Dublin, GA, USA

Reggie Thackston

Georgia Department of Natural Resources, Wildlife Division, East Dublin, GA, USA

ABSTRACT

Like many southeastern states, Georgia's northern bobwhite (*Colinus virginianus*) population has declined by more than 70% since the 1960s. Research has indicated that the primary cause of this decline is the reduction in habitat quality resulting from intensification of agriculture and forestry practices. To address this problem, members of Georgia's General Assembly worked with the Department of Natural Resources Wildlife Resources Division (WRD) and other conservation organizations to develop and fund the Bobwhite Quail Initiative (BQI) during the 1999 legislative session. The BQI was designed to restore habitat for bobwhites, songbirds, and other farm wildlife on private lands, and was implemented in 14 counties in Georgia (subsequently expanded to 17 in 2000). In the first year of the program, BQI personnel provided technical assistance for >100,000 acres of land allocating >\$51,000 to enroll landowners for the first contract period (2000–2002) of the BQI. Although Georgia incurred extreme drought during the summer of 2000, bobwhite quail and songbird response to BQI management practices during the first season of the program indicated that these practices had positive impacts on both. Bobwhite populations remained stable or increased on 71% of the treatment farms, while 75% of the control farms experienced population declines. Sparrow species dependent upon early successional habitat also increased by 30% in managed fields of BQI.

Citation: Baumann, C., B. Bond, J. Bornhoeft, J. Carroll, A. Hammond, R. Hamrick, W. Lane, B. Marchinton, and R. Thackston. 2002. The bobwhite quail initiative: restoring Georgia's state gamebird while improving the environment. Page 245 in S. J. DeMaso, W. P. Kuvlesky, Jr., F. Hernández, and M. E. Berger, eds. Quail V: Proceedings of the Fifth National Quail Symposium, Texas Parks and Wildlife Department, Austin, TX.

CLOSING REMARKS: PIECES OF THE PUZZLE, CIRCLES IN THE STREAM

Leonard A. Brennan

Caesar Kleberg Wildlife Research Institute, Texas A&M University, Kingsville, TX 78363-8202, USA

Citation: Brennan, L. A. 2002. Closing remarks: pieces of the puzzle, circles in the stream. Pages 246–249 in S. J. DeMaso, W. P. Kuvlesky, Jr., F. Hernández, and M. E. Berger, eds. Quail V: Proceedings of the Fifth National Quail Symposium. Texas Parks and Wildlife Department, Austin, TX.

“Some quail populations have been on the decline for more than 2 decades; it will require at least that amount of time to understand the causes of those declines and institute corrective measures to reverse those trends.”
(Robel 1993:158)

INTRODUCTION

Individually and collectively, we continue to add pieces to the quail management and research puzzle. Nevertheless, 2 important questions remain: “Are these the right pieces?” “Does the picture on the puzzle we are putting together really make sense?”

Nearly a decade ago, Bob Robel (1993) challenged quail managers and researchers to consider 6 topics, with an assortment of associated questions (Table 1) that he considered were missing from the Quail III program. Since 10 years and 2 National Quail Symposia have now passed, I thought it would be productive to revisit Robel’s remarks, and use them as a basis to organize these closing comments. Most of Robel’s comments and questions emphasized key points of a national strategic planning workshop, which was conducted at Quail III (Brennan 1993), and revisited at Quail IV (Brennan and Carroll 2000). This Quail V wrap-up, for better or worse, provides an opportunity to elaborate on some points made in my “Progress and Frustration” paper, in the context of all North American quails, not just bobwhites (*Colinus virginianus*). This leads me to my first point, which is to lament the apparent lack of research on and interest in the western species of quail, as shown by these proceedings.

PREDATION AND HUNTING

There has been a renewed interest in addressing the effects of predation on quail populations. New technology (Staller et al. *this volume*) finally allows us to obtain a complete inventory of all the predators that attack quail nests. This represents a significant methodological breakthrough. In the past, we could not identify up to 30–40% of nest losses to predators. Obtaining a complete inventory of all predators that attack quail nests, and understanding how nest depredation varies among sites and years, is absolutely crucial for understanding the different predator contexts

in which quail struggle to reproduce. Agency directors (Southeastern Association of Fish and Wildlife Agencies 2000) recently passed a resolution which supports the philosophy that research on quail predation is a valid avenue of investigation, and that predator management to enhance quail productivity is a legitimate pursuit on private lands, if conducted in accordance with state and federal wildlife law and policy. The predator research and management resolution by the Southeastern Association of Fish and Wildlife Agency directors represents a major agency policy change regarding a topic that was once considered the “third rail” of wildlife management.

Despite this progress, the issue of predation, whether in the arena of quail management or research, remains controversial and divisive. Some feel that aggressive predator reduction through management is a potential silver bullet that will provide significant quail hunting opportunities where none presently exist. Others believe that any and all efforts at predator management are a complete and utter waste of time and effort. The truth, and reality, most likely falls somewhere between these 2 polarized views.

I find it curious that biologists and managers often treat predation and hunting as 2 separate issues when they are really the same thing. Quail get killed. To quote Dale McCullough: “Dead is dead.” Yet, somehow, the perception that death by shotgun is different from death by tooth or talon continues to fascinate me. I think that future efforts to develop models of quail predation (that include human hunting pressure) would be extremely fruitful, especially in light of the new insights gained from infrared video camera analysis of nest losses. The impacts of human hunting and losses to predators are, in many ways, 2 different, but adjoining, pieces of the puzzle.

DISEASES AND PARASITES

There seems to be little interest in conducting comprehensive, contemporary research on quail diseases and parasites. In contrast to Robel’s plea (Table 1), agencies, foundations, and private donors seem to have little interest in supporting research on issues related to quail diseases and parasites. There seems to be a perception that while these topics may be interesting, they are not a priority to be addressed at the present time. This may be a mistake. For example, the

CLOSING REMARKS

Table 1. Six topical areas and related questions that Robel (1993) considered missing from the Quail III program and proceedings.

Topic	Question
Predation and hunting	<i>In today's setting, what are the effects of predation and hunting on North American quail populations?</i>
Diseases and parasites	<i>How do these events [fragmentation, contamination, exotic species and exposure to domestic livestock] alter the effects of pathogenic organisms on wildlife?</i> <i>How does the stress of human intervention alter the immunosuppression systems of wildlife?</i> <i>Specifically, what are the effects of the above alterations on the susceptibility and vulnerability of quail to diseases and parasites, and how do these factors alter the reproductive responsiveness of North American quail?</i>
Habitat loss	<i>What are the effects of habitat alteration and fragmentation on quail populations in North America?</i> <i>How do farm and forestry policies affect quail populations, and how can these policies be modified or formulated to benefit quail populations in North America?</i> <i>What are the economic values . . . of quail populations and how can those values be melded into state and federal programs to foster healthier populations?</i> <i>How can interest groups help develop these policies and assure that necessary legislative guidelines be adopted and programs initiated?</i> <i>What is the most effective way to develop policies and programs to benefit quail populations in North America?</i>
Long-term data sets	<i>Where are the 20- and 30-year data sets?</i> <i>Without solid data, how can we monitor trends?</i> <i>How can we determine impacts of agricultural policies on quail populations?</i> <i>How can we determine if any of our efforts are beneficial to quail populations?</i>
Changing social values	<i>What will be the economic impact of decreased sales of hunting licenses and equipment on the management of North American quail populations?</i> <i>How will passage of biodiversity legislation affect our efforts to manage habitat for specific species of quail?</i>
Basic biology	<i>How can we really determine the quality of quail habitats when we do not understand the macro- and micro-nutrient needs of quail?</i> <i>How do agricultural chemicals and industrial pollution alter the many metabolic and enzymatic pathways in North American quail?</i>

recent discovery of *Baylisascaris* (a severely debilitating nematode) in northern bobwhites from Kansas (Williams et al. 1997) points out that there is still much to be learned on this front.

HABITAT LOSS

Quail V continues a habitat-based theme that has been constant through the National Quail Symposia. With 17 titles on habitat or landscape-scale investigations, this topic is the backbone of Quail V. Improvements in GIS technology are finally allowing quail researchers to assess broad scale land use dynamics in relation to quail population changes. Using GIS to analyze habitat use and movement data from radio-marked quail also represents a major step forward. Still significant issues related to understanding quail habitat ecology remain. Comparative studies that contrast used and available habitat structure are surprisingly scarce in the bobwhite literature.

Two papers at Quail V raised the ugly possibility that traditional quail habitat management methods may be counter productive, because they can potentially benefit fire ants and therefore have unintended negative consequences for quail. These papers make an interesting point about quail management in the context of the contemporary landscape, which is that many of the tried and true management techniques that worked well in the Stoddard-Rosene era no longer seem effective today. This is probably because we do not yet have a reasonable handle on the habitat-area re-

quirements needed to sustain quail populations, despite our best efforts at conducting research on quail-habitat relationships.

LONG-TERM DATA SETS

Several 20- and 30-year (or longer) data sets called for by Robel (1993) have actually started to appear (Brennan et al. 1997, Brennan et al. 2000, Guthery et al. *this volume*, Palmer et al. *this volume*, Thogmartin et al. *this volume*). The information in these long-term data sets is revealing on several levels. First, data from private lands managed for quail typically show level trends over time, in contrast to other broad scale data from hunter bags or landscape-level monitoring. Second, the presence of cyclicity may be more widespread in quail than we once thought (Thogmartin et al. *this volume*). Third, hunter effort in relation to covey locations may be more valuable at providing crude density estimates than we once thought (Palmer et al. *this volume*). Fourth, temperature and precipitation apparently influence bobwhite productivity in a nonlinear manner, with thresholds and asymptotes that call into question the use of linear models for assessing such dynamics (Guthery et al. *this volume*). These studies, while still relatively short-term compared to the data sets compiled from bag records in the United Kingdom (Tapper 1992), will only become more important and useful over time. It would be especially welcome if more state resource agencies would make a renewed

commitment to collect, analyze, and publish long-term data on quail populations and habitats.

CHANGING SOCIAL VALUES

Despite the recent study by Burger et al. (1999) on quail economics in the Southeast, understanding how changing social values are effecting quail populations remains a backwater of quail research. Note the lack of such material in this volume. Past quail symposia have contained important material on attitudes of quail hunters (Roseberry and Klimstra 1993), their demography (Crews and DeMaso 2000), and the potential effects of altering bag limits (Peterson and Perez 2000). Understanding the changing social context in which quail, and other upland game birds are present, is absolutely critical for developing effective wildlife policy. Yet, there is little activity on this front, despite the fact that such analyses can have huge potential impact on setting bag limits, which are often done more for political than biological reasons (Peterson and Perez 2000).

We are headed down a slippery slope in North America. Modern quail hunting, as Mahoney (*this volume*) states, is moving toward the European model of hunting and away from the American one. This is the Grand Opera that Stoddard predicted. Mahoney raises an interesting point. For example, like Robel (1993) we lament the loss of hunting license and equipment revenues generated from quail hunters (Table 1). However, is it realistic for us to think that we can, or perhaps even should, strive to provide more quail hunting opportunities in light of the habitat fragmentation and declines faced by quail populations? Can we afford, or are we willing to pay, the societal and economic costs to do this? As quail managers and researchers, are we really prepared to tackle these challenges if we are given the dollars and the green light to do so? Is it even possible? Maintaining quail habitat (especially for bobwhites in the southeastern United States) is the one of the most expensive forms of wildlife management in the world, except perhaps for captive breeding of endangered species. For quail hunting to become available to the majority of hunters with modest means and incomes will require a massive change of direction in land use. Such changes can only happen if society is willing to provide incentives, and individuals are willing to make the sacrifices, that will be required to reserve a space for quail on the landscape. Given what I have seen in an early draft of the 2002 Farm Bill, there seems to be virtually nothing coming with respect to incentives for people to implement quail-friendly land use practices on farms, forests, or range lands.

BASIC BIOLOGY

The new availability and economy of molecular tools has set the stage for numerous breakthroughs in understanding the basic biology of quail (Faircloth et al. *this volume*). Unique genetic markers will allow us

to answer questions pertaining to the relatedness of quail broods and coveys, how specific alleles are present (or not) in relation to boom and bust population dynamics, and whether there really are >20 subspecies of northern bobwhite, among other things. Roseberry (1993) raised many of these issues, and to date, only Guthery (1997) and his colleagues have systematically approached quail research with a set of multiple working hypotheses based on theory (Hernández et al. 2002).

Despite the need for basic research, applied studies will probably remain the backbone of quail research in the foreseeable future. This represents opportunity. Empirical studies can, and should, be designed and conducted to test theoretical ideas about how living nature is assembled. Consider, for example, the use of GPS and radiotelemetry technology to analyze pointing dog effectiveness. Taking such data, and evaluating it in light of the theory of hunter-covey dynamics (Radomski and Guthery 2000), elevates such an investigation to a new, more productive level.

IN SUMMARY: CIRCLES IN THE STREAM

Scientific research, when published, is like a stone tossed in the water. Most of the time, research generates small pebbles that make small splashes. Once in a while a big rock from research makes a big splash. In either case, pebbles and rocks generate concentric, circular wave patterns over the surface of the water upon which they are tossed. Research works the same way. Ten years ago, Bob Robel tossed half a dozen stones in the stream of quail research. Today, their circles still resonate. Some of these circles obviously resonate more than others. The challenge is to understand where and how these and many other circles in the stream of quail research fit together and overlap.

We have made significant quail research progress on issues related to predation (but not so much with hunting), habitat losses, and understanding long-term population trends. We have virtually ignored issues related to quail diseases, and how changing societal values are affecting quail populations in North America. We hold hope and promise that modern research tools and techniques will provide new insights into the basic biology and management of these birds that we cherish. We need to make better use of theory as we search to unify our understanding of the factors that regulate and limit wild quail populations. We need to pay more attention to the quails of the American West.

ACKNOWLEDGMENT

This is technical article number 01-117 of the Caesar Kleberg Wildlife Research Institute at Texas A&M University, Kingsville.

LITERATURE CITED

- Brennan, L. A. 1993. Strategic plan for quail management and research in the United States: introduction and background. *Proceedings of the National Quail Symposium* 3:160–169.

CLOSING REMARKS

- Brennan, L. A., and J. P. Carroll. 2000. Strategic planning update. *Proceedings of the National Quail Symposium* 4: 233–235.
- Brennan, L. A., J. M. Lee, and R. S. Fuller. 2000. Long-term trends of northern bobwhite populations and hunting success on private shooting plantations in northern Florida and southern Georgia. *Proceedings of the National Quail Symposium* 4:75–77.
- Brennan, L. A., W. Rosene, B. D. Leopold, and G. A. Hurst. 1997. Northern bobwhite population trends at Groton Plantation, South Carolina: 1957–1990. Miscellaneous Publication No. 10. Tall Timbers Research Station, Tallahassee, Florida.
- Burger, L.W., D. A. Miller, and R. I. Southwick. 1999. Economic impact of northern bobwhite hunting in the southeastern United States. *Wildlife Society Bulletin* 27:1010–1018.
- Crews, A. K., and S. J. DeMaso. 2000. Demographics of quail hunters in Oklahoma. *Proceedings of the National Quail Symposium* 4:219–225.
- Hernández, F., F. S. Guthery, and W. P. Kuvlesky, Jr. 2002. The legacy of bobwhite research in south Texas. *Journal of Wildlife Management* 66:IN PRESS.
- Peterson, M. J., and R. M. Perez. 2000. Is quail hunting self-regulatory? Northern bobwhite and scaled quail abundance and quail hunting in Texas. *Proceedings of the National Quail Symposium* 4:85–91.
- Radomski, A. A., and F. S. Guthery. 2000. Theory of the hunter-covey interface. *Proceedings of the National Quail Symposium* 4:78–81.
- Robel, R. J. 1993. Symposium wrap-up: what is missing? *Proceedings of the National Quail Symposium* 3:156–158.
- Roseberry, J. L. 1993. Bobwhite and the “new” biology. *Proceedings of the National Quail Symposium* 3:16–20.
- Roseberry, J. L., and W. D. Klimstra. 1993. Attitudes of a select group of Illinois quail hunters. *Proceedings of the National Quail Symposium* 3:34–42.
- Southeastern Association of Fish and Wildlife Agencies (SEAFWA). 2000. Director’s resolution regarding northern bobwhite predator management and research. On file with SEAFWA Executive Secretary, Tallahassee, Florida.
- Tapper, S. 1992. Game heritage. The Game Conservancy, Fordingbridge, United Kingdom.
- Williams, C. K., R. D. McKown, J. K. Veatch, and R. D. Applegate. 1997. *Baylisascaris* sp. found in a wild northern bobwhite. *Journal of Wildlife Diseases* 33:158–160.

RECOGNITION AWARD RECIPIENTS

Ralph W. Dimmick

Dr. Dimmick worked as a professor at the University of Tennessee for 4 decades. During this time, he conducted a long-term investigation of northern bobwhite populations and habitat at the Ames Plantation in Grand Junction Tennessee, home of the Annual National Bird Dog Field Trial. Dr. Dimmick's data from Ames Plantation tell an interesting story that encapsulates on 1 area what has happened to bobwhites throughout the southeastern coastal plain. Along with documenting the near extinction of a local bobwhite population in relation to habitat loss and deterioration, Dr. Dimmick's research demonstrated how bobwhite coveys are a dynamic social unit. His research also formed a basis for how to index flush counts of bobwhites in relation to mark-recapture population estimates. His work on lipid and triglyceride dynamics was among the first to assess these physiological processes using wild quail. Although Ralph recently retired from UT, he remains active in the southeastern quail world through his service as the leader for developing a Southeastern Plan for Bobwhite Management, at the request of the Directors of the Southeastern Association of Fish and Wildlife Agencies.

Ron Engel-Wilson

Ron Engel-Wilson has been involved in quail research and management in the southwestern United States for over 20 years. During the past 15 years, until his retirement in December 2001, he was the Small Game Supervisor for the Arizona Game & Fish Department (AG&FD). One of his major responsibilities was managing Arizona's 4 native species of quail. Being the pointman for quail management for the AG&FD is a job requiring professionalism, discipline, and almost inhuman patience because it is a job that is often immensely frustrating. Ron constantly had to cajole and attempt to satisfy a diversity of special interest groups all intent on successfully implementing their own specific agendas for quail management in Arizona. Quite often Ron's professionalism and integrity failed to satisfy the self-interests of a few politically well-connected individuals, yet he always endeavored to do what was best for quail conservation with the full knowledge that his official positions would likely aggravate influential people and consequently his supervisors.

Ron always tried to do what was best for quail and as a result, Gambel's, scaled and Montezuma quail populations in Arizona are better off than they might have been had not Ron been involved in their stewardship. Montezuma quail populations in particular have benefitted because of Ron's conservation ethic. Arizona is perhaps the only state in the United States where a harvestable surplus of Montezuma quail is maintained on an annual basis. Therefore, any individ-

ual who has enjoyed a Montezuma quail hunt in Arizona should be grateful for Ron's abilities to get ranchers, sportsmen's groups, as well as state and federal land managers, to work together on behalf of Montezuma quail.

Ron also made significant contributions to endangered masked bobwhite recovery in Arizona and Sonora, Mexico. As a Recovery Committee member, he argued persuasively to modify long-established captive-rearing and release protocols that were not effective, and his efforts helped convince the United States Fish & Wildlife Service to adopt new methodology that ultimately increased post-release survival of masked bobwhite chicks released on the Buenos Aires National Wildlife Refuge. In addition, Ron's professional relationships with agency wildlife biologists in Sonora, facilitated establishment of management actions that enhanced recovery of the last remaining wild masked bobwhite populations in the world. Ron's character and integrity are highly regarded by his colleagues in Mexico. Consequently, an endorsement from Ron always guaranteed cooperation and support from agency biologists in Sonora. Ron deserves much of the credit for the positive cooperative relationship that currently exists among federal and state biologists in both Mexico and the United States who are all working together to recover masked bobwhites.

Ron was also a pleasure to work with in the field. Whenever, his assistance was needed with fieldwork in Sonora, he enthusiastically participated as productive team member. Most often he volunteered his services and expertise without having to be asked to do so, knowing full well that he would have to work long hours under miserable summer field conditions. Yet he never complained, often offered suggestions that increased the efficiency of data collection, and always volunteered to help collect data again. If you were fortunate enough to be doing fieldwork with Ron, you were guaranteed an exceptional meal at the end of the day. He always provided his field partners with superb meals that took considerable time to prepare even when he was exhausted from the daily trials of fieldwork. Many people who have been associated with Ron on a professional level know how much of himself he has devoted to bettering the natural resources in Arizona. He is regarded as a consummate professional who has volunteered for important tasks that no one else wanted to do because of the work involved and/or the political ramifications associated with the task. Ron has almost no ego, and has never sought personal recognition or awards for all that he has accomplished on behalf of quail conservation in particular, and natural resource conservation in general. His reward is knowing that he did the best he could for the outdoors he loves and the animals and plants that inhabit it. Ron will likely be embarrassed by the Distinguished Contribution Award presented to him by his professional quail colleagues attending QUAIL V. He

nevertheless deserves the thanks and recognition of his contemporaries for all he has done for quail conservation in the southwest.

Fred S. Guthery

Fred Guthery was born and raised on small ranch in rural eastern Oregon where he developed a keen interest in wildlife. He attended a Oregon State University where he graduated with a degree in Wildlife Science in 1970. He left Oregon soon thereafter to attend Texas A&M University where he received a M.S. and a Ph.D. in Wildlife & Fisheries Sciences. He started his research with upland gamebirds at Texas Tech University in the late 1970s where he and his students conducted research on ring-necked pheasants, lesser prairie chickens, and scaled quail. He was lured to the Caesar Kleberg Wildlife Research Institute at Texas A&I University to initiate a quail research program. He then spent almost the next 15 years in south Texas, researching numerous aspects of bobwhite life history and management in semi-arid ecosystems. The work of he and his students illuminated previously unknown aspects of bobwhite life history and ecology, particularly as these relate to traditional south Texas land management practices. Consequently, Fred's research was not only of high scientific quality, but also provided ranchers with sound scientifically based management information that directly benefited bobwhite populations on the ground.

During the early 1990s, Fred became involved in efforts to recover the endangered masked bobwhite in southern Arizona and northwestern Sonora, Mexico. Little was known about the habitat requirements of masked bobwhites until Fred became involved in recovery efforts. His encyclopedic knowledge of bobwhite ecology and his strong scientific abilities enabled him to design research that yielded critical information on masked bobwhite habitat requirements and current habitat deficiencies in Sonora and Arizona. This research fundamentally changed the way masked bobwhite habitat is managed in Mexico and the United States. Although masked bobwhites remained endangered, Fred's research significantly enhanced recovery and masked bobwhites are now better off because Fred was involved in their recovery. During his masked bobwhite research, Fred developed new concepts relative to how bobwhites utilize the landscapes they occupy. He used quantitative techniques new to wildlife biologists to develop his space/time theory of habitat use, which has resulted in what appears to be a unifying concept in bobwhite ecology that eventually may be applicable to bobwhites regardless of where they live in their geographic range.

During the late 1990s, Fred moved to Oklahoma State University where he is the current occupant of

the Bollenbach Chair for Wildlife Ecology. He continues to refine his unifying theory about bobwhites with high quality research projects that he and his students are conducting in Oklahoma and the Panhandle of Texas. Fred has inarguably pushed quail conservation forward to an arena that is forcing his contemporaries to reexamine their traditional ideas about quail ecology. He is a scientist of exceptional quality and integrity. His current and former students will tell you that he asked a great deal of them, but most of these students will tell you that they are better wildlife professionals as a result of working with Fred. Moreover, anyone who knows Fred will tell you that he is harder on himself than he is on anyone else. Finally, most people probably view Fred in a professional light as one of the foremost quail experts in North America, and there is no question that this is true. His quarterly Kleberg Reports and now Bollenbach Chair reports in Quail Unlimited magazine have certainly added to his mystique. However, those of us who have been fortunate enough to work with Fred over the years, and have had the good fortune to become his friend know that a very good person lies under that scientific cloak he generally wears. Fred is a kind, compassionate and generous individual. These are the attributes that many are often unaware of, but they are attributes that have enabled to him to relate to people of diverse backgrounds to accomplish things for quail where it really counts—on the ground and out in the pasture. I can say without hesitation, that the only endangered quail in North America might well have become extinct were it not for Fred's ability to establish the trust that persists only among good friends. Few would argue that Fred Guthery is a giant among quail professionals throughout the world and he richly deserves the Distinguished Contribution Award that was bestowed on him by his professional contemporaries who convened at QUAIL V.

Sanford D. Schemnitz

Dr. Schemnitz conducted the first modern, systematic study of scaled quail ecology and published this work as a Wildlife Monograph in 1961. Also, during the early 1960s he published the first definitive comparative analysis of scaled quail and bobwhite ecology. Thirty-four years after conducting his landmark study on scaled quail in the Oklahoma panhandle, Dr. Schemnitz returned to his old study area and collected data for an analysis of land use changes in relation to declining scaled quail numbers. In addition to his work on scaled quail, which also included writing the scaled quail species account for the Birds of North America Series, Dr. Schemnitz served our profession as Editor-in-Chief of the Fourth Edition of the Wildlife Management Techniques Manual.

REVIEWERS FOR QUAIL V

Thomas G. Barnes, University of Kentucky, Lexington
Michael E. Berger, Texas Parks and Wildlife, Austin
Leonard A. Brennan, Texas A&M University–
Kingsville
Kirby Brown, Texas Parks and Wildlife, Austin
L. Wes Burger, Mississippi State University, Starkville
Linda Campbell, Texas Parks and Wildlife, Austin
Kevin E. Church, Advanced Telemetry Systems, Inc.,
Isanti, MN
Stephen J. DeMaso, Texas Parks and Wildlife, Austin
Mike Fies, Virginia Department Game & Inland Fish-
eries, Verona
James R. Gallagher, Texas Parks and Wildlife, Artesia
Wells
Ron R. George, Texas Parks and Wildlife, Austin
Dave Godwin, Mississippi Department of Wildlife,
Fish, and Parks, Starkville
Fred S. Guthery, Oklahoma State University,
Stillwater
Fidel Hernández, Texas A&M University–Kingsville
Paul R. Krausman, University of Arizona, Tucson

William Kuvlesky, Jr., Texas A&M University–
Kingsville
Xiangwen Liu, Texas Parks and Wildlife, Austin
Jeffery J. Lusk, Oklahoma State University, Stillwater
William E. Palmer, Tall Timbers Research Station,
Tallahassee
Robert M. Perez, Texas Parks and Wildlife, La Vernia
Markus J. Peterson, Texas A&M University, College
Station
Jon R. Purvis, Texas Parks and Wildlife, Austin
Paul Robertson, Texas Parks and Wildlife, Austin
Dale Rollins, Texas A&M University, San Angelo
John L. Roseberry, Southern Illinois University,
Carbondale
Nova Silvy, Texas A&M University, College Station
D. Clay Sisson, Auburn University, Auburn
Robert M. Sullivan, Texas Parks and Wildlife, Canyon
Scott Taylor, Nebraska Game and Parks Commission,
Lincoln
R. Montague Whiting, Stephen F. Austin State Uni-
versity, Nacogdoches
John H. Young, Texas Parks and Wildlife, Austin

QUAIL V SPONSORS AND CONTRIBUTORS

Host (\$20,000 and above)

- United States Department of Agriculture, Natural Resources Conservation Service (NRCS), Wildlife Habitat Management Institute

Benefactor (\$10,000 to \$19,999)

Sponsor (\$5,000 to \$9,999)

- Lee and Ramona Bass
- Loring Cook Foundation
- Holt Companies
- Texas State Council, Quail Unlimited

Donor (\$2,500 to \$4,999)

- Austin Chapter, Quail Unlimited
- Bank of America
- East Texas Chapter of Quail Unlimited

Contributor (\$1,000 to \$2,499)

- H-E-B Grocery Stores
- Quail Unlimited, South Texas Chapter
- Houston Chapter of Quail Unlimited

Symposium Associate (\$250 to \$999)

- Texas Wildlife Association
- The University of Arizona
- The Noble Foundation
- Parker Drilling Company

QUAIL V COMMITTEES

Program and Steering Committee

Steve DeMaso, Program Chairman, Texas Parks and Wildlife Department, Austin

Bill Kuvlesky, Member, Caesar Kleberg Wildlife Research Institute, Texas A&M University–Kingsville

Fidel Hernandez, Member, Caesar Kleberg Wildlife Research Institute, Texas A&M University–Kingsville

Fred Bryant, Member, Caesar Kleberg Wildlife Research Institute, Texas A&M University–Kingsville

Dale Rollins, Member, Agricultural Extension Service, Texas A&M University, San Angelo

Local Arrangements Committee

Bill Kuvlesky, Chairman, Caesar Kleberg Wildlife Research Institute, Texas A&M University–Kingsville

Fidel Hernandez, Member, Caesar Kleberg Wildlife Research Institute, Texas A&M University–Kingsville

Alan Fedynich, Web Site, Caesar Kleberg Wildlife Research Institute, Texas A&M University–Kingsville

Steve Kopp, Souvenirs, ExxonMobil Corporation

Terry Blankenship, Registration, Continuing Education, and Field Trip, Welder Wildlife Foundation, Sinton

Dale Rollins, Publicity, Agricultural Extension Service, Texas A&M University, San Angelo

Ken Cearley, Exhibits, Agricultural Extension Service, Texas A&M University, San Angelo

Robert Perez, Raffle Items and Door Prizes, Texas Parks and Wildlife Department, La Vernia

Fund Raising Committee

Fred Bryant, Chairman, Caesar Kleberg Wildlife Research Institute, Texas A&M University–Kingsville

Carolyn Appleton, Member, Caesar Kleberg Wildlife Research Institute, Texas A&M University–Kingsville

Awards

Lenny Brennan, Chairman, Caesar Kleberg Wildlife Research Institute, Texas A&M University–Kingsville

To purchase additional copies of Quail V: Proceedings of the Fifth National Quail Symposium. Please contact:

Ceasar Kleberg Wildlife Research Institute
Texas A&M University–Kingsville
Attn: Quail V Proceedings
MSC 218
Kingsville, TX 78363-8202

Phone: (361) 593-3922

**TALL TIMBERS RESEARCH STATION
NATIONAL QUAIL SYMPOSIUM PROCEEDINGS PUBLICATIONS**

The following is a list of proceedings from the National Quail Symposia and National Bobwhite Quail Symposia offered for sale by Tall Timbers Research Station. Postage and Handling must be added to all purchases. Bulk rates available when purchasing 10 or more of the same title. Tall Timbers' members receive a 10% discount on price of the publication. Florida sales tax of 7% is due from Florida residents and institutions, unless a current tax-exempt certificate is held.

Publication code	Title/Brief Description	Quantity	Unit Price	Total Price
GBNQ4	Proceedings Fourth National Quail Symposium. Tall Timbers Research Station, Tallahassee, FL. 2000. 255 p.		\$20.00	
GBNQ3	Proceedings Third National Quail Symposium. Kansas Department of Wildlife and Parks, Pratt. 1993. 202 p.		\$15.00	
GBNQ2	Proceedings Second National Bobwhite Quail Symposium. Oklahoma State University, Stillwater. 1982. 96 p.		\$10.00	
GBNQ1	Proceedings First National Bobwhite Quail Symposium. Oklahoma State University, Stillwater. 1972. 390 p.		\$10.00	
Tall Timbers Member: Yes ___ No ___ (Members receive a 10% discount on all orders) If you are interested in becoming a member and would like information on Tall Timbers, check here ___ or visit our website at www.talltimbers.org		TT Member Discount (10%)		
State of FL Sales Tax Exemption No: _____		Florida Sales Tax (7%) (Applies to Florida residents & institutions unless a current FL tax-exempt certificate is held.)		
Postage & Handling-\$3.50 1st item/\$1.00 each additional item **Foreign country postage, contact Publications Office about additional postage due.		**Postage & Handling		
			TOTAL	

DATE _____ NAME _____

AFFILIATION _____ POSITION _____

ADDRESS _____

CITY _____ STATE _____ ZIP _____

HOME PHONE (____) _____ WORK PHONE (____) _____ EMAIL _____

Method of Payment : VISA MasterCard Check/Money Order

Credit Card Account Number _____ Credit Card Expiration Date _____ (Make payable to Tall Timbers Research Station)

----- / -----

Signature _____ Purchase Order (Purchase Order # _____)

Send Completed Order Form with Payment to:

Publication Sales
Tall Timbers Research Station
13093 Henry Beadel Drive
Tallahassee, Florida 32312-0918

 (850) 893-4153 extension 222 / FAX (850) 668-7781

Inquire to Lisa Baggett (e-mail: lisa@ttrs.org)

