



University of Tennessee, Knoxville
**Trace: Tennessee Research and Creative
Exchange**

Home Garden, Lawn, and Landscape

UT Extension Publications

10-11-2012

PB1069 Hobby Greenhouses in Tennessee

Mary Lewnes Albrecht

Follow this and additional works at: http://trace.tennessee.edu/utk_agexgard

 Part of the [Agriculture Commons](#), [Botany Commons](#), and the [Horticulture Commons](#)

Recommended Citation

"PB1069 Hobby Greenhouses in Tennessee," Mary Lewnes Albrecht,
PB1068
, http://trace.tennessee.edu/utk_agexgard/116

The publications in this collection represent the historical publishing record of the UT Agricultural Experiment Station and do not necessarily reflect current scientific knowledge or recommendations. Current information about UT Ag Research can be found at the [UT Ag Research website](#).

This Gardening - Greenhouse is brought to you for free and open access by the UT Extension Publications at Trace: Tennessee Research and Creative Exchange. It has been accepted for inclusion in Home Garden, Lawn, and Landscape by an authorized administrator of Trace: Tennessee Research and Creative Exchange. For more information, please contact trace@utk.edu.

HOBBY GREENHOUSES IN TENNESSEE



TABLE OF CONTENTS

Introduction	3
Pros and Cons of a Hobby Greenhouse	3
Greenhouse Size	4
Greenhouse Type	5
Frame Materials	7
Foundations	7
Floors and Walks	7
Benches	7
Covering Materials	8
Utilities	8
Drives and Walkways	9
Aesthetic Value	9
Locating and Orienting	9
Heating Considerations	12
Size of Heaters	13
Type of Heat	13
Ventilation	15
Cooling	15
Managing a Hobby Greenhouse	18
Organizations and Further Information	19
Appendix	19
Use Heated Growing Frames to Produce Early Plants	19
A Plastic-Covered Greenhouse, No. 5946	23
Plastic Covered Greenhouse, Coldframe, No. 5941	24

HOBBY GREENHOUSES IN TENNESSEE

*Mary Lewnes Albrecht, Professor and Head
Originally developed by James L. Pointer, Professor Emeritus
Ornamental Horticulture and Landscape Design*

INTRODUCTION

For the avid gardener or plant lover, a hobby greenhouse can be like the icing on the cake. A greenhouse allows you to extend the gardening season by growing plants inside when outside weather conditions make plant growing impossible. It will also provide many hours of pleasure and relaxation while growing your favorite plants.

There are other factors you should consider. Does your plant growing interest span the whole year, or do you get excited about growing plants only during the spring gardening season? If you are only interested in growing annual flowers and vegetable plants, you may want to consider a hot bed or a coldframe. They are cheaper to build and maintain, yet a good quality plant can be grown with little difficulty.

PROS AND CONS OF A HOBBY GREENHOUSE

If you want to grow plants all year, consider the following:

An adequate greenhouse structure may cost from a few hundred up to several thousand dollars, depending on the type of house, covering materials, heating, cooling, ventilation and other equipment.

A greenhouse used for year-round production can be time consuming. Plants should have daily attention. Who will look after your plants when you are on vacation and during other absences?

A hobby greenhouse, like many other hobbies, can be expensive to operate, especially heating and cooling.

A hobby greenhouse should have a minimum of 100 square feet (Fig. 1).

Can a greenhouse be added to your landscape without detracting from the aesthetic value of your property as well as your neighbors?

Will neighborhood covenants allow you to build a greenhouse?

Will county and city building codes permit you to build a greenhouse on your premises? Are there any restrictions as to type of house, covering or materials?

Check with your insurance agent to determine the impact on your home-owner's insurance. Can you afford the increase?

Will it affect the real estate appraisal upon which taxes are based?

After considering all these factors, if you are still enthusiastic about building a hobby greenhouse, look at some other important factors and study how they relate to your particular situation before you purchase or build a greenhouse.

GREENHOUSE SIZE

The specific size of a hobby greenhouse depends on each individual's need. Most hobby houses are arranged so that about 70 to 80 percent of the total floor area is devoted to benches or growing area. Most annuals can be grown in bedding plant trays (about 1 1/2 square feet per tray) or 3- or 4-inch pots (about three to five pots per square foot). A larger area is needed for pot plants. For chrysanthemums and poinsettias in 6-inch pots, a space of about 1 1/2 square feet is needed to finish the plant to full flower. Ten-inch hanging baskets grown on a bench will need about 2 square feet.

Multiplying your desired volume of plants by space required for each plant will give you the total size house needed. A house of less than 100 square feet would probably not be economical to build and maintain. If you need less space, you should consider a window greenhouse (Fig. 2) or a lighted plant cart (Fig. 3).

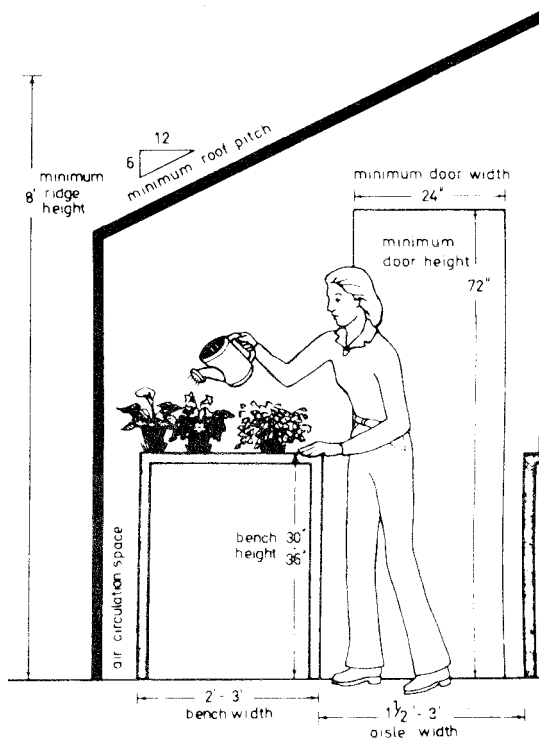

Figure 1. Lean-to greenhouse. A greenhouse may be from 6 to 12 feet wide and suggested minimum area of 100 square feet.

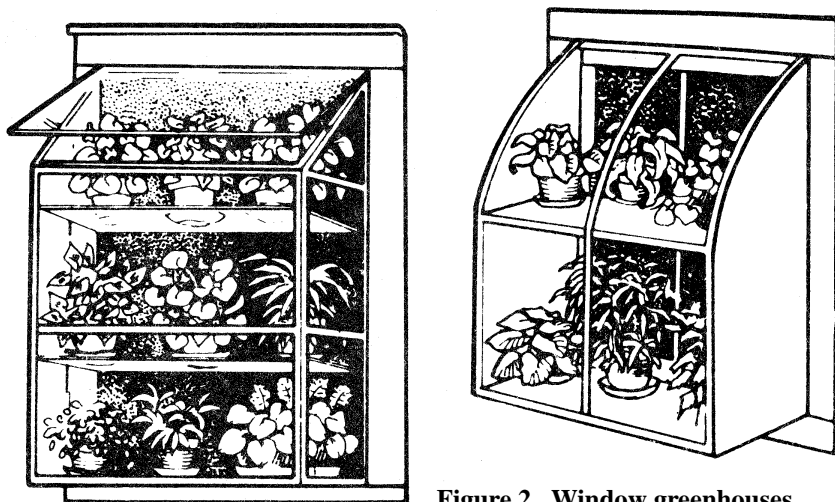

Figure 2. Window greenhouses

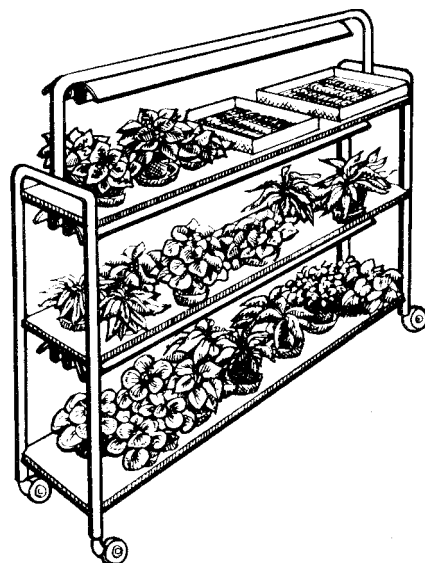

Figure 3. A lighted cart for plants. Fluorescent lamps can supplement indoor lighting to make an area of the home an attractive greenhouse.

GREENHOUSE TYPE

The type of house that would be desirable for you may not be suitable for someone else. Many homeowners design and build their own greenhouses by using materials that can be secured at bargain prices, such as old picture windows, sliding glass doors, etc. This is not the best way to build a greenhouse, especially if the aesthetic values are considered, but can be done if planned properly.

The following designs or modifications are the norm in greenhouse designs:

Lean-to or attached greenhouses (Figs. 4 and 5) suit many people, especially where space is limited. They can be designed and built onto a new home or added to older homes to fit into the landscape. If they are attached to a wall with a doorway, entry into the greenhouse can be made conveniently without going outside.

Water, electricity and heating from the house usually can be shared at a moderate cost. The cost of heating an attached house is cheaper than a free-standing greenhouse of the same size due to the attachment of one side of the greenhouse to an existing wall.

Pit houses (Fig. 6) are unusual in Tennessee, yet have some very definite advantages. They are built partially below ground (usually 3 to 4 feet), often attached on the south side of another building and are normally used like a coldframe with only bottom heat provided. They are less expensive to build and require less heat if you want to maintain a constant temperature.

Pit houses require proper drainage for the pit or trench. Ventilation needs can be taken care of by providing end windows or a roof that will open. If a pit house can be connected with a doorway from the basement into the pit or trench, it adds convenience and is easier to heat by hooking into the existing heating system.

A-frame houses (Fig. 7) have too many disadvantages, except in very unusual circumstances, to consider for plant growing. If protection is desired for a special plant such as camelias, gardenias, or hibiscus, an A-frame house may be considered due to its simple frame design, good head room and easy construction.

They are not unattractive, but do not readily blend into the normal surroundings. The side walls are hard to reach, and the growing area in relation to the outside exposed surface is small.

Figure 4.
Straight side
lean-to
greenhouse

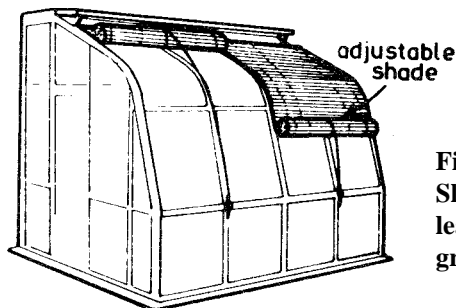
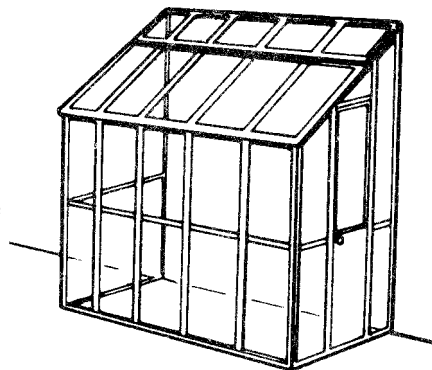

Figure 5.
Slant side
lean-to
greenhouse

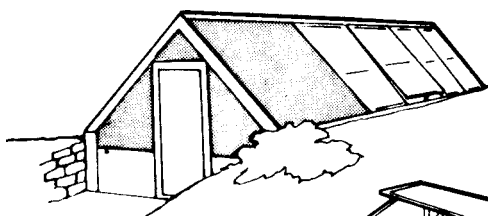

Figure 6.
Pit houses:
(a) gable design,
(b) slant frame.

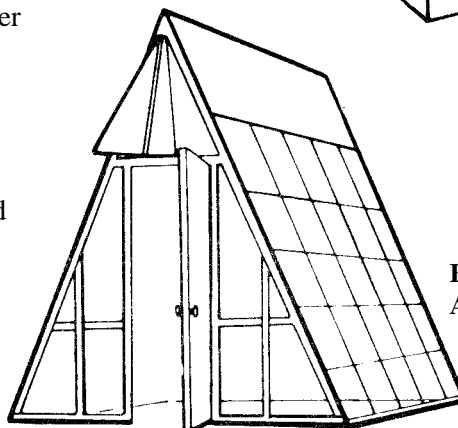
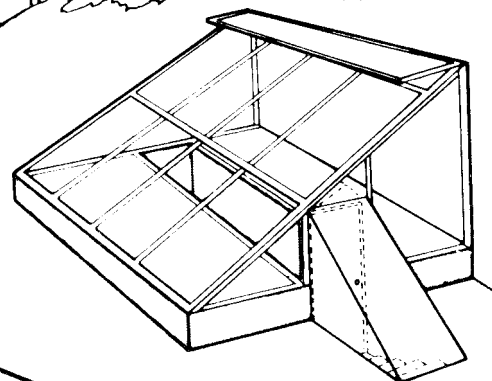

Figure 7.
A-frame greenhouses.

Free-standing greenhouses (Fig. 8) can be purchased or built in many different dimensions and designs. These houses allow more flexibility because they can be of any size desired and placed where they receive more sun, or be sheltered from the wind. They can be screened off from the home and therefore will not interfere with existing home landscaping.

There are several different designs of free-standing greenhouses: A-frame (Fig. 7), gable house (Fig. 9), slant leg (Figs. 8 and 10), quonset (Fig. 12) or combinations of some of these.

Attached greenhouses (Fig. 11) can be of any of the previously-mentioned designs or adaptation of them.

Quonset greenhouses (Fig. 12) are popular as hobby- or commercial-growing structures. They are the cheapest per square foot to construct. They may be covered with fiberglass or polyethylene. Double-layered, air-inflated polyethylene is the covering most used. A quonset greenhouse can be built to the size that meets the need of the builder. A cheap-and-easy-to-construct quonset plan may be found on page 26.

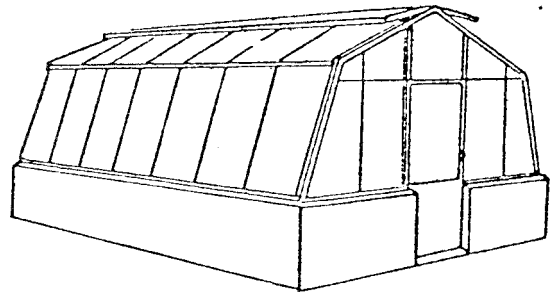

Figure 8. Slanted free-standing greenhouse.

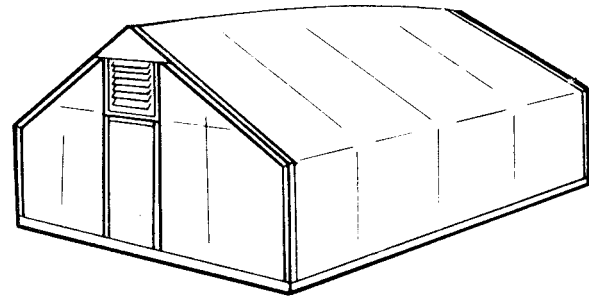

Figure 9. Gable roof.

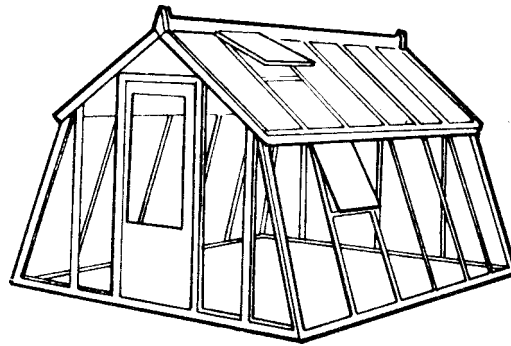

Figure 10. Slant leg.

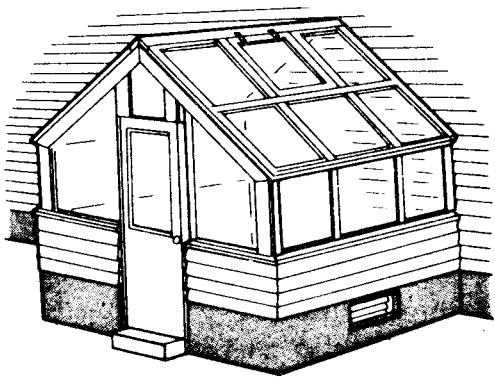

Figure 11. Another version of attached greenhouse.

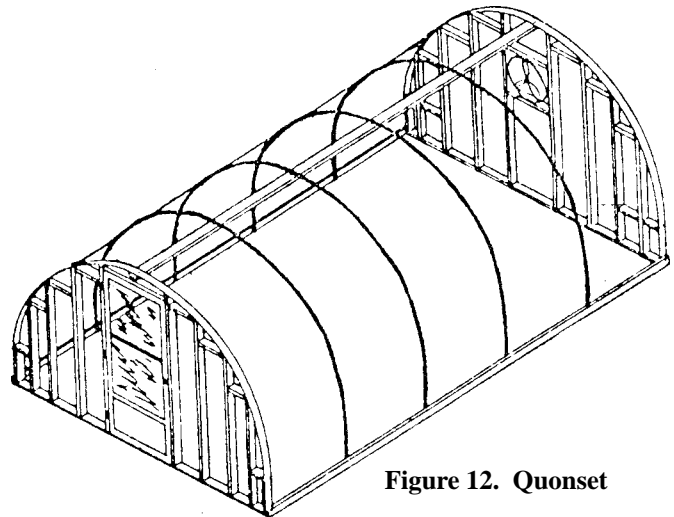

Figure 12. Quonset

FRAME MATERIALS

A few years ago, framing materials for greenhouses were exclusively wood. Now most greenhouses are framed with metal — aluminum, galvanized pipe or tubing — and PVC pipe. Any one of these materials will make satisfactory frames if they are built strong enough to withstand the wind, snow and the weight of hanging plants which in many cases are hung from the frame. The weight of hanging baskets in many greenhouses exerts more load on the frame than snow or wind. But when the forces of all three are combined, damage or collapse of the greenhouse might occur unless this is taken into consideration in planning or selecting a greenhouse.

FOUNDATIONS

Foundations for greenhouses covered with fiberglass or plastic are usually unnecessary (see anchor detail, page 27). However, a house attached to an existing building or covered with glass requires a good strong foundation. Concrete or concrete blocks are the most commonly used. If the greenhouse is to be attached to a brick home, then it is advisable to use matching brick veneer for the foundation.

The foundation should extend below the frost line and may extend up to 6 inches above the height of inside benches. If plants are to be grown on the ground, the foundation wall should be a minimum of 6 inches and not extend higher than 12 inches above floor level (Fig. 13).

Greenhouses with low or no foundation provide more growing space under the benches.

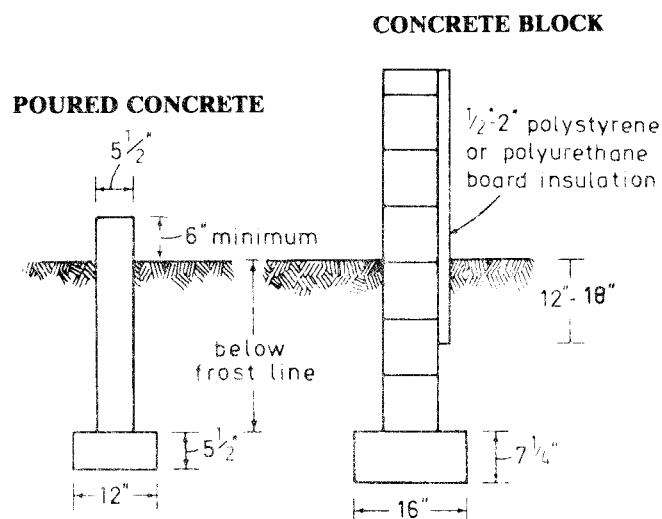

Figure 13. Typical masonry foundations

FLOORS AND WALKS

A solid floor in greenhouses is not necessary and in many cases may be undesirable, unless attached to the home and used as a sunroom or solarium.

A 2- to 4-inch layer of 3/4-inch crusher-run stone or pea gravel up to 3/4-inch in diameter makes a very desirable greenhouse floor. It does not hurt your feet to walk on, yet allows excellent percolation of water.

Flat stone, concrete stepping stones or brick laid on sand also makes a good floor but may eventually become uneven due to water eroding the sand base. The idea of having a surfacing material on top of the soil is for sanitation purposes, and to keep the walkways free of mud. Covering only the walk areas and using gravel under the benches provides both convenience and good drainage.

A solid concrete floor is very easy to keep clean, helps reduce weeds, insects and disease problems and is most desirable when the greenhouse is attached to the residence or doubles as a living space. When a poured concrete floor is selected, make sure floor drains are installed before the concrete is poured. A vapor barrier and insulation can be installed before concrete is poured. This will help reduce heat demands in the winter.

BENCHES

Many different types of benches can be used in a hobby greenhouse as illustrated on page 25. The type of bench to be built will depend on its use. Benches are usually constructed of cypress, redwood or recycled, preformed plastic board. Snow fence is being used with very good results. The fencing is made of redwood or treated wood laths about 1/2 inch thick and 1 1/2 inches wide and 4- or 6-foot lengths. These wooden strips are spaced about 1 inch apart and interwoven with wire, and come in 50-foot rolls. If built according to recommendations, it is strong enough to support pot plants. Very attractive benches are made with pressure-treated lumber with welded 1 inch x 1 inch mesh or expanded metal used as bench tops. There are bench tops made from recycled plastics available.

COVERING MATERIALS

Glass is the preferred covering material for greenhouses. Clear single, double or triple pane glass provides high interior light level, long life, stability, durability and strong aesthetic quality. Tempered glass is strong enough to withstand most hail. The major drawbacks are the weight and narrow widths that necessitate more roof and side bars and a stronger, more expensive structure. Single-pane glass has no insulation value adding to the heat load. Double-pane and triple-pane glass is available to reduce the heat demand. Glass that has reflective properties to reduce light infiltration also reduces cooling needs in the summer, but might not provide enough light during winter months.

Polyethylene films are less expensive than glass and when used as an air-inflated, double layer can save as much as 40 percent of heating costs in comparison to glass. A major drawback is that they are not as aesthetically pleasing for residential applications. If ultra-violet light resistant (UVR) plastics are not used, they will become brittle after one growing season and will need to be replaced. Some of the newer materials will last up to five years depending upon care, thickness and the manufacturer. Greenhouses covered with polyethylene films are less costly to build because the support structure requires fewer members due to the low weight of the films.

Rigid plastics are becoming more common. **Fiberglass** has been available for several decades. It comes in flat and corrugated sheets up to 4 feet wide. The outer surface needs to be treated to prevent degradation from ultra-violet light. Fiberglass does not have any insulation value and loses heat at the same rate as glass or single-layer polyethylene film. Fiberglass is also extremely flammable because of the acrylic resin used to bind the glass fibers, thus increasing the cost of insuring the structure. Check local building codes and your homeowner's insurance carrier to find out if this is an acceptable covering material.

Newer, **structured rigid plastics** are available. The structured rigid plastics are double-layered and ribbed for strength, creating an air pocket and reducing heat loss. These come in thicknesses of 6 to 16 millimeters and panels that are up to 6 feet wide. Heat savings are from 30 percent for the 6 mm-thick sheets

up to 50 percent for the 16 mm-thick sheets. They are made from two types of plastic resins: polycarbonates and acrylics. The polycarbonates are more resistant to hail damage and are not flammable. Both are available in bronze colors that reduce light intensity. Fewer structural members are needed in greenhouse roofs and side walls than if glass construction is used, helping to reduce the cost of the structure. These materials are very expensive in comparison to double-layer polyethylene but comparable to glass.

UTILITIES

Electricity may or may not be a problem, depending on where you live and strictness of local electrical codes. In some areas, the utility company may request that you have a separate meter for the greenhouse if electricity is the main energy source. All wiring should be done in accordance with the local electrical codes. In some cases, a utility pole will be needed to extend electrical services. Underground cable may be cheaper or required by zoning codes.

Water can usually be taken from the home supply line, provided it is large enough to give you the volume and pressure needed. All lines should have a backflow preventer valve installed to prevent contamination of the household water supply. Install at least two spigots to meet all needs.

Gas, if hooked onto natural gas from existing lines, will save a considerable amount over having a meter installed. If natural gas is not available, check with your local propane gas company to see if it will supply you a free storage tank, or if you will be required to rent or purchase your own. If you purchase, consider which size tank is the most economical for your operation.

Unfortunately, plumbing for sinks and drains is sometimes overlooked when planning for a hobby greenhouse. After the house has been constructed, installation costs may be several times more expensive. These should be considered before beginning construction.

DRIVES AND WALKWAYS

If a driveway is needed to receive supplies or haul out plants, it should be considered in the overall plan of locating your greenhouse. Walks are also to be considered before building a greenhouse. Walks or driveways in many cases can be built with simple materials. These could range from crushed stone to blacktop to concrete. Plan in advance; know what you are going to build and how it fits into your landscape.

AESTHETIC VALUE

Will a greenhouse add or detract from the aesthetic value of your surroundings? A greenhouse can be constructed from many different materials and shapes. If proper consideration is given to the existing surroundings, a greenhouse can be purchased or built that will add to the beauty of your surroundings and blend into the existing landscape. Check local zoning codes prior to selecting and building the home greenhouse.

Solar Altitude Angle, B **Shadow Length**
(see Fig. 18)

7.5	7.60 x H
15	3.73 x H
20	2.75 x H
30	1.73 x H
45	1.00 x H

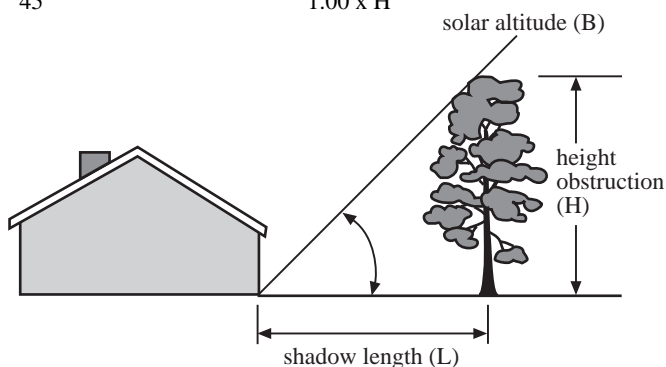

Figure 14. Ratio of shadow length and obstruction height for selected solar altitudes.

LOCATING AND ORIENTING

One of the most important requirements for good plant growth is light. Therefore, be sure that you locate a greenhouse where you take advantage of the most desirable exposure. For a lean-to or a window greenhouse, an eastern, southern or western exposure is acceptable, but a southern exposure is preferred. A northern exposure may be used but due to limited light, especially in winter, the plant species grown successfully will be somewhat limited and the number of plants grown in a given area will be reduced unless supplemental light is used.

All greenhouses should be located to receive direct sun; therefore, avoid shade cast by evergreen trees. Light shade from deciduous trees is tolerated because they cast very little shade during winter. You can figure whether a tree or a group of trees are too close to your greenhouse by using the data shown in Figure 14.

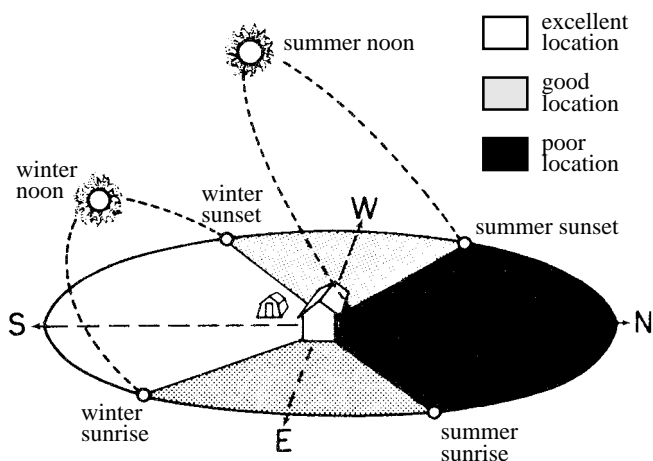

Figure 15. Location of the greenhouse; a sunny area is best.

In Figure 15, the location priorities are shown. In Figure 16, you can compare the horizontal angles of the sun on June 21 at latitude for Tennessee of 36° , and in Figure 17, you can compare the reduced horizontal angles of the sun on December 21 at the same latitude. By spending a little time studying these figures, and with a compass, you can stake out the angles of the compass to determine the need to remove trees and other obstructions. Figure 18 shows the altitude angles of the sun at different times of the day on June 21 and December 21 at 36° latitude (Tennessee). Note that all times are for local solar time. In Tennessee solar time is approximately one-half hour earlier than Eastern standard time and one-half hour later than Central standard time.

Proximity and accessibility of roadways, walks, water lines, gas and electrical utilities and drainage pipes are important because an extension of any of these can be costly. Gas, water, electrical and drainage lines should be placed in separate trenches. The water line should be below the frost line, usually 12 to 18 inches deep.

As mentioned in **Pros and Cons**, the greenhouse location, structure, material and design affect the aesthetics of the landscape on both your property and your neighbors' property. Use reason and care to select a greenhouse that will not lower the aesthetic value of your landscape or your neighbors'.

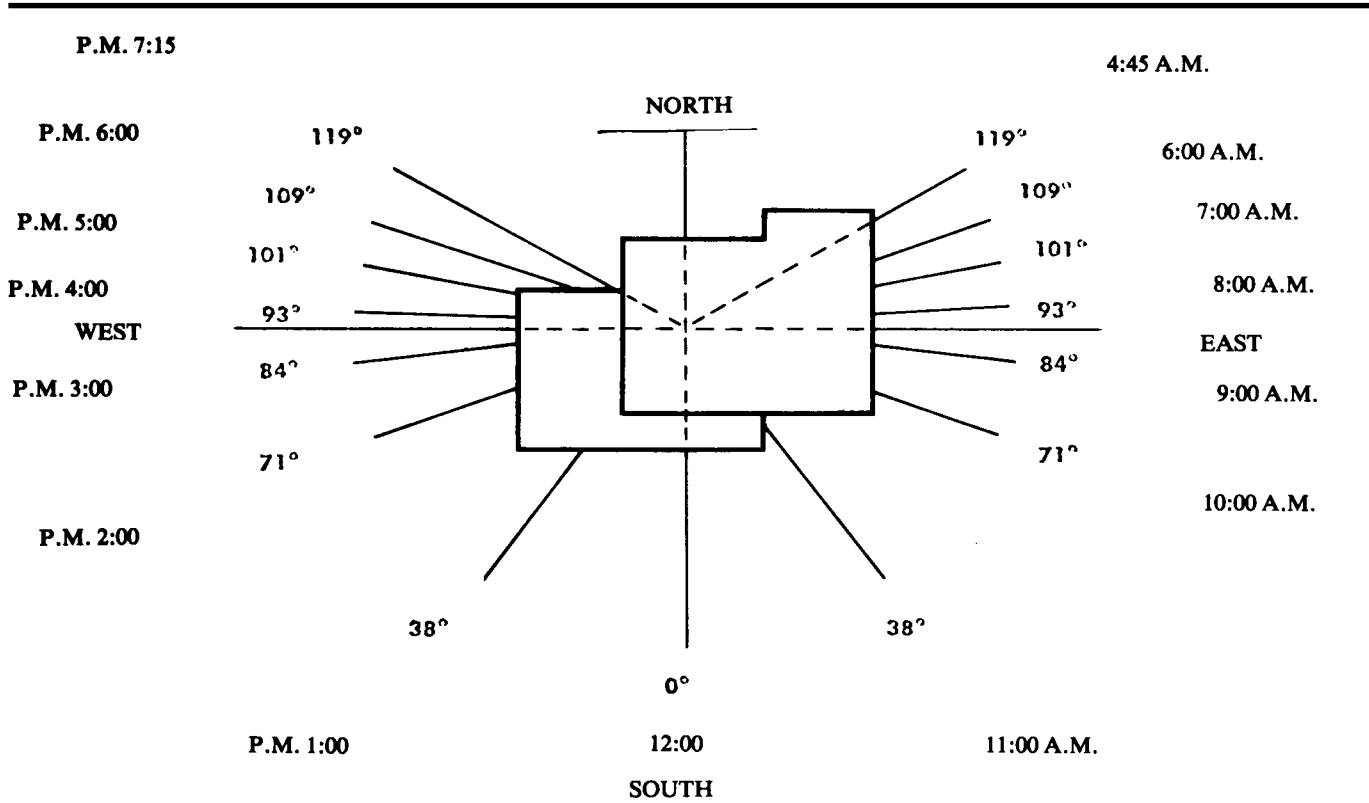

Figure 16. Horizontal angles of the sun July 21; latitude 36° .

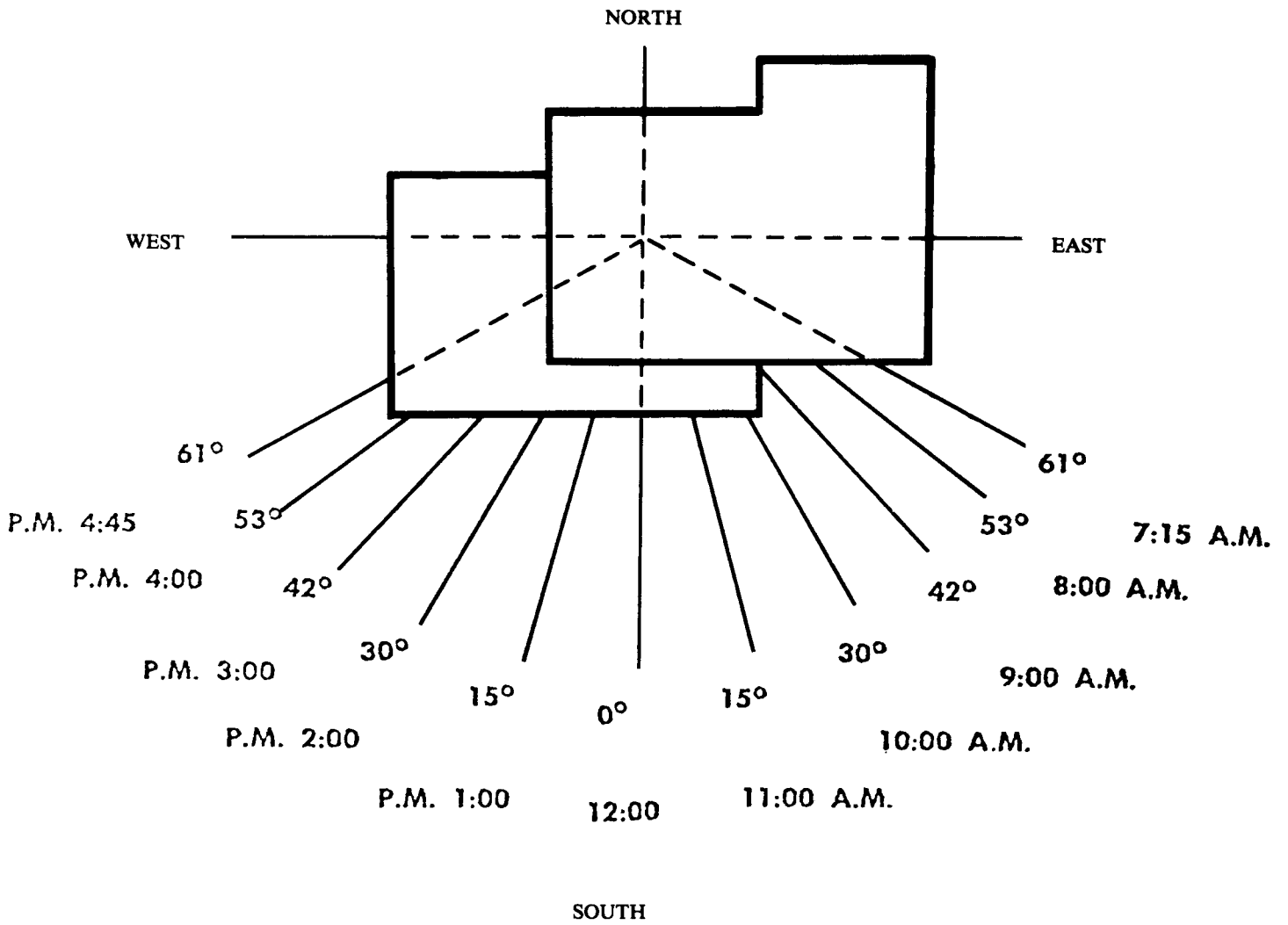

Figure 17. Horizontal angles of the sun December 21; latitude 36°.

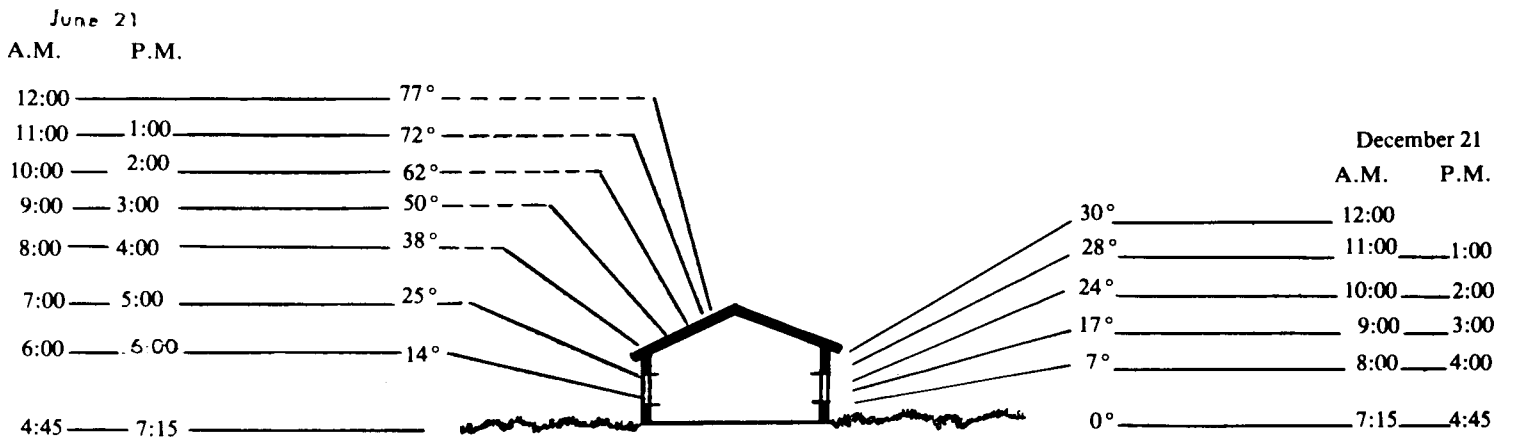

Figure 18. Altitude angles of the sun, latitude 36°.

HEATING CONSIDERATIONS

Greenhouses must be heated in Tennessee from about October through April. Heating for a hobby greenhouse does not usually present a big problem because of the small area heated and the alternate sources of heat we may use. The heat source may be from electricity, bottled or natural gas, oil or kerosene, or by hooking into the home heating system. Each has its advantages and possible disadvantages.

Heat exchange with benches, floor and plants in a greenhouse does occur when the temperature changes. However, the heat released or absorbed is so small, when compared to the heat loss through the outer surface of the greenhouse, that this is ignored. Therefore, it is an accepted practice to figure the heat loss that occurs through the outside exposed greenhouse surface to determine the heat requirements.

As a general rule, a heat loss factor for glass or fiberglass of 1.2 BTU's per hour per square foot of outside greenhouse surface times degree differential desired (inside and outside temperature difference) should provide maximum heat needed. In Figure 19 an 8-foot x 12-foot lean-to house covered with glass has an exposed area of (A+B+2C) 283 square feet.

If you plan to grow plants that require warm temperatures, such as African violet, begonia, Christmas cactus, chrysanthemum and most foliage plants, a 70 F daytime temperature and a 60 F night temperature should be maintained. Therefore, if we expect the lowest outside temperature to be 0, the night temperature differential would be 60 F; heat requirements would be determined by the following formula:

Heat loss per square foot X total exposed area and temperature differential desired = required BTU's per hour.

Example: 1.2 BTU's X 283 sq. ft. X 60 = 20,367 BTU's or 6 KW of electricity per hour.

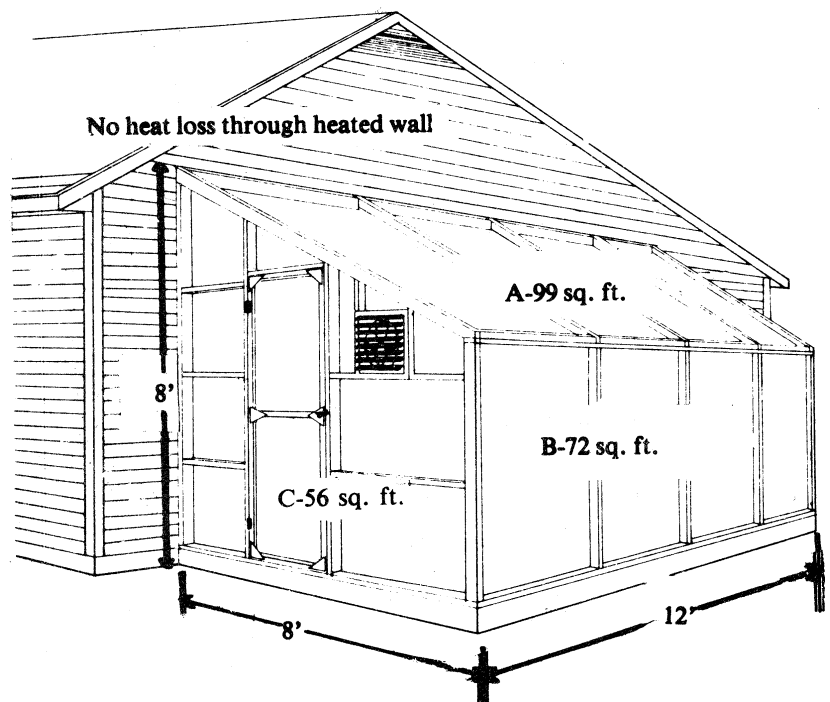

Figure 19. A lean-to greenhouse

COMPARING VALUES OF DIFFERENT FUELS.

The cost of fuel will vary from area to area throughout Tennessee due to availability, transportation charges and other factors. The cost of heat must be considered locally and compared to determine the economics of alternative energy sources. The energy source you choose will depend on the convenience, availability and cost. In Table 1, a comparison is made of four energy sources that may be used in heating a hobby greenhouse.

Fuel	Units	Heat capacity BTU's/unit	Percentage of average burn efficiency	Fuel units per 100,000 BTU heat output
Electricity	KWH	3,413	100	29.3 KWH
Natural Gas	Cu. Ft.	1,050	75	127.0 Cu. ft.
LP-Gas	Gal.	92,000	75	1.45 Gal.
No. 2 Fuel Oil	Gal.	138,000	70	1.04 Gal.

HEAT COST

The cost to heat a hobby greenhouse depends on many factors — covering material, location, how well the house is sealed, insulation of flooring and side walls, etc.

SIZE OF HEATERS

To make a positive statement that a greenhouse would require a certain size heater would be erroneous. There are several factors to be considered, such as type of building material, location, exposure to wind, whether it is attached to a heated building, whether heat-conserving practices are being used and the area of the outside exposed surface. The heating system for each house should be determined by using the formula provided in the previous section.

TYPE OF HEAT

Solar. Solar heat has received considerable publicity and interest as an alternative to conventional energy heat sources for greenhouses. To date, there are no economical, active solar systems that can be recommended for a greenhouse.

The best idea is to use known energy conservation methods in construction to reduce heating costs. Many passive solar systems help to supplement conventional heating systems.

Electric. Electric heaters (Fig. 20) are clean, efficient and easier to install than other heating units. They may be purchased in several different models, sizes and for 115V or 220V current. Wall-mounted or suspended units with a fan and built-in thermostat usually meet all the expectations of the most discreet hobbyist. The fan circulates the heat and at the same time provides air circulation. They are easy to install without the need for vents or plumbed fuel lines. Electric heat is safe and practically troublefree.

Cost is a disadvantage to the use of electric heat. However, if electricity costs more in the future, other energy sources will increase in proportion.

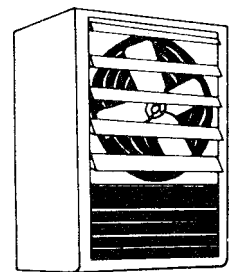

Figure 20. Wall-mounted electric heater.

Kerosene. Small portable kerosene heaters (Fig. 21) may be used only as emergency heaters in small greenhouses. If kept in proper condition and used for a short period of time, a chimney vent is not required. However, they do produce fumes that might injure plants, especially those that are sensitive to low concentrations of ethylene such as cucumbers, tomatoes, fuchsias and others.

These heaters do not have thermostatic controls or fans to help regulate and distribute the heat; therefore, those plants closest to the heater may be burned while those farthest away may be chilled. **Some of the heaters on the market do not have a UL label and may be unsafe.**

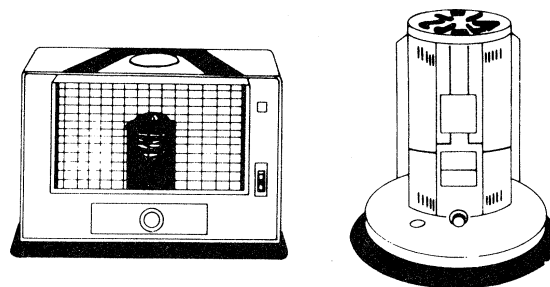

Figure 21. Two types of kerosene heaters.

Portable Oil. Oil-fueled portable space heaters (Fig. 22), such as Salamanders used in the building trades, should not be used in hobby greenhouses. They give off vast amounts of harmful fumes and soot. Heat radiates away from their surface and could damage plants nearest the heaters.

Space (Natural or LP Gas). Space heaters (Fig. 23) are used extensively to heat greenhouses. Some heaters are completely self-contained units with a fan and heat exchanger.

Space heaters, like electrical heating units, should be suspended overhead for space conservation if they cannot be placed in the greenhouse wall. They must be vented to the outside in accordance with local city and county building codes. Heaters installed through the wall require no additional venting, since the fumes are released to the outside through special vents built into the heating unit.

The extension of the home heating system to a small attached hobby house is sometimes possible. The feasibility of extending the home heating system will depend on whether or not adequate capacity exists and the proximity of air ducts to the greenhouse. The company which services your heating system can advise you about this alternative.

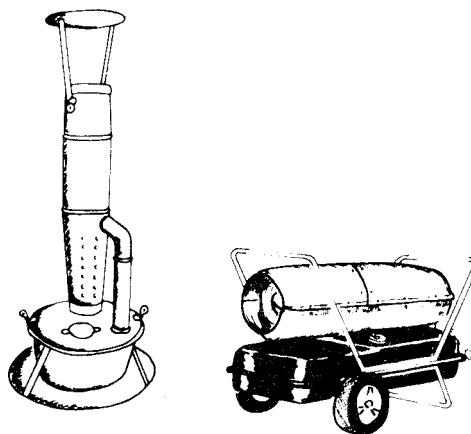

Figure 22. (a) Radiant heater, (b) hot-air heater.

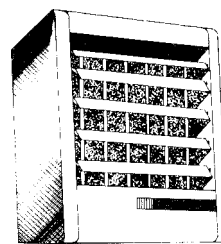

Figure 23. Gas heater.

VENTILATION

Many people confuse greenhouse cooling with ventilation and vice versa, but look upon these as two entirely different functions. Cooling is, as the name implies, for temperature reduction. This is not to deny that some decrease in temperature does occur during the ventilation process in changing of the air.

Adequate ventilation is essential for healthy plant growth since the primary purpose is to supply carbon dioxide and control humidity to some extent. Ventilation should be given special attention in tightly constructed greenhouses. The most convenient way to ventilate a hobby greenhouse is by a thermostatically controlled two-speed fan to change the inside air.

Selecting a fan. It is not always easy to find an appropriate fan to install in a hobby greenhouse due to fanhousing, motor size and fanspeed.

To determine the fan capacity of one air change per minute for the house used in Figure 19, we use the following formula:

$$\begin{aligned} \text{width} \times \text{length} \times \text{height} &= \text{cubic feet;} \\ \text{therefore } 8' \times 12' \times 7' &= 672 \text{ cu. ft. inside area.} \end{aligned}$$

A fan with a capacity to move 672 cubic feet of air per minute (CFM) is needed. A two-speed fan is preferred. The fan would move 336 CFM on low speed and 672 on high speed. Early in the morning and late afternoon when the temperature is too cool for maximum cooling, the low speed would reduce cool shock on the plants.

Once you have determined the fan capacity, look for a fan (Fig. 24) with a housing dimension that can be installed in your greenhouse with the least amount of trouble and requiring the least amount of greenhouse frame alteration to install. In most cases, you will need to alter the greenhouse frame so the fan housing fits appropriately.

Make sure the fans come with appropriate guards to avoid personal injury during operation.

COOLING

Cooling takes over after the temperature cannot be controlled by the normal ventilation process. Temperatures can be changed quickest by the positive action of appropriately sized fans placed on the leeward side of the greenhouse, with appropriately sized louvers on the opposite end. They may serve as ventilation fans on low speed and cooling fans at high speed, or a combination of both. The temperature may be kept 5 to 10 degrees lower than the outside air temperature. Two-speed fans are desirable because during the fall and spring, the low speed reduces the air exchange rate to one-half the total fan capacity.

Fans cannot do an adequate job of cooling during the summer months without an assist by shading or the use of an evaporative cooling system. The sun's rays can add as much as 300 BTU's per hour per square foot of surface area inside a greenhouse. Therefore, shading reduces the heat load coming inside the greenhouse. Shade cloth with different percentages of shading, or other adjustable shades made of wood, aluminum or fiberglass are most commonly used on hobby greenhouses. The shading plus moisture evaporation from the floor, benches and plants can lower greenhouse temperatures as much as 10 to 15 degrees.

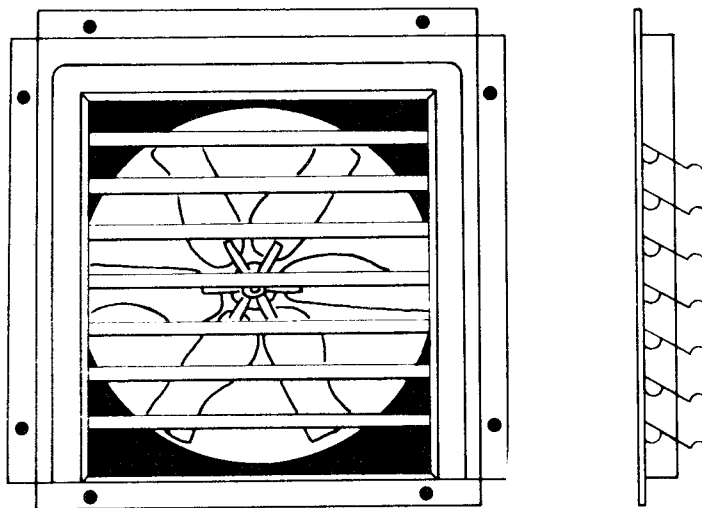

Figure 24.
Exhaust fan
and Louver.

Shading compounds (paint) are available from greenhouse supply companies. However, they are not recommended due to their unattractiveness and the difficulty in removing the paint to permit more light to enter during fall and winter. If you decide on a greenhouse shading compound, it must be compatible with the type of greenhouse covering. They are not used on polyethylene film plastics.

Evaporative cooling. Cooling by pulling air through wet pads is recommended in Tennessee since summer temperatures rise above 90 F for several days during the year. Evaporative cooling is most effective when used with some type of greenhouse shade. Cooling of the inside temperature to 10 or 15 degrees below the outside air temperatures by evaporation may be generally expected. In extremely hot weather, an inside temperature equal to the outside air temperature is considered good. The process of moving cool moist air through the plants increases the humidity and reduces the rate of plant transpiration (giving off water), which reduces wilting.

The process of lowering the inside greenhouse temperature is sometimes misunderstood. The heat that

	Relative humidity (percent)			
Outside air	30	50	70	90
Outside air temperature F	Cooled air temperature F			
100	79	86	91	97
90	71	77	83	88
80	63	69	74	78
70	56	60	64	68

*"Greenhouse — Heating, Cooling and Ventilation," by Cecil Hammond and Douglas Crater. Bull. 792, 1976, University of Georgia

enters a greenhouse on a bright, hot day is trapped inside the greenhouse and causes the temperature to increase as much as 25 to 30 F above the outside temperature. By moving dry air through a wet pad, water evaporates. It takes approximately 1,000 BTU's of heat to evaporate one pound of water. When the heat is removed from the air by evaporating the water, the air is cooled. The lower the relative humidity of the

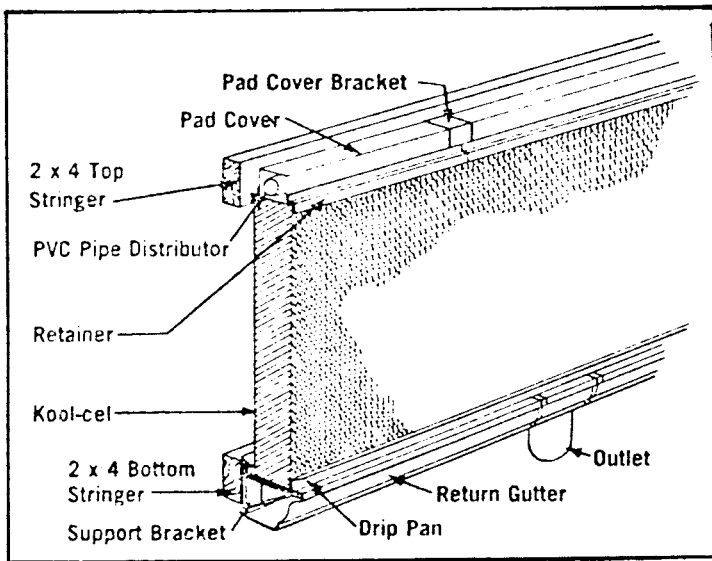
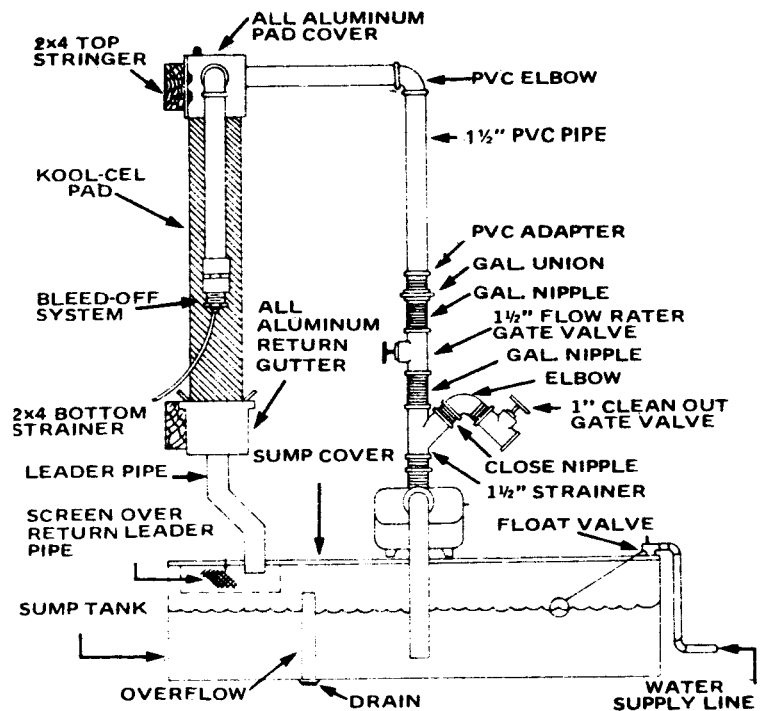

Figure 25. Evaporative cooling pad installation diagram.



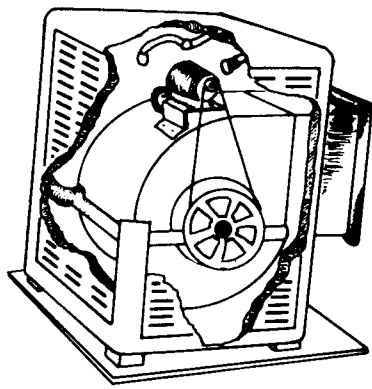

Figure 26. Box cooler.

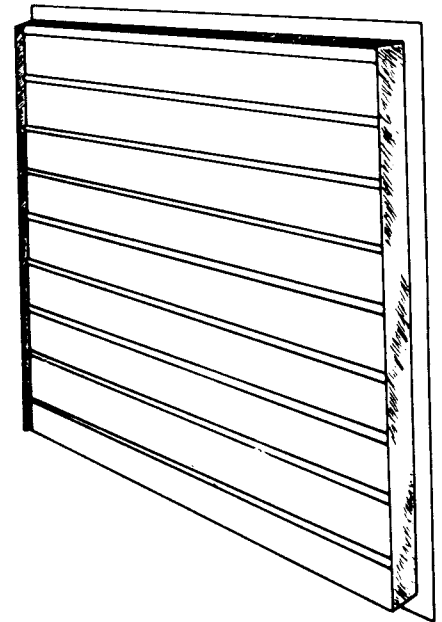

Figure 27. Louver.

Figure 28. Watering devices.

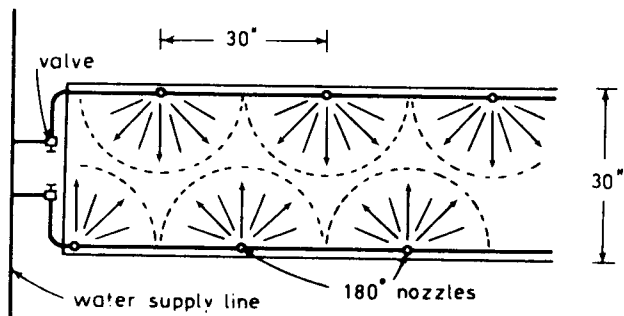

Figure 28a. 180° spray watering system.

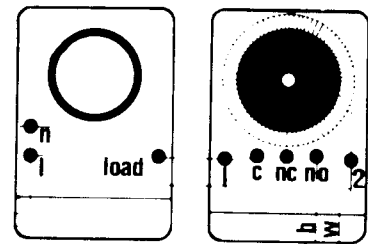

Figure 28b. Time clock.

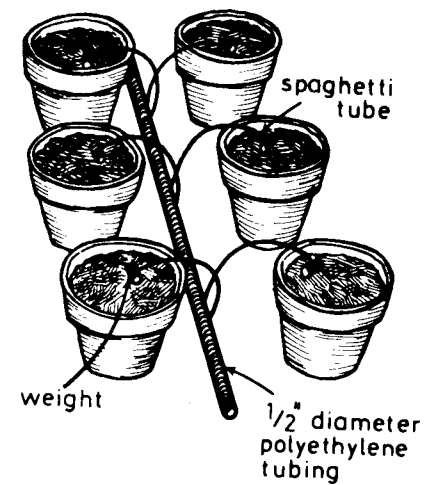

Figure 28c. Spaghetti Tube watering system.

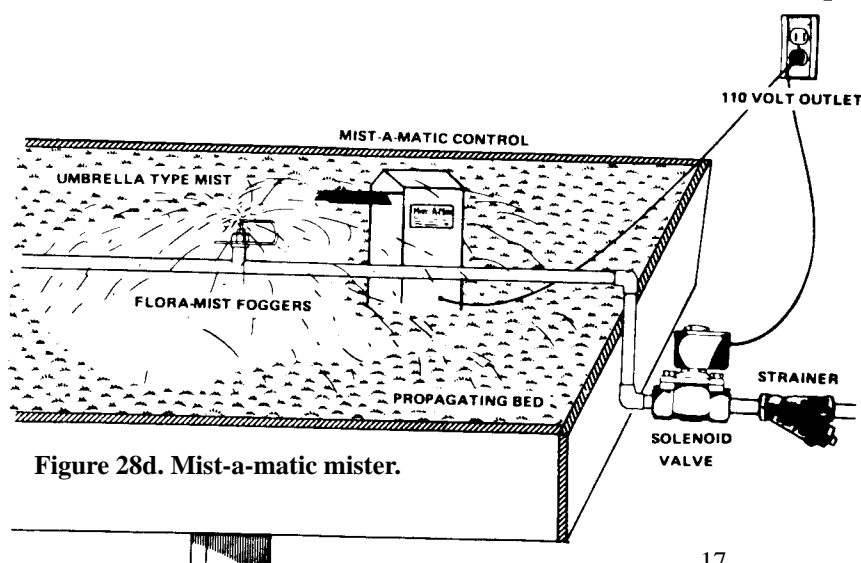

Figure 28d. Mist-a-matic mister.

outside air, the greater the water evaporation from the pad and the lower the air temperature.

A one-square-foot pad area should be provided for each 15 CFM of air circulation to provide a cooling efficiency of 85 percent (Table 2).

In Tennessee greenhouses, the relative humidity is usually lowest in summer, except during a rain and a short time thereafter. Therefore, the evaporative cooling pad system for a hobby greenhouse should be correctly designed to give maximum cooling at one air change per minute. A solar heat gain of 10 F can be expected using one air change per minute. If the outside air was 90 F and the relative humidity 50 percent, the resultant temperature inside the greenhouse would be about 87 F (77 F taken from Table 2 + 10 F solar heat gain = 87 F).

An efficient and properly installed evaporative cooling pad system shown in Figure 25 is made from a cellulose material. It has a crossfluted configuration which gives maximum flow of air and water. It takes about one-third less pad area to give the equivalent cooling compared to Aspen Pad systems that have been used for many years. The life expectancy for the new material is about five years. The complete pump kit can be purchased from any greenhouse supplier.

Packaged or box-type evaporative coolers are practical for hobby greenhouses with 300 square feet or less. The box cooler shown in Figure 26 has evaporative pads on three sides. The water reservoir, pump and distribution lines are built into the unit. The fan is located inside the box to draw the air through the pads and blow the cool air into the greenhouse. A louver (Fig. 27) must be placed in the opposite end of the greenhouse to permit an equal amount of air to move outside as the fan is pulling air into the house.

This type of cooler is usually cheaper and easier to install in a hobby greenhouse and the appearance is better than the pad systems previously described.

MANAGING A HOBBY GREENHOUSE

Now that you have decided to buy or build a hobby greenhouse, give some consideration to management. The following is a “Do and Don’t” list that can help reduce your potential problems.

DO

1. Keep greenhouse clean at all times.
2. Spend enough time with your hobby to assure success in growing.
3. Read and learn how others have operated their hobby houses.
4. Keep your greenhouse in a good state of repair and keep all equipment working.
5. Discard weak and diseased plants.
6. Maintain a good disease-and-insect eradication program.

DON'T

1. Don't run a sick-plant hospital for your friends. If you do, you are asking for constant trouble.
2. Don't try to grow many different plants, at least while you are an amateur grower.
3. Don't neglect your greenhouse. If you do, it will probably wind up a junk house for plants.
4. Don't think you can leave your plants without care; they need daily attention.
5. Don't overwater, overfertilize, overheat or overcool your plants.
6. Don't think of the operational cost; think of the joy of growing your own plants.

ORGANIZATIONS AND FURTHER INFORMATION

The Hobby Greenhouse Association is a non-profit organization of gardeners in hobby greenhouses, window greenhouses and other indoor areas. Membership in HGA includes a subscription to *Hobby Greenhouse* and *HGA News*. Other membership benefits include round robin letters, help and advice on greenhouse gardening, a seed exchange, videotape and book libraries and access to certain print materials at discount. They can be contacted at **HGA, 8 Glen Terrace, Bedford, MA 01730-2048**. They have a web site at: <http://www.hortsoft.com/HGA.html>

There are numerous books and gardening magazines available at your public library about hobby greenhouses. Check the library catalog under the following topics: indoor gardening, hobby greenhouses, foliage plants, horticulture. If you have an interest in a specific group of plants, check the library catalog using that name, such as cacti and succulents, bromeliads or orchids. A basic reference to start with is *Greenhouse Gardener's Companion: Growing Food & Flowers in Your Greenhouse or Sunspace* by Shane Smith (1992, Fulcrum Publishing, Golden, Colorado). Other places to start are the Time-Life gardening series, Ortho gardening series and Sunset Books gardening series. Two magazines to look for are *Horticulture* and *The American Gardener* (formerly *American Horticulturist*).

If you have access to the Internet, searches on various key words including horticulture, specific groups of plants (e.g., bromeliads), greenhouse gardening, gardening and related terms will locate many sites with useful information. Many states' cooperative and agricultural extension services also have publications posted on the Internet. Two sites to start your Internet gardening library are:

1. The Virtual Garden

<http://pathfinder.com/vg/>

The Virtual Garden provides extensive, searchable databases for gardening accessories (e.g., clothing, tools and supplies, seeds, plants and heirloom varieties), monthly gardening information by USDA, hardiness zones and a search engine for gardening information.

2. The National Gardening Association

<http://www2.garden.org/nga/>

This site includes information on "Kids & Classrooms" and other "Gardening Links" from alpine plants to vegetables. It also accesses plant societies, colleges and universities and cooperative extension services. It includes searchable plant data bases including the Time-Life® Electronic Encyclopedia.

Many state cooperative and agricultural extension services have their publications posted on the Internet. They are posted in various formats, most commonly *html* or *pdf* formats. Just follow instructions for viewing or downloading provided at the different web sites.

APPENDIX

USE HEATED GROWING FRAMES TO PRODUCE EARLY PLANTS

Let's take a look at growing plants in heated growing frames. They can be built to suit the needs of the home gardener. Electrically heated growing areas are relatively cheap to build and operate from an energy standpoint. Temperature can be kept uniform with positive controls. Therefore, more uniform plants of the desired quality can be produced.

Heated growing frames can also help during those few weeks before the plants are moved to the garden. Plants can be hardened off or acclimated to withstand the garden climate.

There are many different designs of growing frames but the two offered should serve the needs of most hobbyists, since they can be decreased or increased in size to meet individual needs.

The frame is covered with 6 ml. Polyethylene UVR film. The film is fastened permanently down the ridge or top of the frame with lath strips (use double-headed nails to make replacement easier) and roll each side up from the bottom edge to the ridge as ventilation is needed. The bottom edge of the polyethylene is anchored to a 2" x 2" x 21' piece of redwood which holds the cover down and is used to wind up the cover. Flexible rubber straps nailed to the end of the frame are stretched over the 2" x 2" at whatever point the edges are raised. This firmly anchors the cover and prevents wind damage.

Thermostatically controlled electrical heaters may be installed as needed.

The frame should be placed on a 2" x 8" x 16" solid block at each corner and in the center of the side wall to hold the wood off the ground to prevent decay. Cover the inside floor with about 2 inches of 3/4-inch crusher-run gravel for drainage and to prevent an accumulation of mud.

To summarize, growing frames give us these advantages:

1. Cheap to build and provide adequate conditions to harden off plants
2. Allow additional space so plants will grow larger before planting in the garden
3. Quality of plants can be improved by providing adequate room to space plants farther apart
4. Plant quality is not affected if weather prevents movement to the garden

MATERIAL LIST FOR FRAME 1

CAUTION: use redwood or pressure-treated lumber. **Do not use material treated with creosote, pentachlorophenol or similar preservatives.**

- 1 piece 18' x 20' 6 ml UVR polyethylene cover**
- 2 pieces 2" x 6" x 20' bottom rail**
- 2 pieces 2" x 6" x 16' bottom rail**
- 2 pieces 2" x 4" x 8' side post**
- 6 pieces 2" x 4" x 8' end post**
- 6 pieces 2" x 4" x 8' end frame**
- 1 piece 2" x 4" x 20' top rail**
- 12 pieces 2" x 4" x 9' top rafters**
- *6 pieces 3/8" x 4' x 8' marine plywood ends and side**
- 1 piece 2" x 4" x 22' polyethylene anchor**
- 8 pieces 2" x 8" x 16" solid concrete blocks**
- 2 pieces 1" x 3" x 10' plastic anchor — top rail**

***Tongue-and-grooved lumber may be used instead of the plywood.**

All lumber should be painted white, inside and outside the greenhouse.

MATERIAL LIST FOR FRAME 2

CAUTION: Use redwood or pressure-treated lumber. **Do not use material treated with creosote, pentachlorophenol or similar preservatives.**

- 1 piece 20' x 21' 6 ml. UVR polyethylene cover**
- *6 pieces 3/8" x 4' x 8' marine plywood**
- 2 pieces 2" x 6" x 16' bottom rail**
- 2 pieces 2" x 6" x 20' top rail**
- 1 piece 2" x 4" x 20' side rail**
- 10 pieces 2" x 4" x 10' end frame**
- 2 pieces 1" x 3" x 10' anchor plastic or top rail**
- 3 pieces 3/4" x 21' pipe bows**
- 6 pieces 1" x 2' pipe anchor**
- 8 pieces 2" x 8" x 16" solid concrete blocks**

***Tongue-and-grooved lumber may be used instead of the plywood.**

All lumber should be painted white, inside and outside the greenhouse.

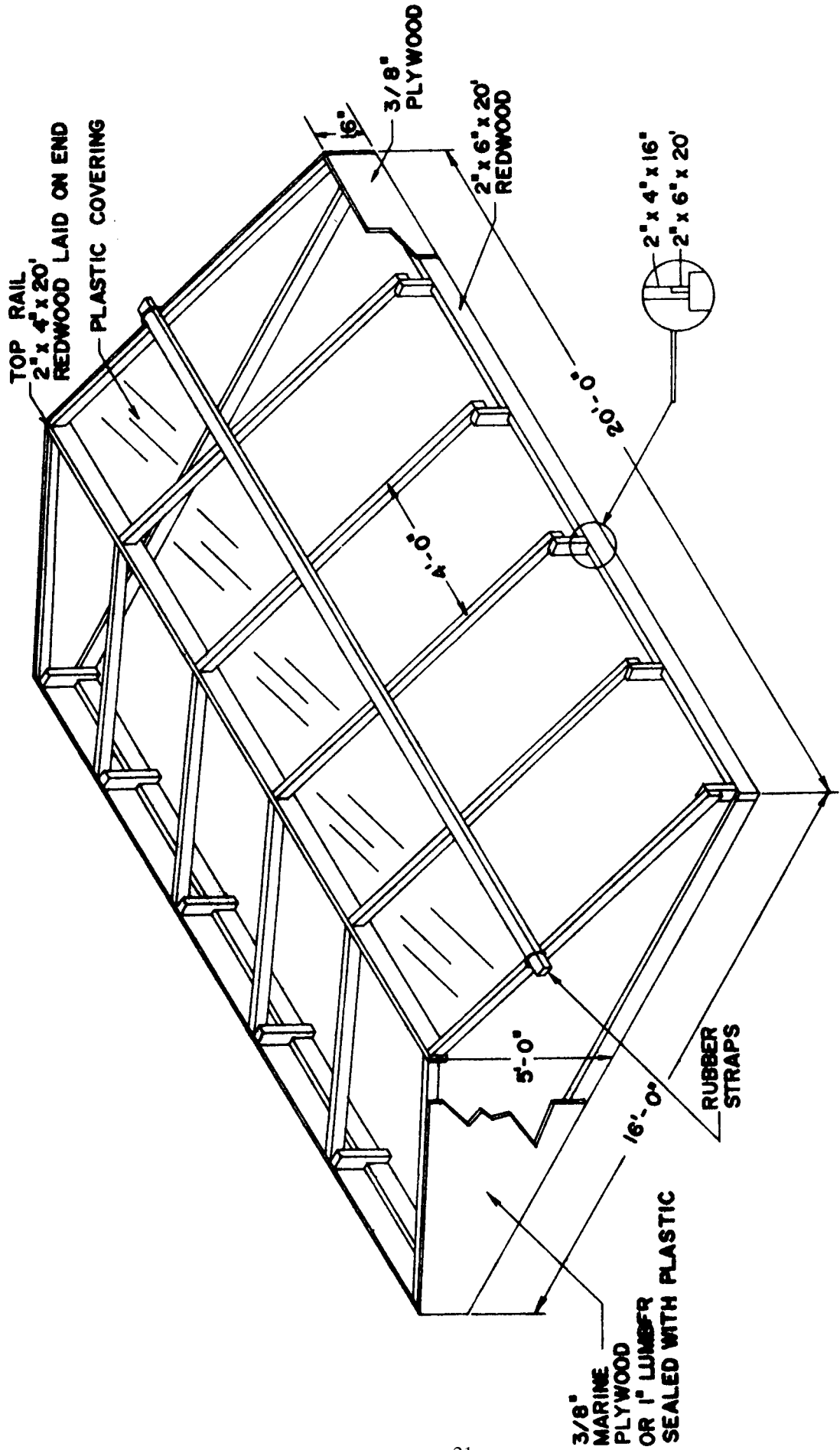

FRAME 1

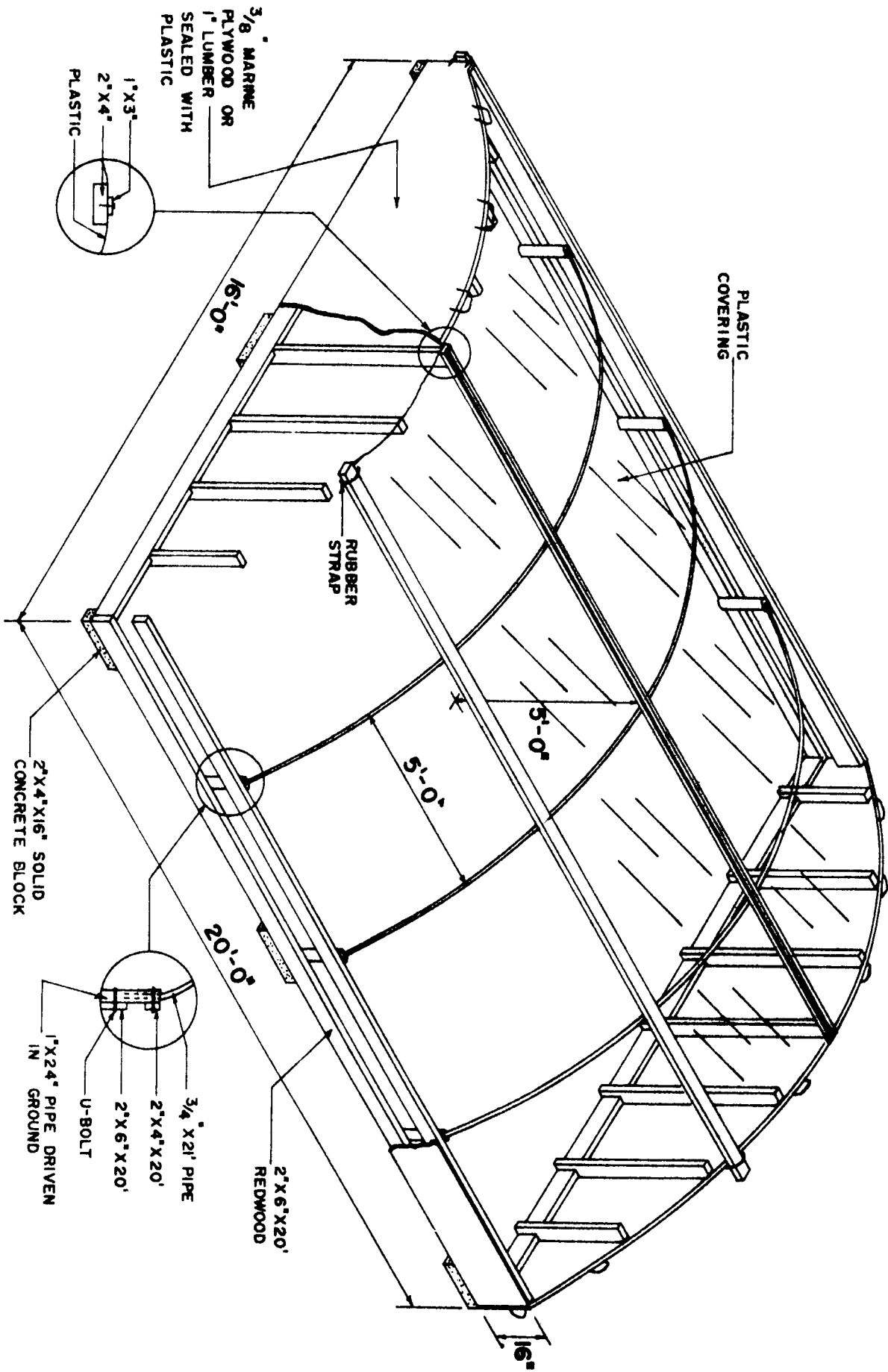

FRAME 2

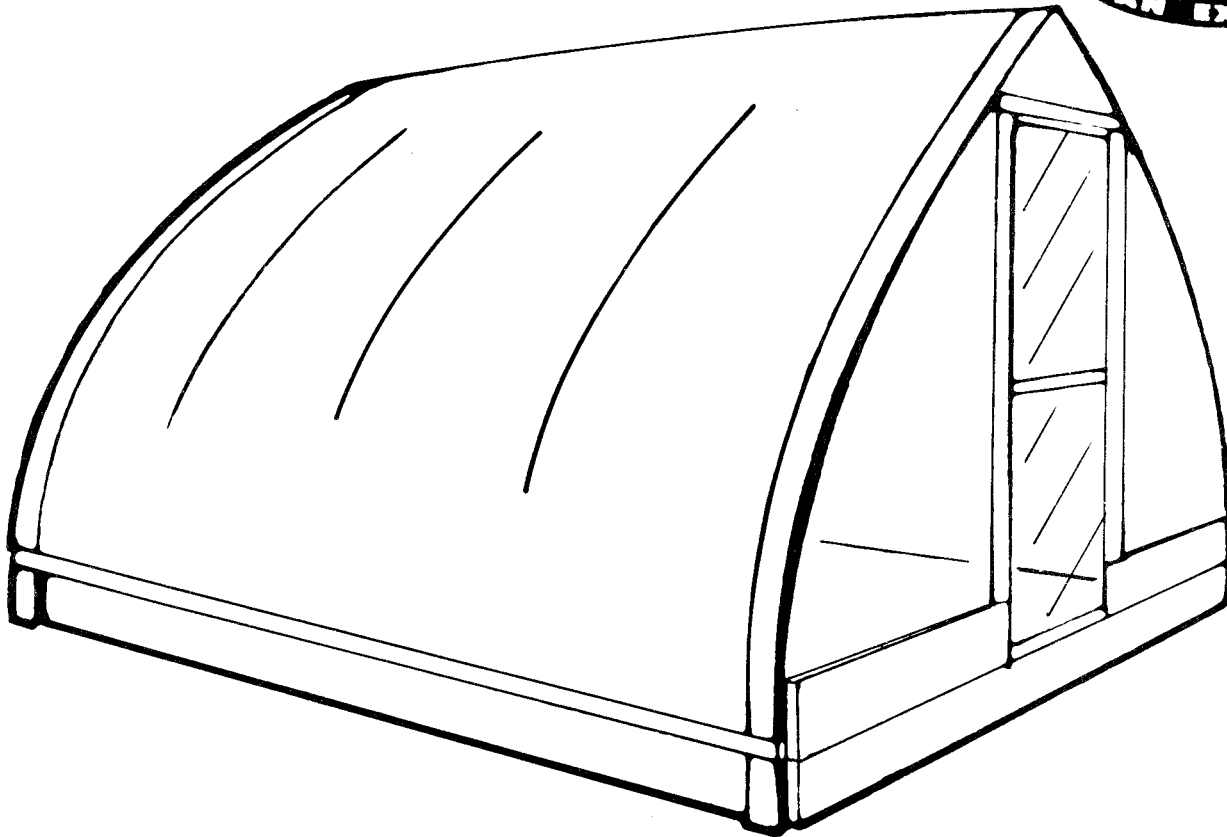

PLASTIC-COVERED GREENHOUSE

This portable greenhouse is attractive, easily constructed and inexpensive. Its roof slope approximates that of a gothic arch extending from the ground to the ridge. This surface is steep enough to shed snow, water and debris. However, a large accumulation of snow may pile up against the sides and apply lateral pressure to the plastic film.

The structure resists wind very well. A low-cost polyethylene cover has a service life of three to eight months. More expensive films last two to three years or even longer. The film must be securely fastened to the frame; and the house must be staked down to prevent the wind from blowing it away.

In late summer, the house can be used as a propagating frame by replacing the plastic film with a lath-type snow fence.

Two small ventilators at the top of the door provide limited ventilation. When more air is needed on hot days, the doors can be opened or the house can be raised off the ground.

The width (8 feet) allows space for a walkway with a row of flats on each side, and the height (7 feet) allows most people to stand without touching the top. With doors in each end, several units of this greenhouse can be placed in a series, and tools can be moved from section to section.

Two persons can move the greenhouse short distances, and three or four persons can lift it above their heads. Construction is rather simple; only a little experience with common tools is required. The most complicated job — forming the ridge beam — is easy if a table saw with an adjustable table or blade is available to rip the board.

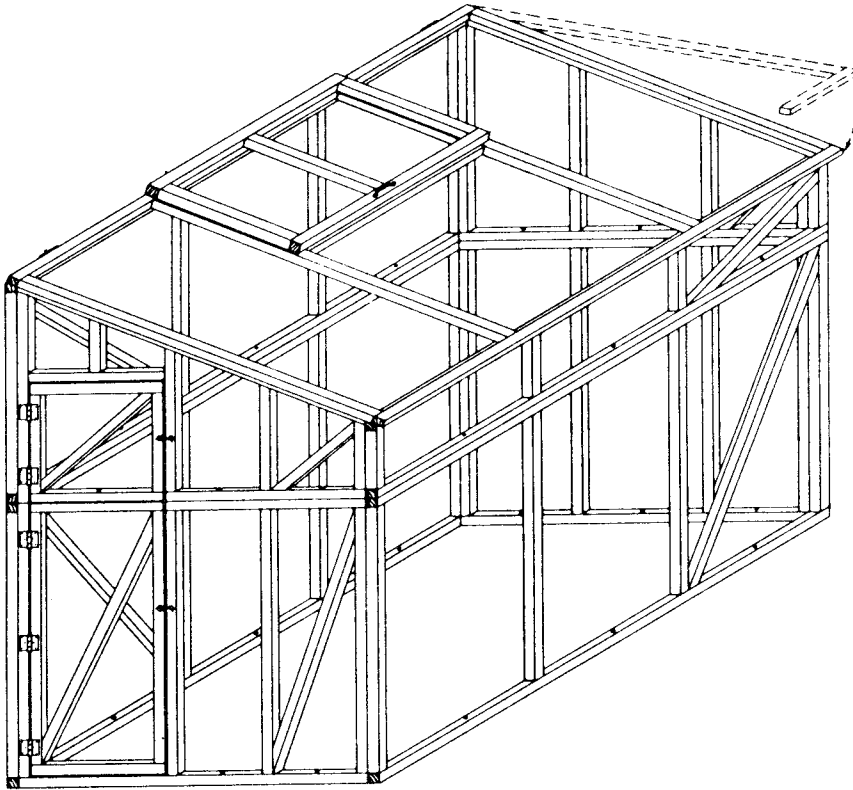

PLASTIC-COVERED GREENHOUSE COLDFRAME

This plan features a removable top that can be used as a coldframe. For example, tomato plants may be given a head start on the frost-free season.

To germinate seeds and grow starter plants, install a heating cable in the assembled unit. When the plants are about 3 inches high, they should be moved to a coldframe.

Select a 5- by 7-foot plot of ground favorably located in the corner of the garden. Remove the coldframe portion from the top of the greenhouse. Place it over the plants to protect them from the night frost.

If everything is timed right, they will be of proper size for field planting at the frost-free date.

The wooden parts for the frame should be pressure treated to prevent rotting. All hardware, including nails, should be galvanized.

The greenhouse should be anchored to the ground with steel rods.

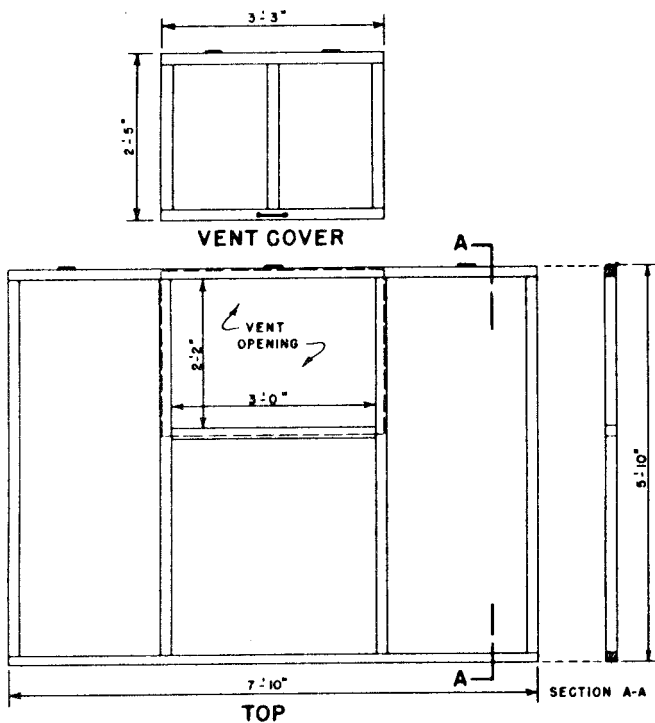

PB1068- 3M-5/98(Rev)

E12-2015-00-031-98



A State Partner in the Cooperative Extension System

The Agricultural Extension Service offers its programs to all eligible persons regardless of race, color, age, national origin, sex or disability and is an Equal Opportunity Employer.

COOPERATIVE EXTENSION WORK IN AGRICULTURE AND HOME ECONOMICS

The University of Tennessee Institute of Agriculture, U.S. Department of Agriculture,
and county governments cooperating in furtherance of Acts of May 8 and June 30, 1914.

Agricultural Extension Service

Billy G. Hicks, Dean