

LOAD BEARING CAPACITY OF THE GLASS RAILING ELEMENT

ELIZABETA ŠAMEC*, DOMAGOJ DAMJANOVIĆ, JOŠKO KROLO

University of Zagreb, Faculty of Civil Engineering, Fra A. K. Miošića 26, Zagreb, Croatia

* corresponding author: elizabetha.samec@gmail.com

ABSTRACT. In this paper some basic physical and mechanical properties of glass as structural material are presented. This research is about specifically manufactured glass railing element that will be a part of a pedestrian bridge construction in Zagreb, Croatia. Load bearing capacity test of the glass railing element is conducted within the Faculty of Civil Engineering in Zagreb and obtained experimental results are discussed and compared to the ones provided by the numerical model. Taking into account the behaviour of laminated glass and results of experimental and numerical testing, glass railing element can be regarded as safe.

KEYWORDS: glass railing element, load bearing capacity test, wind load, modulus of elasticity, numerical model.

1. INTRODUCTION

When we have glass elements that are specifically manufactured for construction projects it is highly important to perform laboratory testing in order to confirm their load capacity. Necessity for laboratory testing follows from potential unexpected breakdown under the load due to special properties of the glass as a construction material. Unlike steel, plastic and wood, glass has no plastic properties and consequently no yield point [1]. Because of the property of pure elasticity with brittleness the glass cannot be permanently deformed by load and it fails without warning as shown on a stress-strain curve (Fig. 1). Failure always happens in tension because it has high compressive strength [2].

The cause of the glass failure is not necessarily concentrated impact; fracture may occur due to bending stress, thermal stress or deformation. A fracture which occurs will depend on the number of surface defects, the duration of the load, the size of the tensed surface and the stress level. By increasing the dimensions of the glass elements the number of imperfections will increase as well [3]. This kind of behaviour is undesirable for a construction material. Despite possible problems with brittle behaviour and unexpected breakdown, application of structural glass has undergone remarkable development in the last twenty years. The opportunities and attractiveness that this type of material provides have been recognized and glass has become more than “window material”.

The subject of this research is the glass railing element designed for the pedestrian bridge construction planned to be built in Zagreb, Croatia. Usually for tempered glass guardrails, live loads caused by use and wind loads need to be considered. Other loads such as a permanent load, snow load, and seismic load are insignificant because of their low range compared to the overcharge caused by use or wind [4]. In this case, the wind is also the main load on the glass element,

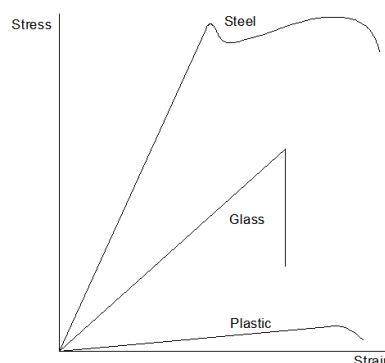

FIGURE 1. Stress-strain diagram for steel, glass and plastic [2].

so it is necessary to test the bearing capacity of the glass railing element under the influence of the wind. In most cases glass will behave entirely elastic until the moment of fracture and this kind of behaviour is expected to be confirmed by experimental analysis.

The literature review in [1] shows that earlier research has been conducted on behaviour, strength, analytical and numerical modelling of laminated glass with PVB but still the knowledge required to use laminated glass as a load bearing element in every-day construction, is not sufficient. The aim of this paper is to gain a deeper knowledge of the behaviour of laminated glass by experimental investigations and by numerical model simulation. To pursue the proposed study, load bearing capacity test was performed on the glass railing element in the scale 1:1. Corresponding finite element numerical models were created in the software SAP 2000 to discuss and compare displacements in the points most affected by the wind influence. The main question that needs to be answered is whether the glass railing element can be regarded as safe to install on the pedestrian bridge. Therefore, safety factor is calculated and expected

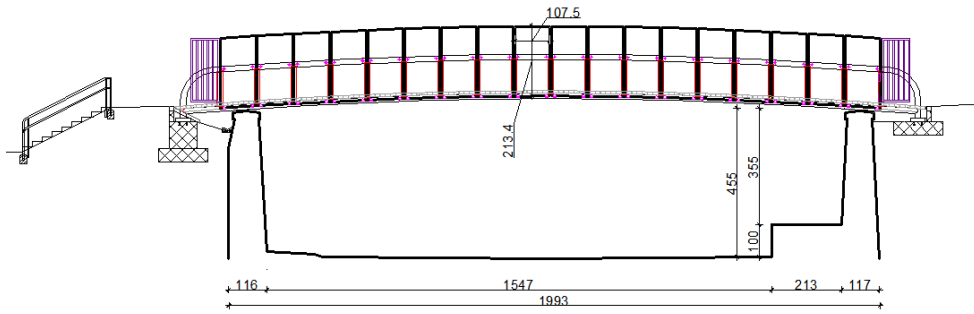

FIGURE 2. Bridge plan.

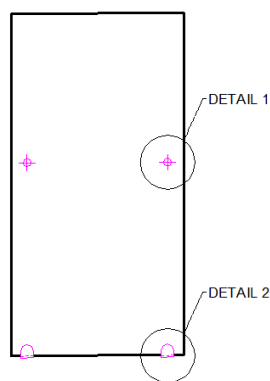

FIGURE 3. Glass railing element with positions of attachment details.

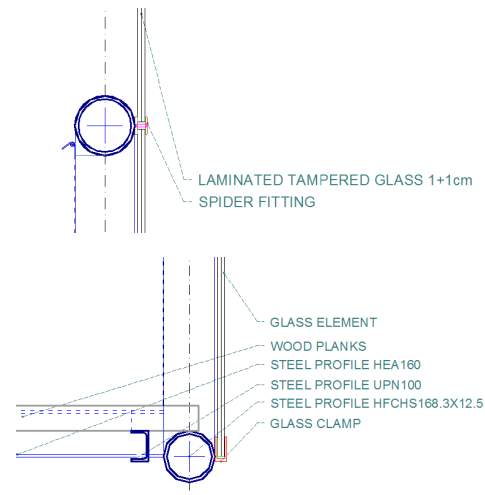

FIGURE 4. DETAIL 1: spider fitting (up), DETAIL 2: inox clamps connecting the element to the main steel profile (down).

behaviour under the wind load is tested on a life-size sample of the glass railing element.

2. BRIDGE PROJECT DETAILS

2.1. BRIDGE CONSTRUCTION

The future pedestrian bridge is planned to be built in Miramarska Street in Zagreb. The railing elements are going to be put along the bridge to protect the pedestrians from the influence of wind and to ensure their safety. The plan of the future bridge is shown in Fig 2.

2.2. RAILING ELEMENT

The glass element consists of two 10 mm thick tempered glass panes bonded by interlayer (polyvinyl butyral-PVB). The stiffness of laminated glass depends on the shear strength of the panes and the PVB foil. Factors that influence the behaviour of these connections are load duration, intermediate layer thickness, temperature and position of the intermediate layer with respect to the center of gravity. The behaviour of laminated glass is different under the long-term and short-term load. Under the influence of short-term load, laminated glass acts as a composite carrier. Under the influence of long-term load, the load is distributed on two panes due to their rigidity because of the deformation of the interlayer. In the case of a breakdown, glass fragments remain linked to the PVB layer. Therefore, laminated tempered glass

is chosen for the railing element of the pedestrian bridge.

The dimensions of the railing element are 213.4 x 107.5 cm. The element is attached to the bridge construction at four points. As you can see in the Fig. 3 and Fig. 4, the element is put in the inox glass clamps on the bottom, and on the handlebar section it is fixed to the handlebar with two spider fittings.

2.3. WIND LOAD

As mentioned in the introduction, the wind load is authoritative load and calculation of the design value used in laboratory and numerical analysis is further described below. The design value is calculated according to Croatian valid norm for wind load *HRN EN 1991-1-4:2012/ NA2012*. Depending on the sensitivity of construction on the dynamic impulse, two procedures exist to calculate wind load:

- Simplified procedure: applies to structures that are insensitive or moderately sensitive to dynamic impulse,
- Detailed procedure: applies to structures sensitive to dynamic impulse which have the value of the dynamic coefficient greater than 1.2.

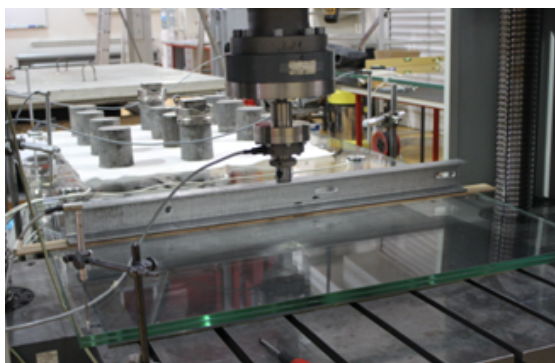

FIGURE 5. Load bearing capacity test.

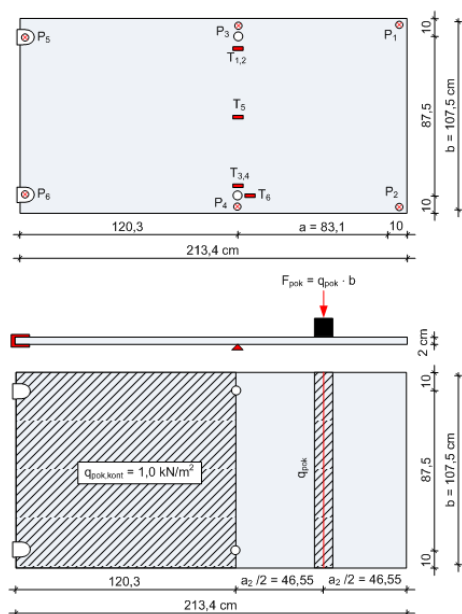

FIGURE 6. Positions of measurement points (up) and load distribution (down).

For the construction of the pedestrian bridge in Zagreb the simplified method is applied since the construction is not sensitive to dynamic impulse. Simplified calculation implies that the wind action is taken as a replacing static load. For the bridges, the wind pressure is calculated from the forces in all horizontal directions. To determine the wind load on the glass railing element according to *HRN EN 1991-1-4:2012/NA2012* the following parameters are required:

- basic wind speed: $v_b = 20$ m/s
- height above the ground: $h = 5$ m
- field category: IV.

The design value of the wind load determined by the project designer is 1 kN/m^2 .

3. LOAD BEARING CAPACITY TEST

The load bearing capacity of the element (in the scale 1:1) was tested on one sample until breakdown in the Structural Testing Laboratory operating at the

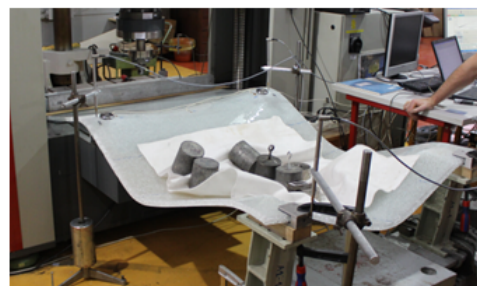

FIGURE 7. Breakdown of the glass railing element.

Faculty of Civil Engineering in Zagreb. The testing was conducted on the universal testing machine Zwick Z600. During the test, displacements and strains were measured using LVDT sensors (P) and strain gauges (T) as shown in Fig. 6 (up).

The sample was tested in the horizontal position and the wind load was simulated with two types of loading. The first type is a continuous load (1 kN/m^2) on the surface between the supports ($107.5 \times 120.3 \text{ cm}$) which was applied with 12 weights during the whole test. The second one is a linear load (q_{pok}) applied on the console part with the help of the previously mentioned machine Zwick Z600. The two types of loading can be seen on the Fig. 5.

The bending moment at the handlebar section provoked by the design value of wind load ($F=1 \text{ kN/m}^2$) on the surface of the console part of the glass element (Fig. 6) is calculated as follows:

$$M = F * \frac{a_2^2}{2} = 1 * \frac{0.931^2}{2} = 0.433 \text{ kNm/m}. \quad (1)$$

The linear load (q_{pok}) applied in the experiment must cause bending moment at the support (handlebar section) equivalent to the one caused by the assumed wind force calculated above:

$$M = q_{pok} * a_2/2, \quad (2)$$

$$q_{pok} = \frac{M}{a_2/2} = \frac{0.433}{0.466} = 0.93 \text{ kN/m}. \quad (3)$$

Knowing the required value of liner load (q_{pok}) concentrated force (F_{pok}) on the steel element is according to Fig. 6 (down):

$$F_{pok} = q_{pok} * b = 0.93 * 1.075 = 1.0 \text{ kN}. \quad (4)$$

In this way continuous load on the whole surface of the railing element that would be provoked by wind

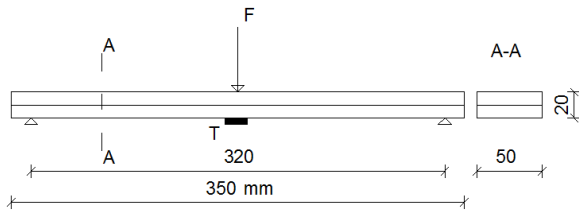

FIGURE 8. Bending test for glass canopy specimens [5].

| Sample | Strain [‰] | E [MPa] |
|--------|------------|---------|
| 1 | 0.60 | 38 833 |
| 2 | 0.58 | 40 167 |
| 3 | 0.56 | 41 607 |

TABLE 1. Results of the bending test at the glass canopy specimens [11].

is simulated. By using a machine to apply F_{pok} we were able to continually increase the force until the breakdown of the sample.

The linear load is applied by increments of 0.5 kN until the force value of 2.0 kN, after which it is applied continuously until breakdown. After each load stage, the element is unloaded to determine the existence of any permanent displacements and strains. When the force reached the value of 6.55 kN, breakdown started rapidly expanding through the sample (Fig. 7). The safety factor of the glass element can be calculated as the ration between failure load and design load.

$$SF = \frac{6.55 \text{ kN}}{1.00 \text{ kN}} = 6.55. \quad (5)$$

4. SIMULATION OF LOAD BEARING CAPACITY TEST IN SAP 2000

As well as the laboratory test, a numerical model was made in SAP 2000. A numerical modelling of laminated glass by finite element method is complex, mainly because of the very thin interlayer in comparison with other dimension and because of the large difference in modulus of elasticity of glass ply and interlayer material, especially for PVB [1]. The failure of a laminated glass sheet can be subdivided in five phases [5]:

- (1.) Elastic behavior of the glass plies.
- (2.) The first glass ply is broken, the other is still intact; the interlayer is not damaged.
- (3.) The second glass ply fails; the interlayer behaves elastically.
- (4.) The interlayer behaves plastically; the splinters are kept together by the interlayer.
- (5.) The interlayer fails by reaching its failure strength or by cutting from the splinters.

While phase (1.) can be modelled with analytical or numerical methods, phases (2.) to (5.) are more

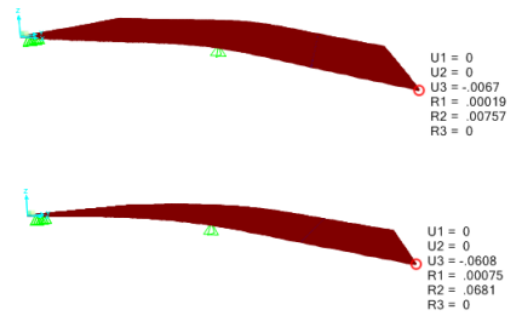
FIGURE 9. Numerical model in SAP2000 for $F_{pok} = 1.00 \text{ kN}$ (up) and $F_{pok} = 6.55 \text{ kN}$ (down). (U-displacement, R-rotation, 1-x axis, 2-y axis, 3-z axis)

complex to simulate. As shown in [5] several material models based on finite elements can be found in the literature to simulate the failure of the glass as well as of the interlayer. Models with one shell element through the thickness use layered materials with integration points over the thickness. In [6] a material model for the glass which allows a two dimensional failure is presented. A combination of two shells and one solid element through the thickness can be found in [7]. Authors [8], [9] and [10] present 3D models with solid elements which allow using a detailed material law for the interlayer.

The aim of the paper is just to compare displacement results in points most affected by wind, so it is concluded that a single thin plate model describes the behaviour of laminated glass for the current application well enough, and it is not expensive in terms of time and problem size. Since the test to determine mechanical properties was not performed for this specific railing element, modulus of elasticity was chosen based on the previously known test results. These results are obtained in the same laboratory during the test conducted for the construction of glass canopy [11]. For the glass canopy analysis a bending test was performed on three laminated tempered glass specimens consisting of two 10 mm thick tempered glass panes as shown in Fig 8. During the test, strains were measured using strain gauge in the middle of the sample. From the obtained data, modulus of elasticity was calculated using Hooke's law. Results of this testing are summarized in the Table 1, and since the railing element also consists of two 10 mm thick tempered glass panes, the chosen value of modulus of elasticity for this numerical model is $E = 40\,000 \text{ MPa}$. Supports are defined in reliance to Fig. 4 and they have prevented displacements in all three directions (x, y and z) while the rotation angle is free around all three axes [12].

The first numerical analysis was made for the load of 1 kN/m^2 on the surface between the supports and linear load q_{pok} corresponding $F_{pok} = 1.00 \text{ kN}$ as it is

| Loading | Experiment | SAP 2000 |
|-----------------------------|--------------|----------|
| Force | Displacement | U3 |
| $F_{pok} = 1.00 \text{ kN}$ | 8.00 mm | 6.70 mm |
| $F_{pok} = 6.55 \text{ kN}$ | 58.54 mm | 60.80 mm |

TABLE 2. Comparison of experimental and numerical displacement results.

shown in the Fig. 6 (down) and described earlier. The second numerical analysis was conducted in the same way for the maximum load at breakdown $F_{pok} = 6.55 \text{ kN}$ obtained during the experimental testing. Models and given results are shown in Fig. 9.

5. RESULTS

Results obtained by the load bearing capacity test are processed and shown in Force-Strain (Fig. 10) and Force-Displacement diagram (Fig. 11). From the Force-Strain diagram obtained during the experimental analysis, we can confirm that the glass behaved linearly elastic without any damages until breakdown. After all phases of loading, the residual strains were within the boundaries of 4% and the residual displacements within the limits of 10%.

Even though the displacements were measured during the test at 6 points (P1-P6), the most interesting points to compare obtained experimental and numerical results are points P1 and P2. In those points wind will cause the biggest displacement since they are the top points of the free console part (Fig. 6 (up)). In the numerical model there will be no difference between the displacement of the point P1 and P2 so the point P2 is chosen due to an easier display of numerical results. The comparison of the displacement results obtained by numerical and experimental analysis at the measurement point P2 is given in Table 2. In Fig. 8 displacement gained from numerical model is marked with U3.

From the table we can see that the obtained experimental and numerical results differ by less than 15%. As already discussed in the previous section, the simple single plate model is chosen. The thin plate model does not take into account a fact that laminated glass is three layer composite, instead the modulus of elasticity is defined for whole element. The test to determine the mechanical parameters was not performed, so the chosen value of modulus of elasticity based on the comparison of previously known test results can differ for two main reasons. The first reason is that even though the thickness of the glass panes was the same in both cases, different glass is used in manufacturing canopy and railing elements. Secondly, we do not know exactly what impact interlayer has on the modulus of elasticity of composed element.

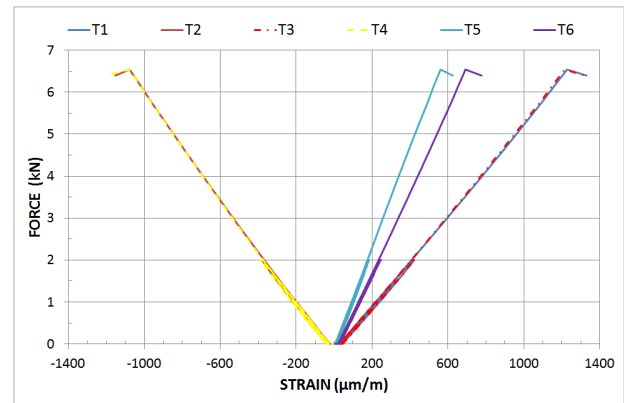

FIGURE 10. Force-Strain diagram.

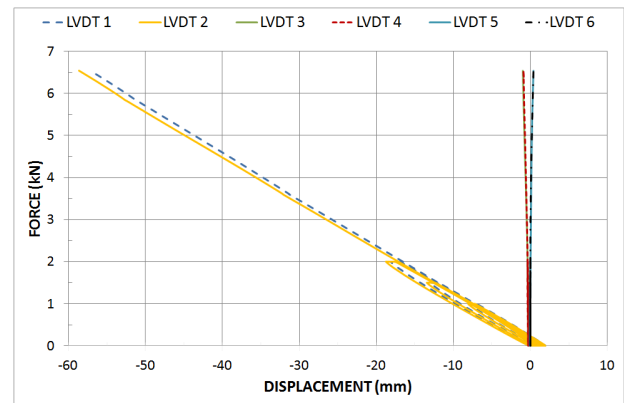

FIGURE 11. Force-Displacement diagram.

6. CONCLUSION

The combination of hard glass with a soft interlayer limits the use of laminated glass as structural load carrying element due to difficult behaviour prediction. Glass has a modulus of elasticity several thousand times larger than the interlayer material, which makes the behaviour and the modelling complex. With the simple single thin plate model used in this study, where modulus of elasticity for the whole laminated glass sheet was chosen based on the previous similar testing, gained results for displacement differ from experimental ones by less than 15%. The results show that for studies which include stress-failure models, taking into account the interaction behaviour of glass with interlayer is compulsory. It is also important to perform the test to determine mechanical parameters for each composed glass element because their accuracy can considerably influence the quality of the numerical model. In future studies it is necessary to observe the influence that thickness of interlayer has on the modulus of elasticity of laminated glass elements. The proper understanding of the interaction behaviour will enable wider usage of laminated glass as load carrying element.

The safety factor of tested railing element reached in regard to the design wind load is $k = 6.55$. The glass railing element can endure six times higher load than anticipated so we can conclude that there are high

reserves in the bearing capacity of tested glass element. Since the test was performed at the room temperature and PVB is highly temperature dependent material, by taking into account the weather conditions on the bridge we can expect the safety factor to be lower. Considering the behaviour of laminated glass during the test and results of experimental testing compared to numerical ones, glass railing element can be regarded as safe.

LIST OF SYMBOLS

| | |
|-----------|---|
| v_b | Basic wind speed [m/s] |
| F_{pok} | Concentrated force in the experiment [kN] |
| F | Design wind load [kNm/m ²] |
| h | Height above the ground [m] |
| q_{pok} | Linear load in the experiment [kN/m] |
| M | Moment on the handlebar section [kNm/m] |
| SF | Safety factor [/] |

REFERENCES

- [1] Akter S. T., Khani M. S. Characterisation of laminated glass for structural applications. Master thesis, 2013
- [2] "Saint Gobain". Updated Mar. 2015, Accessed 13 Apr. 2015. <http://uk.saint-gobain-glass.com>
- [3] Neugebauer J. Design of glass structures, Scientific Symposium: Future Trends in Civil Engineering, Zagreb, Croatia, 2014.
- [4] "Manual for design of Guardrails". Accessed 05 Jun. 2015. <http://www.allium.com/pdf/Manuel-en.pdf>
- [5] Larcher M., Solomos G., Casadei F., Gebbeken N. Experimental and numerical investigations of laminated glass subjected to blast loading. *International Journal of Impact Engineering* 2012; 39:42-5
DOI:10.1016/j.ijimpeng.2011.09.006
- [6] Müller R., Wagner M. Berechnung sprengwirkungshemmender Fenster - und Fassadenkonstruktionen. *Bauingenieur* 2008;81(11):475-87
- [7] Sun D., Andrieux F., Ockewitz A., Klamser H., Hogenmüller J. Modelling of the failure behaviour of windscreens and component tests. 5th European LSDYNA Users Conference, 25-26 May, 2005.
- [8] Morison C., Zobec M., Franceschet A. The measurement of PVB properties at high strain rates, and their application in the design of laminated glass under bomb blast. ISIEMS 2007, International symposium on interaction of the effects of munitions with structures, 17-21 September, Orlando, US, 2007.
- [9] Bennison S.J., Jagota A., Smith C.A. Fracture of glass/poly(vinyl butyral)(butacite)laminates in biaxial flexure. *Journal of the American Ceramic Society* 1999; 82(7):1761-70.
- [10] Duser A.V., Jagota A., Bennison S.J. Analysis of glass/polyvinyl butral laminates subjected to uniform pressure. *Journal of Engineering Mechanics* 1999; 125(4):435-42.
DOI:10.1061/(ASCE)0733-9399(1999)125:4(435)
- [11] Rak M., Damjanović D., Krolo J.: Report on testing the glass beam, University of Zagreb, Faculty of CE., 2013.
- [12] "SAP 2000" 16 Eval, Computers and Structures, Inc., 2013.