

# Dynamic Bridge Response for a Bridge-friendly Truck

V. Šmilauer, J. Máca, M. Valášek

A truck with controlled semi-active suspensions traversing a bridge is examined for benefits to the bridge structure. The original concept of a road-friendly truck was extended to a bridge-friendly vehicle, using the same optimization tools. A half-car model with two independently driven axles is coupled with simply supported bridges (beam, slab model) with the span range from 5 m to 50 m. Surface profile of the bridge deck is either stochastic or in the shape of a bump or a pot in the mid-span. Numerical integration in the MATLAB/SIMULINK environment solves coupled dynamic equations of motion with optimized truck suspensions. The rear axle generates the prevailing load and to a great extent determines the bridge response. A significant decrease in contact road-tire forces is observed and the mid-span bridge deflections are on average smaller, when compared to commercial passive suspensions.

**Keywords:** half-car model, semi-active suspension, bridge-friendly truck, bridge response, dynamics.

## 1 Introduction

One of the most important factors determining road design is the intensity of heavy trucks which is often higher than originally assumed by the designers. According to the traffic prognosis for Europe and the USA, there is an annual increase in such vehicles, and new trucks with multiple axles or trailers appear. There are additional costs for road repair and maintenance.

Unevenness on the road surface generates, aside from static, a dynamic contact force which can be controlled and reduced possibly. While direct reduction of bridge deflections was found to be complicated, e.g. tuned mass dampers or intelligent stiffeners [1], new trends in suspension development follow the concept of semi-active suspensions, directly on the vehicle axles. The driving force that controls the damping properties of a suspension is negligible when compared to the active damper force, while semi-active suspensions offer a good compromise between performance and price. A mechatronic solution combined with a controlled damper provides the a tool for its optimization and for reducing the dynamic contact force. The concept of road-friendliness has been extended to bridge-friendliness by optimizing the damper parameters on bridges [2, 3, 4]. The

aim of this work is to explore the benefits of bridge-friendly trucks on ordinary, simply supported bridges.

The results from previous studies with a quarter-car model were so promising that a more accurate model with a half-car and a slab bridge was assembled [3]. A similar model was produced for a simply supported bridge with a specific road profile, traversed by a quarter-car model with a passive, sky-hook and ground-hook control configuration. The effect of a semi-controlled damper on the bridge response is significant for close natural frequencies of the vehicle and the bridge [5].

## 2 The half-car model

The proposed half-car model is based on the parameters of the commercially available LIAZ truck, simplified to four DOF [6]. Fig. 1 displays the configuration of the truck together with a bridge. The front axle comprises two axles of a real car, and the rear axle comprises the four axles. The model parameters were set to:  $m_1 = 15$  t,  $m_2 = 0.75$  t,  $m_3 = 1.5$  t,  $a = 4$  m,  $b = 1.3$  m,  $k_{12} = 430$  kN/m,  $k_{13} = 650$  kN/m,  $k_{20} = 1700$  kN/m,  $k_{30} = 4900$  kN/m,  $I_\omega = 50$   $\text{tm}^2$ , and the damping factors of the tires were set to zero. Damper forces  $F_{d12}$  and  $F_{d13}$  result from the movement

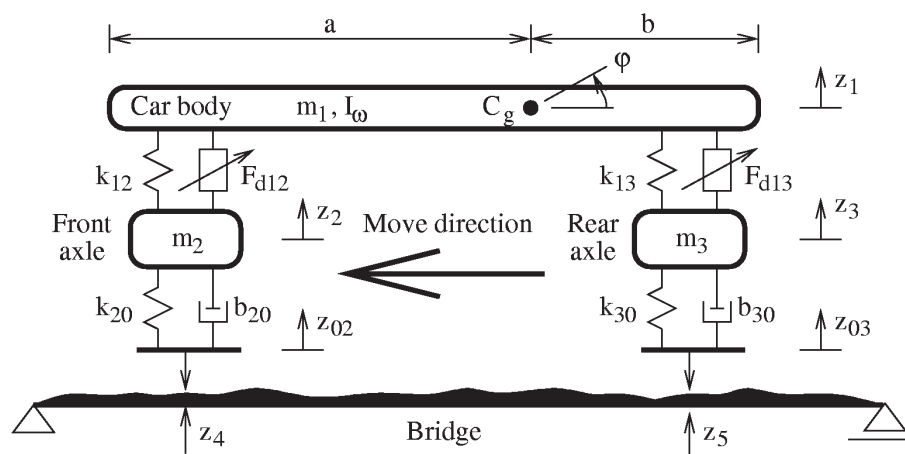

Fig. 1: Nonlinear half-car model traversing the bridge

of the damper attachment, and they depend on an operative algorithm, as will be explained further. All springs in the car model are considered to be linear without hysteresis.

The road profile superimposed on the bridge deck deflection determines the position of the tire contact area. The equations of motion describing car the dynamic behavior and the damper force are as follows:

$$m_1 \ddot{z}_1 = -k_{12}(z_1 - z_2 - a\varphi) - 2F_{d12} - k_{13}(z_1 - z_3 + b\varphi) - 4F_{d13}, \quad (1)$$

$$I_{01} \ddot{\varphi}_1 = ak_{12}(z_1 - z_2 - a\varphi) + 2aF_{d12} - bk_{13}(z_1 - z_3 - b\varphi) - 4bF_{d13}, \quad (2)$$

$$m_2 \ddot{z}_2 = k_{12}(z_1 - z_2 - a\varphi) + 2F_{d12} - k_{20}(z_2 - z_{02}(t)) - b_{20}(\ddot{z}_2 - \ddot{z}_{02}(t)), \quad (3)$$

$$m_3 \ddot{z}_3 = k_{13}(z_1 - z_3 - b\varphi) + 4F_{d13} - k_{30}(z_3 - z_{03}(t)) - b_{30}(\ddot{z}_3 - \ddot{z}_{03}(t)), \quad (4)$$

$$F_{d12} = b_{f1}(\dot{z}_2 - \dot{z}_{02}) - b_{f2}(\dot{z}_1 - \dot{\varphi}a) - b_{f12}(\dot{z}_1 - \dot{\varphi}a - \dot{z}_2) + \Delta k_{f10}(z_2 - z_{02}) - \Delta k_{f12}(z_1 - \varphi a - z_2), \quad (5)$$

$$F_{d13} = b_{r1}(\dot{z}_3 - \dot{z}_{03}) - b_{r2}(\dot{z}_1 + \dot{\varphi}b) - b_{r12}(\dot{z}_1 + \dot{\varphi}b - \dot{z}_3) + \Delta k_{r10}(z_3 - z_{03}) - \Delta k_{r12}(z_1 + \varphi b - z_3), \quad (6)$$

$$z_{02}(t) = z_4 + z_r, \quad (7)$$

$$z_{03}(t) = z_5 + z_r, \quad (8)$$

where  $z_4, z_5$  are the bridge displacements and  $z_r$  is a road irregularity. This extended ground-hook model consists of three damping rates, where  $b_{f(r)1}$  and  $b_{f(r)2}$  corresponds to the damping factor of the ground hook and sky-hook respectively, and the passive damper corresponds to the damping factor  $b_{f(r)1}$ . The semi-active damper forces  $F_{d12}$  and  $F_{d13}$  are changed with the setting of the damping rate  $b_{f(r)1}$ ,  $b_{f(r)2}$  and  $b_{f(r)12}$  in such a manner that the damping force approaches the desired value. The typical 17 ms delay response of the damper is further considered. Four values can be assigned to each damping factor, depending on the velocity and direction of the damper attachment [6]. The numerical experiments proved small dependence on the fictitious change in stiffness  $\Delta k_{f(r)10}$  and  $\Delta k_{f(r)12}$ , therefore only damping factors are employed in the optimization process. During optimization,  $4 \cdot 3 = 12$  free damping parameters are involved for each axle. Since the half-car model holds two independently controlled dampers, 24 free parameters in total are optimized, using genetic algorithms [4]. The multi objective parameter optimization method (MOPO) within the MATLAB/SIMULINK environment was found appropriate for such a large task [4]. The first part of the objective function for optimization on both axles took the form of the square root of the time integral of the dynamic contact force:

$$RF_{SUM,RMS} = \sqrt{\int_0^t F_{1,2,dyn}^2 dt}. \quad (9)$$

The second performance criterion considered driver comfort in the form of truck sprung mass acceleration:

$$ACC_{SUM} = \sqrt{\int_0^t (\ddot{z}_1 - \ddot{\varphi}a)^2 dt}. \quad (10)$$

The truck moved at a velocity of 50 km/h during all simulations, and passive or bridge-friendly damper control was adopted for the purposes of comparison. The unevenness amplitudes of the road profile were set to 20 mm for a bump or a pot in the mid-span, or for a stochastic road, Fig. 2.

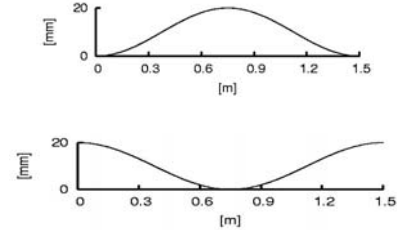

Fig. 2: Bump and pot used for damper response on the bridges

### 3 The bridge model

The bridge is modeled as a simply supported Euler-Bernoulli beam or as a slab bridge for shorter spans, in order to include the bridge torsional effect. The bridge span varies from 5 to 50 m, covering the majority of real bridges made from concrete or steel with such a statical system [7]:

- reinforced concrete bridges – span of 5 to 12 m
- prestressed concrete bridges – span of 12 to 30 m
- composite steel-concrete bridges – span of 15 to 50 m

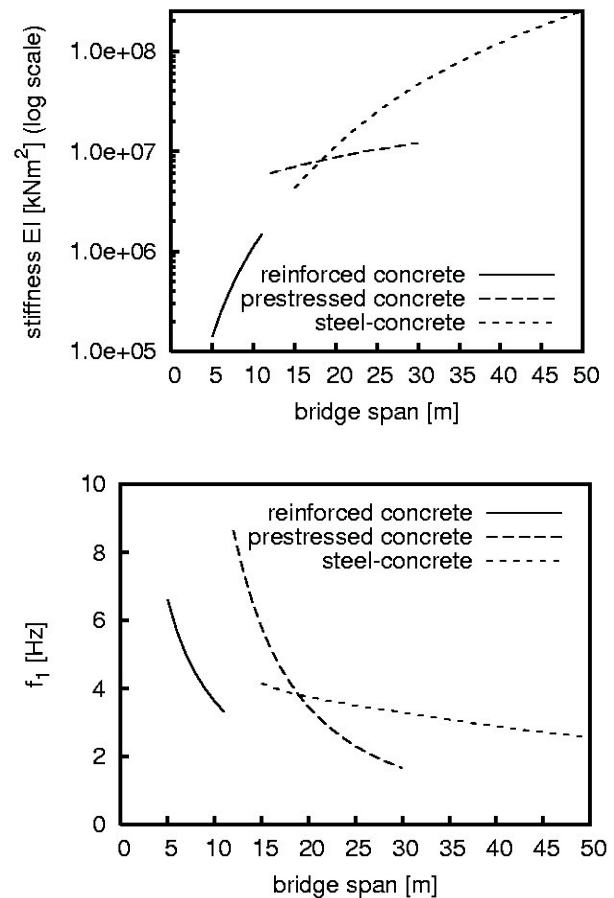

Fig. 3: Bending stiffness and the first eigenfrequency of bridges (5–50) m

Each bridge consists of two road lanes and two sidewalks, and the preliminary design calculations provide bridge parameters for the simulation [7, 8]. The bending stiffness and the first eigenfrequency for all considered bridges are given in Fig. 3. The first truck eigenvalue is 9.3 Hz.

It is assumed that the vehicle passes over the beam bridge on the symmetry axis and on the slab bridge as close as possible to the sidewalks, Fig. 5. FEM with equally spaced nodes in combination with the bridge parameters provides the equation of motion in the form:

$$\mathbf{M}\ddot{\mathbf{r}} + \mathbf{B}\dot{\mathbf{r}} + \mathbf{K}\mathbf{r} = \mathbf{F}, \tag{11}$$

where  $\mathbf{M}$ ,  $\mathbf{B}$ ,  $\mathbf{K}$ ,  $\mathbf{r}$ ,  $\mathbf{F}$  are the mass, damping, stiffness matrices, the displacement vector and the vector of contact axle forces. Rayleigh damping with a logarithmic decrement of 0.05 was used for all bridges for the damping matrix assemblage. Two contact forces from the truck axles are linearly distributed between adjacent nodes to vector  $\mathbf{F}$ :

$$F_{1dyn} = k_{20}(z_2 - z_{02}), \tag{12}$$

$$F_{2dyn} = k_{30}(z_3 - z_{03}). \tag{13}$$

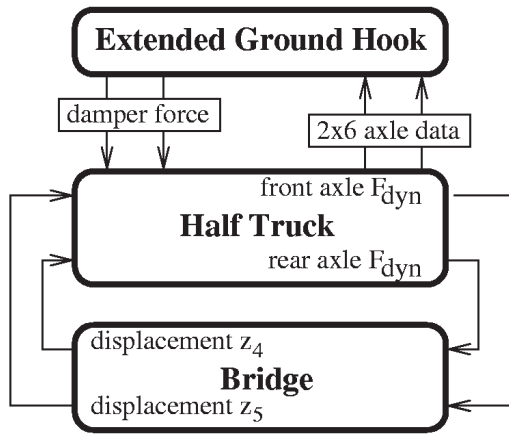

Fig. 4: Interconnection of truck and bridge model

The connection links between the bridge and the car model are the bridge deflections below the axle and the contact force between the tire and the road, Fig. 4.

The equations of motion (1)–(8) and (11) are simultaneously solved in the MATLAB/SIMULINK environment with an implicit trapezoidal integration scheme, using a variable time step. Fig. 6 displays the SIMULINK scheme of the bridge model as an example. The lowest critical speed of the vehicle is over 220 km/h and the first natural frequency is higher than all first bridge frequencies considered. No frequency-matching phenomenon is observed during the simulations.

### 4 Dynamic contact force

Dynamic contact force is a variable part of the total contact force between the tire and the road, with the positive direction upward. The slab bridge model, Fig. 5, as a short bridge with the same parameters as the beam model was proposed and verified. In all such cases, the bump is placed in the mid-span of a beam or slab bridge. Fig. 7 shows similar behavior of both bridges with a different damper control strategy. Even when compared to a road on a solid base, only the damper control mode plays a significant role in reducing the dynamic contact force.

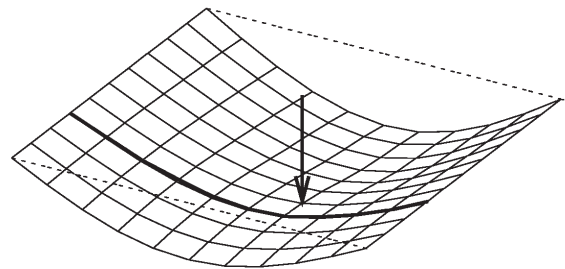

Fig. 5: Slab bridge model with 10 m span and the traversing axle path

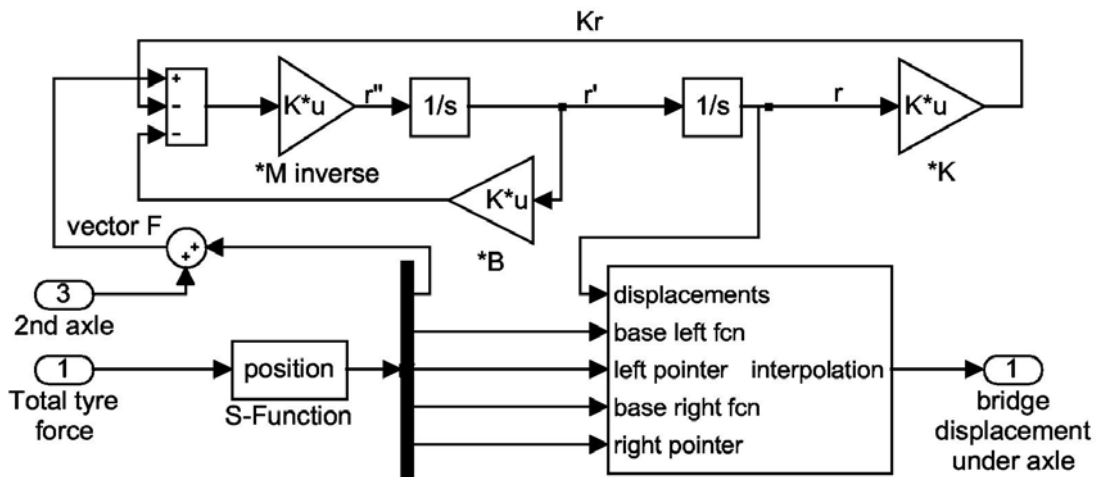

Fig. 6: The SIMULINK scheme of the bridge model

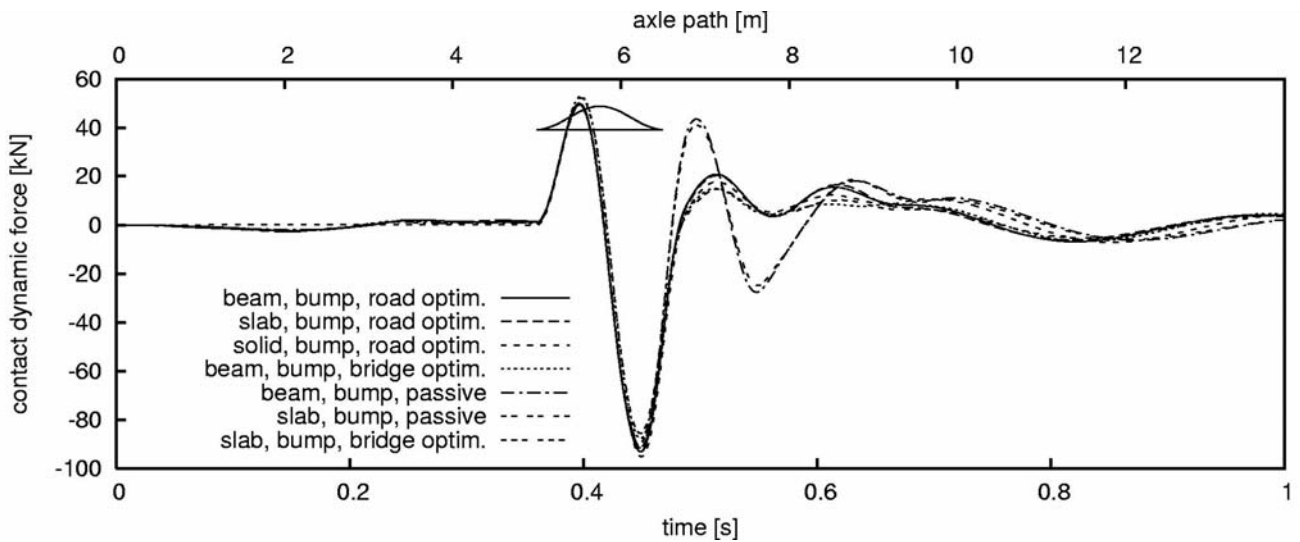

Fig. 7: Comparison of semi-active and passive damper performance on the bridge type across a bump: the bridge span is 10 m

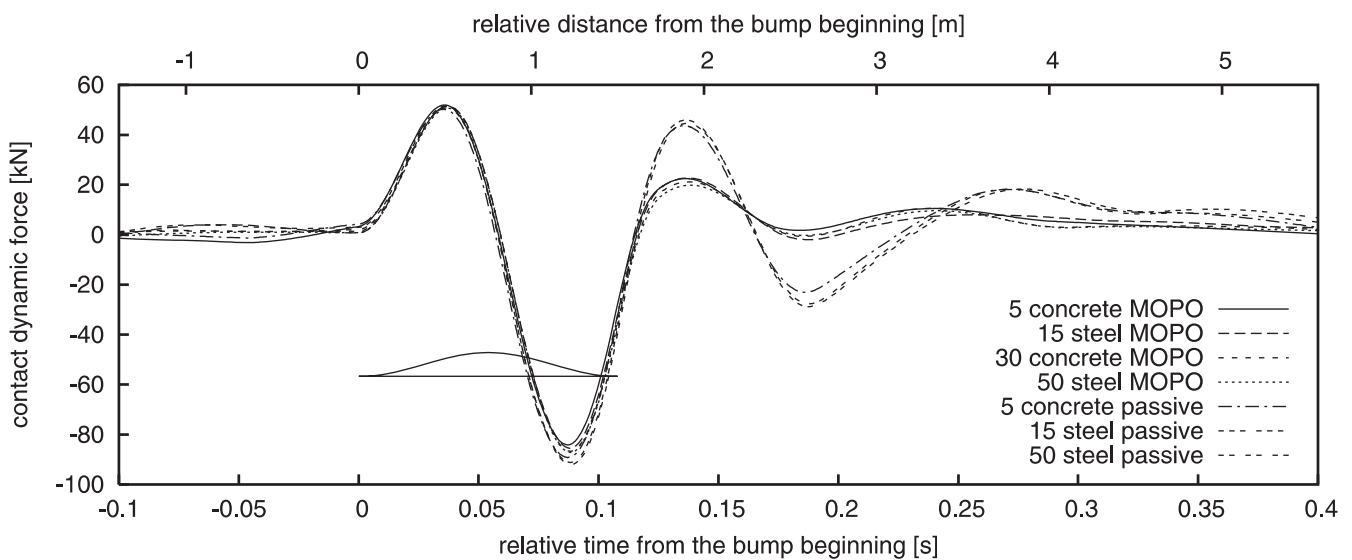

Fig. 8: Contact dynamic force of the rear axle across a bump on bridges (5-50) m

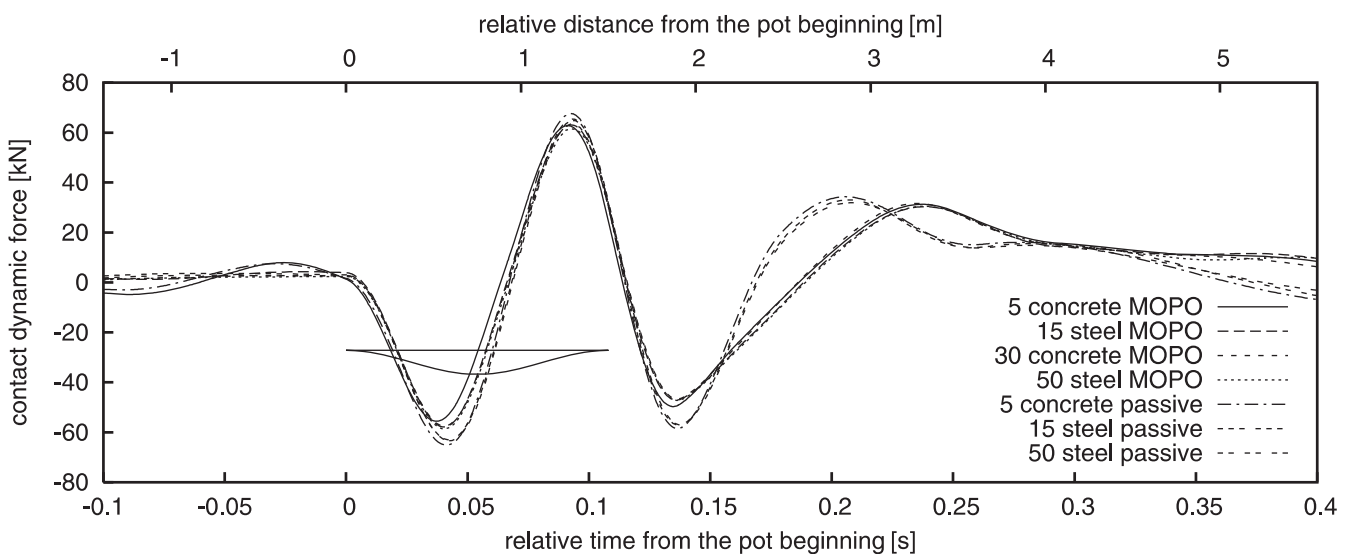

Fig. 9: Contact dynamic force of the rear axle across a pot on bridges (5-50) m

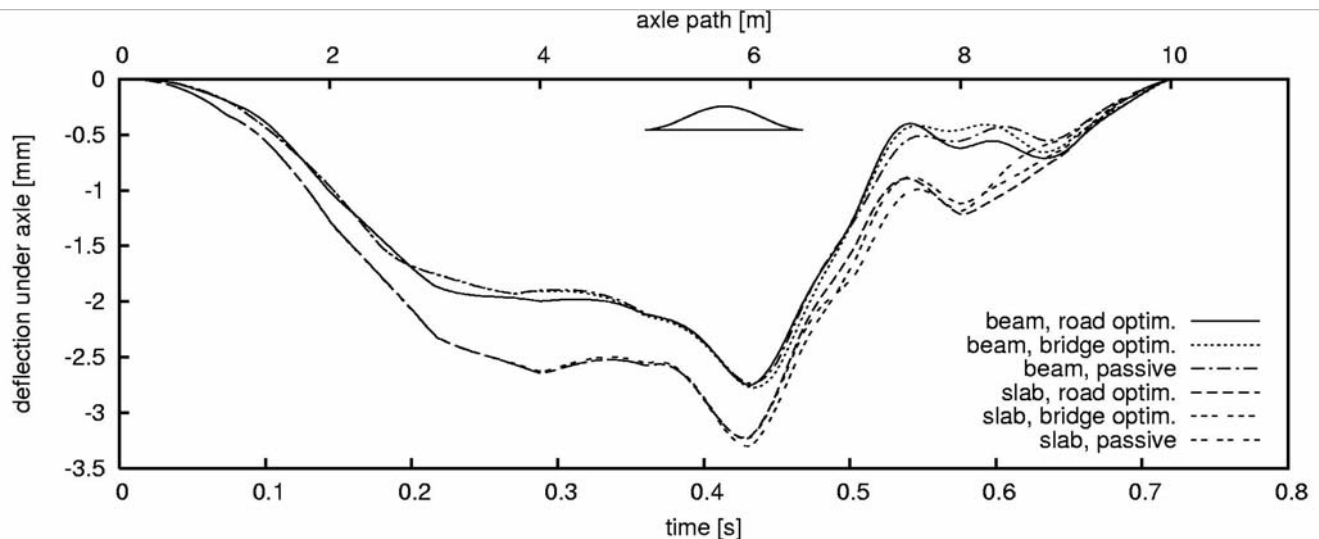

Fig. 10: Deflections of the beam and slab bridge under one axle of 10 m span

For the half-car model, the results for the rear axle are in Figs. 8 and 9 for the bump and the pot. The change of dynamic contact force is evident shortly after unevenness passing, reducing force value in the next peak. Again, the bridge parameters have minor effect on the truck response.

It is evident that damper functionality for the pot is not as much effective as for the bump. The reason lies in low damping values when the damper is under contraction. Nevertheless, the phase of dynamic contact force is shifted and its value slightly reduced as well in the case of MOPO control strategy [8]. The front axle carries about a third of the total static truck load and an effect of damper is lower than it is for the rear axle.

## 5 Bridge deflections

Bridge deflections express the effect of the truck on the bridge structure itself. The difference for beam and slab bridge response reveals the qualitative behavior of these two models. The torsional effect is taken into account for the slab

bridge, hence higher deflection values are expected. Fig. 10 shows similar behavior of both bridge systems, and approx. 15 % difference in bridge deflection is observed. The beam bridge model is found to be sufficient even for a bridge of nearly square shape desk.

Short and long bridges are compared as an example of bridge excitation, using the same truck. The majority of the car weight is located in the rear axle, and the reading on the graph is therefore from this axle. Short bridges are mainly influenced by the shape of the unevenness, Fig. 11. There are two reasons for their excitation: the truck load prevails on short bridges because of the available space and the bridge stiffness, and also because its mass is low. No significant force impulse would appear for a stochastic road, and the deflections are then close to the static values.

An overall response of 5 m–50 m spans is illustrated in Fig. 12, depending on the damper control strategy. An average semi-active dampers reduce maximum deflections on a stochastic road by 2.5 %, and on bump unevenness by 3.6 %.

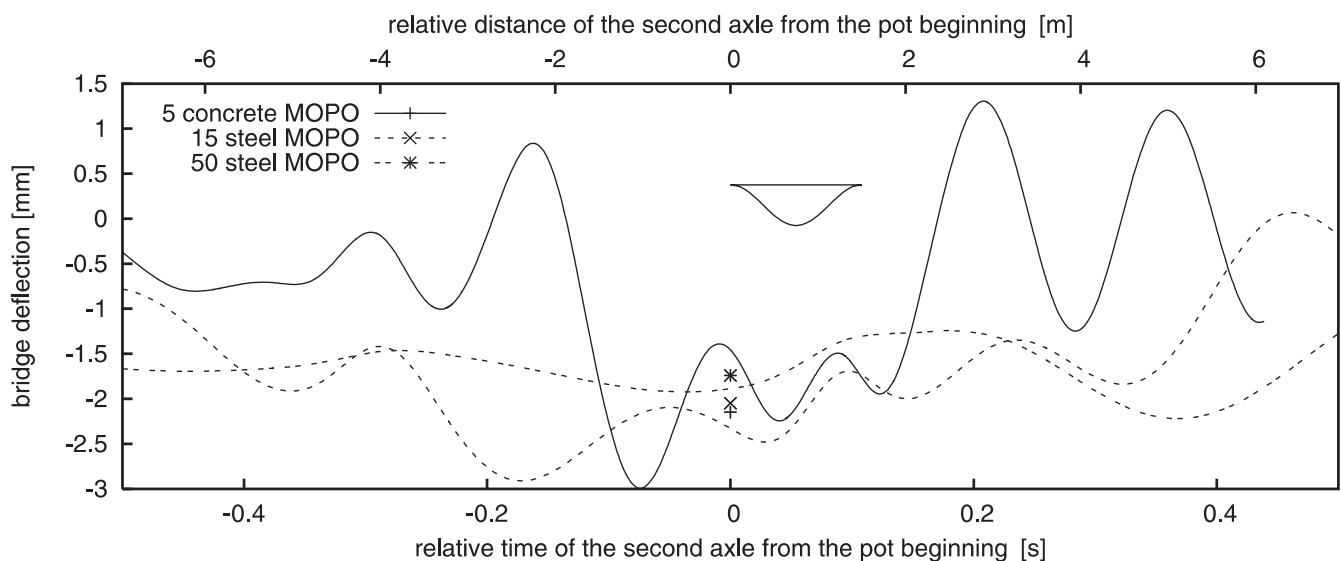

Fig. 11: Mid-span bridge deflections with spans 5 m - 50 m and a comparison with static displacements

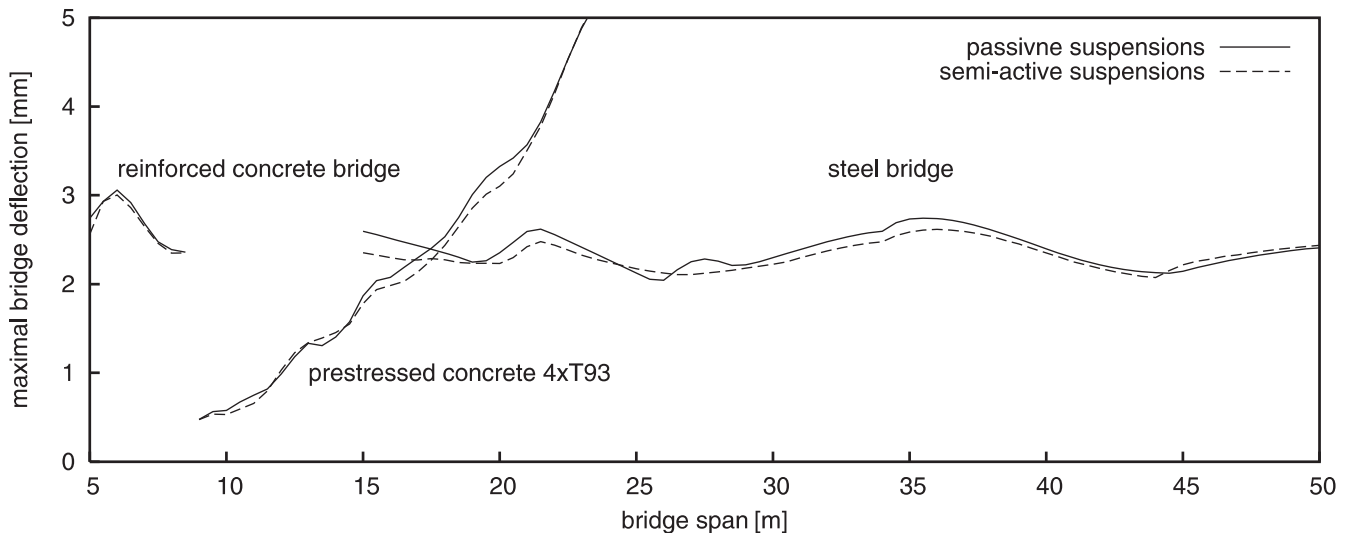

Fig. 12: Maximum bridge deflection on a stochastic road on (5 m–50) m spans for various bridges and two control strategies

## 6 Conclusions

The paper describes the effect of a bridge-friendly truck on a road and bridge structures, and proves that the concept of road-friendliness can be extended to bridges. A semi-active optimized damper, when compared to a passive damper, reduces the local contact force in all cases and shifts the contact force peaks after passing the unevenness. Bridge-friendly truck dampers are beneficial for decreasing road damage, mainly the rear axle, which bears the prevailing truck load. The dynamic contact force is influenced mainly by the shape of unevenness and the control strategy of the damper. The bridge span plays a minor role in this case.

A beam bridge for a span of 10 m captures the qualitative behavior of the truck well when compared to the more sophisticated slab bridge. The average reduction of deflections on bridge spans of 5 m–50 m using semi-active suspensions is found to be an average of 2.5 % lower for a stochastic road, and 3.6 % for a bump, respectively, in comparison with passive dampers.

## 7 Acknowledgments

The authors gratefully acknowledge support for this work from the Ministry of Education, Youth and Sports as a part of grant MSM 210000003.

## References

- [1] Kwon H. C., Kim M. C., Lee I. W.: "Vibration Control of Bridges under Moving Loads." *Computers & Structures*, Vol. 66 (1998), p. 473–480.
- [2] Valášek M., Kejval J.: "New Direct Synthesis of Nonlinear Optimal Control of Semi-Active Suspensions." Proc. of AVEC 2000, Ann Arbor, 2000, p. 691–697.
- [3] Máca J., Valášek M.: "Dynamic interaction of trucks and bridges." *Advanced Engineering Design*, 3<sup>rd</sup> International Conference, Prague, 2003.
- [4] Valášek M., Kejval J., Máca J.: "Control of truck-suspension as bridge-friendly," In: *Structural Dynamics*

*Eurodyn 2002*. (Editors: H. Grundmann and G. I. Schueller), Munich, Balkema, 2002, p. 1015–1020.

- [5] Chen Y. et al.: "Smart Suspension Systems for Bridge-Friendly Vehicles." Paper 4696-06. Proc. of 9<sup>th</sup> SPIE Annual International Symposium on Smart Structures and Materials, San Diego, 2002.
- [6] Valášek M., Kejval J.: "Bridge-friendly Truck Suspension," In: *Proc. of Mechatronics, Robotics and Biomechanics*, VUT Brno, Trest, 2001, 277–284.
- [7] Šmilauer V., Máca J.: "Dynamic Interaction of Bridge and Truck with Semi-active Suspension." *Engineering Mechanics 2003*, Svatka, Czech Republic, 2003.
- [8] Šmilauer V., Máca J., Valášek M.: "Dynamic Bridge Response for a Truck with Controlled Suspensions." *Engineering Mechanics 2004*, Svatka, Czech Republic, 2004.

Ing. Vít Šmilauer  
e-mail: vit.smilauer@fsv.cvut.cz

Doc. Ing. Jiří Máca, CSc.  
phone: +420 224 354 500  
e-mail: maca@fsv.cvut.cz

Department of Structural Mechanics  
Czech Technical University in Prague  
Faculty of Civil Engineering  
Thákurova 7  
166 29 Prague 6, Czech Republic

Prof. Ing. Michael Valášek, DrSc.  
phone: +420 224 357 361  
fax: +420 224 916 709  
e-mail: valasek@fsik.cvut.cz

Department of Mechanics  
Czech Technical University in Prague  
Faculty of Mechanical Engineering  
Karlovo nám. 13  
121 35 Prague 2, Czech Republic