

## A new species of tapir from the Amazon

MARIO A. COZZUOL,\* CAMILA L. CLOZATO, ELIZETE C. HOLANDA, FLÁVIO H. G. RODRIGUES, SAMUEL NIENOW, BENOIT DE THOISY, RODRIGO A. F. REDONDO, AND FABRÍCIO R. SANTOS\*

Universidade Federal de Minas Gerais, Avenida Antonio Carlos 6627, Belo Horizonte, Minas Gerais, Brazil (MAC, CLC, FHGR, RAFR, FRS)

Universidade Federal do Rio Grande do Sul and Fundação Zoobotânica do Rio Grande do Sul, R. Dr. Salvador França, 1427, Porto Alegre, Rio Grande do Sul, Brazil (ECH)

Instituto Pró-Carnívoros, Avenida Horácio Neto, 1030, Atibaia, São Paulo, Brazil (FHGR)

Instituto Chico Mendes de Biodiversidade, Avenida Dr. Mendonça Lima 481, Guajará-Mirim, Rondônia, Brazil (SN)

Kwata NGO & Institut Pasteur de la Guyane, 23 Avenue Pasteur, Cayenne, French Guiana (BdeT)

Institute of Science and Technology, Am Campus 1, 3400, Klosterneuburg, Austria (RAFR)

\* Correspondents: [cozzuol@icb.ufmg.br](mailto:cozzuol@icb.ufmg.br), [fsantos@icb.ufmg.br](mailto:fsantos@icb.ufmg.br)

All known species of extant tapirs are allopatric: 1 in southeastern Asia and 3 in Central and South America. The fossil record for tapirs, however, is much wider in geographical range, including Europe, Asia, and North and South America, going back to the late Oligocene, making the present distribution a relict of the original one. We here describe a new species of living *Tapirus* from the Amazon rain forest, the 1st since *T. bairdii* Gill, 1865, and the 1st new Perissodactyla in more than 100 years, from both morphological and molecular characters. It is shorter in stature than *T. terrestris* (Linnaeus, 1758) and has distinctive skull morphology, and it is basal to the clade formed by *T. terrestris* and *T. pinchaque* (Roulin, 1829). This highlights the unrecognized biodiversity in western Amazonia, where the biota faces increasing threats. Local peoples have long recognized our new species, suggesting a key role for traditional knowledge in understanding the biodiversity of the region.

Key words: Amazon, biodiversity, cladistics, genetics, morphometry, new species, *Tapirus*

© 2013 American Society of Mammalogists

DOI: 10.1644/12-MAMM-A-169.1

The known living tapirs inhabit southeastern Asia, Central America, and South America (Nowak 1997). Extant tapir diversity and distribution are relicts of a richer group of species and larger distribution range attained during the Pleistocene (Simpson 1945; Nowak 1997; Hulbert 1999; Holanda et al. 2011). Despite some controversies (Hershkovitz 1954), the 4 living and many fossil species from Eurasia and the Americas are all placed in the genus *Tapirus* (Simpson 1945; Hershkovitz 1954; Yingjun and Gaunfu 1987; Hulbert 1999; Spassov and Ginsburg 1999; Holanda and Cozzuol 2006; Ferrero and Noriega 2007; Holanda et al. 2011). Tapirs reached South America during the Great American Biotic Interchange, where they survived the late Pleistocene extinction, as the largest living terrestrial mammal on the continent (Woodburne 2010). All extant species are currently considered to be vulnerable or endangered, by overhunting and habitat destruction (International Union for the Conservation of Nature and Natural Resources 2009). As seed predators and dispersers, they have key roles in the dynamics of rain forests, Cerrado, Pantanal, and high mountain ecosystems (Olmos 1997). They

are preferred food for local human populations and are actors in the traditional beliefs of Amerindian communities (Nowak 1997; International Union for the Conservation of Nature and Natural Resources 2009).

Here we describe a 5th living species of *Tapirus*, the 4th in the Neotropics, the 1st since *T. bairdii* Gill, 1865, one of the largest land mammals recently described, and the only new Perissodactyla in more than 100 years (Ceballos and Ehrlrich 2009). Despite popular accounts of the occurrence of more than 1 tapir species in lowland Amazonia, it was assumed that observed diversity of both morphological (Hershkovitz 1954) and molecular (de Thoisy et al. 2010) characters represented variations of *T. terrestris* (Linnaeus, 1758). We present here detailed morphological and molecular (mitochondrial DNA [mtDNA]) comparisons of specimens from western Brazilian Amazon with all other *Tapirus* species, which indicate the



presence of this new taxon. Our study includes the largest geographic sampling of *T. terrestris* so far attempted.

## MATERIALS AND METHODS

**Samples.**—Skull samples and measures were obtained from specimens in museum collections, those collected in the field, or animals provided by indigenous hunters. Skull and tissue samples obtained from collected specimens in Brazil were approved by Ministério do Meio Ambiente, Sistema de Autorização e Informação em Biodiversidade—SISBIO (number: 21055-2; issue date: 11 December 2009). No permit was required for field sampling carried out in French Guiana. A sample of *Tapirus indicus*, Desmarest, 1819, was provided by the San Diego Zoo, San Diego, California. Sequence data for other specimens and species from different countries were retrieved from GenBank (Benson et al. 2005), or published elsewhere (de Thoisy et al. 2010).

**Morphological studies.**—Canonical variate analysis (multivariate analysis of variance [MANOVA]–canonical variate analysis [CVA]) of 22 cranial measurements (Supporting Information S1, DOI: 10.1644/12-MAMM-A-169.S1) was performed with the software PAST version 2.14 (Hammer et al. 2001), using the Hotelling's Bonferroni-corrected option to test the discrimination of each of the species. Data were available for all living species: *T. terrestris*:  $n = 52$ , *T. indicus*:  $n = 3$ , *T. bairdii*:  $n = 4$ , *T. pinchaque* (Roulin, 1829):  $n = 3$ , *Tapirus* sp. nov.:  $n = 8$  (for a list of the specimens see Supporting Information S2, DOI: 10.1644/12-MAMM-A-169.S2). Some fossil species were included, which represent all of the South American and several North American taxa known from skulls complete enough to take most, if not all, the measurements used. Although some skulls of *Tapirus* sp. nov. collected by the Karitiana Indians were partially damaged, so some measurements are missing, they were included in some of the analyses. Qualitative comparison of discrete characters was derived from available specimens, museum collections, and the literature. A figure including the measurements, their descriptions, and a list of specimens used in the analyses are provided in Supporting Information S1 and S2.

Morphological cladistic analysis was performed using TNT version 1.1 (Goloboff et al. 2008) to infer phylogenetic relationships of the tapirs using parsimony with the script aquickie.run, provided with the TNT package. The matrix (see Supporting Information S3, DOI: 10.1644/12-MAMM-A-169.S3) included 15 taxa and 60 cranial, dental, and postcranial characters, modified from Hulbert and Wallace (2005), with characters treated as unordered (the character list is shown in Supporting Information S4, DOI: 10.1644/12-MAMM-A-169.S4). The in-group included all known living species and 6 fossil *Tapirus* from the Miocene to the Pleistocene of North and South America. Out-groups included the extinct genera *Plesiotapirus* and *Paratapirus*, following previous propositions (Hulbert 1999).

**Molecular phylogenetic analyses.**—The following total sample numbers, or sequences, or both, were included in the analyses: *T. terrestris*:  $n = 52$ , *T. bairdii*:  $n = 3$ , *T. pinchaque*:  $n = 5$ , *T. indicus*:  $n = 4$ , *Tapirus* sp. nov.:  $n = 4$ . *Equus caballus* or Rhinocerotidae, or both, were used as out-groups.

The DNA sequences from 3 mtDNA genes (cytochrome *b* [*Cytb*], cytochrome oxidase I [COI], and cytochrome oxidase II [COII]) from living *Tapirus* species were generated and compared to previously published data (Ashley et al. 1996; Norman and Ashley 2000; de Thoisy et al. 2010). We included a thorough analysis of the *Cytb* in a large geographic sampling in South America, such as has been shown to be useful in recovering mammalian phylogeny and exposing cryptic species (Baker and Bradley 2006; Redondo et al. 2008). Sequence alignments were performed using Clustal W 2.1 (Larkin et al. 2007) and edited or concatenated, or both, when necessary with the Alignment Explorer function implemented in MEGA 5.1 (Tamura et al. 2011). The resulting alignments were used in phylogenetic reconstructions by 2 methods. First, a maximum-likelihood search was performed in PhyML 3.0.1 (Guindon et al. 2010) using the GTR+ $\Gamma$ +inv model with parameters estimated from the data by the maximum-likelihood approach. The initial tree was a BioNJ tree and the search was performed using both NNI and SPR rearrangements in each iteration keeping only the tree with best likelihood score. After a full PhyML search on tree topology and parameters, the maximum-likelihood tree was used again as an initial tree for a new run and the search was repeated until no significant gain in likelihood was observed in a likelihood-ratio test. The confidence in the clades was assessed through the approximate likelihood-ratio (aLRT) test (Anisimova and Gascuel 2006; Anisimova et al. 2011). Second, we used a Bayesian inference method with MrBayes 3.2.1 (Ronquist et al. 2011) using a GTR+ $\Gamma$ +inv model of nucleotide evolution and assuming flat Dirichlet priors for parameter estimates and unconstrained branch lengths. The search was carried out using 2 independent runs of 4 Markov chains (1 cold and 3 heated) for  $3 \times 10^6$  generations, sampling every 300 generations with a burn-in of 25% of the samples for the estimates of topology and parameters. Stationarity of the chains was checked by plotting parameters against generation in Tracer 1.5 (Rambaut and Drummond 2007).

We also carried out phylogenetic reconstructions based on maximum-parsimony criteria for the *Cytb* data set using the software TNT. Additionally, we used the algorithm Median-Joining (Bandelt et al. 1999), as implemented in the software Network 4.6 (Fluxus Technology Ltd., Suffolk, England), to build a *Cytb* haplotype network to infer all the most-parsimonious relationships among haplotypes, which allowed the inclusion of multiple allele states and observation of homoplastic reticulations.

**Divergence times.**—Two methods were used to estimate divergence times among the *Tapirus* lineages. In the 1st, we used the Linetree method of Takezaki–Rzhetsky–Nei (Tamura et al. 2007), which assumes a strict molecular clock. We assumed an evolutionary substitution rate of 2.5% per million

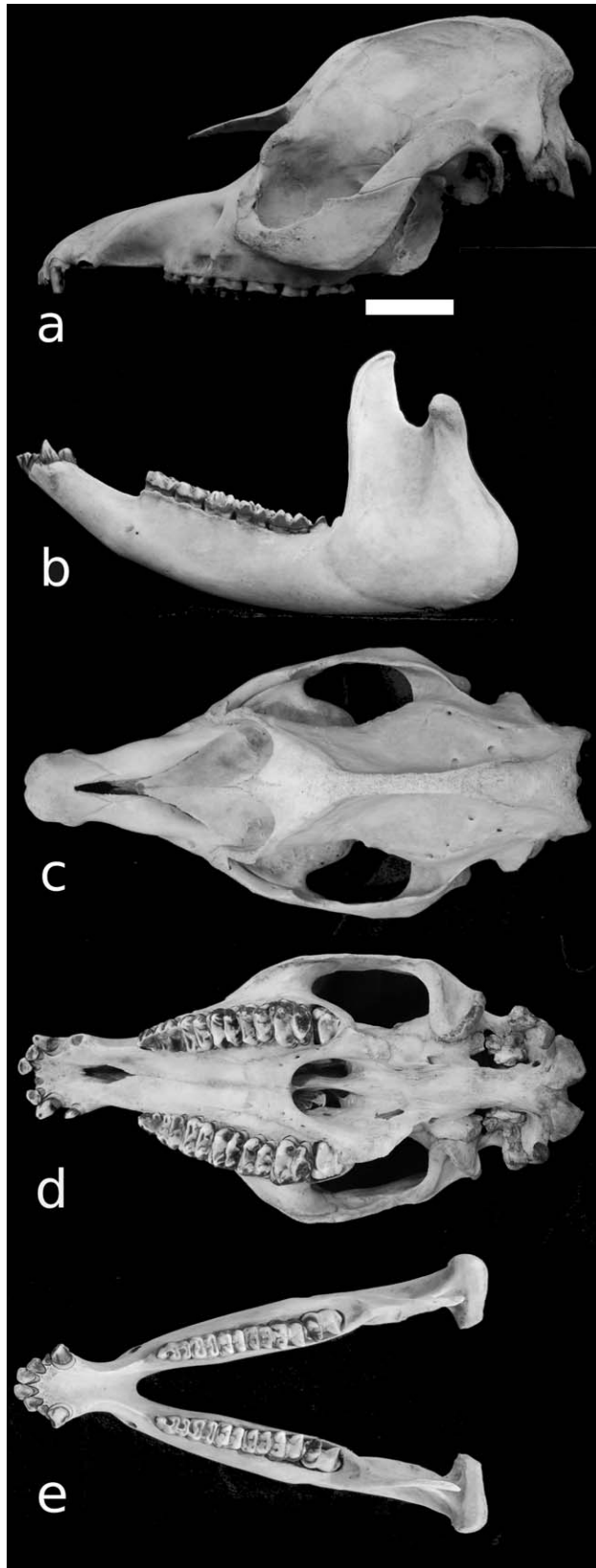

FIG. 1.—Skull and mandible of the holotype of *Tapirus kabomani* sp. nov., UFMG 3177. a) Skull, left lateral view; b) mandible, left lateral view; c) skull, dorsal view; d) skull, ventral view; e) mandible, occlusal view. White bar = 5 cm.

years (Nabholz et al. 2008). Furthermore we used estimated dates from the fossil record to calibrate the molecular clock and set boundaries in some of the clade splits on the tree to refine the estimates (see Hulbert 1999; Spassov and Ginsburg 1999; Holanda and Cozzuol 2006; Ferrero and Noriega 2007; Holanda et al. 2011; and the morphological analysis below). These age boundaries determined by fossil dates were set in the split between the Asian and American tapirs ( $15 \pm SD 5$  million years ago [mya]), for the divergence between *T. bairdii* and the South American tapirs ( $7.5 \pm 1$  mya), and also the diversification of South American tapirs ( $0.13 \pm 0.1$  mya). In a 2nd method, we used a Bayesian estimation implemented in BEAST 1.5.3 (Drummond et al. 2007), with a relaxed molecular clock using the same fossil calibrations above to set the means and standard deviations of a normal distribution used as prior probabilities for the nodes' ages (Drummond and Rambaut 2006). We also used a strict clock model without constraints on the divergence times of the nodes, with the evolutionary rate described above (2.5%). All estimates were congruent.

We have deposited all newly generated sequences in GenBank and the COI sequences of all *Tapirus* species in the Barcodes of Life Database (Ratsinagan and Hebert 2007). GenBank accession numbers for sequences generated in this work are GU593658–GU593682 and GU737551–GU737565. Details can be found in Supporting Information S5 (DOI: 10.1644/12-MAMM-A-169.S5).

## RESULTS

### *Tapirus kabomani*, new species

*Etymology*.—Arabo kabomani signifies tapir in the Paumari native language from southern Amazonas, Brazil, where the holotype was collected in December 2009.

*Holotype*.—Universidade Federal de Minas Gerais (UFMG) 3177, a complete skeleton and parts of the skin of a young adult male, with complete fused epiphyses in long bones, but with 3rd molars unerupted (Figs. 1a–e). This specimen has the long-bone epiphyses and vertebral disks fused, indicating physical maturity, although tooth-eruption is incomplete. Tapirs with M1 erupted are already sexually mature and the skull and size subsequently changes little or not at all. The only significant change after M1 eruption is closure of the sutures (M. A. Cozzuol, pers. obs.).

*Referred specimens*.—UFMG 3176, a skull, ribs, and a vertebra of a young adult male (2nd molars unerupted), hunted a few months before collection at  $8^{\circ}11'13.2''S$ ,  $65^{\circ}41'41.2''W$ . Universidade Federal de Rondonia (UNIR-M21); a skull of a mature adult, sex unknown (3rd molars in use) with indication of being shot, from the right margin of the Madeira River, a few kilometers north of Porto Velho, Rondônia, Brazil ( $8^{\circ}38'08.3''S$ ,  $63^{\circ}53'00''W$ ). Six partial skulls (UFMG 3178–3183), hunted by Karitiana Indians in their territory, Rondônia, Brazil, and donated by them to one of us (SN). American Museum of Natural History (AMNH) 36661, partial skull and skin of an adult young male, collected by Theodore Roosevelt





FIG. 2.—Map for the known localities of *Tapirus kabomani* sp. nov. Circle = collected specimens; diamond = DNA inference; triangle = photographs.

in January 1912, in Porto Campo at Sepotuba River, Mato Grosso, Brazil.

*Type locality*.—Southern Amazonas, Brazil, near BR 319 Highway, about 90 km north from Porto Velho, Rondônia, Brazil (8°07'45.73"S, 63°42'09.64"W; Fig. 2).

*Distribution*.—The new species is present in Amazonas, Rondônia, and Mato Grosso states in Brazil and in Amazonas Department in Colombia. The habitats in the localities where the species was recorded so far are mosaics of forest and open savanna. Local people's knowledge and photographic documents also suggest that it may be present in the eastern Amazon along the Guiana Shield (Amapá in Brazil and southern French Guiana; Fig. 2).

*Diagnosis*.—*Tapirus kabomani* is the smallest living tapir, with total length 130 cm, height at shoulder 90 cm, and body mass estimated at about 110 kg. Externally, it differs from the sympatric *T. terrestris* by darker hair, lower mane, broader forehead, and smaller size; cranially, it differs from *T. indicus* because the maxillary-premaxillary suture ends anterior to the canine; from *T. bairdii* by the absence of an ossified nasal septum and dorsal maxillary flanges; from *T. terrestris* by a lower sagittal crest, frontals broad and inflated behind the

nasals, extending up to the frontal-parietal suture; from *T. pinchaque* by the gently inclined sagittal crest rising posteriorly instead of parallel to the toothrow; from *T. bairdii* and *T. indicus* by having a single narrow sagittal crest; from *T. pinchaque*, *T. terrestris*, *T. bairdii*, and *T. indicus* by a shallower and less dorsally extended meatal diverticulum fossa, and generally smaller size. It differs from all living species plus the extinct *T. webbi*, *T. veroensis*, *T. johnsoni*, and *T. cristatellus* by its relatively short limbs (femur length shorter than dentary length). Molecularly, the 4 samples of *T. kabomani* analyzed shared 7 unambiguous apomorphic characters in mtDNA *Cytb* (960 base pairs [bp]), *COI* (650 bp), and *COII* (642 bp) genes, compared with *T. indicus*, *T. bairdii*, *T. pinchaque*, and *T. terrestris*. The following autapomorphic characters define *T. kabomani*: position 620 in the *Cytb* gene (homoplasically present in an individual of *T. terrestris* as shown by the parsimony reconstruction), position 401 and 413 of the *COI* gene, and positions 254, 329, 389, and 395 of the *COII* gene. *T. kabomani* also is defined by absence of 3 synapomorphic positions (302, 401, and 497 of the *Cytb* gene) that unite the clade *T. pinchaque*–*T. terrestris* (see Supporting Information S5 for GenBank accession numbers).

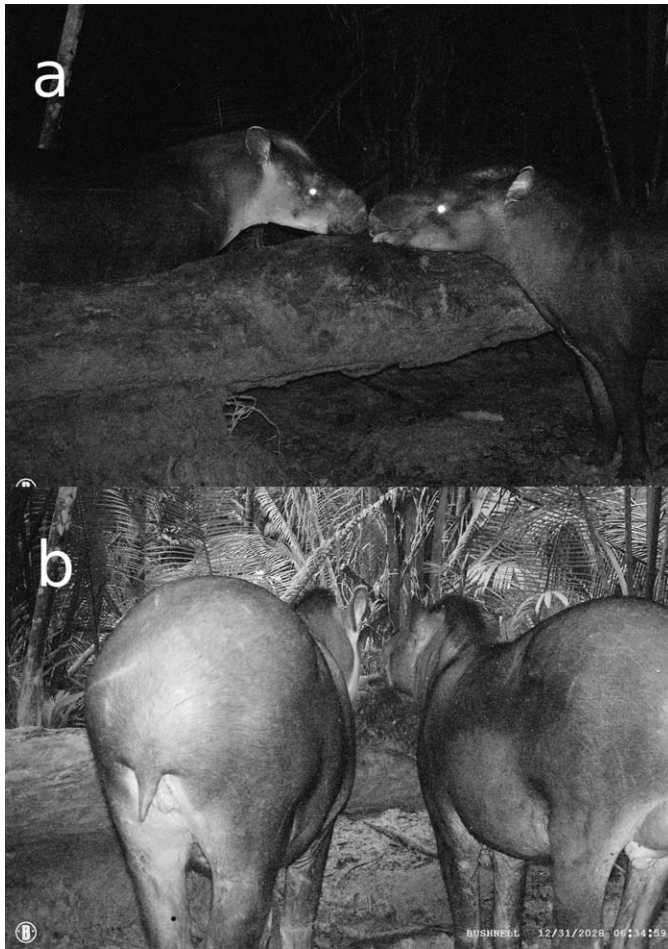

**FIG. 3.**—Camera-trap photos of 2 specimens of *Tapirus kabomani* in the type locality (southern Amazonas State from Brazil). a) Lateral view of the head and anterior body of a male (right) and female (left) specimens. b) Posterior view of the same specimens in the same locality and day, female (left) and male (right). Note the lighter colored patch on lower head and neck of the female.

*Potential synonyms.*—Many names have been proposed for putative taxa of the genus *Tapirus* from South America (Hershkovitz 1954), and possibly 1 or more of those names refer to the species we are describing here.

Several early names were proposed as substitutes for the original Linnean name, *Hippopotamus terrestris*, or were independent descriptions of the same species, and thus are objective synonyms of *T. terrestris* (Linnaeus, 1758), type locality Pernambuco, Brazil. In this category are included *Hydrochaerus tapir* Erxleben, 1777, *Tapir suillus* Blumenbach, 1779, and *Tapir americanus* Gmelin, 1788, from Suriname; *Tapir anta* Zimmermann, 1780, from Pernambuco, Brazil; and *T. tapirus* Merriam, 1895. No types are available for these names.

*Tapirus terrestris* has no originally designated holotype and its type locality is Pernambuco, Brazil (Linnaeus, 1758).

Other names proposed for putative new species, including *T. maypuri* Roulin, 1829, from the Guianas, *T. sabatyrta* Liais,

1872, from Pernambuco, Brazil, *T. brasiliensis* Liais, 1872, from Minas Gerais, Brazil, and *T. anulipes* Hermann, 1924, from Mato Grosso, Brazil, also have no designated holotypes and cannot be assigned. All of these should be considered as *nomina dubia*.

*Tapirus aenigmaticus* Gray, 1872, from Macas, eastern Ecuador, was considered by Hershkovitz (1954) to be a young *T. terrestris*, based on its immature skull, despite that its associated skin supposedly showed characteristics that appear closer to some juveniles of *T. pinchaque*. As Hershkovitz (1954:476) noted, Gray's (1872) revision of tapirs is a "... confusing and misleading source of information. The work is characterized by numerous typographical errors, misquotations of authors, contradictions, and assumptions derived from specimens mislabeled as to sex and locality and mismatched as regards skins and corresponding osteological material." The skull illustrated by Gray (1872:491) is from a very young animal and the globular shape of the braincase is most likely due to this condition. Because no sign of a sagittal crest is visible in this specimen, and because in *T. terrestris* the crest is formed at the fetal stage, it seems most likely that the skull and skin may represent a single individual of *T. pinchaque*. In fact, the collector of this specimen noted that it was captured along with an adult female that did not separate from it. For obscure reasons, Gray (1872) doubted this assertion, and placed the young animal in a different species than the adult, which he called *T. leucogenys*. The latter specimen has some characteristic features of *T. pinchaque*, such as white upper and lower lips, but does not possess all characteristics. In any case, neither the skull nor pelt matches the observed specimens of *T. kabomani*. However, in our analysis some DNA sequences from the lower cordillera in Ecuador were closer to *T. pinchaque* than to other *T. terrestris* (see Genetic Evidence section). The possibility should be pursued that those samples may represent animals like the one described as *T. leucogenys*.

*Tapirus ecuadorensis* Gray, 1872, from Macas, eastern Ecuador, was based on a juvenile skin. Hershkovitz (1954:485) states that "Descriptions of species based on skins of striped juveniles (*T. aenigmaticus*, *T. ecuadorensis*, *T. peruvianus*) and young adults with persistent juvenile striping (*T. anulipes*) are trivial." Our search of photographic material, zoo specimens, and consultation with colleagues uncovered no work available on intraspecific and interspecific variation of young pelts in tapirs. Gray used few specimens to make his observations, giving it an unjustified taxonomic value. The skins are now more than 150 years old, and curatorial procedures at that time included formalin and arsenic as preservatives, which preclude DNA extraction and analyses by current methods.

*Tapirus rufus* Fisher, 1814, probably from French Guiana, was based on a skin and a skull, but efforts to locate the specimen in the institution where it was deposited have been unsuccessful, and it is assumed lost.

The type of *T. laurillardi* Gray, 1867, without precise type locality, based on an adult skull, we ascribe to *T. terrestris*



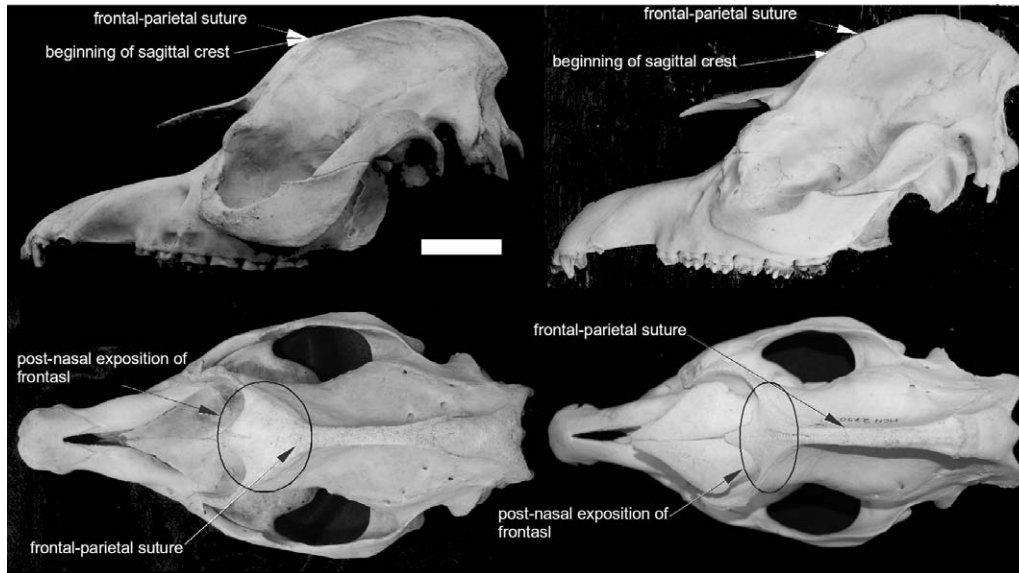

FIG. 4.—Comparison of the skull of *Tapirus kabomani* (left, holotype) and *T. terrestris* (right, Museu de Ciências Naturais, Pontifícia Universidade Católica de Minas Gerais, Belo Horizonte, Minas Gerais, Brazil, MCN 2750). Left lateral view (above), dorsal view (below). The most significant differences described in text are indicated. White bar = 5 cm.

(Gray, 1867:882, figure A) because it has a high and very curved sagittal crest, with origin in the frontals.

*Tapirus peruvianus* Gray, 1872, from Peruvian Amazon, was based on a juvenile skin and skull. Despite the inutility of the skin as a character, the skull lacks any indication of a sagittal crest, which precludes assignment to *T. terrestris*. Juveniles of comparable age are still unknown for *T. kabomani*. The morphology of the upper deciduous premolar lacks the cinguloid shelf of the protocone, like *T. pinchaque*, but this feature is present in *T. terrestris* and in all the known specimens of *T. kabomani* (Hershkovitz 1954:487). We therefore identify this specimen as a *T. pinchaque*.

We examined the holotype skull of *T. spegazzinii*, Ameghino, 1909 (Museo Argentino de Ciencias Naturales, Bernardino Rivadavia, Buenos Aires, Argentina [MACN] 5.41), from Rio Pescado, Departamento de Orán, Salta, Argentina. It has the skull characters of *T. terrestris*, with a long and high sagittal crest starting in the frontals.

*Tapirus terrestris colombianus* Hershkovitz, 1954, from El Salado, eastern slope of Sierra Nevada, department of Magdalena, Colombia, is based on a young adult male skull that has all the characteristics of *T. terrestris*.

Consequently, we cannot link any previous names to our specimens, and thus we propose a new taxon name.

**Description.**—External appearance. For external characters we use information from local hunters, who identified the animals in the camera-trap photos (Fig. 3) from the type locality as belonging to the new species. The hair is dark, from dark gray to dark brownish. The mane, as an external expression of the sagittal crest, is lower and starts posteriorly. The forehead behind the nasals is broader than in *T. terrestris*. From the photos, specimens of known sex show that females have a gray–white area that extends from the

lower jaw to the cheeks and the base of the ears, and extends ventrally to the neck, similar to that of *T. bairdii*. Males do not show this patch and seem to be smaller (Figs. 3a and 3b; Supporting Information S6 and S7, DOI: 10.1644/12-MAMM-A-169.S6 and DOI: 10.1644/12-MAMM-A-169.S7). The ear tips have a white line as in all *Tapirus* species.

**Skull.**—The sagittal crest is single and narrow, as in *T. terrestris* and adults of *T. pinchaque*, but lower than in the 1st and higher than in the 2nd. Because only adult specimens are currently known, we do not know if the sagittal crest occurs in newborns or if it develops later, as in *T. pinchaque* (Holbrook 2002). Unlike the latter, the sagittal crest is not horizontal, almost parallel to the toothrow, but it gradually rises posteriorly, as in some young specimens of *T. terrestris*. However, the sagittal crest is lower, shorter, and wider than in the latter species. The frontal bones are inflated to form a large triangular convex exposure, with a longitudinal medial depression, ending posteriorly at the frontal–parietal suture, where the sagittal crest begins. In *T. terrestris* the sagittal crest starts in the frontals, much anteriorly than in *T. kabomani*. These features are illustrated in Fig. 4, in comparison with a skull of *T. terrestris*. The meatal diverticulum fossae are shallower than in the other species, with reduced dorsal extension. The nasals are similar to those of *T. terrestris* in shape and do not project upward, as in *T. bairdii* and *T. pinchaque*. As in all Neotropical species, the maxillary–premaxillary suture is anterior to the canine. The anteromedial process of the maxilla is dorsal to premaxilla. The rostrum is not upturned as in most adults of *T. terrestris*.

Some features show intraspecific variability. The spiral grooves in the nasals are shallow in UNIR-M21, AMNH 36661, and UFMG 3177, but a little deeper in the holotype.

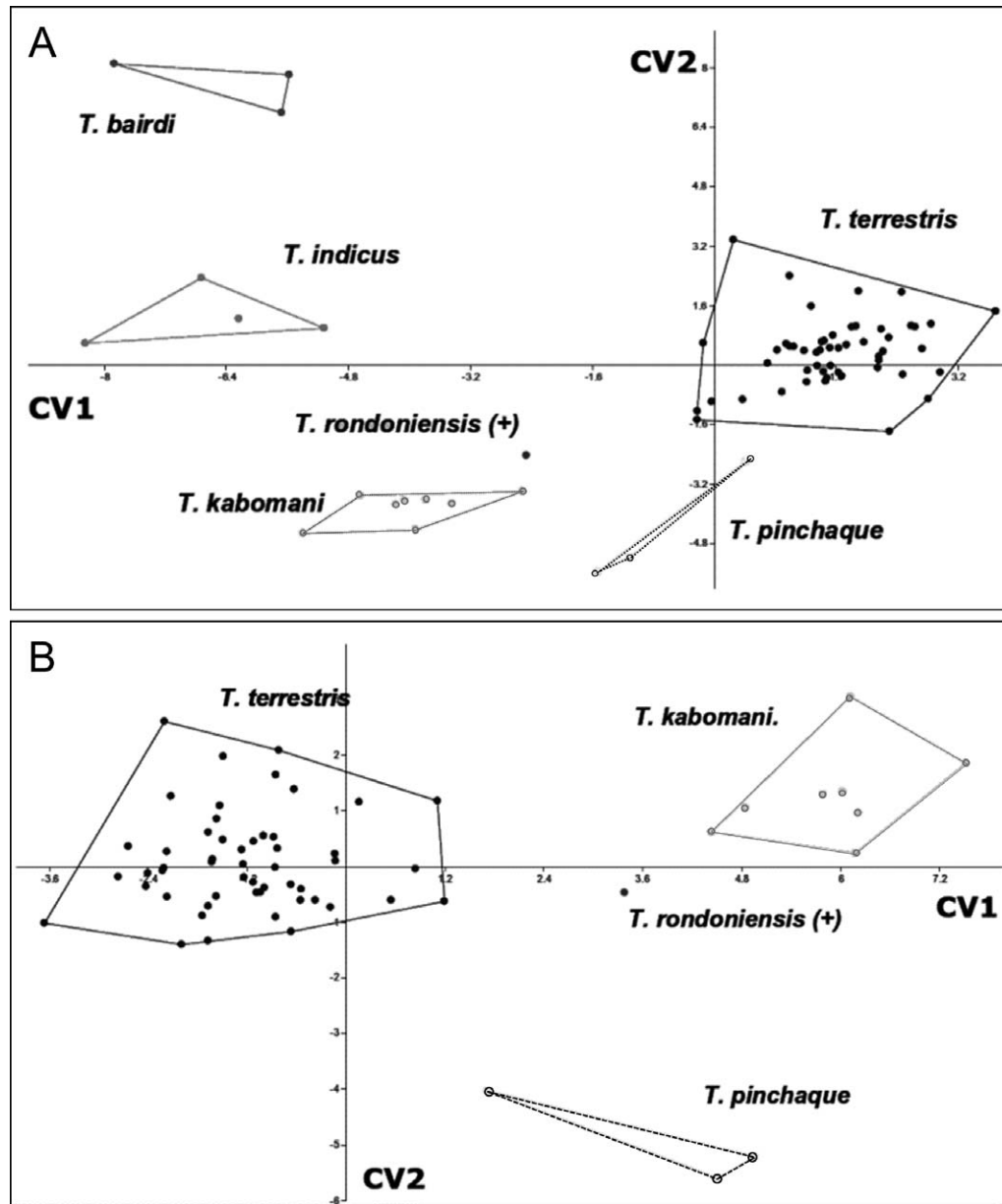

FIG. 5.—Canonical variate analysis scatter-plot for 21 cranial measures of all living *Tapirus* species and *T. rondoniensis*. A) All species, B) South American species.

Diastema and rostrum are short in UNIR-M21, but not in UFMG 3177 and in the holotype.

**Morphometrics.**—A MANOVA–CVA, including all living species, plus the holotype of *T. rondoniensis* (Fig. 5A) and then *T. kabomani*, *T. pinchaque*, *T. terrestris*, and *T. rondoniensis* (Fig. 5B), was performed.

In both analyses, *T. terrestris* discriminates clearly from all the others with significant discriminant function values, but the small sample sizes of the other species preclude the calculation of a discriminant function among them (see Supporting Information S8, S9, and S10; DOI: 10.1644/12-MAMM-A-169.S8, DOI: 10.1644/12-MAMM-A-169.S9, and DOI: 10.1644/12-MAMM-A-169.S10). In the CVA

scatter-plots (Fig. 5) all species appear clearly separated. The single specimen of *T. rondoniensis* falls between *T. terrestris* and *T. kabomani*, but out of the range of both of them.

**Morphological cladistics.**—The morphological cladistic analysis, which includes all living and selected fossil North and South American species, results in a single most-parsimonious tree. The genus *Tapirus* exhibits monophyly. The middle to late Miocene species *T. johnsoni* and the late Miocene *T. webbi*, both from North America, appear as successive clades, the latter is the sister group of the 2 major clades, one containing all of the South American species (*T. kabomani*, *T. terrestris*, *T. pinchaque*, *T. cristatellus*, *T. mesopotamicus*, and *T. rondoniensis*) and the other

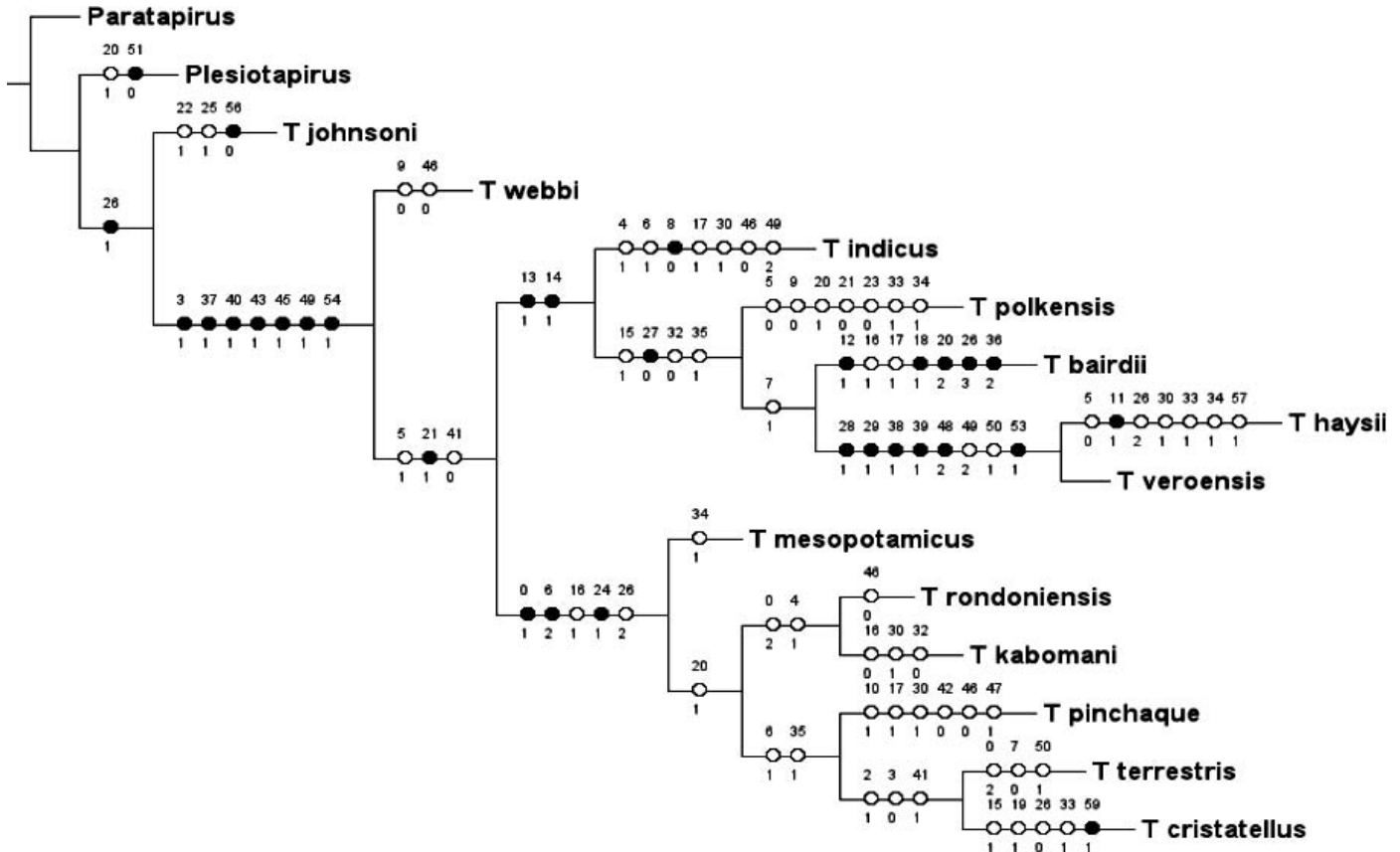

FIG. 6.—Morphological maximum-parsimony tree including all living species and selected fossils of *Tapirus*. The numbers above hash marks correspond to character numbers and, above them, character states.

containing the Asian, North American, and Central American species (*T. indicus*, *T. bairdii*, *T. polkesnsis*, *T. haysii*, and *T. veroensis*) supported by 2 synapomorphies. The South American clade is supported by 5 synapomorphies. *T. mesopotamicus* is the sister group of the remaining South American species. *T. kabomani* appears as the sister taxon of *T. rondoniense*, from which it differs by possessing 3 autapomorphies, whereas *T. rondoniense* has 1 autapomorphy. The character distribution in these taxa precludes considering these 2 species as synonyms. They are, in turn, the sister group of a clade including *T. terrestris*, *T. pinchaque*, and *T. cristatellus* (Fig. 6).

The grouping of *T. indicus* with *T. bairdii* and several North American fossil species is the major difference between phylogenetic results of morphological and DNA characters (see below). The reason for this is not clear. Because the several fossil species included in the morphological matrix cannot be assessed genetically, a likely alternative would be a long-branch attraction causing *T. bairdii* to appear as sister taxon of *T. indicus* in the morphology analysis. Furthermore, many other genetic markers have shown *T. bairdii* as sister group of the South American tapirs (Steiner and Ryder 2011), the same topology we recover in our mtDNA analyses. Because no fossil tapirs from Asia are well known enough to

be included in the morphological matrix, the position of *T. indicus* may change in future morphological analyses.

**Genetic evidence.**—A total of 960 bp of the *Cytb* gene, 617 bp of the COI gene, and 690 bp of COII gene were sequenced for the holotype (UFMG 3177) and 1 paratype (UFMG 3176), and compared with sequences of 64 tapir individuals. Between-taxa distances for COI, COII, and *Cytb* data were calculated using Kimura 2 parameter (Supporting Information S11, S12, and S13; DOI: 10.1644/12-MAMM-A-169.S11, DOI: 10.1644/12-MAMM-A-169.S12, and DOI: 10.1644/12-MAMM-A-169.S13), and reveal a high similarity because of a close relationship among the 3 South American species.

Bayesian inference and maximum-likelihood phylogenetic trees for the *Cytb* data set were mostly congruent, with small discrepancies only in node support (Fig. 7), both having the same topology, which also was replicated using the *Cytb* + COI + COII data set (Supporting Information S14, DOI: 10.1644/12-MAMM-A-169.S14). The last one used a smaller sample set. The proposed *T. kabomani* formed a clade with moderate (*Cytb*, aLRT = 0.55, posterior probability [PP] = 0.73) to strong (all genes combined, aLRT = 0.88, PP = 0.93) support, sister to *T. terrestris* and *T. pinchaque* in all phylogenetic reconstructions, involving combined data set (*Cytb* + COI + COII) or only *Cytb* with a larger sample size. Moreover, a similar topology is observed in the maximum-parsimony tree



(figure not shown) and median-joining network analyses (Fig. 8). In all trees, the 2 DNA samples from southeastern Colombia and 1 on the Brazilian border also were shown to belong to the *T. kabomani* clade (Fig. 7).

*Tapirus pinchaque* presented a well-supported clade, but *T. terrestris* was shown to be paraphyletic with *T. pinchaque* nested inside it (Fig. 7). *T. terrestris* appears to be composed of at least 5 different clusters (or clades including *T. pinchaque*) in the Bayesian inference reconstructions, each supported by PP > 0.99 (aLRT > 0.91 for maximum-likelihood tree). The restricted and peripheral distribution range of *T. pinchaque* suggests it to be the result of a peripatric speciation process. Molecular dating methods (linearized tree and Bayesian estimation—see “Materials and Methods”) indicate a late Miocene to early Pliocene time of divergence of *T. bairdii* and the South American clade (3.16–7.55 mya), and a late Pleistocene divergence for the *T. kabomani* and *T. terrestris*–*T. pinchaque* complex (288–652 thousand years ago; Fig. 7).

The *Cytb* median-joining network analysis (Fig. 8) supported the basal position of *T. kabomani*, but also indicated that *T. terrestris* includes at least 2 main clusters, separated by 6 mutational steps. *T. pinchaque* is nested between these 2 clusters (Figs. 7 and 8), 5 steps distant from the larger *T. terrestris* cluster, and 9 from the smaller one.

## DISCUSSION

Morphological and molecular data are in general agreement (Figs. 6 and 7; Supporting Information S15, DOI: 10.1644/12-MAMM-A-169.S15) and unambiguously identified a new well-supported clade among the South American tapirs, proposed as *Tapirus kabomani* sp. nov.

Other studies have highlighted the high level of genetic and species diversity among several vertebrate taxa in this region (Haffer 1969; Ashley et al. 1996; Avise et al. 1998; Brumfield and Edwards 2007). *T. kabomani* sp. nov. is an example of newly uncovered biodiversity of the Amazon, and shows the congruence of both often-denigrated traditional knowledge with more widely accepted scientific approaches for biodiversity discovery (Sheil and Lawrance 2004). In a context of global change and accelerated loss of biodiversity, discovery and description of species should rely on strong and efficient collaborations with local communities (Pfeiffer and Uril 2003). Despite technical limits and the obstacle of intellectual property that need to be properly managed, the benefits of the involvement of local people as “parataxonomists” in biodiversity surveys appear indisputable (Janzen et al. 1993; Basset et al. 2000; Bass et al. 2004; Arias et al. 2012). In the case of a newly discovered and already threatened large Neotropical mammal, local conservation initiatives, as soon as they are also shared with communities, are more prone to tangible results (Shanley and Gaia 2002). It is noteworthy that the 1st known specimen collected for this species (AMNH 36661) remained unidentified for almost 100 years although the collector, Theodore Roosevelt, remarked (Roosevelt 1914: 76) that this specimen “... was a bull, full grown but very much smaller

than the animal I had killed. The hunters said that this was a distinct kind.” Roosevelt sent the specimen to the United States for analysis, but it was considered just a variation of *T. terrestris* (Allen 1914).

The morphological analysis clearly discriminates *T. kabomani* from all other species, particularly from the apparently sympatric *T. terrestris*, with which it has been confused. The late Pleistocene *T. rondoniensis* (Holanda et al. 2011), which comes from close to the type area of *T. kabomani*, falls between *T. terrestris* and *T. kabomani* in the CVA, especially when only South American species are analyzed (Figs. 5A and 5B). In the morphological cladogram, *T. kabomani* is the sister taxon of *T. rondoniensis*, from which it differs by possessing 3 autapomorphies. Together they are the sister group of the other 2 living South American species.

Our results concur partially with previous molecular phylogenies (Norman and Ashley 2000; de Thoisy et al. 2010; Steiner and Ryder 2011). The mtDNA gene trees (*Cytb*, or *Cytb* + COI + COII) show strong support for a unique Neotropical clade, encompassing a strict South American tapir subclade (Fig. 7). In the Bayesian inference and maximum-likelihood phylogenetic analyses, the *T. kabomani* clade is associated with moderate (only *Cytb*) to strong (*Cytb* + COI + COII) PP and aLRT values. These results support *T. kabomani* as a distinctive taxon in a basal position with regard to the other 2 unambiguously recognized South American species (*T. pinchaque* and *T. terrestris*).

The oldest record for the genus in South America is about 2 mya (Ensenadan South American Land Mammal Age). During the late Pleistocene the genus attained its largest diversity on the continent (Holanda and Cozzuol 2006), which led to living species: *T. terrestris*, *T. pinchaque*, and *T. kabomani*. The late Pleistocene has been identified of major importance for tapir diversification (Hulbert 1999), and more widely for many other vertebrate taxa (Haffer 1969; Avise et al. 1998; Brumfield and Edwards 2007).

Based on knowledge of local peoples and our own observations it appears that the new species is not rare in the upper Madeira River region, in the southwestern Brazilian Amazon, where mosaics of forest and patches of open savanna are present, probably Holocene relicts of Cerrado. Where only forest or open areas are dominant, the species seems to be rare or absent. If this pattern is confirmed in the future, it may imply an origin of this species during dry periods of the Pleistocene, associated with forest fragmentation (Haffer 1969; Costa 2003; Mayle 2004; Bonaccorso et al. 2006; Cossios et al. 2009).

Fecal samples collected from paths where *T. kabomani* was found contained leaves and seeds of the palm trees *Atalea maripa*, *Orbignya phalerata*, and *Astrocaryum aculeatum*. The ecology of *T. kabomani* is otherwise unknown.

Southwestern Amazonia is currently undergoing intense landscape modification by deforestation and increasing human population. The region is likely threatened more by global warming than are other South American regions (Wright et al. 2009), and it is considered a biodiversity hot spot (Haffer 1969; Harcourt 2000) with undocumented species richness. Particu-



B)

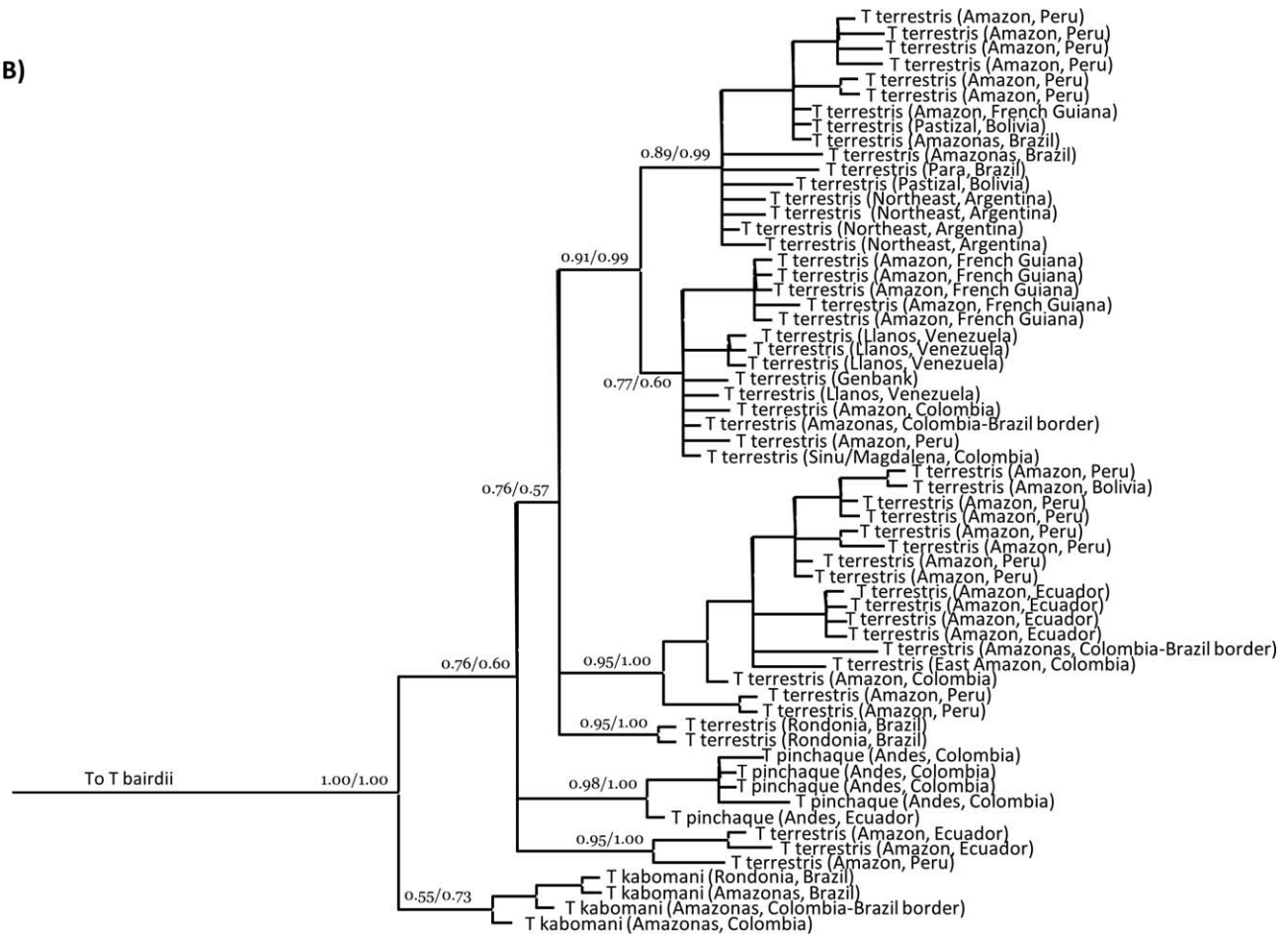

FIG. 7.—(continued) B) A detail of the above tree showing all branch support values for the South American tapir clade.

do que *T. terrestris* (Linnaeus, 1758) com morfologia distinta do crânio, sendo basal ao clado formado por *T. terrestris* e *T. pinchaque* (Roulin, 1829). Esta descoberta destaca a biodiversidade oculta no oeste da Amazônia, onde a biota enfrenta ameaças crescentes. Alguns povos locais há muito tempo reconheceram esta nova espécie, sugerindo um papel fundamental para o conhecimento tradicional na compreensão da biodiversidade da região.

#### ACKNOWLEDGMENTS

This work received grants from Fundação O Boticário (FBPN), CNPq, and FAPEMIG from Brazil, and JAGUARS program (funders: Kwata non-governmental organization (NGO), Institut Pasteur de la Guyane, and Labex Centre d'Etude de la Biodiversité Amazonienne) of Kwata NGO (www.kwata.net). We thank J. Patton (Museum of Vertebrate Zoology, Berkeley, California) for providing data and measurements of tapir skulls from his institution, initial comments, and advising on early stage of this manuscript; J. Vianna (Pontificia Universidad Católica de Chile, Santiago, Chile) and A. A. Nascimento (Universidade Federal de Minas Gerais, Belo Horizonte, Brazil) for participation and discussion in the initial stages of this work; C. Pedraza (Universidad de Los Andes, Bogotá, Colombia), A. Tapia (Universidad Central del Ecuador, Quito, Ecuador), M. R. Garcia (Universidad Javeriana, Bogotá, Colombia), O. Ramirez (Universidad

Peruana Cayetano Heredia, Lima, Peru), and A. G. Silva (University of British Columbia Okanagan, Kelowna, Canada), who provided some samples of Neotropical *Tapirus* (de Thoisy et al. 2010); the San Diego Zoo, San Diego, California, which provided a sample of *T. indicus*; L. Avilla (Federal University of the State of Rio de Janeiro, UNIRIO), who lent us 2 camera-traps; M. Marmontel (Instituto Sustentável Mamirauá, Tefé, Brazil), P. Médiçi (Tapir Specialist Group, www.tapirs.org), and C. Maria Jacobi (Universidade Federal de Minas Gerais, Belo Horizonte, Brazil), who helped to improve the manuscript text; and L. Emmons (National Museum of Natural History, Smithsonian Institution, Washington, D.C.), who provided many comments and English review of the final text. We thank the biology student G. Braga, who kindly made the life drawings of the male and female specimens of *T. kabomani* in Supporting Information S6 and S7.

#### SUPPORTING INFORMATION

**SUPPORTING INFORMATION S1.**—Morphometry.

Found at DOI: 10.1644/12-MAMM-A-169.S1

**SUPPORTING INFORMATION S2.**—List of the specimens used in the morphometric analysis other than *Tapirus kabomani*.

Found at DOI: 10.1644/12-MAMM-A-169.S2

**SUPPORTING INFORMATION S3.**—Data matrix for the morphological phylogenetic analysis.



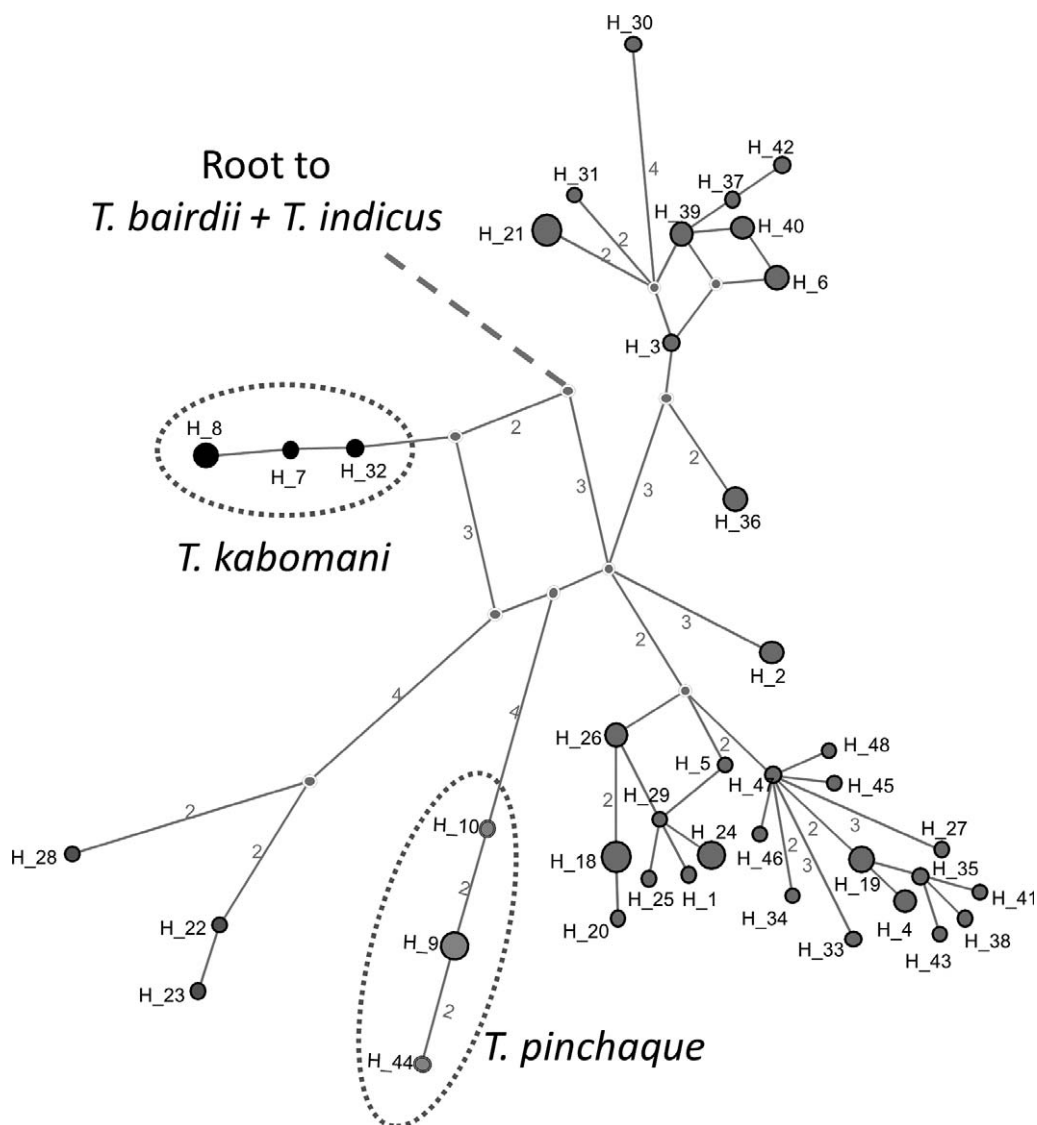

**FIG. 8.**—Median-joining network of cytochrome-*b* (*Cytb*) sequences of *Tapirus terrestris*, *T. kabomani*, and *T. pinchaque*. Numbers of mutational steps larger than 1 are shown for each branch connecting haplotypes. The circle size of each haplotype is proportional to the number of individuals found, and the monophyletic clades belonging to *T. kabomani* and *T. pinchaque* are indicated, as well as the out-group root (*T. bairdii* + *T. indicus*). See list of *Cytb* haplotypes, access numbers, population distribution, and other results for molecular analyses in Supporting Information S5 and S11–S15.

Found at DOI: 10.1644/12-MAMM-A-169.S3

**SUPPORTING INFORMATION S4.**—Morphological cladistics.

Found at DOI: 10.1644/12-MAMM-A-169.S4

**SUPPORTING INFORMATION S5.**—GenBank accession numbers of new sequences generated in this work.

Found at DOI: 10.1644/12-MAMM-A-169.S5

**SUPPORTING INFORMATION S6.**—Pictorial representation of the head of a male *Tapirus kabomani*. Drawn by Grazielle Braga, UFMG.

Found at DOI: 10.1644/12-MAMM-A-169.S6

**SUPPORTING INFORMATION S7.**—Pictorial representation of the head of a female *Tapirus kabomani*. Drawn by Grazielle Braga, UFMG.

Found at DOI: 10.1644/12-MAMM-A-169.S7

**SUPPORTING INFORMATION S8.**—Multivariate analysis of variance–canonical variate analysis discriminant function for all living species of the genus *Tapirus*.

Found at DOI: 10.1644/12-MAMM-A-169.S8

**SUPPORTING INFORMATION S9.**—Multivariate analysis of variance–canonical variate analysis discriminant function for South American species of the genus *Tapirus*.

Found at DOI: 10.1644/12-MAMM-A-169.S9

**SUPPORTING INFORMATION S10.**—Jackknifed confusion matrix from the multivariate analysis of variance–canonical variate analysis for South American species of the genus *Tapirus*.

Found at DOI: 10.1644/12-MAMM-A-169.S10

**SUPPORTING INFORMATION S11.**—Between-taxa distances for cytochrome oxidase I calculated using Kimura 2-parameter models.

Found at DOI: 10.1644/12-MAMM-A-169.S11

**SUPPORTING INFORMATION S12.**—Between-taxa distances for cytochrome oxidase II calculated using Kimura 2-parameter models.

Found at DOI: 10.1644/12-MAMM-A-169.S12

**SUPPORTING INFORMATION S13.**—Between-taxa distances for cytochrome *b* calculated using Kimura 2-parameter models.

Found at DOI: 10.1644/12-MAMM-A-169.S13

**SUPPORTING INFORMATION S14.**—Maximum-likelihood tree for cytochrome *b* (*Cytb*) + cytochrome oxidase I + cytochrome oxidase II mitochondrial DNA genes. The tree presents the same topology as the Bayesian inference tree (not shown), and the taxa grouping reveal about the same branches as shown for the Bayesian inference tree using only *Cytb* (Fig. 7), without several taxa, including an Ecuadorian *Tapirus terrestris* branch sister to *T. pinchaque*. All branches with approximate likelihood-ratios (aLRT) or posterior probabilities (PP) < 0.50 were collapsed. Values are shown for the main branches (aLRT/PP).

Found at DOI: 10.1644/12-MAMM-A-169.S14

**SUPPORTING INFORMATION S15.**—List of specimens for each cytochrome-*b* haplotype and locality (only for *Tapirus terrestris*, *T. pinchaque*, and *T. kabomani*), according the representation in Fig. 8.

Found at DOI: 10.1644/12-MAMM-A-169.S15

### LITERATURE CITED

- ALLEN, J. A. 1914. Mammals collected on the Roosevelt Brazilian expedition, with field notes by Leo Miller. *Bulletin of the American Museum of Natural History* 35:559–610.
- AMEGHINO, F. 1909. Una nueva especie de tapir (*Tapirus Spegazzinii* n. sp.). *Anales del Museo Nacional de Buenos Aires*. 1909, 20(13):31–38.
- ANISIMOVA, M., AND O. GASCUEL. 2006. Approximate likelihood-ratio test for branches: a fast, accurate, and powerful alternative. *Systematic Biology* 55:539–552.
- ANISIMOVA, M., M. GIL, J. F. DUFAYARD, C. DESSIMOZ, AND O. GASCUEL. 2011. Survey of branch support methods demonstrates accuracy, power, and robustness of fast likelihood-based approximation schemes. *Systematic Biology* 60:685–699.
- ARIAS, R. I., A. TAPIA, L. SANTACRUZ, R. YASACA, AND N. MIRANDA. 2012. Evaluación de la biodiversidad en cinco comunidades Kichwa de la zona de colonización de la alta Amazonía ecuatoriana. *Revista Amazónica Ciencia y Tecnología* 1:157–172.
- ASHLEY, M. V., J. E. NORMAN, AND L. STROSS. 1996. Phylogenetic analysis of the perissodactylan family Tapiridae using cytochrome *c* oxidase COII sequences. *Journal of Mammalian Evolution* 2:204–215.
- AVISE, J. C., D. WALKER, AND G. C. JOHNS. 1998. Speciation durations and Pleistocene effects on vertebrate phylogeography. *Proceedings of the Royal Society of London, B. Biological Sciences* 265:1707–1712.
- BAKER, R. J., AND R. D. BRADLEY. 2006. Speciation in mammals and the genetic species concept. *Journal of Mammalogy* 87:643–662.
- BANDEL, H. J., P. FORSTER, AND A. RÖHL. 1999. Median-Joining networks for inferring intraspecific phylogenies. *Molecular Biology and Evolution* 16:37–48.
- BASS, Y., V. NOVOTNY, S. E. MILLER, G. D. WEIBLEN, O. MISSA, AND A. J. A. STEWART. 2004. Conservation and biological monitoring of tropical forests: the role of parataxonomists. *Journal of Applied Ecology* 41:163–174.
- BASSET, Y., V. NOVOTNY, S. E. MILLER, AND R. PYLE. 2000. Quantifying biodiversity: experience with parataxonomists and digital photography in Papua New Guinea and Guyana. *BioScience* 50:899–908.
- BENSON, D. A., I. KARSCH-MIZRACHI, D. LIPMAN, J. OSTELL, AND D. L. WHEELER. 2005. GenBank. *Nucleic Acids Research* 33(database issue):D34–D38.
- BLUMENBACH, J. F. 1779. *Handbuch der Naturgeschichte. Mit Kupfern. Erster Theil*, Göttingen, Germany.
- BONACCORSO, E., L. KOCH, AND A. T. PETERSON. 2006. Pleistocene fragmentation of Amazon species' ranges. *Diversity and Distributions* 12:157–164.
- BRUMFIELD, R. T., AND S. V. EDWARDS. 2007. Evolution into and out of the Andes: a Bayesian analysis of historical diversification in *Thamnophilus* antshrikes. *Evolution* 61:346–367.
- CEBALLOS, G., AND P. R. EHLRICH. 2009. Discovery of new mammals species and their implications for conservation and ecosystem services. *Proceedings of the National Academy of Sciences* 106:3841–3846.
- COSSIOS, D., M. LUCHERINI, M. RUIZ-GARCÍA, AND B. ANGERS. 2009. Influence of ancient glacial periods on the Andean fauna: the case of the pampas cat (*Leopardus colocolo*). *BMC Evolutionary Biology* 9:68.
- COSTA, L. P. 2003. The historical bridge between the Amazon and the Atlantic forest of Brazil: a study of molecular phylogeography with small mammals. *Journal of Biogeography* 30:71–86.
- DESMAREST, A. G. 1819. *Nouveau dictionnaire d'histoire naturelle, appliquée aux art, principalement à l'agriculture et à l'économie rurale et domestique; par une société de naturalistes. Nouvelle édition, presque entièrement refondue et considérablement augmentée*. Deterville, Paris, France.
- DE THOISY, B., ET AL. 2010. Population history, phylogeography, and conservation genetics of the last Neotropical mega-herbivore, the lowland tapir (*Tapirus terrestris*). *BMC Evolutionary Biology* 10:278.
- DRUMMOND, A. J., S. Y. W. HO, M. J. PHILLIPS, AND A. RAMBAUT. 2006. Relaxed phylogenetics and dating with confidence. *PLoS Biology* 4:e88.
- DRUMMOND, A., AND A. RAMBAUT. 2007. BEAST: Bayesian evolutionary analysis by sampling trees. *BMC Evolutionary Biology* 7:214.
- ERXLEBEN, J. C. P. 1777. *Systema regni animalis per classes, ordines, genera, species, varietates, cum synonymia et historia animalium. Classis I: Mammalia. Weygandianis, Lipsiae, Germany*.
- FERRERO, B. S., AND J. I. NORIEGA. 2007. A new upper Pleistocene tapir from Argentina: remarks on the phylogenetics and diversification of Neotropical Tapiridae. *Journal of Vertebrate Paleontology* 27:504–511.
- FISHER, G. 1814. *Zoognosia tabulis synopticis illustrate*. 3 (Guiana) ed. Nicolai Sergeidis Vsevolozky, Moscow, Russia.
- FUNK, D. J., AND K. E. OMLAND. 2004. Species level paraphyly and polyphyly: frequencies, causes, and consequences, with insights for animal mitochondrial DNA. *Annual Review of Ecology and Systematics* 34:397–423.
- GILL, T. 1865. *Proceedings of the Academy of Natural Science of Philadelphia* 17:183.
- GMELIN, J. F. 1788. *Caroli a Linné systema naturae per regna tria naturae, secundum classes, ordines, genera, species, cum characteribus, differentiis, synonymis, locis. Tomus I. Editio decima tertia, aucta, reformata. Lipsiae, Germany*.
- GOLOBOFF, P. A., J. S. FARRIS, AND K. C. NIXON. 2008. TNT, a free program for phylogenetic analysis. *Cladistics* 24:774–786.
- GRAY, J. E. 1867. Notice of new species of American tapir, with observations on the skulls of *Tapirus*, *Rhinochoerus*, and *Elasmognathus* in the collection of the British Museum. *Proceedings of the Zoological Society of London* 1867:876–886.
- GRAY, J. E. 1872. Notes on a new species of tapir (*Tapirus leucogenys*) from the snowy regions of the cordilleras of Ecuador,

- and the young spotted tapirs of tropical America. *Proceedings of the Zoological Society of London* 1872:483–492.
- GUINDON, S., J. F. DUFAYARD, V. LEFORT, M. ANISIMOVA, W. HORDIJK, AND O. GASCUEL. 2010. New algorithms and methods to estimate maximum-likelihood phylogenies: assessing the performance of PhyML 3.0. *Systematic Biology* 59:307–321.
- HAFFER, J. 1969. Speciation in Amazonian forest birds. *Science* 165:131–137.
- HAMMER, Ø., D. A. T. HARPER, AND P. D. RYAN. 2001. PAST: Paleontological Statistics Software Package for Education and Data Analysis. *Palaeontologia Electronica* 4(1):article 4, 9 pp.
- HARCOURT, A. H. 2000. Coincidence and mismatch of biodiversity hotspots: a global survey for the order, Primates. *Biological Conservation* 93:163–175.
- HERMANN, R., 1924. Ein neuer Tapir aus Brasilien und ost Bolivien. *Mittlungen aus dem Zoologischen Museum in Berlin* 11:167–168.
- HERSHKOVITZ, P. 1954. Mammals of northern Colombia. Preliminary report no. 7: tapirs (genus *Tapirus*), with a systematic review of American species. *Proceedings of the United States National Museum* 103:465–496.
- HOLANDA, E. C., AND M. A. COZZUOL. 2006. New records of *Tapirus* from the late Pleistocene of southwestern Amazonia, Brazil. *Revista Brasileira de Paleontologia* 9:193–200.
- HOLANDA, E. C., J. FERIGOLO, AND A. M. RIBEIRO. 2011. New *Tapirus* species (Mammalia: Perissodactyla: Tapiridae) from the upper Pleistocene of Amazonia, Brazil. *Journal of Mammalogy* 92:111–120.
- HOLBROOK, L. T. 2002. The unusual development of the sagittal crest in the Brazilian tapir (*Tapirus terrestris*). *Journal of Zoology (London)* 256:215–219.
- HULBERT, R. C., JR. 1999. Nine million years of *Tapirus* (Mammalia, Perissodactyla) from Florida. *Journal of Vertebrate Paleontology* 19(3, supplement):53A.
- HULBERT, R. C., AND S. C. WALLACE. 2005. Phylogenetic analysis of late Cenozoic *Tapirus* (Mammalia, Perissodactyla). *Journal of Vertebrate Paleontology* 25(3, supplement):72A.
- INTERNATIONAL UNION FOR THE CONSERVATION OF NATURE AND NATURAL RESOURCES. 2009. IUCN Red list of threatened species. *Tapirus terrestris*. [www.iucnredlist.org](http://www.iucnredlist.org). Accessed 10 October 2009.
- JANZEN, D. H., W. HALLWACHS, J. JIMENEZ, AND R. GAMEZ. 1993. The role of parataxonomists, inventory managers and taxonomists in Costa Rica's national biodiversity inventory. Pp. 223–254 in *Biodiversity prospecting: using genetic resources for sustainable development* (Reid et al., eds.). World Resources Institute, Washington, D.C.
- LARKIN, M. A., ET AL. 2007. Clustal W and Clustal X version 2.0. *Bioinformatics* 23:2947–2948.
- LIAIS, E. 1872. *Climate, geologie, faune et geographie botanique do Bresil*. Garnier Frères, Paris, France.
- LINNAEUS, C. 1758. *Systema naturae per regna tria naturae, secundum classis, ordines, genera, species cum characteribus, differentiis, synonymis, locis*. 10th ed. Vol. 1. Laurentii Salvii, Stockholm, Sweden.
- MAYLE, F. E., D. J. BEERLING, W. D. GOSLING, AND M. B. BUSH. 2004. Responses of Amazonian ecosystems to climatic and atmospheric carbon dioxide changes since the last glacial maximum. *Philosophical Transactions of the Royal Society of London, B. Biological Sciences* 359:499–514.
- MERRIAM, C. H. 1895. Brisson's genera of mammals, 1762. *Science, New Series* 1:374–377.
- NABHOLZ, B., S. GLEMIN, AND N. GALTIER. 2008. Strong variations of mitochondrial mutation rate across mammals—the longevity hypothesis. *Molecular Biology and Evolution* 25:120–130.
- NORMAN, J. E., AND M. V. ASHLEY. 2000. Phylogenetics of Perissodactyla and tests of the molecular clock. *Journal of Molecular Evolution* 50:1–21.
- NOWAK, R. M. 1997. *Walker's mammals of the world on-line 5.1*. Johns Hopkins University Press, Baltimore, Maryland.
- OLMOS, F. 1997. Tapirs as seed dispersers and predators in Tapirs—status survey and conservation action plan (D. M. Brooks, R. E. Bodmer, and S. Matola, comps.). IUCN/SSC Tapir Specialist Group, IUCN, Gland, Switzerland, and Cambridge, United Kingdom (in English, Spanish, and Portuguese).
- PFEIFFER, J., AND Y. URIL. 2003. The role of indigenous parataxonomists in botanical inventory: from Herbarium Ambonense to Herbarium Florense. *Teleopea* 10:61–72.
- RAMBAUT, A., AND A. J. DRUMMOND. 2007. Tracer v1.5. <http://beast.bio.ed.ac.uk/Tracer>. Accessed 10 October 2009.
- RATSINAGAN, S., AND P. D. HEBERT. 2007. BOLD: the Barcode of Life Database system ([www.barcodinglife.org](http://www.barcodinglife.org)). *Molecular Ecology Notes* 7:355–364.
- REDONDO, R. A. F., L. P. S. BRINA, R. FRANÇA-SILVA, A. DITCHFIELD, AND F. R. SANTOS. 2008. Molecular systematics of the genus *Artibeus* (Chiroptera: Phyllostomidae). *Molecular Phylogenetics and Evolution* 49:44–58.
- RONQUIST, F., ET AL. 2011. MrBayes 3.2: efficient Bayesian phylogenetic inference and model choice across a large model space. *Systematic Biology* 61:539–542.
- ROOSEVELT, T. 1914. *Through the Brazilian wilderness*. Cooper Square Press, New York.
- ROULIN, F. D. 1829. *Memoir pour servir a l'histoire du tapir; et description d'une espece nouvelle appartenant aux hautes regions de la Cordillere des Andes*. *Annales des Sciences Naturelles—Zoologie et Biologie Animale* 18:46.
- SHANLEY, P., AND G. R. GAIA. 2002. Equitable ecology: collaborative learning for local benefit in Amazonia. *Agricultural Systems* 73:83–97.
- SHEIL, D., AND A. LAWRANCE. 2004. Tropical biologists, local people and conservation: new opportunities for conservation. *Trends in Ecology & Evolution* 19:634–638.
- SIMPSON, G. G. 1945. Notes on Pleistocene and Recent tapirs. *Bulletin of the American Museum of Natural History* 86:33–82.
- SPASSOV, N., AND L. GINSBURG. 1999. *Tapirus balkanicus* nov. sp., nouveau tapir (Perissodactyla, Mammalia) du Turolien de Bulgarie. *Annales de Paléontologie* 85:265–276.
- STEINER, C. C., AND O. A. RYDER. 2011. Molecular phylogeny and evolution of the Perissodactyla. *Zoological Journal of the Linnean Society* 163:1289–1303.
- TAMURA, K., D. PETERSON, N. PETERSON, G. STECHER, M. NEI, AND S. KUMAR. 2011. MEGA5: molecular evolutionary genetics analysis using maximum likelihood, evolutionary distance, and maximum parsimony methods. *Molecular Biology and Evolution* 28:2731–2739.
- VELASCO, J. D. 2009. When monophyly is not enough: exclusivity as the key to defining a phylogenetic species concept. *Biology and Philosophy* 24:476–483.
- WOODBURNE, M. O. 2010. The Great American Biotic Interchange: dispersals, tectonics, climate, sea level and holding pens. *Journal of Mammalian Evolution* 17:245–264.
- WRIGHT, S. J., H. C. MULLER-LANDAN, AND J. SCHIPPER. 2009. The future of tropical species on a warmer planet. *Conservation Biology* 23:1418–1426.



YINGJUN, T., AND Z. GAUNFU. 1987. Fossil mammals from the Pliocene of Hanzhong region, Saanxi Province, and their stratigraphic significance. *Vertebrata Paleasiatica* 3:222–235.

ZIMMERMANN, E. A. W. VON 1780. *Geographische Geschichte des Menschen, und der allgemein verbreiteten vierfüßigen Thiere.*

Zweiter Band. Enthält ein vollständiges Verzeichni aller bekannten Quadrupeden. Weygandschen Buchhandlung, Leipzig, Germany.

*Submitted 26 June 2012. Accepted 11 June 2013.*