

# Application of the Erbium : YAG Laser to Cavity preparation for Cast Metal Inlay Restoration

著者名(英)	Yuji IBARAKI, Yasuhiko NAGAI, Tomofumi KAWAKAMI, Katsuhiro HARAGUCHI, Tatsuzi ODACHI, Teturo MATSUDA, Sin TSUKAGOSHI, Koichi MATSUDA
journal or publication title	東日本歯学雑誌
volume	18
number	1
page range	25-32
year	1999-06-30
URL	<a href="http://id.nii.ac.jp/1145/00008380/">http://id.nii.ac.jp/1145/00008380/</a>

[ORIGINAL]

## Application of the Erbium : YAG Laser to Cavity preparation for Cast Metal Inlay Restoration

Yuji IBARAKI, Yasuhiko NAGAI, Tomofumi KAWAKAMI, Katsuhiko HARAGUCHI,  
Tatsuzi ODACHI, Tetsuro MATSUDA, Shin TSUKAGOSHI and Koichi MATSUDA

Department of Operative Dentistry & Endodontology, School of Dentistry,  
Health Sciences University of Hokkaido

(Chief : Prof. Koichi MATSUDA)

### Abstract

Recently, an Er : YAG laser has been developed for dental hard tissue cutting. This laser has been usually used for cavity preparation of composite resin restorations, but not for cast metal inlays, because it is difficult to create a cavity form which ensures retention form and convenience form. An experimental chisel shaped contact tip for use in cavity preparation for cast metal inlays was developed. This tip has specified irradiation energy distribution characteristic and the usefulness of this tip in inlay cavity preparation was examined. The tooth cutting efficiency was determined in extracted human and bovine teeth, and the irradiated sites were observed with SEM. The experimental tip cuts dentin as well as conventional tips while enamel cutting is poorer than with the conventional tip. It was possible to obtain flat properly inclined dentin walls in the cavity preparation. It is suggested that inlay cavity preparation is possible using the experimental chisel shaped contact tip.

**Key words :** Erbium : YAG Laser, Cavity preparation, Cast metal inlay restoration.

### Introduction

In recent years, various lasers have been applied to dental treatment<sup>1-3)</sup>. A dental Er : YAG laser which is mainly used for dental hard tissue cutting has been newly developed<sup>1-11)</sup>. The radiation from this laser is well absorbed into the water which exists in small quantities in tooth hard tissue, and it is useful for removal of living body tissue rich in water, unlike conventional CO<sub>2</sub> and Nd : YAG lasers. Therefore, it has been hypothesized that the quick evaporation of water which absorbs the energy to create the large pressure in the irradiated structure may be used to destroy tooth substrate, and that tooth cutting may be performed

---

Accepted : March 29, 1999

easily by this laser.

In restorative dentistry, this laser is usually used in cavity preparation for composite resin restorations, but not for cast metal inlay restorations<sup>12-14</sup>. Because it is difficult to make the cavity form for cast metal restorations, to ensure retention form and convenience form, by using laser irradiation<sup>10,11</sup>. It is impossible to form the flat surface in the cavity by using a laser with current method.

To apply the Er : YAG laser to cast metal restorations, an experimental contact tip for use in the finishing of the cavity preparation was newly developed.

In this study, the effectiveness and the usefulness of this experimental contact tip in inlay cavity preparation was examined.

### Materials and methods

An Erwin (ERW1 : HOYA Co. and MORITA Co.) Er : YAG laser apparatus was used in this study. The wavelength of the laser was  $2.94\mu\text{m}$ , the maximum energy 350mJ, the pulse repetition rate 1, 3, 5, or 10 pulse per second (pps) with a pulse duration of  $200\mu\text{sec}$ . The application of laser irradiation involves contact to the surface with a contact tip.

The following two types of contact tips were used in this study.

A : conventional contact tip

0.6mm in diameter and cylindrical, made from pure silicon fiber (Fig. 1 : A). It is characterized by the irradiated energy concentrating at the center of the contact surface.

B : experimental chisel shaped contact tip (ECSC tip)

It had a rectangular top (0.16x1.6mm) and specified irradiation energy distribution characteristic (Fig. 1 : B). The distribution pattern of energy of this tip is wide and highly diffused.

#### A: Conventional contact tip

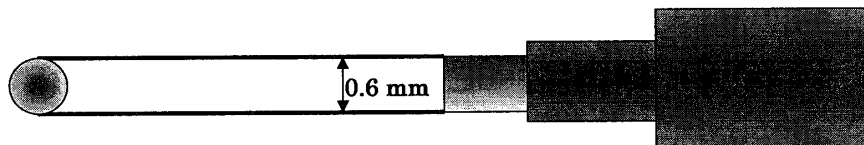

#### B: Experimental chisel shaped contact tip (ECSC tip)

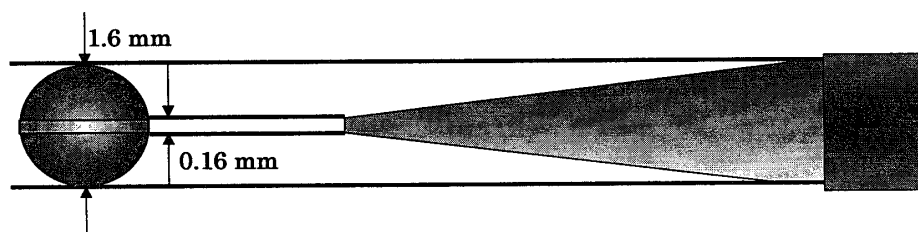

Fig. 1 Shape of contact tip

This tip designed as the abrasion happens to equality to an irradiation surface and avoid the concentration of energy. The irradiation of this chip is about 80% of energy concentration at center of the contact surface in comparison with the conventional contact tip.

#### 1. Measurement of cutting efficiency with laser irradiation

The tooth cutting efficiency of these tips was determined in enamel and dentin blocks (10x15x2mm) as a cutting materials made from extracted fresh bovine central and lateral incisors stored in water. These blocks were attached to the moving stage of the experimental test machine for cutting tests by the laser at 50, 100, 150, 200 of 250mj power, repetition rate 10pps, and the speed of moving of the stage at 10mm/min according to Japanese Industrial Standard T5201 cutting tests (Fig. 2)<sup>11)</sup>. The previous reports indicated that the crack may happens to the irradiated area of tooth structure in 250mj power <sup>8,9)</sup>. Then test was done at 50 to 200mj power in the conventional contact tip. Each sample were irradiated for 30seconds in tests. Five sample were tested for each condition in this experiment. After the test, the volume of irradiated material and abraded area of the sample was measured and calculated as the cutting efficiency ( $\text{cm}^3/\text{min}$ ) <sup>9,11)</sup>. The surface of the irradiated site was also observed with SEM.

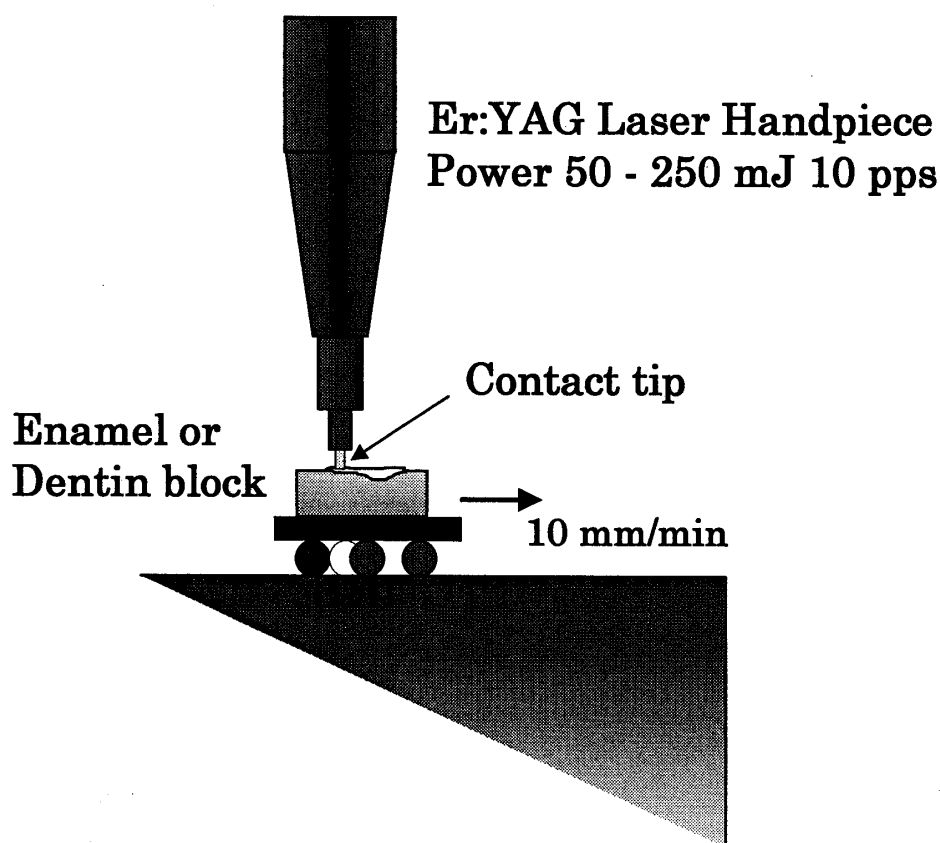

Fig. 2 Test method for cutting efficiency evaluation  
Taper angle of cavity :  $(a+a')/2$  Roughness of cavity floor : b

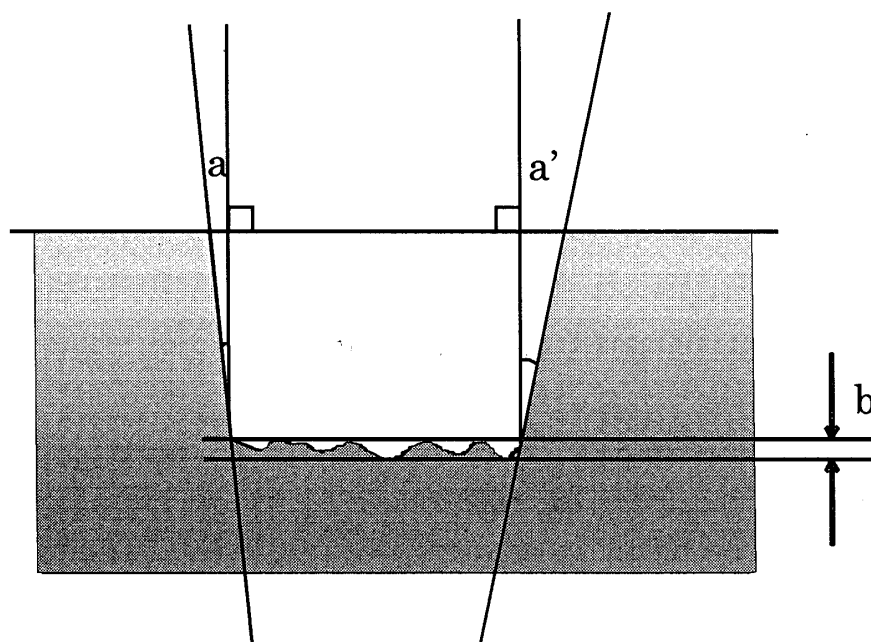

Fig. 3 Characteristics of prepared cavity

## 2 . Evaluation of the cavity preparation with laser irradiation

Extracted bovine central and lateral incisors were used as sample in this experiment. 2x6mm, 1.5mm deep box form cavities were made on the labial surfaces of tooth crowns with the following two methods.

A : Cavity preparation with only the conventional contact tip.

B : Removal of enamel with the conventional contact tip and dentin and finishing of the cavity preparation used with the ECSC tip.

Ten cavity specimens were prepared with each method. After the cavity preparation, the specimens were sectioned and measured the taper angle of the axial wall and flatness of the cavity floor (Fig.3). The time required for the cavity preparation was also measured. Following these results, the effectiveness and the usefulness of the ECSC tip in inlay cavity preparation was evaluated.

## Results

Fig.4 shows the result of measurements of the cutting efficiency. In enamel, the cutting efficiency of the ECSC tip is significantly lower than the conventional tip while at most of the experimental conditions, it was similar in the dentin. No abrasion area was recognized in 50mj power with the ECSC tip.

The SEM observations should that surface irradiated with the ECSC tip was flatter than that of conventional tip. The profile of the removed area irradiated with the conventional tip was cone shaped or hemispherical, while that using the ECSC tip, box shape removed area created with laser irradiation (Fig.5).

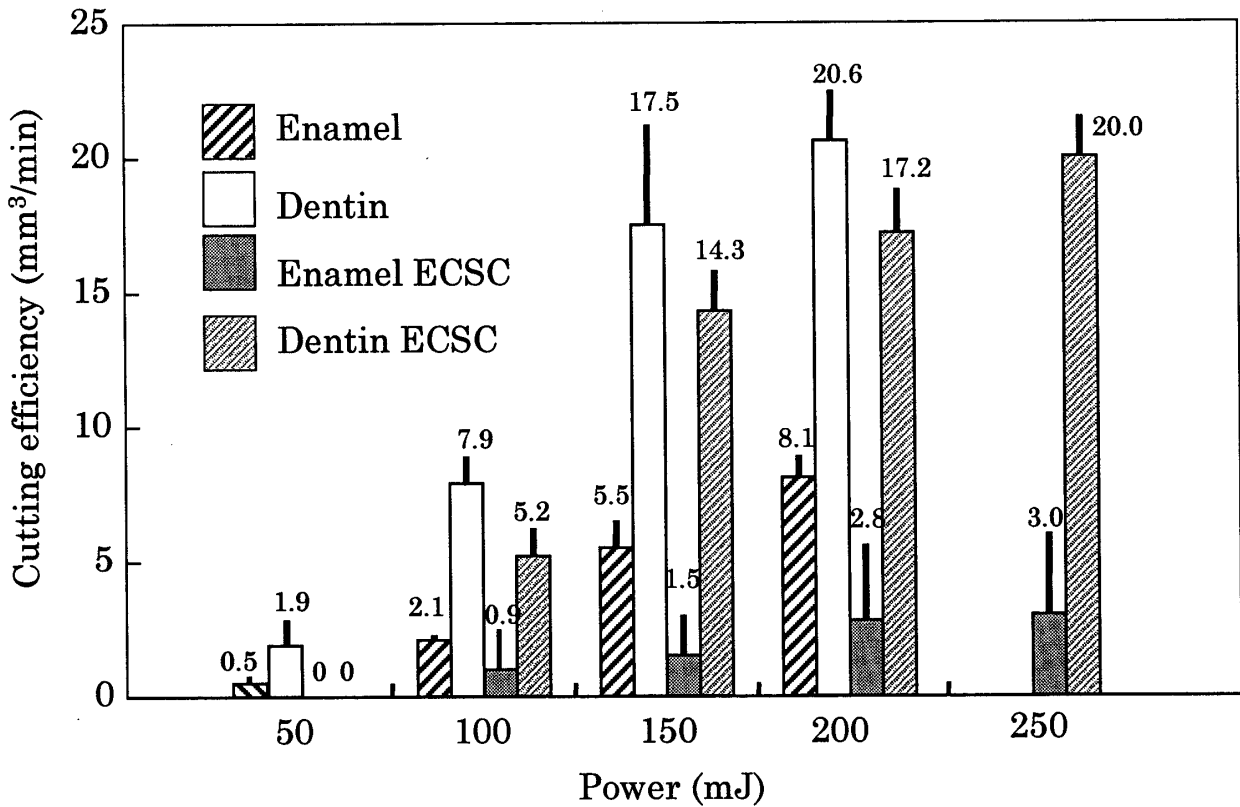

Fig. 4 Cutting efficiency

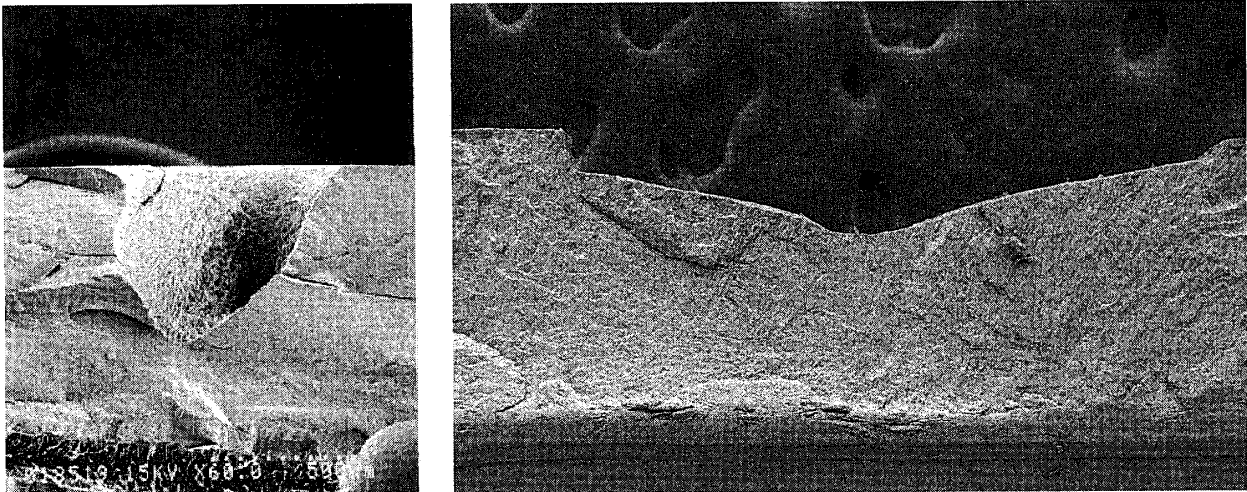

Fig. 5 SEM observations in irradiated Dentin

The results of measurements of the taper angle and the roughness of the cavity floor are shown in Fig.6 and 7. The taper angle of the axial wall was 18.3 degrees with the conventional contact tip and it decreased to 12.2 degree using ECSC tip. The roughness of the cavity floor was smaller, flatter with the ECSC tip.

The time for required of the cavity preparation was shorter with the ECSC tip (Fig.8).

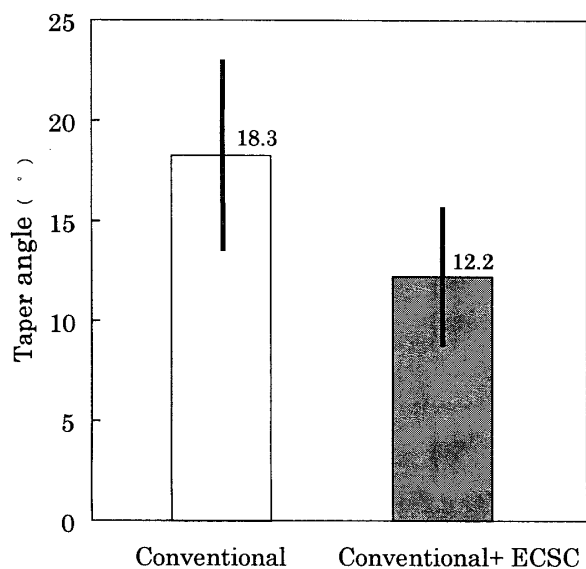

Fig. 6 Taper angle of cavity

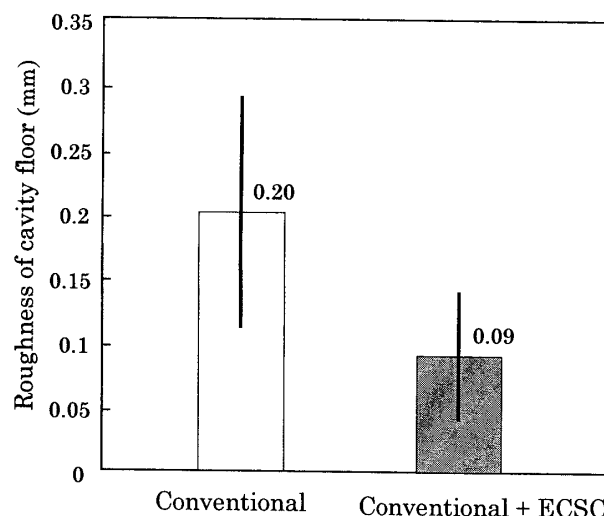

Fig. 7 Roughness of cavity floor

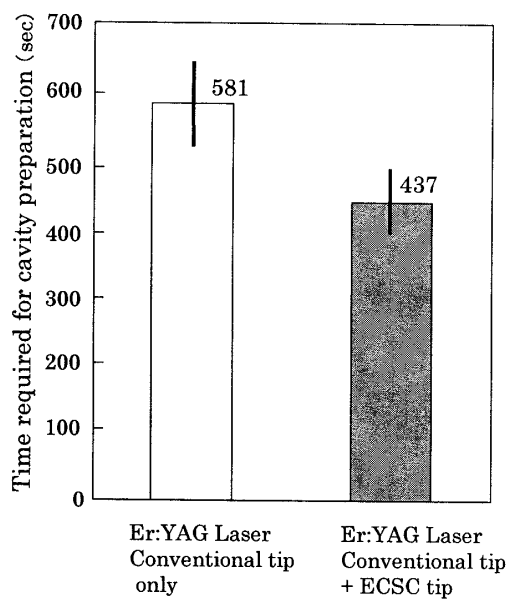

Fig. 8 Time required for cavity preparation

### Discussion

Recently, the Er : YAG laser has been developed for use in dentistry, and with its excellent performance it offers the potential for clinical application. Studies have shown that hard dental substances can be removed by pulsed Er : YAG laser irradiation, and the Er : YAG laser has attracted attention due to its capacity for cutting hard tissue with extremely small thermal effect<sup>13-18</sup>. The 2.94 $\mu$ m wavelength is highly absorbed by water and for this reason it provokes little damage on hard tissue<sup>20-22</sup>. This serves several different purposes together with absence of pain and safe temperature rise, which should make safe clinical use possible<sup>11,15</sup>.

To apply the Er : YAG laser to cast metal restorations, we newly developed an experimental contact tip (ECSC tip) for use in the cavity preparation. The cutting efficiency of the ECSC tip is significantly lower than conventional tip in enamel although in dentin it was equal for most experimental conditions. It is thought that the concentration of energy obtained in enamel irradiation would be insufficient with the ECSC chip, because of its wide highly diffused irradiation pattern. Further, dentin has much more water in the tissue than enamel. The laser light is well absorbed into water in tissue, and it has a good ability for removal of living body tissue rich in water<sup>8,9)</sup>. The irradiated surface with the ECSC tip was flatter than that of the conventional tip in SEM observations. The roughness of the cavity floor was lower with the ECSC tip. The flatness of the prepared cavity wall relates to the resistance of the restored teeth and the ability to adapt of the restorations to the cavity, and optimum flat walls were obtained for the prepared cavity using the ECSC tip. Furthermore the optimum taper angle of cavities is defined as 5 to 14 degrees in instruction manuals and excess taper angles should be decrease the retentive force of the restorations<sup>23)</sup>. Generally, taper of the cavity was impossible to retention of metal cast inlay restoration. Using the ECSC tip, the taper angle of the axial wall was small and optimized for metal cast restoration. Also, the time required for cavity preparation was shorter using the ECSC tip. It is thought that it become more easily to conduct the finishing of the cavity using ECSC tip.

These results suggested that metal cast inlay cavity preparation by laser is possible with the ECSC tip from aforementioned discussion. We hoped that the cavity preparation for cast metal restoration using the laser is soon put to clinical use.

### Conclusion

In cavity preparation using an Er : YAG laser, an experimental chisel shaped contact tip (ECSC tip) cut dentin as well as the conventional contact tip while enamel cutting with the ECSC tip was poorer than with the conventional tip. It was possible to obtain flat dentin walls and optimum taper angles of the cavity in the preparation with the ECSC tip. It is suggested that clinical use for metal cast inlay cavity preparation is possible with the Erwin Er : YAG laser using the ECSC tip.

### Acknowledgement

The author wishes to thank Kenzo KATAOKA and Yoshihide OKAGAMI (MORITA Co) for cooperation in making of the ECSC tip.

### References

1. Zharikov EV, Zhekov VI, Kulevskii LR, Murina TM, Osiko VV, Prokhorvor AD, Saveliev AD,

Simirnov VV, Starikov BP, Timoshehkin MI : Stimulated emission from Er<sup>3+</sup> ions in yttrium aluminium garnet crystals at  $\lambda = 2.94\mu$ , Sov J Quant Elect, 4 : 1039-1040, 1975.



2. Yamamoto, H and Sato, K. : Prevention of dental caries by Nd : YAG laser irradiation, . J. Dent.Res., **59** : 2171-2177, 1980.
3. Melcer, J., Chaumette, MT., Melcer, F., Dejaradin, J., Marson, R., Merard, R., Pinaudeau, Y. and Weill, R : Treatment of dental decay by CO<sub>2</sub> laser beam. Lasers, Surg. Med. **4** : 311-321, 1984.
4. Hilbst, R. ; Keller, U. : Experimental studies of the application of the Er : YAG laser on the dental hard substances, I. Measurement of the ablation rate, Lasers Surg. Med., V. **9** : p. 338 -344, 1989.
5. Keller, U. and Hilbst, R. : Experimental studies of the application of the Er : YAG laser on dental hard substances : 2. light microscopic and SEM investigations, Laser Surg-Med., **9** : 345-351, 1989.
6. Walsh, JT, Jr. and Deutsch, TF. : Er : YAG laser ablation of tissue : Measurement of the ablation rates, Laser Surg-Med, **9** : 327-337, 1989.
7. Sekine, Y. : Histopathological Study of Er : YAG Laser Application to Cavity Preparation, J Conserv Dent, **38** : 211-233, 1995.
8. Takizawa, M., Aoki, S., Takase, Y., Ishikawa, et al : Clinical Evaluation of Er : YAG Laser for Cavity Preparation, J Conserv Dent, **38** : 1035 -1047, 1995.
9. Takizawa. M.: A Study on Er : YAG Laser Ablation for Dental Hard Substances, J Conserv Dent, **39** : 1089-1128, 1996.
10. Ishikawa, I., Aoki, A., Watanabe, H. et al : Erbium : YAG Laser Promising Procedure for Caries Treatment, Dentistry in Japan, **33** : 165 -169, 1997.
11. Ibaraki, Y., Nagai, Y., Kawakami, T. et al : Clinical Application of Er : YAG laser. Part1. Evaluation of the Cavity Preparation by Er : YAG Laser, J Conserv Dent, **39** : 116, 1996.
12. Nagai, Y., Kawakami, T., Ibaraki, Y. et al : Clinical Application of Er : YAG Laser. Part2. Clinical Evaluation, J-Conserv Dent. **39** : 117, 1996.
13. Melendez EJ, Arcoria CJ, Dewald JP, Wagner MJ : Effect of laser-etch on bond strengths of glass ionomers ; J Prosth Dent, **67** : 307-312, 1992.
14. Kumazaki M, Kumazaki M : Etching with the Er : YAG Laser ; J Jpn Soc Laser Dent, **5** : 103 -110, 1994.
15. Sakakibara Y, Ishimaru K, Asano S, Takamizu M, Gotoh S, Kohno A : Morphological change of tooth surface irradiated by Er : YAG laser, SPIE 1984, 168-189, 1994.
16. Kumazaki M, Toyoda K : Removal of hard dental tissue (cavity preparation) with the Er : YAG Laser, J Jpn Soc Laser Dent, **6** : 16-24, 1995.
17. Visuri SR, Gilbert JL, Wright DD, Wigdor HA, Walsh JT Jr : Shear strength of composite bonded to Er : YAG Laser-prepared dentin, J Dent Res, **75** : 599-605, 1996.
18. Ishimaru k et. al.: Morphological change of tooth surface irradiated by Er : YAG laser ; Tsurumi Dent J, **22** : 175-184, 1996.
19. Ishimaru k et. al.: The Influence of Erbium : YAG Laser on the Tooth Surface Morphology, J Conserv Dent, **39** : 1229-1239, 1996.
20. Takano T : A study on Morphological and Component Change of Tooth Surface Irradiated by Er : YAG Laser Part1. SEM Observation and EDS Analysis of Lased Cavity Floor, J Conserv Dent, **40** : 908-919, 1994.
21. Takano T et. al.: A Study on Histopathological Effect of Er : YAG Laser on Dental Pulp, J Conserv Dent, **40** : 1147-1153, 1997.
22. Araki A. T.; IBARAKI, Y., LAGE-MARQUES, J. L., et al : Study on morphological changes of periapical cementum irradiated by Er : YAG laser, 6th Int. Congress on laser in Dentistry. Maui, Hawaii, USA. Abst, **95** : p. 48, 1998.
23. Baum L, Mccoy R. B : Adovanced Restorative Dentistry, 2, Saunders, 1984, 179-188.