



A PORTABLE AND INEXPENSIVE DO-IT-YOURSELF TEMPERATURE SENSOR

Jorge Silva,¹ Emmanuel Lomba,¹ Sílvia D. Martinho² and Abel J. Duarte^{1,2*}

¹School of Engineer – Polytechnic of Porto, Rua Dr. António Bernardino de Almeida 431, 4200-072 Porto, Portugal

²REQUIMTE/LAQV, School of Engineer - Polytechnic of Porto, Dept of Chemical Engineering, Rua Dr. António Bernardino de Almeida 431, 4200-072, Porto, Portugal

*Corresponding author: ajd@isep.ipp.pt

Article History: Received on 15th June 2017, Revised on 19th July 2017, Published on 20th July 2017

Abstract—Nowadays it is important to have commercial solutions to be used in teaching and research laboratories for the needs. We can have different equipment according to the necessary parameters of control being related to the influence of parameters internal or external to the laboratory practice. However they can't be straightforward to use, their costs can be considerable. In this context, the do-it-yourself approach is an interesting alternative. In this paper we report the construction of a temperature sensor made by students. Based on a probe taken from a deactivated equipment, the sensor development and validation encompassed its design and building up, the establishment of a connection to a personal computer via USB, the setup of computer-controlled processes, which included remote control, graphical and numerical displaying and signal acquisition, and finally its testing. Tests were performed in water containers with different temperatures, namely boiling, room and ice. The obtained results are comparable to those from a commercial thermometer. This student experiment project allowed not only to contact different disciplines such as chemistry, electronics, and programming but also to gain competencies that can be used outside the class context. We proved it is possible to build tailor-made electronic devices capable of providing useful measurements to chemical purposes old equipment in an inexpensive and trustworthy way.

Keywords—Computer-controlled, do-it-yourself, multidisciplinary, sustainability, temperature.

I. INTRODUCTION

Chemistry and chemical engineering teaching laboratories are full of electrical and electronic equipment. From unitary operation equipment such as stirrers, mills or hot plates, to measuring equipment, they are becoming increasingly complex and automatized, which makes them user-unfriendly. The use of electronics and software development allows one to measure characteristics as simple as temperature or pressure, but also to monitor more complex variables such as absorbance of the electromagnetic radiation or fluorescence. Although the market has plenty of diversified and intelligent options for variables monitoring during a chemistry experiment, the do-it-yourself

building of sensors hardware and software is an asset, not only in economic terms, because commercial products are often expensive, but also because this strategy leads to the knowledge and mastery of several disciplines that their development entails [1]. In fact, development and construction of measuring equipment are activities that address different areas of engineering, and so require an extensive articulation among different experts. Only integrated knowledge make it possible to develop strategies to achieve miniaturization and automation of current measuring equipment, not only in their mechanical and electronic components but mainly in conceiving the structure upon which the sensor is based and can work. The miniaturization of the various components of the measuring equipment may result in an inexpensive and portable object with reliable and real-time measurement capabilities. Mastering these different areas and bringing them together are necessary conditions to reach more complex monitoring systems such as a low-cost spectrograph [2], or design laboratories the size of an electronic chip [3].

II. EXPERIMENTAL/AN OVERVIEW OF THE TEMPERATURE MEASURE

A. Temperature

The knowledge of a system's temperature is almost a mandatory requirement for every performed experiment. Temperature is a physical parameter representative of a system. The macroscopic concept of temperature is given by thermodynamics, for a given time interval, as a measure of average amount body energy or a system in thermal equilibrium. In general, almost all the remaining physical properties of matter have a narrow temperature dependence in some way. For example density, solubility, electrical conductivity or vapor pressure, are temperature-dependent. Since its first definition, several measurement scales have been proposed. The Kelvin scale, K, adopted by the International System of Units – SI, is defined as 273.16 units of the temperature range between the absolute zero (0 K) and the triple point of water (273.16 K). This scale derived from an older and more practical one, the Celsius scale (°C), set as

1/100th of the temperature range between the melting and boiling points of water under a pressure of 1 Atmosphere. These scales are related as follow: Absolute zero is 0 K / - 273.15 °C; water melting temperature, under 1 Atmosphere of pressure, is 273.15 K / 0 °C; water triple point temperature is 273.16 K / 0.01 °C; and water boiling temperature, under 1 Atmosphere of pressure, is 373.15 K / 100 °C.

B. Thermometers

The development of the different scales has always been associated with the design and assembly of equipment that enables one to measure them. Correlating measurable physical characteristic with a well-defined thermodynamic state was a sufficient condition for temperature setting itself. In their construction, the focus is always on materials whose variation with temperature is linear or monotonous. The most popular and with widespread use among them are the glass thermometers. They are simple to design devices, and they work based on the expansion of several liquids upon thermal balance, in which the expansion caused by the temperature increase channeled into a capillary tube and the liquid displacement is correlated with a scale. Depending on the range of temperature to be monitored one can have different materials, such as gases [7]. Other widespread temperature-measuring devices, nowadays, are thermometers which display changes in their electrical properties in response to temperature changes. There are various ways of determining the temperature electrically, however, and in general, resistive, thermoelectric and infrared sensors are used [7].

Resistive sensors are temperature-dependent variable resistors. Two types of sensors can be highlighted among them, thermistors and resistance temperature detectors (RTD). Thermistors are non-linear sensors very sensitive to temperature variations. The RTD sensors are made with metals whose electrical resistance present high-temperature coefficients and show a high linearity in a given temperature range. Some examples of these sensors are platinum (PT100 and PT1000), nickel and copper [8]. Thermoelectric sensors, better known as thermocouples, are sensors that produce an electromotive force (EMF) signal due to the Seebeck effect, thermoelectric effect. Finally, infrared sensors based on electromagnetic radiation-

capturing sensors at the infrared wavelength, taking into account that this frequency range is characteristic of heat emission [8].

The great advantage of constructing electrical temperature sensors is the conversion of analog features into digital ones, allowing for further signal processing; whether for simple logging for controlling/interacting with other system's variables.

III. STRUCTURE OF THE TEMPERATURE SENSOR

A. Sensor assembly and testing

The manual record of temperature evolution using a commercial thermometer is a straightforward process, which explains its wide application in laboratories and even small companies. However, it is also a lagging process. In order to avoid such inconvenience a computer-assisted, a graphical monitoring thermometer was developed. The block diagram depicting the system is shown in Fig. 1.

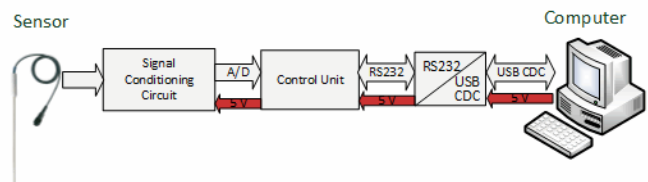
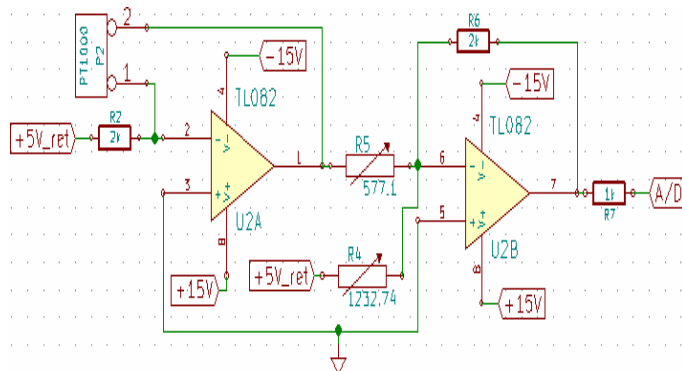

Fig. 1 Block diagram of the sensor-computer system.

In this block diagram, the arrows show the direction of information flow and the feeding of electric circuits. The Signal Conditioning block is responsible for adapting its input signal to the full-performance input characteristics of the Analog-to-Digital Converter (ADC), thus aiming for the best measurement resolution. Inside of control unit, the ADC takes a sample of its input signal and converts it into a digital quantity. After that, the control unit will pre-process the digital values to find the right temperature. Furthermore, the control unit is responsible for managing the communication with the Host computer. The RS232 / USB CDC block is a Serial-to-USB interface to allow the use of any computer's USB facility. The PT1000 RTD sensor was used as temperature sensing device. This platinum sensor presents a high linearity and behaves like a resistance of 1000Ω at 0 °C.

B. Hardware development

The initial step in the thermometer's assembly consisted in the development of a signal conditioning circuit that adapts the voltage range produced by the PT1000 sensing temperatures between -20 and 130 °C, into a voltage ranging from 0 to 5 V (ADC input range). The circuit is based on the TL082's operational amplifiers with appropriated resistors, to achieve



the desired goal. Splitting the circuit by operational amplifier, the first one establishes a voltage from sensor temperature resistance, so when the sensor resistor increases the voltage increase too and in the opposite way the voltage decrease. The second operational amplifier and its resistors and trimmers create a linear function $y = mx + b$; in this case the trimmer R4 corresponds to unknown variable b and the dimmer R5 corresponds to unknown variable m (slope). Thus, with the second operational amplifier, it is possible to define the maximum and minimum voltage values for the ADC, and when it is not calibrated, it is easy to adjust to correct values. The proposal of the R7 resistor is to define the charge constant (τ) of the sample-and-hold capacitor. So considering the total resistors of ADC circuit, the constant of charge determined is 1.08 μ s, consequently the acquisition time is 8.23 μ s. The signal conditioning circuit is shown in Fig. 2.

The PT1000 temperature sensor used came from the dismantling of some old equipment that was given away for slaughter. The equation describing the ADC input voltage variation is described below [eqn (1)]. As referred earlier, the

Fig 2. The signal conditioning circuit

trimmer R5 defines the slope and trimmer R4 defines the offset of the linear equation.

$$V_{A/D} = 5 \times \left(\frac{R_{PT1000}}{R_2} \frac{R_6}{R_5} - \frac{R_6}{R_4} \right) \quad (1)$$

Once the signal conditioning circuit was built the next step was to develop the control unit. This unit is responsible for controlling the ADC, process the acquired signal and control the communication between the Host computer and itself, as depicted in Fig. 1. The signal processing consists of a Low-Pass filtering and averaging of the ADC readings, in order to reduce noise and undesired measurements effects. The communication management between this unit and the Host computer is the ability to process any received information from the computer and to answer back in accordance to the

protocol. In order to meet such requirements and because the PIC18F252 microcontroller was available at the electronic lab, this one was chosen. However, others can be used such as PIC18F2550, PIC12F1880, etc. The main factor in the microcontroller choice was the number of USART, A/D modules and timers available. The PIC18F252 basic features are: one A/D module, one USART module and four timers, besides that the maximum operating frequency is 40MHz.

Other components that are part of the circuit are: DCP020515D, FTDI FT232L and REF02BPTI. The first one is used to produce two independent voltages (+15 and -15) to supply the operational amplifiers of the signal conditioning circuit, the FTDI FT232L is a serial communication to USB CDC communication converter, and the REF02BP-IT device shown in fig.3, aims to establish a 5 V-precision reference voltage for the operational amplifiers, with the purpose of reducing voltage variations and hence A/D reading errors. The remaining assembled devices are intended to ensure the system's correct functioning.

C. Software development

After the hardware assembly, the software development took place. Two types of software were created, one for the control unit and the other for the host computer.

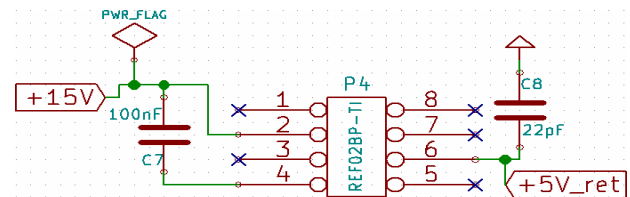

Fig. 3 5 Volts precision circuit.

The control unit software aims to define the A/D module acquisition rate, to establish the communication protocol between the host computer and the control unit, introduce a low-pass filter and a sliding average filter for noise reduction. A/D sampling frequency of 300 microseconds was set to allow three sensor readings *per* second, which is enough for general purposes. This sampling frequency allows a large number of samples for a 1 °C-variation range which, by its turn, allows one to determine the actual temperature with better accuracy. The block diagram depicting the A/D reading is shown in Fig. 4.

ISR Timer

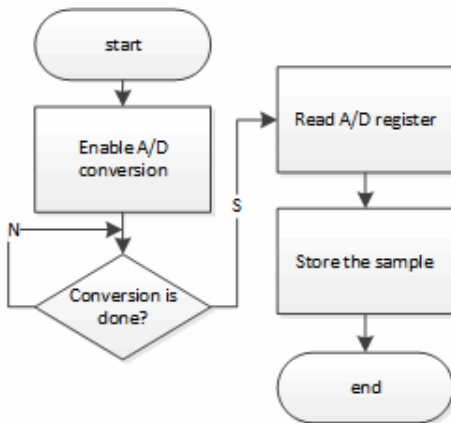

Fig. 4 Block diagram of the A/D reading.

The communication protocol used between the PC and the control unit is the query-response protocol that makes the PC send a query to the unit and wait for an answer from this one. In other words, whenever the PC sends a query with the character 'a' to the unit, the last response with the last acquired temperature value. This communication protocol has the advantage of setting the temperature reading rate on the PC, thus allowing a greater range acquisition rates. The sliding average filter is performed after the 'a' character is received in the control unit, and it uses the most recent set of 25 samples. The block diagram depicting the communication and the sliding average filter performance is presented in Fig. 5.

Main function

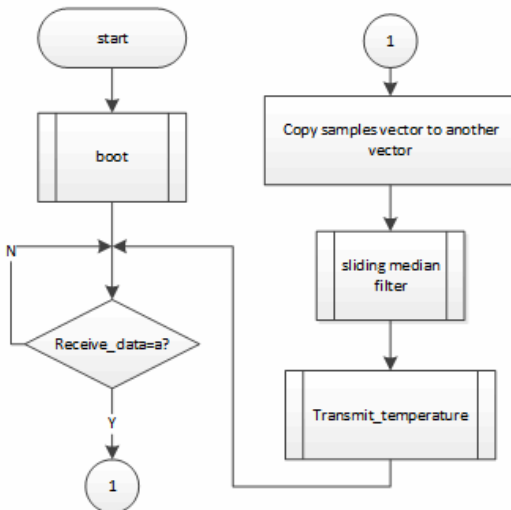

Fig. 5 Block diagram of the sliding median filter performance.

With regard to the computer software, the main goals are: reading the received data and display them graphically, setting

the temperature sampling frequency and data storage in a file. In Fig. 6 the graphical interface for temperature display is shown.

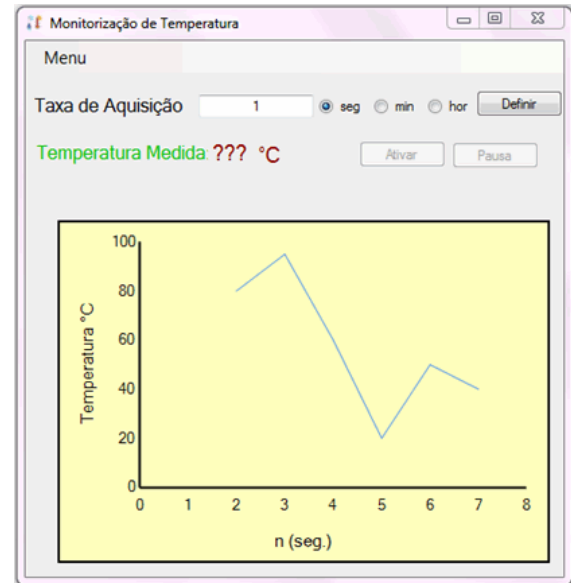

Fig. 6 Computer interface (in Portuguese).

The graphical interface displays the temperature monitoring in a chart format. Above it, the setting options are available. Those are the sampling frequency setting in either seconds, minutes or hours, and the thermometer operation setting in modes 'enabled,' 'disabled' and 'pause.' Also, a menu that allows one to set both the COM port setting and the file where the data are to be saved, is presented. The available settings for the COM port are the communication speed, the parity, and the data and stop bits. Their default values are '9600', 'none,' '8' and '1', respectively.

IV. PROOF OF CONCEPT – TESTING THE TEMPERATURE

The completed sensor and the corresponding controlling computer are presented in Fig. 7 and Fig. 8.

Temperature readings of our acquisition system were always compared with a commercial thermometer (handheld digital thermometer 620-0916 from VWR) with a replacement probe 620-1666 (also from VWR) whose accuracy is 0.5°C for range of reading from -50 to 200°C. Three testing temperatures were chosen. For the ice-water temperature, beaker with deionized water and ice in constant stirring was prepared, and care was taken to avoid ice depletion during measurements (Fig. 7, point 4). Regarding the ambient temperature, a beaker with plain deionized water was prepared (Fig. 7, point 6). Similarly, boiling water temperature measurements, a beaker with deionized water on a heating mantle with stirring was prepared (Fig. 7, point 5). All these measurements were performed at room temperature.

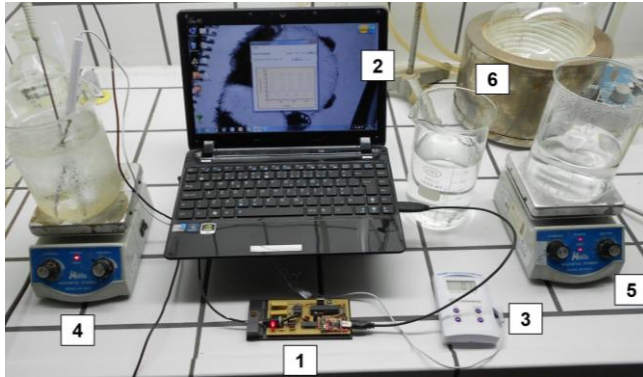

Fig. 7 The completed homemade sensor and its testing. a, Overall picture: 1, sensor; 2, controlling computer; 3, commercial thermometer (for comparison); 4, ice cold water container; 5, hot water container; 6, room temperature water container.

The Fig. 8 show the sensor close-up that was used in the temperature sensor.

The evolution of temperature when systematically passing from ice-water (stage 1 in Fig. 9 a) to room temperature (stage 2) and boiling water (stage 3), and then back to ambient temperature and ice-water. Our thermometers showed a reading time of 1 second and quick response; it was found that, for the wider temperature difference (between water at ambient temperature and boiling), the temperature stabilized in less than 10 seconds, a similar result compared to a commercial thermometer.

Although the calibration of the two thermometers was beyond the scope of the testing, it was found that both thermometers responded very well to the temperature of boiling water ($100.5 \pm 0.6^\circ\text{C}$ for our thermometer and $100.5 \pm 0.3^\circ\text{C}$ for the commercial one, Fig. 9b) and the melting temperature of ice ($-0.8 \pm 0.5^\circ\text{C}$ for our thermometer and $-0.1 \pm 0.1^\circ\text{C}$ for the commercial one, Fig. 9d). Regarding water, at room temperature (Fig. 9c) a slight increase in temperature over time was verified. This was due to the proximity of the beaker with water at room temperature (Fig. 7 a, point 6) and the beaker with boiling water (Fig. 7 a, point 5). From the analysis of these 10 measurements, and disregarding the heating effect, an average water temperature of $19.9 \pm 0.2^\circ\text{C}$ for both systems was obtained. Generally both thermometers achieved the same temperature value, with accuracies with 95% confidence level in the order of tenths of a degree.

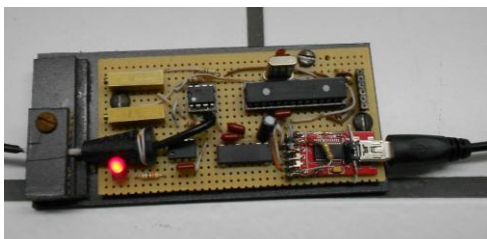

Fig. 8. Sensor close-up.

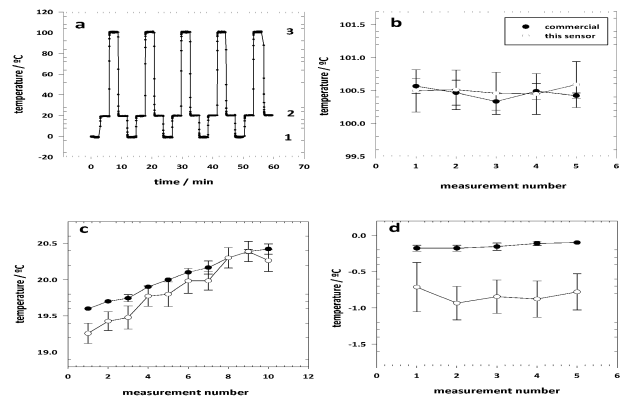

Fig. 9 Testing results. a, temperature evolution over time (in minutes) when the sensor was dipped in 1-ice-water, 2-room temperature water and 3-boiling water. Comparison between this sensor (open circles) and a commercial thermometer (closed circles) dipped in b-boiling water, c-room temperature water and d-ice-water. Results are mean \pm standard deviation (95%) for 5 measurements periods (the stages in a 1, 2 and 3) in b and d, and 10 measurements in c.

V. CONCLUSION

In this work the design, development, and testing of a user-friendly, cost-effective do-it-yourself temperature sensor was presented. This project served two main goals. On the one hand, it is a solution to a common laboratory problem – the continuous and slow record of a variable, in this case, the temperature. Because herein developed sensor is automated, several measurements can be performed and recorded during enlarged periods of time without human intervention. The thermometer rapidly responds to temperature variations in a precise and exact fashion. Furthermore, the sensor was assembled with components from discarded equipment, which not only reduces costs of production but also contributes to recycling purposes. On the other hand, the whole process was of pedagogical interest. Students were asked to obtain an answer for a proposed problem, which led to the commitment of people with different academic backgrounds. With this approach students can apply concepts learned in classes to real life situations and develop soft skills such as teamwork and long-term focus on a project. Based on the successful conception, design, implementation and operation of this sensor, it can be assumed the possibility of building and remotely controlling other small, useful and inexpensive devices for the reliable measurement of several physical and chemical parameters.

REFERENCES



- [1] X.P. Tracy, I. Edmond, N. Mickleborough. (2012). Promoting Multi-layered Peer Learning in a Course on Engineering Grand Challenges. *Procedia – Social and Behavioral Sciences* [Online]. 56, pp. 74-87.
- [2] A. Trindade, B. Falcão, L. F. N. D. Carramate, M. I. S. F. Marques, R. A. S. Ferreira and P. S. André. (2014). Low-cost spectrograph based on a WebCam: a student project. *International Journal of Electrical Engineering Education*. [Online]. 51(1), pp. 1-11.
- [3] M.Carmen Estevez, Mar Alvarez and Laura M. Lechuga. (2012). Integrated optical devices for lab-on-a-chip biosensing applications. *Laser Photonics Rev.* [Online]. 4, pp. 463-487.
- [4] J. Inczédy, T. Lengyel. (1998). Pure and International Union of Pure and Applied Chemistry, *Compendium of analytical nomenclature: Definitive rules 1997*. (6th ed.) [Online]. Blackwell Science, Osney Mead, Oxford, Malden, MA.
- [5] Perry's chemical engineers' handbook, 8th ed. McGraw-Hill Companies, Inc., McGraw-Hill, New York, 2008.
- [6] W. Billy, G. Mangum, T. Furukawa, "Guidelines for Realizing the International Temperature Scale of 1990 (ITS-90)", NIST technical note 1275, 1964.
- [7] P. R. N. Childs, J. R. Greenwood and C. A. Long. (2000). Review of temperature measurement. *Review of scientific instruments*. 71(8), pp. 2959-2978.
- [8] V. M. Quan, G. S. Gupta, S. Mukhopadhyay. (2011). *Review of sensors for greenhouse climate monitoring. Sensors Applications Symposium – IEEE*. pp. 112-118.
- [9] Microchip Technology Inc. (2006). High-Performance, Enhanced Flash Microcontrollers with 10-Bit A/D. [Online] Available: <http://ww1.microchip.com/downloads/en/DeviceDoc/39564c.pdf>