

West Chester University

## Digital Commons @ West Chester University

---

Sustainability Research & Practice Seminar  
Presentations

Sustainability Research & Creative Activities @  
WCU

---

11-20-2019

### Copenhagen: Sustainable by Design

David P. Jones

*West Chester University of Pennsylvania*, [djones2@wcupa.edu](mailto:djones2@wcupa.edu)

Karen M. Watkins

*West Chester University of Pennsylvania*, [kwatkins@wcupa.edu](mailto:kwatkins@wcupa.edu)

Follow this and additional works at: [https://digitalcommons.wcupa.edu/srca\\_sp](https://digitalcommons.wcupa.edu/srca_sp)



Part of the [Sustainability Commons](#)

---

#### Recommended Citation

Jones, D. P., & Watkins, K. M. (2019). Copenhagen: Sustainable by Design. Retrieved from [https://digitalcommons.wcupa.edu/srca\\_sp/13](https://digitalcommons.wcupa.edu/srca_sp/13)

This Seminar Presentation is brought to you for free and open access by the Sustainability Research & Creative Activities @ WCU at Digital Commons @ West Chester University. It has been accepted for inclusion in Sustainability Research & Practice Seminar Presentations by an authorized administrator of Digital Commons @ West Chester University. For more information, please contact [wcrestler@wcupa.edu](mailto:wcrestler@wcupa.edu).

K Ø B

E N H

A V N

# Thank you

AINSLEY HUME

AMANDA BROOKS

ANDREW SNYDER

CHERYL WANKO

THE OFFICE OF SUSTAINABILITY

GLOBAL RAM PROGRAM

HEATHER SHARPE

JEN BACON

JEREMY HOLMES

JOHN GONTARZ

KATE WICKERSHAM

LAURIE MORAN

WILL MCGRORY

WCU INSTRUCTIONAL MEDIA CENTER

THE WCU FOUNDATION

BRAD FLAMM

K Ø B

E N H

A V N

# Danish Design

Who.

What.

When.

Where.

Why.

Arne Jacobsen.

What.

When.

Where.

Why.

Arne Jacobsen.

A chair.

When.

Where.

Why.



Arne Jacobsen.

A chair.

1925.

Where.

Why.

Arne Jacobsen.

A chair.

1925.

Paris.

Why.

Why?



















CHEMIN DE FER DU NORD

A.M.CASSANDRE

# NORD EXPRESS

SOUTHERN RAILWAY - CHEMINS DE FER BELGES

DEUTSCHE REICHSBAHN GES. - POLSKIE KOLEJE PANSTWOWE

LONDRES BRUXELLES PARIS LIEGE BERLIN VARSOVIE RIGA  
COMPAGNIE DES WAGONS - LITS

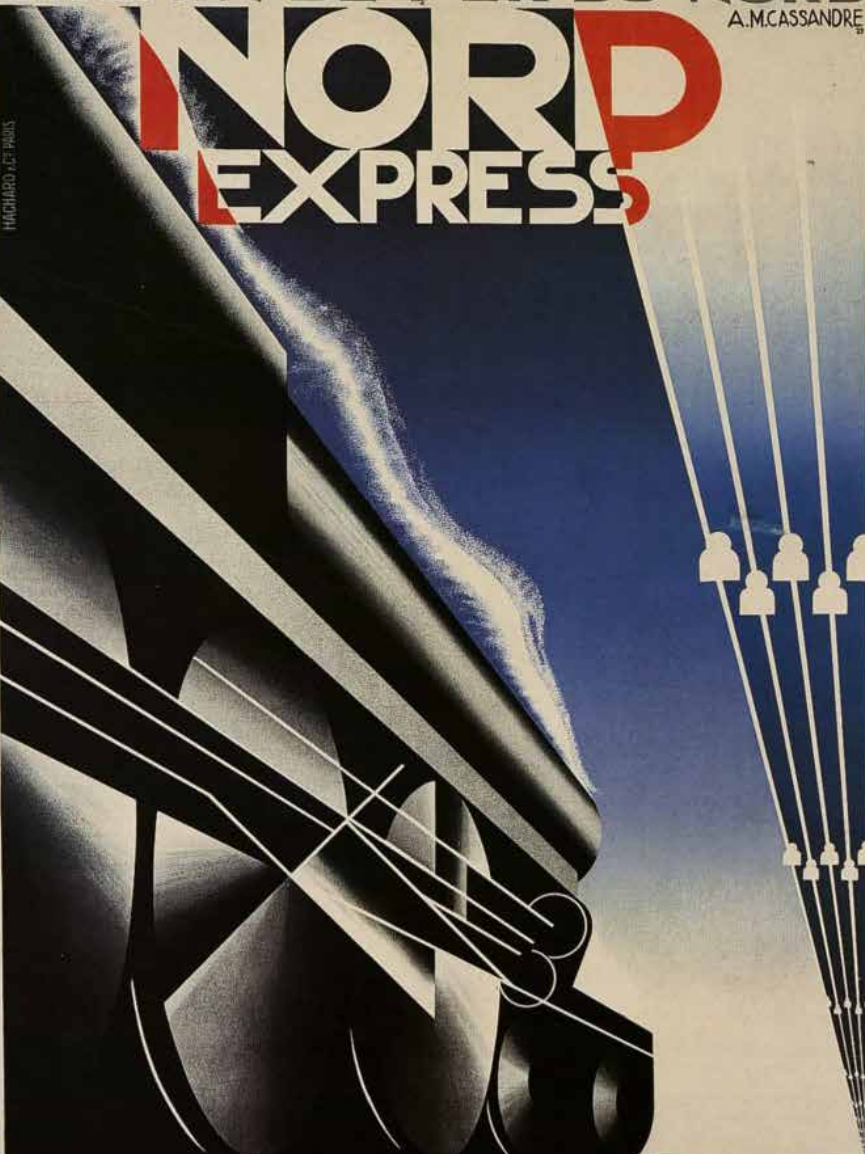

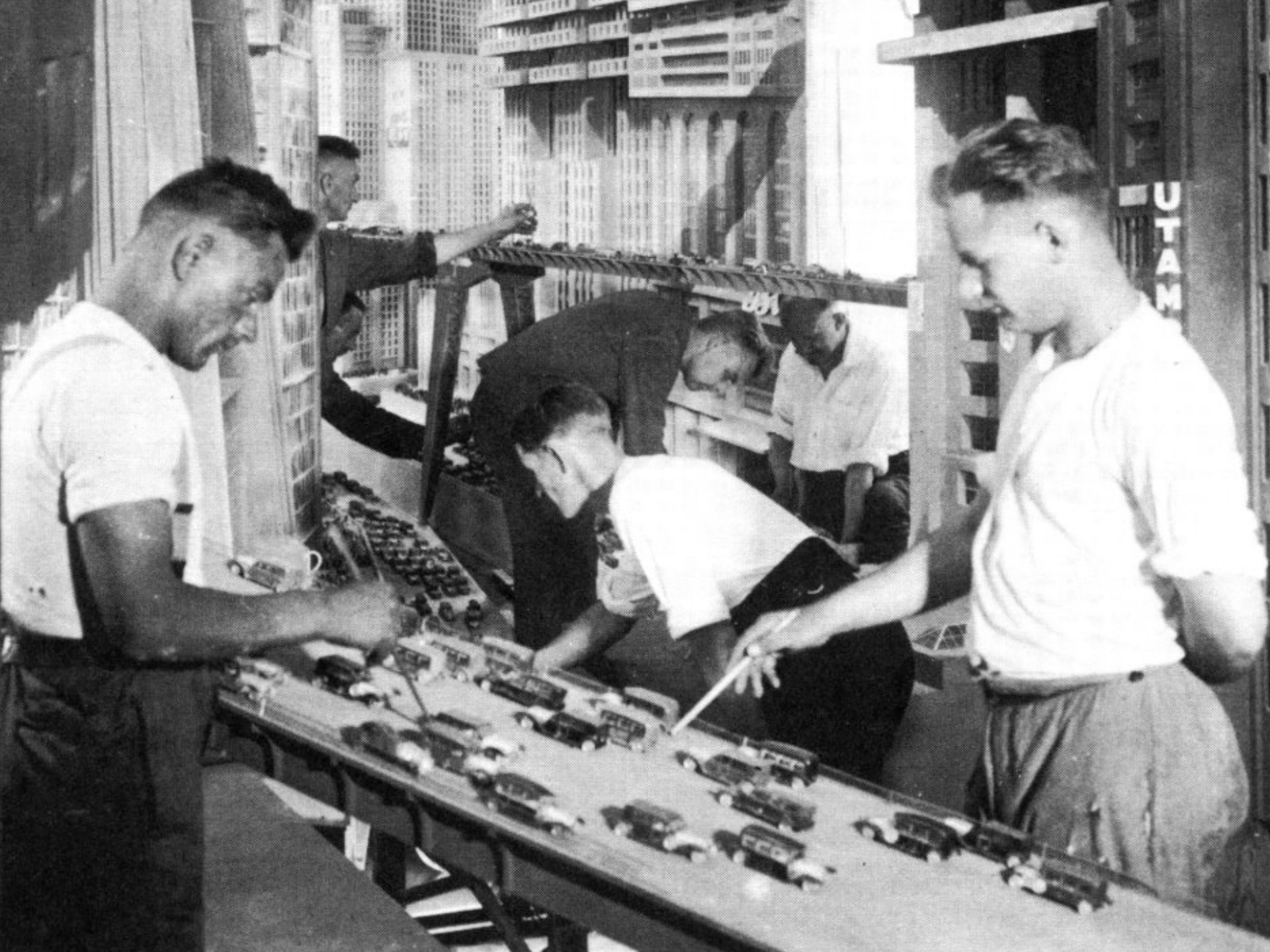



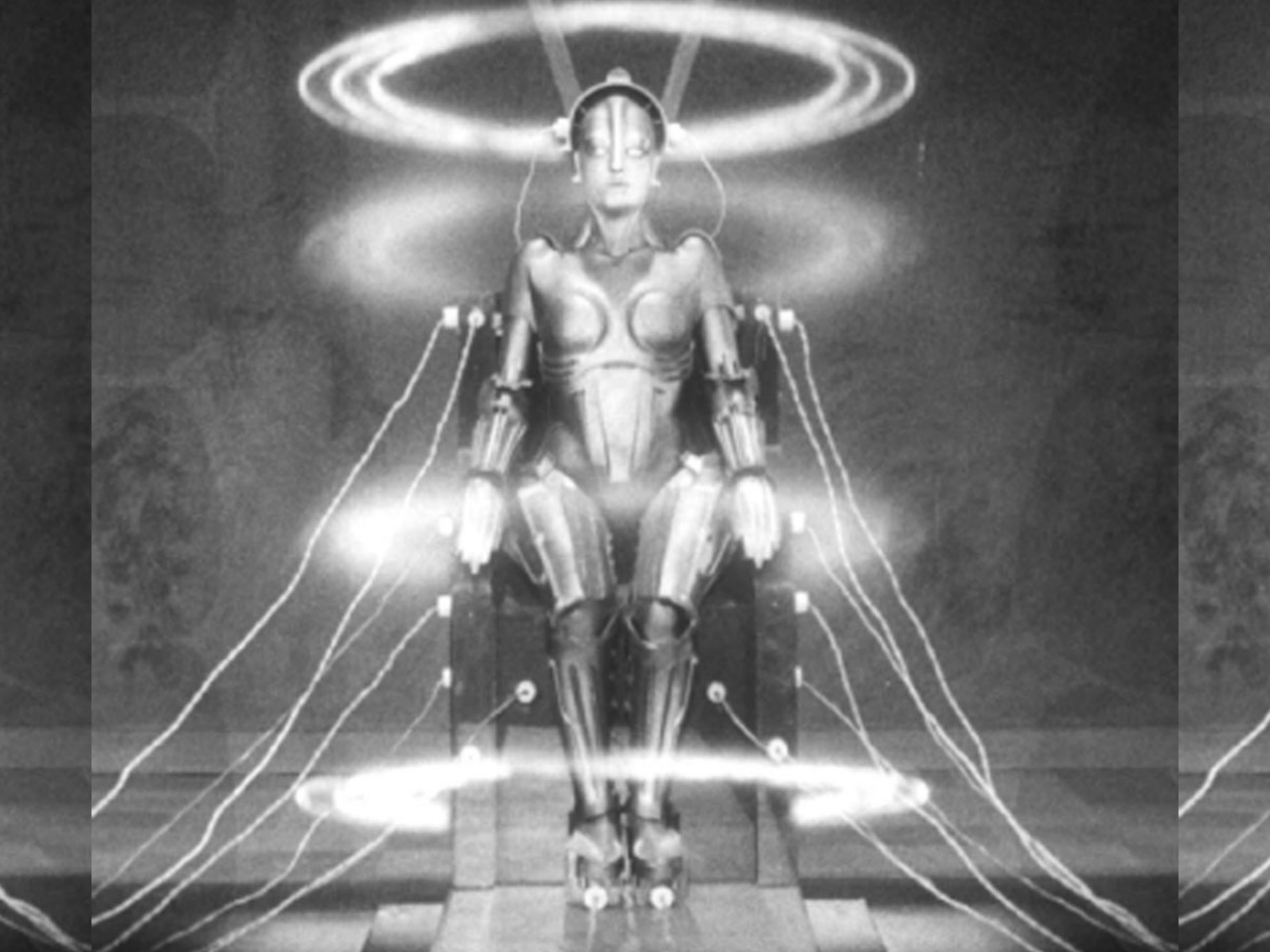

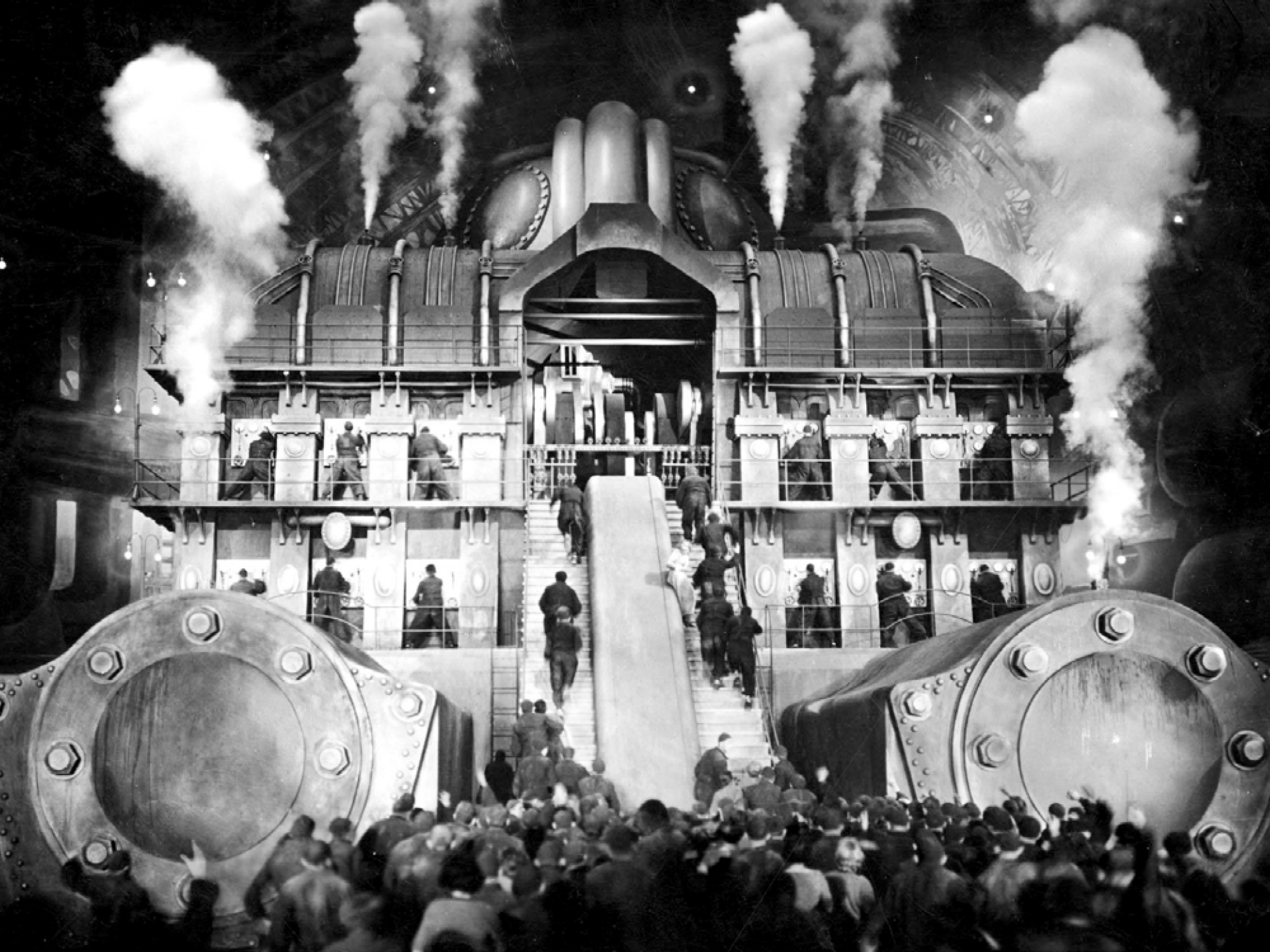



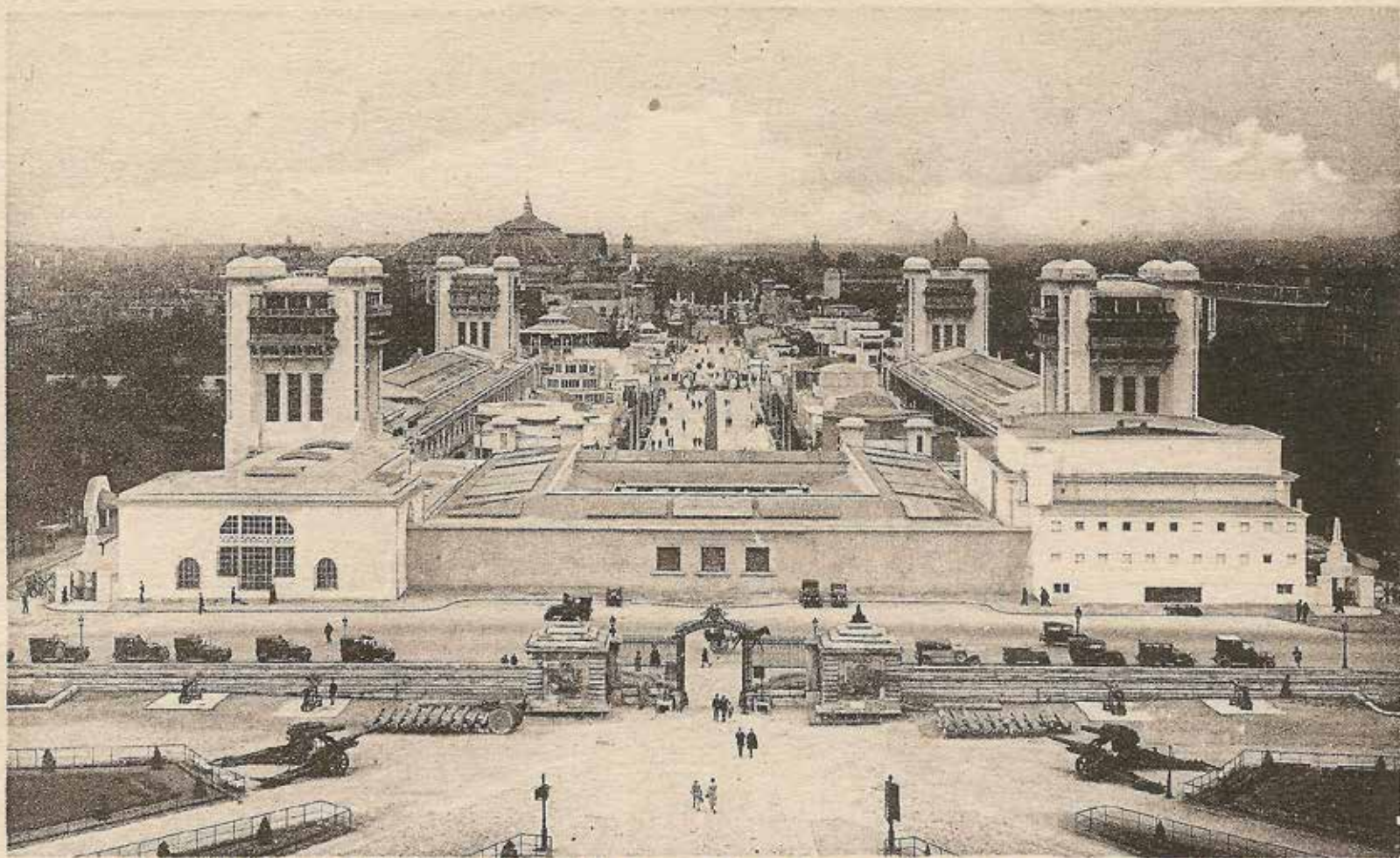

EXPOSITION INTERNATIONALE DES ARTS DÉCORATIFS — PARIS 1925  
1- Vue Générale sur l'Esplanade des Invalides — *Principal view on the "Esplanade des Invalides"*

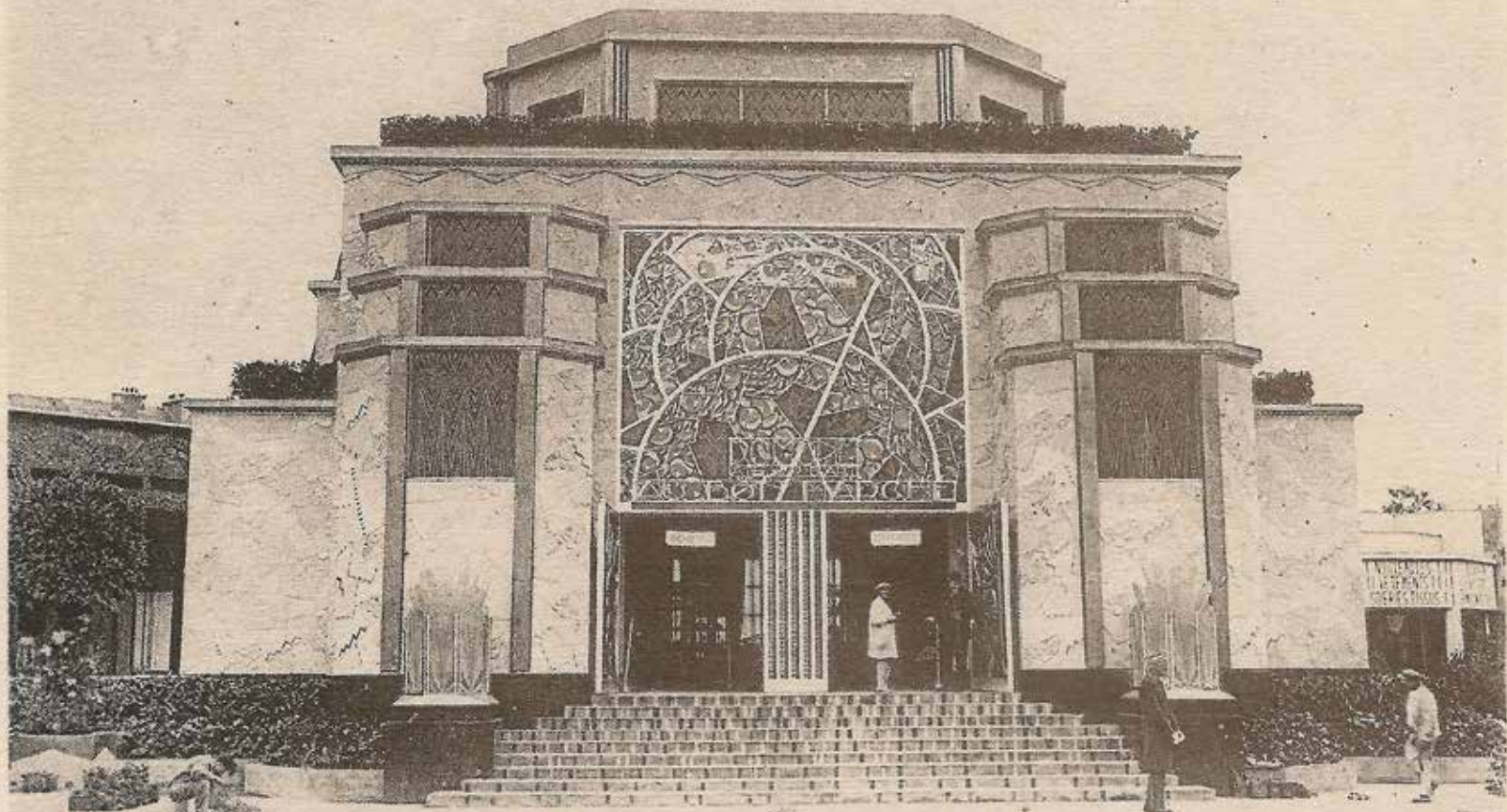

EXPOSITION INTERNATIONALE DES ARTS DÉCORATIFS — PARIS 1925  
15 - Le Pavillon du Bon Marché — *The Pavilion of the firm "Bon Marché"*







Proportionally sound.

Proportionally sound.

Simple forms.

Proportionally sound.

Simple forms.

**Pragmatic and versatile.**



Proportionally sound.

Simple forms.

Pragmatic and versatile.

**Democratic.**

Proportionally sound.

Simple forms.

Pragmatic and versatile.

Democratic.

Let the materials speak.



Proportionally sound.

Simple forms.

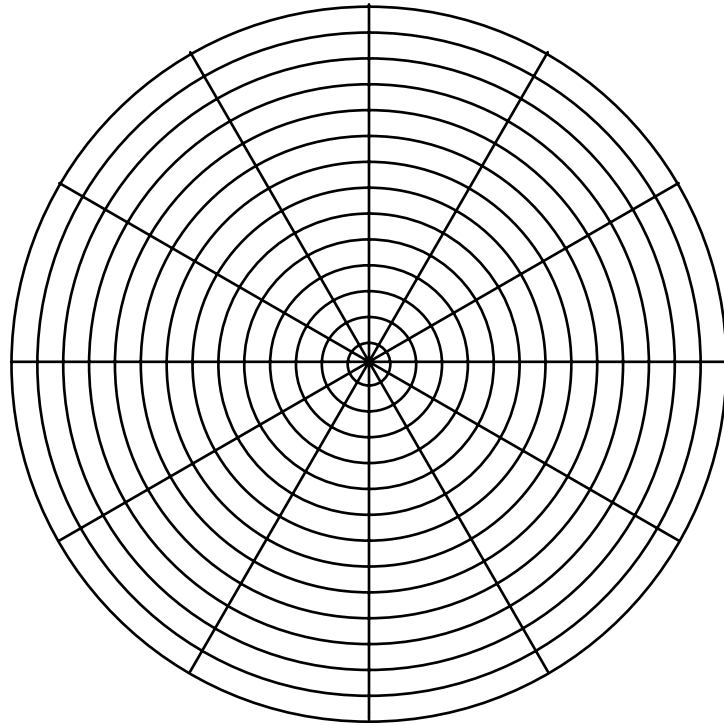

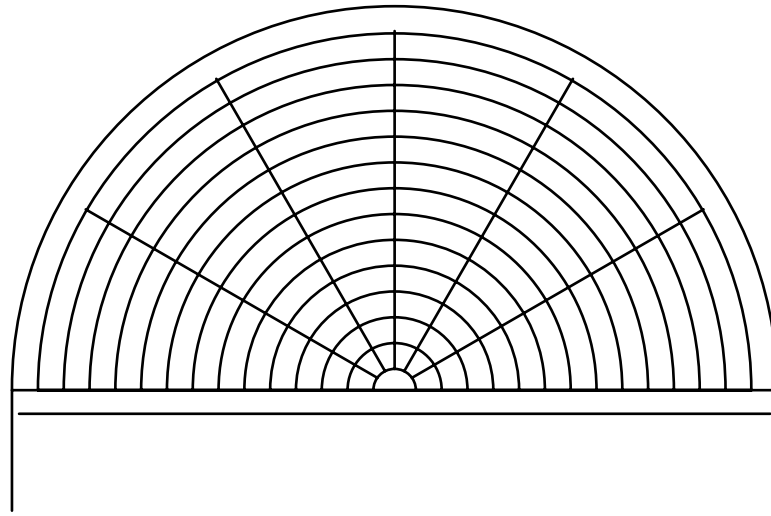

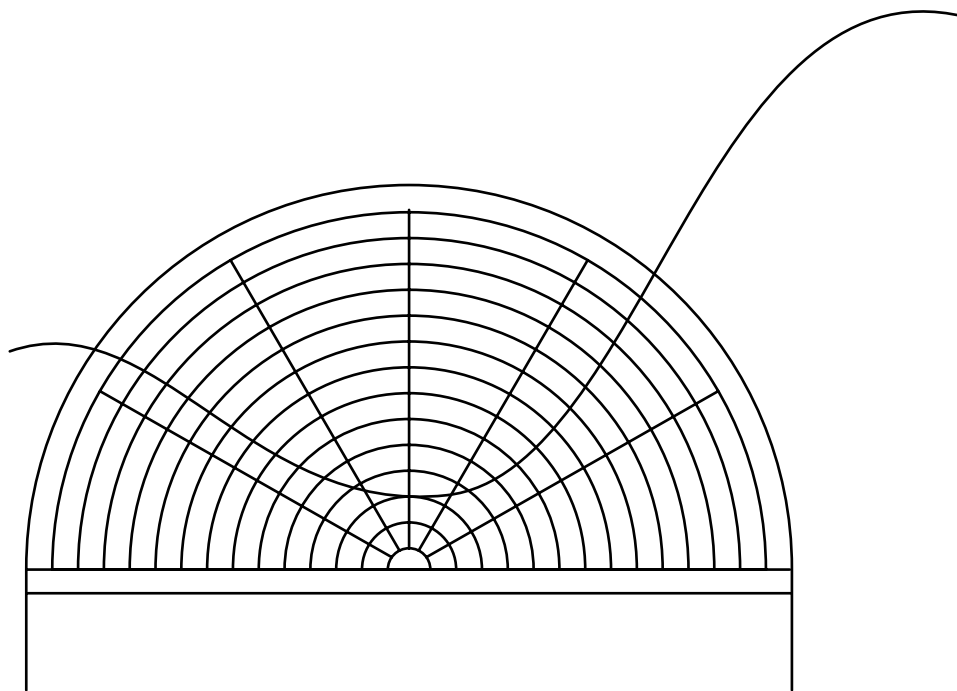





Pragmatic and versatile.

Democratic.

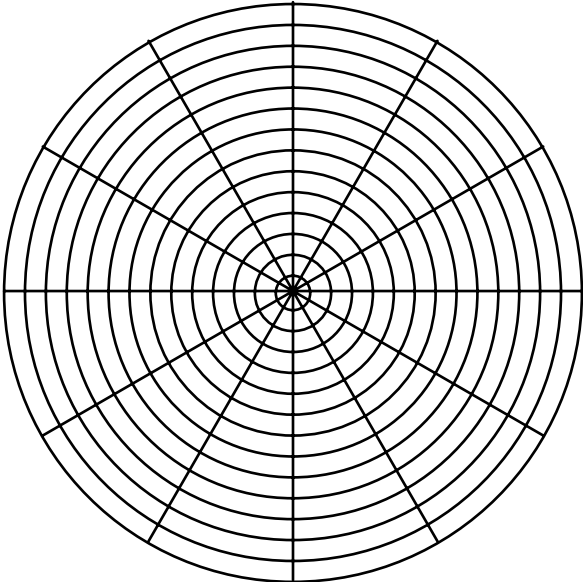











ARoS Triennial  
The Garden  
2018-2020  
ARoS Aarhus Art Museum  
Aarhus University











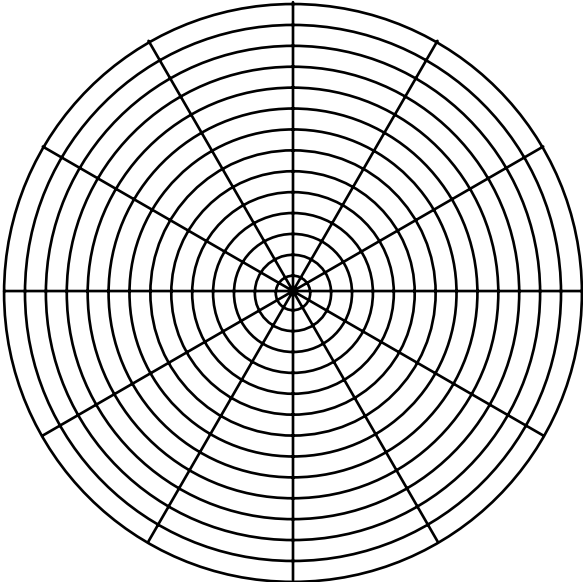

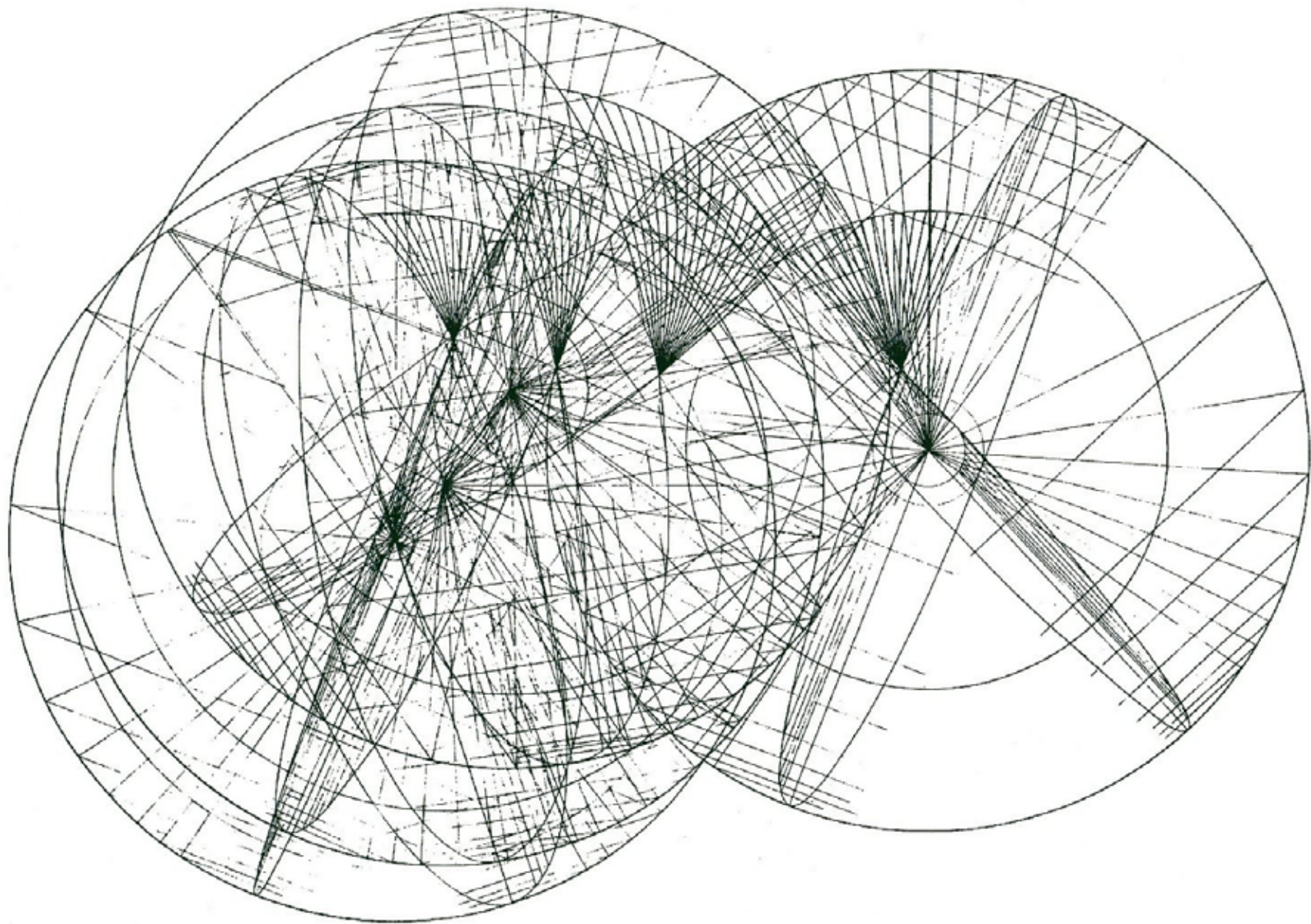

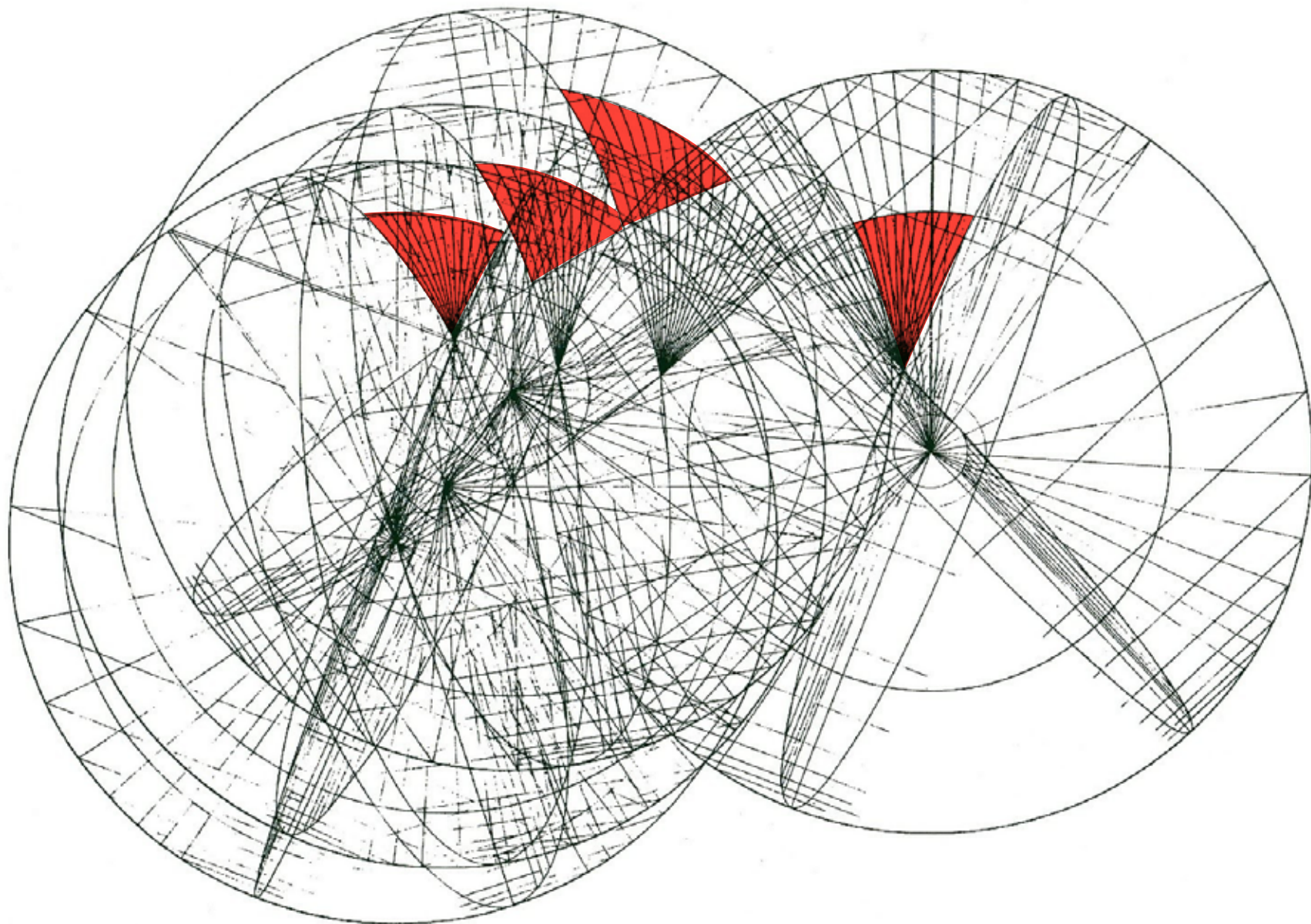

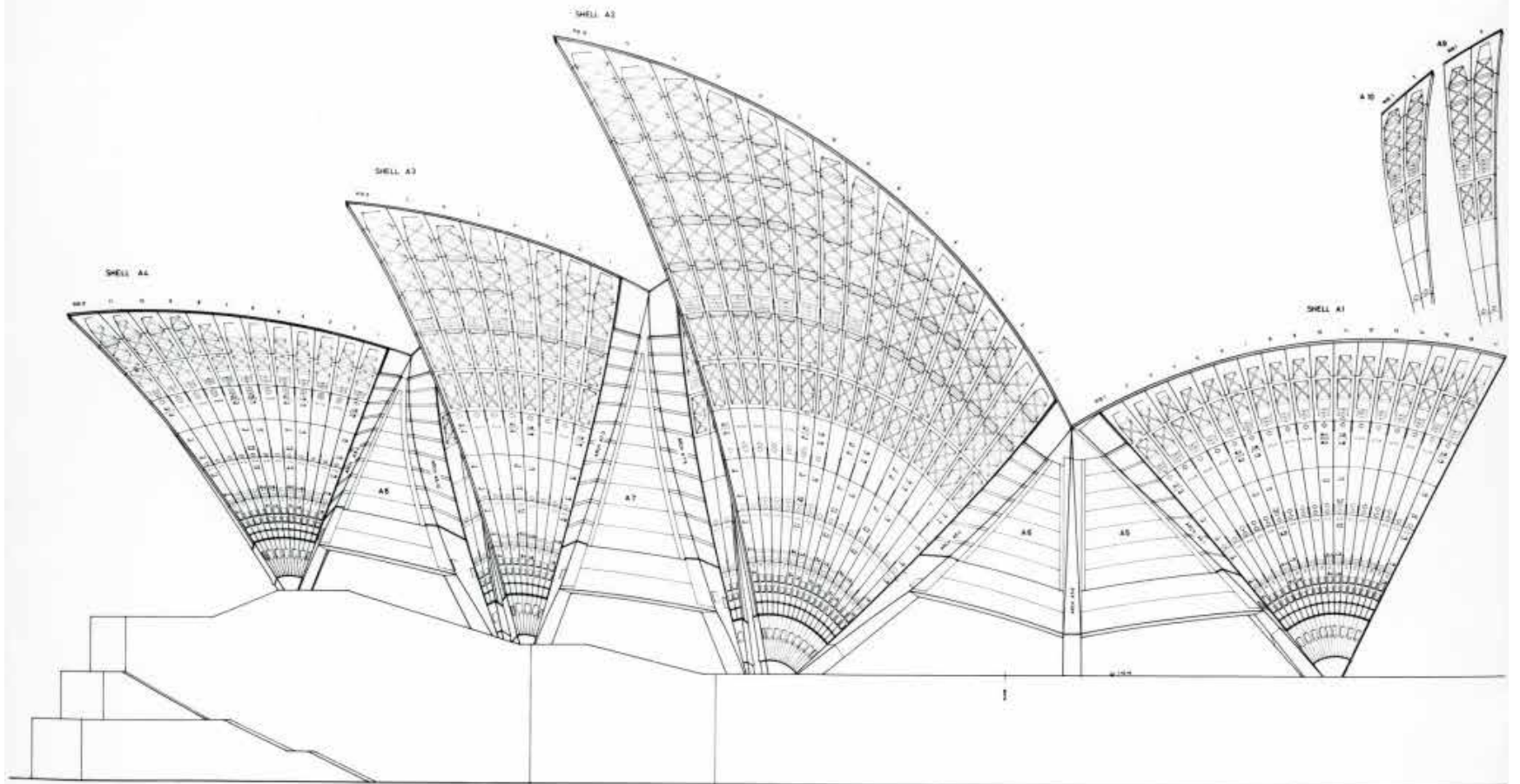

SECRET, STARS, GDSGS  
 WJDA-WJLL  
 ELEVATION OF SUPERSTRUCTURE  
 ... .. NO 1112-56-1013









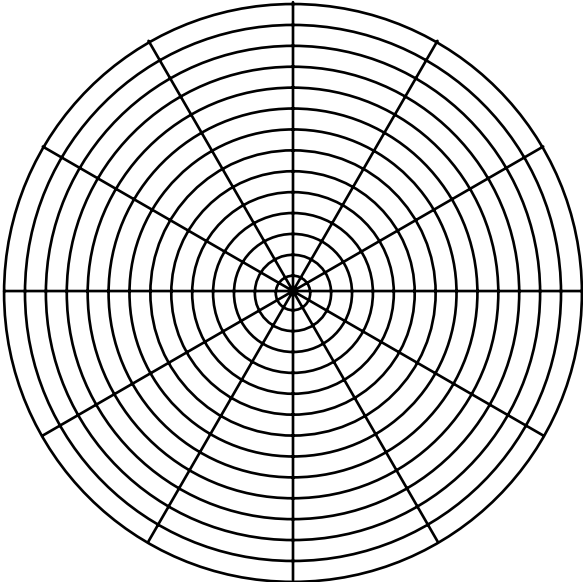













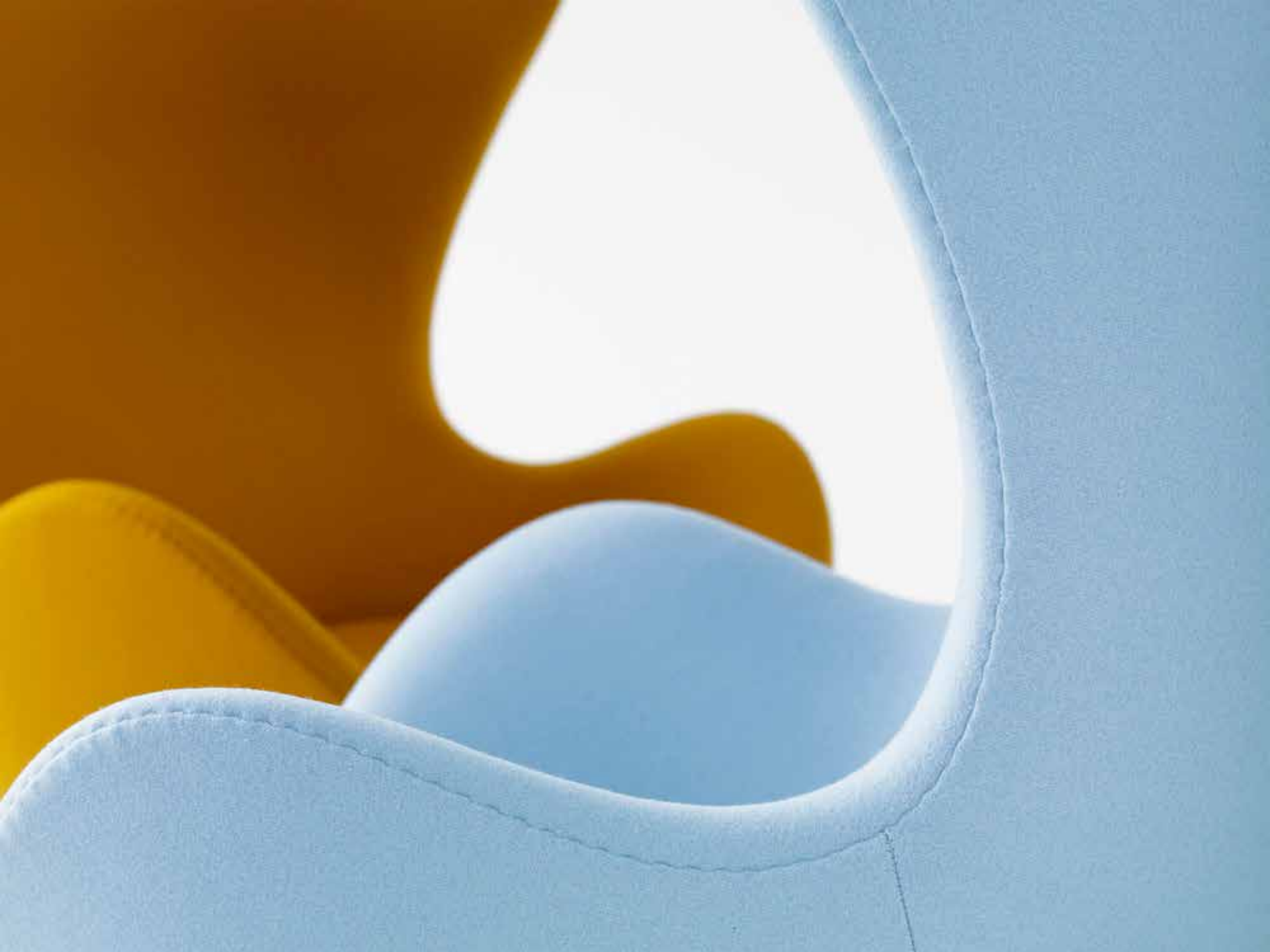



SAS

HOTEL

AIR TERMINAL

Luigi

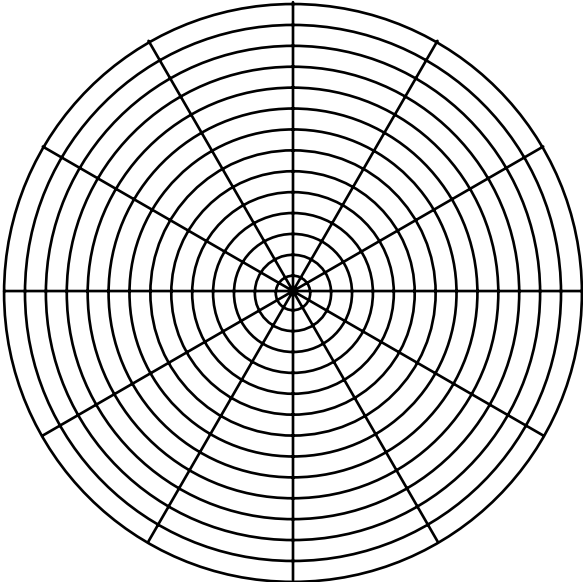

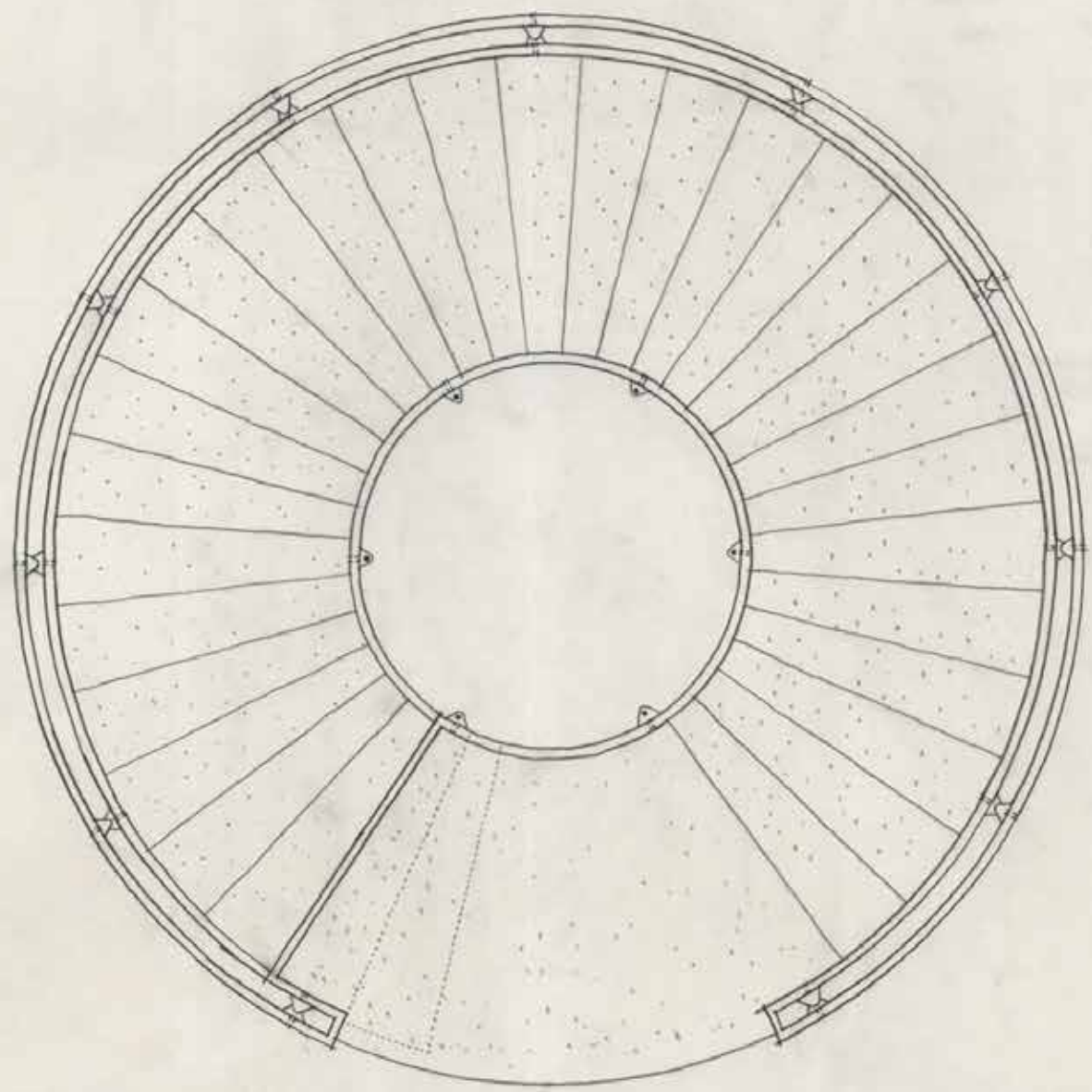

MAPPE 7 1130

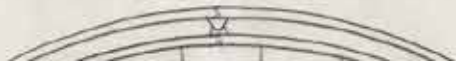
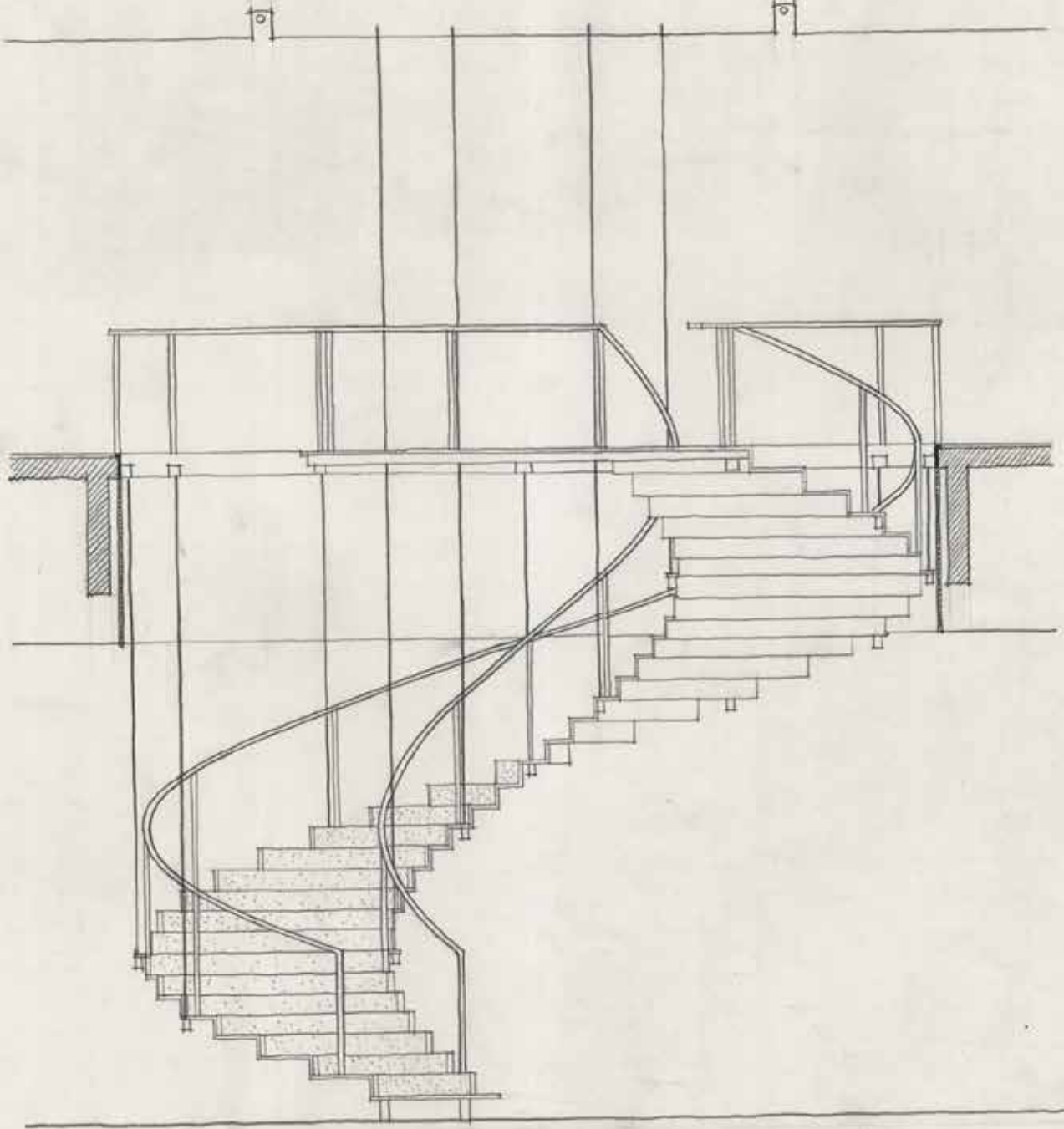





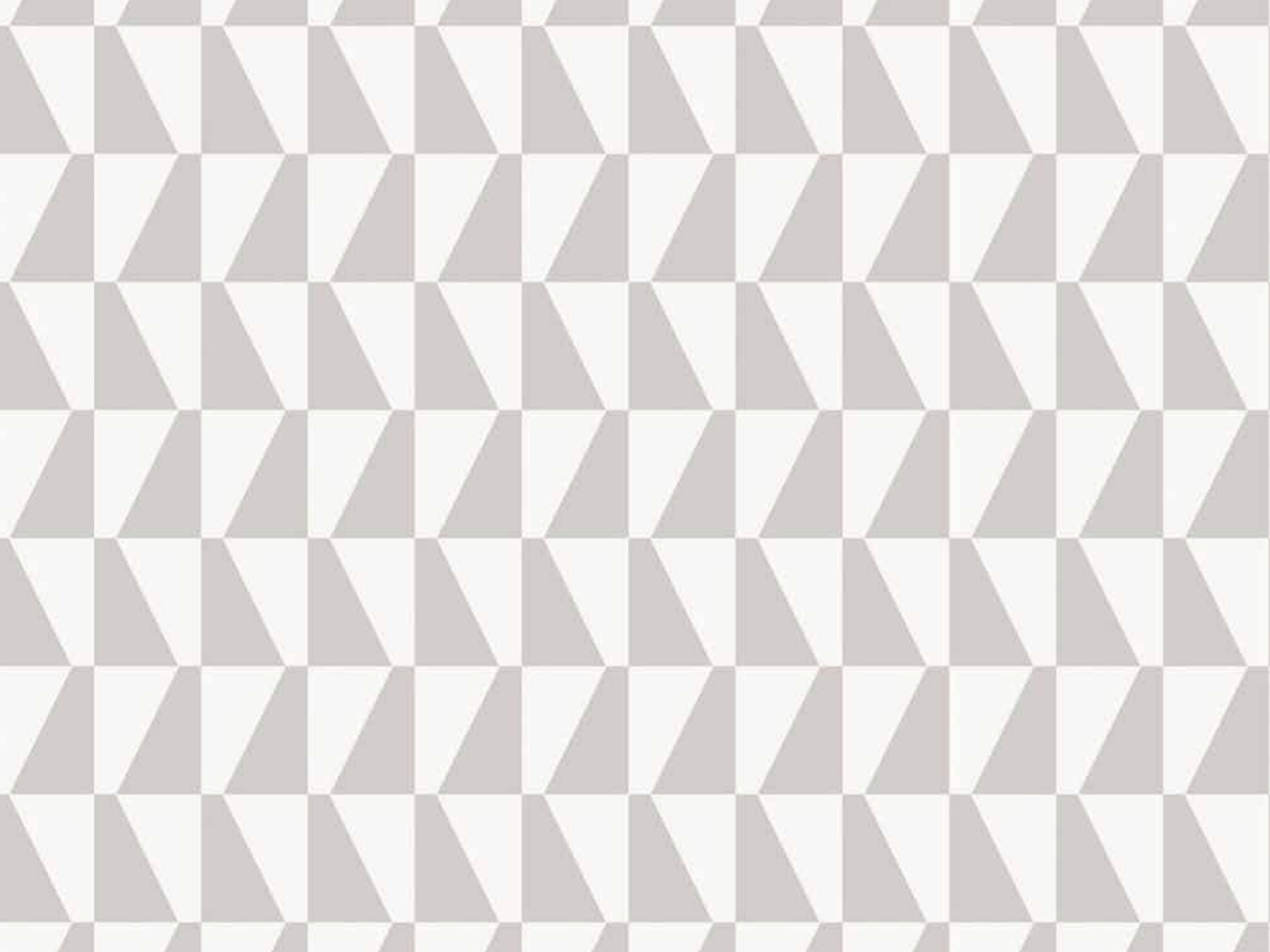



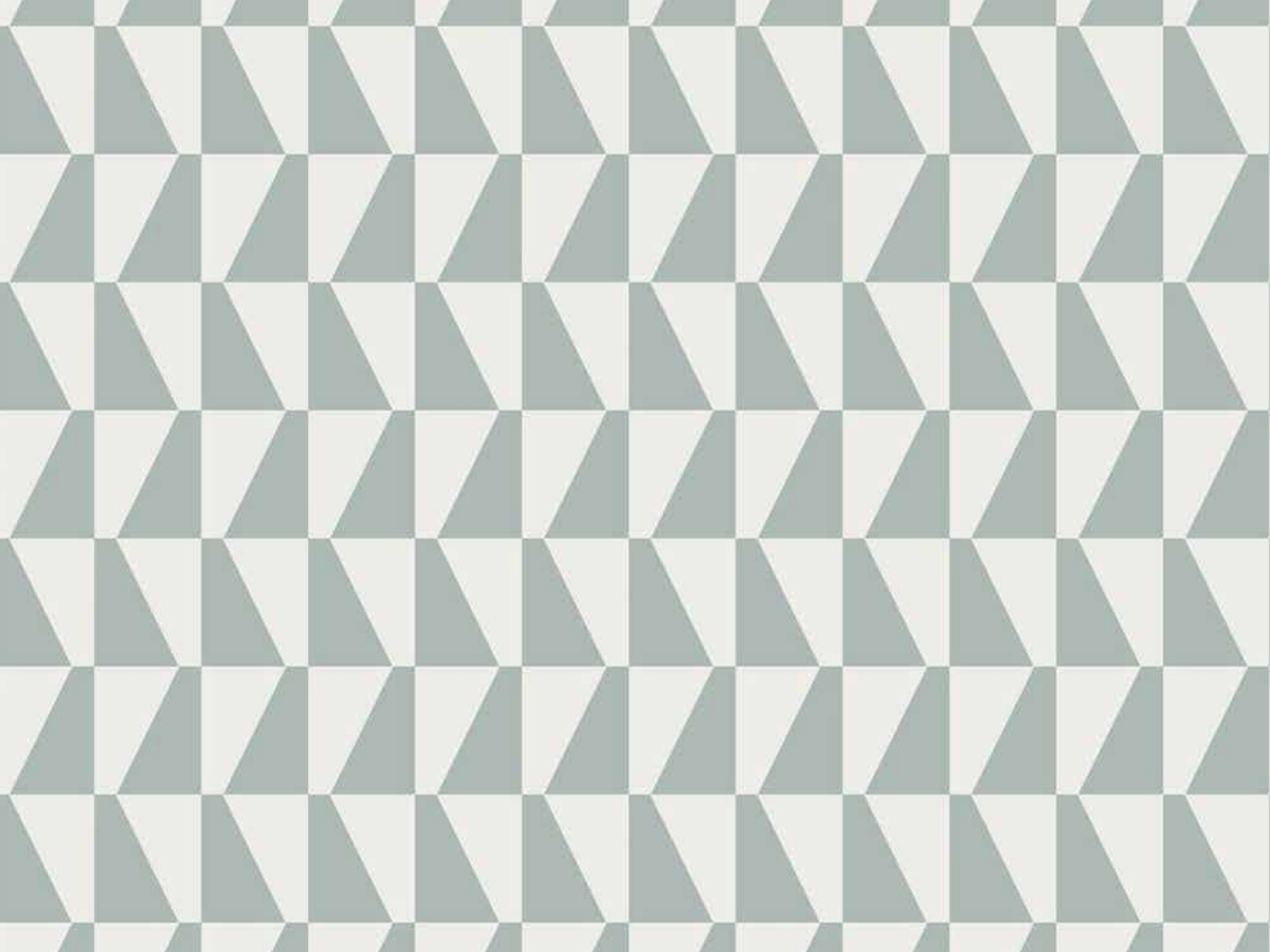

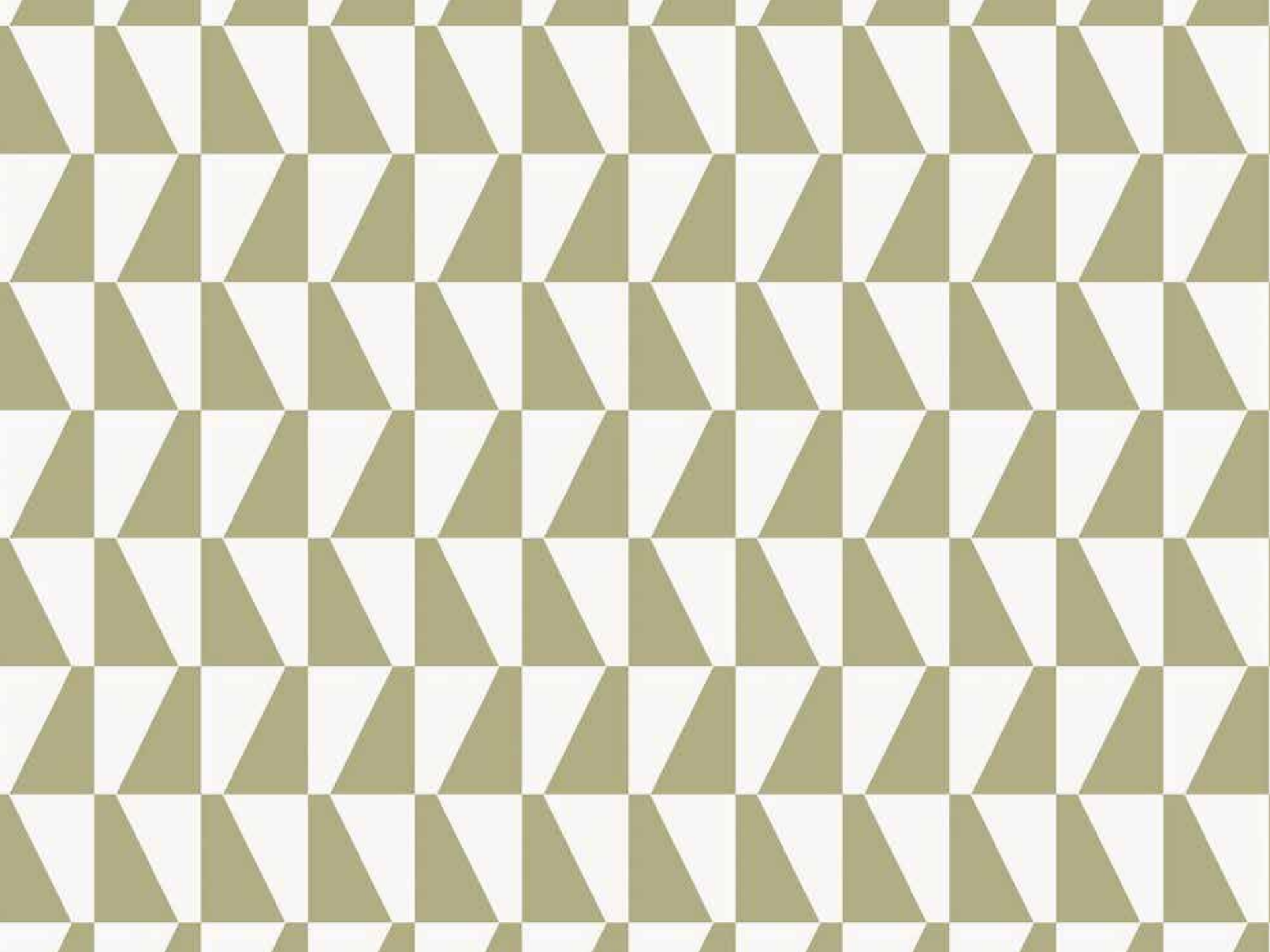



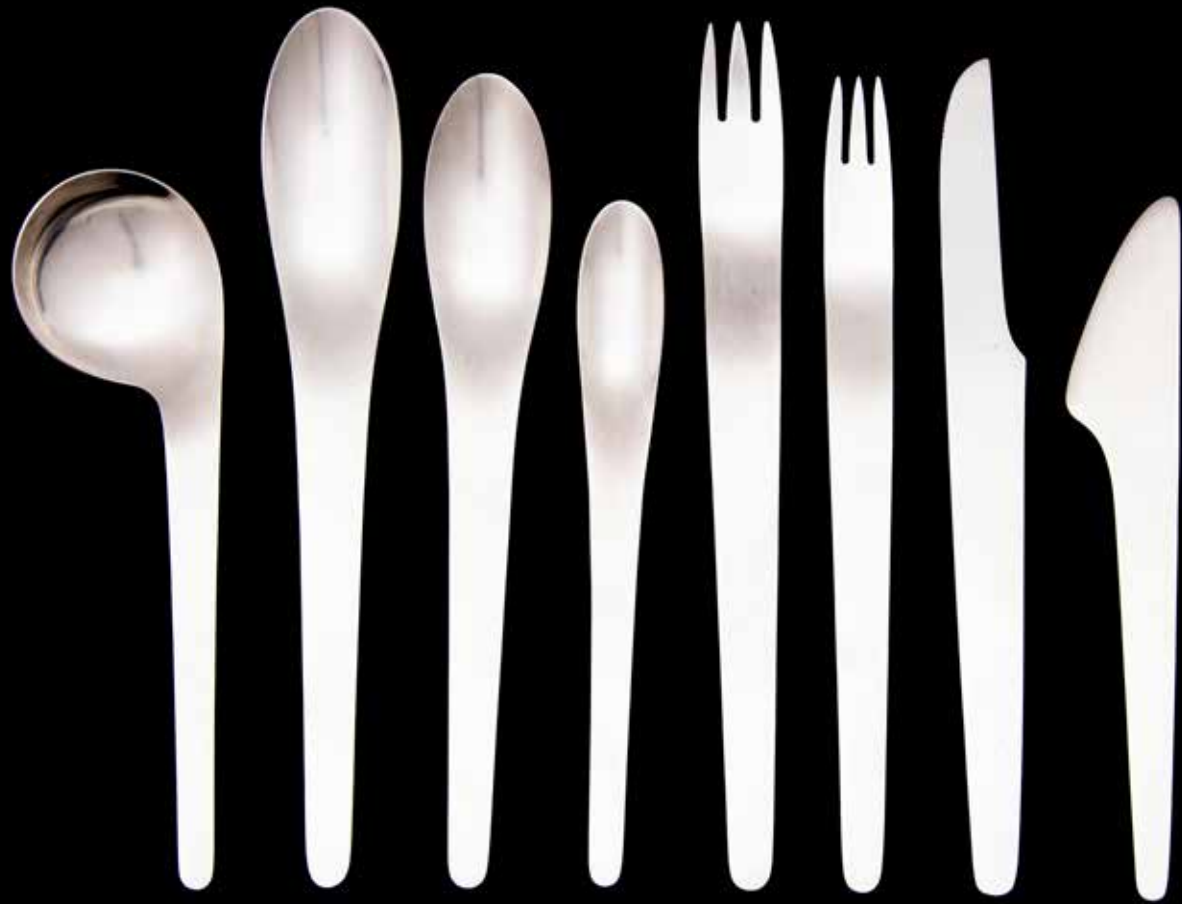





# Gesamtkunstwerk

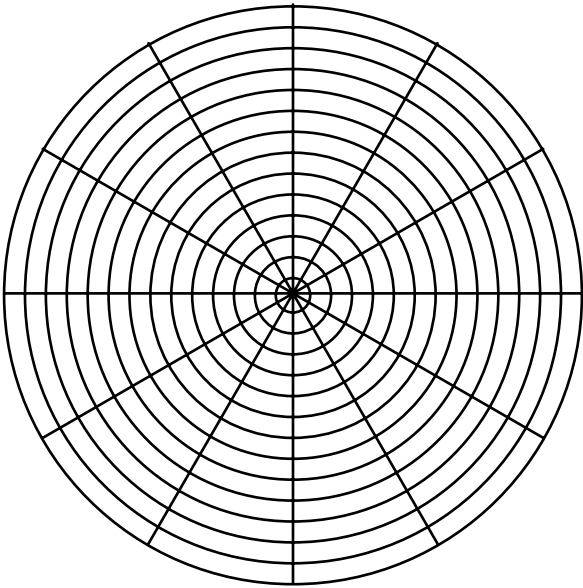



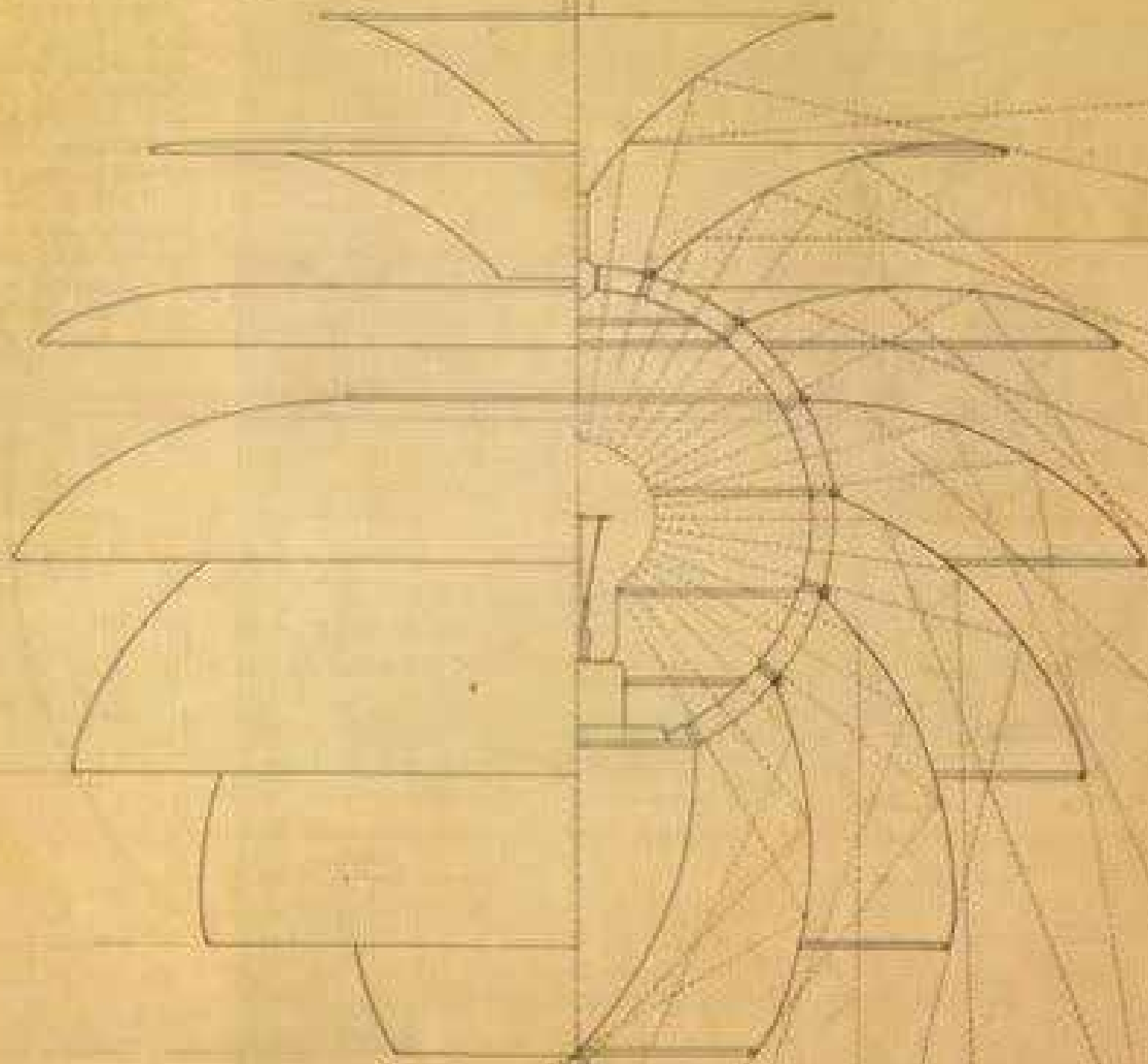

Let the materials speak.

























BY APPOINTMENT TO THE  
ROYAL DANISH COURT

Carlsberg

DANISH  
PILSNER

1847 ONWARDS

BEER IN THE WORLD



PLANTYPES



# Tupografi







UDSTILLING

GRØNLAND  
1932

radio  
UDSTILLING

DE STORE  
AUTOMOBIL  
UDSTILLING  
FORUM

KØB  
KOMMUNENS  
TAVLS

TIVOLI

Danmarks radio

OKAFI  
ZOO  
KØBENHAVN

INDEN  
FILM!

Stævning  
eller  
Kaos  
Socialdemokratisk!

STÆVNING  
OL

ØSERI  
Der skuder  
's alle...

Til Kom med Spild  
Spilindsomlingen er en  
national Opgave

NORDISK  
REKLAME  
KONGEN

Knopern

Knopern

INTERNATIONAL  
TOMOBIL  
UDSTILLING  
KØBENHAVN 23 FEBR - 4 MARCH 1938

MADGA

MADGA

ØSERI

ØSERI

ØSERI

ØSERI

ØSERI

ØSERI

# danish chair

International  
fair







A' DESIGN AWARD  
& COMPETITION 

AWARD WINNING DESIGN  
GOLD A' DESIGN AWARD

2018





LIBEREMUS PRO PATRIA







Samtidig er Priserne på  
for Heltflækker (70 cl)  
" Heltflækker (35 cl)

POLITIKKEN

Novbr 1919

# Carlsberg Mineralvande

Carlsberg  
Apollinaris

og Carlsberg  
Citronsaft

fremstillet af Vand fra egne Bredde der  
ifølge videnskabelig Undersøgelse  
afgiver det sundeste og reneste Vand  
tilvirket under Iagttagelse af alle  
hygiejniske Fordringer saavel hvad  
Fabrikation som Afføpning angaar

Under Kontrol af  
Carlsberg Laboratorium  
er bedste



Prøv **Kick** - den nye Drik  
... køler fra første Slurk...



SHOOT ALL

SPRING  
BREAK















# Images

THEATLANTIC.COM

ARCHITECTURALDIGEST.COM

ARTNET.COM

BRITANNICA.COM

COLLECTIONS.ARTSMIA.ORG

COMPETITION.ADESIGNAWARD.COM

EXHIBITIONS.GUGGENHEIM.ORG

HARPGALLERY.COM

ICONTEXTILES.CO.NZ

INTERNATIONALPOSTER.COM

MAAS.MUSEUM

SCANDINAVIASTANDARD.COM

SKANDIUM.COM

SOTHEBYS.COM

SYDNEYDESIGNSCHOOL.COM.AU

TATE.ORG.UK

K Ø B

E N H

A V N