



Optimum Design for Controlling the Scouring on Bridge Piers

Abdul-Hassan K. Al-Shukur ^a, Manar Hussein Ali ^{b*}

^a Professor, Department of Civil Engineering, Faculty of Engineering, Babylon University, Babylon, Iraq.

^b M.Sc. Student, Department of Civil Engineering, Faculty of Engineering, Babylon University, Babylon, Iraq.

Received 25 May 2019; Accepted 24 August 2019

Abstract

The scouring around bridge pier can be considered the most important reasons of bridge failure. Therefore, we investigated by using physical models of piers and we used single pier with square collar, circular collar and interaction of two piers in laboratory channel, its width 1 m and applied three velocities (0.1, 0.08, and 0.07) m/sec. This experimental investigation was made to choose the optimum shape and location of collar of single pier and comparing it with the interaction of two piers, the results showed that both square and circular collar decrease the scour depth, but the square collar is more effective of reducing scouring and the best location at bed level for single pier, comparing the results of single pier with the interaction of two piers, the interaction of two piers without any countermeasure reduced scour depth about 58%.

Keywords: Bridge Piers; Collar; Scour; Interaction.

1. Introduction

Scour can be considered a natural reaction caused by the erosive action of flowing water in the channels and river bed. This can be happened by removing sediment particles near structure that is existed in flowing water. This erosive action of water leads to reduce the river bed level as a result foundation fails by converting it from stable state to unstable state [1]. Many reasons can cause scour of sediment and cause different temporal range in level of bed sediment, in case of normal flow, scour occurs slowly by moving sediment around structure that is located in flowing water and transport it to another side, this type of scour can be prevented by observation and maintenance, but the main reasons to scour sediment with a large amount and cause damage of structure is flood [2].

The existing of bridge pier in flowing water streams produces a three dimensional reaction of flow, there is an additional pressure head upstream of the pier due to hitting of water to bridge pier which then makes its path down into the scour hole and a horseshoe vortex is formed, the accumulated flowing water on the surface pushes back as a result bow wave creation is completed and the water that existed around the pier takes its path down and produces a wake vortex, from that above it can be define the local scour as a combination that results from the horseshoe and wake vortices. We can define the scour depth is the reduction of the bed sediment level around the obstruction due to removing the sediment [3]. The necessity of scour studying because of difficulties to understand the complex flow and mechanism of scouring that caused of bridge failure in high percentage in many countries of the world and how to find effective solutions to control and predict the scour around bridge piers and prevent bridge failure [4].

The magnitude of scour depth is governed by these factors: velocity of the approach flow, flow depth, pier width, flow rate, pier length if skewed to flow, size and gradation of bed material, the attack angle of approach flow to pier,

* Corresponding author manarhusein868@yahoo.com

 <http://dx.doi.org/10.28991/cej-2019-03091381>



© 2019 by the authors. Licensee C.E.J, Tehran, Iran. This article is an open access article distributed under the terms and conditions of the Creative Commons Attribution (CC-BY) license (<http://creativecommons.org/licenses/by/4.0/>).

shape of pier or abutment, bed configuration, ice formation or jams and debris [5].

Deng and Cia (2010) studied the effect of using collar with rounded shape and founded that the collar divided the region of flow into two parts above the collar and below the collar. The collar make as an obstacle against down flow and decreases its strength and diminish the scour depth therefore the efficiency of collar depends on its size and location according to the bed level [6]. Wang et al. (2017) made reviewing from previous studies, their reviewing showed that the collars are environment friendly that have a good stability, efficiency and a good economical countermeasure [7].

Kumar et al. (1999) studied the effect of collar size and location of reducing the scour depth, it was used circular collar to study the case of reducing the scour depth, and it was found that the larger size in lower level gave little scour depth comparing with the smallest size with higher level [8]. Negm et al. (2009) made an experimental investigation on four types of collar (circular, trapezoidal, triangular, and rectangular) with cylindrical pier of diameter (3) cm; the width of collar was (1.5, 2, 3, 3.5, 4, 4.5 and 5) of pier diameter, it was found that the percentage of scour reduction was 62, 65, 68% and 72% for triangular, trapezoidal, circular and rectangular collar shapes, respectively. Also, it was found for all collar shapes, when the width of the collar was increased the scour depth was reduced to minimum limit. The circular collar reduced the scour depth by 32, 48, 61, 69, 75, 83, 85% and 87% for collar width (1.5, 2, 3, 3.5, 4, 4.5 and 5) of pier diameter, respectively [9].

Jahangirzadeh et al. (2012) investigated of using rectangular collar and its optimum dimensions, it was founded when the collar width increases the scour depth decreases, and therefore the width of the collar is a very important and effective factor on scouring process [10]. Ardeshiri et al. (2014) made a comparison with three types of collars lozenge, circle and square around cylindrical pier, the diameter of pier ($D=40$ mm, 30 mm and 21 mm), the dimension of collar (width= $2D$), it was founded that the lozenge collar was more efficient than the square, the percentage of scour depth decreasing was 70% for square collar and the percentage of scour depth decreasing was 65% for the circle collar [11].

Jahangirzadeh et al. (2014) made an experimental and numerical investigation in two types of collars rectangular collar and circular collar, the results indicated that the rectangular collar gave a scour depth less from circular collar and the percentage of reduction for the rectangular collar was 79% [12]. Chen et al. (2018) investigated experimentally of using hooked collar on cylindrical pier with diameter equal to 4 cm, the diameter of the hooked collar was 1.25 the diameter of the cylindrical pier, the collar was put in two locations, first above bed level equal to 0.25 diameter of the pier, the percentage of reduced scour hole was equal to 24% comparing with the pier without collar and the other position of the collar was at bed level and the percentage of reduced scour hole was 100% or in the same meaning the scour depth was zero [13].

Khodashenas et al. (2018) made a comparison between two types of collars circle and square, the dimensions of them were twice the diameter of the pier with three locations under bed level, at bed level and above bed level, it was found that the square was more efficient than the circular collar and percentage of reduction of scour depth in square collar was 70% while the percentage of reduction in circular collar was 50% and the best location for two collar was under bed [14]. Moncada-M et al. (2009) made experimental investigation on cylindrical pier of diameter 7.3 cm and used circular collar with different sizes and different locations, the size of collar ($W=2D, 3D$) where W the size of the collar and D the diameter of the pier, the results showed that the wider size of collar and near the bed level gave best results to reduce the scour depth [15].

Vittal et al. (2009) made comparison between three cases, the first case group of three piers the angle between them 120 degree, the second single pier with slot and the third single pier with collar, the results showed that the group pier was more effective than the other case and it could be given scour reduction about 40% [16]. Shrestha (2015) made experimental investigation of interaction of two piers with different spacing ($L/D=0$ to 12) where L spacing between two piers from center to center and D diameter of pier, the results showed that the scour depth for the second pier is less than the first pier and for single pier [17]. Raleigh (2015) used experimentally triple collar on cylindrical pier, the dimensions of collar was three times the diameter of the pier and the distance between them $1/6$ diameter of pier, the results showed that the reduction percentage of scour depth about 82 % compare with the single pier [18].

Wang et al. (2016) investigated experimentally of twin piers, it was found that the scour depth for the first pier was higher than the second pier [19]. Keshavarzi et al. (2018) made experimental investigation of interaction of two piers (L/D) from zero to twelve where L spacing between two piers from center to center and D the diameter of the pier with different flow intensities, it was found that the scour depth when the spacing $1 < L/D < 2.5$ increases, in the same meaning when the spacing increases the scour depth at upstream of the front pier increases [20]. Vikas et al. investigated experimentally of using a collar plate at bed level of different sizes, the larger size was three times the diameter of pier and gave zero scour depth, also it was studied the using of triple collar with different spacing between them, it was found when the spacing between collar ($D/6$) reduces the scour by 84 % comparing with the pier without any protection [21].

Malik and Baldev (2018) investigated experimentally of effecting of arrangement and spacing of pier groups, it was taken three cases of arrangement for piers, tandem, side by side and staggered arrangement, they concluded for the tandem arrangement, that the scour depth at upstream of front pier is higher than the scour for the second pier and when

the spacing between two piers is 16 times (16D) the pier diameter then the pier show independent behavior, in the same meaning behave as single pier [22]. Wang et al. (2016) made investigation of interaction of three piers in a tandem arrangement and it was found that the scour depth at upstream of pier was the same in single pier and the important factor of interaction in a tandem arrangement the spacing between piers and compered with interaction of two piers and found that the critical velocities of rear pier were larger than the critical velocities for case of two piers [23].

2. Material and Methods

2.1. Laboratory Channel

The channel that was used to make the experiment was built from block and concrete located at Kufa University and has the following parts:

- 1- The flume has length 18 m, wide 1m and depth 1.1 m.
- 2- Lateral basin has length 19 m, wide 1.5 m and 0.6 m depth.
- 3- Head basin has length 2 m, wide 3.6 m and 1.1 m depth.
- 4- Two types of vertical sluice gate (head gate of 1 m wide and 2 m height) to control the incoming water to the flume and(tail gate of 1m wide and 1.25 m height is located at the end of the flume) to make the depth of the water at the head and at the end equal.
- 5- Stilling screens of 1×1 m to make the flow more serene.
- 6- Point gauge at the middle of the flume too measure the required water depth and scour depth.
- 7- Main pump is used to supply the whole system of the channel with water.
- 8- Two types of pipe with valve (over flow pipe 10 cm in diameter is existed in the head basin to keep the water level within it constant) and (lower flow pipe 10 cm in diameter at the lower end of lateral basin for reducing the amount of water and cleaning).

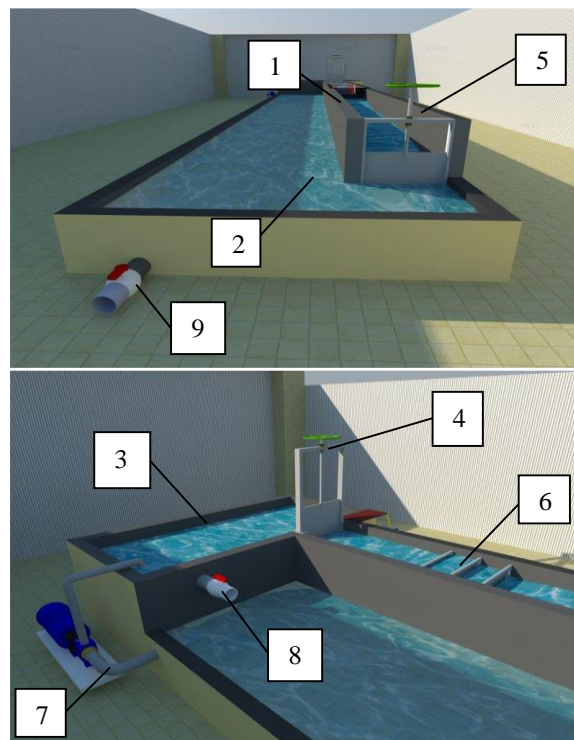

Figure 1. Laboratory channel: 1- The flume; 2- The lateral basin; 3- The head basin; 4- Vertical sluice head gate; 5- Vertical sluice tail gate; 6- Stilling screens; 7- Main pump; 8- Over flow pipe; 9- Lower flow pipe [24]

2.2. Pier Models

We used pier of diameter 8 cm and length 60 cm and put square collars for single pier of dimensions 16×16 cm and 24×24 cm with two positions at bed level 30 cm and above bed level 34 cm as shown in Figures 2 and 3:

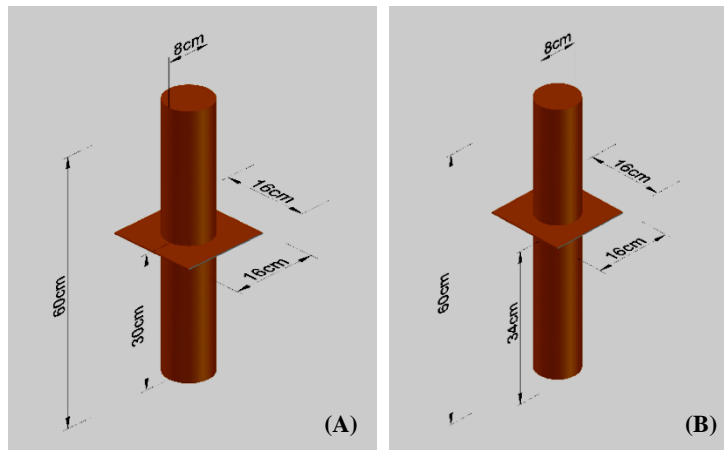

Figure 2. Square collar of dimensions 16×16 cm with two positions; (A) At bed level 30 cm, (B) Above bed level 34 cm put in pier of diameter 8 cm and length 60 cm

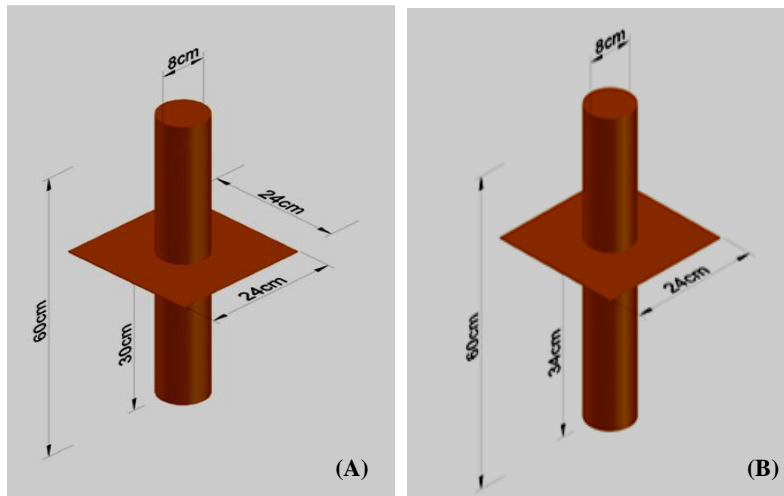

Figure 3. Square collar of dimensions 24×24 cm with two positions; (A) At bed level 30 cm (B) Above bed level 34 cm put in pier of diameter 8 cm and length 60 cm

Also, we used circular collar for single pier of two diameters 16 and 24 cm and two positions at bed level 30 cm and above bed level 34 cm as shown in Figures 4 and 5:

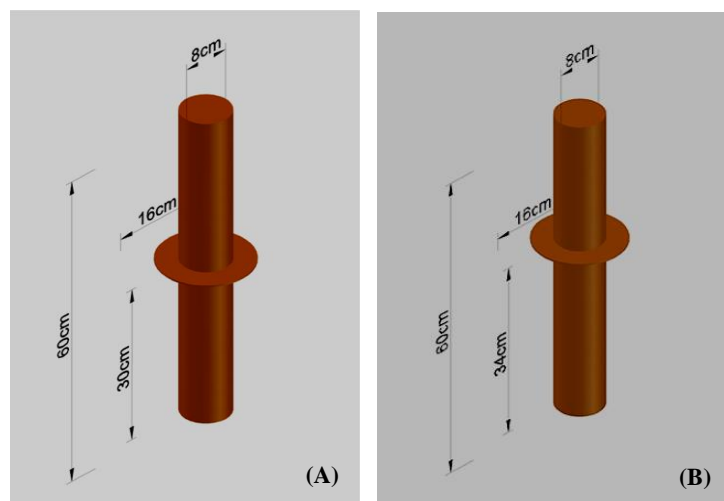

Figure 4. Circular collar of diameter 16 cm with two positions; (A) at bed level 30 cm (B) Above bed level 34 cm put in pier of diameter 8 cm and length 60 cm

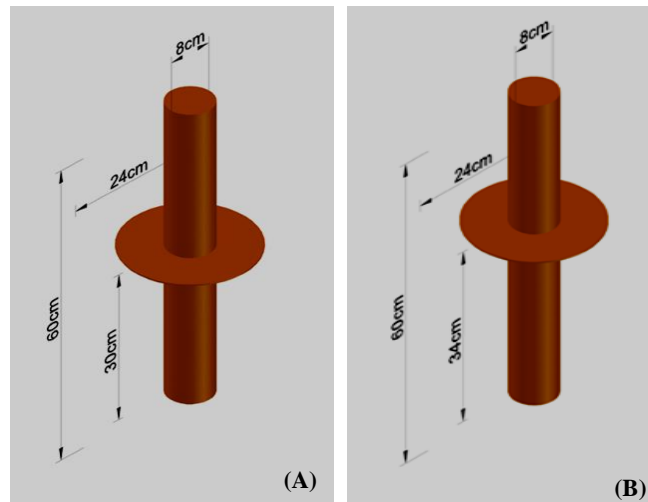

Figure 5. Circular collar of diameter 24 cm with two positions; (A) at bed level 30 cm (B) Above bed level 34 cm put in pier of diameter 8 cm and length 60 cm

Also, we used interaction of two piers $L/D = 3.5$ in a tandem arrangement where L spacing between two piers from center to center and D diameter of pier and pier length 60 cm without any countermeasure, then we used square collar of dimension 24×24 cm at bed level 30 cm for each pier as shown in Figures 6 and 7.

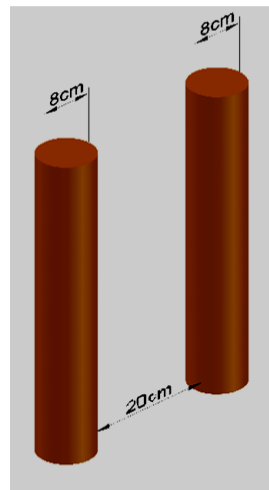

Figure 6. Interaction of two piers ($L/D=3.5$) without any countermeasure in a tandem arrangement

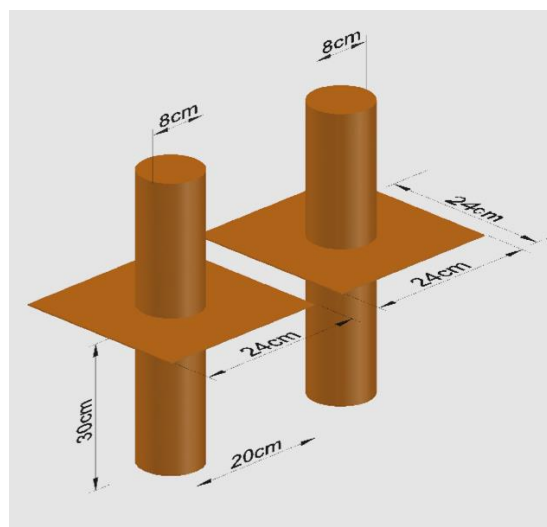

Figure 7. Interaction of two piers ($L/D=3.5$) with square collar of dimension 24×24 cm on bed level 30 cm in a tandem arrangement

Also, we used triple square collar for each pier (pier diameter 8 cm, its length 60 cm) in a tandem arrangement, the distance between collars equal to $(D/4)$ and the dimensions of them 24×24 cm as shown in Figure 8.

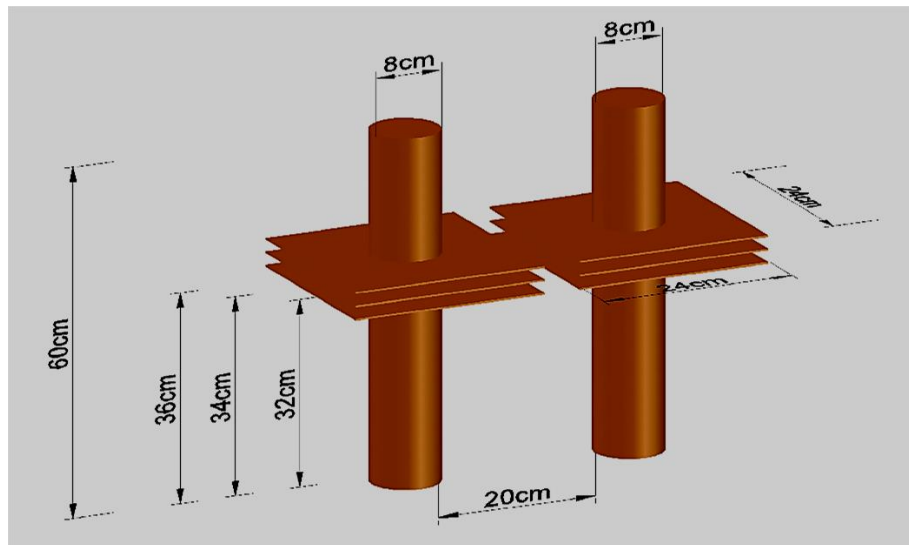

Figure 8. Interaction of two piers in a tandem arrangement with triple square collars of dimensions 24×24 cm

2.3. Experimental Procedure

- 1- Firstly, we filled the lateral basin with water from the water supply.
- 2- The water that supplied to the lateral basin was lifted to the head basin by the main pump of the channel.
- 3- After lifting the water to the head basin, the water was raised to the flume by opening the head gate, before arriving the water to the flume, the water flowed through the stilling screens to make the flow more serene.
- 4- The laboratory model of pier was fixed by putting it in the center of the sand layer, its length was 2 m and the thickness was 0.3 m, the piers were made from MDF wood and coated with varnish to avoid MDF swelling of water, according to Chiew and Melville (1987) recommendations, pier diameter should not be more than 10% of flume width to avoid wall effect on scouring. In this study, the flume width is more than 10 times of pier width [25].
- 5- The model was covered with water, after arrival the water to the end of the flume, the depth of the water could be kept it to be equal by using the tail gate by lifting it to the particular height, then the water returned to the lateral basin and the process of circulation of water continued to five hours and a half hour.
- 6- Turning off the main pump switch and waiting for draining all the water from the sand and measuring the scour depth around the pier by gauge point.
- 7- The sand was re-levelled and the previous procedure was repeated for the other case.

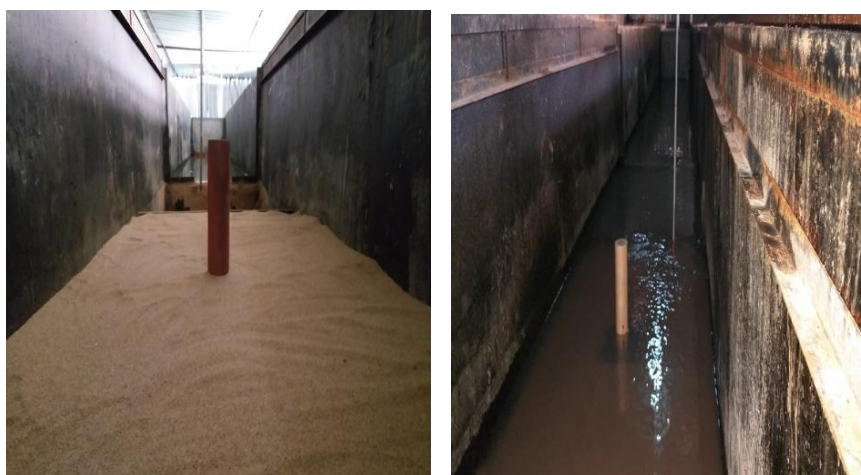

Figure 9. Fixed pier model

2.4. Dimensional Analysis

The variables that effect on the local scour mechanism are listed in this relationship: $f(y_s, w, D, L, K_s, B, d_{collar}, L_{collar}, D_c, L_{int}, S, Y, V, V_c, \rho_s, d_{50}, \sigma_g, \rho, g, \mu, T)$ where y_s the scour depth, w the width of the channel, D diameter of the pier, K_s shape factor of pier, B angle of attack of approach flow, d_{collar} diameter of the collar, L_{collar} length of the collar, D_c collar distance from bed level, L_{int} distance between two piers from center to center, S bed slope of channel, y water depth, V velocity of water, V_c critical velocity of flow, ρ_s density of the sediment, d_{50} median particle size of sand, σ_g geometric standard deviation, ρ fluid density, g gravitational acceleration, μ fluid viscosity, T time. The variables that are selected as repeated variables are ρ, V, W , the dimensionless that effect on scour process:

$$y_s/D = f(L_{collar}/D, d_{collar}/D, D_c/D, L_{int}/D, V/V_c, Fr)$$

2.5. Test program

In this study, we used three different velocities 0.1, 0.08 and 0.07 m/sec, the flow intensity should be less than one to get the clear-water condition, also we used point gauge to measure the maximum scour depth for each case that was used in each case and also to measure the required water depth, the median particle size of used sand (d_{50}) equal to 0.72 mm and the depth of sand layer was 0.3 m, the test condition for each case are summarized in table 1.

Table 1. Test condition for test series

Q (Lit/sec)	Velocity in flume (m/sec)	Flow intensity	Water depth (cm)
37	0.1	0.5	40
31	0.08	0.4	40
26	0.07	0.35	40

3. Result and Discussion

3.1. Results of Square Collar

We list the results of collar of two dimensions 16×16 cm and 24×24 cm of two positions on bed level and above bed level as shown in Tables 2 and 3.

Table 2. Scour depth of square collar (16×16) cm

Velocity (m/sec)	Measured scour depth without collar y_s (cm)	Scour depth of collar ($D_c/D = 0.5$) above bed level (34 cm)	Scour depth of collar ($D_c/D = 0$) at bed level (30 cm)
0.10	8.5	7	0.75
0.08	7	5	0.4
0.07	6	4	0

Table 3. Scour depth of square collar (24×24) cm

Velocity (m/sec)	Measured scour depth without collar y_s (cm)	Scour depth of collar ($D_c/D = 0.5$) above bed level (34 cm)	Scour depth of collar ($D_c/D = 0$) at bed level (30 cm)
0.10	8.5	4.5	0.25
0.08	7	4	0
0.07	6	3.5	0

We notice from results of Table 2 that the percentage of reduction of scour depth for the collar of dimensions (16×16) cm at bed level equal to 91, 94 and 100% for three discharges, comparing it with reduction percentage of collar above bed level 17, 28 and 33%, it was more effective to put the collar at bed level.

Compare this case of collar with results of Table 3 for square collar of wider size (24×24) cm, the percentage of reduction of collar at bed level equal to 97, 100, 100% for three discharges and the percentage reduction of collar above bed level 47, 42 and 41%, from these percentages we concluded that the square collar of dimension (24×24) cm was more effective than the square collar of dimension 16×16 cm, and the best location at bed level.

Khodashenas et al. (2018) [14] studied the case of location of square collar and it was found when the collar close to the bed it was more effective to reduce scours depth, also Jahangirzadeh et al. (2012) investigated the optimum dimension of collar, it was found the effectiveness of collar increased when the size of collar increased [10, 14].

3.2. Results of Circular Collar

We list the results of circular collar of two diameters 16 cm and 24 cm of two positions on bed level and above bed level as shown in Tables 4 and 5.

Table 4. Scour depth of circular collar of diameter 16 cm

Velocity (m/sec)	Measured scour depth without collar y_s (cm)	Scour depth of collar ($D_c/D = 0.5$) above bed level (34 cm)	Scour depth of collar ($D_c/D = 0$) at bed level (30 cm)
0.10	8.5	7.25	0.8
0.08	7	5.5	0.45
0.07	6	5	0

Table 5. Scour depth of circular collar of diameter (24 cm)

Velocity (m/sec)	Measured scour depth without collar y_s (cm)	Scour depth of collar ($D_c/D = 0.5$) above bed level (34 cm)	Scour depth of collar ($D_c/D = 0$) at bed level (30 cm)
0.10	8.5	5.5	0.3
0.08	7	4.25	0.25
0.07	6	3.75	0

The percentages of reduction scour depth that it was declared in Table 4 of using collar of diameter 16 cm at bed level was 90, 93, 100% for three discharges respectively, comparing these percentages with the percentages of using collar above bed level was 14, 21 and 16% , from these comparing , the effective position of collar was at bed level.

The percentage of reduction scour depth from Table 5 of using collar, its diameter 24 cm, when the collar was at bed level 96, 97, and 100% for three discharges, comparing these percentages with reduction percentages of using the collar above bed level, the reduction percentage was 35, 32 and 37%, from this comparing, the effective position was at bed level and the wider size of circular collar was the best to reduce the scour depth.

Kumar et al. (1999) studied the effect of collar size and location of reducing the scour depth, it was used circular collar to study the case of reducing the scour depth, and it was found that the larger size in lower level gave little scour depth comparing with the smallest size with higher level [8].

From Tables 2, 3, 4 and 5 and comparing the reduction percentages of square collar and circular collar, it was found that the square collar was more effective than circular collar as Khodashenas et al. (2018) made a comparison between two types of collars circle and square, the dimensions of them were twice the diameter of the pier with three locations under bed level , at bed level and above bed level , it was found that the square Was more efficient than the circular collar and percentage of reduction of scour depth in square collar was 70% while the percentage of reduction in circular collar was 50% [14]. Figure 10 to 15 show the results of scour depth of our experimental investigation:

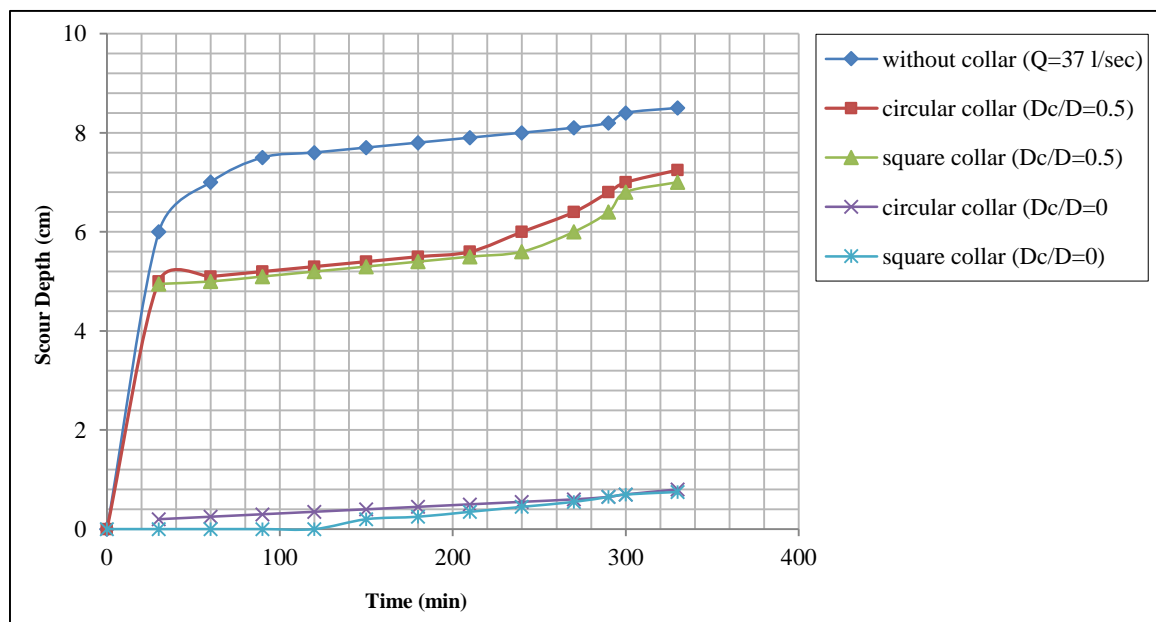

Figure 10. Scour depth of square collar of dimension 16×16 cm and circular collar of diameter 16 cm

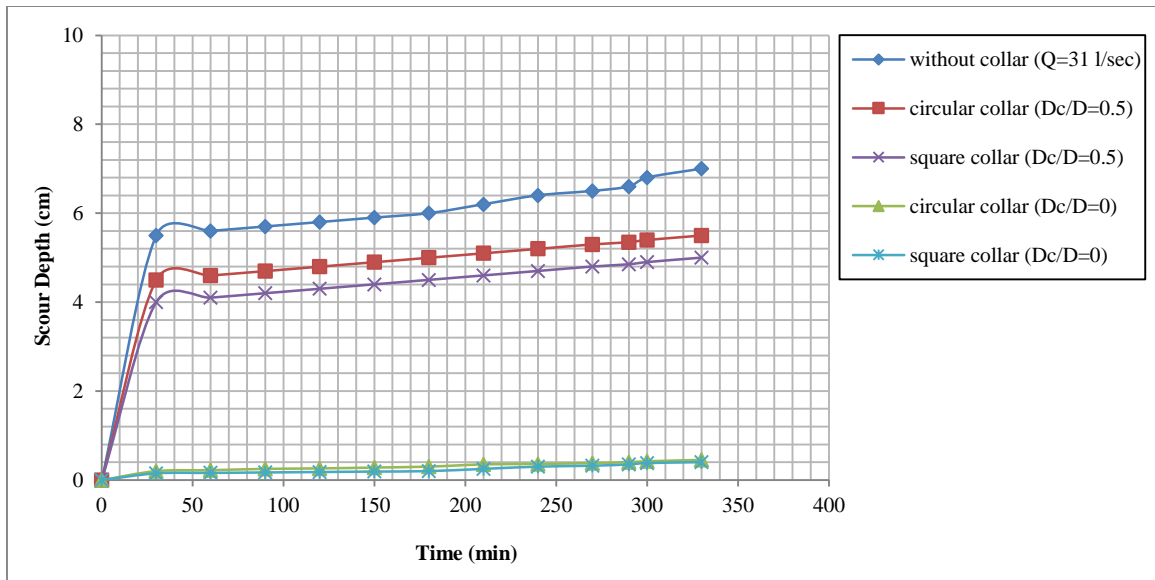

Figure 11. Scour depth of square collar of dimension 16×16 cm and circular collar of diameter 16 cm

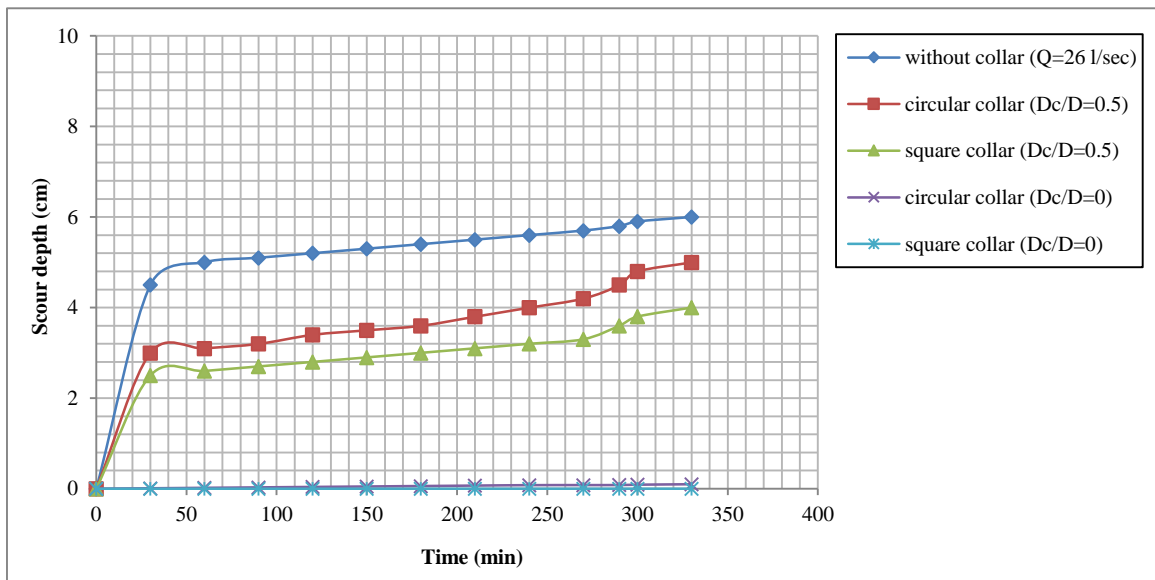

Figure 12. Scour depth of square collar of dimension 16×16 cm and circular collar of diameter 16 cm

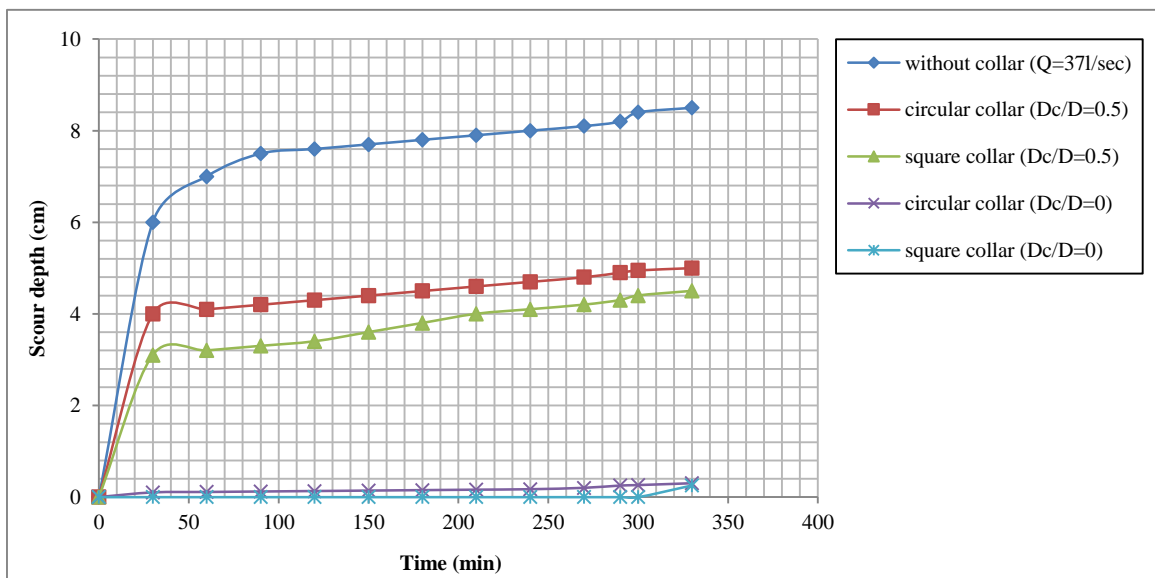

Figure 13. Scour depth of square collar of dimension 24×24 cm and circular collar of diameter 24 cm

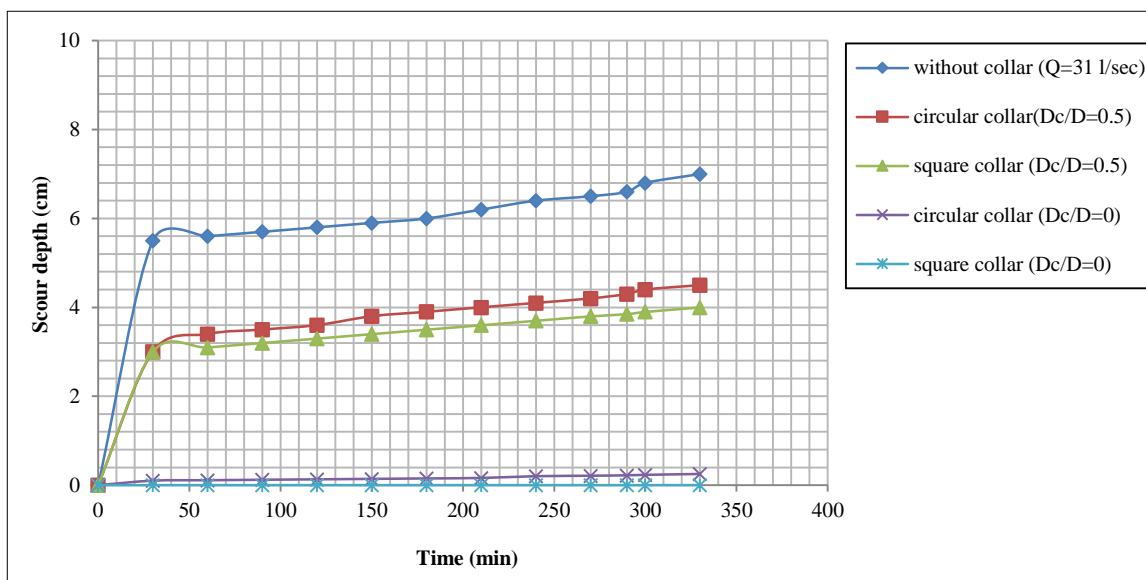

Figure 14. Scour depth of square collar of dimension 24×24 cm and circular collar of diameter 24 cm

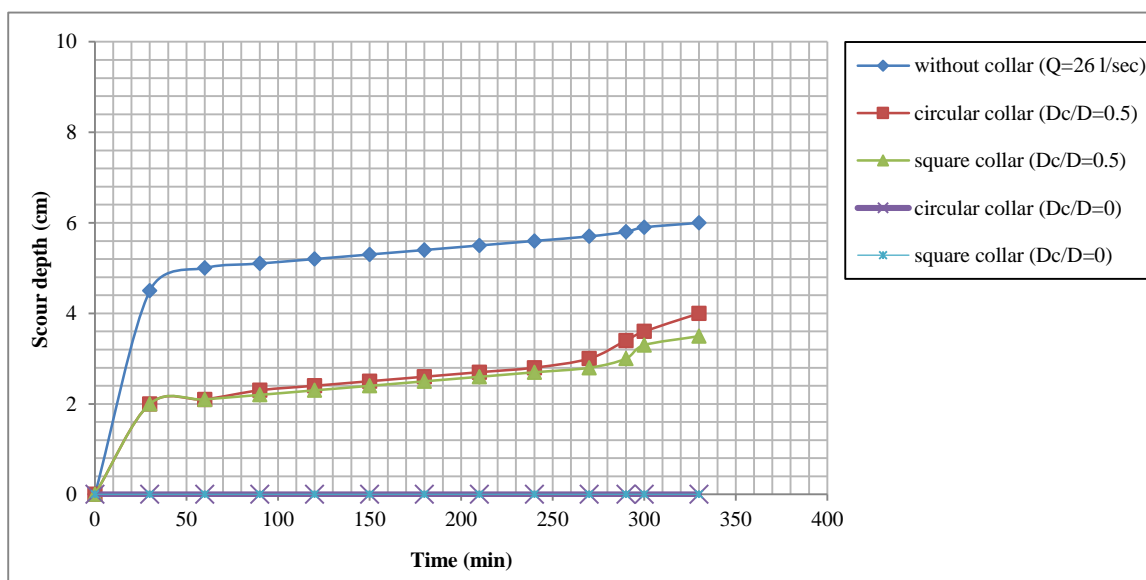

Figure 15. Scour depth of square collar of dimension 24×24 cm and circular collar of diameter 24 cm

3.3. Results of Interaction of Two Piers

In this case, we made interaction of two piers for the higher discharge, $L/D = 3.5$ where L the distance between two piers from center to center and D diameter of the pier, we made three cases of interaction, the first case interaction of two piers without collar, the second interaction. It was used square collar of dimension 24×24 cm on bed level 30 cm for each pier and the last case we used triple collar for each pier distance between them ($D/4$), the results as shown in Table 6.

Table 6. Scour depth of interaction of two piers

No	Measured scour depth with interaction	Measured scour depth with one collar on bed level 30 cm	Measured scour depth with triple collar
Pier 1	6.5	0	4
Pier 2	3.5	0	2.5

From these results of Table 6, it was clearly that the scour depth of pier 2 was very little and comparing with the single pier of high discharge, the reduction percentage of pier 2 without any countermeasure was 58% and with using collar for each pier, the reduction percentage of scour depth equal to 100% and the reduction percentage of using triple collar was 30% and 28% respectively, the case of collar on bed level was the best from using triple collar to reduce scour depth. We compare the case of single pier with or without countermeasure and with interaction of two piers; we concluded that the interaction of two piers without any countermeasure reduced about 58% of scour depth.

Vittal et al. (1994) made comparison between three cases, the first case group of three piers the angle between them 120 degree, the second single pier with slot and the third single pier with collar , the results showed that the group pier was more effective than the other case and it could be given scour reduction about 40% [16]. The figures that showed the scour depth for the three cases in this paper:

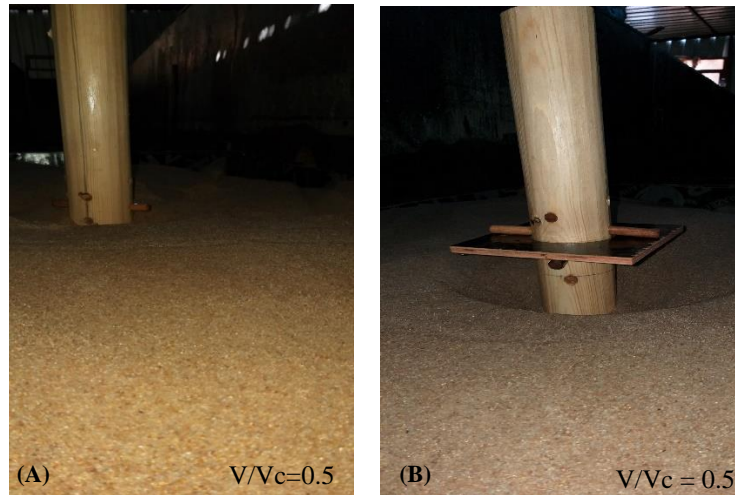

Figure 16. Scour depth of square collar of dimension 16×16 cm Collar on (A) bed level (B) collar above bed level

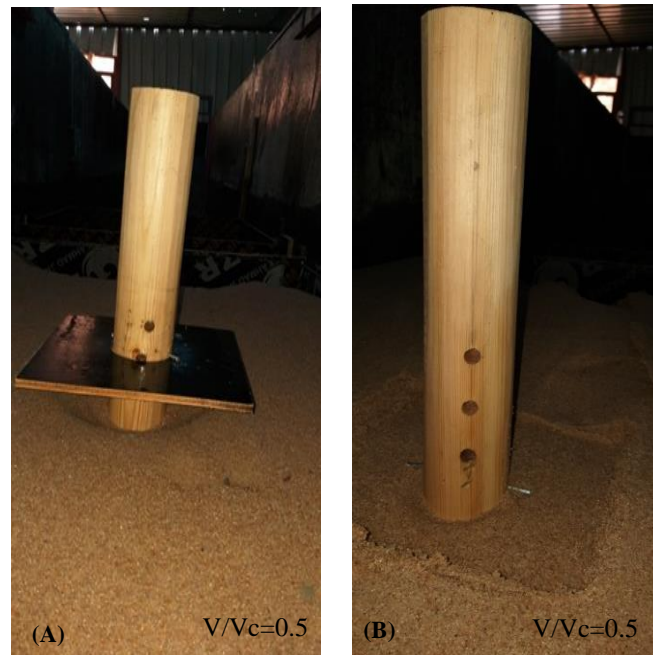

Figure 17. Scour depth of square collar of dimension 24×24 cm Collar on (A) bed level (B) collar above bed level

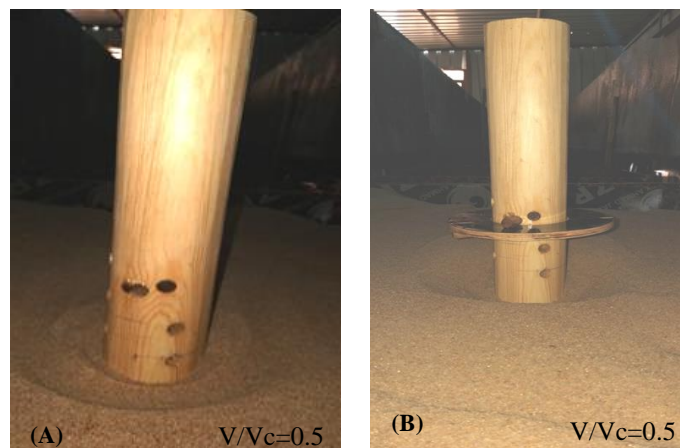

Figure 18. Scour depth of circular collar of diameter 16 cm collar on (A) bed level (B) collar above bed level

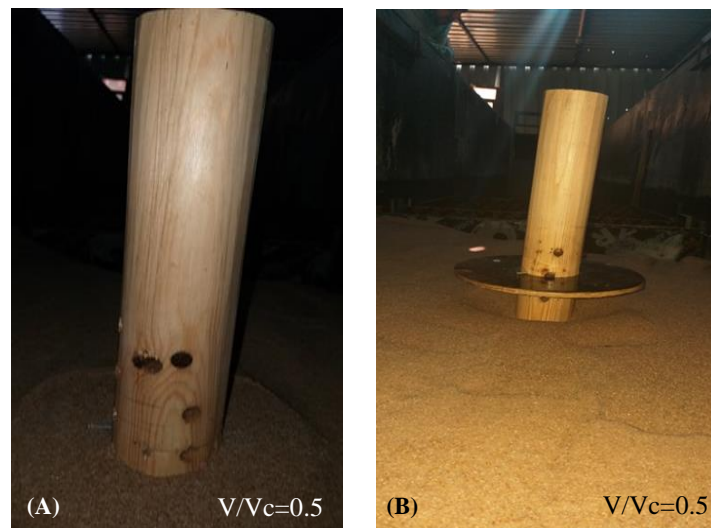

Figure 19. Scour depth of circular collar of diameter 24 cm collar on (A) bed level (B) collar above bed level

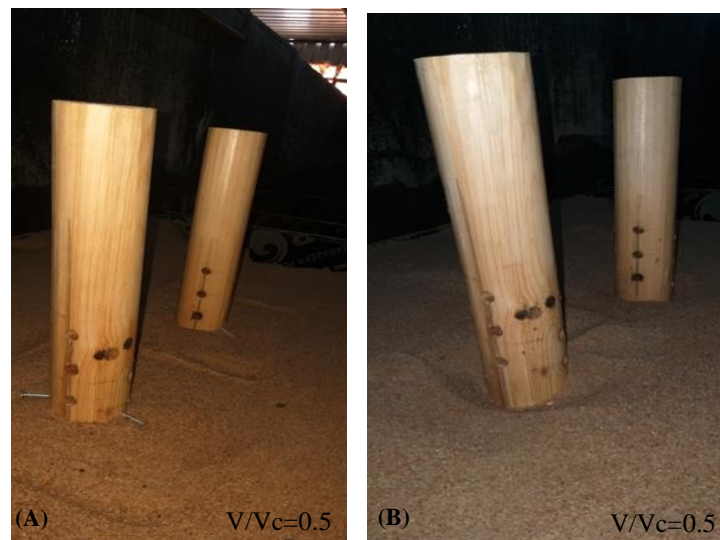

Figure 20. Scour depth of interaction of two piers; (A) square collar of dimension 24×24 cm on bed level; (B) triple collar of dimension 24×24 cm

4. Conclusion

Many researchers had studied the bridge scour and using countermeasures, it is very important subject to prevent the structure from failing, we concluded from our experimental search that using collar could reduce the scour depth, the wider size of collar and the position near the bed level gave zero scour depth and comparing the square collar with circular collar, the square collar was the best of reducing scour. Comparing the single pier with interaction of two piers without any countermeasure gave less scour depth than the single pier about 58%, therefore we considered the interaction of two piers in our experimental investigation was the best.

5. Conflicts of Interest

The authors declare no conflict of interest.

6. References

- [1] Jalali, Seyed Kamran. "Prediction of clear water local scour at bridge piers." (2014).
- [2] Anderson, Ian A., Mandar M. Dewoolkar, Donna M. Rizzo, and Dryver R. Huston. "Scour Related Vermont Bridge Damage from Tropical Storm Irene." Structures Congress 2014 (April 2, 2014). doi:10.1061/9780784413357.046.
- [3] Raleigh, Andrew. "How to mitigate the effects of scour on bridge piers through the use of combined countermeasures." (2015).
- [4] Amini, Seyed Ata, Pezhman Taherei Ghazvinei, Shervin Motamedi, and Roslan Bin Hashim. *Physical Modelling of Local Scouring at Complex Bridge Piers*. IIUM Press, International Islamic University Malaysia, 2016.

- [5] Arneson, L. A., L. W. Zevenbergen, P. F. Lagasse, and P. E. Clopper. "Evaluating scour at bridges." (2012).
- [6] Deng, Lu, and C. S. Cai. "Bridge Scour: Prediction, Modeling, Monitoring, and Countermeasures—Review." *Practice Periodical on Structural Design and Construction* 15, no. 2 (May 2010): 125–134. doi: 10.1061/(asce)sc.1943-5576.0000041.
- [7] Wang, Chen, X. Yu, and Fayun Liang. "A Review of Bridge Scour: Mechanism, Estimation, Monitoring and Countermeasures" *Natural Hazards* 87, no. 3 (March 27, 2017): 1881–1906. Doi: 10.1007/s11069-017-2842-2.
- [8] Kumar, Virender, Kittur G. Ranga Raju, and N. Vittal. "Reduction of Local Scour around Bridge Piers Using Slots and Collars." *Journal of Hydraulic Engineering* 125, no. 12 (December 1999): 1302–1305. doi: 10.1061/(asce)0733-9429(1999)125:12(1302).
- [9] Negm, Abdelazim M., Gamal M. Moustafa, Yasser M. Abdalla, and Amira A. Fathy. "Optimal shape of collar to minimize local scour around bridge piers." *Proc. of IWTC13* (2009): 12-15.
- [10] Jahangirzadeh, Afshin, S. Akib, Zubaidah Ismail, Babak Kamali, Mahshid Kakouei, and Arash Behnia. "Determination of rectangular collar dimensions for reducing scour around bridge pier." In *Proceeding of the 6th International Conference on Scour and Erosion*, vol. 2731. 2012.
- [11] Ardeshiri, Amirreza Mohammadnezhad, and Mojtaba Saneie. "Experimental Study on Lozenge Collar Affection in Reduce Amount of Scouring Around Bridge Piers." *Journal of River Engineering* 2 (2014): 7-11.
- [12] Jahangirzadeh, Afshin, Hossein Basser, Shatirah Akib, Hojat Karami, Sareh Najji, and Shahaboddin Shamshirband. "Experimental and Numerical Investigation of the Effect of Different Shapes of Collars on the Reduction of Scour around a Single Bridge Pier." Edited by Vanesa Magar. *PLoS ONE* 9, no. 6 (June 11, 2014): e98592. Doi:10.1371/journal.pone.0098592.
- [13] Chen, Su-Chin, Samkele Tfwala, Tsung-Yuan Wu, Hsun-Chuan Chan, and Hsien-Ter Chou. "A Hooked-Collar for Bridge Piers Protection: Flow Fields and Scour." *Water* 10, no. 9 (September 14, 2018): 1251. doi:10.3390/w10091251.
- [14] Khodashenas, Saeed Reza, Hossain Shariati, and Kazem Esmaeeli. "Comparison Between the Circular and Square Collar in Reduction of Local Scouring Around Bridge Piers." Edited by A. Paquier and N. Rivière. *E3S Web of Conferences* 40 (2018): 03002. Doi:10.1051/e3sconf/20184003002.
- [15] Moncada-M, A.T., J. Aguirre-Pe, J.C. Bolívar, and E.J. Flores. "Scour Protection of Circular Bridge Piers with Collars and Slots." *Journal of Hydraulic Research* 47, no. 1 (January 2009): 119–126. doi:10.3826/jhr.2009.3244.
- [16] Vittal, Nandana, U. C. Kothiyari, and Morteza Haghighat. "Clear-Water Scour around Bridge Pier Group." *Journal of Hydraulic Engineering* 120, no. 11 (November 1994): 1309–1318. doi:10.1061/(asce)0733-9429(1994)120:11(1309).
- [17] Shrestha, Chij Kumar. "Bridge pier flow interaction and its effect on the process of scouring." PhD diss., 2015.
- [18] Raleigh, Andrew. "How to mitigate the effects of scour on bridge piers through the use of combined countermeasures." (2015).
- [19] Wang, Hao, Hongwu Tang, Quanshuai Liu, and Yao Wang. "Local Scouring Around Twin Bridge Piers in Open-Channel Flows." *Journal of Hydraulic Engineering* 142, no. 9 (September 2016): 06016008. doi:10.1061/(asce)hy.1943-7900.0001154.
- [20] Keshavarzi, Alireza, Chij Kumar Shrestha, Bruce Melville, Hadi Khabbaz, Mohsen Ranjbar-Zahedani, and James Ball. "Estimation of Maximum Scour Depths at Upstream of Front and Rear Piers for Two in-Line Circular Columns." *Environmental Fluid Mechanics* 18, no. 2 (January 9, 2018): 537–550. doi:10.1007/s10652-017-9572-6.
- [21] Garg, Vikas, Baldev Setia, and D. V. S. Verma. "Reduction of Scour around a Bridge Pier by Multiple Collar Plates." *ISH Journal of Hydraulic Engineering* 11, no. 3 (January 2005): 66–80. doi:10.1080/09715010.2005.10514802.
- [22] Malik, Rahul, and Baldev Setia. "Local Scour around Closely Placed Bridge Piers." *ISH Journal of Hydraulic Engineering* (December 21, 2018): 1–8. doi:10.1080/09715010.2018.1559772.
- [23] Wang, Hao, HongWu Tang, J.Feng Xiao, Yao Wang, and Sheng Jiang. "Clear-Water Local Scouring Around Three Piers in a Tandem Arrangement." *Science China Technological Sciences* 59, no. 6 (April 1, 2016): 888–896. doi:10.1007/s11431-015-5905-1.
- [24] Hasan FA. Experimental investigation of scour downstream combined structure of weir and gate. A Doctorate thesis, October 2015.
- [25] Chiew, Y. M., and B. W. Melville. "Local Scour around Bridge Piers." *Journal of Hydraulic Research* 25, no. 1 (January 1987): 15–26. doi:10.1080/00221688709499285.