



Circularization Technique for Strengthening of Plain Concrete Short Square Columns Subjected to a Uniaxial Compression Compressive Pressure

Ahmed W. Abdulsattar^{a*}, Hayder A. Al-Baghdadi^b

^a M.Sc. student, Department of Civil Engineering, College of Engineering, University of Baghdad, Baghdad, Iraq.

^b Department of Civil Engineering, College of Engineering, University of Baghdad, Baghdad, Iraq.

Received 24 December 2018; Accepted 28 February 2019

Abstract

This paper presents an experimental **study** for strengthening existing columns against axial compressive loads. The objective of this work is to study the behavior of concrete square columns strengthening with circularization technique. In Iraq, there are significantly more reinforced rectangular and square columns than reinforced circular columns in reinforced concrete buildings. Moreover, early research studies indicated that strengthening of rectangular or square columns using wraps of CFRP (Carbon Fiber Reinforced Polymer) provided rather little enhancement to their load-carrying capacity. In this paper, shape modification technique was performed to modify the shape (cross section) of the columns from square columns into circular columns. Shape modification technique is also called circularization technique because the cross section is modified from square into circular cross section. Then, the circularized columns were wrapped with CFRP wraps. Shape modification is the strengthening method adopted in this paper as a mean to strengthen existing square columns. Columns studied in this paper are short columns with square sections as a special case of rectangular columns. Columns in this study are plain concrete columns (having concrete strength of $f'_c = 24.41$ MPa) with no internal steel reinforcement. The aim of this research is to study experimentally the behavior of circularized concrete square columns confined with CFRP wraps. Then, for better understanding, the results were compared with another, more widely used, strengthening technique which is the direct wrapping of square columns with CFRP wraps. Thus, investigating experimentally the effectiveness of the two aforementioned strengthening techniques in increasing the load-carrying capacity and ductility of the existing concrete columns. The methodology of this research is that six plain concrete short square columns were casted. These six columns were exerted to compressive pressure using concrete testing machine. These six columns were divided into three groups, each group consisted of 2 columns. The three groups were classified as follows: first group (titled L0) consisted of two square columns which were not strengthened by any method, second group (titled L1) consisted of two square columns confined by one layer of CFRP wraps, finally, the third group (titled LC1) consisted of two circularized square columns confined by one layer of CFRP wraps.

Experimental results showed that load bearing capacity and ductility of square columns have been significantly enhanced. Test results showed that shape modification technique (columns LC1) produced enhancement in load carrying capacity about 167.8 % of the original non-strengthened columns (columns L0). Furthermore, square columns wrapped by one layer of CFRP wraps (columns L1) produced enhancement in load carrying capacity about 56.1% of the original non-strengthened columns (columns L0). As such, it was evident that circularization technique resulted in enhancement in load carrying capacity far more than the enhancement obtained from wrapping the square columns with CFRP wraps.

Keywords: Circularization; Plane Concrete Columns; Confinement; Stress Concentration; Load Bearing Capacity; Uniaxial Compressive Pressure; CFRP (Carbon Fiber Reinforced Polymer).

* Corresponding author: ahmad_waad_24@yahoo.com

 <http://dx.doi.org/10.28991/cej-2019-03091275>

➤ This is an open access article under the CC-BY license (<https://creativecommons.org/licenses/by/4.0/>).

© Authors retain all copyrights.

1. Introduction

Increasing the load carrying capacity of structural elements, such as columns, can be done conventionally by increasing the concrete strength properties, column section, and/or reinforcement. On the other hand, it is worthwhile to mention that recently worldwide and especially in Iraq, the need to increase the bearing load capacity of post column construction (existing column) is one of the big challenges. The complete lateral “clothing” of post-constructed columns by a sheet-like reinforcement (attached by strong adhesives) has been commonly used to provide certain improvement in strength properties of columns. Warping columns with that sheet-like reinforcement had been studied by many researchers and results showed that sheet-like reinforcement strengthening is a promising approach in terms of increasing the load carrying capacity of such columns.

Columns are the most important structural members in any structure, it is only reasonable to acquire new methods for strengthening existing columns. Many researches have been published which studied the behavior of strengthened existing columns. Columns can be strengthened by steel cages (ACI Committee 440 2008) [1], by CFRP (Carbon Fiber Reinforced Polymer) (Sangeetha 2007) [2], or by GFRP (Glass Fiber Reinforced Polymer) (A. and N. 2015) [3]. However, when strengthening square columns, confinement effect is reduced due to the existence of stress concentration areas at the sharp corners of the square cross section. This is where circularization plays its role. Circularization is considered as an effective mean to eliminate stress concentration areas and it restores membrane effect which was reduced due to the existence of sharp edges and flat sides of the cross section, Yan & Pantelides, (2008) [4].

The practical procedures to modify the rectangular or square columns into circular columns are considered many, and may be summarized as follows:

- Surrounding the square column by a circular mold. Then, pouring a concrete mix which is suitably designed to fill the gaps between the mold and the hardened square column.
- Segments of concrete, casted and hardened previously, are attached by adhesives to the faces of the non-circular column in such a manner that the final shape of the whole column and segments form a circular cross section.

2. Confinement

Confinement is a strengthening method that is applied to structural members which are subjected to compressive pressure. This process is performed to increase load carrying capacity as well as ductility of such members, Rolli and Chandra (2015) [5].

According to ACI Committee 440 (2008) [1], using FRP jackets as an external confinement for reinforced concrete columns can increase their strength and ductility. In terms of increased capacity, the results are immediate and are expressed in terms of increased load resistance. Whereas increased ductility requires calculation to determine the ability of the confined element to sustain rotation as well as drift without any major loss in strength.

2.1. Definition of Passive Confinement

Passive confinement is the condition where the FRP shells do not cause confinement immediately for the member. Instead, the confining pressure of FRP shells is activated as a result to the lateral dilation of the member under axial compression load. When concrete starts to dilate (laterally expand) due to the applied load, tensile pressure along the hoop direction starts to develop in (or exerted on) the FRP wraps. Thus, the confining pressure, developed in FRP shells, increases proportionally with the dilation of the concrete until the system fails when the FRP shells rupture, Ozbakkaloglu, Lim and Vincent (2012) [6].

FRP wraps, used to confine a concrete member, usually provide passive confinement, i.e. the fibers remain unstressed until sufficient dilation had occurred, ACI Committee 440 (2008) [1].

2.2. Application of Confinement

2.2.1. Confinement of Circular Columns

According to Mirmiran and Shahawy (1997) [7], the confinement obtained by using either internal reinforcement, e.g. longitudinal steel reinforcing bars, or external confinement, e.g. FRP jackets, is an external passive confinement. Passive confinement means that confining effect is activated only after the confined member dilates in the hoop direction (Poisson's effect in concrete). Therefore, the mechanism of confinement depends on two factors; dilation of concrete column and the radial stiffness of the confining member (FRP jackets) to suppress the dilation. As a result, two conditions must be met; geometric compatibility between the concrete and the wraps, and equilibrium of forces in the free body diagram at any section as shown in Figure 1.

In case of circular cross-sectional columns confined with FRP wraps, the lateral confining pressure f_l , exerted by FRP wraps on the concrete—can be considered to be uniformly distributed along the circumference of the section as illustrated in **Figure 1**, Ozbakkaloglu, Lim and Vincent (2012) [6]. It should be noted that in **Figure 1**, D is the diameter

of the circular column, f_r is the FRP confining pressure, f_j is the hoop stress, t_f is the thickness of FRP wraps.

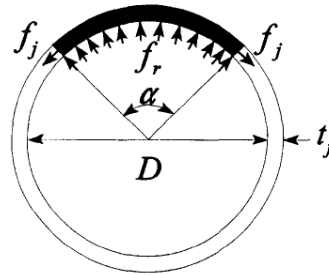

Figure 1. Confined action on a circular column section

2.2.2. Confinement of Square or Rectangular Columns

When externally wrapping circular concrete columns with FRP wraps, it is correct to assume that the confining pressure is continuous along the circumference of the section. However, FRP sheets have a weak flexural stiffness, thus, low transverse confining stress can be developed in square or rectangular sections. At the edges and sharp corners of square or rectangular sections, high axial stiffness and low flexural stiffness of FRP sheets result in stress concentration zones at these corners. Stress concentration is deemed dangerous and it develops continuously until failure occurs at these regions, i.e. at edges precisely. Failure happens generally by rupture of FRP sheets at corners (stress in fibers at corners reaches ultimate strength of the FRP fibers), while stresses in the fibers lying along the sides of the section are still lower than the ultimate strength of the FRP fibers, Campione, Miraglia and Papia (2004) [8].

Figure 2 shows that there is a reduction in the effective confinement area. For square column with sharp corners, the confinement area initiates at the corners in the form of a second-degree parabola having an initial slope of 45°. However, for square column with rounded corners with a radius R_c , the parabolic confining action is again assumed but for this case; the effective confinement area is considerably larger than the case of sharp corners, Benzaid and Mesbah (2013) [9].

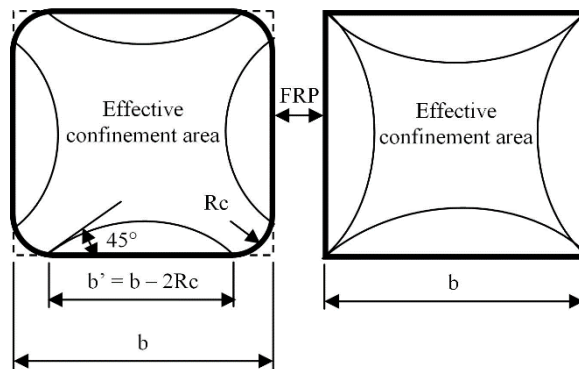

Figure 2. Active confined area for square sections confined with FRP wraps [9]

In contrast to circular cross-sectional columns, FRP fibers exerts a non-uniform lateral stress on square columns caused by the non-uniform dilation of square columns. Flat sides of the square column are subjected to lower confining pressure compared to the sharp corners, i.e. stress is being concentrated at the edges. Therefore, due to the cross-sectional shape and due the non-uniform distribution of the confining stress, only a portion of the whole cross-sectional area is confined effectively. Thus, confinement efficiency in this case is lower than the case of circular cross sectional columns. Additionally, another reason for the lower efficiency is that in circular columns; the confining pressure depends greatly on the tensile stiffness of the wraps, whereas in square columns; the confining pressure depends on the flexural stiffness of the wraps, which is much lower than the tensile stiffness of the wraps, Al-Khafaji (2016) [10].

2.3. Circularization Definition

Circularization is defined as a method applied to non-circular concrete members in order to change their shape, (i.e. cross section) from non-circular shape, whether it be rectangle or square or any other shape, into a circular shape, Pham, Doan and Hadi (2013) [11].

On the other hand, Yan, Pantelides, & Reaveley (2008) [12], defined shape modification process as a practical method to remove the effects of sharp corners of the column’s cross section, thus, improving the compressive response of the square columns confined externally by FRP.

3. Research Methodology

In the experimental work, six square concrete columns were casted for laboratory experiments. The experimental tests can be categorized into three main groups:

- Testing of 1/10th-scale square-section specimens (2 columns).
- Testing of 1/10th-scale square-section specimens wrapped with one layer of CFRP sheet (2 columns).
- Testing of 1/10th-scale square-section specimens wrapped with one layer of CFRP sheet and using circularization technique (2 columns).

All column specimens were to be subjected to a uniaxial compressive load applied on them by using a universal compression machine. All column specimens were designed as short columns with a normal concrete strength of $f'_c = 24.41$ MPa. All the columns were plain concrete columns. For circularization process, a plain concrete was used with a concrete strength (for circularization) of $f'_c = 28.8$ MPa. Finally, the lateral dilation at the midheight of the specimens was measured by using two dial gauges. The two dial gauges were installed on two opposite sides of the columns, i.e. the angle between the two gauges was 180°. Figure 3 shows experimental matrix, column specimens casted and tested, and naming process for all of the specimens.

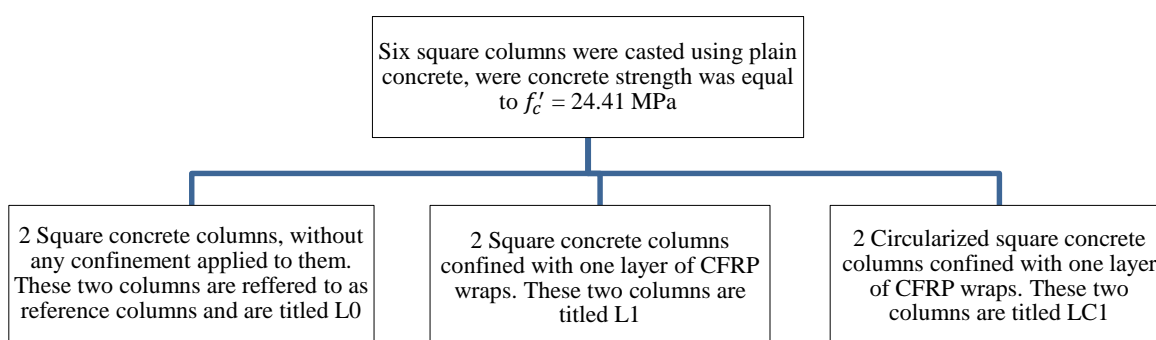

Figure 3. Bar chart to demonstrate experimental matrix, specimens, and naming process

4. Experimental Matrix

4.1. Design of Specimens

Six short plain concrete columns with a height of 30 cm and square cross sectional area of 10 X 10 cm were used. These dimensions were chosen such as to comply to the minimum limit allowed by the ACI Committee 318 (2014) [13] for considering the member as a short column, where ACI stated that a structural member is considered a column if the ratio of height-to-least lateral dimension was greater than 3, if the member was vertical or predominantly vertical, and if the member was used primarily to support axial compressive load.

In this study, six square plain concrete columns were casted without any internal reinforcement. The six square columns were divided into three groups and each group consisted of two column specimens. First group (L0) consisted of two columns (L0-1 and L0-2) with no external confinement. Columns in this group were considered as the reference columns. The second group (L1) consisted of two columns (L1-1 and L1-2) confined with one layer of CFRP wraps as an external confinement. The third group (LC1) consisted of two square columns circularized with concrete to form a circular column section, i.e., the two hardened square columns, were modified into circular columns by circularization technique. The circularized columns (LC1-1 and LC1-2) had a height equal to the original height of the square columns (30 cm), and a circular cross sectional area with diameter of 15 cm. Finally, the circularized columns were wrapped with one layer of CFRP wraps as an external confinement. Wrapping was achieved by using epoxy resin.

Circularized square columns are sometimes referred to as composite columns since they are consisted of two parts; the existing square column part and semicircular circularization concrete part that was used to modify the shape of the column's cross-section from square into a circle.

The description of the specimens is summarized in Table 1.

Table 1. Description of the specimens

Name	Specimen Description
L0	The specimen is a square column with concrete strength of $f'_c = 24.41$ MPa without any confinement
L1	The specimen is a square column with a concrete strength of $f'_c = 24.41$ MPa confined with one layer of CFRP sheets
LC1	The specimen is a square column with a concrete strength of $f'_c = 24.41$ MPa circularized with concrete of $f'_c = 28.8$ MPa and confined by one layer of CFRP sheets

4.2. Circularization Process

Many methods for performing shape modification to square and rectangular sections are available. However, the method of direct circularization was adopted for this study—as shown in Plate 1 A, In this method, the square columns were placed concentrically inside the cylindrical mold in order to perform shape modification. Shape modification was performed by casting the concrete mix inside the gaps between the cylindrical molds and the square columns. It is worthwhile to mention that by using direct circularization process the final composite column assemble as a perfect cylinder without any distortions or any discontinuity in the final shape. Plate 1 B, shows circularized square columns.



(a) Circularization Process



(b) Circularized columns

Plate 1. Performing shape modification

4.3. External Confinement Process

When applying epoxy resin over the column surface, the resin was spread evenly by using a brush all over the surface of the columns. Then, one layer of CFRP was attached to surface of the columns. For good impregnation of the resin into the CFRP layer, also, to avoid any air bubble that may form or may be trapped inside the epoxy, a small serrated roller was used. Finally, an overlap of 10 cm adopted for each layer, as illustrated in Figure 4. Furthermore, the fibers were wrapped around the column in the hoop orientation. The serrated roller was rolled in the direction of the fibers in order avoid any air bubble entrapped and the epoxy resin was left for 7 days to fully dry.

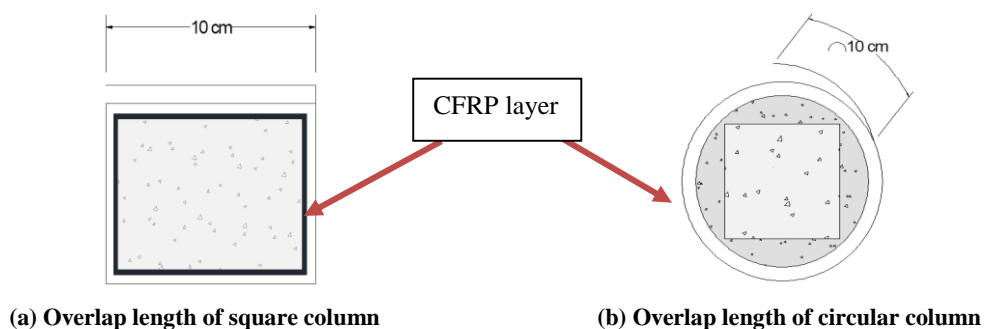

(a) Overlap length of square column

(b) Overlap length of circular column

Figure 4. Overlap length of CFRP

4.4. Selecting Appropriate Aggregate Size

Maximum size for coarse aggregate used for both square column concrete and shape modification concrete, was chosen in compliance with ACI Committee 318 (2014) [13], where, according to ACI, the maximum size for coarse aggregate used cannot exceed any of the following:

- 1/5 of the smallest dimension between sides of forms.
- 1/3 of the depth of slabs.
- 3/4 of minimum specified clear spacing between the individual reinforcement bars or wires, i.e. ties.

Concrete used in this study was plain concrete, thus, the third condition shall be omitted. Furthermore, since specimens in this study are columns, the second condition shall also be omitted. The remaining first condition is of great importance. Thus, in compliance with the first condition, $1/5$ of the least dimension is $1/5 \times 10 = 2$ cm. Furthermore, since there is a small area (spacing) between the sides of the square column and the inner fiber of the cylindrical mold, a max size of half inch was chosen. Thus, the gravel used was of size of $1/2$ inch or 1.25 cm, as shown in Figure 5.

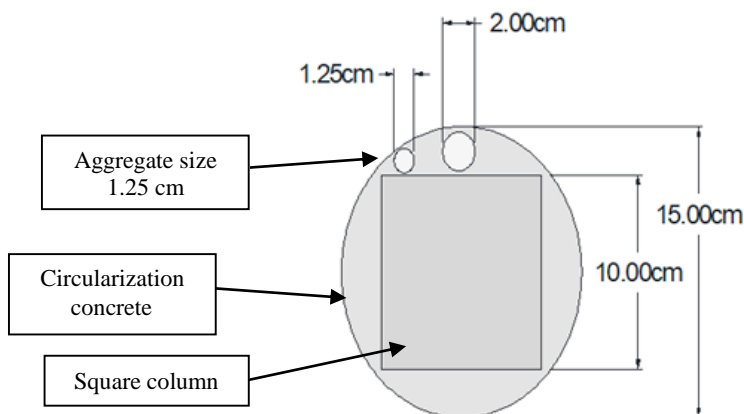

Figure 5. Sketch to illustrate size comparison between different gravel sizes

4.5. Material Properties

Materials used to cast columns were constituents of concrete, which are cement sand and gravel. Gravel used was crushed gravel with maximum size of half inch. For sand, ordinary river sand is used and it was bought from local market. Finally, sulfate resisting cement was used since it is one of the most universal type implemented in Iraq and abroad as well. Concrete mixture properties are shown in Table 2.

Commercially available carbon fibers (CFRP) which are categorized by unidirectional fibers was bought from local market and used in laboratory experiments. This CFRP wraps was used to cover (jacket) columns L1 and LC1. To attach the CFRP wraps on the circumference of the columns, epoxy resin was used as an adhesive material. CFRP material used was Sika Wrap 301 C, while for the epoxy resin, Sikadur 330 was used. The properties of both CFRP material and epoxy resin are shown in Table 3, Table 4, and Table 5.

Table 2. Concrete mixture properties

Compressive strength for all square columns	24.41 MPa
Compressive strength for circularization concrete	28.8 MPa
Concrete mix ratio for square columns	Volumetric ratio of 1:1.5:2.5 corresponding to cement, sand and gravel
Concrete mix ratio for circularization concrete	Weight ratio of 1:1.24:2.16 corresponding to cement, sand and gravel
Maximum size of grave or coarse aggregate	12.5 mm
Type of cement used for concrete mixture	Sulfate resisting cement
Water	Normal potable water available at the laboratory
PH of water used for concrete mixture	6.8 - 7.2
Lab temperature	25°C

Table 3. Dry fiber properties of Sika Wrap 301 C

Dry fiber tensile strength	4900 N/mm ²
Dry fiber tensile modulus of elasticity	230 000 N/mm ²
Dry fiber elongation at break	1.7 %
Dry fiber density	1.80 g/cm ³

Table 4. Laminate properties of CFRP wraps (Sika Wrap 301 C) after being embedded in Sikadur 330 epoxy resin

Laminate fiber tensile strength	4300 N/mm ²
Laminate fiber tensile modulus of elasticity	225 kN/mm ²
Laminate fiber elongation at break	1.91 %

Table 5. Sikadur 330 epoxy resin properties

Resin tensile strength	30 N/mm ² (7 days at +23°C)
Resin tensile modulus of elasticity	4500 N/mm ² (7 days at +23 °C)
Resin elongation at break	0.9 % (7 days at +23 °C)
Resin tensile adhesion strength	Concrete fracture (> 4 N/mm ²) on sandblasted substrate
Resin density	1.30 ± 0.1 kg/l (component A+B mixed) (at +23 °C)

4.6. Instrumentation and Test Setup

To measure the lateral deformation of the columns under axial loads, two dial gauges were used. The two dial gauges were installed in horizontal direction so that they would measure the horizontal displacements at the midheight of each specimen. Furthermore, to gain better understanding of the horizontal displacement, the two gauges were installed in two opposite sides on each specimen, i.e. the angle between them was 180°, as shown in Plate 2. A uniaxial compressive load was exerted on the columns by using a universal compression machine as shown in Plate 2.



(a) Compression machine



(b) Dial gauges

Plate 2. Installing dilation gauges for columns

5. Results and Discussion

5.1. Square Columns with no External Confinement by CFRP Wraps

Columns in this group are titled (L0-1 and L0-2) and are subjected to axial loads until failure. Plate 3 shows failure modes of columns L0-1 and L0-2. It was noticed that failure occurred because of crushing of concrete at top regions, precisely at the corners of the column. The load began from zero and increased until failure. Columns were failed by crushing; this is a typical failure mode for compression short members. Failure of columns was sudden, and prior to failure there were cracks that started to develop and increase in number and size with increased loading until the columns failed.



(a) Column L0-1 at failure



(b) Column L0-2 at failure

Plate 3. Modes of failure of columns (L0)

Load-displacement curves were measured by using two dial gauges at mid-height of columns. Figure 6 and Figure 7, show load displacement curve for columns L0-1 and L0-2 respectively. As observed from load displacement curve, the lateral displacement continued to increase until failure occurred where columns were crushed. Table 6 presents laboratory experimental results for columns L0-1 and L0-2. During testing, there was an observed small lateral buckling experienced in both columns L0-1 and L0-2. However, this small buckling didn't affect the overall behavior of columns; as the columns were designed as short columns and they behaved and failed as short columns. Furthermore, for each one of the two columns, the net side displacement obtained from the difference of the two lateral displacements was

used to plot Figure 6 and Figure 7. The net side displacement for column L0-1 for instance was -0.45 mm and 0.59 mm. Thus, the net side displacement was $0.59 - 0.45 = 0.14$ mm. This net displacement (0.14 mm) was plotted against the applied load in Figure 6.

Table 6. Experimental results for columns L0

Specimen	Unconfined column strength (MPa)	Left side lateral dilation (mm)	Right side lateral dilation (mm)	Net side dilation (mm)
L0-1	20.94	-0.45	0.59	0.14
L0-2	20.52	-0.26	0.36	0.1

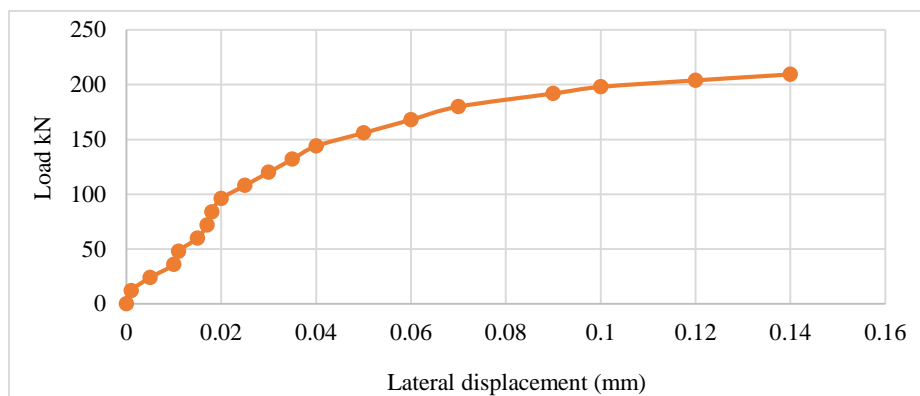

Figure 6. Load-displacement curve of column L0-1

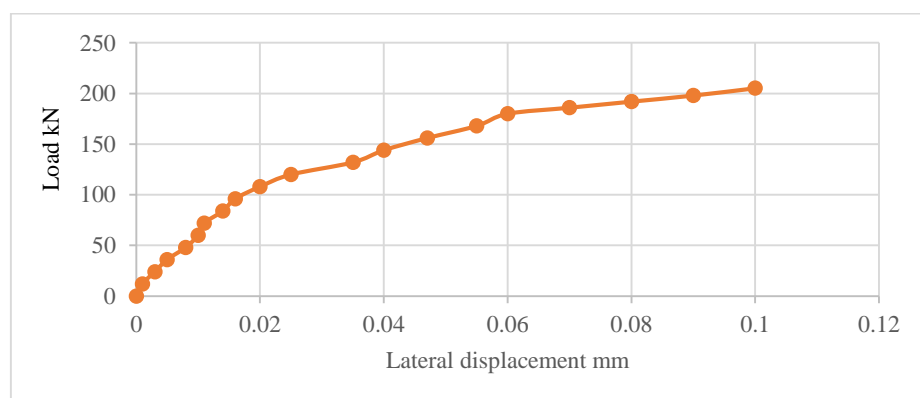

Figure 7. Load-displacement curve of column L0-2

5.2. Square Columns Confined with one Layer of CFRP Wraps

Columns in this group were titled L1-1 and L1-2. Plate 4 shows failure modes of columns L1. Observing modes of failure for this group L1, it was noticed that the columns failed prematurely. This means that the concrete was crushed before CFRP wrap could reach its ultimate strain. Thus, due to this mode of failure; the concrete was crushed inside the CFRP layers. It should be noted that loading was applied by a compression machine. Loading was applied continuously on the columns until they failed. Since the columns failed prematurely, crushed concrete wasn't observable by eye. However, after closer inspection, there was a slight noticeable bulge in the columns indicating that indeed concrete was crushed before CFRP wrap reached its full strain capacity. It is worthwhile to mention that this type of failure for columns confined with CFRP wraps was experienced also by Benzaid and Mesbah (2013) [9].

As loading increased, and especially when the applied load was near the load which the reference columns L0 failed at, there was a large cracking sound heard from CFRP wraps. This is thought to be an indication that the CFRP wraps were fully activated and confining pressure had started to take full effect.

Strengths of unconfined columns subjected to axial compressive load were 20.94 and 20.52 MPa for columns L0-1 and L0-2 respectively. Average strength of unconfined columns is $f'_{co} = 20.73$ MPa. Whereas the strengths of confined square column obtained from laboratory experiments were 31.19 and 33.53 MPa for columns L1-1 and L1-2 respectively. The average confined concrete strength is $f'_{cc} = 32.36$ MPa. Thus, by providing external CFRP confinement, an enhancement in load carrying capacity was about 56.1%. This high increase in load bearing capacity is believed to be due to the premature failure of columns L1, were the concrete, although being crushed, was still confined inside the CFRP layer. Table 7 shows data acquired from laboratory tests. Figure 8 and Figure 9 show load displacement diagram for

columns L1-1 and L1-2 respectively, and for plotting the two diagrams, net side displacement was also used since both columns L1-1 and L1-2 experienced lateral buckling.



(a) Column L1-1 at failure



(b) Column L1-1 at failure

Plate 4. Modes of failure of columns (group L1)

Table 7. Strength and lateral dilation of columns L0 and L1

Specimens	Column L0-1	Column L0-2	Column L1-1	Column L1-2
Variables				
Unconfined column strength (MPa)	20.94	20.52	---	---
confined column strength (MPa)	---	---	31.19	33.53
Left side lateral dilation (mm)	-0.45	-0.26	-0.92	-0.71
Right side lateral dilation (mm)	0.59	0.36	1.28	1.11
Net side dilation (mm)	0.14	0.1	0.36	0.41
Average load bearing capacity increment %	---	---	56.1%	

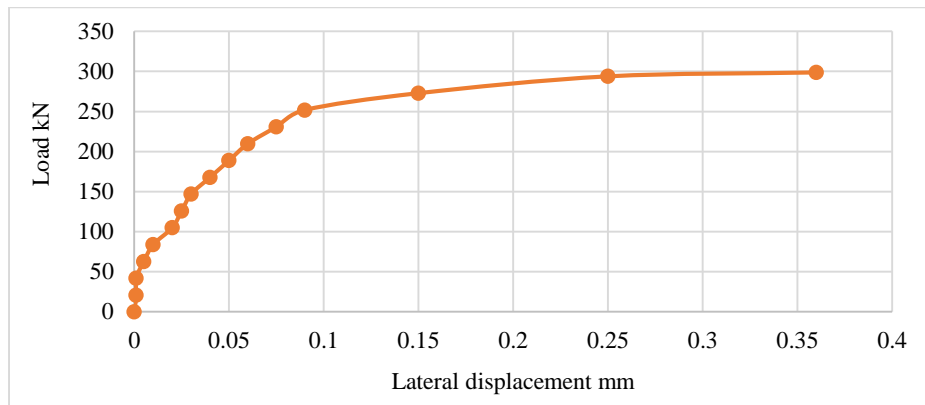

Figure 8. Load displacement curve of column L1-1

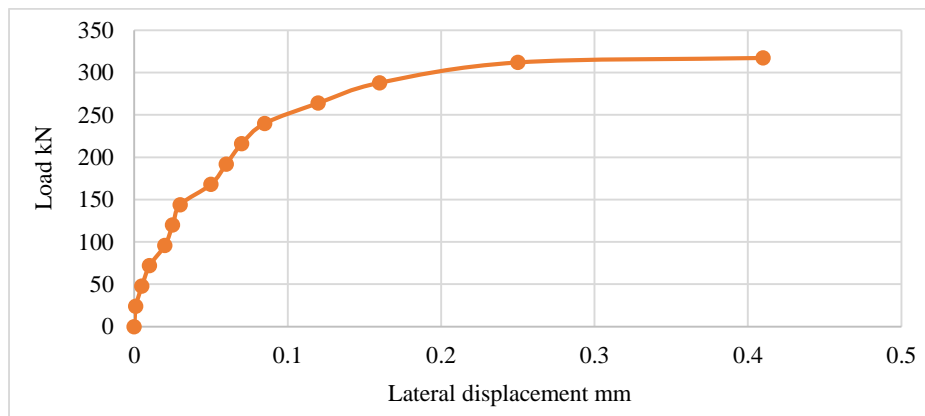

Figure 9. Load displacement curve of column L1-2

Columns L1 failed prematurely by crushing of concrete without any significant damage happening to the CFRP wraps. It is for this reason that the load bearing capacity was greatly increased by 56.1%. Similar large increment in load carrying capacity was reached also in the work of Khan and Fareed (2012) [14], where they fully confined concrete short square columns by one layer of CFRP wraps. Their columns were subjected to concentric compressive loads. In their experiment, the basic unconfined columns failed by crushing and withstood a maximum load of 302 kN, while the wrapped square columns failed by rupture of CFRP wrap (unlike columns L1 where CFRP wraps were not ruptured) and withstood a maximum load of 412 kN, thus, achieving an increase in load bearing capacity about 36.16%.

5.3. Circularized Columns Confined with One Layer of CFRP Wraps

In columns LC1, the columns were composite columns, meaning that each column consisted of two parts. The first part was the original square column with concrete strength $f'_c = 24.41$ MPa. The second part was the concrete (with $f'_c = 28.8$ MPa) used to change the section of the hardened square column into a circular cross section. Finally, the composite columns were externally confined with CFRP wraps. Circularization technique was used to eliminate the phenomenon of stress concentration caused by sharp edges of square columns when confined with CFRP wraps, Pantelides, Yan and Reaveley (2004) [15]. Columns in this group were titled LC1-1 and LC1-2. The columns are subjected to compressive pressure until failure occurred. Plate 5 shows failure modes of columns LC1.

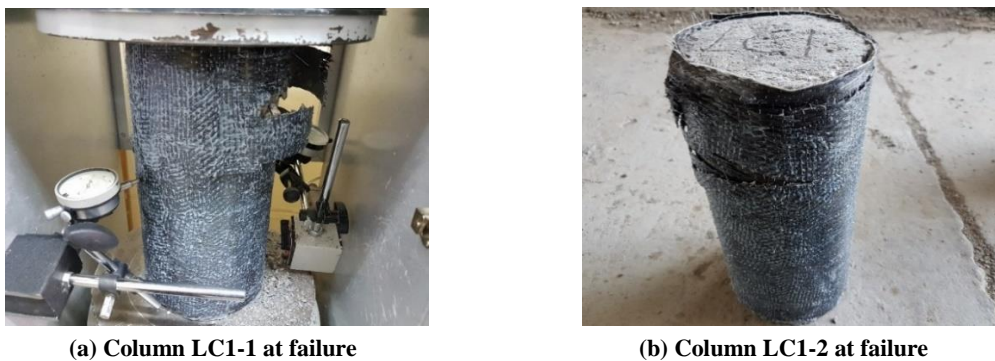

Plate 5. Modes of failure of columns LC1

Columns LC1-1 and LC1-2 failed in a brittle manner in an explosive nature. Due to the fact that circularization technique was used to eliminate the phenomenon of stress concentration, restore membrane effect of CFRP wraps, and increase confinement effect, thus, columns LC1 failed in an explosive manner where large strain energy was absorbed and then released at failure. During testing of columns LC1, cracking sound originated from FRP wraps was heard. As the applied load increased, the cracking sound also increased; until failure occurred at ultimate load where CFRP ruptured and the concrete burst out and scattered in an explosive nature.

The strengths of unconfined column strength obtained from testing of square plain concrete columns under uniaxial loading condition were 20.94 and 20.52 MPa for columns L0-1 and L0-2 respectively. The average unconfined concrete strength is $f'_{co} = 20.73$ MPa. Whereas the strengths of circularized square columns obtained from laboratory experiments were 54.06 and 56.97 MPa for columns LC1-1 and LC1-2 respectively. The average circularized concrete strength is $f'_{cci} = 55.52$ MPa. Thus, by providing external CFRP confinement, an enhancement in load carrying capacity was about 167.8%. Table 8 shows data acquired from laboratory tests.

Similar results were obtained from the work of Rolli and Chandra (2015) [5]. In their study, they experimented reinforced concrete (RC) square columns circularized then wrapped by three layers of CFRP wraps. Columns had dimensions of 150×150 mm as cross section and 750 mm as height. Columns were subjected to axial compressive loads until failure occurred. In their experiment, the average peak load exerted on the square columns was 726.3 kN, while for circularized columns, the average peak load exerted on them was 2896.68 kN. Thus, circularization technique resulted in an increment in load carrying capacity for the columns about 299%. Surely, the increment in load carrying capacity achieved in their experiment is much larger than the increment observed in columns LC1 in this paper. There are many reasons to this variation (difference in increment percentage) but mainly it is due to different wrap thickness, i.e. different number of CFRP layers. Another reason is the difference in concrete strength, i.e. f'_c . From their experiments, square columns as well as circularization concrete were both casted using concrete mix of strength of grade M30. While as for columns LC1, i.e. columns in this paper, square columns were casted using concrete mix of strength equal to $f'_c = 24.41$ MPa, while circularization was performed using concrete mix of strength equal to $f'_c = 28.8$ MPa.

Table 8. Strength and lateral dilation of columns L0 and LC1

Specimens	Column L0-1	Column L0-2	Column LC1-1	Column LC1-2
Variables				
Unconfined column strength (MPa)	20.94	20.52	---	---
confined column strength (MPa)	---	---	54.06	56.97
Left side lateral dilation (mm)	-0.45	-0.26	0.58	0.2
Right side lateral dilation (mm)	0.59	0.36	0.25	0.69
Net side dilation (mm)	0.14	0.1	0.83	0.89
Average load bearing capacity increment %	---	---	167.8 %	

Figure 10 and Figure 11 show load displacement curves for columns LC1-1 and LC1-2 respectively. Since the two columns in the third group didn't experience any lateral buckling at midheight of the columns, the load displacement diagrams for both of them was plotted based on the highest displacement of the two dial gauges for each column. For instance, in case of column LC1-1, the two dial gauges recorded dilation at the location where they were installed. Thus, the largest of the two recordings, i.e. the largest of 0.58 and 0.25 mm (which is 0.58 mm), was plotted in Figure 10 versus the applied load. For column LC1-2, the largest of the two dial gauge readings 0.2 and 0.69 mm, which is 0.69 mm, was plotted in Figure 11 versus the applied load.

Additionally, Figure 12 shows maximum loads exerted on the columns L0, L1, and LC1. It should be noted that for square columns L0, stress was calculated normally by dividing the applied load by the area of square column. However, for columns LC1, the stress was calculated by dividing the applied load by the area of square section instead of the area of the new composite circular section. This was done in order to ease understanding of strengthening by circularization effect on square columns.

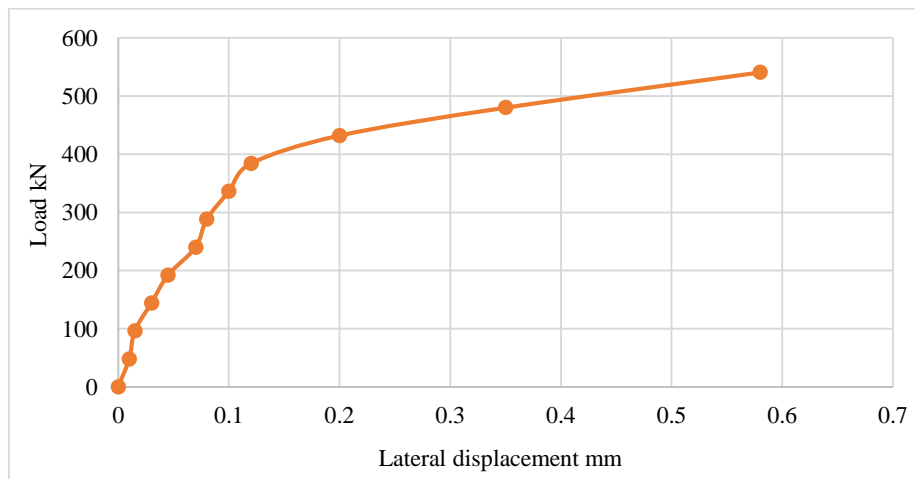

Figure 10. Load displacement curve of column LC1-1

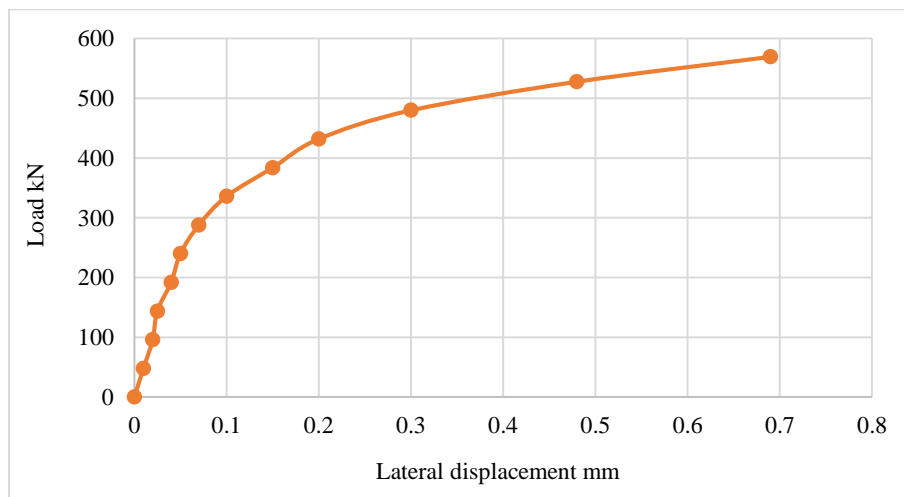

Figure 11. Load displacement curve of column LC1-2

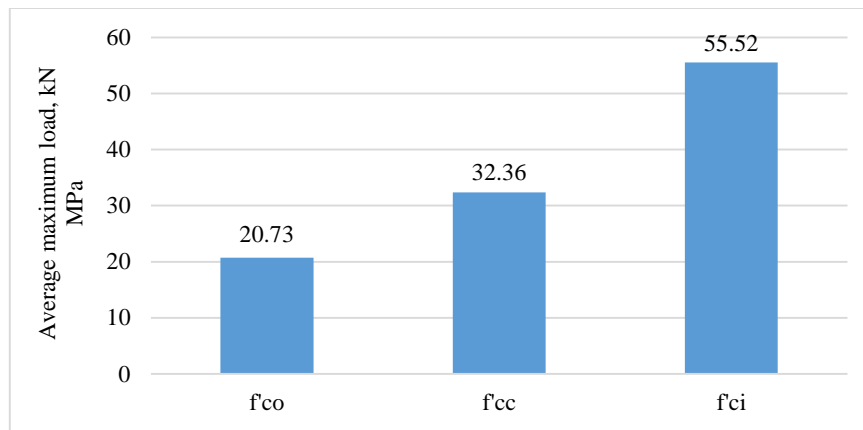

Figure 12. Bar chart for maximum average stress carried by the column, f'_{co} , f'_{cc} and f'_{cci}

Where:

f'_{co} : Average maximum stress applied, i.e. strength, on the reference non-confined square columns.

f'_{cc} : Average maximum stress applied, i.e. strength, on the externally confined square columns.

f'_{cci} : Average maximum stress applied, i.e. strength, on circularized confined square columns.

6. Conclusions

- Strengthening method by performing circularization technique and applying external passive confinement to the columns provided by CFRP wraps, deemed excellent results in terms of enhancing load bearing capacity and ductility of square columns.
- Strengthening method by directly applying, on the square column, an external passive confinement provided by CFRP wraps, deemed conveniently good results in terms of enhancing load bearing capacity and ductility of square columns.
- When comparing results between circularized columns and square columns (both confined with CFRP) in terms of load bearing capacity, it was observed that circularized columns enhanced and increased load bearing capacity far better than the increment resulted by direct application of CFRP without shape modification. Circularized columns enhanced load carrying capacity up to 167.8 %. Whereas confined square columns enhanced load carrying capacity up to 56.1%.
- When comparing results between circularized columns and square columns (both confined with CFRP) in terms of ductility, it was observed that both strengthening methods provided significant increase in ductility. However, circularized columns behaved in a more ductile manner than the confined square columns behaved.
- Circularization method effectively eliminated to a great extent stress concentration areas which would result if a non-circular column is wrapped with CFRP. This resulted in better enhancement in terms of load bearing capacity and ductility.

7. Acknowledgement

The authors gratefully acknowledge the support of the Department of Civil Engineering, University of Baghdad.

8. Conflicts of Interest

The authors declare no conflict of interest.

9. References

- [1] ACI Committee 440. "Guide for the Design and Construction of Externally Bonded FRP Systems for Strengthening Concrete Structures." ACI 440.2R. (2008).
- [2] Sangeetha, P. "Analysis of FRP Wrapped Concrete Columns under Uniaxial Compression." journal of scientific and industrial research 66. (2007).
- [3] Beryl Shanthapriya A, and Sakthieswaran N. "Optimization of GFRP Confinement in RC Columns Using Shape Modification Technology." International Journal of Engineering Research and V4, no. 08 (August 31, 2015). doi:10.17577/ijertv4is080394.

- [4] Yan, Z., and C. Pantelides. "External FRP Confinement of Concrete Columns Using Shape Modification Technology." Fourth International Conference on FRP Composites in Civil Engineering (CICE2008). Zurich, Switzerland. (2008).
- [5] Rolli, Yuvaraj, and K. V. Mahesh Chandra. "An Experimental Study on Strengthening OF RC Square Columns by Circularizing and Wrapping with FRP." International Research Journal of Engineering and Technology (IRJET) 02 (05). (2015).
- [6] Ozbakkaloglu, Togay, Jian C. Lim, and Thomas Vincent. "FRP-Confined Concrete in Circular Sections: Review and Assessment of Stress-strain Models." Engineering Structures 49 (April 2013): 1068–1088. doi:10.1016/j.engstruct.2012.06.010.
- [7] Mirmiran, Amir, and Mohsen Shahawy. "Behavior of Concrete Columns Confined by Fiber Composites." Journal of Structural Engineering 123, no. 5 (May 1997): 583–590. doi:10.1061/(asce)0733-9445(1997)123:5(583).
- [8] Campione, G., N. Miraglia, and M. Papia. "Strength and Strain Enhancements of Concrete Columns Confined with FRP Sheets." Structural Engineering and Mechanics 18, no. 6 (December 25, 2004): 769–790. doi:10.12989/sem.2004.18.6.769.
- [9] Benzaid, Riad, and Habib-Abdelhak Mesbah. "Circular and Square Concrete Columns Externally Confined by CFRP Composite: Experimental Investigation and Effective Strength Models." Fiber Reinforced Polymers - The Technology Applied for Concrete Repair (January 23, 2013). doi:10.5772/51589.
- [10] Al-Khafaji, Hayder. "Experimental Investigation of CFRP Wrapped Square Non-Ductile Reinforced Concrete Columns" (n.d.). doi:10.15760/etd.3330.
- [11] Pham, Thong M., Le V. Doan, and Muhammad N.S. Hadi. "Strengthening Square Reinforced Concrete Columns by Circularisation and FRP Confinement." Construction and Building Materials 49 (December 2013): 490–499. doi:10.1016/j.conbuildmat.2013.08.082.
- [12] Yan, Z., C. P. Pantelides, and L. D. Reaveley. "Seismic Retrofit of Bridge Columns Using Fiber Reinforced Polymer Composite Shells and Shape Modification." The 14 th World Conference on Earthquake Engineering. Beijing, China (2008).
- [13] ACI Committee 318. "Building Code Requirements for Structural Concrete." ACI 318. (2014).
- [14] Khan, Asad-ur-Rehman, and Shamsoun Fareed. "Confinement of Short Concrete Columns with CFRP Wraps Subjected to Concentric and Eccentric Loading." Taylor & Francis Group. (2012).
- [15] Pantelides, Chris P., Zihan Yan, and Lawrence D. Reaveley. "Shape Modification of Rectangular Columns Confined with FRP Composites." University of Utah/ college of engineering/ civil & environmental engineering. (2004).