

Calculation of marine air conditioning systems based on energy savings

Cálculo de sistemas de climatización marinos con base en ahorros energéticos

DOI: 10.25043/19098642.156

Ricardo A. Lugo-Villalba ¹

Mario Álvarez Guerra ²

Bienvenido Sarria López ³

Abstract

The development of ship propulsion in the areas of Economic Operation, Environmental Protection and Ship Efficiency (Triple E - Economy, Environment, Efficiency) is the comparison standard of the manufacturers of contemporary ships. The standard is based on the application of a more modern design of the diesel engines, the wide use of waste heat and the efficient operation of the ship. In accordance with the Economic Operation, the need to evaluate the design of air conditioning systems has been identified in order to determine the possible savings, which are represented by a decrease in fuel consumption, as a result of: the significant impact of this consumption in the operation of the ship, the current high costs of this energy, the periodic increase in the price of the same, and the international policies for the reduction of emissions to the atmosphere and preservation of the environment. By means of the energy diagnosis of the air conditioning system it is possible to determine the possible opportunities of energy saving during the operation of the ship. The results indicate that the thermal load and the cooling capacity required by the air conditioned spaces have a difference between their maximum and average value of 14%. This justifies the need to use a conditioning system with a variable volume of air supplied to the air conditioned space.

Key words: Thermal load, solar radiation, life cycle cost, marine air conditioning.

Resumen

El desarrollo de la propulsión de los buques en los aspectos de Operación Económica, Protección del Medio Ambiente y Eficiencia de la Propulsión del buque (Triple E- Economy, Environment, Efficiency) constituye el estándar de comparación de los fabricantes de buques contemporáneos. El estándar está basado en la aplicación de un diseño más moderno de los motores (máquinas) diésel, en la utilización amplia del calor de desecho y en la operación eficiente del barco. En correspondencia con la Operación Económica se ha identificado la necesidad de evaluar el diseño de los sistemas de aire acondicionado con el objetivo de determinar los posibles ahorros, que se vean representados en disminución del consumo de combustible, dado por: el significativo impacto de este consumo en la operación del buque, los altos costos de este energético en la actualidad, el incremento periódico en el precio del mismo, y las políticas internacionales para la reducción de emisiones a la atmósfera y preservación del medio ambiente. Mediante el diagnóstico energético del sistema de aire acondicionado se puede determinar las posibles oportunidades de ahorro energético durante la operación de la embarcación. Los resultados indican que, la carga térmica y la capacidad de enfriamiento requerida por los espacios acondicionados tienen una diferencia entre su valor máximo y medio del 14 %. Esto justifica la necesidad de utilizar un sistema de acondicionamiento con volumen variable del aire suministrado al espacio acondicionado.

Palabras claves: Carga térmica, radiación solar, costo de ciclo de vida, climatización marina.

Date Received: May 1st 2017 - Fecha de recepción: Mayo 1 de 2017

Date Accepted: May 13th 2017 - Fecha de aceptación: Mayo 13 de 2017

¹ Head of Material, Colombian Navy. Bogotá, Colombia. Email: ralogov@yahoo.com

² Universidad de Cienfuegos. Cienfuegos, Cuba. Email: maguerra@ucf.edu.cu

³ Biofilm Energy Manager. Cartagena, Colombia. Email: bslopez2000@yahoo.es

Introduction

Most of the ships that are built today are based on traditional design concepts. Improvements are observed in simple components such as the engine and the propeller; but this does not apply to the ship as a complete system. Many shipbuilders concentrate and make efforts to improve capacity but, unfortunately, they still consume a lot of fuel unnecessarily.

The shipbuilding industry makes very little effort to reduce operational costs for new vessels or for repaired vessels, as the builder is not responsible for the fuel bill; in general, little time and resources are devoted to monitoring and controlling the use of energy on board ships.

Poor energy knowledge and the absence of a systematic control are the two main barriers to improving energy efficiency in ships. An important tool to overcome this barrier is the conversion of energy flow into monetary flow (money).

On the other hand, the International Maritime Organization (IMO) has established several levels of emissions to the environment. According to IMO, NO_x emissions from 2016 should be below 3 g / kWh. CO₂ emissions should be reduced by 30%.

Together with the requirements of the IMO for the protection of the environment, as a result of the increase in the price of crude oil, there has been an increase in the application of technologies and measures that result in fuel savings on ships

The air conditioning systems installed in the frigate units of the Colombian Navy were selected according to the initial cost, with technical capacities similar to those installed in the 1980s when these vessels were acquired, which is why it has technological equipment from 2000 but with energy consumptions similar to those originally installed.

The energy demand for air conditioning systems, for frigate type units, when in operation, on average, is above 40% of total demand. Working to increase energy savings in these systems not only improves

fuel economy and economic effectiveness; it also decreases the emission of harmful substances to the environment.

This paper presents the results of applying the energy analysis to the entire air conditioning system. It shows the actual consumption and the potential energy savings that can be achieved during the daily operation of the ship.

Calculation of the thermal load in boats

For the calculation of the thermal load in ships, methodologies have been developed by entities such as the Society of Engineers and Naval Architects of North America (SNAME) who in the technical bulletin T & R 4-16 published the methodology under the name "Calculations for Merchant Ships Heating, Ventilation and Air Conditioning Design" as well as some standards of the International Organization for Standardization (ISO) which will be taken as reference for this paper.

The methodology applied in the energy evaluation of the air conditioning system is summarized below.

The components of the thermal load are as follows:

- Transmission load
- Solar + Transmission Load
- Radiation load through glass
- Lighting Load
- Equipment Load
- Personnel Load
- Infiltration load for port operation

The load components of the system are:

- Fan load (considered as an equipment load)
- Supply duct load
- Load per Return path load
- Outdoor air load

The calculation equations used are shown in Table 1.

Each frigate has an air conditioning system composed of two chiller plants of 457.2 kW (130 TR) each; one in operation and the other as

Table 1. Equations used to calculate the thermal load

TYPE OF LOAD	EQUATION	VARIABLES	DATA SOURCE
WALL AND CEILING TRANSMISSION	$q_{sk} = U \times A \times CLTD_C + (78 - Tr) + (To - 85)] f$ $CLTD_C = [(CLTD + LM) k$	<p>CLDT: Temperature difference for the cooling load according to the group to which the wall belongs.</p> <p>LM: Correction according to the latitude of the place and the selected design month.</p> <p>K: Correction by color.</p>	ASHRAE. (1989). Fundamentals Handbook. Atlanta, USA.
GLASS	<p>Conduction $q = U \times A \times CLTD_C$ $CLTD_C = CLTD + (78 - Tr) + (To - 85)$</p> <p>Radiation $q = A \times SC \times SHGF \times CLF$</p>	<p>SC: Shading coefficient for glass.</p> <p>SHGF: Solar Heat Gain Factor in Btu/h*ft²</p> <p>CLF: Cooling charge factor for glasses.</p>	ASHRAE. (1989). Fundamentals Handbook. Atlanta, USA.
ILLUMINATION	$q = 3,41 \times W \times CLF \times Ful \times Fsa$	<p>Ful = $W_{installed} / W_{used} = 64/64 = 1$</p> <p>Fsa = Special lighting factor depends on the type of luminaire and ballast</p> <p>CLF = Cooling load factor. depends on the number of hours on</p>	ASHRAE. (1989). Fundamentals Handbook. Atlanta, USA.
POWER EQUIPMENT	$q_{motor} = 2545 \times \left(\frac{P}{E_M} \right) \times F_{UM} \times F_{LM}$	<p>P = The nominal power of the motor in HP.</p> <p>E_M = Motor efficiency as a decimal fraction less than 1.0.</p> <p>F_{UM} = The usage factor applies when it is known that the motor will be used intermittently for a significant time of not using the total hours of operation.</p> <p>F_{LM} = Load factor corresponding to the fraction of the nominal power of the shaft being developed by the equipment under the conditions of the estimated cooling load.</p>	ASHRAE. (1989). Fundamentals Handbook. Atlanta, USA.
MINOR EQUIPMENT	$q_{sensible} = q_{entrada} \times F_U \times F_R$	<p>F_U = Usage factor</p> <p>F_R = Radiation factor</p>	ASHRAE. (1989). Fundamentals Handbook. Atlanta, USA.
PEOPLE	$q_{sensible} = G_{sp} \cdot N \cdot CLF$ $q_{latente} = G_{lp} \times N$	<p>G_{sp}, G_{lp}: Sensible and latent heat gain per person respectively.</p> <p>CLF: Cooling load factor for people.</p>	ASHRAE. (1989). Fundamentals Handbook. Atlanta, USA.
DOORS INFILTRATION	$q_s = 1,1 \times CFM \times \Delta T$ $q_l = 4840 \times CFM \times \Delta W$	<p>ΔT: Temperature difference = outer T - inner T. °F</p> <p>ΔW: Specific humidity difference in lb water vapor / lb dry air. The values of W are obtained from the psychrometric chart.</p> <p>CFM: Air infiltration or ventilation flow rate. (ft³/min)</p>	ASHRAE. (1989). Fundamentals Handbook. Atlanta, USA.

backup, this value corresponds to the hottest time of the day. The cold water is sent to six (6) handling units denominated Z which air-conditioning the residential zones and they have capacity to renew

and recirculate the air. The cold water is also sent to one (1) handling unit denominated L and eight (8) handling units denominated U for workshops and warehouses; the L and U type units have

recirculation capacity. The thermal load of 457.2 kW was calculated under the following conditions:

- Dry Bulb Outside Temperature: 35 C
- Wet Bulb Outside Temperature: 27.7 C
- Dry Bulb Inside Temperature: 25.5 C
- Wet Bulb Inside Temperature: 18.3C (50% RH)
- Temperature of the horizontal sheet exposed to the sun: 63 C
- Temperature of vertical blade sheet exposed to the sun: 52 C
- Sea Water Temperature: 29.5 C

Calculation of the load of the Air Handling Units (AHU)

The calculation of heat transfer through bulkheads and decks exposed to the sun is performed according to the following formulation,

$$Q = UA \Delta t \tag{1}$$

where U is the total heat transfer coefficient, A is the area exposed to the sun and Δt is the difference between the surface temperature of the sheet and the indoor temperature of the heated area.

The value of U varies depending on the external material (steel or aluminum), the structural arrangement, the thickness and type of insulation and the interior finish.

The value of the transfer coefficient U for air-air is calculated by means of the equation:

$$U = \frac{1}{\frac{1}{fp} + \frac{1}{C} + \frac{1}{fs}} \tag{2}$$

and for surface-air

$$U = \frac{1}{\frac{1}{C} + \frac{1}{fs}} \tag{3}$$

where C is the thermal conductivity of the structure material, fp is the film coefficient of the structural

sheet and fp is the film coefficient of the structural reinforcements.

By means of the measurements performed in this investigation, the surface temperatures of the sheets or casings of the ship that are exposed to the solar radiation are obtained. These temperatures vary according to the position of the sun (time of day) as shown in Table 2. These values were measured in Cartagena, with the sheets painted and installed.

Table 2. Temperature variation of the sheets exposed to the sun

TIME	Type		Rh
	Horizontal	Vertical	%
7	29.15	29.60	89%
8	34.73	38.02	84%
9	43.25	41.84	79%
10	47.91	41.65	67%
11	52.80	41.88	70%
12	57.88	41.69	75%
13	62.95	41.50	71%
14	62.63	42.43	59%
15	59.83	44.45	66%
16	50.10	43.97	66%
17	42.70	38.68	66%

Fig. 1 shows the variation of the surface temperature of the ship's deck. Using the data in the above table, the thermal load is recalculated according to the time of day, keeping the thermal loads due to personnel, equipment, lighting, etc. constant. The results are presented in Table 3.

Fig. 1. Variation of surface temperature of the ship's deck

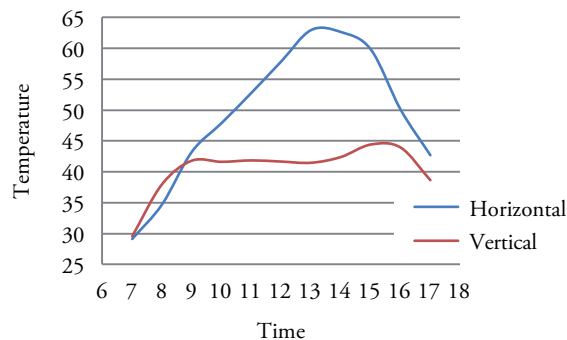
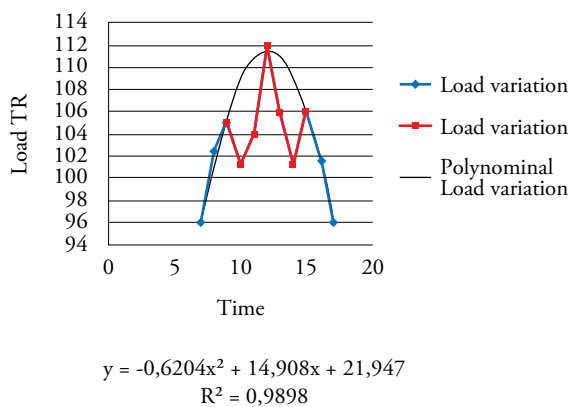

Table 3. Load variation according to the time of day (W)

	TIME										
	7	8	9	10	11	12	13	14	15	16	17
Z1	43.245	47.671	49.544	47.202	49.307	54.867,48	51.204	47.800	50.948	47.211	43.555
Z2	17.760	18.017	18.049	17.797	17.914	18.320,94	17.953	17.665	17.952	17.758	17.570
Z3	49.636	55.227	57.155	54.181	56.163	61.896,39	57.429	53.814	57.782	54.333	50.151
Z4	45.787	50.485	51.946	48.854	50.851	56.792	52.148	48.280	52.158	48.703	45.082
Z6	56.759	62.135	63.627	59.880	62.070	68.825	63.293	58.796	63.410	59.671	55.618
Z8	42.472	45.976	47.943	47.646	48.767	51.377	50.095	49.206	50.404	48.067	45.353
L13	19.845	19.845	19.845	19.845	19.845	19.845	19.845	19.845	19.845	19.845	19.845
U1	2.977	2.977	2.977	2.977	2.977	2.977	2.977	2.977	2.977	2.977	2.977
U2	14.884	14.884	14.884	14.884	14.884	14.884	14.884	14.884	14.884	14.884	14.884
U4	3.969	3.969	3.969	3.969	3.969	3.969	3.969	3.969	3.969	3.969	3.969
U5	2.977	2.977	2.977	2.977	2.977	2.977	2.977	2.977	2.977	2.977	2.977
U7	23.153	23.153	23.153	23.153	23.153	23.153	23.153	23.153	23.153	23.153	23.153
U8	2.977	2.977	2.977	2.977	2.977	2.977	2.977	2.977	2.977	2.977	2.977
U9	4.961	4.961	4.961	4.961	4.961	4.961	4.961	4.961	4.961	4.961	4.961
U10	4.961	4.961	4.961	4.961	4.961	4.961	4.961	4.961	4.961	4.961	4.961
Total (W)	336.364	360.215	368.968	356.264	365.776	392.783	372.825	356.265	373.357	356.447	338.033
Total TR	96	102	105	101	104	112	106	101	106	101	96

From the above table it is evidenced that at midday a maximum cooling capacity is required with 392 kW (112 TR), which is in accordance with the highest temperature of the sheet 60 C. In Fig. 2, the variation of the total thermal load is observed according to the time, in tons of refrigeration (TR).

Fig. 2. Load variation by time



It is observed that the Zs exhibit significant variations in the thermal load, with the exception of Z2. Likewise the U and L do not present significant variations. For large consumers, the load varies according to Fig. 3

Fig. 3. Load variation for large consumers by time

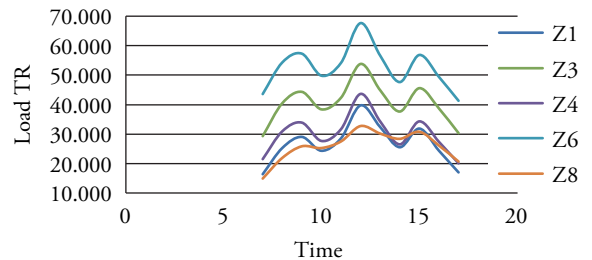

When calculating the air flow rate as a function of the variation of the thermal load, the air flow values for this condition are found, as shown in Table 4 and Fig. 4.

Table 4. Variation of the air flow as a function of the thermal load

AHU	TIME										
	7	8	9	10	11	12	13	14	15	16	17
Z1	3.962	4.163	4.380	4.476	4.581	4.686	4791	4.793	4.755	4.545	4.337
Z3	4.646	4.971	5.190	5.240	5.306	5.361	5416	5.441	5.469	5.337	5.087
Z4	3.984	4.159	4.307	4.359	4.418	4.474	4530	4.539	4.533	4.414	4.260
Z6	5.117	5.311	5.454	5.494	5.543	5.587	5631	5.644	5.652	5.553	5.396
Z8	5.353	5.703	5.970	6.086	6.176	6.300	6346	6.399	6.392	6.173	5.895

Fig. 4. Variation of loads in air-conditioned spaces according to the time

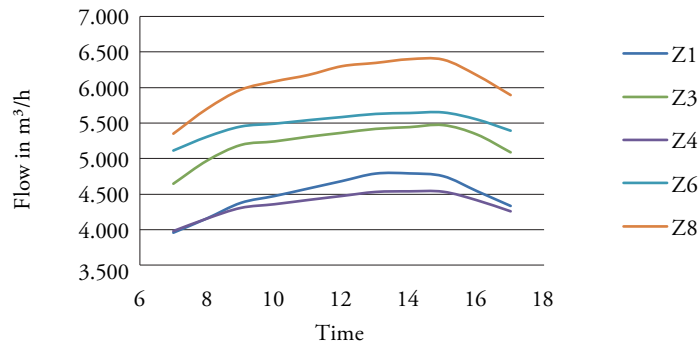

By similarity laws the velocities, powers and discharge pressures of each of the fans and the results shown in Table 5 are calculated for each handler.

Table 5. Behavior of the fans depending on the time of day

Handler Z1					Handler Z4				
Time	Q m³/h	H m	kW	Rpm	Time	Q m³/h	H m	kW	Rpm
7	3.955	0,1758	3,3264	2.889	7	3.981	0,1782	3,3925	2.908
8	4.198	0,1981	3,9776	3.066	8	4.178	0,1962	3,9217	3.052
9	4.351	0,2128	4,4295	3.178	9	4.290	0,2069	4,2458	3.133
10	4.477	0,2254	4,8259	3.270	10	4.365	0,2142	4,4727	3.188
11	4.599	0,2378	5,2322	3.359	11	4.429	0,2205	4,6714	3.235
12	4.713	0,2497	5,6297	3.442	12	4.489	0,2265	4,8633	3.279
13	4.796	0,2586	5,9322	3.503	13	4.539	0,2316	5,0278	3.315
14	4.820	0,2612	6,0206	3.520	14	4.564	0,2342	5,1128	3.334
15	4.760	0,2547	5,8001	3.477	15	4.546	0,2323	5,0516	3.320
16	4.608	0,2388	5,2636	3.366	16	4.465	0,2241	4,7868	3.261
17	4.382	0,2159	4,5263	3.201	17	4.307	0,2086	4,2976	3.146

Handler Z3					Handler Z6				
Time	Q m ³ /h	H m	kW	Rpm	Time	Q m ³ /h	H m	kW	Rpm
7	4.641	0,1755	3,7500	2.960	7	5.115	0,2132	5,0211	3.263
8	4.986	0,2025	4,6484	3.180	8	5.321	0,2306	5,6495	3.393
9	5.161	0,2170	5,1568	3.292	9	5.439	0,2411	6,0366	3.469
10	5.248	0,2244	5,4216	3.347	10	5.507	0,2471	6,2642	3.512
11	5.300	0,2289	5,5848	3.380	11	5.551	0,2511	6,4175	3.541
12	5.347	0,2329	5,7343	3.410	12	5.592	0,2548	6,5590	3.566
13	5.395	0,2372	5,8906	3.441	13	5.635	0,2587	6,7105	3.594
14	5.430	0,2402	6,0052	3.463	14	5.670	0,2620	6,8388	3.617
15	5.417	0,2391	5,9624	3.455	15	5.671	0,2620	6,8409	3.617
16	5.304	0,2292	5,5977	3.383	16	5.587	0,2543	6,5406	3.563
17	5.023	0,2056	4,7540	3.204	17	5.343	0,2326	5,7217	3.408

Handler Z8				
Time	Q m ³ /h	H m	kW	Rpm
7	4.641	0,1228	2,6061	2.576
8	4.986	0,1417	3,2304	2.767
9	5.161	0,1519	3,5838	2.864
10	5.248	0,1570	3,7678	2.913
11	5.300	0,1602	3,8812	2.942
12	5.347	0,1630	3,9851	2.968
13	5.395	0,1660	4,0938	2.994
14	5.430	0,1681	4,1734	3.014
15	5.417	0,1673	4,1436	3.006
16	5.304	0,1604	3,8901	2.944
17	5.023	0,1439	3,3038	2.788

Fig. 5. Flow behavior to ensure comfort at different times, for each handler

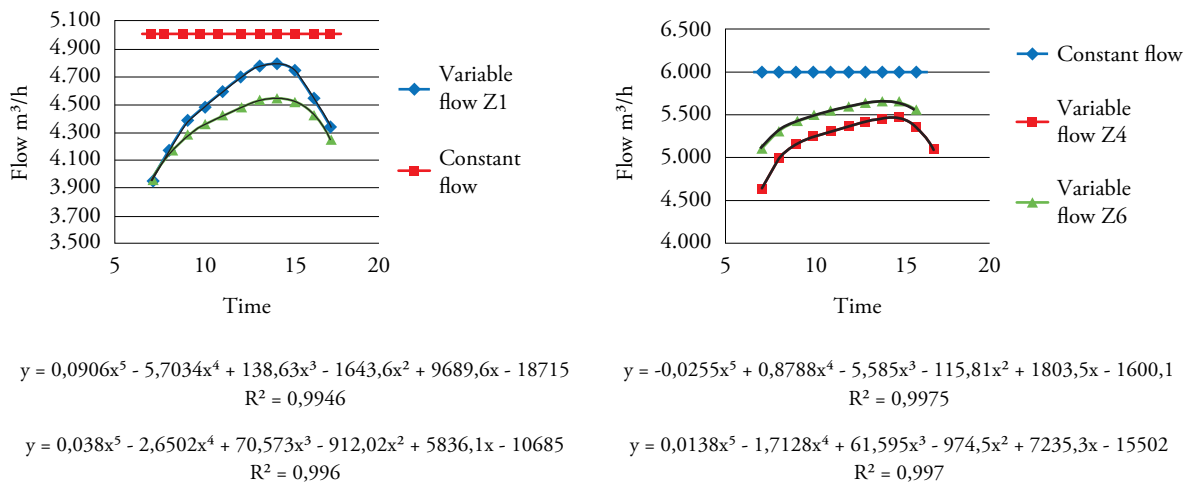

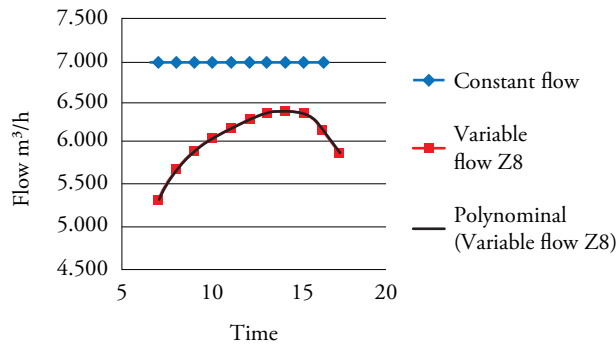

$$y = 0,05x^5 - 3,7366x^4 + 104,74x^3 - 1414,3x^2 + 9430,3x - 19159$$

$$R^2 = 0,9962$$

Based on the above results, a system is recommended to vary the airflow of each fan, such as a speed variator for the electric motor and to complement it with variable air flow distribution boxes which operate with sensors that open or close depending on the temperature of each conditioned room, as shown in Fig. 6. An example of the above can be seen in the catalog of the brand TRANE VariTrane TM Products Single Duct/Dual Duct Units VAV-PRC011M-EN

Calculation of the load variation in the chiller feed pump

Taking into account that the thermal load varies according to the time of day, the water flow required by the Z must vary according to this load. Therefore, the calculation is performed by finding

the results shown in Table 6 and comparing them with the currently installed pump as shown in Fig. 7. Therefore a system is recommended which varies the water flow of the pump, such as a speed variator for the electric motor.

Electrical power will also vary. This variation is observed in Table 7.

To estimate the energy savings at night, it is assumed that the pump operates the minimum flow calculated on the day, ie at 52.11 m³/h. Taking into account that the pump operates 100% of the year, current demand is estimated at 84 534 kWh year, with the speed variator, demand is estimated at 31 840 kWh year, saving 52 695 kWh year, which means savings with the proposed system are around 62.3% of current consumption. This variation is shown graphically in Fig. 8.

Fig. 6. Operation of the TRANE variable air volume system

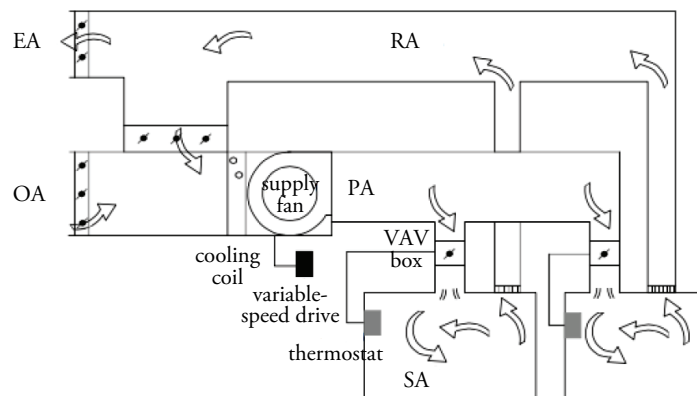
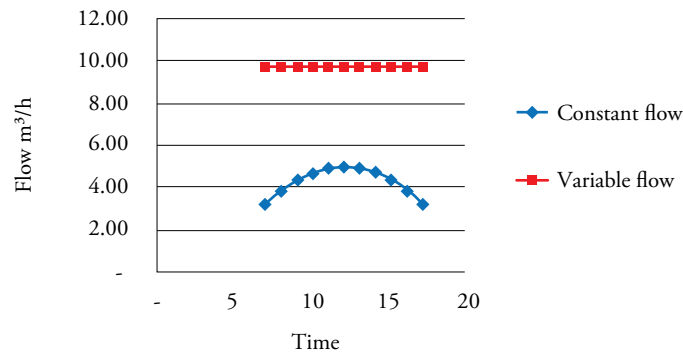

Table 6. Variation of the flow as a function of the time of day

	Time										
	7	8	9	10	11	12	13	14	15	16	17
Q m ³ /h	52.11	55.15	57.52	59.22	60.24	60.59	60.26	69.26	57.59	55.24	52.22
H m	11.50	12.88	14.01	14.85	15.36	15.54	15.38	14.87	14.04	12.92	11.55
rpm	1205	1276	1330	1370	1393	1401	1394	1371	1332	1278	1208
kW/h	3.15	3.74	4.24	4.63	4.87	4.95	4.87	4.64	4.25	3.75	3.17

Fig. 7. Behavior of the flow according to the time of day



$$H = -0,337Q^2 + 8,0991Q + 11,928 \quad R^2 = 0,98989$$

Table 7. Variation of pump power as a function of time of day

Time	Current operation		Proposed operation with speed variator		
	Q m ³ /h	kW	Q m ³ /h	rpm	kW
7	80	9,65	52,11	1.205	3,15
8	80	9,65	55,15	1.276	3,74
9	80	9,65	57,52	1.330	4,24
10	80	9,65	59,22	1.370	4,63
11	80	9,65	60,24	1.393	4,87
12	80	9,65	60,59	1.401	4,95
13	80	9,65	60,26	1.394	4,87
14	80	9,65	59,26	1.371	4,64
15	80	9,65	57,59	1.332	4,25
16	80	9,65	55,24	1.278	3,75
17	80	9,65	52,22	1.208	3,17

Fig. 8. Variation of the power consumed by the pump according to the time of day

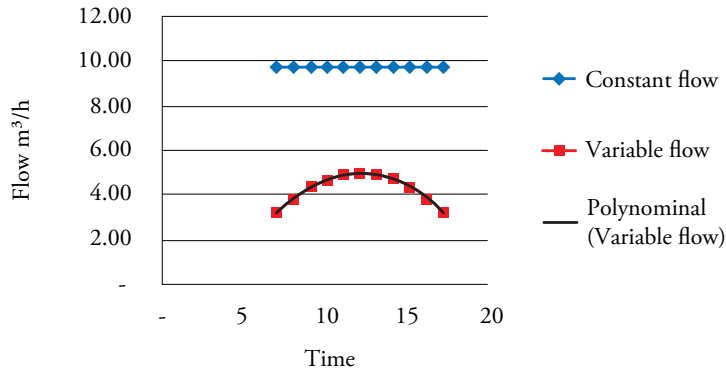

$$y = 0,0004x^4 - 0,0206x^3 + 0,2881x^2 - 0,968x + 1,9744 \quad R^2 = 1$$

Total electrical consumption in operation of the current and proposed system

Based on the above, it is possible to estimate the total consumption per hour of the day, taking into account the consumption of the compressor, cold water pump and handlers, as shown in Table 8.

These consumptions are related to the variation of the total load due to the solar radiation on the outer sheets of the boat. For the night an average constant demand of 145 kW-h is estimated, as shown in Fig. 9.

Currently the ship has a constant and independent demand of the variation of the load due to the action of the sun; the estimated value of current consumption is equal to constant 174 kW-h. Fig. 10

shows the current consumption comparison curves for the proposed variable energy consumption.

Based on the information in Table 8, consumption is estimated at 3576kWh/day for the complete system with the proposed modifications, assuming that in the hours without solar charge the demand is equal to the lowest with solar load, which means 145.4 kW-hr. Currently, the system consumes 4180 kW-h/day, which is why energy savings of 14.5% are estimated.

Life cycle cost

Based on the above analysis, the life cycle cost of the asset is projected from its acquisition to decommissioning taking into account installation, maintenance and operation to determine the total cost of the asset. Therefore, the life cycle cost of an asset can be calculated by the following equation:

Fig. 9. Variable consumption, depending on the thermal load

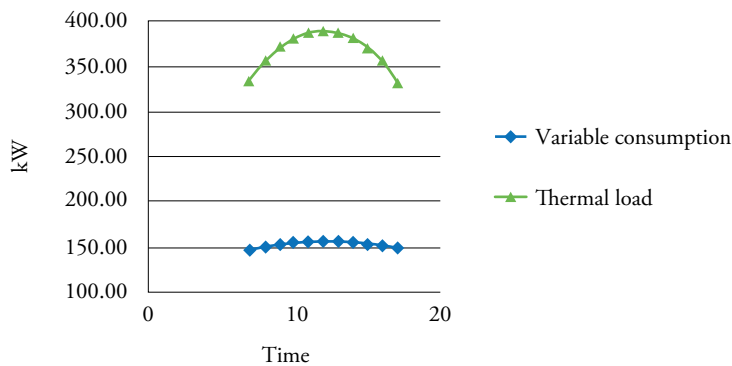

Table 8. Total energy consumption per operation (kW-h)

AHU	TIME										
	7	8	9	10	11	12	13	14	15	16	17
Z1	3.33	3.98	4.43	4.83	5.23	5.63	5.93	6.02	5.80	5.26	4.53
Z2	1.20	1.20	1.20	1.20	1.20	1.20	1.20	1.20	1.20	1.20	1.20
Z3	3.75	4.65	5.16	5.42	5.58	5.73	5.89	6.01	5.96	5.60	4.75
Z4	3.39	3.92	4.25	4.47	4.67	4.86	5.03	5.11	5.05	4.79	4.30
Z6	5.02	5.65	6.04	6.26	6.42	6.56	6.71	6.84	6.84	6.54	5.72
Z8	2.61	3.23	3.58	3.77	3.88	3.99	4.09	4.17	4.14	3.89	3.30
L13	1.00	1.00	1.00	1.00	1.00	1.00	1.00	1.00	1.00	1.00	1.00
U1	0.20	0.20	0.20	0.20	0.20	0.20	0.20	0.20	0.20	0.20	0.20
U2	0.55	0.55	0.55	0.55	0.55	0.55	0.55	0.55	0.55	0.55	0.55
U4	0.20	0.20	0.20	0.20	0.20	0.20	0.20	0.20	0.20	0.20	0.20
U5	0.20	0.20	0.20	0.20	0.20	0.20	0.20	0.20	0.20	0.20	0.20
U7	2.50	2.50	2.50	2.50	2.50	2.50	2.50	2.50	2.50	2.50	2.50
U8	1.25	1.25	1.25	1.25	1.25	1.25	1.25	1.25	1.25	1.25	1.25
U9	1.35	1.35	1.35	1.35	1.35	1.35	1.35	1.35	1.35	1.35	1.35
U10	1.35	1.35	1.35	1.35	1.35	1.35	1.35	1.35	1.35	1.35	1.35
COMP	114.4	114.4	114.4	114.4	114.4	114.4	114.4	114.4	114.4	114.4	114.4
PUMP	3.15	3.74	4.24	4.63	4.87	4.95	4.87	4.64	4.25	3.75	3.17
TOTAL	145.4	149.3	151.8	153.5	154.8	155.9	156.7	156.9	156.2	154.0	149.9

$$L_{CC} = (C_{ic} + C_{in} + C_e + C_o + C_m + C_s + C_{amb} + C_d) \quad (4)$$

Where

- C_{ic} = initial cost or equipment purchase cost.
- C_{in} = cost of installation and commissioning.
- C_e = energy cost.
- C_o = operation cost.
- C_m = maintenance cost.
- C_s = cost due to breakdown time.
- C_{amb} = environmental costs.
- C_d = withdrawal and final closure

In this case, the useful life of the asset is projected in 20 years and the study is conducted in US dollars under the Net Present Value (NPV) methodology, an increase in the cost of energy and spare parts of 8% per annum, no funding is sought for the additional equipment to be installed, as shown in Table 9.

As shown in Table 9, the proposed option will save 10.17% in 20 years of operation. The distribution of costs is shown in Fig. 11.

Fig. 10. Comparison between the current consumption and the proposed variable consumption

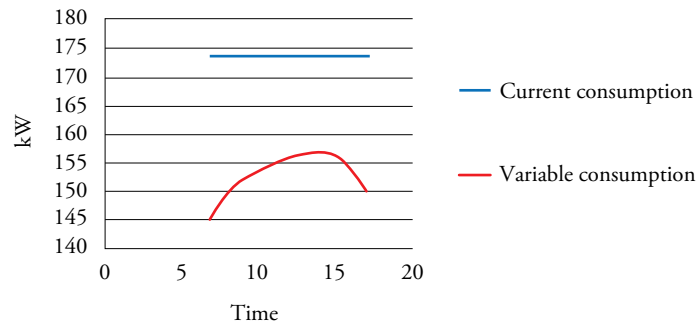
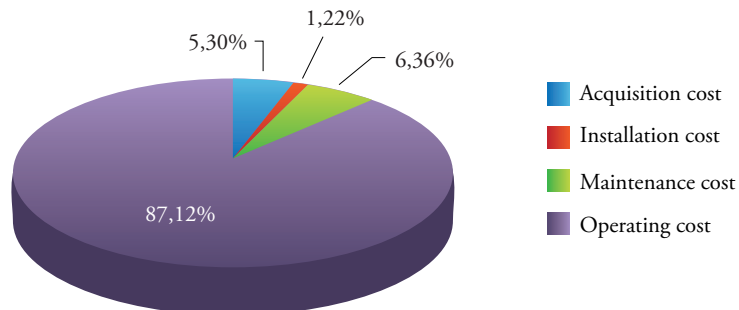

Table 9. Lifecycle cost for the current equipment and the proposed option

Input Information				
Components cost per boat		Current system	Proposed system	Unit
0	Acquisition	Unit Cost		
1	Chiller + evaporator + condenser + control	359,488.00	359,488.00	U\$
2	Cold water pump	6,116.00	6,116.00	U\$
3	Cold water pump speed variator	-	2,935.33	U\$
4	Cold water pipe (includes valves and accessories)	33,333.33	50,000.00	U\$
5	Condensation water pump	6,116.00	6,116.00	U\$
6	speed variator condensation water pump	-	2,935.33	U\$
7	Condensation water pipe (includes valves and accessories)	10,000.00	10,000.00	U\$
8	AHU (Z1 Z2 Z3 Z4 Z6 Z8)	349,207.00	349,207.00	U\$
9	Speed variators AHU	-	10,198.67	U\$
	Z1	-	1,931.00	U\$
	Z3	-	2,039.33	U\$
	Z4	-	1,931.00	U\$
	Z6	-	2,039.33	U\$
	Z8	-	2,258.00	U\$
10	Variable Flow Boxes	-	64,855.00	U\$
11	<i>Total acquisition</i>	<i>764,260.33</i>	<i>861,851.33</i>	<i>U\$</i>
12	Installation			
13	Chiller + evaporator + condenser + control	100,000.00	100,000.00	U\$
14	cold water pump	611.60	611.60	U\$
15	cold water pump speed variator	-	293.53	U\$
16	cold water pipe	3,333.33	5,000.00	U\$
17	condensation water pump	611.60	611.60	U\$
18	speed variator condensation water pump		293.53	U\$
19	water condensation pipe	1,000.00	1,000.00	U\$
20	AHU	82,563.00	82,563.00	U\$
21	Speed variators AHU	-	1,019.87	U\$
22	Variable Flow Boxes	-	6,485.50	U\$
23	Total Installation	188,119.53	197,878.63	U\$
24	Total initial investment	952,379.87	1,059,729.97	U\$
25	Maintenance	22,927.81	25,855.54	U\$/year
26				U\$/year
27	Total maintenance	22,927.81	25,855.54	U\$/year
28	Energy Costs			
29	Power Consumption	4,180.00	3,657.00	kW-h/day
30	Days of operation year	346.75	346.75	Days
31	Days of operation with generators	255.41	255.41	Days
32	Days of operation with earth current	91.34	91.34	Days

33	Total Power Consumption	1,449,415.00	1,268,064.75	kW.h/year
34	diesel consumption to produce electricity consumption	1,128.00	984.00	l/d
35	Diesel consumption per year	288,102.48	251,323.44	l/year
36	Diesel cost	1.04	1.04	US/l
37	Total diesel cost per year	299,626.58	261,376.38	US/year
38	Current consumption	381,801.20	334,030.38	kW-h/year
39	Actual earth current cost	0.14	0.14	US/kW-h
40	Total actual earth current cost per year	54,835.56	47,974.56	US/year
41	Total Energy Costs	354,462.14	309,350.93	US/year
42	Operating Costs	-	-	US/year
43	Cost per breakdown	-	-	US/year
44	Environmental costs	-	-	US/year
45	Inflation	0.0677	0.0677	
46	% Fuel increase	0.08	0.08	
47	salvage value	0	0	
48	Total equipment value	764,260	861,851	US
49	initial investment	764,260	861,851	US
50	Financing	-	-	US
51	number of installments	48	48	months
52	financing interest	22	22	% year
53	financing interest	0.018333333	0.018333333	
54	equipment life	20	20	years
55	installment value	-	-	US
56	total loan	-	-	US
57	Installation cost	188,119.53	197,878.63	US
58	Maintenance Costs	916,664.66	1,033,716.69	US
59	energy costs	16,220,883.81	14,156,506.41	US
60	TOTAL	18,089,928.34	16,249,953.06	US
61	Saving		1,839,975.27	US
62	% saving		10.17	%

Fig. 11. Cost distribution of the proposed option



Environmental impacts

Environmental impacts are measured in accordance with the International Maritime Organization (IMO), which regulates emissions to the environment by marine diesel engines for Nitrogen Oxides (NO_x) in g / kWh according to the following equation:

$$NO_x = 45,0n^{0.2} \quad (5)$$

Where n is the engine speed equal to or greater than 130 rpm but less than 2,000 rpm. Therefore, NO_x emissions generated by generators, which operate at 1800 rpm are estimated at 214 586 Ton over 20 years of equipment life for the current system and 187 377 Ton over 20 years of equipment life for the proposed system, which means avoiding the emission of 26 849 Ton NO_x, (12.67%) over 20 years, with the proposed system.

Conclusions

The currently used thermal load calculation methods do not take into account the actual changes in temperature of the outer sheet of the vessels as a function of the time and place of operation, and therefore the result of the calculation will have constant and oversized consumption.

The operating costs of the asset correspond to 87.12% of the total costs in the life cycle, so the savings in operation will have significant impacts on the life cycle cost.

There are opportunities to save on the operation of the fans in the handling units Z and the cold water pump passing from a constant energy consumption to a variable consumption depending on the load, which varies with the time of day.

By integrating the proposed savings measures to the fans, pipes and pumps, savings of 10.17% are estimated in the life cycle of the asset.

Due to fuel savings, the environmental impacts would reduce NO_x emissions by 12.6% compared to the current system.

Bibliography

COLOMBIA, Armada Nacional. Fragatas Clase Padilla. Manual 460 Sistema Técnico de Ventilación. 1982. [250] p.

INTERNATIONAL Organization for Standardization. ISO 7547 – Ship and marine technology - Air conditioning and ventilation of accommodation spaces - Design Conditions and basis of calculations. Geneva, Switzerland: 2002. 13 p.

ORGANIZACION Marítima Internacional. Convenio Marpol Anexo VI 73/78 - Reglas para prevenir la contaminación atmosférica, ocasionada por buques, regla 13 óxidos de nitrógeno. Londres, Inglaterra: 2002. 553 p.

OROZCO C., y CASTAÑO J. (2008). Optimización financiera de sistema de aire acondicionado para cuartos limpios. *Scientia et Technica* [en línea]. Año XIV, no. 39. Septiembre 2008 [Fecha de consulta: 11 de abril de 2016]. Available en: <http://www.redaluc.org/articulo.oa?id=84920503034> ISSN: 0122-1701

RAMIREZ Carlos [et al]. *Fundamentos de Matemáticas Financieras* [en línea]. Cartagena de Indias, Colombia: Editorial Universidad Libre sede Cartagena, 2009 [fecha de consulta: 8 de abril de 2016]. Available http://www.uv.mx/personal/cbustamante/files/2011/06/MATEMATICAS_FINANCIERAS.pdf ISBN: 978-958-8621-03-6

RODRIGUEZ Carlos [et al]. Diagnostico energético del sistema de aire acondicionado y refrigeración de un buque tipo nodriza fluvial. *Ciencia y Tecnología de Buques*, 1 (1): 27 – 41, Julio 2007. ISSN 1909 8642

SNAME. Technical & Research Bulletin 4-16 - Recommended Practices for Merchant Ship Heating, Ventilation and Air Conditioning

- Design Calculations. Jersey City, NJ, USA. 1980. 75 p.
- SNAME. Technical & Research Bulletin 4-7 - Thermal Insulation Report. Jersey City, NJ, USA. 1963. 129 p.
- UNIVERSIDAD de Cienfuegos. Maestría en Eficiencia Energética - Máquinas de flujo, eficiencia en su aplicación. Cienfuegos, Cuba. 2003. [100] p.