

University of Montana

ScholarWorks at University of Montana

Geosciences Faculty Publications

Geosciences

11-14-2008

Air compression as a mechanism for the underdamped slug test response in fractured glacier ice

Toby W. Meierbachtol
University of Montana - Missoula

Joel T. Harper
University of Montana - Missoula, joel.harper@mso.umt.edu

Neil Humphrey
University of Wyoming

Jeremy Shaha
Aspect Consulting

John Bradford
Boise State University

Follow this and additional works at: https://scholarworks.umt.edu/geosci_pubs



Part of the [Geology Commons](#)

Let us know how access to this document benefits you.

Recommended Citation

Meierbachtol, T. W., J. T. Harper, N. F. Humphrey, J. Shaha, and J. H. Bradford (2008), Air compression as a mechanism for the underdamped slug test response in fractured glacier ice, *J. Geophys. Res.*, 113, F04009, doi:10.1029/2007JF000908.

This Article is brought to you for free and open access by the Geosciences at ScholarWorks at University of Montana. It has been accepted for inclusion in Geosciences Faculty Publications by an authorized administrator of ScholarWorks at University of Montana. For more information, please contact scholarworks@mso.umt.edu.

Air compression as a mechanism for the underdamped slug test response in fractured glacier ice

Toby W. Meierbachtol,¹ Joel T. Harper,¹ Neil F. Humphrey,² Jeremy Shaha,³ and John H. Bradford⁴

Received 17 September 2007; revised 30 March 2008; accepted 25 August 2008; published 14 November 2008.

[1] Artificial perturbations of borehole water levels, known as slug tests, are a useful means of characterizing the glacier hydrologic system. Slug tests were performed on Bench Glacier, Alaska, in 21 boreholes over three field seasons during the transition from a winter to a summer drainage mode. Fifty-four slug tests were conducted, with water level monitoring in up to five boreholes adjacent to the slugged borehole. Seven of the slug tests were performed in conjunction with dye dispersion tests to identify water pathways within the slugged borehole following perturbation. Nearly 60% of monitored adjacent boreholes showed a hydraulic connection to the slugged borehole via the glacier bed. The nature and degree of connectivity was temporally variable, suggesting that the drainage network at the bed was highly dynamic on a daily timescale and spatial scale of tens of meters. The variability of slug test responses over time and space limit the feasibility of six alternative explanations for the oscillatory water level behavior characteristic of the underdamped response. We propose a seventh, that is, that coherent air packages are a reasonable means of producing the compliance needed to generate the underdamped slug test responses on Bench Glacier, and that these air packages may exist within the glacier at the tips of subglacially propagated fractures.

Citation: Meierbachtol, T. W., J. T. Harper, N. F. Humphrey, J. Shaha, and J. H. Bradford (2008), Air compression as a mechanism for the underdamped slug test response in fractured glacier ice, *J. Geophys. Res.*, 113, F04009, doi:10.1029/2007JF000908.

1. Introduction

[2] Increased surface melting of snow and ice masses in a glacier setting can alter the subglacial hydrology by increasing the amount of water routed to the bed. Subglacial hydrologic processes are known to impact glacier flow dynamics, however the relation between glacier motion and basal mechanics is still poorly understood [Clarke, 2005]. Improving our understanding of the dynamics of the basal system thus necessitates detailed study. The slug test is one of the few available techniques for actively characterizing conditions at the bed of glaciers.

[3] The slug test involves artificially perturbing the static water level in a well or borehole and measuring the response to that perturbation. These tests are conducted by either injecting a volume of water in the well or borehole, or inserting (slugging) and removing (bailing) a sealed pipe to induce an instantaneous change in water level. Slug tests were originally performed in conventional hydrogeological settings to determine aquifer transmissivity and hydraulic

conductivity. Various models have been created to estimate these parameters [e.g., Bouwer and Rice, 1976; Kabala et al., 1985; Kipp, 1985; McElwee and Zenner, 1998; van der Kamp, 1976]. Slug test responses range from overdamped, which is characterized by an exponential water level recovery toward the initial condition, to underdamped recovery in which the water level oscillates about the initial level following perturbation. The transition between the two responses is represented by the critically damped case. Overdamped responses are typically related to low transmissivities, while underdamped responses commonly occur in settings with high aquifer transmissivities and in wells with long borehole column lengths [Bredehoeft et al., 1966; Fetter, 2001].

[4] Slug tests have become valuable experiments used to estimate subglacial hydraulic properties. Water level responses to perturbations were first observed in glacier boreholes by Hodge [1976] during borehole drilling. He found oscillatory responses were induced when (1) a suspected englacial cavity was intersected during drilling and (2) the water level was perturbed by submerging the drill tip in the borehole. Stone and Clarke [1993] developed a one dimensional model for radial flow through a homogeneous subglacial medium in response to induced changes in basal water pressure. Through an inversion scheme this model was employed, using slug test results, to calculate hydraulic properties at the bed of Trapridge Glacier, Yukon, Canada [Stone et al., 1997]. Iken et al. [1996] used slug tests to generate a conceptual model for the drainage

¹Department of Geosciences, University of Montana, Missoula, Montana, USA.

²Department of Geology and Geophysics, University of Wyoming, Laramie, Wyoming, USA.

³Aspect Consulting, Bainbridge Island, Washington, USA.

⁴Department of Geosciences, Boise State University, Boise, Idaho, USA.

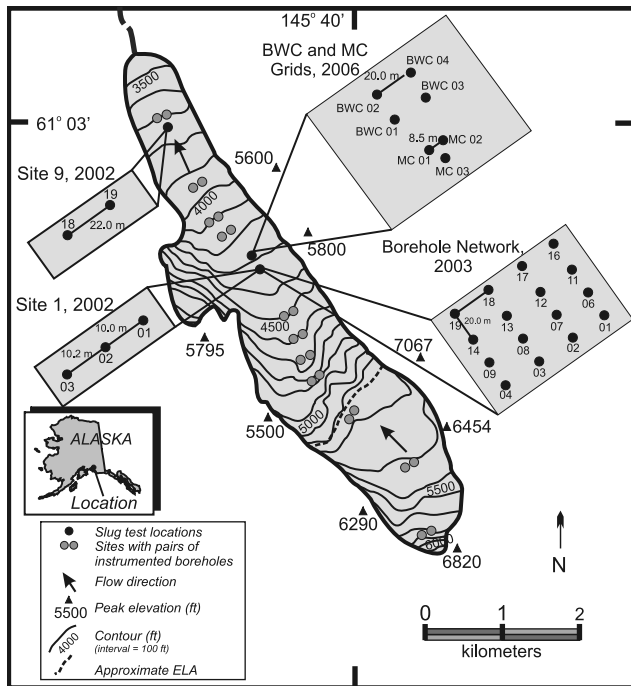

Figure 1. Topographic map of Bench Glacier, including borehole slug test sites from 2002, 2003, and 2006. All slugged borehole sites are located below the equilibrium line altitude (ELA).

network at Gornergletscher, Valais, Switzerland. They interpreted underdamped slug test responses to be associated with a drainage network consisting of well connected discrete passageways on clean bedrock. Short-term water storage during oscillations was thought to be induced by compression of the overlying ice or changes in the pore pressure of a sediment layer. In contrast, overdamped slug test responses were interpreted to result from laminar flow in a subglacial sediment layer. *Kulessa and Hubbard* [1997] conducted 116 slug and bail tests at Haut Glacier d'Arolla, Switzerland, and used these data to derive representative subglacial sediment transmissivities with techniques frequently used in aquifer settings [*Kulessa et al.*, 2005]. Slug tests have also been used as a means of inferring differences in subglacial properties between surge and nonsurge type glaciers [*Kulessa and Murray*, 2003].

[5] Reports of neighboring borehole responses due to slug tests are limited. A slight disturbance was noted in a nearby hole when a slug test was performed by *Iken et al.* [1996]. In the 43 tests performed by *Kulessa and Hubbard* [1997] with adjacent borehole monitoring, no subglacial linkages were detected between holes. *Hubbard et al.* [1998] presented a water level disturbance in a neighboring borehole to a slug test, but the connection was shown to be englacial in origin.

[6] Here borehole slug test data are presented from field experiments conducted during 3 years on Bench Glacier, Alaska. Slug tests were conducted in a grid of closely spaced boreholes, and water levels were monitored in up to five adjacent boreholes to generate a spatial field of slug test responses for each experiment. Tests were conducted over a ~ 1 month period in each field season to capture daily

to weekly scale response changes. Borehole dye tracing was incorporated in seven of the slug tests to isolate borehole water flow dynamics during the slug response. Using these data, we evaluate the feasibility of various mechanisms for generating underdamped water level curves, and offer air compression as a new means of producing oscillatory responses.

2. Methods

2.1. Field Site and Setting

[7] Slug tests were conducted in June of 2002, 2003, and 2006 on Bench Glacier, Alaska (Figure 1). Bench Glacier is a temperate glacier located in the Chugach Mountain Range, approximately 30 km from the Pacific Ocean. It spans about 1200 m in elevation, has a simple geometry and relatively shallow surface slope of $\sim 10^\circ$, and an average elevation of 1300 m. The glacier is approximately 7.5 km long with a surface area of about 7.5 km², and reaches a maximum thickness of about 200 m. The glacier has been characterized as having a hard bed from penetrometer tests and borehole video inspection [*Harper et al.*, 2005], however, patchy subglacial sediment packages may still be possible.

[8] Boreholes were drilled using pressurized hot water methods, resulting in average borehole diameters of 12 cm. All holes in which slug tests were conducted intersected the glacier bed near the glacier centerline. Bed intersection during drilling was inferred from jumping and slackening of the drill hose, and later confirmed by video observation of boreholes. In 2002, nine pairs of boreholes were drilled at multiple sites spanning the length of the glacier. In 2003, a grid of 16 boreholes was drilled with hole spacing approximately 20 m in orthogonal coordinates. In 2006, two borehole clusters were drilled down glacier from the 2003 grid, consisting of a three borehole triangle with 8.5 m spacing and a grid of four holes with 20 m surface spacing in orthogonal coordinates.

[9] Slug tests from all field seasons were conducted prior to or during a well-documented spring speed up of Bench Glacier that apparently occurs each year [*Anderson et al.*, 2004; *Harper et al.*, 2007]. The speed up is composed of two individual events, each of which lasts a few days to about a week and temporarily increases the velocity by up to ninefold. The first acceleration has been closely tied to bed separation, and the second to an unusually high level of connectivity of subglacial waters [*Harper et al.*, 2007]. These changes in the subglacial hydrological system and the associated rapid sliding occur during the transition from a winter drainage mode to a summer mode [*Harper et al.*, 2005]. This period of change forms the hydrological context of our slug experiments.

2.2. Slug Test Procedure

[10] Slug tests were performed by rapidly emptying a 75 l volume of water into a borehole. This injection was as instantaneous as possible, taking no more than 20 s to complete. Impulse testing by rapidly introducing water to a well is a common approach in groundwater studies [*Butler*, 1998], and has been performed in a glacier setting as well [*Iken et al.*, 1996]. While noninstantaneous injection can influence water level behavior, our results are similar in

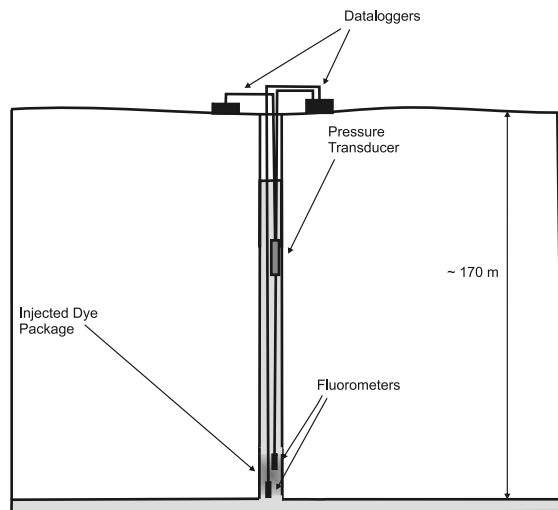

Figure 2. Experimental setup for slug/dye combination experiments. Fluorometers were placed within the injected dye package to record dye concentrations. A pressure transducer was placed in the borehole to monitor water levels and recorded to a separate synchronized data logger.

character to those from previous glacier studies in which slug tests were performed by submerging a sealed pipe [Iken *et al.*, 1996; Kulesa *et al.*, 2005], and dumping water [Iken *et al.*, 1996]. The duration of injection was constant in each test and contrasted with the temporal scale in our responses, leading us to believe that this method was unlikely to influence our results. Water levels were recorded in the slugged borehole and up to five observation boreholes with independently calibrated 10^5 Pa pressure transducers, which have a borehole water level resolution of about 10^{-3} m. The pressure transducers were set in boreholes at least 20 min prior to slug injection to thermally equilibrate and document preslug water level trends, and continued to record water levels for 20–30 min after water level recovery to document postslug trends. Water levels were measured at 2 s intervals and recorded by a data logger. Sixteen slug tests were performed in six boreholes in 2002, 20 slug tests were conducted in 10 different boreholes in 2003, and 18 slug tests were performed in five different boreholes in 2006.

2.3. Slug/Dye Combination Procedure

[11] Dye tracing was performed in conjunction with slug tests to study intraborehole or englacial hydraulics which may dictate slug test responses. Slug/dye combination experiments were executed by injecting dye at a point depth in a borehole, and then conducting a slug test in the same hole. Dye was injected by attaching a test tube containing 0.002–0.005 ml of Rhodamine WT dye (20% active) to a steel platform. The platform was attached to a cable and lowered to the desired depth, where the test tube was broken via a sliding hammer on the cable. Two submersible fluorometers were then lowered to desired depths in the test borehole to record dye concentrations as depicted in Figure 2. Comparing dye concentrations measured at two separated fluorometers allowed us to determine water flow direction in the borehole. A data logger recorded measurements at 2 s intervals. The fluorometers had a minimum detection limit of 0.04 ppb and were capable of reading dye concentrations of at least of 60 ppb. The fluorometers were synchronized with the data logger connected to the pressure transducer to ensure consistency in time. After lowering the fluorometers a slug test was performed according to the method described above.

3. Results

3.1. Response Curves

[12] Underdamped responses and overdamped responses were documented during each of the three field seasons, with half of the total slugged boreholes showing each response (Figure 3 and Table 1). Maximum drainage velocity and water level change, or initial amplitude, were calculated for all slugged and adjacent boreholes (Table 2). Overdamped responses were typically characterized by a higher initial amplitude and slower drainage velocity than oscillatory-type responses in slugged holes. The average period of oscillation was calculated for all underdamped responses on the basis of the second through fourth oscillation cycles measured from their peaks. The first oscillation cycle was omitted in order to capture the natural frequency of the system, similar to the approach of Iken *et al.* [1996]. The period of oscillation ranged from 12–43 s during all field seasons, with longer periods more common in 2003. The degree of damping in oscillatory responses also varied among slug tests. Figure 3 illustrates this range

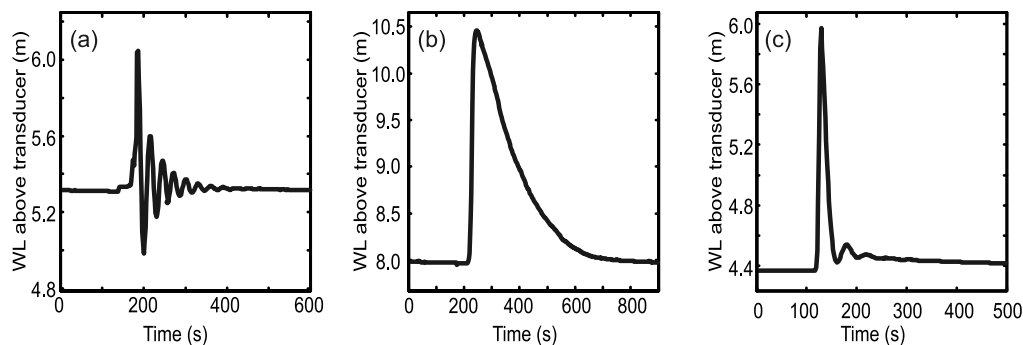

Figure 3. Variations in slug test responses showing (a) underdamped, (b) overdamped, and (c) underdamped behavior with increased damping. Note (1) the difference in timescales between the three figures and (2) the attenuation of oscillation peaks between Figures 3a and 3c.

Table 1. Underdamped and Overdamped Slug Test Responses for Slugged and Adjacent Boreholes

Year	Slugged Borehole		Adjacent Borehole			Total Number of Slug Tests
	Overdamped Responses	Underdamped Responses	Overdamped Responses	Underdamped Responses	No Response	
2002	6	10	6	3	4	16
2003	9	11	33	31	29	20
2006	12	6	1	1	18	18

of influence and shows that the attenuation of some underdamped responses approached critical damping. Compilations and additional results are presented by *Meierbachtol* [2007] and *Shaha* [2004].

3.2. Spatial Relationships

[13] The majority (60%) of monitored adjacent boreholes showed a water level disturbance in response to a slug test in a nearby borehole. These neighboring disturbances showed no pattern in connectivity across or down glacier, and were not limited to the observation holes closest to the slugged hole. In some cases boreholes 40 m or more from the test hole responded to a slug test while holes just 20 m distant showed no connection. Interestingly, while most adjacent borehole responses to an underdamped slugged hole showed oscillatory behavior, some holes responded in an overdamped manner (Figure 4). In contrast, overdamped responses in the slugged borehole were accompanied by only overdamped responses in observation boreholes if any response was documented at all (Figure 5). Initial amplitude and drainage velocities in adjacent boreholes were always attenuated from the slugged borehole responses. The period of oscillation in underdamped cases, however, was similar to the slugged hole (Table 2). Responses in observation boreholes 20–45 m from the test hole were consistently lagged by 2–12 s from the perturbation in the slugged borehole, but closer holes did not always show shorter lags than their distal counterparts.

3.3. Temporal Variability

[14] Phase changes between underdamped and overdamped responses were documented on daily timescales in both slugged and adjacent boreholes. Slugged boreholes showed shifts from overdamped to underdamped and vice versa as shown in Figure 4 and Table 3. While mode switching was common in tests, some boreholes retained a type response throughout the duration of slugging. No pattern in phase changes was decipherable over the test period.

[15] Similarly, changes in water level behavior in adjacent boreholes showed little consistency during the field seasons and did not necessarily follow the phase changes shown by the slugged borehole. This is depicted in Figure 4, which shows borehole 08 changing from an overdamped to an underdamped response over a 9 day period in 2003, with adjacent boreholes 12 and 13 showing similar behavior. Yet borehole 07 responds in the opposite manner, shifting from an underdamped to an overdamped response. Borehole connections were sometimes transient, as shown by a new connection that formed between boreholes 03 and 08 from day 155 to day 158 (Figure 4).

[16] Temporal changes in overdamped responses were also noted in the experiments. This somewhat more subtle evolution is exemplified by borehole MC 03 when it was slugged over a 3 day period in 2006 (Table 4). Water level recovery in the borehole was increasingly prolonged over the time period, suggesting movement toward a more isolated, less transmissive system.

3.4. Slug/Dye Tests

[17] Of the seven slug/dye combination experiments performed, five were completed in a borehole (BWC 03) which oscillated when slugged. This borehole was chosen to elucidate potential factors influencing underdamped water level behavior. In each of the five tests the dye package was flushed first from the fluorometer placed higher in the borehole column, and then from the lower fluorometer after a time delay of ~2–6 s (Figure 6). The fluorometer readings were recorded by the same data logger, hence the time difference in concentration changes cannot be an artifact of the time measurement. The initial motion of the dye was therefore from top to bottom in the borehole. Return dye pulses related to water level oscillations were also recorded by the fluorometers and in phase with water level peaks recorded by the pressure transducer (Figure 6). These return pulses suggest a subsequent reversal of flow and support the notion that water motion at the bottom of the boreholes

Table 2. Slug Test Response Parameters From the Three Field Seasons for Slugged and Adjacent Boreholes

Year	Overdamped Response		Underdamped Response		
	Amplitude (m)	Velocity (m/s)	Period (s)	Amplitude (m)	Velocity (m/s)
<i>Slugged Borehole</i>					
2002	1.39–3.50	0.001–0.05	12–36	0.47–1.54	0.09–0.63
2003	1.33–3.90	0.001–0.019	28–43	0.44–2.68	0.09–0.63
2006	0.66–4.04	<0.001–0.03	26–30	0.73–1.52	0.07–0.22
<i>Adjacent Borehole</i>					
2002	0.02–0.07	<0.003 ^a –0.002	24–27	0.12–0.16	0.01–0.03
2003	0.02–0.12	<0.003 ^a –0.03	29–45	0.01–0.46	0.001–0.05
2006	0.02	<0.001	29	0.2	0.03

^aNot possible to determine drainage velocities below 0.0029 m/s because of noise in the first derivative drainage curve.

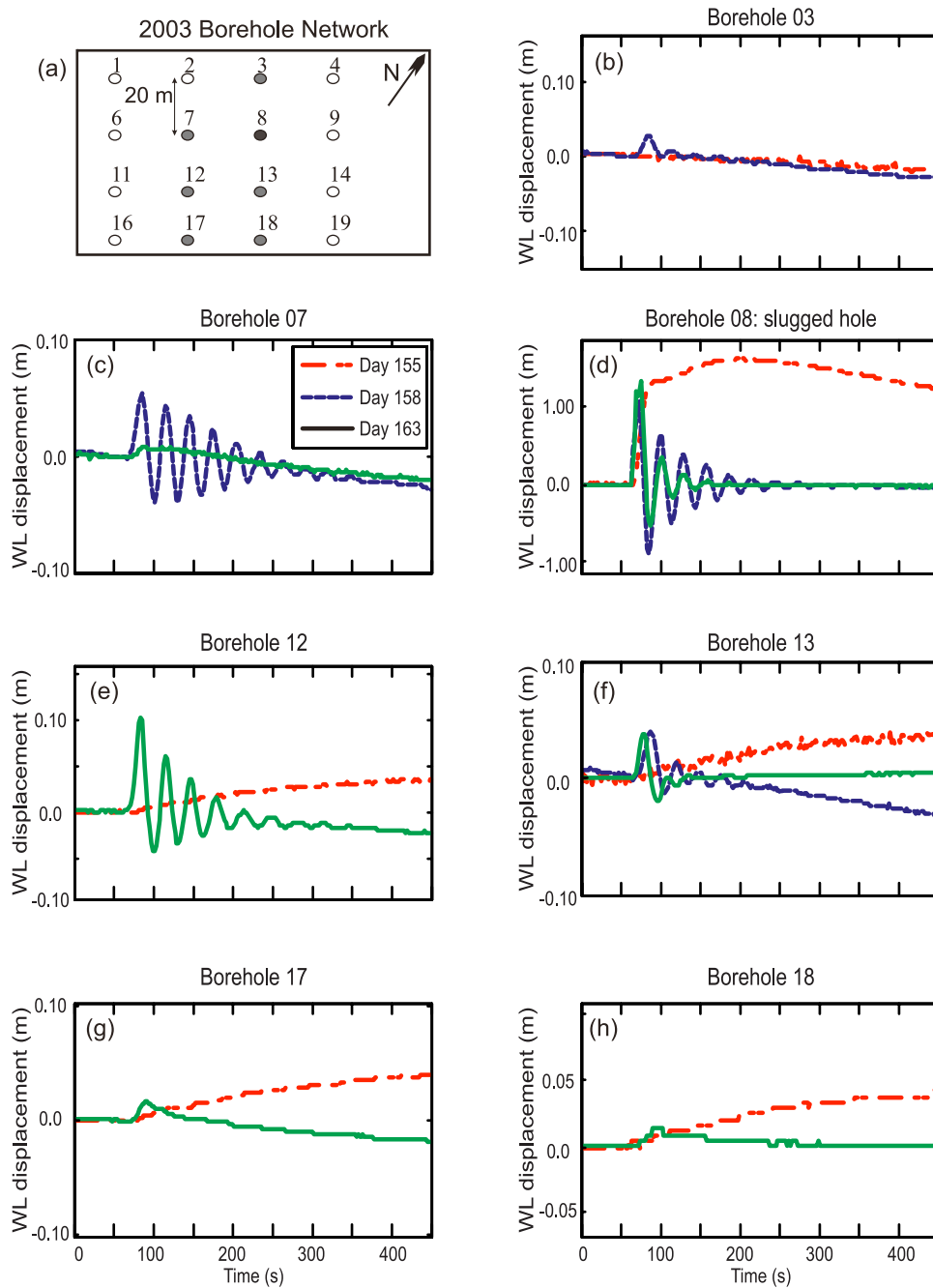

Figure 4. Borehole responses to three slug tests performed in borehole 08 over 9 days in 2003. Borehole network (a) is located as shown in Figure 1. Day of slug test is represented by color shade for each borehole. Timescale is the same for all boreholes. Change in water level is relative to the preslug level just prior to slug injection. Borehole response trends (b, c, e, f, g, and h) are variable and do not mimic the slugged borehole trend (d) in all cases.

followed the water level trends measured by the pressure transducer near the water surface.

4. Discussion

[18] Slug test results from the three field seasons provide uniquely extensive data that reveal characteristics of the subglacial drainage network. Here we examine the feasibility of various mechanisms that could produce the under-

damped response, and what these experiments reveal regarding glaciological processes.

4.1. Underdamped Response

[19] The water level change in an underdamped response can be described as a damped simple harmonic oscillator, defined by *Potter* [1978] as

$$y(t) = Ae^{-\frac{\sigma t}{2M}} \cos(\omega_0 t - \delta), \quad (1)$$

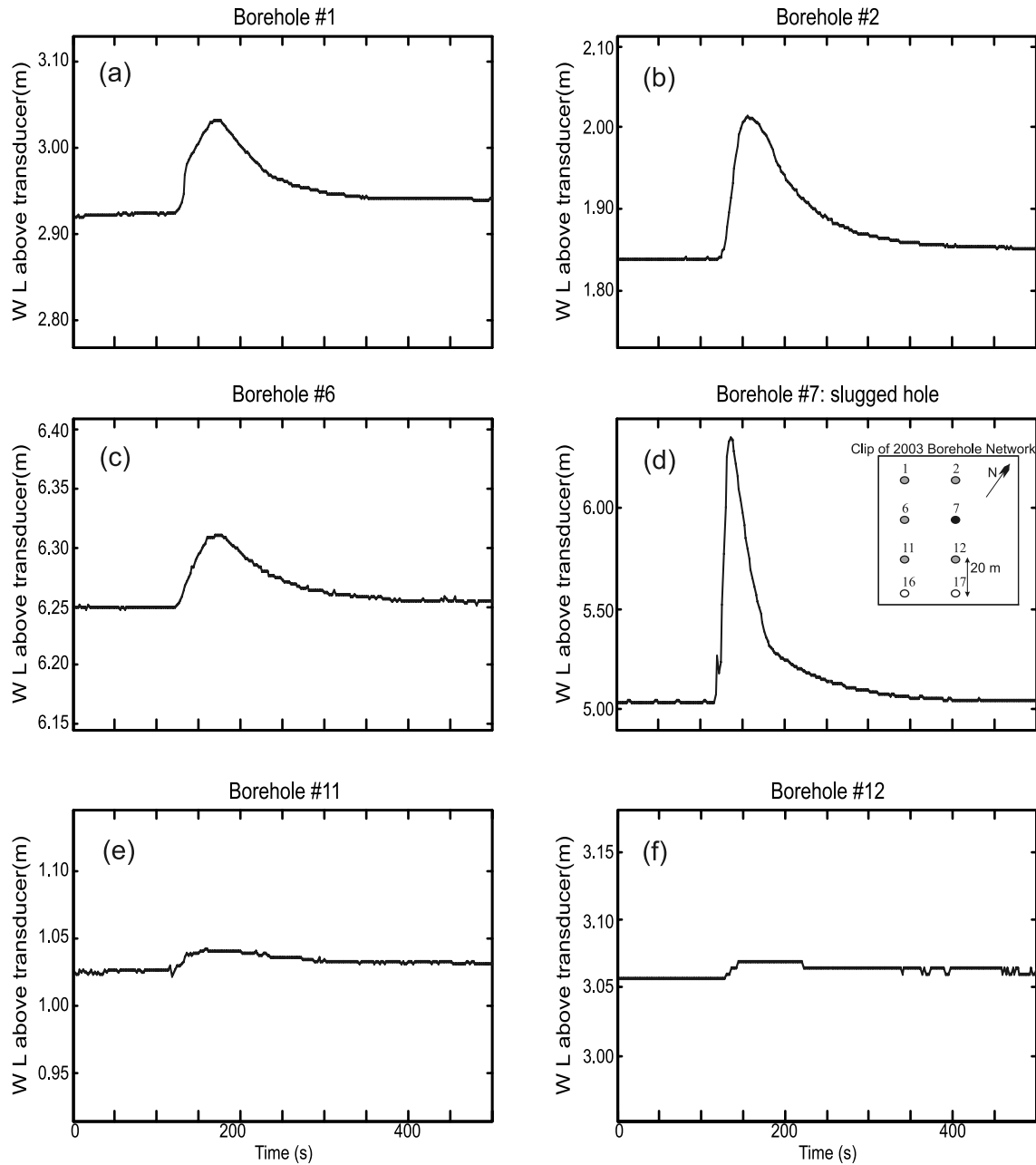

Figure 5. Borehole responses to a slug test performed in borehole 07 (d) on day 160, 2003. All adjacent boreholes (a, b, c, e, f) responded in an overdamped manner. Timescale is the same for all boreholes. In all tests, adjacent boreholes responded in an overdamped manner when the slugged borehole showed an overdamped response.

where

$$\omega_0 = 2\pi f. \tag{2}$$

Here $y(t)$ is the water level height at time t , A is the initial amplitude of the response, C is the viscous damping constant, M is the mass of water in the system, and $(\omega_0 t - \delta)$ is the frequency component of the oscillatory response, where δ is the phase shift component. In this case the frequency of the response is related to the spring constant (K) by

$$f = \frac{1}{4\pi M} \sqrt{4KM - C^2}. \tag{3}$$

A decaying exponential function fit to the peaks of the oscillations can be used to derive C , leaving K and M as unknowns.

[20] Various mechanisms might exist in a glacier that could act as the spring and provide the compliance necessary to produce an oscillatory response with frequencies matching those from the actual slug tests. Seven possible mechanisms are analyzed as potential candidates to explain the underdamped responses we observed. We consider each mechanism acting alone, and do not address the interaction between different mechanisms. Calculations of possible mechanisms generating underdamped responses are based on 10 underdamped slug tests from the three field seasons.

Table 3. Slugged Borehole Responses in the 2003 Field Season Over Time^a

Slugged Borehole	Julian Day							
	154	155	156	158	159	160	161	163
08		OD		UD				UD
09			UD	UD				
12	UD				UD			UD
13			UD	UD				UD
17		UD						OD
18	UD							OD

^aUD, underdamped; OD, overdamped.

These slug tests span the range of oscillatory responses and reflect the underdamped behavior characteristic of tests on Bench Glacier (Table 5). The average periods of the responses range from 25–40 s.

[21] Some assumptions regarding pressure and volume changes are inherent in the following calculations. We assume here that the subglacial system is open, causing a fraction of the total slug volume to evacuate the system upon injection. Therefore, we calculate pressure change using the first water level maximum. Water level maxima range from 0.43–2.68 m above static water level, resulting in induced pressure changes of 4274–26,370 Pa. The change in water level between the first minimum and second maximum is assumed to be a realistic representation of the volume change of the system. First water level minima and second maxima range from –0.89 to –0.11 m and from 0.20 to 0.67 m, respectively, resulting in volume changes of 0.004–0.018 m³.

4.1.1. Water Compression

[22] The feasibility of oscillatory water level responses occurring from compression of the water package can be evaluated by the bulk modulus of elasticity equation, which is given by

$$B_m = \frac{\Delta P}{\Delta V/V'}, \quad (4)$$

where B_m in this case is the bulk modulus of water, ΔP is the change in pressure associated with the added slug of water, ΔV is the change in volume necessary to accommodate the volume of water added, and V' is the initial volume of water connecting boreholes. Using 4.4×10^{10} Pa for the bulk modulus of water [Stone and Clarke, 1993], water volumes of about 13,000–71,800 m³ are needed to generate the observed oscillations. Such a volume would require that the slugged hole be connected to a water-filled borehole length equivalent of 1100–6300 km at the bed of the glacier. While this scenario is purely hypothetical, it illustrates that the required range of volumes is unrealistic for an ice mass of Bench Glacier's size. If such a volume did somehow exist, assuming that the compression wave travels through water at 1497 m s^{-1} [Ohanian, 1985], the adjacent boreholes would be expected to oscillate in phase with the slugged borehole if they were connected to the same volume of water. Instead, adjacent borehole responses were lagged by up to 12 s, and in some cases oscillated out of phase with the slugged borehole. As a result, compression of subglacial waters is not a plausible cause of the underdamped response observed in our slug tests.

4.1.2. Uplift of the Glacier

[23] Detachment of the glacier from the bed and resulting elastic uplift in response to a slug test may produce underdamped water level behavior. Here we consider radial flow and a uniformly distributed pressure across the bed, as this provides the minimum value for the radius of uplift. This approach utilizes a plate stiffness factor (D) which, following Sechler [1952], we calculate as

$$D = \frac{Eh_i^3}{12(1-\nu)^2}, \quad (5)$$

where h_i is the ice thickness, E is the elastic modulus of ice ($\sim 9.6 \times 10^9$ Pa), and ν is Poisson's ratio (~ 0.33 for ice [Hobbs, 1974]). Simplifying the uplift to a conical geometry yields

$$w(0) = \frac{P_w R_u^4}{64D}, \quad (6)$$

where $w(0)$ is the maximum uplift at the center of the plate. The volume of uplift then necessary to accommodate the slugged volume of water is

$$V_e = \frac{1}{3} \pi R_u^2 w(0). \quad (7)$$

By substituting (6) into (7), the radius of uplift (R_u) can be calculated. Using our measured ice thickness of 185 m, the volume changes in our slug tests can be accommodated by uplifting circular areas with radii of 68.4–91 m. This requires maximum uplift values of 6.0×10^{-7} – 2.1×10^{-6} m. Comparison of conical versus a Gaussian uplift geometry for test BG03_158_08 showed that the simplified conical estimation resulted in a minimum radius 11% greater than that calculated using a Gaussian geometry. This discrepancy is insignificant with respect to our interpretation of results and so we assume the conical geometry to be reasonable for this exercise. Given the 80×80 m dimensions of the 2003 borehole grid, the calculated range of uplift radii would cause most or all boreholes in the grid to respond in an oscillatory manner to a slug test. In practice, some boreholes as close as 20 m from the slugged hole showed no response. Furthermore, holes which did respond did so in both an overdamped and oscillatory manner. Thus, we conclude that ice uplift alone is not a plausible option for providing the compliance necessary to produce our oscillatory responses.

4.1.3. Ice Compression

[24] In the ice compression model, the induced pressure from the slug test temporarily deforms a circular area of the glacier sole, resulting in upward compression of basal ice.

Table 4. Evolution of Slug Test Parameters in Borehole MC 03 From the 2006 Field Season^a

Julian Day of Year	Amplitude (m)	Water Level Recovery Time (s)	Mean Drainage Velocity (m/s)
157	1.67	2.6×10^3	0.0006
158	2.58	1.1×10^4	0.0002
159	3.10	$>2.5 \times 10^4$	<0.0001

^aDrainage velocity is calculated from given amplitudes and recovery times.

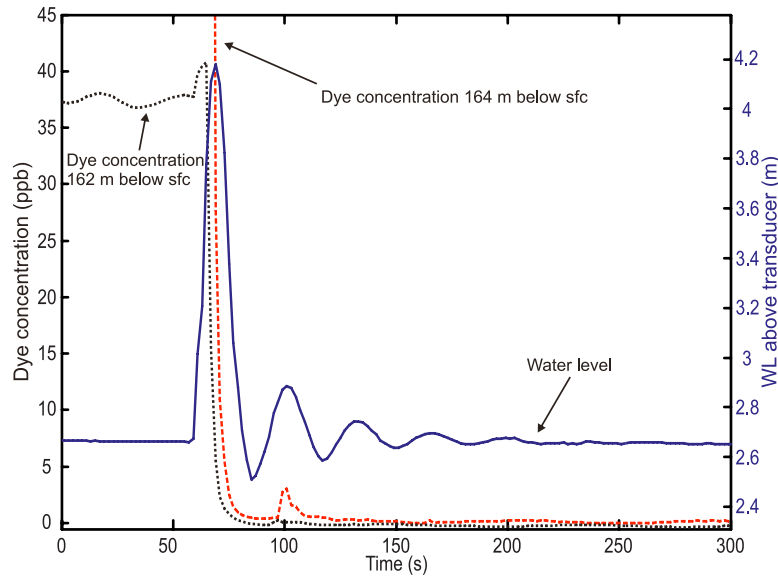

Figure 6. Slug/dye experiment performed on day 169, 2006. Water level response is indicated by the blue line, and dye concentration at depths of 162 and 164 m below snow surface are represented by black dotted and red dashed lines, respectively. The fluorometer placed at the glacier bed (red dashed line) showed a delayed reduction in concentration and greater return pulse with respect to the fluorometer placed 2 m above. Maximum dye concentration at the glacier bed was >60 ppb but omitted here to highlight response pulses of lower concentration.

The elastic compression produces the underdamped response. This calculation was performed by *Iken et al.* [1996], and is given by [Timoshenko and Goodier, 1982]

$$w_{\max} = \frac{2(1-\nu)^2 P_w R_d}{E}. \quad (8)$$

Here w_{\max} is the maximum deflection at the center of the circle, P_w is the pressure of the added slug of water, R_d is the radius of deformation, and E and ν have been previously defined. The resulting volume change from deformation is estimated by

$$V_e = \frac{1}{3} \pi R_d^2 w_{\max}. \quad (9)$$

Substitution of (9) into (8) and solving for R_d yields

$$R_d = \sqrt[3]{\frac{3V_e E}{2\pi P_w (1-\nu)^2}}. \quad (10)$$

Using equation (10) and assuming a uniformly distributed load along the bed of the glacier, radii of deformation ranging from 11.5–20.3 m and corresponding deflection values of 3.2×10^{-5} – 4.1×10^{-5} m can accommodate the volume change induced by the 10 test results. In reality, ice deformation would most likely occur along cavity and conduit walls in a linked cavity network, as presented by *Iken et al.* [1996]. The spatial heterogeneity in borehole connections during slug testing suggests that such a network likely exists at the bed of Bench Glacier. Yet evidence for efficient connections between boreholes comes from both underdamped and overdamped slug tests (e.g., Figures 4 and 5). In a linked cavity network, all connected boreholes

should display oscillatory behavior if ice compression is the cause of the underdamped response. Our observations of efficient connections between holes showing overdamped responses contradict this and lead us to conclude that, while possible, ice compression is not likely to be the sole mechanism responsible for the underdamped response.

4.1.4. Within-Borehole Compression/Dilation

[25] Underdamped slug test responses may be caused by processes occurring within the slugged borehole, such as compression/dilation of the borehole itself, or compression of air bubbles along the borehole walls. However, results from the slug/dye tests show that water motion at the bottom of boreholes is in direct response to and in phase with the surface water level behavior. This suggests that water acts as a homogenous entity throughout the length of the borehole and exits the bottom, where an external medium or process acts as the spring to create the underdamped response. Furthermore, the mode switching documented in the slug tests is not readily explained by processes occurring within the borehole itself. Slug tests were performed prior to the initiation of large diurnal water level fluctuations when daily borehole water levels were fairly passive. As a result, borehole properties within each hole are assumed to remain constant over the test interval, and are unlikely to cause the phase changes associated with slug testing on a daily scale. Combination of the temporally variable slug responses with slug/dye testing provides strong evidence against processes within boreholes dictating underdamped responses.

4.1.5. Direct Interaction With Adjacent Boreholes

[26] Oscillatory behavior may be induced by temporary accommodation in boreholes, where inertial effects cause transfer of water back and forth between the slugged hole and neighboring holes. Such a system would require that the sum of the water declines (e.g., 1st peak minus 1st trough)

Table 5. Inputs and Results for Air Compression Modeling of 10 Slug Tests Spanning the Three Field Seasons^a

Slug Test	f ($\times 10^{-2} \text{ s}^{-1}$)	A (m)	V_e ($\times 10^{-3} \text{ m}^3$)	C ($\times 10^2 \text{ kg}$)	P_0 ($\times 10^6 \text{ Pa}$)	V_{air} (m^3)
BG02_159_02 ^b	3.49	0.58	6.66	9.08	1.55	0.16
BG03_154_18	2.45	0.40	4.53	5.34	1.57	0.34
BG03_156_09	2.79	0.66	7.43	15.62	1.67	0.27
BG03_156_13	2.96	1.09	12.3	7.38	1.61	0.24
BG03_158_08	3.43	1.55	17.6	9.82	1.48	0.16
BG03_158_09	2.93	1.08	12.2	6.01	1.66	0.25
BG03_159_12	3.25	1.02	11.6	10.66	1.53	0.19
BG06_165_bwc03	3.37	0.62	7.00	10.29	1.44	0.16
BG06_167_bwc03_2	3.55	0.50	5.61	16.57	1.43	0.14
BG06_169_bwc03_2	4.16	0.45	5.05	17.15	1.40	0.10

^aModel results are given for the scenario in which boreholes are connected to 25 m³ of water (mass = 2.5 $\times 10^4$ kg).

^bWater level estimated from Julian day 162.

in adjacent boreholes approximately equal the subsequent water level rise in the test hole, but this was never the case. For example, in slug test BG06_165_bwc03, 59% of the subsequent water level peak in the test hole was accounted for when all nearby holes were monitored. The remaining 41% must have been accommodated elsewhere in the system.

[27] Further, if underdamped responses were dominated by inertial effects, overdamped observation holes would be expected to show lower peak rising velocities than their oscillating counterparts. However, Table 2 shows that peak water level velocities were similar in all adjacent responses, suggesting that the type response was independent of the rate of water motion. Thus, while adjacent holes can account for part of the necessary water storage, the interaction between adjacent holes and the test hole cannot be the lone cause of oscillatory water level behavior.

4.1.6. Sediment Compression

[28] Water flow through a subglacial sediment package and the resulting compression of the package skeleton has previously been used to explain slug test responses [Kullessa et al., 2005; Stone and Clarke, 1993]. The bulk modulus of elasticity equation (4) is employed to calculate the sediment volume necessary to induce oscillations with the observed frequency. Such an analysis is an oversimplification of the processes involved in flow through an aquifer, but it does provide a first-order approximation of the magnitude of sediment volume needed for accommodation. Using 1×10^8 Pa for the bulk modulus of the subglacial sediments [Stone and Clarke, 1993] requires sediment packages of 60–320 m³ to generate the compliance necessary for documented oscillatory behavior. Volumes of this magnitude contradict our observations of over 50 boreholes on Bench Glacier via penetrometer tests, borehole video, and monitoring of the drill tip when it intersected the bed. Furthermore, accounting for the changes documented in the response character of slugged and adjacent boreholes on a daily timescale is difficult by sediment compression. For example, Figure 4 shows a response change from overdamped to underdamped in boreholes 03, 07, 08, and 13 between days 155 and 158. Explaining this change by sediment compression requires that all boreholes connect to a sediment package at the bed, presumably via glacier sliding. To achieve this, the glacier would have to either slide on the order of 40 m to connect all boreholes to a coherent package, or open connections to an irregularly shaped volume of sediment. Given a maximum observed

glacier velocity during the speed up of $\sim 0.3 \text{ m d}^{-1}$, shifting boreholes 40 m onto a sediment package is not feasible. Opening connections to existing sediment with the calculated volume is possible, but unsupported by direct observations of the glacier bed. Hence, we conclude that it is possible but unlikely that sediment compression provides the spring source which induces oscillatory behavior at Bench Glacier.

4.1.7. Compression of Air

[29] Compression of air within the glacier is a potential mechanism for generating underdamped slug test responses which has not been previously proposed. Air is far more compressible than water or ice, and as such could prove to be a realistic source of compliance necessary to induce oscillatory water level behavior.

[30] As shown in equation (3), the oscillation frequency in the case of simple harmonic motion is governed by the mass of the system (M) and spring constant (K) of the source medium. The spring constant for air when compressed has been further derived as (see Appendix A)

$$K = \frac{P_0 V_e X_b}{V_0 A}, \quad (11)$$

where K is the spring constant, P_0 is the initial pressure of the system, V_e is the volume change induced by the slug test, V_0 is the initial air volume, X_b is the borehole cross-sectional area, and A is the difference between the first water level minimum and second water level maximum. Equation (11) shows that K is inversely proportional to the initial volume of the air package (V_0). The mass of water in the system can be related to a water volume, so the oscillation frequency is governed by the volume of water in the system (V_w) and the initial volume of the air package (V_0). By combining (3) and (11), a range of air volumes can be calculated for different water volumes in the system that will generate an oscillatory response with the range of frequencies documented in the slug tests (Figure 7). For example, oscillation frequencies of 25–40 s⁻¹ can be explained by borehole connection to an air source of 0.12–0.33 m³ via a network containing 25 m³ of water (Figure 7 and Table 5). This analysis suggests that when subjected to elastic compression, air packages which we later argue to be a reasonable size will produce oscillations with frequencies observed on Bench Glacier.

[31] A means of generating and maintaining coherent and reasonably sized air packages within the glacier must exist

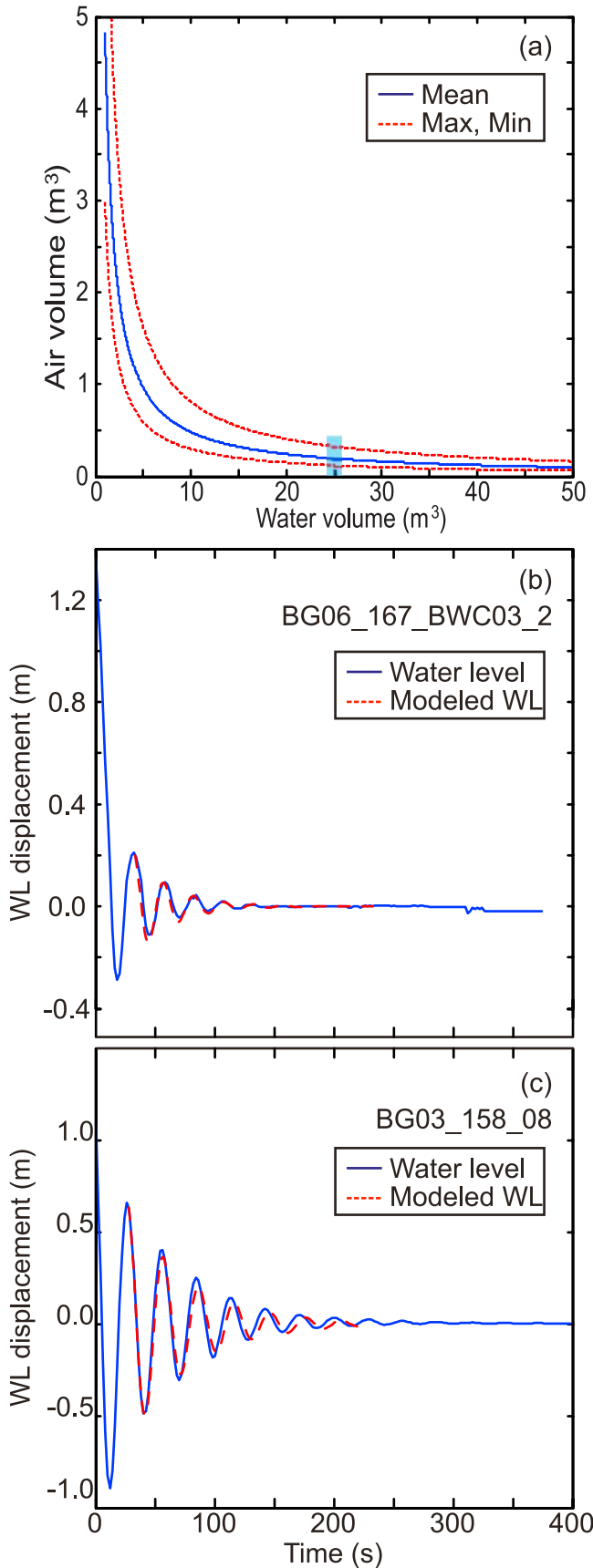

for air compression to remain a viable option for producing oscillatory behavior. Borehole video observations of upwelling bubble events show notable quantities of air do exist in the glacier (Figure 8). Dissolved atmospheric gases are likely to be inherent in subglacial water, originally introduced to the glacial system through surface inputs such as moulins. Air may also enter the subglacial system through frictional heating and subsequent melting of bubbly ice as subglacial water flows along the bed. *Martinerie et al.* [1992] calculated air contents of $120 \text{ mm}^3 \text{ g}^{-1}$ (about 11% by volume) of ice in a polar climate at an elevation approximately equal to the median elevation of Bench Glacier (1400 m). This value can be assumed to be a minimum, as the total volume of gas per unit mass of ice typically increases by about $0.2 \text{ mm}^3 \text{ g}^{-1}$ with a 1 K increase in temperature [Paterson, 1994], and Bench Glacier is located in a warmer region than Martinerie's Antarctic study site. In practice, modeling of high-frequency acoustic waves in borehole slug tests has shown significant aeration contents can be present in borehole meltwater [Kulesa and Müller, 2006].

[32] We propose that fracture propagation upward from the bed of the glacier provides a likely means of creating coherent air packages by depressurization and exsolution of dissolved gases during fracture inception. As fractures propagate upward into the ice, the overburden pressure at the crack tip decreases accordingly. Thus as pressurized subglacial water rises to fill the newly opened void, depressurization results in the exsolution of gases. The exsolved gases coalesce at the fracture tip, forming a coherent air package that is connected to the bed of the glacier via the newly formed fracture. *Nolan and Echelmeyer* [1999] proposed that exsolution of dissolved gas from pore water in subglacial till caused the till layer to become seismically transparent. While the subglacial media between these authors' study site on Black Rapids Glacier, Alaska, and the hard bed on Bench Glacier are different, it nevertheless illustrates that exsolution of dissolved gas from depressurization is a realistic occurrence in glaciers.

[33] Englacial fractures have been documented on various glaciers [Fountain et al., 2005; Harper and Humphrey, 1995; McGee et al., 2003], and were noted again in video imaging on Bench Glacier in 2006. Video imaging of boreholes shows these fractures to be ubiquitous, averaging about 2 fractures per borehole completed to the bed of Bench Glacier. Radar profiling of Bench Glacier during the 2003 and 2006 field seasons also shows evidence of englacial fractures existing at depth in the glacier [Bradford et al., 2005]. Subglacial propagation of fractures has been documented under jökulhlaup conditions [Roberts et al., 2000; Roberts et al., 2002]. Analytical investigations of

Figure 7. (a) Model results show that as water volume increases, the volume of air needed to produce oscillations with the range of observed frequencies declines exponentially. Application of the model to two slug test results from (b) 2006 and (c) 2003, respectively, show a good fit for calculated air volumes given a water volume of 25 m^3 (shaded box in Figure 7a). Timescales are consistent for Figures 7b and 7c. Calculated air volumes for Figures 7b and 7c are 0.11 and 0.16 m^3 , respectively.

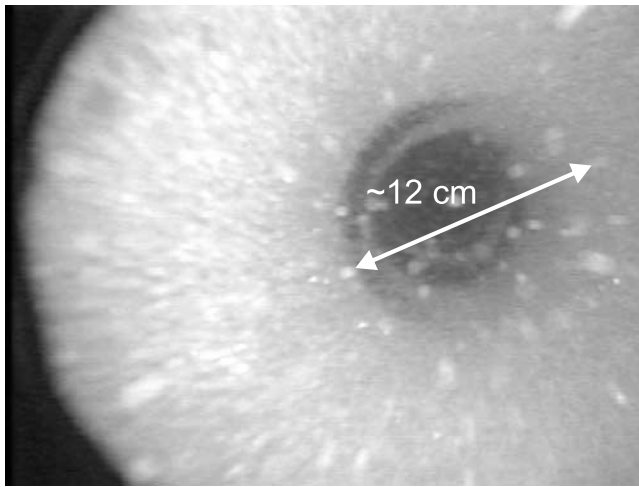

Figure 8. Photograph from borehole video documenting upwelling air bubbles. Borehole diameter is approximately 12 cm. Events of upwelling gas bubbles have been documented on numerous occasions on Bench Glacier during video observation of boreholes.

subglacial fracture propagation have shown the process to be a realistic occurrence under normal conditions on grounded glaciers when subglacial water pressures are high as well [van der Veen, 1998]. Subglacial water pressures during all three field seasons were consistently at or above 90% of ice overburden, providing requisite conditions for propagating fractures from the bed of Bench Glacier. Indeed, initiation and propagation of a fracture was directly observed approximately 35 m above the glacier bed [McGee *et al.*, 2003].

[34] In a simple conceptual model of a borehole connected to an englacial fracture via a subglacial pathway (Figure 9), oscillatory water level behavior can be generated

in the borehole by elastic compression of the fracture's air package. Following this model, values in the compressed air model shown in Figure 7 can be translated into fracture geometries as a first-order means of assessing model viability. While data on fracture geometries is scarce, our borehole video observations allow some limiting constraints. Fractures appear to be planar, steeply dipping ($60\text{--}90^\circ$), and are documented at all depths within the glacier. However, it is unclear if near-surface fractures are subglacial or surficial in origin. From borehole video estimations, a fracture width (W_f) of 0.06 m is assumed. To accommodate the 25 m^3 volume used in the modeling in Figure 7, and assuming an arbitrary fracture height (H_f) of 20 m, resulting fracture lengths (L_f) range from 19.2–19.5 m. This requires air package heights (H_a) of 0.10–0.29 m to achieve the air package volumes necessary to generate oscillations with the documented range of frequencies. We do not propose that the oscillatory behavior we observed was necessarily a result of fractures with these exact dimensions. Rather, this exercise merely demonstrates that the air compression model could be implemented with reasonable real world fracture dimensions.

[35] The air compression model also provides an explanation of the varying frequencies of oscillation documented in our experiments. Increasing the volume of water to which the spring system is connected while maintaining a constant air volume effectively adds mass to the mass spring system. The result of this increase, as shown in the simplified model in Figure 10, is a longer period of oscillation. Increasing the volume of connected water in the system is unlikely to account for complete phase changes from underdamped to overdamped, as this necessitates adding an unreasonable volume of water. Rather, it provides a means of modulating the frequency documented in tests. It is important to note that it is not necessary to increase the volume by adding water to the subglacial system. Instead, increasing the volume in the system can be achieved by connecting with existing water bodies which were previously isolated.

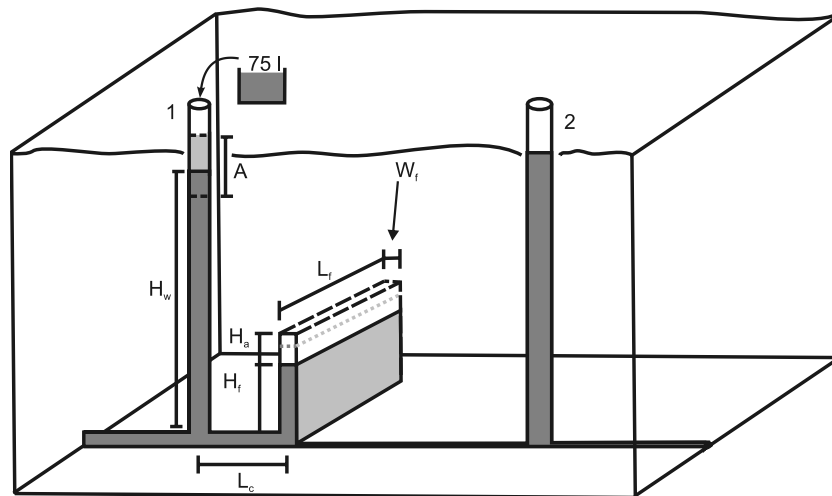

Figure 9. Simplified conceptual model of the interconnected system at the bed of Bench Glacier. Boreholes 1 and 2 are connected via a subglacially propagated fracture with an air package at the tip and dimensions $H_a \times L_f \times W_f$. Slug testing borehole 1 results in compression of the air package in the fracture, causing an oscillatory response in boreholes 1 and 2.

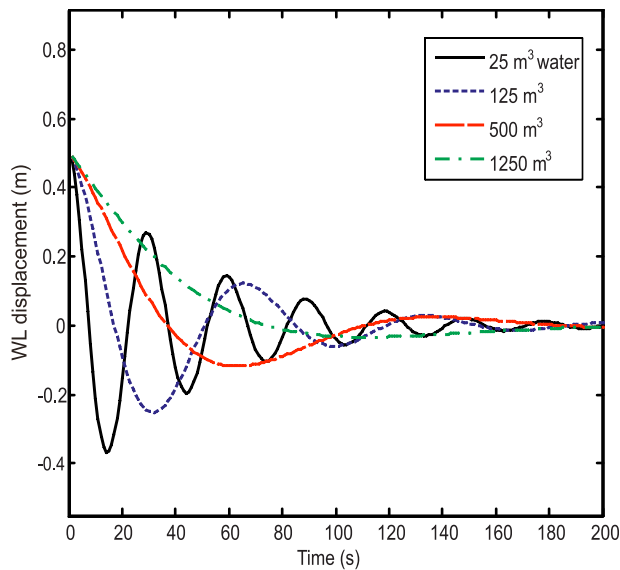

Figure 10. Modeled relationship between oscillation frequency and water volume. Keeping the air volume static and increasing the volume of water connected to the system (hence increasing the mass) results in longer periods of oscillation.

[36] Observed underdamped responses were typically accompanied by faster recovery times than their overdamped counterparts, suggesting that boreholes exhibiting underdamped responses were connected to a higher transmissivity system. This may be because subglacially propagated fractures can be expected to provide a greater potential for connection with high transmissivity regions of the bed. Alternatively, if a fracture did not intersect a conductive system the result would be oscillatory behavior imprinted over a longer, overdamped recovery. Indeed, this was occasionally observed on Bench Glacier as shown in Figure 11.

4.2. Synthesis of Mechanisms for the Underdamped Response

[37] Seven mechanisms which could account for underdamped responses on Bench Glacier have been analyzed using 10 slug tests gathered over the three field seasons. When acting alone, compression of water, ice uplift, ice deformation, processes occurring within the borehole, interaction between boreholes, and sediment compression have difficulty in describing the documented responses. This difficulty arises from the borehole volume change induced by slug tests, the phase changes in slug test responses with time, and the spatial heterogeneity in responses from neighboring boreholes. While each of these mechanisms is unlikely to be the dominant process dictating water level behavior, interactions between multiple mechanisms could potentially alter slug response curves. Assessment of the influence of multiple mechanisms is beyond the scope of this study and necessitates future research under controlled conditions.

[38] The compression of air at the tips of subglacially propagated fractures is a new mechanism that could induce

oscillatory water level behavior. In contrast to previous explanations which require a very large volume of water [Iken et al., 1996], the air compression explanation is novel in that it provides a mechanism for underdamped responses with a limited reservoir. Fracture propagation has been observed on Bench Glacier and could explain the change from overdamped to underdamped slug response curves. Given the irregular spatial nature of the borehole connections and the assumption that Bench Glacier has a hard bed, we infer that the drainage network at the time of our measurements is likely a linked cavity system. In this system, ice displacement as the glacier slides over the bed creates tenuous linkages in the subglacial system. This could cause the spatial and temporal variations we documented as linkages intersecting fractures form and break connections with boreholes.

5. Conclusions

[39] Repeated slug tests were conducted over three field seasons in a network of boreholes on Bench Glacier, Alaska, with monitoring in up to five adjacent boreholes. In addition, dye tracing was incorporated in seven of the slug tests as a new method of monitoring water level motion over the length of the borehole column. Results from the slug tests with multiple observation holes illustrates the following: (1) subglacial flow paths are connected on spatial scales of tens of meters and (2) the spatial distribution and character of these pathways is dynamic on a daily scale. An explanation of the mechanism(s) responsible for generating the underdamped response observed in the experiments must accommodate these spatial and temporal elements of slug testing. The compression of air in the glacier at the tips of subglacially propagated fractures is proposed as a new mechanism that can induce oscillatory water level behavior. The presence of free air has been observed in Bench Glacier, and modeling of multiple slug tests shows air packages of reasonable volume can generate underdamped responses. Englacial fractures are sufficiently common, can accommodate required air and water volumes with sensible geometries, and could account for the spatial and temporal variability

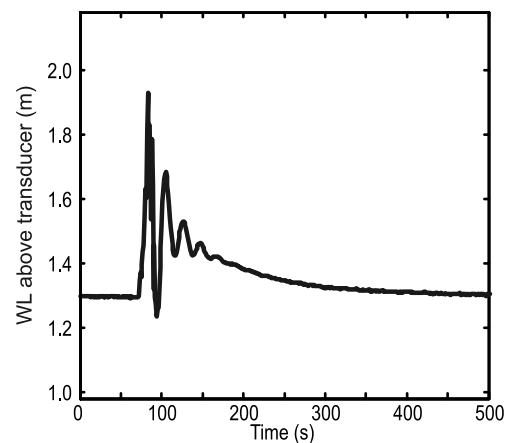

Figure 11. Slug test response behavior exemplifying an initial oscillatory response, followed by a slow recovery toward equilibrium.

exhibited by the slug test responses when coupled to the transient linkages in the subglacial drainage system.

Appendix A

[40] The following is the derivation of the model equation for an underdamped slug test response via compression of an air package. Refer to Figure 9 for definition of variables (A , L_c , D_f , H_a , and R_b).

[41] We begin with the initial pressure in an air cavity of initial volume (V_0), which is defined as

$$P_0 = \rho_w g h_w. \quad (\text{A1})$$

[42] The volume change in the air cavity due to the slug test (the effective volume) comes from the difference between the first water level minimum and second water level maximum, as proposed in the discussion, and is defined as

$$V_e = \pi r_b^2 A. \quad (\text{A2})$$

[43] The new volume of air in the fracture is

$$V = V_0 - V_e \quad (\text{A3})$$

or

$$V = V_0 - \pi r_b^2 A. \quad (\text{A4})$$

[44] Assuming that air behaves as an ideal gas where $P_0 V_0 = PV$, then

$$P = \frac{P_0 V_0}{V}. \quad (\text{A5})$$

[45] By substituting (A3) into (A5) and simplifying, pressure is defined as

$$P = \frac{P_0}{1 - \frac{V_e}{V_0}}. \quad (\text{A6})$$

[46] We assume that $\frac{V_e}{V_0}$ is small, thus according to series expansion ($\frac{1}{1+t} = 1 - t$), (A6) simplifies to

$$P = P_0 \left(1 + \frac{V_e}{V_0} \right), \quad (\text{A7})$$

or

$$P = P_0 + P_0 \left(\frac{V_e}{V_0} \right). \quad (\text{A8})$$

[47] The effective pressure, which here is the change in pressure of the cavity as a result of the slug test, can be defined as $P_e = P - P_0$. This leads to

$$P_e = P_0 \left(\frac{V_e}{V_0} \right). \quad (\text{A9})$$

[48] According to Hooke's Law for an ideal spring

$$F = KA. \quad (\text{A10})$$

[49] The effective force of the air compressions is given by

$$F = P_e X_b, \quad (\text{A11})$$

where

$$X_b = \pi R_b^2. \quad (\text{A12})$$

[50] Thus by substituting (A11) into (A10) and solving for K

$$K = \frac{P_e X_b}{A}. \quad (\text{A13})$$

[51] Further substitution of (A9) into (A13) yields

$$K = \frac{P_0 V_e X_b}{V_0 A}. \quad (\text{A14})$$

[52] Substituting (A14) into (3), the frequency equation, yields the equation upon which the model is based

$$f = \frac{1}{4\pi M} \sqrt{4 \left(\frac{P_0 V_e X_b}{V_0 A} \right) M - C^2}. \quad (\text{A15})$$

[53] In (A15), the frequency (f), initial pressure (P_0), area (X_b), effective volume (V_e), and amplitude (A) can be derived from the slug test data. The damping constant (C) can be calculated by fitting an exponentially decaying function to water level peaks. Thus, the mass of the system (M), and initial volume of the air cavity (V_0) are left as the unknowns which must be defined to generate oscillations with the desired frequency.

Notation

- A first water level minimum minus second water level max.
- B_m bulk compressibility of material.
- C viscous damping constant.
- D plate stiffness factor.
- E elastic modulus of ice.
- f frequency.
- h_i ice thickness.
- H_a air package height.
- H_f fracture height.
- H_w hydraulic head.
- K spring constant.
- L_c length of connecting path.
- L_f fracture length.
- M system water mass.
- P pressure.
- P_w pressure of added water slug.
- R_b borehole radius.
- R_d radius of deformation.

R_u	radius of uplift.
t	time.
ν	Poisson's ratio.
V	volume.
V'	initial material volume.
V_0	initial air volume.
V_e	effective volume.
V_w	water volume
$w(0)$	maximum uplift at the center of a plate.
w_{\max}	maximum deflection at the center of a circle.
W_f	fracture width.
X_b	borehole cross-sectional area.
$y(t)$	water level.
ω_0	angular frequency.

[54] **Acknowledgments.** The authors thank G. Flowers, B. Hubbard, and B. Kulesa for their insightful comments on this manuscript. We also thank J. Johnson and W. Woessner for reviews of an early draft. This project was funded by NSF Office of Polar Programs, Arctic Natural Sciences (OPP-ANS-0454789).

References

- Anderson, R. S., S. P. Anderson, K. R. MacGregor, E. D. Waddington, S. O'Neel, C. A. Riihimaki, and M. G. Loso (2004), Strong feedbacks between hydrology and sliding of a small alpine glacier, *J. Geophys. Res.*, *109*, F03005, doi:10.1029/2004JF000120.
- Bouwer, H., and R. C. Rice (1976), Slug test for determining hydraulic conductivity of unconfined aquifers with completely or partially penetrating wells, *Water Resour. Res.*, *12*(3), 423–428, doi:10.1029/WR012i003p00423.
- Bradford, J., J. Harper, S. Hess, and A. Allen (2005), Three-dimensional GPR investigation of intraglacial hydrologic structures, *Eos Trans. AGU*, *86*(52), Fall Meet. Suppl., Abstract C51B–0299.
- Bredehoeft, J. D., H. H. Cooper, and I. S. Papadopoulos (1966), Inertial and storage effects in a well-aquifer system: An analog investigation, *Water Resour. Res.*, *2*, 697–707, doi:10.1029/WR002i004p00697.
- Butler, J. J. (1998), *The Design, Performance, and Analysis of Slug Tests*, CRC Press, Boca Raton, Fla.
- Clarke, G. K. C. (2005), Subglacial processes, *Annu. Rev. Earth Planet. Sci.*, *33*, 247–276, doi:10.1146/annurev.earth.33.092203.122621.
- Fetter, C. W. (2001), *Applied Hydrogeology*, Prentice-Hall, Upper Saddle River, N. J.
- Fountain, A. G., R. W. Jacobel, R. Schlichting, and P. Jansson (2005), Fractures as the main pathways of water flow in temperate glaciers, *Nat.*, *433*(7026), 618–621, doi:10.1038/nature03296.
- Harper, J., and N. Humphrey (1995), Borehole video analysis of a temperate glaciers englacial and subglacial structure: Implications for glacier flow models, *Geology*, *23*(10), 901–904, doi:10.1130/0091-7613[1995]023<0901:BVAOAT>2.3.CO;2.
- Harper, J., N. Humphrey, W. Pfeffer, T. Fudge, and S. O'Neel (2005), Evolution of subglacial water pressure along a glacier's length, *Ann. Glaciol.*, *40*, 31–36, doi:10.3189/172756405781813573.
- Harper, J. T., N. F. Humphrey, W. T. Pfeffer, and B. Lazar (2007), Two modes of accelerated glacier sliding related to water, *Geophys. Res. Lett.*, *34*, L12503, doi:10.1029/2007GL030233.
- Hobbs, P. V. (1974), *Ice Physics*, Clarendon, Oxford, U. K.
- Hodge, S. M. (1976), Direct measurement of basal water pressures: A pilot study, *J. Glaciol.*, *16*(74), 205–219.
- Hubbard, B., A. Binley, L. Slater, R. Middleton, and B. Kulesa (1998), Inter-borehole electrical resistivity imaging of englacial drainage, *J. Glaciol.*, *44*(147), 429–434.
- Iken, A., K. Fabri, and M. Funk (1996), Water storage and subglacial drainage conditions inferred from borehole measurements on Gornegletscher, Valais, Switzerland, *J. Glaciol.*, *42*, 233–248.
- Kabala, Z. K., G. F. Pinder, and P. C. D. Milly (1985), Analysis of well-aquifer response to a slug test, *Water Resour. Res.*, *21*(9), 1433–1436, doi:10.1029/WR021i009p01433.
- Kipp, K. L., Jr. (1985), Type curve analysis of inertial effects in the response of a well to a slug test, *Water Resour. Res.*, *21*(9), 1397–1408, doi:10.1029/WR021i009p01397.
- Kulesa, B., and B. Hubbard (1997), Interpretation of borehole impulse tests at Haut Glacier d'Arolla, Switzerland, *Ann. Glaciol.*, *24*, 397–402.
- Kulesa, B., and G. Müller (2006), Numerical modelling of the propagation of pressure pulses as modified acoustic waves through glacial melt water systems, paper presented at International Symposium on Cryospheric Indicators of Global Climate Change, Int. Glaciol. Soc., Cambridge, U. K.
- Kulesa, B., and T. Murray (2003), Slug-test derived differences in bed hydraulic properties between a surge-type and a non-surge-type Svalbard glacier, *Ann. Glaciol.*, *36*, 103–109, doi:10.3189/172756403781816257.
- Kulesa, B., B. Hubbard, M. Williamson, and G. H. Brown (2005), Hydrogeological analysis of slug tests in glacier boreholes, *J. Glaciol.*, *51*(173), 269–280, doi:10.3189/172756505781829458.
- Martinerie, P., D. Raynaud, D. M. Etheridge, J. M. Barnola, and D. Mazaudier (1992), Physical and climatic parameters which influence the air content in polar ice, *Earth Planet. Sci. Lett.*, *112*, 1–13, doi:10.1016/0012-821X(92)90002-D.
- McElwee, C. D., and M. A. Zenner (1998), A nonlinear model for analysis of slug-test data, *Water Resour. Res.*, *34*(1), 55–66, doi:10.1029/97WR02710.
- McGee, B. W., J. T. Harper, N. F. Humphrey, and W. T. Pfeffer (2003), Water flow through widespread and interconnected void spaces at depth in a temperate glacier, *Eos Trans. AGU*, *84*(46), Fall Meet. Suppl., Abstract C11C–0850.
- Meierbachtol, T. (2007), Borehole measurements of dynamic basal drainage adjustments during sliding accelerations: Bench Glacier, Alaska, M.S. thesis, Univ. of Mont., Missoula, Mont.
- Nolan, M., and K. Echelmeyer (1999), Seismic detection of transient changes beneath Black Rapids Glacier, Alaska, U.S.A.: Part II. Basal morphology and processes, *J. Glaciol.*, *45*(149), 132–146.
- Ohanian, H. C. (1985), *Physics*, vol. 1, W. W. Norton, New York.
- Paterson, W. S. B. (1994), *The Physics of Glaciers*, Elsevier Sci., Tarrytown, N. Y.
- Potter, M. C. (1978), *Mathematical Methods in the Physical Sciences*, Prentice-Hall, Upper Saddle River, N. J.
- Roberts, M. J., A. J. Russell, F. S. Tweed, and Ó. Knudsen (2000), Ice fracturing during jökulhlaups: Implications for englacial floodwater routing and outlet development, *Earth Surf. Processes Landforms*, *25*(13), 1429–1446, doi:10.1002/1096-9837(200012)25:13<1429::AID-ESP151>3.0.CO;2-K.
- Roberts, M. J., F. S. Tweed, A. J. Russell, Ó. Knudsen, D. E. Lawson, G. J. Larson, E. B. Evenson, and H. Björnsson (2002), Glaciohydraulic supercooling in Iceland, *Geology*, *30*(5), 439–442, doi:10.1130/0091-7613(2002)030<0439:GSII>2.0.CO;2.
- Sechler, E. E. (1952), *Elasticity in Engineering*, John Wiley, New York.
- Shaha, J. M. (2004), Investigation of subglacial and englacial hydrology using borehole slug tests; Bench Glacier, Alaska, M.S. thesis, Univ. of Wyo., Laramie, Wyo.
- Stone, D. B., and G. K. C. Clarke (1993), Estimation of subglacial hydraulic properties from induced changes in basal water pressure: A theoretical framework for borehole-response tests, *J. Glaciol.*, *39*(132), 327–340.
- Stone, D. B., G. K. C. Clarke, and R. G. Ellis (1997), Inversion of borehole-response test data for estimation of subglacial hydraulic properties, *J. Glaciol.*, *43*(143), 103–113.
- Timoshenko, S. P., and J. N. Goodier (1982), *Theory of Elasticity*, McGraw-Hill, New York.
- van der Kamp, G. (1976), Determining aquifer transmissivity by means of well response tests: The underdamped case, *Water Resour. Res.*, *12*(1), 71–77, doi:10.1029/WR012i001p00071.
- van der Veen, C. J. (1998), Fracture mechanics approach to penetration of bottom crevasses on glaciers, *Cold Reg. Sci. Technol.*, *27*(3), 213–223, doi:10.1016/S0165-232X(98)00006-8.

J. H. Bradford, Department of Geosciences, Boise State University, 1910 University Drive, Mailstop 1535, Boise, ID 83725, USA.

J. T. Harper and T. W. Meierbachtol, Department of Geosciences, University of Montana, 32 Campus Drive #1296, Missoula, MT 59812, USA. (meierbtw@gmail.com)

N. F. Humphrey, Department of Geology and Geophysics, University of Wyoming, 1000 University Avenue, Department 3006, Laramie, WY 82071, USA.

J. Shaha, Aspect Consulting, 179 Madrone Lane North, Bainbridge Island, WA 98110, USA.