

University of Montana

ScholarWorks at University of Montana

Numerical Terradynamic Simulation Group
Publications

Numerical Terradynamic Simulation Group

1999

Land Ecosystems and Hydrology

Steven W. Running

University of Montana - Missoula

G. J. Collatz

J. Washburne

S. Sorooshian

Follow this and additional works at: https://scholarworks.umt.edu/ntsg_pubs

Let us know how access to this document benefits you.

Recommended Citation

Running, S. W., Collatz G. J., Washburne J., and Sorooshian S. Land Ecosystems and Hydrology. EOS Science Plan, Michael D. King (ed). NASA, 1999, pp. 197-260.

This Book Chapter is brought to you for free and open access by the Numerical Terradynamic Simulation Group at ScholarWorks at University of Montana. It has been accepted for inclusion in Numerical Terradynamic Simulation Group Publications by an authorized administrator of ScholarWorks at University of Montana. For more information, please contact scholarworks@mso.umt.edu.

EOS

SCIENCE PLAN

The State of Science in the EOS Program

EOS

The State of Science in the EOS Program

EDITOR **Michael D. King**

TECHNICAL EDITORS

DESIGN AND PRODUCTION

TABLE OF CONTENTS

<i>Foreword</i>	1
<i>Preface</i>	3
<i>Chapter 1</i> Overview	5
<i>Chapter 2</i> Radiation, Clouds, Water Vapor, Precipitation, and Atmospheric Circulation	39
<i>Chapter 3</i> Ocean Circulation, Productivity, and Exchange with the Atmosphere	115
<i>Chapter 4</i> Atmospheric Chemistry and Greenhouse Gases	163
<i>Chapter 5</i> Land Ecosystems and Hydrology	197
<i>Chapter 6</i> Cryospheric Systems	261
<i>Chapter 7</i> Ozone and Stratospheric Chemistry	309
<i>Chapter 8</i> Volcanoes and Climate Effects of Aerosols	339
<i>Acronyms</i>	381
<i>Index</i>	387

Foreword

From the dawn of space exploration NASA has been in the forefront of providing the unique vantage point of space as an ideal setting for observing Earth as a whole system consisting of atmosphere, oceans, and continents capable of supporting life in our solar system. Today, NASA continues to sponsor research and development towards understanding the origins of life in the universe. The best proxy for this search and discover mission is life on Earth, and the NASA Earth Science Enterprise captures the spirit of exploration and focuses it back on our home planet. But this requires understanding Earth as an integrated system of atmosphere, land, oceans, and life, which has evolved in the past and will continue to evolve in the future. Building on our observations of the Earth since the earliest days of the space program—NASA built the first weather and land observing satellites—we are using orbiting spacecraft to bring congruency to multiple disciplines within Earth sciences through integrated observations, interdisciplinary scientific research and analysis, and modeling. This is the blueprint for the Earth Science Enterprise at NASA and its Earth Observing System (EOS) program.

The EOS program was established in 1991 as a U.S. Presidential initiative to provide in-depth scientific understanding about the functioning of Earth as a system. It was envisioned that such scientific knowledge would provide the foundation for understanding the natural and human-induced variations in Earth's climate system and also provide a sound basis for environmental policy decision making. Beyond scientific discovery and explorations, it was also envisioned that EOS would have practical societal benefits in the form of providing scientific knowledge toward the efficient production of food and fiber, management of fresh water resources, and improvement of air quality. Less than a decade later, EOS is now a reality and delivering on its promises. During the first phase of the EOS program NASA is funding the development and launch of 25 satellites, and a uniquely comprehensive Earth observations-related data and information system. Hundreds of Earth scientists and engineers are supported, and more than 350 students per year are pursuing graduate degrees in Earth science with NASA funding.

The EOS Science Plan is the product of several years of discussion and debate among the EOS investigators. The considerable time required to develop this document should be viewed as a major strength because of the deep-rooted commitments of the contributors to this document and their ability to deliver on their promise. The objective of this Plan is to convey how EOS investigators plan to utilize the space-based and in situ observations along with modeling and data analysis methods/techniques to address the EOS scientific and applications objectives. Therefore, the principal intended audience for this plan is the body of international Earth scientists and science program directors. Given the complexity of the task at hand and the level of details that had to be provided, the Plan became more than 350 pages long. A short version of the Plan has also been developed in the form of an Executive Summary. We believe that these two documents will be seen to be an effective means of communicating the scientific priorities of the EOS program and how NASA and EOS investigators plan to implement these priorities during the next 5-7 years.

As we move towards the next century the changing Earth's environment will be the focus of many agricultural, industrial, and societal concerns and policy decisions. NASA's Earth Science Enterprise is committed to timely provision of the scientific knowledge needed by world leaders to formulate sound and equitable environmental decisions.

Ghassem R. Asrar
Associate Administrator

Office of Earth Science
NASA Headquarters
Washington, D.C.

Preface

The EOS Science Plan was first proposed to the community of EOS investigators at a meeting of the EOS Investigators Working Group in the fall of 1994. As the concept of the Plan evolved, it was decided that the primary audience for the Plan would be the scientific community and not the general public. Thus, the audience not only includes members of the EOS scientific community, but also includes scientists in related fields who are not necessarily acquainted with the goals and philosophies of scientists in the EOS program.

Accordingly, readers will find a very thorough presentation of the state of the science being investigated by participants in the EOS program. They also will find discussions on how science investigations are being conducted both before and after launch of the EOS satellites. This review of the state of the science, along with its extensive documentation of scientific references, should be of value to both working scientists and to the graduate students who will take their place in the scientific endeavors of the next century.

Both the anticipated contributions of the EOS satellites to our knowledge of Earth science and the synergisms existing between the various instruments are discussed throughout the plan. Also described are the many theoretical studies [called Interdisciplinary Science (IDS) investigations] that draw upon the satellite observations, and the role of field investigations in both validating instrument observations and enhancing our understanding of Earth System processes.

The Plan consists of an overview chapter followed by seven topical science chapters that discuss, in considerable detail, all aspects of EOS science. The overview chapter was written by Eric Barron of The Pennsylvania State University and gives the background of concerns and recommendations that led to the formation of the EOS Program. Each of the topical science chapters has a lead author(s) who is an expert in the particular field and is a Principal Investigator on a related IDS team. Typically, lead authors were heading up EOS scientific working groups at the time they assumed responsibility for their respective chapters. Each lead author has drawn on a team of "contributing" authors who are named at the start of each chapter. The seven science topics addressed in the plan, with their corresponding chapter names and lead authors, are as follows:

2. Radiation, clouds, water vapor, precipitation, and atmospheric circulation
D. L. Hartmann – *University of Washington*
3. Ocean circulation, productivity, and exchange with the atmosphere
D. A. Rothrock – *University of Washington*
4. Atmospheric chemistry and greenhouse gases
D. Schimel – *National Center for Atmospheric Research*
5. Land ecosystems and hydrology
S. W. Running – *University of Montana*
G. J. Collatz – *Goddard Space Flight Center*
J. Washburne – *University of Arizona*
S. Sorooshian – *University of Arizona*

6. Cryospheric systems
 - B. E. Goodison – *Atmospheric Environment Service, Canada*
 - R. D. Brown – *Atmospheric Environment Service, Canada*
 - R. G. Crane – *Pennsylvania State University*
7. Ozone and stratospheric chemistry
 - M. R. Schoeberl – *Goddard Space Flight Center*
8. Volcanoes and climate effects of aerosol
 - D. L. Hartmann – *University of Washington*
 - P. Mouginiis-Mark – *University of Hawaii.*

Readers wishing to know more details about the IDS investigations or the planned EOS spacecraft missions and the instruments they will carry are advised to consult the 1998 edition of the Earth Science Enterprise/EOS Reference Handbook. The handbook also provides the names of all IDS Principal Investigators and Co-Investigators as well as the names of the EOS instrument team leaders, team members, Principal Investigators, and Co-Investigators. An excellent way to keep current with EOS developments is to consult the EOS Project Science Office website at <http://eos.nasa.gov/>.

It should be noted that EOS is a fluid program, with changes in long-term plans always a possibility due to new scientific developments or to budgetary considerations. Authors and editors have tried to keep abreast of changes in mission and instrument names, but some of the older terminology may not have been caught in every instance. For this we apologize.

Acknowledgments

Special thanks go to D. A. Rothrock, University of Washington, who provided the outline for all the topical science chapters, and thus, in a sense, gave the necessary impetus to the launching of this Plan. Much of the technical material in the Plan was provided not only by the listed lead authors and named contributors, but also by many other unnamed EOS scientists and engineers. R. Greenstone and W. R. Bandeen (both of Raytheon Corporation) provided technical editing throughout the lengthy process of assembling and refining in standard format the text and appendices of this Plan. Design and layout of the Plan were the work of Sterling Spangler (also of Raytheon Corporation).

Michael D. King
EOS Senior Project Scientist

January 1999

CHAPTER 5

Land Ecosystems and Hydrology

CO-AUTHORS S. W. Running
G. J. Collatz
J. Washburne
S. Sorooshian

CONTRIBUTING AUTHORS T. Dunne
R. E. Dickinson
W. J. Shuttleworth
C. J. Vorosmarty
E. F. Wood

CHAPTER 5 CONTENTS

5.1	Introduction	201
5.1.1	Land-climate	201
5.1.2	Land-hydrology	201
5.1.3	Land-vegetation	202
5.2	Major land-surface science issues	202
5.2.1	Land-climate science issues	202
5.2.1.1	The development of land surface models (LSMs)	203
5.2.1.2	Quantifying atmospheric forcings and states	204
5.2.1.3	The role of remote sensing	204
5.2.1.4	AGCM research specifically related to EOS	205
5.2.1.4.1	How will the land surfaces' biophysical controls on the carbon, energy, and water cycles respond to and feed back on climate?	205
5.2.1.4.2	Effects of land-cover change on climate	206
5.2.1.4.3	How will biospheric responses to changing climate and atmospheric CO ₂ levels affect and feed back on atmospheric composition and climate?	208
5.2.1.4.4	How does local-scale heterogeneity in land-surface properties affect regional-to-continental climate?	209
5.2.1.4.5	How do land surface-atmospheric interactions affect weather and climate at seasonal to annual time scales?	210
5.2.2	Land-hydrology science issues	210
5.2.2.1	Quantifying and modeling hydrologic variables	211
5.2.2.1.1	Precipitation	211
5.2.2.1.2	Runoff	213
5.2.2.1.3	Evapotranspiration (ET)	213
5.2.2.1.4	Near-surface soil moisture	215
5.2.2.1.5	Infiltration and deep percolation	216
5.2.2.1.6	Radiation	216
5.2.2.1.7	Near-surface meteorology	217
5.2.2.2	Estimating and validating the land-surface water balance	218
5.2.2.3	Extreme hydrologic events	218
5.2.2.3.1	Introduction	219
5.2.2.3.2	Severe storms	219
5.2.2.3.3	Floods	220
5.2.2.3.4	Floodplains	221
5.2.2.3.5	Droughts	221
5.2.2.3.6	The causes of extreme events	221
5.2.2.4	River biogeochemistry	222
5.2.3	Land-vegetation science issues	223
5.2.3.1	The role of EOS in global change studies of vegetation	223
5.2.3.2	Land cover	223
5.2.3.2.1	Landsat and high-spatial-resolution land science	224
5.2.3.3	Vegetation structure	225
5.2.3.3.1	LAI	225
5.2.3.3.2	FPAR	226
5.2.3.3.3	Vegetation indices	226
5.2.3.4	Vegetation phenology	227
5.2.3.5	Net Primary Production (NPP)	227
5.2.3.5.1	Stem and soil carbon	229
5.2.3.6	Regional weekly application products	230
5.2.3.7	Biogeochemistry	231
5.2.3.8	Predictions of terrestrial biospheric dynamics	232
5.3	Required measurements and data sets for quantifying land-surface attributes	233
5.3.1	Introduction	233
5.3.2	EOS Sensors	233
5.3.2.1	MODIS	233
5.3.2.2	MISR	233

CHAPTER 5 CONTENTS (CONT.)

5.3.2.3	ASTER	234
5.3.2.4	Landsat 7	234
5.3.3	Ancillary data sets	235
5.3.3.1	Soils	235
5.3.3.2	Topography	235
5.3.3.3	River and flood control networks	236
5.3.4	Assimilation data sets	236
5.4	Validation programs for EOS	236
5.4.1	Responsibility hierarchy	236
5.4.2	Global organization of terrestrial observations	237
5.4.3	EOS IDS field sites	238
5.4.3.1	Arid/semi-arid: Sahel and Upper San Pedro River basins	238
5.4.3.2	Biogeochemical analysis of savanna ecosystems	238
5.4.3.3	Humid/coastal: Susquehanna River Basin Experiment (SRBEX)	238
5.4.3.4	Southern Great Plains: Arkansas/Red River basins	239
5.4.3.5	LSM parameterizations from FIFE and BOREAS campaigns	239
5.4.3.6	Tropical: Amazon	240
5.4.3.7	Global biogeochemical cycles	240
5.4.3.8	Canadian studies of carbon and hydrologic cycles	240
5.4.3.9	Cryospheric System (CRYSYS)	240
5.4.3.10	Seasonally snow-covered alpine basins	241
5.4.4	Land-vegetation science	241
5.4.5	Terrestrial validation activity	243
5.4.5.1	Tier 1 major field experiments	243
5.4.5.1.1	Past experiments	243
5.4.5.1.1.1	First ISLSCP field experiment	243
5.4.5.1.1.2	HAPEX-Sahel	243
5.4.5.1.1.3	EFEDA	244
5.4.5.1.1.4	BOREAS	244
5.4.5.1.1.5	OTTER	244
5.4.5.1.2	Opportunities from current and future experiments	244
5.4.5.1.2.1	LBA	244
5.4.5.1.2.2	GCIP	245
5.4.5.1.2.3	CART-ARM	245
5.4.5.1.2.4	CASES	245
5.4.5.1.2.5	NOPEX	245
5.4.5.2	Tier 2-3 validation monitoring for terrestrial fluxes	246
5.4.5.2.1	FLUXNET and EUROFLUX	246
5.4.5.2.2	Carbon America	247
5.4.5.2.2.1	Continuous flux measurements	247
5.4.5.2.3	TRAGNET	247
5.4.5.3	Tier 3-4 permanent ecological field station networks	248
5.4.5.3.1	NSF LTER Project, MODLERS	248
5.4.5.3.2	GLCTS: The Global Land Cover Test Site Program	249
5.4.5.3.3	IGBP terrestrial transects	249
5.4.5.3.4	The Gap Analysis Program	249
5.4.5.3.5	IGBP NPP data initiative	249
5.4.6	EOS-related land science modeling plans	251
5.4.6.1	PILPS: Project for Intercomparison of Land-surface Parameterization Schemes	251
5.4.6.2	VEMAP	251
5.4.6.3	PIK-NPP	252
	References	253
	Chapter 5 Index	258

5.1 Introduction

The terrestrial biosphere is an integral component of the Earth Observing System (EOS) science objectives concerning climate change, hydrologic cycle change, and changes in terrestrial productivity. The fluxes of CO₂ and other greenhouse gases from the land surface influence the global circulation models directly, and changes in land cover change the land surface biophysical properties of energy and mass exchange. Hydrologic cycle perturbations result from terrestrially-induced climate changes, and more directly from changes in land cover acting on surface hydrologic balances. Finally, both climate and hydrology jointly control biospheric productivity, the source of food, fuel, and fiber for humankind. The role of the land system in each of these three topics is somewhat different, so this chapter is organized into the subtopics of Land-Climate, Land-Hydrology, and Land-Vegetation interactions (Figures 5.1, 5.2, and 5.3).

The magnitude of spatial and temporal heterogeneity of the global land system is extreme. The range of a simple variable like albedo can be 10-80% over different land surfaces globally, or a single location can change over this same magnitude during an annual cycle. Likewise, land covers range from deserts to rainforests globally, yet an agricultural field can change from bare soil to complete canopy coverage within two months. The EOS satellites will accurately quantify this spatial and temporal variability of critical land-surface attributes. The EOS biospheric models will then ingest these land-surface parameters and calculate important land-surface processes such as fluxes of CO₂ and H₂O, and primary productivity.

exemplified by the Biosphere-Atmosphere Transfer (BATS) model of the Dickinson Interdisciplinary Science Investigation (IDS) team and the Simple Biosphere (SiB) model of the Sellers IDS team. These and other LSP models require a suite of land-surface variables for operation in the AGCMs, including land cover, leaf-area index (LAI), roughness length, and albedo. Some of these variables change seasonally, so EOS sensors will be used to monitor the natural growing season variability of, for example, albedo and LAI. Interannual variability in climate—El Niño events for instance—feed back to cause changes in timing and magnitude of change in these vegetation variables. At decadal time scales, changes in land cover caused by natural and human disturbances may also influence aerodynamic roughness. Land-Climate models also require atmospheric data as described in Chapter 2 for forcing and validation of their AGCM components. These will be supplied by a number of EOS sensors and

FIGURE 5.1

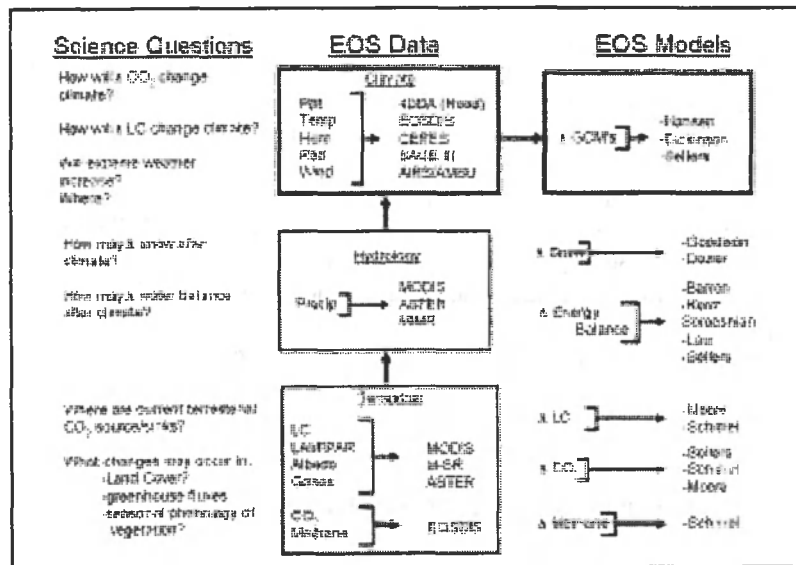

A summary diagram of land-climate research in EOS.

5.1.1 Land-Climate

The Land-Climate interaction section deals with the fluxes of energy and mass between the atmosphere and land surfaces. The central question here for EOS is “How will changes in land-surface processes/properties interact with regional and global climate?” Specifically, this section discusses the scientific questions being addressed through the use of Land-Surface Parameterizations (LSPs) coupled to atmospheric general circulation models (AGCMs), as

the Four-Dimensional Data Assimilation (4DDA) products (see Table 5.1, pg. 207).

5.1.2 Land-Hydrology

The Land-Hydrology section addresses how changing climate and land-surface characteristics may combine to change precipitation patterns, surface-water partitioning and storage, and river flows. Hydrologically-controlled

land-surface energy partitioning directly feeds back to the climate system. In addition, hydrologic extremes such as droughts and floods have severe human consequences. Terrestrial variables for hydrologic modeling are similar to those required by climate models, but topography and spatial details are more critical for defining hydrologic routing. An additional dimension of hydrologic questions relates to water quality, the land processes that change erosion, sedimentation, and river biogeochemistry—all important to human welfare.

5.1.3 Land-vegetation

The Land-vegetation section addresses responses of terrestrial vegetation at multiple time scales, from daily to decadal. At the first time scale are questions of ecosystem gas-exchange activity. What is the current global terrestrial CO₂ balance? What is the distribution and contribution of different biomes to the global CO₂ flux? Fluxes and dynamics of other greenhouse gases are covered in Chapter 4. At intermediate time scales are questions of interannual climatically-induced variability of vegetation structure and canopy density. Longer-range questions are related to how biome distribution is influenced by changing land cover and climate. Some of the most serious questions of human habitability relate to how the regional distribution and magnitude of crop, range, and forest pro-

FIGURE 5.2

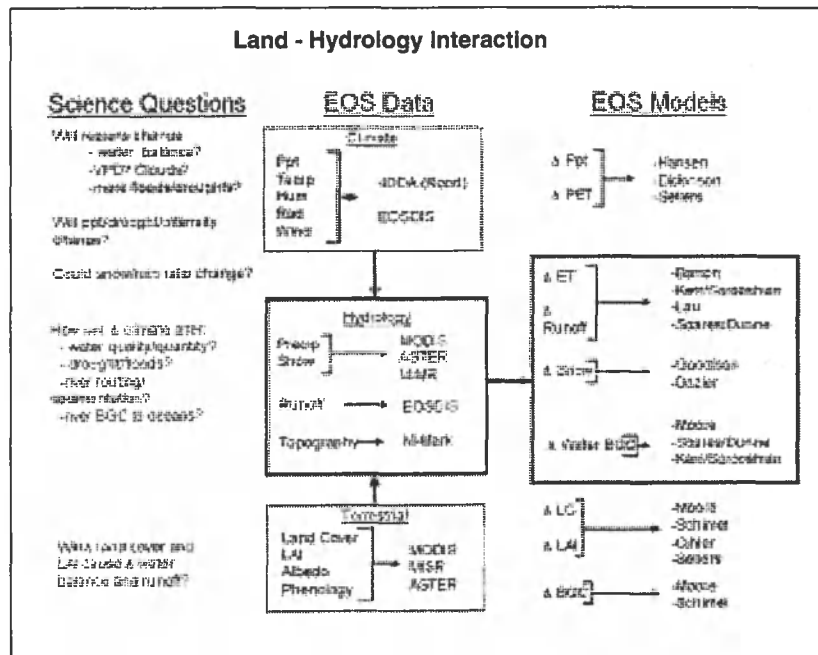

A summary diagram of land-hydrology research in EOS.

ductivity will change with climate and land-use change. Clearly there are important interactions between these vegetation questions and the hydrologic extreme event questions on droughts and floods. If the mean climate changes, the geographic distribution of biomes and agricultural crops will change. EOS satellites will provide regular global monitoring of land cover, LAI, and various spectral vegetation indices that will be used in biospheric carbon balance models to answer these questions.

5.2 Major land-surface science issues

5.2.1 Land-climate science issues

In order to understand these effects we are particularly interested in the following issues related to how the climate is influenced by the land surface. These issues are developed further in Section 5.2.1.4.

- To what extent do land-surface processes affect global, continental, and regional climate?
- Is there a positive feedback between the loss or degradation of vegetation and climate?
- How do changes in radiative forcing from terrestrial greenhouse gases influence climate, and how might land-surface-atmosphere interactions be affected by increasing atmospheric CO₂?
- How do terrestrially-produced aerosols influence climate?
- How might changes in land-surface energy partitioning potentially influence climate?

- How might climate-induced changes in seasonality of surface temperature, snowpack, vegetation phenology, etc., interact with the biosphere and cause changes that feed back to the climate?
- How do land-surfaces characteristics influence the likelihood and severity of extreme weather events?

Based on the answers to these questions, we would then like to know:

- How might changes in global climate be manifested in terms of regional climates?
- How might changes in regional climates affect agriculture and water resources?
- How might short-term weather forecasting be improved?

In addressing these issues, we recognize that changes in the Earth's climate are a natural part of its evolution; climate changes have occurred in the past and will inevitably be part of its future. However, successful predictions of such changes will enable humans to moderate the influence of climate variations on their well-being and on the well-being of the ecosystems in which they live.

A promising approach to understanding and predicting climate is the use of numerical models of atmospheric circulation. The current generation of AGCMs that are being used to study climate contain representations of land and ocean surface interactions with the atmosphere. With improved models and parameter estimates it will be possible to reduce the uncertainty surrounding the important scientific questions regarding the role of land-surface processes and climate change.

5.2.1.1 The development of land-surface models (LSMs)
 Evidence that land-surface processes affect climate comes largely from AGCM sensitivity studies, which have shown that a number of land-surface characteristics influence the continental and global climate; these include albedo

FIGURE 5.3

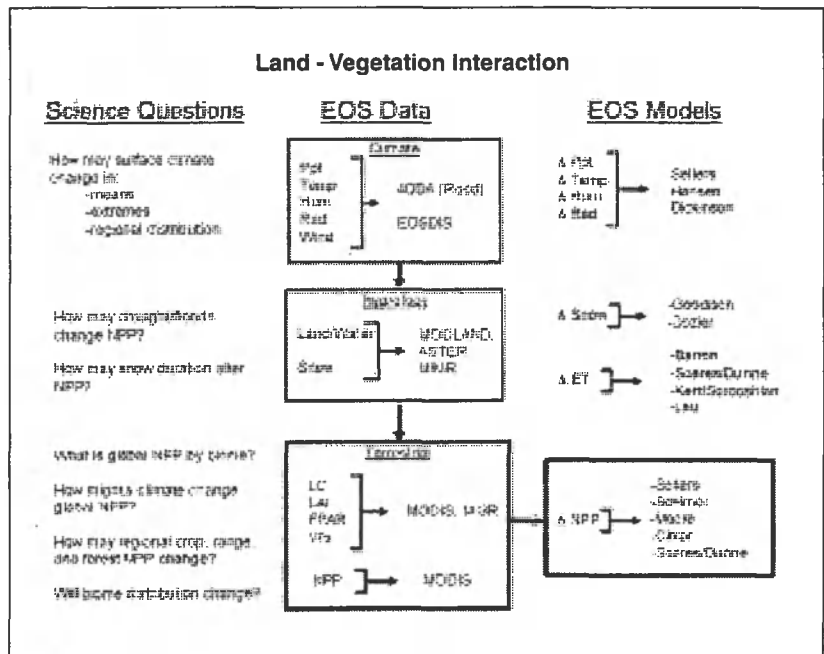

A summary diagram of land-vegetation research in EOS.

FIGURE 5.4

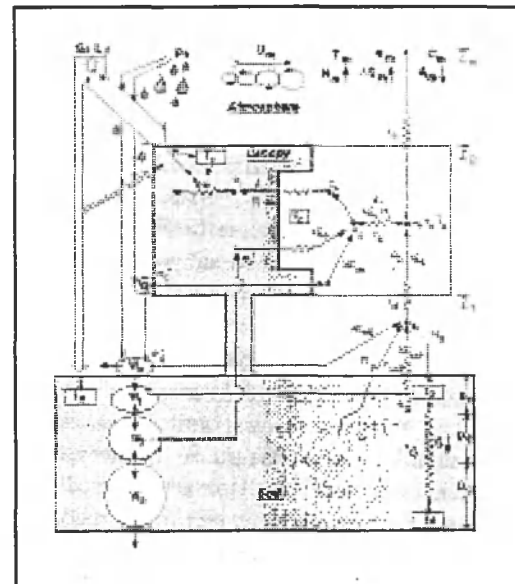

Schematic diagram depicting most of the processes modeled in SIB 2.

(Charney 1977), soil moisture (Shukla and Mintz 1982), roughness (Sud et al. 1988), and land-cover change (Nobre et al. 1991). Such evidence and the increasing sophistication of atmospheric models have stimulated the development of a new generation of LSMs for implemen-

tation within AGCMs (Dickinson 1984; Sellers et al. 1986; Xue et al. 1991; Thompson and Pollard 1995). These models generally contain formulations that model surface radiation fluxes, turbulent heat and mass fluxes, liquid water fluxes, and the control of water vapor and CO₂ fluxes by vegetation. An example of the structure and processes represented in a typical "state-of-the-art" LSM is illustrated in Figure 5.4 (pg. 203).

Because of factors related to the nature of atmospheric circulation as well as numerical constraints, coupled LSM-AGCMs are currently operated at short time scales (< hour) and large spatial scales (> 10,000 km²). Although long-time-scale, small-spatial-scale processes associated with ecosystem function and biogeochemistry are recognized as important in understanding and predicting climate, their implementation awaits the next generation of LSMs. Meanwhile, accurate representations of short-time-scale, surface-atmosphere interactions are crucial for improving climate predictions and for the development of integrated Earth system models in which LSMs will be the interface between long-time-scale hydrological, ecological, and geological processes, and the short-time-scale atmospheric circulation. For example, responses of ecosystem structure and function to climate and land-use change might be expressed in LSMs through changes in model parameters (LAI, land-cover type, and surface roughness).

While much progress has been made toward realistic and accurate formulation of LSMs, there is plenty of room for improvement. A recent LSM intercomparison study showed large discrepancies between the predictions made by the various models (Pitman et al. 1993), and it is not clear which formulations are better. Consensus on how LSMs should be formulated and parameterized awaits further testing using local and regional observations.

5.2.1.2 Quantifying atmospheric forcings and states

Land-surface processes are, in large part, controlled by water and energy exchanges with the atmosphere. For many studies these exchanges can be measured, but for comprehensive models used to study and predict changes, they must be determined as part of the model. Perhaps the most important of these exchanges are the temporal and spatial fields of precipitation and surface radiation (Figure 5.5). Unfortunately, these exchanges are also poorly represented in current models as indicated by comparisons between observations and model predictions. For example, radiation is in large part controlled by clouds, which remain a weak element of climate models, and precipitation depends substantially on processes at smaller spatial scales than those resolved by the models. Also important are the near-surface meteorological fields; in par-

FIGURE 5.5

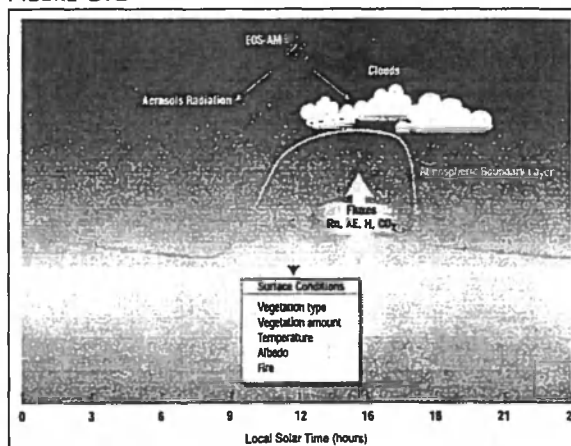

AM-1 Platform diagram showing types of measurements made from the EOS AM-1 satellite platform that will contribute to parameterization and testing of land-surface models. Note that the morning equatorial overpass will improve measurements of surface conditions by avoiding interference from afternoon convective clouds.

ticular, winds, temperature, and humidity, which are largely determined from parameters related to the land surface (soil moisture and temperature) and the overlying atmosphere.

Improved quantification of these exchanges depends on progress being made in the areas of data assimilation, model parameterization, and model validation. Current procedures for 4DDA do not make use of observations of precipitation and surface radiation, nor do they use observations of near-surface meteorological fields. These fields are constructed internally by the models, and can be seriously in error. One recent exception is the use by the European Centre for Medium-Range Weather Forecasts (ECMWF) of near-surface humidity observations to nudge soil moisture to improve the match between modeled and observed humidities (Viterbo and Beljaars 1995). Further improvements in data assimilation should not be long coming; the World Climate Research Program (WCRP) Surface Radiation Budget (SRB) project has demonstrated how satellite data can be used to provide surface solar radiation, and rapid advances are being made in developing comprehensive observations of precipitation from combinations of surface and satellite observations. EOS cloud, radiation, humidity, and temperature profiles products (see Chapter 2) will provide data needed to validate atmospheric components of climate models as well as that needed for initialization/assimilation.

5.2.1.3 The role of remote sensing

LSM development is constrained to a large extent by the availability of data required to initialize, parameterize,

FIGURE 5.6

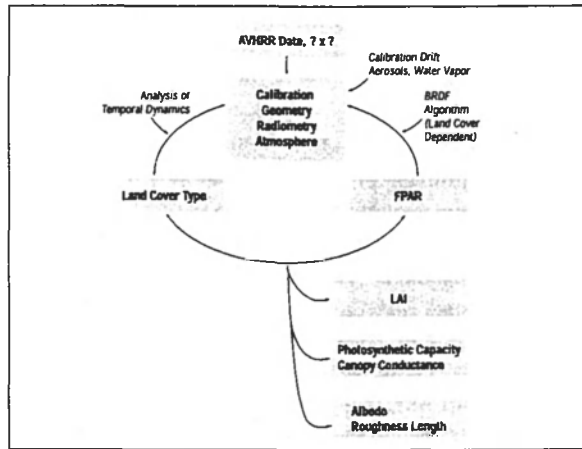

Vegetation algorithm diagram representing an approach to specify vegetation type and characteristics using currently-available satellite data. Satellite-derived surface attributes are used to parameterize land-surface models used in global climate simulations.

and test the models. The most promising approach to obtaining these data is the development of algorithms to predict the state of the land surface and the atmosphere from remote-sensing platforms. Intensive, multi-scale field studies such as the First International Satellite Land Surface Climatology Project (ISLSCP) Field Experiment (FIFE), the Hydrological-Atmospheric Pilot Experiment (HAPEX), and the Boreal Ecosystems Atmosphere Study (BOREAS) are examples of such efforts. Satellite observations are the most practical means of supplying LSMs with parameters and validation data (see Figure 5.6) at continental and global scales. EOS instruments will play an important role in this effort by providing high-quality remote-sensing data to complement ground-based observations during the EOS era. Many instrument and IDS teams plan to play major roles in the development and maintenance of several long-term validation/calibration sites.

5.2.1.4 AGCM research specifically related to EOS

The first science question addressed below—that of how land surfaces interact with climate—is related to the others that follow. Better understanding of land-atmosphere feedbacks will provide answers to questions regarding the climatic implications of land-use change, of atmospheric composition, and of land-surface heterogeneity. Work on these and other related questions will in turn further our understanding of land-atmosphere feedbacks. Improvements in land-surface-atmosphere models will produce practical benefits such as better predictions of weather, climate, and biospheric productivity. The EOS program was designed to fill critical gaps in our knowledge in the

land-surface climate system by supplying data that only satellites can provide.

5.2.1.4.1 How will the land surfaces' biophysical controls on the carbon, energy, and water cycles respond to, and feed back on, climate?

There is mounting evidence for the important role of land-atmosphere interaction in determining regional, continental, and global climate. Progress towards accurately forecasting climate from seasons to decades to centuries will depend in part on improving the representation of land surfaces in climate models. The fluxes of energy, mass, and momentum from land surfaces adjust to and alter the state of the atmosphere in contact with land, allowing the potential for feedback at several time and spatial scales. Earlier climate sensitivity simulations in which land-surface properties (such as albedo [Charney et al. 1977], soil moisture [Shukla and Mintz 1982], roughness [Sud et al. 1988]) were changed for the entire Earth showed significant climate alterations. More recently, Bonan et al. (1992), Nobre et al. (1991), and others have shown that continental-scale modifications representing dramatic change in vegetation type cause significant changes in simulated continental-scale climate. Avissar (1995) reviews examples of model and observational evidence showing that regional-scale precipitation patterns are affected by land-surface features such as discontinuities in vegetation type. In some cases positive feedback has been observed between large-scale precipitation patterns and land surface, resulting in the extension of drought or wet periods (Entekhabi 1995). Another example of land-surface atmosphere interaction is the measurable seasonal cycle in trace gases composition of the atmosphere over the Northern Hemisphere that results from the seasonality in the physiological activity of the biosphere, which in turn is controlled by climate (Keeling and Heiman 1986).

Because of this high degree of interaction between land-surface processes and climate, a useful way to study and predict the outcome of feedback is to use an LSM coupled to an AGCM. Several biophysical LSMs have been developed and implemented in AGCMs (Dickinson 1984; Sellers et al. 1986; Bonan 1995; Sellers et al. 1996) for studying surface-climate interactions. LSMs are necessarily simplistic because of: 1) limited knowledge of how relevant processes work, 2) computational constraints, and 3) lack of continuous temporal and spatial information required to characterize the state of the land-surface-atmosphere system. All three limitations are the focus of current research activity.

LSMs have improved in large part due to the increasing availability of observations necessary for

development and testing. Several intensive regional-scale field campaigns have been launched over the last 10 years such as FIFE, HAPEX-Sahel, and BOREAS that were designed to develop and test LSM and remote-sensing models. During these campaigns, teams of scientists observe the state of various components responsible for the energy and CO₂ fluxes from the surface. Models developed and tested using remote sensing from aircraft and satellites provide a way to extend the insights gained to similar ecosystems elsewhere.

The limited number and scale (time and space) of these observational campaigns present a problem for parameterizing and validating global climate models. Long-term measurements of canopy fluxes of energy and carbon such as those pioneered by Wofsy et al. (1993) help to bridge the gap between the time scales of atmospheric turbulence and climate. Two spatial-scale issues are more difficult to resolve: the differences in spatial scale between the sampling footprint of an eddy flux tower (m to km) and the typical AGCM grid cell (100s of km) and, related to this, the small number of measuring sites relative to total global land surface. Satellite observations are the most plausible way of providing continuous global measurements of the state of the land surface and atmosphere (Running et al. 1994; Sellers et al. 1995; Nemani and Running 1995).

EOS contribution: In the pre-EOS era, satellite data largely from the National Oceanic and Atmospheric Administration (NOAA) weather satellites are used to provide global estimates of land-surface conditions for use in land-climate models (Figure 5.6). Specifically the visible, near-infrared, and thermal channels on the Advanced Very High Resolution Radiometer (AVHRR) instrument are being processed into global fields of model parameters and are surrogates for much-improved EOS products to come. The Moderate-Resolution Imaging Spectroradiometer (MODIS) instrument, for instance, has greater spectral resolution, greater number of spectral bands, higher spatial resolution, better viewing time, better calibration, and will make coincident measurements with other instruments on a common platform—characteristics that make it far superior for parameterizing LSMs than existing satellite instruments.

The Sellers IDS Team (Sellers et al. 1996) has processed AVHRR data into seasonally-varying land-surface characteristics needed by LSMs, such as fraction of incident radiation absorbed by vegetation (FPAR), LAI, and surface aerodynamic roughness. They have initially released two years (1987 and 1988) of this data to the Earth scientific community (Figure 5.6). The Dickinson IDS Team is also using existing remote-sensing data in anticipation of the improved EOS instruments (MODIS and

the Multiangle Image Scanning Radiometer [MISR]) to specify vegetation class, structure, and composition in their LSM. The Lau IDS Team is developing continental-scale models that they hope to force and validate using MODIS products (land-surface characteristics, clouds, and surface temperatures) and Multi-frequency Imaging Microwave Radiometer (MIMR)/Advanced Microwave Scanning Radiometer (AMSR) products (atmospheric water, soil water, and precipitation). The Barron IDS Team is likewise using current satellite data (from AVHRR and Landsat) to model atmosphere/hydrology interactions on a regional scale and plans to ultimately use EOS products. Besides providing important model parameters EOS instruments will also measure the state of the atmosphere (temperature, humidity, clouds, radiation, and wind speed) (Table 5.1 and Figure 5.5). These data in conjunction with the 4-D data assimilation products that are to be produced by the Goddard Data Assimilation Office (DAO) will be used to provide atmospheric modelers including all IDS teams involved with land-atmosphere interactions (Lau, Barron, Hansen, Dickinson, Sellers) with data to initialize and test their models. Simultaneous and continuous global measurements of climate-state variables from EOS satellites will provide unprecedented opportunities for evaluating the performance of climate models (Sellers et al. 1995; Nemani and Running 1995).

5.2.1.4.2 Effects of land-cover change on climate

Both natural (floods, fires, volcanoes, solar output, etc.) and human (deforestation, overgrazing, and pollution) influence are known to cause massive changes in the vegetation cover. Imhoff (1994) estimated that 15% of the global forests have been converted to agriculture. Drastic changes in land-surface properties, such as occur due to deforestation or desertification, are likely to have climatic consequences. Satellites are currently providing better estimates of land-surface change than can be obtained by any other method. For instance, Skole and Tucker (1993) using Landsat data were able to improve estimates of deforestation and forest fragmentation in the Amazon Basin. When these estimates were used to parameterize an LSM-general circulation model (GCM), significant decreases in simulated precipitation over the region occurred (Walker et al. 1995). Extensive disturbance of vegetation cover will change the way the land surface interacts with the atmosphere. For example, Bougeault et al. (1991) were able to model, and confirm with observations, the influence of forest-crop boundary on cloud and precipitation patterns. Discontinuities in landscape patterns, as occur when forests are cleared, can affect when clouds form and the amount and distribution of rainfall (Avisar and Chen 1993). Nemani and Run-

ning (1995) have published the first consistent satellite-derived estimate of global land-cover change (Figure 5.7, pg. 208).

Modeling studies have been performed for land-cover changes at continental scales using GCMs. Notable examples include several Amazon deforestation simulations which showed the deterioration of the regional climate caused by deforestation (Nobre et al. 1991; Dickinson and Kennedy 1992; and Henderson-Sellers et al. 1993). Bonan et al. (1992) used an LSM-GCM to examine the impact of the boreal forests on climate. They found that the lower albedo caused by the presence of the

forest caused the boreal climate to be warmer all year round compared to the case in which the forests were converted to tundra. The altered climate simulated by these deforestation experiments is large enough to feed back on the land and alter the recovery response. The ability to simulate vegetation responses in a fully-coupled way with a GCM is yet to be achieved. Initial work has shown that feedbacks between climate and vegetation result in different vegetation and climate distributions from those predicted without considering feedback (Henderson-Sellers and McGuffie 1995).

TABLE 5.1

<i>INSTRUMENT</i>	<i>PRODUCTS</i>	<i>USES</i>
ASTER	Land-surface temperature, snow, cover, cloud characteristics, albedo Visible and near-IR bands, elevation, albedo	forcing parameterization validation
CERES	Albedo, radiation fluxes, precipitable water, cloud forcing characteristics, surface temperature, aerosols, temperature, humidity, and pressure profiles albedo	forcing parameterization validation
MIMR	Precipitation, snow cover, soil moisture albedo, cloud fraction, aerosols, soil moisture, BRDF	forcing parameterization validation
MODIS	Temperature and water-vapor profiles, cloud cover, albedo, surface temperature, snow cover, aerosols, surface resistance/ evapotranspiration, land-cover-classification, vegetation indices, BRDF	parameterization validation
SAGE III	Cloud height, H ₂ O concentration and mixing ratio, temperature and pressure profiles	validation
TRMM	Rainfall profile, surface precipitation (PR, TMI, VIRS)	forcing, validation
Other	4D data assimilation including wind, temperature, and humidity profiles; momentum, energy and precipitation fluxes	forcing, validation

Listing of EOS instruments and products and how they will be used by land-surface climate models.

FIGURE 5.7

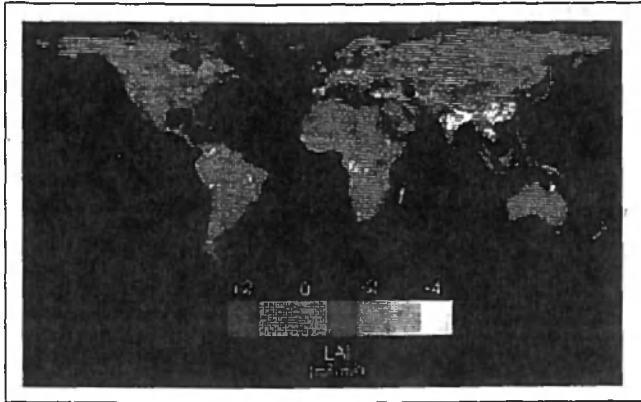

Human-induced changes in global land cover estimated by comparing AVHRR NDVI data, expressed as leaf-area index, with potential leaf index computed from long-term climatological data and hydrologic-vegetation equilibrium theory (Nemani et al. 1996).

Severe disturbance of vegetation cover sometimes results in an increase in atmospheric aerosols. The reductions in the surface solar radiation and the heating of the atmosphere as a result of aerosols are expected to alter atmospheric and land-surface processes. The process of deforestation often involves burning of biomass, which may cause significant reductions in the solar radiation incident on the surface (Penner et al. 1992). Disturbance, both natural and human, can lead to soil erosion and increased dust loading of the atmosphere. Using atmospheric transport model and satellite data Tegen et al. (1996) predict that around 50% of the total atmospheric dust is derived from land-surface disturbance. The alterations in the radiation reaching the Earth's surface and the heating of the atmosphere are likely to have climatic impacts that could feed back on land-surface properties and, therefore, must be taken into account when considering the impacts of land-cover change on climate.

EOS contribution: EOS instruments have been designed to measure the nature and extent of changes in land cover. MODIS, for instance, will produce calibrated and corrected global vegetation-cover data at 250-m resolution for over a decade. In particular, vegetation indices and surface radiative temperature will be used to diagnose land-cover change from MODIS data in a similar manner to the analysis Nemani and Running (1995) have done with AVHRR data in Figure 5.7. Sellers IDS team members are measuring deforestation using AVHRR and Landsat data. They are currently prescribing observed interannual variability in vegetation cover in their LSM-GCM to estimate the climatic impacts of such changes. MODIS products will provide better quality data (calibration, atmospheric corrections), higher spatial reso-

lution, and, in the tropics, less cloud contamination (EOS AM-1 series) than current satellite data. MISR products will be used to observe changes in the three-dimensional structure of vegetation cover. The improved quality of EOS data will provide more-realistic estimates of land-cover disturbance for climate sensitivity studies and will support the development of models that predict land-cover change in response to climate change and human activities. Barron, Dickinson, Hansen, Lau, and Sellers IDS teams all have plans to evaluate the impact of land-cover changes on climate using MODIS products as inputs to their LSM-GCMs.

Several EOS instruments (Earth Observing Scanning Polarimeter [EOSP], MODIS, MISR, High Resolution Dynamics Limb Sounder [HIRDLS], Stratospheric Aerosol and Gas Experiment III (SAGE III), and ESA's Polarization and Directionality of the Earth's Reflectance [POLDER]) will provide aerosol estimates which will be useful for land-surface climate studies because of two elements: the impact of aerosols on climate as recently observed in the case of the 1991 eruption of Mt. Pinatubo (McCormick et al. 1995), and, since aerosols interfere with other EOS measurements, accurate estimation will permit better aerosol corrections. Hansen and Sellers IDS teams are currently exploring the impacts of land-cover changes on atmospheric dust and climate using remote-sensing products and GCMs. EOS aerosol products will allow better quantification of the climatic impacts of dust generated from land-cover change.

Fire that causes changes in land cover will be monitored by MODIS. Hansen's team has developed a lightning parameterization for their GCM that can be used to predict lightning-caused fires. MODIS will provide observations of global fire-occurrence data, and the Lightning Imaging Sensor (LIS) (Tropical Rainfall Measuring Mission-1 [TRMM-1]) will supply direct measurements of lightning, both of which will contribute to model validation and further development.

5.2.1.4.3 How will biospheric responses to changing climate and atmospheric CO₂ levels affect and feed back on atmospheric composition and climate?

There are two issues addressed here that are associated with atmospheric composition and land-surface processes: 1) The interaction between the biosphere and atmospheric CO₂ composition, and 2) the interaction between land surface and climate in response to increasing atmospheric CO₂. Land surfaces play an important role in the composition of the atmosphere. Various nitrogen compounds, methane, CO₂, and plant secondary products exchange

between the atmosphere and land. For instance, biological processes occurring on land surfaces significantly affect the CO₂ concentration in the atmosphere. The amount of carbon in the terrestrial biosphere is almost three times greater than in the atmosphere, and on an annual basis about 20% of the atmospheric carbon is removed by photosynthesis and returned through respiration. Anthropogenic CO₂ emissions on the other hand are less than 5% of the photosynthetic flux. Alterations in the balance between photosynthesis and respiration causing changes in the size of the biospheric carbon stores will have dramatic effects on the CO₂ concentration of the atmosphere and, as a result, on the climate.

The seasonal and spatial patterns in the atmospheric CO₂ concentration and its isotopic composition imply that the Northern Hemisphere land surfaces are currently acting as a CO₂ sink (see Figure 5.11 on pg. 220 and Ciais et al. 1995; Tans et al. 1990). These and other studies show that almost a quarter of the anthropogenic CO₂ release is taken up by the terrestrial biosphere causing the atmospheric CO₂ to rise more slowly than predicted by human activities alone. The specific locations and the nature of this biospheric sink are yet to be determined and are the focus of continued research because of the importance of the CO₂ balance of the atmosphere on climate. If in the future the biosphere changes from a net sink for CO₂ to a net source, atmospheric CO₂ will rise much faster than the current rate, possibly leading to faster and greater climate change.

Local-scale experimental studies continue to show that biospheric processes controlling CO₂ and water vapor exchange often respond directly to the atmospheric levels of CO₂. These results imply that, as global atmospheric CO₂ concentrations continue to increase as a result of human activities, the behavior of land surfaces will change due both to the climate change associated with increased radiative forcing and to direct response of the biosphere to CO₂. This opens the possibility for complicated feed-back interaction between the biosphere and climate. The elevated CO₂ scenario has been well studied using GCMs, but only recently have LSMs attempted to incorporate plausible biospheric responses to CO₂. Sellers et al. (1996) have used such an LSM coupled to a GCM for a series of 2 × CO₂ scenarios and observed that biospheric responses to CO₂ cause changes in continental climates that are of similar magnitude to CO₂ radiative forcing effects and continental deforestation effects.

EOS contribution: The Sellers IDS team has committed much effort to developing an LSM with realistic representation of physiological control of CO₂ and water vapor fluxes from the biosphere. Two important findings to date have come from this work. First, the covariance

of the height of the atmospheric boundary layer and photosynthetic activity of the vegetation both diurnally and seasonally has important consequences for the prediction of spatial and temporal variations in atmospheric CO₂ (Denning et al. 1995). Second, the direct response of vegetation to increased atmospheric CO₂ may lead to decreases in evapotranspiration (ET) and to further surface heating beyond that caused by CO₂ radiative forcing effects alone (Sellers et al. 1996). The Sellers and Hansen IDS team members are attempting to predict the location and strength of CO₂ sinks and sources using atmospheric models together with the observed atmospheric CO₂ signal and satellite-derived measurements of vegetation cover. EOS-era land-cover products such as those associated with biospheric productivity will be used by these teams and others in conjunction with ground-based atmospheric composition data and models to identify and monitor feedback between the biosphere and atmospheric composition at regional-to-global scales.

5.2.1.4.4 How does local-scale heterogeneity in land-surface properties affect regional-to-continental climate?

Variations in the properties of vegetation and soil that affect energy and mass exchange between the land surface and the atmosphere are often measured at spatial scales of less than a meter and operate on temporal scales from less than an hour to centuries. Computational constraints as well as the lack of high-spatial-resolution global data sets limit running climate models at resolutions necessary to explicitly include fine-scale heterogeneity. The issue of spatial heterogeneity involves many aspects of model operation. Data required to initialize, force, and validate LSMs such as meteorological conditions, the parameters required by the model to characterize the land surface, and the measured fluxes are generally obtained at individual points. Climate models, on the other hand, predict regionally-averaged forcing and fluxes and require regionally-averaged parameters. Intensive field experiments such as HAPEX, FIFE, and BOREAS were designed to learn how local forcing, model parameters, and surface fluxes can be integrated up to the region.

Mesoscale atmospheric models have been used to study the impacts of surface heterogeneity on atmospheric circulation. Model and observational results show that atmospheric circulation is sensitive to the length scale of the surface patches (Avisar 1995). Model parameters associated with vegetation cover are some of the most important and most variable of those needed by LSMs (Bonan et al. 1993; Li and Avisar 1994). Vegetation cover can be measured by remote sensing of leaves, canopies, and the landscape using sensors that are hand held or mounted to towers, aircraft, and satellites, each level rep-

representing an integration of lower-scale levels of heterogeneity. Recent work has confirmed the applicability of coarse-scale satellite observation as an integrator of heterogeneity as in the amount of solar radiation absorbed by vegetation (Hall et al. 1992). Other encouraging results indicate that it should be possible to scale up from point data to the climate model grid cell using relatively simple rules based on theoretical and observational information (Noilhan and Lacarrere 1995; Sellers et al. 1995), although scaling of soil moisture and mesoscale atmospheric circulation remain problematic.

EOS contributions: Various strategies for dealing with subgrid-scale heterogeneity in global climate models are being pursued by EOS IDS teams (Barron, Lau, Dickinson, Hansen, and Sellers). In particular, Dickinson's team is studying the extent to which surface heterogeneity can affect local circulation systems that produce summer convective precipitation. The Sellers team is testing various techniques of aggregating condition and fluxes using multi-scale data obtained during FIFE and BOREAS. Some important processes controlling the interaction between land and the atmosphere have been shown to be scale-invariant and measurable with spatially-coarse satellite observations.

Certainly, an important step towards resolving issues of heterogeneity is to measure it. Several EOS instruments will provide regional and global products that will measure heterogeneity at various relevant scales. Examples include MODIS and MISR global products at 1 km or less, and the Advanced Spaceborne Thermal Emission and Reflection Radiometer (ASTER) and the Enhanced Thematic Mapper Plus (ETM+) at less than 100-m horizontal resolution. EOS measurements of parameters (vegetation type, FPAR, etc.) and state variables (such as surface temperature, clouds, etc.) at different scales will provide the information that is critically needed to address the questions of accounting for sub-grid-scale heterogeneity in climate models.

5.2.1.4.5 How do land surface-atmospheric interactions affect weather and climate at seasonal-to-annual time scales?

Improved climate forecasts have obvious economic and human welfare benefits. Agriculture and water resource planning are currently limited by currently unpredictable meteorological conditions. With better long-term forecasts mitigation strategies can be implemented far enough ahead to reduce the impact of extreme weather events. Improvement in modeling land-surface atmosphere interactions contributes not only to better long-term climate predictions, but also to better weather prediction at shorter time scales of weeks to years. Much progress has been made in extending weather forecasts with numerical models as

shown by the improved ability to predict the occurrence and intensity of El Niño events. Short-term weather forecasts (days) are more dependent on initialization and less on interaction with land surfaces. But, as forecasts extend to weeks, months, and longer, land-surface processes are expected to play a greater role, and realistic representations of land-surface processes are needed to improve these forecasts. The influence of land-surface cover on cloudiness and precipitation patterns (Avissar 1995) and the feedbacks between soil moisture and precipitation (Entekhabi 1995) are examples of how land-surface processes control weather. Recognizing the importance of land-atmosphere interactions, weather forecasting organizations (the National Aeronautics and Space Administration [NASA]-DAO, National Meteorological Center [NMC], and ECMWF) are currently working on upgrading their LSPs. Large-scale field experiments play an important role in the development of improved LSM formulations. For instance, as a result of analysis of data collected during FIFE, the soil parameterization in the ECMWF model has been improved, resulting in improved weather predictions for the central U.S. (Viterbo and Beljaars 1995). Application of remote-sensing data to parameterization and initialization of weather forecasting models is likely to greatly improve forecasting skill. Satellites can estimate state variables over land that are not available as yet globally at high-enough resolution from ground observations (precipitation, radiation, and biophysical characteristics).

EOS contributions: The availability of high-spatial-and-temporal-resolution surface and atmosphere conditions from EOS sensors will present unique opportunities for parameterization and initialization of weather forecasting models especially over land. EOS instruments will measure a number of important meteorological state variables globally at daily frequencies. Surface and top-of-the-atmosphere conditions will be supplied by MODIS, MISR, AMSR-E, and the Clouds and the Earth's Radiant Energy System (CERES). HIRDLS, SAGE III, the Atmospheric Infrared Sounder (AIRS)/Advanced Microwave Sounding Unit (AMSU)/HSB, and the Tropospheric Emission Spectrometer (TES) will provide profiles of atmospheric conditions above land surfaces. The combination of improved model formulations and assimilation of EOS data products should lead to important practical benefits associated with more-accurate longer range predictions of weather.

5.2.2 Land-hydrology science issues

Hydrologic processes must be understood within a space-time continuum (Figure 5.8), which separates natural linkages between scale and hydrologic response. While

our understanding of global hydrology will only be complete when we understand, can observe, and model hydrologic phenomena from the micro-scale to the global-scale, most land-surface hydrologic phenomena of interest in assessing impacts on humankind are below the GCM and synoptic scales, which have received the greatest scientific investigation to date. The challenge to EOS scientists is to strive to improve our hydrologic understanding at these critical human scales. Section 5.2.1.1 introduced LSMs in the context of land-climate issues and some ways EOS can contribute to their improvement. One important difference between that section and this one is that land-surface hydrology is mainly concerned with processes and events at smaller scales.

Key land-hydrology science issues of interest, particularly in the context of EOS are:

- a) the identification and quantification of key hydrologic variables across a range of scales, and
- b) the development or modification of hydrologic process models to take advantage of operational and realistic data sources.

EOS data and systems present many new opportunities for evaluating global and regional water balances on a regular and objective basis. The wide variety of previously unattainable and potentially useful data that will become available over the next decade is likely to result in significant improvements in the understanding of land-surface hydrology. However, unlike parameters described in many other sections of this report, hydrologic fluxes are not directly observable from space. Thus, another challenge to EOS scientists is to learn how to estimate these fluxes through a combination of satellite, ground, and model data. So far, the only major components of the hydrologic cycle that are estimated operationally using remotely-sensed data are precipitation (indirectly) and snow cover (directly).

The following section will address the two key science issues outlined above. This will be done by concentrating on the most important hydrologic variables and what we stand to learn from them over the next decade. Later sections will discuss the importance of estimating and validating the land-surface water balance, the significance of extreme events to hydrologic analysis, and river biogeochemistry.

5.2.2.1 Quantifying and modeling hydrologic variables
How are the key hydrologic variables distributed in space and time? How will EOS data be used to derive these variables?

FIGURE 5.8

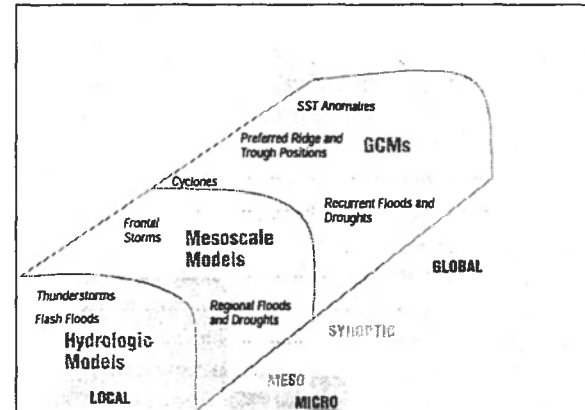

Space-time scales of interest in hydrology (Hirshboeck 1988).

The global hydrologic cycle is illustrated in Figure 5.9 (pg. 212), showing the importance of moisture transport from the oceans to the land with surface runoff and ET completing the cycle (Lau IDS homepage 1996). The continental water balance is augmented by a 36% surplus of precipitation over ET as a result of this advection. While this aspect of the general circulation is reproducible in the current generation of GCMs (Shaikh 1996), the details of how and where the land surface redistributes this excess remain to be worked out (Avisar 1995).

The primary components of the water balance at the land surface are precipitation, runoff, ET, soil-water, and ground-water storage. An energy balance is often used to derive ET from radiation, near-surface meteorology, and surface temperature. Although each of these components is closely tied to the others, they will be reviewed separately below.

5.2.2.1.1 Precipitation

How is precipitation distributed in time and space?

Importance: Precipitation is the sole mechanism by which water enters the land surface system. While rainfall is the primary form of precipitation in many regions of the world, some regions receive more than half of their precipitation in the form of winter snowfall, which significantly affects energy and mass transfers between the land surface and the atmosphere. Time delays between precipitation events and the redistribution of that water to rivers, the subsurface, and back into the atmosphere are drastically altered as well. To assess, forecast, and predict hydrologic responses, it is important to understand how the amount, rate, duration, and purity of precipitation are distributed in space and time. Such knowledge is also key to improving the specificity, accuracy, and reli-

ability of weather/climate forecasts. Precipitation climatology may come to be considered as important as are temperature anomalies in the current debate about climate change and its impact on critical human infrastructures because of those systems' sensitivity to rapid change (Shuttleworth 1996).

There are significant physical contrasts between snow- and non-snow-covered areas, but an assessment of snow properties (such as snow water equivalent [SWE] and depth) is difficult to achieve in topographically rough terrain where typical patch-length scales may be on the order of 100 m. Nonetheless, satellites have and will continue to play a significant role in the real-time monitoring of many cryospheric parameters. The frequency of abnormal weather patterns coupled with the volatility of the spring snow pack make cryospheric variables a sensitive and critical parameter in the context of hydrologic science. More details of cryospheric factors that influence the hydrological cycle can be found in Chapter 6.

Current capabilities: Until recently, data regarding rainfall and snow accumulation were obtained primarily using networks of rain gauges and snow courses. Advanced ground-based radar systems, such as the Next Generation Weather Radar (NEXRAD) Weather Surveillance Radar (WSR)-88D in the U.S. (Crum et al. 1993), now represent the state of the art in precipitation measurement, and techniques for compositing the radar data with ground-level gauge data are under development. These techniques still need improvement (Smith et al. 1996), particularly in mountainous terrains. Outside of the most-developed countries, existing and projected gauge and ground-based radar networks are unable to provide adequate coverage. For this reason satellite methods hold great promise.

EOS capabilities: Remote sensing of precipitation is a key component of Earth Science Enterprise missions such as TRMM and EOS PM-1. Several EOS sensors such as TRMM Microwave Imager (TMI), Visible Infrared Scanner (VIRS), Precipitation Radar (PR), AMSU, and AMSR have been specifically designed for the collection of data relating to precipitation and clouds. The TRMM mission, launched in 1997 and conducted in cooperation with Japan, measures the diurnal variation of precipitation in the tropics. Precipitation is measured at a spatial scale of 4.3 km using a PR (13.8 GHz) between $\pm 30^\circ\text{N}$ (220-km swath) and a 5-channel TMI (10-91 GHz, dual polarization) between $\pm 38^\circ\text{N}$ (760-km swath). Further, a 5-channel visible/infrared imaging radiometer (VIRS) provides data at a nominal 2-km resolution at nadir and 1500-km swath. The mission is expected to provide at least three years of rainfall and climatological observations for the tropics. These unique data sets will facilitate

FIGURE 5.9

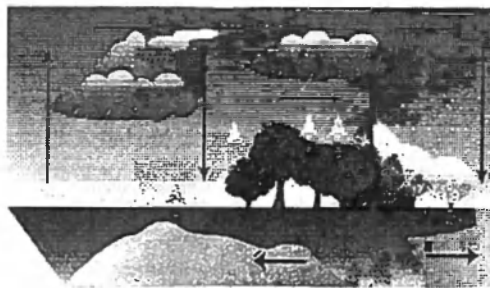

A schematic diagram of components of the global hydrologic cycle.

detailed studies of the rainfall climatology in areas dominated by the Inter-Tropical Convergence Zone (ITCZ), continental monsoons, hurricanes, and the El Niño-Southern Oscillation (ENSO) cycle. In addition, because these data will be collected simultaneously with multiple sensors they will facilitate analyses of sensor capabilities leading to improvements in the rainfall estimation techniques that employ data from the geosynchronous Special Sensor Microwave/Imager (SSM/I), the Geostationary Operational Environmental Satellite (GOES), and the NOAA series of satellites.

The EOS PM-1 mission is expected to be equipped with an AIRS (infrared sounder) and two microwave sounders (AMSU and HSB). These three instruments will, together, provide information regarding precipitation volumes, cloud thickness, and cloud water content.

IDS team contributions: Because precipitation combines and interacts with the landscape, topography, land use, and soil moisture with great variability, synoptic and climatological-scale precipitation is of little use in predicting the hydrologic response of the land. Local inferences cannot safely be drawn from regional precipitation climatologies and data sets, regardless of the methods used to build these data sets. Therefore, a top priority of several IDS teams is to investigate methods of distributing observed rainfall in both time and space.

The IDS team led by Kerr and Sorooshian has contributed to this by successfully using historical rainfall climatologies and land-surface topography to distribute subgrid-scale precipitation (Gao and Sorooshian 1994). The IDS team led by Lau is participating in rainfall algorithm development in conjunction with the TRMM mission, using both single and combined satellite sensors. The three IDS teams, led respectively by Barron, Brewer, and Dickinson, will be using the precipitation estimates provided by AMSR and AIRS/AMSU in their modeling studies. The IDS team led by Dozier has been working on estimating snow cover (Rosenthal and Dozier 1996) and

SWE (Shi and Dozier 1995) from remote-sensing data provided by Landsat, Airborne Visible-Infrared Imaging Spectrometer (AVIRIS), and Synthetic Aperture Radar (SAR); they will extend these techniques for subpixel snow mapping using MODIS and ASTER data. Several IDS teams have proposed new land validation sites in Oklahoma (Lau/Wood) and Arizona (Dickinson/Sorooshian). Further details of EOS cloud and precipitation research can be found in Chapter 2.

One area where satellite data will make a strong impact is in our ability to follow and analyze regional trends and patterns in the spatially-distributed precipitation field. How to effectively make use of these patterns is less certain although observed climatologies are likely to replace historical rainfall climatologies in the studies cited above. Another approach to disaggregation is to use climate statistics (Gong et al. 1994). The process preserves subgrid moments but is valid only for average behavior (rather than event-based behavior) and loses relevance under non-stationary (climate change) conditions. Researchers at Pennsylvania State University (PSU) are using neural nets to derive transfer functions from larger-scale circulations to local precipitation based on a 5-year data assimilation effort at Goddard Space Flight Center (GSFC). EOS must help transfer to its scientists the wealth of knowledge from ongoing programs such as the Global Precipitation Climatology Project (GPCP) and similar efforts led by WCRP and the International Geosphere-Biosphere Programme (IGBP).

5.2.2.1.2 Runoff

How will the timing and volume of runoff be affected by climate change?

Importance: Runoff is a unique basin-integrated variable and, as such, is extremely useful for validation of most land-surface modeling schemes. Runoff is a critical component of a regional water balance, the source of agricultural irrigation, many municipalities' water supplies, recreation, and a sustaining factor to the web of ecological interrelationships in wetlands. If climate were to change, the resulting shifts in the timing and volume of runoff could upset the most basic assumptions which underlie every large water diversion and storage project.

Current and EOS capabilities: Ground-based historical records of streamflow are available for almost all the world's major river systems (GRDC 1996). However, with the exception of water contained in the floodplain or in wide, shallow braided channels, it is not clear how runoff can be measured through remote sensing.

IDS team contributions: Hydrologic science has traditionally focused on the development of watershed

models that estimate the production of runoff based on measurements of precipitation. These models need, however, to be modified to function at the larger scales characteristic of LSMs. The original LSMs such as BATS (Dickinson 1995) and SiB2 (Sellers et al. 1986, 1996c) incorporated highly-simplified representations of the runoff mechanisms so as to focus on the modeling of ET feedbacks to the atmosphere. Many new land-surface schemes are currently under development that provide more-realistic representations of the runoff generation mechanisms. The IDS team led by Kerr/Sorooshian is investigating the kinematic wave overland flow, channel routing, and erosion model (KINEROS) (Woolhiser et al. 1990) for application to arid/semi-arid (A/SA) regions. The IDS team led by Barron is developing the Terrestrial Hydrology Model (THM), which includes comparison of the runoff generated by the Green-Ampt and Phillips equations, as well as kinematic wave and Muskingum channel-routing mechanisms. The IDS team led by Lau is investigating the Massachusetts Institute of Technology (MIT) hillslope model, the Princeton Terrestrial Observation Panel (TOP) and the Variable Infiltration Capacity (VIC) models, and the United States Geological Survey (USGS) Modular Modeling System (MMS). The IDS team led by Dunne is investigating how changes in climate and land use in the Amazon Basin are modifying the generation of runoff and its chemical and sediment load. These materials are then routed through the channel and valley-floor network of the basin. C. J. Vorosmarty of the IDS Moore team is assembling a Global River and Drainage Basin Archive, sponsored also by the IGBP-Biospheric Aspects of the Hydrological Cycle (BAHC) project to assemble and reproduce on CD-ROM comprehensive databases of global runoff and related hydrologic variables.

As the EOS program moves forward, the improved understanding of the interaction between land and atmosphere will lead to the development of more effective land-surface schemes with appropriate representations of the runoff processes. Newly-available, globally-consistent river networks (Oki et al. 1995) will further these improvements, particularly at the GCM scale. Much work remains to be done to find common ground between basin observations of runoff and grid (model) estimates (Arnell 1995).

5.2.2.1.3 Evapotranspiration (ET)

Importance: ET is a variable of primary interest to many end-users of hydrologic data because it represents a loss of usable water from the hydrologic supply (e.g., agriculture, natural resources, and municipalities; Miller et al. 1995). ET has an impact on plant water stress and gen-

eration of convective precipitation patterns, and is required to close both the water and energy budgets. ET is a variable of utmost importance in land-surface hydrologic models because it represents direct feedback of moisture to the atmosphere from the land surface. Consequently, evaporation demands on vegetation help limit and define the biological environment and agricultural efficiency. Vegetation adapts to climatic moisture conditions such that LAI alone is insufficient to derive stomatal controls on transpiration. In fact, several biophysical factors exert vastly different controls on the spatial and temporal variability of land-surface ET (Choudhury 1995).

Current capabilities: There are several approaches used to calculate ET. One involves analyzing combinations of remotely-sensed observations in the context of simplifying boundary assumptions. Moran et al. (1996) use a Penman-Monteith model to define a theoretical polygon or area in temperature (T_s - T_a) versus vegetation index (Normalized Difference Vegetation Index [NDVI]) space, from which fractional canopy can be estimated. Carlson et al. (1994) and Moran et al. (1994) have developed similar models. The second approach involves energy-balance modeling based on observations of radiation, near-surface and surface temperature, albedo, and even boundary-layer height (Hall et al. 1992). From these observations, ET is calculated as a residual. These calculations hold the promise of being valid over a wide range of space scales and are useful to bridge the gap between mesoscale and GCM fluxes (Noilhan and Lacarrere 1995). ET is also simulated by complex biospheric models that use satellite-derived biome class and LAI parameterizations, then are driven by regular surface meteorology data. These models compute components of the hydrologic balance—interception, evaporation, and transpiration—and can simulate land-cover change effects on hydrology (Vegetation/Ecosystem Modeling and Analysis Project [VEMAP] 1995; Hunt et al. 1996).

The issue of validation again is extremely important but difficult. Validation of ET calculations at a point can be made through direct measurements (Shuttleworth 1988). Regional-scale estimates can be validated using basin-wide rainfall-runoff measurements (Oki et al. 1995) or using calculations of moisture divergence from balloons or radiosondes (Hipps et al. 1994). Indirect validation of ET as a residual of watershed-discharge measurements is the most common validation for ET, but provides only an annual ET estimate.

EOS capabilities: While these techniques help explain observations at relatively small scales, too little verification and analysis of spatial averages and of values for individual pixels has been done. Miller et al. (1995)

noted that the full suite of environmental observations available through the Earth Observing System Data and Information System (EOSDIS) is required to advance this research. Seasonally-variable surface characteristics and thermal images from high-spectral-resolution MODIS images will be of great interest. Precipitation and atmospheric data are critical to solve the water and energy balances. Thermal emissivity from ASTER (Hook et al. 1992) and a measure of soil moisture will also be useful. The MODIS-Running team plans a simple ET estimate as an EOS PM-1 standard product. This product will compute absorbed shortwave radiation from the FPAR, albedo, and photosynthetically-active radiation (PAR) products, then assign a biome-specific energy conversion factor to complete an estimate of daily ET. This MODIS ET product will be executed at 1 km on the 8-day composite cycle planned for many MODIS land products. Although not a research-quality computation of ET, this product should have good utility for water resource management applications that need a regular ET estimate as part of hydrologic balance calculations.

IDS team contributions: Many of the IDS teams are using environmental data provided by measurement campaigns like FIFE, HAPEX, the Global Energy and Water Cycle Experiment (GEWEX) Continental-Scale International Project (GCIP), and the Atmospheric Radiation Measurement (ARM)-Southern Great Plains (SGP) to test their methods for estimation of ET. The IDS team led by Yann/Sorooshian is studying HAPEX and ARM-SGP. Estimating and making use of partial-vegetation canopy plays a critical role in the semi-arid regions they have studied (Chehbouni et al. 1995). The IDS team led by Lau is studying the Little Washita River Basin. The IDS teams led by Dickinson and Sellers, respectively, are studying FIFE and BOREAS. Dunne's IDS team is computing ET from satellite and ground-level data and will validate the calculations against streamflow and radiosonde data over the Amazon River Basin. In the Susquehanna River Basin, Gillies and Carlson (1995) found that 90% of the variance in surface ET can be explained by spatial variations in fractional cover and surface moisture availability. This suggests that the distribution of surface energy fluxes is insensitive to the distribution of root zone soil water, although their magnitudes might be closely related. Other teams (Dickinson, Barron, and Lau) are planning to use their advanced LSMs coupled with GCMs or mesoscale models to obtain diagnostic analyses of the water-vapor hydrology at the regional and global scale. E. Wood of the IDS Lau team will test the MODIS-derived ET estimate being produced by the MODIS Land (MODLAND)-Running team over the GCIP study area.

5.2.2.1.4 Near-surface soil moisture

How will soil moisture be represented in EOS-era hydrologic models?

Importance: Soil moisture is a critical hydrologic parameter that partitions energy between sensible and latent heat fluxes, and that partitions rainfall between runoff and root-zone storage. Despite its importance, three factors limit its use in most hydrologic models. First, near-surface soil moisture changes more quickly than deeper soil moisture, which makes inferring general soil wetness difficult from surface observations alone. Second, soil moisture exhibits considerable variability in time and space. The importance of soil and soil moisture heterogeneity is unclear but must have some scale-dependent properties (Vinnikov et al. 1996). Third, until now, soil moisture has not been consistently observed at time and space scales useful to large and mesoscale models. The GEWEX Global Soil Wetness Project Report (Sellers et al. 1995) summarizes this issue by stating: "The practical result of this is that soil moisture has not been treated as a measurable variable in any of our current hydrologic, climatic, agricultural, or biogeochemical models." This situation is frustrating since the prospect for successfully applying microwave techniques to surface soil-moisture detection, at least across areas of minimal canopy cover, is good.

Current capabilities: There are few, mainly local, soil-moisture monitoring networks. Some idea of what continental-scale patterns show can be found in historical data from the Former Soviet Union (Robock et al. 1995) but this network has largely broken down. Other networks exist or are being developed in Illinois (Kunkel 1990) and Oklahoma (ARM-SGP site).

There are two basic microwave approaches; one is based on passive radiometry, the other on active radar. Both approaches utilize the large contrast between the dielectric constant of dry soil and water. There are major differences between these two systems in terms of spatial resolution, swath width, data rate, and power requirements. However, in almost every case, these two systems are complementary in that strengths in one are matched with weaknesses in the other (Kerr and Jackson 1993). NASA-sponsored aircraft studies of soil moisture have been invaluable to assess the potential of remote detection of soil moisture (Schmugge et al. 1994) but various engineering issues have limited the deployment of L-band radars in space.

Today's microwave efforts rely on the heritage of the Scanning Multichannel Microwave Radiometer (SMMR) and SSM/I radiometer programs, the focus of which was on oceanographic and cryospheric problems

because of existing technology and lower frequency cut-offs of 5.6 GHz and 19 GHz, respectively. Currently, operating satellites include the SSM/I (K-band), the European Remote-sensing Satellite-1 (ERS-1) and the Japanese Earth Remote-sensing Satellite-1 (JERS-1) (C-band), and (Radar Satellite) Radarsat (C-band) systems. Like earlier efforts, only limited resources are being applied to soil-moisture studies using these non-optimal frequencies (Kerr and Njoku 1990; Kerr 1991). Numerous studies have attempted to relate K-band passive microwave radiometer signals to soil moisture, but the physical basis for this is tenuous with most of the signal coming from surface roughness and vegetation. An optimal satellite mission would consist of a multi-polarization L-band radiometer having a 25-km instantaneous field of view (IFOV) and would focus on areas of little or no canopy cover (LeVine 1996).

Without direct satellite observations of soil moisture, options are limited for generating a map of this variable. Many current models approach this problem by setting relatively dry initial conditions and then letting the value follow the model without any real constraints. Satellite data can be used indirectly by looking for cool spots or thermal inertia anomalies in thermal infrared (TIR) data, tracking clouds associated with precipitation, or assuming that as the vegetation index increases, soil moisture stress decreases. Finally, limited ground data, soil maps, satellite data, and model simulations can be combined into an assimilated product. These alternative approaches might prove to be more useful in that the emphasis is on soil water availability rather than surface wetness, which is more closely tied to plant and atmospheric demand.

EOS capabilities: A scaled-back EOS program has missed the opportunity to launch an active microwave soil-moisture sensor, but there are many secondary strategies being pursued to estimate this critical state variable. Current space-based efforts focus on promoting both conventional and experimental (such as inflatable antennas) L-band radiometers under NASA's Small Satellite and New Millennium Programs, developing algorithms to assimilate mixed polarization and multi-sensor signals, and improved representation of soil moisture in LSMs of sub-humid regions across a variety of scales.

IDS team contributions: Almost every IDS team has proposals to produce soil moisture products, most notably the GSFC Data Assimilation System (DAS), which proposes to produce a 3-hour, 1-degree, and 3-level (shallow, root, and deep) product based on a hydrologic balance model. Other approaches to this problem include soil-moisture nudging of global forecast models (Mahfouf

1991; Bouttier et al. 1993), assimilation of model and satellite microwave data (Houser 1996), and the application of crop-soil models (Maas et al. 1992).

Because of the difficulty of soil moisture measurement, and the important role played by soil moisture in land-surface hydrology, most of the IDS teams studying land-atmosphere interactions are using advanced LSMs instead of a bucket model as the land-surface interface with their climate models. In this way, soil moisture is actively linked with the overlying atmosphere, and the water balance is maintained (note that in the original bucket model, prescribed soil-moisture levels provided unlimited water to the atmosphere). In this regard, the IDS team led by Dickinson is studying appropriate treatments of land-surface parameters to improve calculations of the soil moisture. The IDS team led by Lau is working on a statistical description of soil-moisture distribution at the subgrid scale. The IDS team led by Yann/Sorooshian is investigating soil-moisture measurement in the A/SA regions using remote-sensing data. The IDS team led by Dunne intends to map the inundated areas of the Amazon River Basin with passive microwave imagery and to couple these measurements with routing models to account for the spatial distribution of the stored water within geomorphically-distinct reaches of the valley floor. Koster (1996) has developed a standard model that allows all but the most disparate soil-moisture schemes to be compared.

A major issue that requires further consideration deals with validation. The NASA Soil Moisture Workshop (1994) found that "the potential ease with which remote-sensing instruments can estimate the large-scale distribution of soil moisture is attractive (in sub-humid regions); the difficulty lies in validating such maps and relating them to subpixel distributions and profiles of field soil moisture," particularly in the root zone. At intermediate space-time scales, Washburne and Shuttleworth (1996) are evaluating the similarities between area-averaged soil moisture across central Oklahoma based on soil-moisture sensor data from the Department of Energy's (DOE's) Atmospheric Radiation Measurement program and forecast data from NMC's Eta-model. Other potential validation data sets include a new network of monthly gravimetric data collected by students under the guidance of EOS-affiliated scientists as part of the Global Learning and Observations to Benefit the Earth (GLOBE) program.

5.2.2.1.5 Infiltration and deep percolation

How much water is lost to long-term storage?

Importance: Arid-region ephemeral streams are characterized by large channel losses, and many coarse Quaternary deposits are active recharge zones. Beyond the scope of this discussion is the general problem of groundwater recharge (representing a significant store of fresh water) but its time constant of change is often decades if not centuries.

Current capabilities: Of primary importance to issues of infiltration and soil storage are knowledge of soil texture and soil depth. The pioneering and comprehensive work of FAO (1978) to define a global soil-classification scheme and produce a global soil map are reflected in the almost exclusive use of their base maps for producing most current soil products. The original FAO map units have been rendered more usable to the modeling community (but not more accurate) by reclassification and gridding (to $1^\circ \times 1^\circ$) as part of ISLSCP's Initiative I (Sellers et al. 1995d). An example of this product is given for soil depth, Figure 5.10. The main limitations of this product are the assumptions constraining the soil units, a lack of quality control, and low spatial resolution. Its advantages are that it is the only global product of its kind and maintains some uniformity in classification and relative accuracy. There are several active programs to develop the next generation of soil survey products, most notably by the IGBP Soils task force.

EOS contributions: The role EOS will play in this area is not clear. Satellite and ground-based studies of riparian-zone water and energy balances may improve our understanding of some recharge issues, particularly in conjunction with a focused effort to quantify other energy and water fluxes, as has been proposed for the Semi-Arid Land-Surface-Atmosphere (SALSA) Experiment (Wallace 1995). Supporting comprehensive and uniform soil and soil-property mapping is one activity that will benefit the hydrologic community.

5.2.2.1.6 Radiation

How well can we predict surface radiation fields, especially under partly cloudy and hazy (smokey) conditions?

Importance: The spatial and temporal distribution of solar radiation is a primary variable for atmospheric and vegetation systems. Accurate knowledge of these systems is required by energy balance models which complement direct hydrologic reckoning and are mandatory for 4DDA techniques. One of the greatest current uncertainties is with regard to atmospheric radiative transfer, particularly

the effect of aerosols and multiple cloud layers (McCormick et al. 1995; Penner et al. 1992). In addition, fractional cloud cover represents a significant, scale-dependent problem related to the surface-energy budget and hence the important question of cloud-climate radiation feedback. Many of these issues have been addressed in Chapter 2, but the importance of this issue for land-surface studies must be stressed.

Current capabilities: Two approaches to calculating shortwave fluxes are common (Wielicki et al. 1996). The first involves using a global network of surface stations (Global Energy Balance Archive [GEBA], and Baseline Surface Radiation Network [BSRN]) to adjust simultaneously-observed TOA and surface fluxes. The second involves applying an atmospheric radiative transfer model to observed cloud and TOA fields. Considerable progress has been made in estimating near-surface radiation as an outgrowth of the NASA ERBE, the NOAA GOES program, and the GEWEX ISCCP. Current methodologies for estimating surface shortwave radiation involve sampling the mean and standard deviation of multiple 8-km pixels, applying a cloud filter and 2-stream atmospheric correction to give a product at 50-km and 3-hour resolution (Pinker et al. 1994).

EOS capabilities: Knowledge of the spatial and temporal distribution of radiation will be greatly improved as a result of EOS. While the need for global coverage mandates typical resolutions of 25 km and greater (achieved by CERES), MODIS has the potential for supplying higher-spatial-resolution data on a limited basis. Four observations per day will be achievable, given the deployment of both EOS AM-1 and PM-1, and are required to define the important diurnal component of radiation, cloud, and precipitation fields. This should be considered marginal, and considerable attention and resources must be focused on the use of data from non-EOS geostationary satellites to supplement this information.

Shortwave radiation accuracies of 5 Wm^{-2} should be achievable from the EOS CERES sensor. While larger than estimated climate forcings, they are helpful in light of larger inconsistencies among current GCMs (see Chapter 2). Much better spatial resolution of the general atmospheric models will be possible using the CERES and AIRS sensors. Improved knowledge of bidirectional surface reflectance from MISR will further refine future estimates of net shortwave radiation.

Considerable work needs to be done to improve satellite estimates of the surface net longwave flux. Longwave radiation accuracies of 20 Wm^{-2} or less should be achievable using EOS sensors. Errors are greatly influenced by variable patterns of low-level water vapor and cloud-base heights, which are difficult to obtain from

FIGURE 5.10

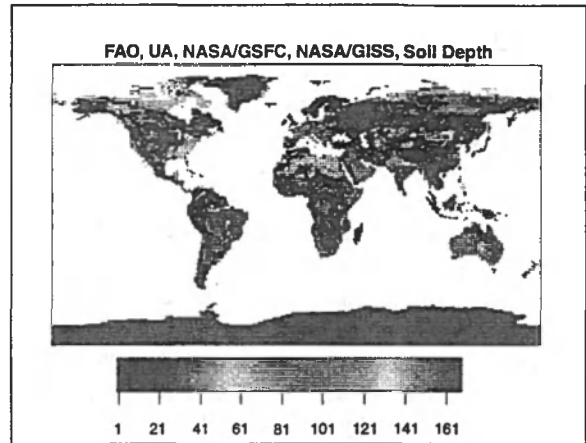

A global database of soil depth. This $1^\circ \times 1^\circ$ data set, developed by the ISLSCP Initiative 1 project, is used in global climate, hydrologic, and biogeochemical modeling (Sellers et al. 1996).

space. Again, the AIRS/Humidity Sounder Brazil (HSB) should prove valuable, as well as ASTER to determine longwave surface emissivities (Hook et al. 1992).

IDS team contributions: Observation strategies for determining fractional cloudiness are an important component of the ARM-SGP (Stokes and Schwartz 1994) and Pennsylvania State University (PSU) IDS efforts, using a variety of instruments. Models which realistically simulate continental temperatures of both the annual and diurnal cycle are planned, given adequate observations, where this level of accuracy is still under investigation. Cloud properties will be mapped at scales of 25 km at several atmospheric levels by CERES in support of many IDS investigations. Some studies have shown that no significant spatial variability is discernible below this scale (Pinker and Laszlo 1992) although some researchers find a 250-m scale more valuable for detailed radiation studies (Dubayah 1992).

5.2.2.1.7 Near-surface meteorology

Importance: Near-surface air temperature, humidity, and wind speed are pivotal parameters in many energy balance and satellite flux models, yet relatively little attention has been given to defining regional and local verification data sets for these variables, which vary significantly in space and time. Typical hydrometeorologic applications such as calculating sensible heat flux, estimating partial canopy fraction, and crop stress all depend on being able to calculate the difference between surface and air temperature. Algorithms developed over oceans, which estimate these parameters, cannot be used; land-surface

estimates must rely on the assimilation of ground data and forecast or mesoscale model data. This realistically limits spatial resolutions to 10-50 km with temporal resolutions of 1-3 hours. In some terrains, this may be adequate, but use of these data in mountainous or highly dissected or heterogeneous areas will significantly limit the use of these methods (Li and Avissar 1994).

Current capabilities: Many process-based model studies make an assumption of uniform driving fields across relatively small areas or adjust meteorology using linear adiabatic assumptions. Across larger areas, radiation can be distributed using common geographic adjustments, but atmospheric correction and cloudiness are, at best, often based on a single radiosonde sounding. This approach was taken by Rahman et al. (1996) in conjunction with satellite-derived land-surface characteristics and a Digital Elevation Model (DEM). Another approach is to use a 30-to-50-km gridded forecast meteorological model to drive a distributed hydrologic model. These data are readily available but must be applied judiciously. An effort is currently under way to compare a year of surface model output from NMC's Eta model with area-average fluxes observed over the ARM-SGP site (Washburne and Shuttleworth 1996). Using a nested mesoscale model to drive regional process models is the next level of sophistication but usually requires a major modeling effort.

EOS capabilities: Direct observation of near-surface continental meteorology from space is unlikely in the near future. EOSDIS can play a significant role in this area by making non-EOS data sets (global and regional meteorology assimilations) readily available and by helping to translate data into appropriate EOS formats. Well-defined data standards and a clear appreciation for the critical need these data play in hydrologic modeling are minimum requirements for the EOSDIS system in this area.

IDS team contributions: Application of nested models falls neatly into the overall mission of the Barron IDS, but their effort is likely to be focused on regional areas of interest. The Rood IDS team and the DAO will produce the most basic assimilated data set of surface meteorology for land science application. This 6-hour, near-real-time production of land-surface incident radiation, temperature, precipitation, and humidity will be useful to many hydrology and vegetation models. For many purposes, especially regional calculations, the $2^\circ \times 2^\circ$ gridded data set from the DAO will need to be disaggregated to finer spatial detail using a DEM and appropriate meso- and micro-climate models. The VEMAP ecosystem modeling activity for the continental U.S. illustrates how gridded global climate data sets can

be enhanced for simulations with finer spatial detail data. (VEMAP 1995).

5.2.2.2 *Estimating and validating the land-surface water balance*

How do changes in the water balance feed back and influence the climate and biosphere? How will EOS help monitor these changes? How will we validate models of these changes?

Regional water balances are poorly known in all but a few countries in temperate regions. Major uncertainties regarding the validity of GCM outputs arise because of the sparse nature of rain-gauge, stream-gauge, and other hydrologic data sets. Not only are the day-to-day issues important, but hydrologists must address questions posed by longer-term hydrologic variability and gauge the nuances posed by questions of natural and anthropogenic causes of these events. Additional questions arise because of uncertain model calibrations and the necessity of spatial averaging over large areas. Seasonal and inter-annual storage of moisture in snow packs, soils, groundwater bodies, and large surface water bodies further complicates the picture in ways that are scientifically and societally important, but the paucity of data on these large-scale storage elements continues to degrade modeling computations and predictions of the behavior of regional water resources. The resulting uncertainty in quantification of regional water balances affects calculation of:

- 1) regional evaporation fields,
- 2) land-atmosphere feedback on drought formation,
- 3) the role of antecedent moisture in the flooding of continental-scale rivers, and
- 4) the timing of snowmelt runoff and dry-weather water supply in response to climate change.

Various programs have been proposed to validate both remote sensing data and model fields derived from EOS products. This effort must be international and span a wide range of climates and biomes, and it must be a long-term effort to maintain a strong level of confidence in the data sets.

5.2.2.3 *Extreme hydrologic events*

What changes in the surface water budget may occur with climate change? Will the frequency and magnitude of extreme hydrologic events change? In which direction will the change be, and what effects will it produce?

5.2.2.3.1 Introduction

Like many water resources issues, extreme hydrologic events cover a wide range of spatial and temporal scales. These events can be characterized as instantaneous localized events such as flash floods, hurricanes, and heavy precipitation, or long-duration widespread events such as general floods and droughts. In both cases, extreme hydrologic events can cause significant economic losses as well as social and environmental stresses.

For the past 50 years, scientists have studied extreme hydrologic events, mostly within a probabilistic framework. Numerous reports and studies can be found in the literature regarding the identification, use, and limitations of probability density functions describing the frequency and magnitude of floods and droughts. The apparent increase over the past decade of the frequency and magnitude of extreme hydrologic events is fostering a growing interest in quantifying more process-based relationships between these frequencies and climate variability and climate change.

Many of the analyses concerning the hydrologic impacts of climate variability and long-term climate change are speculative and qualitative; however, quantitative assessments of the second-order social, environmental, and economical impacts are possible at various spatial and temporal scales (AIP 1993). What is more important is the fact that flood levee systems, reservoirs, and water distribution systems have been designed to balance reliability with demand on the basis of historical hydrologic data. In most cases, the design paradigm assumes a stationary climate system in which the point probability of occurrence for extreme events does not change. It is quite possible that the potential water resources impacts from climate change and variability can be significant at local-to-regional scales while larger-scale phenomena and averages remain. Environmental impact models that are unable to transform realistically global average results to local scales will only confuse the public's perception of the issues. These and other topics have been addressed in recent years by several National Research Council (NRC) research reports on estimating extreme hydrological events; for example, NRC (1988) on flood risk estimation, and NRC (1994) on extreme precipitation.

Predicting how hydrologic extreme events may change is very speculative. More severe floods and a change in the distribution and timing of spring snowmelt have been suggested as likely effects of CO₂ doubling that would have significant human impact. At best, GCMs can be used to indicate how the hydrological and meteorological processes may change if global warming takes

place. Macroscale heterogeneity can impede the reliability of regional- and global-scale predictions for localized studies of extreme hydrologic events because of the existing gaps in the spatial resolutions of GCM, mesoscale, and macroscale hydrologic models. Bridging these gaps will result in gains on several fronts, including 1) improving the ability to extend the forecasting lead time, 2) improved understanding of the causes and conditions underlying extreme events, and 3) improving the ability to predict the impacts of climate variability on the frequency and magnitude of extreme events.

Three potential impacts are considered below: increased incidence of severe storms, increased snowmelt-based floods due to rain on snow, and decreased precipitation leading to increased drought.

5.2.2.3.2 Severe storms

Will the frequency and intensity of hurricane and severe storms change?

Importance: Hurricanes, tornadoes, hail, and lightning storms can be highly destructive in an urban environment. Loss of lives, severe erosion, wind damage, flooding, crop damage, road and power grid disruption are all common human consequences of these storms. If we focus only on hurricanes, the intensity of a given storm determines its potential for destruction, while the actual amount of damage depends on the density of development, the population, and the economic interests in the impacted coastal areas. Clearly, the increasing urbanization of coastal areas around the world will only intensify the importance of severe cyclonic storms. Additionally, the highly-nonlinear relationship between the wind speed of hurricanes and their potential for destruction indicates that even a minor change in hurricane intensity and frequency can lead to significant increases in damage. The potential for human impact by an especially vigorous tropical storm environment was well documented in the millions of dollars in damage and dislocations as a result of the 1995 storm season along the southeast coast of the U.S. (Figure 5.11, pg. 220, from WPX homepage: <http://thunder.atms.purdue.edu>).

Current capabilities: Presently, the spatial resolution of most GCMs cannot accommodate detailed simulation of hurricanes. GCMs can be used to evaluate the impacts of climate-change scenarios on the tropical disturbances leading to the occurrence of hurricanes. For example, Emanuel (1987) suggests that as sea-surface temperatures (SSTs) rise in doubled CO₂ scenarios, tropical cyclones intensify and winds increase. He reports that a 3°C SST increase would result in a 30-40% increase in

FIGURE 5.11

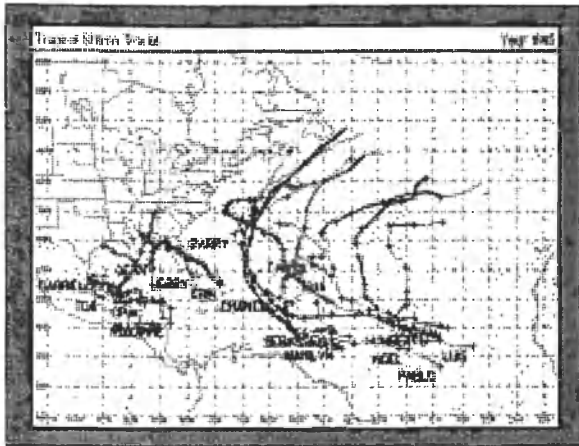

Tropical storm tracks as observed along the southeast coast of the United States in 1995.

the maximum pressure drop and 15-20% increase in wind speeds. In another study, Haarsma et al. (1992) reported an increase in the number of tropical disturbances under the doubled CO₂ scenario. In general, there is considerable potential for research to better understand the impact of climate change and variability on the frequency and magnitudes of severe storms and hurricanes.

EOS capabilities: EOS instruments such as MODIS will provide high-resolution spatial coverage of SST and higher-level products, such as pressure. Further understanding of the land-surface-ocean processes is also expected to provide insights into the processes associated with the occurrence of severe storms. Recent studies indicate a good correlation between hurricane intensities determined via SSM/I and remotely-sensed SST observed a day earlier; such studies are in their early stages. Further improvements are possible in the forecasting of mid-range tropical cyclones using remotely-sensed outgoing longwave radiation.

5.2.2.3.3 Floods

Will the frequency and magnitude of floods change due to global change? In what direction will the change be, and how will water resources management and infrastructure change or be affected?

Importance: The main difference between flash floods and general floods is in their spatial coverage and temporal duration. Floods may occur due to various combinations of extreme conditions. For example, rain on snow combined with relatively mild ambient temperature accelerates melting. This is one of the primary

processes causing early spring flooding in snowy regions. Other processes such as above-normal winter precipitation which leads to soil saturation followed by early-to-mid-spring heavy rainfall can cause both types of floods. Severe convective storms also cause localized flash floods. Floods such as the Great Flood of 1993 on the Mississippi River can produce a substantial amount of damage. Adding to the economic loss from floodplain agriculture are environmental damages due to severe erosion and overbank deposition.

A definitive assessment of the hydrologic impacts of climate change has yet to be made but many scenarios have been analyzed. Changes in flood frequencies and magnitudes can result from a combination of the hydrologic impacts of climate change as well as from land-use changes and direct anthropogenic factors. Dracup and Kendall (1991) argued that operational policies that require maintaining water in reservoir systems at maximum levels and physical encroachment into the floodplains have contributed to the higher flood stages in the Colorado River. The critical issue of separating impacts of climate variability and those resulting from anthropogenic factors on flood frequency and magnitude must be addressed. This is made even more difficult because of the possible changes in anthropogenic conditions as a response to climate change.

Current capabilities: River runoff is likely to increase as a result of global warming (Revelle and Waggoner 1983). Lettenmaier and Gan (1990) and Running and Nemani (1991) determined that climate change due to global warming would lead to earlier snow melting in the western U.S. and more-frequent rain-on-snow events. Hughes et al. (1993) analyzed two basins in Washington State and showed that for basins in which the floods were snowmelt-dominated, global warming would increase the magnitude of low-occurrence floods, and, for the basin in which floods are rain-dominated, there would be a decrease in magnitude of extreme events. Concerning increases in convective rainfall, which leads to severe local flooding, much of the arguments for increased severity for hurricanes can be used for thunderstorms; i.e., increased heating of the land surface would increase lifting and convergence of moisture and increased storm severity.

EOS capabilities: A primary challenge in the years to come will be to use EOS-era science and data to help furnish the contextual information that will help hydrologists analyze not only the flood event but the global and regional influences behind it. In the arena of predictive advances, we must take a more-cautious approach. As often mentioned, there is a fundamental discontinuity in the predictive capability of GCMs below the length and

time scales of synoptic meteorology, such that important seasonal weather patterns can be resolved, but the watershed and date-specific circumstances that combine in local hydrologic events remain indiscernible. Thus, an important challenge in the years to come will be to take EOS data and model improvements and relate these to issues of particular urgency such as hazard assessment and water resources planning. Whereas anomalous atmospheric circulation patterns can be linked to certain catastrophic floods (Hirschboeck 1988) and the large-scale atmospheric motion is reasonably defined by contemporary GCMs (Barron 1995), it is a much different and difficult task to go from the synthesis of model and observation we will have to the discrete type of events most hydrologists are used to working with. Yet the need for improved climate models and LSPs is real and will undoubtedly advance our ability to better understand and prepare for hydrologic hazards.

5.2.2.3.4 Floodplains

How do floods spread into the complex, low-amplitude topography of alluvial lowlands, such as floodplains, deltas, and other large swamps?

Importance: Inundation of vast alluvial lowlands is a complex process involving local generation of runoff from rainfall or snowmelt, flow from the surrounding highlands, overbank spilling along floodplain channels, and tidal and storm influences near coastlines. The interplay of these processes depends upon the timing of hydrologic events and their alteration by engineered structures. A contributing factor is the intricate geometry of the lowlands themselves, composed of tidal channels, levees, distributory channels, scroll bars, and floodplain lakes.

Current capabilities: Predicting areas of inundation is limited by inaccuracies of hydrologic routing in areas of low relief and by poor spatial resolution of precipitation data.

EOS contributions: These difficulties are being reduced by improved computer models and especially by new satellite information on the extent of inundation. The Soares/Dunne IDS team, studying the Amazon River Basin, is mapping inundation using passive microwave sensors (SMMR and SSM/I), SAR, Landsat Thematic Mapper (TM), and it is exploring the use of AVHRR data. The spatial and temporal patterns of inundation are exceedingly complex because they depend not only on runoff generation but also on subtle details of floodplain topography. These empirical studies to document inundation are combined with model-based investigations of channel-floodplain interactions during floods and the influence of climate and land cover up stream. Significant progress

on this topic will allow hydrologists to study the formation of large floods using space technology and eventually to issue gradually-updated forecasts of where inundation is likely. Satellite altimetry of water surfaces in extensive inundation areas can also assist with understanding the spread of floodwaters and the calibration of hydrodynamical models in other complex flood-prone areas.

5.2.2.3.5 Droughts

Droughts are characterized by their duration and severity. It is unclear how climate change will affect precipitation. Early GCM simulations (Delworth and Manabe 1988) implied that global warming would result in decreases in precipitation and soil wetness, especially in the central portion of large continents. These results must be viewed with extreme caution for two reasons. One, early GCMs had a poor representation of land-surface hydrological processes. It is well known that the lack of vegetation interception storage underestimates land-surface evaporation, thus reducing GCM rainfall (Scott et al. 1996), and a similar argument can be made for single-storage soil-column representations, which lack a surface thin layer that can enhance re-evaporation. The second reason for caution is the generally poor ability of GCMs to reproduce current climate at local-to-regional scales. The characteristics of rain storm and interstorm durations are critical to soil dryness and whether drought occurs. Palmer (1986) reported a strong relationship between global patterns of SST anomalies and drought frequency in the Sahel region.

5.2.2.3.6 The causes of extreme events

More research is required to understand the source of the major weather patterns that lead to floods, droughts, blizzards, tornadoes, and hurricanes (Loaiciga et al. 1996). Teleconnections between widespread hydrologic phenomena, of which ENSO is the most common example, are better left for discussion in Chapters 2 and 3, whose focus is more global, but EOS will make significant contributions to our understanding of these events and how well we monitor them. Anthropogenic influences on the timing or strength of seasonal and longer climate variability are presently speculative but are surely having an effect. More pertinent to this section and chapter is the need to better understand the ties between land-use change and drought, particularly as characterized by reports from the Sahel of Africa. The hope for EOS is that an objective and comprehensive global record of climate and land-sur-

face response will better allow us to discern the causes and effects of critical hydrologic phenomena.

5.2.2.4 River biogeochemistry

What is the role of river biogeochemistry in the Earth system and in affecting water quality and the functioning of aquatic ecosystems?

Importance: An underdeveloped aspect of continental hydrology, but one which is extremely important for understanding both the habitability of valley floors and the ecology and biogeochemistry of wetland and aquatic ecosystems, is the relationship between the regional-scale hydrology of continental-scale watersheds and the flux of water and mobile terrestrial materials (organic and inorganic sediment and solutes) along river networks and into valley floors. These fluxes determine the nutrient loading of river water. The resulting in-channel processing of nutrients causes sedimentation problems, but is also responsible for constructing floodplains and maintaining the biogeochemistry of the associated wetlands. The frequency and duration of flooding affect the oxidation state of the wetlands, and therefore the partitioning of carbon into CO_2 , CH_4 , and stored particulate forms, with associated effects on the mobility of other nutrients. The rate and form of sedimentation, produced by the basin hydrology and sediment supply, control the nature of floodplain geomorphology, channel shifting, the formation and connection to the river of the various river water bodies, and various engineering problems associated with maintaining the habitability of valley floors. An important task for regional hydrology involves understanding the controls on the flux, processing, and disposition of these mobile terrestrial materials in order to predict their response to large-scale environmental change within continental drainage basins.

The river corridors of a region accumulate the runoff that is the excess of precipitation over ET on the surrounding continental surface. The annual distribution of flow in large rivers is determined by the seasonal variability of the land-surface water balance, transit times, and storage within soils, ground water, and valley floors. Large rivers receive water from source areas with diverse climatology and other hydrologic characteristics, generating extended periods of high runoff that support vast wetlands in the lowlands of the continental-scale river basins. Wetlands may be associated with flowing water, such as river floodplains, or they may be located in areas of low-permeability soils or of constricted drainage on gentle topography.

The Amazon basin, for instance, is a region dominated by the abundance of water. This abundance is evident

in the extensive river and its vast associated areas of periodically inundated land. Junk and Furch (1993) estimate that the floodplain of the Amazon main-stem and primary tributaries covers about 300,000 km^2 , whereas riparian zones of small rivers may cover about 1 million km^2 . Furthermore, savannas exposed to overland flow may account for another 40,000-250,000 km^2 . That is, approximately 15-30% of the area of the basin is subject to periodic saturation and inundation. These periodically or permanently flooded areas play important roles in the hydrology and biogeochemistry of the basin. Because the poorly drained areas often receive transfers of water and materials from nearby and upstream areas, they are subject to indirect impacts as the uplands undergo development. Many of the inundated areas support productive ecosystems including resources such as timber and fish, which are then subject to impacts from the changes which alter the volumes, sediment loads, and chemistry of the regional runoff. The biogeochemistry of these wetlands is driven by the extent, duration, and intensity of their inundation. When saturated, they support anaerobic conditions where microbiological activities such as methane production and denitrification prevail. Hence, an accurate estimate of gas exchange between the land and the atmosphere must consider the vast saturated and flooded regions of river lowlands. In addition, these areas frequently sequester organic carbon and nutrients from the upland environments.

The challenge of global- and continental-scale river biogeochemistry in the EOS program is to link the flow of water through the landscape and down river channels to the ecological and chemical attributes of basins at scales much larger than the relatively-small watersheds that are typically studied. The capability to predict how changes in drainage basins will impact river systems and coastal seas in different parts of the globe can be developed from use of large-scale river models of how changes in land-surface processes will be reflected in the down-river transport and processing of elements and the ultimate marine fate of river-borne materials.

An important task is to collate and check the widespread under-used ground-level data sets on these components of the surface water balance and to interpret them in the context of physics-based mathematical models that accurately represent large-scale hydrologic processes in a way that can be checked against available data such as: stream-flow measurements, satellite-based mapping of inundated areas, and the seasonal condition of vegetation.

Current capabilities: Current predictions of river biogeochemistry involve empirical models of the loading of sediment and nutrients from watershed areas in vari-

ous natural and distributed conditions, and the alteration of these materials during river transport.

EOS capabilities: The availability of satellite information on land-surface characteristics that control the energy and material balances of watersheds holds the possibility of linking large-scale models of hydrology and of primary production and nutrient mobilization, such as the Carnegie-Ames-Stanford Approach (CASA) and Biome-BGC models, over continental-scale watersheds to predict the biogeochemistry of large river basins. Both the IDS Soares/Dunne and IDS Moore teams are specifically working on continental-scale hydrogeochemistry models.

5.2.3 Land-vegetation science issues

5.2.3.1 The role of EOS in global change studies of vegetation

Vegetation responds to climate at virtually all space and time scales. Photosynthetic activity of a leaf changes within seconds when a cloud blocks direct solar illumination. Daily variations in temperature control the CO₂ balance between photosynthesis, respiration, and soil decomposition. The spring-time growth of vegetation is clearly visible continentally by time sequences of NDVI. Interannual variability in atmospheric CO₂ concentrations illustrates that the terrestrial biospheric activity shows high geographic and seasonal dynamics. At decadal time scales land-cover changes, predominantly human-induced, cause measurable changes in terrestrial biogeochemistry.

EOS science questions encompass regional-to-global scales, from the carbon balance of the boreal forest to biospheric net primary production (NPP). The short time scale of vegetation responses to climate considered by EOS will range from following interannual variability in spring phenology, to seasonal changes in daily terrestrial surface CO₂ balance and other greenhouse gas fluxes, to annual NPP and interannual climate-driven variability in NPP. Over multiple years, terrestrial vegetation responds to changing climate with changes in density, which will be quantified as changes in LAI. The most permanent change in vegetation occurs by land-cover change, when one biome type is replaced by another. For example, if climatic warming proceeds, the alpine forest timberline may encroach upon mountain tundra. However, these changes take many decades to occur. The fastest and least predictable changes in global vegetation are caused by direct human activity—cutting forests, draining wetlands, irrigating deserts. EOS has measurements planned to evaluate the terrestrial biosphere at all of these space/time scales.

This section will first cover plans for EOS monitoring of directly-observable vegetation variables, primarily land cover, and land-cover change. Next, derivable biophysical variables, such as LAI, FPAR, albedo, and vegetation indices will be described. Finally the most complex Level 4 products require integration of EOS satellite data with ancillary data to drive biospheric simulation models. These models will produce global estimates of NPP and ET.

5.2.3.2 Land cover

Land cover is the initial variable for parameterizing terrestrial vegetation in virtually all GCM and biospheric models. Land cover does not quantify the vegetation as LAI or biomass does. It only provides a descriptive definition of the biome type present at a given location. The accuracy of global land-cover mapping influences all other biospheric process calculations. Furthermore, the accurate detection of temporal change is one of the most fundamental measures of global change. Ecologically, change in land cover from one biome to another signals the most permanent type of vegetation change, and naturally requires decades to occur. The human-caused changes in land cover, termed land use, are now occurring much faster, and are more relevant to change detection than natural causation. Despite the importance of land cover, it has been poorly quantified (Townshend et al. 1991) and poorly defined (Running et al. 1995) until recently. Nemani and Running (1995) have now estimated from AVHRR 8-km data forest cover of 52.3 million km². They also reported 40% of temperate forests have now been converted to other uses, but only 26% of tropical and 20% of boreal forest land has been cut. These are the first global completely satellite-derived estimates of global deforestation rates.

EOS contribution: Mapping of existing land cover requires satellite data, and a global 8-km current land-cover product from AVHRR is now available (Figure 5.12, pg. 224, Nemani and Running 1995). DeFries et al. (1995) and Nemani and Running (1995) are exploring advanced logic for discriminating biomes with a combination of spectral vegetation indices and surface-temperature thresholds. These groups plan the first full 1-km global land-cover analysis with completion of the AVHRR 1-km Pathfinder data set in 1996. The EOS AM-1 at-launch land-cover product will be derived from 1997 1-km AVHRR data. After launch, the first MODIS-derived 1-km global land cover product will be complete in one year, as an important discrimination criterion for land cover is differences in seasonality of Visible (VIS)/Near Infrared (NIR) spectral reflectances. More-accurate land-cover mapping will be possible as bidirectional reflectance

distribution functions (BRDFs) from MISR are integrated with the MODIS land-cover product. This advanced land-cover product should first be available around 2000 (Lambin and Strahler 1994). Townshend (1996) will produce a MODIS-derived land-cover-change product specifically with the 250-m channels of MODIS for high-resolution tracking of regional land cover and land-use change.

Potential, or climatically-defined land cover is being computed by a number of biogeography models, the most well developed being the Biogeochemical Information Ordering Management Environment (BIOME)2 model (Prentice et al. 1992) and the Mapped Atmosphere-Plant Soil System (MAPSS) model by Nielson (1995). Good definition of potential land cover is a prerequisite for land-cover change analysis and will be used by the Moore-IDS and Schimel-IDS teams for biospheric modeling.

5.2.3.2.1 Landsat and high-spatial-resolution land science

Although EOS is predominantly planned as a global-scale science program, some of the satellites will produce imagery at high spatial resolution. For example, Landsat-7 will produce data at 10- to 30-m spatial resolution with a 16-day repeat cycle. The long history of Landsat science and applications has illustrated that this spatial/temporal combination is best used for regional land-cover mapping. The data volume is too high for global use, and temporal constraints preclude seasonal time-series analysis. However, the high spatial detail makes Landsat-7 the preferred platform for land-cover change detection, particularly where human-induced changes often occur at sub-kilometer scales (Skole and Tucker 1993).

Opportunities to improve mapping of land cover and vegetation structure, such as stem biomass and forest

FIGURE 5.12

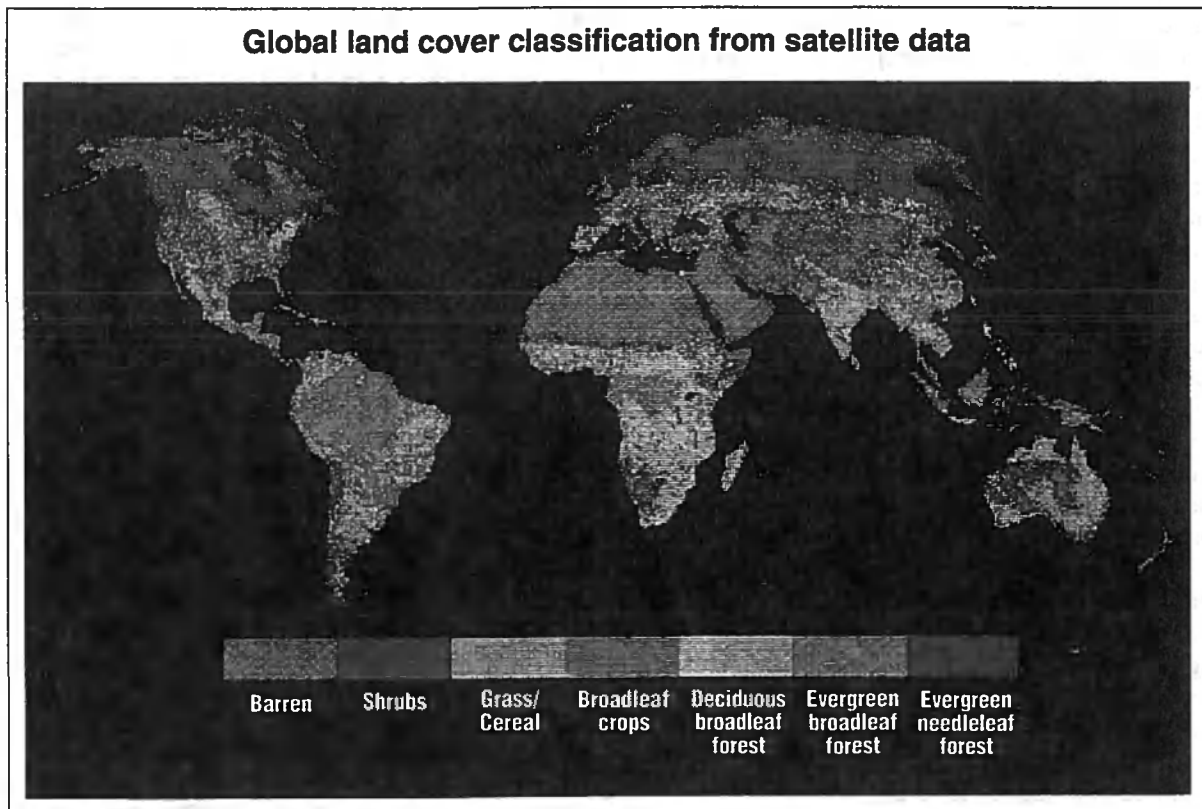

The existing global distribution of terrestrial biomes derived from AVHRR data for 1989 (Nemani and Running 1995). These land-cover data sets are used to quantify land-surface characteristics in global climate, hydrology, and carbon-cycling models. Land-cover monitoring is also important for quantifying deforestation/reforestation rates and land-use change and urbanization. EOS will produce a global land-cover product similar to this at 1-km resolution beginning with the EOS AM-1 launch.

density, lie primarily with the high-spatial-resolution sensors like Landsat, and the multi-look-angle MISR sensor. MISR will provide seven looks at a target in one overpass with its multiple-sensor design. As with Landsat, the long repeat time and high data volume will preclude it from routine full global monitoring in the way that MODIS is scheduled, but will allow enhanced capability for detection of vegetation variables and change analysis not possible with MODIS. ASTER will also provide spatial resolution of 15- to 90-m for selected target scenes. MODLAND-Townshend will supplement 250-m MODIS data with Landsat and ASTER data to produce a high-resolution land-cover-change detection that will include a regional change "alarm" to detect areas undergoing very rapid change. This alarm should alert scientists to large land-cover perturbations in uninhabited areas. Dave Skole of the Moore-IDS team will continue to monitor tropical deforestation rates with Landsat and ASTER sensors (Skole and Tucker 1993).

5.2.3.3 *Vegetation structure*

5.2.3.3.1 Leaf-Area Index (LAI)

Plant canopies are the critical interface between the atmosphere and the terrestrial biosphere. Exchanges of energy, mass, and momentum between the atmosphere and vegetation are controlled by plant canopies. When considering the array of global vegetation, there is an infinite variety of plant canopy shapes, sizes, and attributes. Over the last few decades, ecologists have found that a useful way to quantify plant canopies in a simple yet powerful way is by defining the LAI (the projected leaf area per unit ground area). This parameter represents the structural characteristic of primary importance, the basic size of the canopy, while conveniently ignoring the complexities of canopy geometry that make global comparisons impossible otherwise. Characterization of vegetation in terms of LAI, rather than species composition, is considered a critical simplification for comparison of different terrestrial ecosystems worldwide.

Because LAI most directly quantifies the plant canopy structure, it is highly related to a variety of canopy processes, such as interception, ET, photosynthesis, respiration, and leaf litterfall. LAI is an abstraction of a canopy structural property, a dimensionless variable that ignores canopy detail such as leaf-angle distribution, canopy height, or shape. Hence the definition of LAI is used by terrestrial models to quantify those ecosystem processes. FPAR is a radiation term, so it is more directly related to remotely-sensed variables such as Simple Ra-

tio, NDVI, etc., than LAI. FPAR is frequently used to translate direct satellite data such as NDVI into simple estimates of primary production. It does not define plant canopies as directly as LAI, but is more specifically related to the satellite indices.

As remote sensing became an important tool in terrestrial ecology, initial efforts concentrated on measuring LAI by satellite (Asrar et al. 1984; Peterson et al. 1987). Remote sensing of LAI was first attempted for crops and grasslands, correlating spectral reflectances against direct measurement of vegetation LAI. Various combinations of near-infrared and visible wavelengths have been used to estimate the LAI of wheat (Wiegand et al. 1979; Asrar et al. 1984). Peterson et al. (1987) first estimated the LAI of coniferous forests across an environmental gradient in Oregon using airborne Thematic Mapper Simulator data. NDVI is found to vary monotonically with fraction of vegetation cover for various biome types, a variable related to LAI (Price 1992; Huete et al. 1988; Nemani et al. 1993).

In perennial biome types such as forests, LAI reflects climatic optima; warm, wet climates produce forests of high LAI, while colder, drier climates produce lower LAI. Because plants regrow and recycle their canopies on a regular basis, LAI provides a direct measure of the magnitude of biogeochemical cycling of a vegetation type. LAI changes seasonally in crops and annual vegetation types, and the weekly increase in LAI provides a good monitor of crop development. Even in permanent vegetation types such as forests, LAI will change interannually with climatic fluctuations, particularly of water balance. Defining the length of growing season of deciduous vegetation can best be done by tracking spring growth and fall senescence of LAI.

The advanced biospheric models such as TEM, Century, and BIOME-BGC all use LAI as the vegetation structural variable. Neither LAI nor FPAR are critical variables themselves, rather they are both essential intermediate variables used to calculate terrestrial energy, carbon, water cycling processes, and biogeochemistry of vegetation. Although the NPP of grasslands, annual crops, and other seasonal biome types can be estimated by the time integration of observed developing biomass, for biome types such as forests, chaparral, and other evergreen broadleaves, permanent live biomass occupies the site continuously, causing annual NPP to not be visible from orbiting satellites. The current consensus is that LAI will be used preferentially by ecological and climate modelers who desire a representation of canopy structure in their models.

5.2.3.3.2 Fraction of Photosynthetically-Active Radiation (FPAR)

FPAR will be preferentially used by remote-sensing scientists to interpret satellite data, and projects interested in simple direct estimates of photosynthetic activity and primary production without using mechanistic biome models. Much of the ambiguity involved in using either LAI or FPAR in global-scale models can be eliminated if one also knows some general details about the basic life form of the vegetation, i.e., whether it is forest, grass, crop, etc. That is why the land-cover product discussed above is a necessary initial step in computation of LAI and FPAR.

FPAR is the radiometric equivalent of the structural variable LAI. The satellite-driven global computations of NPP use FPAR to avoid the inversion to LAI and then re-translation back from a satellite-defined Spectral Vegetation Index. Theoretical studies of canopy radiation penetration theory explore the physics of how light interacts with a plant canopy, in order to better understand remote-sensing data. (Myneni et al. 1992). These studies concentrate on the fate of incoming radiation, not on the canopy structure, and describe their results as intercepted PAR, or FPAR, paying specific attention to spectral differences in radiation absorption and reflection (Goward and Huemmerich 1992). A recent refinement of this logic is to represent the FPAR, the fraction of PAR absorbed relative to the incident spectral radiation. A significant part of the theoretical effort recently has been the unification of theory between description of plant canopies by LAI and by FPAR through the separation of ground cover and clump-leaf area (Asrar et al. 1992; Sellers et al. 1992). Asrar et al. (1992) theoretically showed an important interrelationship amongst LAI, FPAR, and NDVI that improves the utility of these biophysical variables. They found that under specified canopy reflectance properties (for a given biome), FPAR was linearly related to NDVI, and curvilinearly related to LAI, approaching the asymptote at an LAI of 6 where virtually all incident shortwave radiation is absorbed by the canopy. Similar results were shown by Sellers (1985, 1987, 1992) and Myneni and Williams (1994).

Consequently, given a canopy of known structure (land-cover type) and light scattering and absorbing properties, any one measure of the canopy can be used interchangeably with the others with some algebraic manipulation of formulae. Accurate utilization of the NDVI requires that the biome type be known so that the appropriate NDVI-to-LAI-or-FPAR conversion can be made. Further, observational details such as the solar zenith angle, sensor look angle, background (soil) exposure frac-

tion, and extent of uncorrected atmospheric interference change the NDVI-LAI-FPAR relationship significantly (Sellers 1985, 1987; Asrar et al. 1992; Myneni and Williams 1994).

EOS contribution: Satellite definition of LAI uses various VIS and NIR channels for optimum sensitivity for different biome types (Myneni et al. 1996). The regular weekly EOS monitoring of global LAI will be done by MODIS at 1 km, and will use biome-specific algorithms (Figure 5.13). However, the multiple-look angles of MISR will provide improved LAI definition of complex canopies such as forests, but with longer than the monthly repeat times of MODIS. Also, ASTER can provide regional LAI data to 15-m resolution with appropriate algorithms. The Schimel-IDS team is using advanced spectral mixture modeling to improve the LAI estimate of the structurally complex tree/grass savanna mixtures. The MODIS Land team is producing a standard combined LAI/FPAR product weekly at 1 km for the globe. The Sellers-IDS team is researching advanced formulations for deriving FPAR from Spectral Vegetation Indices. The Schimel-IDS team is concentrating on the particular problems of defining LAI and FPAR for the complex savanna canopies. The Cihlar-IDS team is exploring the problems of low-illumination angles at high boreal latitudes on LAI and FPAR retrieval.

5.2.3.3.3 Vegetation indices

The first global vegetation analyses were done with the NDVI from the AVHRR sensor (Tucker et al. 1985; Justice et al. 1985; Goward et al. 1985). A continuous record of consistently-processed terrestrial NDVI from 1981 to the present now exists in the EOS AVHRR Pathfinder program. These data are a priceless archive of the global terrestrial land surface, and have provided valuable lessons on the challenges of processing the volumes of global data that will be generated by EOS (Justice and Townshend 1994).

A number of improvements have been made to the original 2-channel NDVI algorithm (Pinty and Verstraete 1992; Qi et al. 1994). The soil-adjusted vegetation index (SAVI) introduced a soil calibration factor, L , to the NDVI equation to minimize the soil background bias resulting from first-order soil-plant spectral interactions (Huete 1988). This not only minimized soil background effects on the vegetation index (VI), but also eliminated the need for additional calibration for different canopy background conditions. The atmospherically-resistant vegetation index (ARVI) incorporates the blue band into the NDVI equation to stabilize the index to temporal and spatial

variations in atmospheric aerosol content (Kaufman and Tanré 1992).

The MODIS VIs are envisioned as improvements over the current NOAA-AVHRR NDVI as a result of both improved instrument design and characterization and the significant amount of VI research conducted over the last decade. The new indices are based on improved knowledge of atmospheric effects, soil effects, sun- and view-angle effects, surface anisotropy, and canopy radiant transfer models. Improved vegetation sensitivity will be achieved with improved MODIS sensor characteristics and from the optimal utilization of MODIS sensor wavebands. The new MODIS VI will: 1) increase sensitivity to vegetation; 2) further normalize internal and external noise influences, thus improving the vegetation signal-to-noise ratio (external-, internal-, and sensor-caused); and 3) provide new, unique information for vegetation analysis. External variations will be minimized through atmospheric correction algorithms, an atmospherically-resistant NDVI equation, and a level 3 compositing algorithm which incorporates the anisotropic reflectance behavior of vegetated surfaces utilizing directional MISR data.

EOS contribution: The commonly-used 2-channel NDVI algorithm will be produced by the MODIS Land Team as a heritage NDVI to maximize consistency of the continuous record of AVHRR data since 1981 (Huete et

al. 1994). In addition to the heritage NDVI, MODLAND-Huete will also produce advanced Vegetation Indices that correct for variable background and soil reflectance using multiple wavelengths from the 36-channel MODIS sensor and incorporating atmospheric corrections of all channel reflectances done automatically in the MODIS data processing stream.

5.2.3.4 Vegetation phenology

Possibly the most direct and observable response of vegetation to climatic fluctuations is the interannual variability in the timing of spring vegetation growth, primarily, the leafing out of tree canopies and greening of grasses. This seasonal timing, termed phenology, has been found to vary by more than a month. During cool springs, plant development begins later in temperate and boreal latitudes than in warm years. This rather abrupt change in surface albedo, roughness, and wetness measurably changes the energy exchange characteristics of the land surface (Schwartz 1996). Studies have capitalized on the high temporal frequency of AVHRR, and the simple greenness definition provided by NDVI to study phenology at continental scales (Reed et al. 1994).

EOS contribution: During the EOS era MODIS data will be processed at high temporal resolution over certain mid-to-high-latitude cloud-free areas to monitor interannual variability in vegetation phenology. As global climatic change progresses, this phenology monitoring will provide a consistent and rapid measure of vegetation response.

5.2.3.5 Net Primary Production (NPP)

Current best estimates of terrestrial carbon fluxes are 100 to 120 Pg of carbon ($= 10^{15}$ g or a Gigatonne) taken up over a year by photosynthesis, and about 40-to-60 Pg are released over a year by autotrophic respiration for a total terrestrial NPP of about 50 Pg C (Post et al. 1990; Melillo et al. 1993). This averages out to about 370 gC m^{-2} of land surface. Currently about 1.8 Pg of the carbon released by fossil fuel combustion and deforestation are not accounted for by the atmosphere or ocean, and are presumably taken up by terrestrial ecosystems (Tans et al. 1990; Quay et al. 1992; Sundquist 1993). This represents about 4% of the annual NPP, which is well below the amount which may be detected from ground measurements. The spatial variability of NPP over the globe is enormous, from about 1000 gC m^{-2} for evergreen tropical rain forests to less than 30 gC m^{-2} for deserts. With increased atmospheric CO_2 and global climate change, NPP over large areas may be changing. To be sensitive to spatial variability, global NPP is best determined by remote

FIGURE 5.13

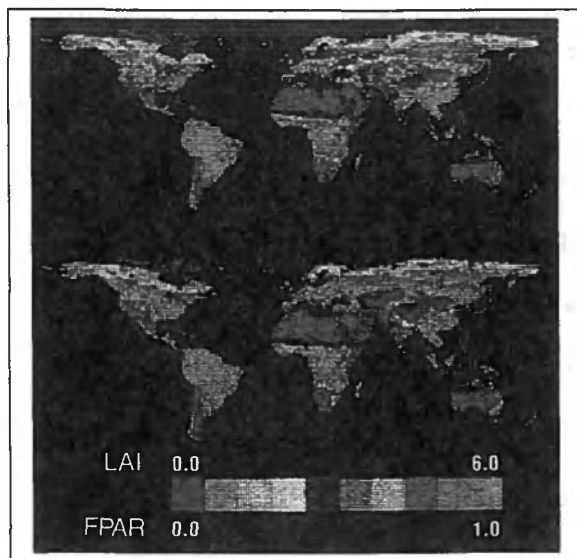

Global fields of leaf-area index (LAI) and fraction-absorbed photosynthetically-active radiation (FPAR) computed with AVHRR data for 1982-1991 (Myneni et al. 1996). EOS will produce these products weekly at 1-km resolution from MODIS and MISR data beginning with the EOS AM-1 launch.

sensing, which is one of the key objectives of NASA's Earth Science Enterprise. EOS, and specifically MODIS, were designed in part for the scientific objective of calculating global terrestrial NPP (MODIS Instrument Panel Report 1986).

Goward et al. (1985) was the first study showing a relationship between NPP and NDVI, which was confirmed by Box et al. 1989. Running and Nemani (1988) used a model, the forest-biogeochemistry cycles (FOREST-BGC) model, to show that photosynthesis (PSN) and NPP were also related to NDVI. Sellers (1985, 1987) derived the theoretical relationship between NDVI, the Absorbed Photosynthetically-Active Radiation (APAR), and photosynthesis for unstressed vegetation. Cihlar et al. (1992) showed a similar relationship between PSN and NDVI with the experimental data from the FIFE. Most recently, Runyon et al. (1994), from the Oregon Transect Terrestrial Ecosystem Research (OTTER) experiment, showed NPP to be related to the annual intercepted PAR (about equal to APAR). The advanced MODIS data product of daily PSN more correctly defines terrestrial CO₂ fluxes than simply NDVI to increase understanding on how the seasonal fluxes of net photosynthesis are related to seasonal variations of atmospheric CO₂.

The NPP products are designed to provide an accurate, regular measure of the production activity or growth of terrestrial vegetation. These products will have both theoretical and practical utility. The theoretical use is primarily for defining the seasonally-dynamic terrestrial surface CO₂ balance for global carbon cycle studies such as solving the "missing sink question" of carbon (Tans et al. 1990). The spatial and seasonal dynamics of CO₂ flux are also of high interest in global climate modeling, because CO₂ is an important greenhouse gas (Keeling et al. 1989). Currently, global carbon-cycle models are being integrated with climate models, towards the goal of integrated Earth Systems Models that will represent the dynamic interaction between the atmosphere, biosphere, and oceans. The weekly PSN product is most useful for these theoretical CO₂ flux questions.

The practical utility of the NPP product is as a measure of crop yield, forest production, and other economically and socially significant products of vegetation growth. As our regular global NPP products become well known, we expect a wide variety of derived products to be developed, making regionally-specific estimates of local crop production. NPP is important for a wide variety of uses, from applications like regional crop/range/forest yield forecasting to biospheric carbon cycle increments of biomass sequestration. Regional-to-global NPP may have the highest commercial potential of any EOS variable because it can be used by the agribusiness sector

for crop futures commodity planning, disaster insurance analysis, etc.

The algorithms for these products are based on the original logic of J. L. Monteith (1972, 1977), which relates PSN and NPP to the amount of APAR. Spectral Vegetation Indices (SVI) are useful for quantifying the FPAR that is absorbed and the LAI. To implement the algorithms, ancillary data on climate and incident PAR from the Rood-IDS DAO and MODIS land-cover type are required.

The MODIS NPP product is designed to provide a weekly NPP estimate for time-critical activities where the data are only useful if delivered in near-real time (Figure 5.14). Because a comprehensive biospheric model cannot be run every week, this NPP product will be produced from simpler algorithms based on the time-integrated Production Efficiency Model (PEM) logic (Prince and Goward 1995). The weekly MODIS NPP will use the MODIS land cover to define a biome type and a biome-and-seasonally-specific conversion from PAR to NPP. Then the weekly composited FPAR will be generated, and weekly PAR. The weekly MODIS NPP will be available globally at 1-km resolution. The first stage of algorithm development (at launch) will use a simple PEM with temperature and humidity controls on photosynthesis estimated from gridded DAO climate data. With further development (post launch), the efficiency parameter may be determined remotely from the MODIS Vegetation Index (MVI), land-cover type, land-surface temperature, snow/ice cover, surface resistance index, and ancillary meteorological data.

The main problem after computing FPAR and PAR is the determination of the PAR conversion efficiency, ϵ (Field et al. 1995). Prince (1991) summarized values for herbaceous vegetation and found an average from 1.0 to 1.8 gC/MJ for plants with the C₃ photosynthetic pathway, and higher for plants with the C₄ photosynthetic pathway. Running and Hunt (1993) and Hunt (1994) found published values of ϵ for woody vegetation were lower, from about 0.2 to 1.5 gC/MJ. Global variation of the efficiency factor is controlled partially by varying climatic conditions, and partially by inherent physiologic differences of vegetation. Hunt and Running (1992a, 1992b) and Hunt et al. (1996) used a general ecosystem model, BIOME-BGC, to simulate ϵ and found that climate and land-cover types are extremely important factors determining the observed global range of values. Cold temperatures and water stress limit the length of the growing season thereby decreasing conversion efficiency. The maintenance respiration costs of, for example, tree stems, reduces the conversion efficiency for forests and other perennial vegetation.

FIGURE 5.14

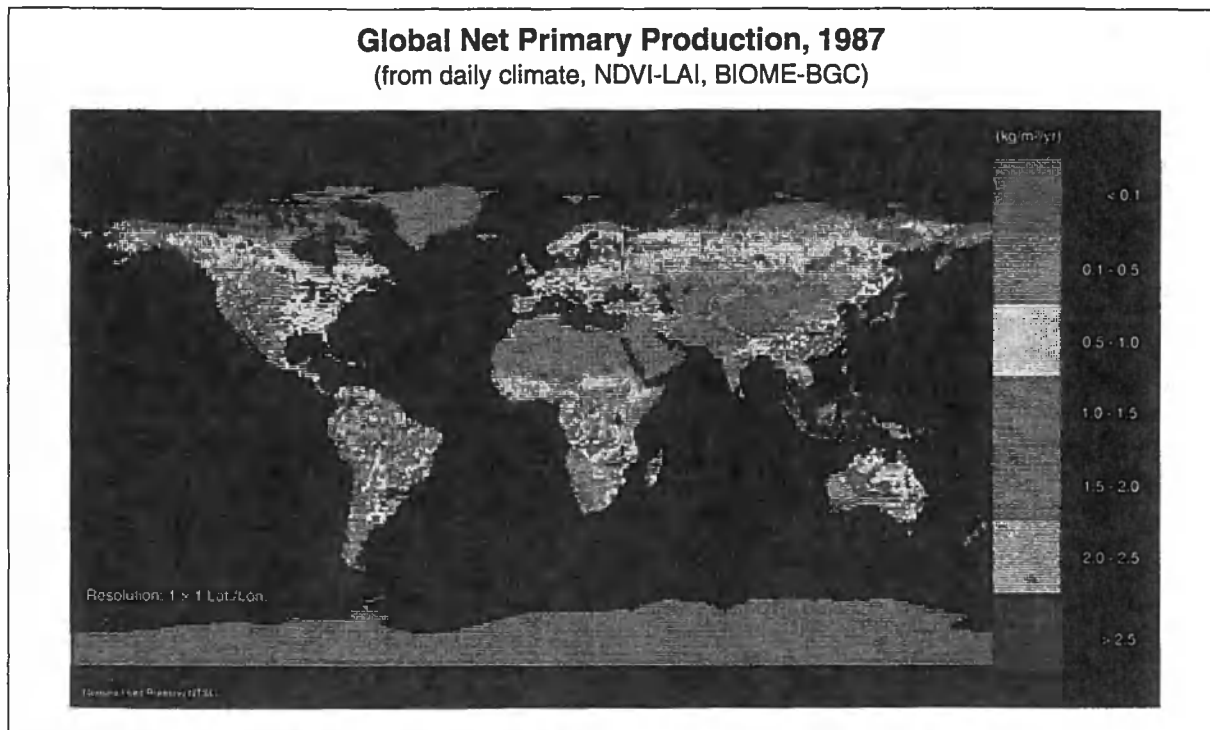

The global annual net primary production (NPP) for 1987 computed from AVHRR data. EOS will produce a weekly global NPP at 1 km beginning with the launch of the AM-1 platform. These NPP data will be useful for crop production forecasting, range management, and forest yield estimates.

EOS contribution: The MODIS Land Team will generate a standard weekly EOS NPP product for public use. The Moore-IDS and Sellers-IDS teams will compute global annual NPP as research activities. The Cihlar-IDS team will compute the global boreal forest NPP, and IDS-Schimel the global grassland biome NPP. These IDS teams will use MODIS land-cover and weekly FPAR products, daily 4DDA surface climatology, and EOS ancillary topography and soils databases to parameterize their models. The biospheric simulation models TEM (Moore-IDS), Century (Schimel-IDS), and Biome-BGC (MODLAND-Running) compute NPP as a part of comprehensive ecosystem simulations, which also include photosynthesis-respiration, allocation, litterfall, and decomposition processes, with water and nitrogen cycle controls. Each defined biome type is simulated with biome-specific parameterizations. These advanced models are being developed as components in dynamic Earth Systems Models that will allow accurate future biospheric response forecasting (VEMAP 1995).

An intercomparison test of these terrestrial carbon balance models for the continental U.S. has recently been completed and global model NPP intercomparisons are

underway (Potsdam Institute for Climate Impact Research [PIK]-95, see Section 5.4.6.3). These NPP calculations will be part of global carbon-cycle analyses exploring changes in NPP predicted from climate-change scenarios, answering questions of the "missing sink" in current biospheric carbon-cycle science. Highest priority for these studies is accuracy, so these NPP calculations will be done with year-end EOS data sets that have been error checked, updated, and calibrated. A global database of field-measured NPP from different biomes is being assembled to provide a source of validation data for this NPP product (see Sec 5.4.5.3.5).

5.2.3.5.1 Stem and soil carbon

All computations of terrestrial carbon-cycle balances require input of the live biomass in tree stems that emit CO₂ in maintenance respiration activity, and the dead carbon in soil horizons that release CO₂ from decomposition activity. These ecosystem properties are not directly remote sensible, so a number of inference techniques must be used to provide estimates. Inferences are best done by considering the NPP and biome-specific vegetation life-history characteristics of a region. A forest primarily

accumulates stem carbon while a grassland accumulates soil carbon. The final step is analysis of the land-cover-change rate for a region. The presumed stem carbon of a mature forest would clearly not be accurate in an area that had been deforested.

EOS contribution: Because of the complicated and biome/region-specific nature of these variables, no standard EOS product generation is planned. Each IDS team is building estimates of stem and soil carbon for research activities in specific areas. The Schimel-IDS team has the most specific research on these problems because grasslands and savanna sequester the highest percentage of annual NPP in soil carbon of any biome type. Boreal forests with low temperature and nutrient-limited decomposition activity are also biomes with high soil carbon sequestration, the focus of the Cihlar-IDS team.

5.2.3.6 Regional weekly application products

Although much of the EOS datastream is meant for long-term monitoring and global science, some of the terrestrial satellite data can have immediate utility if delivered in real time. The Running-MODLAND team will produce some weekly land products for use by natural resource land managers. Critical to these products is 1 km or better spatial resolution and near-real-time delivery at the end of each weekly computation period. These are crop/range/forest productivity index, drought index (Figure 5.15), and fire danger index. An integrated program for landscape fire management is planned from EOS, which will include fire danger monitoring, mapping ignitions at high frequency and accuracy, tracking fire behavior and movement, computing trace gas emissions, and finally post-fire ecosystem responses (Kaufman et al. 1996). Because all of these indices require the computationally-

FIGURE 5.15

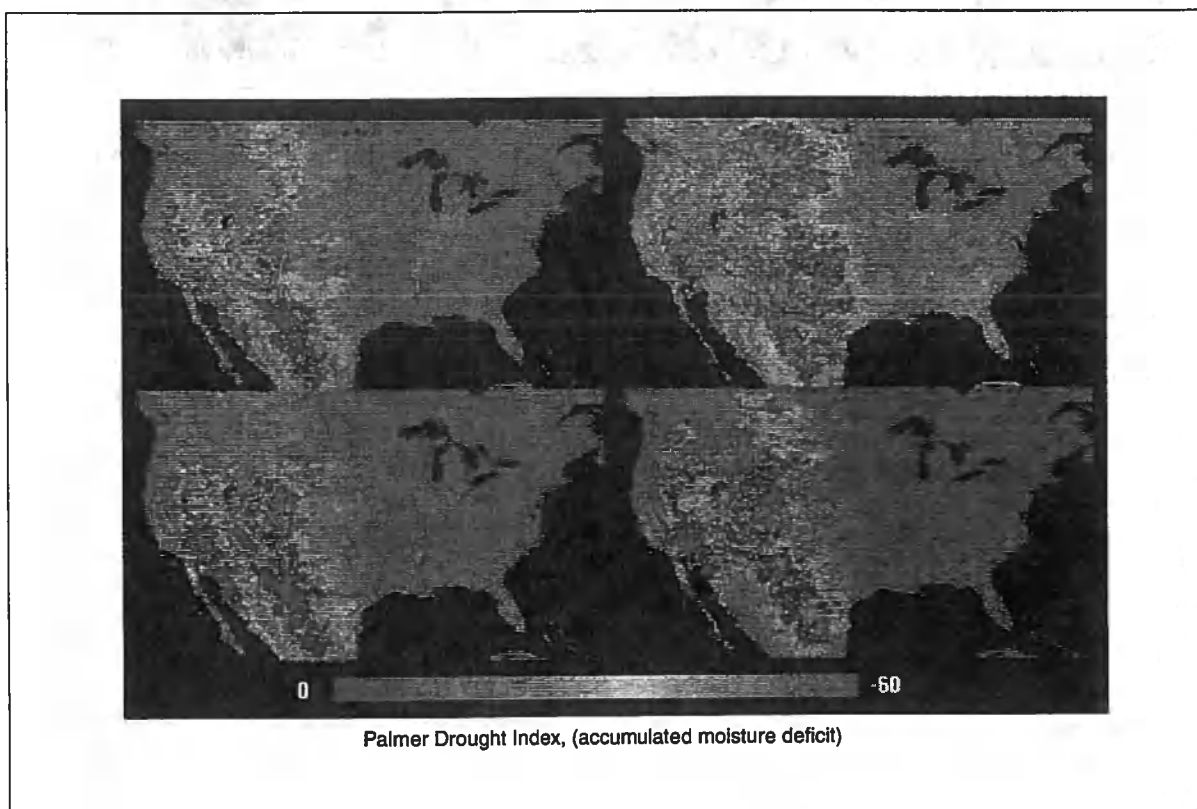

Comparison of the mid-summer drought intensity across the United States for 1988, the year of the Yellowstone Park fires, with the more-normal summer of 1989. This drought index is derived from the NDVI and surface-temperature data from AVHRR using the methodology of Nemani et al. (1993) and Nemani and Running (1989). This satellite-derived drought index will be produced weekly by EOS for applications in agriculture, range and forest management, and for wildfire danger monitoring.

FIGURE 5.16

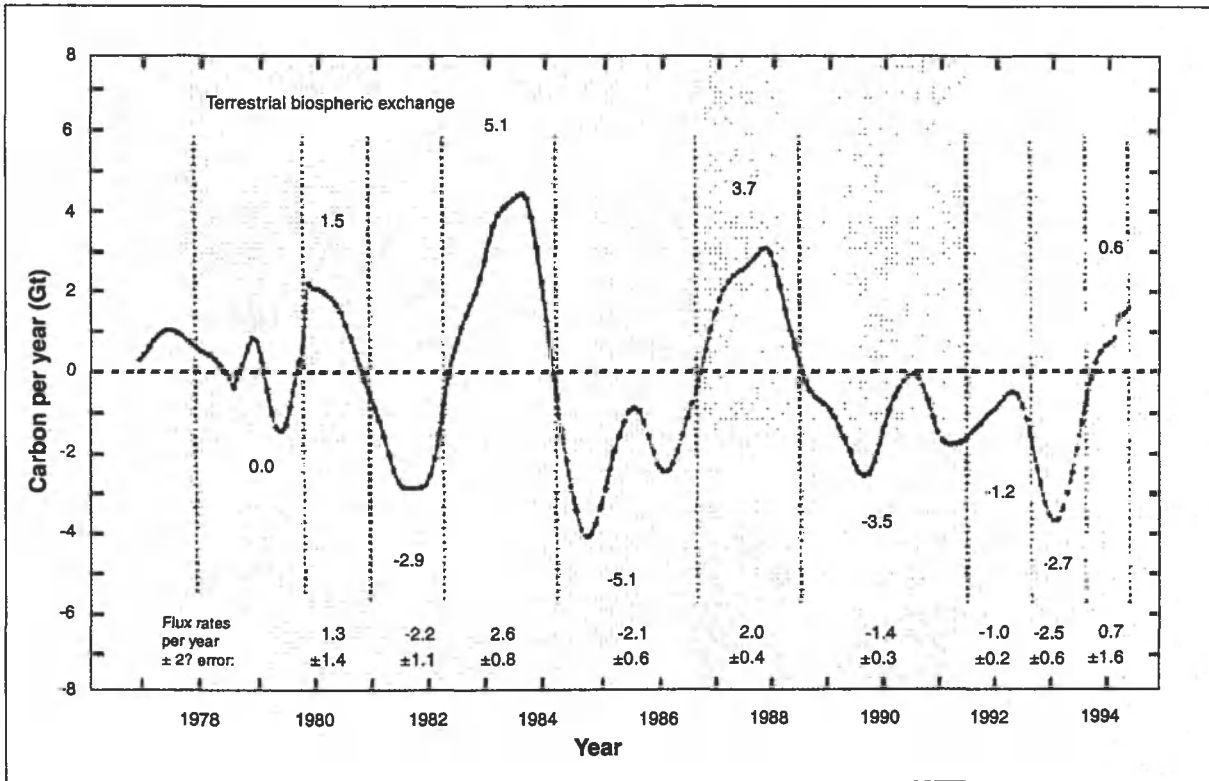

Interannual variability in terrestrial biospheric net CO₂ exchange, computed from the network of flask sampling of atmospheric CO₂ and an atmospheric transport model (Keeling et al. 1995).

intensive surface resistance product from the PM-1 MODIS sensor and rapid delivery, this product is currently planned to be available only for the continental U.S.

5.2.3.7 Biogeochemistry

The necessity to more accurately quantify global terrestrial vegetation activity was emphasized by attempts in the late 1970s to calculate a global carbon budget. Although it was clear from the Mauna Loa CO₂ concentration record that global atmospheric CO₂ was increasing, the anthropogenic sources did not seem to balance the ocean and terrestrial sinks. In an effort to locate the missing carbon, measured atmospheric CO₂ concentrations around the world were used in global models tracing known sources and sinks (Keeling et al. 1989; Tans et al. 1990). Previously, Tucker et al. (1986) showed NDVI alone can explain much of the global patterns of atmospheric CO₂ concentration. More significantly, this problem underscored the lack of defensible measurement capability of terrestrial primary production at global scales.

CO₂ is the most important carbon cycle flux variable, and because it is a greenhouse gas, is a critical

connecting point between the biosphere and the atmosphere. CO₂ is absorbed by vegetation during photosynthesis, and released by respiration and decomposition processes. Hence, CO₂ flux rates can be positive or negative, depending on the level of activity of the underlying ecosystem processes, and can change hourly as microclimatic conditions change at the surface. Because photosynthesis can only occur during daylight, while respiration and decomposition occur continuously, at global scales, the relative CO₂ balance is influenced by latitude and the seasonal changes in daylength (Ciais et al. 1995). Additionally, CO₂ flux rates are very different for different vegetation types, and stages of vegetation development. The summary of this seasonally-changing vegetation activity is observable in the atmospheric CO₂ concentration records, such as the record for Mauna Loa (Keeling et al. 1989). El Niño interannual climate variations cause measurable perturbations regionally to atmospheric CO₂ signals. The role of climate in controlling interannual variability in biospheric CO₂ balances was dramatically illustrated by the effect the Mt. Pinatubo eruption in 1991 had in slowing the rate of rise in atmo-

spheric CO₂, beginning immediately in 1992 (Figure 5.16) (Keeling et al. 1995).

EOS contribution: All EOS global CO₂ flux research will be model-generated because CO₂ is not directly observable by satellite. The IDS-Sellers team will use SiB2 for global CO₂ flux calculations similar to the work in Sellers et al. (1996) where the influence of vegetation physiological controls on summer air temperatures was studied. Mid-continent air temperatures were found to be higher in the summer when stomatal closure by vegetation was included in the GCM dynamics of the land surface. SiB2 will use MODIS standard products for land cover and LAI/FPAR for initial parameterization. These CO₂ balances from SiB2 will be used in GCMs as part of their greenhouse gas balances. The Schimel-IDS team is emphasizing global grasslands and arid lands in their carbon balance simulations. They find an important conceptual simplification that maximum photosynthetic activity scales linearly with absorbed light in complex multi-storied savannas. This result solidifies the logic for the EOS productivity calculations planned. The Cihlar-IDS team is concentrating on global boreal forest carbon balances. The Cihlar team is currently testing EOS vegetation algorithms under the rather unique conditions of boreal landscapes. Arid and high-latitude regions have been identified as areas where climatic change consequences could be particularly severe. The Moore-IDS team, in addition to computing annual terrestrial CO₂ fluxes, is modeling the transport of carbon via rivers to the oceans.

Other aspects of terrestrial biogeochemistry are also being studied, particularly greenhouse gas dynamics of different biomes. The Schimel-IDS team will calculate methane and N₂O for global grasslands using their Century biospheric model. The Moore-IDS team will assemble a global methane budget from Measurements of Pollution in the Troposphere (MOPITT), TES, and ground data sources for use in their TEM biospheric model.

5.2.3.8 Predictions of terrestrial biospheric dynamics

The only means of predicting future biospheric dynamics is with comprehensive simulation models. Because of the intimate interrelationships amongst the oceans-atmosphere-biosphere, component models cannot effectively provide predictive capability in isolation. Only comprehensive dynamic coupled Earth systems models will provide the predictive accuracy needed by policy makers and society. These models do not yet exist, although prototypes are nearly ready for initial testing. The ultimate accuracy of Earth systems models will rely both on the quality of the models, which are under intensive development now, and the quality and regularity of the

global-monitoring data used by the models to define the Earth system. The role of EOS is clear here: no Earth systems model, no matter how theoretically rigorous and elegant, will have adequate predictive capability without being initialized by accurate, timely, and complete global information.

EOS contribution: The most organized terrestrial modeling programs operating now are VEMAP, a multi-model simulation of the continental U.S., and PIK-NPP, an international effort to improve global NPP models, hosted by PIK. In the VEMAP activity, three GCM climate-change scenarios (United Kingdom Meteorological Office [UKMO], Geophysical Fluid Dynamics Laboratory [GFDL], and Oregon State University [OSU]) are being used to drive coupled biogeography and biogeochemistry models of the U.S., to explore how both potential biome distribution and carbon-cycle processes will change concurrently with doubled CO₂ and resulting climatic change. The biogeography models (BIOME2, Prentice et al. 1992; DOLY [the Dynamic Global Phyto-geography model], Woodward et al. 1995; MAPSS; Neilson 1995) all use climatic indices and thresholds to determine the geographic distribution of biomes. The biogeochemistry models TEM, Century, and BIOME-BGC, calculate the carbon, water, and nutrient cycle balances of the system. The first VEMAP results (VEMAP 1995) suggest high uncertainty on whether continental forest cover may increase or decrease dependent on how precipitation patterns change. The biogeochemistry models all predict a modest overall increase in NPP because the CO₂ enhancement effect counteracts climatic change effects. However, some specific regions may have significant reduction in NPP. Although all of these models are structurally similar, results reflect subtle differences in the theoretical balancing of water, energy, and nutrition in controlling biome distribution and biogeochemistry. These uncertainties must be overcome before trustworthy dynamic Earth systems models can become a reality.

The PIK-NPP project is intercomparing the calculations of global annual NPP made by 18 top research laboratories worldwide. These global NPP models exhibit different logics and theoretical rigor, and rely in varying ways on remote sensing for inputs. Some models are completely defined by the satellite data; others use satellite data to initialize land cover and LAI, then simulate NPP using surface climate data. This intercomparison is an important test of the EOS algorithms for NPP, probably the most important terrestrial vegetation variable generated by the program.

5.3 Required measurements and data sets for quantifying land-surface attributes

5.3.1 Introduction

The derivation of biophysical parameters (net radiation, temperature, precipitation, ET, LAI, non-photosynthetic vegetation, thermal inertia) from remote-sensing data is highly dependent on calibration, spectral and spatial imaging resolution, illumination and measurement geometry, and atmospheric conditions. To determine the impact of these factors on models of hydrology or primary production and nutrient cycling requires that investigators have easy access to Level 1b imaging products. At this level it is possible to analyze images using nominal calibrations and then to perturb calibrations to examine the sensitivity of interpreted biophysical parameters that are entering the model predictions. This level of processing allows screening of data to guarantee specific spatial resolutions and viewing geometries (solar zenith, azimuth, phase, and viewing angles) to minimize uncertainties resulting from extreme viewing angles.

Land-surface remote sensing and modeling is a particularly difficult task. Unlike the world's oceans whose roughness, albedo, heat capacity, and emissivity vary slowly (if at all) and can be estimated accurately, the world's land surface is characterized by considerable spatial and temporal heterogeneity in these basic parameters and additional processes which variably regulate the partitioning and magnitude of near-surface energy and water fluxes. These features are particularly divisive in regions with mixed or partial canopies. The consequence of this for satellite remote sensing and modeling is a requirement for more-accurate and higher-resolution measurements made more often.

5.3.2 EOS sensors

5.3.2.1 MODIS

MODIS will be the primary daily global monitoring sensor on the EOS AM-1 and PM-1 satellites. MODIS is a 36-channel nadir-pointing radiometer covering 0.415–14.235 μm wavelengths, with spatial resolution from 250 m to 1 km at nadir. The global repeat time will be from 1–4 days, depending on latitude and view-angle limits. MODIS will be the primary EOS sensor for providing data on terrestrial biospheric dynamics and vegetation process activity. The suite of global land products planned for EOSDIS implementation includes spectral albedo, land cover, spectral vegetation indices, snow and ice cover, surface temperature and fire, and biophysical variables (LAI and fractional PAR) that will allow computation of global carbon cycles, hydrologic balances,

and biogeochemistry of critical greenhouse gases (Running et al. 1994). The regular global production of these variables will allow accurate land-surface-change detection, a fundamental determinant of global change. The MODIS instrument has the capability to provide measurements to derive most of the parameters required for the global-scale models of interest in hydrology and biogeochemistry on a one-to-two-day period, and, thus would be the primary data source.

Satellite-derived vegetation indices, such as the well known AVHRR NDVI, are used by numerous scientists for quantifying a number of vegetation attributes. The primary EOS vegetation index will be the MODIS Vegetation Index, or MVI, which will be produced weekly at 1 km, with a 2-channel version available at 250 m (Huete et al. 1994). Advanced multi-channel VIs are planned by the MODIS Land science team. MISR will provide BRDF data to improve the nadir VIs of MODIS.

5.3.2.2 MISR

MISR will obtain multidirectional observations of each scene within a time scale of minutes, thereby under virtually the same atmospheric conditions. MISR uses nine separate charge-coupled device (CCD)-based pushbroom cameras to observe the Earth at nine discrete view angles: One at nadir, plus four other symmetrical fore-aft views up to $\pm 70.5^\circ$ forward and afterward of nadir. Images at each angle will be obtained in four spectral bands centered at 0.443, 0.555, 0.67, and 0.865 μm . Each of the 36 instrument-data channels (four spectral bands for each of the nine cameras) is individually commandable to provide ground sampling of 240 m, 480 m, 960 m, or 1.92 km. The swath width of the MISR imaging data is 356 km, providing multi-angle coverage of the entire Earth in 9 days at the equator and 2 days at the poles. MISR images will be acquired in two observing modes, Global and Local. Global Mode provides continuous planet-wide observations, with most channels operating at moderate resolution and selected channels operating at the highest resolution for cloud screening, image navigation, and stereo-photogrammetry. Local Mode provides data at the highest resolution in all spectral bands and all cameras for selected 300×300 km regions.

MISR will be used to monitor global and regional trends in radiatively important optical properties (opacity, single scattering albedo, and scattering phase function) of natural and anthropogenic aerosols—including those arising from industrial and volcanic emissions,

slash-and-burn agriculture, and desertification—and to determine their effect on the solar radiation budget. Over land, the dependence of absolute radiance and scene contrast as a function of angle will be used to retrieve opacity, absorptivity, and phase function. The measured radiances will be directly integrated to yield estimates of reflected flux, hence albedo. For determinations of these quantities at the surface, radiative transfer inversions of the top-of-atmosphere radiances will be used to retrieve multi-angle surface reflectances using aerosol information also derived from MISR data. Automated stereo-image-matching algorithms will be used to derive surface topography and cloud elevations from multi-angle stereoscopic observations. Over the land surface, these data will aid studies of the impact of land-surface processes on climate variables. BRDF measurements of various scene types will be used for the development and validation of models relating soil, snow, and ice angular reflectances to surface albedo. For vegetated terrain, measured angular signatures will be related to canopy structural parameters, will provide improved vegetation cover classifications, and will be used to retrieve surface hemispherical albedos. This information will be used to derive APAR and improved measurements of vegetation canopy photosynthesis and transpiration rates.

5.3.2.3 ASTER

ASTER will operate in three visible and near-infrared (VNIR) channels between 0.5 and 0.9 μm , with 15-m resolution; six short-wavelength infrared (SWIR) channels between 1.6 and 2.5 μm , with 30-m resolution; and five TIR channels between 8 and 12 μm , with 90-m resolution. The instrument will acquire data over a 60-km swath whose center is pointable cross-track $\pm 8.5^\circ$ in the SWIR and TIR, with the VNIR pointable out to $\pm 24^\circ$. An additional telescope (aft pointing) covers the wavelength range of Channel 3. By combining these data with those for Channel 3, stereo views can be created with a base-to-height ratio of 0.6. ASTER's pointing capabilities will be such that any point on the globe will be accessible at least once every 16 days in all 14 bands and once every 5 days in the three VNIR channels. However, global coverage at 15 m might require most of a year to acquire.

ASTER will provide surface reflectances and radiative (brightness) temperatures. The multispectral TIR data can be used to derive surface kinetic temperature and spectral emissivity. This temperature/emissivity information can be used to verify similar procedures employing MODIS data. Surface kinetic temperature can be used to determine elements of surface process models, sensible heat flux, latent heat flux, and ground heat conduction.

Surface temperatures are also related to thermophysical properties (such as thermal inertia), vegetation health, soil moisture, temporal land classification (wet vs. dry, vegetated vs. bare soil), and ET.

Both ASTER and MISR image data will be used to assist in defining spectral trajectories associated with atmospheric variations that are not visually resolvable in MODIS data. Several specific sites will be selected to aid in calibrating and defining adaptive filters that minimize the effect of spectrally complex areas on biophysical parameter estimates. In forested areas the spectral measurements of vegetation are not useful as a measure of cover (all areas are 100% covered by vegetation), but rather correspond largely to canopy architecture and foliar anatomy. Both ASTER and MISR data sets are useful because they can provide a series of measurements over a range of look angles. Differences in the seasonal phenology of different forest community types can be detected using measurements that characterize the photometric function.

5.3.2.4 Landsat-7

The Earth-observing instrument on Landsat-7, the ETM+, replicates the capabilities of the highly successful TM instruments on Landsats-4 and -5*. The ETM+ also includes new features that make it a more-versatile and efficient instrument for global-change studies, land-cover monitoring and assessment, and large-area mapping than its design forebears. The primary new features on Landsat-7 are:

- a panchromatic band with 15-m spatial resolution;
- on-board, full aperture, 5% absolute radiometric calibration; and
- a thermal IR channel with 60-m spatial resolution.

Landsat-7 and ETM+ will have the following characteristics:

The instrument will be supported by a ground network that will receive ETM+ data via X-band direct downlink only at a data rate of 150 Mbps. The primary receiving station will be at the USGS's Earth Resources Observation System (EROS) Data Center (EDC) in Sioux Falls, South Dakota. Substantially cloud-free land and coastal scenes will be acquired by EDC through real-time downlink, and by playback from an on-board, solid-state, recording device. The capacities of the satellite, instrument, and ground system will be sufficient to allow for continuous acquisition of all substantially cloud-free scenes at the primary receiving station. In addition, a worldwide network of receiving stations will be able to receive real-time, direct downlink of image data via

X-band. Each station will be able to receive data only for that part of the ETM+ ground track where the satellite is in sight of the receiving station.

The Landsat-7 system will ensure continuity of TM-type data into the next century. These data will be made available to all users through EDC at the cost of fulfilling user requests. Browse data (a lower-resolution image for determining image location, quality, and information content) and metadata (descriptive information on the image) will be available, on-line, to users within 24 hours of acquisition of the image by the primary ground station. EDC will process all Landsat-7 data received to "Level 0R" (i.e., corrected for scan direction and band alignment but without radiometric or geometric correction) and archive the data in that format. A systematically-corrected product (Level 1G) will be generated and distributed to users upon request. The user will have the option of performing further processing on the data on user-operated digital processing equipment or by employing a commercial, value-added firm.

<http://geo.arc.nasa.gov/sge/landsat/17.html>

5.3.3 Ancillary data sets

These data are critical to any investigation of the surface but represent static data sets whose need and responsibility cut across many groups.

5.3.3.1 Soils

Soils data are required by virtually every climate, hydrology, or ecosystem model, although again, different variables are important to the different disciplines. Surface albedo is required for energy balance models and for vegetation radiative transfer models. Soil depth, water-holding capacity, and texture or drainage characteristics are needed by all models to quantify the retention and release of water by soils to the atmosphere, hydrologic systems, and vegetation. In water-abundant regions, soil capacitance partially defines the time constant of flood-water dynamics. In water-limited areas, soil water depletion regulates the increase of sensible heat partitioning that feeds back to climate models and produces the drought effects that reduce vegetation primary production. The ecosystem models also require some measure of soil carbon and nutrient content for biogeochemical modeling. However, beyond some general definition of parent materials, global soil nutritional estimates can best be estimated by biospheric models specializing in soil biogeochemical dynamics such as Century (Schimel et al. 1994).

The EOS soils data set planned for AM-1 at-launch use is being developed as part of an IGBP-led project to compile and unify soils data sets from every country. Globally-relevant pedo-transfer functions are being built to translate a global pedon database into the soil physical and geochemical properties required. The final global soils database from the IGBP-DIS Global Soils Data Task will be gridded at 5° resolution, and will include soil carbon, soil nitrogen, water-holding capacity, and thermal properties.

The distribution of rock types constitutes the first-order influence on spatial patterns of soils and topography, and therefore on regional hydrologic responses, erosion rates, and natural hazards. Construction of consistent global maps of lithology through digitizing currently available national maps and augmenting with Landsat or ASTER would provide an extraordinary resource for interpreting many of the land-surface characteristics that will be used in models of vegetation, hydrology, and biogeochemistry.

5.3.3.2 Topography

The most important ancillary data set required by EOS land science is global topography. However, the resolution of topographic data needed differs among climate, hydrology, and vegetation disciplines. While 1-km horizontal resolution DEMs are adequate for LSM parameterizations of 1° × 1°, hydrology and vegetation scientists working with 1 km and finer sensor data require the full 100-m horizontal resolution and 1-m vertical resolution possible with best current technology. Hydrologists use topographic data for microclimate corrections, snow-melt models, and for river-drainage-network delineation, and coastline identification. Vegetation scientists use topographic data to correct raw sensor radiances for elevational pathlength and topographic shading corrections, slope-related pixel illumination corrections, and geolocation corrections. For MODIS land products at 1-km, 500-m, and 250-m resolution, and ASTER and MISR land products of even finer resolution, consistent global topographic data of highest possible accuracy will improve these land products.

The Global Land 1-km Base Elevation project plans a 1-km/100-m horizontal/vertical resolution global data set as the best topographic database possible for at-launch AM-1 requirements of January 1998 delivery to EOSDIS. Although higher detail DEMs are available for some parts of the world, such as the U.S. and Europe, no globally-consistent database of higher accuracy is possible with current national databases. Future efforts, possibly includ-

ing a Shuttle Radar Topography Mission may provide data for resolution to 30-m/16-m horizontal/vertical resolution by mid-1999.

NASA is currently sponsoring the Digital Topography Program to evaluate different technologies for the production and use of DEMs. Under this program, DEMs generated from airborne (Topographic SAR [TOPSAR]) and spaceborne (ERS-1, Shuttle Imaging Radar-C [SIR-C]) radars are being compared with topographic models derived via traditional photogrammetric techniques, as well as state-of-the-art global positioning system (GPS) arrays such as real-time kinematic (RTK-GPS). Numerous field sites are located within the U.S., including the Mississippi River, the southwestern desert, and volcanic terrains in Hawaii, plus additional sites in the Philippines and Japan. These studies are also precursors to the Shuttle Radar Topographic mission scheduled for 1999/2000 and data from the Environmental Satellite's (ENVISAT's) Advanced Synthetic Aperture Radar (ASAR) and the Advanced Land Observation Satellite (ALOS).

5.3.3.3 River and flood control networks

Topographic data alone are not adequate to define river runoff routing. Man has placed control structures such as levees and dams along many of the world's major streams, and their ability to confound comparisons between satel-

lite rainfall and model runoff is extreme without an effort to compile or link stage/discharge and flow records in such a way that the data are accessible. EOS or EOSDIS can contribute to efforts to overcome these problems by making this type of information available for U.S. waterways and putting forward a template for collecting this information from abroad. The Global River and Drainage Basin Archive now being assembled (led by Charles Vorosmarty of the Moore-IDS team) will include a reservoir and dam database.

5.3.4 Assimilation data sets

The most critical assimilation data set for land science will be the surface meteorology provided by the Rood-IDS team and the Goddard DAO. The 6-hour near-real-time production of land-surface incident radiation, temperature, precipitation, and humidity will be required by all hydrology and vegetation models. For many purposes, especially regional calculations, the $2^{\circ} \times 2.5^{\circ}$ gridded data set from the DAO will need to be disaggregated to finer spatial detail, using the topographic data set and appropriate meso- and micro-climate models. The VEMAP ecosystem modeling activity for the continental U.S. illustrates how gridded global climate data sets can be enhanced for simulations with finer spatial detail (VEMAP 1995).

5.4 Validation Programs For EOS

5.4.1 Responsibility hierarchy

Global-scale monitoring and validation will be very complicated, both scientifically and politically. For this reason it is imperative for every plan that it be clear who is responsible for execution of the work and what funding is provided. Five fundamental levels of responsibility have been identified that need to be dealt with:

- 1) *Individual*: Each EOS team member takes responsibility within their own EOS funding to do certain measurements at certain field sites.
- 2) *Sensor team*: Each sensor science team, for example the MODIS Land Team, may collectively agree to do certain joint validation activities, again, within their current funding.
- 3) *EOS project*: The EOS project may organize certain activities with joint cooperation from members of appropriate sensor and IDS teams. These activities will be executed solely with funding controlled by NASA.
- 4) *United States*: Some activities may be pursued jointly with agencies outside of NASA. For example, work with NOAA and the CO₂ flask network, DOE and the Free-Air Carbon dioxide Enrichment (FACE) program, and the National Science Foundation (NSF) with the Long-Term Ecological Research (LTER) program are logical and desirable. We must be very aware that these plans require ongoing interagency agreement on objectives, funding level etc., and are therefore much more difficult than activities sponsored from within NASA alone.

- 5) *Global*: The final most difficult activities will be international networks of sites and measurements requiring standardized measurement protocols, equipment calibration, archiving plans, etc. These programs can only be organized by international science organizations such as IGBP, WCRP, the International Hydrological Program (IHP), etc. Because the participation of each nation is both essential for global coverage but totally voluntary, these global networks are simultaneously both the most important yet most difficult aspect of EOS validation and monitoring.

Validation of vegetation variables: The Global Terrestrial Observing System (GTOS) and the terrestrial section of the Global Climate Observing System (GCOS) have been developing a 5-Tier approach to defining the level of financial and scientific activity required for different types of validation effort. These tiers recognize the joint necessity of large but temporary projects like FIFE, HAPEX, and BOREAS for certain EOS validations, but more-permanent geographically-distributed facilities like national resource station networks for other global validation activities. This organizing vision is essential for EOS to produce globally-consistent and representative validations of the full suite of land-science products.

5.4.2 Global organization of terrestrial observations

<http://www.wmo.ch/web/gcos/gcoshome.html>

GCOS/GTOS TOP: GCOS was established to provide the observations needed to meet the scientific requirements for monitoring the climate, detecting climate change, and for predicting climate variations and change. It was initiated via a Memorandum of Understanding (MOU) among WMO, the Intergovernmental Oceanographic Commission (IOC) of the United Nations Educational, Scientific, and Cultural Organization (UNESCO), the United Nations Environment Program (UNEP), and the International Council of Scientific Unions (ICSU), which set up a Joint Scientific and Technical Committee (JSTC) and a Joint Planning Office (JPO) located in WMO Headquarters in Geneva to develop the plans and strategy for implementation of the system. The Terrestrial Observation Plan (TOP) is a joint panel established by GCOS and GTOS to assure that a coordinated plan is produced and implemented. The panel made significant progress on drafting the initial terrestrial observation plan which was presented to the JSTC in October 1995. The strategy for implementing the plan is being developed in conjunction with the WCRP and IGBP.

The plan will provide the necessary climate requirements for GTOS and the terrestrial requirements for GCOS. The objective of the plan is to provide a rationale for the structure and implementation of the initial operational system. Following an introductory chapter, the plan describes the uses of the data, provides a rationale for selection of specific variables, describes a design for sampling sites, a rationale for site selection, a short description of the GCOS data and information system, and lays out specific tasks to be completed to implement the system.

The TOP for climate includes elements of hydrosphere, cryosphere, and biosphere. Shifts in temperature and precipitation will affect energy and water balances, which in turn will cause changes in distribution and abundance of vegetation. Shifts in vegetation patterns then feed back directly to climate. Consequently, understanding the interactions between hydrosphere, cryosphere, and the biosphere is important both from the point of view of understanding and predicting climate change and from understanding the effects of climate change on terrestrial ecosystems. One of the most significant accomplishments at the TOP meeting was to agree on a sampling design for the ecological variables. Many hundreds of variables are potential candidates for global climate monitoring, and there are many thousands of potential sample locations. It is neither feasible nor desirable to measure everything, everywhere, all the time. Most variables have characteristic time-and-space domains in which they should be monitored.

Infrastructure Hierarchy: The GCOS/GTOS observation network planning team developed a 5-Tier approach for defining the relative role, capability, and permanence of different research programs and facilities in different countries. These tiers are:

- *Tier 1*: Major experiment sites such as FIFE or BOREAS. Intensive but usually short-term measurements. Global availability < 20
- *Tier 2*: Major permanent research facilities such as the ARM-Cloud and Radiation Testbed (CART) site with complete instrument suite and comprehensive on-site staff. Global availability ~ 30
- *Tier 3*: Permanent research networks such as the U.S. LTER network. Permanent facilities but measurements of regular meteorology, vegetation, hydrology only. Global availability ~ 300
- *Tier 4*: Temporary sampling points for specific variable acquisition. No permanent on-site facilities, but

may be coordinated from a Tier 2-3 station. Global availability ~10,000

- *Tier 5:* Sensor calibration sites with stable radiometry such as White Sands or Railroad Playa

When planning different measurement/monitoring activities, it is useful to suggest the Tier that each site would best fall into for purposes of organizing activities appropriate to the infrastructure required.

5.4.3 EOS IDS field sites

Various programs have been proposed to validate both remotely-sensed data and model fields derived from EOS products. This effort must be international and span a wide range of climates and biomes, and it must be a long-term effort to maintain a level of confidence in the data sets. A number of basin-to-regional-scale validation and process study efforts and how they fit into each IDS team's overall effort are summarized below. Of primary importance in these investigations is the continuing need and support required to carefully validate satellite observations, algorithms, and model results with comparable-scale ground observations.

5.4.3.1 A/SA: Sahel and Upper San Pedro River basins

IDS: Utilization of EOS data in quantifying the processes controlling the hydrologic cycle in A/SA regions

PIs: Y. Kerr and S. Sorooshian

Two EOS IDS teams were combined to better study hydrologic processes of A/SA regions. The U.S. team has been developing process models starting at the local-watershed-to-regional scale while the French team is more concerned with large-scale operational remote-sensing issues, using existing and planned satellite missions (both EOS and international). Each team is working toward linking their findings at intermediate scales. A degree of model simplification has been achieved by considering the discontinuous nature of storm and interstorm processes that are common in A/SA environments.

Both teams devote considerable resources toward maintaining regional calibration/validation sites and activities in the African Sahel (Hapex-Sahel; Prince et al. 1995) and southeast Arizona (Upper San Pedro and Walnut Gulch; Kustas and Goodrich 1994) regions. An international, multi-agency, trans-border effort called the SALSA Program is being organized to study regional issues and mesoscale modeling with significant leadership

and participation by this group (Wallace 1995). Areas of primary interest include scaling, remote sensing, and process studies in semi-arid mixed grass-shrub watersheds including: geographic information system (GIS) development (particularly around riparian stream corridors), retrospective land-use studies, mesoscale modeling, rain-fall-runoff modeling, and soil moisture data assimilation, and collaboration with the United States Department of Agriculture (USDA) Walnut Gulch Experimental watershed, the SALSA project, and EOS Instrument Team (IT)/IDS calibration/validation efforts. The nested approach followed by this group involves calibration and validation activities at a range of scales from the 10^2 km² Walnut Gulch watershed to the 10^6 km² Lower Colorado watershed (Figure 5.17; Michaud and Sorooshian 1994).

5.4.3.2 Biogeochemical analysis of savanna ecosystems

IDS: Using multi-sensor data to model factors limiting the carbon balance in global arid and semi-arid lands

PI: Dave Schimel

The Schimel-IDS team is studying the responses of global grasslands to global change. This team is emphasizing carbon-cycle processes, primary productivity, and biogeochemical cycling. The team uses the Century ecosystem model and specializes in soil carbon and nutrient cycling limits on global grasslands (Parton et al. 1993; Schimel et al. 1994). Savanna ecosystems cause special problems for estimating FPAR and LAI for tree/

FIGURE 5.17

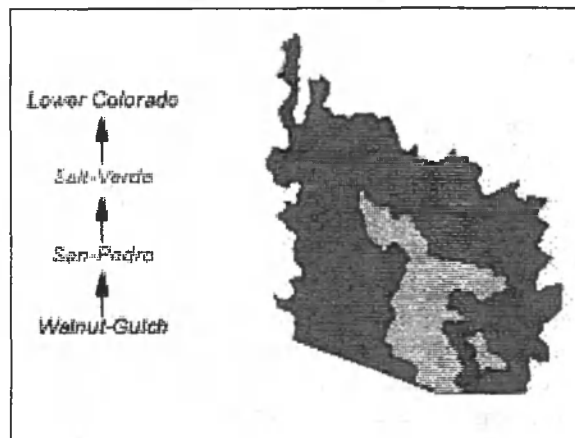

Use of nested watersheds to provide a multiple-scale analysis of hydrologic processes from 10^2 to 10^6 km² in the southwestern United States (Michaud and Sorooshian 1994).

grass mixtures. A primary research site is the La Copita savanna in the Rio Grande Plains of Texas with secondary sites in Africa and China. Applications of this research will have high value for range resource management worldwide. The team also is developing global biospheric models, and is participating in the VEMAP project for model intercomparisons (VEMAP 1995).

5.4.3.3 *Humid/coastal: Susquehanna River Basin Experiment (SRBEX)*

IDS: Global water cycle—extension across the Earth sciences

PI: E. Barron

A series of nested and coupled models spanning a range of scales will be used to translate large-scale GCM results to shorter space-time scales. The goal is to produce global-change predictions at a spatial scale which is appropriate to assess their impact. A primary task in this effort is the collection of useful initialization/validation data sets and the integration of regional studies. To date, much of the emphasis of the project has been in conjunction with SRBEX. This team has an extensive and on-going study looking at technology and management issues in this humid, mixed-use coastal region including: comprehensive GIS development; hydrologic and meteorologic studies; remote sensing; and evaluation of a soil hydrology model, mesoscale atmospheric model, and a GCM to study scale and parameter issues. Water chemistry and human influences are also being studied.

5.4.3.4 *SGP: Arkansas/Red River basins*

IDS: Hydrologic processes and climate

PI: W. Lau

This group is focusing ground validation efforts in the Arkansas-Red River basins, which include most of Oklahoma. A rich cache of pre-EOS satellite and ground data sets exist in this area for scale and process-model studies including: AVHRR, SSM/I, GOES, NEXRAD, river stage, atmospheric structure, and soil moisture. The approximately coincident CART-ARM and Oklahoma Mesonet networks provide an especially rich base level of meteorologic and atmospheric information. Local-scale remote-sensing studies have been made across the Little Washita sub-watershed (Schmugge et al. 1994). Other activities planned in this central semi-humid grassland

province include: comprehensive GIS development, rainfall-runoff modeling, collaboration with USDA Chickasaw and Little Washita Experimental watershed, DOE CART-ARM SGP study area, the proposed Cooperative Atmosphere-Surface Exchange Study (CASES) Walnut Creek site, soil moisture studies, and EOS IT/IDS calibration/validation.

This IDS investigation has a significant land-atmosphere sub-group working on a variety of model and data issues. The larger group is focused on developing a better understanding, improved models, and linkages between the major hydrologic domains of atmosphere, ocean, and land. E. Wood is working with the MODLAND-Running team to develop and validate the MODIS standard ET and surface resistance products using field data from the Arkansas/Red River basin area.

5.4.3.5 *LSM parameterizations from FIFE and BOREAS campaigns*

IDS: Biospheric-atmospheric interactions

PIs: P. Sellers and H. Mooney

The unique approach adopted by this group has been to link canopy-scale processes to leaf-scale properties. Not only have they helped investigate fundamental processes but they have worked hard to link these with remotely-sensed data such that their modeling domain is global (Sellers et al. 1994). In support of the modeling effort, field validation measurements have been made of a humid grassland (FIFE; Sellers et al. 1995a) and the boreal forest of Canada (BOREAS; Sellers et al. 1995b). Each of these studies has been well-supported with a wide range of ground, aircraft, and satellite measurements of surface energy fluxes, CO₂, and vegetation parameters. Additional validation studies are planned in collaboration with GCIP and the Large Scale Biosphere-Atmosphere Experiment in Amazonia (LBA). This group has refined the Simple Biosphere (SiB) model (Sellers et al. 1996a) and has been able to calibrate it in many environments, particularly those dominated by an active canopy. The current model, SiB2-GCM, realistically simulates energy, water, and carbon exchanges from short-to-interannual time scales. It incorporates a state-of-the-art canopy photosynthesis-conductance model and uses vegetation boundary conditions extracted from global satellite data. Future plans call for linking SiB2 with the CASA carbon model.

5.4.3.6 *Tropical: Amazon*

IDS: Patterns and processes of change in the Amazon River Basin - The EOS Amazon Project

PIs: J. Soares and T. Dunne

The EOS Amazon Project is collating and mapping ground-level data on precipitation and stream flow to estimate regional-scale rainfall-runoff relationships and evaporation fields. Mathematical models of hydrologic processes at three scales (10^7 , 10^2 - 10^4 , and 1-10 km^2) then allow the analysis of flow paths, storage, and water yields, and their alteration through climate change and anthropogenic disturbance. These models require the collation of ground-level and remotely-sensed data on vegetation, soils, radiation, and air and canopy temperature with other data generated by atmospheric models. Validation of the hydrologic models is presently accomplished through comparisons of measured and predicted streamflow, but the era of EOS missions holds out the promise of incorporating temporal and spatial distributions of canopy characteristics and valley-floor water storage into the validation. The next phase of this Project will involve a mesoscale (10^2 - 10^4 km^2) comparison of two basins in western Brazil. One retains a more-or-less pristine forest cover, while the other is massively deforested.

5.4.3.7 *Global biogeochemical cycles*

IDS: Changes in biogeochemical cycles

PI: B. Moore

The Moore-IDS team has as its ultimate goal the generation of a dynamic Earth System Model incorporating full atmosphere-ocean-terrestrial coupling. In the land-science domain, B. Moore has coordinated the PIK-NPP project of intercomparisons of terrestrial NPP models (Moore and Cramer 1996). J. Melillo has led the VEMAP project intercomparing GCM-driven biogeography and biogeochemistry models, participating with their TEM (VEMAP 1995). C. Vorosmarty is assembling a Global River and Drainage Basin Archive Series for use with continental-scale hydrologic models. This series will include all archived river-discharge data, lake levels, sediment and water quality records, and related socioeconomic data for all major global rivers. The Water Balance Model has been used to study biogeochemical transport via river discharge from terrestrial sources to oceanic sinks (Vorosmarty et al. 1996; Vorosmarty and White 1996).

These component models will be assembled in the EOS era to provide fully coupled global modeling capabilities.

5.4.3.8 *Canadian studies of carbon and hydrologic cycles*

IDS: Northern biosphere observation and modeling experiment

PI: J. Cihlar

The Northern Biosphere Observation and Modeling Experiment (NBIOME) project is evaluating responses of northern latitude ecosystems to globally-changing conditions of climate, atmospheric chemistry, and human activity. Climatic change is predicted to be largest at high latitudes. Chen and Cihlar (1996) have addressed the special problems of extracting vegetation biophysical properties from optical sensors under the extreme illumination angles of high latitudes. A regional-scale computation of forest productivity for the entire province of Quebec using FOREST-BGC parameterized by AVHRR data has been recently completed (Liu et al. 1996). Extrapolation of these same technologies to the circumpolar boreal forest is planned after the launch of the EOS AM-1 platform. Understanding the role of boreal biomes as sources or sinks of CO_2 will be one result of these studies.

5.4.3.9 *Cryospheric System (CRYSYS)*

IDS: CRYSYS used to monitor global change in Canada

PI: B. Goodison

Every aspect of CRYSYS is under investigation by an IDS team hosted by Canadian agencies and universities. Its objective is an improved understanding of the climate system through monitoring, modeling, and process studies within the Canadian cryosphere. A challenge to EOS is to take these products developed in a uniquely Canadian environment and supply comparable products globally. Snow-cover and snow-climatology studies are the most critical components from the land-surface hydrology perspective. Existing techniques that estimate snow cover from satellite (microwave) data have been improved. New, operational techniques for detecting permafrost and for deriving SWE from SSM/I data have been developed. In support of climate monitoring and validation activities, key historical, operational, and research data sets have been assembled and analyzed. Based on

these observations, most Canadian valley glaciers appear to have receded over the last century. Snow validation sites are being maintained across the Canadian Prairie Region and in collaboration with the BOREAS field sites.

5.4.3.10 Seasonally snow-covered alpine basins

IDS: Hydrology, hydrochemical modeling, and remote-sensing in seasonally snow-covered alpine drainage basins

PI: J. Dozier

This investigation involves working on the challenging problems associated with monitoring the source areas and hydrology of much of our fresh-water supply—seasonally snow-covered alpine drainage basins. This group will supply improved algorithms and process models to EOS, including useful code for calculating insolation in topographically-complex regions, snowmelt modeling, and using Landsat data to estimate fractional snow-covered area (Rosenthal and Dozier 1996). There are several operational efforts to measure snow, forecast runoff, and evaluate atmospheric deposition in relation to global climate. Field studies in support of this effort are being conducted in the Sierra Nevada, Rocky Mountains, Austrian Alps, Tien Shen, and Andes. This group will depend heavily on new and high-resolution DEMs supplied by EOS. Unlike many other EOS teams, this group's focus is local, and many standard global-resolution satellite products are unusable. Thus, many of their results emphasize developing technologies at high spatial, temporal, and spectral resolution that will not be supplied by EOS platforms. Considerable effort has been made to adapt to other satellite platforms such as Radarsat, ERS-2, and the Lewis Hyperspectral Imaging system. One particularly relevant result is that a two-frequency, co-polarized SAR is needed to map important snow properties through cloud cover (Shi and Dozier 1995).

5.4.4 Land-vegetation science

Biogeochemistry: At global scales, possibly the most easily validated terrestrial carbon-cycle variable will be seasonal and interannual variability in land surface CO₂ fluxes as monitored by atmospheric CO₂ concentrations (Figure 5.18, pg. 242). To convert the surface fluxes simulated by the terrestrial models to atmospheric concentrations, atmospheric transport models are used for CO₂ source-sink mixing (Heimann and Keeling 1989), then comparisons with the observed dynamics measured at the global CO₂ networks are made (Tans NOAA net-

work and Keeling network). For this strategy to be effective, a higher density of monitoring stations will be needed, with emphasis on mid-continental locations, possibly with very tall (1000 m+) towers. Original locations were chosen to sample oceanic air uninfluenced by local CO₂ sources such as cities. A new effort to organize a more-advanced tower eddy-correlation-based CO₂/H₂O flux network (FLUXNET) globally is under way (Baldocchi et al. 1996). A flux network allows more direct validation of the CO₂ and H₂O fluxes simulated by the terrestrial biogeochemical models, and avoids the large uncertainties brought about by the atmospheric transport modeling used for the CO₂ concentration-based validations. This IGBP-led network acknowledges that there already are almost a dozen continuously operating flux towers globally, needing only international coordination and centralized data archiving. Once established, at least 20 more sites are possible from research teams already active in this research.

Vegetation structure: Global validation of vegetation structural variables will be a tremendous task requiring international cooperation and leadership of groups like IGBP and WCRP. An initial effort is being made beginning in 1996 to identify, organize, geolocate, and digitize all published NPP data for global ecosystems, and to archive them with IGBP-DIS (see Section 5.4.5.3.5). Because vegetation structure is highly heterogeneous in both space and time, and sampling is typically labor intensive, and not easily automated, a large number of study sites will be required. Projects like the Global Landcover Test Site Initiative (GLCTS) are attempting to get high-spatial-resolution (Landsat TM) data for a global array of test sites established by 1997. A project with the NSF Long-term Ecological Research Sites plans to develop sampling procedures for measuring land cover, LAI, and NPP over tens of kilometers efficiently with standard field instrumentation in different biome types represented by the network in the U.S. The IGBP is planning a suite of global climatic/biome gradient transects, such as tropical-desert Australia, that will cross critical continental ecotones between major biomes and measure a variety of climatic and vegetation variables important to EOS.

Terrestrial ecosystems are highly variable in space for two reasons. First, vegetation is inherently controlled by microclimate and soils influences that change at the kilometer level across the Earth's surface. Second, human activity has dramatically changed the landscape down to even the hectare scale. Terrestrial ecosystems are equally variable in time, particularly at higher latitudes. The seasonal germination, growth, maturation, and se-

FIGURE 5.18

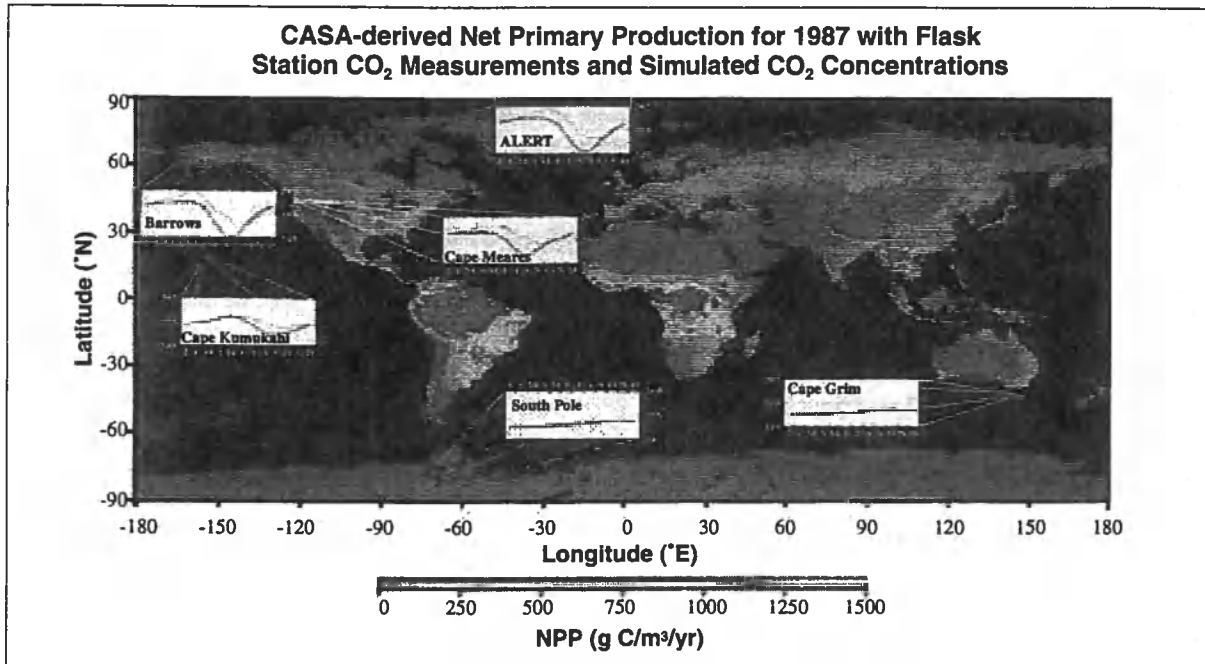

Use of the global flask network of seasonal atmospheric CO_2 trends to validate the global NPP map for 1987 produced by the CASA terrestrial biogeochemical cycle model (Field et al. 1995).

nescence (or harvest) of vegetation is well known, and illustrates that certain measures of vegetation may need to be repeated as often as monthly for any accuracy. Perennial vegetation such as forests are fortunately not as variable temporally, although deciduous forests have a very seasonal canopy cover.

Consequently, any terrestrial validation measurements must be very explicit about the size of area being represented by the data, and the temporal frequency required for remeasurement. It appears that there are two primary categories of terrestrial vegetation measurements possible for EOS validation over multi-kilometer scales. One class is the vegetation structural measurements that can be taken by field crews using routine field ecology techniques. These include land cover, LAI, and NPP. The other class of measurements is the automated atmospheric CO_2 monitors and eddy correlation flux towers.

While the measurement of the structural variables is straightforward in the field on sub-hectare-size plots, they are samples that require extrapolation to at least kilometer scales for use as EOS validations. Also these measures have varying temporal stability. The plan is to treat land cover as a rather conservative variable, needing remeasures only every five years. Various land-cover maps have been created for large areas, even entire coun-

tries. The only usable ones for EOS validation are databases derived from satellite data so that they are measuring existing, not potential vegetation, and are relatively current and repeatable, as land cover changes over time (Running et al. 1994).

LAI may require at least two measures per year, a winter minimum and a summer maximum. The time sequence of LAI through the growing season is a useful validation for APAR models of NPP. However the remeasure frequency would need to be at least monthly, so it is feasible only at the most intensive study sites. The spring greenup or canopy leafout, often termed spring phenology is a very sensitive measure of climate-vegetation interactions, and can be observed and monitored with particular accuracy over large areas. Fall canopy senescence and leaf drop is much more complicated ecologically and much less observable.

NPP is the single most measured field ecology variable, and so a large global database exists of expected values. The critical difficulty is that nearly all reported measurements are on tiny study plots, often 0.1ha. NPP may be most easily represented as accumulated NPP at the end of the growing season although that misses some seasonal dynamics in certain biome types.

The tower-based measurements are able to represent ecosystem carbon-cycle biogeochemical dynamics over larger areas that are difficult to define; the reference area is a function of the height of the tower and upwind dynamics. In general, these techniques are the only real possibility for regional-scale carbon-balance monitoring. They measure net ecosystem production as the difference between net CO₂ uptake by photosynthesis and net ecosystem CO₂ evolution from plant respiration and soil litter decomposition. However, these measurements cannot separate the components of the system CO₂ flux—biospheric models are used for that deconvolution.

Measurement or monitoring of radiometric variables to validate products such as surface reflectance, BRDF, and MVIs require very different plans because of the extreme temporal and spatial variability of solar radiation delivered to the terrestrial surface.

5.4.5 Terrestrial validation activity

5.4.5.1 Tier 1 major field experiments

Global terrestrial carbon models have progressed from simple aggregate budget calculations to relatively mechanistic models including key processes of photosynthesis, respiration, and decomposition specific to given biome types. Major large-scale experiments have been run in a number of biomes to build understanding and tools for spatial scaling. HAPEX, FIFE, the European International Project on Climate and Hydrological Interactions between Vegetation, Atmosphere, and Land Surfaces (ECHIVAL), OTTER, the BOREAS, amongst others, have all had the common objective of developing biophysical techniques and remote sensing to spatially upscale terrestrial surface processes to regional landscapes. These major experiments measure both vegetation structural variables and flux variables from towers. However, these projects typically have intensive field seasons for 1-3 years followed by data analysis and modeling; they are not designed as long-term monitoring programs. The Tier 2 permanent research facilities are better suited for biospheric monitoring programs.

5.4.5.1.1 Past experiments

5.4.5.1.1.1 First ISLSCP Field Experiment (FIFE)

FIFE was conducted across a 15- × 15-km patchwork of burned and unburned prairie near Manhattan, Kansas, during four intensive field campaigns (IFCs) between 1987 and 1989. The objectives of this experiment were two-fold: 1) to test and improve the upscaling of micrometeorological models from scales of 1 m to 1 km

and 2) to investigate the use of satellite remote sensing to infer climatologically-significant land-surface parameters. Fluxes of heat, moisture, CO₂, and radiation were measured across the surface and in the air using a wide variety of instrumentation and compared with estimates from satellite sensors. Many of these results have been reported in two special issues of *Journal of Geophysical Research* (Sellers et al. 1992 and 1995).

Soil moisture, photosynthetic capacity, canopy density, and conductance were among the most important variables identified by FIFE scientists. At a larger scale, precipitation, topography, and the diurnal variability of radiative forcing significantly affect surface fluxes. However, surface physiological feedbacks are more important than variable atmospheric forcings in controlling surface fluxes. This result emphasizes the need to physically characterize the vegetation surface and not expect that the atmosphere will control the fluxes: "...vegetation physiology actively damps out large variations in surface energy budget forced by diurnal variations in atmospheric conditions...." Soil respiration and photosynthetic rates appeared to be closely coupled. Soil moisture is particularly important below the wilting point, where it starts to affect stomatal conductance, and above field capacity as soil evaporation begins to dominate transpiration.

5.4.5.1.1.2 HAPEX-Sahel

HAPEX-Sahel (Hydrologic Atmospheric Pilot Experiment in the Sahel) was an international program focused on the soil-plant-atmosphere energy, water, and carbon balance in the west African Sahel (Prince et al. 1995). It was intended to improve our understanding of the interaction between the Sahel and the general atmospheric circulation, both at present and in the future, providing a baseline for studies of climate change. It was carried out in a 1° × 1° area of west Niger over a 3-to-4-year period with an 8-week intensive observation period from August to October 1992. HAPEX-Sahel was funded by a wide range of agencies in seven participating countries. Over 170 scientists visited and worked in the field. An interdisciplinary approach was adopted with contributed studies in hydrology and soil moisture; surface fluxes and vegetation; remote-sensing science; and meteorology and mesoscale modeling. Detailed field measurements were concentrated at 3 ancillary sites. Four aircraft were used for remote sensing and flux measurement. Observations from space were acquired from nine sensors on seven different satellite platforms.

5.4.5.1.1.3 ECHIVAL Field Experiment in Desertification-Threatened Areas (EFEDA)

EFEDA addressed global-change issues, mainly land degradation and desertification processes in the semi-arid region of Castilla la Mancha in southern Spain. Interactions of land-surface processes, mesoscale atmospheric circulations, and impacts of human activities (like rapidly falling groundwater levels) were assessed. From the experiment conclusions may be drawn for a sustainable use of the natural resources in the Mediterranean and other semi-arid regions. EFEDA has made available data for the regions that cover a wide range of hydrological, vegetation, and atmospheric information. Through these data the representation of energy, water, and CO₂ fluxes between vegetation and the atmosphere has been improved substantially for semi-arid regions.

5.4.5.1.1.4 BOREAS

BOREAS is a large-scale international field experiment that has the goal of improving our understanding of the exchanges of radiative energy, heat, water, CO₂, and trace gases between the boreal forest and the lower atmosphere (Sellers et al. 1995). An important objective of BOREAS is to collect the data needed to improve computer simulation models of the processes controlling these exchanges so that scientists can anticipate the effects of global change.

From August 1993 through September 1994, a continuous set of monitoring measurements—meteorology, hydrology, and satellite remote sensing—were gathered over the 1000 × 1000-km BOREAS study region that covers most of Saskatchewan and Manitoba, Canada. This monitoring program was punctuated by six campaigns that saw the deployment of some 300 scientists and aircrew into the field, supported by 11 research aircraft. The participants were drawn primarily from U.S. and Canadian agencies and universities, although there were also important contributions from France, the United Kingdom, and Russia. The field campaigns lasted for a total of 123 days and saw the compilation of a comprehensive surface-atmosphere flux data set supported by ecological, trace gas, hydrological, and remote-sensing science observations. The surface-atmosphere fluxes of sensible heat, latent heat, CO₂, and momentum were measured using eddy correlation equipment mounted on a surface network of ten towers complemented by four flux-measurement aircraft. All in all, over 350 airborne missions (remote sensing and eddy correlation) were flown during the 1994 field year.

Preliminary analyses of the data indicate that the area-averaged photosynthetic capacity of the boreal forest is much less than that of the temperate forests to the

south. This is reflected in very low photosynthetic and carbon drawdown rates, which in turn are associated with low transpiration rates (< 2 mm day⁻¹ over the growing season for the coniferous species in the area). The strong sensible fluxes generated as a result of this often lead to the development of a deep dry planetary boundary layer over the forest, particularly during the spring and early summer. The effects of frozen soils and the strong physiological control of ET in the biome do not seem to be well represented in most operational GCMs of the atmosphere.

Analyses of the data have continued through 1995 and 1996. Some limited revisits to the field are anticipated.

5.4.5.1.1.5 OTTER

The OTTER project in Oregon studied a climatic gradient that represents nearly the global range of LAI of evergreen forests but with small study plots (Peterson and Waring 1994). This gradient is 200-km long from the ocean into the desert, and provides three land covers (crop, evergreen forest, and shrubland). The objective of the OTTER study was to test the ability to use remotely-sensed vegetation biophysical variables to accurately parameterize an ecosystem biogeochemical simulation model for landscape-scale processes. The intensive study period was summer 1990, and included acquisitions from satellite- and aircraft-mounted sensors. Remote sensing of forest LAI and canopy chemistry was tested, and model simulations of NPP and stand biomass development were executed. Details are available in a special issue of *Ecological Applications* (Peterson and Waring 1994).

5.4.5.1.2 Opportunities from current and future experiments

5.4.5.1.2.1 The Large Scale Biosphere-Atmosphere Experiment in Amazonia (LBA)

LBA is an international research initiative led by Brazil. It is designed to create the new knowledge needed to understand the climatological, ecological, biogeochemical, and hydrological functioning of Amazonia, the impact of land-use change on these functions, and the interactions between Amazonia and the Earth system. LBA is centered around two key questions that will be addressed through multi-disciplinary research, integrating studies in the physical, chemical, biological, and human sciences:

- How does Amazonia currently function as a regional entity?
- How will changes in land use and climate affect the biological, chemical, and physical functions of

Amazonia, including the sustainability of development in the region and the influence of Amazonia on global climate?

In LBA, emphasis is given to observations and analyses which will enlarge the knowledge base for Amazonia in six general areas: physical climate, carbon storage and exchange, biogeochemistry, atmospheric chemistry, hydrology, and land use and land cover. The program is designed to address major issues raised by the Climate Convention of Rio de Janeiro in 1992. It will help provide the basis for sustainable land use in Amazonia, using data and analysis to define the present state of the system and its response to observed perturbations, complemented by modeling to provide insight into possible changes in the future.

<http://yabae.cptec.inpe.br/LBA/>

5.4.5.1.2.2 GCIP

As part of an overall scientific strategy of the WCRP and GEWEX to improve global climate predictability, the GEWEX Continental-Scale International Project (GCIP) was formed in 1990. The overall goal of GCIP is to improve climate models by bridging the gap between small scales appropriate for modeling discrete processes over land and large scales practical for modeling the global climate system. The primary objectives of GCIP are to determine the variability of the Earth's hydrological cycle and energy exchange budget over a continental scale; to develop and validate techniques for coupling atmospheric and surface hydrological processes in climate models; and to provide a basis for translating the effects of future climate change to impacts on regional water resources.

The Mississippi River basin was selected as the GCIP study site because of its extensive hydrological and meteorological observation network. Part of the initial phase of GCIP is to build up the science base and technical expertise on regional, continental-scale processes. Included in this first phase are plans for a 5-year period of enhanced observations commencing in late 1995. The surface-based, model-derived, and spaceborne data will be used to develop models that couple complex atmospheric and surface hydrological processes that can operate on a wide range of space scales. A second phase of GCIP will focus on extending this capability to the global scale, using observations that will be forthcoming towards the turn of the century from the next generation of Earth observing satellite systems.

http://www.ncdc.noaa.gov/gcip/gcip_home.html

5.4.5.1.2.3 CART-ARM

The Atmospheric Radiation Measurement (ARM) Program is a multi-laboratory, interagency program that was created in 1989 with funding from the U.S. DOE. The ARM Program is part of DOE's effort to resolve scientific uncertainties about global climate change with a specific focus on improving the performance of GCMs used for climate research and prediction. These improved models will help scientists better understand the influences of human activities on the Earth's climate. In pursuit of its goal, the ARM Program establishes and operates field research sites, called CARTs, in several climatically-significant locales. Scientists collect and analyze data obtained over extended periods of time from large arrays of instruments to study the effects and interactions of sunlight, radiant energy, and clouds on temperatures, weather, and climate.

<http://info.arm.gov/>

5.4.5.1.2.4 CASES

A CASES site is being established within the ARM-CART research area to provide a facility for scientists to study mesoscale processes of meteorology, hydrology, climate, ecology, chemistry, and their complex linkages, and to serve as a focal point to provide field experience for students of the natural sciences. The location of the CASES site is the upper Walnut River watershed north of Winfield, Kansas. Here, boundary layer instrumentation can be deployed such that it coincides with the natural boundaries of the Walnut River watershed. Thus, the boundary layer instrumentation, in conjunction with WSR-88D radars, stream gauges, soil moisture data, topographic and land-use data, mesonet surface data, and atmospheric-hydrologic models, will allow for a detailed description of the hydrologic cycle between the watershed and the atmosphere above. Once fully established, CASES is projected to have a minimum lifetime of three years with possible continuance for the duration of ARM-CART.

5.4.5.1.2.5 Northern Hemisphere Climate-Processes Land-Surface Experiment (NOPEX)

NOPEX is devoted to studying land-surface-atmosphere interaction in a northern European forest-dominated landscape. The NOPEX main study region was selected to represent the southern part of the boreal zone. Central

Sweden is situated in the middle of the densest part of the northern European boreal forest zone. The main NOPEX region is centrally situated in the Baltic Sea drainage basin, the study region for the Baltic Sea Experiment (BALTEX) project. NOPEX is specifically aiming at investigating fluxes of energy, momentum, water, and CO₂—and the associated dynamics—between the soil, the vegetation, and the atmosphere, between lakes and the atmosphere, as well as within the soil and the atmosphere on local-to-regional scales ranging from centimeters to tens of kilometers.

5.4.5.2 Tier 2-3 validation monitoring for terrestrial fluxes

5.4.5.2.1 FLUXNET and EUROFLUX

Strategies for Monitoring and Modeling CO₂ and Water Vapor Fluxes over Terrestrial Ecosystems (IGBP Core Projects BAHC, Global Change in Terrestrial Ecosystems [GCTE], International Global Atmospheric Chemistry [IGAC]).

New micrometeorological technologies have recently been perfected that allow continuous flux

measurements, and a few sites have begun this data collection. Relative to the high cost of the spatial scaling studies, these continuous flux studies are modest in financial requirement. Since these continuous time CO₂ flux data sets have immense value for global carbon and climate modeling, continuous flux measurements should be encouraged in an array of biomes and climates worldwide. Additionally, an organized flux network with standard measurement and data presentation protocols, and an active centralized archive would make these data, critical for validation and testing carbon balance simulation models, available to the wider global science community most quickly.

Although the primary science justification offered here is carbon-balance-related, hydrologic balances are also of high importance, and will be an integral component of flux network measurements (as they were previously in the large-scale experiments described above). As for the carbon cycle, the non-growing season is also critical for hydrologic balances. The continuous measurements of the terrestrial hydrologic balance and ET, and the vegetation (carbon cycle) controls will con-

TABLE 5.2

<i>SIMPLE INTEGRATED TOWER CONCEPT</i>				
<i>COMPONENT TOWER VARIABLES</i>	<i>VARIABLE DEPENDENCIES</i>			
	<i>EB</i>	<i>ATM</i>	<i>BRDF</i>	<i>TG</i>
- Energy Budget/Surface Meteorology (Euroflux, Fluxnet, etc.)	O	X	X	-
- Atmospheric Corrections, Aerosols (Sun Photometer, Shadow-Band Radiometer, Lidar)	X	O	X	-
- Bidirectional Spectral Radiances (Sun Photometer, CCD Camera)	X	X	O	-
- Trace Gas Fluxes/Concentrations (Carbon America, Tragnet, etc.)	X	X	X	O
<i>FOOTPRINT (100 KM²) VEGETATION ANALYSIS</i>				
- Land Cover	X	X	X	X
- LAI/FPAR	X	X	X	X
- Net Primary Production	X	X	X	X
- Stem and Soil Carbon	X	X	X	X

tribute equally to producing better global hydrologic models.

5.4.5.2.2 Carbon America

Goal: Determine the location and magnitude of regional CO₂ sources and sinks in North America and develop an understanding of the mechanisms for terrestrial carbon storage or loss.

The strategy consists of three elements: 1) monitoring of mixing ratios in the vertical dimension, 2) monitoring of surface fluxes in specific ecosystems with co-located additional measurements relevant to the biogeochemical cycle of carbon, and 3) continental-scale modeling of the carbon cycle and atmospheric transport.

By observing the spatial patterns in more detail than ever before, persistent source/sink regions can be identified so that targeted process studies can be planned. Furthermore, by observing the large flux changes known to occur (from studies of global concentration variations and from continuous flux measurements) as a result of regional climate variations, we can uncover major driving forces of short-term terrestrial C storage.

The general feasibility of uncovering regional fluxes through repeated aircraft sampling, based on an analysis of the signal-to-noise of atmospheric measurements, has been shown in "A feasible global carbon cycle observing system" (Tans et al. 1996, NOAA/Climate Monitoring and Diagnostics Laboratory [CMDL]). It is envisioned that these measurements are carried out for an initial period of five years spanning one El-Niño cycle, in order to make use of and characterize interannual variations. The frequency of the flights should be once or twice per week.

5.4.5.2.2.1 Continuous flux measurements

The first continuous long-term flux measurements have been performed at the Harvard Forest site. These measurements enable us to calculate the net fluxes integrated over the entire year and, more importantly, to study specific mechanisms controlling the rates of C uptake and loss. The true value of continuous flux measurements can only be realized if the measurements are used to test and develop regionally-specific models of the terrestrial carbon cycle, and the observational data sets on which the models are based. In this way the local results of the flux measurements can be extrapolated to regional scales. Such a strategy calls for many additional measurements to be performed at each flux site. A partial list of additional projects would be a good ecological characterization of the site including the soil, soil humidity and temperature, PAR, N-deposition, meteorological variables, and fluxes. Land-use histories are also crucial in order to allow the

separation of land-use or management-associated fluxes (forest regrowth) from fluxes associated with climate, nitrogen deposition, CO₂ fertilization, or other unknown processes. There is potential to use isotopic measurements in the atmosphere to infer biological processes (photosynthesis and respiration), in which case the isotopic signatures of precipitation, soil water, new plant material, and microbial respiration must be obtained via field studies at the monitoring sites.

5.4.5.2.3 The United States Trace Gas Network (TRAGNET)

The atmospheric concentrations of greenhouse gases such as carbon dioxide (CO₂), methane (CH₄), and nitrous oxide (N₂O) are increasing substantially. These increases are expected to result in global warming and changes in precipitation patterns, and may directly affect terrestrial ecosystems. TRAGNET is tasked with accomplishing the following two goals:

- Document contemporary fluxes of CO₂, CH₄, and N₂O between regionally-important ecosystems and the atmosphere
- Determine the factors controlling these fluxes and improve our ability to predict future fluxes in response to ecosystem and climate change

The proposed network is designed to contribute to our understanding of trace gas fluxes to the atmosphere through six principal objectives.

- 1) The network will promote the comparability of trace gas flux measurements. As discussed later in this report, the network will provide guidance on sampling designs that are site-appropriate; provide suggestions and updated information on appropriate analytical and sample collection methods; and facilitate intercomparisons and intercalibrations.
- 2) The network will provide for more-extensive coverage of ecosystem variability. Identification of regions where no long-term measurements are available, or where replication is needed, will be assessed; the network participants can then encourage the development of research sites in such areas.
- 3) Data synthesis will be facilitated by the network. Data collected from sites that span a range of controlling factors or that represent a range of ecoregions will be available to the group for synthesis and hypothesis setting.

TABLE 5.3

<i>SPECIFIC VARIABLES MEASURED</i>
<i>Surface meteorology</i>
- incoming and outgoing shortwave radiation, diffuse, and direct
- incoming and outgoing longwave radiation
- temperature (air, soil, surface temperature + profile)
- canopy and soil heat fluxes
- wind speed and direction
- relative and absolute humidity
- barometric pressure
<i>Atmospheric properties and corrections</i>
- spectral aerosol optical thickness
- total precipitable water vapor
- particle size distribution
- phase function
- single scattering albedo
<i>Bidirectional spectral radiances</i>
- spectral albedos
- vegetation indices
- directional reflectances
- seasonal reflectance dynamics
<i>Trace gas fluxes</i>
- eddy correlation fluxes of CO ₂ and H ₂ O
- flask measures of isotopic ratios of C, H, and N
- CH ₄ and N ₂ O
<i>Footprint terrestrial ecology</i>
- land-cover class
- leaf-area index
- net primary production
- stem and soil carbon storage

- 4) Interactions between measurement and modeling groups will be facilitated by the network. Data collection at appropriate frequency and spatial scales will allow model development and model testing. Hypotheses generated from the model synthesis activities will foster new field research.
- 5) Intercomparisons of model results will be facilitated. It will be possible to make comparisons that utilize

identical estimates of input and output. In addition, model modularity will be developed where possible, facilitating the identification of reasons models produce different results.

- 6) A long-term data archive for trace gas flux and other ecosystem processes will be established as a component of the network. The purpose of the network is to foster a better understanding of midlatitude trace gas contributions to the global budget by facilitating data access and interactions among those measuring and modeling gas fluxes.

5.4.5.3 Tier 3-4 permanent ecological field station networks

5.4.5.3.1 NSF LTER Project, MODLERS

This project brings together 14 LTER Network sites and NASA's MODLAND Science Team for the purpose of locally validating EOS-era global data sets. Using several standardized methods that incorporate extensive ground data sets, ecosystem models, and remotely-sensed imagery, each LTER site is developing local maps of land-cover class, LAI, and above-ground net primary productivity for a 100 km² area at a grain size of 25 m. A nested, hierarchical ground-based sampling scheme will help establish error bounds on the variable estimates. These sites represent evergreen forests, deciduous forests, grasslands, croplands, shrublands, deserts, and alpine mountains for a reasonable sampling of biome types for MODLAND tests.

A number of different strategies are being used to spatially aggregate the fine-grain site maps to a coarse grain (1 km) so that they can be compared to coincident portions of global maps of the same three biosphere variables developed by the MODLAND Science Team. This coordinated, multi-site grain-size aggregation exercise presents us with an opportunity to grapple with one of the most vexing current problems in ecology: effects of scaling from a fine grain to a coarse grain on estimates of important biosphere variables. We are using several spatially-explicit, geostatistical methods to address this issue, with the intent of determining how best to maintain crucial information among grain sizes. Additionally, we are characterizing similarities and differences among the multiple sites and biomes and between the MODLAND maps and the site maps at each grain size, in terms of the three mapped biosphere variables.

<http://atlantic.evsc.virginia.edu/~jhp7e/modlers/>

5.4.5.3.2 GLCTS: The Global Land Cover Test Site Program

The Global Land Cover Test Site (GLCTS) project is developing a multitemporal data set of satellite imagery for a globally-distributed set of test sites. This data set will provide a resource for research on land-cover characterization and the testing of algorithms for EOS. The selected test sites will represent a wide range of land-cover types and will be well characterized on the ground, have ongoing field-based observation programs, and be of interest to the international global change research community. GLCTS development is being coordinated with a number of affiliated organizations. It is currently proposed that between 40-80 sites be developed for broad land-cover representation. The initial site selection process has identified a set of established and emerging long-term monitoring sites where there is in-situ expertise and infrastructure to facilitate research. Candidate sites under consideration are displayed on the GLCTS homepage. The database to be created for each of the selected sites will consist of a common set of Landsat, AVHRR, land-cover, and elevation data.

<http://glcts.maxey.dri.edu/glcts/index.html>

5.4.5.3.3 IGBP terrestrial transects

The IGBP Terrestrial Transects are a set of integrated global-change studies consisting of distributed observational studies and manipulative experiments coupled with modeling and synthesis activities organized along existing gradients of underlying global-change parameters, such as temperature, precipitation, and land use. The global-change issues that can best be addressed with the gradient approach include questions where a long period of prior equilibration is required, spatial context is essential, identification of thresholds along a continuum is important, and gradient-driven processes are important. The transect approach also promotes collaborative, interdisciplinary research and leads to an efficient use of scarce scientific resources.

The IGBP Terrestrial Transects consist of a set of study sites arranged along an underlying gradient; they are of order 1000 km in length and are wide enough to encompass the dimensions of remote-sensing images. The transects can be visualized most easily where they represent a simple gradient of a single controlling factor that varies in space, for example, the gradient in precipitation from moist tropical forest to dry savanna. In addition to relatively straightforward transects in which a single environmental factor varies continuously in space, a set of IGBP Terrestrial Transects has been identified in which the underlying gradient is one of land use.

The initial set of IGBP Terrestrial Transects is located in four key regions, with three or four existing, planned, or proposed transects contributing to the set in each region.

IGBP -	http://www.ciesin.org/TG/HDP/igbp.html
BAHC -	http://www.PIK-Potsdam.DE/~bahc/
GCTE -	http://jasper.stanford.edu/GCTE/main.html
GAIM -	http://pyramid.sr.unh.edu/csrg/gaim/
IGAC -	http://web.mit.edu/afs/athena.mit.edu/org/iigac/www/

5.4.5.3.4 The Gap Analysis Project (GAP)

Gap Analysis provides a quick overview of the distribution and conservation status of several components of biodiversity. It seeks to identify gaps (vegetation types and species that are not represented in the network of biodiversity management areas) that may be filled through establishment of new reserves or changes in land management practices. Maps of existing vegetation are prepared from satellite imagery (Landsat) and other sources and entered into a GIS. Because entire states or regions are mapped, the smallest area identified on vegetation maps is 100 ha. Vegetation maps are verified through field checks and examination of aerial photographs.

Although Gap analysis is coordinated by the National Biological Survey, it is composed of (to date) over 200 collaborating organizations from businesses, universities, and state, local, and federal governments. Thirty-seven states are currently developing GAP analysis maps of land-cover habitat types. When these maps are complete, the land-cover classes can be aggregated into MODLAND land-cover classes which, being for global use, are much more general. The GAP maps will then provide a TM-scale validation of the MODLAND land covers for these areas of the US.

<http://www.nr.usu.edu/gap>

5.4.5.3.5 IGBP NPP data initiative

Global modeling and monitoring of NPP is currently a high-priority issue because of increasing concern over issues such as the consequences of perturbations in the carbon cycle, the impacts of global land-use change, global climate change, and global food security. Monitoring primary production provides information on many inter-related ecological processes as well as the flux of carbon dioxide from the atmosphere. Georeferenced estimates of NPP, including seasonal and interannual variability, are

key components for modeling of the terrestrial carbon cycle and its response to climate change and CO₂ fertilization.

During the past few years, a coordinated strategy to improve global estimates of terrestrial primary production through measurements and modeling has emerged. An essential part of this effort is compiling a reference database of NPP ground-based data to parameterize and validate global ecosystem models. Such data are important to diagnostic-parametric models (using satellite remote sensing), correlative-empirical models (based on

climate regressions), or more mechanistic biogeochemical models. The need for NPP reference data has been endorsed by IGBP's scientific committees of Data and Information System (DIS); Global Analysis, Interpretation, and Modeling (GAIM); GCTE; BAHC; and by the ICSU Scientific Committee on Problems of the Environment (SCOPE).

In addition, the Global Terrestrial Net Primary Productivity First Model Intercomparison Workshop, hosted by PIK at Potsdam, Germany, in July 1994, resulted in a recommendation to develop and distribute a database of

TABLE 5.4

<i>P/DURATION</i>	<i>INSTITUTE</i>	<i>FIELD SITE</i>	<i>VEGETATION</i>
Wofsy/4yrs+	Harvard Univ	Harvard Forest, MA	temperate deciduous forest
Wofsy/1yr+	Harvard Univ.	Thompson, Manitoba	boreal spruce forest
Jensen/5yrs+	RISO	Roskilde, Denmark	crops
Valentini/2yrs+	Univ. Tuscia	Appenines, Italy	beech forest
Baldocchi/2yrs+	NOAA/ATDD	Oak Ridge, TN	temperate deciduous forest
Verma/1yr+	Univ. Nebraska	Valentine, NE	wetlands
Hollinger/6mo+	USFS	Howland, ME	conifer
Meyers/3mo+	NOAA/ATDD	Little Washita, OK	rangeland
Black/1yr	Univ. British Columbia	Prince Albert, Sask.	boreal aspen
Grace	Univ. Edinburgh	Manaus, Brazil	tropical forest
Black	Univ. British Columbia	Prince Albert, Sask.	boreal aspen
Black	Univ. British Columbia	Vancouver, B.C.	Douglas fir
den Hartog	Atmos. Environ. Service	Borden, Ontario	temperate deciduous forest
Field	Carnegie Inst. Wash	Stanford, CA	grassland
Dunin	CSIRO	WaggaWagga, Australia	crops
Desjardins	Agric. Canada	Ottawa, Ontario	crops
Anderson	USGS	Trout Lake, WI	mixed forests
Bakwin	NOAA/CMDL	North Wisconsin	mixed forests
Jarvis	Univ. Edinburgh	Prince Albert, Sask.	boreal spruce
Oechel	San Diego State Univ.	Northern Alaska	tundra
Gholz	Univ. Fla	Florida	slash pine
Miranda		Brazil	cerrado
Kelliher	Landcare	Southern New Zealand	Pinus radiata
Ham	Kansas State Univ.	Manhattan, KS	Konza prairie
Valentini et al.	EUROFLUX project	15 sites in Europe	conifer and broadleaf forests
Baldocchi	NOAA/ATDD	Western Oregon	Ponderosa pine

List of Investigators conducting long-term studies of carbon and water vapor exchange over vegetated ecosystems using the eddy covariance method (+ denotes ongoing operation).

NPP data. The goals of the PIK Workshop, held again in 1995, were to advance the development of terrestrial carbon modeling on global scales through the intercomparison of terrestrial NPP simulation models. Twenty global ecosystem models of NPP have been evaluated in the workshops. The workshops compiled NPP baseline data sets, established intercomparison methodology and protocols, and executed the intercomparison of the model outputs. Comparing the model outputs indicated both spatial and temporal differences and identified a need for validation data.

As a result of the PIK Workshop recommendation, the Global Primary Production Data Initiative Project Description (IGPPDI) (Prince et al. 1995) was prepared and has been endorsed by a steering committee of representatives from the international groups listed above. The initiative will identify and compile reliable NPP data and associated environmental data for field sites and will interpret the data to a range of spatial scales to provide parameterization and validation data needed in support of modeling global primary production and other applications. The IGPPDI includes: 1) identifying and compiling field data sets; 2) scaling field observations to larger grid cells; and 3) storing and distributing data.

These tasks are divided between several institutions, including the Oak Ridge National Laboratory (ORNL), Oak Ridge, Tennessee, U.S. (natural systems); the University of Maryland, College Park (UMCP), College Park, Maryland, U.S. (estimating NPP for grid cells); Laboratoire d'Études et de Recherches en Teledetection Spatiale (LERTS)/Centre d'Études Spatiales de la Biosphère (CESBIO), Toulouse, France (managed systems); and the PIK, Potsdam, Germany (meteorology and other physical variables for the selected sites and cells).

http://www-eosdis.ornl.gov/npp/npp_igbp.html

5.4.6 EOS-related land science modeling plans

5.4.6.1 Project for Intercomparison of LSP Schemes (PILPS)

PILPS is a WCRP project operating under the auspices of GEWEX and WCRP. It has been designed to be an ongoing project. Since its establishment in 1992, PILPS has been responsible for a series of complementary experiments with focuses on identifying parameterization strengths and inadequacies. About 30 land-surface-process modeling groups have been participating in PILPS.

"PILPS is a project designed to improve the parameterization of the continental surface, especially

hydrological, energy, momentum, and carbon exchanges with the atmosphere. The PILPS science plan incorporates enhanced documentation, comparison, and validation of continental surface parameterization schemes by community participation. Potential participants include code developers, code users, and those who can provide data sets for validation and who have expertise of value in this exercise. PILPS is an important exercise because existing intercomparisons, although piecemeal, demonstrate that there are significant differences in the formulation of individual processes in the available land-surface schemes. These differences are comparable to other recognized differences among current global climate models such as cloud and convection parameterizations. It is also clear that too few sensitivity studies have been undertaken, with the result that there is not yet enough information to indicate which simplifications or omissions are important for the near-surface continental climate, hydrology, and biogeochemistry. PILPS emphasizes sensitivity studies with, and intercomparisons of, existing land-surface codes and the development of areally extensive data sets for their testing and validation." (Henderson-Sellers et al., 1993).

<http://www.cic.mq.edu.au/pilps-rice/pilps.html>

5.4.6.2 VEMAP

The overall objective of the VEMAP project is to make an initial determination of the ability of the U.S. vegetation to sequester carbon in a changed global climate. In order to make a fast-track evaluation, a set of leading ecological models was designated to make this assessment. Three biogeochemistry models have been selected, one of them being the BIOME-BGC model (Running and Coughlan 1988; Running and Gower 1991; Running and Hunt 1993). The other biogeochemistry models in the project are Century by Schimel from NCAR and TEM by Melillo from Woods Hole. For objective one, each biogeochemistry model will be run under a current climate and $2 \times \text{CO}_2$ changed-climate scenarios from three GCMs: OSU, GFDL, and UKMO models. Annual NPP, plant and soil carbon sequestration, and ET will be simulated for the continental U.S. objective. The results from each biogeochemistry model will be compared to assess the level of consistency currently possible from leading ecological models for continental-scale carbon-balance questions. In objective three, the simulations from each GCM scenario will also be compared to determine the relative level of uncertainty that can be ascribed to climate modeling versus ecological modeling when asking these continental-scale vegetation response questions.

In a second aspect of the project, three biogeography models will be also run with current and GCM-based changed climate scenarios to assess the possibilities of vegetation biome shifts in the U.S. These are MAPSS by Nielson from OSU, BIOME2 by Prentice from Sweden, and DOLY by Woodward from Britain. In Objective 4, the final set of simulations, the biome distribution changes simulated by these models, will be used to initialize the three biogeochemistry models for the U.S. The BIOME-BGC model will be initialized in turn with MAPSS vegetation, BIOME2 vegetation, and DOLY vegetation, and the results from each model compared, and with each GCM climate base for the continental U.S. These simulations will produce the most comprehensive assessment yet made of the potential response of the U.S. terrestrial vegetation to climatic change because it will entail the three sequentially-linked simulations of global climate—biogeography—biogeochemistry responses.

<http://www.cgd.ucar.edu:80/vemap/>

5.4.6.3 PIK-NPP

Global primary production of ecosystems on land and in the oceans is a crucial component of biogeochemical model development within IGBP. The second in a series

of IGBP GAIM-DIS-GCTE workshops, "Potsdam '95," on global modeling of net primary productivity was held at PIK, June 20-22 1995. The purpose of Potsdam '95, like Potsdam '94, was to support a series of model intercomparisons by the various modeling teams around the globe that are currently modeling the terrestrial biosphere at large scales.

A focus of the intercomparison was net primary productivity. Global primary productivity of ecosystems is a crucial component of biogeochemical model development within IGBP. The subject is complex and central to models of the global carbon cycle. The importance of this subject rests upon the fact that most terrestrial carbon-cycle models, as well as terrestrial models that treat energy and water fluxes, must address in a fundamental manner either gross primary productivity (GPP) and/or NPP. There are significant differences in the calculation of NPP within current global terrestrial models, and Potsdam '95 was held in order to compare model parameters and outputs. One important aspect of the ongoing PIK-NPP project is compilation of a comprehensive database of published NPP measurements globally for all biome types (Prince et al. 1995).

<http://pyramid.sr.unh.edu/csrc/gaim/NPP.html>

<i>Region</i>	<i>Contributing transects in Initial set</i>
Humid tropics	Amazon Basin/Mexico Central Africa/Miombo Southeast Asia/Thailand
Semiarid tropics	Savannas in the Long Term (West Kalahari Southern Africa) Northern Australia Tropical Transect
Midlatitude semiarid	Great Plains (USA) Argentina North East China Transect
High latitudes	Alaska Boreal Forest Transect Case Study (Canada) Scandinavia Siberia

References

- AIP (1993). *The World at Risk: Natural Hazards and Climate Change*, Bras, R. (ed), AIP Conf. Proceedings 277, American Institute of Physics, New York, 352 pp.
- Amell, N. W., 1995: Grid mapping of river discharge. *J. Hydrology*, **167**, 39-56.
- Asrar, G., B. J. Myneni, and B.J. Choudhury, 1992: Spatial heterogeneity in vegetation canopies and remote sensing of absorbed photosynthetically active radiation: A modeling study. *Remote Sens. Environ.*, **41**, 85-103.
- Asrar, G., M. Fuchs, E. T. Kanemasu, and J. L. Hatfield, 1984: Estimating absorbed photosynthetic radiation and leaf-area index from spectral reflectance in wheat. *Agronomy Journal*, **76**, 300-306.
- Avissar, R., 1995: Recent advances in the representation of land-atmosphere interactions in general circulation models. *Rev. Geophys.*, **2**, 1005-1010.
- Avissar, R., and F. Chen, 1993: Development and analysis of prognostic equations for mesoscale kinetic energy and mesoscale (subgrid-scale) fluxes for large scale atmospheric models. *J. Atmos. Sci.*, **50**, 3751-3774.
- Baldocchi, D., R. Valentini, S. Running, W. Oechel, and R. Dahlman, 1996: Strategies for measuring and modeling carbon dioxide and water vapour fluxes over terrestrial ecosystems. *Global Change Biology*, **2**, 159-168.
- Barron, E. J., 1995: Climate Models: How reliable are their predictions?. *Consequences*, **1**(3), 17-27.
- Bonan, G. B., 1995: Land atmosphere CO₂ exchange simulated by a land-surface process model coupled to an atmospheric general circulation model. *J. Geophys. Res.*, **100**, 2817-2831.
- Bonan, G. B., D. Pollard, and S. L. Thompson, 1993: Influence of subgrid-scale heterogeneity in leaf-area index, stomatal resistance and soil moisture on grid-scale land-atmosphere interactions. *J. Climate*, **6**, 1882.
- Bonan, G. B., D. Pollard, and S. L. Thompson, 1992: Effects of boreal forest vegetation on global climate. *Nature*, **359**, 716-718.
- Bougeault, P., B. Bret, P. Lacarrere, and J. Noilhan, 1991: An experiment with an advanced surface parameterization in a mesobeta-scale model. Part II: the 16 June 1986 simulation. *Mon. Wea. Rev.*, **119**, 2374-2392.
- Bouttier, F., J-F. Mahfouf, and J. Noilhan, 1993: Sequential assimilation of soil moisture from atmospheric low-level parameters, part I: Sensitivity and calibration studies. *J. Appl. Meteor.*, **32**(8), 01335-1351.
- Box, E. O., B. N. Holben, and V. Kalb, 1989: Accuracy of the AVHRR vegetation index as a predictor of biomass, primary productivity and net CO₂ flux. *Vegetatio*, **80**, 71-89.
- Carlson, T. N., R. R. Gillies, and E. M. Perry, 1994: A method to make use of thermal infrared temperature and NDVI measurements to infer soil water content and fractional vegetation cover. *Rem. Sens. Rev.*, **52**, 45-59.
- Charney, J.G., W. J. Quirk, S. H. Chow, and J. Kornfield, 1977: A comparative study of the effects of albedo change on drought in semi-arid regions. *J. Atmos. Sci.*, **34**, 1366-1385.
- Chehbouni, A., E. G. Njoku, J.-P. Lhomme, and Y.H. Kerr, 1995: Approaches for averaging surface parameters and fluxes over heterogeneous terrain. *J. Climate*, **8**, 1386-1393.
- Chen, J.M., and J. Cihlar, 1996: Retrieving leaf-area index of boreal forests using Landsat TM images. *Remote Sens. Environ.*, **55**, 153-162.
- Choudhury, B. J., 1995: Relations between evaporation coefficients and vegetation indices studied by model simulation. *Remote Sens. Environ.*, **50**, 1-17.
- Ciais, P., P. Tans, M. Trolier, J. W. C. White, and R. J. Francey, 1995: A large Northern-Hemisphere terrestrial CO₂ sink indicated by the C-13/C-12 ratio of atmospheric CO₂. *Science*, **269**, 1098-1102.
- Cihlar, J., P. H. Caramori, P. H. Schuepp, R. L. Desjardins, and J. I. MacPherson, 1992: Relationship between satellite-derived vegetation indices and aircraft-based CO₂ measurements. *J. Geophys. Res.*, **97**, 18515-18522.
- Crum, T.D., R. L. Alberty, and D. W. Burgess, 1993: Recording, archiving and using WSR-88D data. *Bull. Amer. Meteor. Soc.*, **74**(4), 645-653.
- Delworth, T.L., and S. Manabe, 1988: The influence of potential evaporation on the variabilities of simulated soil wetness and climate. *J. Climate*, **1**, 523-547.
- DeFries, R. S., M. Hansen, and J. Townshend, 1995: Global discrimination of land cover types from metrics derived from AVHRR pathfinder data. *Remote Sens. Environ.*, **54**, 209-222.
- Denning, A.S., I. Y. Fung, and D. Randall, D, 1995: Latitudinal gradient of atmospheric CO₂ due to seasonal exchange with land biota. *Nature*, **376**, 240-243.
- Dickinson, R. E., 1995: Land processes in climate models. *Remote Sens. Environ.*, **51**, 27-38.
- Dickinson, R. E., and P. J. Kennedy, 1992: Impacts on regional climate of Amazon deforestation. *Geophys. Res. Lett.*, **19**, 1947.
- Dickinson, R.E., 1984: Modeling evapotranspiration for three-dimensional global climate models. *Climate Processes and Climate Sensitivity*, J. E. Hansen and T. Takahashi, Eds., American Geophysical Union, Washington, DC, 58-72.
- Dracup, J. A., and D. R. Kendall, 1991: Climate uncertainty: implications for operations of water control systems. *Managing Water Resources in the West under Conditions of Climate Uncertainty*, Nat. Acad. Press, 177-216.
- Dubayah, R., 1992: The topographic distribution of annual incoming radiation in the Rio Grande River basin. *Geophys. Res. Lett.*, **19**(22), 2231-2234.
- Emanuel, K., 1987: The dependence of hurricane intensity on climate. *Nature*, **326**, 483-485.
- Entekhabi, D., 1995: Recent advances in land-atmosphere interaction research. *Rev. of Geophys.*, **2**, 995-1003.
- FAO Soil Map of the World (1978), scale 1:5,000,000, UNESCO, Paris, Vols. I-X.
- Famiglietti, J. S., and P. Houser, 1995: Spatially-distributed hydrological modeling with soil moisture remote sensing applications at Walnut Gulch, AZ. Presented at Fall AGU, San Francisco.
- Field, C. B., J. T. Randerson, and C. M. Malmstrom, 1995: Global net primary production: Combining ecology and remote sensing. *Remote Sens. Environ.*, **51**, 74-88.
- Gao, X., and S. Sorooshian, 1994: A stochastic precipitation disaggregation scheme for GCM applications. *J. Climate*, **7**(2), 238-247.
- Gillies, R. R., and T. N. Carlson, 1995: Thermal remote sensing of surface soil water content with partial vegetation cover for incorporation into climate models. *J. Appl. Meteor.*, **34**, 745-756.
- Gong, G., D. Entekhabi, and G. Salvucci, 1994: Regional and seasonal estimates of fractional storm coverage based on station precipitation observations. *J. Climate*, **7**, 1495-1505.
- Goward, S. M., and K. E. Huemmerich, 1992: Vegetation canopy PAR absorptance and the Normalized Difference Vegetation Index: An assessment using SAIL model. *Remote Sens. Environ.*, **39**, 119-140.

- Goward, S. N., C. J. Tucker, and D. G. Dye, 1985: North American vegetation patterns observed with the NOAA-7 Advanced Very High Resolution Radiometer. *Vegetatio*, **64**, 3-14.
- GRDC, 1996: Activities of the global runoff data center, GEWEX SSG meeting, Irvine CA, 1/15-19/96.
- Haarsma, R., J. Mitchell, and C. Senior, 1993: Tropical disturbances in a GCM. *Climate Dynamics*, **8**, 247-257.
- Hall, F. G., F. Huemmrich, S. J. Goetz, P. J. Sellers, and J. E. Nickeson, 1992: Satellite remote sensing of surface energy balance: Success, failures, and unresolved issues in FIFE. *J. Geophys. Res.*, **97**, 19061-19089.
- Heimann, M., and C.D. Keeling, 1989: A three-dimensional model of atmospheric CO₂ transport based on observed winds: 2. Model description and simulated tracer experiments, Peterson, D.H. (ed), Aspects of climate variability in the Pacific and the Western Americas, American Geophysical Union, Washington, DC, p. 165-236.
- Henderson-Sellers, A. and K. McGuffie, 1995: Global climate models and 'dynamic' vegetation changes, *Global Change Biology*, **1**, 63-75.
- Henderson-Sellers, A., R. E. Dickinson, T. B. Durbidge, P. J. Kennedy, K. McGuffie, and A. J. Pitman, 1993: Tropical deforestation: Modeling local- to regional-scale climate change. *J. Geophys. Res.*, **98**, 7289.
- Hipps, L. E., E. Swiatek, and W. P. Kustas, 1994: Interaction between regional surface fluxes and the atmospheric boundary layer over a heterogeneous watershed, *Water Resour. Res.*, **30**(5), 1387-1392.
- Hirschboeck, K., V. R. Baker, R. C. Kochel, and P. C. Patton, eds., 1988: Flood Hydroclimatology, *Flood Geomorphology*, John Wiley & Sons, pp. 27-49.
- Hook, S.J., A. R. Gabell, A. A. Green, and P. S. Kealy, 1992: A comparison of techniques for extracting emissivity information from thermal infrared data for geologic studies, *Remote Sens. Environ.*, **42**, 123-135.
- Houser, P. R., 1996: Remote-sensing of soil moisture using four-dimensional data assimilation, PhD., Univ. Arizona, Dept. of Hydrology, 391 pp.
- Huete, A.R., 1988: A soil-adjusted vegetation index (SAVI), *Remote Sens. Environ.*, **25**, 295-309.
- Huete, A.R., C. Justice, and H. Lui, 1994: Development of vegetation and soil indices for MODIS-EOS, *Remote Sens. Environ.*, **48**, 1-11.
- Hughes, J. P., D. P. Lettenmaier, and E. F. Wood, "An approach for assessing the sensitivity of floods to regional climate change", in Bras, Rafael (editor) *The World at Risk: Natural Hazards and Climate Change*, AIP Conference Proceedings 277, American Institute of Physics, New York, 1993, pp. 112-124.
- Hunt, E. R., Jr., S. C. Piper, R. R. Nemani, C. D. Keeling, R. D. Otto, and S. W. Running, 1996: Global net carbon exchange and intra-annual atmospheric CO₂ concentrations predicted by an ecosystem process model and three-dimensional atmospheric transport model, *Global Biogeochemical Cycles*, **10**(3), 431-456.
- Hunt, E. R., Jr., 1994: Relationship between woody biomass and PAR conversion efficiency for estimating net primary production from NDVI, *Int. J. Remote Sensing*, **15**(8), 1725-1730.
- Hunt, E. R., Jr., and S. W. Running, 1992: Simulated dry matter yields for aspen and spruce stands in the North American boreal forest, *Canadian J. Remote Sensing*, **18**, 126-133.
- Hunt, E. R. Jr., and S. W. Running, 1992: Effects of climate and lifeform on dry matter yield from simulations using BIOME-BGC, International Geosciences and Remote Sensing Symposium IGARSS 92, 1631-1633.
- Imhoff, M. I., 1994: Mapping human impacts on the global biosphere, *Bioscience*, **44**, 598.
- Junk, W. J., and K. Furch, 1993: A general review of South American floodplains, *Wetlands Ecology and Management* **2**, (4), 231-238.
- Justice, C. O., and J. R. Townshend, 1994: Data sets for global remote sensing: lessons learned, *Int. J. Remote Sensing*, **15**(17), 3621-3639.
- Justice, C. O., J. R. G. Townshend, B.N. Holben, and C. J. Tucker, 1985: Analysis of the phenology of global vegetation using meteorological satellite data, *Int. J. Remote Sensing*, **6**, 1271-1318.
- Kaufman, Y. J., C. O. Justice, L. Flynn, E. Prins, D. E. Ward, P. Menzel, and A. Setzer, 1996: Monitoring global fires from EOS-MODIS, (in press).
- Kaufman, Y. J., and D. Tandré, 1992: Atmospheric resistant vegetation index, *IEEE Geosci. and Rem. Sens.*, **30**, 261-270.
- Keeling, C. D., T. P. Whorf, M. Wahlen, and J. van der Plicht, 1995: Interannual extremes in the rate of rise of atmospheric carbon dioxide since 1980, *Nature*, **375**, 666-670.
- Keeling, C. D., R. B. Bacastow, A. F. Carter, S. C. Piper, T. P. Whorf, M. Heimann, W. G. Mook, and H. Roeloffzen, A three-dimensional model of atmospheric CO₂ transport based on observed winds, 1, Analysis of observational data, Aspects of Climate Variability in the Pacific and the Western Americas, *Geophys. Monogr. Ser.*, **55**, edited by D.H. Peterson, pp. 165-236, AGU, Washington, D.C., 1989a.
- Keeling, C. D., and M. Heiman, 1986: Meridional eddy diffusion model of the transport of atmospheric carbon dioxide; 2, Mean annual carbon cycle, *J. Geophys. Res.*, **91**, 7782-7796.
- Kerr, Y. H., and E. G. Njoku, 1990: A semiempirical model for interpreting microwave emissions from semiarid land surfaces as seen from space, *IEEE Geosci. and Rem. Sens.*, **28**, 384-393.
- Kerr, Y. H., 1991: The multi-frequency imaging microwave radiometer (MIMR): Applications to land-surface parameter retrieval, Proc. IGARSS '91, 2365-2368.
- Kerr, Y. H., and T. Jackson, T. (eds.), 1993: Soil moisture working group report, Saint-Lary ESA/NASA Workshop, Available from authors.
- Koster, R. D., and P. C. D. Milly, 1996: The interplay between transpiration and runoff formulations in land-surface schemes used with atmospheric models, *J. Climate*, (in press).
- Kunkel, K. E., 1990: Operational soil moisture estimation for the midwestern United States, *J. Appl. Meteor.*, **29**, 1158-1166.
- Kustas, W. P., and D. C. Goodrich, 1994: Preface to the special section on MONSOON '90, *Water Resour. Res.*, **30**(5), 1211-1225.
- Lambin, E. F., and A. H. Strahler, 1994: Change-vector analysis in multitemporal space: A tool to detect and categorize land-cover change processes using high temporal-resolution satellite data, *Remote Sens. Environ.*, **48**, 231-244.
- Lettenmaier D. P., and T. Y. Gan, 1990: Hydrologic sensitivities of the Sacramento-San Joaquin River basin, CA, to global warming, *Water Resour. Res.*, **26**(1), 69-86.
- LeVine, D. M., 1996: Strawman Proposal for the Global Land Observation (GLO) satellite, NASA.
- Liu, J., J. M. Chen, J. Cihlar, and B. Park, 1996: A process-based boreal ecosystem simulator using remote sensing inputs, *Remote Sens. Environ.*, (in press).
- Li, B., and R. Avissar, 1994: The impact of spatial variability of land-surface characteristics on land-surface heat fluxes, *J. Climate*, **7**, 527.
- Loaiciga, H. A., J. B. Valdes, R. Vogel, J. Garvey, and H. Schwarz, 1996: Global warming and the hydrologic cycle, *J. Hydrology*, **174**, 83-127.
- Mahfouf, J. F., 1991: Analysis of soil moisture from near-surface parameters: A feasibility study, *J. Appl. Meteor.*, **30**(11), 1534-1547.
- Maas, S. J., M. S. Moran, and R. D. Jackson, 1992: Combining remote sensing and modeling for regional resource monitoring, Part II: A simple model for estimating surface evaporation and biomass production, Proc. ASPRS/ACSM Conv., 225-233.

- McCormick, M. P., L. W. Thompson, C. R. Trepte, 1995: Atmospheric effects of the Mt. Pinatubo eruption, *Nature*, **373**, 399-404.
- Melillo, J. M., A. D. McGuire, D. W. Kicklighter, B. Moore III, C. J. Vorosmarty, and A. Schloss, 1993: Global climate change and terrestrial net primary production, *Nature*, **363**, 234-240.
- Michaud, J. and S. Sorooshian, 1994: Comparison of simple versus complex distributed runoff models on a mid-sized semiarid watershed, *Water Resour. Res.*, **30**(3), 593-605.
- Miller, D., J. Washburne, E. Wood, 1995: EOS Workshop on land-surface evaporation and transpiration, *The Earth Obs.*, **7**(4), 52-56.
- Monteith, J. L., 1972: Solar radiation and productivity in tropical ecosystems, *J. Applied Ecology*, **9**, 747-766.
- Monteith, J. L., 1977: Climate and the efficiency of crop production in Britain. *Philosophical Transactions of the Royal Society of London*, **B 281**, 277-294.
- Moore & Cramer: 1996, (in press).
- Moran, M. S., T. R. Clarke, Y. Inoue, and A. Vidal, 1994: Estimating crop water deficit using the relation between surface-air temperature difference and spectral vegetation index, *Remote Sens. Environ.*, **49**, 246-263.
- Moran, M. S., A. F. Rahman, J. C. Washburne, D. C. Goodrich, M. A. Weltz, and W.P. Kustas, 1996: Combining the Penman-Monteith equation with measurements of surface temperature and reflectance to estimate evaporation rates of a semiarid grassland, *Ag. and Forest Meteor.*, (submitted).
- Myneni, R. B., R. R. Nemani, and S. W. Running, 1996: Algorithm for the estimation of global landcover, LAI and FPAR based on radiative transfer models. IEEE (in review).
- Myneni, R. B., and D. L. Williams, 1994: On the relationship between FAPAR and NDVI, *Remote Sens. Environ.*, **49**, 200-211.
- Myneni, R. B., G. Asrar, D. Tanré, and B. J. Choudhury, 1992: Remote sensing of solar radiation absorbed and reflected by vegetated land surfaces, *IEEE Trans. Geosci. Remote Sens.*, **30**, 302-314.
- NASA Soil Moisture Workshop, 1994: M-Y Wei (ed), NASA Conf. Pub. 3319, 77 p.
- National Research Council, Estimating Bounds on Extreme Precipitation Events, National Academy Press, Washington, DC, 1994, 25 pp.
- National Research Council, Estimating Probabilities of Extreme Floods—Methods and Recommended Research, National Academy Press, Washington, DC, 1988, 141 pp.
- Nielson, R. P., 1995: A model for predicting continental-scale vegetation distribution and water balance, *Ecological Applications*, **5**, 362-385.
- Nemani, R. R., and S. W. Running, S.W., 1995: Satellite monitoring of global land cover changes and their impact on climate, *Climatic Change*, **31**, 395-413.
- Nemani, R., S. W. Running, R. A. Pielke, and T. N. Chase, (1996). Global vegetation cover changes from coarse resolution satellite data, *J. Geophys. Res.*, **101**(D3), 7157-7162.
- Nemani, R., L. Pierce, S. Running, and L. Band, 1993: Forest ecosystem processes at the watershed scale: sensitivity to remotely-sensed leaf-area index estimates, *Int. J. Remote Sensing*, **14**(13), 2519-2534.
- Nobre, C. A., P. J. Sellers, and J. U. Shukla, 1991: Amazonian deforestation and regional climate change, *J. Climate*, **4**, 957-987.
- Noilhan, J., and P. Lacarrere, 1995: GCM grid-scale evaporation from mesoscale modeling, *J. Climate*, **8**, 206-223.
- Oki, T., K. Musiakke, H. Matsuyama, and K. Masuda, 1995: Global atmospheric water balance and runoff from large river basins, *Hydrol. Proces.*, **9**, 655-678.
- Palmer, T. N., 1986: Influence of the Atlantic, Pacific, and Indian Oceans on Sahel Rainfall, *Nature*, **322**, 251-253.
- Parton, W. J., J. M. O. Scurlock, D. S. Ojima, T. G. Gilmanov, R. J. Scholes, D. S. Schimel, T. B. Kirchner, J. C. Menaut, T. Seastedt, E. Garcia Moya, A. Kamnairut, and J. Kinyamario, 1993: Observations and modeling of biomass and soil organic matter dynamics for the grassland biome worldwide, *Global Biogeochemical Cycles*, **7**, 785-809.
- Penner, J. E., R. E. Dickinson, C. A. O'Neill, 1992: Effects of aerosol from biomass burning on the global radiation budget, *Science*, **256**, 1432-4.
- Peterson, D. L., and R.H. Waring, 1994: Overview of the Oregon Transect Ecosystem Research Project, *Ecological Applications*, **4**(2), 211-225.
- Peterson, D. L., M. A. Spanner, S. W. Running, and L. Band, 1987: Relationship of Thematic Mapper Simulator data to leaf-area index, *Remote Sens. Environ.*, **22**, 323-341.
- Pinker, R. T., and I. Laszlo, 1992: Modeling surface solar irradiance for satellite applications on a global scale, *J. Appl. Meteor.*, **31**, 194-211.
- Pinker, R. T., W. P. Kustas, I. Laszlo, M. S. Moran, and A. R. Huete, 1994: Basin-scale solar irradiance estimates in semiarid regions using GOES 7, *Water Resour. Res.*, **30**(5), 1375-1386.
- Pinty, B., and M. M. Verstaete, 1992: GEMI: A non-linear index to monitor global vegetation from satellites, *Vegetatio*, **101**, 15-20.
- Pitman, A. J., et al., 1993: Project for intercomparison of land-surface parameterization schemes (PILPS), Results from off-line control simulations (Phase 1a). IGPO #7, World Climate Research Program.
- Post, W. M., T.-H. Peng, W. R. Emanuel, A. W. King, V. H. Dale, and D. L. DeAngelis, 1990: The global carbon cycle, *American Scientist*, **78**, 310-326.
- Prentice, I. C., W. Cramer, S. P. Harrison, R. Leemans, R. A. Monserud, and A. M. Solomon, 1992: A global biome model based on plant physiology and dominance, soil properties and climate, *J. Biogeogr.*, **19**, 117-134.
- Price, J. C., 1992: Estimating vegetation amount from visible and near infrared reflectances, *Remote Sens. Environ.*, **41**, 29-34.
- Prince, S. D., Y. H. Kerr, J. -P. Goutorbe, T. Lebel, A. Tinga, P. Bessemoulin, J. Brouwer, A. J. Dolman, E. T. Engman, J. H. C. Gash, M. Hoepffner, P. Kabat, B. Monteny, F. Said, P. Sellers, and J. Wallace, 1995: Geographical, biological, and remote sensing aspects of the hydrologic atmospheric pilot experiment in the Sahel (HAPEX-Sahel), *Remote Sens. Environ.*, **51**, 215-234.
- Prince, S. D., R. J. Olson, G. Dedieu, G. Esser, and W. Cramer, 1995: Global Primary Production Land Data Initiative Project Description, IGBP-DIS Working Paper No. 12, IGBP-DIS, Paris.
- Prince, S. D., and S. N. Goward, 1995: Global primary production: A remote sensing approach, *J. Biogeogr.*, **22**, 815-835.
- Prince, S. D., 1991: A model of regional primary production for use with coarse resolution satellite data, *Int. J. of Remote Sensing*, **12**, 1313-1330.
- Qi, J., A. Chehbouni, A. R. Huete, Y. H. Kerr, and S. Sorooshian, 1994: A modified soil adjusted vegetation index, *Remote Sens. Environ.*, **48**, 119-126.
- Quay, P. D., B. Tilbrook, and C. S. Wong, 1992: Oceanic uptake of fossil fuel CO₂: Carbon-13 evidence, *Science*, **256**, 74-79.
- Rahman, A. F., J. C. Washburne, M. S. Moran, and A. K. Batchily, 1996: Regional-scale surface flux estimation by combined use of remote sensing and meteorological data, *Water Resour. Res.*, (submitted).
- Reed, B. C., J. F. Brown, D. VanderZee, T. R. Loveland, J. W. Merchant, and D. O. Ohlen, 1994: Measured phenological variability from satellite imagery, *J. Vegetation Science*, **5**, 703-714.
- Revelle, R.R., and P. E. Waggoner, 1983: Effects of climate change on water supplies in the Western United States, in: Changing Climate, Nat. Acad. Sci., Washington, DC.

- Robock, A., K. Y. Vinnikov, C. A. Schlosser, N. A. Speranskaya, and Y. Xue, 1995: Use of midlatitude soil moisture and meteorological observations to validate soil moisture simulations with biosphere and bucket models, *J. Climate*, **8**, 15-35.
- Rosenthal, W., and J. Dozier, 1996: Automated mapping of montane snow cover at subpixel resolution from the Landsat Thematic Mapper, *Water Resour. Res.*, (in press).
- Running, S. W., T. R. Loveland, L. L. Pierce, R. R. Nemani, and E. R. Hunt, Jr., 1995: A remote sensing based vegetation classification logic for global land cover analysis, *Remote Sensing Environ.*, **51**, 39-48.
- Running, S. W., C. O. Justice, V. Salomonson, D. Hall, J. Barker, Y. J. Kaufmann, A. H. Strahler, A. R. Huete, J.-P. Muller, V. Vanderbilt, Z. M. Wan, P. Teillet, and D. Carneggie, 1994: Terrestrial remote sensing science and algorithms planned for EOS/MODIS, *Int. J. Remote Sensing*, **15**, 3587-3620.
- Running, S. W. and E. R. Hunt, Jr., 1993: Generalization of a forest ecosystem process model for other biomes, BIOME-BGC, and an application for global-scale models, pp. 141-158, IN: *Scaling Processes Between Leaf and Landscape Levels*. J.R. Ehleringer and C. Field eds., Academic Press.
- Running, S. W., and R. Nemani, 1991: Regional hydrologic and carbon balance responses of forests resulting from global climate change, *Climatic Change*, **19**, 349-368.
- Running, S. W., and R. R. Nemani, 1988: Relating seasonal patterns of the AVHRR vegetation index to simulated photosynthesis and transpiration of forests in different climates, *Remote Sens. Environ.*, **24**, 347-367.
- Running, S. W., and S. T. Gower, 1991: FOREST-BGC, a general model of forest ecosystem processes for regional applications II, Dynamic carbon allocation and nitrogen budgets, *Tree Physiology*, **9**, 147-160.
- Running, S. W., and J. C. Coughlan, 1988: A general model of forest ecosystem processes for regional applications, *Ecological Modelling*, **42**, 125-154.
- Runyon, J., R. H. Waring, S. N. Goward, and J. M. Welles, 1994: Environmental limits on above-ground production: observations for the Oregon transect, *Ecological Applications*, **4**, 226-237.
- Schimel, D. S., B. Braswell Jr., B. H. Holland, E. A. McKeown, D. S. Ojima, T. H. Painter, W. J. Parton, and A. R. Townsend, 1994: Climatic, edaphic, and biotic controls over carbon and turnover of carbon in soils, *Global Biogeochemical Cycles*, **8**, 279-293.
- Schmugge, T., T. J. Jackson, W. P. Kustas, R. Roberts, R. Perry, D. C. Goodrich, S. A. Amer, and M. A. Weltz, 1994: Push broom microwave radiometer observations of surface soil moisture in Monsoon '90, *Water Resour. Res.*, **30**(5), 1321-1328.
- Schwartz, M. D., 1996: Examining the Spring discontinuity in daily temperature ranges, *J. Climate*, **9**, 803-808.
- Scott, R., R. Koster, D. Entekhabi, and M. Suarez, 1996: "Effect of a canopy interception reservoir on hydrological persistence in a general circulation model, *J. Climate*, **8**, 1917-1922.
- Sellers, P. J. (ed.), 1995: The GEWEX Global Wetness Project Report, WCRP-IGPO report xxx.
- Sellers, P. J., D. A. Randall, G. J. Collatz, J. Berry, C. Field, D. A. Dazlich, C. Zhang, 1996a: A revised land-surface parameterization (SiB2) for atmospheric GCMs. Part 1: Model formulation, *J. Climate*, **9**, 738-763.
- Sellers, P. J., S. O. Los, C. J. Tucker, C. O. Justice, D. A. Dazlich, G. J. Collatz, and D. A. Randall, 1996b: A revised land-surface parameterization (SiB2) for atmospheric GCMs. Part 2: The generation of global fields of terrestrial biophysical parameters from satellite data, *J. Climate*, **9**, 706-737.
- Sellers, P. J., L. Bounoua, G. J. Collatz, D. A. Randall, D. A. Dazlich, S. Los, J. A. Berry, I. Fung, C. J. Tucker, C. B. Field, T. G. Jensen, 1996c: Comparison of the radiative and physiological effects of doubled atmospheric levels of CO₂ on climate, *Science*, **271**, 1402-1406.
- Sellers, P. J., M. D. Heiser, F. G. Hall, S. J. Goetz, D. E. Strelbel, S. B. Verma, R. L. Desjardins, P. M. Schuepp, and J. I. MacPherson, 1995a: Effects of spatial variability in topography, vegetation cover and soil moisture on area-averaged surface fluxes: A case study using the FIFE 1989 data, *J. Geophys. Res.*, **100**, 25607-25629.
- Sellers, P. J., F. Hall, H. Margolis, B. Kelly, D. Baldocchi, G. denHartog, J. Cihlar, M. G. Ryan, B. Goodison, P. Crill, K. J. Ranson, D. Lettenmaier, and D. Wickland, 1995: The Boreal Ecosystem—Atmosphere Study (BOREAS): An overview and early results from the 1994 field year, *Bull. Amer. Meteor. Soc.*, **76**(9), 1549-1577.
- Sellers, P. J., W. W. Meeson, F. G. Hall, G. Asrar, R. E. Murphy, R. A. Schiffer, F. P. Bretherton, R. E. Dickinson, R. G. Ellingson, C. B. Field, K. F. Huemmrich, C. O. Justice, J. M. Melack, N. T. Roulet, D. S. Schimel, and P. D. Try, 1995: Remote sensing of the land surface for studies of global change: Models-algorithms-experiments, *Remote Sens. Environ.*, **51**, 3-26.
- Sellers, P. J., C. J. Tucker, G. J. Collatz, S. O. Los, C. O. Justice, D. A. Dazlich, and D. A. Randall, 1994: A global 1° by 1° NDVI data set for climate studies. Part2: The generation of global fields of terrestrial biophysical parameters from the NDVI, *Int. J. Remote Sensing*, **15**, 3519-3545.
- Sellers, P. J., J. A. Berry, G. J. Collatz, C. B. Field, and F. G. Hall, 1992: Canopy reflectance, photosynthesis, and transpiration. III. A re-analysis using improved leaf models and a new canopy integration scheme, *Remote Sens. Environ.*, **42**, 187-216.
- Sellers, P. J., Y. Mintz, Y. C. Sud, and A. Dalcher, 1986: A simple biosphere model (SiB) for use within general circulation models, *J. Atmos. Sci.*, **43**, 505-531.
- Shaikh, M. J., 1996: Precipitation simulation in global climate models: Impact of horizontal resolution and improved land-surface scheme, Ph.D., Univ. of Arizona, 246 p.
- Shi, J., and J. Dozier, 1995: Inferring snow wetness using C-band data from SIR-C's polarimetric synthetic aperture radar, *IEEE trans. Geosci. and Rem. Sens.*, **33**(4), 905-914.
- Shukla, J., and Y. Mintz, 1982: Influence of land-surface evapotranspiration on the Earth's climate, *Science*, **215**, 1498-1501.
- Shuttleworth, W. J., 1988: Macrohydrology - The new challenge for process hydrology, *J. Hydrology*, **100**, 31-56.
- Shuttleworth, W. J., 1996: The challenges of developing a changing world, *EOS*, **77**(36), 347.
- Skole, D., and C. J. Tucker, 1993: Tropical deforestation and habitat fragmentation in the Amazon: Satellite data from 1978 to 1988, *Science*, **260**, 1905-1910.
- Smith, J. A., D. J. Seo, M. L. Baeck, and M. D. Hudlow, 1996: An intercomparison study of NEXRAD precipitation estimates, *Water Resour. Res.*, **32**(7), 2035-2045.
- Stokes, G. M., and S. E. Schwartz, 1994: The Atmospheric Radiation Measurement (ARM) program: programmatic background and design of the Cloud and Radiation Testbed (CART), *Bull. Amer. Meteor. Soc.*, **75**(7), 1201-1221.
- Sud, Y. C., J. Shukla, and Y. Mintz, 1988: Influence of land-surface roughness on atmospheric circulation and precipitation: A sensitivity study with a General Circulation Model, *J. Climate*, **2**, 105-125.
- Sundquist, E. T., 1993: The global carbon dioxide budget, *Science*, **259**, 934-941.

- Tans, P. P., P. S. Bakwin, and D. W. Guenther, 1996: A feasible global carbon cycle observing system: a plan to decipher today's carbon cycle based on observations, *Global Change Biology*, **2**, 309-318.
- Tans, P. P., I. Y. Fung, and T. Takahashi, 1990: Observational constraints on the global atmospheric CO₂ budget, *Science*, **247**, 1431-1438.
- Tegen, I., A. A. Lacis, and I. Fung, 1996: The influence of mineral aerosols from disturbed soils on climate forcing, *Nature*, (in press).
- Thompson, S. L., and D. Pollard, 1995: A global climate model (GENESIS) with a land-surface-transfer scheme (LSX). Part 1: present climate simulation, *J. Climate*, (in press).
- Townshend, J. T., C. Justice, W. Li, C. Gurney, and J. McManus, 1991: Global land cover classification by remote sensing: Present capabilities and future possibilities, *Remote Sens. Environ.*, **35**, 243-255.
- Tucker, C. J., I. Y. Fung, C. D. Keeling, and R. H. Gammon, 1986: Relationship between atmospheric CO₂ variations and a satellite-derived vegetation index, *Nature*, **319**, 195-199.
- Tucker, C. J., J. R. G. Townshend, and T. E. Goff, 1985: African land cover classification using satellite data, *Science*, **227**, 369-374.
- VEMAP, 1995: Vegetation/ecosystem modeling and analysis project (VEMAP): Comparing biogeography and biogeochemistry models in a continental-scale study of terrestrial ecosystem responses to climate change and CO₂ doubling, *Global Biogeochemical Cycles*, **9**(4), 407-437.
- Vinnikov, K. Y., A. Robock, N. A. Speranskaya, and C. A. Schlosser, 1996: Scales of temporal and spatial variability of midlatitude soil moisture, *J. Geophys. Res.*, **101**(D3), 7163-7174.
- Viterbo, P., and A. C. M. Beljaars, 1995: An improved land surface parameterization scheme in the ECMWF model and its validation, *J. Climate*, **8**, 2716-2748.
- Vorosmarty, C. J., and R. W. White, 1996. Suspended sediment delivery from the continental land mass to the coastal ocean: GIS based analysis for South America, *J. Hydrology*, (in press).
- Vorosmarty, C. J., C. J. Wilmott, B. J. Choudury, A. L. Schloss, T. K. Stearns, S. M. Robeson, and T. J. Dorman, 1996: Analyzing the discharge regime of a large tropical river through remote sensing, ground-based climatic data and modeling, *Water Resour. Res.*, (in press).
- Walker, G. K., Y. C. Sud, and R. Atlas, 1995: Impact of the ongoing Amazonian deforestation on local precipitation: A GCM simulation study, *Bull. Amer. Meteor. Soc.* **76**, 346-361.
- Wallace, J., 1995: Multidisciplinary program studies land-atmosphere interactions in semi-arid regions, *EOS*, **76**(46), 465-469.
- Washburne, J., and J. Shuttleworth, 1996 NMC Eta model surface fluxes—Are they an accurate representation for hydrologic models over the CART-ARM/GCIP-SW region, Presented at the 2nd GEWEX Sci. Conf., Washington, DC.
- Wiegand, C. L., A. J. Richardson, E. T. Kanemasu, 1979: Leaf-area index estimates for wheat from Landsat and their implications for evapotranspiration and crop modeling, *Agronomy Journal*, **71**, 336-342.
- Wielicki, B. A., R. D. Cess, M. D. King, D. A. Randall, and E. F. Harrison, 1996: Mission to Planet Earth: Role of Clouds and Radiation in Climate, *Bull. Amer. Meteor. Soc.*, **76**(11), 2125-2153.
- Wofsy, S. C., M. L. Goulden, J. W. Munger, S.-M. Fan, P. S. Bakwin, B. C. Daube, S. L. Bassow, and F. A. Bazzaz, 1993: Net exchange of carbon dioxide in a midlatitude forest, *Science*, **260**, 1314-1317.
- Woolhiser, D. A., R. E. Smith, and D. C. Goodrich, 1990: KINEROS, A kinematic runoff and erosion model: Documentation and users manual, U.S.D.A. Ag. Research Service, ARS-77.
- Woodward, F. I., T. M. Smith, and W. R. Emanuel, 1995: A global land primary productivity and phytogeography model, *Global Biogeochemical Cycles*, **9**, 471-490.
- Xue, Y., P. J. Sellers, J. L. Kinter, and J. Shukla, 1991: A simplified biosphere model for global climate studies, *J. Climate*, **4**, 345-364.

Chapter 5 Index

- 4-D assimilation 207
 4DDA 204, 207, 216
 A/SA 216, 238
 aerosols 208
 agriculture 203, 206, 210, 213, 220, 230, 234, 238
 AIRS/AMSU/HSB 210, 212, 217
 ALOS 236
 AMSR 206, 212
 APAR 228, 234, 242
 ARM 215, 217-218, 245
 assimilation data sets (see 4DDA)
 ASTER 210, 213-214, 217, 234
 atmospheric forcings 204
 AVHRR 206, 208, 221-229, 233, 239-240, 249
 AVIRIS 213
 BAHC 213, 246, 249-250
 BATS 201, 213
 biodiversity 249
 biogeochemistry, river 222-223
 biogeochemistry, terrestrial 231-232
 BIOME2 232, 252
 biospheric responses-dynamics 208-209, 232
 BOREAS 237, 239, 241-244
 BRDF 207, 233-234, 243, 246
 calibration 205-206, 221, 226, 233-234, 237-239
 Carbon America 247
 carbon cycle 228-229, 231-232, 238, 241, 243, 246-249, 252
 carbon dioxide (CO₂) 201-209, 219-238, 240-251
 CART 237-239, 245
 CART-ARM 239, 245
 CASES 239, 245
 CCD 233, 246
 CERES 207, 210, 217
 CESBIO 251
 CMDL 247, 250
 convection 251
 cryosphere 237, 240
 CRYSYS 240
 DAO 206, 210, 218, 228, 236
 DoE 236, 239, 245
 droughts 221, 230
 ECMWF 204, 210
 ecosystem 202-204, 214, 218, 225, 228-231, 235-238, 243-244, 247-251
 EDC 234-235
 EFEDA 244
 El Niño 201, 212, 231, 247
 ENSO 212, 221
 EOS instrument products 205-206, 208
 EOS AM 204, 208, 217, 223, 233, 240
 EOS PM 212, 214
 EOSDIS 214, 218, 233, 236, 251
 EOSP 208
 EROS 234
 ERS 215, 236, 241
 ETM+ 234-235
 evapotranspiration (ET) 209-214, 222-225, 233-234, 239, 244, 246, 251
 extreme hydrologic events-severe storms, floods, droughts 218-222
 FAO 216-217
 FIFE 205-206, 209-210, 214, 228, 237-239, 243
 fires 206
 floodplains 220-222
 FLUXNET and EUROFLUX 241, 246-247
 FPAR 206, 210, 214, 223, 225-226, 246
 GCIP 214, 239, 245
 GCMs 201, 203, 205-210, 219, 221
 GCOS/GTOS TOP 237-238
 GCTE 246, 249-251
 GEBA 217
 GEWEX 214-217, 245, 251
 GFDL 232, 251
 GIS 238-239, 248
 GISS 217
 GLCTS 241, 249
 GLOBE 216
 GOES 212, 217, 239
 GPCP 213
 GPS 236
 GRDC 213
 GSFC 213, 215, 217
 HAPEX-Sahel 206, 238, 243
 heterogeneity 209-210
 HIRDLS 208, 210
 HSB 210, 212, 217
 humidity 204, 206-207, 217-218, 228, 236, 247-248
 hydrology 201, 252
 ICSU 237, 250
 IDS 201-252
 IDS field sites 238
 IFOV 215
 IGAC 246
 IGBP 213, 216, 235, 237, 241, 246
 IGPPDI 251
 IHP 237
 infiltration and deep percolation 216
 interannual variability 201, 208, 223, 227, 231, 241, 249
 IOC 237
 IR 207, 234
 ISLSCP 205, 217, 243
 IT 238-239
 ITCZ 212
 JERS 215
 JPO 237
 KINEROS 213
 LAI 201-206, 214, 223-233, 238, 241-244, 248
 land-climate interaction 201-210
 land hydrology 201-233
 land-surface water balance 218
 land-vegetation 223-232, 241-243
 Landsat-7 224-225, 234-235
 LBA 239, 244-245
 LERTS 251
 lidar 208, 246
 lightning 219
 LIS 208
 LSMs 203-206, 208-210, 239
 LSPs 201, 210, 221
 LTER 236-237, 248
 MAPSS 224, 232, 252
 methane (CH₄) 222, 247-248
 MIMR 206-207
 MISR 206, 208, 210, 217, 224-227, 233-234
 MIT 213
 MMS 213
 modeling 213-217, 224-228, 232-252
 MODIS 208, 210, 213-214, 217, 220, 223-229, 231-233
 MODLAND 248
 MODLERS 248

MOPITT 232
MOU 237
MVI 228, 233
NASA 215-217, 236
NBIOME 240
NCAR 251
NDVI 214, 223, 233
near-surface meteorology 217-218
NEXRAD 212, 239
NIR 223, 226
NMC 210
NOAA 206, 212, 217, 227, 236, 241,
247, 250
NOPEX 245-246
NPP 223, 227-229, 241-242, 249-251
NRC 219
NSF 236, 241, 245
ORNL 251
OSU 232, 251-252
OTTER 228, 243-244
PAR 204, 214, 226, 228, 233, 247
PEM 228
PIK-NPP 232, 250-252
PILPS 251
POLDER 208
PR 207, 212
precipitation 211-213, 233, 236-243,
247-249
PSU 213, 217
RADARSAT 215, 241
radiation 216-217
runoff 213
SAGE III 208, 210
SALSA 216, 238
SAR 213, 221, 236, 241
SAVI 226
SCOPE 250
SiB 201, 203, 239
SMMR 215
snow cover 207, 211, 240
soil moisture 215-216
soils data 216, 235-236
SRB 204
SRBEX 239
SSM/I 215, 239-240
SST 219-221, 241
stem and soil carbon 229-230
surface observations 215
SWE 212-213, 240
SWIR 234
TEM 225, 229, 232, 240, 251
THM 213
TIR 215, 234
TM 221, 234-235, 241, 249
TMI 207, 212
TOA 217
topography 202, 212, 221-222, 229,
234-236, 243
TOPSAR 236
tower sites 246
TRAGNET 246-247
TRMM 212
UKMO 232, 251
UMCP 251
UNEP 237
UNESCO 237
USDA 238-239
USGS 213, 250
validation 201, 204-208, 213-216, 229,
234-252
vegetation indices 202, 207-208, 223,
226-227
vegetation phenology 203, 223, 227,
234, 242
vegetation structure 241-243
VEMAP 214, 218, 229, 232, 236, 239,
240, 251-252
VIC 213
VIRS 207, 212
VIS 223, 226
VNIR 234
volcanoes 206
WCRP 204, 213, 237, 241, 245, 251
wind 206-207, 217, 219-220, 248
WMO 237
WSR 212, 245