



<https://theses.gla.ac.uk/>

Theses Digitisation:

<https://www.gla.ac.uk/myglasgow/research/enlighten/theses/digitisation/>

This is a digitised version of the original print thesis.

Copyright and moral rights for this work are retained by the author

A copy can be downloaded for personal non-commercial research or study, without prior permission or charge

This work cannot be reproduced or quoted extensively from without first obtaining permission in writing from the author

The content must not be changed in any way or sold commercially in any format or medium without the formal permission of the author

When referring to this work, full bibliographic details including the author, title, awarding institution and date of the thesis must be given

Enlighten: Theses

<https://theses.gla.ac.uk/>
research-enlighten@glasgow.ac.uk

THE EFFECT OF OESTRADIOL-17 β ON THE RIBONUCLEASES
AND RIBONUCLEASE INHIBITOR OF IMMATURE RAT UTERUS

Neil Alexander Steven Brockdorff, B.Sc. (Hons.)

Submitted for the degree of Doctor of Philosophy from
the Department of Biochemistry, University of Glasgow

October 1985

ProQuest Number: 10907147

All rights reserved

INFORMATION TO ALL USERS

The quality of this reproduction is dependent upon the quality of the copy submitted.

In the unlikely event that the author did not send a complete manuscript and there are missing pages, these will be noted. Also, if material had to be removed, a note will indicate the deletion.



ProQuest 10907147

Published by ProQuest LLC (2018). Copyright of the Dissertation is held by the Author.

All rights reserved.

This work is protected against unauthorized copying under Title 17, United States Code
Microform Edition © ProQuest LLC.

ProQuest LLC.
789 East Eisenhower Parkway
P.O. Box 1346
Ann Arbor, MI 48106 – 1346

TABLE OF CONTENTS

	<u>Page No.</u>
Acknowledgements	i
Dedication	ii
Abbreviations	iii
Summary	iv
1. INTRODUCTION	1
1.1 The mechanism of action of steroid hormones.	2
1.1.1 Entry of steroid hormones into target cells.	4
1.1.2 Binding of steroid hormones to cytoplasmic receptor proteins.	4
1.1.3 Binding of steroid/receptor complexes to target cell nuclei.	6
1.1.4 Post-transcriptional effects of steroid hormones.	9
1.1.5 Classical steroid hormone systems.	10
1.2 Oestrogen effects in the rat uterus.	13
1.2.1 The overall response.	13
1.2.2 The heterogeneity of oestrogen binding sites.	14
1.2.3 The hypertrophic response.	15
1.3 RNA metabolism in eukaryotic cells.	20
1.3.1 Stability of eukaryotic mRNA.	20
1.3.2 The role of Poly (A) in mRNA stability.	22
1.3.3 The role of 5' 'cap' in mRNA stability.	24
1.3.4 The role of mRNP particles in the control of mRNA stability.	25
1.4 Mammalian ribonucleases and the ribonuclease inhibitor.	30
1.4.1 Classification of mammalian ribonucleases.	30

1.4.2	Ribonuclease inhibitor protein:- purification and properties.	32
1.4.3	Ribonucleases associated with the inhibitor <u>in vivo</u> .	38
1.4.4	The ribonuclease/ribonuclease inhibitor system:- Functional aspects.	43
1.5	Aims of the project.	51
2.	MATERIALS AND METHODS	53
2.1	Suppliers.	54
2.2	Sterile precautions.	55
2.3	Glassware.	55
2.4	Radiochemicals and scintillation counting.	56
2.5	Experimental animals.	56
2.6	Preparation and administration of hormone.	57
2.7	Methods:- Proteins.	58
2.7.1	Protein assays.	58
2.7.2	Assay of ribonuclease inhibitor.	58
2.7.3	Assay of ribonuclease activity.	59
2.7.4	Preparation of cytoplasmic fractions.	61
2.7.5	Purification of rat liver ribonuclease inhibitor protein.	62
2.7.6	Purification of cytoplasmic ribonucleases associated with the inhibitor <u>in vivo</u> .	65
2.7.7	Polyacrylamide gel electrophoresis (PAGE).	68
2.8	Immunological methods.	71
2.8.1	Immunization schedule.	72
2.8.2	Enzyme linked immunosorbant assay (ELISA).	72
2.8.3	Immuno-electrophoresis.	73

2.8.4 Immunoabsorption.	74
2.8.5 Immuno (western) blotting.	74
2.9 Nucleic acid methods.	75
2.9.1 Preparation of [³ H] labelled BHK cell RNA.	75
2.9.2 Source of plasmids and routine analysis of nucleic acids.	76
2.9.3 Transformation of <u>E.coli</u> .	77
2.9.4 Isolation of plasmid DNA.	77
2.9.5 Preparation of total RNA.	79
2.9.6 Preparation of Poly (A) ⁺ and Poly (A) ⁻ fractions from total RNA.	81
2.9.7 Isolation of DNA from agarose gels.	82
2.9.8 Nick translation of DNA.	82
2.9.9 Northern blotting.	83
3. RESULTS.	85
3.1.1 The effect of oestrogen on the activity of uterine cytoplasmic ribonuclease inhibitor.	86
3.1.2 Qualitative and quantitative analysis of ribonuclease inhibitor in the rat uterus using antibodies to the purified protein.	89
3.2.1 The effect of oestrogen on uterine cytoplasmic ribonuclease activity.	102
3.2.2 Characterization of the ribonuclease(s) found in uterine cytoplasm.	105
3.2.3 Studies on the mode of induction of uterine cytoplasmic ribonucleases by oestrogen.	110
3.2.4 Characterization and isolation of insert DNA from pcXP6-105.	113
3.2.5 Northern blot analysis.	117
3.3.1 Detection of inhibitor/ribonuclease complexes by immunoblotting from non-denaturing gels.	120

3.3.2	Ferguson plot analysis of inhibitor/ ribonuclease complexes.	125
3.3.3	Analysis of inhibitor/ribonuclease complexes in various tissues of the rat.	130
3.4.1	Purification and characterization of cytoplasmic ribonucleases.	132
3.4.2	Purification of cytoplasmic ribonucleases from rat liver.	133
3.4.3	Purification of cytoplasmic ribonucleases from the uterus of mature rats.	140
3.4.4	Comparison of the properties of the purified ribonucleases.	141
3.4.5	Characterization of rat liver cytoplasmic ribonuclease I (RLC I).	147
3.4.6	Characterization of rat liver cytoplasmic ribonuclease II (RLC II).	148
3.4.7	Characterization of rat uterine cytoplasmic ribonuclease I (RUC I).	148
3.4.8	Characterization of rat uterine cytoplasmic ribonuclease II (RUC II).	149
3.4.9	Characterization of rat uterine cytoplasmic ribonuclease III (RUC III).	149
4.	DISCUSSION	151
4.1	The effect of method of administration and dose of oestrogen on uterine inhibitor activity.	152
4.2	Quantitative analysis of uterine ribonuclease inhibitor.	154
4.3	Analysis of ribonuclease inhibitor in other rat tissues.	157
4.4	Studies on the uterine cytoplasmic ribonucleases.	160
4.5	Studies on the purified ribonucleases of rat liver and uterine cytoplasm.	170

	<u>Page No.</u>
4.6 Conclusions concerning the function of the inhibitor/ribonuclease system.	178
4.7 Some considerations for future studies.	178
4.7.1 Studies on the localization of the inhibitor protein.	181
4.7.2 Further studies on the cytoplasmic ribonucleases.	182
REFERENCES	184

LIST OF FIGURES

	<u>Page No.</u>
Figure 1. The Jenson-de Sombre two-step model of steroid hormone action.	3
Figure 2. Oestrogen effects in the rat uterus.	12
Figure 3. Tentative flow diagram of mRNA in the cytoplasm of duck erythroblasts.	29
Figure 4. The effect of oestradiol 17- β and stage of development on the activity of uterine ribonuclease inhibitor.	88
Figure 5a. Sepharose-RNase A affinity chromatography of rat liver ribonuclease inhibitor.	95
Figure 5b. SDS-PAGE analysis of purified rat liver inhibitor.	95
Figure 6. Assessment of the specificity of anti-ribonuclease inhibitor serum:- Immunoelectrophoresis.	97
Figure 7. Assessment of the specificity of antiserum raised to ribonuclease inhibitor:- ELISA of fractions from immunoadsorption column.	98
Figure 8. Immunoblot analysis of ribonuclease inhibitor in various tissues of the rat.	99
Figure 9. Quantitation of ribonuclease inhibitor in uterine cytoplasm by immunoblotting.	100
Figure 10. The effect of oestradiol-17 β on total and free uterine cytoplasmic ribonuclease activity.	104
Figure 11. Analysis of uterine cytoplasmic ribonuclease by activity staining.	108
Figure 12. Immunoblot analysis of uterine cytoplasmic protein using antiserum raised to bovine pancreatic RNase A.	109
Figure 13. Diagrammatic representation of rat pancreatic RNase A cDNA recombinant (pcXP6-105).	115

Figure 14.	Characterization and preparation of insert DNA from pcXP6-105.	116
Figure 15.	Northern blot analysis of uterine RNA and pancreatic RNA.	119
Figure 16.	Analysis of inhibitor/ribonuclease complexes by immunoblotting from non-denaturing polyacrylamide gels.	123
Figure 17.	Detection of inhibitor/ribonuclease complexes by assay of gel slices after non-denaturing PAGE.	124
Figure 18.	Ferguson plot analysis of inhibitor/ribonuclease complexes: non-denaturing PAGE.	128
Figure 19.	Ferguson plot analysis of inhibitor/ribonuclease complexes: Plot of log R_f against % acrylamide.	129
Figure 20.	Detection of inhibitor/ribonuclease complexes in various tissues of the rat.	131
Figure 21a.	Chromatography of inhibitor/ribonuclease complexes from rat liver on DEAE-cellulose.	136
Figure 21b.	Chromatography of cytoplasmic ribonucleases from rat liver on SP-sephadex.	136
Figure 22a.	Chromatography of cytoplasmic ribonucleases from rat liver on heparin-sepharose.	137
Figure 22b.	Affinity chromatography of RLC I on uridine 2'(3')5' diphosphate agarose.	137
Figure 23.	Analysis of the purification of rat liver cytoplasmic ribonuclease by SDS-PAGE.	138
Figure 24.	Chromatography of cytoplasmic ribonucleases from mature rat uteri on heparin-sepharose.	142
Figure 25.	Analysis of purified ribonucleases by activity staining.	143

Figure 26.	Lineweaver-Burke plots for the purified cytoplasmic ribonucleases RLC I, RLC II, RUC I, RUC II and RUC III.	144
Figure 27.	pH optima of the purified cytoplasmic ribonucleases of rat liver and rat uteri.	145

LIST OF TABLES

Table 1.	Classical steroid hormone systems.	10
Table 2.	Purification of rat liver ribonuclease inhibitor.	96
Table 3(A).	Uterine ribonuclease and ribonuclease inhibitor levels.	101
Table 3(B).	Approximate inhibitor levels in various tissues of the rat.	101
Table 4.	Uterine ribonuclease activity during the first 24 h of oestrogen-stimulation.	111
Table 5.	Relative molecular weights of the inhibitor/ribonuclease complexes.	126
Table 6.	Purification of cytoplasmic ribonuclease from rat liver.	139
Table 7.	Comparison of the properties of purified cytoplasmic ribonucleases.	146

Acknowledgements

I would like to express my sincere thanks to the following people:

Professor R.M.S. Smellie for making the facilities of the Department of Biochemistry available for this research.

Dr J.T. Knowler for his guidance, useful criticism, and friendship throughout the course of this work.

All other members of the Biochemistry Department for their support and advice. A special thank you to Dr L. Fixter for his guidance.

All of my family, especially Mum, Dad, Erik, Sonja, tante Kathe and Eva for their encouragement over the years. An extra special thank you to Anita for her love and help in preserving my sanity during the final year.

All of my friends, especially Amy, Stuart, Terry and the crowd from the Research Club.

Mrs L. Peedle for typing this manuscript.

The Science and Engineering Research Council for their financial support of this work.

Dedication

To the memory of Otto and Stella

October 1985

Abbreviations

The abbreviations used in this thesis are in agreement with recommendations of the editors of the Biochemical Journal (Biochem. J. (1983) 209, 1-27), except the following.

SDS	Sodium dodecyl sulphate.
hnRNA	Heterogenous nuclear RNA.
mRNP	Messenger ribonucleoprotein particle.
Oestradiol-17 β	1,3,5 (10)-estratriene-3-17 β diol.
Kbp (bp)	Kilobase pairs (base pairs).
SSC	Standard saline citrate.
RNase A(B)	Pancreatic ribonuclease A(B).
BSA	Bovine serum albumin.
bis-acrylamide	N,N'-methylene bisacrylamide.
cpm	Counts per minute.
ELISA	Enzyme linked immunosorbant assay.
TEMED	N,N,N',N'-tetramethylethylene diamine.
Poly (A) ⁺ RNA	Polyadenylated mRNA species.
Poly (A) ⁻ RNA	Non-polyadenylated mRNA species.
M.E.M.	Minimal essential medium.
BHK cells	Baby Hamster Kidney cells.
SSPE	Standard saline phosphate EDTA.
BSS	Balanced salt solution.
TWEEN 20	Polyoxyethylene sorbiton monolaurate.
P _i	Isaelectric point.
Sarkosyl	N-lauroyl Sarcosine,

SUMMARY

The cytoplasmic ribonuclease inhibitor/ribonuclease system has been detected in a wide variety of tissues and species. In most of the tissues studied, cytoplasmic ribonuclease is undetectable due to the presence of excess inhibitor. The observation that tissues with high levels of RNA/protein synthesis have high levels of free inhibitor has been taken to imply some essential role for the inhibitor in the control of protein synthesis. The precise nature of this regulatory function is however unknown. Studies on the enzyme associated with the inhibitor in vivo indicated that it was similar, but not identical to secretory pancreatic RNase A.

Previous studies on the inhibitor/ribonuclease system of rat uterus revealed that free inhibitor was detectable in the uteri of immature rats, but disappeared after administration of oestrogen or during normal sexual maturation of the rat. The following studies were undertaken in order to determine the mechanism whereby oestrogen decreased inhibitor activity, and to gain a better understanding of the precise function of the inhibitor/ribonuclease system. The main points to emerge from these studies were as follows:-

(i) Antiserum raised to purified rat liver inhibitor was used to quantitate total inhibitor levels in control, oestrogen-treated, and mature rat uteri. These studies revealed that inhibitor levels increased by up to 50% after hormone-treatment and normal development. It was therefore apparent that the

loss of inhibitor activity was not due to reduced synthesis of the protein.

(ii) Total and free ribonuclease activity was assayed, and revealed that the total activity increased by up to eight fold after oestrogen-treatment and during normal development.

Free enzyme activity became detectable in uterine cytoplasm.

Taken together, these results indicated that the loss of inhibitor activity arose through saturation by endogenous ribonuclease.

(iii) Activity stain analysis of the uterine cytoplasmic ribonucleases revealed the presence of at least two distinct species with approximate molecular weights of 14,000 and 18,000. The activity of both of these species appeared to increase after oestrogen-treatment and during normal development. An attempt to detect and quantitate these enzymes using antiserum raised to bovine RNase A was not successful.

(iv) A cDNA clone encoding rat pancreatic RNase A mRNA was obtained, and used in an attempt to detect the mRNA encoding the endogenous uterine enzymes. It was not possible to detect a clear cut example of an RNase A like mRNA in control or oestrogen-treated uterine RNA. These results did not however rule out the possibility that the uterine enzymes were induced at the transcriptional level by oestrogen.

(v) A technique was developed whereby free inhibitor and inhibitor/ribonuclease complexes could be resolved on non-denaturing polyacrylamide gels, and subsequently detected by immunoblotting. These studies confirmed that the loss of

inhibitor activity was due to saturation by endogenous enzyme. Furthermore, it was found that 5-6 distinct enzyme species or enzyme variants were present in the cytoplasm of oestrogen-treated uteri. The relative levels of these enzymes were found to differ in a variety of tissues analysed. Ferguson plot analysis revealed that they differed on the basis of charge, and to a lesser extent, molecular weight.

(vi) The cytoplasmic ribonucleases of rat liver and mature rat uteri were purified using a relatively rapid procedure giving high yields. The different species were resolved to some extent using chromatography on heparin-sepharose. Thus, in rat liver one major and one minor species were resolved, (RLC I and RLC II), whilst in mature rat uteri three species were resolved, (RUC I, RUC II and RUC III). RLC I was shown to be homogeneous as determined by SDS-PAGE. Insufficient quantities of the other enzymes were available for similar analyses. The relative molecular weight of each activity was determined by activity staining. These studies revealed that each activity consisted of more than one distinct species or variant. It was assumed that heparin-sepharose chromatography did not completely resolve all of the species present. Tentative analysis indicated that the species RUC II and RUC III corresponded to the oestrogen-induced species.

(vii) Some of the properties of the purified enzymes were compared. The enzymes were shown to differ on the basis of pH optima, kinetic parameters, and their relative activity

towards the homopolymers Poly (U) and Poly (C) relative to yeast RNA.

The aforementioned results are discussed in relation to the possible function of the inhibitor/ribonuclease system.

1. INTRODUCTION

This thesis describes an analysis of the effects of oestrogen on the ribonuclease and ribonuclease inhibitor activity of the immature rat uterus. The study is introduced by brief reviews of both the mechanism of action of oestrogen, and of mammalian ribonuclease, its cytoplasmic inhibitor, and their possible roles in the modulation of RNA stability.

1.1 The mechanism of action of steroid hormones

The classical two step model of steroid hormone action, proposed by Jenson and de Sombre (1972), is illustrated in Figure 1. The following sections are intended to highlight recent advances in our understanding of the various steps involved in this model.

Figure 1. The Jenson-de Sombre two-step model of steroid hormone action.

Key: R_p - Plasma steroid binding protein.
S - Steroid hormone.
 R_c - Cytoplasmic steroid receptor.
 R_c^T - Transformed cytoplasmic steroid receptor.
 R_N - Nuclear receptor.

According to the Jenson-de Sombre two-step model, the steroid hormone, bound to plasma steroid binding protein, (e.g. sex hormone binding-globulin), enters the target cell by passive diffusion across the plasma membrane (a). Binding of free steroid by the cytoplasmic receptor (b) results in a change in the nature of the receptor, termed transformation (c). The transformed receptor has increased affinity for DNA/chromatin. Subsequent translocation of the transformed receptor/hormone complex (d) and binding to specific regions of DNA/chromatin, results in increased transcription from specific genes (e) and consequential translation of the induced RNA, (f,g).

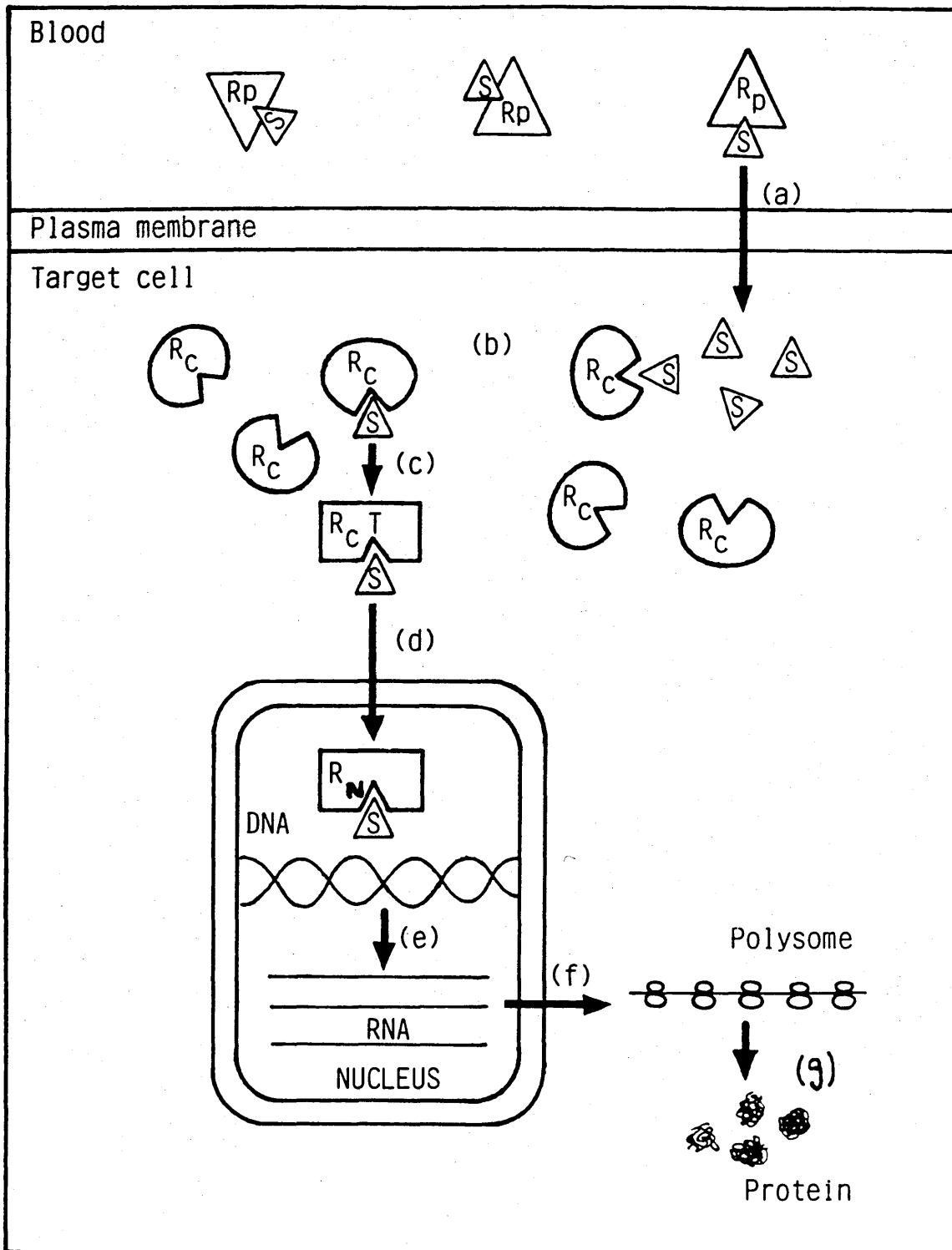

1.1.1 Entry of steroid hormones into target cells

It is generally held that steroid hormones, due to their lipophilic nature, enter cells by passive diffusion across the plasma membrane, and are concentrated in target cells due to the presence of a cytoplasmic receptor protein specific for a given steroid hormone. The evidence for this model is not unequivocal: Milgrom et al. (1973), presented evidence for facilitated transport of oestrogen into target cells, whilst others have also postulated a protein mediated step in the entry of oestrogen into uterine cells (Baulieu, 1975; Uriel et al., 1976). Whilst these studies are of interest, further work is required to confirm their significance.

1.1.2 Binding of steroid hormones to cytoplasmic receptor proteins

The cytoplasmic receptor proteins for a number of steroid hormones have been extensively studied. Briefly, it is apparent that binding of steroid to receptor results in changes in the nature of the receptor, termed transformation, that result in translocation of the hormone/receptor complex from the cytoplasm to the nucleus.

The nature of the transformation process is poorly understood, and there is evidence that different mechanisms are operating for different steroid/receptor systems. For example, the oestrogen receptor of rat uterus, prior to hormone binding, sediments in sucrose gradients at a value of 4 s. Binding of oestrogen shifts the sedimentation coefficient to 5 s and increases the affinity of the receptor for DNA/chromatin (Jenson and de Sombre, 1973). It has been

suggested that the transition from the 4 s to 5 s form results from dimerization of receptor monomers or the addition of a non-steroid binding subunit, (Notides and Nielson, 1974; Yamamoto and Alberts, 1974). In contrast, transformation of the glucocorticoid receptor is not accompanied by any change in its sedimentation coefficient (Kalimi et al., 1976).

Recent evidence suggests that a common non-hormone binding protein is associated with the non-transformed receptors of progesterone, oestrogen, androgens and glucocorticoids (Joab et al., 1984). This discovery may be of importance to our understanding of the mechanism of steroid hormone receptor transformation. Studies on steroid hormone receptors have been extensively reviewed by Grody et al. (1982).

The mechanism whereby transformed steroid receptors are translocated to target cell nuclei is also poorly understood. Some of the mechanisms proposed have been reviewed by Knowler and Beaumont (1985). More recently, evidence has arisen that brings into question the existence of cytoplasmic receptor proteins: Welshons et al. (1984) used cytochalasin B induced enucleation to obtain cytoplasm and nucleoplasm fractions from oestrogen receptor rich GH₃ cells, derived from rat pituitary tumours. The cytoplasm was found to contain little oestrogen binding activity, with most of the unfilled receptor residing within the nucleoplasm. More convincingly, King and Greene (1984), carried out immunohistochemical analysis on a wide range of oestrogen receptor positive tissues and cell lines using a monoclonal antibody specific for oestrogen receptor. The presence of receptor protein was confined to

the nucleus in all of the tissues and cell lines analysed. Clearly, further studies are required to confirm these findings and to determine whether a similar situation is pertaining in other steroid/receptor systems. If this is found to be the case, the classical Jenson and de Sombre model will have to be modified.

1.1.3. Binding of steroid/receptor complexes to target cell nuclei

Many steroid hormone effects are directly attributable to increased transcription from specific genes. The mechanism whereby hormone/receptor complexes enhance transcription has been extensively studied. One of the methods employed to analyse transcriptional activation has been to use cloned fragments of specific genes to detect changes in the DNase 1 sensitivity of the genes after hormone administration. Increased DNase 1 sensitivity has been associated with the activation of a number of eukaryotic genes, and reflects local changes in the chromatin structure around the gene, (for review see Mathis et al., 1980). Thus, in the liver of male Xenopus laevis frogs, oestrogen induces DNase 1 sensitivity in the vitellogenin gene family (Gerber-Huber et al., 1981). Similarly, in the chick oviduct the ovalbumin gene, as well as the related pseudogenes X and Y are rendered sensitive to DNase 1 after oestrogen-stimulation (Lawson et al., 1980).

Recently, evidence has accumulated that indicates that steroid/receptor complexes interact specifically with DNA in the region of hormone induced genes. Studies on the insect steroid hormone ecdysone revealed that fluorescently

labelled ecdysone/receptor complexes bind to regions of the giant polytene chromosomes of Drosophila melanogaster salivary glands at which ecdysone induced chromosomal 'puffs' are seen (Ashburner, 1974; Gronemeyer and Pongs, 1980; Bonner, 1982).

When cloned mouse mammary tumour virus (MMTV) DNA is transfected into cultured hepatic cells, glucocorticoids induce MMTV specific mRNA 8 fold over control values (Hynes et al., 1981). Utilizing purified glucocorticoid receptor, Payvar et al. (1981) demonstrated that four widely separated regions of MMTV proviral DNA were efficient competitors for glucocorticoid receptor binding. One of these regions was located 400 b.p. upstream of the proviral promotor. Further studies, utilizing techniques such as transfection of chimeric genes into receptor positive cell lines and DNA footprinting studies have helped to delineate a DNA sequence that is involved in receptor binding, (Hynes et al., 1983; Scheidereit et al., 1983).

A consensus hexanucleotide TGTTCCT has been found in all glucocorticoid receptor binding sites analyzed so far, including two sites upstream of the chicken lysozyme gene (Renkawitz et al., 1984), two sites in the human metallothionein IIA gene (Karin et al., 1984), and three sites in the rabbit uteroglobin gene (Cato et al., 1985). Similarly, DNA sequences that bind progesterone receptor have been detected in the ovalbumin gene (Compton et al., 1983; Mulvihill et al., 1982), and sequences that bind the oestrogen receptor have been found in the xenopus vitellogenin genes (Jost et al., 1985)

and also in the chicken vitellogenin and apo VLDL II genes (Burch, 1984).

One of the more interesting observations concerning these receptor binding elements is the sequence homology they share with viral enhancer elements (Parker, 1983). In addition, like viral enhancers, the glucocorticoid receptor binding element has been shown to increase transcription from a heterologous promoter independently of its orientation or distance from the gene. (Hynes et al., 1983; Chandler et al., 1983). Another interesting observation has been that in genes which can be regulated by more than one steroid hormone, for example the chicken lysozyme gene and MMTV proviral DNA, the binding sites for the different receptors map to the same region of DNA (Renkawitz et al., 1984). Presumably different steroid receptors recognize distinct DNA sequences in these regions.

The mechanism whereby binding of receptor to these elements induces transcription from nearby genes is still largely unknown, and it is possible that interaction of the receptors with other components of the nucleus is also important. Schrader et al. (1977) have proposed that the two subunits of the progesterone receptor A and B bind to DNA and group of non-histone proteins, the AP₃ proteins, respectively. More recently however, the binding of the B subunit to AP₃ proteins has been disputed (Loosfelt et al., 1984; Gronemeyer et al. 1985).

Whilst recent progress in this area has been fruitful, further studies are clearly required to elucidate the mechanism

of action of steroid hormones on the transcription of specific genes. Recently, the nucleotide sequence of mRNA coding for the glucocorticoid receptor has been published (Miesfield et al., 1984). This information should facilitate studies on the structure of steroid receptors and hence provide an approach to studying in more detail the interaction of receptors with receptor binding elements.

1.1.4 Post-transcriptional effects of steroid hormones

In addition to the well characterised effect of steroid hormones on the transcription of specific genes, there have also been a number of reports of regulation of gene expression at the post-transcriptional level.

Cox (1977), has reported that oestrogen selectively stabilizes ovalbumin mRNA in the chick oviduct. The half life of ovalbumin RNA in oestrogen stimulated chick oviduct was approximately 24 h. Withdrawal of the hormone reduced the half life to between 4 and 5 h. In the liver of Xenopus laevis, the stability of vitellogenin mRNA increased in the presence of oestrogen. This effect was shown to be independent of de novo protein synthesis (Brock and Shapiro, 1983). Interestingly, the stability of albumin mRNA in Xenopus liver decreases in the presence of oestrogen. (Wolffe et al., 1985).

As distinct from steroid effects on mRNA stability, a number of groups have reported steroid effects on the efficiency of translation. Robins and Schimke (1978) demonstrated that progesterone increases the efficiency of initiation of ovalbumin RNA in the chick oviduct, whilst Pennequin et al. (1978) found that oestrogen increased the

efficiency of initiation of all classes of oviduct mRNA. In the rat uterus, Whelley & Barker (1982) demonstrated that oestrogen increased the rate of nascent polypeptide elongation during the first hour of stimulation. Actinomycin did not block this effect, suggesting its independence from nuclear events.

Generally, the mechanisms whereby post-transcriptional regulation of gene expression occurs are poorly understood, and considerably more work is required to determine how steroid hormones can effect these mechanisms.

1.1.5 Classical steroid hormone systems

Table 1 illustrates some of the characteristics of the most extensively studied steroid hormone systems. The effect of a given hormone on a given target tissue can be conveniently divided into two types: Firstly, the steroid can result in increased synthesis of major secretory proteins, such as vitellogenin in xenopus liver, and secondly, the steroid can result in a hypertrophic response where overall protein synthesis is increased, often leading to subsequent cell growth and division e.g. oestrogen effects in the mammalian uterus. Some target tissues undergo both of these responses to a given steroid hormone, e.g. oestrogen effects in the chick oviduct.

Table 1. Classical steroid hormone systems.

This table is intended to illustrate the systems through which progress in our understanding of the mechanism of steroid hormone action has been made. Where possible, the references cited represent recent reviews of the topic.

1. Knowler and Beaumont, (1985).
2. Parker and Scrace, (1978).
3. Higgins et al., (1979).
4. Mester and Baulieu, (1984).
5. Rousseau, (1984).

Steroid hormone	Tissue	Major induced proteins	Other effects	References
Oestrogens	Chick oviduct	Ovalbumin Conalbumin lysozyme	Cell growth and differentiation	1.
	Avian liver	Vitellogenin	-	1.
	Amphibian liver	Vitellogenin	-	1.
	Mammalian uterus	-	Cell growth/hypertrophy	1.
	Mammalian breast	-	Cell growth/hypertrophy	1.
Androgens	Rat ventral prostate	Prostatic steroid binding proteins	Cell growth/hypertrophy	2.
	Rat seminal vesicle	Secretory glycoproteins 'F' and 'S'	Cell growth/hypertrophy	3.
Progestins	Chick oviduct	Avidin		4.
	Mammalian uterus	Uteroglobulin	Cell differentiation	4.
Glucocorticoids	Rat liver	Enzymes associated with gluconeogenesis α_2 globulin	Hypertrophy	5.

Figure 2. Oestrogen effects in the rat uterus.

- (a) Cross sectional diagram showing structure and cell types of the rat uterus.
- (b) Sequence of events in oestrogen-induced growth of the uterus of the immature rat.

The various steps illustrated in this model are discussed in the text.

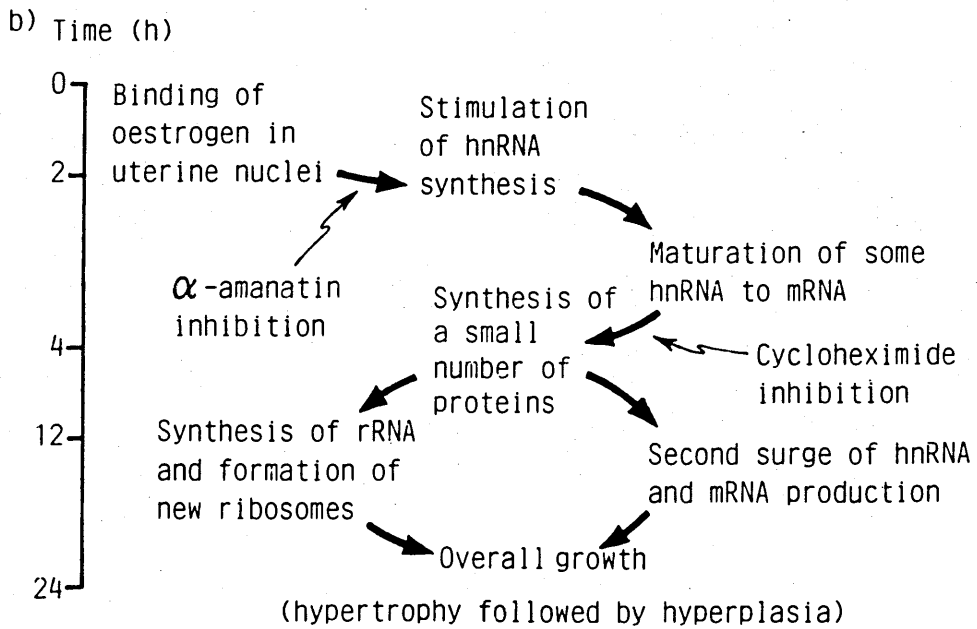
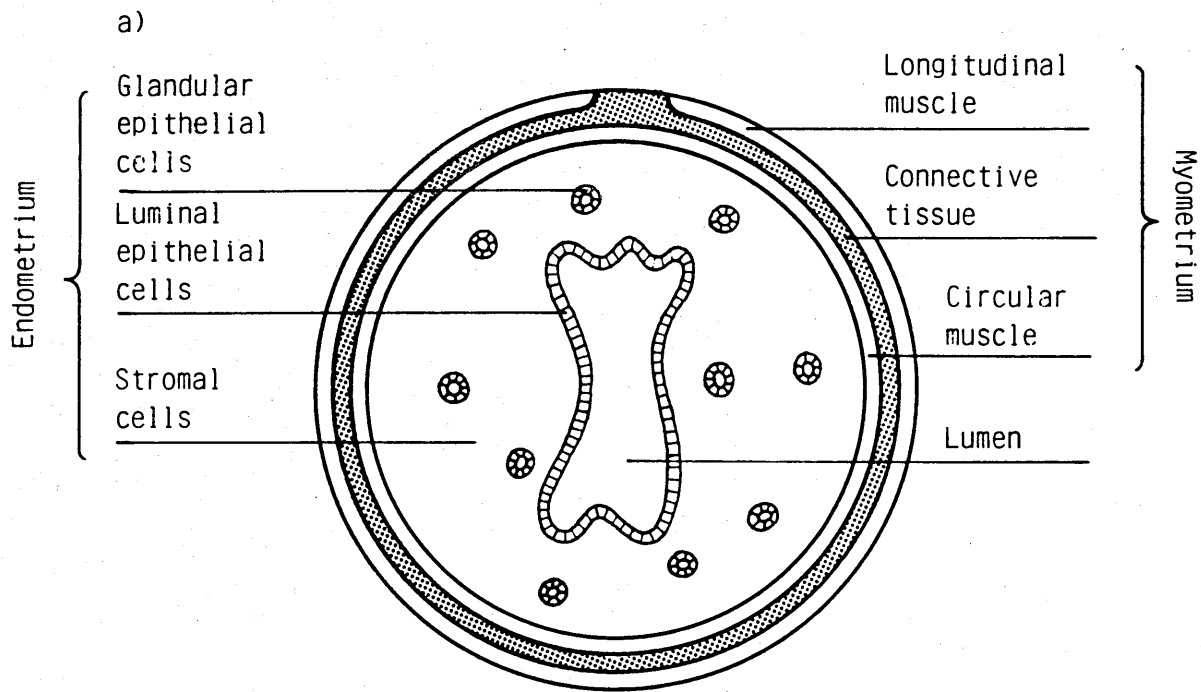

1.2 Oestrogen effects in the rat uterus

1.2.1 The overall response

Figure 2(a) illustrates a diagrammatic cross section of the rat uterus. Briefly, the uterus can be sub-divided into two main components, the myometrium, consisting of longitudinal and circular muscle and connective tissue, and the endometrium, consisting of stromal packing tissue and glandular and luminal epithelial cells, the latter forming the lining of the lumen. Oestrogen receptors are found predominantly in the endometrial cells (McCormack and Glasser, 1980). Because of the complexity of cell types and different hormones acting on the uterus, it has been difficult to determine the specific effects of oestrogens. This problem has been partly overcome by studying the effect of administered oestrogen on ovariectomized animals and on immature rats between 15 and 30 days old.

Administration of a single injection (1 μg) of oestradiol-17 β to 20 day old female rats results in hypertrophy and subsequent hyperplasia of the endometrial cells. Thus, during the first 12 h of the response increased uptake of glucose and RNA precursors, imbibition of water with subsequent increase in wet weight and increased RNA and protein synthesis are all observed (Knowler, 1983_a). Between 12 and 24 h after hormone administration, RNA and protein synthesis remains elevated and DNA synthesis and subsequent cell division of all cell types occurs. After 24 h uterine dry weight is increased.

Immature rats less than 15 days old do not respond to oestrogen despite the presence of receptors and apparent nuclear translocation (Kaye, 1983). In ovariectomised mature

rats, a single injection of oestradiol 17 β produces a response similar to the aforementioned. However, hypertrophy and hyperplasia appear to be confined to epithelial cells, particularly the luminal epithelium. Essentially similar events have been shown to occur in the uterus of other mammalian species.

1.2.2 The heterogeneity of oestrogen binding sites

Multiple binding sites for steroid hormones have been reported to exist in the cytoplasm and nucleus. In the rat uterus, Eriksson et al. (1978) reported oestrogen binding sites other than the classical receptor in the cytoplasm and nuclear fractions. In the cytoplasm, type I sites (the classical receptor) have high affinity (k_d 1 nm) and low capacity (1pmol/uterus) for oestrogen. Type II sites are present at 4 times the level of type I sites and have a lower affinity for oestrogen (k_d 30 nm). Although their function is not known, it may be that type II sites serve to concentrate oestrogen in the target tissue. Nuclear type II sites also have lower affinity (k_d 10-30 nm) and higher capacity than the normal nuclear receptor (nuclear type I sites). They do not originate from either type I or type II cytoplasmic sites. The accumulation of nuclear type II sites is stimulated by oestrogen, and high levels are maintained for up to 72 h. Type I nuclear sites decline to low levels by 24 h after oestrogen treatment (Markaverich and Clark, 1979). It was hypothesized that stimulation of type II sites correlated with long term uterine growth responses but not with early responses. Their increase is dependent on long term (6 h) nuclear occupancy of type I

sites. The sub-optimal inducer oestriol, which fails to elicit the full growth response, also fails to stimulate long term retention of type I sites or increased levels of type II sites. Further, nuclear type II sites are absent from the target tissues hypothalamus and pituitary, neither of which grow in response to oestrogen (Kelner and Peck, 1981).

Secondary sites for oestrogen have now been described for mouse and human mammary tissue (Watson and Clark, 1980; Panke et al., 1981) and chick oviduct (Smith et al., 1979).

1.2.3. The hypertrophic response

In the oestrogen-stimulated rat uterus, increased transcriptional activity results in the synthesis of a broad spectrum of proteins. The stimulation of abundant secretory proteins has not been detected. It is possible that the synthesis of some proteins is repressed by oestrogen, although this has yet to be clearly demonstrated.

Uptake of RNA precursors and subsequent RNA synthesis are among the earliest responses observed in the rat uterus (Means and Hamilton, 1966a; Means and Hamilton, 1966b). Synthesis of hnRNA becomes detectable 15-30 min after administration of oestrogen (Aziz and Knowler, 1980). Maturation of early hnRNA to mRNA and subsequent translation by pre-existing ribosomes occurs during the first 4 h of stimulation (Merryweather and Knowler, 1980). Stimulation of hnRNA correlates with increased RNA polymerase II activity (Glasser et al. 1972). Synthesis of rRNA and tRNA is first detectable 1-2 h post-stimulation and continues up to 12 h. This stimulation

correlates with increased RNA polymerase I and III activity, (Weil et al., 1977). A second peak of hnRNA and mRNA synthesis occurs between 4-12 h post-stimulation, and translation of this RNA depends on newly synthesized ribosomes (Merryweather and Knowler, 1980). Studies with α -amanatin, an inhibitor of RNA polymerase II, and with cycloheximide, an inhibitor of translation, indicated that translation of early mRNA is a pre-requisite for the continuation of the response, i.e. the synthesis of rRNA, tRNA and the second peak of mRNA (Borthwick and Smellie, 1975; Baulieu et al., 1972). These observations have led to the hypothesis that some of the proteins encoded by early mRNA's are involved in stimulation of rRNA, tRNA, and mRNA production. This hypothesis is summarised in the model presented in Figure 2b.

R_0t analysis of uterine RNA has been used to compare the RNA populations at various stages of the oestrogen response (McCormack and Glasser, 1980; Aziz and Knowler, 1980; Aziz et al., 1979a; Aziz et al. 1979b). Briefly, 4 h after oestrogen-stimulation, between 8000 and 12000 diverse mRNA species were present. Of these sequences approximately 11% were present in unstimulated uteri and approximately 56% were present 2 h after stimulation. cDNA derived from 4 h mRNA was fractionated into abundance classes and subsequent heterologous hybridization with 2 h mRNA revealed that the main differences between these populations resided in the intermediate abundance species. Homologous hybridization indicated the presence of approximately 150 diverse sequences. The proteins encoded for by these species of mRNA are likely to be important in the regulation of late events and hence

in the maintenance of the oestrogen response.

Amongst the candidates for proteins encoded by early mRNA's are those involved in stimulation of the genes coding for rRNA's, tRNA's and ribosomal proteins (Merryweather and Knowler, 1980; Muller and Knowler, 1984), non-histone chromatin proteins, which have been shown to be induced between 30 min and 12 h after oestrogen-stimulation (Barker, 1971; Pollard and Martin, 1977), and the oestrogen receptor, which is synthesized 6-12h after stimulation (Korach and Ford, 1978). The proteins involved in the stimulation of late mRNA synthesis are likely to be included amongst the non-histone chromatin protein fraction. Recent work in our laboratory has demonstrated that the mRNA encoding the proto-oncogene c-myc was induced 2-4 h after oestrogen-treatment (Travers and Knowler, 1985). The protein product of the c-myc gene is a DNA binding protein which is induced early in the response of a number of cells and tissues to mitogenic stimuli (Robertson, 1984). It is tempting to speculate that in the rat uterus, c-myc protein plays a role in the stimulation of late RNA synthesis.

Early studies on the oestrogen response in the rat uterus identified a protein that is induced very early in the response (Notides and Gorski, 1966). This protein, originally designated I.P. (induced protein) was later found to be creatine kinase, an enzyme involved in storing excess ATP generated by glycolysis. Walker and Kaye (1981) demonstrated that creatine kinase is induced, at least partly, at the transcriptional level.

Candidate proteins encoded by mRNA appearing between 4-12 h include those proteins required for DNA synthesis and subsequent mitosis. Induction of DNA polymerase α has been demonstrated to occur 16-18 h after stimulation (Harris and Gorski, 1978). The mRNA coding for the proto-oncogenes c-Ha-ras and c-sis was induced 12 h post-stimulation (Travers and Knowler, 1985). The protein product of c-Ha-ras is a GTP binding membrane protein implicated in the maintenance of the mitogenic response in a number of tissues and cell lines. (Bishop, 1983). The protein product of c-sis is platelet derived growth factor (Heldin and Westermark, 1984). The induction of a growth factor in the rat uterus is suggestive of an autocrine mechanism involved in regulating the growth response of the uterus.

Studies on the mechanism of action of steroid hormones have generally been directed towards genes/proteins that are induced in response to a given hormone. Little attention has been given to the possibility that steroid hormones may also repress the levels of specific proteins.

One exception to this is the studies carried out on the cytoplasmic ribonuclease inhibitor protein of the rat uterus. Zan-Kowalczevska and Roth (1975) observed that ribonuclease inhibitor activity, readily detectable in the uteri of immature rats, was absent in the uteri of mature rats. Furthermore, ovariectomy of mature rats resulted in some restoration of inhibitor activity, suggesting that the repression of this protein was brought about by oestrogen action. McGregor et al. (1981), demonstrated that the inhibitor

activity of immature rat uteri was lost within 2-3 days of administration of oestrogen implants, whilst Munro and Knowler (1982) confirmed that inhibitor activity disappeared during the normal sexual maturation of female rats.

McGregor et al. suggested that the ribonuclease inhibitor may represent a protein whose levels are repressed by oestrogen. However, work to be presented in this thesis, (also Brockdorff and Knowler, 1984 and 1985), indicated that the loss of inhibitor activity is caused by increased cytoplasmic ribonuclease, thus saturating the inhibitor activity found in untreated immature rats.

As indicated, the uterus is a difficult system to work with, it contains many cell types and its response to oestrogen and other hormones is complex. Despite these drawbacks it is a key mammalian target tissue, and its study is relevant to the use of oestrogens and anti-oestrogens in the control of the ovarian cycle and in cancer chemotherapy. In addition, the uterus provides a suitable system in which to study the mitogenic effect that oestrogens exert on certain target tissues. It will be interesting to see whether the induction of a broad spectrum of proteins in the uterus is achieved by the same mechanism to that which has been proposed to occur with the activation of specific genes in other classical steroid hormone systems, or whether a distinct mechanism is operating under these conditions.

1.3 RNA metabolism in eukaryotic cells

1.3.1 Stability of eukaryotic mRNA

Much of the mRNA of eukaryotic cells is synthesized in the nucleus in the form of high molecular weight precursors, (hnRNA). As far as is known, processing of these precursors to mature cytoplasmic mRNA occurs solely in the nucleus (for a recent review see Knowler, 1983b).

The mechanism whereby processed mRNA is transported from the nucleus to the cytoplasm and polyribosomes is poorly understood (Nevins, 1983). It is however of interest to note that this mechanism represents a possible site for the regulation of gene expression, as evidenced by the observation that adenovirus infected cells show decreased levels of host mRNA transport, despite the continuance of mRNA synthesis (Babich *et al.*, 1983).

In contrast to the rapidly degraded mRNA of prokaryotes (Datta and Niyogi, 1976), it is known that a number of eukaryotic mRNA's are remarkably stable. Perhaps the best known example is the reticulocyte in which mRNA for globin continues to function for a number of days after its synthesis has ceased.

Studies on the stability of mRNA in cell cultures (Greenberg, 1972) revealed that the mRNA of exponentially growing mouse L cells turned over with first order kinetics and had a mean half-life of 10 h. This stochastic decay of mRNA implied that new and old chains have an equal probability of being degraded. First order kinetics for mRNA degradation have been demonstrated in a number of systems (Greenberg, 1975). Singer and Penman (1973) reported that the mRNA of

HeLa cells consisted of two populations, one third having a mean half-life of 7 h, and two thirds with a mean half-life of 24 h. The aforementioned studies utilized techniques such as pulse labelling or steady state labelling in the presence of transcriptional inhibitors to calculate the half-life of mRNA populations. One problem with this approach is that the values obtained may mask more subtle differences in the stability of specific mRNA species.

The advent of recombinant DNA technology has facilitated the analysis of stability of specific mRNA's, using cloned DNA/cDNA probes. Thus, it was demonstrated that the mRNA coding for chick ovalbumin had a half life of 24 h in the presence of oestrogen. Withdrawal of hormone however resulted in a 20-fold decrease in ovalbumin mRNA stability (Cox, 1977). Similarly, the stability of casein mRNA in the mouse mammary gland was increased by up to 25-fold by the hormone prolactin (Guyette et al., 1979). Generally speaking, it appears that mRNA's coding for major secretory proteins are highly stable. In contrast, the mRNA's coding for certain other proteins are rapidly degraded. Examples include the mRNA coding for the proto-oncogenes c-myc and c-fos, which have half lives of less than 30 min (Muller et al., 1984).

The high stability of a number of eukaryotic mRNA's implies that the proteins encoded by these species cannot be regulated simply by termination of transcription. It therefore seems likely that the control of expression of some of these gene products occurs at the post-transcriptional level. Expression of c-myc and c-fos genes can presumably be regulated at the transcriptional level due to the low stability

of their mRNA's. Some of the ideas concerning control of mRNA stability and translation are detailed in the following sections.

1.3.2. The role of Poly (A) in mRNA stability

mRNA chains from a number of biological sources contain, in addition to coding sequences, regions located at the 3' and 5' termini that are not translated. The non-translated region at the 3' terminus is often followed by a tract of adenosine residues, designated the Poly (A) tail. The structure and function of the Poly (A) tail has been reviewed by Littauer and Soreq (1982). Briefly, polyadenylation of mRNA has been demonstrated to occur in the nucleus and cytoplasm. The size of the Poly (A) tail varies from 20-200 residues and appears to show no constancy for a given mRNA. It has been proposed that the Poly (A) tail plays a role in translation, transport and/or control of stability of mRNA. Recent evidence indicates that the latter possibility is most likely.

Evidence indicating that the Poly (A) tail is involved in the control of mRNA stability falls into two classes: Firstly, microinjection of adenylated and de-adenylated globin mRNA into xenopus laevis oocytes revealed that de-adenylation resulted in a marked destabilization of this mRNA (Huez et al., 1974; Nudel et al., 1976). Re-addition of Poly (A) to de-adenylated globin mRNA resulted in complete restoration of functional stability (Huez et al., 1975). Histone mRNA, which is naturally de-adenylated was rapidly degraded when

injected into HeLa cells. However, addition of a Poly (A) tail to histone mRNA resulted in a marked increase in stability (Huez et al., 1978). Secondly, the addition of Poly (A) in vivo can be inhibited by Cordycepin, without any short term effects on RNA processing and transport (Zeevi et al., 1981). RNA synthesized under these conditions did not accumulate in the cytoplasm although almost normal amounts were transported (Zeevi et al., 1982). These findings have been taken to imply that Poly (A) stabilizes cytoplasmic mRNA.

The mechanism whereby Poly (A) can selectively stabilize mRNA is poorly understood. The observation that the Poly (A) tract of specific mRNA's is progressively shortened during the mRNA's lifetime has led to the idea that Poly (A) may serve to protect mRNA from a 3'→5' exonuclease (Sheiness and Darnell, 1973). However, the stochastic decay of cytoplasmic mRNA would seem to disqualify this possibility.

Evidence against a role of Poly (A) in the control of mRNA stability includes the observation that the stability of interferon mRNA, after microinjection into *Xenopus laevis* oocytes, was unaffected by de-adenylation (Sehgal et al., 1978). Microinjection of naturally de-adenylated histone mRNA from sea urchin eggs revealed that whilst most histone mRNA decayed stochastically with a half-life of 3 h, a small fraction (1-5%) remained stable in the oocytes for up to 4 weeks (Woodland and Wilt, 1980). This fraction of histone RNA may represent mRNA that has been sequestered by the stable free mRNP pool. (See Section 1.3.4). It therefore seems that the Poly (A) tail is involved in the

control of mRNA stability, but that other mechanisms may also be operative.

1.3.3. The role of 5' 'cap' in mRNA stability

Most eukaryotic mRNA's contain a 5' terminal 'cap', M⁷G (5') ppp (5')-X. (Shatkin, 1976). It is known that the 'cap' site is required for the formation of stable translation complexes between the mRNA and ribosomes. (Kozak and Shatkin, 1976).

Microinjection of mRNA devoid of a 'cap' structure into *Xenopus laevis* oocytes, or incubation of this RNA in cell free protein synthesizing extracts of wheat germ or mouse L-cells revealed that this mRNA was rapidly degraded (Furuichi et al., 1977; Shimotohno et al., 1977). It was proposed that this degradation was the result of the action of a 5' exoribonuclease. The fact that the 'cap' site is present on most mRNA's indicates that it is unlikely to be involved in the regulation of mRNA stability. However, these findings illustrate the point that both the 3' and 5' termini of eukaryotic mRNA are protected from exonucleolytic attack (the former due to the presence of Poly (A) binding proteins; see Section 1.3.4). This observation indicates that degradation of eukaryotic mRNA is likely to be initiated by an endoribonuclease, with subsequent hydrolysis occurring through the action of an exoribonuclease. Kumagai et al. (1985 a , 1985 b) have purified an endoribonuclease and a 3' exoribonuclease from rat liver microsomes. They propose that these enzymes are involved in mRNA degradation.

1.3.4. The role of mRNP particles in the control of mRNA stability

That the mRNA of eukaryotic cells can exist in the form of nucleoprotein complexes, (mRNP's), was first reported after studies on the mRNA of sea urchin eggs (Spirin and Nemer, 1965). Since that time extensive studies have revealed that two major types of mRNP are found in the cytoplasm of eukaryotic cells; free mRNP's, isolated from the post-microsomal supernatant, and polyribosome bound mRNP's that can be dissociated from polyribosomes by treatment with EDTA. Some of the major proteins associated with mRNP's appear to be common to free and polyribosomal particles (Bag, 1983). Of particular note are two polypeptides (M.W. 75,000 and 50,000) that bind to Poly (A) tails with a high affinity. These proteins have been detected in the mRNP's from a variety of biological sources (Spirin and Ajtkhozhin, 1985). The protein to RNA mass ratio of free mRNP's is about 3:1 whilst that of polyribosomal mRNPs is about 2:1.

The mRNA associated with free mRNP's is untranslatable in cell free extracts unless the particles are deproteinized (Spirin, 1969). This observation has led to the proposal that mRNP's contain a protein factor that represses translation. A translational repressor activity has been detected in the free mRNP particles of duck reticulocytes (Civelli et al., 1980), but the repressor protein itself has not been isolated. The function of other proteins found in free mRNP particles is largely unknown. One possibility is that some of these proteins bind to specific regions of

mRNA, such as double stranded RNA, and thereby protect the mRNA from nucleolytic attack. It has recently been demonstrated that ribonuclease and ribonuclease inhibitor protein are bound to the free cytoplasmic mRNP's of human placenta (Gileadi et al., 1984). The possible significance of this finding is discussed in Section 1.4.4.

Spirin and Ajtkhozin (1985) proposed that the RNA found in free mRNP particles could represent one or more of the following:- 'masked' mRNA which is to be translated only at a later stage in cell differentiation, temporarily untranslated RNA on its way from nucleus to polyribosomes, or 'run off' mRNA released from a translational complex.

In addition to the tightly bound proteins of polyribosomal mRNP's, there exist many loosely associated proteins that seem to be in dynamic equilibrium with a cytoplasmic pool of free proteins (Spirin and Ajtkhozin, 1985). Some of the candidates for this group of proteins are the elongation factors EF-1 and EF-2, ADP-ribosyl transferases, and amino-acyl tRNA synthetases.

One of the systems in which mRNP's have been most extensively studied is the duck reticulocyte (Vincent et al., 1981). The findings of these studies have led to the proposed model, illustrated in Figure 3, indicating the inter-relationship of the different mRNP particles. In this model, 'transfer mRNP's' represent a putative particle, as yet undetected. The free mRNP's are further divided into three groups: Pretranslation mRNP's represent particles containing repressed mRNA that is in equilibrium with its counterpart in polyribosomal mRNP's. Long term repressed mRNP's represent

stable mRNA sequences with no counterpart in the polyribosomal fraction. An example of this type of particle is the maternal mRNP of sea urchin eggs. This mRNA is stable for up to 60 days and is only sequestered by polyribosomes after fertilization of the egg (Spirin and Nemer, 1965). Short term repressed mRNP's represent a fraction that appears to decay in a stochastic manner with an intrinsic half-life. Because the reticulocyte represents a high level of specialization, it is likely that variations in this model occur in other systems.

Studies carried out on HeLa cells (Spohr et al., 1970) revealed that 40-60% of the total mRNA is present in free mRNP particles. Only a small fraction of this RNA was chaseable into polyribosomes. Mauron and Spohr (1978) reported that the mean half-life of mRNA in free particles was 1-2 h, whilst that of RNA associated with polyribosomal mRNP was 24 h. These findings are reminiscent of the report of Singer and Penman (1973), who found that one third of HeLa cell mRNA decays with a half-life of 7 h whilst the remaining two thirds has a half-life of 24 h. The relatively short half-life of free mRNP's may reflect low levels of long term repressed mRNA's or alternatively, the calculation of mean half-life may mask a small fraction of highly stable free mRNP.

In conclusion, there appear to be two ways in which mRNP can affect mRNA stability; Firstly, the proteins of mRNP that bind RNA tightly may serve to protect the RNA from nucleolytic attack. Secondly, competition between different mRNA's for specific stabilization factors and/or

translational repressors, or sequestration of specific mRNA's by specific mRNP pools, may provide a mechanism whereby mRNA stability can be differentially regulated.

Some unusual findings indicate that the translation products of certain mRNA's may be associated with their own mRNA in free mRNP particles. Thus, actin and other muscle specific proteins were found in the free mRNP fraction of cultured muscle cells. Heat shock treatment of the same cells resulted in the association of one of the heat shock proteins with free mRNP's (Bergmann et al., 1982; Bag, 1983). Babich and Nevins (1981) reported that the 100 kd L4 protein of adenovirus acts to selectively stabilize late adenovirus mRNA in infected cells. Preliminary studies indicated that the L4 protein associates with the free mRNP's of infected cells (Nevins, 1983). Taken together, these findings indicate the existence of a feedback mechanism whereby the protein product of a given mRNA can regulate the stability/translation of its own mRNA.

Figure 3. Tentative flow diagram of mRNA in the cytoplasm of duck erythroblasts.

This figure illustrates the proposed inter-relationship of the various mRNP fractions found in the duck erythroblast, (Vincent et al., 1981). Further details are given in the text.

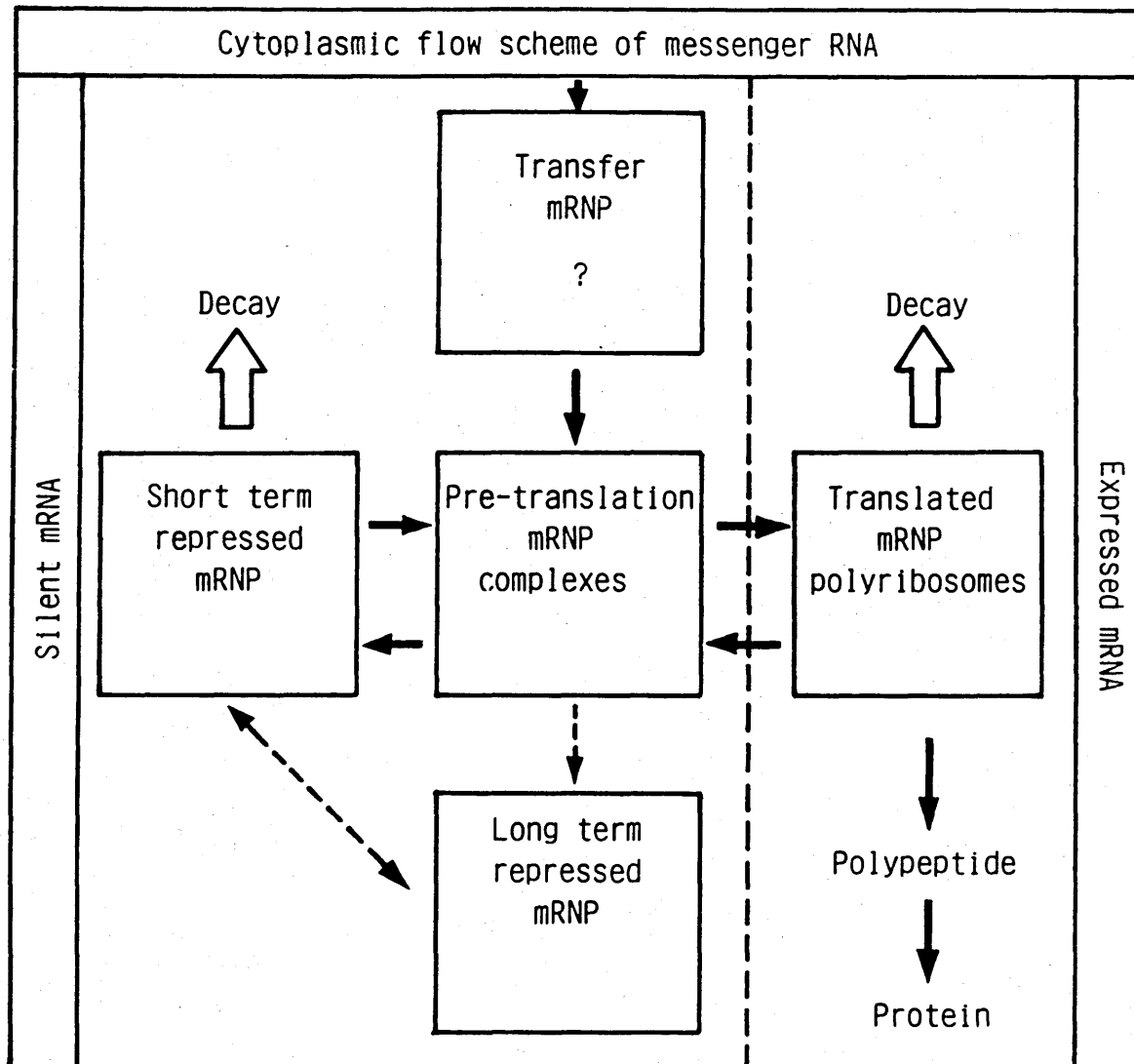

1.4 Mammalian ribonucleases and the ribonuclease inhibitor

1.4.1 Classification of mammalian ribonucleases

Various attempts have been made to classify the wide range of known mammalian ribonucleases on the basis of a number of properties. For the purpose of this report, the classifications employed by Sierakowska and Shugar (1977) will be utilized. The most clear cut distinction is that between endoribonucleases, enzymes that cleave RNA at specific residues yielding oligonucleotide fragments, and exoribonucleases, enzymes that digest RNA sequentially from the 3' or 5' terminus. The latter group of enzymes are not affected by the endogenous ribonuclease inhibitor proteins and have therefore been omitted from this discussion.

Endoribonucleases can be further sub-divided into type I and type II endoribonucleases. Type I endoribonucleases are defined as enzymes optimally active at neutral or alkaline pH, that cleave RNA endonucleolytically via the formation of products with terminal pyrimidine nucleoside 2',3'-cyclic phosphates. They also share other common properties such as acid thermostability and sensitivity to the endogenous ribonuclease inhibitor protein.

Type II endoribonucleases are optimally active at pH 5-6, show no base specificity and are thermolabile. They are found exclusively in the lysosomal fraction of mammalian cells and are insensitive to the endogenous ribonuclease inhibitor (Roth, 1967).

A number of other endoribonucleases do not fall into either of these categories. These include the nucleases involved in processing of rRNA, hnRNA, and tRNA, nucleases active towards double stranded RNA, hybrid nuclease (RNase H) that digests the RNA moiety of DNA:RNA hybrids, and an endoribonuclease activated in response to interferon. None of these enzymes are sensitive to the endogenous ribonuclease inhibitor (Sierakowska and Shugar, 1977).

Type I endoribonucleases can be further sub-divided into secretory and non-secretory types. Predominant among the secretory type I enzymes are the well characterized pancreatic ribonucleases A and B (RNase A and RNase B). Bovine RNase A has been the subject of intensive research, and as a consequence its primary structure, tertiary structure, and catalytic mechanism have been elucidated. (For review see Blackburn and Moore, 1982). RNase B has the same primary sequence as RNase A, but has a higher level of glycosylation (Blackburn and Moore, 1982). It has been observed that the highly glycosylated RNase B is more resistant to proteolytic digestion, suggesting that it is probably the main form of RNase that is secreted by the pancreas into the duodenum (Birkeland and Christenson, 1975).

Pancreatic type ribonucleases are secreted by the pancreas and salivary glands of all mammals and are found in the duodenal contents, serum, kidney and urine. Generally, the pancreatic type ribonucleases have a molecular weight in the region of 14,000. However, under certain conditions

aggregation can occur resulting in the formation of dimers and higher oligomers (Crestfield et al., 1962). Some non-pancreatic type I ribonucleases, such as that isolated from bovine semen (D'Alessio et al., 1975), form natural dimers by sulfhydryl cross linking of two RNase A like subunits.

In addition to the secretory type I ribonucleases, all mammalian tissues contain small quantities of non-secretory type I ribonucleases. It is this group of enzymes that associate with the endogenous ribonuclease inhibitor in vivo. A detailed account of these enzymes is presented in Section 1.4.3.

1.4.2 Ribonuclease inhibitor protein: Purification and properties

Roth (1956) first described the occurrence of a ribonuclease inhibitor in the high speed supernatant fraction prepared from the liver and other tissues of the rat. The inhibitor was detected by its ability to inhibit the digestion of RNA by exogenously added bovine pancreatic RNase A. Preliminary studies (Roth, 1956; 1958a; 1962 and Shortman, 1961, 1962) revealed that the inhibitor is a labile protein, readily inactivated by heat or acid. Its activity was dependent on the integrity of one or more sulfhydryl groups, and it could therefore be inactivated by heavy metal ions (Hg^{++} and Pb^{++}), and sulfhydryl blocking reagents, p-chloro-mercuribenzoate (pCMB/pHMB) and others (Roth, 1958b). In most tissues studied the inhibitor is present in a molar excess over cytoplasmic type I ribonuclease, and as a consequence the latent ribonuclease activity can only be detected when the inhibitor is inactivated.

The ribonuclease inhibitor has since been detected in the cytoplasmic fraction of a wide range of mammalian tissues, including those of marsupials (Kraft and Shortman, 1970a). A similar activity has also been reported to exist in the liver of avian (Kraus and Scholtissek, 1974) and amphibian species (Malicka-Blaskiewicz, 1978). Further evidence for the ubiquity of ribonuclease inhibitor is provided by the report (Aoki and Natori, 1981) of a similar activity in the larvae of ^{the} flesh fly (sarcophaga peregrina).

Preliminary attempts to purify the inhibitor of rat liver utilized a combination of ammonium sulphate fractionation of the post-mitochondrial supernatant, followed by ion exchange chromatography and gel filtration (Gribnow et al., 1969). The partially purified protein (3,000 fold) was found to have a molecular weight near to 50,000 as estimated by gel filtration. This purification procedure was extended by using affinity chromatography on RNase A coupled to carboxymethyl-cellulose (Gribnow et al., 1970, Gagnon and de Lamarinde, 1973). This approach gave near homogeneous preparations, but with a low yield. Gribnow et al. (1969) demonstrated the importance of maintaining the level of free thiol (either β -mercaptoethanol or Dithiothreitol) and EDTA throughout the purification procedure. Homogeneous inhibitor was purified from human placenta using ion exchange chromatography and affinity chromatography on RNase A - sepharose 4B (Blackburn et al., 1977).

A simplified purification procedure utilized only ammonium sulphate precipitation and affinity chromatography (Blackburn, 1979). High yields (40-60%) were obtained with this procedure. A similar approach has now been used to purify the inhibitor from bovine brain (Burton et al., 1980) and the livers of five mammalian species (Burton and Fucci, 1982). The molecular weight of the inhibitor, derived from a number of mammalian sources, has been found to be approximately 50,000 as determined by gel filtration and SDS-PAGE.

The human placental inhibitor is an acidic protein (Pi 4.5 - 4.8), that forms a 1:1 complex with bovine pancreatic RNase A, resulting in apparent non-competetive inhibition (K_i 3×10^{-10} M) of the enzyme. (Blackburn et al., 1977). Similar findings were reported for the inhibitor of bovine brain (Burton et al., 1980), and rat liver (Bartholeyns and Baudhin, 1977). However, Turner et al. (1983) suggested that Michaelis-Menton kinetics were not applicable to the ribonuclease inhibitor and that the inhibition of RNase A was better described using the kinetic procedures for slow tight-binding inhibitors (Morrison, 1982). Application of these procedures to the inhibition of RNase A by porcine inhibitor protein indicated that the inhibition was competetive. Further, the authors point out that when kinetic analysis is carried out under the conditions described by those authors claiming non-competetive inhibition (enzyme:inhibitor ratio approaches unity and $K_m \gg K_i$), Lineweaver-Burke plots invariably indicate non-competetive inhibition, even though the inhibition may well be otherwise. Finally, a non-

competetive mode of inhibition would predict the existence of enzyme:substrate:inhibitor complexes. Such complexes have never been detected.

The ribonuclease inhibitor is generally assayed by its ability to inhibit RNase A. One unit of inhibitor is defined as the quantity required to inhibit the RNase A catalysed digestion of RNA by 50%. One unit approximates to 10-12 ng of purified protein.

Amino acid analysis of inhibitor from human placenta (Blackburn et al., 1977), bovine brain (Burton et al., 1980), and the livers of five mammalian species (Burton and Fucci, 1982), revealed few significant differences in these proteins. Antiserum raised against human placental inhibitor cross reacted to some extent with the inhibitors from bovine, murine, porcine, rat and sheep liver (Burton and Fucci, 1982). Taken together, these results indicated that the mammalian inhibitor protein exhibits some degree of evolutionary conservation.

All of the inhibitor proteins analyzed contained a high level of cysteine + 1/2 cysteine residues (between 26-31 per molecule). Blackburn et al. (1977) calculated that at least 8 of these were present as free sulfhydryl groups but has subsequently amended this figure to approximately 25 (Blackburn, personal communication). The inhibitor from non-mammalian sources has not been characterized so extensively. That of rooster liver (Dijkstra et al., 1978) does not inhibit mammalian RNase A, but does inhibit chicken type I ribonucleases. The inhibitors from other non-mammalian species share the common characteristic of being dependent on the maintenance

of free sulfhydryl groups for their activity (Aoki and Natori, 1981; Malicka-Blaskiewicz, 1978).

The structure of bovine pancreatic RNase A has been the subject of extensive studies for a number of years (for a recent review see Blackburn and Moore, 1982). The mass of data on the primary, secondary and tertiary structure of this enzyme, along with detailed knowledge of the mechanism of catalysis have facilitated studies on the interaction of this enzyme with human placental ribonuclease inhibitor (Blackburn and Gavilanes, 1980 and 1982; Blackburn and Jaiikhani, 1979). Information regarding the interaction of enzyme with inhibitor was obtained either by modifying specific residues on the enzyme, and examining the effect on inhibitor binding utilizing a competition assay, or by determining the degree of protection afforded to specific residues by binding of the inhibitor. Some of the main points to emerge from these studies were as follows:

Modification of the active site residues His-12 and His-119, or the auxiliary residues Phe-120, Asp-121 and Ser-123 did not affect inhibitor binding. Although Blackburn and Moore (1982) cited these observations as supporting a non-competitive mode of inhibition, competitive inhibition does not necessarily involve direct blocking of the active site, but may arise through a partial blockage of the active site or a conformational change that alters the juxtaposition of residues involved in either catalysis or substrate binding. Protection studies indicated that a number of Lysine residues in the enzyme are involved in inhibitor-enzyme binding. Specific carboxymethyl-

ation of Lys 41, a residue whose modification results in a 95% loss of enzyme activity (Carty and Hirs, 1968), reduced significantly the strength of the interaction between enzyme and inhibitor. Circular dichromism measurements on a number of derivatives of RNase A indicated that one or more tyrosine residues are important for its interaction with inhibitor.

A summary of the data obtained from these studies (Blackburn and Moore, 1982) indicated that there are at least three regions on the three dimensional model of RNase A that are involved in the interaction with inhibitor. The first region includes Lys - 7, Lys - 41, Pro - 42, Val - 43, Lys-91, Tyr-92 and Pro-93. The second region includes Lys-31 and Lys-37, and the third region is represented by Lys-61 and adjacent residues. A key ionic interaction involves the positively charged ϵ -NH₂ group of Lys-41, probably through an interaction with a negatively charged group of the inhibitor. Blackburn suggested that this interaction may account for the inactivation of the enzyme, since modification of the ϵ -NH₂ group of Lys-41 abolishes enzyme activity.

More recently, Blackburn et al. (personal communication, 1985) utilized a similar approach to define the role of the free sulfhydryl groups of the inhibitor on its interaction with RNase A. Briefly, they found that of the 25 free sulfhydryl groups of human placental inhibitor, at least twelve were exposed to solvent and reacted readily with alkylating agents. Of 4-6 of the most rapidly reacting sulfhydryl groups, 2 appeared to be most important for full inhibitor activity.

Further studies on the interaction of inhibitor with RNase A will be facilitated when the primary structure of the inhibitor is known. Given our extensive knowledge of the structure of RNase A, such studies could provide an interesting model for the detailed analysis of protein-protein interactions.

1.4.3. Ribonucleases associated with the inhibitor *in vivo*

Acid-thermostable endoribonucleases optimally active at neutral or alkaline pH have been reported to occur in a wide range of tissues, cells and sub-cellular fractions (for reviews see Shugar and Sierakowska, 1967; Sierakowska and Shugar, 1977). Evidence that some of the non-secretory type I ribonucleases are distinct from their secretory counterparts comes from immunological studies (Gordon, 1965) and studies on differential activity towards the synthetic substrate uridine 3'-(α -naphthyl)phosphate (Zan-Kowalczevska *et al.*, 1974; Bardon *et al.*, 1976). Further evidence has been provided by comparison of properties such as pH optima, metal ion requirements and differential activity towards the homopolymers Poly (C) and Poly(U). (Sierakowska and Shugar, 1977).

The wide variety of species and tissues examined, together with the variety of cell fractionation and enzyme purification techniques used makes it difficult to discern any clear cut rules concerning the localization, properties and function of these enzymes. The rat liver has perhaps been the most extensively studied tissue in this respect, and for this reason the following account will concentrate on the findings in this system.

Early studies on the ribonucleases of rat liver indicated that type I ribonucleases are found in all of the major sub-cellular fractions. Beard and Razell (1964) reported that a type I ribonuclease is associated with the mitochondrial fraction of rat liver. Further analysis by Bartholeyns et al. (1975) suggested that this activity may actually arise from rat liver lysosomes. Razell (1963) obtained a partially purified type I ribonuclease from rat liver nuclei. However, the thermolability of this enzyme indicated that it is not related to other type I ribonucleases. Another thermolabile type I ribonuclease was reported to occur in the microsomal fraction of rat liver (Kumagai et al., 1985a). A type I ribonuclease activity was detected in rat liver cytoplasm after inactivation of the endogenous inhibitor with PHMB, heat or acid treatment, (Roth, 1958b). Similarities between this activity and the mitochondrial type I ribonuclease led to the proposal that the cytoplasmic activity represented enzyme released by sub-cellular components during growth and aging (Beard and Razell, 1964).

Gagnon et al. (1974) examined the effect of partially purified inhibitor on the acid-thermostable type I ribonucleases associated with nuclear, mitochondrial, lysosomal, ribosomal, and cytoplasmic fractions of rat liver. Whilst all of these activities were inhibited, albeit to differing extents, the problem of cross contamination of sub-cellular fractions makes it difficult to draw any concrete conclusions from these results. The fact that the ribonuclease inhibitor is found exclusively in the cytoplasmic fraction of all tissues examined raises doubts about the significance of its

ability to inhibit ribonucleases from other subcellular fractions.

Bartholeyns et al. (1975) proposed that the bulk of liver type I ribonuclease activity is associated with the lysosomal fraction. The observation that pancreatectomy resulted in reduced levels of this activity, together with similarities between the liver and pancreatic/serum ribonucleases, led to the suggestion that the liver enzyme is of extrahepatic origination (Bartholeyns and Baudhin, 1977). However, this hypothesis is inconsistent with other findings where it has been demonstrated that liver and pancreatic type I ribonucleases are distinct enzymes. (Zan-Kowalczywska et al., 1974; Bardon et al., 1976).

A type I ribonuclease, sensitive to the endogenous inhibitor, has been reported to be associated with the plasma membrane fraction of rat liver (Gavard et al., 1974; Aronsen and Yannarell, 1975). However, the low levels of this activity suggested that it may be adsorbed from the cytoplasmic fraction.

It is clear from the examples cited thus far that there is considerable confusion concerning the number of different type I ribonucleases and their intracellular distribution in the rat liver. This confusion appears to arise from two main problems: Firstly, contamination problems inherent in sub-cellular fractionation procedures make it difficult to assign a given activity to a given sub-cellular component. Further, because different workers have utilized different fractionation procedures, it is difficult to relate the findings into an overall model. The second problem concerns

the definition of specific activities. Generally, the different activities have been differentiated on the basis of differences in pH optima, metal ion requirements etc. However, whilst some groups have assayed activities in crude extracts, other groups have used partially purified enzymes. This latter problem could be overcome to some extent by obtaining homogeneous preparations of the enzymes concerned. This approach has not been facilitated by the fact that these enzymes are present at very low levels relative to other liver proteins. Another problem inherent in this approach is that most of the purification procedures utilized up to recent times have involved an acid extraction step. Bartholeyns et al. (1974) have reported that acid extraction results in changes in the properties of pancreatic RNase A during its purification. Specifically, the physiological form exhibits a dual pH optimum at pH 4.5 and pH 7.5. The purified enzyme is devoid of activity at pH 4.5.

On a more optimistic note, recent developments have led to the purification to homogeneity of some of the enzymes of rat liver without the utilization of acid extraction. Kumagai et al. (1983) have developed a lengthy purification procedure, involving ion-exchange chromatography, gel filtration and affinity chromatography, to purify the cytoplasmic type I ribonuclease associated with the inhibitor from rat liver. Whilst the yield from this procedure was low (8%), sufficient quantities were obtained to characterize the enzyme. The purified enzyme was found to have a molecular weight of 16,000, being optimally active at pH 7.5-8. It was shown to differ from rat pancreatic RNase A on the basis

that unlike the pancreatic enzyme, it cleaved the homopolymer poly (C) at a greater rate than Poly (U). A second, minor species of ribonuclease was detected at an early stage of the purification. This species was not further characterized.

The idea that more than one type I ribonuclease is associated with the inhibitor in vivo has been supported by recent findings in other systems. Button et al. (1982) reported the partial purification of cytosolic ribonuclease from porcine thyroid. They found that the activity was composed of a variety of species, distinguishable on the basis of molecular weight. The major species (59% of activity) had an apparent molecular weight of 51,000 as determined by gel filtration. The remainder of the activity was contributed by species of molecular weight 13,000 - 28,000. All of the activity could be inhibited by the endogenous inhibitor. The ability of the inhibitor to bind to the high molecular weight species is unusual considering the work of Blackburn et al.⁽¹⁹⁸¹⁾ that suggested that ribonucleases associated with the inhibitor should bear a close resemblance to pancreatic RNase A in order to interact with the inhibitor (see Section 1.4.1). It is conceivable that the high molecular weight species reported by Button et al.⁽¹⁹⁸²⁾ arises through aggregation. Aoki et al. (1981) reported that chromatography of intact inhibitor/ribonuclease complexes from rat reticulocytes on DEAE-cellulose reveals two peaks of latent ribonuclease activity. Similarly, Little and Whittingham (1981) reported that DEAE-cellulose chromatography of mouse skeletal muscle

inhibitor/ribonuclease complexes reveals two peaks of activity. As there have been no reports of heterogeneity of the inhibitor from a given species, these differences in the behaviour of the complexes presumably reside in the ribonuclease moieties.

Other groups have also reported heterogeneity of the type I ribonuclease of bovine skeletal muscle (Davies et al., 1980) and Ehrlich ascites cells and normal mouse tissues (Von Tigerstrom and Manchak, 1977). However, these studies were carried out using whole tissue extracts rather than cytoplasmic fractions, and it is therefore not clear which of the species observed are associated with the inhibitor in vivo.

Finally, recent work on the inhibitor from human placenta (P. Blackburn, personal communication) indicated that there are two major, and a number of related minor ribonuclease species associated with the inhibitor in this system. These observations are supported by data presented in the ensuing thesis and will be analysed more fully in the discussion section.

1.4.4 The ribonuclease/ribonuclease inhibitor system:

Functional aspects.

In a wide range of cells and tissues in which the ribonuclease/ribonuclease inhibitor system has been studied, it has been observed that the ratio of inhibitor to ribonuclease increases in cells engaged in active protein synthesis and decreases in cells with increased catabolism

(Kraft and Shortman, 1970b). These observations have been taken to imply some essential role for the inhibitor in the control of RNA metabolism and protein synthesis.

Some examples of tissues showing increased ratios of inhibitor to ribonuclease are tumourous and lactating mammary glands relative to glands of virgin rats, (Liu et al., 1975), the thyroid gland of patients with hyperthyroidism relative to normal thyroids (Grief and Eich, 1977), TSH-stimulated rat thyroids relative to normal glands (Grief and Eich, 1972), in rapidly proliferating mouse spleen (Poels, 1976), in the estrogen-stimulated rooster liver (Dijkstra et al., 1978) and in the regenerating rat liver (Moriyama et al., 1969). Tissues exhibiting a decreased ratio of inhibitor to ribonuclease include the muscle of dystrophic mice relative to normal muscle (Little and Meyer, 1970), the brain of patients suffering from Alzheimers disease relative to normal brain (Sajdel-Sulkowska and Marotta, 1984), the liver of rats fed on a protein free diet (Quirin-Stricker et al., 1968), or after adrenalectomy (Liu and Matrison, 1976), various tissues of the rat during aging (Chesters and Will, 1978), and Ehrlich ascites cells after actinomycin D treatment (Von Tigerstrom, 1972).

Other evidence pointing to an essential role of the inhibitor in the control of RNA metabolism includes the observation that isolation of intact polysomes is facilitated in tissues with high levels of inhibitor (Blobel and Potter, 1966; Takahashi et al., 1966). Purified inhibitor has been used to facilitate the isolation of intact polysomes from tissues with low inhibitor levels (Burghouts et al., 1970).

Purified inhibitor has also been used to increase the size of polypeptides synthesized in cell free translation systems (Hiranyavasit and Kusamran, 1983; Robbi and Lazarow, 1978; Scheele and Blackburn, 1979), to improve the yield of high molecular weight cDNA obtained in reverse transcription reactions (de Martynoff et al., 1980), and to improve the synthesis of RNA in in vitro transcription systems (Eichler et al., 1981).

The evidence linking increased protein synthesis to increases in the ratio of inhibitor to ribonuclease is not unequivocal. Gauvreau et al. (1974) reported that the level of free inhibitor in Novikoff hepatoma is considerably lower than that found in normal rat liver. Roth (1967) reported that the level of free inhibitor in Dunning hepatoma and the Morris 7288 C hepatoma is higher than that found in normal rat liver, but in contrast, he also reported that free inhibitor levels in the Morris 4123 D hepatoma was reduced compared to normal rat liver. It is apparent from these studies that there is no clear cut relationship between the level of free inhibitor and increased growth in rat liver hepatomas.

The level of free inhibitor in the uterus of immature rats is similar to that found in rat liver (McGregor et al., 1981). Administration of oestrogen or normal sexual maturation resulted in the loss of this activity (McGregor et al., 1981; Munro and Knowler, 1982). Ovariectomy of mature animals resulted in partial restoration of inhibitor activity, indicating that these effects were due to oestrogen action

(Zan-Kowalszewska and Roth, 1975). Because the oestrogen-stimulated uterus is characterized by elevated levels of RNA and protein synthesis, (Section 1.2.3), these findings appear to be contradictory to the proposed relationship between free inhibitor levels and protein synthesis.

Kraft and Shortman (1970b) suggested that such deviations from the general rule may be accounted for by the heterogeneity of cell types in the tissues. This point is illustrated by studies on regional variations in inhibitor levels in the rat kidney (Liu and Matrisan, 1976). High speed supernatants prepared from total kidney or kidney cortex have no free inhibitor activity. However, high speed supernatants prepared from white or red medulla did show some free inhibitor activity. It is unlikely that heterogeneity of cell types contributes to the loss of free inhibitor in the rat uterus as ovariectomized uteri, with the same cell composition as normal uteri, displayed restored inhibitor levels.

Another possible source of these discrepancies may lie in the definition of "elevated levels of protein synthesis". In an early review of this topic (Roth, 1967), it was suggested that there are two distinct situations where elevated protein synthesis occurs: Firstly, is the situation where a fully differentiated cell is producing large quantities of abundant secretory/structural proteins. In this situation it seems likely that there will be minimal breakdown of mRNA such that a given transcript can be translated a number of times. Thus, the mRNA coding for a number of major secretory/structural proteins has been

found to be relatively stable (Section 1.3.1). The second situation occurs in a cell that is undergoing rapid growth and/or differentiation. In this situation, the discontinuation of synthesis of old types of protein and the transient expression of some proteins involved in the cell cycle might mean that the cell requires increased ribonuclease activity. At least some of the mRNAs transiently expressed during the cell cycle have been shown to have relatively short half-lives (e.g. c-myc and c-fos mRNA; Muller et al., 1984).

It is interesting to note that tissues associated with the synthesis of major abundant proteins often have high levels of free inhibitor. Examples include rat liver (Roth, 1967), where albumin and other major serum proteins are synthesized, reticulocytes (Aoki et al., 1981), where the globin proteins are synthesized, lactating mammary gland (Liu et al., 1975) where the major milk proteins such as casein are synthesized, calf lens (Ortworth and Byrnes, 1971), where α -crystallin is synthesized, skeletal muscle (Little and Whittingham, 1981) where the major muscle proteins are synthesized, and in adrenal (Girija and Sreenivasan, 1966), thyroid (Grief and Eich, 1977), thymus (Kraft and Shortman, 1970 b) and parotid (Robinovitch et al., 1968) glands. In contrast, tissues with low inhibitor activity are not associated with the synthesis of major abundant proteins, e.g. lung, spleen, and kidney (work to be presented in this thesis, and Brockdorff and Knowler, 1985). However, the overall picture is complicated by systems where increased cell proliferation is

accompanied by the synthesis of major abundant proteins, e.g. the PHA stimulation of lymphocytes, where immunoglobulin proteins are synthesized in concert with increased cell proliferation. In this system, free inhibitor levels were reported to increase (Kraft and Shortman, 1970b).

Returning to the situation occurring in the rat uterus, oestrogen-stimulation results in rapid cell and tissue growth preceded by elevated levels of synthesis of all classes of RNA, but with no preferential stimulation of major abundant proteins. It is conceivable that under these circumstances increased cytoplasmic ribonuclease activity will be required.

The observations cited thus far indicate that the inhibitor/ribonuclease system may play a role in the control of protein synthesis. However, at present little is known about its precise function. One of the more important questions relating to the function of this system concerns the role of the enzymes associated with the inhibitor in vivo. If, as present evidence indicates, these enzymes are distinct from their counterparts in serum etc., then it would seem likely that they carry out a specific function. However, the fact that in most tissues analysed the enzymes are maintained in an inactive form by an excess of inhibitor casts some doubt on the significance of this idea.

A number of workers have proposed that there may exist circumstances under which the inhibitor is reversibly inactivated, thus liberating the ribonuclease activity. This idea has recently received some support from the

observations of Blackburn et al. (Personal communication, 1985). They have found that oxidized glutathione can reversibly inactivate the ribonuclease inhibitor of human placenta through thiol-disulphide exchange. Further, they argue that this observation may have physiological significance based on the observation that calf lens cataractogenesis is accompanied by decreased inhibitor and increased ribonuclease activity (Maione et al., 1968), together with increased levels of oxidized glutathione (Reddy et al., 1976). Further studies are clearly required to confirm this hypothesis and to determine whether a similar mechanism is operative in other tissues.

Meyer and Meyer (1979) reported that administration of double stranded RNA to mice resulted in increased cytoplasmic ribonuclease and decreased inhibitor activity in liver and muscle. They suggested that these observations may account for the inhibition of cellular protein synthesis caused by agents such as viruses. This hypothesis is not supported by studies that indicate that increased ribonuclease activity in virus infected cells results from the interferon mediated activation of a novel ribonuclease species, (Clemens and Williams, 1977).

A number of inhibitor insensitive endoribonucleases and exoribonucleases have been reported to occur in the ribosomal fraction of eukaryotic cells (Reboud et al., 1976; Swida et al., 1981; Kumagai et al., 1985a,b). It has been suggested that these enzymes are responsible for mRNA degradation in eukaryotes. If this is indeed the case, then

a function for inhibitor bound ribonucleases in the control of RNA metabolism is doubtful. An alternative hypothesis for the role of the inhibitor is that it acts as a scavenger protein, inhibiting type I ribonucleases that may be taken up into cells from serum or released from intracellular organelles.

The recent finding that inhibitor/ribonuclease complexes are bound to the free mRNP particles of human placenta (Gileadi et al., 1984) indicates a possible function of the inhibitor, perhaps in stabilizing long term repressed mRNP's (see Section 1.3.4). However, only 1% of the total inhibitor/ribonuclease of placental cytoplasm is found in mRNP particles, raising some doubts about the significance of this finding. It will be interesting to see whether the inhibitor/ribonuclease is also found in polyribosomal mRNP's. This possibility has not been tested as yet.

1.5. Aims of the project

Studies on the mechanism of action of steroid hormones have revealed that they elicit their effects by influencing the level of specific proteins at the transcriptional level and/or at the post-transcriptional level. Generally speaking, these studies concentrated on gene products whose levels were enhanced by the steroid hormone. The disappearance of ribonuclease inhibitor activity from the immature rat uterus in response to oestrogen, or during normal development provided a putative example of a protein that was repressed by a steroid hormone. Therefore, the primary aim of this project was to determine the mechanism whereby the ribonuclease inhibitor activity was lost in response to oestrogen. There are three hypotheses that could account for this effect: Firstly, oestrogen could cause repression at the transcriptional level of the gene coding for the ribonuclease inhibitor. Secondly, oestrogen could repress the translation or decrease the stability of the mRNA encoding ribonuclease inhibitor, i.e. a post-transcriptional mechanism. Finally, oestrogen could repress the activity of the ribonuclease inhibitor protein, perhaps indirectly through the action of a putative oestrogen-induced factor or by effects that result in the re-localization of the inhibitor to a sub-cellular fraction other than the post-mitochondrial supernatant.

As has been discussed in Section 1.4.3 the reduction in ribonuclease inhibitor activity in the oestrogen-stimulated uterus, a tissue with elevated levels of RNA and protein synthesis, is in contrast to the general finding that tissues

with elevated levels of RNA/protein synthesis have increased levels of ribonuclease inhibitor activity. The secondary aim of this project was therefore to attempt to explain these findings and thereby increase our understanding of the precise function of the ribonuclease/ribonuclease inhibitor system.

2. MATERIALS AND METHODS

2.1. Suppliers

Unless otherwise specified, all chemicals used were AnalaR grade supplied either by BDH Chemicals Ltd., Formachem (Research International) Ltd., or Fisons Scientific Apparatus. Where chemicals and equipment were obtained from other sources, this is indicated in the text, and a list of the names and addresses of the suppliers is given below.

BDH Chemicals Ltd., Poole, Dorset, U.K.

Beckman-Spinco Ltd., Palo Alto, California, U.S.A.

Becton, Dickinson and Co., Oxnard, California, U.S.A.

Bio-Rad Laboratories Ltd., Watford, Herts, U.K.

Boehringer Corporation, London, U.K.

B.R.L., Rockville, Bethesda, U.S.A.

Corning Glassworks, New York, U.S.A.

Corning Universal, Palo Alto, California, U.S.A.

Difco Laboratories, Detroit, Michigan, U.S.A.

Eastman-Kodak Co., Rochester, New York, U.S.A.

Eppendorf Geratebau, Hamburg, W. Germany.

Fisons Scientific Apparatus Ltd., Loughborough, Leics., U.K.

Formachem. Ltd., Strathaven, Scotland, U.K.

Hopkins and Williams, Chadwell Heath, Essex, U.K.

Jencons, Hemel Hempstead, Herts., U.K.

Koch-Light Laboratories Ltd., Colnbrook, Bucks, U.K.

Labsure, Christor Hill Group Ltd., Poole, Dorset, U.K.

L.K.B. Instruments Ltd., S. Croydon, Surrey, U.K.

Miles Laboratories, Stoke Poges, U.K.

Pharmacia (G.B.) Ltd., London, U.K.

Radiochemical Centre, Amersham, Bucks., U.K.

Scottish Antibody Production Unit (SAPU), Glasgow, U.K.

Schleicher and Schüll, Dassel, W. Germany.

Sigma (London) Chemical Co. Ltd., Kingston-upon-Thames, Surrey,
U.K.

Whatman Ltd., Maidstone, Kent, U.K.

2.2. Sterile precautions

All glassware used in the handling of ribonuclease was decontaminated by soaking in a chromic acid bath. Where possible, disposable polyethylene tubes were used.

All solutions used in the handling of nucleic acids were autoclaved at 15 p.s.i. for 20-30 min. β -mercaptoethanol and dithiothreitol (DTT) were added to solutions after autoclaving. Any solutions that could not be autoclaved were sterilized by passing the solution through a nitro-cellulose selectron filter (Schleicher and Schüll, 45 μ m).

Glassware used in the preparation of RNA or DNA, for example corex tubes (Corning), was coated with Repelcote (Hopkins and Williams) and then autoclaved. Polyethylene microfuge tubes were also treated with Repelcote and autoclaved. Tips for automatic pipettes were autoclaved.

2.3. Glassware

Glass homogenizers with motor driven teflon pestles were purchased from Jencons Ltd. Ground glass homogenizers were purchased from Kontes glassware. Corex glass centrifuge

tubes were obtained from Corning Glassware. Glass chromatography columns were purchased from Pharmacia Ltd. All other glassware was obtained from laboratory stocks.

2.4. Radiochemicals and scintillation counting

All radioactive isotopes were purchased from the Radiochemical Centre, Amersham. AnalaR grade toluene and P.P.O. (2,5 diphenyloxazole) were obtained from Koch-Light Laboratories Ltd.

Determination of radioactivity for the ribonuclease and ribonuclease inhibitor assays (Sections 2.7.2 and 2.7.3) was carried out as follows: Dried kieselguhr pads were incubated at 60°C for 20 min. in the presence of 0.3 ml of hyamine hydroxide. 10 ml of toluene/0.5% (w/v) PPO was added to each sample and the radioactivity determined on a Beckman LS8100 scintillation counter.

Cherenkov counting of nick translated DNA (Section 2.9.8) was carried out by adding 1 µl of sample to 1 ml of H₂O. The radioactivity was measured on a Beckman LS8100 scintillation counter.

Measurement of [¹²⁵I] was carried out on an LKB 1275 Minigamma counter.

2.5. Experimental animals

All animals were supplied by the departmental animal house. The immature female rats used were from the Wistar strain and were weaned at 18-21 days after birth. The weight of these animals was between 30 g and 40 g. Weanling rats were killed by cervical dislocation after ether

anaesthesia.

The adult male and female rats used were also of the Wistar strain, and weighed between 150 g and 250 g. These animals were killed by concussion.

The adult rabbits used for raising antibodies were of the white New Zealand strain and were bled from the ear vein.

All animals used were given free access to food (supplied by Labsure) and water.

2.6. Preparation and administration of hormone

(a) Intraperitoneal injection

Oestradiol-17 β (Sigma) or Oestradiol benzoate (Sigma) was solubilized at 10 μ g/ml in 0.3M NaCl/0.5% (v/v) ethanol by the method of Roberts and Szego (1947). All immature rats received 1 μ g oestradiol by intraperitoneal injection in 0.1 ml of carrier. Control animals received carrier only.

(b) Subcutaneous implantation

50 mg and 10 mg paraffin wax pellets containing either 10% or 1% estradiol-17 β (w/w) were made by the method of Clark et al. (1978). Briefly, the required amount of oestradiol-17 β was added to hot paraffin wax and suspended by sonication. The resultant suspension was stirred on a heated magnetic stirrer and the required volume pipetted onto a cold glass plate. Subcutaneous implantation was carried out under light ether anaesthesia. Control rats received implants of paraffin wax only.

2.7. Methods

2.7.1. Protein assays

Generally, protein concentrations were determined by the method of Lowry^{et al} (1951). Various amounts of a 1 mg/ml solution of BSA (Sigma) were used as standards. Samples containing substances known to interfere with the Lowry assay were extensively dialysed against distilled water.

Occasionally protein concentrations were assayed by the method of Bradford (1976), using the micro-assay method of Spector (1978).

The protein concentration of fractions from chromatographic columns was estimated by measuring the absorbance at 280 nm using a quartz cuvette in a Cecil CE 272 spectrophotometer. One absorbance unit at 280 nm was taken to be equivalent to approximately 1 mg of protein.

2.7.2. Assay of ribonuclease inhibitor

Ribonuclease inhibitor activity was determined by the method of McGregor et al. (1981). Various amounts of sample were incubated in a final volume of 1.5 ml containing 0.02M Tris-HCl pH 7.4, 2 mM EDTA, 125 µg of unlabelled highly polymerized yeast RNA (B.D.H. London) and $2-3 \times 10^3$ c.p.m. (1.5 - 2.25 µg) of [³H] BHK cell RNA.

The reaction, conducted for 20 min. at 37°C was initiated by the addition of 10 ng of bovine pancreatic ribonuclease A (Sigma), and terminated by the addition of 1.5 ml of 10% (w/v) trichloroacetic acid containing 2% (w/v) Kieselguhr (Celite Hyflo supercell; Koch-Light). Acid

insoluble RNA was collected by filtration on to a pad of Kieselguhr, washed with 3 x 10 ml of 5% (w/v) trichloroacetic acid, 2 x 10 ml of methanol and 2 x 5 ml of diethyl ether, and prepared for scintillation counting as described in Section 2.4.

The above assay conditions were derived for a preparation of [³H] BHK cell RNA which lasted for the duration of the project. The 20 min. time point for the assay of inhibitor was selected because the ribonuclease A catalyzed digestion was linear over this length of time, and resulted in conversion of approximately 60% of the RNA to acid soluble product. Fresh preparations of [³H] RNA would require recalibration and might result in different combinations of labelled and unlabelled RNA, RNase A concentration, or incubation times.

The ribonuclease inhibitor activity of cytoplasmic fractions and of fractions derived from the purification of rat liver inhibitor was determined by measuring the activity of 4-6 different sample volumes in duplicate in comparison with non-inhibited controls.

Generally, one unit of inhibitor activity is defined as the amount required to inhibit by 50% the degradation of RNA by 5 ng of ribonuclease A. As our assay utilizes 10 ng of ribonuclease A, the quantity of inhibitor resulting in 50% inhibition of digestion was taken to be two units.

2.7.3. Assay of ribonuclease activity

Ribonuclease activity in uterine supernatants was determined by the method of McGregor et al. (1981). Various volumes of uterine cytoplasm prepared as high speed supernatants

were incubated at 37°C for 30 min. in a final volume of 1.5 ml containing 0.02 M Tris/HCl pH 7.4, 2 mM EDTA, 15 µg unlabelled yeast RNA (BDH) and 2×10^3 c.p.m. (1.5 µg) of BHK cell [^3H] -RNA. In order to distinguish between free and total (free + ribonuclease inhibitor bound) activity, samples were incubated in the presence or absence of 10^{-4} M para Hydroxymercuribenzoate (pHMB), a sulfhydryl blocking reagent that at this concentration completely inactivates the inhibitor, but has no effect on the ribonuclease activity, (McGregor et al., 1981; Roth, 1967). pHMB was added as a X10 concentrate in 0.25 M glycyl glycine (BDH, London), pH 7.4. Samples to which pHMB were added were pre-incubated at 37°C for 30 min. so that all cytoplasmic inhibitor was inactivated. The reaction was initiated by the addition of the RNA and terminated by the addition of 1.5 ml of 10% (w/v) trichloroacetic acid, 2% (w/v) Kieselguhr. All subsequent steps were as described for the assay of ribonuclease inhibitor in the previous section. One unit of ribonuclease activity was arbitrarily designated as the amount required to digest the [^3H] -RNA by 50%.

Whilst this assay was suitable for the accurate determination of activity in a relatively small number of samples, a simpler, more rapid assay was used to measure the ribonuclease activity of large numbers of samples e.g. fractions from a column during the purification of cytoplasmic ribonucleases. This assay was developed by Blackburn et al. (personal communication, 1985). Various amounts of sample were incubated for 30 min. at 37°C in a final volume of 150 µl containing 0.1 M Tris/HCl pH 7.5, 1mM EDTA, 0.02% BSA

and 500 µg yeast RNA (Sigma). The reaction was initiated by the addition of the RNA, and terminated by the addition of 50 µl of ice-cold 24% (v/v) perchloric acid, 40 mM in lanthanum acetate (Ventron). The samples were then transferred to ice for 20 min. and centrifuged for 5 min. at 4°C in an Anderman 5414 microcentrifuge. The acid soluble nucleotides in 100 µl of resultant supernatant were diluted to 1.0 ml with water and the absorbance at 260 nm was measured on a Cecil CE 272 spectrophotometer. The reaction was carried out in 1.5 ml polyethylene microfuge tubes that had previously been treated with Repelcote (Hopkins and Williams), and sterilised. One unit of ribonuclease activity in this assay was designated as being the amount required to give an increase in absorbance at 260 nm of one O.D. unit.

The relative activity of purified ribonucleases towards the homopolymers Poly(U) (Miles), Poly(C) (Boehringer), Poly(A) and Poly(G) (Sigma) was determined by the same method except a 5 mg/ml solution of the homopolymer was used as substrate.

Changes in assay conditions for the determination of kinetic parameters or pH optima for the purified ribonucleases, are detailed in the relevant figure legends.

2.7.4. Preparation of cytoplasmic fractions

(a) Uterus

Uteri were excised and dissected free of adipose tissue before being rapidly frozen in a solid CO₂/methanol bath. Groups of uteri were then ground up with a mortar and pestle

and subsequently homogenised in ice-cold 0.05 M Tris/HCl pH 7.6 containing 0.35 M sucrose, 0.025 M KCl, 0.01 M Mg $(\text{CH}_3\text{COO})_2$ and 0.01 M β -mercaptoethanol in a Kontes ground glass homogeniser. Approximately 7 ml of buffer was used per g wet weight of tissue. High speed supernatants were prepared by centrifuging the homogenate at $105,000 \times g_{\text{av}}$ for 2 h at 4°C using an SW 50.1 rotor in a Beckman model L5 50B ultracentrifuge. The resultant supernatant was decanted and stored at -20°C .

(b) Other tissues

Cytoplasmic fractions were prepared from rat liver, kidney, spleen, lung, brain or pancreas as follows: All steps were carried out at 4°C . After removal, the organs were washed and chopped into small pieces in homogenising buffer (see previous section). The chopped tissue was then homogenised with 20 strokes in a glass homogeniser with a motor driven pestle. Approximately 3 volumes of buffer was used per g wet weight of tissue. The resultant homogenate was then centrifuged at $105,000 \times g_{\text{av}}$ for 2 h at 4°C , either in a Beckman SW 27 or SW 50.1 rotor, depending on the amount of tissue being processed. The resultant supernatant was decanted and either used immediately or stored at -20°C .

2.7.5. Purification of rat liver ribonuclease inhibitor protein

Rat liver inhibitor was purified essentially as described by Burton and Fucci (1982). All steps were carried out at 4°C unless otherwise indicated.

Bovine pancreatic RNase A (Sigma) was covalently linked to CNBr. activated sepharose-4B (Sigma) as follows; 10 mg of enzyme was solubilised in 5 ml of coupling buffer, 0.2 M NaHCO₃ pH 8.5, 0.5 M NaCl, and added to an equal volume of resin. The mixture was shaken for 2 h at room temperature on an end to end rotating wheel. After the coupling reaction, excess CNBr groups were blocked by mixing the resin with an equal volume of 0.2 M glycine, pH 8, for 2 h. The resin was then extensively washed with coupling buffer, followed by 0.1 M sodium acetate pH 4, 0.5 M in NaCl.

(a) Preparation of high speed supernatants

High speed supernatants were prepared as described in Section 2.7.4. In a typical preparation the livers of 25 mature male rats were processed, yielding approximately 1 litre of homogenate.

(b) Ammonium sulphate precipitation

The high speed supernatant was brought up to 35% ammonium sulphate saturation by the gradual addition of solid ammonium sulphate. The resultant solution was stirred for 30 min. and then centrifuged at 16,000 x g_{av.} for 15 min. in a Sorvall RC-5 centrifuge. The supernatant was then brought to 60% ammonium sulphate saturation, stirred for 30 min. and centrifuged as above. The supernatant was discarded and the pellet resuspended in a minimum volume of 45 mM potassium phosphate buffer, pH 6.4, and dialysed overnight against 2 x 20 volumes of the same buffer.

(c) Sepharose-RNase A affinity chromatography

The dialysed 35-60% ammonium sulphate fraction was centrifuged at $50,000 \times g_{av}$. for 1 h , in order to remove particulate matter, and passed through a bed of sepharose-RNase A at a flow rate of 25 ml/h. 1 ml of sepharose-RNase A has a capacity of approximately 100,000 units of RNase inhibitor activity, and a column bed volume was used so as to permit saturation of the column by inhibitor. The run through from this step was retained and stored at -20°C for use in the purification of latent cytoplasmic ribonuclease (see Section 2.7.6). The column was then washed with 40 ml of starting buffer followed by 40 ml of the same buffer 0.5 M in NaCl. Bound RNase inhibitor was eluted with 0.05 M Borate buffer, pH 6, 4 M NaCl, 1 mM EDTA, 1 mM β -mercapto-ethanol and 15% (v/v) glycerol. Elution was carried out at a flow rate of 10 ml/h , and 1 ml fractions were collected and assayed for inhibitor as described in Section 2.7.2., and for protein by measuring absorbance at 280 nm. Purified inhibitor from the first elution was found to contain contaminating proteins (as judged by SDS-PAGE) and it was therefore necessary to rechromatograph the eluate on Sepharose-RNase A. Peak fractions from the first eluate were dialysed overnight against 45 mM potassium phosphate buffer, pH 6.4, 15% (v/v) glycerol and re-chromatographed on sepharose-RNase A as described above. Inhibitor from the second elution was found to be homogeneous as judged by SDS-PAGE. Purified inhibitor was dialysed against 20 mM Tris/HCl buffer, pH 7.5, 15% (v/v) glycerol and 0.15 M NaCl, and stored at -20°C .

2.7.6. Purification of cytoplasmic ribonucleases associated with the inhibitor in vivo

Ribonucleases were purified from the cytoplasm of rat liver and mature rat uterus using a modification of the procedure used by Blackburn et al. (personal communication, 1985) to purify the latent ribonucleases of human placenta.

The method employed for liver and uterus was identical, although due to the small quantity of material available from the latter there was no extensive characterization of the purification steps.

The starting material for the purification of liver ribonuclease was the run-through fraction from the sepharose-RNase A affinity chromatography step of the inhibitor purification (Section 2.7.5). This fraction contains ribonuclease/inhibitor complexes, but no free ribonuclease or inhibitor. The starting material for the purification of uterine ribonuclease was a 35-60% ammonium sulphate precipitate of uterine cytoplasm.

(a) DE-52 cellulose chromatography

Ribonuclease/inhibitor complexes have a slightly acidic pI and are therefore retained by anion exchange chromatography resins such as DE 52 cellulose (Whatman). This step has the major advantage that most of the basic proteins in the mixture are eluted through the column. Subsequent inactivation of the complexes means that the highly basic ribonucleases represent a large part of the total population of basic proteins.

Approximately 10 g of protein from rat liver, or approximately 1 g of protein from mature rat uterus was dialysed against 20 mM Tris-HCl, pH 7.5; 1 mM EDTA; 1 mM β -mercaptoethanol. The dialysate was centrifuged at $50,000 \times g_{av}$. for 1 h in order to remove particulate matter, and applied to a column (2.5 x 30 cm) of DE-52 cellulose. The column was washed with two sample volumes of starting buffer and then eluted with a linear gradient of 0 - 0.5 M NaCl in the same buffer (400 ml).

(b) Inactivation of ribonuclease/inhibitor complexes

Peak fractions of latent ribonuclease activity from step (a) were pooled and dialyzed against 2 x 20 volumes of 20 mM Tris-HCl, pH 7.5; 1 mM EDTA. The solution was then made 10^{-4} M in pHMB and incubated at 37°C for 2 h. After incubation, the solution was cooled to 4°C and the pH adjusted to pH 5 by the dropwise addition of 20% (v/v) acetic acid. This resulted in the formation of a heavy protein precipitate which was removed by ultracentrifugation at $50,000 \times g_{av}$. for 1 h. The pH of the supernatant was adjusted to pH 8.5 by the dropwise addition of 5M NaOH.

(c) SP-sephadex chromatography

In this step, the basic ribonucleases released from inhibitor/ribonuclease complexes were further purified by cation exchange chromatography.

Protein from step (b) was applied to a column (2.5 x 30 cm) of SP-sephadex (Pharmacia). The column was washed with three sample volumes of 20 mM NH_4HCO_3 , pH 8.5, and the ribonucleases eluted with 500 mM NH_4HCO_3 , pH 8.5.

(d) Heparin-sepharose chromatography

Linear gradient elution from Heparin-sepharose was utilized to separate the total ribonuclease activity into its constituent peaks.

Peak fractions of ribonuclease activity from step (c) were pooled and dialysed against 20 mM NH_4HCO_3 , pH 8.5. The dialysate was applied to a column (1.5 x 10 cm) of heparin-sepharose (Pharmacia). The column was washed with three sample volumes of starting buffer, and eluted with a linear gradient of 20-500 mM NH_4HCO_3 , pH 8.5 (300 ml).

(e) Affinity chromatography on uridine 2'(3')5'-diphosphate-agarose

This step, although not included in the original protocol of Blackburn et al. was found to be necessary to obtain a homogeneous preparation of ribonuclease. Each separate peak of ribonuclease activity from step (d) was processed separately.

The enzyme solution was dialysed against 2 x 20 volumes of 20 mM sodium acetate, pH 5.5; 1 mM EDTA. The dialysate was applied to a column (1 x 3 cm) of uridine 2'(3')5'-diphosphate-agarose (Sigma). The column was then washed with 50 ml of X10 starting buffer and subsequently eluted with 10 mM Tris-HCl, pH 7.9; 0.5 M NaCl; 0.5% (v/v) glycerol. Peak fractions of ribonuclease activity were pooled, aliquoted, and stored at -20°C .

2.7.7. Polyacrylamide gel electrophoresis (PAGE)

Discontinuous SDS-PAGE

SDS-PAGE was performed essentially as described by Laemmli (1970), using the procedure of Le Stourgeon and Beyer (1977).

Stock solutions:

Acrylamide: 30% acrylamide (w/v), 0.8% bis-acrylamide (w/v).

Resolving gel buffer: 1.5 M Tris-HCl (pH 8.8), 0.4% SDS (w/v).

Stacking gel buffer: 0.5 M Tris-HCl (pH 6.8), 0.4% SDS (w/v).

Electrophoresis buffer: 0.025 M Tris, 0.19 M glycine (pH 8.3)
0.1% SDS (w/v).

Sample buffer: 0.0625 M Tris-HCl (pH 6.8), 2% SDS (w/v) 5%
β-mercaptoethanol (v/v), 10% glycerol (v/v)
abd 0.001% Bromophenol blue (w/v).

Procedure

Samples containing substances that interfere with SDS-PAGE were dialysed against distilled water. When necessary, proteins were concentrated by lyophilization. After addition of sample buffer, samples were heated to 100°C for 2 min.

10% or 12.5% slab gels were prepared by mixing the required amounts of stock solutions in a Buchner flask, and degassing the mixture under vacuum. Polymerization was initiated by the addition of TEMED and ammonium persulphate. The resultant gels (1mm thick, 15 x 18 cm) were electrophoresed on a BRL horizontal slab gel apparatus at 20-40 mA until the tracking dye reached the bottom of the gel. Gels were stained in 0.5% (w/v) Coomassie blue G (Sigma), 50%

methanol (v/v), 10% (v/v) acetic acid for 1-2 h. The background was destained by diffusion in 40% (v/v) methanol, 10% (v/v) acetic acid.

High pH discontinuous non-denaturing PAGE

Non-denaturing PAGE was performed essentially as described by Davis (1964), using the procedure of Hames (1981). This system electrophoreses at pH 9.3.

Stock solutions:

Acrylamide: 30% acrylamide (w/v), 0.8% bis-acrylamide (w/v).

Resolving gel buffer: 3.0 M Tris-HCl (pH 8.8).

Stacking gel buffer: 0.5 M Tris-HCl (pH 6.8).

Electrophoresis buffer: 0.025 M Tris, 0.19 M glycine (pH 8.3).

Sample buffer: 0.05 M Tris-HCl (pH 6.8), 10% sucrose (w/v),
1 mM β -mercaptoethanol, 0.001% (w/v) bromophenol
blue (added immediately before sample loading).

Procedure

Due to the lability of the ribonuclease inhibitor protein, it was necessary to take various precautions to ensure the maintenance of inhibitor activity prior to electrophoresis. Therefore, samples of purified rat liver inhibitor and high speed supernatants from various tissues were dialysed against sample buffer at 4°C immediately after preparation. Samples were then aliquoted and stored at -20°C. Re-freezing of samples led to some loss of inhibitor activity and was therefore avoided.

7%, 9%, 10%, 11% and 13% polyacrylamide slab gels were prepared by mixing the required amount of stock solutions in a Buchner flask and degassing the mixture under vacuum. Polymerisation was initiated by the addition of TEMED and ammonium persulphate. The resultant gels were electrophoresed for 2-4 hours at 4°C using a current of 20-30 mA. Staining for protein was performed as described for SDS-PAGE.

Extraction of gel slices after non-denaturing PAGE

This method was utilized to determine the position of latent and free ribonuclease activities after electrophoresis. Individual tracks from the gel were cut out and sliced into 3 mm pieces. Each gel slice was placed in a 1.5 ml polyethylene microfuge tube containing 100 µl of 0.1 M Tris-HCl pH 7.5; 1 mM EDTA; 0.02% (w/v) BSA. When free ribonuclease activity was to be determined, 1 mM β-mercaptoethanol was included in the buffer in order to reduce the inactivation of inhibitor/ribonuclease complexes. The gel slices were then homogenized and the tubes mixed overnight at 4°C on a rotating end to end wheel. Fragments of polyacrylamide were excluded by centrifugation for 10 min. in an Anderman microcentrifuge. The supernatant was decanted and assayed for total or free ribonuclease activity as described in Section 2.7.3.

Ribonuclease activity gels

Ribonuclease activity was detected in polyacrylamide gels using the method described by Blank *et al.* (1982). Lyophilized samples were resuspended in SDS-PAGE sample buffer

from which β -mercaptoethanol was omitted. 10% SDS polyacrylamide gels were prepared as has already been described, except that highly polymerized yeast RNA (Sigma) was added to the gel mixture at a concentration of 0.5 mg/ml. It was found that some leakage of sample occurred at the junction of stacking gel and resolving gel. Therefore, stacking gels were usually omitted from this procedure. Electrophoresis was for 2.5 h at 4°C using a current of 50-60 mA.

After electrophoresis, the gels were washed in 10 mM Tris-HCl pH 7.4; 25% (v/v) isopropanol (250 ml) in a shaking water bath (2 x 15 mins). The isopropanol was included to aid in the removal of SDS. The gel was then washed in buffer alone (2 x 15 min., 25°C), before being incubated for 2 h at 37°C in 100 mM Tris-HCl, pH 7.4. After incubation, the undigested RNA remaining in the gel was stained in 10 mM Tris-HCl, pH 7.4, 0.2% (w/v) toluidine blue 'O' (Sigma) for 10 mins.

The gel was destained in buffer alone on a shaking water bath. Usually, destaining took approximately 1 h and was taken to be complete when ribonuclease activity, detected as clear bands against a blue background, was clearly discernable. The resultant gel could be stored for a number of days prior to photography if wrapped in cling film and kept at 4°C.

2.8. Immunological methods

Phosphate buffered saline (PBS) used in many of the following methods contained the following: 0.14 M NaCl,

2.7 mM KCl, 1.5 mM KH_2PO_4 and 1.8 mM Na_2HPO_4 .

2.8.1. Immunization schedule

Primary immunizations were prepared by mixing 0.5 ml of PBS containing 100-200 μg of purified protein with 0.5 ml of Freund's complete adjuvant (Difco). An emulsion was formed by sonicating the mixture for 3 x 10 s. The emulsion was injected sub-cutaneously in 5-8 sites on the rabbits back (0.1 - 0.2 ml per site). Booster immunizations, made using Freund's incomplete adjuvant (Difco) were given every 10-14 days until a reasonable titre was obtained. The titre was assessed by ELISA (Section 2.8.2). Complement proteins in the immune serum were inactivated by heating the serum to 50°C for 1 h. Particulate matter was removed by centrifugation at 16,000 x g_{av} for 10 min. in a Sorvall RC-5 centrifuge.

2.8.2. Enzyme linked immunosorbant assay (ELISA)

The ELISA system, performed essentially as described by Voller et al. (1976), was used to measure antibody levels in samples of immune serum.

Antigen, in 100 μl of PBS, was allowed to bind to the bottom of a well of a Falcon microtitre plate, either for 2 h at 25°C or overnight at 4°C. The plate was then washed with washing buffer (PBS; 0.05% TWEEN 20 v/v), for 2 h at 25°C. Serum, diluted 1/10² to 1/10⁶ in washing buffer, was placed in the wells, again for 2 h at 25°C. Once again the plate was washed. A sample of goat anti-rabbit gamma globulin, conjugated to horseradish peroxidase (Miles), was diluted 1/500 in washing buffer and 100 μl added to each well. After 2 h at 25°C the plate was extensively

washed. The quantity of peroxidase activity bound to the plate was determined spectrophotometrically using 100 μ l per well of 36 mM citric acid, 128 mM Na_2HPO_4 , 0.04% (w/v) O-phenylene diamene (Sigma) and 0.04% (v/v) hydrogen peroxide. The reaction was allowed to develop for 20 min. in the dark at 25°C, after which time it was stopped by the addition of 50 μ l of 4N H_2SO_4 . The absorbance at 492 nm was determined for each well using a Titertek multiscan spectrophotometer.

The titre of immune serum was determined by finding the dilution at which immune serum and pre-immune serum from the same animal gave an equal absorbance at 492 nm.

2.8.3. Immuno-electrophoresis

This method, performed essentially as described by Johnstone and Thorpe (1982), was used to assess the specificity of antiserum raised against the ribonuclease inhibitor. Samples of protein were loaded into the wells of a 1 mm thick agarose immuno-electrophoresis plate (Corning Universal), and electrophoresed for 2 h at 3 v/cm, using Barbitone electrophoresis buffer, pH 8.2. After electrophoresis, 20 μ l of antiserum was loaded into the troughs of the plate and the plate was left for 24 h at 4°C. Precipitin bands were visualised by staining the plates with 0.025% (w/v) Coomassie brilliant blue R in methanol: water: acetic acid (50:45:5 by volume), and destaining in water: acetic acid: methanol (87:8:5 by volume).

2.8.4. Immunoabsorption

This method, performed essentially as described by Johnstone and Thorpe (1982), was employed in order to improve the specificity of antiserum raised against the ribonuclease inhibitor.

Protein from the run through fraction of RNase-sepharose affinity chromatography (Section 2.7.5), was covalently linked to activated sepharose-4B (Sigma) essentially as described in Section 2.7.5. Approximately 20 mg of protein were bound per ml of swollen resin. Immune serum was passed through an 8 ml bed of resin at a flow rate of 10 ml/h , and 1 ml fractions were collected and monitored for specificity by ELISA and immunoelectrophoresis. The column was regenerated by eluting bound antibody with 0.5 M ammonium hydroxide containing 3 M potassium thiocyanate. It was found that an 8 ml bed of resin was sufficient to remove contaminating antibodies from 10 ml of immune serum.

2.8.5. Immuno (western) blotting

Immunoblots were performed on proteins resolved on both SDS-PAGE and high pH non-denaturing PAGE, using a modification of the method of Towbin et al. (1979). After electrophoresis the proteins were electrophoretically transferred onto nitrocellulose filters (Schleicher and Schüll) at 350 mA for 2 h in a Bio-Rad electroblotting apparatus. All subsequent steps were carried out at 37°C in a shaking water bath. The filters were washed for 2 h in 100 ml of washing buffer (20 mM Tris-HCl, pH 7.2, 0.15 M NaCl and 0.5% (v/v) TWEEN 20

(Sigma)), and then incubated for 2 h in 100 ml of washing buffer containing 5% (v/v) inactivated goat serum (SAPU) and 0.5 - 1% (v/v) immune serum. After extensive washing, bound antibody was decorated with Protein A (Sigma, U.K.) labelled with [^{125}I] by the Iodogen method of Salinzinski et al. (1981). Approximately 3×10^6 c.p.m. of [^{125}I] labelled Protein A in 100 ml of washing buffer was used per filter. Once again, the filters were extensively washed and then dried and autoradiographed for 24-48 h with an intensifier screen.

Densitometric analysis of autoradiographs was carried out using an LKB ultrascan, linked to a recording integrator.

2.9. Nucleic acids

2.9.1. Preparation of [^3H] labelled BHK cell RNA

BSS: 6.8% NaCl, 0.4% KCl, 0.2% $\text{MgSO}_4 \cdot 7\text{H}_2\text{O}$, 0.14% $\text{NaH}_2\text{PO}_4 \cdot 2\text{H}_2\text{O}$, 0.39% $\text{CaCl}_2 \cdot 6\text{H}_2\text{O}$, 0.0015% phenol red (all w/v) 0.1% Chloroform (v/v).

RSB: 10 mM Tris-HCl, pH 7.4, 10 mM NaCl and 1.5 mM MgCl_2 .

Procedure:

250 μCi of 5-6 [^3H] uridine (Amersham) in 50 ml of Eagles M.E.M. (Busby et al. 1964) was added to each of two burlers of BHK cells grown to near confluence. After 18 h, the medium was discarded and the cells washed twice with BSS, scraped off into 3 x 10 ml of BSS, and centrifuged at $4,000 \times g_{\text{av}}$ for 2 min. The pelleted cells were resuspended in 8 ml of ice cold RSB, and homogenized in a teflon glass homogenizer with a motor driven pestle. The homogenate was then centrifuged

at 16,000 x g_{av} . for 5 min. and RNA was prepared from the supernatant by extraction with an equal volume of water saturated phenol: chloroform: isoamyl alcohol (50:48:2) at room temperature. The aqueous phases from two extractions were pooled and the RNA precipitated overnight at -20°C by the addition of 2.5 volumes of ethanol. The RNA was quantitated by measuring the absorbance at 260 nm, and the specific activity calculated by scintillation counting, (Section 2.4).

2.9.2. Source of plasmids and routine analysis of nucleic acids

Plasmid pCXP6-105 was a kind gift from Dr R.MacDonald, Department of Biochemistry, University of Texas. pCXP6-105 contains an insert of approximately 550 bp, corresponding to most of the coding region of rat pancreatic ribonuclease A mRNA, in the Pst I site of pBR 322. It is therefore tetracycline resistant and ampicillin sensitive. Plasmid p8749 (a kind gift from Dr D.P. Leader, Department of Biochemistry, University of Glasgow) contains a 500 b.p. cDNA insert of rat skeletal muscle actin mRNA. The insert is in the Pst I site of pBR322.

All restriction enzyme digests were performed according to the supplier's recommendations.

Rapid analysis of DNA and RNA samples was carried out using a Uniscience minigel apparatus.

The agarose used for all gels was from Miles Laboratories Ltd., code No. 95200-2.

2.9.3. Transformation of E.Coli

L-Broth: 1% Bactotryptone (Difco), 1% NaCl, 0.5% yeast extract (Difco), (all w/v).

L-Agar: 1.5% (w/v) Agar (Difco) in L-Broth.

Tetracycline: 13 µg/ml for transformation or 20 µg/ml for routine growth.

Competent E.coli HB101 cells were prepared by growing 500 ml cultures until the absorbance at 600 nm was 0.2. The cells were harvested by centrifuging at 5,000 x g_{av.} for 15 min., resuspended in 250 ml of cold 100 mM CaCl₂, and left on ice for 20 min. The cells were then centrifuged again and resuspended in 5 ml of 100 mM CaCl₂. 0.5 ml of sterile glycerol was added and aliquots of 1 ml were frozen in liquid nitrogen and stored at -70°C. Transformation was effected by adding 0.2 - 1 ng of plasmid DNA to a series of 100 µl aliquots of competent cells (thawed for 30 min. in water-ice mix). The cells were left on ice for 30 min. before being heat shocked (37°C for 2 min.), and then plated directly on tetracycline plates.

2.9.4. Isolation of plasmid DNA

Large scale plasmid purification was carried out using the method of Birnboim and Doly (1979). A single colony of transformed bacteria was transferred to 25 ml of L-Broth containing tetracycline at 20 µg/ml, and grown up overnight. 2 x 5 ml of overnight culture were used to inoculate 2 x 800 ml of L-Broth. The bacteria were grown until the absorbance at 600 nm was approximately 0.8, at which time

Choroamphenicol (Sigma), at a concentration of 165 $\mu\text{g/ml}$ was added. The cultures were then left overnight in an orbital shaker. The bacteria were harvested by centrifugation at $5000 \times g_{\text{av}}$ for 10 min. in a Sorvall GS3 rotor, and then resuspended in 10 ml of alkaline lysis buffer I (50 mM glucose, 10 mM EDTA, 25 mM Tris-HCl, pH 8), containing 2 mg/ml lysozyme (Sigma grade I). After 30 min. at 0°C , 20 ml of alkaline lysis buffer II (0.2 M NaOH, 1% (w/v) SDS) was added, and the mixture left for a further 5 min. at 0°C . Finally, 15 ml of alkaline lysis buffer III (3 M Na Acetate, pH 4.8) was added and the mixture left for 1 h at 0°C , before being centrifuged for 30 min. at $70,000 \times g_{\text{av}}$ in a Beckman Ti 60 rotor (4°C). Total nucleic acid was precipitated from the resultant supernatant by the addition of 0.6 volumes of isopropanol. After centrifugation (15 min. at $16,000 \times g_{\text{av}}$) the precipitate was resuspended in 30 ml of T.E. buffer (10 mM Tris-HCl, pH 8, 1 mM EDTA). Plasmid DNA was purified by CsCl density centrifugation; 28.9 g of CsCl and 1.8 ml of ethidium bromide (10 mg/ml) were added, and the solution clarified by centrifugation (30 min. at $2000 \times g$). The solution was then carefully transferred to VTi 50 sealable tubes (Beckman) and centrifuged overnight at 50,000 r.p.m. in a Beckman model L5-50B ultracentrifuge (20°C). After centrifugation the plasmid DNA could be visualised as a dark band using a long wave U.V. lamp. The plasmid DNA was collected into a syringe after piercing the tube with a 21 g needle. A second CsCl spin was carried out using the Beckman

VTi 65 rotor at 65,000 r.p.m. overnight. Plasmid DNA was isolated as described above. Ethidium bromide was extracted with isoamyl alcohol (3 methyl-1-butanol; Koch-Light) and the DNA precipitated by the addition of 0.1 volumes of 3 M NaAc. pH 6 and 2.5 volumes of cold ethanol. Precipitated DNA was resuspended in T.E. buffer and stored at -20°C .

2.9.5. Preparation of total RNA

(a) Isolation of pancreatic RNA

Pancreatic RNA was prepared essentially as described by Chirgwin et al. (1979). The pancreas was removed from two mature male rats, teased free of fatty tissue and rapidly frozen in liquid nitrogen. The tissue was then ground to a fine powder using a mortar and pestle and added to 16 ml of guanadidium thiocyanate solution, (5 M guanidinium thiocyanate (BDH); 5% (v/v) β -mercaptoethanol; 50 mM Tris; 2% (w/v) sarkosyl (Sigma U.K.)). The ground tissue was then homogenized in a glass/teflon homogenizer with a motor driven pestle. Genomic DNA in the homogenate was sheared by taking the solution up into a 10 ml syringe, 10 times through a 19 g needle and a further 10 times through a 23 g needle. The homogenate was then heated to 50°C for 5 min. before being centrifuged for 10 min. at $16,000 \times g_{\text{av}}$. CsCl was added to the solution at a concentration of 1g/2.5 ml homogenate. The homogenate was then layered onto a 1.2 ml cushion of 5.7 M CsCl: 50 mM EDTA, pH 7, in a Beckman SW 50.1 ultra-centrifuge tube, and centrifuged at $115,000 \times g_{\text{av}}$ for 12 h

at 20°C. After centrifugation, the supernatant was discarded and the RNA pellet resuspended in 200-300 µl of sterile distilled water. The RNA was stored at -70°C after the addition of 0.1 volumes of 3 M sodium acetate, pH 6 and 2.5 volumes of ethanol.

(b) Isolation of uterine RNA

Groups of uteri from hormone-treated and untreated immature rats were excised, teased free of adipose tissue, and rapidly frozen in liquid nitrogen. The tissue was then ground up into a fine powder and added to a 50:50 mixture of Calouria buffer (50 mM NaCl; 50 mM sodium acetate; 10 mM EDTA; 1% SDS (w/v), pH 5) and phenol:chloroform:isoamyl alcohol (25:24:1). 32 ml of the mixture was used per g wet weight of tissue. The mixture was then heated to 60°C for 3 min., with constant shaking, and the phases separated by centrifugation at 5,000 x g for 20 min. The phenol phase was re-extracted with calouria buffer, and the aqueous phases pooled and re-extracted with phenol:chloroform:isoamyl alcohol. Total nucleic acid was precipitated from the aqueous phase by the addition of 0.1 volumes of 3 M sodium acetate, pH 6, and 2.5 volumes of ethanol, overnight at -20°C. The precipitate was redissolved in 4 ml of 1% (w/v) sarcosyl: 100 mM EDTA, pH 7, and the genomic DNA sheared by taking the solution into a 5 ml syringe, ten times through a 19 g needle, and a further ten times through a 23 g needle. 4 g. of CsCl was added to the solution, which was then divided into two, and layered onto 2 ml

cushions of 5.7 M CsCl: 50 mM EDTA, pH 7, in Beckman SW40 ultracentrifuge tubes. The tubes were filled to the top with paraffin oil and then centrifuged at $35,000 \times g_{av}$. for 17 h at 20°C . After centrifugation, the supernatant was discarded and the pellet resuspended in sterile distilled water. The RNA was stored at -70°C as an ethanol precipitate.

2.9.6. Preparation of Poly(A)⁺ and Poly(A)⁻ fractions from total RNA

Total RNA was resuspended in binding buffer (10 mM Tris-HCl, pH 7.5; 0.5 M LiCl; 1 mM EDTA) at a concentration of 0.5 mg/ml, heated to 60°C for 5 min. and rapidly cooled on ice. The solution was then chromatographed through a 0.2 ml bed of oligo dT cellulose (BRL) at a flow rate of 10 ml/h. The run through was re-heated, cooled and reapplied to the column. The second run through (Poly(A)⁻ fraction) was ethanol precipitated and stored at -70°C . The column was then washed with binding buffer 0.1%(w/v) in SDS, until the absorbance of the eluate at 260 nm was less than 0.05. Poly(A)⁺ RNA was eluted from the column with 1 ml aliquots of elution buffer (10 mM Tris-HCl, pH 7.5; 1 mM EDTA). The absorbance at 260 nm of each fraction was measured and the peak fractions pooled, ethanol precipitated, and stored at -70°C . Typically, approximately 5% of the total RNA was recovered in the Poly(A)⁺ fraction.

2.9.7. Isolation of DNA from agarose gels

Plasmid DNA, digested with the relevant restriction enzyme, was electrophoresed on a 1% agarose gel for 3-4 h. Excised insert DNA was visualised under U.V. light after staining with ethidium bromide, and the required band cut out with a scalpel. The agarose slice was placed in a piece of dialysis tubing (3/8" - 9 mm) with a minimal volume of running buffer (0.04 M Tris-acetate, pH 7.8; 0.002 M EDTA). The dialysis tubing was sealed with plastic clips and placed on the central platform of the electrophoresis apparatus, at right angles to the direction of the current. Electrophoresis was performed for 2 h at 60 V, after which time the solution was removed from the dialysis bag. Agarose debris was removed from the solution by centrifugation in a microcentrifuge. The DNA was precipitated overnight after the addition of 0.1 volume of 3 M sodium acetate, pH 6, and 2.5 volumes of ethanol. This DNA was suitable for the nick translation reaction described in the following section.

2.9.8. Nick translation of DNA

A typical reaction contained the following:

1 mCi/100 μ l α - [32 P] dATP	- 5 μ l (50 μ Ci)
100 mM Tris-HCl, pH 7.4: 100 mM MgSO ₄	
500 mM NaCl: 100 mM DTT	- 1.8 μ l
DNA at approximately 1 mg/ml	- 0.5 - 1 μ l
DNA Polymerase I (Boehringer-Mannheim)	
5 units/ μ l	- 1 μ l
100 μ M dCTP	- 0.5 μ l

100 μ M dTTP - 0.5 μ l
100 μ M dGTP - 0.5 μ l
H₂O to give final volume of 18 μ l.

Due to DNase I contamination of the DNA polymerase, it was not necessary to add exogenous DNase I.

The reaction was allowed to proceed for 4 h at 15°C, after which time the labelled DNA was purified by chromatography through a small column of Biogel P-60 (Biorad). The radioactivity incorporated was determined by Cherenkov counting. Nick translated DNA was stored at -20°C.

The specific activity of DNA labelled by this method was between 5×10^7 and 10^8 c.p.m./ μ g DNA.

2.9.9. Northern blotting

Between 1 and 25 μ g of Poly(A)⁺ or Poly(A)⁻ RNA was solubilized in running buffer, (20 mM MOPS (Sigma), 5 mM sodium acetate, 1 mM EDTA, pH 7), 50% formaldehyde (v/v). The RNA was then heated to 60°C for 5 min., rapidly cooled and electrophoresed on 1% agarose/formaldehyde gels as described by Seed (1982). Electrophoresis was for 3-4 h at 60 V. 18 s and 28 s rRNA's were used as M.W. markers.

After electrophoresis the gel was soaked in 20 x SSC (3 M NaCl, 3 M sodium citrate, pH 7) for 30 min. and the RNA transferred to nitrocellulose filters (Schleicher and Schüll) as described by Southern (1975). After blotting, filters were air dried and then baked for 2 h at 80°C in

a vacuum oven.

The baked filters were pre-hybridized for 6-8 h at 42°C in sealed plastic bags containing 10 ml of hybridization buffer (5 x SSPE*; 10 x Denhardtts⁺; 0.1% (w/v) SDS; 50% (v/v) formamide; 10 µg/ml in Poly(A) and Poly(C) and 100 µg/ml sonicated salmon sperm DNA). Filters were then hybridized in the same volume of hybridization buffer containing $5 \times 10^6 - 10^7$ c.p.m. of heat denatured probe (specific activity approximately 10^8 c.p.m./µg). The filters were hybridized for 24-48 h at 42°C in a shaking water bath. Filters were then washed, first in 2 x SSC; 0.1% SDS (w/v) at 25°C, and then in 0.1 x SSC; 0.1% SDS (w/v) at 50°C (low stringency). Filters were then autoradiographed for 2-14 days in the presence of an intensifier screen.

*20 x SSPE; 3 M NaCl, 0.2 M $\text{NaH}_2\text{PO}_4 \cdot \text{H}_2\text{O}$, 20 mM EDTA, pH 7.4.

⁺50 x Denhardtts; 1% Ficoll (Sigma) w/v, 1% Polyvinylpyrrolidone (Sigma) w/v, 1% BSA (Pentax fraction V, Sigma) w/v.

3. RESULTS

3.1.1. The effect of oestrogen on the activity of uterine cytoplasmic ribonuclease inhibitor

As has been outlined in Section 1.4.3, cytoplasmic preparations from the uterus of the immature rat contained ribonuclease inhibitor activity at a similar level to that found in rat liver (McGregor et al., 1981). Within three days of administration of oestrogen implants, this activity disappeared. The loss of inhibitor activity also occurred during normal sexual maturation of female rats. Figure 4 illustrates a repeat of the original experiments that formed the basis of this project. It can be seen that under these conditions, uterine inhibitor activity disappeared after only 24 hours. The difference between this result and that presented by McGregor et al. (1981), where inhibitor activity was not completely lost until three days after administration of oestrogen, was probably due to the use of a smaller quantity of carrier RNA in the assay (125 μ g as opposed to 250 μ g), thus increasing its sensitivity to the exogenously added pancreatic RNase A. Figure 4 also confirmed that the uterus of mature rats contained no detectable inhibitor activity.

In a previous experiment, the effect of 50 mg and 10 mg paraffin wax implants, (either 10% (w/v) or 1% (w/v) in oestradiol-17 β), on uterine inhibitor levels was tested. It was found that only the 50 mg/10% or 10 mg/10% implants elicited the full response. Therefore, in this experiment and all further experiments described in this thesis, 10 mg/10% implants were utilized.

Experiments using a single injection of oestradiol-17 β or oestradiol benzoate failed to produce any significant change in inhibitor activity, (data not shown). The reason for this observation remains unclear but presumably implies that continued exposure to oestrogen, or a higher dose than that obtained with single injections is required to elicit the response. The fact that inhibitor activity is lost during normal development of the uterus indicates that the changes brought about by administration of oestrogen implants do reflect a normal response to the hormone.

Figure 4. The effect of oestradiol-17 β and stage of development on the activity of uterine ribonuclease inhibitor.

High speed supernatants were prepared from groups of uteri as described in Section 2.7.4. The inhibitor activity of each sample was determined as described in Section 2.7.2. The protein content of the samples was determined by the method of Lowry (Section 2.7.1). The cytoplasm was derived from mature female rat (\blacktriangle) or from immature rats which were untreated (\bullet) or given oestrogen implants 1 day (\circ), two days (\blacksquare), or four days (\square) before death.

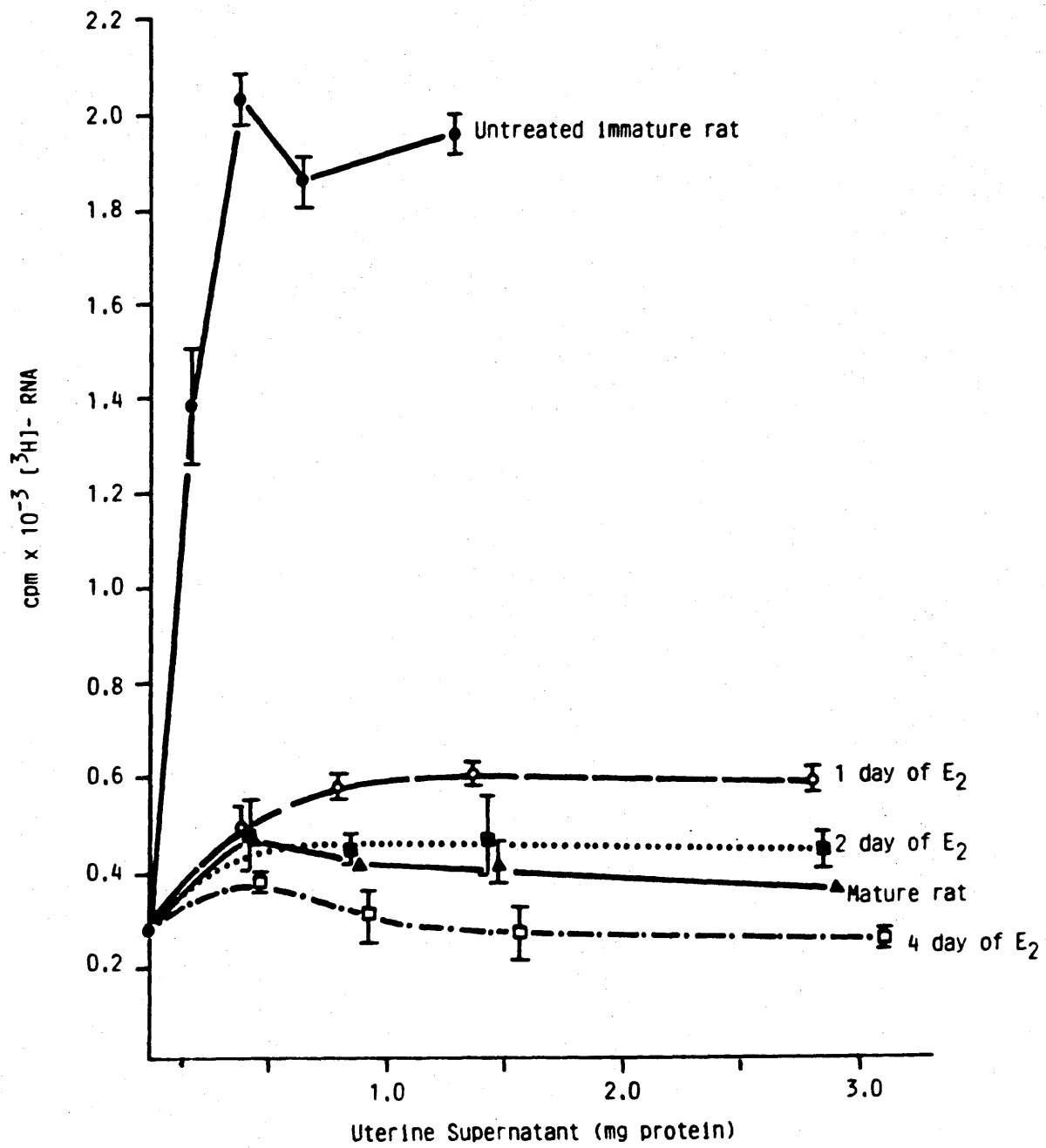

3.1.2. Qualitative and quantitative analysis of ribonuclease inhibitor in the rat uterus using antibodies to the purified protein

In order to determine whether the loss of inhibitor activity observed was due to a coincident reduction in the level of the protein, it was necessary to obtain antibodies to purified inhibitor for use in quantitative analysis.

Rat liver was chosen as a source of inhibitor protein due to its high level of inhibitor activity and availability (Roth, 1967). There have been no reports of heterogeneity of ribonuclease inhibitor within a given species and it was therefore considered likely that antibodies raised to liver inhibitor would cross react with uterine inhibitor. This assumption was later confirmed.

The purification procedure adopted was that of Burton and Fucci (1982). (See Section 2.7.5). The first step, preparation of a 35-60% ammonium sulphate precipitate from rat liver cytoplasm, resulted in a purification factor of approximately 1.5 (Table 2). Blackburn (1977) has demonstrated that the 35-60% ammonium sulphate precipitate of human placental cytoplasm contains inhibitor/ribonuclease complexes, as well as free inhibitor. Evidence that inhibitor/ribonuclease complexes are also present in the ammonium sulphate precipitate of rat liver is presented in Section 3.3.1.

The second step, affinity chromatography using sepharose-RNase A, resulted in an overall purification of approximately 25,000 fold (Table 2). The run through from this affinity

chromatography step was retained and used in the purification of cytoplasmic ribonuclease, as described in Section 2.7.6. In the remainder of this text the ammonium sulphate fraction will be referred to as the AmSO_4 + I fraction whilst the run through from the affinity column will be referred to as the AmSO_4 - I fraction.

The profile of a typical affinity chromatography fractionation is illustrated in Figure 5a. SDS-PAGE analysis of inhibitor after this step (Fig. 5b) revealed the presence of a single major band corresponding to a molecular weight of 48,000. This is in agreement with previous reports of the molecular weight of inhibitor from rat tissues (Burton and Fucci, 1982). It was also possible to detect a number of minor bands in this fraction, indicating the presence of contaminating proteins. This was particularly apparent if the gel was overloaded, (data not shown). In order to reduce the level of contaminating proteins the eluate from the first affinity fractionation was re-chromatographed on Sepharose-RNase A. SDS-PAGE analysis of inhibitor after two passages through the affinity column revealed that this precaution resulted in the removal of most contaminating protein (Fig. 5b, lanes 5 and 6). Details of the progress of a typical purification are given in Table 2. The overall yield was typically in the range of 35-40%. 1 unit of inhibitor was equivalent to approximately 10 ng of purified protein.

Antiserum was raised to the purified inhibitor as detailed in Section 2.8.1. The titre of the immune serum was determined by ELISA analysis (Section 2.8.2), and was defined as the dilution required for immune serum to give the same reading at 492 nm as did pre-immune serum. Of the four animals immunized, two gave antiserum with a workable titre (1/50,000 to 1/100,000).

The specificity of the immune serum was tested by immunoelectrophoresis. In this method, proteins are electrophoresed on thin layer agarose gels, and then reacted with antiserum placed in a trough running parallel to the direction of electrophoresis. Recognition of proteins by the antiserum is detected by the formation of precipitin arcs. When this was carried out using $\text{AmSO}_4 + \text{I}$ as antigen, at least two precipitin arcs were detected in addition to that corresponding to inhibitor (Fig. 6, lane b). The precipitin arc corresponding to inhibitor was identified by comparing the pattern obtained using $\text{AmSO}_4 + \text{I}$ and $\text{AmSO}_4 - \text{I}$ as antigen. (Compare lane b and lane c). If the serum was to be used to assay for inhibitor in crude cytoplasm, it was necessary to remove the contaminating antibodies. This was achieved by immunoadsorption (Section 2.8.4). Proteins from the $\text{AmSO}_4 - \text{I}$ fraction were covalently attached to sepharose-4B, and immune serum was passed through a bed of this resin, the run through being collected in fractions and tested for specificity by ELISA and immunoelectrophoresis. Figures 6 and 7 illustrate the results obtained. ELISA assay of the fractions collected from the column employed $\text{AmSO}_4 - \text{I}$ as

92

an antigen, and showed that the first 8 ml of eluent did not elicit a reaction greater than the pre-immune serum, i.e. contaminating antibodies appeared to have been removed. Thereafter the eluents reactivity increased (fractions 5-9) to a level similar to that obtained with pre-adsorbed immune serum. This increase in reactivity was presumed to be due to saturation of the column, and only fractions 1-4 were taken as adsorbed serum. Figure 6 illustrates an assessment of the adsorbed serum using immunoelectrophoresis. The precipitin bands corresponding to contaminating antibodies using pre-adsorbed serum (lane b, trough II), were not detected using adsorbed serum (lane d, trough III). All experiments detailed hereafter were performed using the adsorbed antiserum.

Confirmation of the specificity of the antiserum was obtained by immunoblotting (Section 2.8.5). An analysis of cytoplasmic preparations from various tissues of the rat is shown in Figure 8. A single band, corresponding to a molecular weight of 48,000 was seen in most of the tissues analysed; the one exception being an extra band (molecular weight 60,000) in the proteins of the cytoplasm of rat pancreas. Because of the high level of secretory RNase A found in this tissue, it is possible that this band corresponds to inhibitor/ribonuclease complexes that were not fully dissociated by the denaturing conditions used. This has not however been investigated any further.

Comparison of the level of inhibitor in the immature rat uterus (IU) and the oestrogen-treated uterus (EU) indicated that there was little or no difference in the level of inhibitor. This observation is addressed more fully in the following experiment: Quantitation of inhibitor levels was achieved by densitometric analysis of immunoblots (Fig. 9). Various known amounts of purified inhibitor were used to generate a standard curve (Fig. 9 (A), lanes 1-4). The relationship between density and inhibitor concentration was essentially linear over the range used (Fig. 9 (B)). The density obtained with the various unknowns (lanes 6-10) was read off the standard curve and after allowing for differences in the width of the bands, an estimate of inhibitor levels was obtained. The average result obtained from two separate experiments is shown in Table 3(A), and demonstrated that inhibitor levels had increased by approximately 50% four days after treatment with oestrogen. The level of inhibitor in mature rat uterus was similar to that found in oestrogen-treated immature animals.

An approximate quantitation of inhibitor levels in the tissues analysed in Figure 8 was obtained by comparing the density of the autoradiographic signal with that obtained from the uterus. It was assumed that the relationship between density and concentration of inhibitor was linear, as was found with the quantitative analysis of uterine inhibitor levels (Fig. 9 (B)). This data is presented in Table 3(B).

The level of free inhibitor in uterine cytoplasm was calculated by converting units of activity into ng of protein (Table 3(A), column 2). Comparison of this figure with the total inhibitor concentration indicated that in untreated immature rats the ratio of free inhibitor to bound inhibitor is about 3:1. In treated rats however there was no free inhibitor.

Taken together, these experiments demonstrated that the loss of inhibitor activity associated with oestrogen-treatment or normal development was due to inactivation of the protein rather than its loss. It was therefore necessary to investigate how the inhibitor was being inactivated.

Figure 5(a). Sepharose-RNase A affinity chromatography of rat liver ribonuclease inhibitor.

Chromatography was performed as described in Section 2.7.5. Ribonuclease inhibitor activity (●) was determined as described in Section 2.7.2. Protein concentration (O) was determined by absorbance at 280 nm. The eluent at A was 45 mM potassium phosphate buffer, pH 6.4, and at B was changed to the same buffer made 0.5 M with respect to NaCl. At C the buffer was changed to 0.05 M Borate, pH 6: 4 M NaCl: 1 mM EDTA: 1 mM β -mercaptoethanol: 15% (v/v) glycerol.

(b). SDS-PAGE analysis of purified rat liver inhibitor.

Samples were electrophoresed on a 10% SDS-polyacrylamide gel as described in Section 2.7.7. Lane 1 contained 100 μ g of rat liver cytoplasmic protein. Lane 2 contained 100 μ g of protein from a 35-60% ammonium sulphate precipitate of rat liver cytoplasm. Lane 3 contained 5 μ g of purified inhibitor after one passage through the sepharose-RNase A affinity column. Lanes 5 and 6 contained 5 μ g of purified inhibitor after two passages through the sepharose-RNase A affinity column, (two separate experiments). The molecular weight markers used were BSA (67,000), ovalbumin (43,000) and chymotrypsinogen (28,000).

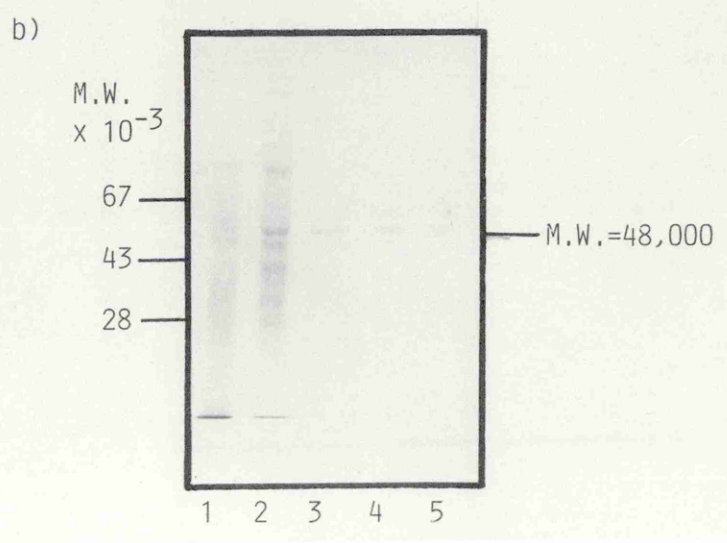
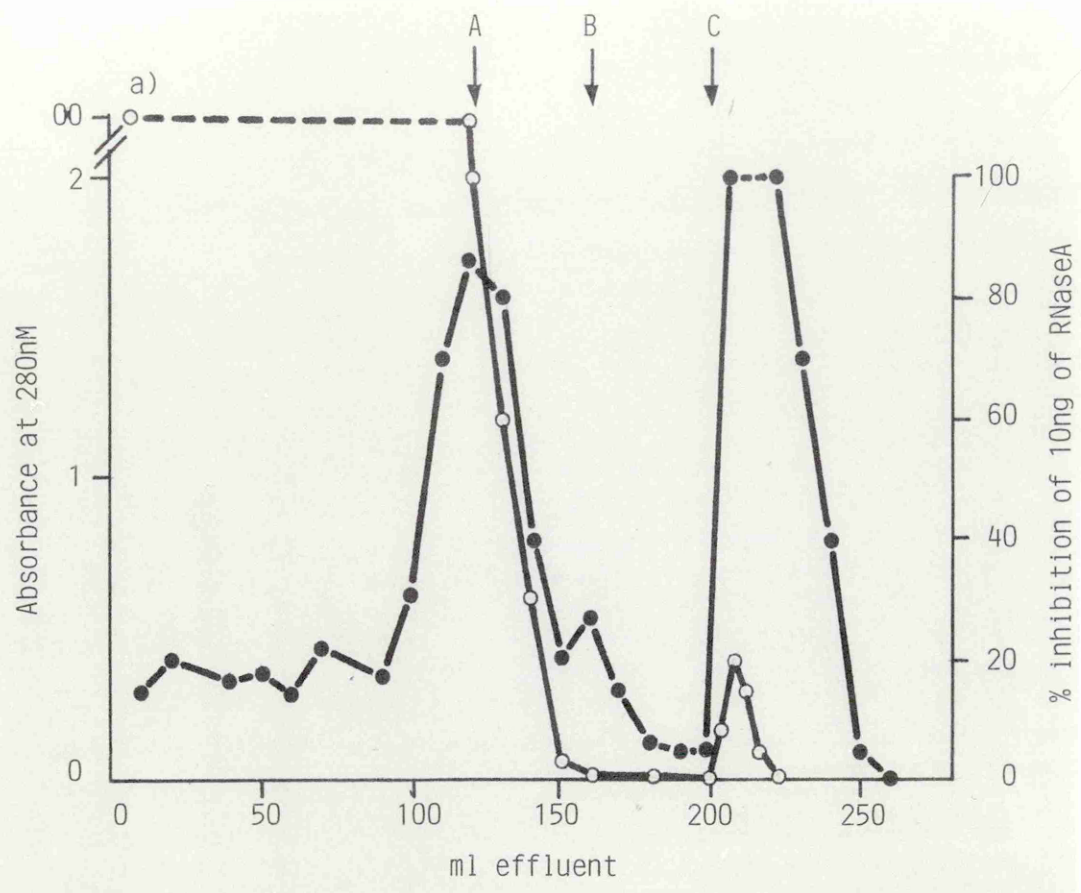

Table 2. Purification of rat liver ribonuclease inhibitor.

The data was derived from a typical experiment. Ribonuclease inhibitor was assayed as described in Section 2.7.2. Protein concentration was assayed by the method of Lowry (Section 2.7.1.).

*1 unit of inhibitor was defined as the quantity required to inhibit the digestion of ^3H -RNA by 5 ng of RNase A by 50%.

	Total protein (mg)	Total activity (units)	Specific activity (units/mg)*	Purification factor	Yield
Rat liver cytoplasm	81,500	300,000	3.68	0	100%
35-60% ammonium sulphate precipitate	43,680	236,500	5.42	1.47	79%
Affinity chromatography eluate (1st passage)	1.3	126,500	97,400	26,500	42%
Affinity chromatography eluate (2nd passage)	1.1	107,400	97,700	26,500	36%

Figure 6. Assessment of the specificity of anti-ribonuclease inhibitor serum: Immunoelectrophoresis.

Immunoelectrophoresis was performed as described in Section 2.8.3. (A) illustrates a photograph of the stained immunoelectrophoresis plate. (B) illustrates a diagrammatic representation of (A), indicating the major precipitin arcs observed.

Key: (1) Antigen loaded in wells.

(a) Purified inhibitor protein	(3 μ g).	
(b) AMSO ₄ + I	(25 μ g).	
(c) AMSO ₄ - I	(25 μ g).	
(d) AMSO ₄ + I	(25 μ g).	
(e) AMSO ₄ - I	(25 μ g).	
(f) Purified inhibitor protein	(3 μ g).	} Stained protein
(g) AMSO ₄ + I	(25 μ g).	
(h) AMSO ₄ - I	(25 μ g).	

(2) Antiserum added to troughs.

I and II	- Pre-adsorbed serum	(20 μ l)
III	- Adsorbed serum	(20 μ l)
IV	- Potassium thiocyanate column washing	(20 μ l).

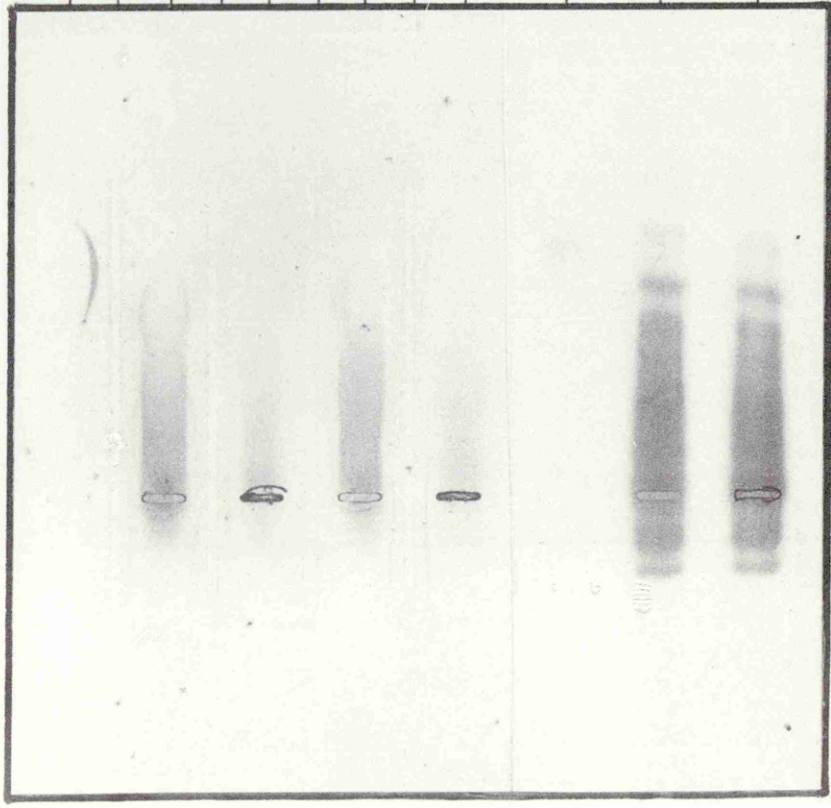
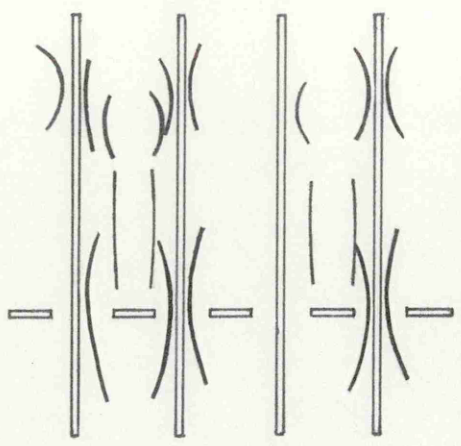
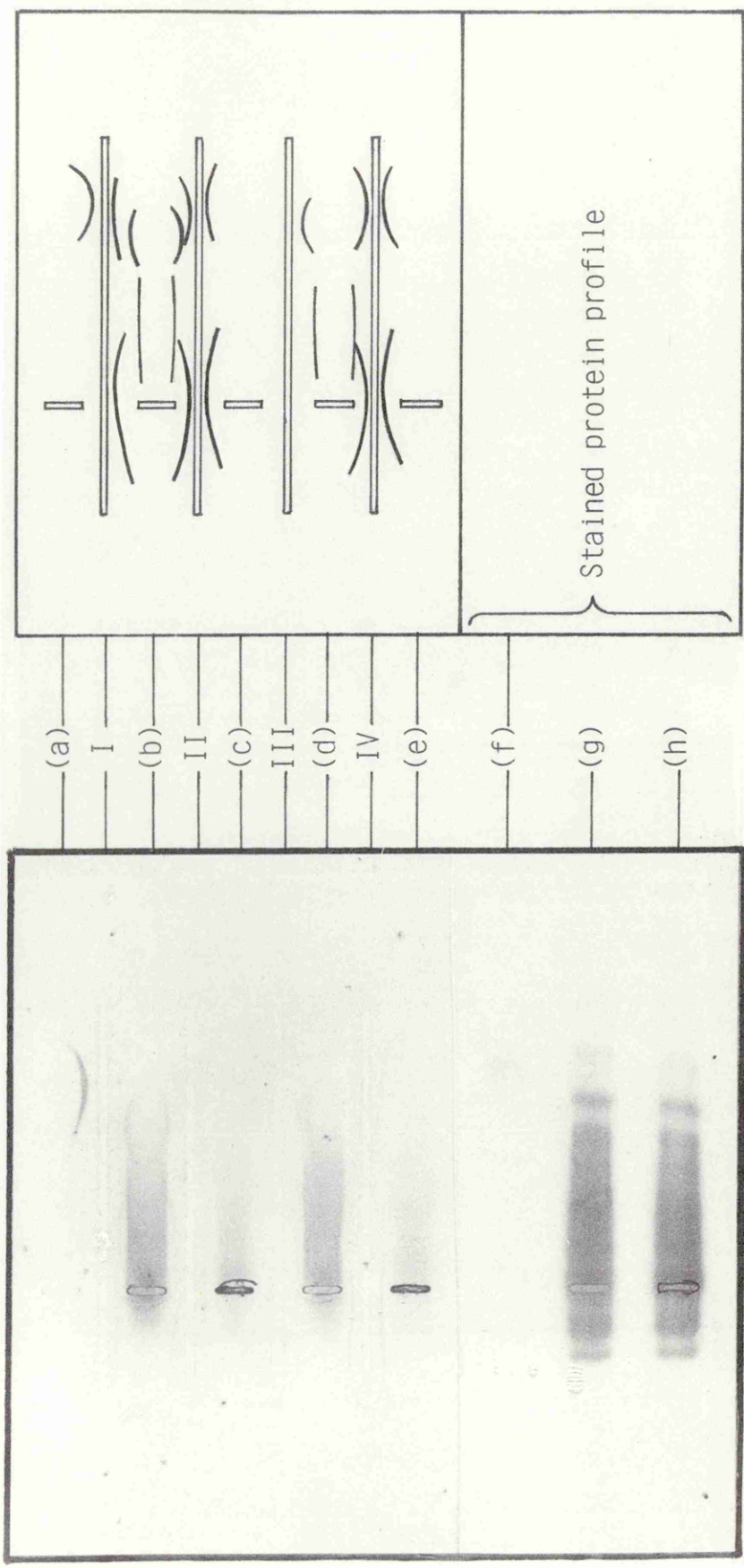

Figure 7. Assessment of the specificity of antiserum raised to ribonuclease inhibitor: ELISA of fractions from immunoadsorption column.

ELISA was performed as described in Section 2.7.5. AMSO₄-I diluted 1/1000 in PBS was used as antigen. Fractions from the immunoadsorption column, diluted 1/1000 in PBS, were used as antiserum. The absorbance values shown were derived from the average of duplicate samples. 'A' designates the absorbance at 492 nm obtained with pre-adsorbed immune serum. 'B' designates the absorbance at 492 nm obtained with pre-immune serum.

Immunoadsorption was performed as described in Section 2.8.4.

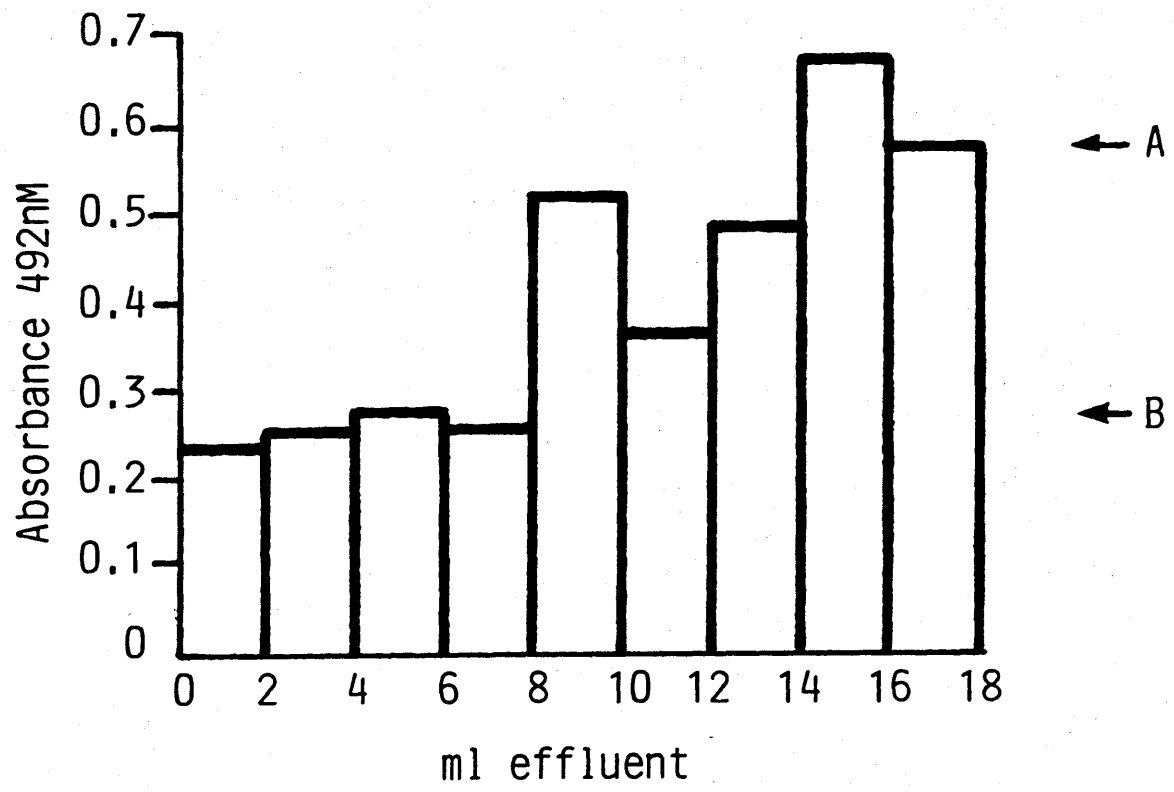

Figure 8. Immunoblot analysis of ribonuclease inhibitors in various tissues of the rat.

High speed supernatants were prepared as described in Section 2.7.4. 150 μ g of protein from the uteri of immature rats (IU), the uteri of rats that had received oestrogen implants four days before death (EU), rat liver (Li), spleen (Sp), kidney (Ki), brain (Br), Lung (Lu) and pancreas (P) were electrophoresed on a 10% SDS-polyacrylamide gel as described in Section 2.7.7. Lanes X and Y contained 5 μ g and 25 ng of purified rat liver inhibitor respectively.

One half of the gel (a) was stained for protein, whilst the other half (b) was immunoblotted as described in Section 2.7.4. The autoradiograph was exposed for 24 h.

The molecular weight markers used in this, and all subsequent SDS-PAGE experiments, (unless otherwise indicated), were phosphorylase b, (90,000), BSA, (67,000), ovalbumin, (43,000), Carbonic Anhydrase, (30,000), Soybean Trypsin inhibitor, (20,000), and α -lactaglobulin (14,000). These markers were obtained in the form of a kit from Pharmacia Ltd.

a)

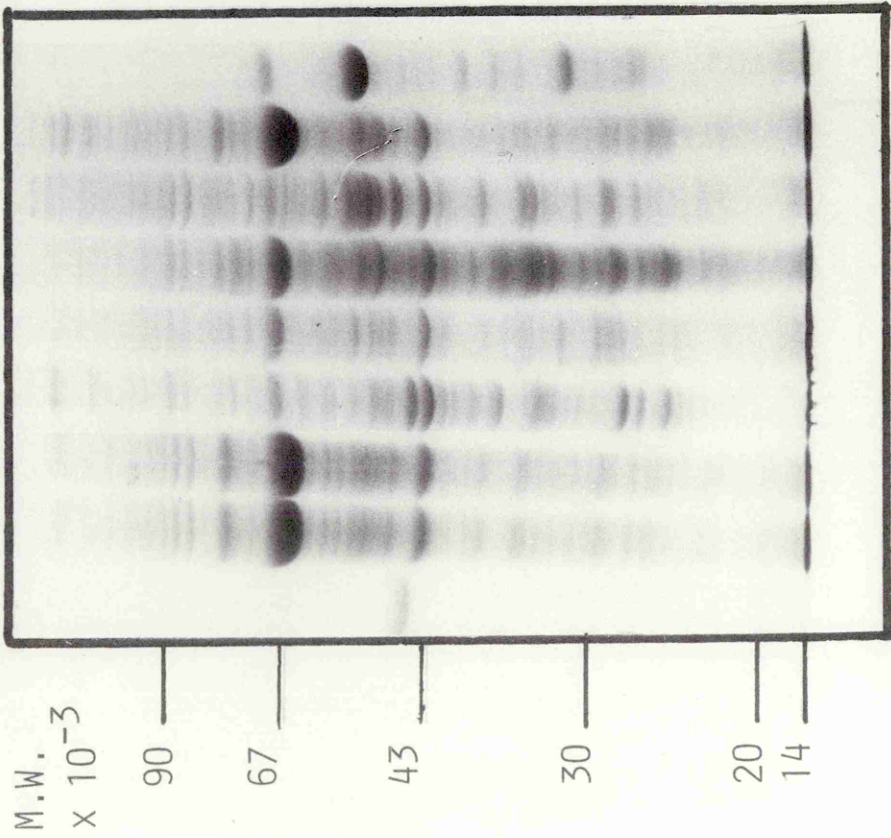

b)



Figure 9. Quantitation of ribonuclease inhibitor in uterine cytoplasm by immunoblotting.

(A) Samples were electrophoresed on a 10% SDS-polyacrylamide gel and immunoblotted as described in Sections 2.7.7. and 2.7.4. Lanes 1-4 contained 50 ng, 25 ng, 10 ng and 5 ng of purified inhibitor respectively. Lane 5 contained a ^{125}I -labelled 28,000 molecular weight marker. Lanes 6-10 contained 150 μg of uterine cytoplasmic protein which was derived from immature rats (lane 6), immature rats that had received oestrogen implants 1 day (lane 7), 2 days (lane 8) and 4 days (lane 9) before death. Lane 10 contained 150 μg of cytoplasmic protein from mature rat uteri. The autoradiograph was exposed for 24 h.

(B) Plot of the density of the autoradiograph (lanes 1-4) against the concentration of purified inhibitor. Error bars indicate the degree of variation in the densitometric reading obtained from two separate regions of each band. The level of inhibitor in the various uterine samples was determined using this plot.

The molecular weight markers used, (BSA - 67,000, ovalbumin - 43,000, and chymotrypsinogen - 28,000), were labelled with ^{125}I by the method of Salanzinski et al. (1981). 17,000 c.p.m. of labelled protein were used per lane.

A) Autoradiograph

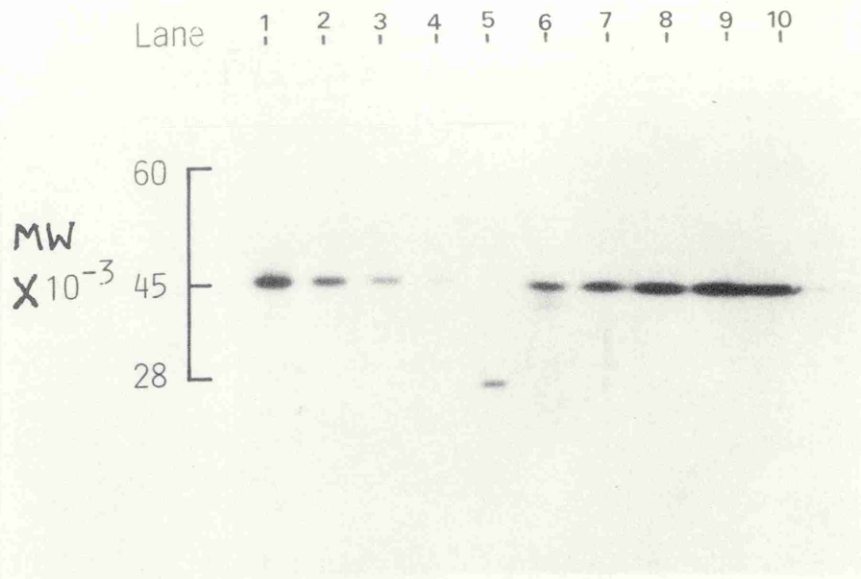

B) Densitometric Analysis

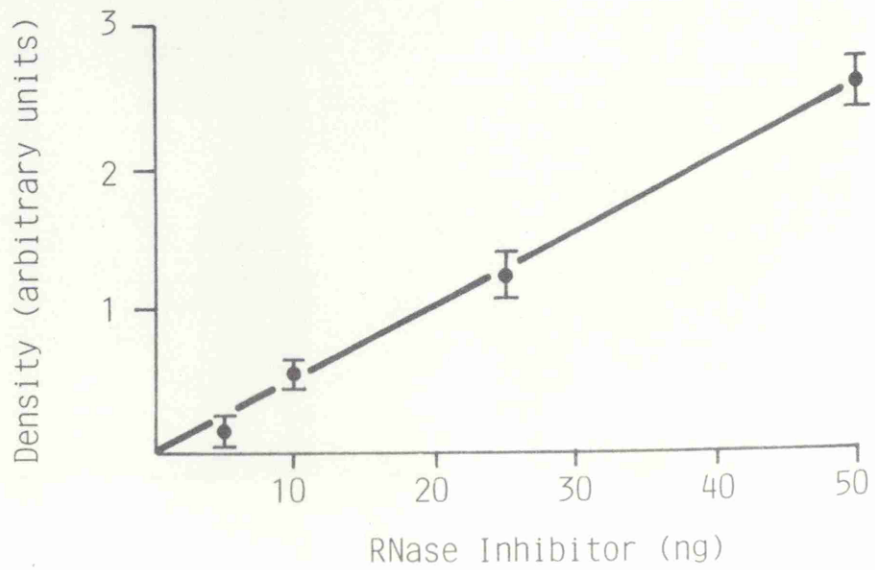

Table 3. (A). Uterine ribonuclease and ribonuclease inhibitor levels.

- (a) Estimated from average of two separate immunoblot experiments (Fig. 9).
- (b) Determined from inhibitor assay, (two experiments).
1 unit = approximately 10 ng inhibitor.
- (c) Assayed in the presence of 10^{-4} M pHMB, (two experiments).
- (d) Assayed in the absence of pHMB, (two experiments).

1 unit of ribonuclease was designated as the amount required to digest the ^3H RNA by 50% under the conditions described (Figure 10).

(B). Approximate inhibitor levels in various tissues of the rat.

The intensity of the bands seen in the autoradiograph (Fig. 8) was measured by laser densitometry. The density obtained with each band was expressed as a percentage of the signal obtained with oestrogen-treated uterine cytoplasm, (EU), and extrapolated, using the quantitation shown in Table 3(A), to give a value for inhibitor concentration in ng/mg cytoplasmic protein.

(A)

Time after oestrogen treatment	Ribonuclease inhibitor, ng/mg cytoplasmic protein		Cytoplasmic ribonuclease units/mg cytoplasmic protein	
	Total ^(a)	Free ^(b)	Total ^(c)	Free ^(d)
Untreated	165 ± 3.5	125 ± 5	14.7 ± 1.7	0
1 day	235 ± 15	0	69 ± 3	21 ± 6
2 day	251 ± 8.5	0	91 ± 3	17 ± 3
4 day	260 ± 7	0	107 ± 3.5	32 ± 1
Mature animals	239 ± 5.5	0	93 ± 1	35 ± 1

(B)

Tissue	Intensity of band in Figure 8 (% of EU band)	Approximate inhibitor concentration (ng/mg cytoplasmic protein)
Liver	48%	125
Spleen	90%	234
Kidney	73%	190
Brain	40%	104
Lung	36%	94
Pancreas	68%	177

3.2.1. The effect of oestrogen on uterine cytoplasmic ribonuclease activity

One possible explanation for the above findings was that the loss of inhibitor activity resulted from an increase in the level of cytoplasmic ribonuclease(s) and their association with the inhibitor. The original experiments carried out by McGregor et al. (1981) and Munro and Knowler (1982), demonstrated that the loss of inhibitor was accompanied by an increase in cytoplasmic ribonuclease activity. However, the increase did not appear sufficiently dramatic to account for the loss of inhibitor activity. Further, the assay conditions utilised in these experiments were such that it was difficult to discern the degree of change. It was decided to repeat and extend these studies under conditions where changes in ribonuclease activity were clearly discernable. This was achieved by using carrier RNA to decrease the sensitivity of the assay (Section 2.7.3). Further, it was decided that both free and total (free plus inhibitor bound) ribonuclease activities should be measured in order to gain a clearer understanding of the changes occurring in the oestrogen-stimulated uterus. Total ribonuclease activity was assayed after the inhibitor had been inactivated by treatment with pHMB. The results obtained are illustrated in Figure 10. In the untreated uterine cytoplasm there was little or no free ribonuclease activity detected. Treatment with pHMB revealed the presence of some latent ribonuclease activity. After various periods of oestrogen-treatment

free ribonuclease appeared in the uterine cytoplasm. Treatment with pHMB revealed even higher levels of ribonuclease activity, indicating that active enzyme was being released from inhibitor complexes. One unit of ribonuclease activity was arbitrarily designated as the amount required to digest the [³H] RNA by 50%, and the total ribonuclease activity of each sample was calculated on this basis. The average result obtained from two separate experiments is shown in Table 3(A). The results showed that, by four days after oestrogen-treatment, the increase in ribonuclease activity was approximately eight fold. An approximate calculation, taking into account the ratio of inhibitor to ribonuclease in untreated animals, and the small increase in levels of inhibitor in response to oestrogen, indicated that an 8 fold increase in ribonuclease would be more than enough to account for the loss of inhibitor activity. This calculation is only an approximation, and is subject to at least two assumptions. Firstly it is assumed that all of the induced ribonuclease activity results from enzyme that can associate with the inhibitor. This assumption was tested by titrating oestrogen-stimulated uterine cytoplasm with purified inhibitor to see if all the free ribonuclease activity could be saturated. This was found to be the case (data not shown). The second assumption was that the increase in ribonuclease activity was paralleled by a similar increase in the quantity of ribonuclease protein present. Investigation of the validity of this assumption is the subject of the following sections.

Figure 10. The effect of oestradiol-17 β on total and free uterine cytoplasmic ribonuclease activity.

Uterine cytoplasm was prepared as described in Section 2.7.4. The ribonuclease assay was carried out in the presence (—○—○—) and absence (—●—●—) of pHMB as described in Section 2.7.3. Protein determinations were carried out using the method of Lowry (Section 2.7.1).

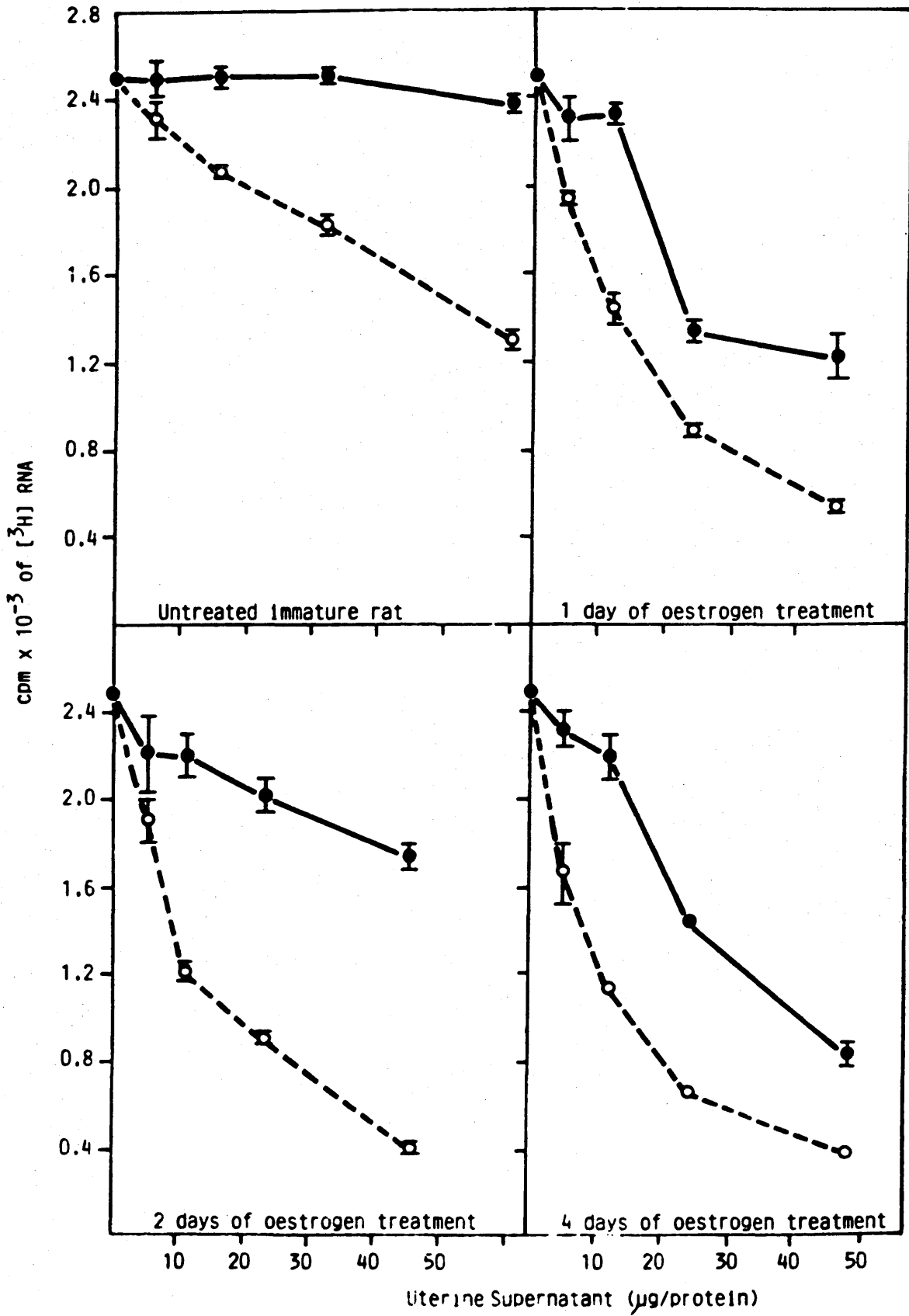

3.2.2. Characterisation of the ribonuclease(s) found in uterine cytoplasm

The first method used to gain more information on the nature of uterine cytoplasmic ribonuclease(s) was ribonuclease activity staining. Total cytoplasmic protein was electrophoresed on SDS-polyacrylamide gels impregnated with yeast RNA. The resultant gels were washed and incubated, and regions containing ribonuclease activity were detected as clear bands on the gel after staining with an RNA specific dye. As little as 100 pg of bovine pancreatic RNase A could readily be detected using this method (see Fig. 25).

An analysis of uterine cytoplasm from adult rats and from immature rats before and after oestrogen-treatment is illustrated in Figure 11. Two bands of ribonuclease activity were detected corresponding to molecular weights of 14,000 and 18,000. The lower molecular weight band was seen in untreated rats and appeared to intensify with time after oestrogen-treatment or during normal development. The higher molecular weight band was barely detectable in untreated animals and intensified considerably with time after oestrogen-treatment or during normal development.

Investigation by other groups (Kumagai et al., 1983; P. Blackburn, personal communication) indicated that cytoplasmic ribonucleases are similar in properties and molecular weight to pancreatic RNase A. An attempt was therefore made to use antibodies raised to bovine pancreatic RNase A to detect and quantitate the enzymes of uterine cytoplasm.

Antiserum was raised to commercially available pancreatic RNase A (Sigma), essentially as was described for the raising of antisera to ribonuclease inhibitor (Section 2.8.1). Immunoblot analysis of this antisera using pancreatic RNase A as antigen (Fig. 12a) revealed that the antiserum detected a major band of molecular weight 14,000 and a minor band of molecular weight 16,500. The former corresponds to the molecular weight of pancreatic RNase A, whilst the latter probably represents pre-RNase A, an active pre-secretory form of the enzyme that has been detected by in vitro translation experiments (Haugen and Heath, 1979). Pre-RNase A has a reported molecular weight of 16,500. It can be seen that 25 ng of RNase A was readily detected using this antiserum. As little as 10 ng could be detected (data not shown).

Figure 12b illustrates an attempt to detect the ribonucleases of uterine cytoplasm using this antiserum. No bands were detected in the molecular weight range 14,000 - 20,000, despite the fact that the gel was overloaded with 500µg of cytoplasmic protein. A band of molecular weight 25,000 was detected, but was present at similar levels in untreated and treated uterine cytoplasm. Another band of molecular weight 100,000 was detected in untreated uterine cytoplasm and was absent in oestrogen-treated animals. It is not known whether these bands correspond to species of ribonuclease and no attempt was made to characterize them further. The failure to detect those species observed using

the activity staining method was presumably due to low immuno-crossreactivity of the antiserum with rat cytoplasmic ribonucleases, coupled with the low abundance of these enzymes in cytoplasmic preparations.

Figure 11. Analysis of uterine cytoplasmic ribonuclease by activity staining.

Electrophoresis and the detection of ribonuclease activity was carried out as described in Section 2.7.7. Lanes 1-5 contained 200 μ g of cytoplasmic protein from the uterus of untreated animals (lane 1), animals having received oestrogen implants 1, 2 and 4 days before death (lanes 2, 3 and 4 respectively) and from mature animals (lane 5).

M.W.
 $\times 10^{-3}$

90
67
43
30
20
14

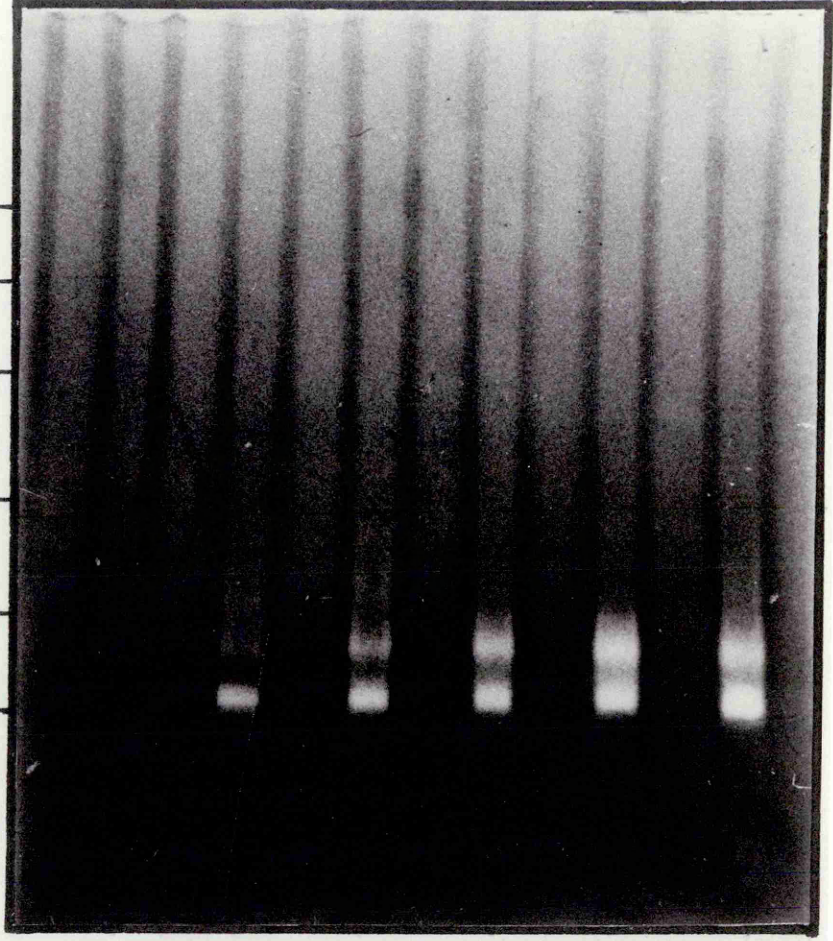

1 2 3 4 5

Figure 12. Immunoblot analysis of uterine cytoplasmic protein using antiserum raised to bovine pancreatic RNase A.

(a) 25 ng of bovine pancreatic RNase A was electrophoresed on a 12.5% SDS-polyacrylamide gel and immunoblotted as described in Sections 2.7.7. and 2.8.5. The autoradiograph was exposed for 24 h.

(b) Electrophoresis and immunoblotting were performed as described above. Lane 1 contained 500 μ g of cytoplasmic protein from the uteri of immature rats. Lane 2 contained 500 μ g of cytoplasmic protein from the uteri of immature rats given oestrogen implants 4 days before death. The autoradiograph was exposed for 48 h.

The bands detected in (a) and (b) are discussed in the text.

The radioactive molecular weight markers were the same as those described in the legend to Figure 9.

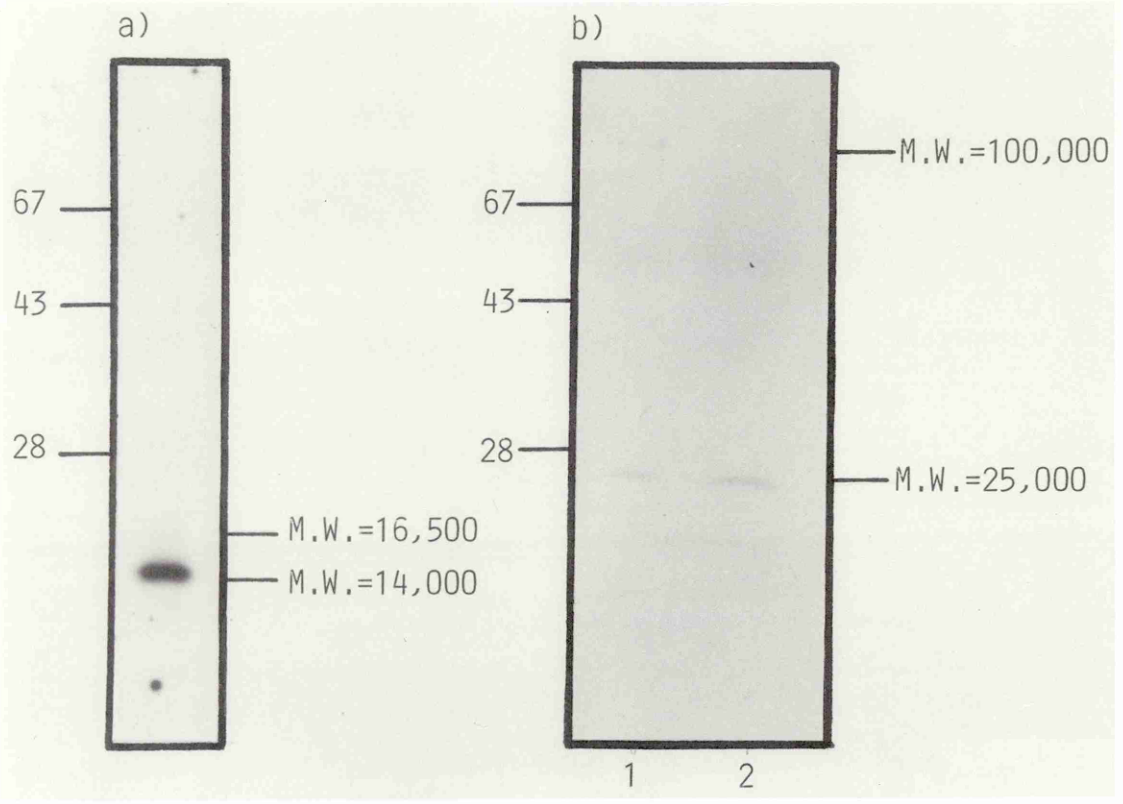

3.2.3. Studies on the mode of induction of uterine cytoplasmic ribonucleases by oestrogen

The following experiments illustrate an attempt that was made to use a rat pancreatic ribonuclease A cDNA recombinant to detect the mRNA coding for the cytoplasmic ribonucleases of rat uterus. The rationale behind this approach was that homology between the pancreatic and cytoplasmic ribonuclease proteins may be reflected at the nucleic acid level. Specifically, regions of the pancreatic RNase A molecule that are required for inhibitor binding (Section 1.4.1) are likely to be conserved in the cytoplasmic ribonucleases. Furthermore, it seems likely that the overall three-dimensional shape of both enzymes should be similar in order for interaction with the inhibitor to occur. Taken together with other similarities between the two enzymes, such as the mode of cleavage of RNA, molecular weight, and pH optima, it seems likely that these enzymes are the product of evolutionarily related, or even identical genes. Finally, a recent report of the amino acid composition of a cytoplasmic ribonuclease from human placenta (P. Blackburn et al., personal communication), revealed that there are few differences between this enzyme and human pancreatic RNase A.

It was hoped that the recently isolated cDNA recombinant of rat pancreatic RNase A (MacDonald et al., 1982) could be used to detect the mRNA coding for uterine cytoplasmic ribonuclease. Thus, it would be possible to determine whether the oestrogen-induced stimulation of cytoplasmic ribonuclease was due to transcriptional enhancement or some other mechanism.

Furthermore, if successful this approach would provide a method by which information on the primary sequence of cytoplasmic ribonucleases could be obtained.

It was decided that the best approach to this problem would be to carry out northern blot analysis of uterine RNA before and at various times after oestrogen-treatment using the cDNA recombinant as a probe. Before proceeding with these experiments it was necessary to determine the exact time at which oestrogen-induced cytoplasmic ribonuclease first appears in uterine cytoplasm. This was achieved by assaying the total cytoplasmic ribonuclease activity of uterine cytoplasm at various times within the first 24 h of oestrogen-stimulation. The results obtained are shown in the table below.

Table 4. Uterine cytoplasmic ribonuclease activity during the first 24 h of oestrogen-stimulation.

Time after oestrogen-stimulation (h)	Cytoplasmic ribonuclease activity (units/mg of protein)
0	15.5
6	20
12	17.5
18	68.5
24	72

This experiment demonstrated that oestrogen-induced cytoplasmic ribonuclease is detectable between 12 h and 18 h after hormone treatment. If this induction resulted from transcriptional enhancement, the mRNA coding for the cytoplasmic ribonucleases should appear in uterine cytoplasm between 12 h and 18 h after hormone treatment.

3.2.4. Characterization and isolation of insert DNA from pcXP6-105

Figure 13 presents a diagrammatic illustration of the rat pancreatic RNase A cDNA recombinant plasmid (pcXP6-105). The host plasmid (pBR322) contains a 550 b.p. insert in the Pst I site, representing the entire coding region of rat pancreatic RNase A mRNA. Analysis of pcXP6-105 with restriction enzymes however revealed that the structure of the plasmid was not as originally described by MacDonald et al. (1982), and that a Pst I site flanking the insert appeared to have been replaced by an EcoRI site.

The evidence for this, presented in Figure 14 was as follows: A single digestion with Pst I linearized the plasmid but did not excise the insert (Fig. 14a, lane 5). A single digestion with EcoRI, that should have only linearized the plasmid, excised a 750 b.p. fragment (Fig. 14b, lane 6). A double digestion with EcoRI and Pst I yielded two fragments of 750 b.p. and 550 b.p. (Fig. 14b, lane 7). It seemed likely that the 750 b.p. fragment corresponded to the segment of host plasmid lying between the Pst I and EcoRI sites, while the 550 b.p. fragment was the insert cDNA sequence. If this interpretation was correct, then the 550 b.p. fragment should contain sites for the restriction endonucleases Bgl I and Hinf I while the 750 b.p. fragment should contain no sites for either enzyme. Figure 14c confirms that this was the case, and the fragment lengths generated from the 550 b.p. fragment by the

two enzymes were consistent with its identification as the cDNA insert encoding RNase A mRNA. Possible reasons for the conversion of the Pst I site to an EcoRI site are given in the discussion of this thesis.

Figure 13. Diagrammatic representation of rat pancreatic RNase A cDNA recombinant (p c XP6-105).

Representation of pc XP6-105 showing some of the restriction sites in the 550 bp insert.

*One of the Pst I sites flanking the insert has been replaced by an EcoRI site.

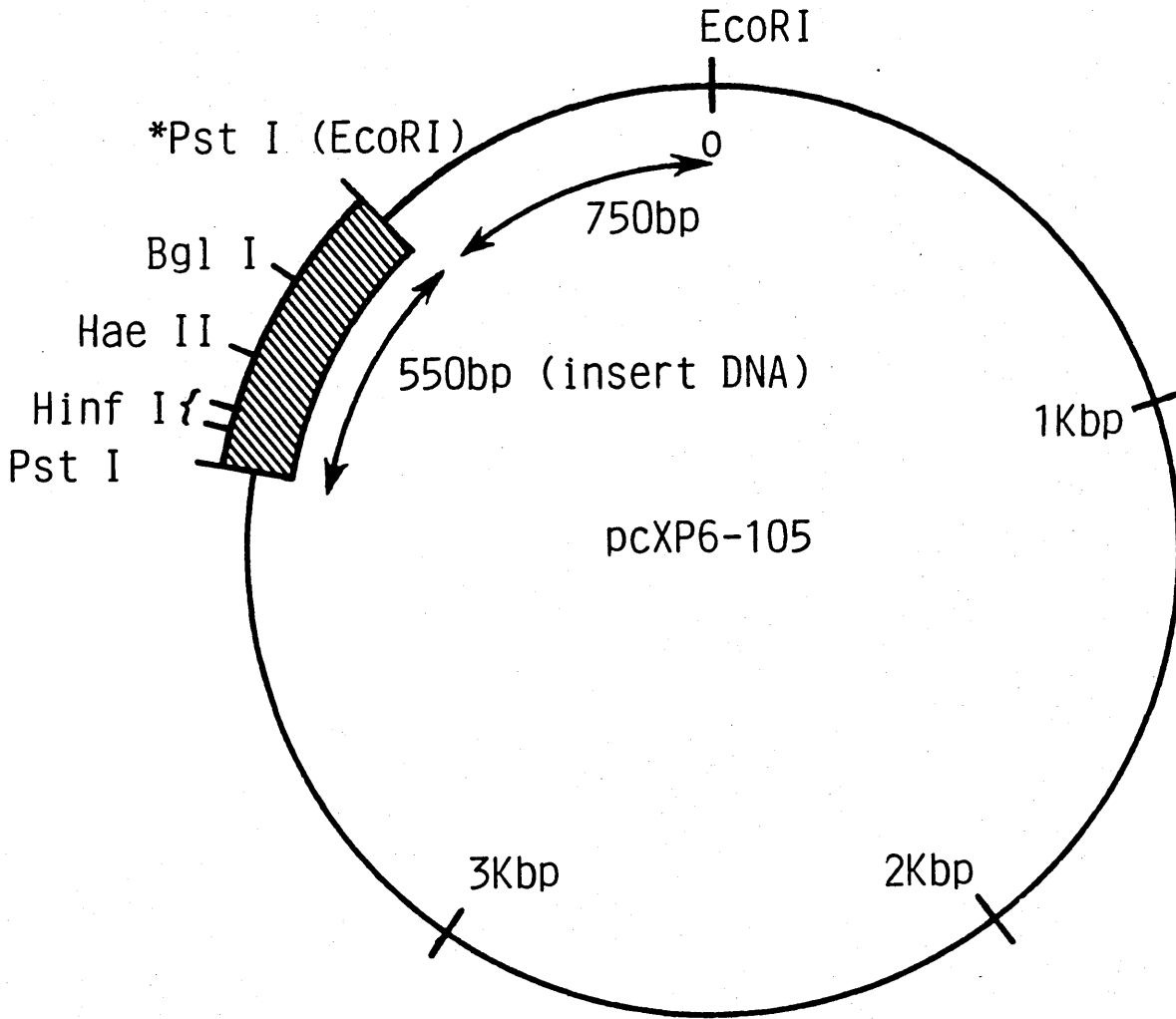

Figure 14. Characterization and preparation of insert DNA from pc XP6-105.

Restriction enzyme digests, electrophoresis of DNA on minigels, and electroelution of DNA from agarose were performed as described in Sections 2.9.2 and 2.9.7 respectively. DNA was visualized under U.V. light after staining the gels with 0.5 μ g/ml ethidium bromide for 30 min.

<u>Key:</u>	<u>Lane</u>	<u>DNA</u>	<u>Restriction enzyme</u>
(a)	2	500 ng of pBR322	-
	3	500 ng of pBR322	Pst I
	4	500 ng of pcXP-105	-
	5	500 ng of pcXP-105	Pst I
(b)	2	500 ng of pBR322	-
	3	500 ng of pBR322	Eco RI
	4	500 ng of pBR322	Eco RI + Pst I
	5	500 ng of pcXP6-105	-
	6	500 ng of pcXP6-105	Eco RI
	7	500 ng of pcXP6-105	Eco RI + Pst I
(c)	2	200 ng of 550 b.p.*	-
	3	200 ng of 550 b.p.	Bgl I
	4	200 ng of 550 b.p.	Hinf I
	5	200 ng of 550 b.p.	Bgl I + Hinf I
	6	200 ng of 750 b.p. ⁺	-
	7	200 ng of 750 b.p.	Bgl I
	8	200 ng of 750 b.p.	Hinf I
	9	200 ng of 750 b.p.	Bgl I + Hinf I

* - 550 b.p. fragment seen in (b), lane 7.

⁺ - 750 b.p. fragment seen in (b), lane 7.

Lane 1 in (a), (b) and (c) contained DNA from a Hinf I digest of pBR322. The size of the fragments generated are 1631, 517, 506, 396, 344, 298, 221,220, 155 and 75 b.p.

(a)

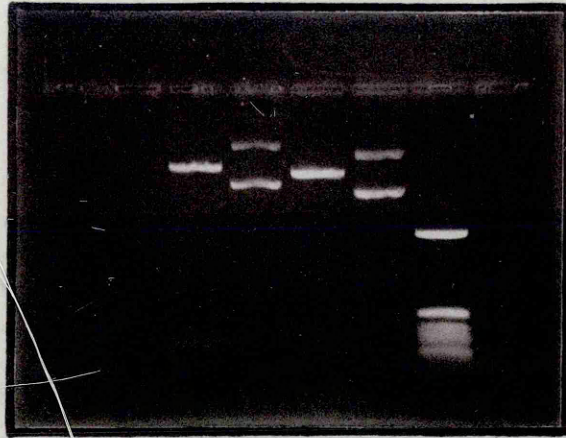

5 4 3 2 1

(b)

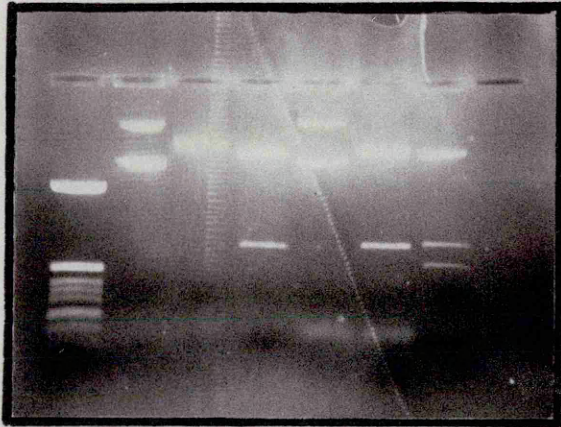

1 2 3 4 5 6 7

(c)

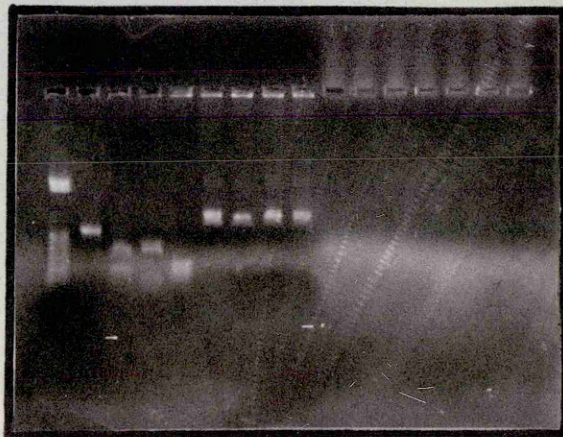

1 2 3 4 5 6 7 8 9

3.2.5. Northern blot analysis

A preliminary experiment is illustrated in Figure 15a. In order to determine the integrity of Poly(A)⁺ RNA isolated from untreated and oestrogen-treated uteri, the RNA was analysed by northern blotting using a rat skeletal muscle actin cDNA probe (p 8749). A single major band, corresponding to the known size of rat skeletal muscle mRNA (1400 bases) was detected in oestrogen-treated and control uterine RNA (Fig. 15a, lanes 1 and 2). The same RNA was also probed with nick translated pcXP6-105 insert DNA. 15 µg of poly(A)⁺ RNA was used in this experiment. Both 24 h and seven day exposures of the filter are shown (Fig. 15a, lanes 3-4 and 6-7). Careful examination of the 7 day exposure revealed that the probe recognized two bands in both control and oestrogen-treated RNA. However, these bands corresponded in size to 18s and 28s rRNA, indicating that this signal may arise through non-specific binding to these abundant species. Whilst it was not possible to detect any clear band that was induced in the oestrogen-treated RNA, a faint putative band was seen in the position indicated by an 'X'. Lane 5 contained 1 µg of Poly(A)⁺ RNA from rat pancreas. Analysis with pcXP6-105 insert as probe revealed a single major band corresponding in size to rat pancreatic RNase A mRNA (783 bases).

Whilst the above experiment was not very encouraging with respect to detecting uterine cytoplasmic ribonuclease mRNA, it was decided to attempt a more extensive experiment,

(Fig. 15b). In order to increase the possibility of detecting the uterine mRNA, larger quantities of Poly(A)⁺ RNA were utilized (30 µg as opposed to 15 µg). In addition, a wider range of time points were used, as it was possible that the 14 h time point utilized in the previous experiment was too early to detect the putative induced mRNA. Finally, Poly(A)⁻ RNA (30 µg) from each time point was analysed to allow for the possibility that the putative ribonuclease mRNA was de-adenylated. The first point to emerge from this experiment was that the bands recognized by the probe that corresponded in molecular weight to 18s and 28s rRNA were seen using both Poly(A)⁺ and Poly(A)⁻ RNA. This observation supported the contention that these signals arose through some sort of association between rRNA and the probe. When similar quantities of uterine RNA were probed using nick translated pBR322 (data not shown), no non-specific binding to rRNA occurred. This would seem to indicate that the association between the pcXP6-105 insert and rRNA involves some weak homology. Once again it was not possible to detect a clear cut example of a band induced by oestrogen. There did appear to be more binding of the probe to oestrogen-stimulated Poly(A)⁺ RNA in the region below the 18s rRNA marker, but it was not possible to define a specific band.

At this point in these studies, it was decided to discontinue this approach and to attempt to analyse the oestrogen-induced cytoplasmic ribonucleases by other means.

Figure 15. Northern blot analysis of uterine RNA and pancreatic RNA.

RNA was prepared and fractionated into Poly (A)⁺ and poly (A)⁻ as described in Sections 2.9.5 and 2.9.6. The RNA was electrophoresed, blotted and hybridized as described in Section 2.9.9.

(a) Lanes 1 and 2 contained 1 µg of poly (A)⁺ RNA from immature rat uteri, before (lane 1) and 14 h. after oestrogen-treatment (lane 2). The RNA was probed with nick translated p8749 (rat skeletal muscle actin cDNA recombinant). Lanes 3,4,6 and 7 contained 15 µg of poly (A)⁺ RNA from immature rat uteri, before (lanes 3 and 6) and 14 h. after oestrogen treatment (lanes 4 and 7). Lanes 5 and 8 contained 1 µg of poly (A)⁺ RNA from rat pancreas. The RNA was probed with nick translated insert DNA from pc XP6-105 (rat pancreatic RNase A cDNA recombinant).

(b) Lanes 1-4 contained 30 µg of poly (A)⁺ RNA from the uteri of immature rats before (lane 1) and 12 h. (lane 2) 16 h. (lane 3) and 20 h. (lane 4) after oestrogen-treatment. Lanes 5-8 contained 30 µg of poly (A)⁻ RNA from the same time points. Nick-translated insert DNA from pcXP6-105 was used as probe.

The time of exposure is indicated above each filter.

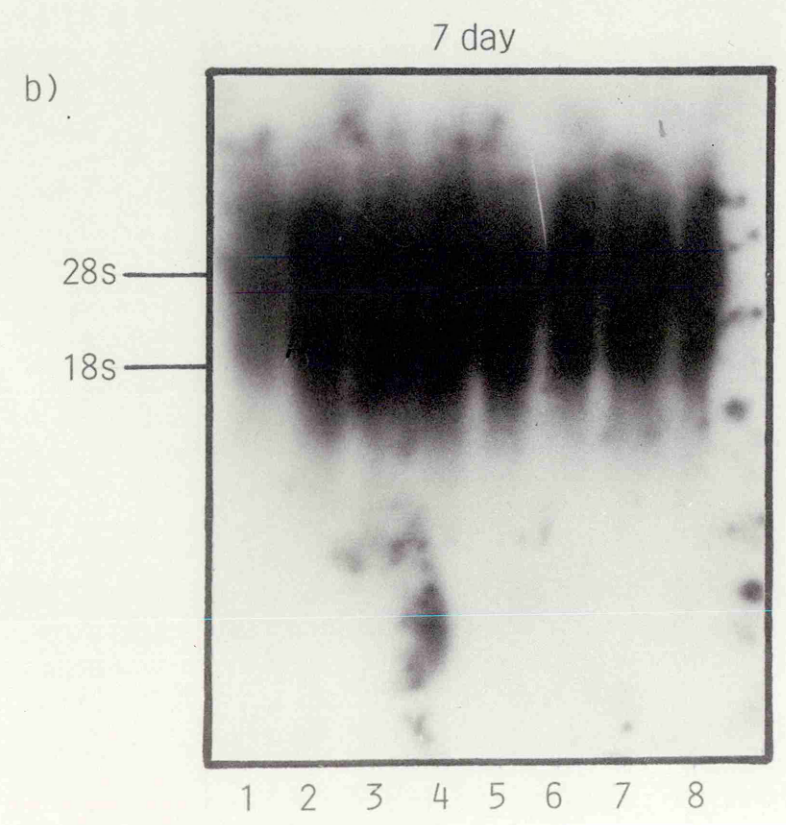
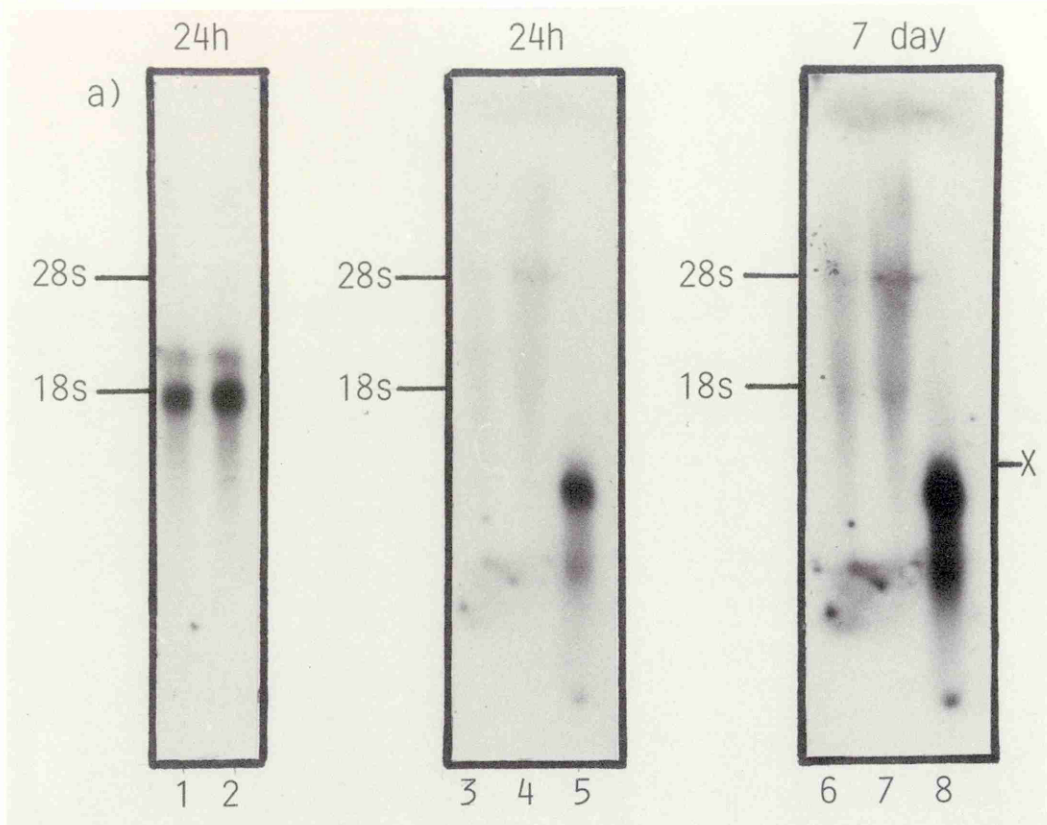

3.3.1. Detection of inhibitor/ribonuclease complexes by immunoblotting from non-denaturing gels

In the previous sections, evidence was presented demonstrating that the loss of inhibitor activity in the immature rat uterus exposed to oestrogen or during normal sexual maturation resulted from a marked increase in the level of endogenous cytoplasmic ribonucleases, such that all the inhibitor was present as inhibitor/ribonuclease complexes. To analyse this further, a method was developed to detect inhibitor/ribonuclease complexes after electrophoresis on non-denaturing polyacrylamide gels.

The acidic inhibitor protein (pI 4.8) and the slightly acidic inhibitor/ribonuclease complexes were resolved on non-denaturing polyacrylamide gels, run at alkaline pH (pH 9.3). The activity of the inhibitor protein, and hence inhibitor/ribonuclease complexes is dependent on the maintenance of free sulfhydryl groups, and is sensitive to heat or acid pH. The following precautions were taken to minimise the possibility of losing inhibitor activity prior to or during electrophoresis: Fresh homogenates were processed rapidly and stored at -20°C . Samples were not re-frozen after use. Free thiol levels were maintained at all times by the inclusion of β -mercaptoethanol, and electrophoresis was carried out at low temperature (4°C).

Figure 16a illustrates a preliminary experiment in which cytoplasmic protein from immature rat uteri before (lane 2) and 4 days after oestrogen-treatment (lane 3) was analysed.

Lanes 1 and 4 contained purified rat liver inhibitor. In the untreated uterus, free inhibitor (A) and two putative inhibitor/ribonuclease complexes (B,C) were detected. After oestrogen-treatment free inhibitor was no longer detectable but three putative inhibitor/ribonuclease complexes were seen (B, C and D).

Figure 16b illustrates an experiment in which purified rat liver inhibitor was incubated in the presence of bovine pancreatic RNase A prior to electrophoresis. It was observed that pre-incubation with RNase A resulted in the loss of the band corresponding to free inhibitor, and the appearance of a diffuse band(s) closer to the origin of the gel. The relative weakness of this diffuse band indicated that some of the total inhibitor was lost under these conditions. The reasons for this are unclear. Figure 16c illustrates an analysis of the $\text{AmSO}_4 + \text{I}$ and $\text{AmSO}_4 - \text{I}$ fractions of rat liver cytoplasm. In the $\text{AmSO}_4 + \text{I}$ fraction free inhibitor (A), and a putative inhibitor/ribonuclease complex (C) were seen. In the $\text{AmSO}_4 - \text{I}$ fraction, free inhibitor was absent, and a faint putative complex (B) was seen in addition to the putative complex C.

In order to confirm that the bands B, C, and D shown in Figure 16a were indeed inhibitor/ribonuclease complexes, gel slices from a non-denaturing gel were analyzed for free and latent ribonuclease activity (Fig. 17). Latent ribonuclease activity, detected by assaying in the presence of pHMB, was recovered from the gel slices containing the presumed inhibitor/

ribonuclease complexes but could not be detected in the slices containing free inhibitor or from other areas of the gel. Free ribonuclease activity was not detected in any part of the gel. It was presumed that this was because the basic ribonuclease proteins did not electrophorese beyond the stacking gel. It can be seen that the pattern of bands detected by immunoblotting in this experiment was more complex than that shown in Figure 16a. Thus, the band designated B in Figure 16a resolved into a doublet (B, B'), as did the band designated C in Figure 16a (C, C'). In addition a faint band, designated E, was observed in oestrogen-treated uterine cytoplasm. The detection of this more complex pattern of bands was found to be repeatable in subsequent experiments.

Figure 16. Analysis of inhibitor/ribonuclease complexes by immunoblotting from non-denaturing polyacrylamide gels.

Samples were electrophoresed and immunoblotted as described in Sections 2.7.7 and 2.8.5.

(a) Lanes 1 and 4 contained 150 ng of purified rat liver inhibitor. Lanes 2 and 3 contained 150 μ g of cytoplasmic protein from the uteri of immature rats before (lane 2), and four days after oestrogen-treatment (lane 3). A,B,C and D refer to bands discussed in the text. The autoradiograph was exposed for 36 h.

(b) Lane 1 contained 25 ng of purified rat liver inhibitor. Lanes 2 and 3 contained the same quantity of inhibitor, pre-incubated for 30 min. at 37^oC in the presence of 25 ng (lane 2) and 50 ng (lane 3) of bovine pancreatic RNase A. The autoradiograph was exposed for 3 days.

(c) Lane 3 contained 25 ng of purified rat liver inhibitor. Lane 1 contained 150 μ g of the AmSO₄ + I fraction of rat liver. Lane 2 contained 150 μ g of the AmSO₄ - I fraction of rat liver. The autoradiograph was exposed for 24 h.

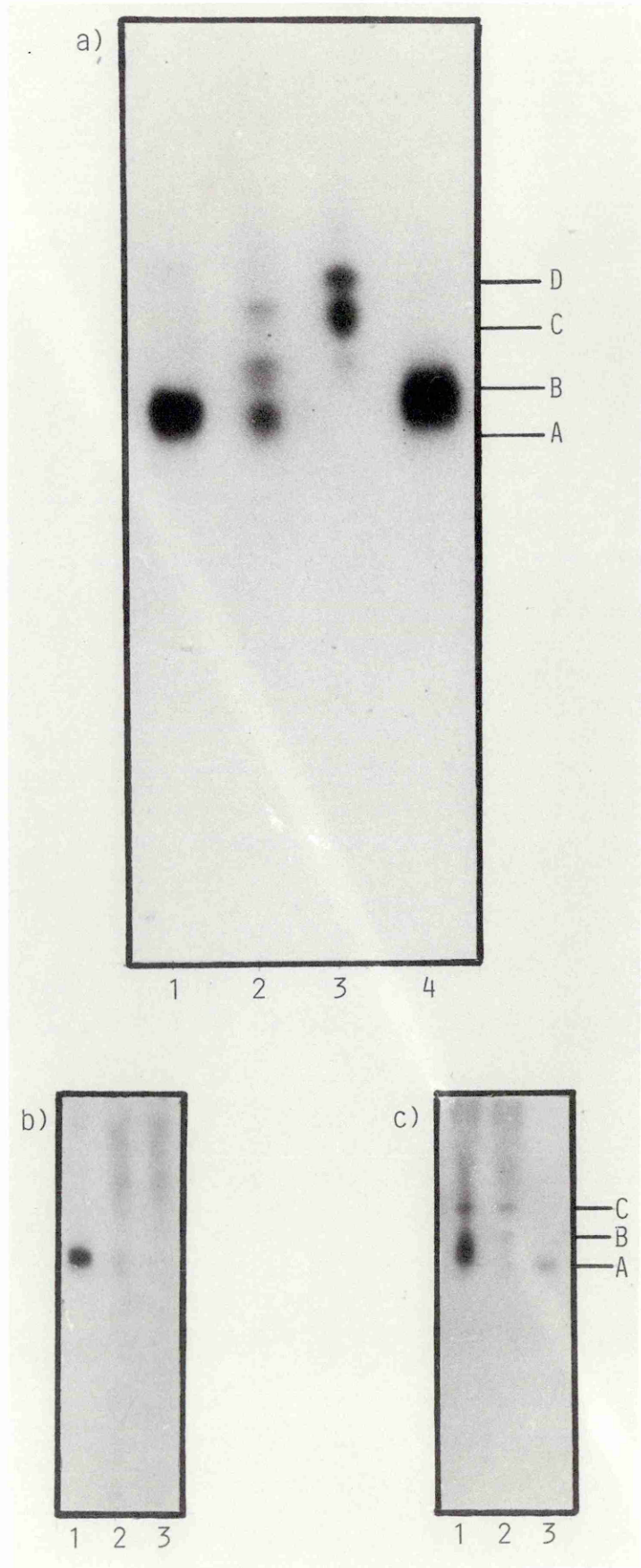
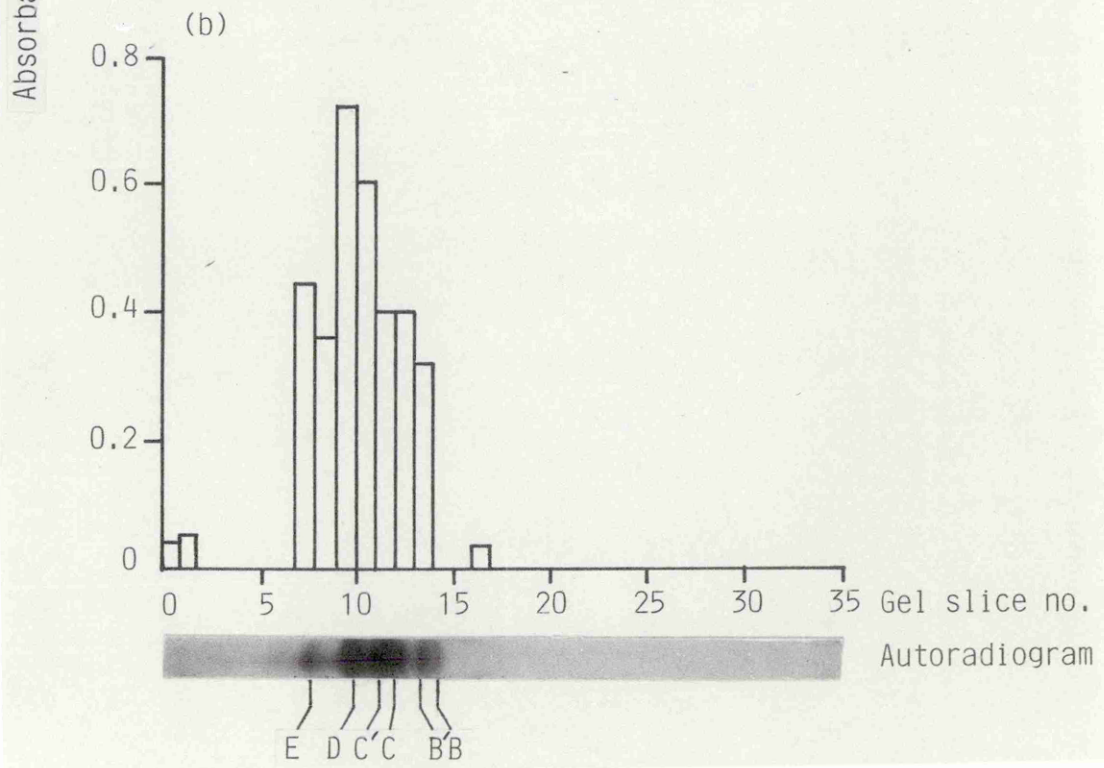
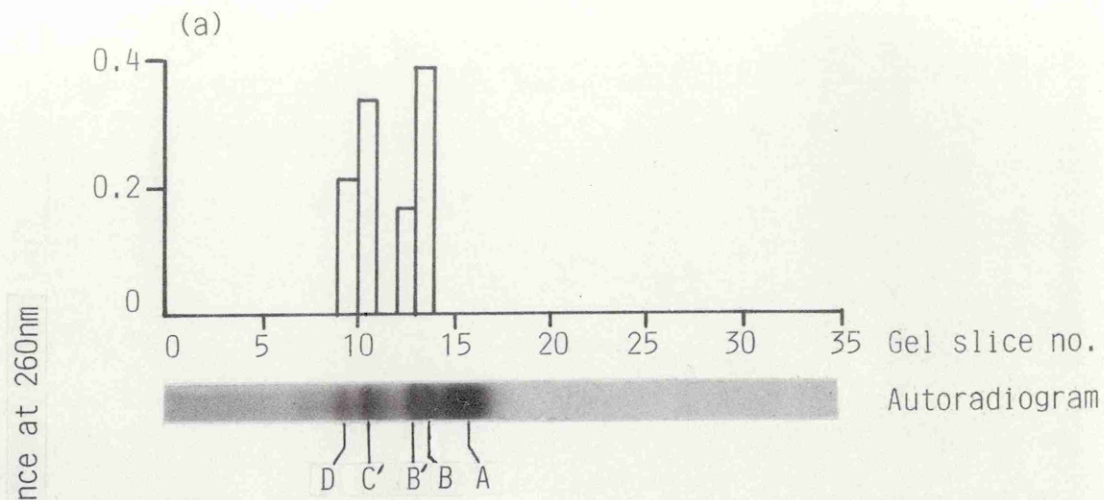

Figure 17. Detection of inhibitor/ribonuclease complexes by assay of gel slices after non-denaturing PAGE.

Duplicate samples of 200 µg of cytoplasmic protein were loaded on either side of a 10% polyacrylamide gel, and electrophoresed as described in Section 2.7.7. One half of the gel was immunoblotted (Section 2.8.5), whilst the other half was sliced and analysed for ribonuclease activity, as described in Section 2.7.7.

(a) Protein from immature rat uterus.

(b) Protein from immature rat uterus 4 days after oestrogen treatment. A,B,B',C,C', D and E refer to bands on the immunoblot discussed in the text.



3.3.2. Ferguson plot analysis of inhibitor/ribonuclease complexes

Information regarding the molecular weight and charge of the inhibitor/ribonuclease complexes electrophoresed on non-denaturing gels was obtained by constructing a Ferguson plot (Ferguson, 1964; Hedrick and Smith, 1968). The R_f of each complex was calculated after electrophoresis through gels of four different polyacrylamide concentrations (Fig. 18). A plot was then constructed of $\log R_f$ against acrylamide concentration (Fig. 19). The slope of the plot is inversely proportional to the molecular weight of the protein. Information regarding the charge of the various proteins is derived from the point of intersection with the 'Y' axis. For instance, a number of proteins with identical charge but different molecular weights (e.g. the conditions pertaining in SDS-PAGE) would have different slopes on a Ferguson plot, but would converge at or very near the 'Y' axis. In contrast, a group of proteins with identical molecular weight, but differing in charge would have identical slopes and would not converge at or near the 'Y' axis.

Analysis of uterine cytoplasm (Fig. 18) revealed the presence of a number of bands; A, B, B', C, C', D and E. In the untreated uterus bands A, B, B', C' and D were detected (Fig. 18, 9% IU lane). In the oestrogen-treated uterus bands B, B', C, C', D and E were detected (Fig. 18, 9% EU lane). Band 'E' was only seen clearly in the 13% and 11% gels. Band 'A' corresponds to free inhibitor.

A Ferguson plot was constructed for each of the bands indicated (Fig. 19). The plots derived for each of the inhibitor/ribonuclease complexes were nearly parallel to each other. This observation indicated that the major difference between the various complexes resided in differences in charge. It was assumed that these differences resided in the ribonuclease moiety of the complexes, as purified rat liver inhibitor gave a single band under these conditions, (Fig. 16). Therefore, it seemed likely that the enzymes that give rise to the complexes B through to E have increasing basicity, due to the increased retardation of the complexes that they formed.

The molecular weight of a given protein is inversely proportional to the slope of its Ferguson plot (slope = K_R = retardation coefficient; Hedrick and Smith, 1968). The K_R was calculated for each of the bands seen in Figure 18, and is shown in the table below.

Table 5. Relative molecular weights of the inhibitor/ribonuclease complexes.

Band from Fig. 18	Retardation coefficient
A	0.5
B	0.45
B'	0.45
C	0.44
C'	0.45
D	0.47
E	0.47

This data indicated that the highest molecular weight complex was C, followed by B, B', and C', and then by D and E. Free inhibitor (A) had the lowest relative molecular weight.

Figure 18. Ferguson plot analysis of inhibitor/ribonuclease complexes: Non-denaturing PAGE.

Duplicate samples of 150 μ g of cytoplasmic protein from the uteri of immature rats (IU) and immature rats which had received oestrogen implants 4 days before death (EU), were electrophoresed on 13%, 11%, 9% and 7% polyacrylamide gels as described in Section 2.7.7. Immunoblotting was performed as described in Section 2.8.5. The autoradiograph was exposed for 36 h. A,B,B',C,C', D and E refer to bands discussed in the text.

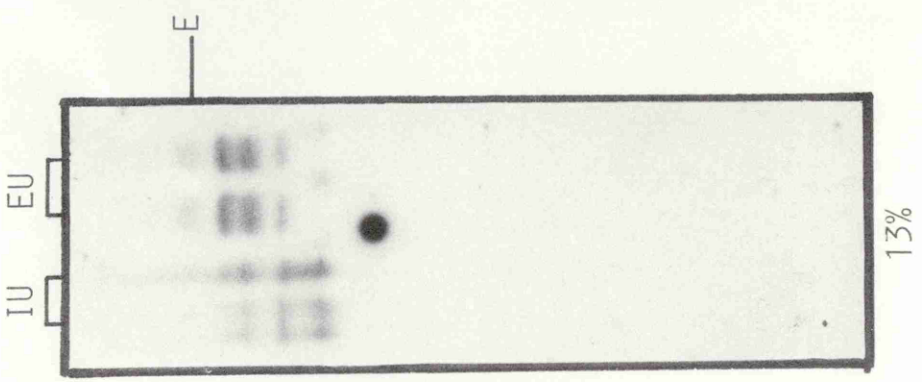
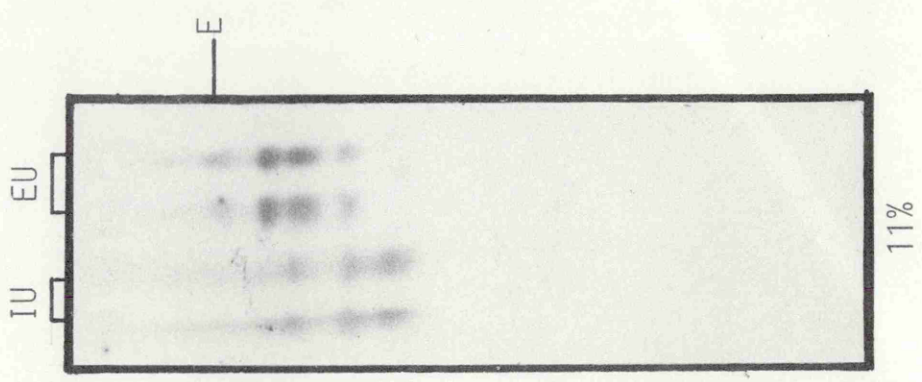
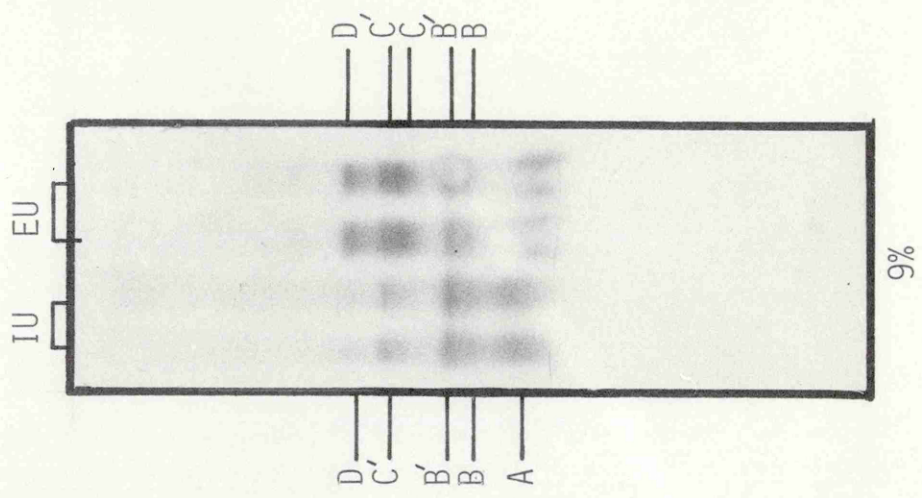
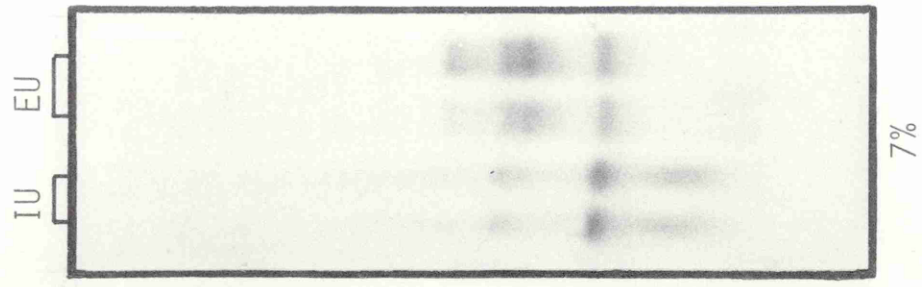
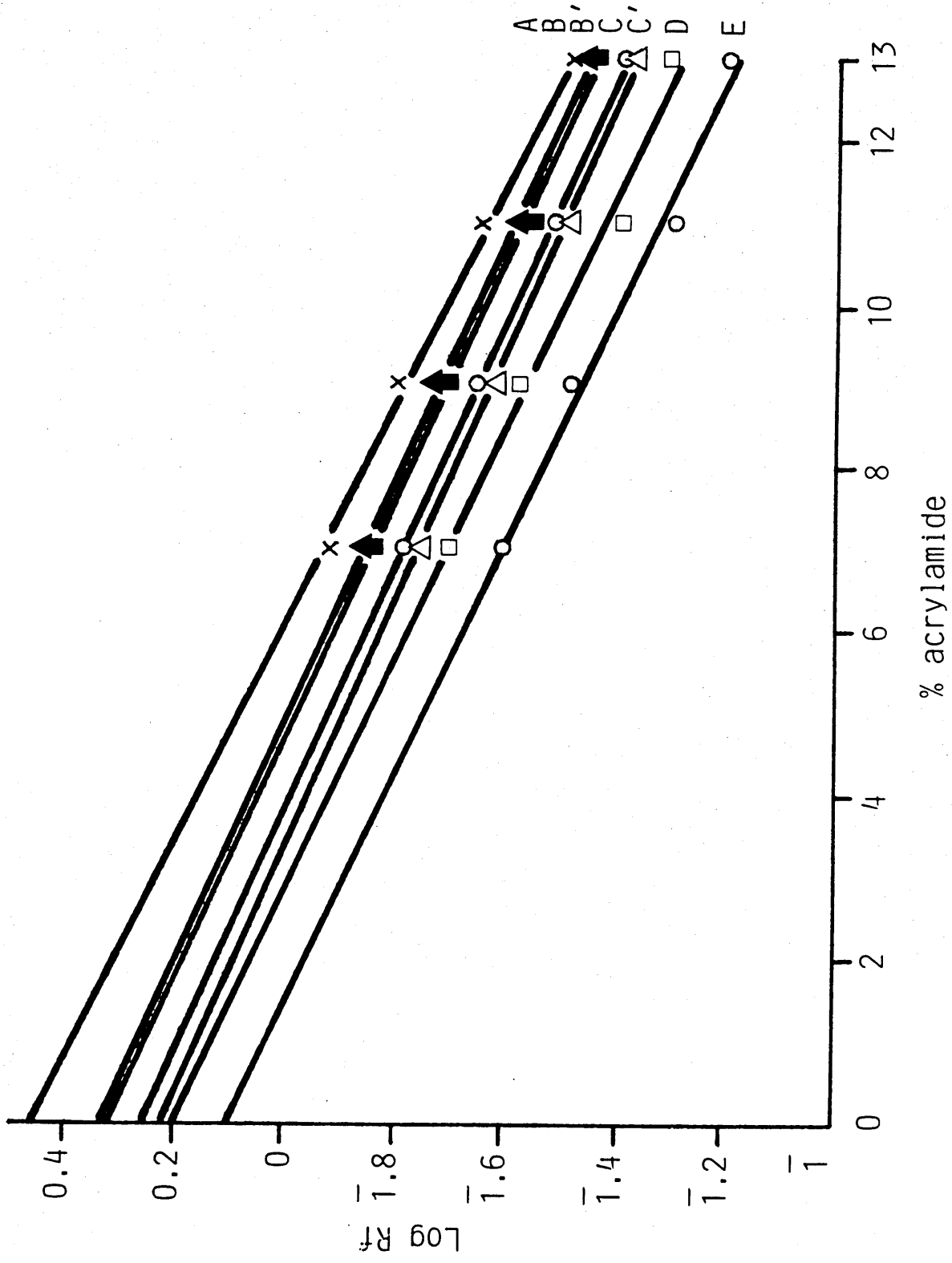

Figure 19. Ferguson plot analysis of inhibitor/ribonuclease complexes: Plot of log.Rf against % acrylamide.

The Rf of each of the bands A, B, B', C, C', D and E was calculated from the autoradiograph shown in Figure 18. A plot of log Rf against acrylamide concentration was constructed for each band: A(X), B (▲), B'(■), C (●), C' (△), D (□) and E (○). A best fit linear function was derived for each set of points by regression analysis, using the MINITAB statistics package on Glasgow University's GVME 2976 computer.



3.3.3. Analysis of inhibitor/ribonuclease complexes in various tissues of the rat.

Figure 20 illustrates an analysis of the inhibitor/ribonuclease complexes found in various tissues of the rat. In the uterus of the mature rat (MU), the pattern of bands was identical to that found in the oestrogen-treated immature uterus (EU). This observation supported the idea that the induction of ribonuclease activity after oestrogen-treatment also occurred during normal development of the uterus. The pattern of bands seen in the brain (Br) and Liver (Li) was similar to that found in the untreated ^{immature} uterus (IU), although very little free inhibitor was detected in brain. No bands were detected using pancreatic cytoplasm (Pa), contrary to the findings using immunoblot analysis after electrophoresis on SDS-PAGE (Fig. 8). The reason for this is not clear. In the kidney (Ki), spleen (Sp) and lung (Lu) the pattern of bands seen resembled that found in the oestrogen-stimulated or mature uterus. In addition to the major bands A, B, B', C, C', D and E seen in the various tissues, a region close to the origin of the resolving gel appeared to contain some ribonuclease inhibitor. The reason for this is not known, although one possibility is that this region represents ribonuclease inhibitor associated with cytoplasmic mRNP particles.

Figure 20. Detection of inhibitor/ribonuclease complexes in various tissues of the rat.

Duplicate samples of cytoplasmic protein from the various tissues were electrophoresed on a 10% polyacrylamide gel as described in Section 2.7.7. One half of the gel (a) was stained for protein, whilst the other half (b) was immunoblotted as described in Section 2.8.5.

Most of the lanes contained 150 μ g of cytoplasmic protein, and are identified as follows: Immature rat uteri, (IU), 4 day oestrogen-treated immature rat uteri (EU), liver (Li), Brain (B), Kidney (Ki), Spleen (Sp) and Lung (Lu). Due to the low protein concentration of the original homogenates of mature rat uteri (MU) and pancreas (P), it was only possible to load 75 μ g of these preparations. Lane 1 contained 25 ng of purified rat liver inhibitor. The autoradiograph was exposed for 48 h. A, B, B', C, C', D and E designate bands detected on the immunoblot that are discussed in the text.

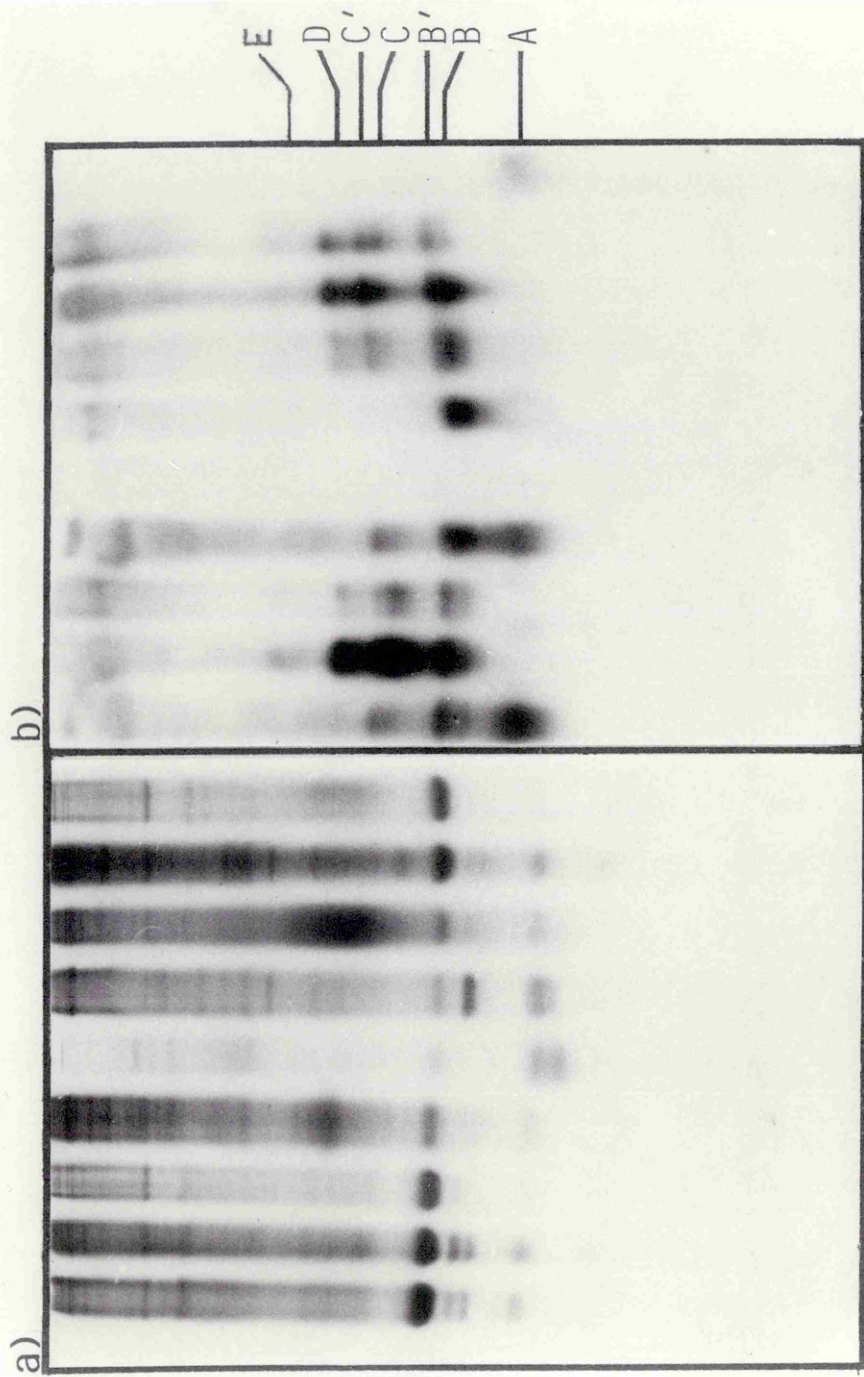

Iu Eu Mu Li Pa Br Ki Sp Lu Iu Eu Mu Li Pa Br Ki Sp Lu I

3.4.1. Purification and characterization of cytoplasmic ribonucleases

The demonstration that multiple forms of ribonuclease associate with the inhibitor in vivo raises a number of questions concerning the function of these enzymes. It is not as yet clear whether the differences in properties observed (i.e. molecular weight and charge heterogeneity) reflect differences in function for all or some of these enzymes.

Recent work on the inhibitor found in human placenta (P. Blackburn et al., personal communication) has demonstrated that at least five distinct species of ribonuclease are associated with the inhibitor in this tissue. These enzymes have been purified and to some extent characterised. Briefly, it emerges that there are two distinct major species of ribonuclease present, differing in their amino acid composition and their differential activities towards the homopolymers Poly (U) and Poly (C). One of these species closely resembles human pancreatic ribonuclease A whilst the other is similar to a ribonuclease purified from human liver (Frank and Levy, 1976). The other species appear to resemble one of the two major species.

The following sections illustrate an attempt to purify and characterise the ribonucleases associated with the inhibitor in rat liver and uterus. Whilst the main interest of this work was in the ribonucleases found in the uterus, the difficulty in obtaining workable quantities of material from this tissue meant that it was more practical to determine the conditions for the purification using a more readily available tissue i.e. rat liver.

3.4.2. Purification of cytoplasmic ribonucleases from rat liver.

The purification of rat liver cytoplasmic ribonucleases essentially followed the three steps described by Blackburn et al. (personal communication) for the human placental ribonucleases. However, the activities recovered still contained considerable contamination (as determined by SDS-PAGE) which was removed by the inclusion of a final step, affinity chromatography on agarose-2'(3')5' UDP.

The starting material for this purification was the run through fraction from the affinity purification of the inhibitor (Section 2.7.5). This fraction contained inhibitor/ribonuclease complexes, but no free inhibitor (Fig. 16c). The first step of the purification procedure was chromatography of the starting material through the anion exchanger, DEAE-cellulose. The rationale for this was that the slightly acidic enzyme/inhibitor complexes would be retained by the column, whilst basic proteins, including any basic ribonucleases not associated with the inhibitor, would pass through the column. The complexes were eluted from the column with a linear salt gradient of 0-500 mM NaCl in starting buffer. This step is illustrated in Figure 21a. The elution of complexes was assayed after the release of ribonuclease activity by pHMB. The latent enzyme was eluted as a single peak when the salt concentration reached approximately 220 mM.

The peak fractions from DEAE-cellulose chromatography were pooled and the complexes dissociated, firstly by removing free thiol by dialysis, and subsequently by incubation in the

presence of pHMB. The liberated ribonucleases, being basic proteins, were further purified by chromatography on the strongly acidic cation exchanger SP-sephadex. This step is illustrated in Figure 21b. The ribonucleases were eluted with 500 mM ammonium bicarbonate, pH 8.5. Although, in this figure, the ribonuclease activity appears to be eluted as two overlapping peaks, this result was not consistently repeatable and no attempt was made to separate the two components when they were seen.

The next step in the purification procedure employed chromatography on heparin-sepharose, as described by Blackburn et al. (personal communication), to separate the constituent ribonuclease species from one another. Heparin has been used as a specific inhibitor of ribonucleases due to its ability to bind small basic proteins through cation exchange. The bound ribonucleases were eluted from the heparin-sepharose column using a linear salt gradient of 20-500 mM ammonium bicarbonate. The elution profile of a typical experiment is illustrated in Figure 22a. The bulk of the ribonuclease activity was eluted as a single peak at a salt concentration of 120 mM. A second, minor peak was eluted at a higher salt concentration (220 mM). These two activities were designated rat liver cytoplasmic ribonuclease I and II (RLC I and II) respectively. RLC I represented approximately 98% of the total activity.

Analysis of RLC I by SDS-PAGE (Fig. 23, lane 4), revealed that the preparation was not entirely homogeneous at this stage. In order to improve the purification, an extra step, affinity chromatography using agarose-UDP, was added to the purification procedure of Blackburn et al. Affinity chromatography of RLC I is illustrated in Figure 22b. SDS-PAGE analysis of the main peak of eluted protein (Fig. 23 lane 5) showed that the ribonuclease had been purified to homogeneity. The molecular weight of this enzyme, as judged by SDS-PAGE, was 20,000. This figure is not in agreement with the findings of Kumagai et al. (1983) who quote a molecular weight of 16,000 for the purified rat liver cytoplasmic ribonuclease. However, bovine pancreatic ribonuclease A also had an anomalous molecular weight in Figure 23 (lane 6), i.e. 16,500 as opposed to the known molecular weight of approximately 14,000. These differences may arise from the anomalous behaviour of some highly basic proteins in SDS-PAGE (Hames, 1981).

A full analysis of the purification of rat liver ribonuclease is presented in Table 5. The enzyme(s) was purified 125,000 fold with a yield of approximately 60%.

Figure 21 (a). Chromatography of inhibitor/ribonuclease complexes from rat liver on DEAE-cellulose.

Approximately 5 g of protein from a 35-60% ammonium sulphate precipitate of rat liver cytoplasm (after removal of free inhibitor by affinity chromatography, Section 2.7.5) was chromatographed on DEAE-cellulose as described in Section 2.7.6. The figure illustrates the elution step, using a linear salt gradient of 0-500 mM NaCl in starting buffer. 7 ml fractions were collected and assayed for latent ribonuclease activity (O), using the micro-assay described in Section 2.7.3, and for protein (●) by measuring the absorbance at 280 nm.

(b). Chromatography of cytoplasmic ribonuclease from rat liver on SP-sephadex.

Peak fractions of latent ribonuclease activity from DEAE-cellulose chromatography were pooled and prepared for chromatography on SP-sephadex as described in Section 2.7.6. The buffer was changed to 20 mM NH_4HCO_3 at (A) and to 500 mM NH_4HCO_3 at (B). 10 ml fractions were collected and assayed for ribonuclease activity (O) and protein concentration (●) as above.

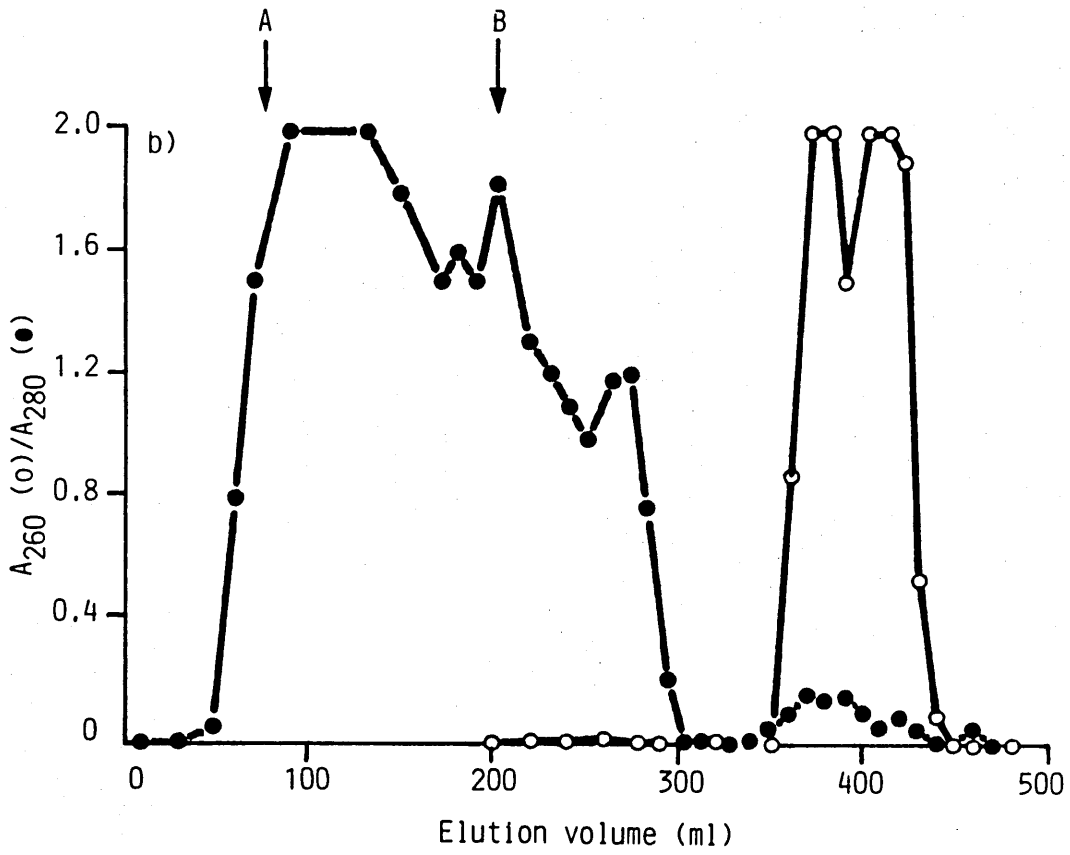
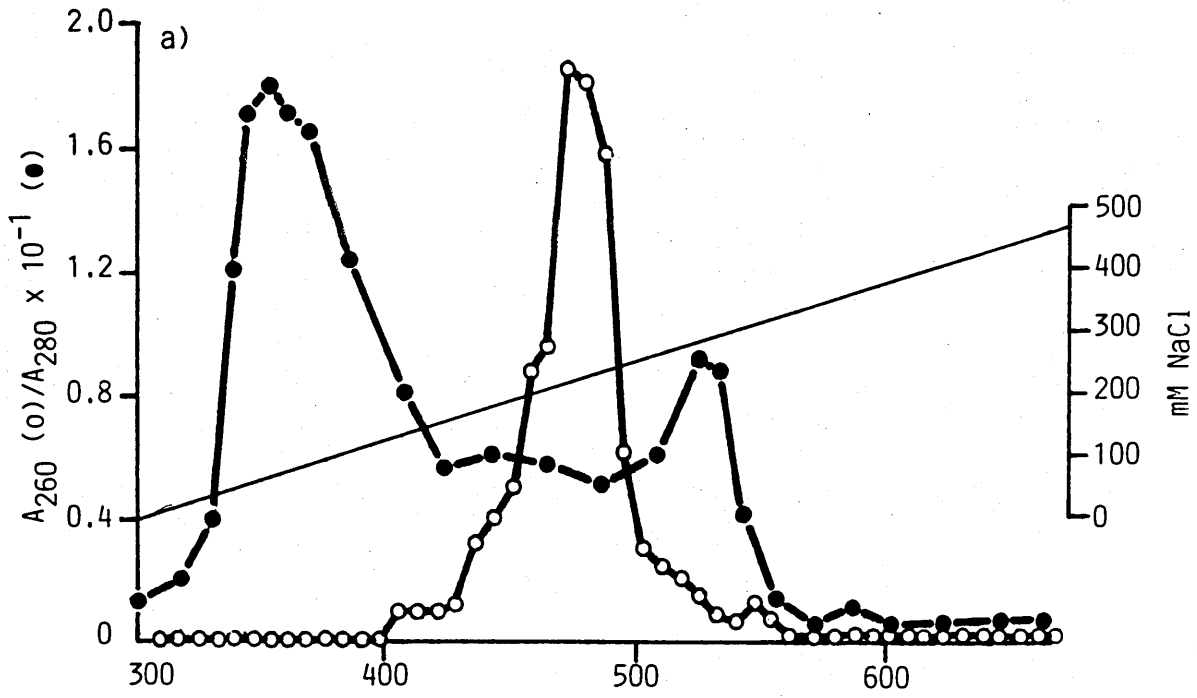

Figure 22 (a). Chromatography of cytoplasmic ribonucleases from rat liver on heparin-sepharose.

Peak fractions of ribonuclease activity from SP-sephadex chromatography were pooled and prepared for chromatography on heparin-sepharose as described in Section 2.7.6. The figure illustrates the elution step, using a linear salt gradient of 20-500 mM NH_4HCO_3 , (300 ml). 5 ml fractions were collected and assayed for ribonuclease activity (O) as described in the previous figure legend. Two peaks of activity were detected, and have been designated RLC I and RLC II. ('RLC' stands for rat liver cytoplasm).

(b). Affinity chromatography of RLC I on Uridine 2'(3')5' diphosphate-agarose.

Chromatography was performed as described in Section 2.7.6. The buffer was changed to 200 mM sodium acetate: 10 mM EDTA, pH 5.5 at (A), and to 10 mM Tris-HCl, pH 7.9: 5% glycerol (v/v) at (B). 2 ml fractions were collected and assayed for ribonuclease activity (O) as previously described.

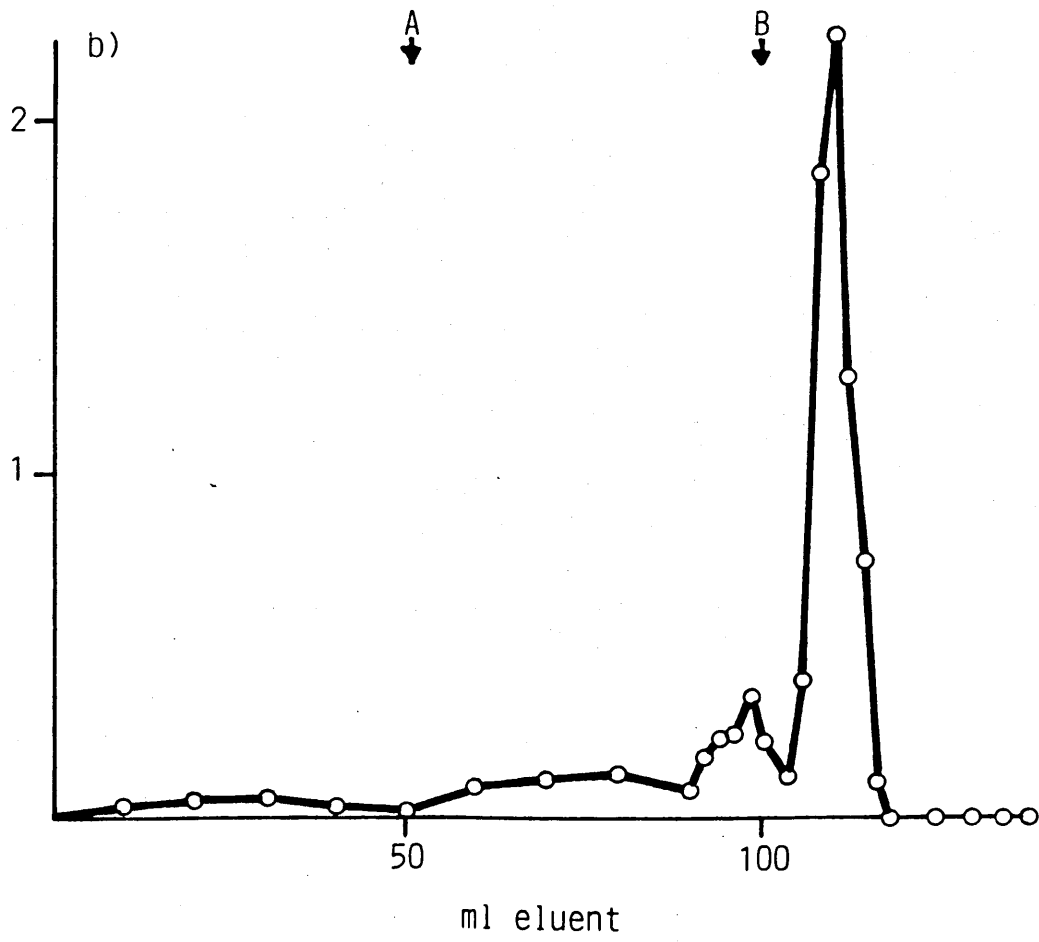
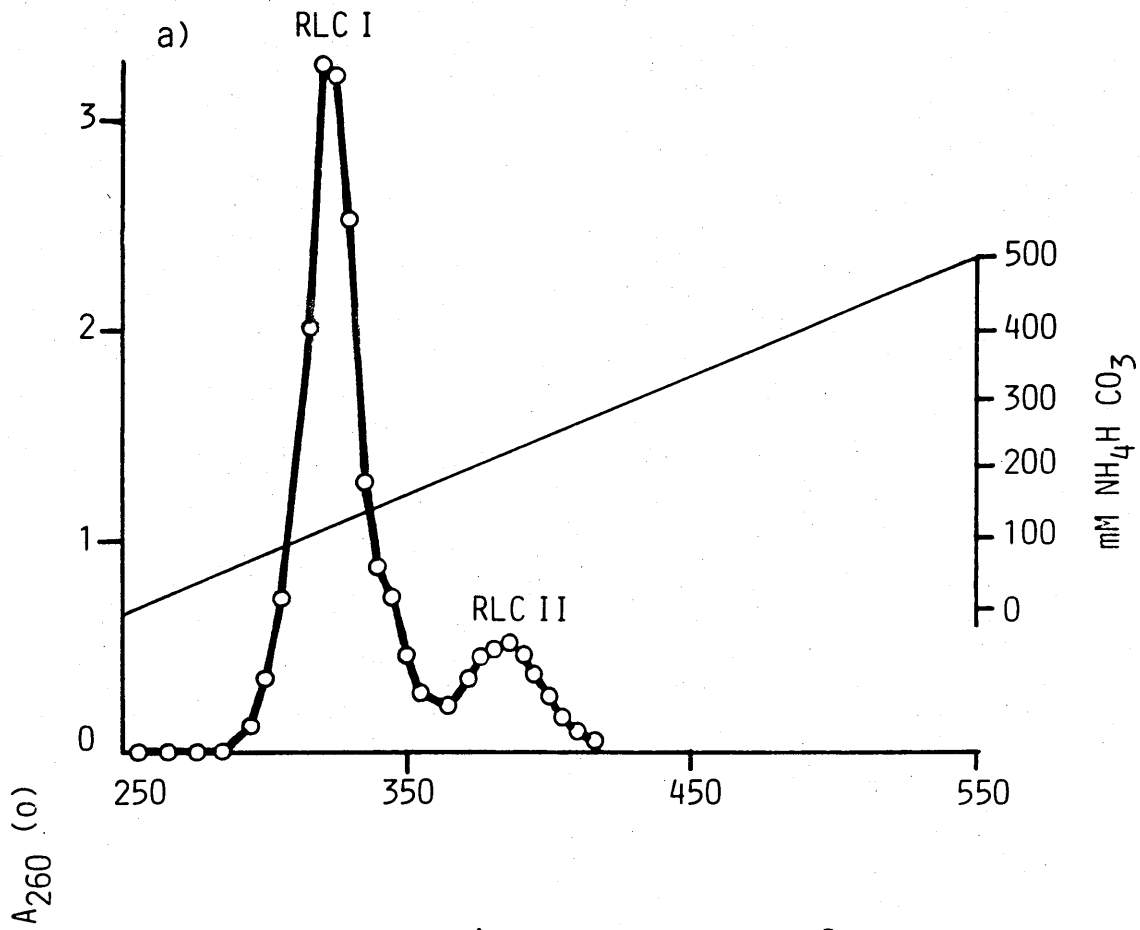

Figure 23. Analysis of the purification of rat liver cytoplasmic ribonuclease by SDS-PAGE.

The samples were electrophoresed on a 12.5% SDS-polyacrylamide gel as described in Section 2.7.7. Lane 1 contained 200 μg of protein from the AMSO_4 -I fraction. Lane 2 contained 200 μg of protein from the ribonuclease peak recovered from DEAE-cellulose. Lane 3 contained 100 μg of protein from the ribonuclease peak recovered from SP-sephadex. Lane 4 contained 25 μg of protein from the RLC I peak recovered from heparin-sepharose. Lane 5 contained 3 μg of protein from the RLC I peak recovered from agarose-UDP affinity chromatography. Lane 6 contained 5 μg of bovine pancreatic RNase A. The lanes designated M contained molecular weight markers.

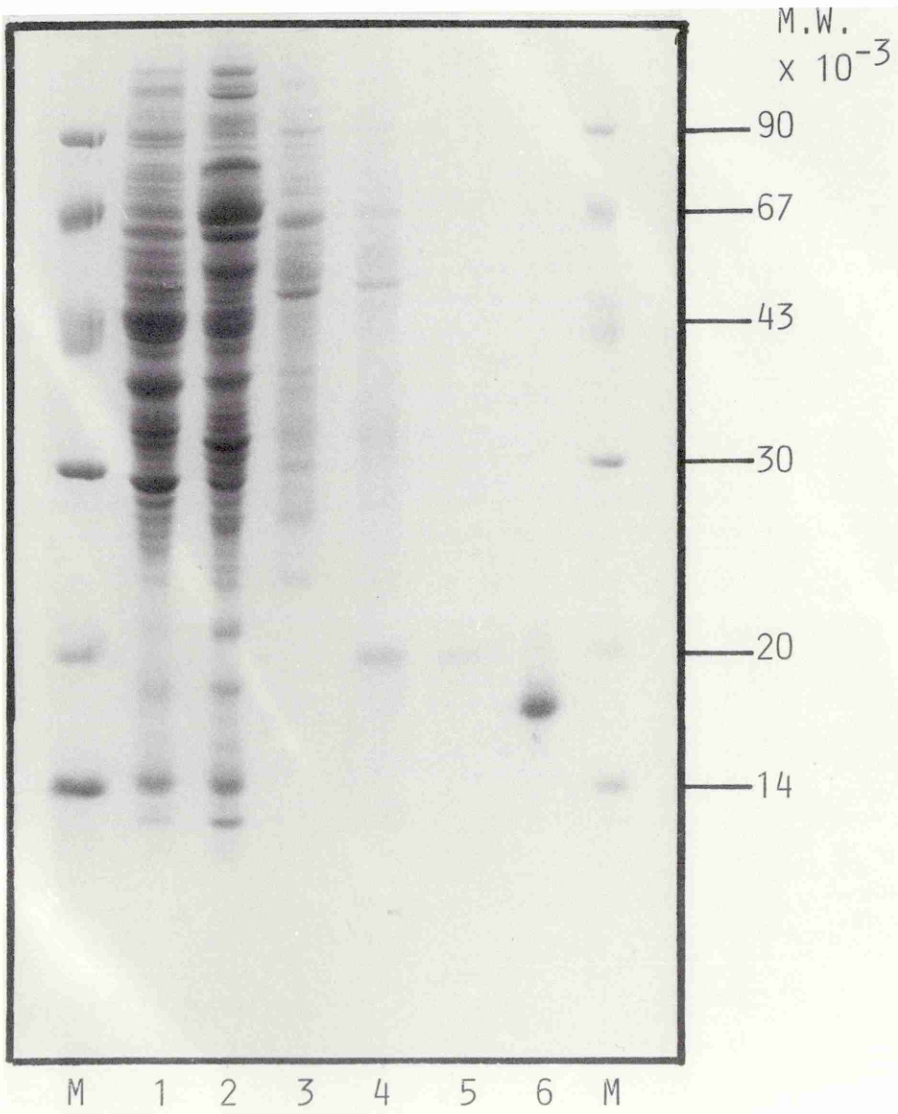

Table 6. Purification of cytoplasmic ribonuclease from rat liver.

1 unit of ribonuclease is defined as the amount required to give an increase in absorbance of one absorbance unit using the micro-assay described in Section 2.7.3. Protein concentration was estimated by the method of Lowry (Section 2.7.1.).

The final step of this purification, UDP-agarose affinity chromatography was performed on the major peak (RLC I) from the previous step.

	Total Protein (mg)	Total units	Specific activity (units/mg)	Purification factor	Yield
Rat liver cytoplasm	12,300	31,300	2.55	0	100%
AmSO ₄	3,900	24,500	6.3	2.47	78%
DEAE-cellulose	350	23,200	66.2	25.9	74%
SP-sephadex	4.2	22,500	5,360	2,100	72%
Heparin-sepharose	0.47	19,700	41,840	16,400	63%
UDP-agarose	0.057	18,100	317,980	124,700	58%

3.4.3. Purification of cytoplasmic ribonucleases from the uterus of mature rats.

Uterine cytoplasm from approximately 100 rats was accumulated over a period of time and kept frozen at -20°C . A 35-60% ammonium sulphate precipitate of the uterine cytoplasm was prepared and used as the starting material for the purification of ribonuclease. All the steps in the purification were the same as those already described for the purification of liver ribonuclease. Because of the limited availability of uterine tissue, no attempt was made to conduct a full analysis of the various stages of purification.

Figure 24 illustrates the result obtained with heparin-Sepharose chromatography of the uterine ribonucleases. Three distinct peaks of activity were eluted from the column and were designated rat uterine cytoplasmic ribonucleases I, II and III (RUC I, II and III). RUC I was eluted at a similar salt concentration to RLC I (150 mM ammonium bicarbonate), and was the smallest of the three peaks. RUC II was eluted at a similar salt concentration to RLC II (225 mM ammonium bicarbonate). RUC III was by far the largest peak and was eluted when the salt concentration reached approximately 350 mM. The data obtained using immunoblotting from non-denaturing gels (Section 3.3.2) suggested that as many as six different ribonuclease species are present in uterine cytoplasm. It therefore seemed likely that due to the close similarity of these enzymes, heparin-sepharose chromatography did not completely resolve some of the species, and that

the peaks observed may be composed of more than one distinct species. Evidence that this is indeed the case is presented in the following sections.

Further purification of each of the three ribonuclease peaks from heparin-sepharose was achieved by affinity chromatography on agarose-UDP. The yield for each activity was similar to that obtained with RLC I (between 90% and 95% for this step alone). Sufficient protein was not however available for analysis on stained gels and further characterization was based solely on enzyme activity.

3.4.4. Comparison of the properties of the purified ribonucleases

In the following sections, a number of experiments are described that were intended to highlight any differences or similarities in the properties of the purified ribonucleases, and to compare them with the properties of the cytoplasmic ribonucleases of human placenta, purified and characterised by Blackburn et al. (personal communication). The following experiments were carried out for each purified enzyme:

Comparison of the molecular weight and assessment of the homogeneity of each activity by ribonuclease activity staining, (Fig. 25). Estimation of K_M and V_{max} for each activity (Fig. 26). Determination of the pH optimum for each activity (Fig. 27) and comparison of the relative rates of digestion using RNA, Poly(C), Poly(U), Poly(G) or Poly(A) as substrate (Table 7).

Figure 24. Chromatography of cytoplasmic ribonucleases from mature rat uteri on heparin-sepharose.

The ribonuclease of mature rat uteri were purified using the same procedure as that described for rat liver (Section 2.7.6). This figure illustrates the third step in the purification procedure, chromatography on heparin-sepharose. The ribonucleases were eluted from the column with a linear salt gradient of 20-500 mM NH_4HCO_3 , pH 8.5, (200 ml). 2 ml fractions were collected, and assayed for ribonuclease activity as previously described (See Figure 22a).

Three major peaks of activity were detected and have been designated RUC I, RUC II and RUC III. (RUC stands for rat uterine cytoplasm).

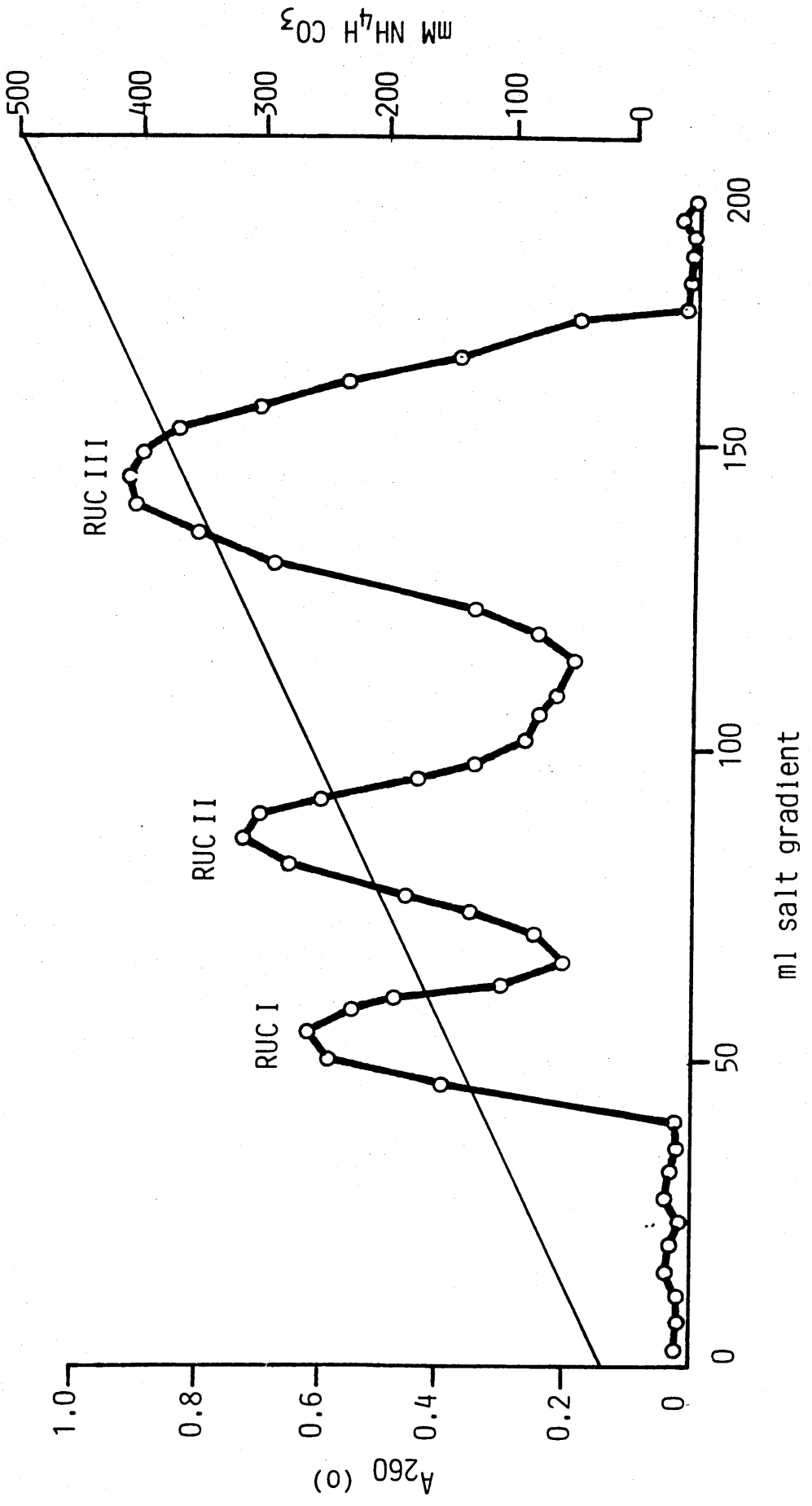
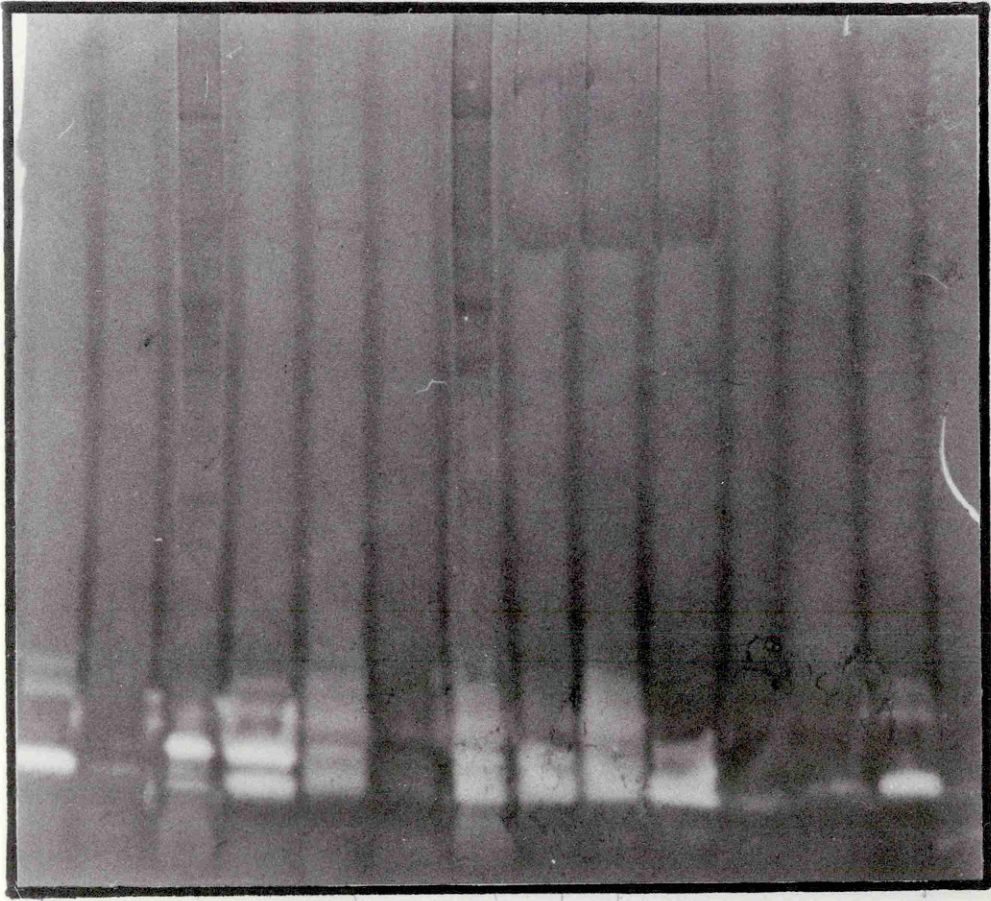

Figure 25. Analysis of purified ribonucleases by activity staining.

Ribonuclease activity staining was performed as described in Section 2.7.7, except that a 12.5% polyacrylamide gel was used. Lanes 1 and 9 contained 100 μ g of bovine pancreatic RNase A. Lane 2 contained 200 μ g of cytoplasmic protein from rat liver. Lanes 3 and 4 contained 10 units of RLC I and RLC II respectively. Lane 5 contained 200 μ g of cytoplasmic protein from mature rat uteri. Lanes 6, 7 and 8 contained 10 units of RUC I, RUC II and RUC III respectively.



1 2 3 4 5 6 7 8 9

Figure 26. Lineweaver-Burke plots for the purified cytoplasmic ribonucleases RLC I, RLC II, RUC I, RUC II and RUC III.

One unit of each of the enzymes was assayed in triplicate using a variety of substrate concentrations (0.75 - 5 mg/ml yeast RNA) by the micro-assay procedure described in Section 2.7.3.

A best fit linear function was derived for each set of points by regression analysis on MINITAB. The apparent K_M and V_{max} of each enzyme is presented in Table 7.

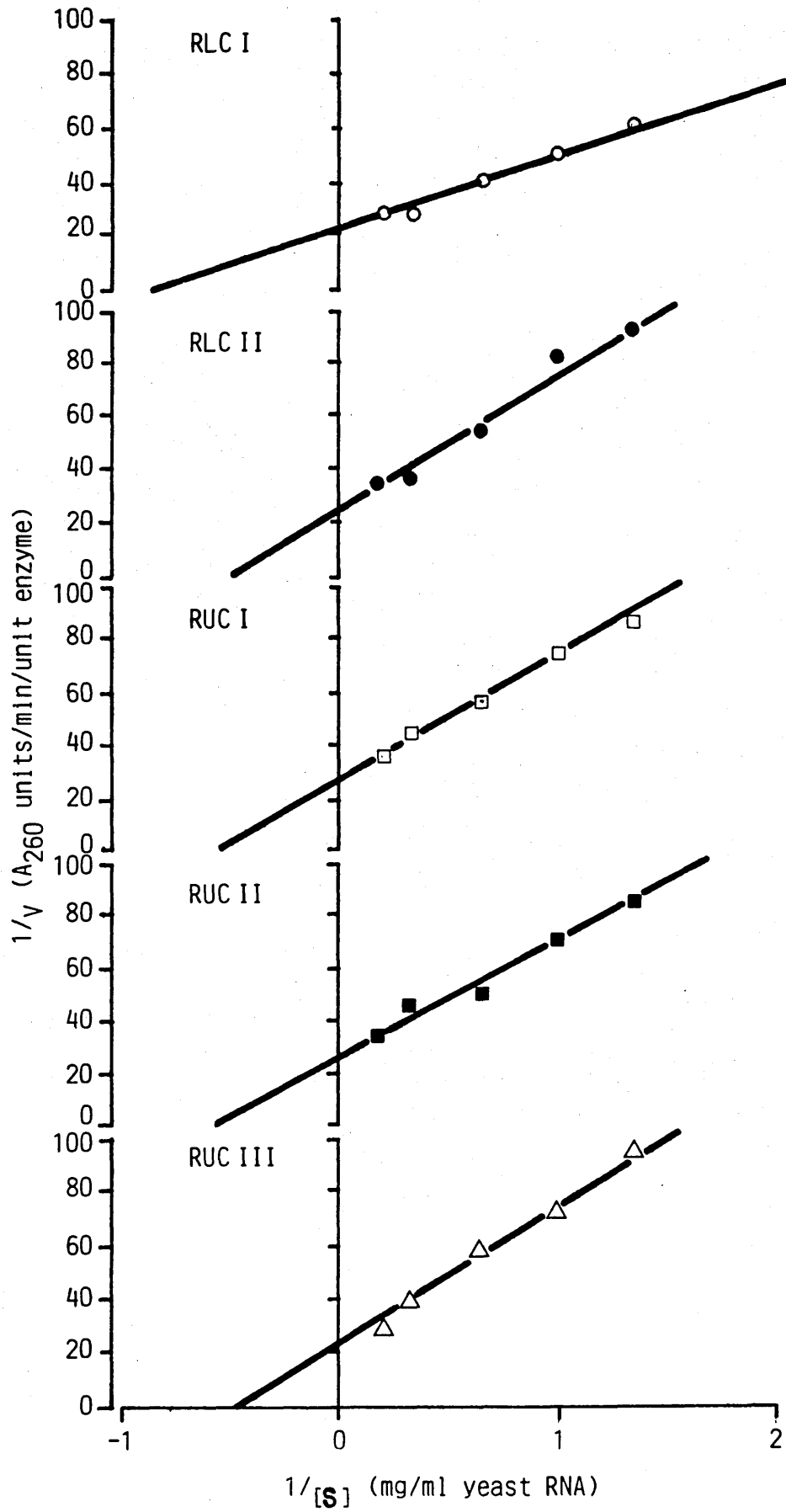

Figure 27. pH optima of the purified cytoplasmic ribonucleases of rat liver and rat uteri.

The purified ribonucleases, RLC I (○), RLC II (◻), RUC I (●), RUC II (■), and RUC III (▲) were assayed in duplicate at each pH value shown, using the micro-assay described in Section 2.7.3.

The buffers used were 100 mM sodium acetate buffer (A), 100 mM potassium phosphate buffer, (B), and 100 mM Tris buffer (C). The pH of the buffers was adjusted with acetic acid, (A), sodium hydroxide, (B), and HCl, (C).

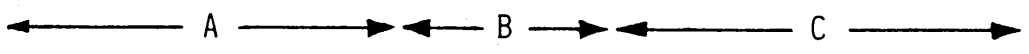
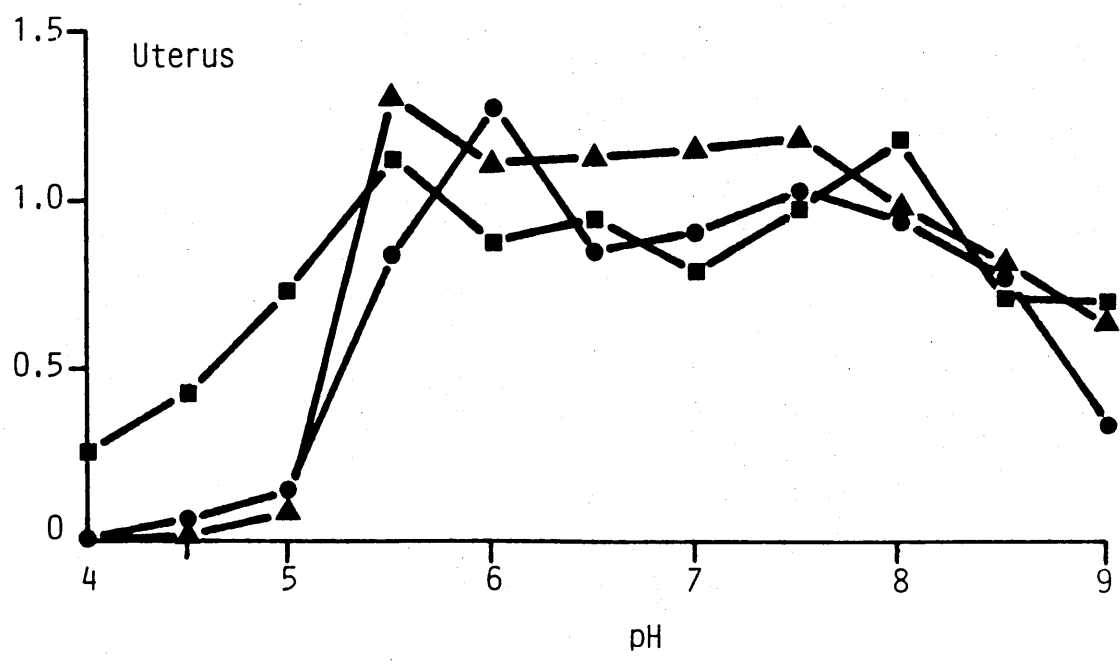
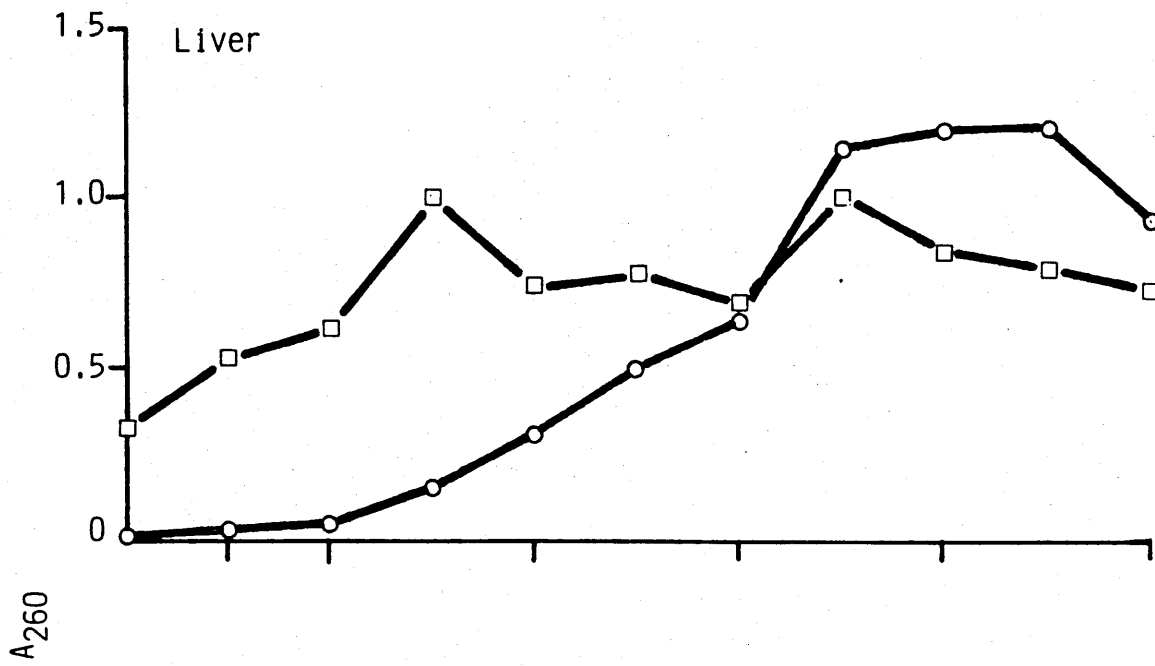

Table 7. Comparison of the properties of purified cytoplasmic ribonucleases.

- (a) The relative activity refers to the ratio of activity towards the homopolymer compared with that obtained with yeast RNA. The relative activity of the human placental enzymes was derived from the ratio of activity towards the homopolymer, compared with that obtained with yeast tRNA (Blackburn et al., personal communication, 1985).
- (b) The figures in brackets refer to those obtained by Kumagai et al. (1983) for what is assumed to be the same enzyme (RLC I).
- (c) HP designates 'human placental' (Blackburn et al., personal communication, 1985).

K_m and V_{max} values were obtained from Figure 26.

Enzyme	(a) Relative activity towards homoribopolymers				Kinetic parameters	
	Poly(C)	Poly(U)	Poly(A)	Poly(G)	K_m (μ g yeast RNA/ml)	V_{max} (A_{260} units/min/unit enzyme)
RLC I	2.03(1.95) ^b	0.05(0.12) ^b	0	0	1.2 × 10 ³ (0.95 × 10 ³) ^b	4.3 × 10 ⁻²
RLC II	0.15	0	0	0	2 × 10 ³	4.1 × 10 ⁻²
RUC I	0.26	0.08	0	0	1.8 × 10 ³	3.8 × 10 ⁻²
RUC II	0.18	0.02	0	0	1.7 × 10 ³	3.8 × 10 ⁻²
RUC III	0	0.32	0	0	2.2 × 10 ³	4.5 × 10 ⁻²
(c)HPRNase I	0.8	0.05	-	-	-	-
HPRNase II	0.06	0.2	-	-	-	-
HPRNase III	6	0.4	-	-	-	-
HPRNase IV	17.5	0.85	-	-	-	-
HPRNase V	16.05	0.92	-	-	-	-
HPRNase VI	0.09	0.6	-	-	-	-

3.4.5. Characterisation of rat liver cytoplasmic ribonuclease I (RLC I)

Figure 25 compares the activity of the purified ribonucleases with total activity of the tissue of origin, and with bovine pancreatic ribonuclease A. RLC I (lane 3) appeared to contain four bands of activity. The main band corresponded to the major band seen in total liver cytoplasm (lane 2) and had a molecular weight slightly higher than pancreatic RNase A (lanes 1 and 9). A second species, barely detectable in total liver cytoplasm, and with an identical molecular weight to pancreatic RNase A was also present. Two very faint bands of higher molecular weight were also detected. The K_m and V_{max} of RLC I were calculated and found to be $1.2 \times 10^3 \mu\text{g RNA/ml}$ and $4.3 \times 10^{-2} A_{260} \text{ units/min./unit enzyme}$ respectively. These figures agree fairly well with those determined by Kumagai et al. (1983), for what is assumed to be the same enzyme (Table 7). The pH optimum of RLC I was pH 8 - 8.5 (Fig. 26). This was also in agreement with the findings of Kumagai et al. (1983). The relative rate of digestion of homo-ribo polymers compared with that of yeast RNA is presented in Table 7. RLC I shows a preference for Poly(C) over Poly(U) and yeast RNA. In this respect it was similar to human placental ribonuclease IV and V (HP RNase IV and V, Table 7).

3.4.6. Characterisation of rat liver cytoplasmic ribonuclease

II. (RLC II).

Activity stain analysis of RLC II revealed the presence of four equally intense bands, (Fig. 25, lane 4). These bands appeared to migrate at slightly different rates to those seen with RLC I (lane 3).

The K_m and V_{max} of this activity were 2×10^3 and 4.1×10^{-2} respectively. This indicated that RLC II has a slightly lower affinity for yeast RNA than does RLC I.

Unlike RLC I, RLC II exhibited a broad pH optimum over the range pH 5-9. Minor peaks were seen at pH 5.5 and 7.5 (Fig. 27).

RLC II exhibited little activity towards Poly(C), and no activity towards the other homopolymers tested (Table 7).

3.4.7. Characterisation of rat uterine ribonuclease I (RUC I)

Ribonuclease activity stain analysis of total uterine cytoplasmic protein revealed the presence of four bands (Fig. 25, Lane 5). Previously, it was suggested that the ribonuclease activity of mature uterine cytoplasm consisted of two species as determined by activity staining (Section 3.2.2, Fig. 11). It is however apparent from this experiment that each of the two bands described in Figure 11 consists of two closely separated bands.

RUC I contained two of these bands in similar positions to those seen with RLC I (compare lanes 3 and 6, Fig. 25). However, unlike RLC I it was the lower molecular weight band that predominated in RUC I.

The K_m for RUC I was found to be 1.8×10^3 $\mu\text{g RNA/ml}$, indicating a lower affinity for substrate than RLC I (Table 7). The V_{max} of RUC I was 3.8×10^{-2} A_{260} units/min./unit enzyme.

RUC I was found to have a broad pH range (5.5 - 8.5), with the main peak of activity at pH 6 and a minor peak at pH 7.5 (Fig. 27).

RUC I showed a preference for Poly(C) over Poly(U), but unlike RLC I, activity towards Poly(C) was less than towards yeast RNA. In this respect RUC I most closely resembled human placental RNase I (HP RNase I, Table 7).

3.4.8. Characterisation of rat uterine cytoplasmic ribonuclease II (RUC II).

Activity stain analysis of RUC II (Fig. 25, lane 7) revealed the presence of three major bands of activity. One of these bands had a similar molecular weight to pancreatic RNase A. The other two bands were of higher molecular weight, and corresponded to the high molecular weight band that was induced in response to oestrogen (Fig. 11).

The kinetic parameters and rates of cleavage of Poly(U) and Poly(C) for RUC II were similar to those of RLC II (Table 7). The pH optimum of RUC II occurred over a broad range with dual peaks at pH 5.5 and pH 8 (Fig. 27).

3.4.9. Characterisation of rat uterine cytoplasmic ribonuclease III (RUC III).

Activity stain analysis of RUC III (Fig. 25, lane 8)

revealed a similar pattern to that seen with RUC I, with a predominant band corresponding in molecular weight to pancreatic RNase A, and a minor band corresponding to the predominant band of RLC I.

Like RLC II, RUC I, and RUC II this preparation displayed activity over a broad pH range, and a K_m of approximately 2.0×10^3 $\mu\text{g RNA/ml}$. However, unlike the other activities, RUC III showed a preference for Poly(U) compared with Poly(C) (Table 7). In this respect it most closely resembles the placental enzyme HP RNase II (Table 7).

Before concluding this report, it is necessary to remark that the interpretation of the activity strain data (Fig. 25) is subject to some criticism due to the indistinctness of some of the bands. Further experiments of this nature would have been desirable, but the small quantities of the uterine enzymes available, together with restrictions on the time available made this impossible.

4. DISCUSSION

4.1 The effect of method of administration and dose of oestrogen on uterine inhibitor activity

The preliminary studies of McGregor et al. (1981) demonstrated that the effect of a single injection (1 µg) of oestradiol 17-β on immature rat uterine ribonuclease inhibitor was small and highly variable. The inhibitor activity was assayed at various times up to 16 h after hormone treatment. In this study the effect of a single injection was reexamined. No significant change in inhibitor activity was seen during the 48 h post-treatment period that was tested. Taken together with the observation that administration of oestrogen implants resulted in the complete loss of inhibitor activity, these results suggested that either prolonged exposure to oestrogen, or a higher dose than that obtained with a single injection, was required to elicit the response. The former hypothesis was investigated by examining the effect of oestradiol benzoate on uterine inhibitor activity. Unlike oestradiol-17β, oestradiol benzoate is metabolised slowly in vivo. Once again, no significant change in inhibitor activity was observed within 48 h of hormone-treatment. The effect of hormone dose was tested by examining the effect of paraffin wax/oestradiol 17β implants of different sizes (10 mg or 50 mg), and oestrogen content (1% or 10%). Under the conditions utilized, inhibitor activity was completely lost within 24 h using 50 mg/10% or 10 mg/10% implants, but the 1%/50 mg and 1%/10 mg caused only a small decrease in inhibitor activity. Taken together

these results suggested that the loss of uterine cytoplasmic inhibitor activity required a high dose of oestrogen.

It seemed likely that the level of circulating oestrogen obtained with these implants would be considerably higher than physiological levels of the hormone. Clark et al. (1978) compared the effect of a single injection of oestradiol-17 β with that of 50 mg/10% implants. Animals treated with implants showed increased long-term nuclear retention of oestrogen receptor, increased RNA polymerase activity, and increased hypertrophy of luminal epithelial cells relative to animals receiving a single injection. Waters and Knowler (1981), compared the effect of a single injection and oestrogen implants on RNA synthesis in immature rat uteri. A peak of uterine RNA synthesis occurring between 2 and 12 h after administration of a single injection was less prevalent in implanted animals, whilst a peak of uterine RNA synthesis, occurring between 8 and 24 h after administration of implants, was not detectable in animals receiving a single injection. The aforementioned observations presumably relate to the differential effect of single injections and oestrogen implants on uterine ribonuclease inhibitor.

That the response to implants was physiological was indicated by the disappearance of inhibitor activity during normal sexual maturation of the rat (Munro and Knowler, 1982 and work presented in this thesis), and the partial restoration of inhibitor activity after ovariectomy of mature rats (Zan-Kowalszewska and Roth, 1975).

4.2 Quantitative analysis of uterine ribonuclease inhibitor

Experiments illustrating the quantitation of inhibitor, using antiserum raised to purified rat liver inhibitor, were described in Section 3.1.2. In order to obtain a good monospecific antiserum, it was first necessary to purify the inhibitor to homogeneity. Initially the procedure described by Blackburn (1979) to purify the inhibitor from human placenta was utilized. This employed ammonium sulphate precipitation followed by affinity chromatography on sepharose-RNase A, and in the author's hands yielded an apparently homogeneous inhibitor with an overall yield of 40-60%. When this procedure was applied to the purification of rat liver inhibitor, contaminating proteins were detected in the final preparation. The problem was overcome by re-chromatographing the purified inhibitor on sepharose-RNase A. Burton and Fucci (1982) also found that it was necessary to take this precaution in obtaining homogeneous inhibitor from the liver of a number of mammalian species. Further, they demonstrated that a more homogeneous preparation was obtained by ensuring that the sepharose-RNase A column became saturated with inhibitor. Presumably this was due to non-specific binding of other liver proteins to the RNase A moiety of the resin. Burton and Fucci reported yields of purified inhibitor between 60-80%. In this study the yield was never greater than 40%. The reason for this anomaly remains unclear.

The antiserum raised to purified inhibitor was found to contain some contaminating antibodies. This was unexpected in view of the apparent homogeneity of the inhibitor preparation. The most probable explanation is that the inhibitor preparation contained low levels of contaminating proteins, not detected by SDS-PAGE, but nonetheless present in sufficient quantities to elicit an immune response. Contaminating antibodies were removed by adsorbing the antiserum with the antigens present in the run through fraction of the sepharose-RNase A affinity column. The adsorbed antiserum was found to be mono-specific and was considered suitable for use in quantitation experiments.

The conclusions to emerge from the quantitation of uterine inhibitor (Table 3A) were as follows:

- (i) The concentration of total inhibitor increased gradually with time after oestrogen-treatment and, 4 days after oestrogen-treatment, reached levels 50% greater than those of control animals.
- (ii) A similar increase was observed in mature rat uteri.
- (iii) The ratio of free to bound inhibitor in immature rat uteri was approximately 3:1.
- (iv) No free inhibitor was detected in oestrogen-treated or mature animals.
- (v) The observed increase in total uterine cytoplasmic ribonuclease activity, and the appearance of free ribonuclease in oestrogen-treated and mature uteri indicated that the loss of inhibitor activity resulted from saturation of the inhibitor by endogenous ribonuclease.

From the data in Table 3(A) it was possible to calculate the ribonuclease activity associated with a given quantity of inhibitor. Thus, as there was no free enzyme in immature uteri, the quantity of bound inhibitor was divided by the total enzyme activity. This yielded a figure of approximately 2.6 units/ng inhibitor. Conversely, in the oestrogen-treated uterus a similar calculation for bound enzyme yielded an average figure of 3.8 units/ng inhibitor. Thus it was apparent that there were differences either in the specific activities and/or the stoichiometry of interaction between the ribonucleases and the ribonuclease inhibitor present in untreated and oestrogen-treated/mature animals.

The aforementioned data was expressed on the basis of units of ribonuclease or ng of inhibitor per mg of cytoplasmic protein. Because oestrogen-treatment results in elevated levels of total uterine protein, (Billing et al., 1969), the actual increase in inhibitor and ribonuclease would be higher than indicated. This however is offset by the increased cell content of oestrogen-stimulated uterus, as evidenced by a two-fold increase in uterine DNA content, (Waters and Knowler, 1981). Thus, the results presented in Table 3(A) should approximate to the inhibitor and ribonuclease levels per cell. The immature rat uterus has been estimated to contain 13 different cell types distributed through three different tissues:- the epithelium, myometrium and stroma. The data presented in Table 3(A) obviously takes no account of the possibility that the observed differences may reside in different cells.

4.3 Analysis of ribonuclease inhibitor in other rat tissues

The total inhibitor content of various tissues of the rat was estimated by densitometric analysis of the immunoblot shown in Figure 8 (see Table 3(B)). The inhibitor content of spleen, kidney and pancreas was similar to that found in untreated immature uteri, whilst that of liver, brain and lung were relatively low. This experiment did not give any indication of the ratio of free to bound inhibitor in these tissues, as inhibitor/ribonuclease complexes were dissociated under these conditions.

In a later experiment, (Figure 20), the same tissues were analyzed by immunoblotting from non-denaturing gels. In this manner it was possible to gain information on the ratio of free to bound inhibitor. Apart from immature rat uteri, the only tissues with detectable levels of free inhibitor were liver and brain. The free inhibitor of liver appeared to constitute approximately 50% of the total liver inhibitor, whilst that of brain was barely detectable.

Previous comparisons of inhibitor levels in various tissues have relied on the assay of inhibitor activity rather than direct quantitation of the protein. Roth (1956) found that inhibitor activity was highest in rat brain, followed by liver, lung, spleen and kidney. The activities of lung, spleen and kidney were approximately 50% of those found in brain and liver. There was however considerable variation in the activities of all of the tissues except liver. In a later study, Bartholeyns and Baudhin (1977) reported that

the inhibitor activity of rat brain and kidney were insignificant compared with that of liver. They also reported that the activity of lung and spleen were relatively high. Once again, considerable variation was seen about the mean value obtained from a number of determinations. The results of Bartholeyns and Baudhin (1977) are subject to some criticism: It was claimed that the inhibitor activities were corrected for the ribonuclease content in the tissue concerned, but the method by which this correction was derived was not stated. As a consequence it is not clear whether the inhibitor activities quoted by these workers referred to free inhibitor or free plus bound inhibitor.

The determination of the ratio of free to bound inhibitor has previously been calculated by assuming that the cytoplasmic ribonucleases have a similar specific activity, molecular weight and stoichiometric interaction with the inhibitor as has bovine RNase A. Thus, Roth (1967) calculated that the ratio of free to bound inhibitor in rat liver is approximately 5:1.

Clearly the ratios of Roth (1967), as well as some of the data of other workers mentioned above, differ considerably from the results presented in Figure 20. Some possible reasons for these discrepancies are as follows:-

(i) Chesters and Will (1978) reported that the inhibitor activity of various rat tissues decreases with ageing and in animals fed on a restricted diet. Thus, some of the variation seen in the inhibitor activity of various tissues

may be attributable to differences in the age and diet of the animals used. The tissues analysed in Figure 20 were derived from ex-breeding stock female rats and may therefore have unrepresentative free inhibitor levels.

(ii) Differences in the procedures used to isolate the various tissues and to prepare sub-cellular fractions may result in variations in inhibitor or enzyme levels.

(iii) Differences in the procedures utilized to assay inhibitor and enzyme, together with differences in the definition of units in the early literature, make it difficult to compare results from different laboratories.

(iv) The assumption that the ratio of free to bound inhibitor can be calculated by expressing cytoplasmic ribonuclease activity as RNase A equivalents is subject to some criticism. Results presented in this thesis and from other laboratories (Button et al., 1982; Davies et al., 1980; Kumagai et al., 1983), demonstrate that the cytoplasmic enzymes are distinct from their secretory counterparts on the basis of molecular weight and a number of other properties.

The results presented in Figure 20 are in agreement with those of Roth (1956) and Bartholeyns and Baudhin (1977) to the extent that free inhibitor was detected in rat liver and brain, and not in kidney. Whilst it is clear that further studies are required, it is hoped that immunoblotting from non-denaturing gels will provide a powerful technique for the analysis of the inhibitor/ribonuclease system. The use of immunoblots to study inhibitor/ribonuclease complexes did however produce some unexplained artifacts:-

(i) For unknown reasons immunoblots did not detect the ribonuclease inhibitor in rat pancreas, (Figure 20). Furthermore, pre-incubation of purified inhibitor with excess RNase A decreased the quantity of total bound and unbound inhibitor detected (Figure 16b). These two results indicated that the presence of high levels of secretory ribonuclease had some unknown effect on the electrophoretic mobility of inhibitor/ribonuclease complexes.

(ii) An unidentified band occurred near the origin of the gel in Figure 20. It is possible that this represented inhibitor associated with free mRNP particles, as described by Gileadi et al. (1984). Confirmation of this awaits further analysis. Whether this signal represents inhibitor associated with enzyme or not is also of interest.

(iii) Possible differences in the ability of the antiserum to recognize free or bound inhibitor, together with possible differences in the efficiency of transfer of free and bound inhibitor, may lead to inaccuracies in any attempt to quantitate free to bound ratios.

4.4 Studies on the uterine cytoplasmic ribonucleases

McGregor et al. (1981) and Munro and Knowler (1982) found that the loss of inhibitor activity in oestrogen-treated and developing uteri was accompanied by an increase in total cytoplasmic ribonuclease activity. However, because it was not possible to relate units of enzyme and inhibitor activity to molar ratios, the possibility that the increased enzyme activity could lead to the loss of inhibitor activity was not investigated.

In these studies, quantitative data on the level of inhibitor, together with studies on the level of free and bound enzyme activities, provided evidence that the loss of inhibitor activity resulted from increased cytoplasmic ribonuclease (Table 3 (A)).

A number of studies have demonstrated that the ribonuclease inhibitor activity in various tissues changes in response to certain physiological and pharmacological stimuli (Section 1.4.4). Although these studies have often demonstrated that such changes are accompanied by increased or decreased total cytoplasmic ribonuclease activity, many workers seem to have assumed that inhibitor activity is regulated by changes in the level of the inhibitor protein. Thus, Shortman (1961) proposed that the increase in inhibitor activity seen in regenerating rat liver results from increased concentration of the inhibitor protein. Liu et al. (1975) proposed that the increased inhibitor activity of lactating mammary glands was also due to increased levels of the inhibitor protein. However, in both of these cases a decrease in total cytoplasmic ribonuclease activity was also seen. It was therefore possible that the observed changes were in the enzyme rather than the inhibitor.

Careful analysis of the literature reveals that increased inhibitor activity is often accompanied by decreased total cytoplasmic ribonuclease activity, whilst decreased inhibitor activity is often accompanied by increased total cytoplasmic ribonuclease activity (von Tigerstrom, 1972; Chesters and Will, 1978; Poels, 1976; Quirin-Stricker et al. 1968 and others).

This observation raises the possibility that regulation of the inhibitor:ribonuclease ratio may be attributable to changes in the level of the enzyme moiety rather than the inhibitor. Confirmation of this hypothesis will require a detailed quantitative analysis of the systems concerned, using methods similar to those applied to the oestrogen-treated uterus in this study.

In the previous section it was stated that the data presented in Table 3(A) indicated that the ribonuclease activity bound to a given quantity of inhibitor increased in the oestrogen-treated or mature uterus relative to untreated immature rat uteri. Whilst some of this increase may be attributable to variability in the quantitative analysis, the overall implication was that there are differences in the properties of the ribonuclease present in control and oestrogen-stimulated uteri. This hypothesis was supported indirectly by the observation that there is heterogeneity amongst the ribonucleases present in uterine cytoplasm, and that the level of the different species is differentially affected by oestrogen-treatment.

Activity stain analysis of uterine cytoplasm (Figure 11) revealed the presence of at least two ribonuclease species differing on the basis of molecular weight. This method had previously been used to analyze the secretory type I ribonucleases, (Blank et al., 1982). The method was particularly suited to the detection of these enzymes due to their ability to regain activity after SDS-denaturation. The activity of

most enzymes is lost after SDS-denaturation, and activity stain methods using SDS-polyacrylamide gels have been developed for relatively few enzymes, e.g. proteases, amylases and dehydrogenases (Lacks and Springhorn, 1980) and DNA polymerases (Spanos et al., 1981). The method of Blank et al. (1982) was very sensitive, detecting as little as 10 pg of bovine RNase A. Ribonucleases from human serum were also readily detected. The result presented in Figure 11 however represents the first demonstration that the non-secretory type I ribonucleases can also be detected by this method.

Some caution should however be exercised in the interpretation of the results. The reasons for this are as follows:-

- (i) Because the samples were boiled in the presence of SDS prior to electrophoresis, enzymes existing as dimers or higher oligomers in vivo would become dissociated. Thus multiple subunit ribonucleases, if they exist, would be missed.
- (ii) Because β -mercaptoethanol was omitted from the sample buffer, it is possible that some of the disulphide bonds of the enzymes remained intact. This would affect their mobility in the gel and lead to anomalous molecular weights. Furthermore, it is not known what effect the RNA incorporated into the gel may have on the migration of the enzymes and molecular weight markers.
- (iii) The slow migration of RNA during the period of electrophoresis meant that the top part of the gel was weakly stained. As a consequence it would have been difficult to detect species

with high molecular weights. This problem was less apparent when a stacking gel containing RNA was utilized. This however led to leakage of samples at the stacking gel/resolving gel junction, resulting in cross contamination of the tracks.

(iv) Some enzyme species detected may not have renatured as efficiently as others, whilst some species may not have renatured at all. Therefore the apparent relative intensity of the bands may not have reflected the actual enzyme concentration in the original sample.

(v) The zymogram method would not resolve enzymes with the same molecular weight but different charges.

The ribonuclease species detected by activity staining were not detectable by immunoblot analysis using antiserum raised to bovine RNase A, (Figure 12). In retrospect this finding was not altogether unexpected: Firstly, the pancreatic enzymes exhibit a relatively rapid rate of evolutionary change (Blackburn and Moore, 1982). It would perhaps have been wiser to raise antisera to rat pancreatic RNase A, although this would have involved purifying the enzyme. Secondly, immunological studies on human ribonucleases (Weickmann and Glitz, 1982) demonstrated that antiserum raised to human RNase A cross-reacted with the enzymes of human serum and urine, but not with the intracellular enzymes of spleen and liver. Similar findings were reported for the ribonucleases of rat (Gordon, 1965).

Immunoblot analysis of uterine cytoplasm using anti-bovine RNase A did however reveal two bands (molecular weight 25,000 and 100,000), although as was previously stated the identity of these proteins was unknown. A preliminary activity stain experiment revealed a faint band with a molecular weight of approximately 100,000, that was present in immature uterine cytoplasm, but disappeared in response to oestrogen, (data not shown). This result was not however repeatable, possibly because the omission of stacking gels made it difficult to detect high molecular weight bands. It is therefore possible that the high molecular weight protein seen by immunoblot analysis represents a ribonuclease that is either repressed or relocalized in response to oestrogen. This result probably warrants further investigation. The 25,000 molecular weight band detected by immunoblotting may represent a rat serum ribonuclease, as contamination from the serum fraction is likely to occur in the cytoplasmic preparations. There is however no direct evidence to support this contention.

The experiments presented in Sections 3.2.3 - 3.2.5 represented an attempt to determine whether the induction of uterine cytoplasmic ribonucleases was due to increased transcription from the gene(s) coding for these enzymes. The observation that the induced ribonucleases first appear in uterine cytoplasm 12-18 h after hormone treatment supported this hypothesis, as a marked stimulation of uterine RNA synthesis occurs 8-24 h after administration of oestrogen implants, (Waters and Knowler, 1981). Unfortunately, this

approach failed to detect a clear example of a RNase A like mRNA that was induced in response to oestrogen. This was most likely due to insufficient homology between the probe and the induced mRNA, although the possibility that the cytoplasmic ribonucleases were induced by a mechanism other than transcriptional activation cannot be ruled out. Further studies are clearly required in order to clarify this point.

As was described in Section 3.2.4, the plasmid pcXP6-105 was not as originally described by MacDonald et al. (1982). A Pst I site flanking the insert appeared to have been replaced by an EcoRI site. One possible explanation for this observation was that a small deletion occurred in the region containing the Pst I site, probably as a result of nicking of the homopolymeric dC/dG tails used in cloning the insert, thus bringing together sequences that formed an EcoRI site. Because the plasmid was supplied in the form of naked DNA it was necessary to reclone it in E.coli HB101 cells. Thus, the events leading to the mutation of the plasmid may well have occurred during the transformation process. The plasmid utilized in subsequent analyses was derived from a single colony after transformation. In retrospect it would have been better to select a number of colonies, prepare plasmid DNA by a mini-prep method, and confirm that the insert could be removed by Pst I digestion.

The method of immunoblotting from non-denaturing gels was developed in order to confirm that the loss of inhibitor activity from immature rat uteri was due to saturation of the inhibitor by the induced ribonucleases, (Section 3.3.1).

These experiments also provided further evidence of the heterogeneity of uterine cytoplasmic ribonucleases, and demonstrated that the enzymes differ on the basis of charge as well as molecular weight (Sections 3.3.2 and 3.3.3).

Previously, van der Broeck et al. (1974) demonstrated that ribonuclease inhibitor activity could be recovered from polyacrylamide gel slices after electrophoresis of crude cytoplasm on alkaline pH polyacrylamide tube gels, under non-denaturing conditions. Furthermore, it was found that free ribonuclease activity was present near the origin of the gel, whilst latent ribonuclease was present between the free ribonuclease and free inhibitor. Thus, the acidic inhibitor migrated most rapidly, the slightly acidic inhibitor/ribonuclease complexes were slightly retarded and the basic free ribonucleases migrated least rapidly. In this study the method of van der Broeck et al. (1974) was extensively modified:-

- (i) A discontinuous high pH slab gel system was utilized in order to improve the resolution of the method.
- (ii) The inhibitor and inhibitor/ribonuclease complexes were detected by immunoblotting. The identity of the bands was however confirmed by assaying gel slices for free and latent ribonuclease activity (Figure 17). The failure to detect free ribonuclease activity in the gel slices was probably due to the inability of the enzymes to migrate beyond the stacking gel because of their low mobility at alkaline pH.

(iii) The precautions described in Section 3.3.1 were taken in order to ensure the maintenance of inhibitor activity prior to or during electrophoresis.

Analysis of uterine cytoplasmic protein resulted in the detection of 5-6 inhibitor/ribonuclease complexes. These were designated B, B', C, C', D and E (Fig. 18). Ferguson plot analysis of these bands (Section 3.3.2) indicated that the major difference in the complexes resided in charge heterogeneity of the enzyme moiety, although small differences in molecular weight were also observed.

Chromatography on DEAE cellulose of inhibitor/ribonuclease complexes from rat reticulocytes (Aoki et al., 1981), and human placenta (Blackburn et al., personal communication, 1985), revealed the presence of 2-3 overlapping peaks of latent ribonuclease activity. These findings also implied that the inhibitor/ribonuclease complexes differ on the basis of charge, although it is unlikely that this technique could resolve some of the more closely related species seen by immunoblotting from non-denaturing gels.

It is difficult to determine the molecular weight of proteins with any degree of accuracy using the method of non-denaturing polyacrylamide gel electrophoresis. Hedrick and Smith (1968) demonstrated that the slope of the Ferguson plot for a given protein, (K_R), is inversely proportional to the molecular weight of the protein. By determining the K_R for a large number of proteins of known molecular weight, they succeeded in constructing a standard plot from which the molecular weight of unknown proteins could be estimated.

However, the large number of proteins required to construct a significant plot meant that this method was impractical for routine analyses. Whilst the derivation of K_R values negates the effect of charge differences, the effect of the shape of individual proteins on their electrophoretic mobilities is not accounted for. For these reasons it was not possible to determine the molecular weight of the inhibitor/ribonuclease complexes detected.

The molecular weight of the individual complexes relative to one another and to free inhibitor was however estimated, (Table 5). This data indicated that the highest molecular weight complexes were C, C' and B, B'. The fact that C and C' intensify after treatment with oestrogen suggested that the enzymes giving rise to these complexes may correspond to the oestrogen-induced high molecular weight ribonuclease detected by activity staining (Figure 11). The low molecular weight band detected by activity staining also intensified after oestrogen-treatment, and it is possible that this species, when complexed to inhibitor gives rise to the complexes D and E detected by immunoblotting. These complexes had the lowest relative molecular weight and were induced by oestrogen-treatment. These interpretations are however speculative and could only be tested if the complexes were reconstituted using purified inhibitor and enzyme.

4.5 Studies on the purified ribonucleases of rat liver and uterine cytoplasm

The purification and characterization of cytoplasmic ribonucleases was described in Sections 3.4.1 - 3.4.9. These studies were performed primarily to compare the properties of the different species present. In addition it was hoped that sufficient quantities could be obtained to use in the raising of antisera, that could in turn be used to quantitate the enzymes of uterine cytoplasm. Unfortunately the time available was not sufficient to carry out these studies.

The cytoplasmic ribonucleases of mammalian tissues are present in very small quantities. As an approximate guide, in rat liver they represent 1/150,000 part of the total cytoplasmic protein (Table 6).

Until recently, attempts to purify these enzymes from various sources have resulted in only partial purifications (Gordon, 1965; Okazaki et al., 1975; Bartholeyns and Baudhin, 1977; Frank and Levy, 1976; Davies et al., 1980, and Button et al. 1982). Some of these studies were performed on crude tissue extracts and it was therefore unknown whether the enzymes purified represented those associated with the inhibitor in vivo. Furthermore, most of these studies utilized an acid extraction step in addition to salt fractionation, ion exchange chromatography and gel filtration. The exception to this was the purification of the cytoplasmic ribonucleases of porcine thyroid, (Button et al., 1982), using salt fractionation and affinity chromatography. In a later study

by the same group (Rutherford et al., 1983), the same enzymes were purified by a procedure involving an acid extraction step. Comparison of this activity with the affinity purified enzymes indicated that acid extraction resulted in changes in the charge, molecular weight and other properties of the enzymes.

Kumagai et al. (1983) described a procedure whereby the cytoplasmic ribonuclease associated with the inhibitor in vivo was purified to homogeneity from rat liver. The purification procedure was however extremely lengthy and resulted in relatively low yields, (approximately 8%). As a consequence, large quantities of tissue had to be processed.

None of the above procedures were considered suitable for the purposes of this study. Fortunately, at this point in these studies P. Blackburn was kind enough to send the unpublished details of a purification procedure utilized to purify the cytoplasmic enzymes of human placenta. This procedure was relatively simple and resulted in high yields of the enzymes. However, extensive characterization of the homogeneity of the purified enzymes was not available.

The purification of rat liver cytoplasmic ribonucleases using the aforementioned procedure was described in Section 3.4.2. It was necessary to include an extra step, namely affinity chromatography on agarose - 2'(3')5' UDP in order to obtain homogeneous enzyme preparations. This affinity resin has been utilized in the purification of various type I ribonucleases, including those of porcine thyroid (Button et al., 1982), and rat liver (Kumagai et al., 1983).

The kinetic parameters, pH optimum and preference for poly (C) of the main peak of liver activity (RLC I), indicated that it was the same enzyme described by Kumagai et al. (1983). The molecular weight of RLC I was slightly higher than bovine RNase A (Figure 23). Whilst this finding was in agreement with that of Kumagai's group, the actual molecular weights derived in this study appeared to be aberrant for RLC I and bovine RNase A, (20,000 and 16,500 respectively). This observation may relate to the abnormal behaviour displayed by some highly basic proteins in SDS-PAGE although it is not clear why Kumagai's group did not encounter a similar problem. The only differences in the procedures was that Kumagai et al. (1983) utilized a 14% acrylamide gel (as opposed to 12.5% in this study), and a different set of molecular weight standards. Purified RLC I had a specific activity of 3×10^5 units/mg protein (Table 6), whilst the enzyme of Kumagai et al. had a specific activity of 1.5×10^5 units/mg protein. This difference was probably due to the different assays utilized: Kumagai assayed ribonuclease using 1 mg/ml RNA, which corresponds to the K_M of the enzyme (i.e. $1/2 V_{max}$). RLC I was assayed in 5 mg/ml RNA, a concentration at which the enzyme should hydrolyze RNA at its maximum velocity.

Activity stain analysis of RLC I (Figure 25) revealed the presence of two bands, one with a molecular weight slightly higher than bovine RNase A, and a weaker band with a similar molecular weight to RNase A. It seemed likely that the minor band corresponded to a minor species detected

at an early stage in the purification procedure of Kumagai et al. (1983). This however was not investigated further. It was assumed that heparin-sepharose chromatography was not sufficient to resolve these species, although on one occasion overlapping peaks were seen using SP-sephadex chromatography (Figure 21b).

The major inhibitor/ribonuclease complexes detected in rat liver by immunoblotting were B and B', (Figure 20). It therefore seemed likely that these complexes arose through binding of the inhibitor to the RLC I species. A third complex, C', was also detected in rat liver cytoplasm. This complex may have arisen through binding of the inhibitor to the minor RLC II peak detected by heparin-sepharose chromatography (Figure 22a). This contention was supported by the observation that RLC II was eluted from heparin-sepharose by high salt concentrations relative to RLC I, indicating that it was a more basic protein, and the complex C' was more basic than B and B', as indicated by its slower migration rate.

Heparin-sepharose chromatography of mature rat uterine cytoplasm revealed the presence of three major peaks of ribonuclease activity, RUC I, RUC II and RUC III (Figure 24). RUC I was eluted by a similar salt concentration to RLC I, and appeared to be similar when analysed by activity staining (Figure 25). It therefore seemed likely that this activity gives rise to the complexes B and B' seen in immature, oestrogen-treated, and mature rat uterine cytoplasm (Figure 20). This contention was supported by the observation that RUC I,

(and RLC I) were eluted from heparin-sepharose by lower salt concentrations than any of the other species observed, indicating that they were the most acidic enzymes present, and that B and B' were the most acidic complexes detected. Using the same argument, it seemed likely that RUC II gave rise to the complexes C and C', and that RUC III gave rise to the complexes D and E. Further support for this contention comes from the observation that the molecular weight, as determined by activity staining was higher for RUC II than for RUC III (Figure 25), and that the apparent molecular weight of the complexes C and C' was higher than that of D and E (Table 5). If the above contentions are correct, then RUC II and RUC III represent the enzymes induced by oestrogen, as the complexes C, C', D and E all intensify after oestrogen-treatment, (Figure 18).

When the cytoplasmic ribonucleases of human placenta were chromatographed on heparin-sepharose, (Blackburn et al., personal communication, 1985), 5-6 overlapping peaks of activity were seen. The amino acid composition of the two major peaks (HP RNase II and HP RNase V, (Blackburn et al., 1985)) was compared, and it was found that HP RNase V resembled human pancreatic RNase A, whilst HP RNase II resembled a ribonuclease purified from human liver (Frank and Levy, 1976). HP RNase II showed a preference for poly (U) compared with tRNA and poly (C), whilst HP RNase V showed a preference for poly (C) compared with tRNA and poly (U). It was suggested that the 3-4 remaining species were related to one or other of the major species on the basis of their relative activities towards

tRNA, poly (C) and poly (U). However, it was not known whether the minor species represented distinct enzymes or whether the different behaviour on heparin-sepharose was due to post-translational modification of one of the major species. Furthermore, Blackburn calculated that up to 2% of the total activity may be contributed by contaminating serum ribonucleases. It was therefore possible that one of the minor species was derived from the serum fraction. Similarly, it is not known whether the different properties of the ribonucleases described in this thesis arise through post-translational modification, or whether some or all of the enzymes are the products of distinct genes. The extent to which serum ribonucleases contributed to the activities purified from rat liver and uterus is likely to be similar to that calculated by Blackburn, although this requires further investigation.

In this study, immunoblot analysis of inhibitor/ribonuclease complexes (Figure 20), indicated that 5-6 ribonucleases were present in the uterine cytoplasm of oestrogen-treated or mature rats. Heparin-sepharose chromatography however revealed only three species. The failure to resolve all of the species present was probably due to the relatively small quantity of material processed, thus making it difficult to distinguish overlapping peaks. The relative activity of the uterine enzymes towards poly (C), poly (U) and yeast RNA revealed that RUC I and RUC II showed a preference for poly (C) over poly (U) whilst RUC III showed a preference for poly (U). The liver enzyme RLC I showed a preference for

poly (C) compared with poly (U) and yeast RNA. In general these findings resemble those of Blackburn, specifically in that enzymes showing a preference for poly (U) or poly (C) are both present. Any differences observed may be attributable to species variations or the fact that Blackburn used tRNA as a substrate as opposed to the yeast RNA used in this study.

The use of relative activities towards homopolymers to compare type I ribonucleases is subject to some criticism: Firstly, the rate of cleavage of homopolymers by bovine RNase A depends on the ionic strength of the medium, and is modified by polyamines (Ball, 1974). Secondly, a preference for poly (C) or poly (U) by a given enzyme does not necessarily reflect a similar preference for these residues in RNA (von Tigerstrom and Manchak, 1976). Finally, the observation that rat RNase A shows a preference for poly (U), (Beintema et al., 1973), whilst bovine RNase A shows a preference for poly (C), (Blackburn and Moore, 1982), indicates that these studies can only be used to compare the enzymes within a given species.

In the introduction to this thesis it was stated that the definition of a type I ribonuclease is "a pyrimidine specific endoribonuclease, optimally active at neutral or alkaline pH, and acid-thermostable". The observation that none of the enzymes purified from liver or uterus showed any activity towards poly (A) or poly (G) provided indirect evidence that they are pyrimidine specific endoribonucleases. Further studies are however required to confirm this. The

thermostability of these enzymes was indicated by the fact that prior to activity staining, samples were boiled for 2-3 min. However, as shown in Figure 27, the pH optimum of all of the enzymes except RLC I was not restricted to neutral or alkaline pH. This finding was somewhat unexpected and it will be interesting to see whether a similar pattern is seen with cytoplasmic ribonucleases derived from other sources. Bartholeyns et al. (1974) demonstrated that the physiological form of bovine RNase A exhibits a dual pH optimum at pH 4.5 and 7.5, but that the purified enzyme is only active at pH 7.5. It was suggested that the use of acid extraction in such purifications may give rise to this phenomenon. It is therefore possible that the dual pH optimum seen with the rat cytoplasmic ribonucleases may be a general characteristic of type I ribonucleases, and that the acid extraction utilized in the purification of most of these enzymes has led to the idea that these enzymes are only active at neutral or alkaline pH.

It was difficult to draw any concrete conclusions from the kinetic data derived for the purified enzymes. The data presented in Table 3(A) indicated that the specific activity of the oestrogen-induced ribonucleases was higher than that of the enzymes present in unstimulated uteri. The similar K_M values obtained for RUC I, II and III does not support this idea. It is however possible that the assay conditions used for the kinetic analysis were not optimal for one or more of the enzymes. Thus, variations in the pH

or ionic strength of the medium may reveal more notable differences.

Finally, it should be stated that the heterogeneity of the purified activities when they were analysed by activity staining (Figure 25), means that the interpretation of the data concerning the characterization of the enzymes is subject to some criticism.

4.6. Conclusions concerning the function of the inhibitor/ ribonuclease system

The precise function of the inhibitor/ribonuclease system is unknown at present. It was hoped that these studies would help to answer this question. In general, this aim has not been achieved, although certain observations have provided an indication of areas for future research.

The presence of excess ribonuclease inhibitor in the immature rat uterus, a tissue with low biosynthetic activity, and the appearance of free ribonuclease in oestrogen-treated uteri, a tissue with elevated levels of RNA and protein synthesis, appeared to contradict the hypothesis that elevated levels of inhibitor are present in tissues with high biosynthetic activity. It was stated in the introduction to this thesis that this observation may relate to the increased cell growth and differentiation of the oestrogen-treated uterus. It is however difficult to explain why a single injection of oestradiol-17 β , which induces the growth response, has no effect on the inhibitor/ribonuclease system. It is possible that these results do not reflect the situation

in vivo:-

(i) The heterogeneity of cell types in the uterus make it difficult to attach great significance to findings with whole tissue homogenates.

(ii) It is conceivable that homogenization disrupts some form of intracellular structure that would normally separate the components of the system, (RNA, inhibitor and ribonuclease).

In contrast to the findings in the rat uterus, the effect of oestrogen in rooster liver was to increase the activity of ribonuclease inhibitor (Dijkstra et al., 1978). However, unlike the uterus, oestrogen effects in rooster liver include the induction of the major yolk protein vitellogenin. As was discussed in Section 1.4.4, high inhibitor activity appears to correlate with the production of major abundant proteins in various tissues. Ambellan and Roth (1968) reported that corticoid treatment resulted in a large increase in the cytosolic ribonuclease activity in lymphoid tissues. In a later study (Ambellan, 1978) it was demonstrated that glucocorticoid treatment of liver cytoplasm in vitro reduced the activity of the ribonuclease inhibitor by 50%. Taken together, these results provided a further example of steroid hormones decreasing cytoplasmic inhibitor levels and an indication that such events can occur independently of nuclear binding of steroid/receptor complexes. However, the fact that the ribonuclease induced in lymphoid tissue was purportedly an acid ribonuclease, and the fact that glucocorticoid effects in vivo were not examined in the latter study, indicate that further studies are required to determine the significance of these results.

There has been a recent interest in the effect of

ribonuclease on the physico-chemical properties of untransformed steroid hormone receptors. Tymoczko and Phillips (1983) reported that the 8S glucocorticoid receptor is converted to a 4S form by RNase A treatment. The 4S form showed increased affinity for DNA-cellulose. Essentially similar findings were reported for the oestrogen receptor of rat and rabbit uterine cytosol (Thomas and Kiang, 1985). RNA is known to compete for DNA binding sites of androgen, oestrogen and glucocorticoid receptors (Liao et al., 1980; Feldman et al., 1981). It is therefore possible that steroid receptors bind to RNA in the target cell cytoplasm. Whether this binding is specific, and plays a role in the function of the receptors remains to be determined. Furthermore, whether or not this phenomenon reflects a function for the endogenous cytoplasmic ribonucleases is conjectured.

The work presented in this thesis and by other workers indicates that the type I ribonucleases bound to the inhibitor in vivo are distinct from their secretory counterparts. However, the precise function of these enzymes remains unclear. Some of the main points that require clarifying are the following:-

- (i) If these enzymes are involved in eukaryotic RNA metabolism, under what circumstances are they liberated from the endogenous inhibitor?
- (ii) Does the heterogeneity of these enzymes reflect different functions for the various species?

(iii) To what extent do serum ribonucleases or enzymes from sub-cellular fractions other than the cytoplasm contribute to the activity recovered from tissue homogenates?

4.7 Some considerations for future studies

One criticism of the aforementioned studies is that the attempts to relate the purified enzymes with the activity stain and non-denaturing immunoblot data is not supported by any direct evidence. A priority for future studies would therefore be to obtain sufficient quantities of the purified enzymes to carry out reconstitution studies with purified inhibitor, and subsequently analyse the reconstituted complexes by non-denaturing immunoblots.

4.7.1 Studies on the localization of the inhibitor protein

Immunohistochemical studies on the rat uterus may help to achieve a better understanding of the changes in the inhibitor/ribonuclease system after oestrogen-treatment. Such studies could be extended to a cell culture system in order to determine the localization of the inhibitor in intact cells. In addition the effect of varying the growth state of the cells could be investigated. Preliminary studies in our laboratory have shown that both free inhibitor and inhibitor/ribonuclease complexes can be detected in a number of rodent cell lines using the non-denaturing gel immunoblot method.

The observation that inhibitor/ribonuclease complexes are bound to free mRNP particles isolated from human placenta

(Gileadi et al., 1984) warrants further investigation. Such studies should be extended to investigate whether the inhibitor associates with polyribosomal mRNP's. It will also be interesting to determine whether it is the enzyme or inhibitor that binds to the RNA or protein of mRNP's. The answer to this question may have some bearing on the question concerning the mode of inhibition of the enzymes, i.e. do enzyme:inhibitor:substrate complexes exist?

4.7.2 Further studies on the cytoplasmic ribonucleases

A number of properties of the purified enzymes described in this thesis were not investigated. These include the effect of monovalent and divalent ions and of polyamines on the activity of the enzymes, identification of the products of RNA hydrolysis, and studies on the stoichiometry of enzyme/inhibitor interaction. Determination of the sequences cleaved in an RNA molecule of known sequence may provide some information on the function of the different enzymes. Such studies would be facilitated if larger quantities of the enzyme were available. In this respect, rat kidney appears to contain all of the enzymes detected in other tissues (Figure 20), and may provide a good source for the purification. It may also be possible to resolve the individual species seen in each of the purified activities (Figure 25), using a technique such as HPLC.

The availability of larger quantities of the enzymes would also facilitate immunological studies. Thus, a mono-specific antiserum could be prepared and used to quantitate and compare the various enzymes. Antiserum could also be used to isolate cDNA clones encoding these enzymes. Similar

studies are already in progress in our laboratory, using the antiserum raised against rat inhibitor to screen a cDNA expression library. The availability of primary sequence data for the inhibitor and enzymes would provide an interesting system in which to study protein-protein interactions.

REFERENCES

Babich, A. and Nevins, J.R. (1981), Cell 26, 371-379.

- Ambellan, E. (1978) *J. Steroid Biochem.* 13, 177-183.
- Ambellan, E. and Roth, J.S. (1968) *Biochem. Biophys. Res. Commun.* 68, 244-248.
- Aoki, Y., Mizuno, D., and Goto, S. (1981) *J. Biochem. (Tokyo)* 90, 737-748.
- Aoki, Y. and Natori, S. (1981) *Biochem. J.* 196, 699-703.
- Aronson, N.N. Jr. and Yannarell, A. (1975) *Biochim. Biophys. Acta* 413, 135-142.
- Ashburner, M. (1974) *Dev. Biol.* 39, 141-157.
- Aziz, S. and Knowler, J.T. (1978) *Biochem. J.* 172, 587-593.
- Aziz, S. and Knowler, J.T. (1980) *Biochem. J.* 187, 265-267.
- Aziz, S. Balmain, A. and Knowler, J.T. (1979a) *Eur. J. Biochem.* 100, 85-94.
- Aziz, S., Balmain, A. and Knowler, J.T. (1979b) *Eur. J. Biochem.* 100, 95-100.
- ← * Babich, A., Feldman, L.T., Nevins, J.R., Darnell, J.E. Jr. and Weinberger, C. (1983) *Mol. Cell Biol.* 3, 1212-1221.
- Bag, J. (1983) *Eur. J. Biochem.* 135, 187-196.
- Ball, W.D. (1974) *Biochim. Biophys. Acta*, 341, 305-309.
- Bardon, A., Sierakowska, H. and Shugar, D. (1976) *Biochim. Biophys. Acta* 438, 461-473.
- Barker, K.L. (1971) *Biochemistry* 10, 284-291.
- Bartholeyns, J. and Baudhin, P. (1977) *Biochem. J.* 163, 675-683.
- Bartholeyns, J., Moore, S. and Stein, W.H. (1974) *Int. J. Peptide and Protein Res.* 6, 407-417.
- Bartholeyns, J., Peeters-Joris, C., and Baudhin, P. (1975) *Eur. J. Biochem.* 60, 385-393.
- Baulieu, E. (1975) *Mol. Cell. Biochem.* 7, 157-174.
- Baulieu, E.M., Alberga, A., Raynaud-Jammet, C., and Wira, C.R. (1972), *Nature New Biol.* 236, 236-239.
- Beard, J.R. and Razell, W.E. (1964) *J. Biol. Chem.* 239, 4186-4193.

Billing, R.J., Barbiroli, B. and Smellie, R.M.S. (1969), *Biochim. Biophys. Acta* 190, 60-65.

Beintema, J.J., Campagne, R.N., and Bruber, M. (1973)
Biochim. Biophys. Acta, 310, 145-160.

Bergmann, I.E., Cereghini, S., Geoghegan, T. and Brawerman, G.
(1982) J. Mol. Biol. 156, 567-582.

←*

Birkeland, A.J. and Christensen, T.G. (1975) J. Carbohydr. 2,
83-89.

Birnboim, H.C. and Doly, J. (1979) Nucleic Acids Res. 7,
1513-1523.

Bishop, J.M. (1983) Ann. Rev. Biochem. 52, 301-354.

Blackburn, P. (1979) J. Biol. Chem. 254, 12484-12488.

Blackburn, P. and Gavilanes, J.G. (1980) J. Biol. Chem. 255,
10959-10965.

Blackburn, P. and Gavilanes, J.G. (1982) J. Biol. Chem. 257,
316-321.

Blackburn, P. and Jailkhani, B.L. (1979) J. Biol. Chem. 254,
12488-12493.

Blackburn, P. and Moore, S. (1982) in "The Enzymes, Vol. XV"
(ed. P.D. Boyer) Academic Press. pp.317-433.

Blackburn, P., Wilson, G. and Moore, S. (1977) J. Biol. Chem.
252, 5904-5909.

Blank, A., Sugiyama, R.H. and Dekker, C.A. (1982) Anal.
Biochem. 120, 267-275.

Blobel, G. and Potter, V.R. (1966) Proc. Natl. Acad. Sci. USA
55, 1283-1288.

Bonner, J.J. (1982) Cell 30, 7-9.

Borthwick, N.M. and Smellie, R.M.S. (1975) Biochem. J. 147,
91-101.

Bradford, M. (1976) Anal. Biochem. 72, 248-254.

Brock, M.L. and Shapiro, D.J. (1983) Cell 34, 207-214.

Brockdorff, N.A. and Knowler, J.T. (1984) Abstr. of the 23rd
Harden Conference on Molecular and Cellular Aspects
of Reproduction, Abstract No.18.

- Brockdorff, N.A. and Knowler, J.T. (1985) *Biochem. Soc. Trans.*
Abstracts of the 614th meeting, Oxford. (in the press).
- Burch, J.B.E. (1984) *Nucleic Acid Res.* 12, 1117-1135.
- Burghouts, J.T.M., Stols, A.L.H. and Bloemendal, H. (1970)
Biochem. J. 119, 749-756.
- Burton, L.E., Blackburn, P. and Moore, S. (1980) *Int. J.*
Peptide and Protein Res. 16, 359-366.
- Burton, L.E. and Fucci, N.P. (1982) *Int. J. Peptide and Protein*
Res. 19, 372-379.
- Busby, D.W.G., House, W. and McDonald, J.R. (1964) in
Virological techniques. pp.218. Churchill, London.
- Button, E.E., Guggenheimer, R. and Kull, F.J. (1982) *Arch.*
Biochem. Biophys. 219, 249-260.
- Carty, R.P. and Hirs, C.H.W. (1968) *J. Biol. Chem.* 243, 5244-
5253.
- Cato, A.C.B., Geisse, S., Wenz, M., Westphal, H.M. and Beato, M.
(1985) *Eur. Mol. Biol. Org. J.* 3, 2771-2778.
- Chandler, V.L., Maler, B.A. and Yamamoto, K.R. (1983) *Cell* 33,
489-499.
- Chesters, J.K. and Will, M. (1978) *Br. J. Nutr.* 39, 375-381.
- Chirgwin, J.M., Przybyla, A.E., MacDonald, R.J. and Rutter, W.J.
(1979) *Biochemistry* 18, 5294-5299.
- Civelli, O., Vincent, A., Maundrell, K., Buri, J.F. and
Scherrer, K. (1980) *Eur. J. Biochem.* 107, 577-585.
- Clark, J.H., Hardin, J.W., Padykula, H.A. and Cardasis, C.A.
(1978) *Proc. Natl. Acad. Sci. USA* 75, 2781-2784.
- Clemens, M.J. and Williams, B.R.G. (1977) *Cell* 13, 565-572.
- Compton, J.G., Schrader, W.T. and O'Malley, B.W. (1983)
Proc. Natl. Acad. Sci. USA 80, 16-20.
- Cox, R.F. (1977) *Biochemistry* 16, 3433-3443.
- Crestfield, A.M., Stein, W.H. and Moore, S. (1962) *Arch.*
Biochem. Biophys. suppl. 1, 217-220.
- D'Alessio, G., Malorni, M.C. and Parente, A. (1975) *Biochemistry*
14, 1116-1122.
- Davies, G.E., Karpetsky, P., and Levy, C.C. (1980) *Biochem. J.*
189, 263-275.

Gavard, D., Gagnon, C. and deLamarinde, G. (1974), *Biochim. Biophys. Acta* 374, 207-219.

- Davis, B.J. (1964) Ann. N.Y. Acad. Sci. 121, 404-427.
- Datta, A.K. and Niyogi, S.K. (1976) Prog. Nuc. Acid Res. Mol. Biol. 17, 271-308.
- de Martynoff, G., Pays, E. and Vassart, G. (1980) Biochem. Biophys. Res. Comm. 93, 645-653.
- Dijkstra, J., Touw, J., Halsema, I., Gruber, M. and Ab, G. (1978) Biochim. Biophys. Acta 521, 363-373.
- Eichler, D.C., Tatar, T.E. and Lasater, S. (1981) Biochem. Biophys. Res. Comm. 101, 396-403.
- Eriksson, H.C., Upchurch, S., Hardin, J.W., Peck, E.J. and Clark, J.H. (1978) Biochem. Biophys. Res. Commun. 81, 1-7.
- Feldman, M., Kallos, J. and Hollander, V.P. (1981) J. Biol. Chem. 256, 1145-1148.
- Ferguson, K.A. (1964) Metabolism 13, 985-1002.
- Frank, J.J. and Levy, C.C. (1976) J. Biol. Chem. 251 5744-5751.
- Furuichi, Y., La Fiandra, A., and Shatkin, A.J. (1977) Nature, 266, 235-239.
- Gagnon, C. and de Lamarinde, G. (1973) Biochem. Biophys. Res. Comm. 51, 580-586.
- Gagnon, C., Lalonde, G. and de Lamarinde, G. (1974) Biochim. Biophys. Acta 353, 323-331.
- Gauvreau, D., Gagnon, C. and de Lamarinde, G. (1974) Cancer Res. 34, 2500-2503.
- ← * Gerber-Huber, S., Felber, B.K., Weber, R. and Ryffel, G.U. (1981) Nuc. Acids Res. 9, 2475-2494.
- Gileadi, O., Lorberboum, H., de Groot, N. and Hochberg, A.A. (1984) Molec. Biol. Rep. 9, 241-244.
- Girija, N.S. and Sreenivason, A. (1966) Biochem. J. 98, 562-566.
- Glasser, S.R., Chytil, F., and Spelsberg, T.C. (1972) Biochem. J. 130, 947-957.
- Gordon, J. (1965) Arch. Biochem. Biophys. 112, 429-435.

- Greenberg, J.R. (1972) Nature 240, 102-104.
- Greenberg, J.R. (1975) J. Cell Biol. 64, 269-288.
- Gribnow, A.A.M., Schoenmakers, J.G.G. and Bloemendal, H.
(1969) Arch. Biochem. Biophys. 130, 48-52.
- Gribnow, A.A.M., Schoenmakers, J.G.G., Van Kraaikamp, M.
and Bloemendal, H. (1970) Biochem. Biophys. Res.
Comm. 38, 1064-1068.
- Grief, R.L. and Eich, E.F. (1977) Metabolism 26, 851-856.
- Grief, R.L. and Eich, E.F. (1972) Biochim. Biophys. Acta 286,
350-359. ↗
- Grody, W.W., Schrader, W.T. and O'Malley, B.W. (1982)
Endocrine reviews 3 (No.2), 141-163.
- Gronemeyer, H. and Pongs, O. (1982) Proc. Natl. Acad. Sci.
USA 77, 2108-2112.
- Gronemeyer, H., Govindan, M.V. and Chambon, P. (1985) J.
Biol. Chem. 260, 6916-6925.
- Guyette, W.A., Matuski, R.J. and Rosen, J.M. (1979) Cell 17,
1013-1023.
- Hames, B.D. (1981) in "Gel Electrophoresis of Proteins: a
practical approach" pp. 1-86. (Eds. B.D. Hames and
D. Rickwood). IRL Press Limited, London and
Washington D.C.
- Harris, J.N. and Gorski, J. (1978) Mol. Cell Endocrinol. 10,
293-305.
- Haugen, T.H. and Heath, T.C. (1979) Proc. Natl. Acad. Sci.
USA 76, 2689-2693.
- Hedrick, J.L. and Smith, A.J. (1968) Arch. Biochem. Biophys.
126, 155-164.
- Heldin, C. and Westermark, B. (1984) Cell 37, 9-20.
- Higgins, S.J., Parker, M.G., Fuller, F.M. and Jackson, P.J.
(1979) Eur. J. Biochem. 102, 431-440.
- Hiranyavasit, W. and Kusamran, T. (1983) FEBS LETT. 152,
35-38.
- Hynes, N.E., Kennedy, N., Rahmsdorf, U. and Groner, B. (1981)
Proc. Natl. Acad. Sci. USA 78, 2038-2042.
- Hynes, N., Ooyen, A., Kennedy, N., Herrlich, P., Ponta, H.
and Groner, B. (1983) Proc. Natl. Acad. Sci. USA 80,
3637-3641.

- Huez, G., Marbaix, G., Hubert, E., Leclercq, M., Nudel, U., Soreq, H., Salomon, R., Lebleu, B., Revel, M. and Littauer, U.Z. (1974) Proc. Natl. Acad. Sci. USA 71, 3143-3146.
- Huez, G., Marbaix, G., Hubert, E., Cleuter, Y., Leclercq, M., Chantrenne, H., Devos, R., Sereq, H., Nudel, U. and Littauer, U.Z. (1975) Eur. J. Biochem. 59, 589-592.
- Huez, G., Marbaix, G., Gallwitz, D., Weinberg, E., Devos, R., Hubert, E. and Cleuter, Y. (1978) Nature 271, 572-573.
- ~~Jacob, S.T. and Schindler, D.G. (1972) Biochem. Biophys. Res. Comm. 48, 126-142.~~
- Jensen, E.V. and de Sombre, E.R. (1972) Ann. Rev. Biochem. 41, 203-230.
- Jensen, E.V. and de Sombre, E.R. (1973) Science 182, 126-133.
- Joab, I., Radanyi, C., Renoir, M., Buchou, T., Catelli, M., Binart, N., Mester, J. and Baulieu, E. (1984). Nature 308, 850-853.
- Johnstone, A. and Thorpe, R. (1982) in "Immunochemistry in Practice" (Eds. A. Johnstone and R. Thorpe). Blackwell Scientific Publications.
- Jost, J.P., Geiser, M. and Seldran, M. (1985) Proc. Natl. Acad. Sci. USA 82, 988-991.
- Kalimi, M., Tsai, S.Y., Tsai, M., Clark, J.H. and O'Malley, B. (1976) J. Biol. Chem. 251, 516-523.
- Karin, M., Haslinger, A., Holtgreve, H., Richards, R.I., Krauter, P., Westphal, H.M. and Beato, M. (1984) Nature 308, 513-519.
- Kaye, A.M. (1983) in "Regulation of Gene Expression by Steroid Hormones" (K.W. McKerns, ed.) Plenum Press/New York and London. pp103-128.
- Kelner, K.L. and Peck, E.J. Jr. (1981) J. Receptor Res. 2, 47-62.
- King, W.J. and Greene, G.L. (1984) Nature 307, 745-747.
- Knowler, J.T. (1983^a) in "Regulation of Gene Expression by Steroid Hormones" (K.W. McKerns, ed.) Plenum Press/New York and London. pp.129-150.
- Knowler, J.T. (1983^b) Int. Rev. of Cytology 84, 103-153.
- Knowler, J.T. and Beaumont, J.M. (1985) Essays in Biochem. 20, 1-39.

- ~~Knowler, J.T., Borthwick, N.M. and Smellie, R.M.S. (1975)
Biochem. Soc. Trans. 3, 1177-1180.~~
- Korach, K.S. and Ford, E.B. (1978) Biochem. Biophys. Res. Commun. 83, 327-333.
- Kozak, M. and Shatkin, A.J. (1976) J. Biol. Chem. 251, 4259-4266.
- Kraft, N. and Shortman, K. (1970a) Austr. J. Biol. Sci. 23, 175-182.
- Kraft, N. and Shortman, K. (1970b) Biochim. Biophys. Acta 217, 164-175.
- Kraus, A.A. and Scholtissek, C. (1974) Eur. J. Biochem. 48, 345-350.
- Kumagai, H., Kato, H., Igarashi, K. and Hirose, S. (1983) J. Biochem. (Tokyo) 94, 71-77.
- Kumagai, H., Abiko, T., Ono, C., Marumo, Y., Enomoto, S., Igarashi, K. and Hirose, S. (1985a) Biochim. Biophys. Acta 827, 424-430.
- Kumagai, H., Nakamura, M., Ozaki, N., Igarashi, K. and Hirose, S. (1985b) Biochim. Biophys. Acta 827, 431-438.
- Lacks, S.A. and Springhorn, S.S. (1980) J. Biol. Chem. 255, 7467-7473.
- Laemmli, U.K. (1970) Nature 227, 680-685.
- Lawson, G.M., Tsai, M., and O'Malley, B.W. (1980) Biochemistry 19, 4403-4411.
- Le Stourgeon, W.M. and Beyer, A.L. (1977) Methods in Cell Biol. 16, 387-406.
- Liao, S., Smythe, S., Tymoczko, J.L., Rossini, G.P., Chen, C., and Hiipakka, R.A. (1980) J. Biol. Chem. 255, 5545-5551.
- Littauer, U.Z. and Soreq, H. (1982) Prog. Nucleic Acid Res. Mol. Biol. 27, 53-83.
- Little, B.W. and Meyer, W.L. (1970) Science 170, 747-749.
- Little, B.W. and Whittingham, L.S. (1981) Biochim. Biophys. Acta 655, 251-255.

- Liu, D.K. and Matrison, P.E. (1976) Biochem. J. 164, 371-377.
- Liu, D.K., Williams, G.H. and Fritz, P.J. (1975) Biochem. J. 148, 67-76.
- Loosfelt, H., Logeat, F., Hai, M.T.V. and Milgrom, E. (1984) J. Biol. Chem. 259, 14196-14202.
- Lowry, O.H., Rosebrough, N.J., Farr, A.L. and Rondall, R.J. (1951) J. Biol. Chem. 193, 265-275.
- MacDonald, R.J., Story, S.J. and Swift, G.H. (1982) J. Biol. Chem. 257, 14582-14585.
- Maione, M., Moraini, G. and Carta, F. (1968) Exp. Eye Res. 7, 546-550.
- Malicka-Blaskiewicz, C. (1978) Proc. 12th FEBS Meet. Dresden, Abstr. 0122.
- ~~Manniatis, T., Fritsch, E.F. and Sambrook, J. (1982) in "Molecular Cloning, a Laboratory Manual" Cold Spring Harbour Press, New York.~~
- Markaverich, B.M. and Clark, J.H. (1979) Endocrinology 105, 1458-1462.
- Mathis, D., Oudet, P. and Chambon, P. (1980) Prog. Nuc. Acid Res. and Mol. Biol. 24, 2-56.
- Mauron, A. and Spohr, G. (1978) Eur. J. Biochem. 82, 619-625.
- McCormack, S.A. and Glasser, S.R. (1980) Endocrinology 106, 1634-1649.
- McGregor, C.W., Adams, A. and Knowler, J.T. (1981) J. Steroid Biochem. 14, 415-419.
- Means, A.R. and Hamilton, T.H. (1966a) Proc. Natl. Acad. Sci. USA 56, 686-693.
- Means, A.R. and Hamilton, T.H. (1966b) Proc. Natl. Acad. Sci. USA 56, 1594-1598.
- Merryweather, M.J. and Knowler, J.T. (1980) Biochem. J. 196, 405-410.
- Mester, J. and Baulieu, E.E. (1984) Trends Biochem. Sci. 9, 56-59.
- Meyer, D.H. and Meyer, L.M. (1979) Life Sciences 24, 51-58.

Okazaki, H., Ittel, M.E., Niedergang, C. and Mandel, P. (1975)
Biochim. Biophys. Acta 391, 84-95.

Miesfield, R., Okret, S., Wikström, A., Wrangle, O., Gustaffson, J., and Yamamoto, K.R. (1984) *Nature* 312, 779-781.

Milgrom, E., Atger, M. and Baulieu, E. (1973) *Biochim. Biophys. Acta* 320, 267-283.

Moriyama, T., Umeda, T., Nakashima, S., Oura, H. and Tsukada, K. (1969) *J. Biochem. (Tokyo)* 66, 151-157.

Morrison, J.F. (1982) *Trends Biochem. Sci.* 7, 102-105.

~~Moss, B., Rosenblum, E.N. and Paoletti, E. (1973) *Nature New Biol.* 245, 59-63.~~

Muller, R., Bravo, R. and Burckhardt, J. and Curran, T. (1984) *Nature* 312, 716-720.

Muller, R.E. and Knowler, J.T. (1984) *FEBS Letters* 174, 253-257.

Mulvihill, E.P., LePenne, J.P. and Chambon, P. (1982) *Cell* 24, 621-632.

Munro, J. and Knowler, J.T. (1982) *J. Steroid Biochem.* 16, 293-295.

Nevins, J.R. (1983) *Annual Rev. Biochem.* 52, 441-466.

Notides, A.C. and Nielson, S. (1974) *J. Biol. Chem.* 249, 1866-1873.

Notides, A. and Gorski, J. (1966) *Proc. Natl. Acad. Sci. USA* 56, 230-235.

Nudel, U., Soreq, H., Littauer, U.Z., Marbaix, G., Huez, G., Leclercq, E., Hubert, E. and Chantrenne, H. (1976) *Eur. J. Biochem.* 64, 115-121.

← *

Ortworth, B.J. and Byrnes, R.J. (1971) *Exp. Eye Res.* 12, 120-127.

Panke, W.B., Watson, C.S. and Clark, J.H. (1981) *J. Steroid Biochem.* 14, 1311-1316.

Parker, M. (1983) *Nature* 304, 687-688.

Parker, M.G. and Scrace, G.T. (1978) *Eur. J. Biochem.* 85, 399-406.

Payvar, F., Wrangle, O., Carlstedt-Duke, J., Okret, S., Gustaffson, J.A. and Yamamoto, K.R. (1981) *Proc. Natl. Acad. Sci. USA* 78, 6628-6632.

- Pennequin, P., Robins, D.M. and Schimke, R.T. (1978)
Eur. J. Biochem. 90, 51-78.
- Poels, L.G. (1976) Biochim. Biophys. Acta 432, 245-253.
- Pollard, J.W. and Martin, L. (1977) Mol. Cell. Endocrinol.
6, 223-229.
- Quirin-Stricker, C., Gross, M. and Mandel, P. (1968) Biochim.
Biophys. Acta 159, 75-80.
- Razell, W.E. (1963) in "Methods in Enzymology" (ed. S.P.
Colowick and N.O. Kaplan). Vol. VI pp.249, Academic
Press, New York.
- Reboud, A., Buisson, M., Marion, M.J. and Reboud, J.P. (1976)
Biochim. Biophys. Acta 432, 176-184.
- Reddy, V.N., Schwass, D., Chakrapani, B. and Lim, C.P. (1976)
Exp. Eye Res. 23, 483-493.
- Renkawitz, R., Schultz, G., Von der Ahe, D. and Beato, M. (1984)
Cell 37, 503-510.
- Robbi, M. and Lazarow, P.B. (1978) Proc. Natl. Acad. Sci. USA
75, 4344-4348.
- Roberts, S. and Szego, C.M. (1947) Endocrinol. 40, 73-85.
- Robertson, M. (1984) Nature 309, 585-587.
- Robinovitch, M.R., Sreebny, L.M. and Smuckler, E.A. (1968)
J. Biol. Chem. 243, 3441-3446.
- Robins, D.M. and Schimke, R.T. (1978) J. Biol. Chem. 253, 8925-
8934.
- ~~Rose, K.M., Morris, H.P. and Jacob, S.T. (1975) Biochemistry
14, 1025-1032.~~
- Roth, J.S. (1956) Biochim. Biophys. Acta 21, 34-43.
- Roth, J.S. (1958a) J. Biol. Chem. 231, 1085-1096.
- Roth, J.S. (1958b) J. Biol. Chem. 231, 1097-1105.
- Roth, J.S. (1962) Biochim. Biophys. Acta 61, 903-915.
- Roth, J.S. (1967) Methods Cancer Res. 3, 153-242.
- Rousseau, G.G. (1984) Biochem. J. 224, 1-12.

- Rutherford, K.D., Button, E.E. and Kull, F.J. (1983) *Comp. Biochem. Physiol. B*, 75, 545-552.
- Sajdel-Sulkowska, E.M. and Marotta, C.A. (1984) *Science* 225, 947-949.
- Salanzinski, P.R.P., McClean, C., Sykes, J.E.C., Clement-Jones, V.V. and Lowry, P.J. (1981) *Anal. Biochem.* 117, 136-146.
- Scheele, G. and Blackburn, P. (1979) *Proc. Natl. Acad. Sci. USA* 76, 4898-4902.
- Scheidereit, C., Geisse, S., Westphal, H.M. and Beato, M. (1983) *Nature* 304, 749-752.
- Schrader, W.T., Kuhn, R.W. and O'Malley, B.W. (1977) *J. Biol. Chem.* 252, 299-307.
- Seed, B. (1982) *Nuc. Acid Res.* 10, 1799-1810.
- Sehgal, P.B., Soreq, H. and Tamm, I. (1978) *Proc. Natl. Acad. Sci.* 75, 5030-5032.
- Shatkin, A.J. (1976) *Cell* 9, 645-653.
- Sheiness, D. and Darnell, J.E. (1973) *Nature New Biol.* 241, 265-268.
- Shimotohno, K., Kodama, Y., Hashimoto, J. and Miura, K. (1977) *Proc. Natl. Acad. Sci. USA* 74, 2734-2738.
- Shortman, K. (1961) *Biochim. Biophys. Acta* 51, 37-49.
- Shortman, K. (1962) *Biochim. Biophys. Acta* 55, 88-96.
- ~~Shugar, D. (1974) *Biochim. Biophys. Acta* 341, 138-156.~~
- Shugar, D. and Sierakowska, H. (1967) *Prog. Nuc. Acid Res. and Mol. Biol.* 7, 369-427.
- Sierakowska, H. and Shugar, D. (1977) *Prog. Nuc. Acid Res. and Mol. Biol.* 20, 60-120.
- Singer, R.H. and Penman, S. (1973) *Nature* 240, 100-102.
- Smith, R.G., Clarke, S.G., Zalta, E. and Taylor, R.N. (1979) *J. Steroid Biochem.* 10, 31-35.
- Spanos, A., Sedgwick, S.G., Yarranton, G.T., Hübscher, U. and Banks, G.R. (1981) *Nucleic Acids Res.* 9, 1825-1839.

Spohr, G., Granboulan, N., Morel, C. and Scherrer, K. (1970)
Eur. J. Biochem. 17, 296-318.

van der Broeck, W.G.M., Koopmans, M.A.G., and deLamarinde, G.
(1974), Mol. Biol. Rep. 1, 295-298.

Spector, T. (1978) Anal. Biochem. 86, 142-146.

Spirin, A. (1969) Eur. J. Biochem. 10, 20-35.

Spirin, A.S. and Ajtkhozhin, M.A. (1985) Trends Biochem. Sci. 10 (No.4), 162-165.

Spirin, A.S. and Nemer, M. (1965) Science 150, 214-217.

← *

Southern, E. (1975) J. Mol. Biol. 98, 503-517.

Swida, U., Schultz-Harder, B., Kucherer, C., and Käufer, N. (1981) Biochim. Biophys. Acta 652, 129-138.

Takahashi, Y., Mase, K. and Sugano, H. (1966) Biochim. Biophys. Acta 119, 627-629.

Thomas, T. and Kiang, D.T. (1985) J. Steroid Biochem. 23, 19-25.

Towbin, H., Staehelin, T. and Gordon, J. (1979) Proc. Natl. Acad. Sci. USA 76, 4350-4354.

Travers, M.T. and Knowler, J.T. (1985) Biochem. Soc. Trans. Abstracts of the 614th Meeting, Oxford. (in the press).

Turner, P.M., Lerea, K.M. and Kull, F.J. (1983) Biochem. Biophys. Res. Commun. 114, 1154-1169.

Tymoczko, J.L. and Phillips, M.M. (1983) Endocrinology 112, 142-149.

Uriel, J., Bouillon, D., Aussel, C. and Dupiers, M. (1976) Proc. Natl. Acad. Sci. USA 73, 1452-1456.

← *

Vincent, A., Goldenberg, S., Standart, N., Civelli, O., Imaizumi-Scherrer, T., Maundrell, K. and Scherrer, K. (1981) Molec. Biol. Rep. 7, 71-81.

Voller, A., Bidwell, D.E. and Bartlett, A. (1976) Bull. World Health Org. 53, 55-65.

Von Tigerstrom, R.G. (1972) Can. J. Biochem. 50, 244-252.

Von Tigerstrom, R.G. and Manchak, J.M. (1976) Biochim. Biophys. Acta 418, 184-194.

Von Tigerstrom, R.G. and Manchak, J.M. (1977) Can. J. Biochem. 55, 1171-1179.

Walker, M.D. and Kaye, A.M. (1981) J. Biol. Chem. 256, 23-26.

- Waters, A.P. and Knowler, J.T. (1981) J. Steroid Biochem. 14, 625-630.
- Watson, C.S. and Clark, J.M. (1980) J. Receptor Res. 1, 91-111.
- ~~Weber, K. and Osborn, M. (1969) J. Biol. Chem. 244, 4406-4412.~~
- Weickmann, J.L. and Glitz, D.G. (1982) J. Biol. Chem. 257, 8705-8710.
- Welshons, W.V., Lieberman, M.E. and Gorski, J. (1984) Nature 307, 745-747.
- Weil, P.A., Sidikaro, J., Stancel, G.M. and Blatti, S.P. (1977) J. Biol. Chem. 252, 1092-1098.
- Whelly, S.M. and Barker, K.L. (1982) J. Steroid Biochem. 16, 495-501.
- Wolffe, A.P., Glover, J.F., Martin, S.C., Tenniswood, M.P.R., Williams, J.L. and Tata, J.R. (1985) Eur. J. Biochem. 146, 489-496.
- Woodland, H.R. and Wilt, F.H. (1980) Dev. Biol. 75, 199-213.
- Yamamoto, K.R. and Alberts, B.M. (1974) J. Biol. Chem. 249, 7076-7086.
- Yannarell, A. and Aronson, N.N. (1973) Biochim. Biophys. Acta 311, 191-204.
- Zan-Kowalczevska, M. and Roth, J.S. (1975) Biochem. Biophys. Res. Commun. 65, 833-837.
- Zan-Kowalczevska, M., Sierakowska, H., Bardon, A. and Shugar, D. (1974) Biochim. Biophys. Acta 341, 138-146.
- Zeevi, M., Nevins, J.R. and Darnell, J.E. (1981) Cell 26, 39-46.
- Zeevi, M., Nevins, J.R. and Darnell, J.E. (1982) J. Mol. Biol. 131, 353-373.

