

Status Report of the ATLAS SCT Optical Links.

D.G.Charlton, J.D.Dowell, R.J.Homer, P.Jovanovic, T.J. McMahon, G.Mahout
J.A.Wilson

School of Physics and Astronomy, University of Birmingham, Birmingham B15 2TT, UK

N. Kundu, R.L.Wastie, A.R.Weidberg

Physics Department, Oxford University, Keble Road, Oxford, OX1 3RH, UK,

t.weidberg@physics.ox.ac.uk

S.B. Galagedera, J. Matheson, C.P. Macwaters, M.C.Morrissey,

CLRC Rutherford Appleton Laboratory, Chilton, Didcot, Oxon, OX11 0QX, UK

A.Rudge, B. Skubic

CERN, CH-1211, Geneva 23, Switzerland

M-L.Chu, S.C.Lee, P.K.Teng, M.J.Wang, P.Yeh

Institute of Physics, Academia Sinica, Taipei, Taiwan 11529.

Abstract

The ATLAS SCT optical links system is reviewed. The assembly and testing of prototype opto-harnesses are described. Results are also given from a system test of the SCT barrel modules, including optical readout.

I. INTRODUCTION

Optical links will be used for the readout of the ATLAS SCT and Pixel detectors [1]. The specifications for the links are summarised briefly in section II. The radiation hardness of the system is briefly reviewed in section III. The assembly and test results of the prototype barrel opto-harness are described in section IV and a similar discussion is given for the forward fibre harness is given in section V. Some results from the SCT barrel system test are given in section VI. Conclusions and future prospects are discussed in section VII.

II. LINKS SPECIFICATIONS

The SCT links transfer digital data from the SCT modules to the off-detector electronics (RODs) at a rate of 40 Mbits/s. Optical links are also used to transfer Timing, Trigger and Control (TTC) data from the RODs to the SCT modules. Biphase mark encoding is used to send the 40 Mbit/s control data for a module on the same fibre as the 40 MHz bunch crossing clock.

The architecture illustrated in Figure 1 below, contains immunity to single point failure to maximise the system robustness[1]. If a TTC link to a module fails, the TTC data can be routed to a module from the opto-flex of its neighbour module. 12 modules are connected in a redundancy loop. One data link reads out the data from the 6 ABCDs on one side of the module. If one of the two data links for a module fails, the corresponding data can be routed through the other data link.

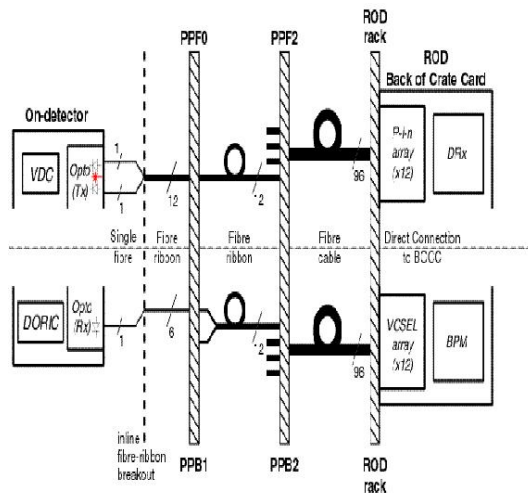

Figure 1 SCT links architecture.

III. RADIATION HARDNESS

The radiation hardness and lifetime after irradiation of the PIN diodes has been demonstrated up to a fluence of 10^{15} 1MeV_{neq}/cm²[2]. The radiation hardness and lifetime after irradiation of VCSELs produced by Truelight have been tested with good results[3]. The radiation hardness and lifetime of the front-end ASICs VDC and DORIC4A have been shown to be sufficient for the SCT application[4]. The pure silica core step index fibre has been shown to be extremely radiation hard[5]. The effects of Single Event Upsets on the system have been studied and shown to be acceptable for the SCT operation in LHC[6].

IV. BARREL OPTO HARNESS

The barrel opto-harness provides all the electrical and optical services for 6 barrel SCT modules. A harness contains 6 opto-flex kapton cables connected to 6 sets of low mass Aluminium tapes to bring in the electrical power. The VCSEL/PIN opto-package and the DORIC4A and VDC ASICs[4] are die bonded to the opto-flex and then wire bonded as shown in Figure 2 below. The single fibres from the pig-tailed opto-package are protected by 900 μ m diameter furcation tubing. The two data fibres from each opto-flex are fusion spliced to a 12 way ribbon and the 6 TTC fibres are fusion spliced into a 6 way ribbon. The data and TTC ribbons are terminated with MT 12 and MT8 connectors.

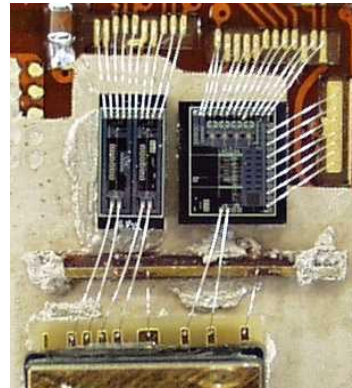

Figure 2 Opto-package and ASICs wire bonded to opto-flex.



Figure 3 Opto-flex and Aluminium low mass cables with three fibres in furcation tubing.

The completed harness is shown in Figure 4 below.

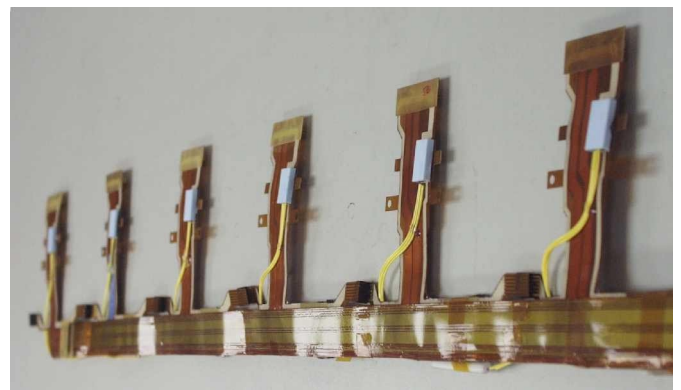

Figure 4 A prototype barrel opto-harness.

The average coupled power of the VCSELs was measured as a function of the drive current and the results are shown in Figure 5 below.

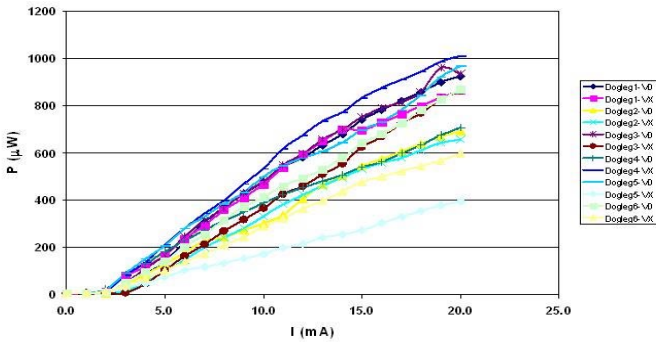

Figure 5 LI curves for VCSELs on an opto-harness. The mean DC power is measured at 50% duty cycle.

The BER of the data links were measured by sending 40 Mbits/s pseudo-random data to the VDC ASICs[4] and receiving the optical signal with 4 channel PIN arrays and the DRX-4 receiver ASIC. The results for the BER scan as a function of the DAC value, which controls the DRX discriminator level, is shown in Figure 6 below. From this it can be seen that there is a wide range of DAC values for which the system can be operated without any errors.

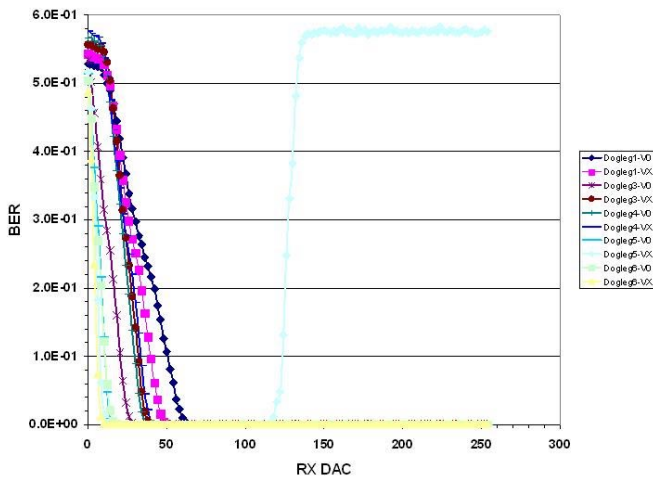

Figure 6 BER scan for the 12 data links on a harness as function of the DAC value that sets the discriminator value for the DRX-4 ASIC.

The BER of the TTC links was measured in a similar way. The BPM-4 ASIC was used for biphasic mark encoding of the 40 Mbits/s control data signal with the 40 MHz clock and used to drive VCSELs. The optical signal was taken to the PIN diode on the opto-package and the resulting electrical signal decoded by the DORIC4A ASIC[4] on the opto-flex cable. The BER was measured by comparing the recovered data with the sent data. The BER was measured as a function of the DAC value, which controls the amplitude of the optical signal. The results for one harness are shown in Figure 7 and demonstrate that

there is a large range of DAC values for which the system works reliably.

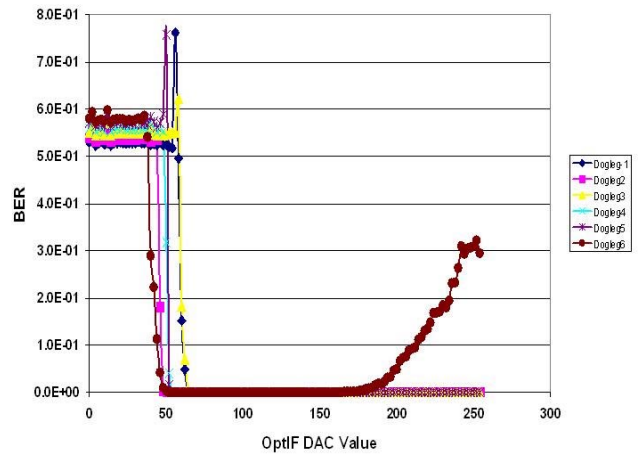

Figure 7 BER scan for the 6 TTC links on an opto-harness as a function of the DAC value which sets the current for the VCSELs.

Four such prototype barrel opto-harnesses have been assembled and tested. These opto-harnesses are being used in the barrel SCT system test at CERN (see section VI).

V. FORWARD FIBRE HARNESS

The services for one of the forward SCT disks is illustrated in Figure 8 below.

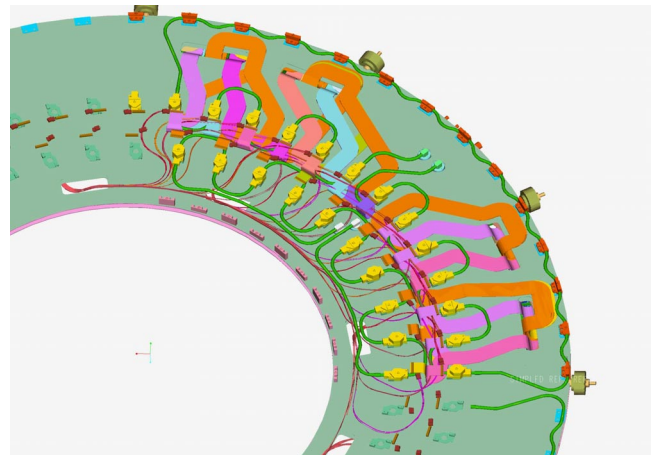

Figure 8 Forward SCT services

The electrical and optical services for the forward SCT are separated. The optical services consist of 6 opto-packages assembled on a PCB with a 6 pin connector. The PCB plugs into a connector on the main forward SCT hybrid and the DORIC4A and VDC ASICs are mounted on the hybrid. A photograph of one of these forward opto plug-in packages is shown in Figure 9 below.

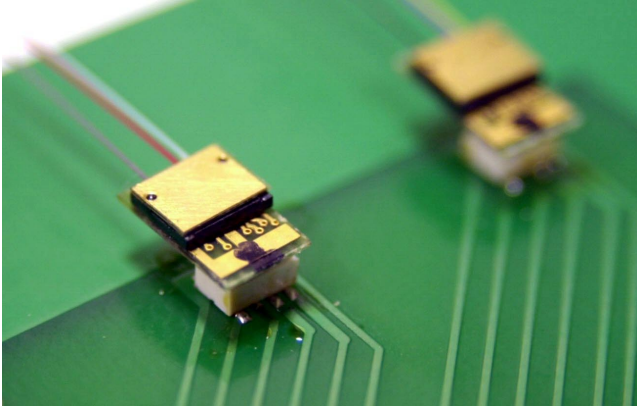

Figure 9 photograph of a forward SCT plug-in opto-package.

The individual fibres are protected by the same furcation tubing as for the barrel. The individual fibres are spliced into 12 way and 6 way ribbons in the same way as for the barrel opto-harness. A photograph of a completed forward fibre harness is shown in Figure 10 below.

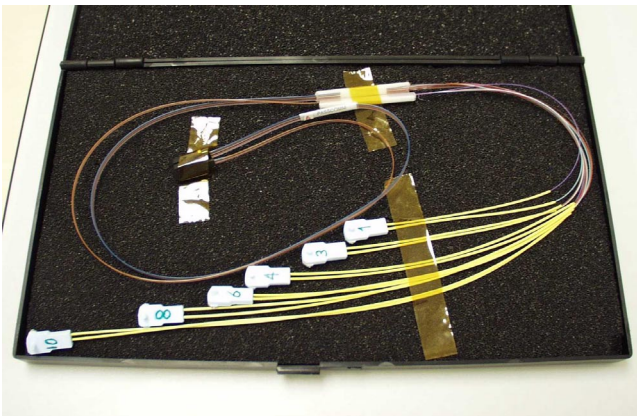

Figure 10 A forward fibre harness containing 6 plug-in opto-packages.

Six of these forward fibre harness have been assembled. Equivalent tests as those performed for the barrel fibre harness have been performed and they are all fully functional.

VI. BARREL SYSTEM TEST

The four barrel opto-harnesses have been used in the SCT barrel system test at CERN. A photograph of 15 barrel SCT modules mounted on a carbon fibre sector with three of the the four opto-harnesses is shown in Figure 11 below.

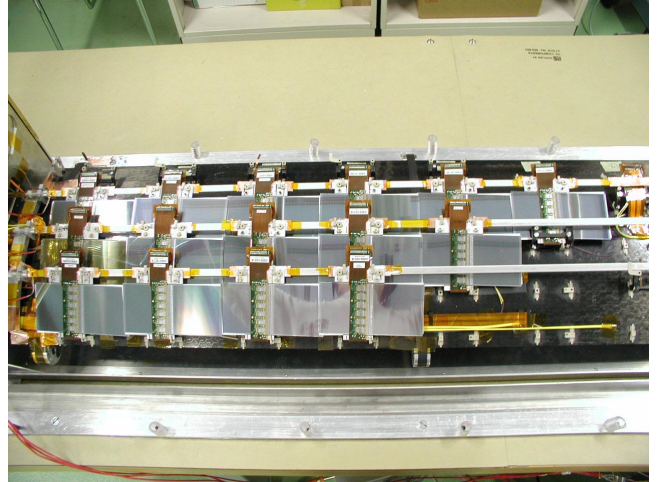

Figure 11 The barrel SCT system test.

The system test has been used to perform many studies and full information is available[7]. One of the key tests performed was to measure the noise of modules in the system test and compare this with the noise values measured for individual modules on an electrical test stand. The results shown in Figure 12 below show no evidence for any excess system noise.

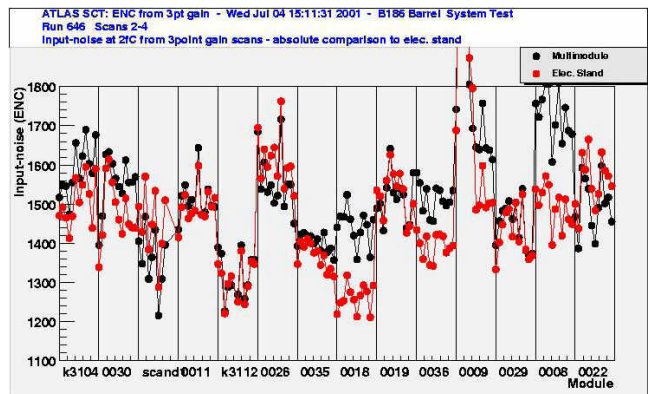

Figure 12 Measured noise for modules measured with optical readout at the system test compared with measurements of the same modules on an electrical test stand.

One of the key performance specifications for a binary system is the noise occupancy. The results of noise occupancy measurements for the 12 ASICs on the 15 barrel modules are shown in Figure 13 below and are generally lower than the system specification of $5 \cdot 10^{-4}$.

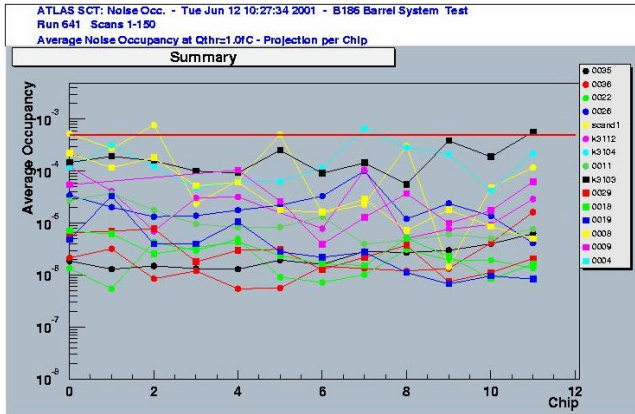

Figure 13 Measured noise occupancy for the 15 barrel SCT modules in the system test as a function of chip number on the module.

Another interesting measurement from the point of view of the optical links is the use of the redundant TTC links. This requires sending the TTC signals to a relatively long way to a neighbour module. Since these lines run parallel to the silicon strips there is a potential pick-up problem. To test this 12 modules were mounted on neighbouring harnesses. The redundant TTC links were used for 8 out of the 12 modules (those for which the redundant TTC links were functional). The noise was measured for this configuration and compared with the noise measured with the modules receiving their normal TTC data (local TTC data). The data shown in Figure 14 below show no evidence for any significant increase in noise.

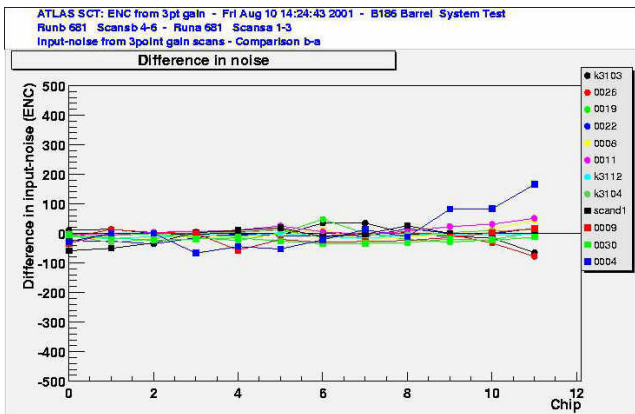

Figure 14 Measured difference in noise for modules read out using the redundant TTC links compared to the noise measured using the normal TTC links.

VII. CONCLUSIONS AND OUTLOOK

Prototype barrel and forward SCT harnesses have been successfully assembled and tested. The barrel harnesses have been used in the barrel SCT system test at CERN. The

results are very encouraging for the operation of the system. Slightly modified prototype harnesses are now being assembled to take into account the new round cooling pipe. A further round of system tests will be required for these harnesses as well as a forward SCT system test.

The prototyping for the on-detector components should be completed this autumn and production started early in 2002.

VIII. ACKNOWLEDGEMENTS

Financial help from the UK Particle Physics and Astronomy Research Council is acknowledged.

IX. REFERENCES

1. ATLAS Inner Detector TDR, CERN/LHCC/97-16.
2. J.D. Dowell et al., Radiation Hardness and Lifetime Studies of the Photodiodes for the Optical Readout of the ATLAS SCT, Nucl. Instr. Meth. A 456 (2000) 292.
3. Information available on www at url: <http://hepmail.phys.sinica.edu.tw/~atlas/radiation.html>
4. D.J. White et al., Radiation Hardness Studies of the Front-end ASICs for the Optical Links of the ATLAS SemiConductor Tracker, Nucl. Instr. Meth. A457 (2001) 369.
5. G. Mahout et al, Irradiation Studies of multimode optical fibres for use in ATLAS front-end links, Nucl. Instr. Meth. A 446 (2000) 426.
6. J.D. Dowell et. al., Single Event Upset Studies with the optical links of the ATLAS semiconductor tracker, accepted for publication in Nucl. Instr. Meth. A.
7. Information available on www at url: <http://asct186.home.cern.ch/asct186/systemtest.html>.