

Test of a LED monitoring system for the PHOS spectrometer

A.M.Blick, M.Yu.Bogolyubsky, S.V.Erin, Yu.M.Kharlov,
M.O.Lobanov, Yu.V.Mikhailov, N.G.Minaev, V.A.Petrov,
S.A.Sadovsky, V.D.Samoylenko, V.I.Suzdalev, V.A.Senko
and V.V.Tikhonov

Institute for High Energy Physics, Protvino, 142284 Russia

Abstract

A prototype of monitoring system for the Photon Spectrometer (PHOS) of the ALICE experiment at LHC is described in details. The prototype consists of Control and Master modules. The first one is 8x8 matrix of Light Emitting Diodes coupled with stable generators of current pulses. The system provides an individual control for each of the 64 channels of PHOS prototype based on lead-tungstate crystals. A long term stability of order of 10^{-3} has been achieved in integral beam test of the monitoring system and PHOS prototypes.

1 Introduction

PHOS (PHOton Spectrometer) is an electromagnetic calorimeter of high granularity consisting of 17280 detection channels of lead-tungstate crystals (PWO) of 2.2x2.2x18 cm³ dimensions, coupled to large-area PIN-photodiodes with low-noise preamplifiers, see [1]. The calorimeter will operate at a temperature of -25° C, stabilized with a precision of $\approx 0.3 - 0.4^\circ$ C. Although the PIN diodes do not require gain monitoring, and the preamplifiers have their own calibration unit, a Monitoring System (MS) which can test simultaneously all the components of the PHOS channels will be very useful for a set of general tests of the calorimeter. This includes checks of the channel

matching and optical contacts between crystals and PIN diodes after assembly and/or before cooling of the PHOS modules. The MS will provide also a powerful tool to check the transparency of crystals, the gain factors and their stability, the linearity of full electronic chain including preamplifiers, shapers and ADCs for all PHOS channels during physical runs.

In this paper we describe a monitoring system based on a 8x8 matrix of Light Emitting Diodes (LED) coupled with stable generators of current pulses, and present results of integral beam test of the MS and PHOS prototype module which consists of 8x8 PWO crystals. Compared with the types of MS based on the use of LEDs, see for example [2–5], the present LED system has several features essential for operation with the PHOS spectrometer in ALICE. The main features are as follows:

- wavelength, duration and intensity of the light flashes are similar to those generated by photons in PWO crystals used in the PHOS,
- minimal power consumption for reduction of temperature field distortions in the thermostabilized volume of the PHOS at a temperature of -25°C ,
- high stability of the light flashes,

2 Description and performance of the monitoring system

The MS prototype consists of two modules, the Control Module (CM) and the Master Module (MM). The Master module is located in the control room, and connected by a flat cable with the Control module which is located inside the PHOS. The functions of the MS are shared between these modules as follows. The Master module being connected with a host computer through the CAMAC interface receives and keeps in a memory all information about the MS operation and, after a special command, transmits it in digitized form to the Control module. The CM decodes the obtained information and transforms it in a sequence of analogs signals which are stored in the analog memory (capacitances) for a short time. After the command "Fire" the given configuration of the LEDs at the CM will be fired.

The Control module of the MS is a two layer printed circuit board with the 8x8 matrix of LEDs positioned centrally over the front face of the crystals.

The generators of current pulses as well as control circuits are mounted on the same board. A functional diagram of the Control module is shown in Fig.1. The Control module consists of the decoder of MM commands, four

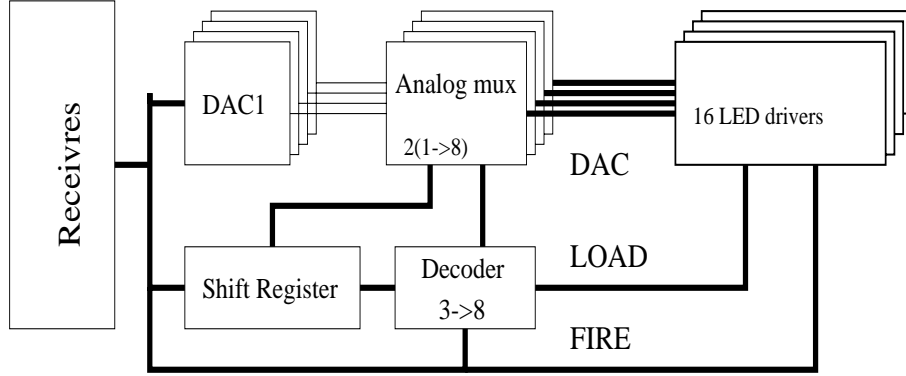

Fig. 1. Functional diagram of the Control module.

8-bit Digital-Analog Converters (DAC), 4x2 analog multiplexers and 64 LED drivers coupled with LEDs (the superbright LED L132SG of Kingbright and DAC AD5300BRT of Analog Device with a setting time of $4 \mu s$ are used in the prototype). Thus the management of each channel of the Control module is performed in digitized form, and therefore it is noise protected. The analog part for each channel, LED driver, is spacially dense and located just near the corresponding LED. Therefore it is also well noise protected. As a result we obtain a very stable generator of light pulses.

The schematics of the LED driver is shown in Fig.2. At the first stage of the CM operation the specific code is loaded in the DAC by the master module (if the DAC has been already loaded and the code should not be changed, this stage is omitted). At the second stage the capacitance C_1 is charged by the DAC through the connected analog switch S_1 of the 74HCT4066 type. The capacitance is used as an analog memory and should have a low leakage current and high stability. At the last stage the switch S_1 is disconnected and the switch S_2 is connected, and the capacitance C_1 is discharged through the LED. The duration of the leading edge of the LED flash is defined by the speed of the switch S_2 , the trailing edge is defined by the $C_1 R_1$ time constant ($\sim 1 \mu s$ in our case), and the $C_2 R_2$ chain shapes the pulse. The whole amount of light is defined by the charge kept at the capacitance C_1 and can be adjusted by the DAC.

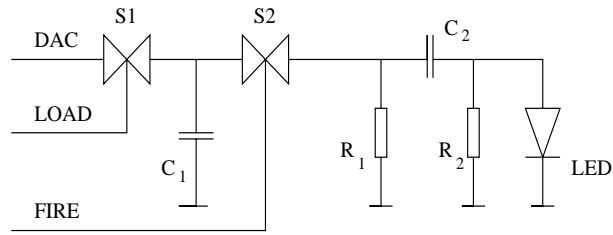

Fig. 2. Schematics of the LED driver.

For temperature and time stability we used capacitances with the NPO dielectric. The leakage current for such type of capacitance is about 100 pA . An additional decrease of the leakage current is achieved due to the low temperature of analog switches. These features ensure a stability of $\sim 10^{-3}$ during about 1 ms . A typical light pulse is shown in fig. 3. The pulse duration ($\sim 100 \text{ ns}$) is of the same order of magnitude as that from PWO crystals of the PHOS.

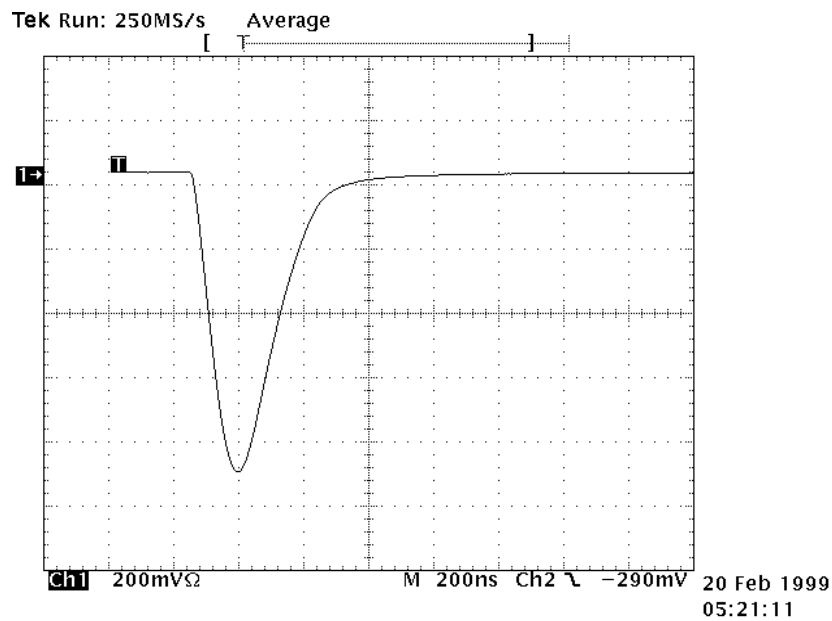

Fig. 3. The light flash from LED viewed by fast photomultiplier 56AVP and digitized by the oscilloscope TDS724.

The LED is fired in the forward direction by a low-voltage pulse with an

amplitude up to 5 V. This soft mode of LED operation decreases the effect of LED ageing. The voltage variation at the C_1 capacitance using an 8-bit DAC changes the light intensity by two order of magnitude and overlaps the whole dynamical range of the PHOS. The dependence of the LED light intensity on the DAC code is of the exponential type. It has been measured with a 11-bit ADC in a special test run with the PHOS prototype, see below, and is shown in Fig. 4. A power consumption of the Control module is of the order of 0.3 *mW*/channel in an idle state, whereas in the active state it is about two times higher. This is negligible small compared with the heat penetrating through the walls of thermostabilized volume of the PHOS.

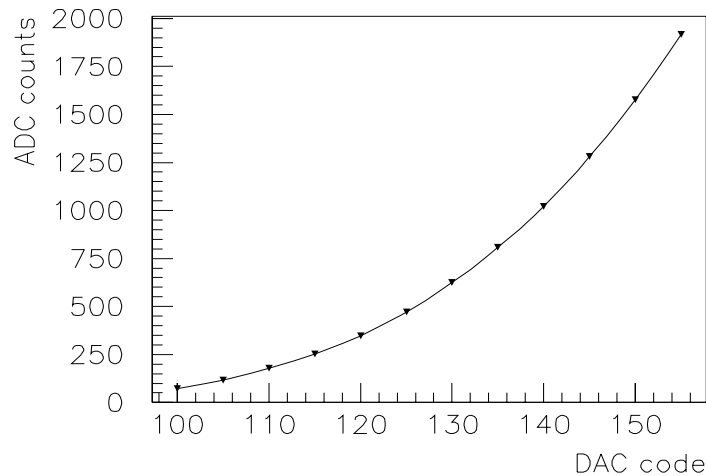

Fig. 4. Dependence of the amplitude from the LED in a PHOS channel on the DAC code. The measurements were performed with 11-bit ADC. The curve is an interpolation of the measurements.

The operation of the LED monitoring system is defined by the Master module. There are four operational modes:

- "Slipping" mode, i.e no LED signals, minimal power consumption by the CM.

- "Fast" mode, i.e. the mode when the channel pattern is sent in the CM without the DAC loading. This mode is the main in a physical run for channel monitoring.
- Amplitude scan and different channel pattern loading. The main purpose of this mode is a total test of the cable connections, quality of the optical contacts and the electronics chain. This mode is intended for an installation stage of the PHOS and for periods between runs for checking the PHOS performance.

- Loading of the *shower pattern* and the *physical event image*. In this mode the physical performance of the PHOS based on the Monte-Carlo minimum bias events (which are loaded into the CM) can be estimated. The performance of PHOS will be checked 'in vitro' without beams.

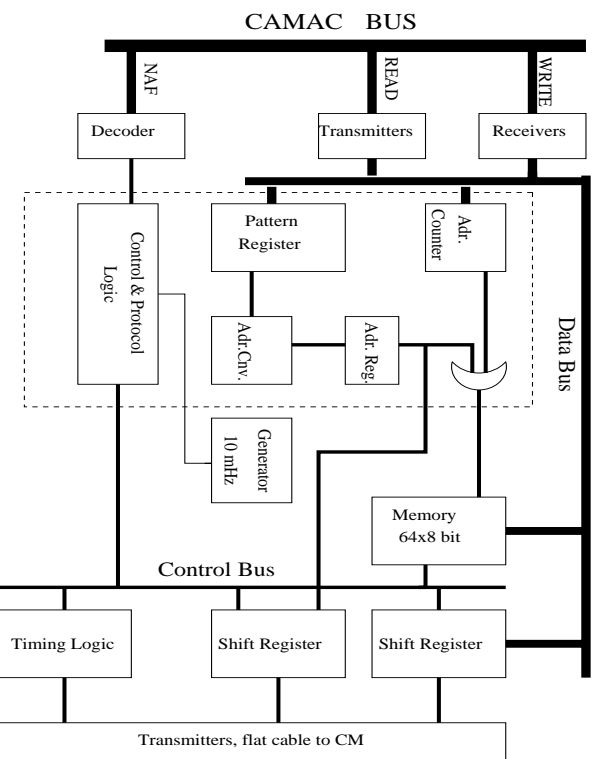

Fig. 5. Functional diagram of the Master module. The part marked by dashed line is realized in ALTERA.

The MM prototype is realized as a CAMAC module. Its functional diagram is shown in Fig.5. The decoding circuitry, ancillary logic and memory

counters are realized on the Float Programmable Gate Array (FPGA) ALTERA EPM7160SLC84-10 [6]. The current configuration of loaded channels is saved in the MM memory and then can be sent to the Control module at any time. The SPI protocol is used to link the Master and Control modules. In the MS prototype the rate of pattern loading has been limited by a 10 MHz clock pulse.

The Master module as CAMAC module has the following CAMAC functions:

- Reset of the MM memory address pointer,
- Read/Write the pattern configuration in the MM memory,
- Read/Write the address pointer in the MM memory,
- Read/Write the DAC code in the MM memory,
- Direct Write the DAC code to the CM,
- Load the pattern and DAC memory in the CM,
- Load the pattern and DAC memory in the CM and 'Fire' it,
- Send the command 'Fire' to the CM,

3 Prototype beam test

The prototype of monitoring system discussed above has been tested simultaneously with the 8x8 PHOS prototype in 1999 at the T10 beam of the PS CERN accelerator. The CM was housed in front of the PHOS prototype inside the thermostabilization volume at -20° C. The temperature stabilization was provided with accuracy of $\pm 0.2^{\circ}$ C. The signals from the PHOS channels (PWO crystals in junction with PIN-diodes, preamplifiers and shapers) were measured with an 11-bit LeCroy ADC. The stability of the preamplifier and shaper chains was checked in special pulser runs, when calibrated signals were transmitted to the inputs of preamplifiers. The LED monitoring runs followed as a rule just after the pulser runs. During the monitoring the Master module was controlled by an autonomous host computer which also initiates the special monitoring trigger to collect the monitoring data. The

LED trigger rate was 0.3 kHz. In average a monitoring run takes 5-10 min of real time.

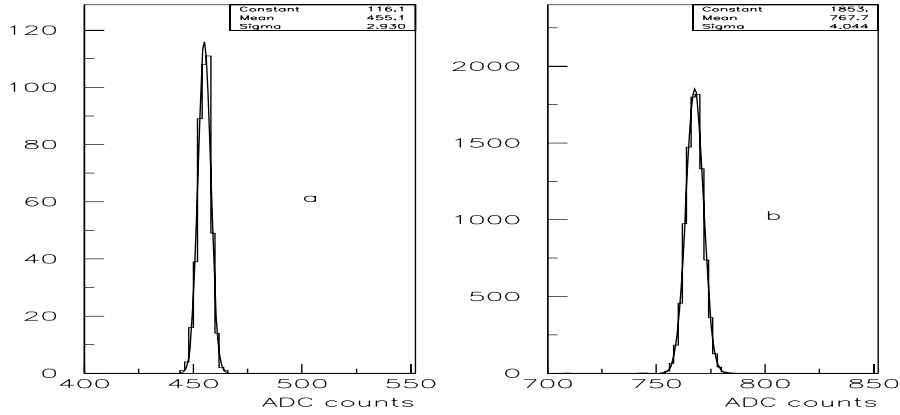

Fig. 6. Amplitude spectra in the same PHOS channel: a) pulser run, b) LED monitoring run.

As a typical example the amplitude spectra in one PHOS channel are shown for pulser and monitoring runs in Fig. 6. As one sees from the figure the widths of the pulser and LED spectra are quite similar. Thus we can conclude that the light flash fluctuations are small compared with the noise level in the electronics chains of the PHOS.

As for the quality of channel monitoring it is useful to distinguish long and short term instabilities. The last one means LED signal variation during a monitoring run. It can be characterized by variation of the LED signal ratio for two different PHOS channels. Measurements of the short term instability have been performed for several monitoring runs. The typical results are presented in Fig. 7, where the LED signals from two different PHOS channels averaged over 16 triggers (one measurement) as well as their ratio are shown. The relative deviation of two signal ratio to its average value is $\sigma_R / \langle R \rangle = 1.2 \cdot 10^{-3}$ during a monitoring run. No systematics in the variation of the ratio was found, Fig. 7c: a linear fit of the distribution gives for the slope a value of $\sim 3 \cdot 10^{-7}$.

The long term instability is characterized by the deviation of the average value of LED ratio from one monitoring run to another. The measurements

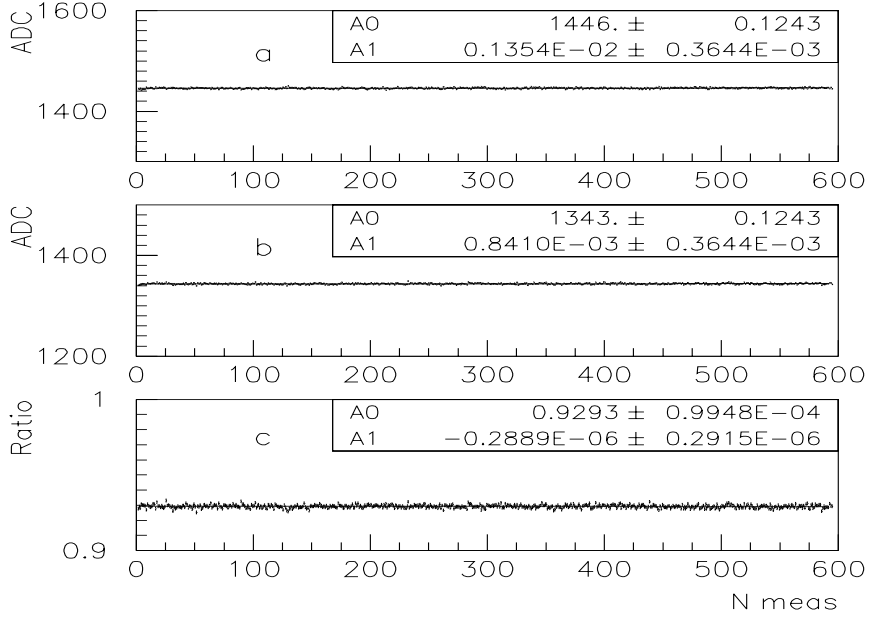

Fig. 7. The short term instability of LED monitoring system: a) channel A, b) channel B, c) the ratio A/B. Each point is an average over 16 ADC values. The A0 and A1 are parameters of linear fit $F(N) = A0 + A1 \cdot N$. The time covered in the figure is 10 min.

are presented in Fig. 8. As one sees the relative deviation from the average value is equal $\sigma_R / \langle R \rangle = 10^{-3}$, which is in good agreement with the value obtained for short term measurements. Thus we conclude that the general instability of the LED monitoring system prototype is of the order of the $\sim 10^{-3}$.

4 Conclusion

The prototype of LED monitoring system for the PHOS spectrometer of the ALICE has been tested simultaneously with PHOS prototype at T10 beam of the PS accelerator in CERN. The system provides an individual control of

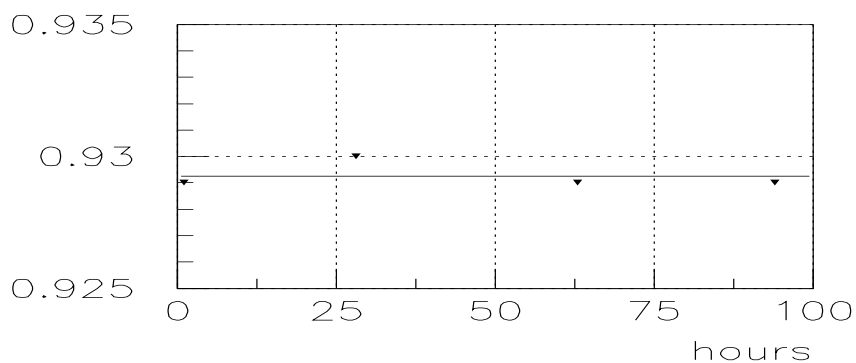

Fig. 8. The long time stability of two channels ratio, the line is the fitting constant.

each of the 64 channels of the PHOS prototype. It is based on the very stable generators of the current pulses which were used for the LEDs excitation. The achieved stability of the system is of the order of the 10^{-3} during ≈ 100 hours.

The authors wish to thank G.Paic for useful discussions.

References

- [1] CERN/LHCC 99-4, ALICE TRD 2, 5 March 1999.
- [2] D.Autiero et al., A high stability light emitting diode system for monitoring lead glass electromagnetic calorimeter, Nucl. Instr. Meth. A 372 (1996) 556.
- [3] T.Hehl et al., A gain monitoring system for scintillation detectors using ultra bright LEDs, Nucl. Instr. Meth. A 354 (1995) 505.
- [4] G.Anton et al., A LED monitoring system for pulse height and time measurement with scintillation counters, Nucl. Instr. Meth. A 274 (1989) 222.
- [5] Yu. Gouz et al., LED monitoring system for the STIC calorimeter, preprint IHEP 95-108.

- [6] ALTERA Corporation. Data Book 1998.
- [7] Hewlett Packard. Optoelectronic Designer's Catalog 1998.
- [8] Analog Device. Data Book 1998.