

WOUND-ON-TENSION FOR TWO DRUM WINDERS

by

J. K. Good¹, B. R. Cowan², L. E. Dolezal³, and R. Markum¹
Oklahoma State University¹
Orbus Medical Technologies²
IBM³
USA

ABSTRACT

The two drum winder remains to be a high productivity winder for rewinding some paper and nonwoven webs at very high speeds. Winding models of varied capabilities exist for center winders, center winders with rider rollers, and surface winders. Winding models for two drum winders however are still in the introductory stages. Two drum winders are somewhat more complex than other winders due to the number of rollers, driven and undriven, which impinge the surface of the winding roll. The objectives of this paper are to show the influence of various winder operating parameters and thread path on the wound-on-tension in the outer layer (WOT).

NOMENCLATURE

TORQ1	Torque applied to Drum 1
TORQ2	Torque applied to Drum 2
T_w	Web tension prior to winder entry
V_{web}	Web velocity prior to winder entry
WOT1	WOT measured between Drum 1 and the rider roller
WOT2	WOT measured between the rider roller and Drum 2
WOT PT	Final value of WOT inferred from measured wound roll pressures and use of a wound roll model
Δ_1	Slippage induced between the outer layer and the layer below by Drum 1
Δ_2	Slippage induced between the outer layer and the layer below by Drum 2
Δ_{rider}	Slippage induced between the outer layer and the layer below by the rider roller

INTRODUCTION

One of the most important winding parameters is the Wound-On-Tension (WOT) in the outer layer of a winding roll. This tension in the outer layer is more important than any other parameter in dictating the pressures and stresses that will reside in the roll after winding. Two drum winders offer more potential control features for WOT than any other type winder. A schematic of a typical two drum winder is shown in Figure 1. In the paper industry Drum 2 is known as the “Front Drum” as it is closest to the operator and Drum 1 is known as the “Rear Drum” as it is furthest from the operator.

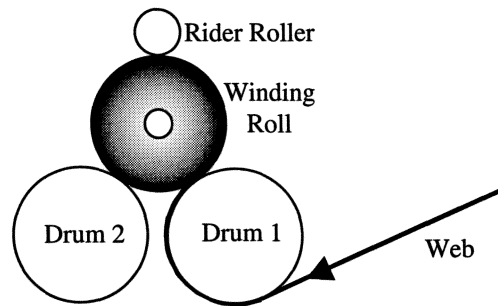

Figure 1 – A Two Drum Winder

The variables the operator can control include the incoming web tension, the relative torque between Drums 1 and 2 (which will be more thoroughly discussed later), and the load which is exerted down upon the rider roller. The contact loads between the drums and rider roller upon the winding roll are called nip loads in most web related industries. Although the rider roller nip load is controlled by the operator, the nip loads between the drums and the winding roll are not. These nip loads have a component due to the rider roller load plus another component due to the dead weight of the winding roll. The dead weight component of nip load between the drums and the winding roll has historically been the bane of two drum winders. The final wound roll diameter was limited by these nip loads which induced tensions in the outer layer of the winding roll beyond the breaking strength of the web. Some gains have been made in the technology by pressurizing the space between the two drums to provide a relieving load and in other cases by supporting the majority of the roll weight on belts rather than on a drum. In most cases the rider is an idler roller but in some cases the rider roller is driven. Typically this is a tendency drive whose purpose is to ensure the rider roller speed matches the core speed at the start of winding.

There are several potential web thread paths other than that shown in Figure 1, in addition to various drive possibilities. In the thread path shown, it is common to use velocity control on Drum 1 and torque control on Drum 2. Typically there will also be velocity limits set on Drum 2 as a percentage (+/-) of the set point velocity for Drum 1 to prevent a runaway of Drum 2. One of the objectives of this study is to explore the effect of winder input variables on the wound-on-tension in the outer layer of the winding roll. A second objective will be to demonstrate the affect of various thread paths on the relationship between winder input parameters and the wound-on-tension.

METHODS OF EXPLORATION

These studies were conducted using a two drum winder that was instrumented specifically for this research, shown schematically in Figure 2. The web first exits the unwind stand at the right. The lateral position of the unwind guide is controlled by a pneumo-hydraulic guide system, the pneumatic edge sensor is shown. The web tension is measured with an idler roller supported on load cells. The web tension is controlled by a closed loop controller whose output is input to a magnetic particle brake on the unwind core shaft. The web then passes beneath Drum 1 which is driven by a motor in velocity control. The web then passes beneath Drum 2 which is driven by a motor in velocity control.

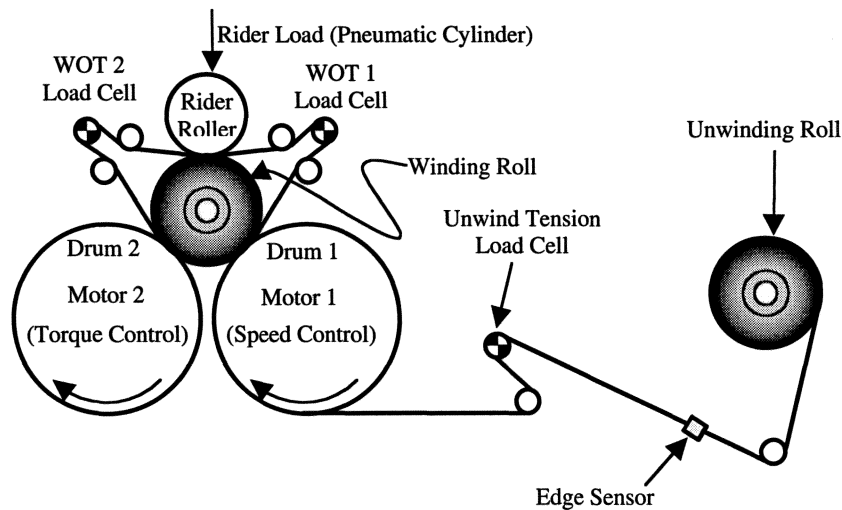

Figure 2 – Winding Apparatus

The motor is restrained from rotating by a load cell which provides a precise and continuous measurement of the torque input (TORQ1) to Drum 1. As the web exits from contact with Drum 1 it can be routed around another idler on load cells where the level of WOT in the outer web layer between Drum 1 and the rider roller (WOT1) was measured. The nip load exerted on the wound roll by the rider roller was measured and controlled. The web then proceeds beneath the rider roller after which it can be routed around another idler on load cells where the level of WOT in the outer layer between the rider roller and Drum 2 (WOT2) was measured. Similar to Drum 1, the motor which drives Drum 2 is restrained by a load cell and a torque measurement (TORQ2) is available. The motor on Drum 2 is in torque control.

The two drums on this winder are 61 cm in diameter. The center of rotation of each drum is at the same elevation and there is 1.27 cm of separation between the two drum surfaces. There were three rider rollers with outside diameters of 5.08, 16.51, and 25.4 cm available for use in the winder.

Previous research [1] has shown that routing the web away from the surface of the wound roll interferes with the level of WOT in the outer layer. The drums and rider roller induce slippage between the outer layer and the layer beneath. Thus routing the web away from the wound roll surface limits the frictional forces between the outer sheets which through equilibrium affect the level of WOT in the outer layer. Therefore the

traditional load cell measurement of WOT coined by Pfeiffer [2] is suitable for measuring trends between winder input parameters and WOT, but not the absolute levels of WOT. Tests were also run in which the web bypassed the WOT1 and WOT2 measurement rollers and remained in contact with the wound roll after the initial contact beneath Drum 1. In these cases pull tabs [3] were inserted into the winding roll such that pressures could be measured and profiled for discrete radii throughout the wound roll. Using a winding model [4] with known inputs for tangential and radial moduli, core stiffness, and the starting and finishing winding radii, the WOT could be iterated until the pressures predicted by the model converged upon those measured by pull tabs. For the newsprint which was wound, the necessary properties needed for input to the model are given in Table 1.

Web Properties:	news print
web thickness	76.2 μm
web width	24.45 cm
Radial Modulus - E_r	$K_2(P+K_1)$ where P is pressure in KPa
K_1	20 KPa
K_2	23.9
Tangential Modulus - E_t	5.36 GPa
Core Properties:	
Core ID	15.4 cm
Core OD	16.7 cm
Roll OD	33.3 cm
Core Material Modulus	68.9 GPa
Core Poisson Ratio	0.33

Table 1 – Web and Core Properties required to Infer WOT from a Winding Model

When measuring the WOT with load cell measurements, the WOT2 signal discussed above is most likely not the final value of the WOT in the outer layer of the winding roll. The outer layer is subjected to Drum 1, the rider roller, and finally Drum 2 before it proceeds to contact Drum 1 again. Each of the three rollers alter the WOT level and the WOT2 measurement is made prior to Drum 2. It is likely that the WOT increases further after the web passes beneath Drum 2. Therefore the WOT data inferred from pull tab pressures is important as it provides the final level of the WOT in the outer layer. Had it been physically possible, a third WOT load cell measurement would have been made between Drums 2 and 1, but there was inadequate space to make such a measurement between the two drums and the wound roll. The WOT1 and WOT2 measurements are important since they provide continuous indications of WOT in the respective zones, which can be studied as functions of web tension, rider nip load, rider roller diameter, and the torque input to the Drum 2.

Tests were conducted with the rider roller impinged at discrete nip load levels into the wound roll and with the rider roller retracted. When the rider roller was retracted, the core was loaded with lead weights such that the drum loads remained at the same levels as one of the discrete rider nip load test cases. This allowed a direct comparison of the WOT with and without the rider roller. Plots of drum load versus wound roll radius are shown in Figure 4. The drum loads vary with wound roll radius due to the weight of the web, which has been wound onto the core, and also because the direction of the drum load changes with increasing wound roll radius. The drum loads begin to increase quite

dramatically for large wound roll radii. For the range of wound roll radius associated with these tests, the drum loads did not vary a great deal.

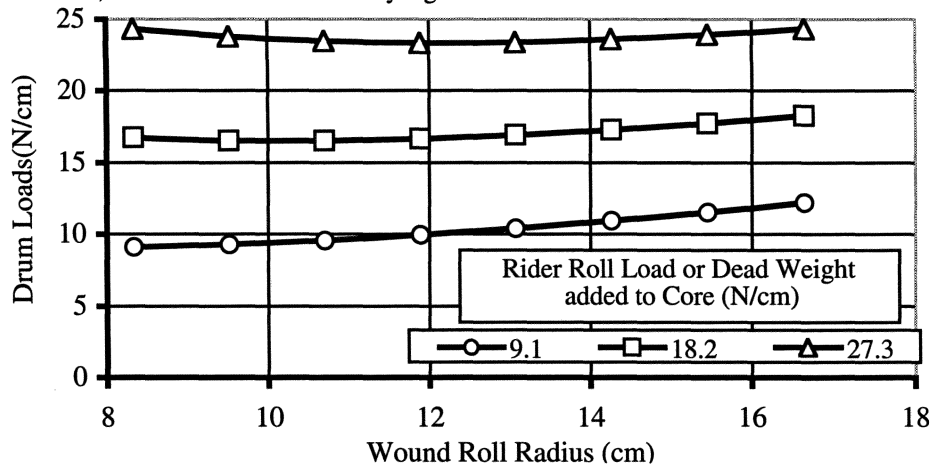

Figure 4 – Drum Loads for Winding News Print

RESULTS OF TESTS

The results from winding a roll at fixed winder conditions are shown in Figure 5. Steady state conditions were achieved typically by the time about 1 cm of web was wound onto the core. These results were typical of those recorded for all test cases. There is a slight increase in WOT2 with respect to wound roll radius that was apparent in all the tests conducted.

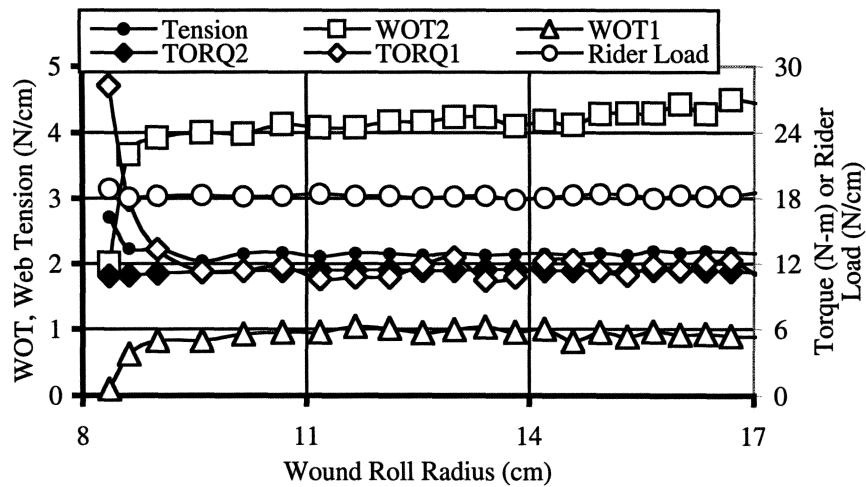

Figure 5 – WOT Results using the Load Cell Method. Web Tension = 2.18 N/cm, Drum Torque 2 = 11.3 N-m, Rider Load = 18.2 N/cm, Rider Diameter = 15.24 cm

Pull tab pressures were also measured such that the final value of WOT could be assessed. In Figure 6 results are shown for 3 winding tests all at the same operating

conditions. The radial pressure is nearly constant in this roll. The decay near the outer radius is expected since the pressure should decay to zero at the outer layer based upon equilibrium. A constant pressure profile with respect to wound roll radius is indicative of winding a web material whose radial modulus is much less than its in-plane modulus at constant WOT. Thus based upon the nearly constant WOT1 and WOT2 data presented in Figure 5 and the nearly constant pressure data presented in Figure 6, it was determined that averaging the WOT measurements would yield meaningful results that would allow the comparison of WOT for different winder operating conditions.

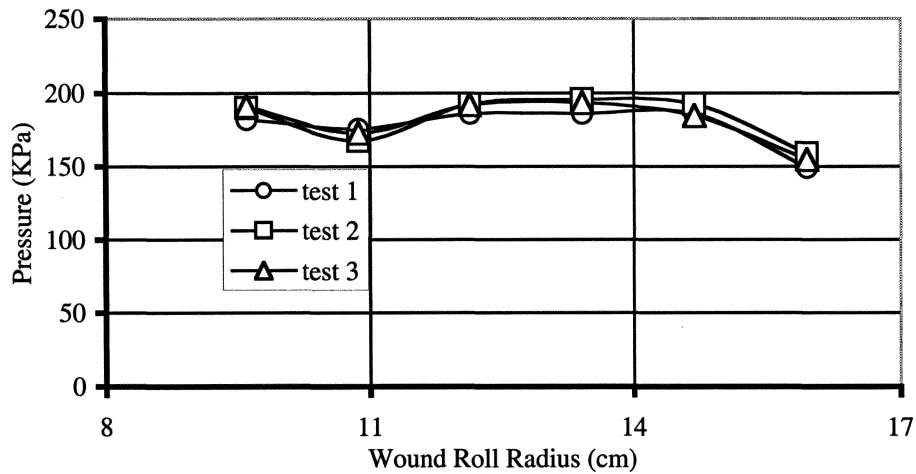

Figure 6 – Wound Roll Pressures measured using Pull Tabs. Web Tension = 2.18 N/cm, TORQ2 = 11.3 N-m, Rider Load = 18.2 N/cm

The effect of web tension on WOT is shown in Figure 7 for a case in which the rider roller was engaged. Note that varying web tension has very little effect on WOT1, WOT2, and WOT inferred from pull tab pressures.

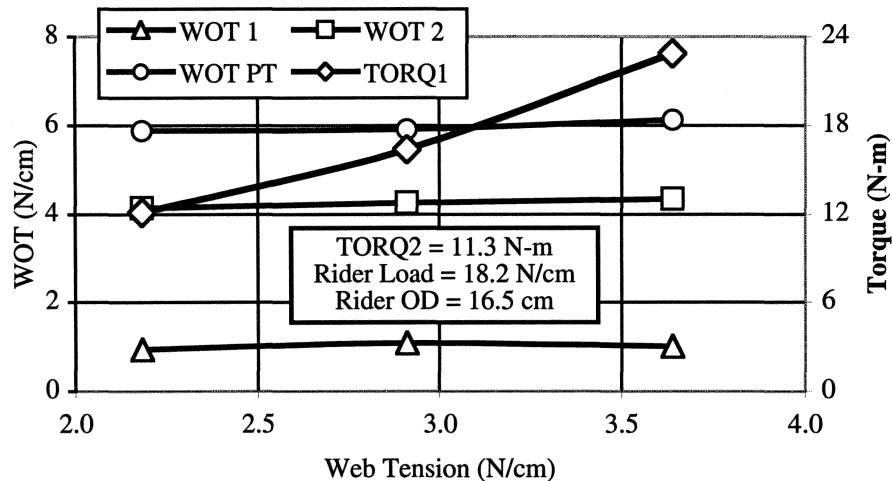

Figure 7 – Impact of Web Tension on WOT

Note also that the torque required to keep Drum 1 rotating at constant velocity appears to be increasing linearly as a function of web tension. Thus increasing web tension has had no impact on the WOT and the pressures and stresses within the wound roll. Similar tests were conducted in which rider rollers of 5.1 and 25.4 cm in diameter were used. Although the rider roller diameters had an influence on the level of WOT, web tension had no effect for those cases as well.

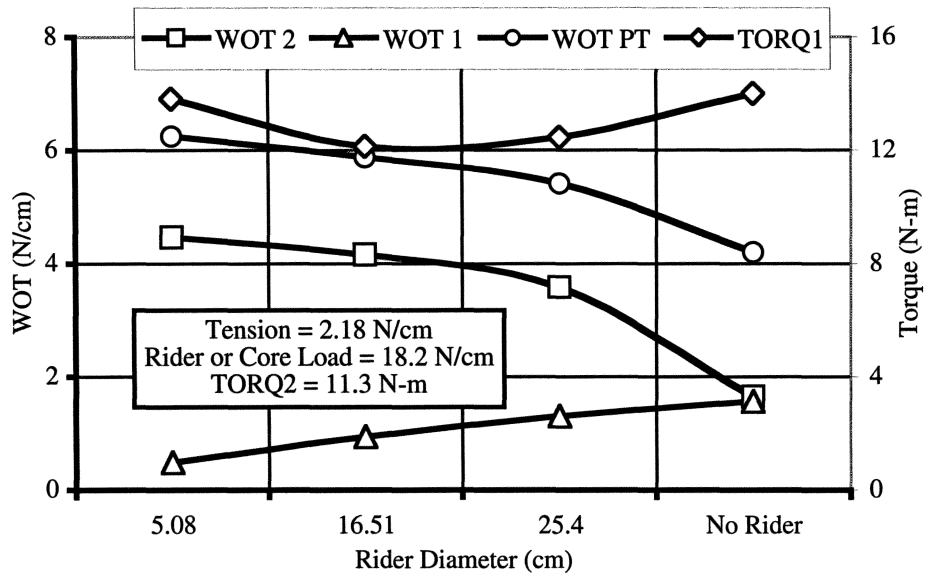

Figure 8 – Influence of Rider Roller Diameter or No Rider on WOT

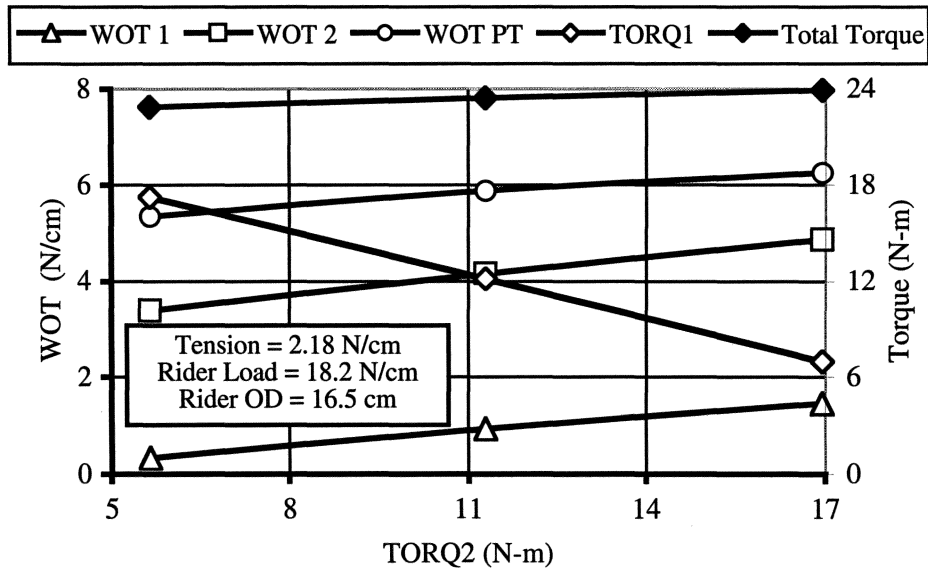

Figure 9 – Influence of Drum 2 Torque on WOT

The influence of rider roller diameter or the lack thereof is seen in Figure 8. Smaller rider roller diameters provide the largest values of WOT2 and final values of WOT as inferred from pull tab pressures. Note that while WOT2 decreases with rider roller diameter, WOT1 increases. Thus it is evident that the rider roller is inducing slippage between the outer layer and the layers beneath which results in a decrease in WOT1 and a corresponding increase in WOT2. This becomes evident if WOT1 and WOT2 are averaged for the three different rider roller diameters, the average WOT is 2.5 N/cm in each case.

It is also evident that retracting the rider results in a minimum level of WOT2. The difference between the WOT inferred from pull tabs and the WOT2 data is reasonably consistent as well (about 1.8 N/cm). The difference can be accounted for as the WOT which is being induced by Drum 2.

The effect of varying the torque input to the second drum is shown in Figure 9. Note as the torque to Drum 2 is increased, the torque required to maintain Drum 1 at constant velocity decreases. Also note that total torque, which is the sum of the torques input to the two drums, remains relatively constant. The increase in WOT2 with respect to Torque 2 is very nearly the increase in torque divided by the drum radius and the web width. The WOT inferred from pull tab pressures shows a similar but smaller increase which is expected due to the friction between the outer layer and the layer beneath. Thus not all the increase in torque results in a tension increase in the outer layer.

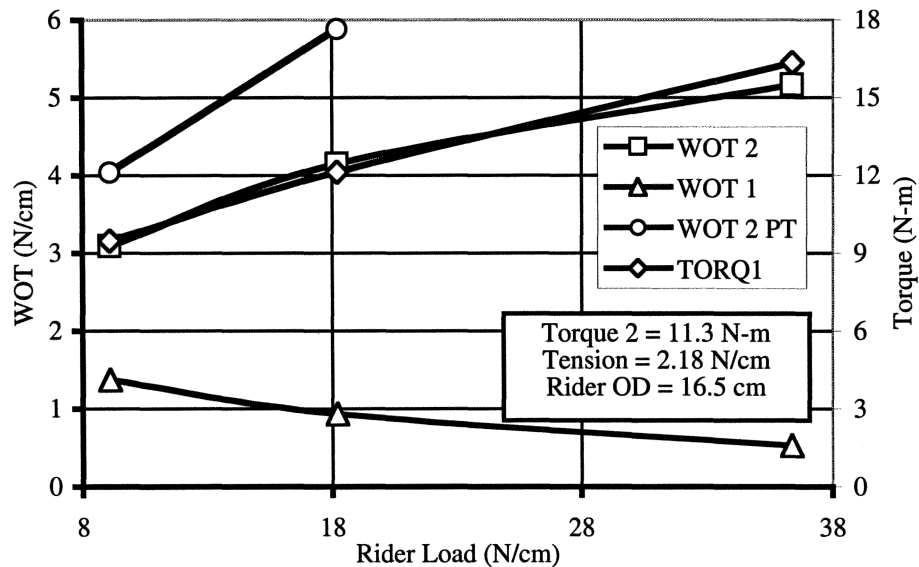

Figure 10 – Influence of Rider Load on WOT

The effect of varying rider load or the core load when the rider is retracted is seen in Figures 10 and 11. With the rider roller retracted, WOT2 is largely unaffected with increasing core load. The WOT inferred from pull tabs appears to increase linearly with increasing core loading when the rider roller is retracted. Thus the increase in WOT must occur after the web has passed Drum 2. When the rider roller is engaged, both WOT2 and the WOT inferred from pull tab pressures increase with increasing nip loads. In three of the cases in which WOT was inferred from pull tabs, the resulting pressures were so high that the steel pull tabs failed due to tensile stresses in excess of the ultimate tensile

strength. In those cases, results are seen only at lower nip load levels. Since both WOT2 and WOT PT increase with rider load when the rider roller was engaged, it appears that the final value of WOT was affected by nip induced tensions from the rider roller and Drum 2.

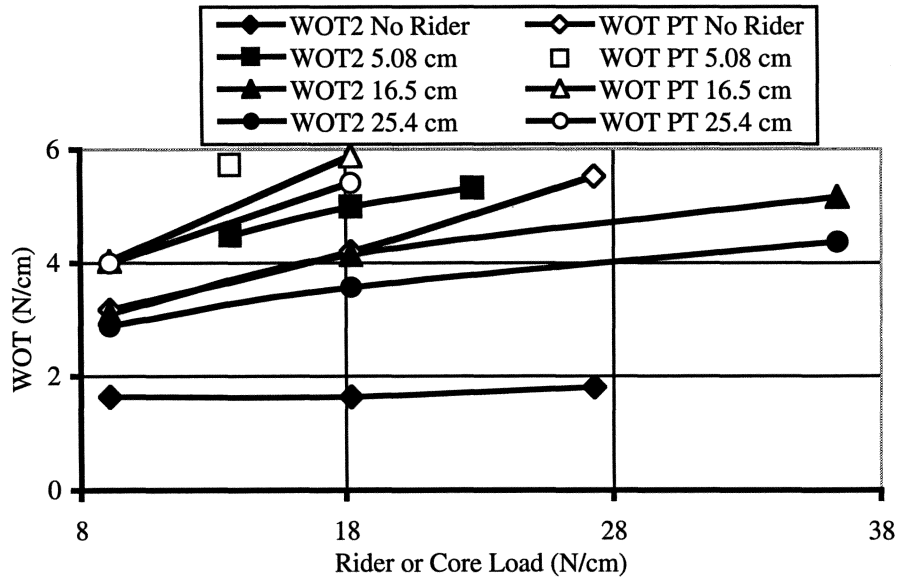

Figure 11 – Influence of Rider or Core Load on WOT for various Rider Roller Diameters and for the Condition in which the Rider is Retracted.

DISCUSSION

Pfeiffer was the first to note that the tension in the outer layer of a winding roll was affected by slippage induced by nip rollers in contact with the winding roll. Some ability now exists to predict how the tension is altered [5,6]. These models predict at lower nip loads that the nip-induced-tension from a nip roller is the product of the nip load and the friction coefficient between web layers. This can be affected by friction, and in the extreme webs with adhesive coatings may have no interlayer slip and hence no nip-induced-tension due to a passing nip roller. When webs without adhesive coatings are subjected to high nip loads, regions of stick behavior exist in the nip contact zone that limit the nip-induced-tension to values less than the product of the nip load and the coefficient of friction. When this behavior occurs, smaller diameter nip rollers induce more slippage and hence more nip induced tension than larger diameter nip rollers.

Perhaps the best way of discussing the nip mechanics of the multiple drums is to refer to Figure 12. The outer layer of the winding roll has been drawn in a curvilinear coordinate system after entering the first drum. Cylinders in nip contact with dissimilar properties rotate at different velocities [7]. In most cases the winding roll will have a lower surface velocity than Drum 1 (V_1). Thus as the web first contacts Drum 1 it will be traveling at web velocity (V_{web}) but the web will be slowing down (minutely) as it wraps Drum 1. Frictional forces will result from the velocity difference, which decreases the web tension. Depending on the web modulus and the velocity difference much of the web tension may be lost. The decrease in web velocity results in a decrease in web strain and thus stress and tension. This explains why varying web tension, as shown in Figure 7,

produced little effect on WOT1, WOT2, or the inferred WOT. As the Drum 1 nip load increases, due to wound roll weight or rider roll load, stick behavior in the contact zone between the drum surface and the web may dominate, and the web velocity may essentially be that of Drum 1 throughout the wrap angle.

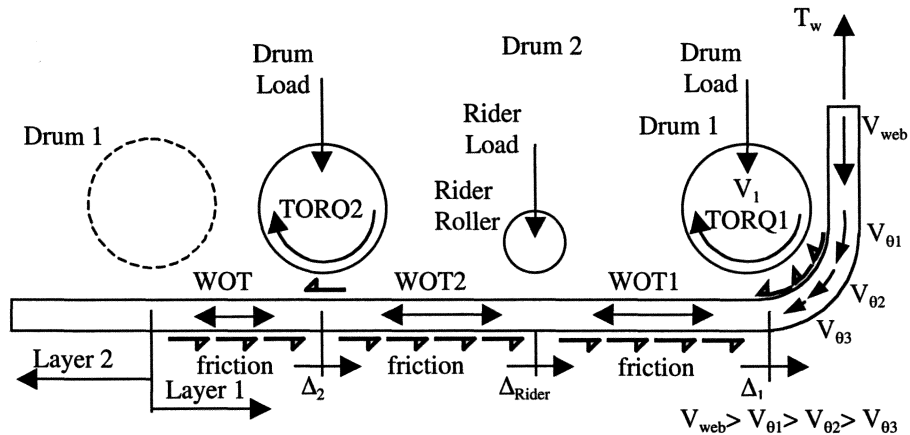

Figure 12 – Free Body of the Outer Layer of Web in a Two Drum Winder

The two drums and the rider induce slip (Δ) between the outer and second layer. The amount of slip is known to be a function of nip load, nip diameter, and web properties. Thus the amount of slip induced by the two drums (Δ_1 and Δ_2) should be nearly identical. Refer to the case in Figure 11 in which the rider is retracted. The WOT2 data shows little influence from nip load. This is reasonable since Δ_1 and Δ_2 are both increasing identically with nip load. WOT2 should change only if Δ_1 was varying differently than Δ_2 as a function of nip load. Note that even though Δ_1 and Δ_2 are equal that their levels must be increasing with nip load since the inferred level of WOT appears to be increasing linearly with nip load.

The effect of nip induced slippage is also seen in Figure 10. Note with increasing nip load that WOT2 is increasing while WOT1 is decreasing. Since the rider is smaller in diameter than the drums, more slippage is induced by the rider than the drums. Thus in Figure 12 Δ_{rider} must be greater than Δ_1 and Δ_2 , which are equal, resulting in a drop in WOT1 and an increase in WOT2. A similar effect is seen in Figure 8 where increasing rider roller diameter results in decreasing levels of WOT2 accompanied by increasing levels of WOT1. Thus it is shown that the slippage beneath the rider between the outer layer and the layer beneath is key in its effect on WOT and that slippage is increased with increasing nip load and decreased with increasing rider roller diameter. Any modeling of the WOT must incorporate the nip induced slippage, the accompanying friction, and the slippage resulting from velocity differences between Drum 1 and the wound roll due to dissimilar material properties. An initial attempt has been made in modeling the WOT on a two drum winder without accounting for the relative levels of slippage [8].

The torque input to Drum 2 (TORQ2) appears to directly impact both WOT2 and the WOT inferred from pull tabs. In the absence of friction between the outer layer and the layer beneath, the torque input to Drum 2 divided by both the drum radius and the web width should yield the portion of the WOT due to TORQ2. In these tests, TORQ2 ranged between 5.6 and 16.9 N-m. The difference in these values divided by the drum radius and

the web width yields a change in WOT of 1.5 N/cm. In Figure 9, a 1.5 N/cm increase in WOT2 is seen over this range of TORQ2. The WOT inferred from pull tab measurements shows only about a 1 N/cm increase over this range of TORQ2, presumably due to frictional losses between Drum 2 and the web and due to the presence of friction between the outer layer and the layer beneath.

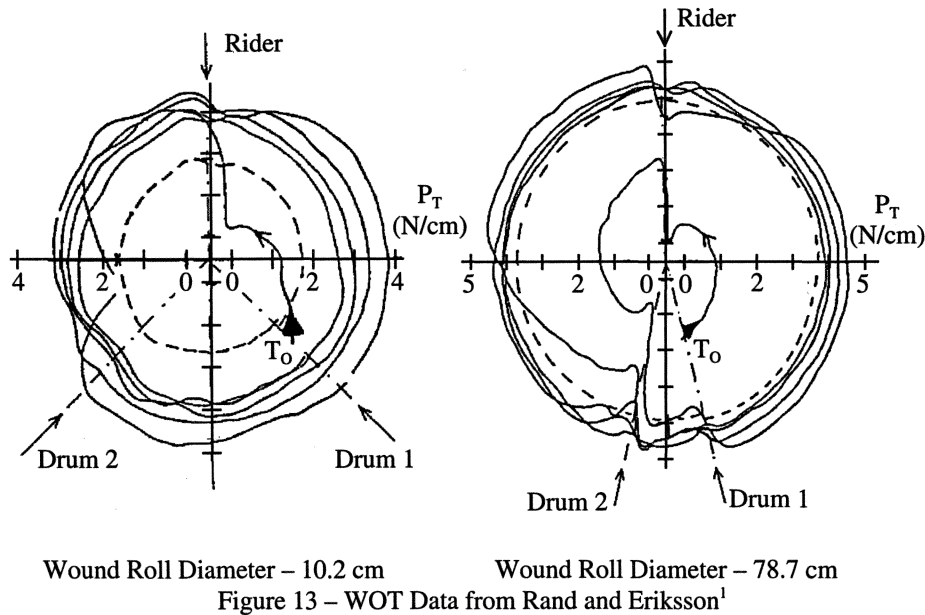

Rand and Eriksson published the only reference in which WOT on a two drum winding was studied in the laboratory [9]. In their study, a newsprint web was instrumented with a strain gage and the web was then wound into a roll on a two drum winder. The strain gage was connected to bridge instrumentation and a data logger through slip rings. In Figure 13, data are shown for conditions near the beginning and the conclusion of the wind. The diameters of the core, drums, and rider roller were 10.16, 25.4, and 15.24 cm, respectively. The web tension (T_o in Figure 13) was about 1.75 N/cm and the rider nip load was 17.5 N/cm. The method of control on the drum drives and the torque levels are not specified. The thread path and wrap of the web about Drum 1 is also unspecified. The unspecified parameters, along with known differences in drum diameters with those used in the current study, make direct comparison difficult. There are some interesting similarities however. In Figure 10, WOT data is displayed for a condition where the rider roller diameter and the web tension is comparable to Rand and Eriksson's winder. At their rider load of 17.5 N/cm a WOT1 of nearly 1 N/cm is shown in Figure 10, a WOT2 of about 4 N/cm, and a WOT of 6 N/cm was inferred from pull tabs. When near the core, Rand and Eriksson's data jumps from about 0.2 to 3 N/cm as the web passes beneath the rider roller, which is comparable to the difference in WOT2 and WOT1 data from this study. After passing Drum 2, Rand and Eriksson's data

¹ This data was reproduced herein with the permission of L.G. Eriksson.

increases to 4 N/cm. Given the limited knowledge of the inputs as discussed, and the different drum sizes and not knowing how the paper properties compare between the two studies, further comparison would appear futile. It is noted that the maximum WOT appears to increase slowly with winding radius. Rand and Eriksson indicate an increase of 4 to 4.5 N/cm while the wound roll increases from 5.1 to 39.35 cm of winding radius. A similar increase was seen in WOT2 in this study in Figure 5 but over an 8 to 17 cm increase in wound roll radius. One interesting feature in Rand and Eriksson's data is in the data taken when the wound roll had achieved 78.7 cm in diameter where the WOT achieved the maximum value in the second layer. This data indicates that WOT2 in the outer layer is about 1.5 N/cm while the maximum value is near 5 N/cm. Such increases between WOT2 and the final WOT were not seen in the present study.

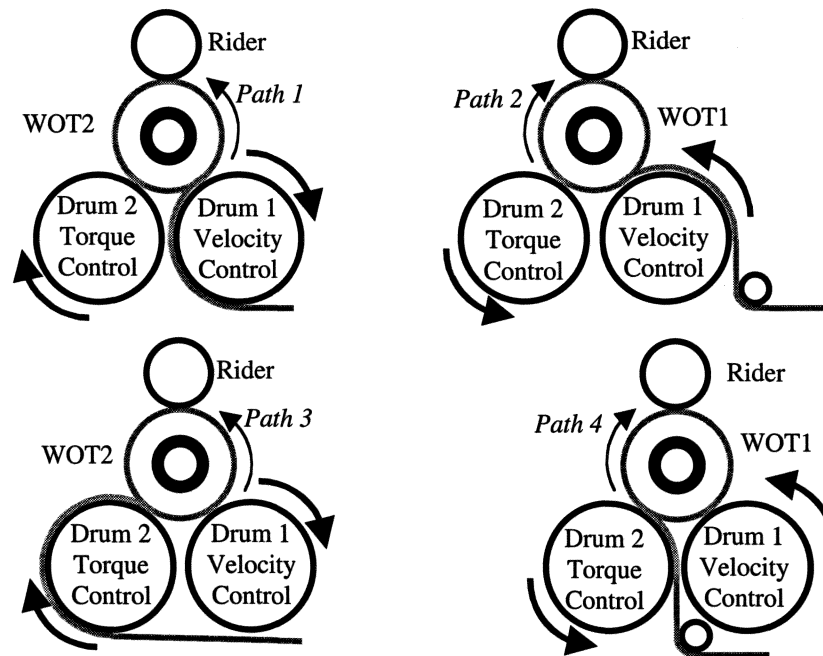

Figure 14 – Web Paths Tested

EFFECT OF THREAD PATH

Another facet of this study was the impact of thread path on WOT. Shown in Figure 14 are the different thread paths that were studied. Note the two drums remained in the same mode of control throughout these tests but depending on the thread path the web may encounter either the velocity controlled Drum 1 or the torque controlled Drum 2 first. The results reported thus far have all been for thread Path 1. Those results showed that the WOT2 data always followed the same trends as the WOT data inferred from pull tabs. In thread paths 1 and 3, the WOT2 measurement is the closest load cell WOT measurement to the position where the outer layer becomes the second layer. In thread paths 2 and 4 the WOT1 measurement is the closest load cell WOT measurement to the

position where the outer layer becomes the second layer. These measurements will be used to compare the four thread paths. Although these measurements will not yield the maximum WOT that could have been measured with pull tabs, they should yield a good means for relative comparison. Several conditions were run during the winding of one roll. Repeat conditions were run intermittently to check the influence of wound roll diameter. The conditions run are shown in Table 2 and conditions 1, 5, and 8 are the repeat conditions.

Condition	Web Tension (N/cm)	Rider Load (N/cm)	TORQ2 (N-m)
1	2.18	18.18	11.3
2	2.91	18.18	11.3
3	3.64	18.18	11.3
4	2.18	9.09	11.3
5	2.18	18.18	11.3
6	2.18	27.27	11.3
7	2.18	18.18	5.65
8	2.18	18.18	11.3
9	2.18	18.18	16.95

Table 2 – Test Conditions for Thread Path Study

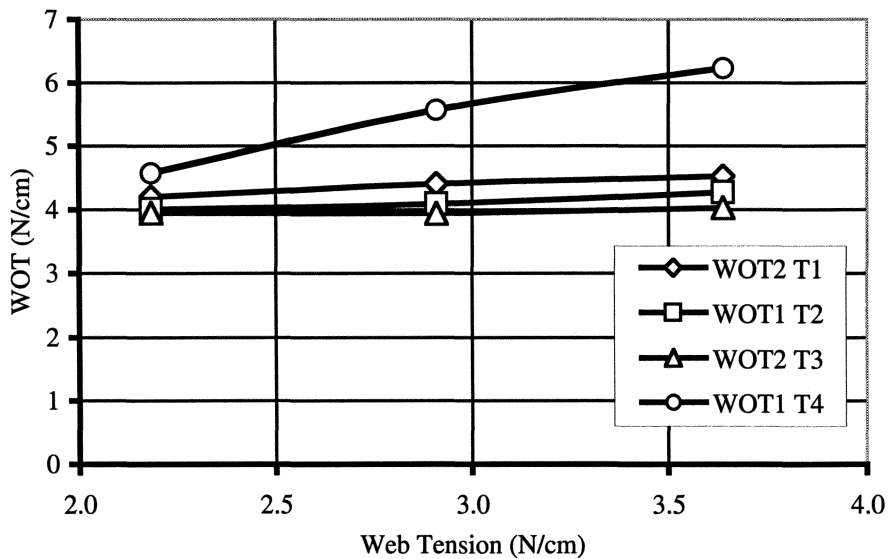

Figure 15 – Effect of Thread Path and Web Tension on WOT resulting from Test Conditions 1, 2, and 3.

The first results shown in Figure 15 show the effects of web tension and thread path on WOT. As mentioned previously, due to dissimilar properties, Drum 1 will have a higher surface velocity than the winding roll. Most of the web tension is lost in friction between the outer layer and Drum 1. Thus varying web tension would be expected to have minimal impact on the WOT in thread paths 1 and 2. In thread path 4, the web first encounters Drum 2. During conditions 1, 2, and 3 TORQ2 is held constant at 11.2 N-m which provides 37.1 N of driving force to the surface of the wound roll. The baseline value of web tension is 2.18 N/cm which when multiplied by the web width is 53.3 N. Thus the torque provided to Drum 2 would be insufficient to wind a roll if it were not for

the torque provided to Drum 1 in effort to maintain constant winding velocity. Thus as web tension is increased, TORQ1 will increase. An increase in TORQ1 results in an increase in WOT1 seen in Figure 15. Thread path 3 appears even less sensitive to increases in web tension than thread paths 1 and 2. Similar to thread path 4, increases in web tension for thread path 3 must be compensated with increases in the torque supplied by Drum 1 in its effort to maintain constant velocity. Although increases in the torque applied to Drum1 (TORQ1) would appear to increase the tension in the outer layer between drums 2 and 1 (on the bottom of the wound roll) for thread path 3, almost no impact is seen in the WOT1 or WOT2 measurements.

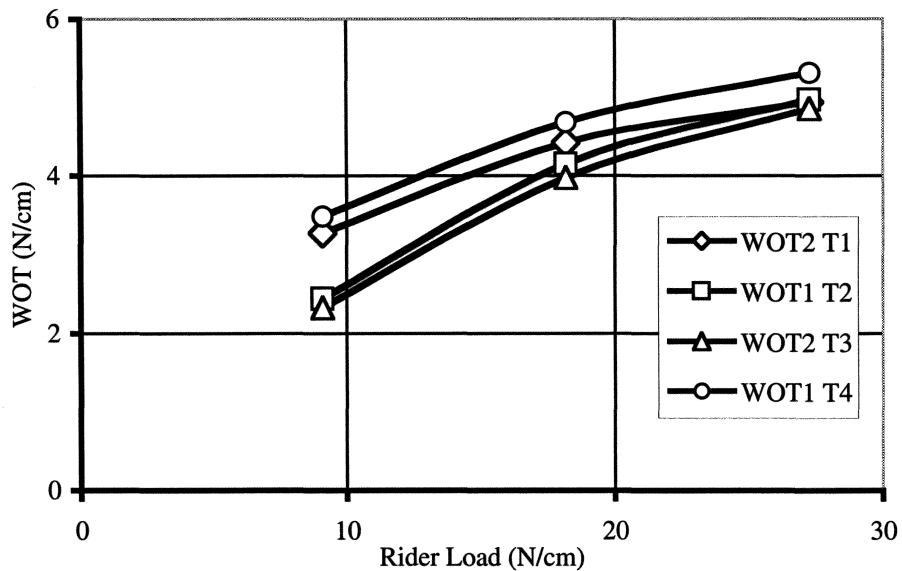

Figure 16 – Effect of Nip Load and Thread Path on WOT

In Figure 16, the effects of nip load and thread path are shown which resulted from data taken during test conditions 4, 5, and 6 for each of the thread paths. In general, it is shown that increased nip load yields increased WOT for all of the thread paths. Beyond this it appears that the results for thread paths 1 and 4 are similar and those results from thread paths 2 and 3 are similar as well. It should be noted that thread paths 1 and 4 are similar in that there is direct contact between the drum and the outer layer just following the WOT2 and WOT1 measurements, respectively. In thread paths 2 and 3 the incoming web is merging with the outer layer just following the WOT1 and WOT2 measurements, respectively. Thus the different friction conditions may explain the difference in behavior at lower rider and drum loads. At higher loads, the majority of the slippage may have been prevented and thus making the WOT independent of friction coefficients.

The effects of the torque applied to Drum 2 and thread path are shown in Figure 17 which resulted from data taken during test conditions 7, 8, and 9 for each of the thread paths. Note that in thread paths 2 and 3 that the web first passes beneath the wound roll between the two drums. An increase in TORQ2 is accompanied by a decrease in TORQ1 required to keep the surface velocity of Drum 1 constant and the net effect is no change in WOT in the outer layer. In thread path 2, two additional conditions were run in which TORQ2 was set at 3.4 and 22.6 N-m while holding nip load and web tension constant per the values set in conditions 7, 8, and 9 with little effect. In thread path 1 the behavior is

similar to that presented in Figure 9. Increase in TORQ2 in Path 1 appears to directly effect the WOT. Finally in Path 4 it is shown that increases in TORQ2 are accompanied by decreases in TORQ1 and since Drum 1 is now downstream of the rider the WOT decreases proportionately.

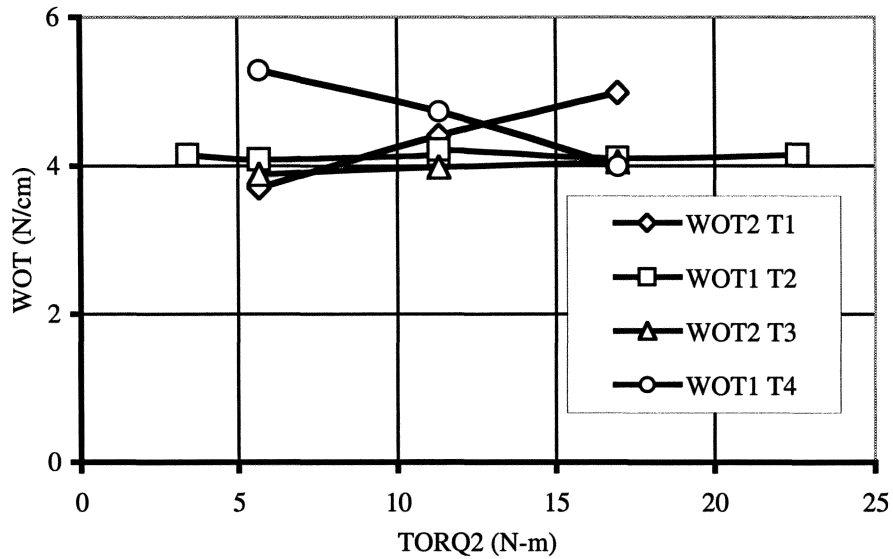

Figure 17 – Effect of TORQ2 and Thread Path on WOT

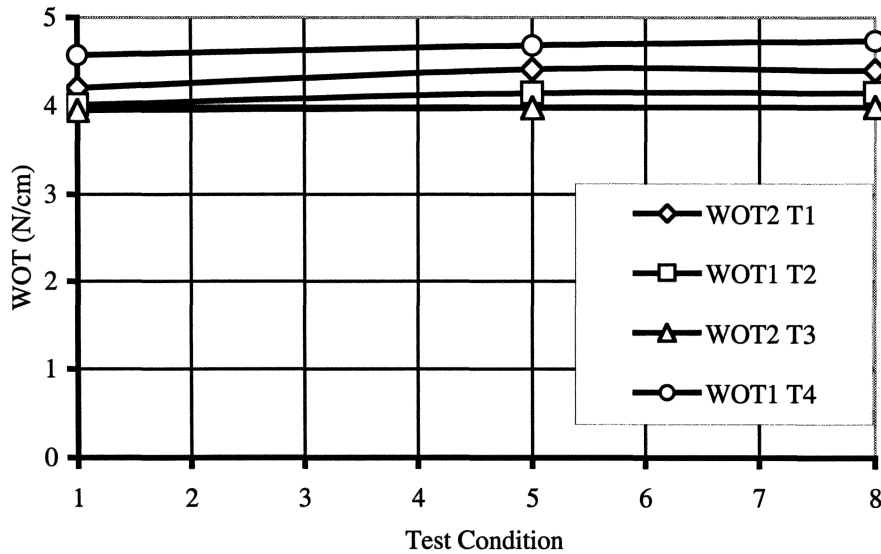

Figure 18 – Variation in WOT for Repeat Conditions for Various Thread Paths

JK 15 11

Finally in Figure 18 the repeat conditions 1, 5, and 8 are shown for the different thread paths. There is a slight increase in WOT with wound roll radius but no variation of a magnitude that would significantly impact the data presented in Figures 15, 16, and 17.

CLOSURE & CONCLUSIONS

Authors [10, 11] in the past have discussed how torque, nip, and web tension affect a wound roll (i.e. the TNT's of winding). The first conclusion from this study is that what have been considered winder input variables in the past may have little impact on the WOT and roll stresses and that one must define the method of control of the drives and the thread path before drawing conclusions.

Given that Drum 1 is in velocity control and Drum 2 is in torque control, conclusions can be drawn regarding how input parameters affect the WOT:

- Web tension has no impact on the WOT in thread paths 1, 2, and 3.
- Web tension has significant impact on the WOT in thread path 4.
- Increases in the torque delivered to Drum 2 have no impact on the WOT in thread paths 2 and 3.
- Increases in the torque delivered to Drum 2 decreases the WOT in thread 4.
- Increases in the torque delivered to Drum 2 increases the WOT in thread path 1.

It is evident why thread path 1 is the most prevalent in the industry since both increases in rider load or the torque provided to Drum 2 can increase the WOT. For low modulus webs, the velocity difference between Drum 1 and the wound roll may be insignificant as the web may have been subject to very large strains in the incoming span. In these cases, it is likely that increasing web tension will yield increased WOT as well.

Thread paths 2 and 3 would appear to be the least popular since only nip load can be used to affect the WOT.

Thread path 4 is the only path in which the web tension, the rider load, and the torque provided to Drum 2 all affect the WOT. Increases in web tension and rider load yield increases in WOT while an increase in TORQ2 yields a decrease in WOT.

Two drum winders are notorious for generating crepe wrinkles in webs wound into rolls. It appears that retaining a positive level of WOT in the each of the three zones (i.e. WOT1, WOT2, and WOT) should be a priority. Results herein have shown that increased rider load will increase WOT2 but at the expense of decreasing WOT1. Thus either low or no tension in the WOT1 zone is possible. High rider loads and small rider roller diameters will induce the highest WOT2 levels and the lowest WOT1 levels as shown in Figures 10 and 11. For thread path 1, the torque delivered to Drum 2 (TORQ2) provides increases in WOT1, WOT2, and WOT as shown in Figure 9. Thus the TORQ2 winder input parameter is more robust than the rider load in that its increase will result in an increase in WOT without increased risk of crepe wrinkles. The product of the Drum 2 nip load, the friction coefficient (web to drum), and the Drum 2 radius dictate the maximum level of TORQ2 that can be input. Thus in some scenarios where high WOT is needed both the rider load and TORQ2 may have to be increased.

REFERENCES

1. Good, J. K., Hartwig, J. and Markum, R. "A Comparison of Center Winding with a Nip and Surface Winding using the Wound-In-Tension Measurement Technique," Proceedings of the Fifth International Conference on Web Handling, "Web Handling Research Center, Stillwater, Oklahoma, June 1-4, 1999.

2. Pfeiffer, J.D., "Nip Forces and their effect on wound-in tension," Tappi Journal , Vol. 60, no. 2, February 1977.
3. Monk, D.W., Lautner, W.K. and McMullen, J.F. "Internal Stresses Within Rolls of Cellophane.", Tappi Journal , Vol. 58, no. 8, August 1975.
4. Hakiel, Z. "Nonlinear Model for Wound Roll Stress," Tappi Journal, Vol. 70, no. 5, pp. 113-117, 1987.
5. Jorkama, M., "Contact Mechanical Model for a Winding Nip," PhD Thesis, Helsinki University of Technology, 2001.
6. Good, J. K., "Modeling Nip Induced Tension in Wound Rolls," Proceedings of the Sixth International Conference on Web Handling," Web Handling Research Center, Stillwater, Oklahoma, June 10-13, 2001.
7. Johnson, K. L., Contact Mechanics, Cambridge University Press, 1985, pp. 247-249.
8. Olsen, J.E, and Irgens, F., "Aspects of TwoDrum Winding," Proceedings of the Fourth International Conference on Web Handling," Web Handling Research Center, Stillwater, Oklahoma, June 1-4, 1997.
9. Rand, T. and Eriksson, L.G., "Physical Properties of Newsprint Rolls During Winding," TAPPI Journal, Vol. 56, N. 6, June, 1973.
10. Frye, K.G., Winding, TAPPI Press, 1990, pp. 13-29.
11. Roisum, D.R., The Mechanics of Winding, TAPPI Press, 1994, pp. 6-12.