



TAMPEREEN TEKNILLINEN YLIOPISTO  
TAMPERE UNIVERSITY OF TECHNOLOGY

Antti Rautiainen

**Aspects of Electric Vehicles and Demand Response in  
Electricity Grids**



Julkaistu 1327 • Publication 1327

Tampere 2015

Tampereen teknillinen yliopisto. Julkaisu 1327  
Tampere University of Technology. Publication 1327

Antti Rautiainen

## **Aspects of Electric Vehicles and Demand Response in Electricity Grids**

Thesis for the degree of Doctor of Science in Technology to be presented with due permission for public examination and criticism in Sähkötalo Building, Auditorium S2, at Tampere University of Technology, on the 6th of November 2015, at 12 noon.

Tampereen teknillinen yliopisto - Tampere University of Technology  
Tampere 2015

ISBN 978-952-15-3586-4 (printed)  
ISBN 978-952-15-3615-1 (PDF)  
ISSN 1459-2045

# Abstract

The growing global energy demand combined with limited resources of fossil energy (especially crude oil), climate change and other environmental issues, the energy system has faced significant challenges. There is significant pressure to diversify the energy sources towards more sustainable choices and to increase energy efficiency. Shifting gradually from the use of fossil fuels to use of renewable energy sources is a long way to go, and to make it economically feasible requires a significant amount of will, effort and innovation.

This thesis deals with two parts of the energy system: the electrical energy system and the energy system of road transportation. A “smart” electrical energy system of the future includes the flexibility of electricity demand, i.e. *demand response (DR)*, enabled by different types of incentives and offering many potential advantages. A road transportation system of the future can include significant amount of *electric vehicles (full electric vehicles – full EVs and plug-in hybrid electric vehicles – PHEVs)* as part of the vehicle fleet. These vehicles could also participate in the operation of an electrical power system. This thesis discusses electric vehicles and demand response in smart grid context.

The most important results and findings of the thesis are the following. In Finland, PHEVs could offer a significant proportion or even most of the benefits of EVs even with a quite modest charging infrastructure, and simultaneously the most severe obstacles of full EVs could be avoided or at least mitigated. In this thesis, a flexible methodology for modeling PHEV charging load using National Travel Survey data has been developed. Statistical PHEV charging load models, taking into account modeled statistical distributions of the loads, have been used by two different real DNOs in their network information systems to assess the impacts of EVs on distribution network planning in urban networks. It seems that high amounts of EVs fit well into Finnish distribution networks, but in certain cases demand response of electric vehicles would be reasonable. Electric vehicles, some DR actions and other changes in electricity use can increase peak powers in distribution networks. New distribution tariffs have been developed and simulated in a real distribution network with the purpose of encouraging small electricity customers towards peak load restriction. It seems that these kinds of tariffs would be efficient in restricting the increase of peak powers of spot price based DR, although it seems to be hard to decrease the present peak powers very much in the distribution networks. Different general DR and smart charging concepts have been sketched, and a practical local customer-site peak load control management algorithm of an EV charging station group has been developed as a tool to realize demand response of a group of electric vehicles.

# Preface

This thesis was made in the Department of Electrical Engineering of Tampere University of Technology. The main supervisor of the thesis has been Professor *Pertti Järventausta*. Pertti has always been ready to discuss not only the outline and the big picture of my thesis, but also the tiniest or the most detailed problem in the research. Pertti's basic attitude and spirit have always been extremely encouraging and positive. Pertti also understands the every-day challenges of a researcher as well as the difficulty of maintaining a balance between work and family life. For all this I want to express my deepest gratitude to Pertti, and I wish you all the best! An additional important supervisor of my thesis, especially during the first years, has been Professor *Sami Repo*. I think Sami has good and extensive general knowledge in many areas of science and engineering, and this combined with Sami's ability to think innovatively makes Sami's support and comments very valuable for me. I want to give my warmest thanks to Sami for all of this.

The pre-examiners of this thesis have been Emeritusprofessor *Seppo Kärkkäinen* and Professor *Goran Strbac*. I want to thank the pre-examiners for the pre-examination, the encouraging feedback and the comments which helped me to improve the manuscript.

I want to thank the whole Department of Electrical Engineering for a good working environment. I also want to thank my colleagues in our research group who have provided a relaxed and inspirational working atmosphere. My colleagues have also helped me in many ways along my research path. I especially want to thank the following persons: *Antti Mutanen, Joni Markkula, Antti Supponen and Kimmo Lummi*. A significant benefit for a researcher is that one does not have to worry about administrative issues. Therefore I want to thank our great administrative personnel *Merja Teimonen* (during my first years in the department), *Terhi Salminen, Nitta Laitinen* and *Mirva Seppänen*.

There are many people outside of our department who deserve acknowledgments. I want to thank Adjunct Professor *Kai Vuorilehto* from Aalto University for the cooperation and for tirelessly teaching me the basics of lithium-ion batteries. I also want to thank *Heikki Liimatainen* from TUT Verne, *Matti Mononen* from UEF, *Heikki Rantamäki* from Pohjois-Karjalan sähkö Oy and *Juha Vesa* from Sesko ry for commenting on some parts of my thesis manuscript. I also thank Ensto Finland Oy for the opportunity to work with you for the smarter charging of EVs.

I also want to thank translator *Sirpa Järvensivu* for improving my tankero English over the years.

My way of doing research has been a bit unusual. I have mostly worked as a remote worker in the campus of University of Eastern Finland in Joensuu, roughly 400 km away of my colleagues in my research group. I want to thank UEF for good office

services. I also want to address special thanks to *Reijo* and *Ulla* for your friendship, help and hospitality during my many visits in Hervanta.

The research work for the dissertation has been funded by several research projects mainly founded by Tekes and various industrial partners in projects such as "Methods for active distribution management (ElDig2\_VPP)", "Interactive customer gateway for electricity distribution management, electricity market, and services for energy efficiency (INCA)", "Smart Grids and Energy Market (SGEM)", "National test site for electric vehicles (EVELINA)", "Demand Response – Practical solutions applied in Finland and network impacts (DR-pooli)", and "National research platform for development of electric vehicles, mobile machinery and systems / EV systems and grid integration (ECV/eCharge)". In addition, the Fortum Foundation, Ulla Tuominen Foundation and Jenny and Antti Wihuri Foundation have participated in the funding of the research work. I warmly thank all the institutes for the funding.

The nearest people around me deserve many acknowledgments. Firstly, I want to thank my parents *Anja* and *Markku* for the warm and solid ground of my life: happy and safe childhood, safe and warm home and the unconditional love. Your support during these years not only for me but my whole family has been significant. I also want to thank my siblings *Miia*, *Nanna*, *Ilkka* and *Mikko*, with your families, for all your support. My parents-in-law, *Eeva* and *Jaakko*, deserve acknowledgments for their significant support along the years. Also my brother and sisters-in-law with their families deserve many thanks. I also want to thank all my friends around Finland who have supported me during the recent years.

I also want to thank my dear, sweet, bright and wonderful children *Vilma*, *Aatu*, *Selina*, *Iivari* and *Mikael* for your whole-hearted love and for the tremendous joy you have brought with you! You are five little shining lights in my days! Daddy loves you so much!

It is hard to find comprehensive enough words to thank the love of my life: my lovely and precious wife *Nanna*. I am as happy as a man can be for having you in my life. You have also given your all for our family 24/7 without sparing your strength. I hope I could somehow really thank you for this.

Life is short. We are here maybe some decades and then flow into eternity. "But if we walk in the light, as he is in the light, we have fellowship one with another, and the blood of Jesus Christ his Son cleanseth us from all sin." 1. John 1:7

Joensuu, August 2015

Antti Rautiainen

# Table of contents

- Abstract ..... i
- Preface..... ii
- Table of contents ..... iv
- List of publications..... vi
- List of abbreviations.....vii
- 1 Introduction..... 1
  - 1.1 The motivation of the thesis ..... 1
    - 1.1.1 Electrical energy system ..... 1
    - 1.1.2 Energy system of transportation ..... 2
  - 1.2 The scope and objectives of the thesis ..... 3
  - 1.3 The structure of the thesis ..... 5
  - 1.4 Author’s contributions in publications ..... 5
- 2 Introduction to demand response ..... 6
  - 2.1 Different market actors of DR ..... 7
  - 2.2 DR resources and their control ..... 8
  - 2.3 DR infrastructure ..... 10
- 3 Demand response in smart grids ..... 12
  - 3.1 TSO driven DR ..... 12
    - 3.1.1 Reserve markets ..... 12
    - 3.1.2 Frequency controlled load based on local frequency measurement ..... 14
  - 3.2 DNO driven DR ..... 16
    - 3.2.1 Distribution tariffs as DR incentives ..... 17
    - 3.2.2 DNO driven “ancillary service” DR ..... 24
  - 3.3 Electricity retailer driven DR ..... 26
  - 3.4 Consumer driven DR ..... 27
  - 3.5 The need for an aggregator or a DR operator ..... 27
  - 3.6 Conflicts of interest and a holistic point-of-view ..... 29
- 4 Introduction to electric vehicles ..... 30
  - 4.1 Definition of electric vehicle ..... 30
  - 4.2 Drivers for EVs ..... 31

4.3	Barriers for EVs.....	34
4.4	PHEVs vs. full EVs .....	36
4.5	Charging of EVs.....	41
4.5.1	Standard charging solutions .....	41
4.5.2	Market mechanisms for EV charging .....	43
4.5.3	Where and what kind of charging infrastructure should be built.....	45
5	Electric vehicles in smart grids.....	48
5.1	EVs as a charging load .....	48
5.2	Impacts of EV charging on electricity grid .....	51
5.2.1	Transmission grid level.....	51
5.2.2	Distribution grid.....	52
5.2.3	Networks of real estates .....	56
5.3	Smart charging .....	56
5.3.1	Smart charging architectures.....	56
5.3.2	Example: coordination of domestic loads.....	58
5.3.3	Example: load control of an EV charging station group.....	61
5.4	EVs as energy storage for the electricity system’s needs.....	65
5.4.1	The applications of EV as an electricity storage.....	65
5.4.2	Battery degradation cost posed by electricity storage use of EVs .....	67
6	Conclusions.....	69
6.1	Main contributions .....	70
6.2	Future work .....	70
	References .....	72



# List of publications

1. **A. Rautiainen**, S. Repo, P. Järventausta, "Using frequency dependent electric space heating loads to manage frequency disturbances in power systems", in *proc. IEEE PowerTech*, 2009, Bucharest, Romania, 6 p.
2. **A. Rautiainen**, A. Supponen, A. Mutanen, K. Lummi, J. Markkula, M. Mononen, S. Repo, P. Järventausta, "Analysis of Power-based Distribution Tariffs for Demand Response of Small Customers – Case Study of a Real DNO's Network", *submitted to Electric Power Systems Research*, 10 p.
3. **A. Rautiainen**, S. Repo, P. Järventausta, A. Mutanen, K. Vuorilehto, and K. Jalkanen, "Statistical charging load modeling of PHEVs in electricity distribution networks using national travel survey data", *IEEE Transactions on Smart Grid*, vol. 3, no. 4, Dec. 2012, pp. 1650-1659.
4. **A. Rautiainen**, A. Mutanen, S. Repo, P. Järventausta, R. Ryymin and J. Helin, A. Tammi, A. Unkuri and M. Pekkinen, "Case studies on impacts of plug-in vehicle charging load on the planning of urban electricity distribution networks," in *proc. IEEE EVER (Electric Vehicles, Renewable Energy) '13*, 2013, Monaco.
5. **A. Rautiainen**, S. Repo, P. Järventausta, C. Evens, "Requirements for an interface between a plug-in vehicle and an energy management system," in *proc. IEEE Powertech 2011*, Trondheim, Norway, 8 p.
6. **A. Rautiainen**, J. Markkula, S. Repo, A. Kulmala, P. Järventausta, K. Vuorilehto, "Plug-in vehicle ancillary services for a distribution network," in *proc. IEEE EVER (Electric Vehicles, Renewable Energy) '13*, 2013, Monaco.
7. **A. Rautiainen**, and P. Järventausta. "Load control system of an EV charging station group", in *proc. of Nordac 2014 – Eleventh Nordic Conference on Electricity Distribution System Management and Development*, Stockholm, Sweden, 11 p.

# List of abbreviations

AMI	Automatic Metering Infrastructure
BA	Building Automation
BPM	Balancing Power Market
DNO	Distribution Network Operator
DR	Demand Response
ERGEG	The European Regulators Group for Electricity and Gas
EREV	Extended Range Electric Vehicle
EV	Electric Vehicle
FCR-D	Frequency Containment Reserve for Disturbances
FCR-N	Frequency Containment Reserve for Normal operation
FRR-A	Automatic Frequency Restoration reserves
GHG	Greenhouse Gas
HA	Home Automation
HEM(S)	Home Energy Management (System)
IC-CPD	In-Cable Control and Protection Device
ICE	Internal Combustion Engine
ICT	Information and Communication Technology
LCO	Lithium-cobalt oxide
LFP	Lithium-iron phosphate
LMO	Lithium-manganese oxide
LTO	Lithium-titanate
NIS	Network information system
NCA	Nickel-Cobalt-Aluminum oxide
NCM	Nickel-Cobalt-Manganese oxide
NTS	National Travel Survey
PHEV	Plug-in Hybrid Electric Vehicle
RCD	Residual Current Device
REEV	Range Extended Electrical Vehicle
SOC	State Of Charge
TSO	Transmission System Operator



# 1 Introduction

## 1.1 The motivation of the thesis

The world uses a lot of energy today, and it seems that the energy need is growing in the future (EIA 2013). Most of the countries in the world try to achieve economic growth which has historically been closely related to increase of energy consumption. Regardless of the change in the expected global trends like energy efficiency and digitalization, the global economic growth does not necessarily disengage from the growth of energy use very rapidly. Today's developed societies are also extremely dependent on reliable and cost-efficient energy supply and the dependency seems to be increasing for example due to digitalization. Different types of environmental issues, especially climate change, have also set demanding requirements for the energy systems. Also energy and fuel supply and especially oil supply include many types of uncertainties which may cause serious problems in the future especially combined with the challenges of climate change (Partanen et al. 2013; Partanen et al. 2015; Höök & Tang 2013; Sorrell et al. 2009). The aim of this thesis has been to make a small contribution towards enabling a smoother transition to a more sustainable and adequate energy system. The thesis deals with two parts of the energy system: *the electrical energy system* and *the energy system of transportation*.

### 1.1.1 Electrical energy system

Today's electrical energy sector and industry are in the middle of changes (Bollen 2011). Climate change and other environmental issues, the opening of the electricity markets and their pursuit of more efficient operation, increased reliability requirements and ageing of network assets have set and will further set new requirements for power systems. An often quoted, emphasized and even hyped concept is the so called "*smart grid*". There are different definitions for smart grid. The European Regulators Group for Electricity and Gas (ERGEG) defines smart grid as follows (ERGEG 2010): "*Smart Grid is an electricity network that can cost efficiently integrate the behavior and actions of all users connected to it – generators, consumers and those that do both – in order to ensure economically efficient, sustainable power system with low losses and high levels of quality and security of supply and safety*". This definition describes in a way an "ideal" electricity grid or the ultimate goal to which development should be targeted. Another example of smart grid definition is stated by Bollen (Bollen 2011): "*smart grids are the set of technology, regulation and market rules that are required to address the challenges to which the electricity network is exposed in a cost-effective way*". ERGEG's definition emphasizes the main targets of the power system and Bollen's definition emphasizes the forthcoming challenges of the electricity network. Neither of the definitions is bound to any specific methods, tools or technologies to achieve the goal(s) of the definition. However in the "smart grid" related activities, ICT (Information and Communication Technology) aspects are very often present.

Especially the rapidly developing ICT sector but also other technological developments bring new possibilities for electrical energy systems. In the future there will be more communication possibilities, more measurements, more computation capacity, better modeling and more controllable resources available than previously. To improve the cost-efficiency of the system or to introduce improvements or new useful services worth money, the new assets and systems mentioned above can be used. New technologies can be used to develop the system to a “smarter” direction. The “smartness” of the grid is not in the use of new technologies, but in the advantages obtained by using the new technologies. In other words, the smartness is in the *achieved cost-effectiveness* of the system and/or in *the improved operation and/or the new functionalities worth the additional money spent*.

A general property of a smart grid is flexibility; the grid adapts to every situation in the best possible way taking into account the available resources (cf. the definitions of a smart grid mentioned above). In a power system, production and consumption of electricity must be kept in a balance all the time (Bollen 2011; Kothari & Nagrath 2004). In a traditional paradigm, electricity demand varies according to consumers’ needs and the production units regulate their production in order to keep the balance (Bollen 2011). Thus, the production operates as the responsive resource. Another possibility is that also some of the consumption would respond to keep the balance between production and consumption (Bollen 2011). Today for example in Finland only some large industrial electricity consumers participate to the power balance management, but there is a growing debate and interest in also having smaller consumers involved. Not only from power balance management but also from a more general point-of-view, electricity consumption today is quite a passive “resource” and participates in the operation of the electricity system only very little. In addition to management of power balance, controllable consumption could also be used for a tool of electricity trade and operation of distribution grids. In order to do this, the consumer has to make some kind of a contract with some party of the electricity sector to achieve some benefit of the actions. In this thesis, all of the *consumption* flexibility and responsiveness described above is called *demand response* (DR). DR is often considered as a built-in part of future’s smarter grids.

### 1.1.2 Energy system of transportation

Today’s societies and especially the transportation system are highly dependent on oil (Partanen et al. 2013; Partanen et al. 2015). Almost every function in today’s society is related in a way or another to oil or oil based transportation. The amount of petroleum in the ground decreases continuously and the global petroleum consumption has been increasing from 21 Mbpd (million barrels per day) to 88 Mbpd between 1960–2012 (Davis et al. 2014), and as living standards in many highly populated developing countries such as China are increasing, the demand for petroleum and energy in general will increase over the course of the coming years (EIA 2013). Most of the petroleum is used as fuels of transportation. Easily drillable and thus “cheap” oil might be running out faster than many people expect (Murray & King 2012; Sorrell et al. 2009). Thus, reducing oil dependency is a significant global challenge of the coming years and

decades. However, it is not an easy thing to do. In principle, there are many ways to reduce oil consumption and oil dependency, such as energy efficiency improvement of conventional vehicles, replacing oil based heat and electricity production by other types of production, new fuels of transportation and new materials replacing other oil based products in general. Also, as global urbanization trend is expected to continue (United Nations 2014), the need for public transport is also probably increasing which tends to decrease the demand for personal passenger car transportation. On the other hand, due to the expected global economic growth of the future, more people will have more possibilities to buy personal cars in the future. This thesis concentrates on the transportation sector and especially road transportation and its electrification.

One possibility to reduce oil dependency, primary energy consumption and emissions of road transportation is to use *electric vehicles (EVs)*. EVs are road vehicles which include an electric power train and an on-board electricity storage which can be charged from an energy source outside the vehicle. There are mainly two types of electric vehicles: *full electric vehicles* and *plug-in hybrid electric vehicles (PHEVs)*. In a full EV, there is only an electric power train. In a PHEV, in addition to the electric power train, there is also another power source, typically internal combustion engine using gasoline or diesel. From the energy system point-of-view, the most important aspect of EVs is that the use of liquid fuel is replaced by the use of electricity produced in electric power plants. Although it is quite clear that there will be many types of vehicles on the roads in the future, and these vehicles will use many types of fuels, electric vehicles (EVs) could contribute significantly to the solution palette of a more sustainable road transportation system. During the last few years almost all car manufacturers have launched some kind of EVs to the market, and innovation and research in this area has accelerated.

If scenarios with large penetration levels of EVs are considered, many questions like “Should EVs be taken into account in electricity distribution network planning?” or “Could the electrical energy system benefit from EVs?” arise. One branch of smart grid related research and innovation has been to “integrate” EVs to the electrical energy system in a way that the full advantage of EVs could be realized. This means that electric vehicles could be used as resources for DR by controlling their charging in different ways, and this is sometimes called “smart charging”. EVs could also be used as electricity storage for the needs of the electrical energy system. The research in these areas has been very extensive and plentiful during the past few years.

## **1.2 The scope and objectives of the thesis**

As mentioned in the previous section, this thesis deals with the energy system of transportation and the electrical energy system. Special attention is focused on two things: *electric vehicles* and *demand response*. Figure 1.1 illustrates the research areas of the thesis. Thematically, the “electric vehicles” theme belongs to the “energy system of transportation” theme but partly also to the “electrical energy systems” and further to “demand response” themes. Also, there are lots of demand response related research questions which do not involve EVs.

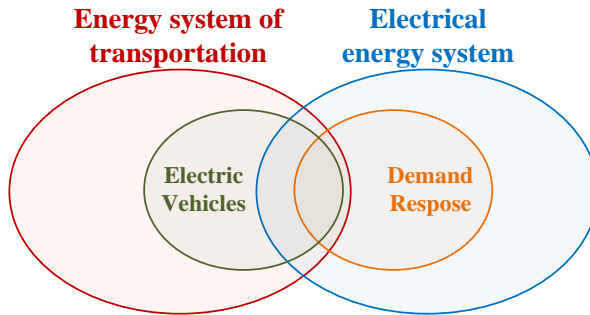

**Fig. 1.1.** *The areas of research of this thesis.*

The first research plan created with this thesis in mind included almost solely related topics such as EV charging load modeling, impacts of EVs to the electricity distribution network design and “smart charging”. Later it was noticed more clearly that many research questions, concepts and thoughts related to smart charging also applied to other types of controllable loads besides EVs. Thus, the research area was then expanded to cover more general demand response related issues.

The objective of the thesis has been to analyze the possibilities of EVs and DR to contribute to the future’s more sustainable society and to analyze and solve some of the possible obstacles which are in the way of integrating EVs and DR in the energy system in a smart way. The contributions of the thesis, which are discussed in Chapter 6, include some practical findings which help in this task.

In this thesis, the scope of the studies is concentrated on the following research topics, which form a cohesive entity.

1. Possibilities of PHEVs and full EVs as contributions to a “sustainable” transportation system (using the methodology of Publication 3).
2. Charging load modeling of EVs in electricity grids (Publication 3).
3. Impacts of EVs on the electricity distribution network design (Publication 4).
4. EVs as a resource of DR by “smart charging”, (Publications 5–7).
5. Methods and incentives for DR, (Publications 1–2).
6. Impacts of DR on electricity distribution networks, (Publication 2).

The main research method of this thesis has been simulation. Simulation is a powerful research method, and taking into account the area of research of this thesis, simulation is often the only practical choice. The research material and data of the thesis consists mainly of the National Travel Survey of Finland, electricity network models and electricity consumption data produced by automatic metering infrastructure (AMI) meters of different companies.

Electrical energy systems and transportation systems in different countries and areas differ from each other in some ways. However, the research questions and methodology are generic and globally applicable, but assumptions and point-of-view are often Finnish and/or Nordic.

### 1.3 The structure of the thesis

Considering the number of publications and the amount of research effort, the electric vehicle theme is the primary theme of the thesis and should therefore be presented first. However, the EV related research was also related to demand response, and for the coherence of the presentation, the DR related parts of the research are presented first.

In *Chapter 2*, the concept of demand response is defined and discussed in general. In *Chapter 3*, different types of DR applications, related actors, relevant incentives and impacts of DR on distribution networks are presented. In *Chapter 4*, different types of EVs and drivers, barriers and possibilities for electrification of road transportation are presented. In *Chapter 5*, EVs in smart grids in different roles are discussed and presented. Charging load modeling methodology and impacts of EV charging in the electricity grids are discussed. Also “smart charging” and the EV as a resource of DR and EVs as electricity storages for the needs of the electricity system and electricity market are discussed. In *Chapter 6*, conclusions are made: the main contributions of the thesis and future work proposals are presented.

### 1.4 Author’s contributions in publications

The author of the thesis has conducted the research of the publications 1–7 and has also written the publications with the following exceptions.

**P. Järventausta** and **S. Repo** have been the supervisors of the thesis (P. Järventausta has been the primary supervisor), and their roles in the publications have been general discussion, guidance and commenting. **A. Mutanen** has produced the load flow calculation algorithm applied in Publication 2. He has also been commenting on Publications 2–4 especially related to AMI measurement and network data and distribution network load flow methodology and calculations. **K. Vuorilehto** and **K. Jalkanen** produced the lithium-ion charging curves for Publication 3 and also commented on issues related to lithium-ion batteries in the publication. **K. Vuorilehto** has also commented on issues related to lithium-ion batteries in Publication 6. **C. Evens** was in charge of writing the standardization related parts of Publication 5. **A. Tammi** and **A. Unkuri** made the network calculations and analysis in their M.Sc. theses, related to Publication 4, when working in two different distribution network companies. **R. Ryymin**, **J. Helin**, **M. Pekkinen** have been commenting on Publication 4 representing the distribution network companies’ points-of-view in the studies. **J. Markkula** has been a commentator of Publications 2 and 6. **A. Kulmala** has been a commentator of Publication 6. **K. Lummi** has been a commentator of Publication 2 especially in distribution tariff related issues. **A. Supponen** was involved in the design and implementation the optimization algorithms applied in Publication 2 and he has also been a commentator of the same publication. **M. Mononen** has been a commentator of Publication 2.



## 2 Introduction to demand response

As described in the introduction chapter, demand response (DR) is often considered as an important part of future's smart grids. DR is quite a broad concept, and generally different types of "demand flexibility", excluding energy saving and other actions which change the amount of electricity consumption, is typically considered to be "demand response". A commonly referred core definition for DR is presented in (DOE 2006): "*Changes in electric usage by end-use customers from their normal consumption patterns in response to changes in the price of electricity over time, or to incentive payments designed to induce lower electricity use at times of high wholesale market prices or when system reliability is jeopardized.*" Some complementing description and classification of different types of DR is made e.g. in (DOE 2006; Albadi & El-Saadany 2008; Bartholomew et al. 2009; Palensky & Dietrich 2011). The aforementioned definition does not, however, include all "demand flexibility" which could be logically thought to be "demand response". For example, the participation of load in power system reserve markets does not directly fit into the definition. In the opinion of the author of this thesis, it would be useful to take all the "demand flexibility" into account in a holistic sense. In this thesis, the following quite broad but compactly presented definition is proposed. *Demand response means that electricity consumers change their electricity consumption in accordance with some input(s) coming from some actor(s) so that the actor(s) and the consumers benefit from the action* (Publication 2). In other words, *demand* for electricity *responds* to some input(s) in a way that benefits all parties involved (Publication 2).

DR can increase the total economical "efficiency" of the electrical energy system. DR can increase the utilization rate of assets and resources and thus the financial benefits of them. DR can also increase the efficiency of the electricity market and lower the price of electricity in short and long terms. DR might also improve the planning and usage of the electricity distribution networks and even increase their reliability. However, the incentives for DR in the future might be smaller as the incentives of DR seen today, because for example in the wholesale market DR decreases the price fluctuations of the spot market which again decreases the incentives for DR from customer point-of-view. On the other hand, there are several issues which increase the incentives for DR in the future on the wholesale market and power system level. Renewable and intermittent energy production is increasing significantly in the following years. Nuclear power plants are also built at the moment and more will probably be built in the future. Nuclear power plants, at least in Finland, and intermittent renewable production do not participate in the balancing of production and consumption in the power system. Also, as at least part of the intermittent production will be connected to the grid with power electronic converters, it decreases the amount of electromechanical inertia of the system, making the management of the power balance more difficult. All these factors increase the potential of DR.

A very fundamental precondition for success of DR is customer acceptance. People have to be ready to let the system control their electric loads. In Finland there is a long history and experience of controlling people's electric heating loads and also today many people use time-of-use tariffs (time-of-day or seasonal tariffs) and some of their loads are controlled in accordance. However, it is uncertain how well people would accept new types of DR. Time-of-use tariffs govern the use of the loads exactly in a predefined way and consumers know pre-hand how their loads are controlled. In possible DR of the future there might not be any pre-hand knowledge of the control actions for example during the next day. Today's DR acceptance depends on many things such as the type and amount of DR, the types of controlled loads, financial incentives etc. From the psychological point-of-view, people have to trust the DR system and related companies, and the transparency of the companies' operation can promote the issue.

The real world activity and market readiness in the area of DR varies by country and region. In (SEDC 2014), an extensive review of 15 European countries from the points-of-view of regulative requirements and market practices is made concerning four criteria: consumer access, program requirements, measurements & verification and finance & risk. When the assessment was made for 2014, the following results were obtained: in six countries the status of DR is "commercially active and established in a range of markets", in four countries the status of DR is "integration into a range of markets is taking place or selected markets are open" and the rest of the countries have plenty of work to be done (SEDC 2014). The US is also an interesting area, and there is non-negligible DR activity. In the US, roughly 5.4 million and 3.7 million customers have enrolled in so called "incentive-based DR programs" and "time-based DR programs" in 2012, respectively (FERC 2014). According to (SEDC 2014), in the US "29 GW of load is registered in some form of Demand Response program". During the recent years, many types of new activities around DR are going on in different parts of the US (FERC 2014). According to (SEDC 2014) "In 2013 in the USA, businesses and homeowners earned over \$2.2 billion in revenues from demand response, over and above avoided investment in grid infrastructure and power plants".

## **2.1 Different market actors of DR**

Around the concept of DR, there are many parties and actors involved. Possible actors are for example

- Electricity consumers including ones with small scale electricity production
- Electricity retailers/balance responsible parties
- Distribution network operators (DNO)
- Transmission system operators (TSO)
- Aggregator/service provider/DR operator.

In addition to these actors, the regulator involved in DR is indirectly a sort of a DR actor. In some cases DR might also affect the electricity generator companies although they are not directly DR market actors. An example of this could be in a situation where intermittent electricity production capacity produces with a power greatly exceeding the

total consumption (over-production situation). If there was an efficient DR market which could temporarily increase the load of the power system, the producers would not necessarily have to cut the intermittent production. Overall, DR can help the integration of intermittent and inflexible production to a power system. All of the DR actors have different goals and needs for DR which makes the whole DR sector somewhat complicated and also forms a significant threat to success of the whole DR concept. The advantage of one actor might be a disadvantage to another. This implies that the whole DR process should be carefully investigated as a whole and the results of the investigations should be taken into account by governments and regulators. In the following sections, different DR related aspects from different actors' points-of-view are discussed in more detail.

## **2.2 DR resources and their control**

The DR resources are owned by electricity consumers, which can be divided for example into three types: small, medium and large. Today in Finland the large electricity consumers such as big industrial facilities already participate to DR to some extent. However, the participation of medium-size and especially small consumers is mostly restricted to the use of two-time tariff based DR.. Especially for medium-size consumers, the implementation costs of DR might be moderate in many cases compared to the expected financial benefits. For small consumers it is estimated that there is roughly about 1800 MW (roughly 12% of the peak load in Finland) of loads currently connected to control relays of AMI (automatic metering infrastructure) meters in households (Honkapuro et al. 2014) in Finland. However, some of the loads can be controlled by so-called time-based control relays and others by so-called load reduction control relays (Honkapuro et al. 2014). In some cases one relay is used for both, and the real possibilities of DNOs to control the loads are often quite limited and depend on the DNO (Honkapuro et al. 2014).

Not all the loads are usable for DR purposes unless there is an electricity storage device available. Especially resistive electric heating and electric storage water heaters are the most interesting DR resources of today's small electricity consumers. But also different heat pumps might have some potential. All these appliances are interesting DR resources because they typically consume quite significant amounts of electricity, their nominal powers can be quite high and it is often not very critical when the load consumes the electricity, i.e. the consumption of the load can be shifted in time. In addition to shiftable loads, there are some loads which can be curtailed for a while like air conditioning and lighting. In addition to the conventional loads, electric vehicles are a new type of DR resource which might become a non-negligible one in the future. In the future, it might be reasonable to control some loads (e.g. washing machines and driers) which do not consume large amounts of energy on an annual scale, but take high electric power. This might be the case for example if peak power based distribution tariffs were applied and the peak power of one hour can influence the customer costs by a non-negligible amount. This topic is discussed more in Section 3.2.1. Electricity consumption and also the controllability of electric loads depend on many things.

Especially the consumption of heating loads depends strongly on the outdoor temperature which means that during warm weather there is only very little heating load for DR purposes. Technically there are many ways to control electric loads, but the possibilities depend on the nature of the load. Fig. 2.1 presents four different control methods.

Fig. 2.1a presents the most trivial way to control an electric load: controlling a controllable switch connected in serial with the load. This can be applied to any type of load and it is simple and robust, but it has certain drawbacks which can be avoided by using more sophisticated control methods illustrated in Fig. 2.1b-2.1d.

Fig. 2.1b presents a general “softly” controllable load: using a special electrical appliance and related communication, a load can be switched “off” and “on” “softly” which means that the process of the load is not interfered with too much. An example of this can be for example a “smart” washing machine which can be stopped in a soft manner so that when the washing machine is switched back on after an off-switching, the washing process continues from an appropriate state to finalize the laundering. This does not necessarily happen in a case where a conventional washing machine is stopped by just cutting the power supply from the device. Also, by using soft control the device can be switched “on” compared to the use of controllable switch which returns the power supply for the appliance but does not necessarily continue the laundering process from the state it was before cutting the power supply.

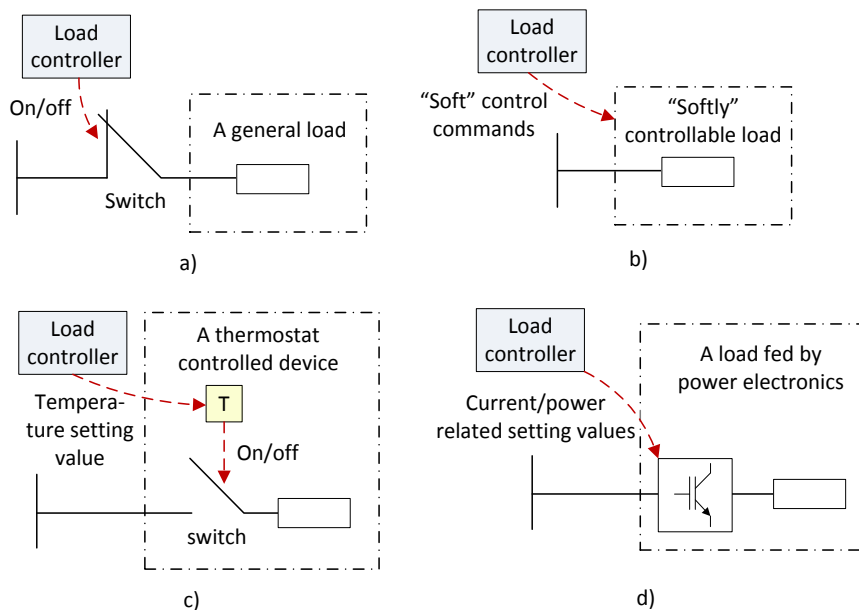

**Fig. 2.1.** Different ways to control an electric load: a) controllable switch, b) “soft” control, c) control of the setting value of a thermostat controlled load d) a load fed by certain type of power electronics.

Fig. 2.1c presents in a way a special case of Fig. 2.1b: controlling a thermostat controlled device by controlling the setting value of the thermostat. A thermostat

controlled load keeps the temperature  $T$  of an object (a room of a house, interior of a freezer etc.) within certain limits near a setting value  $T_{set}$  in accordance of the tolerance of the thermostat:  $T \in [T_{set} - T_{toler}, T_{set} + T_{toler}]$ , where  $T_{toler}$  is the tolerance of the temperature below and above of the setting value. A working cycle of a thermostat controlled load is, by turns, “on” for a while and then “off” for some time. By changing the setting value of the thermostat, a load can be forced to switch “on” or “off” practically at almost any time. With this kind of operation, a wider scale of control actions can be made compared to control of only a switch. One can for example first “store energy” to the load by setting high/low enough setting value during “low electricity price”, and during “high electricity price” the load can be switched off. Also, the adjustment of the setting value of a thermostat always guarantees that the temperature of the object does not become too high or too low (assuming that the setting value is not deviated too much from the original value) during control operation as the thermostat is always working as only the setting value is changed.

Fig. 2.1d presents a load control method which can be applied to loads which are fed by a certain type of power electronics, and the method is also a special case of Fig. 2.1b. In this control method, the load can be not only switched “on” or “off” but the power and/or the current taken by the load can be adjusted within some limits. A practical example of this kind of a load is the charging of electric vehicles. In some standardized charging modes (cf. standard IEC 61851-1), which are also *de facto* standards around the world, the charging currents of electric vehicles can be adjusted within certain limits by the charging station. EV charging and its controllability are discussed in more detail in section 5.3.

## 2.3 DR infrastructure

In addition to the load or resource itself, the infrastructure needed to control and verify the operation of the resources is a very important part of DR. In practice there are many options for the DR control and communication infrastructure for small electricity consumers. At the moment AMI meters or “smart” electricity consumption meters have been installed to most of the customers in Finland in accordance with the Finnish electricity market decree 66/2009. The meters today have some capability to control the loads of the small customers. There are typically one or two relays in the meter (Honkapuro et al. 2014) which can be used to control for example electric heating loads in one way or another. Typically there is at least one relay to realize the day-night tariff or seasonal tariff related load control. It is however under debate what kind of load control operations would be possible with the current meter fleet (Honkapuro et al. 2014; Koponen et al. 2014). Also the information systems of the DNOs form some bottlenecks for DR.

One branch of discussion has focused on whether or not a smart meter would operate efficiently as the “brain” which would control the loads and carry out appropriate communication with relevant DR actors. In practice every electricity consumer has an AMI meter and thus using these in DR would lead to a very wide DR infrastructure. Also, as new generation of AMI meters will be installed in the coming years it could be

very cost efficient to implement sophisticated DR functionalities in the new generation of meters. However, this scenario includes some risks at least in the present regulative and operational environment of the DNOs. The meters are owned by DNOs whose core task is to operate the distribution network. Offering a flexible and open platform for DR purposes for different parties and designing and installing the local load control systems at people's homes is not the DNOs responsibility and the motivation and competence of DNOs to operate as a "DR operator" is questionable.

Another significant branch of discussion is the ability of different types of home automation (HA) systems, building automation (BA) systems or home energy management systems (HEMS) to manage the DR actions in the customer-end. HA/BA/HEMSs would be produced by companies in an open and competitive market. However, without standardized procedures and standardized and open interfaces the HA systems of different HA producers are easily very diverse and realization of large scale DR might become too complex. For example in Finland, some electricity retailers today sell spot price based electricity contracts with a load control device which can shift some of the load to cheap spot price based hours.

A very relevant question is how DR could be economically attractive enough for the customer, taking into account the customer site investments stemming from the DR related equipment and systems. A possible solution for this would be to use the DR resources in an efficient manner. This means that the benefits of DR should be "fished" from many types of DR market. Also, if the customer site DR control was conducted using HA/BA based systems, the investment cost for DR would not have to be very large. A HA/BA system could offer many functionalities such as

- Increased comfort and energy efficiency (control of room temperatures, lighting and air conditioning)
- Increased safety and security (integrated fire detectors, security alarms, water leakage alarm and prevention)
- System monitoring and supervision (monitoring of energy consumption, local energy production and water consumption)
- Back-up power systems (back-up power for full load, partial load or "light" load)
- Demand response services.

As the HA/BA system would anyway be purchased for many different purposes and needs, the DR functionalities required to the system would not necessarily bring about large additional costs.

## 3 Demand response in smart grids

There are different types of demand response domains. One way to classify them is to do it in accordance with the actor offering the incentive for the electricity consumers to participate in DR. Using this classification, different types of DR domains are discussed in this chapter.

### 3.1 TSO driven DR

Two essential tasks of a TSO, especially in Nordic Countries, are to ensure the reliability of the power system and to promote the operation of the electricity market. Implementing DR to the electricity system potentially helps TSO in both of these major tasks. From TSO's interests, DR can be applied in different types of reserve markets and the wholesale electricity market. In the following reserve markets are discussed in more detail especially from the Finnish market point-of-view, where Fingrid Inc. operates as the TSO. Wholesale electricity market related DR is discussed more in Section 3.3.

#### 3.1.1 Reserve markets

Power system reserves are used to ensure the reliability of the whole power system. The Finnish TSO Fingrid uses mostly reserves owned by other parties in a market-based manner, but it has also some reserves of its own. Reserves in general can be divided into two main types: automatically and manually activated. Automatically activated reserves are typically frequency controlled. In a conventional AC power system, change in fundamental frequency of the voltage works as an indicator of the balance between power production and consumption (Kothari & Nagrath 2004). The frequency decreases if the total power production in energy conversion processes of power plants is less than total energy consumption in the system. And vice versa: in the case of power surplus the frequency rises. Frequency is used to adjust production of power plants in order to maintain the balance between power production and consumption.

There are two types of frequency reserves: frequency containment and frequency restoration reserves. The frequency containment reserves are used to stabilize the frequency change and to keep the frequency within certain bounds, but after the operation of these reserves there will always be deviation from the nominal 50 Hz. The restoration reserves are used to restore frequency back to 50 Hz or at least near to it and thus free the activated containment reserves. In the North-European system there are three types of frequency controlled reserves: Frequency Containment Reserve for Normal operation (FCR-N), Frequency Containment Reserve for Disturbances (FCR-D) and Automatic Frequency Restoration reserves (FRR-A) (Fingrid Oyj 2015).

FCR-N operates within frequency ( $f$ ) interval  $50.1 \text{ Hz} \geq f \geq 49.9 \text{ Hz}$ , which is considered a "normal state" frequency range. The target of the TSO is to keep the frequency within this normal operation interval. FCR-N must continuously regulate its power in accordance with its droop so that the dead band is within interval of [49.95 Hz,

50.05 Hz] (Fingrid Oyj 2014b). FCR-N has to activate fully within 3 minutes after a 0.1 Hz frequency change (Fingrid Oyj 2014b). In the future the requirements for dead band might be tightened.

If the frequency decreases below 49.9 Hz, the FCR-D begins to activate. FCR-D is divided into three types: on-line power plants which adjust their output power in accordance with frequency, relay connected loads and off-line reserve power generators (Fingrid Oyj 2014b). On-line power plants operate within the interval  $49.5 \text{ Hz} \leq f < 49.9 \text{ Hz}$  so that the reserves start to activate when frequency decreases below 49.9 Hz and activates totally at 49.5 Hz (Fingrid Oyj 2014b). After a step-like frequency drop of 0.5 Hz 50% of the capacity must be activated in 5 s and all the capacity in must be activated in 30 s (Fingrid Oyj 2014b). Relay connected load, which are in practice large industrial loads, should disconnect immediately when frequency has been  $\leq 49.7 \text{ Hz}$  for 30 s or when frequency has been  $\leq 49.5 \text{ Hz}$  for 5 s (Fingrid Oyj 2014b). The off-line reserve power generator capacity must be totally activated when frequency has been  $\leq 49.7 \text{ Hz}$  for 30 s (Fingrid Oyj 2014b).

FRR-A is operated in accordance with frequency deviation in the North-European synchronous area, but is centrally coordinated by Statnett in Norway (Fingrid Oyj 2014a). The purpose of FRR-A is to restore the frequency close to 50 Hz, and Fingrid sends reserve activation signal to the reserve owners every 10 s (Fingrid Oyj 2014a). FRR-A must operate in accordance with the operation time requirement curves presented in (Fingrid Oyj 2014a).

There are two different types of manual frequency restoration reserves in the Nordic system. The first reserve is the balancing power market (BPM). Capacity owners can make bids to BPM and Fingrid activates the capacity of the bids if necessary. Another manual reserve type is the so-called manual frequency restoration reserve (FRR-M). These reserves contain some gas turbine power plants owned by Fingrid, and Fingrid has also made some contracts with capacity owners for some power plants and large industrial loads. Both of the manually activated reserves (BPM and FRR-M) can be fully activated in 15 minutes.

In principle, a large number of small loads could participate in to different reserve markets. As explained above, different reserves have different response time requirements. Depending on the response time requirements of a reserve type, it might be challenging to construct a system which could control a large number of loads spread out over a large geographical area. However, in many reserve types the required reaction times are many minutes and with modern communication technologies it is possible to spread the required information rapidly enough to a large number of individual places. However, frequency controlled reserves offer a possibility to make the control decisions locally near the physical load. This type of control offers interesting possibilities and is discussed more in the following section.

Participation of “small” electricity consumers to reserve markets should include reasonable financial incentives for the consumers, and the magnitude of the profit potential should be made clear before the possibly required investment would be made



by the consumer. The assessment of the incentives is quite complicated and depends on many things such as the possibilities of the electricity consumers to control their loads, reserve market prices and the market mechanisms in general. The market mechanism is related to the fact that controlling loads might pose a financial imbalance for the electricity retailer (this is discussed more in Section 3.3) which forms a financial risk. There might be many market actors in the load control and market participation chain, such as the owners of the controllable resources, electricity retailers/balance responsible parties, and possible aggregator/service provider/DR operator. Thus, a thorough analysis and different scenarios would be required to find the realistic benefit potential of the end-users that finally make the decision whether to participate to the reserve market(s) or not. An analysis with certain assumptions in this area is made for electricity consumers with electric heating in the Finnish environment in (Järventausta et al. 2015) and in (Valtonen et al. 2015). The studies show that the incentives are not very inviting at the moment and depend on the reserve market type.

### 3.1.2 Frequency controlled load based on local frequency measurement

Controlling the loads in accordance with local frequency measurements would make very fast control possible as the control decisions would be made locally. Research in this area has been made during the past few years, see for example (Short et al. 2007; Zhao Xu et al. 2011; Aunedi et al. 2013; Vedady Moghadam et al. 2014). In Publication 1, (Rautiainen et al. 2009) and (Järventausta et al. 2010) some work in this area has also been made and presented. In Publication 1 and (Järventausta et al. 2010) the use of electric space heating loads to be used as FCR-D has been studied and presented in more detail, and in (Järventausta et al. 2010) and (Rautiainen et al. 2009) also frequency dependent charging of electric vehicles is discussed.

In Publication 1, 580 000 individual frequency controlled space heating loads, operating as FCR-D reserve, are modeled to a two-area power system model in PSCAD software. There are different types of resistive electric space heating systems such as direct (radiators), partly storage (underfloor heating cables) and storage heating. In Publication 1, the operation of the loads is modeled using a first-order thermodynamic modeling assuming that the heating energy would be stored mostly to the walls and to the floor. Therefore the rough model fits mainly to direct heating and/or partly storage heating. In Publication 1, frequency disturbances are posed to the power system and behavior of the frequency dependent heating loads and their impacts on the power system are investigated.

Perhaps the simplest way control the loads would be to use a controllable switch (cf. Section 2.2 and Figure 2.1a) which would cut the power supply of the heaters when the frequency decreases below a certain limit. This could be made easily for example in the switchgear of a detached house or building using a frequency relay based controller or similar type of device such as next generation AMI meters. After the frequency would recover, the power supply of loads would be switched back on. At least in principle, in

addition to the absolute value of the frequency, the load could be controlled also in accordance with the rate of change of frequency ( $df/dt$ ).

The operation of the loads after the “frequency disturbance” is also worth further investigation. A group of thermal loads have a so-called “cold-load pick-up” phenomenon (Publication 1), which means that if thermal loads are switched off for some time and then switched back on, the total power of the load group can be higher than before the off-switching. This should be taken into account if a large amount of thermal loads were to be used as DR resources such as power system reserves. It is not desirable that after an off-switching of a large number of thermal loads, the cold-load pick-up would pose a new frequency decline and would require the use of power system reserves. Therefore the recovery of loads should also be planned carefully (Publication 1). The behavior of a thermal load after a short off-switching depends on the type of the thermostat. If the thermostat is a mechanical one (e.g. bimetal or gas-filled bellows), the load would immediately turn back on after the power supply is recovered. If the thermostat is a “modern” electronic one, the operation of the load depends on how it is constructed. It might turn on immediately or it might wait until the temperature decreases (in case of heating load) below the limit  $T_{set} - T_{tolerlower}$  (cf. section 2.2). If the thermostat waits until the temperature decreases, it delays the cold-load pick-up and might even decrease the amplitude of the cold-load pick-up as can be noticed in the results of Publication 1.

In Publication 1, a load control method of controlling the setting value of the thermostats in accordance with grid frequency is described. The method is especially relevant to HA/BA/HEM systems, and it brings the additional benefits explained in Section 2.2. Additionally, controlling the setting value of the thermostat brings a natural possibility to gradually decrease the load during a decrease of grid frequency if all the loads are not wanted to be switched off simultaneously. This can be done so that the load whose temperature is the highest is switched off first, and when frequency decreases further, the “colder” loads are switched off in decreasing order of the temperatures (Short et al. 2007).

Control based on local frequency measurement does not need communication in the control of the loads. However, if for some reason the parameters of the controllers would have to be changed, some kind of communication between TSO and the local load controllers would be necessary. Communication might also be necessary for verifiability purposes. From this point-of-view, the frequency dependent load based on local frequency measurement would be at its best in the context of home automation systems. In a home automation system where for example room temperatures could be centrally controlled, it would be easy to build the frequency dependent load control in the central controller and it would be easy to construct a possibility for TSO to redefine parameters of the controller and verify the control actions.

It is a question of its own how this kind of frequency dependent load control would be implemented in practice to the customers’ premises especially in case of small domestic customers. The necessary equipment would be easy to implement to *new* houses and

other buildings if only an appropriate business model would exist. However, implementing the control systems to *existing* consumers' premises would be more challenging because the installation costs might become quite high. One way could be that a frequency controlled circuit breaker or set of circuit breakers would be installed to the switchgear of the house and the circuits including heaters would be fed through the circuit breaker(s). If the frequency measurement and related control technology would be implemented to room specific thermostats, the old thermostat devices should be replaced with the new ones. The new thermostats could also include some communication features in order to be able to change the parameters of the controller. In these different cases the cost vs. the benefits should be carefully analyzed.

### 3.2 DNO driven DR

Distribution network operators (DNOs) are responsible for planning, building, maintaining and operating the local distribution networks which are further connected to the national transmission grid. In general, the holistic societal target is to minimize the electricity infrastructure costs within certain boundary conditions such as the level of service of DNOs. DR could be applied also in the operation of distribution networks and thus be taken into account in distribution network planning.

In general, the aim of the network planning tasks can be presented as the following minimization task:

$$\min \sum_{t=1}^T (C_{inv}(t) + C_{loss}(t) + C_{out}(t) + C_{maint}(t)), \quad (3.1)$$

where  $C_{inv}$ ,  $C_{loss}$ ,  $C_{out}$  and  $C_{maint}$  represent the present values of investment, loss, outage and maintenance costs, respectively, of the years (1, 2, ...,  $T$ ) of the planning horizon (Lakervi & Partanen 2008). Of course, different technical and electrical safety related boundary conditions have to be fulfilled. In principle, applying DNO driven DR could decrease at least the three first cost components of (3.1). Lowering the investment costs implies e.g. to an increase in the utilization rates of network and/or reducing the need for back-up connections. In this case, the utilization rate of a network component, such as a line or a distribution transformer, means the average load level divided by the load carrying capacity of the component. A low utilization rate can correlate with oversizing of network components which also means overinvestments. To achieve a high utilization rate, load duration curves in the network should be as flat as possible and the maximum real loading levels of the network components should be near to their technical maximum load levels.

Flattening the load profile would also decrease losses because they are directly proportional to the square of the loading currents (Lakervi & Partanen 2008). However, possibilities of DR to decrease losses might not be very high. For example, in the network calculations of Publication 2, the differences of total annual loss energies between different simulation cases are roughly about 1%.

Another possible application of DR from the DNO's point-of-view is the increase in reliability of the distribution network which could decrease the outage costs in (2.1). In a regulation model of the distribution network business in Finland, the real reliability of the network affects the allowed profit level of a DNO. To increase reliability, DR could be used for example in unusual network configurations during disturbances to cut the peak power in order to enable the use of a back-up connection which would normally have insufficient transfer capacity.

In principle, there are many ways in which DNOs could apply DR and encourage network customers to participate to DNO driven DR. In this thesis, the incentives for the network customers are divided into two types: distribution tariffs and "ancillary service" contracts. In the following sections these themes are discussed in more detail.

### 3.2.1 Distribution tariffs as DR incentives

As stated above, encouraging DR for flattening load profiles of network components is reasonable from the economic point-of-view. There are also some phenomena in the future which might increase peak powers in the networks. One example of this is the possibly increasing use of electrical energy contracts with hourly varying, typically Nord Pool Spot based, price of electricity. Because the hourly prices are the same for all the customers, this might create simultaneous usage of electricity during cheap hours among the customers which might further cause peaks in the network (Publication 2). A DNO could offer some kind of incentives, financial incentives in practice, for the customers to reduce the peaks of the network. Distribution tariffs of a DNO form the main financial relationship between the network customers and the DNO, and one way a DNO could offer financial incentives for small electricity users to decrease the load peaks is to offer distribution tariffs which would include a power or peak power related cost component.

At the moment for small electricity customers (main fuse size of 3×63 A or lower), Finnish DNOs typically have three types of distribution tariffs which all are widely used: general tariff, time-of-day tariff and seasonal tariff. In these tariff structures there is typically a constant basic charge, e.g. in €/month, and a charge component based on electricity consumption (in €/kWh) which can depend on the time when the electricity is consumed. In the general tariff the price of electricity distribution is the same during the whole "contract period", but in time-of-day and seasonal tariffs the distribution charge depends on time. For time-of-day tariff the charge is lower during nights than during daytime, and in seasonal tariffs the charge is higher during winter workdays than other times. None of these tariff types set direct incentives to decrease the peak loads. However, in some cases time-of-day or seasonal tariffs can indirectly decrease the peak loads of the customer and/or the network compared to the situation that these tariffs would not be available, but this depends on customer types and their load profiles in the network.

A way to create new distribution tariffs for small network customers is to include some kind of a power based component to the tariff. This would encourage customers to decrease their peak powers and/or flatten their load profiles, and Publication 2

contributes this discussion. In addition to power based cost components, also different kinds of direct load control possibilities of DNOs could be included in the network service contract so that if the consumer were to let the DNO to control its loads, the consumer would have a reduction for example in their basic charge. These kinds of tariffs were in use in Finland before the opening of the electricity market in the 1990's. At that time "the electricity retailer" and "the DNO" of a network customer were the same utility company.

Distribution tariffs can be "static" or "dynamic". In this thesis, *dynamic tariff* is defined so that *the distribution pricing of a network customer within a "contract period" changes in an unpredictable manner from the consumers' point-of-view* (Publication 2). For example, a DNO could send more or less real-time distribution tariff signal for the customer and the pricing could depend on the current state of the network. Today DNOs update their pricing annually which forms the practical "contract period" mentioned above. *Static distribution tariff* means that *the network customer knows pre-hand exactly how the distribution service is priced for the whole "contract period"*. Static distribution tariffs can include different types of price components such as time-of-use components, peak power related components etc., but the customer has a perfect knowledge of the pricing pre-hand. In this thesis and in Publication 2 static distribution tariffs are under investigation.

In general, distribution fees must be reasonable and they should be based, as much as possible, on the cost matching or cost causation principle. However, the pricing level should be the same for the same kind of customers which means that distribution pricing cannot be dependent on the customer's location in the network. Distribution tariffs should also encourage customers towards energy efficiency.

Over the past few years, research has been conducted concerning distribution pricing in a deregulated electricity market, see for example (Eurelectric 2013; Rodríguez Ortega et al. 2008). There has also been some research work about distribution tariffs encouraging peak load reduction especially in the Finnish electricity market environment, see for example (Similä et al. 2011; Partanen et al. 2012). Related to this area of research, Publication 2 presents different types of distribution tariffs which include a peak power or power based component, and the possible effects of some of these tariffs are simulated with a model of a real distribution network and real consumption data.

Publication 2 presents some theoretical possibilities for distribution tariffs, and three examples are simulated. The simulated tariffs are called PT1, PT2 and PT3 (PT implies to "power tariff"). These tariffs include a constant basic charge and a varying part which includes both energy and power related components. PT1 is a quite similar tariff structure to those DNOs offer today for large network customers. In addition to constant basic charge and a charge for the consumed energy (in €/kWh) there is a "power charge" (€/kW), which is paid monthly in accordance with the peak power of the month. PT2 includes a basic charge and an energy charge (€/kWh) for the whole month which is a function of the monthly peak power. PT3 includes a basic charge and an energy charge (€/kWh) separately for every hour depending on the average power of the hour.

The main idea of the simulations of Publication 2 is the following. The behavior of the network customers who have some kind of an electric heating system is simulated. In the simulations, customers have different kinds of distribution tariffs and/or have a spot price based energy contract. It is also assumed that customers would have a sophisticated load control system (home automation or home energy management based system) which would control loads, especially heating loads, in order to minimize their electricity related costs. Three different network customer related cost minimizations are made: distribution cost minimization, energy cost minimization and total cost minimization. In this way the incentives of the tariffs and the possible interest of conflicts between a DNO and electricity retailer could be exposed. The cost minimizations are made separately for every type of tariff. For PT1 and PT2, two different load control approaches are simulated: low risk (LR) and high risk (HR). The difference between these two is explained in Publication 2, but the differences in the results corresponding to these approaches are very small in the simulations. After the cost minimization behaviors of the customers have been simulated, the resulted new electricity consumption patterns of the customers are fed to a load flow calculation program which calculates the load flow of the network in different simulation scenarios. In this way the effects of customers' load control actions in the distribution networks can be investigated.

The operation of the customers' load control system has to be modeled, and there are many types of load control modeling methods and principles. One branch of modeling is to look at a single network customer, model his/her loads accurately and simulate the control of each load separately. In this method, a good understanding and accuracy of load control possibilities of a customer are obtained. However, the drawback of this approach is that it is very hard in practice to obtain DR models for a very large amount, say thousands, of real customers. Another load control modeling possibility is to make some assumptions and carefully define a generally applicable "hypothetical" load control model, which of course includes more uncertainty compared to detailed modeling, but could be applied to a large amount of customers.

As the simulations of Publication 2 include a large amount of real AMI data, the "hypothetical" DR modeling methodology is applied. The load control system model of the simulations is simple, crude and heuristic, but the model obeys a few fundamental principles which can be thought to be quite general in practical DR load control systems:

1. The amount of used energy of the network customer is the same in all control cases. The purpose of a DR load control system is not to save energy, although in practice small differences in total electricity consumption might occur in real DR load control systems. Also, during high energy price hours some customers might also save energy and not only shift their consumption to cheaper hours.
2. Part of the electricity consumption can be shifted back or forth within a certain time frame. The possibility to shift the loads depends very much on the nature of the load. Loads including significant energy storage elements, such as water heaters and storage electricity heaters, can be shifted within longer time frames compared

to for example direct electric heating. If a network customer would have appropriate electricity storage at their premises, it would expand the time frame regardless of the nature of the electricity consumption. In the simulations of Publication 2, simply a time frame of fixed length is applied for each customer, but in the sensitivity study of the simulations, the lengths of the time frames vary between 4 and 24 hours.

3. The more a network customer consumes electricity during a certain hour, the more probably he/she has some load which can be controlled without too high loss of comfort. However, it is not assumed that all the electric heating energy can be shifted and controlled. The amount of controllable load is also varied in the sensitivity study of the simulations in Publication 2 so that the average controllable load energies during the whole year are about 3800 kWh, 2100 kWh and 1100 kWh which are about 28%, 16% and 8% of the average total consumption of the customers, respectively. Taking into account that in a detached house with electric heating the amount of electricity consumption of space heating and water heating can be for example 75% of the whole electricity consumption (Adato Energia Oy 2013), the amounts of controllable load energy in the simulations can be treated quite moderate.

As an overall statement, the load control model represents a very sophisticated system.

Fig. 3.1 presents the average peak power of the customers over the whole year in different simulation cases. It can be seen that the largest peak powers are in the case where only the energy fee (“E” in Fig. 3.1) is minimized. This result is more or less as expected. The average peak power rose about 1.7 kW which is about 19% compared to the original load profiles. When only distribution fees PT1, PT2 and PT3 are minimized, the average peak powers decrease about 3.5 kW which is about 39% of the original load profile’s case and the decrease is quite large. In Fig. 3.1, also in the cases where both energy and distribution fees with high risk and low risk approaches (i.e. EPT1LR, EPT1HR, EPT2LR, EPTHR and EPT3) are minimized, the peak powers are smaller than in the “original” case. From the customer specific peak power point-of-view, there is no difference between low and high risk options.

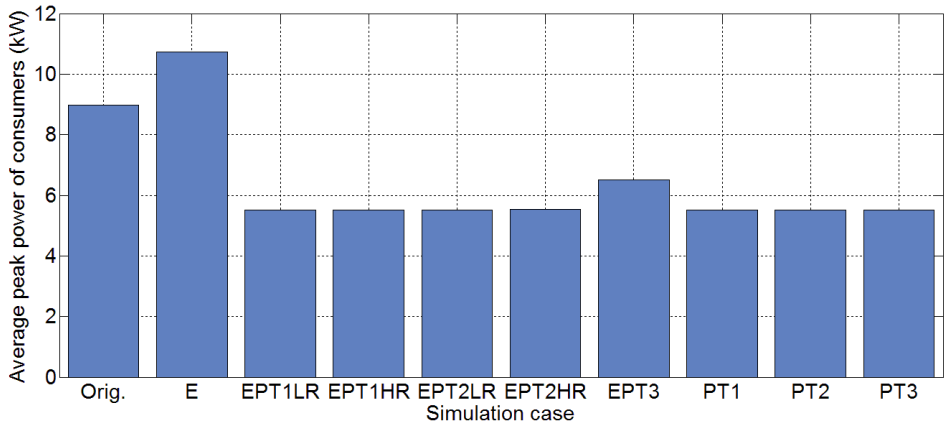

**Fig. 3.1.** Average peak powers of the whole year of all customers in different simulation cases. LR denotes low risk and HR high risk.

Figure 3.2 illustrates the histograms of the peak powers of the distribution transformers, in percentages of the transformers' ratings, in different simulation cases. In the figure, the orange vertical dash lines represent the average values in different cases and the red vertical line represents the value of 100%. When the energy fee only is minimized, it raises the peak powers of the transformers the most, by about 13 % on average (orange dash line in the figure). It can be seen that in cases where customers are encouraged to decrease the peak powers with power based distribution tariffs the average decreases in peak powers were about 3% percent at the highest. It should be, however, remembered that only about 20% of the customers (consuming about 23% of all consumed electrical energy in the network) of the network participated in DR, and considering this the 3% is not as small as it might first appear. Power based tariffs could also help to prevent the increase of the peak loads caused by customers' reactions to spot price based energy contracts. As only part of the customers utilized DR, some transformers have proportionally more DR customers than others. It should also be remembered that the load carrying capacity of a distribution transformer located outside is a function of outdoor temperature. These results do not take the outdoor temperatures into account.



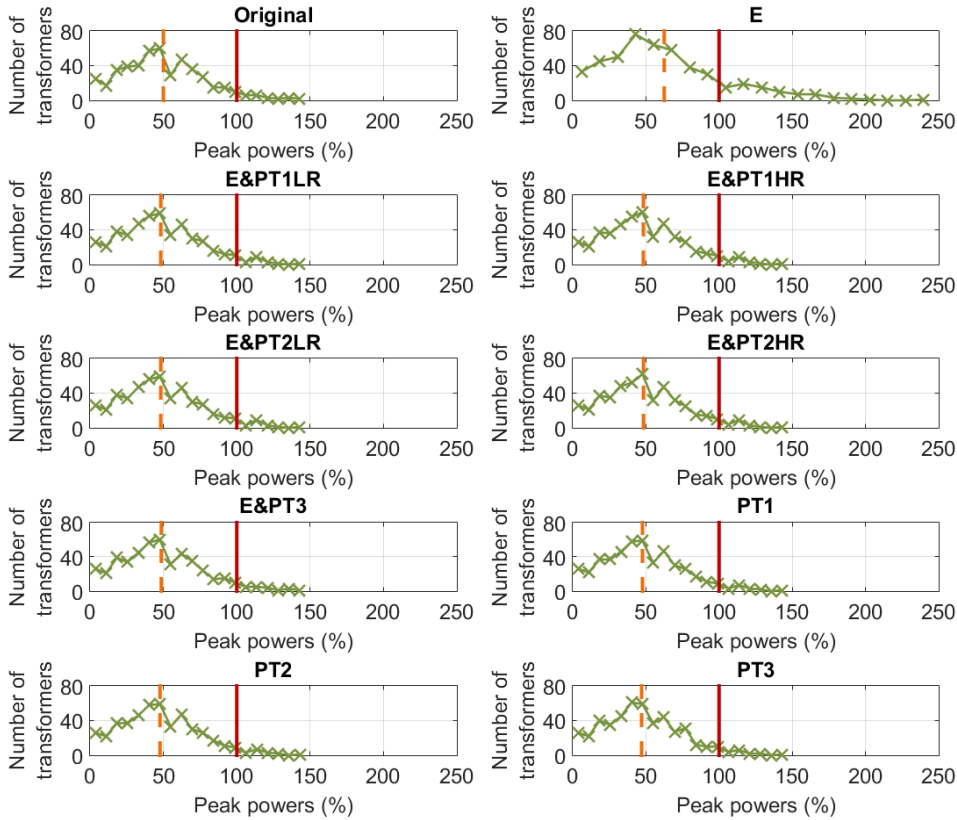

**Fig. 3.2.** The peak powers of distribution transformers in different simulation cases. Peak powers are presented in percentages of the transformers' ratings. The vertical dash lines represent the average peak power level and the vertical solid line the more or less critical limit 100%.

Load levels of the medium voltage (MV) feeders in the network are also studied. The proportions of the customers participating in DR in different feeders vary and are presented in Table 3.1. The peak powers can be seen in Table 3.2. The results are mostly the same as with the distribution transformers. If only the energy fee is minimized, peak powers rise quite significantly. On the other hand, with distribution fee minimization, a peak power decrease of a few percent at the maximum can be obtained. However, interesting phenomena can be seen. For example, the peak power of feeder 9 is increased in case "PT3" compared to the case "Original". It turns out that although the electric heater customers decrease their peak powers and shift their consumption to non-peak times of their own consumption profile, the load is shifted to the peak time of the non-DR customers in the network. Another interesting thing is that the peak power of feeder 6 in case "E&PT3" is lower than in "PT3". High spot prices often correlate with the peak load times of the distribution network under investigation, and therefore in case "E&PT3" would decrease the peak load more than in case "PT3". These phenomena are important to understand when designing new distribution tariffs.

**Table 3.1.** Proportion of DR customers in different MV feeders.

Feeder	1	2	3	4	5	6	7	8	9
Proportion (%)	32	24	13	18	17	11	33	36	31

**Table 3.2.** Peak powers (in MW) of the nine medium voltage feeders in different simulation cases.

	1	2	3	4	5	6	7	8	9
<b>Original</b>	1.4	0.9	2.6	3.0	0.5	4.0	3.6	2.7	4.5
<b>E</b>	1.9	1.2	3.4	4.2	0.8	4.6	5.6	2.9	5.6
<b>E&amp;PT1LR</b>	1.3	0.9	2.6	3.0	0.5	3.8	3.6	2.7	4.5
<b>E&amp;PT1HR</b>	1.3	0.9	2.6	3.1	0.5	3.8	3.6	2.7	4.5
<b>E&amp;PT2LR</b>	1.3	0.9	2.6	3.0	0.5	3.8	3.6	2.7	4.5
<b>E&amp;PT2HR</b>	1.3	0.9	2.6	3.1	0.5	3.7	3.6	2.7	4.6
<b>E&amp;PT3</b>	1.4	0.9	2.7	3.1	0.5	3.6	3.7	2.7	4.7
<b>PT1</b>	1.4	0.9	2.6	3.0	0.5	4.0	3.4	2.7	4.6
<b>PT2</b>	1.4	0.9	2.6	3.0	0.5	4.0	3.4	2.7	4.6
<b>PT3</b>	1.3	0.9	2.6	3.0	0.5	3.9	3.4	2.8	4.6

The main conclusions of the simulation results of Publication 2 are the following. Power based distribution tariffs would encourage the customers to reduce their peak powers which could lead to a reduction of peak powers in the components of the electricity networks. With the load control principle of the simulations, peak powers of distribution transformers and MV feeders could be decreased to some extent, but in a case where only a small proportion of the customers flatten their consumption profiles, they might shift part of their consumption to the peak time caused by other customers of the network, and this might increase the real peak powers of the network components. Also, in this kind of situation, the impact of positive correlation of spot prices and peaks in the distribution network might cause spot price based DR to decrease the peak loads. When DR is implemented to only minimize the spot price based electricity fees of the consumers, it can increase the network load levels depending on the network, customers etc. In this sense, it seems that DR driven by electricity retailers and other non-DNO actors might be more of a threat than an opportunity to the distribution networks. Power based tariffs could be useful in the sense that they could mitigate the increase of the peak loads caused e.g. by spot price based control. All of this implies that in order to have a reasonable system from a holistic point-of-view, new distribution tariffs should be carefully designed. This means that the operation of the customers' load control systems and behavior of the potential users of the "power based tariffs" should be

carefully analyzed with interaction with the customers before launching the tariffs, and the effects of the new tariffs on the customers' behavior should be monitored.

The practical implementation of “power based tariffs” is very essential. In order to mitigate the peak loads in the network caused by spot price or other “non-DNO driven” load control, power based tariffs could be implemented for example by launching new tariffs with progressive power charge component. In this way moderate increases of peak powers could bring no notable additional costs, but if the peak power increased significantly, it would also significantly increase the costs too. On the other hand, if the DNO wants to decrease the peak loads of the customers from the present state in order to decrease the investment needs of the future, things get more complicated. In order to decrease the peak loads in the network and further the network construction and renovation costs, a DNO should be very sure that the customers would really use electricity in a way that would decrease the peak loads so that the DNO could install smaller transformers or lines with smaller cross-section. DNO could offer power based tariffs so that if the customers did nothing, their average annual distribution costs would be roughly the same and if the customers decreased their peak loads, they would have lower annual distribution costs. But if this was the case in an existing network without significant renovation needs in the near future, this would lead to a situation where the costs of the DNO would be roughly the same but income would be lower than before. As a DNO needs certain economical turnover to be able to operate and maintain the network, this would not be reasonable. To solve this problem, a DNO could set the prices so that if customers did nothing, their distribution costs would increase, and if they lowered their peak loads, they would have for example roughly the same distribution service costs as before the new tariff. It is, however, also a matter of the regulator how the income could be secured in these situations. Overall, the practical implementation of new tariffs is a complex issue and should be carefully designed.

### 3.2.2 DNO driven “ancillary service” DR

DNO could make contracts with network customers which would enable the use of the customers' resources, mostly controllable loads, in certain situations for the purposes of the network management. Customers could offer, directly or through an aggregator, these “ancillary services” of their loads to DNOs and get some economic benefit from the DNO or the aggregator. The difference between distribution tariff based DR, which was discussed in the previous section, and ancillary service DR is that “ancillary” DR includes direct load control commands and not only monetary incentive. In the following section, an example of a DNO driven ancillary service case DR is presented.

#### ***Example case study: supporting back-up connections with DR***

By applying DR in some network area in a case of insufficient transfer capacity, DNO could enable the use of some back-up connection to replace the normal state feeding lines to ensure the power supply for the network area. This simplified case study deals with the use of DR in network configurations under faulty network state. The case study deals with a part of a real Finnish DNO's network. The part under investigation is in a rural area which includes one primary substation whose peak load is about 15 MW. In

case of a fault in the primary substation, 12.5 MW of the load can be replaced by different back-up connections leaving a deficit of about 2.5 MW.

There are different possibilities to enable electricity delivery for the network customers. The first one is to construct a new light primary substation to the area which, according to the DNO, costs about 1.35 M€. Of course, in addition to helping with this problem, a new light primary substation would also bring other benefits such as an increase in reliability by new protection zones etc. The second candidate for a solution would be to enforce the back-up connection so that the whole peak load could be fed. This would cost, according to the DNO, about 0.7–0.8 M€, and it would bring no other benefits. The third possible solution would be to use DR. There are 4733 network customers in the area of the primary substation. To cover the deficit of 2.5 MW, the required average power decrease would be about 0.53 kW/customer. As the problem is during peak load during cold weather in winter, it is highly probable that customers have lot of heating loads which could be switched off for some time.

Technically there would be many ways to decrease the consumption by 2.5 MW. One way would be to alternate the loads of different customers so that for example the first half of the customers, which is about 2367 customers, would decrease their loads by 1.1 kW on average for 2 h, and after the 2 h the other half of the customers would make the same average decrease. Of course, cold-load pick-up phenomenon should also be taken into account in the load control process. In principle, the load control could be made using AMI infrastructure, at least in the next AMI meter generation. This would require that the AMI has some load to control and control commands could be sent to the meters. Also, AMI meters should be able to operate during an outage. Another way to do the load decrease is that every customer would decrease their loads by at least 0.53 kW. For example some customers with electric heating could alternate their heaters so that heating circuits would be switched off one at a time. Regardless of which method is chosen to decrease the load, customers would potentially suffer a loss of comfort in one way or another. However, depending on the duration of the disturbance, the loss might be minuscule or at least not very dramatic. In many cases customers would not even recognize that their loads are controlled.

The customers should be rewarded for “helping” the DNO. If we assume that the DR would be used only to manage primary substation fault, the impact of DR would be pretty much the same as when the back-up connections would be enforced. In a way, it can be thought that the economic value of DR would be 0.7–0.8 M€, which would directly be about 150–170 €/customer. On the other hand, the cost of the outage in form of the outage costs of the network business regulation model and other more or less direct costs caused by the outage could be a better measure to quantify the value of the DR investment. However, it is a question of its own how the customers should be rewarded taking into account that the probability of a “long lasting” primary substation fault is quite small.

### 3.3 Electricity retailer driven DR

The core operation of an electricity retailer is to sell electricity to its customers and make profit. A retailer might also have production of its own. In the Nordic/North-European market, retailer's production is typically sold to the wholesale market, and the electricity for the retailer's customers is typically bought from the wholesale market. A retailer can buy electricity bilaterally from some producer or wholesaler or it can buy the electricity from the North-European power exchange operated by *Nord Pool Spot*. In 2013, 84% of the consumed electricity in the Nordic/Baltic market was bought from the Nord Pool Spot's power exchange (Nord Pool Spot 2014). A retailer can operate in two different market places in the power exchange: *Elsport* or *Elbas*. *Elsport* market is a day-ahead market and *Elbas* an intraday market. In order to buy or sell electricity in these market places the retailer (or a producer) has to make binding bids for the markets, and a bid includes volume and price combinations for a certain hour/hours. In addition to physical electricity trade, different financial derivative products are used to hedge the volume and the price of the electricity procurement or production. Financial derivative products can be traded in *Nasdaq OMX Commodities Europe* or in the over the counter market.

A retailer has to estimate the consumption of its customers for every hour in order to purchase the right amount of energy. If the consumption estimate is too low compared to the realized consumption, the retailer must buy the difference from the balance market, and if the consumption estimate is too high, the retailer has to sell the surplus energy to the balance market. In both of the cases, the retailer may suffer a monetary loss compared to the situation where the consumption estimate would match the real consumption. These monetary losses can eventually be quite high.

If the retailer had price sensitive customers with electricity retail prices directly bound to *Elsport* prices and if the retailer could forecast how consumers react to different prices, the retailer could take this into account in its bids: with low prices the volumes would be larger and with high prices the volumes would be lower. This would help the retailer to manage its own balance and if this kind of electricity demand price responsiveness would be applied broadly, it could lower the general price level in power exchange.

If the retailer had price sensitive customers and *could not* forecast the behavior of the customers, the price sensitiveness might still help in the procurement, but this depends on the situation. Depending on the signs of the imbalances in different hours and the demand balance power prices compared to *spot* prices in corresponding hours, the load control of the customers might cause financial benefit or harm to the retailer. Nevertheless, an imbalance always includes a risk of financial losses, and minimization of the imbalance is risk management.

If a retailer can estimate a probable forthcoming imbalance, the retailer could try to compensate it. One option is to trade in the intraday market *Elbas* (Valtonen et al. 2012). Another possibility is to apply some DR measures to minimize the deviation. The retailer could, if relevant methods and systems were available, estimate the real

consumption of its customers close to the trade hour and then try to decrease the deviation by customer load control. Estimations can be carried out before or during the trading hour under investigation. This would set some reaction time requirements for the DR system, and the requirements would be dependent on the moment when the short-term consumption estimations are carried out (see Publication 5).

The potential benefits of DR in the electricity trade in the long run depend on many things such as consumption and customer behavior estimation capability of the retailer and the way and level of hedging of the procurement. However, none of the factors mentioned above are of any importance, unless the end customers have an incentive to alter their behavior during high or low prices. Therefore spot based retail pricing plays a vital role in retailer driven DR. The electricity retailer profit optimization is mostly out of the scope of this thesis, but DR is identified as one of the retailers' future tools whose importance will increase.

### **3.4 Consumer driven DR**

For an individual electricity consumer there might also be some load control possibilities which benefits only the consumer itself. So, reflecting the definition of DR presented in Section 2, there would be no *external* party offering an input in a way it would benefit the external party, but only the consumer would benefit. In this sense, the “consumer driven” load control does not fit perfectly to the definition of DR.

An example of consumer driven load control could be “production following load”. A consumer who owns electricity production capacity such as a solar power plant at his/her premises could use load control to consume the electricity in real time in accordance with the production. A consumer could for example adjust the charging power of an electric vehicle and control other loads such as water heater in accordance of the production of a solar panel. Financially this would be reasonable when the price of the electricity bought by the consumer would be higher than the price by which he/she could sell the produced solar energy to a third party. In this way a consumer could use the indispatchable production to minimize his/her electricity costs.

### **3.5 The need for an aggregator or a DR operator**

Currently in Finland there are two “DR markets” where *small* electricity consumers can directly participate and to which many small consumers participate already today:

- a. electricity retailer driven spot price or other “time-of-use” contract based DR and
- b. DNOs' two-time distribution tariff based DR.

Due to the natural structure of the retail market the consumption of a retailer typically consists of the consumption of a large number of individual customers whose total consumption is aggregated for each hour in the balance settlement process. The retailer can buy electricity for the consumption from for example in the Nord Pool spot market in which the smallest offer for one hour is 0.1 MWh. DNOs' and/or retailers' time-of-use product based DR means that consumers shift part of their electricity consumption to certain time intervals (cf. Section 3.2), and as this is done in mass, a significant

amount of consumption in the network is shifted to times of lower consumption levels. In both of these “DR cases” individual consumer can participate in the “DR markets” because the necessary infrastructure to verify the real DR actions has been installed, i.e. electricity consumption meters, and also “DR suitable” electricity contracts and distribution tariff products are available.

Considering for example reserve markets of the TSO, it is not possible today for a *small* consumer to directly participate for these DR markets. Finnish TSO Fingrid sets two main requirements for the reserves which can be considered quite generic and fundamental (and thus relevant for all kinds of DR): controllability and verifiability. Controllability means that the load must be controllable, and verifiability means that it must be possible to verify whether the load is really controlled in an appropriate manner. In order to fulfill these requirements, some infrastructure is needed. The requirements for reaction times of reserve markets are of the order of seconds to some minutes (cf. Section 3.1.1) which are much shorter compared to the reaction time of spot price based DR. If there was infrastructure to control and verify the DR actions, there would also be appropriate contracts and products for the service. Also, as mentioned above, there are currently minimum capacity requirements in different reserve markets. The minimum requirements vary between 0.1 MW and 10 MW (Fingrid Oyj 2015). If small customers were enabled to participate in these markets, the minimum requirements would have to be changed or the requirements would have to be applied for an aggregated group of loads. It is clear that to have some impact on the power system, the load has to be large enough. To get commercial reserves, Fingrid itself makes contracts with the large DR resource owners and also supervises the control test etc. Doing this for thousands of small customers would be very hard in practice, and the cost for the control and verification system and supervision of the control test would be very high per single small customer.

For these reasons it would be beneficial to have a DR infrastructure, adequate control test of the customer site and related contracts made in cooperation with some other party such as home automation manufacturers or DNOs installing next generation AMI meters to the customers. In this way the business model for collecting large number of small resources could be reasonable. The entity collecting and managing resources for DR is sometimes called *aggregator*, *service provider*, *DR operator* or *virtual power plant*. There are different thoughts about the role and tasks of the aggregator. In some cases the aggregator is thought to be an electricity retailer with the electricity market related responsibilities of a retailer. However, this is perhaps too narrow a point-of-view. As was discussed in previous sections, there are many possible DR applications which do not involve a retailer as a DR actor. In another concept the aggregator is seen only as a “technical service provider”, as in Publications 5 and 6, providing the infrastructure mostly for controllability and verifiability purposes. In this case the aggregator would have a large number of small consumers as customers and the aggregator could offer DR services for retailers for the operation in the wholesale electricity market, reserve markets of TSO and possibly “ancillary service markets” of DNOs. In this concept, the aggregator could invite different DR contracts offering

parties like retailers, TSO and DNOs to bid their services to the consumers collected by the aggregator, and the consumer could select the DR market which they would participate in. This resembles to some extent the current paradigm of consumers asking retailers for bids for electricity contracts and then selecting the cheapest one, for example. However, in this concept the possible imbalance of the retailer/balance responsible party caused by non-retailer driven DR should be taken into account.

### **3.6 Conflicts of interest and a holistic point-of-view**

As different parties in the market have different needs and goals, it is quite obvious that there is a risk of having a conflict between the interests of different parties. For example, when DR is implemented to minimize the spot price based electricity fees of the consumers, it can increase the network load levels. Another example could be that there is a disturbance in the transmission grid and TSO needs to use frequency containment reserve for disturbances, the largely applied disconnection of loads may lead to a significant financial imbalance of the retailer. Thus, a clear possibility of conflict of interest can be seen between electricity retailers, TSO and DNOs. To find a solution to this, a holistic analysis of the impacts of DR should be made and rational compromises would have to be found to increase the holistic societal benefits of DR.



# 4 Introduction to electric vehicles

## 4.1 Definition of electric vehicle

In this thesis, electric vehicle (EV) is defined to be *a road vehicle which includes an electric power train and an on-board electricity storage which can be charged from an energy source outside the vehicle*. From the energy system point-of-view, the most important aspect of EVs is that the use of liquid fuel is replaced by the use of electricity produced in electric power plants, and this is beneficial for many reasons which will be discussed more in Section 4.2. The EV related terminology in the literature and media is quite diverse. In some cases, but not in this thesis, *autonomous hybrid electric vehicles (autonomous HEVs)* which include an electric power train but whose electricity storage cannot be charged outside the vehicle are also considered as “EVs”. In this thesis, electric vehicles are divided into two types: *full electric vehicles (full EV)* and *plug-in hybrid electric vehicles (PHEVs)*. In some cases *plug-in vehicle* (as in Publications 4–6) or *plug-in electric vehicle* are used as synonyms of electric vehicle. Sometimes *battery electric vehicle (BEV)* is used as a synonym for full EV, and *extended range electric vehicle (EREV)* or *range extended electric vehicle (REEV)* are used as synonyms of a PHEV. In some cases PHEV is considered a different type of vehicle than REEV or EREV.

In a full EV, there is only an electric power train. Electrical energy is taken from the battery pack and used in electric motor(s) to produce mechanical energy. Then the mechanical energy is transferred through the transaxle to the driving wheels and converted to the kinetic energy of the car. Compared to conventional internal combustion engine (ICE) based cars, the practical driving ranges of today’s full EVs are typically quite small. A practical range is typically around 100 km with full battery depending on the driving conditions although premium class car *Tesla Model S* is a clear exception with a practical range of around 400–500 km. ICE based passenger cars have a range of at least a few hundred km and up to around 1000 km.

In a PHEV, in addition to the electricity storage, there is also another power source, typically ICE which uses gasoline or diesel. The main idea of a PHEV is that the vehicle always uses electrical energy stored in the battery pack when possible but when electricity cannot be used, the vehicle uses liquid fuel. In a PHEV there are two different fundamental driving modes: charge depleting (CD) and charge sustaining (CS) modes (Kromer & Heywood 2007; Mi et al. 2011) which are illustrated in Fig. 4.1. CD mode means that when the state-of-charge (SOC) of the battery pack is above a certain limit, instead of using liquid fuel the vehicle uses always electricity when possible. There are two different types of CD modes: all-electric or blended. In all-electric CD mode the IC engine is not used at all during CD operation which means that only the electric power train is used. All-electric mode requires that the battery pack and the power train must be capable to deliver all the power the car needs for driving (Mi et al. 2011). This requires large enough electric machine(s) and high enough power delivering

capability of the battery pack. In blended CD mode, the IC engine is used in some situations but so that electricity from the battery pack is always used when possible. Typically in a PHEV with blended mode, the IC engine is used when the velocity of the vehicle is high enough or if the vehicle is accelerated rapidly. In the CS mode PHEV works as an autonomous hybrid: the battery is used as an energy buffer.

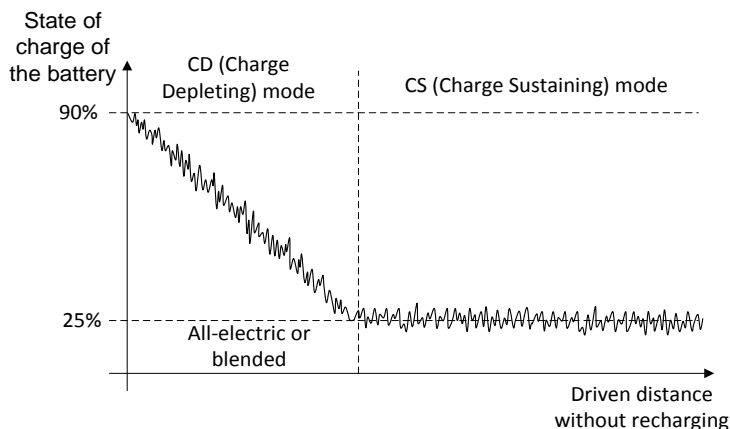

**Fig. 4.1.** Illustrative presentation of the driving modes of a PHEV. Redrawn based on figure 7 in (Kromer & Heywood 2007).

The history of EVs is interesting. EVs, and particularly full EVs, had their “golden days” in the beginning of the twentieth century (Burton 2013). For example in 1900 nearly 40% of the cars sold in the US were EVs and portion of gasoline cars was only about 22% (Burton 2013). There were many reasons for the success of EVs during those days, but as the key technologies related to ICE cars developed, the popularity of EVs started to decrease rapidly. However, because of today’s road transportation related challenges presented in the next section, EVs might become quite popular again during the next decades.

## 4.2 Drivers for EVs

Road transportation is a very important part of today’s society where the free movement of goods and people are of major importance. Road transportation is also a significant consumer of energy (Davis et al. 2014) and the consumption is almost purely based on petroleum. Almost every human activity in modern western way of living is connected to oil based transportation or oil in general in one way or another. For example food production is highly oil intensive and historically the oil price and food prices have had a strong positive correlation (Partanen et al. 2013; Partanen et al. 2015).

The amount of petroleum in the ground continuously decreases, and the demand of petroleum increases. It is quite clear that the increasing oil thirst of mankind will lead to some kind of challenges in the future. A sudden collapse of the modern oil based societies is not however probable (Partanen et al. 2013; Partanen et al. 2015). A more probable case is that increasing oil demand combined with increasing uncertainties in production decreases the economic growth and causes trouble for the economics in

general (Partanen et al. 2013; Partanen et al. 2015). Because all of this, a decrease in the oil dependency of the world is a crucial task for the coming years and decades. The problems with petroleum are not related so much to energy but to fuel. Electric vehicles could be used to decrease petroleum use. The use of electricity in EVs would directly decrease the use of petroleum assuming that the electricity used by EVs is not produced using petroleum. However, a decrease of petroleum consumption by massive EV use could decrease the price of petroleum which would again increase the demand elsewhere. These issues should be taken into careful consideration when discussing oil dependency.

Another fundamental challenge related to the energy systems is the climate change. Climate change has been in active public discussion during the past few years. The Intergovernmental Panel on Climate Change (IPCC) has stated that in order to keep the average temperature increase below 2°C, mankind has to reduce greenhouse gas (GHG) emissions by 40–70% from the emission level of 2010 by the year 2050 and reach roughly zero or even negative emission level by 2100 (IPCC 2014). However, the trend of annual global GHG emissions have been increasing during the last few years and not decreasing (IPCC 2014). The present international policies imply that the global emissions will continue increasing over the course of a few years. In this sense, mankind is in front of an enormous challenge, and significant amount of will and new practical policies are needed in order to set the global GHG emission toward a lowering trend.

EVs could contribute to greenhouse gas emission decrease, but this requires that the electricity used by EVs is *de facto* produced using clean energy sources. When an electric load is connected to a network and the load starts consuming electricity, the additional power drawn from the network has to be produced more or less in real time. Thus, in some power plant(s) the power output has to be increased to fulfill the need of the electric load. When calculating the CO<sub>2</sub> emissions of EVs, one must take this into account. If EVs are charged using for example hydroelectric power, the additional CO<sub>2</sub> emission is roughly 0 g/km. An opposite example would be that the additional energy would be produced using condensing power plant using coal. Specific CO<sub>2</sub> emissions of coal based electricity is in the order of 850 g/kWh (Biomeri Oy 2009), and if average specific electricity consumption of an EV was 0.2 kWh/km, the specific CO<sub>2</sub> emissions of an EV, when driving using electricity only, would be about 170 g/km which corresponds to the CO<sub>2</sub> emission of the use of roughly 6.5 l/100 km gasoline in an ICE. In Europe, the target of EU is that by 2021 average CO<sub>2</sub> emissions of new passenger cars would be 95 g/km (European Commission). In Finland the average CO<sub>2</sub> emissions of the new cars in 2013 was 132.4 g/km (Finnish Information Centre of Automobile Sector).

Life cycle emissions constitute a question of their own, and things get more complicated when they are taken into account. In (Hawkins et al. 2013; Bauer et al. 2015) comparative environmental life cycle assessments of conventional and electric vehicles are made. The results depend on many things, but as a rough overview the manufacturing of EVs produce GHG emissions easily at least some dozens of percent

more than conventional ICE based cars, but still EVs have the potential to reduce GHG gases over the course of the vehicles' lifetime due to potential use of low GHG electricity during the use of the car.

One important driver for EVs is related to air quality, which is significant problem for example in China today. There is a need to reduce the air quality related tail pipe emissions of cars especially in large cities, and EVs could make a contribution to this (Choi et al. 2013). Another local environmental benefit of EVs is the reduced traffic noise in cities where the driving speeds are low and thus the noise component of tires is small (Holtmark & Skonhoft 2014).

A more sustainable transportation system of the future, which might include a significant amount of EVs, will probably have many types of vehicles which use many types of fuels and energy sources. Although petroleum is definitely the main energy source of road transportation today and will maintain a significant role for a long time, there are also other alternatives whose role will increase in the future (IEA 2013; Kay et al. 2013). Figure 4.2 presents some of the variety of energy sources, fuel production and distribution methods and different ways to end use the energy in road transportation. In addition to petroleum there are different types of energy sources such as biomass, waste, industrial by-products, biogas, coal, natural gas and also some sources of electricity such as solar, wind, nuclear and hydroelectric power. Using these energy sources, different types liquid and gaseous fuels and also electricity can be produced and end used in different types of vehicles, and all of the energy sources are already used today in road transportation at least to a small extent. None of the individual energy sources have convincingly proved to be able to tackle all the challenges which the energy system of road transportation has faced. For example in (Kay et al. 2013), a review of forecasts and scenarios of proportions of different types of vehicles, fuels and energy sources in road transportation is presented, but long-term forecasts and realization of long-term scenarios include significant uncertainties. It is important to emphasize that the improvement of energy efficiency of conventional ICE cars also includes significant potential to reduce petroleum and energy consumption and emissions (Nylund et al. 2008; IEA 2009; IEA 2013; Kay et al. 2013).

There are different ways for society to promote "sustainable" passenger cars. Some ways are for example different types of tax incentives including taxation of fuels, direct subvention of purchasing and/or leasing of cars and/or car related equipment, allowance of cars to use bus lanes and free parking. All of these incentives are in use or have been used with different types of combinations for EVs in different countries (Mock & Yang 2014; Figenbaum & Kolbenstvedt 2014). In Finland there is a car related taxation paradigm which favors cars with low CO<sub>2</sub> emissions (Tull 2015; Trafi 2015) and also temporary subvention for the leasing of EVs and charging stations (Sähkoinen liikenne 2015). Also, taxation of liquid fuels vs. taxation of electricity favors the use of electricity in transportation in Finland.

In addition to environmental and energy system related drivers for road electrification, there can be other reasons why some people would like to drive EVs, especially if they

were affordable enough. The fact that EVs are quiet, at least in low driving speeds, and do not release smoke etc., can have surprisingly important role in some people’s buying decisions even though these people would not experience the noise and smoke of ICE cars as problems. Different emotion and social status related issues can also be important.

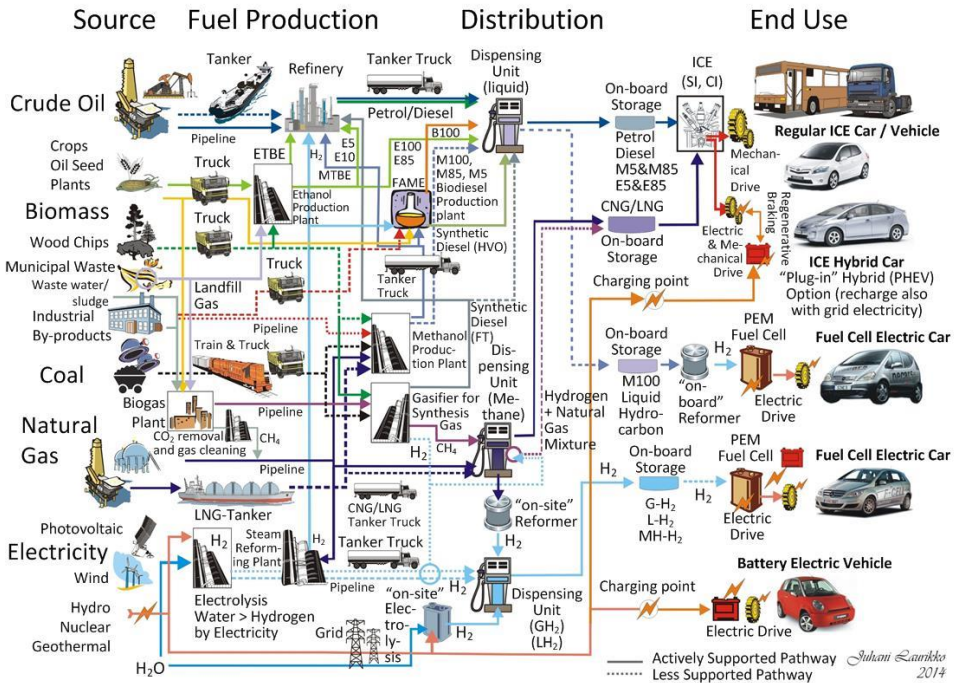

**Fig. 4.2.** Different types of energy sources and ways to produce, distribute and end use the fuels and energy sources of road transportation. The figure is reprinted by courtesy of Dr. Juhani Laurikko, VTT.

### 4.3 Barriers for EVs

There are some barriers to the large scale commercialization of EVs. The barriers are somewhat different for full EVs and PHEVs. In this section, the barriers common to both of the vehicle types are discussed, and a more detailed comparison of PHEVs and full EVs is made in Section 4.4. Globally there are two common and fundamental barriers for EVs: *high prices of EVs* and *lack of sufficient charging infrastructure*. These two issues are not completely separate and independent from each other but have interconnections with each other.

A significant component of the high price of EVs is high battery prices (Luo et al. 2014; Nykvist & Nilsson 2015). In addition to expensive batteries, there are probably also some other price increasing factors, but the battery price level is a very important one. It is hard to know the exact prices or costs of the batteries for EV manufacturers, but the prices are of the order of some hundreds of €/kWh (Nykvist & Nilsson 2015). At the time of writing this thesis, commercial EVs have battery capacities between 4 and 85

kWh (the extremes are *Toyota Plug-in Prius* and *Tesla Model S*, respectively) which imply the battery pack to easily be a significant price component of the car.

In practice, almost all commercial EVs have lithium-ion (Li-ion) batteries. There are different types of lithium-ion batteries regarding the battery chemistry and design. In a lithium-ion battery there are three main components: negative electrode, positive electrode and electrolyte. Almost all Li-ion batteries have graphite ( $\text{LiC}_6$ ) or other carbon based negative electrodes, but some special designs use lithium-titanate ( $\text{Li}_7\text{Ti}_5\text{O}_{12}$  – LTO) (Vuorilehto 2013). Graphite or other carbon based material is cheaper and produces higher voltage and thus higher specific energy (Wh/kg) than LTO. On the other hand, LTO is safer and has significantly longer lifetime, and it enables the use of very high charging and discharging currents. In positive electrodes there are more choices. Typical commercial positive electrode chemistries are cobalt oxide ( $\text{LiCoO}_2$  – LCO), nickel-cobalt-aluminum oxide ( $\text{Ni}_{0.8}\text{Co}_{0.15}\text{Al}_{0.05}\text{O}_2$  – NCA), nickel-cobalt-manganese oxide ( $\text{Ni}_{1/3}\text{Co}_{1/3}\text{Mn}_{1/3}\text{O}_2$  or  $\text{Ni}_{0.4}\text{Co}_{0.2}\text{Mn}_{0.4}\text{O}_2$  – NCM), manganese oxide ( $\text{Mn}_2\text{O}_4$  – LMO) and iron phosphate ( $\text{FePO}_4$  – LFP) (Vuorilehto 2013; Yoshio et al. 2009). All of these options excluding LCO are used in commercial EVs, although LFP is used only in *Fisker Karma* PHEV which is not under production at the time of writing this thesis. LCO is quite expensive due to its large proportion of cobalt. NCA gives very good specific energy and moderate lifetime, but is challenging material from the safety point-of-view. NCM is safer than NCA but gives lower specific energy. Further, LMO is safer than NCM but gives shorter lifetime. LFP is a very safe option and gives long lifetime but it gives modest specific energy. Almost all lithium-ion batteries have a  $\text{LiPF}_6$  based liquid electrolyte and differences in electrolytes between different batteries are quite small.

Even a modest penetration level of EVs requires significant increase in battery production. In 2013, roughly 65 million cars were produced globally (OICA 2014). If for example 5% of the new cars corresponding with the production volume of 2013 were EVs with an average nominal battery capacity of for example 30 kWh, this would mean an additional battery need of about 98 GWh/a. Worldwide lithium-ion battery sales in 2013 was roughly 38 GWh/a (Pillot 2014) which means that in order to produce the batteries for the aforementioned EVs the production has to be increased by 260%. This means that a large amount of EVs require a massive increase in battery production.

It is uncertain how much the production of lithium-ion batteries can be increased worldwide with a reasonable price level taking into account that the prices should decrease in order to compete with conventional cars. When large amounts of batteries are manufactured, the economics of scale and general development might push the prices down (Nykqvist & Nilsson 2015), but limited raw material reserves might become a challenge. It seems that lithium is not an issue (Gruber et al. 2011; Bryner et al. 2013), but some other raw materials such as cobalt can be more problematic (Bryner et al. 2013). In some commercial EVs, cobalt is used in lithium-ion battery cells with NCM and NCA type positive electrodes. Availability of cobalt also depends on the recycling practices. Typically for example cobalt and nickel are recycled today (Dewulf et al. 2010). Alternative commercial EV battery solutions for cobalt based positive electrodes

are LMO and LFP. Both LMO and LFP have no foreseeable serious problems with raw material availability in the case of large volume production. Almost all commercial lithium-ion battery cells have graphite negative electrode, and from the raw material perspective, graphite can be produced in large volumes in the future. Also, there are plenty of materials available for the production of electrolytes.

Lack of sufficient charging infrastructure is another significant barrier for EVs and especially full EVs. Generally it can be said that there is a very extensive coverage of electricity grids in the developed countries, and this forms a strong foundation for EV charging infrastructure development: at least in principle charging stations can be built in many places. EVs are at their best in city areas and in many large cities around the world it is quite hard to construct EV charging stations in parking places. However, in Nordic countries like Finland there are a significant amount of sockets for preheating ICE cars during winter and these sockets can be used to some extent for EV charging. In Europe, the EU directive 2014/94/EU on the deployment of alternative fuels infrastructure obligates the EU member states to build sufficient amounts of public charging stations to each country: *“Member States should ensure that recharging points accessible to the public are built up with adequate coverage, in order to enable electric vehicles to circulate at least in urban/suburban agglomerations and other densely populated areas, and, where appropriate, within networks determined by the Member States. The number of such recharging points should be established taking into account the number of electric vehicles estimated to be registered by the end of 2020 in each Member State. As an indication, the appropriate average number of recharging points should be equivalent to at least one recharging point per 10 cars, also taking into consideration the type of cars, charging technology and available private recharging points.”* In many ways this is a significant step in Europe in promoting electric road transportation. Charging and charging infrastructure issues are discussed more in Section 4.5.

Considering EVs, it should be mentioned that electric buses are a significant potential application for EVs. This is because typically buses are driven in a certain driving route, and therefore the battery pack and its charging can be tailored to fulfill the needs of the bus (Lajunen 2014; Offer et al. 2010), and uncertainty of the sufficiency of the electrical range would then be very small. Although some of the studies of this thesis can be also applied to electric buses, their specific characteristics are outside of the scope of this thesis.

#### **4.4 PHEVs vs. full EVs**

Within the EV community, there is a continuous debate on whether to prefer full EVs or PHEVs. Both types of EVs have certain strengths and weaknesses from the technology and consumer preference points-of-view.

Full EVs have typically larger batteries and thus longer “electric ranges” than PHEVs. This implies that full EVs better enable driving purely on electricity than PHEVs, but this requires that the range of a full EV combined with charging opportunities is sufficient for the car user. For many potential car buyers, a short range might still be a

major barrier to purchasing a full EV (Dong et al. 2014; Steinhilber et al. 2013; Neubauer & Wood 2014) although the *Tesla Model S* has demonstrated that it is possible to construct a commercial high range full EV at least in a premium car class. The short range or “range anxiety” barrier is probably even more significant for example in the Nordic regions as during winter the practical range can decrease very significantly due to increased specific electricity consumption (Laurikko et al. 2013). Also, the absence of extensive charging infrastructure can be a cause for concern especially for many potential full EV buyers (Neubauer & Wood 2014). Consumer preferences and marketing points-of-view are also important. For potential EV buyers, the operating principle and the main idea of full EV are easier to understand compared to a PHEV because the structure of a full EV is simpler. The idea that “this car runs only with electricity” can be a significant positive factor in full EV buying decision.

The main idea of PHEVs is to combine the positive factors of full EVs and conventional ICE cars: electric driving and long range. With a relevant PHEV it is possible to drive quite significant proportion of the mileage using electricity produced by electric power plants and still the driving range of the car is of the same scale than in ICE cars and refueling the car is still as fast as with ICE cars. For many potential EV buyers, PHEVs could be a practical compromise to tackle both the range anxiety and the lack of sufficient charging infrastructure in a sufficient manner. PHEVs have typically smaller batteries than full EVs, and concerning high prices of batteries and the uncertainty of realistic possibilities of large scale battery manufacturing with reasonable price levels (cf. Section 4.3), PHEVs could be a good compromise in this sense as well. Also, if an EV had a very large battery pack, the calendar lifetime of the battery and/or the lifetime of the whole car would very probably be much lower than the time required to “consume” the cyclic lifetime of the battery pack (Publication 6). Thus, most of the large battery investment would not be used at all. In this sense, PHEV battery investment could be used more efficiently and would improve the cost efficiency of the car. This argument, however, requires that there is no significant battery after-car-life market and that the EV’s battery pack would not be used significantly as energy storage for the power system’s needs (Publications 5 and 6).

When the feasibility of PHEVs is investigated, a question arises: how large a proportion of the driven mileage of PHEVs could be driven using electrical energy? This means roughly the same as how a large proportion of the advantages of large range full EVs could be obtained by PHEVs. Figure 4.3 enlightens the question by presenting cumulative proportions of numbers of trips and total mileage (km) with different lengths of trips. The figure is based on all car trips of the National Travel Survey 2010–2011 of Finland. It can be seen that about 51% of all kilometers driven are driven as trips with a length of less than or equal to 50 km. This implies that with PHEVs even with quite modest “electrical ranges”, quite high average “electrical mileages” could perhaps be achieved.

In recent years, research investigating this question has been conducted. To investigate the topic, it would be ideal if long lasting measurements of a large number of different types of real PHEVs charging in a large number of different types of charging spots and



driven by different types of people would be carried out. There are some measurement data of real PHEVs, see for example (Ligterink et al. 2013), which offer valuable data. However, using today’s real measurements to assess the possibilities of PHEVs is limited in many ways. One limitation is that the number of PHEVs in the world is not very high yet, and as reported in (Ligterink et al. 2013), today’s PHEV users do not necessarily represent “the average” potential PHEV user but only a very narrow segment of the users. For example, in (Ligterink et al. 2013) three quarter of the measured vehicles were owned by companies and only one quarter by private owners. Many companies’ employees drove up to over 40 000 km/a which is roughly 150 km/work day, and this mileage is hard to cover by today’s charging infrastructure and the charging possibilities of today’s PHEVs. Also, today’s PHEVs and charging infrastructure will probably be not similar to the ones which are really available in the future markets.

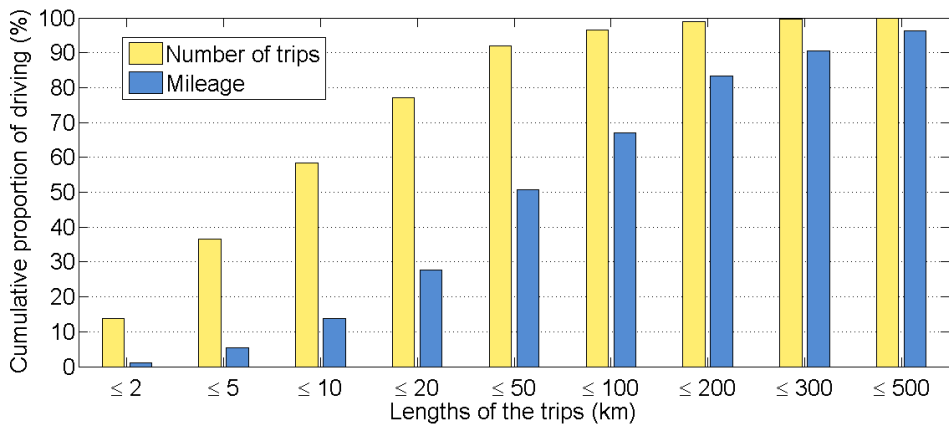

**Fig. 4.3.** Cumulative shares of number of trips and mileage as a function of lengths of the trips.

For previous reasons, it is useful to apply simulation tools for carrying out the investigations with different parameters. Different simulation studies have been made, see for example Publication 3 and (Zhang et al. 2011; Dong & Lin 2012; Kelly et al. 2012; Peterson & Michalek 2013; Zhang et al. 2013; Traut et al. 2012; Dong et al. 2014). In Publication 3, some preliminary results are shown, but in the following a slightly more sophisticated study applying the PHEV charging modeling methodology of Publication 3 is conducted to investigate on average how large a proportion of the mileage of PHEVs could be driven using electricity.

In order to describe some sort of an “average proportion of electric mileage” of PHEVs, it has to be concluded how to define this kind of a quantity. One way to do this is to first simulate a set of PHEVs and then calculate the proportions of the “electrical mileages” of the individual vehicles and then calculate the average value of the proportions. The second way to do this is first to sum up the electrical mileages of all cars and divide it by the sum of the total mileages (including electric and liquid fuel based mileages) of the cars. Table 4.1 illustrates the difference between these two ways. In the table *total*

*mileages* and *electrical mileages* of five PHEVs during a day are presented. One can see that there is a difference between two different quantities. In the following example the “proportion of the sum of the total mileages” approach is used to present the results.

**Table 4.1.** Illustrative example of two different methods to define “average electrical mileage”.

Total mileages of a single day of the cars (km)	Electrical mileages of a single day of the cars (km)	Proportional electrical mileages of the cars
77	20	26%
12	12	100%
9	9	100%
80	44	55%
75	49	65%
Sum: 253	Sum: 134	<b>Average: <u>69%</u></b>
	<b>Proportion of the sum of the total mileages: <u>53%</u> (134 km/253 km)</b>	

Figure 4.4 presents a sensitivity study result of a proportional electric mileage when *effective battery capacities* and *average specific electricity consumption* in CD mode are used as sensitivity variables. The data of the figure is obtained by running the PHEV charging simulation for all of the simulated PHEVs with different values of the sensitivity parameters.

Often in commercial EVs the whole capacity of the battery pack is not in use in order to increase the cyclic lifetime of the battery packs. Effective capacity is the capacity which can be charged to the car after the car informs the user that the battery is “empty”. For example in *Opel Ampera* the nominal capacity is 16 kWh and the effective capacity is around 10 kWh. In the simulations the effective battery capacities of all the PHEVs are varied using values 3, 4, ..., 20 kWh. In all sensitivity study simulations the same size of a battery pack is modeled for each vehicle.

Real specific electricity consumptions (in kWh/km) of PHEVs depend on many things such as characteristics of the car, driving cycle and outdoor temperature. In the data used in the methodology and simulations of Publication 3 (National Travel Survey of Finland (Finnish Transport Agency 2014)) there is no detailed information about the driving cycles (driving speeds, amounts of accelerations and decelerations etc.) of the cars. Therefore, when it comes to driving cycles, averaged specific electricity consumptions are used. However, in the National Travel Survey there is information about the time and geographic area of driving. Using this information with the average month-specific outdoor temperatures of the Finnish provinces (Kersalo & Pirinen 2009), the temperature dependencies can roughly be taken into account. It is a tricky question how average specific electricity consumption should be modeled.

Temperature dependency of specific electricity consumption depends on many things such as type of the heating system of the car and driving cycle. The temperature dependency of an EV using for example a liquid bioethanol heater is quite different

compared to an EV using resistive electric heating (Laurikko et al. 2013). Rough estimates for the temperature dependencies (change in specific electricity consumption compared to change in outdoor temperature:  $\Delta E_{\text{specific consumption}}/\Delta T$ ) can be made based on some data of (Laurikko et al. 2013) and in the case of resistive electric heating the estimates are between  $-0.004$  kWh/km/°C and  $-0.009$  kWh/km/°C depending on the driving cycle and assuming that there is no heating need when outdoor temperature is  $> 18$  °C. In the simulations of Fig. 4.4 an averaged value of  $-0.004$  kWh/km/°C is used as a rough estimate taking into account the possibilities of technological development of cars (e.g. the use of heat pumps). The simulation results are not very sensitive for the dependency value in the range of previous numbers. The specific electricity consumptions of the simulations of Fig. 4.4 are formed as follows. First, specific electricity consumptions of 0.15, 0.16, ..., 0.40 kWh/km, presenting the consumptions *without* heating need, are produced. After this the temperature corrections for the consumption values are made in accordance with the driving province of the car. Thus, the specific electricity consumptions of Fig. 4.4 also include the heating energy. In the simulation example, it is assumed that charging is made at homes and at work places with a charging power of 3.5 kW and that charging is started immediately when a PHEV arrives to a charging station.

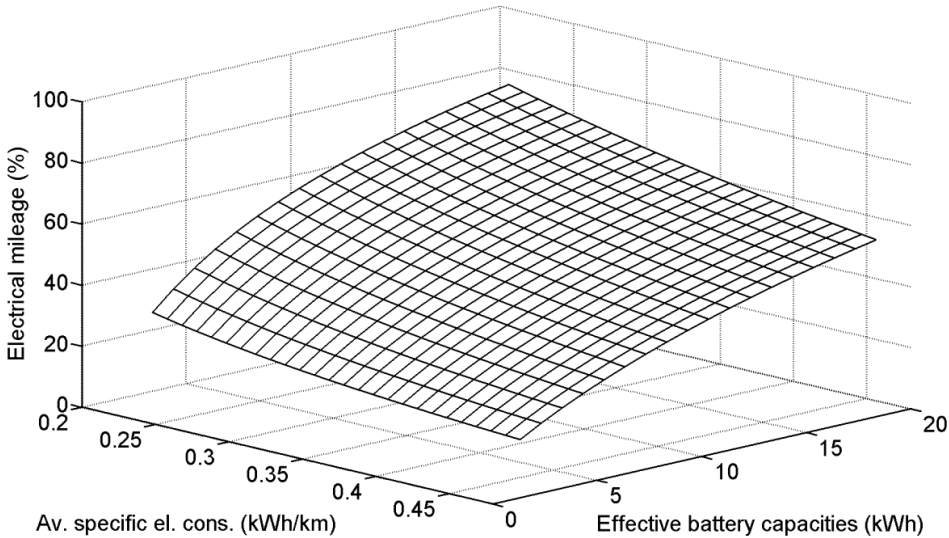

**Fig. 4.4.** *Electrical mileage of an all-electric CD mode PHEV fleet with 3.5 kW charging at homes and at work places.*

The results of the example simulation show that even with quite modest battery capacities PHEVs would enable the use of electricity more than 50% of the driven mileage. Also, it can be noticed that the first kilo-watt-hours of the battery capacity bring most of the benefit of PHEVs. In practice this means that is more useful to increase the battery capacity for example from 5 kWh to 10 kWh than from 10 kWh to 15 kWh. Also, it can be noticed that quite low power charging at homes and at workplaces can offer quite substantial proportional electrical mileage. The question

where and what kind of charging infrastructure should be built for EVs is discussed more in Section 4.5.3.

## 4.5 Charging of EVs



An EV has to be charged using a charging station or at least a socket-outlet. EV charging can be divided into two types: AC and DC charging. In AC charging, an on-board charger is located inside the vehicle and AC voltage and current is fed to the vehicle from the charging station. In DC charging, an off-board charger is located in the charging station feeding DC voltage and current to the vehicle. Globally there are many standardized solutions for EV charging and some of these solutions are described in the next section.

### 4.5.1 Standard charging solutions

The widely respected international standard IEC 61851-1 defines four different charging modes: mode 1, mode 2, mode 3 and mode 4. Mode 1 is mostly intended for charging of light vehicles such as mopeds with low currents and/or short charging times. In practice, modes 2–4 are used in charging of electric passenger cars. Modes 1–3 are AC charging methods and mode 4 is a DC charging method. Table 4.2 presents the main properties and functionalities of the four charging modes.

Mode 2 charging is quite generally considered as a “temporary” charging method or as a charging method of a “transitional period” which means that mode 3 and 4 charging methods would increase their share in the future and the share of mode 2 charging would decrease. Typically every commercial EV is delivered to the consumer with a mode 2 charging cable. In many European countries regular “Schuko” socket outlets are used in mode 2 charging in most of the cases. In a mode 2 charging cable there is a so-called in-cable control and protection device (IC-CPD), which includes some safety functionalities such as a residual current device (RCD). There has been some experience from the field that Schuko socket outlets and plugs and related electric installations have overheated when high currents such as 16 A have been used for long time. IC-CPD also restricts the charging current to a level, typically around 10 A, which is considered safe to use in domestic socket outlets. It is, however, not very clearly shown what would be a “safe” current level to be used in current installations without restricting the use of Schuko charging too much. Using 3-phase IEC 60309 plug and socket outlet or one-phase “camper plug and socket-outlet” offers a safer way to use high currents for longer times. For example in Finland there is a very large number of outdoor Schuko socket outlets for preheating of the car engines in winter, but the number of 3-phase socket outlets is much lower and “camper socket-outlets” are very rare in domestic environments.

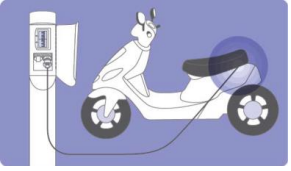
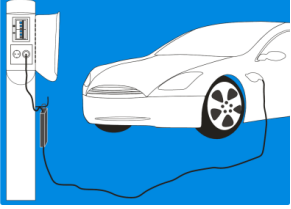
**Table 4.2. Charging modes of EVs (IEC 61851-1, Ed. 2.0).**

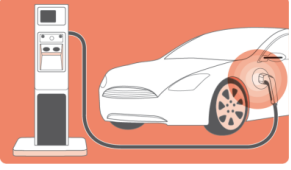
Charging mode	Properties and functionalities
<p>Mode 1</p> 	<ul style="list-style-type: none"> <li>✓ An AC charging method.</li> <li>✓ Intended mostly for charging of light vehicles such as mopeds with modest battery capacities.</li> <li>✓ Typically used with short charging times and/or low charging currents.</li> <li>✓ 1-, 2- or 3-phase charging with an AC current up to 16 A</li> <li>✓ The feeding socket must be equipped with an RCD.</li> </ul>
<p>Mode 2</p> 	<ul style="list-style-type: none"> <li>✓ An AC charging method.</li> <li>✓ Used for “slow” charging of electric cars.</li> <li>✓ 1-, 2- or 3-phase charging with an AC current up to 32 A</li> <li>✓ Charging cable is equipped with an in-cable control and protection device (IC-CPD) which includes some control and safety related functionalities such as possibility to restrict the charging current drawn from the socket outlet.</li> <li>✓ Extended safety functionalities such as the following. <ul style="list-style-type: none"> <li>• Continuous protective earth conductor continuity checking</li> <li>• There is no AC network voltage in the vehicle connector unless a vehicle is appropriately connected.</li> </ul> </li> <li>✓ In practice all commercial EVs are sold with a mode 2 charging cable.</li> </ul>
<p>Mode 3</p> 	<ul style="list-style-type: none"> <li>✓ An AC charging method.</li> <li>✓ Intended for the basic charging of EVs.</li> <li>✓ 1-, 2- or 3-phase charging with an AC current up to 1×70 A or 3×63A</li> <li>✓ Extended safety functionalities such as the following. <ul style="list-style-type: none"> <li>• Continuous protective earth conductor continuity checking.</li> <li>• There is no AC network voltage in the socket outlet unless a vehicle is appropriately connected.</li> </ul> </li> <li>✓ Extended control possibilities such as possibility of the charging station to control the maximum current which the charger can draw from the network.</li> </ul>
<p>Mode 4</p> 	<ul style="list-style-type: none"> <li>✓ DC charging method.</li> <li>✓ Charging control is based on sophisticated communication between the charging station and the vehicle.</li> <li>✓ Enables flexible and controllable charging with a theoretical maximum power of 120–170 kW (IEC 62196-3), although practical products have much lower nominal powers.</li> <li>✓ For mode 4 use, the charging cable with the vehicle connector is fixed in the charging station.</li> </ul>

The figures of the table are reprinted by a courtesy of SESKO ry.

Mode 3 is preferred and recommended for the everyday use by the EV related industry and different regulative and instructive organizations. In mode 3, charging socket outlets dedicated to EV charging are used and the charging mode enables charging rates from one-phase 6 A up to three-phase 63 A. Mode 3 charging includes many

sophisticated, e.g. safety related, functionalities, but also a possibility to control the maximum current which the vehicle can draw from the socket. In most of the countries in Europe, the *de facto* mode 3 socket outlet standard is “type 2” defined in IEC 62196-2. Also, the EU directive 2014/94/EU determines the “type 2” socket outlet to be used in public AC charging stations.

Mode 4 enables the use of very high charging powers, because the charger is located outside the car. Typically mode 4 charging powers have nominal powers up to 50 kW, but there are also for example 130 kW and 20 kW commercial chargers available. DC charging is very useful in cases where the battery pack of the car is large and one needs to have battery charged within an hour. The charging current of the car can also be restricted with mode 4 charger by the charging station. In Europe, the “CHAdEMO” charging connector and vehicle inlet has been used in many countries but also the use of “Combo 2” interface will increase in the future as it is also determined to be used in the public charging stations by the EU directive 2014/94/EU.

In addition to these charging modes, wireless charging technology is also evolving and standardization activity related to it is going on. A practical, safe, energy efficient and cost effective wireless charging system would be very a convenient solution, and when EV users would get used to it, there would be no returning to low power conductive charging anymore.

#### 4.5.2 Market mechanisms for EV charging

Charging of EVs means that electrical energy is drawn from an electricity network, and someone has to build the charging stations and related systems. These cause variable costs, fixed costs and capital costs for some parties. There are different ways to allocate the costs for different parties. There are three main types of charging station owning and service models:

1. Private or domestic ownership. A charging station or at least a socket outlet is installed in someone’s garage or other similar place and the owner of the charging spot pays the electricity and other related costs.
2. Housing companies offering charging opportunity to its inhabitants or companies offering charging opportunities to its employees. In this case the housing company or company would pay the electricity and the charging stations, and charging station users would have to pay some kind of a fee for the charging or for the possibility to charge.
3. Public and commercial ownership. In this model a company or related party builds charging stations and offers commercial charging services available for all EV users. There are many ways to construct the service and realize the transactions. A special case for this ownership model is the *Tesla Motors Inc.*’s free charging for the EVs manufactured by the corresponding company.

Charging station owning and service models 1–2 are quite straightforward, but model 3 includes more options. During the latest years there has been discussion about different ways to do business with EV charging and options for market mechanisms for public

and commercial charging. Perhaps the simplest “market mechanism” is that when a vehicle is using a public charging point, the vehicle user pays a constant payment regardless of the amount of electrical energy taken from the grid (Rautiainen et al. 2010). This energy payment can be included for example in a normal parking payment. In this approach, energy measurement equipment is not mandatory for the charging point, which lowers the infrastructure cost. In normal situations the amount of energy taken from the grid is fairly small and the cost of the energy is also small compared to parking payments especially in city centers. Another option is to measure the charged energy and then charge the customer based on the amount of energy. This kind of a charging event is analog to fueling of conventional ICE base cars. This model leads to greater infrastructure investments compared to “constant payment” option because of the need for charging-station-specific energy measurement. A thing which should be thought by charging service operators is whether or not it is worth the effort and investment to measure the charged energy for EVs. The meaningfulness of the measurement depends on many things such as expected charging powers etc.

In the present open electricity market, consumers have the possibility to choose the electricity retailer from which they will buy the electricity. EVs are mobile electric loads which can use quite a lot of energy and which can be charged in many physical locations. There have been some thoughts about maintaining the freedom of choice, at least to some extent, of the electricity retailer and the electricity product also in public and commercial charging stations (Rautiainen et al. 2010). Fig. 4.5 illustrates two different ways to enable this.

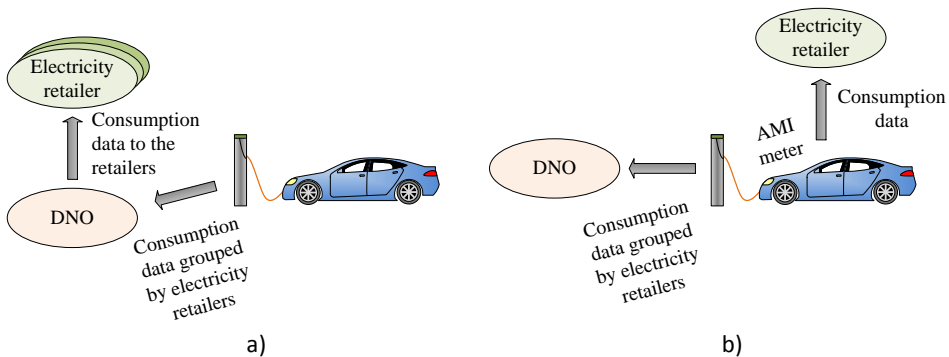

**Fig. 4.5.** Market mechanisms allowing buying electricity from multiple retailers: a) “multi retailer” market mechanism, b) “vehicle electricity” market mechanism

The first option to realize this, illustrated in Fig. 4.5a, is that the vehicle user can choose the electricity retailer and/or a single product from a certain retailer’s product selection offered by the public charging service provider. (Rautiainen et al. 2010) In this case, the user can have freedom to choose for example the cheapest option or renewable energy based option. This requires that the charging service provider must have relevant contracts with many retailers. In this mechanism, it is also possible that the user could use the same retailer as in domestic consumption, and the price of the electricity used by the vehicle could be added to the customer’s normal electricity bill. This kind of an

operation requires an identification of the customer. However, the distribution fee has to be paid to the local DNO for example by the owner of the charging point. Also, in the present electricity market model the consumption data grouped by retailers has to be sent to the DNO for the needs of balance settlement.

Another way to enable buying electricity from different retailers, illustrated in Fig. 4.5b, is the so called “car electricity” concept (Rautiainen et al. 2010). In this concept, the vehicle has its own AMI meter. Wherever the vehicle is charging, the energy which is absorbed from the grid is measured in the vehicle and the billing is carried out by reading the meter remotely. In this model the distribution fee is again paid to the local DNO. This market model offers a great freedom for the vehicle user to use any electricity product available always when charging. However, this mechanism brings the problem of two meters. Vehicles have their own energy meters, and when they connect for example to a regular domestic charging spot the energy is measured also in the domestic meter. To avoid paying twice for the same energy, some kind of communication between meters would be needed. Also, in this mechanism, the distribution fee should somehow be paid to the local DNOs, and the realization of this depends on the charging service provider. Also, for the needs of balance settlement, consumption data grouped by electricity retailers should be delivered to the DNO. These issues make the “vehicle electricity” mechanism very complicated, and infrastructure needed for this is expensive and complex. All these facts make the “vehicle electricity” concept not a reasonable and realistic option.

#### 4.5.3 Where and what kind of charging infrastructure should be built

In order to maximize the benefits of EVs, relevant charging infrastructure should be built. There has been some debate within EV manufacturers over whether to prefer AC or DC charging which usually correspond with low and high power charging, respectively. Also within a larger community there is a debate about the reasonable locations of the charging stations. From the car user point-of-view the characteristics of the charging infrastructure is especially important for full EV users (Neubauer & Wood 2014), because for full EV users the existence of charging possibility might easily be a question of vehicle usability (“Am I able to drive back home without charging?”). For PHEV users, a charging opportunity is more a question of maximizing electric driving. But in order to have a sufficient level of proportional electrical mileage enough charging should be made. An interesting and important question is how the extensiveness and the characteristics of the charging infrastructure affect the electricity usage of PHEVs or usability of full EVs. Also the significance of home, workplace and public charging is interesting. An interesting question is also how much available charging power affects the electricity use of EVs. Research in this area has been made during the recent years; see for example Publication 3 and (Zhang et al. 2011; Dong & Lin 2012; Kelly et al. 2012; Peterson & Michalek 2013; Zhang et al. 2013; Traut et al. 2012; Dong et al. 2014). Some answers for these questions are given in the following simulation example concerning PHEVs with Finnish car use habits and conditions. The results can be partly be interpreted to be relevant also for full EVs.



The following sensitivity simulation example is similar to the simulation example of Section 4.2., but in this case the sensitivity study is conducted also with respect to *charging infrastructure characteristics*. For simplicity of illustration, the example presents only the cases where the average specific electricity consumption of the vehicles is 0.26 kWh/km, which is one of the average specific electricity consumption values of the study in Section 4.2. The following example presents the proportional electrical mileage of the simulated PHEV fleet as a function of effective battery capacity and different *charging infrastructure characteristics*. Concerning charging infrastructure characteristics six different cases are presented.

1. Charging only at *homes* with 3.5 kW charging power.
2. Charging only at *homes* with 10 kW charging power.
3. Charging only at *homes* and *workplaces* with 3.5 kW charging power.
4. Charging only at *homes*, *workplaces* and *public parking places* with 3.5 kW charging power.
5. Charging only at *homes* and *workplaces* with 3.5 kW charging power and in *public parking places* with 20 kW charging power.
6. Charging only at *homes* and *workplaces* with 3.5 kW charging power and in *public parking places* with 50 kW charging power.

Depending on the case the existence of charging opportunities is assumed in three different types of places: homes, workplaces and public parking places. If a charging opportunity is modeled to be in any of the location types, it is assumed that every parking place of that type would have a charging opportunity. Thus, the sensitivity study presents “extreme” cases where there are high amounts of charging stations. Also when modeling high charging powers, 20 kW and 50 kW, it is assumed that the charging power is constant during the charging process. Considering the charging technology of today, this is not necessarily the case in reality (Härkönen 2012), and thus the sensitivity study gives somewhat over-optimistic results.

Figure 4.6 presents the results of the study. A few important observations can be made. It is quite probable that homes would be the most probable place for charging. This is quite logical as on average cars are parked at homes for most of the day. Also, it would be often easy to install a good and feasible charging station at home. If only home charging is made, most of the proportional electrical range potential is already obtained. Boosting the home charging power from 3.5 kW to 10 kW gives only a very modest benefit on average. If a workplace charging opportunity is added, the proportional electrical range is increased only a few percentage points which is quite a modest increase taking into account that the cars are also parked at the workplaces for significant amounts of time. One important observation is that if charging is made with moderate charging powers at homes and at workplaces, the importance of public charging opportunity with all the three simulated charging powers is very small. One can see that adding high power DC charging stations does not necessarily have a very important role for EV users on average. It should however be remembered that there are segments of EV users for whom public low and/or high power charging is very

important. It is not possible for all EV users to charge their vehicles at homes and/or at the workplaces.

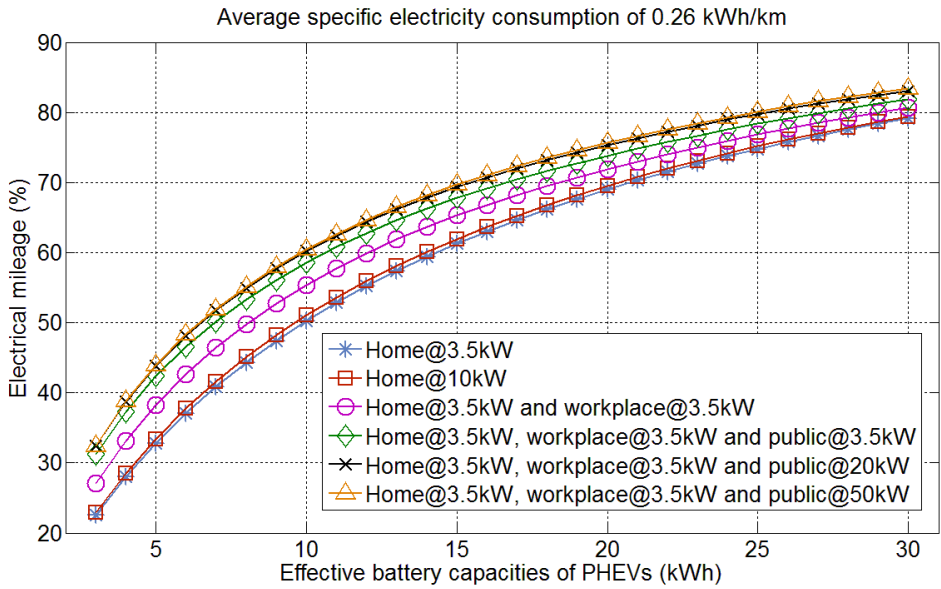

**Fig. 4.6.** Electrical mileage of PHEVs as a function of average effective battery capacity with different charging infrastructure characteristics.

# 5 Electric vehicles in smart grids

Although EV related research in the electrical energy infrastructure context has been conducted over many decades, the interest and the amount of EV related research has exploded during the last few years. As an example of the older studies, a reader can take a look at the paper by Dr. Salihi dating back to 1973 (Salihi 1973) and as examples of more modern studies one can take a look at on papers (Rautiainen et al. 2010; Clement-Nyns et al. 2010; Sortomme et al. 2011; Sortomme & El-Sharkawi 2011; Verzijlbergh et al. 2012; Chao-Kai Wen et al. 2012; Sundstrom & Binding 2012; Richardson et al. 2012; Sanchez-Martin et al. 2012; Rezaee et al. 2013; Kennel et al. 2013; Arancibia et al. 2013; Faria et al. 2014; Tan Ma & Mohammed 2014; Misra et al. 2015).

In academic and industrial environments it is often thought that EVs could have at least three different types of roles in a smart grid. Firstly, EVs can be simply loads consuming electricity from the grid when charging. Secondly, EVs can be used as controllable loads. This means that in addition to only charging the batteries when possible, the charging could be shifted, interrupted or restricted due to needs of for the example power system or electricity market. Considering these first two roles, EV is only a single type of load among other loads. However, the third role differs from most of today's resources: energy storage. The battery pack of an EV could be used to store electricity for the needs of the power system or electricity market, see for example the classical paper (Kempton & Tomić 2005). In general, it can be said that the more EVs would be used for the needs of power system or electricity market the larger would the benefit of EVs be to the vehicle owners and to the power system.

## 5.1 EVs as a charging load

From the electricity networks point-of-view the most obvious role of an EV is to charge energy from the network to the onboard electricity storage, i.e. to operate as a charging load. If large amounts of EVs were to penetrate the market, it could have impacts on the electricity system. In order to study the impacts, the charging load has to be modeled somehow.

In Publication 3, the charging load modeling of PHEVs is made. Full EVs are excluded from the modeling mainly for two reasons. Firstly, the author of the thesis thinks that PHEVs have more important roles on the *large scale* EV penetration and therefore their modeling is more important. Secondly, at least from the car use habits point-of-view, PHEVs are more straightforward to model compared to full EVs. In Publication 3, the data of the National Travel Survey of Finland (NTS) (Finnish Transport Agency 2014) is used to describe the car use habits of Finns. Conventional ICE based vehicles are very user-friendly because it takes only a few minutes to refuel them and their range can be over 1000 km. This is why today people can generally use their cars in a way that corresponds to their travelling needs very well. Thus, NTS data is interpreted to represent *the driving needs* of Finns. And as PHEVs can be used quite similarly as ICE

cars, it can be assumed rather safely assumed that PHEVs could be used in the same way as ICE cars (Publication 3). This is not necessarily the case for full EVs due to many physical and psychological factors. However, it should be noticed that the results of PHEV modeling can be used as an approximate model, i.e. as a model with more uncertainties, also for full EV charging. There are also many psychological factors in people's behavior which are hard to predict, and changes in the way of living, prices of electricity and liquid fuels, and use of public transport, etc., also have an effect on driving needs in the future.

Publication 3 deals with charging load modeling. To model EV charging load, the most essential aspects affecting the charging has to be modeled and the results have to be in a relevant and usable form. The most fundamental aspects of EV charging modeling are car use habits, characteristics of cars, availability and characteristics of charging spots and electricity market functions affecting charging (Publication 3). The target of the work in Publication 3 has been to develop a systematic methodology which could be used to model PHEVs in electricity distribution networks and to produce models also for other modeling needs. NTS includes the data of thousands of respondents' car use during a one-day long period throughout Finland. The data includes for example the following information about every car trip of the respondent: starting time, duration, length of, type of starting place and type of destination. Assuming certain characteristics of the cars and locations and characteristics of the charging stations etc., simple charging modeling can be made. The results can be formulated in a form which for example DNOs can apply directly in their network information systems.

The main idea of the PHEV charging load modeling is illustrated in Fig. 5.1. The figure presents an example driver who makes four car trips during the day. The upper part of the figure presents the state of the car during the day and some information about the trips. In the example it is assumed that in the beginning of the first trip the battery is full, charging is made at home and at the workplace at charging powers of 3.5 kW (15 A) and 2.3 kW (10 A), respectively. Charging starts immediately when the car is parked to the parking place equipped with charging station, and charging ends when the battery is full or the next trip begins. Lower part of the figure presents the charging power of the car during the day. Three charging sessions are carried out: first one at the workplace and the following two at home. In this way, the charging of thousands of respondents of NTS can be simulated and different types of further analysis can be made to the simulated charging profiles.

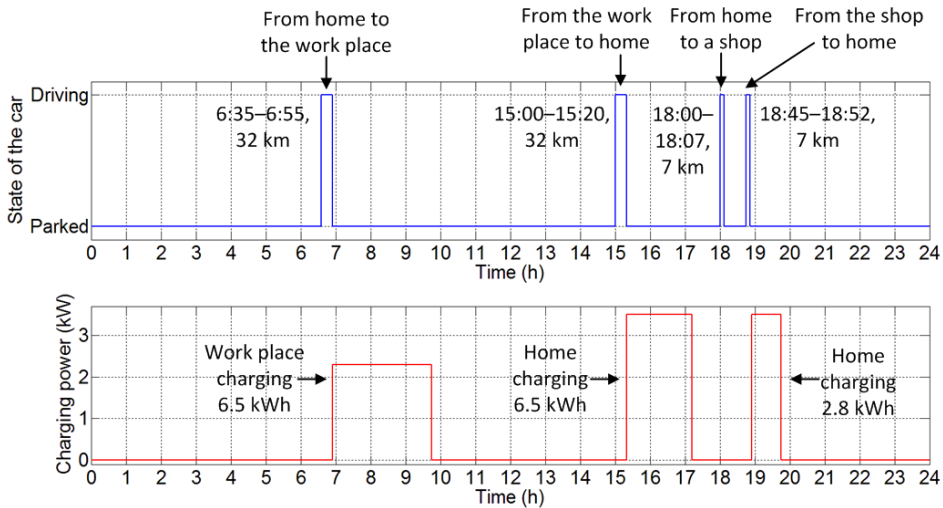

**Fig. 5.1.** Example of the use of the NTS data for PHEV load modeling.

Publication 3 concentrated especially on distribution network load modeling in Finnish network information systems (NIS) and related statistical power flow calculation methods. In Finnish network calculation tradition loads are modeled as statistical distributions and related load flow algorithms are used. Figure 5.2 presents an example of a statistical home charging load curve for a single customer group (respondents living in detached and semi-detached houses, winter time) with certain assumptions (for example that charging is made only at homes and at workplaces at 3.5 kW charging power). Different kinds of ways to group customers such as geographical, type of living etc. can be used. In Fig. 5.2, the mean values and standard deviations of the hourly charged energies for every hour of the day and different types of days (work days, Saturdays and Sundays) are presented. These types of curves can be used with a fair amount of work in the NISs of the Finnish network companies (Publication 4).

The methodology of Publication 3 can be considered very flexible and useful, but there are of course many uncertainties. Some of the uncertainties are due to the nature of the NTS data and some related to the assumptions used. For example, the NTS data describes the trips of individual people and not individual cars. This issue is discussed in more detail in Publication 3 and in (Liu et al. 2015). Some of the assumptions also include significant uncertainties. For example the assumption the PHEVs of the (distant) future would be driven in the same way than current conventional ICE cars includes high uncertainty. It is uncertain how the transportation systems, the way of transport and the whole way of living will change in the future (Publication 3). However, at least some of the uncertainties in Publication 3 can be investigated for example in a form of sensitivity studies.

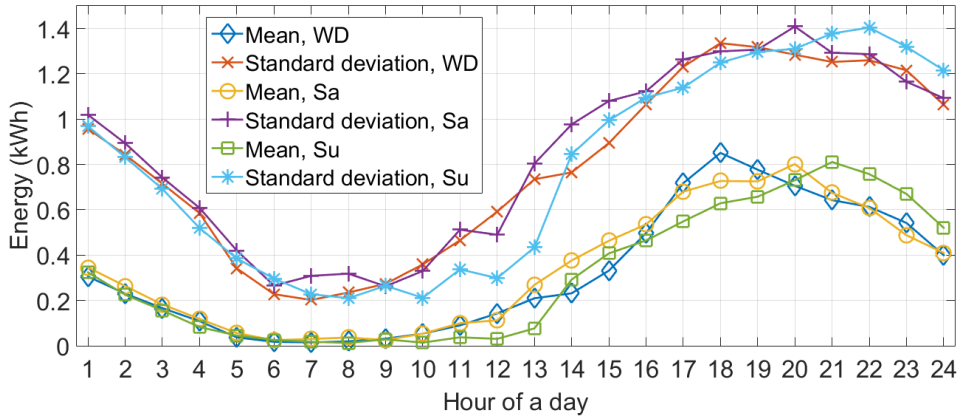

*Fig. 5.2. An example of load curves using the methodology.*

## 5.2 Impacts of EV charging on electricity grid

EV charging load has different impacts on different parts of the electricity system, and the impacts depend on which part of the system is investigated. In the following sections, impacts of EV charging load to the electricity transmission grid, distribution networks and networks of real estates are discussed, and the focus is mostly on distribution networks which Publication 4 is also related to.

### 5.2.1 Transmission grid level

The Finnish and further North-European transmission grids and North-European electricity market have extremely high interdependency with each other. The load flows of the lines and other components in the grid depend on the wholesale electricity markets and vice versa. Impacts of uncontrolled and controlled charging on the Finnish transmission grid are investigated for example in (Kiviluoma & Meibom 2011). In this thesis only a simple illustrative example is shown.

Figure 5.3 shows real total hourly electricity consumption of Finland over an example day 24.1.2014. During the day the load was at very high level. In addition to the real consumption there is also a hypothetical case of the consumption with additional one million PHEVs charging during the day. The charging curve was produced using the methodology of Publication 3 and assuming non-controlled (“dumb”) charging power of 3.5 kW at homes, workplaces and public parking places. Battery capacities and specific electricity consumptions were similar to the example in Publication 3 except the temperature correction was made to the specific electricity consumptions as explained in Section 4.4. It can be seen that in this specific case, one million PHEVs would raise the consumption levels by roughly for some hundreds of MWs and considering the proportional increase and the required time scale to have a million PHEVs on the roads, the impact on the total load level is quite modest.

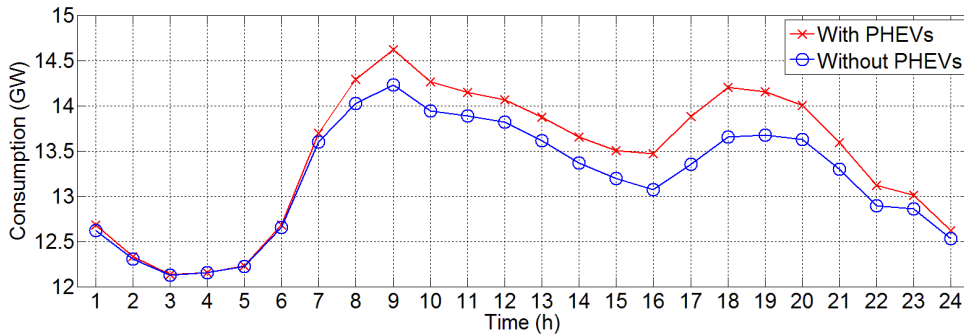

**Fig. 5.3.** Example of the impact of 1,000,000 PHEVs charging load on electricity consumption in Finland.

## 5.2.2 Distribution grid

Many Finnish DNOs have shown interest in the investigation of the impacts of charging EVs in their networks. The distribution networks of DNOs are generally fairly old and also due to increased reliability requirements significant network renovation work will be carried out by many companies in the following years (Järventausta et al. 2010). As the construction of distribution networks is a long-term investment, i.e. the lines and other components will probably be in use for many decades, the DNOs have to somehow assess or approximate the long-term changes in the loads of the networks in the planning process. To assess the impacts of EVs on a distribution network, the effect of the EV fleet’s charging load in the network has to be modeled. In the following, the impacts of EV charging on urban and rural networks are discussed.

### *Urban networks*

In Publication 4, the network impacts of the charging load of EVs on two real Finnish distribution networks is investigated. The networks are owned and managed by two DNOs: *JE-Suurto* (JE) and *Tampereen Sähköverkko* (TS). The studies of Publication 4 are based on the modeling methodology of Publication 3. The calculations were made by the DNOs’ staff. As the two different studies were made independently from each other, their modeling and calculation principles and the way of presenting the results differ from each other. However, the power flow calculation principles, of which a short description is presented in Publication 3, were the same in both cases. In the studies the whole distribution network was modeled: primary substations, medium voltage networks, secondary substations and low voltage networks.

In the calculations of Publication 4, a case in which charging is started immediately when the vehicle is parked at a charging location is considered (“dumb” charging). This kind of charging maximizes the usability of the cars and this case offers a good reference point in order to see also the possible needs for charging control and also the possibilities of EVs to produce different kinds of ancillary services for the electricity system. In Publication 4, load flow calculations were made to assess the impacts of EVs on JE’s and TS’s networks. Five different scenarios with different EV penetration levels

were defined and calculated in the case study of JE and two scenarios in the case study of TS. The studies concentrated mainly on the load rates of different components.

To summarize the results of Publication 4, it was shown that in order to have non-negligible impacts on the networks, penetration levels of dozens of percent are needed. As a conclusion of Publication 4 it can be said that EVs would not cause serious problems in the case networks, and this means that very high amounts of EVs would probably fit well to all Finnish urban distribution networks. However, it should be taken into account that because in urban networks there has to be some marginal in the network components for the possible back-up connection use, the low or moderate load rates of network components might be worse than would appear by the numbers at first. Also, the calculations showed in a preliminary manner that it could be beneficial to control the charging loads, like in Publication 7, or other resources in order to reduce the network impacts in some cases. Also, using the methodology of Publication 4, one can assess the availability of EVs to be used as controllable loads and energy storages.

### ***Rural networks***

In addition to the results of Publication 4, a simple case study concerning the network of Publication 2 is made. In the case study, the focus has been on the modeling of a “rural area”, although the network also covers some quite densely populated areas. For example, in the network 65% of the distribution transformers include maximum 10 network customers. In the case study, different amounts of PHEVs were modeled in the system assuming one car per household with penetration levels of 0%, 20%, 40%, 60%, 80% and 100%. In the case of 100% penetration level, the number of PHEVs in the network is 6754.

Load models are based on the methodology and the examples of Publication 3 except that temperature corrections to the specific electricity consumptions of the cars explained in section 4.4 were made. When forming the load curves, it was assumed that cars would be charged at homes and at workplaces with 3 kW charging powers and charging would be made always and immediately when possible. However, for simplicity reasons the loads were modeled only to homes, and therefore the charging loads in areas where workplaces are located are too low as the workplace charging load was not included in the calculations. In the case study, load flow calculations are not made with statistical load models but as a “snapshot” using the real AMI load measurements of the network customers. Therefore the PHEV load models were used in a heuristic manner by creating a set of “prototype” load curves which roughly obey the mean and standard deviations of the temperature corrected example modeling results of Publication 3.

Figures 5.4–5.6 present the results of the load flow calculations. Figures 5.4 and 5.5 present the peak load levels of distribution transformers (cf. fig. 3.2). The average increases of the peak load rates concerning PHEV penetration levels 20%, 40%, 60%, 80% and 100% are 3%, 5%, 7% 10% and 12%, respectively. Also, the amounts of transformers whose peak power rate increase 20%-points or more with PHEV penetration levels 20%, 40%, 60%, 80% and 100% are 3, 14, 31, 61 and 89,



respectively. It should be mentioned that in cases of many of the distribution transformers including only a few customers, peak load management systems discussed in 5.3.2 and 5.3.3 and Publications 6 and 7 could be used to avoid overloading. Figure 5.6 presents the peak loads (in MW) of the MV feeders (cf. Table 3.2). It can be seen that in order to have non-negligible peak load increases, very high EV penetration levels are required.

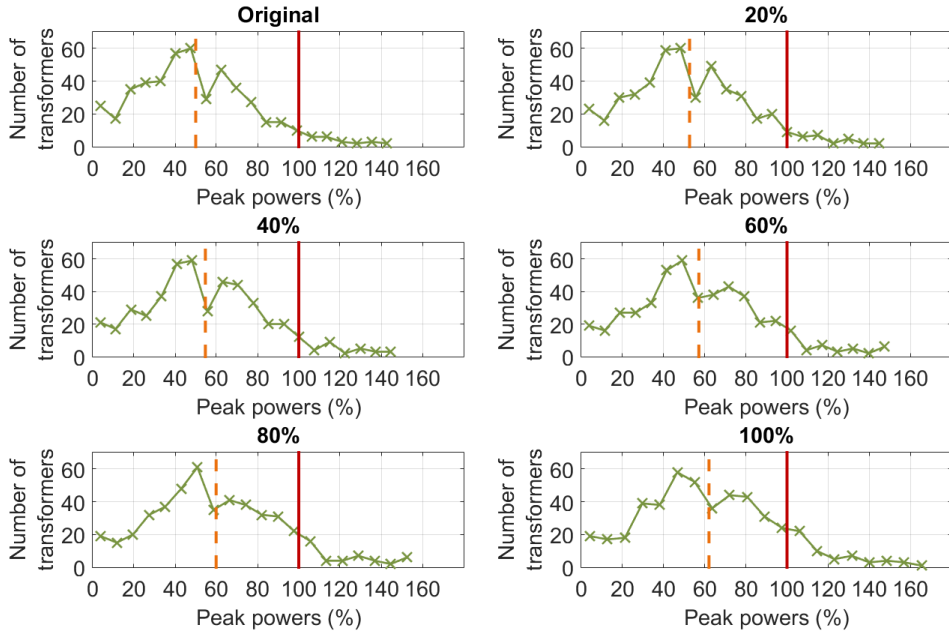

**Fig. 5.4.** The peak powers of distribution transformers with EV penetration levels of 0%, 20%, 40%, 60%, 80% and 100%. Peak powers are presented in percentages of the transformers' ratings. The vertical dash lines represent the average peak power level and the vertical solid line the more or less critical limit 100%.

Evaluation of impacts of EVs to the distribution network planning is a complex task and includes lots of parameters (see Publications 3 and 4). Therefore the uncertainties of the studies should be carefully considered. It would be useful to conduct a more holistic study on the impacts the possible changes of the loads can have on network planning. In such studies, other types of new loads besides EVs should also be taken into account. In Finland there are a lot of households with direct electrical heating, and in the future some proportion of them will be totally or partly replaced by heat pumps. In long term this can cause a remarkable decrease in electricity consumption in some network areas. There are also plenty of houses today in Finland which are heated by heating oil. Some proportion of these households will probably replace the oil heating system with a system which consumes remarkable amounts of electricity, for example heat pumps. This load change can increase peak loads in some parts of the network. In future studies, financial factors concerning network planning should also be taken into account to some extent. In the calculations of this paper, mostly the loading levels or possible overloading of network components were investigated. However, replacing for example

a line with one with a larger cross-section might be economically feasible before the increased load would cause any technical limit violations (Lakervi & Partanen 2008).

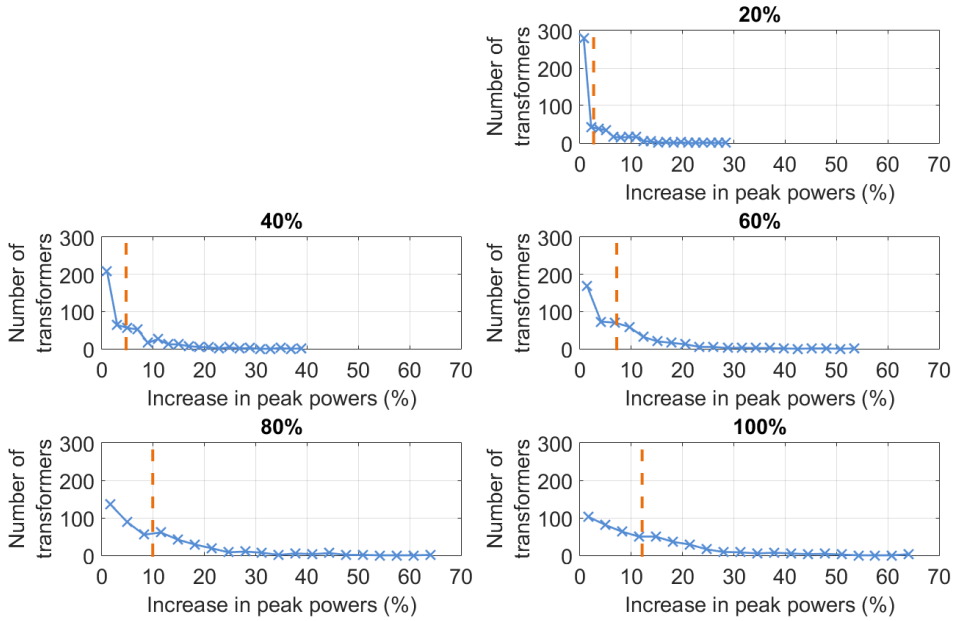

**Fig. 5.5.** The increases of powers of distribution transformers with different penetration levels. Peak powers are presented in percentages of the transformers' ratings. The vertical dash lines represent the average change of peak power levels.

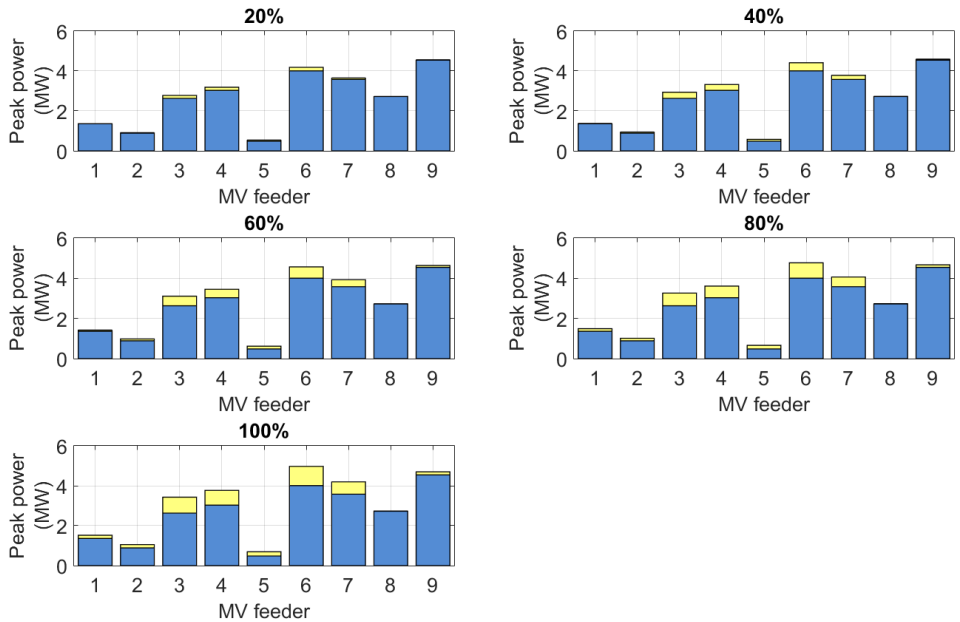

**Fig. 5.6.** Peak powers of the MV feeders of the case network. Each of the bar includes the values of the original load data and the additional peak loads caused by EVs.

### 5.2.3 Networks of real estates

The electricity networks of real estates have different EV charging related challenges compared to public distribution networks and transmission networks. Electricity consumers have a network connection of a certain size, for example 3×25 A. Also, domestic sockets and charging stations are fed with feeders of a certain rating, for example 1×16 A. All of the current limits should be of course respected in order to avoid the tripping of the fuses and/or circuit breakers. As mentioned in Section 4.5.1, if Schuko sockets are used, the current should be restricted to a safe level taking into account the condition of the socket and the installations of the real estate. If a charger with high charging power, such as 10–20 kW (3×15 A – 3×30 A) is used for example in a detached house or if multiple charging stations are fed from the same feeder or from the same main fuses, some kind of a peak load management system could be useful in order to avoid exceeding the relevant current limits. Peak load management systems are discussed in more detail in Publications 6 and 7 and Sections 5.3.1 and 5.3.2. Also, if multiple charging stations or high power charging stations are used, one should also consider power quality issues, but the relevance of power quality issues depend very much on the quality of the current drawn by the chargers (Härkönen 2012).

## 5.3 Smart charging

“Smart charging” or “intelligent charging” of EVs has been somewhat a hyped concept during the past few years. In this thesis, smart or intelligent charging is defined to be *charging behavior of an EV which is influenced by other targets besides the target to charge the battery in order to fulfill the expected energy needs of the car*. Smart charging is often DR made with an EV charger.

Charging of EVs can be controlled in many ways. These ways correspond to the load control methods presented in Section 2.2. On/off switching is simple to realize, but it has to be made in such a way that the control does not interfere with the charging system of the car. For example, experience from the field tells that some models of mode 2 charging related in-cable control and protection devices do not necessarily recover from voltage cut-offs. In mode 3 charging, a maximum charging current level is set for the car by the charging station, and the maximum level can be changed during the charging process. It should be noted that only the maximum current level can be set, and the charger itself decides the charging current. In mode 4 charging the current and/or power of the charger can be controlled by the charging station, but the control possibilities depend on the type of the charging station.

### 5.3.1 Smart charging architectures

From the system point-of-view there are different ways to control the charging of EVs. The control methods can be divided into two different types: control based on local information or control based on communication between the vehicle and an “upper level system” (Publication 5). The upper level system is for example the system of service provider/aggregator/DR operator. The communication could include things like control commands, control parameters and/or different supervision related data to the upper

level system etc. Some of the control actions could be made based on local information like frequency of the power grid or some kind of timing, but in these cases communication could be used to set different control parameters.

The basic control communication architectures are the following: communication directly to the car, communication to the charging station and communication to a home automation systems or AMI meters. The three control architectures, which are illustrated in Fig. 5.7, differ from each other in their ability to produce different services, as the control and other information flows between participants are different in different architectures. Thus, the architectures also have different possibilities to produce benefit for the EV owners and other parties. In the three architectures, the service operator etc. makes contracts for EV controllability with different parties: EV owner, charging station owner and electricity consumer.

In the first architecture (Fig. 5.7a), there is communication between the upper level system and the car regardless of the location of the car. This would require communication and charging control electronics in the car, which means that either the car manufacturer has to install the electronics or the electronics have to be provided and installed by some other parties. From a business perspective, this architecture means that in order to control the car the controlling party must make a contract with the car owner. In this architecture, the location of the controllable resource might change. This means that the car can use many different charging stations and the charging stations can be connected to different DNOs' networks. Thus, the use of this architecture to provide services for a certain distribution network would require geolocation data. On the other hand, this architecture fits very well for providing for example reserve services for a TSO as the TSOs system is typically nationwide and the EVs will be charged mostly in the TSO's network.

In the second architecture (Fig. 5.7b), there would be communication between the upper level system and the charging station. The actions which could be possible to realize in the car depend on the type of the charging interface of the car and properties of the charging station. The offered services must be fitted with needs of the charging customer. For example, if a customer buys charging service, the charging cannot be necessarily interrupted for a long time or restricted too much without customer acceptance. In principle, the charging station owner could promise the charging power to be for example between 70–100% of the maximum power, and this variation interval would be used to produce the ancillary services. From a business perspective, this architecture means that in order to control the car, the controlling party must make a contract with the party which manages the charging station. In this architecture, the location of the controllable resource is constant and connected to a certain DNO's network. Thus, the use of this architecture to provide services for a certain DNO is very straightforward. Also in this architecture, electricity trade related DR possibilities depend on who pays the retailer for the charged electricity.

The third architecture (Fig. 5.7c) is very different compared to the previous ones. In this case, the control commands would be sent to a home automation (HA), building

automation (BA) or AMI system. Now there are many different types of resources which could be controlled in very different ways. HA, BA or AMI could also decide what resources it uses and how. The features and functionalities depend on the characteristics and properties of HA and the type of the resources. From a business perspective, this architecture means that in order to control the resources, the aggregator must make contract with the owner of the house or real estate. In this architecture, the location of the controllable resource is again constant and connected to certain DNO's network. Also electricity trade related DR would probably be very straightforward due to the existing electricity contract with an electricity retailer. This architecture implicitly enables the use of many different types of energy resources which would increase the total volume of the controlled power/energy etc.

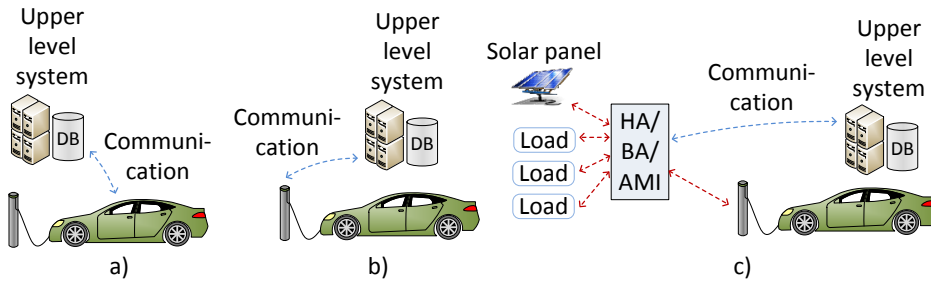

**Fig. 5.7.** Three different communication based charging control architectures: a) communication directly to the car, b) communication the charging station and c) communication to a home automation (HA) or an AMI meter

### 5.3.2 Example: coordination of domestic loads

As mentioned earlier in Section 5, there might be multiple needs to manage the peak load or load in general in the domestic, e.g. a detached house, network. Besides only the limitations of the networks and/or network connections of real estates, the domestic load management system could be used by many types of DR applications. There are several load management methods of different levels of flexibility and complexity. Today in Finnish detached houses, electric space heaters (total amount is usually some kilowatts depending on the size of the house etc.), electric sauna stoves (typically 4–11 kW), which are very common in Finland and storage water heaters (typically 1.5–6 kW) are often alternating with each other to restrict the peak power of a household. When for example a sauna stove is switched on, some space heaters are automatically switched off. In situations where there is a need to charge one or more EVs while having simultaneously other large loads on, these kinds of alternating systems could be extended and applied to EVs (Publications 5 and 6). The simplified principle of this kind of a system is illustrated in Fig. 5.8. Also using the EV as electricity storage in this kind of a system would be possible. This means that energy is stored in the vehicle battery pack and later this energy is fed back to the network during time when energy needs of other loads are high. However, charging control is only considered further in this section.

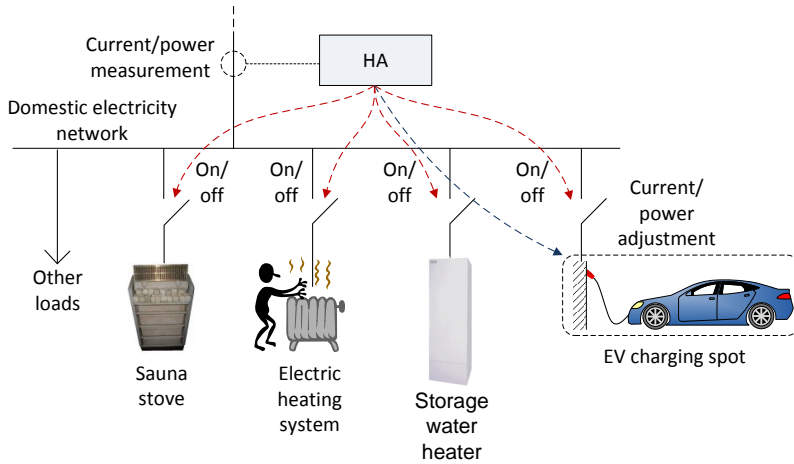

**Fig. 5.8.** A simplified principle of a peak load management system of a detached house.

The load management can be made in at least two ways: by alternating the charger with other loads by on/off switching and by adjusting the charging current/power in accordance of the other loads. It would be possible for example to switch the charging mode from semi-fast (for example 10 kW) to slow (for example 3 kW) or to modify charging current more freely. Peak load management methods can be divided into two different groups also from another point of view: methods in which the total current or power, for example the current or power of the connection point of a property or a parking place, is measured, and methods without the measurement.

Fig. 5.9 presents a simplified example of a simple algorithm managing the peak powers and/or currents of a domestic electric network in the presence of a home automation system, electric space heaters, an electric sauna stove and an electric vehicle. The main idea of the algorithm is that the electric sauna stove has the highest priority and it is enabled to be on if necessary. Then the power/current capacity of the feeders is divided between space heaters and the electric vehicle. The charging power of the EV can be adjusted for example by simply using two different power levels: “low” and “high”. In the algorithm there is also indoor temperature monitoring which ensures that the temperatures do not decrease too low during load control.

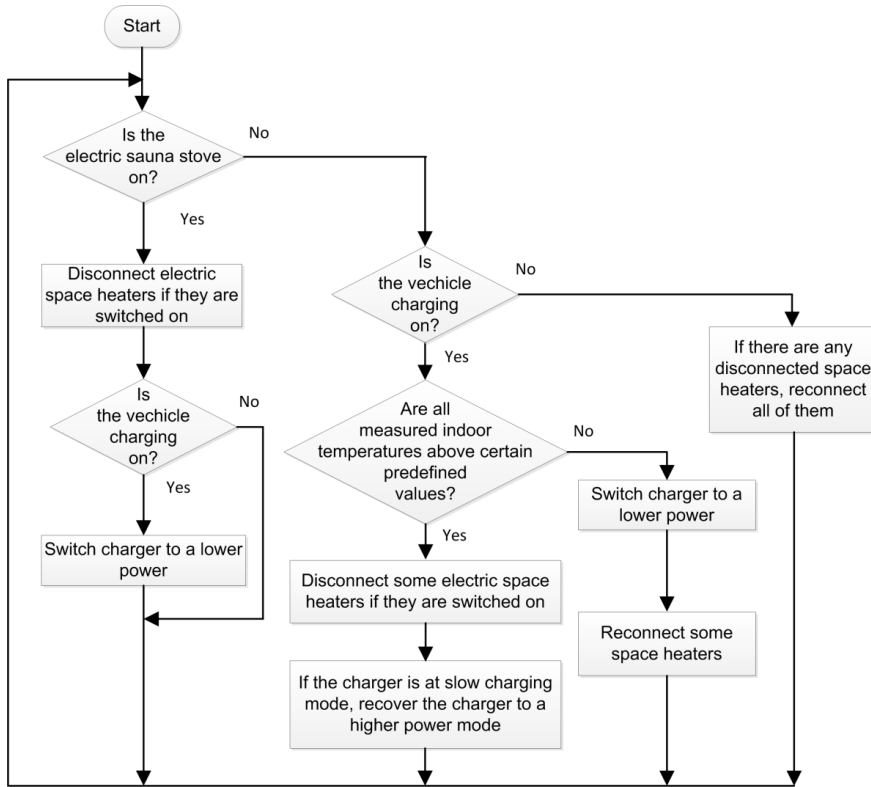

**Fig. 5.9.** A simplified example algorithm how different domestic loads could be managed.

Figure 5.10 presents a simplified example, which is presented for illustration purposes, of a peak load management system in a detached house with multiple high-power loads and an EV charger. In the example, there is a household with multiple loads and three of them are controllable including the EV charger. Of course there could also be several EVs in the household. Fig. 5.10 presents currents of the loads connected to one of the phases (loads can be one-phase or multiple-phase) of the household. It is also assumed that there is a  $3 \times 25$  A network connection and the phase current cannot exceed this value. In the figure there are two different cases. In the first case, illustrated in fig. 5.10a, the controllable loads are only switched on and off one after another so that all of the three loads receive at least some energy. The switching is based on the measurement of the total current of the non-controllable loads and the controllable loads are switched on in accordance with the marginal between the current limit and the total current of the non-controllable loads. If the total current of the non-controllable loads is low enough, more than one of the controllable loads can receive energy simultaneously as illustrated in the figure. Figure 5.10b illustrates another control principle where only two of the controllable loads are alternated with each other and then the current of the EV charger is adjusted in a continuous manner in accordance with the marginal between the current limit and the total current of all other loads besides EV charger. In this way a more efficient use of the available capacity can be achieved. Fig. 5.10 illustrates only the

main principles of such a system and to construct a real system many practical issues have to be taken into account.

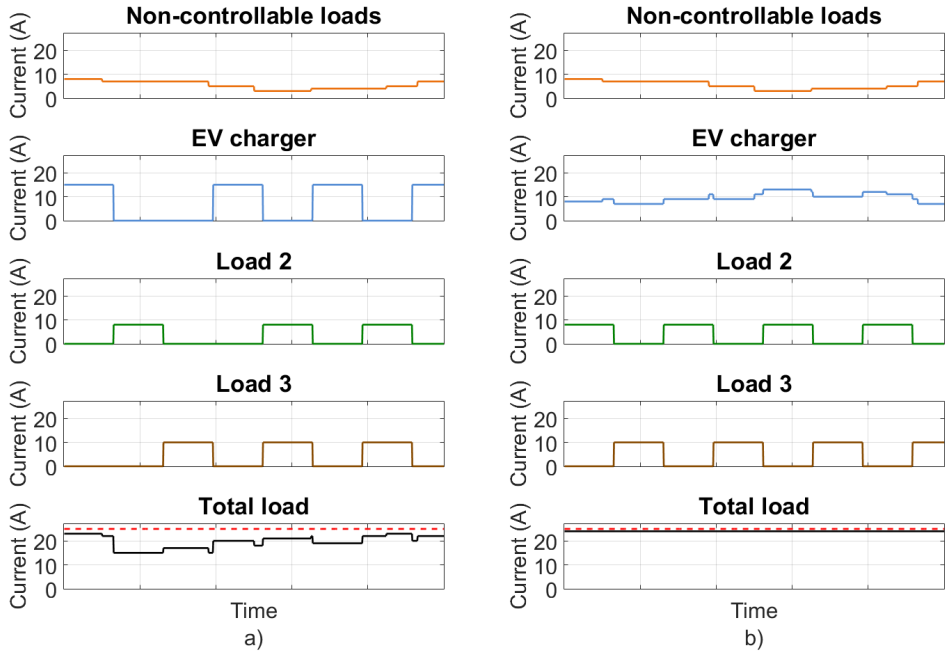

**Fig. 5.10.** A simplified principle example of a peak load management system of a detached house in two cases: a) on/off switching of an EV charger and b) current adjustment of the EV charger. The horizontal dash lines in the lowest subfigures present the 25 A current limit.

### 5.3.3 Example: load control of an EV charging station group

Section 5.3.2 dealt with the peak load management system of a detached house or similar network of real estate. In such a system, the power/current capacity has to be spread between an EV and some other loads in one way or another. Another practical load control need arises when multiple EV charging stations are planned to be installed in a parking hall or other similar place. If there are many EVs charging simultaneously using high powers/currents, the total peak powers/currents of the cables feeding the charging station group or in the network connection can rise to an extremely high level which leads to needs for very thick cables and/or large main fuse sizes/large network connection. Taking into account that these kinds of situations can be very rare in many cases, this is not desirable from the cost-effectiveness point-of-view. It might therefore be reasonable to control the total currents of a charging station group.

A load control system for an EV charging station group can be made in many ways and with different features and properties. Depending on the amount and the properties of EVs, the problem of maximum currents might occur quite rarely and might not last for a very long time. Therefore a simple solution for the problem would probably be enough in many cases. However, if the maximum current problem occurs often and/or takes a



long time, more sophisticated algorithms could be used which would make the system more efficient, but simultaneously the complexity and the cost of the system would increase. Also, the available information sets some limits for the control system. For example, one could optimize the operation of the system if the SOC of the battery packs were known by the charging system. Also, if it was known when the cars leave the parking place, a more efficient system could be made.

A realistic example algorithm to manage the peak currents of an EV charging station group is presented and simulated in Publication 7. The system is based on the charging current controlling possibilities of the present EV charging standards. The main structure of the system of Publication 7 is illustrated in Fig. 5.11. There is a group of  $N$  charging stations and a load controller unit which controls the charging stations to manage the total load of the charging station group. In the figure, there is also the total current measurement of the feeder feeding the charging station group. Also, it is possible to measure the phase currents of each of the charging stations and send the data to the controller. In principle, it would be possible to construct a control system where the total currents or the currents of individual charging stations would not be measured at all, but this would probably lead to an inefficient system.

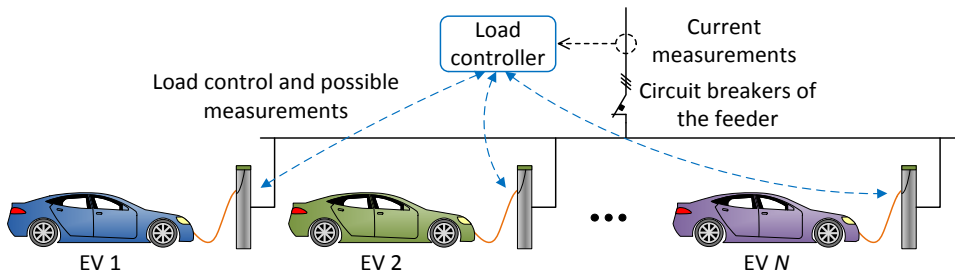

**Fig. 5.11.** The basic setup for the load control system.

In brief, the main idea of the algorithm of Publication 7 is as follows. Chargers are allowed to charge whenever necessary even with the maximum current of the charging station, but if the total current of any of the feeding phases exceeds a certain predefined limit, the currents of mode 3 chargers are restricted to decrease the currents of the overloaded phases. If this is not possible or if it does not solve the problem, the charging of some of the chargers is interrupted from the relevant phases. The interrupted chargers should be then circulated and alternated so that none of the chargers have to be interrupted for too long. In the simulations the circulation time is a rigid 10 min.

The algorithm is designed to react to certain events. The essential events are as follows.

1. The current limit is exceeded in some phases.
2. The current capacity is freed in some phases.
3. An EV starts mode 3 charging.

The algorithm was simulated with a realistic use case. In the simulations the charging behaviors of 10 different EVs were modeled. Fig. 5.12 illustrates the charging station



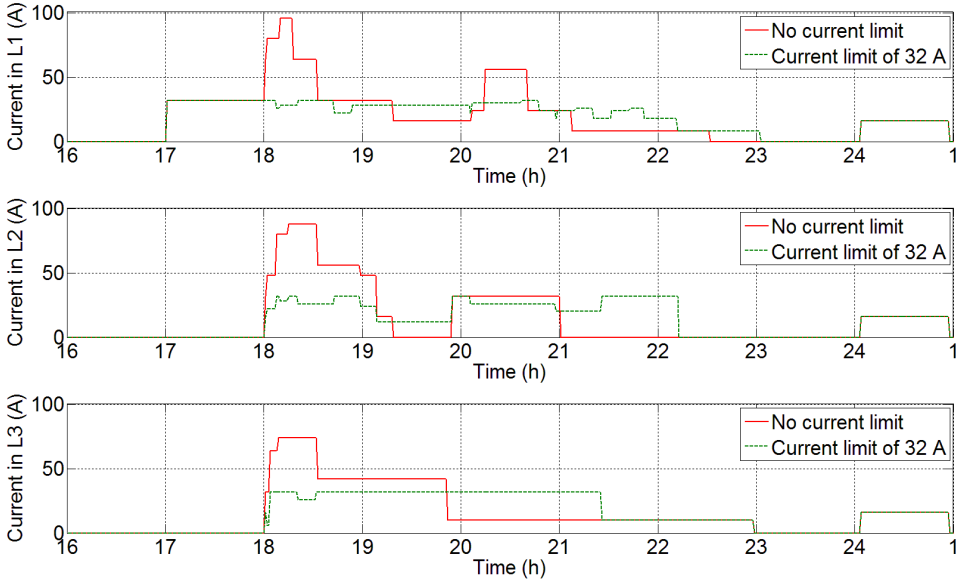

**Fig. 5.13.** Phase currents of the case “no current limit” and with a current limit of 32 A.

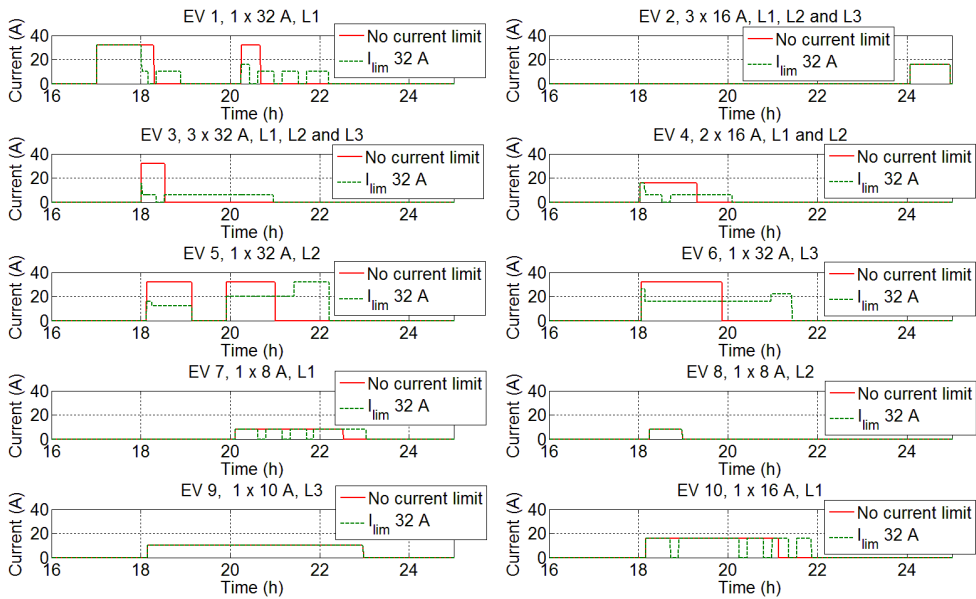

**Fig. 5.14.** Charging currents of the cars with no current limits and with a current limit of 32 A.

## 5.4 EVs as energy storage for the electricity system's needs

Efficient and cost effective energy storage capacity in the electricity system would offer many advantages and possibilities which are analyzed for example in (Jewell et al. 2004). EV battery packs could store relatively large amounts of electrical energy and the power capacity would be quite large. For example, if there were one million EVs in Finland, which would be about 40% of the amount of today's passenger cars of, and if 50 % of them were available for energy storage use and if the vehicles were simultaneously able to discharge 5 kWh per vehicle on average, the total energy capacity would be 2.5 GWh. If the discharging power was 3.5 kW per vehicle, the total discharge power capacity would be 1.75 GW. These numbers are quite remarkable even in the North-European power system.

Using the EV batteries as storages for the power system sets some requirements for the car and its electrical interface (Publication 5). In order to use a vehicle as energy storage for the needs of the power system, a bidirectional converter to the car or an external module with appropriate protection equipment is needed. Also depending on the case, energy meters should be able to handle two-way energy flows. Car batteries could be discharged to public distribution networks or to small isolated network islands such as single households. These energy storage operation modes differ from each other in certain ways. For example, the required protection and other requirements for the network interfaces are different (Publication 5).

The owners or the users of the cars have certain preferences with relation to the use of the car. The vehicle should be charged to full charge at some stage. If the battery pack was "unexpectedly" discharged during the charging process, the state-of-charge (SOC) of the battery pack would temporarily be decreased and vehicle users would have to accept this. Of course it is possible to construct some kind of a charging system which optimizes the charging taking into account car use preferences, dynamic energy pricing and ancillary service profits, see for example (Jin et al. 2014). Users may set the charging system to charge the battery pack to full charge at a certain time at the latest and within that time frame some optimization could be made.

### 5.4.1 The applications of EV as an electricity storage

In principle all DR applications presented in this thesis could be extended by using EVs as electricity storages for electricity systems' needs. In these situations EVs would discharge the energy from the battery pack to a public distribution network. In addition to DR applications, some other applications such as local power quality improvement would be possible at least in principle (Publications 5 and 6). The possibility to discharge some energy to the grid would improve the "ancillary service" potential of EVs significantly. However in practice, the electricity storage application would be a bit more complicated than controlling the unidirectional charging only. If a practical implementation of EVs as energy storages would be made with a large EV penetration level, EVs could benefit many parties in future society. Applications of EVs discharging

energy to the distribution grids are not discussed further in this thesis, but EVs as domestic back-up power will be discussed a bit next.

Today's way of living is highly dependent on reliable electricity distribution. During recent years, there have been many major storms in Finland which have caused long lasting outages for a large amount of electricity users. The reliability of electricity distribution is improved all the time, but outages will always be possible. EVs could be used as a back-up power source during outages. The battery pack would be then used as an energy storage feeding a small network island such as a single household. Also, in the case of a PHEV, the internal combustion engine might also be used to produce electricity from liquid fuel. The energy capacity of the battery pack is very limited which means that all the energy needs of for example a detached house cannot be covered for a long time. However, if the largest loads such as electric heaters and storage water heater were switched off, the sufficiency of the battery capacity would be much higher (Publications 5 and 6). If only a very limited amount of loads such as some lighting and maybe cellular phone or laptop charging would be allowed, the battery capacity would offer back-up power capability for a very long time.

Fig. 5.15 shows average hourly energies during different types of days for the whole year 2010 of a 1000 random customers with 3×25 A main fuses in the distribution network of *Koillis-Satakunnan Sähkö Inc.* The customers of the figure are of different types and also customers with electric heating are included. This simple illustrative example figure shows that with a battery pack from which a few kilo-watt-hours could be used for back-up power purposes, fairly long back-up power capability times could be achieved especially if some of the largest loads were disconnected from the network. In the disconnection process, systems similar to the ones presented for example in Section 5.3 could be used. However, a small battery would be needed in the home automation system to carry out the load reductions as there would be now power supply from the grid.

To realize the EV back-up power service, some special equipment and systems would be needed (Publications 5 and 6). Fig. 5.16 illustrates some features of such a system. One requirement is an isolation switch, which is used to disconnect the household or another small network island from the public distribution network. This isolation has to be made because the EV cannot feed other households or customers connected to the public distribution network. Depending on the preferences of the customer and the design of the circuits of the household, a three-phase network connection of the vehicle would be necessary. Otherwise it would be necessary to connect the loads to be fed to a certain phase. Some load reduction may be necessary to ensure that the power capability of the converter, the feeder and the energy capability of the battery are sufficient as presented above. Assuming that the vehicle works as the only power source (unless there is some sort of small scale power production) during back-up power operation, the feeding equipment has to include all necessary safety related (e.g. fault current feeding capability) capabilities and control and protection functionalities somewhat similar to the ones found in conventional power systems (Publication 5). In practice, a domestic

back-up power system can be bought for example in Japan where EVs can be used as back-up power using the DC charging interface.

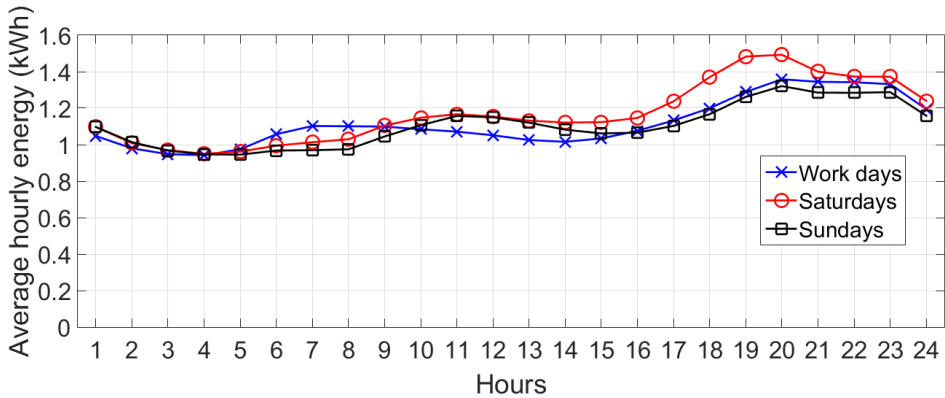

**Fig. 5.15.** Average hourly energies during different types of days of a 1000 random customers with  $3 \times 25$  A main fuses in the distribution network of Koillis-Satakunnan Sähkö Inc.

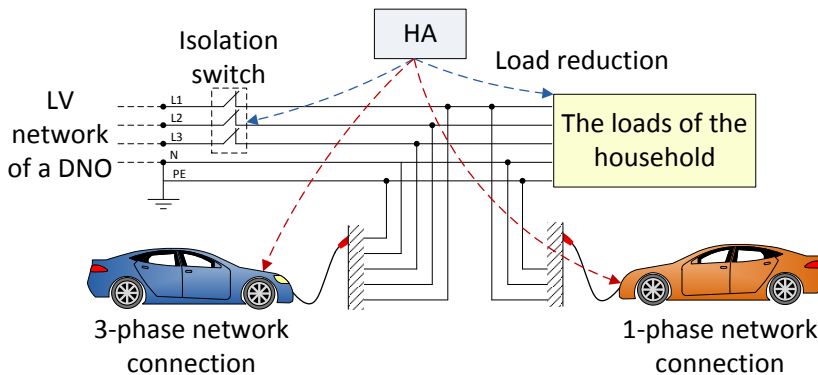
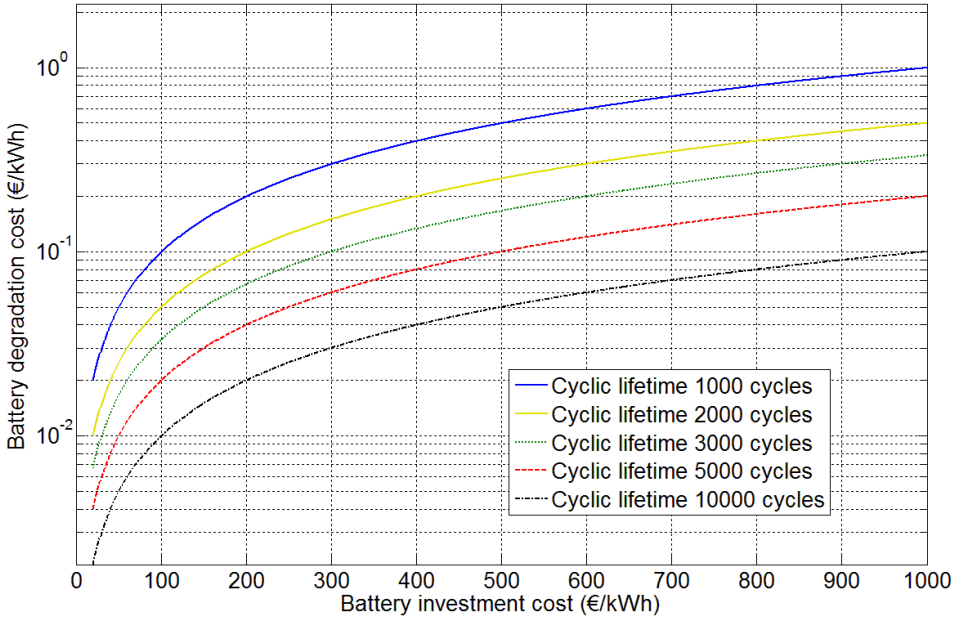

**Fig. 5.16.** Realization of the customer back-up power service.

#### 5.4.2 Battery degradation cost posed by electricity storage use of EVs

The use of the car's battery packs as energy storages for the power system inflicts costs for the car owners. Additional charging-discharging cycles pose additional stress to batteries and decrease their cyclic lifetime. The battery degradation cost of discharging a certain amount of energy from a battery pack and recharging the same amount of energy back to the battery depends on the type of the battery pack. Fig. 5.17 presents a simple calculation concerning battery degradation costs as a function of cyclic lifetime and battery investment cost (Publication 6). The battery degradation cost represents a cost per stored energy (in €/kWh) which is caused by cyclic lifetime loss when discharging a battery pack from a certain state by a certain amount and then charging back to the initial state. Cyclic lifetime is presented as a number of a certain type of charge-discharge cycles (cycle depth of 100% or something else). The values of Fig. 5.17 are obtained by simply dividing the battery investment cost (in €/kWh) by the number of cycles which can be obtained from the battery before its lifetime has ended.

It can be seen that to obtain a battery degradation cost of a few cents/kWh the cyclic lifetime must be very high and/or the investment cost has to be very low.



**Fig. 5.17.** Battery degradation costs as a function of cyclic lifetime and battery investment cost.

These types of theoretical marginal cost calculation principles have certain limitations. Let us consider life cycle costs by means of a simple example (Publication 6). An EV has an effective battery capacity of 30 kWh, which corresponds roughly to a 150 km electric driving range. The battery pack has a cyclic lifetime of 3,000 cycles which corresponds to a total electric driving range of 450,000 km. The average daily driving distance of Finnish cars is about 50 km, which is roughly 18,000 km/a. If all of the driving would be made using electricity, the total electric driving range would be “consumed” in 25 years on average. The lifetimes of EVs and especially calendar lifetimes of today’s lithium-ion batteries are significantly less than 25 years. This means that over the course of an EV’s lifetime, part of the battery capacity will not be used. From this point of view, the battery degradation cost of a moderate amount of electricity storage use can be considered practically zero if there is no significant battery after-car-life market. There have been some ideas about the possible use of batteries in for example power system applications after having been used in cars, but safety and reliability characteristics of reused batteries may have been decreased significantly during the EV use. Thus, the secondary battery market can be quite small also in the future.

## 6 Conclusions

This thesis discusses electric vehicles and demand response in the smart grid context. On one hand these two topics are independent from each other but they also have many interconnections and interdependencies with each other. In a broader view, EVs and DR can be potentially a non-negligible part of the smart grid of the future where more efficient use of the energy resources using ICT and new market models has been realized and deployed.

The challenges of the energy system of transportation drive today's societies to develop new forms of transportation. When it comes to road transportation and especially passenger road transportation (including public transportation), EVs might be an efficient part of the transportation system of the future. It is however quite clear that there will be a multitude of different types of vehicles using different types of fuels and energy sources on the roads in the future, and EVs will not be the only type. The electric vehicle is a new type of device in the modern world. On one hand, an electric vehicle is just a device consuming electricity like any other electrical apparatus, but on the other hand EVs include many new possibilities in the long-term development. A new possibility is for example the use of EVs as electricity storages for domestic back-up power, the electricity system and the electricity market. A possible scenario is that these "ancillary services" of EVs might become a significant additional reason to buy an EV.

Due to the installation of new AMI meters in Finnish households, discussion related to DR especially for small electricity consumers has been increased, activated and extended in Finland during the recent years. If DR could be efficiently integrated to the electricity market actions, many societal benefits could be achieved. However, some practical obstacles should be first removed before efficient and wide-spread DR of small electricity consumers could be realized. Also, the financial benefits for the electricity consumers are often quite small, which is a significant challenge. A pessimistic reader might think that at least in the near future wide spread novel DR of small electricity consumers is a doomed idea. However, integrating different types of DR for different types of DR markets could increase the total financial incentive of DR for an electricity consumer. Also, the financial potential of different types of DR applications might be increasing in the future.

Concerning individual themes, this thesis is quite broad covering many individual topics. The author of the thesis has wanted to produce quite a broad overview on electric mobility and active electricity networks. This means that there is no possibility to extensively cover all of the individual topics, but hopefully a clear and comprehensive overall picture has been drawn.



## 6.1 Main contributions

The main contributions of this thesis include the following things:

- ✓ In Finland, PHEVs could offer a significant proportion or even most of the benefits of EVs even with a quite modest charging infrastructure and battery capacities, and simultaneously the most severe obstacles of full EVs related to short range, restricted charging opportunities and possible challenges in the very large scale battery manufacturing can be avoided or at least mitigated. It seems also that homes would be the most important charging places in many cases.
- ✓ A flexible methodology for modeling PHEV charging load using National Travel Survey data has been developed and the main principles can be used globally although the load modeling techniques especially for the Finnish load modeling tradition have been emphasized.
- ✓ Statistical PHEV charging load models, taking into account the statistical distributions of the loads, produced by the developed methodology have been used by two different real DNOs in their network information systems to assess the impacts of EVs on distribution network planning in urban networks. Also a case study of a rural network carried out by the author is presented. The usability of the practical models has been verified.
- ✓ New distribution tariffs for small electricity customers encouraging customers to manage their peak powers and further peak powers in the distribution networks have been developed and simulated in a real distribution network. It seems that these kinds of tariffs would be efficient in restricting the increase of peak powers caused by spot price based DR although it seems to be hard to decrease the present peak powers by much in the distribution networks.
- ✓ Different general DR and smart charging concepts have been sketched, and a practical local customer-site peak load control management algorithm of an EV charging station group has been developed.

## 6.2 Future work

Due to the nature of the research area, simulation has been used as a main research method. Simulation is a powerful research method but of course compared to for example field tests or practical demonstrations it includes a larger risk that not all relevant aspects have been taken into account in modeling. When simulations are made, one has to make a modeling decision concerning the following two aspects: accuracy and complexity of the models. If a simple model is used, modeling can be made rapidly and with a modest amount of work, but the accuracy is not necessarily good or even good enough. If a complex and detailed model is used, the accuracy could be improved. The price for this is that the usability of the model might become difficult, the required amount of work proportioned to the achieved improvement in accuracy might be high and the availability and the quality of the required data for the model might be poor. Therefore compromises are always made, and they have also been made in the works of this thesis.

A multitude of ideas for future work has arisen from the topics of this thesis, and some of the ideas are also driven by the uncertainties of the studies of the thesis mentioned above. Some of the ideas are the following.

- ✓ Studies of charging infrastructure needs of full EVs and PHEVs in different areas of Finland should be made. Preferably all different types of transportation means which enable a more sustainable road transportation system should also be taken into account in the studies.
- ✓ The holistic impacts of DR, driven by different types of market actors and parties, to the economics of the Finnish society should be investigated.
- ✓ Concerning Publication 1, a more realistic power system model (such as a North-European power system model) should be used and different types of controllable loads and control methods should be investigated.
- ✓ Concerning Publication 2, sensitivity studies with different parameters of the distribution tariffs and more accurate and more extensively validated load control system models for the electricity customers could be made. Also, benefits and practical implementation methods of novel tariffs should be investigated further.
- ✓ Concerning Publication 3, different types of studies with different assumptions and parameters could be made and if there was significant amount of measurements of the charging of real PHEVs in Finnish conditions, the simulation results of Publication 3 should be compared to the results of measurements.
- ✓ Concerning Publication 4, a more holistic overview on the development of the distribution networks should be made taking into account for example other changes in the system besides EV charging. These changes can be related to other forms of electricity use such as heating solutions, and also the development of the whole network should be considered. Also sensitivity of the assumptions of charging load modeling should be made.
- ✓ Concerning Publications 5 and 6, near-to-practice business models should be developed, simulated and demonstrated.
- ✓ Concerning Publication 7, practical demonstrations should be built, tested and according to experiences gathered, the algorithm should be further developed. Also domestic household level systems and algorithms should be simulated and demonstrated in more detail.

# References

- Adato Energia Oy 2013. Kotitalouksien sähkönkäyttö 2011. Adato Energia Oy. 52 p. (in Finnish)
- Albadi, M.H. & El-Saadany, E.F. 2008. A summary of demand response in electricity markets. *Electric Power Systems Research* 78, 11, pp. 1989-1996.
- Arancibia, A., Strunz, K. & Mancilla-David, F. 2013. A Unified Single- and Three-Phase Control for Grid Connected Electric Vehicles. *IEEE Transactions on Smart Grid*, 4, 4, pp. 1780-1790.
- Aunedi, M., Kountouriotis, P.-., Calderon, J.E.O., Angeli, D. & Strbac, G. 2013. Economic and Environmental Benefits of Dynamic Demand in Providing Frequency Regulation. *IEEE Transactions on Smart Grid* 4, 4, pp. 2036-2048.
- Bartholomew, P., Callender, W., Hindes, C., Grimm, C., Johnson, K., Straub, M., Williams, D. & Williamson, M. 2009. Demand Response Measurement & Verification, Applications for Load Research. AEIC Load Reserach Committee. 30 p.
- Bauer, C., Hofer, J., Althaus, H., Del Duce, A. & Simons, A. 2015. The environmental performance of current and future passenger vehicles: Life Cycle Assessment based on a novel scenario analysis framework. *Applied Energy*, in press.
- Biomeri Oy 2009. Sähköajoneuvot Suomessa -selvitys. Ministry of Employment and the Economy of Finland. 130 p. (in Finnish)
- Bollen, M.H.J. 2011. The Smart Grid, Adapting the Power System to New Challenges. Morgan&Claypool Publishers. 180 p.
- Bryner, M., Clarke, G.M., Jansen, A.N., Patel, A. & Spotnitz, R. 2013. Special section: Lithium-ion batteries. *CEP Magazine*. pp. 35-64.
- Burton, N. 2013. A history of electric cars. The Crowood Press Ltd. 224 p.
- Chao-Kai Wen, Jung-Chieh Chen, Jen-Hao Teng & Pangan Ting 2012. Decentralized Plug-in Electric Vehicle Charging Selection Algorithm in Power Systems. *IEEE Transactions on Smart Grid*, 3, 4, pp. 1779-1789.
- Choi, W., Hu, S., He, M., Kozawa, K., Mara, S., Winer, A.M. & Paulson, S.E. 2013. Neighborhood-scale air quality impacts of emissions from motor vehicles and aircraft. *Atmospheric Environment* 80, pp. 310-321.
- Clement-Nyns, K., Haesen, E. & Driesen, J. 2010. The Impact of Charging Plug-In Hybrid Electric Vehicles on a Residential Distribution Grid. *IEEE Transactions on Power Systems* 25, 1, pp. 371-380.

- DOE 2006. Benefits of Demand Response in Electricity Markets and Recommendations for Achieving Them, A report to the United States Congress Pursuant to Section 1252 of the Energy Policy Act of 2005. DOE – U. S. Department of Energy. 122 p.
- Davis, S.C., Diegel, S.W. & Boundy, R.G. 2014. Transportation Energy Data Book. 33rd ed. Oak Ridge National Laboratory. 429 p.
- Dewulf, J., Van der Vorst, G., Denturck, K., Van Langenhove, H., Ghyoot, W., Tytgat, J. & Vandeputte, K. 2010. Recycling rechargeable lithium ion batteries: Critical analysis of natural resource savings. *Resources, Conservation and Recycling* 54, 4, pp. 229-234.
- Dong, J., Liu, C. & Lin, Z. 2014. Charging infrastructure planning for promoting battery electric vehicles: An activity-based approach using multiday travel data. *Transportation Research Part C: Emerging Technologies* 38, pp. 44-55.
- Dong, J. & Lin, Z. 2012. Within-day recharge of plug-in hybrid electric vehicles: Energy impact of public charging infrastructure. *Transportation Research Part D: Transport and Environment* 17, 5, pp. 405-412.
- EIA 2013. International Energy Outlook 2013. DOE/EIA-0484. 312 p.
- ERGEG 2010. Position Paper on Smart Grids – An ERGEG Conclusions Paper. ERGEG. E10-EQS-38-05. 38 p.
- Eurelectric 2013. Network tariff structure for a smart energy system. Eurelectric, 30 p.
- European Commission Reducing CO2 emissions from passenger cars. European Commission [referred 16.3.2015]. Available: [http://ec.europa.eu/clima/policies/transport/vehicles/cars/index\\_en.htm](http://ec.europa.eu/clima/policies/transport/vehicles/cars/index_en.htm).
- FERC 2014. Assessment of Demand Response and Advanced Metering, Staff Report. FERC – Federal Energy Regulatory Commission. 1-40 p.
- Faria, R., Moura, P., Delgado, J. & De Almeida, A.T. 2014. Managing the Charging of Electrical Vehicles: Impacts on the Electrical Grid and on the Environment. *IEEE Intelligent Transportation Systems Magazine* 6, 3, pp. 54-65.
- Figenbaum, E. & Kolbenstvedt, M. 2014. Electromobility in Norway - experiences and opportunities with electric vehicles. TØI - Institute of Transport Economics, Norwegian Centre for Transport Research. TØI report 1281/2013. 170 p.
- Fingrid Oyj 2014a. Automaattisen taajuudenhallintareservin sovellusohje (Application note of an automatic frequency regulation reserve). Fingrid. (in Finnish)
- Fingrid Oyj Market Places. Fingrid Oyj. 2015 [referred 3.2.2015]. Available: [http://www.fingrid.fi/en/Electricity-market/Demand-side\\_management/Market\\_places/Pages/default.aspx](http://www.fingrid.fi/en/Electricity-market/Demand-side_management/Market_places/Pages/default.aspx).

Fingrid Oyj Reserves. Fingrid Oyj. 2015 [referred 3.2.2015]. Available: <http://www.fingrid.fi/en/powersystem/reserves/Pages/default.aspx>.

Fingrid Oyj 2014b. Taajuusohjatun käyttö- ja häiriöreservin tuntimarkkinasopimus NRO XX/2014. Fingrid Oyj. (in Finnish)

Finnish Information Centre of Automobile Sector Road Transport Emissions. Finnish Information Centre of Automobile Sector [referred 16.3.2015]. Available: [http://ec.europa.eu/clima/policies/transport/vehicles/cars/index\\_en.htm](http://ec.europa.eu/clima/policies/transport/vehicles/cars/index_en.htm).

Finnish Transport Agency National Travel Survey. Finnish Transport Agency. 2014 [referred 31.10.2014]. Available: [http://portal.liikennevirasto.fi/sivu/www/e/fta/research\\_development/national\\_travel\\_survey](http://portal.liikennevirasto.fi/sivu/www/e/fta/research_development/national_travel_survey).

Gruber, P.W., Medina, P.A., Keoleian, G.A., Kesler, S.E., Everson, M.P. & Wallington, T.J. 2011. Global Lithium Availability. *Journal of Industrial Ecology* 15, 5, pp. 760-775.

Hawkins, T.R., Singh, B., Majeau-Bettez, G. & Strømman, A.H. 2013. Comparative Environmental Life Cycle Assessment of Conventional and Electric Vehicles. *Journal of Industrial Ecology* 17, 1, pp. 53-64.

Holtmark, B. & Skonhoft, A. 2014. The Norwegian support and subsidy policy of electric cars. Should it be adopted by other countries? Norwegian University of Science and Technology, Department of Economics. Working paper series 20/2014. 20 p.

Honkapuro, S., Tuunanen, J., Valtonen, P., Partanen, J., Järventausta, P. & Harsia, P. 2014. Demand Response in Finland – Potential Obstacles in Practical Implementation. *Eleventh Nordic Conference on Electricity Distribution System Management and Development - NORDAC 2014*, 8.-9.9.2014. pp. 1-8.

Härkönen, T. 2012. Techno-economical studies for grid impacts of electric vehicle fast charging. M.Sc. Thesis, Tampere. Tampere University of Technology. 130 p.

Höök, M. & Tang, X. 2013. Depletion of fossil fuels and anthropogenic climate change—A review. *Energy Policy* 52, 0, pp. 797-809.

IEA 2013. Nordic Energy Technology Perspectives, Pathways to a Carbon Neutral Energy Future. IEA, International Energy Agency; Norden, Nordic Energy Research. 211 p.

IEA 2009. Transport, Energy and CO<sub>2</sub>, Moving Toward Sustainability. IEA, International Energy Agency. 418 p.

IPCC 2014. Climate Change 2014: Mitigation of Climate Change, Summary for policymakers. 33 p.

- Jewell, W., Gomatom, P., Bam, L. & Kharel, R. 2004. Evaluation of Distributed Electric Energy Storage and Generation, Final Project Report. Power Systems Engineering Research Center, Wichita State University. PSERC Publication 04-25. 1-39 p.
- Jin, C., Sheng, X. & Ghosh, P. 2014. Optimized Electric Vehicle Charging With Intermittent Renewable Energy Sources. *IEEE Journal of Selected Topics in Signal Processing* 8, 6, pp. 1063-1072.
- Järventausta, P., Repo, S., Trygg, P., Rautiainen, A., Mutanen, A., Lummi, K., Supponen, A., Heljo, J., Sorri, J., Harsia, P., Honkiniemi, M., Kallioharju, K., Piikkilä, V., Luoma, J., Partanen, J., Honkapuro, S., Valtonen, P., Tuunanen, J. & Belonogova, N. 2015. Kysynnän jousto - Suomeen soveltuvat käytännön ratkaisut ja vaikutukset verkkoyhtiöille (DR pooli). Loppuraportti. DR-pooli consortium. 360 p. (in Finnish)
- Järventausta, P., Repo, S., Rautiainen, A. & Partanen, J. 2010. Smart grid power system control in distributed generation environment. *Annual Reviews in Control* 34, 2, pp. 277-286.
- Kay, D., Hill, N. & Newman, D. 2013. Powering Ahead, The future of low-carbon cars and fuels. Ricardo-AEA. 176 p.
- Kelly, J.C., MacDonald, J.S. & Keoleian, G.A. 2012. Time-dependent plug-in hybrid electric vehicle charging based on national driving patterns and demographics. *Applied Energy* 94, pp. 395-405.
- Kempton, W. & Tomić, J. 2005. Vehicle-to-grid power fundamentals: Calculating capacity and net revenue. *Journal of Power Sources* 144, 1, pp. 268-279.
- Kennel, F., Gorges, D. & Liu, S. 2013. Energy Management for Smart Grids With Electric Vehicles Based on Hierarchical MPC. *IEEE Transactions on Industrial Informatics* 9, 3, pp. 1528-1537.
- Kersalo, J. & Pirinen, P. 2009. Suomen maakuntien ilmasto Helsinki, Finnish Meteorological Institute. 2009:8. 196 p. (in Finnish)
- Kiviluoma, J. & Meibom, P. 2011. Methodology for modelling plug-in electric vehicles in the power system and cost estimates for a system with either smart or dumb electric vehicles. *Energy* 36, 3, pp. 1758-1767.
- Koponen, P., Takki, P. & Huusko, R. 2014. Smart Metering Based Demand Response in Finland. *Eleventh Nordic Conference on Electricity Distribution System Management and Development - NORDAC 2014*, 8.-9.9.2014. pp. 1-8.
- Kothari, D.P. & Nagrath, I.J. 2004. Modern Power System Analysis. Third Edition ed. New Delhi, Tata McGraw-Hill Publishing Company Limited. 694 p.

- Kromer, M.A. & Heywood, J.B. 2007. Electric Powertrains: Opportunities and Challenges in the U.S. Light-Duty Vehicle Fleet. Sloan Automotive Laboratory, Laboratory for Energy and the Environment, Massachusetts Institute of Technology. LFEE 2007-03 RP. 153 p.
- Lajunen, A. 2014. Energy consumption and cost-benefit analysis of hybrid and electric city buses. *Transportation Research Part C: Emerging Technologies* 38, pp. 15.
- Lakervi, E. & Partanen, J. 2008. Sähkönjakelutekniikka. Otatiето. 285 p. (in Finnish)
- Laurikko, J., Granström, R. & Haakana, A. 2013. Realistic estimates of EV range based on extensive laboratory and field tests in Nordic climate conditions. *The 27th International Electric Vehicle Symposium & Exhibition, EVS 27*, 17.-20.11.2013. pp. 1-12.
- Ligterink, N.E., Smokers, R.T.M. & Bolech, M. 2013. Fuel-electricity mix and efficiency in Dutch plug-in and range-extender vehicles on the road. *The 27th International Electric Vehicle Symposium & Exhibition, EVS 27*, 17.-20.11.2013. pp. 1-4.
- Liu, Z., Wu, Q., Christensen, L., Rautiainen, A., Xue, Y. 2015. Driving pattern analysis of Nordic region based on National Travel Surveys for electric vehicle integration. *Journal of Modern Power Systems and Clean Energy* 3, 2, pp. 180-189.
- Luo, C., Leng, M., Huang, J. & Liang, L. 2014. Supply chain analysis under a price-discount incentive scheme for electric vehicles. *European Journal of Operational Research* 235, 1, pp. 329-333.
- Mi, C., Masrur, M.A. & Gao, D.W. 2011. Hybrid Electric Vehicles, Principles and Applications with Practical Perspectives. John Wiley & Sons, Ltd. 468 p.
- Misra, S., Bera, S. & Ojha, T. 2015. D2P: Distributed Dynamic Pricing Policy in Smart Grid for PHEVs Management. *IEEE Transactions on Parallel and Distributed Systems* 26, 3, pp. 702-712.
- Mock, P. & Yang, Z. 2014. Driving Electrification, A Global Comparison of Fiscal Incentive Policy For Electric Vehicles. The International Council on Clean Transportation. 40 p.
- Murray, J. & King, D. 2012. Climate policy: Oil's tipping point has passed. *Nature* 481, 7382, pp. 433-435.
- Neubauer, J. & Wood, E. 2014. The impact of range anxiety and home, workplace, and public charging infrastructure on simulated battery electric vehicle lifetime utility. *Journal of Power Sources* 257, pp. 12-20.
- Nord Pool Spot 2014. Central to European power integration, Annual Report 2013. Nord Pool Spot Ltd. 52 p.

- Nykvist, B. & Nilsson, M. 2015. Rapidly falling costs of battery packs for electric vehicles. *Nature Climate Change* 5, 4, pp. 329-332.
- Nylund, N., Aakko-Saksa, P. & Sipilä, K. 2008. Status and outlook for biofuels, other alternative fuels and new vehicles. Espoo, VTT. VTT Tiedotteita Research notes 2426. 172 p.
- OICA 2013 production statistics. Organisation Internationale des Constructeurs d'Automobiles (OICA). 2014 [referred 1.12.2014]. Available: <http://www.oica.net/category/production-statistics/2013-statistics/>.
- Offer, G.J., Howey, D., Contestabile, M., Clague, R. & Brandon, N.P. 2010. Comparative analysis of battery electric, hydrogen fuel cell and hybrid vehicles in a future sustainable road transport system. *Energy Policy* 38, 1, pp. 24-29.
- Palensky, P. & Dietrich, D. 2011. Demand Side Management: Demand Response, Intelligent Energy Systems, and Smart Loads. *IEEE Transactions on Industrial Informatics* 7, 3, pp. 381-388.
- Partanen, J., Honkapuro, S., Tuunanen, J. & Niemelä, H. 2012. Tariff scheme options for distribution system operators. LUT Energy.
- Partanen, R., Paloheimo, H. & Waris, H. 2013. Suomi öljyn jälkeen. Into. 341 p. (in Finnish)
- Partanen, R., Paloheimo, H. & Waris, H. 2015. The world after cheap oil. Routledge. 249 p.
- Peterson, S.B. & Michalek, J.J. 2013. Cost-effectiveness of plug-in hybrid electric vehicle battery capacity and charging infrastructure investment for reducing US gasoline consumption. *Energy Policy* 52, pp. 429-438.
- Pillot, C. 2014. Battery Market Development for Consumer Electronics, Automotive, and Industrial: Materials Requirements and Trends. *Advanced Automotive Battery Conference*, 3.-7.2.2014. pp. 1-36.
- Rautiainen, A., Repo, S. & Järventausta, P. 2010. Intelligent charging of plug-in vehicles. *Ninth Nordic Conference on Electricity Distribution System Management and Development, NORDAC 2010*, 6.-7.9.2010. 8 p.
- Rautiainen, A., Repo, S. & Järventausta, P. 2009. Using Frequency Dependent Charging of Plug-in Vehicles to Enhance Power System's Frequency Stability. *European conference Smart Grids and Mobility*, 16-17.6.2009. pp. 39-46.
- Rezaee, S., Farjah, E. & Khorramdel, B. 2013. Probabilistic Analysis of Plug-In Electric Vehicles Impact on Electrical Grid Through Homes and Parking Lots. *Sustainable Energy, IEEE Transactions on* 4, 4, pp. 1024-1033.



- Richardson, P., Flynn, D. & Keane, A. 2012. Local Versus Centralized Charging Strategies for Electric Vehicles in Low Voltage Distribution Systems. *IEEE Transactions on Smart Grid* 3, 2, pp. 1020-1028.
- Rodríguez Ortega, M.P., Pérez-Arriaga, J.I., Abbad, J.R. & González, J.P. 2008. Distribution network tariffs: A closed question? *Energy Policy* 36, 5, pp. 1712-1725.
- SEDC 2014. Mapping Demand Response in Europe Today, Tracking Compliance with Article 15.8 of the Energy Efficiency Directive. SEDC - Smart Energy Demand Coalition. 93 p.
- Salihi, J.T. 1973. Energy Requirements for Electric Cars and Their Impact on Electric Power Generation and Distribution Systems. *IEEE Transactions on Industry Applications* IA-9, 5, pp. 516-532.
- Sanchez-Martin, P., Sanchez, G. & Morales-Espana, G. 2012. Direct Load Control Decision Model for Aggregated EV Charging Points. *IEEE Transactions on Power Systems* on 27, 3, pp. 1577-1584.
- Short, J.A., Infield, D.G. & Freris, L.L. 2007. Stabilization of Grid Frequency Through Dynamic Demand Control. *IEEE Transactions on Power Systems* 22, 3, pp. 1284-1293.
- Similä, L., Koreneff, G. & Kekkonen, V. 2011. Network tariff structures in smart grid environment. VTT. VTT-R-03173-11. 57 p.
- Sorrell, S., Speirs, J., Bentley, R., Brandt, A. & Miller, R. 2009. Global Oil Depletion, An assessment of the evidence for a near-term peak in global oil production. UK Energy Research Institute. 228 p.
- Sortomme, E., Hindi, M.M., MacPherson, S.D.J. & Venkata, S.S. 2011. Coordinated Charging of Plug-In Hybrid Electric Vehicles to Minimize Distribution System Losses. *IEEE Transactions on Smart Grid* 2, 1, pp. 198-205.
- Sortomme, E. & El-Sharkawi, M.A. 2011. Optimal Charging Strategies for Unidirectional Vehicle-to-Grid. *IEEE Transactions on Smart Grid* 2, 1, pp. 131-138.
- Steinhilber, S., Wells, P. & Thankappan, S. 2013. Socio-technical inertia: Understanding the barriers to electric vehicles. *Energy Policy* 60, pp. 531-539.
- Sundstrom, O. & Binding, C. 2012. Flexible Charging Optimization for Electric Vehicles Considering Distribution Grid Constraints. *IEEE Transactions on Smart Grid* 3, 1, pp. 26-37.
- Sähköinen liikenne Energiainvestointituki. Sähköinen liikenne. 2015 [referred 19.3.2015]. Available: <http://www.sahkoinenliikenne.fi/energiainvestointituki>.
- Tan Ma & Mohammed, O.A. 2014. Optimal Charging of Plug-in Electric Vehicles for a Car-Park Infrastructure. *IEEE Transactions on Industry Applications* 50, 4, pp. 2323-2330.

- Trafi. (Road Traffic) Taxation. Trafi. 2015 [referred 19.3.2015]. Available: <http://www.trafi.fi/en/road/taxation>.
- Traut, E., Hendrickson, C., Klampfl, E., Liu, Y. & Michalek, J.J. 2012. Optimal design and allocation of electrified vehicles and dedicated charging infrastructure for minimum life cycle greenhouse gas emissions and cost. *Energy Policy* 51, pp. 524-534.
- Tull. Car Tax. 2015 [referred 19.3.2015]. Available: [http://www.tulli.fi/en/persons/car\\_tax/index.jsp](http://www.tulli.fi/en/persons/car_tax/index.jsp).
- United Nations 2014. World Urbanization Prospects, The 2014 Revision, Highlights. New York, United Nations. 32 p.
- Valtonen, P., Honkapuro, S. & Partanen, J. 2015. Economic Potential of Load Control in Balancing Power Market. *23rd International Conference on Electricity Distribution - Cired 2015*, 15.-18.6.2015. Lyon, France, pp. 1-5.
- Valtonen, P., Partanen, J. & Honkapuro, S. 2012. Electricity retailer profit optimization in different operational environments. LUT Energy – Lappeenranta University of Technology. SGEM project research reports 1-85 p.
- Vedady Moghadam, M.R., Ma, R.T.B. & Rui Zhang 2014. Distributed Frequency Control in Smart Grids via Randomized Demand Response. *IEEE Transactions on Smart Grid* 5, 6, pp. 2798-2809.
- Verzijlbergh, R.A., Grond, M.O.W., Lukszo, Z., Slootweg, J.G. & Ilic, M.D. 2012. Network Impacts and Cost Savings of Controlled EV Charging. *IEEE Transactions on Smart Grid*, 3, 3, pp. 1203-1212.
- Vuorilehto, K. 2013. Materialien und Funktion. In: Korthauer, R. (ed.). *Handbuch Lithium-Ionen-Batterien*. Springer. pp. 31-45.
- Yoshio, M., Brodd, R.J. & Kozawa, A. (ed.). 2009. *Lithium-Ion batteries, Science and Technologies*. Springer. 452 p.
- Zhang, L., Brown, T. & Samuelson, S. 2013. Evaluation of charging infrastructure requirements and operating costs for plug-in electric vehicles. *Journal of Power Sources* 240, pp. 515-524.
- Zhang, L., Brown, T. & Samuelson, G.S. 2011. Fuel reduction and electricity consumption impact of different charging scenarios for plug-in hybrid electric vehicles. *Journal of Power Sources* 196, 15, pp. 6559-6566.
- Zhao Xu, Ostergaard, J. & Togeby, M. 2011. Demand as Frequency Controlled Reserve. *IEEE Transactions on Power Systems* 26, 3, pp. 1062-1071.



## **Publication 1**

A. Rautiainen, S. Repo, P. Järventausta, "Using frequency dependent electric space heating loads to manage frequency disturbances in power systems", *in proc. IEEE PowerTech*, 2009, Bucharest, Romania, 6 p. ***The approved version.***

In reference to IEEE copyrighted material which is used with permission in this thesis, the IEEE does not endorse any of Tampere University of Technology's products or services. Internal or personal use of this material is permitted. If interested in reprinting/republishing IEEE copyrighted material for advertising or promotional purposes or for creating new collective works for resale or redistribution, please go to

[http://www.ieee.org/publications\\_standards/publications/rights/rights\\_link.html](http://www.ieee.org/publications_standards/publications/rights/rights_link.html)  
to learn how to obtain a License from RightsLink.



# Using Frequency Dependent Electric Space Heating Loads to Manage Frequency Disturbances in Power Systems

A. Rautiainen, S. Repo and P. Järventausta

**Abstract**—In this paper the use of frequency dependent space heating loads to manage frequency disturbances in power systems is investigated. Setting values of space heater thermostats are made dependent of locally measured network frequency. Studies are carried out through time domain simulations. Studies imply that the use of frequency dependent loads in frequency disturbance management is an efficient tool for managing power unbalances. This kind of load control method’s consequences and harm to the users of the space heaters can be negligible, but the significance of this controllable load to the power system can be very high. It is very important to coordinate the operation of frequency dependent load carefully with other control actions taking into account the cold load pick-up phenomenon related to the use of this type of load.

**Index Terms**—Contingency reserve, demand response, domestic consumer, frequency stability, space heating

## I. INTRODUCTION

Today’s society in developed countries is extremely dependent on electricity and a high level of service reliability is expected. In recent years there have been many serious frequency instability related wide-area power system blackouts in Europe [1] [2] and U.S. [3], and their costs, both economical and social, are high. Also, it is widely expected that intermittent power production, for example wind power and solar power, will increase rapidly at a global level, which sets new challenges for the control of power systems. Frequency stability is an issue of balance between power production and consumption. One way to influence this balance is to regulate power demand and usually large industrial loads are used for this purpose, but domestic loads could also be a very potential option.

In this article, the use of domestic electric space heating load to manage frequency disturbances is explored in a form of simulations using MATLAB and PSCAD software. The paper is organized as follows. In chapter II, the operation of

frequency dependent space heating load is described. In chapter III, the power system model and a thermodynamic model of space heating loads are described. In chapter IV simulation cases and simulation results are presented. Conclusions and discussion is presented in chapter V.

## II. OPERATION OF FREQUENCY DEPENDENT SPACE HEATING LOAD

In this study, the dynamic demand control (DDC) method, presented in [4] and further explored in [5], is applied to electric space heating loads. In the method the temperature settings of an electric space heater thermostat is frequency dependent in accordance with local frequency measurement. Figure 1 illustrates the control method of the loads used in these studies. Fig. 1 a) depicts normal thermostat action. Heater is switched on whenever temperature falls under a certain level, and off-switching occurs when temperature rises high enough. Thereby temperature varies around desired temperature  $T_{des}$ , which is set by user of the load through a manual thermostat adjustment. Fig. 1 b) illustrates DDC method in a disturbance reserve appliance. The set point value of temperature is now a function of grid frequency. Load reacts only at frequencies under  $f_1$  and maximum temperature deviation from normal operation is set to  $\Delta T_{max}$ .

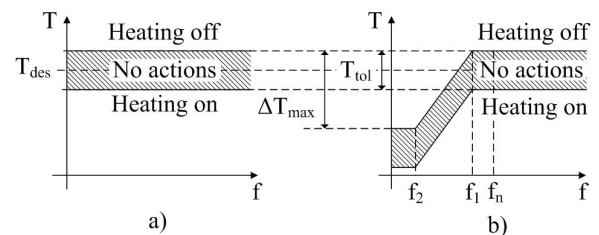

Fig. 1. a) Conventional thermostat action b) Control method of frequency dependent electric space heating load used in these studies (Figure is not in scale.)

## III. MODELING

In this chapter the models which are used in the simulations are introduced.

### A. Power system model

A 60 Hz and 230 kV power system illustrated in figure 2 was used in the simulations. The model was adopted from [6] p. 813–814 with little modifications. Parameters of the

The authors are grateful to the partners of the Eldig2\_VPP project “Active network management in electricity distribution” and INCA project “Interactive customer gateway” for the interesting real life research topic, comments, funding and research co-operation. The projects are financed by Tekes and several Finnish network companies, manufacturers and service companies.

All authors are with Department of Electrical Energy Engineering, Tampere University of Technology, P.O. Box 692, FI-33101 Tampere, Finland (e-mail: antti.rautiainen@tut.fi).

generators were adopted from [7]. All four generators included power system stabilizers that have the parameters presented in [6] p. 814. Turbine and speed governor models of the generators were adopted from [8]. Power lines in the middle of the figure (2 x 110 km) were originally (in [6]) twice as long as here. Shortening was made due to mitigate angle instability which appeared in the simulations. Angle stability was not under investigation in these studies. Ratings of generators were decreased to make the grid operate in very tight power conditions. Spinning reserve of generators was only about 40 MW.

Frequency dependent space heating loads were added as two similar aggregated groups  $L_7$  and  $L_8$  to the nodes 7 and 8 respectively in the power system. The total number of loads added was 580,000. Network's total load was ca. 2600 MW and the power (in normal conditions) of frequency dependent space heating load was ca. 260 MW (which is 10% of the total load) corresponding to 130 MW loads for each node 7 and 8. All loads in the system were modeled as constant impedance loads. In these studies space heating loads, which in reality are connected to the low voltage network, were scaled to transmission network voltage level and connected directly to the transmission network.

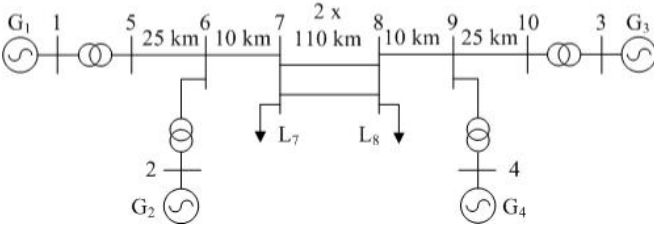

Fig. 2. Power system model used in the simulations

Frequencies which controlled the space heating loads  $L_7$  and  $L_8$  are measured at nodes 7 and 8, respectively. High frequency components of the frequency measurement signal are filtered off with a simple low-pass filter to avoid redundant operation of thermostat switches. Filter also includes a delay part, which simulates time delay between the time of occurrence of frequency disturbance in power system and the time of thermostat switch operation. Filter operates in accordance with a simple transfer function

$$H(s) = \frac{K}{1 - T_f s} e^{-sT_d} \quad (1)$$

where values of  $K$ ,  $T_f$  and  $T_d$  were 1.0, 0.2 s and 0.1 s respectively.

Frequency settings have a major impact on the operation of frequency dependent loads. In this work, frequency thresholds  $f_1$  (refer to fig. 1) of different loads were set at interval 59.7...59.9 Hz, and for each load frequency  $f_2$  were set 0.3 Hz lower than  $f_1$ .

### B. Thermodynamic modeling

To model the dynamic behavior of electric space heating load, a thermodynamic model describing the causality between in-door temperature and the heating power is needed.

In this work a very simple model, which is illustrated in fig. 3, is used. In the model the space which is heated (a room) is bounded with a control surface bounding a control volume. Control volume comprises all the mass which participates to heat storage and forms an effective heat capacity  $C$ , and homogeneous indoor temperature  $T_i$  is assumed in the control volume. Heat is brought into the system through heating equipment at rate  $P_{heat}$ . Heat is transferring outdoors through the system boundary at rate  $P_{loss}$ . Total thermal conductance  $G$  describes the thermal insulation level of the building, and  $T_o$  describes outdoor temperature.

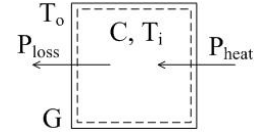

Fig. 3. Principle of the thermodynamic model of a space heating load

To get an equation that describes the indoor temperature with respect to time, an energy balance equation is first written for the system. Heat loss (heat which is conducting through the walls and windows) is directly proportional to total thermal conductance and to the difference between indoor and outdoor temperatures:

$$P_{loss} = G(T_i - T_o). \quad (2)$$

Indoor temperature change  $\Delta T_i$  within time interval  $\Delta t$  can be written as  $\Delta T_i = T_i(t + \Delta t) - T_i(t)$ .  $\Delta T_i$  corresponds to a change in the system's thermal energy  $C\Delta T_i$  which furthermore corresponds (according to the conservation of energy principle) to energy transferred by the difference between heating power  $P_{heat}$  and heat loss  $P_{loss}$ . Now we can write

$$C\Delta T_i = (P_{heat} - P_{loss})\Delta t. \quad (3)$$

Substituting (2) in to (3), dividing both sides of the equation by  $\Delta t$ , rearranging and letting the time interval approach zero ( $\Delta t \rightarrow 0$ ) we get a simple ordinary differential equation

$$C \frac{dT_i}{dt} + GT_i = P_{heat} + GT_o \quad (4)$$

which describes the temperature dynamics. If we treat  $C$ ,  $G$ ,  $P_{heat}$  and  $T_o$  as constants with respect to time, an analytical solution of the ordinary differential equation initial value problem, formed by (3) and the indoor temperature initial value  $T_i(0)$ , is

$$T_i(t) = \left( T_i(0) - \frac{P_{heat}}{G} - T_o \right) e^{-\frac{G}{C}t} + \frac{P_{heat}}{G} + T_o. \quad (5)$$

For numerical computing, it is necessary to determine parameters  $T_i(0)$ ,  $P_{heat}$ ,  $G$ ,  $T_o$  and  $C$ . Initial value of indoor temperature  $T_i(0)$  and outdoor temperature  $T_o$  are easy to determine, because their values can be chosen arbitrarily.

It is quite straightforward to approximate a typical value of thermal conductance  $G$ . In this work, the U-values of different structures which are needed in the determination process of  $G$ , are presented in table I. Thermal conductance is calculated as

$$G = \sum_{i=1}^n U_i A_i \quad (6)$$

where  $U_i$  is a U-value of structure  $i$ ,  $A_i$  is the area of structure  $i$  and  $n$  is the number of different structures.

TABLE I  
U-VALUES OF DIFFERENT STRUCTURES [9]

Structure	U-value (W/m <sup>2</sup> K)
Outer wall	0.21
Roof	0.15
Base floor	0.21
Window	1.40

Determining the heat capacity  $C$  of the heated mass is a more challenging task. In this paper the heat capacity is formed by a 0.08 m thick concrete slab on the floor, and a 0.012 m thick chipboard on floor, walls and ceiling. Properties of these components used in the calculation of  $C$  are presented in table II.  $C$  is calculated as

$$C = \sum_{i=1}^m c_i \rho_i V_i \quad (7)$$

where  $\rho_i$ ,  $V_i$  and  $c_i$  are density, volume and specific heat capacity of component  $i$  respectively and  $m$  is the number of components.

TABLE II  
PROPERTIES OF COMPONENTS OF EFFECTIVE HEAT CAPACITY [10]

Component	Density (kg/m <sup>3</sup> )	Specific heat capacity (J/kgK)
Concrete slab	640	2400
Chipboard	2400	840

Heating power  $P_{heat}$  is determined in accordance with a “power density” (the proportion of power to room volume) 25 W/m<sup>3</sup>.

The data presented above is used to determine thermodynamic parameters of a particular room (“prototype room”) with certain dimensions. The room is 2.5 m high, 3.5 m long and 3.5 m wide, and total area of its windows is 2 m<sup>2</sup>. Half of the room’s wall area is outer wall. Heat transfer through inner wall is assumed to be zero. Using this data, heat capacity, thermal conductance and heating power of the room are calculated and the results are presented in table III.

Using parameter values  $C$  and  $G$  of table III an example calculation of the rate of temperature decline was carried out. When the outer temperature was  $-1$  °C temperature decline from 22 °C to 20 °C took about 5 hours. The order of

magnitude of this time corresponded to the rates of temperature decline presented in [11], where cooling of a school in Finland was measured.

TABLE III  
THERMODYNAMIC PARAMETERS OF THE “PROTOTYPE ROOM”

Parameter	Value
$C$	$2.9 \cdot 10^6$ J/K
$G$	14 W/K
$P_{heat}$	770 W

In the simulations a great number of loads were added to the power system, and thermodynamic parameters had to be determined for each load. Parameters were determined randomly with MATLAB software. In the determination process the parameters of the “prototype room” were used as a reference. First, values of  $C$  were formed so that they were normally distributed having value of table III as a mean and 5% (proportion of mean value) standard deviation. After this the values of  $G$  and  $P_{heat}$  were formed so that the relative differences of different values of  $G$  and relative differences of different values of  $P_{heat}$  were equal to relative differences of different values  $C$ , regarding each load. Then random components with zero mean value and 1 % standard deviation were added to the values of  $G$  and  $P_{heat}$ . Outer temperatures of different loads were normally distributed with a  $-10$  °C mean and 1 °C standard deviation. Values of  $T_{tol}$  and  $T_{des}$  (refer to fig. 1) were uniformly distributed at intervals 0.6...1.0 °C and 19...22 °C, respectively. Initial indoor temperatures  $T_i(0)$  were uniformly distributed at interval  $T_{des} \pm 0.5T_{tol}$ . Maximum drop of temperature setting value  $\Delta T_{max}$  was set to 3 °C for each load.

#### IV. SIMULATIONS

Simulations were carried out mainly with PSCAD software. Parameters of the loads and initial values were formed with MATLAB and transferred at the first time step to PSCAD through the interface between PSCAD and MATLAB. States of frequency dependent space heating loads were not updated every time step, but every 20 ms. This was done to reduce computing time. Every time step in which operation of space heating loads were modeled, temperatures (in accordance with (5)) and on/off information of each 580,000 loads were updated. For modeling the loads, a new PSCAD component was built using Fortran programming language. PSCAD’s computing time step was 100  $\mu$ s. In this work two different cases were simulated.

##### A. Case 1: tripping of generator

In case 1, generator  $G_4$  was tripped off suddenly at 10 s with a power output of 400 MW. The length of the simulation was 900 s (15 min). Length is chosen so that it corresponds with the typical starting time of gas turbines used as disturbance or contingency reserve of a power system.

In fig. 4 frequencies which were measured from nodes 7 and 8 are presented at a time interval of 10...150 s. Simulation was carried out in two different conditions: with and without frequency dependency of the space heaters. Without frequency dependent load (fdl), the system goes into a severe instable



state, and frequency goes down near 57 Hz in 150 s leading to a total collapse of the system. With frequency dependent load, a much higher frequency level is maintained and collapse during simulation period is avoided.

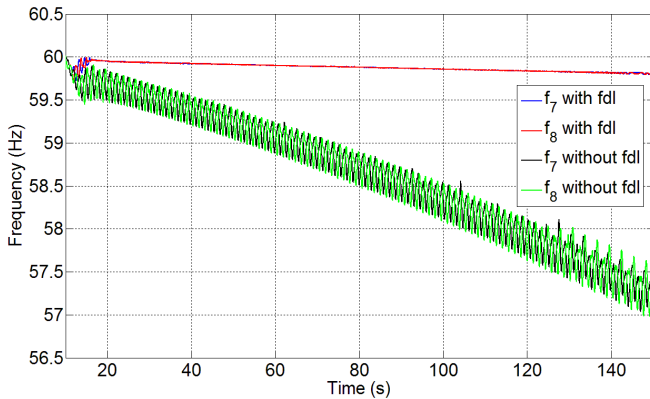

Fig. 4. Frequency behavior of the grid at time interval 10...150 s in case 1

In fig. 5, frequencies and frequency dependent loads' powers during the whole simulation period are presented. Due to frequency swing around time 12 s a great portion of the space heaters are switched off. Part of the decrease of powers during the frequency swing was due to decrease of voltages at nodes 7 and 8. Loads were modeled as constant impedance loads, and their powers are proportional to grid voltage squared. In fig. 6, frequencies, powers and voltages are presented at time interval 9.5...17 s. Voltage change from 1.02 p.u. to 0.96 p.u. corresponds with a load decrease of about 12 %, which has a significant effect on powers drawn by the space heating loads. This effect can be observed also in simulation in which frequency dependency function was not applied. It can also be observed in fig. 6 that local maximums in voltage curves often correspond with local maximums in power curves. In fig. 5, the "ripple" in frequency curve which seems to "change sign" around time 600 s is probably due to the frequency measurement method used in PSCAD software.

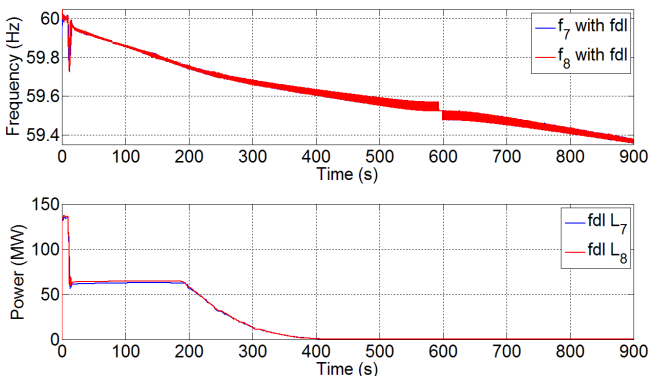

Fig. 5. Frequencies and frequency dependent loads' powers during the whole simulation period of case 1

Space heaters which switched off do not turn back on, when frequencies recover at higher levels around time interval 12...16 s. This is because the frequency rise returns only the setting values and not the original on/off states of the loads. Loads which switch off turn back on when their temperatures fall to a low enough level. After frequency swing frequencies

keep decreasing and load levels stay at a rather steady level at time interval 20...180 s, as can be seen in fig. 5. After 180 s load level continues falling in accordance with frequency fall until all space heaters are switched off.

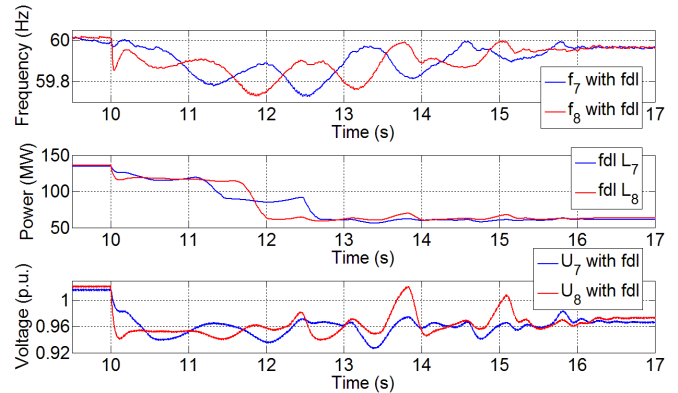

Fig. 6. Frequencies, powers and voltages at time interval 9.5...17 s in case 1

### B. Case 2: load changes

In case 2, a linearly from zero to 400 MW up ramping extra load (disturbance) was introduced in the system at node 8 at time interval 10...70 s, and load ramped down to zero at time interval 900...960 s. Length of the simulation was 10000 s, which is about 2 h 47 min.

In fig. 7 frequencies of the system are presented at time interval 0...425 s with and without frequency dependency of the loads. As in case 1, without frequency dependent load (fdl) the power system soon gets to a point of total collapse. It can be seen that without frequency dependent load frequencies fall fairly slowly after 400 MW load increase. Reason for this is a voltage drop from 1.02 p.u. to 0.96 p.u. during load increase at time interval 10...70 s, which decreased the total load remarkably. This might be too positive a result, because in reality tap changing transformers could increase the voltage at this time scale in the distribution networks, which would increase the load levels.

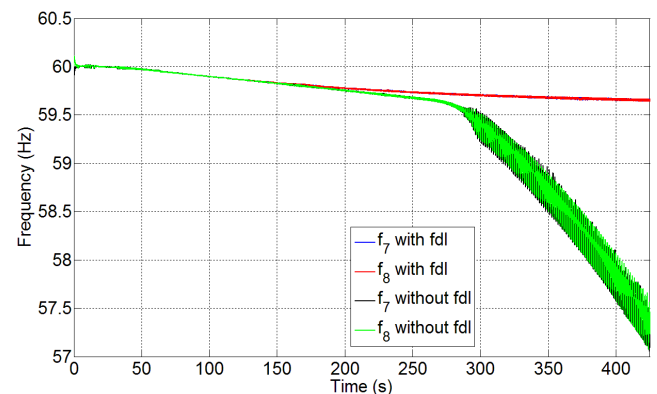

Fig. 7. Frequency behavior of the grid at time interval 0...425 s in case 2

Fig. 8 illustrates the frequencies and powers of the frequency dependent loads in case 2 during the whole simulation period. As an overview it can be said that the result is clearly better than the result without frequency dependent load. Frequencies stay at fairly high levels during the whole simulation.

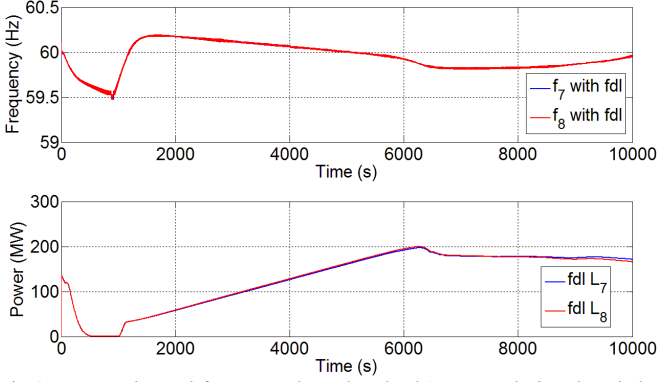

Fig 8. Frequencies and frequency dependent loads' powers during the whole simulation period of case 2

In fig. 8 an interesting phenomena can be observed. After the disturbance, powers of frequency dependent loads rise and exceed the initial values (approx. 130 MW) of the powers. In simulation of case 2, this “cold load pick-up” phenomena can be divided into two parts which can be understood more clearly by examining fig. 9.

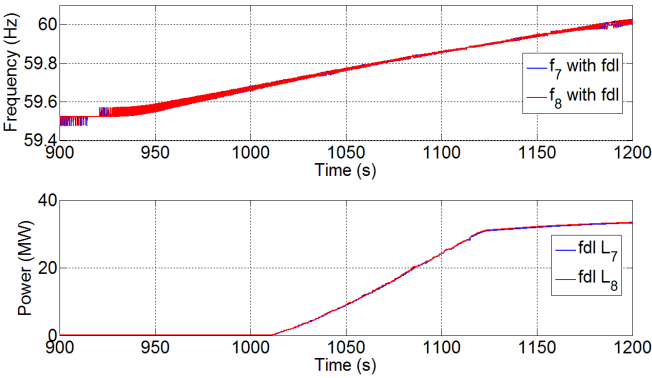

Fig. 9. Frequencies and frequency dependent loads' powers of case 2 at time interval 900...1200 s

In fig. 9, the frequencies and powers are presented at time interval 900...1200 s. When the “disturbance” load begin to ramp down, frequencies start to increase. When frequencies reach values close to 59.7 Hz, loads whose temperatures had fallen below their  $T_{des} - 0.5T_{tol}$  value (refer to fig. 1) begin to switch on in accordance with frequency rise (on-switching of individual load occurs when its on-triggering temperature, reaches the real temperature of the load) until frequencies reach a value slightly below the highest threshold frequency  $f_i$  (59.9 Hz) at time around 1125 s. After this the rate of load increase decreases. The reason is as follows. At approx. time 600 s all loads were switched off and their temperatures began to fall. After the set values of thermostats of all loads are recovered to their original values ( $T_{des}$ ) at time 1125 s, those loads that are still switched off begin to switch on gradually as their temperatures fall below the value  $T_{des} - 0.5T_{tol}$ . Because temperatures fall very slowly, the rate of load increase is also slow. When comparing temperatures at the beginning of the simulation and at time 900 s (15 min difference), the mean temperature decline was about 0.1 °C and standard deviation of temperature decline was 0.04 °C.

As can be seen in fig. 8, individual loads continue switching on until powers of  $L_7$  and  $L_8$  reach values of about 200 MW. Part of the loads is taking back the thermal energy which was dissipated during low grid frequencies. A greater number of loads are on simultaneously (trying to reach the value  $T_{des} + 0.5T_{tol}$ ) when compared to normal and steady conditions, which causes a greater total power of space heating loads. In this simulation, the power system was operating in very tight power conditions. Because of the high total power of frequency dependent loads caused by cold load pick-up phenomenon, frequencies begin to decrease again. This forces some frequency dependent loads to switch off again, and frequencies rise again to a slightly higher level. It can be thought that a down ramping disturbance load at 900...960 s could simulate a reserve capacity, which is operating as a contingency reserve. This reserve should be planned to also be able to cover the extra power caused by the cold load pick-up.

Behavior of the frequency dependent loads after the cold load pick-up could not be investigated in this simulation, because the simulation was not long enough. However, a simulation was carried out (not presented in this paper), in which the heat capacities of the loads were much smaller than in this work. Low heat capacity corresponds with a greater rate of change of temperature and faster phenomena. In the simulation, powers of the frequency dependent loads seemed to stabilize (after cold load pick-up) approximately to the levels of the initial powers of the simulation.

## V. CONCLUSIONS AND DISCUSSION

Using frequency dependent space heating load as a contingency reserve seems to be a very powerful method to manage frequency disturbances in a power system. It could be used to enhance the reserves of the power system. When using frequency dependent space heaters the effect of cold load pick-up has to be taken into account.

When using frequency dependent load in power system frequency control, it is necessary to coordinate its operation with other frequency control actions. As a result of using only space heaters as frequency dependent loads, the availability of the control resource is strongly dependent on outer temperature conditions, and at warm seasons the control resource might not be available at all. For this reason, this kind of load cannot alone substitute any spinning or contingency reserve. However, the use of space heaters could be an option for shedding of big industrial loads, which are available for controlling due to contracts between industrial companies and the grid operator. If space heating loads are not available, industrial loads are shed instead. It is less harmful to cut domestic heaters off for a while than interrupting or disturbing a whole industrial process. The availability of the space heating load can be estimated by the system operator by using load models that take weather conditions into account. If other load types, for example other heating systems, refrigerators, freezers, air conditioners, water heaters, pumps ovens [5] and in the future plug-in vehicles (plug-in hybrid electric vehicles and electric vehicles), were also used as frequency dependent loads, availability of total reserve would be much higher.

The studies presented in this paper include many simplifications and sources of error when compared to real world systems. Firstly, models used in the simulations were very simple. The power system model was a small one, and it did not include any dynamic voltage regulation equipment besides generator exciters. Protection equipment of generators were not modeled and loads were modeled simply by constant impedance loads. Modeling frequency dependent loads in a transmission network level also brings a somewhat of an error source, because small dynamic phenomena between transmission network and low voltage network is excluded from the simulations except the small delay added to the frequency measurement filter presented in (1). The thermodynamic model did not include the effect of ventilation. In addition to heaters, other electrical loads and humans inside the buildings also produce heat. However, the effects of ventilation and other heat sources besides heaters partly compensate each other. Thermodynamic parameters of different loads were distributed hypothetically, and distributions were not based to any particular stock of buildings.

Future work in this field is needed. Longer simulations with more sophisticated and accurate models should be carried out, and also different kinds of practical demonstrations should be built. The authors of this paper are working on a practical demonstration, in which a single frequency dependent space heating load which exploits a commercial smart meter is demonstrated in a laboratory environment. It is also very important to investigate different regulatory and market related issues regarding to the use of this load control method. The authors are also researching the use of frequency dependent charging of plug-in vehicles to enhance the frequency stability of power systems.

## VI. REFERENCES

- [1] UCTE, "Final report of the Investigation Committee on the 28 September 2003 Blackout in Italy", [Online] Available: [http://www.ucte.org/\\_library/otherreports/20040427\\_UCTE\\_IC\\_Final\\_report.pdf](http://www.ucte.org/_library/otherreports/20040427_UCTE_IC_Final_report.pdf)
- [2] UCTE, "Final Report, System Disturbance on 4 November 2006, union for the co-ordination of transmission of electricity", [Online] Available: [http://www.ucte.org/\\_library/otherreports/Final-Report-20070130.pdf](http://www.ucte.org/_library/otherreports/Final-Report-20070130.pdf)
- [3] U.S.-Canada Power System Outage Task Force, "Final Report on the August 14, 2003 Blackout in the United States and Canada: Causes and Recommendations", [Online] Available: <https://reports.energy.gov/BlackoutFinal-Web.pdf>
- [4] F. C. Schweppe, "Frequency adaptive, power-energy re-scheduler", U.S. Patent 4317049
- [5] J. A. Short, D. G. Infield and L. L. Freris, "Stabilization of Grid Frequency through Dynamic Demand Control", IEEE Transactions on Power Systems, vol. 22, 3, pp. 1284–1293, 2007
- [6] P. Kundur, "Power System Stability and Control", McGraw-Hill, Inc., 1994, 979 p.
- [7] Klein, M., Rogers, G. J., Kundur, P., "A fundamental study of inter-area oscillations in power systems", IEEE Transactions on Power Systems, vol. 6, 3, pp. 914-921, 1991
- [8] J. Chow/Cherry Tree Scientific Software, "Power System Toolbox, Version 2.0, Dynamic Tutorial and Functions", 171 p.
- [9] Finland's environmental administration, "Heat insulation of buildings", Regulations 2007, C3 Collection of Finnish building regulations, 9 p. (In Finnish)
- [10] T. Kalema, "Heating and Ventilating Engineering, part 2", Tampere University of Technology, Department of Energy and Process Engineering, 195 p. (In Finnish)
- [11] R. Kohonen, "Discontinuous heating of buildings", National technical research center, Researches 152, Espoo, 1983 (In Finnish)

## VII. BIOGRAPHIES

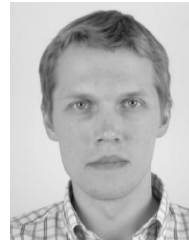

**A. Rautiainen** received his M.Sc degree from Tampere University of Technology in 2008. He is now working as a researcher towards doctoral degree at Tampere University of Technology. His main interest focuses on the using of frequency dependent load to improve power system's frequency stability and effects of plug-in vehicles to electric power systems.



**S. Repo** received his M.Sc. and Dr.Tech. degrees in Electrical Engineering from Tampere University of Technology in 1996 and 2001 respectively. At the present he is a University Lecturer at the Department of Electrical Energy Engineering of Tampere University of Technology. His main interest is the management of active distribution network including distributed energy resources.

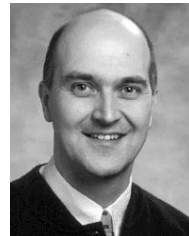

**P. Järventausta** received his M.Sc. and Licentiate of Technology degrees in Electrical Engineering from Tampere University of Technology in 1990 and 1992 respectively. He received the Dr.Tech. degree in Electrical Engineering from Lappeenranta University of Technology in 1995. At present he is a professor at the Department of Electrical Energy Engineering of Tampere University of Technology. The main interest focuses on the electricity distribution and electricity market.

## **Publication 2**

A. Rautiainen, A. Supponen, A. Mutanen, K. Lummi, J. Markkula, M. Mononen, S. Repo, P. Järventausta, “Analysis of Power-based Distribution Tariffs for Demand Response of Small Customers – Case Study of a Real DNO’s Network”, *submitted to Electric Power Systems Research*, 10 p.



# Analysis of Power-based Distribution Tariffs for Demand Response of Small Customers – Case Study of a Real DNO’s Network

A. Rautiainen<sup>1</sup>, A. Supponen<sup>1</sup>, A. Mutanen<sup>1</sup>, K. Lummi<sup>1</sup>, J. Markkula<sup>1</sup>, M. Mononen<sup>2</sup>, S. Repo<sup>1</sup>, P. Järventausta<sup>1</sup>

**Abstract**—In this paper, demand response (DR) of small electricity customers is investigated. New types of distribution tariffs which could encourage customers to decrease their peak powers are presented and discussed. Also, DR based on these distribution tariffs and spot price based electricity contracts is simulated with large real customer and distribution network data. Simulations show that, at least with the modeled load control algorithm, it is possible to decrease the peak powers in a distribution network with distribution tariffs as incentives, but if the tariffs are not designed carefully they could also increase the peak powers. If customers control their loads in accordance with the electricity retailers’ spot price based electricity tariff, it could increase the peak loads of the network quite significantly. In this regard, DR generally might be more of a threat to distribution network companies than an opportunity. However, the use of power component in distribution tariff could mitigate the increase of peak loads. It seems that the combination of spot price and power based distribution tariff based control might in some cases be the best case also from the distribution network’s point-of-view.

**Index Terms**—demand response, electricity distribution, distribution tariffs, network tariffs, electricity market

## I. INTRODUCTION

**D**EMAND response (DR) of small electricity customers (main fuse size of 3×63 A or lower) has been under investigation and discussion for the past few years in Finland. However, there has been no significant DR activity so far. This is mainly because small customers have had no electricity consumption meters which could verify the real demand within short, such as one hour long, time windows. However, the massive installation of automatic metering infrastructure (AMI) capable electricity consumption meters has made some DR applications possible. Since 2013 in Finland, practically almost all customers are provided with a new AMI meter due to the act [1] of the Finnish government and this has brought new possibilities for different players in the DR market.

Demand response is quite a broad concept, and there are

different definitions for it, cf. for example [2]–[4]. In this paper, we propose the following compact definition. *Demand response means that an electricity consumer changes its electricity consumption in accordance with some input(s) coming from some actor(s) so that the actor(s) and the consumer benefit from the action. In other words, demand for electricity responds to some input(s) in a way that benefits both of the parties involved.* There can be many types of market actors and related inputs. Actors can be e.g. electricity retailer, transmission system operator (TSO) or a distribution network operator (DNO) [5].

In general, the holistic societal benefit is to minimize the infrastructure costs of electricity grids within certain boundary conditions such as the level of service of DNOs. This implies a need for a high utilization rate of electricity networks. The utilization rate is often quite low because network components are rated for high peak loads. To achieve a high utilization rate, load duration curves in the network should be quite flat and the levels of the network components should be near to their techno-economic maximum loading levels. From the utilization rate perspective, encouraging DR for load profile flattening is reasonable. One indirect way a DNO may offer financial DR incentives for small electricity users is to offer distribution tariffs which would encourage changing one’s consumption habits.

Over the past few years, some research has been conducted concerning pricing in a deregulated electricity market, cf. for example [6]–[7]. There has also been some research work about distribution tariffs encouraging peak load reduction especially in the Finnish electricity market environment, cf. for example [8] and [9]. In [8], theoretical principles of distribution pricing are extensively covered. One interesting research branch in recent years has been the so-called “power band” tariff [9], which has been widely discussed among Finnish DNOs. In this paper, various types of novel power based tariffs are discussed and simulated.

In many deregulated electricity market environments, such as in Finland, customers pay separately for energy and electricity distribution (“two-bill system” [7]). The energy fee is paid to the electricity retailer, which a customer can select freely from the market. Distribution fees are paid to the DNO whose network the customer is connected to and a customer can select the distribution product from the DNO’s product

<sup>1</sup>Authors are with the Department of Electrical Engineering, Tampere University of Technology, P.O. Box 692, FI-33101 Tampere, Finland (e-mail: antti.rautiainen@tut.fi).

<sup>2</sup>M. Mononen is with Department of Environmental Sciences, University of Eastern Finland, P.O. Box 1627, FIN-70211 Kuopio, Finland

This work was supported in part by the Smart Grids and Energy Markets (SGEM) program.

catalogue. DNO has monopoly in its distribution area but the Energy Authority supervises the business. In this paper a customer-oriented price minimization use case is analyzed. Customers have the freedom to choose how they control their loads independently from retailer and DNO. Retailers and DNOs, which are independent actors, can only offer financial incentives for the customers.

DR is a very multifaceted area and plenty of DR related research has been conducted during the past years. The research topics are for example customer acceptance, financial incentives, different market mechanisms, load control on customer's sites or on some network area and control verification. Also, lots of papers including studies of different combinations of the themes mentioned above have been published. See for example [10]–[16]. However, practical near future distribution service pricing method enhancements utilizing AMI in deregulated electricity market environments have not been researched extensively. This paper contributes to this discussion.

In this paper, answers to the following research questions will be sought:

1. What kinds of distribution tariffs there could be which could encourage customers to decrease their peak powers?
2. If customers used load control systems controlled in accordance with new distribution tariffs in their premises, what could be the impact of this action on the peak powers of the customers and electricity distribution networks?
3. If customers had Nordic power exchange spot price based energy contracts with the retailers, and customers' load control systems were exploited to take advantage of the fluctuating energy prices, how would it impact the customers' and electricity network's peak powers?
4. What would be the total impact of load control based on spot price based electricity contract and power based distribution tariffs on the peak powers of customers and distribution networks?

Research question 1 will be answered in Section II where the foundations of distribution tariffs are discussed and some possible new distribution tariff structures are introduced and discussed. In Section III, the background and the modeling and simulation methodology of the case study are explained. In Section IV, the results of the case study are presented and research questions 2–4 will be answered using case study simulation as a research method. In Section V, conclusions are made and future work is proposed.

## II. DISTRIBUTION TARIFF STRUCTURES

Distribution tariffs can be “static” or “dynamic”. In this paper dynamic tariff is defined so that the distribution pricing of a network customer within a “contract period” changes in an unpredictable manner from the consumers' point-of-view. For example, a DNO could send some kind of a distribution tariff signal for the customer and the pricing could depend on the current state of the network. Static distribution tariff means that the network customer knows pre-hand exactly how the distribution service is priced for the whole “contract period”. Today DNOs update their pricing annually which forms the

practical “contract period”. Static distribution tariffs can include different types of price components such as time-of-use components, peak power related components etc. but the customer has a perfect knowledge of the pricing pre-hand. This paper concentrates on static distribution pricing.

### A. Requirements for distribution tariffs

Distribution tariffs have different basic requirements set by different actors. Such requirements are related to legislation, regulation, DNOs and customers.

Legislation [17] and regulation authorities set some requirements. Distribution fees must be reasonable and they should be based, as much as possible, on the cost matching or cost causation principle. However, the pricing level should be the same for the same kind of customer which means that distribution pricing cannot be dependent on the customer's location in the network. Distribution tariffs should also encourage customers towards energy efficiency.

DNOs have some requirements. Distribution tariffs should cover all the costs and also bring some financial profit depending on the network company's strategy. In the Finnish regulated electricity distribution business model, the maximum amount of profit is determined by Energy Authority according to certain calculation principles [18]–[20]. Tariffs should also be so clear that the customers, who are usually non-professionals in the area, should understand the basis of the distribution fee they pay.

At the moment for small electricity customers, Finnish DNOs typically have three types of distribution tariffs which are all widely used: *general tariff*, *time-of-day tariff* and *seasonal tariff*. All these tariffs have a monthly basic charge (€/month) and an energy charge (€/kWh). In the general tariff, energy charge is the same for every hour of the year. In the time-of-day tariff, there are two different energy charges: for days and nights, where the charge is lower during nights. In the seasonal tariff, energy charge is higher during winter workdays when annual peak loads normally occur, and cheaper at other times. Both two-time tariffs (time-of-day tariff and seasonal tariff) encourage customers to use electricity during certain times, but they do not necessarily encourage customers to decrease the peak powers or to flatten the consumption profiles.

### B. Possible distribution tariff structures

A way to create new distribution tariffs for small customers is to include some kind of a power based component to the tariff. This would encourage customers to decrease their peak powers and/or powers overall. Hereafter in this paper when the term “power” is used, it refers to active power. Today, for large customers, there is also a distribution tariff component for reactive power, but we exclude reactive power from our small customer related studies. Different types of tariff structures are discussed in the following.

#### 1) Present tariff structures for small customers

General tariff and time-of-use tariffs can be formulated in the way presented in (1). The distribution fee  $C_T$  for a certain time interval including  $N$  measuring periods  $\{t_1, t_2, \dots, t_N\}$

corresponding to supplied energies  $\{E_1, E_2, \dots, E_N\}$  during those periods would be

$$C_T = c_b + \sum_{i=1}^N c_e(i) \cdot E_i, \quad (1)$$

where  $c_b$  is the basic charge (e.g. €/month) and  $c_e(i)$  is the energy charge (€/kWh) which is a function of  $i$  meaning that the charge is dependent on time. In practice, the time dependency can mean for example the use of a two-time tariff. In principle, DNOs could also offer other types of time dependent tariffs if they found it useful, and customers would be able to take advantage of them.

In tariff type (1), the only variable charge component is based on the amount of cumulative supplied energy. As mentioned earlier, this principle does not necessarily follow the matching principle. A typical way of thinking among DNOs has been that the same fixed basic charge for different customers would include the “power capacity fee”, but this does not obey the cost causativeness principle very well because among a large amount of customers with the same tariff and thus the same fixed basic charge, the annual peak powers can vary significantly. As the sizing of network components is based more on power capacity need than cumulative energy, the power based tariffs could realize the matching principle in a better way.

#### 2) “Power fee” structure

Today there are distribution tariffs available which include a peak power related component. These tariffs are typically suitable for customers consuming large amounts of energy and having large peak powers, and the tariffs are not applied in Finland for small customers such as residential houses. All AMI meters in Finland are able to measure hourly average powers, and therefore hereafter in this paper it is assumed that the length of the measuring period is one hour. The average power during a one-hour period (in kW) matches the supplied energy (in kWh) during the hour, and for the uniformity of our presentation with (1) we use both the terms “hourly energy” and “hourly average power” (or just “power”) further in this paper.

Today, the following type of distribution tariff structure is used by many large customers. In this tariff type, the fee depends also on the maximum power. This is presented in (2):

$$C_T = c_b + c_p(E_{max}) + \sum_{i=1}^N c_e(i) \cdot E_i, \quad (2)$$

Compared to (1), there is an additional term  $c_p(E_{max})$  in (2). This represents the power fee (in €) and  $E_{max}$  can be the maximum hourly energy  $\max\{E_1, E_2, \dots, E_N\}$ , the mean of a few maximum hourly energies during some time interval or some other power related quantity.

#### 3) “Peak power based energy fee” structure

Another possibility for power based distribution tariff could be

$$C_T = c_b + \sum_{i=1}^N c_p(E_{max}, i) \cdot E_i \quad (3)$$

where  $c_p(E_{max}, i)$  is an energy charge (in €/kWh) which depends on some kind of peak power related quantity of some period. This means that the energy fee for all  $N$  measuring periods would be determined by the maximum value. In practice, this could mean for example that the energy fee for all hours of a month would be determined according to the

peak hour of the month.

#### 4) “Different distribution fee for every hour” structure

The third possibility for a distribution tariff based on power could be

$$C_T = c_b + \sum_{i=1}^N c(E_i, i) \cdot E_i, \quad (4)$$

where  $c(E_i, i)$  is the distribution charge (in €/kWh) of the period and is a function of the amount of supplied energy and time. In this model, the distribution fee of a certain measuring period is dependent on the amount of energy consumed during the interval. Higher hourly energy consumption leads to a higher hourly distribution fee. Compared to (3), in tariff (4) the high energy of a measuring period only affects the distribution fee of the corresponding measuring period and not the fees of any other periods.

### III. CASE STUDY DESCRIPTION

#### A. The main idea of the case study

For the case study, a large amount of AMI data from real customers of a Finnish DNO is used. The data comprises the hourly consumed electrical energies of 7541 customers during a one year time window: 1.11.2011–31.10.2012 (8784 h). Comprehensive network data in primary substation and medium voltage networks including distribution transformers are used. The case study proceeds as follows.

First, based on Section II.B, some new distribution tariffs are set for a certain customer group in the network. The tariff parameters are based on today’s real distribution tariffs for small customers of the company. The parameters are set so that the average annual distribution cost of the customers, based on real consumption data, would remain roughly on the same level compared to current real tariffs. This also means that the income of the DNO remains approximately constant. We consider a case where customers use a Nord Pool electricity exchange spot price based energy product of the energy retailer. This means that the price of energy can be different for every hour and customers can try to minimize their energy costs with load control. These kinds of energy products are already available in Finland.

Next, DR at the sites of a certain customer group is modeled. In this case it is assumed that customers have quite sophisticated home automation (HA) systems. The HA can make short term load forecasts based on the energy need of the customer and some DR load control in order to minimize electricity related costs. As results of DR, changes in the annual distribution fees using different types of distribution tariffs and different types of HA load control actions are investigated. Changes in the customers’ peak powers caused by DR and the impacts of DR on the load levels of the distribution network for the whole year are investigated. In the following subsections, the assumptions and the modeling methods of the case study are explained in more detail.

#### B. The case network

The case network is part of the distribution network of a real Finnish DNO Elenia Ltd. The network is illustrated in Fig. 1. There is one primary substation which has two main transformers and nine medium voltage feeders. There are also 469 distribution transformers (20 kV/0.4 kV). The total



number of low voltage customers in the network area is about 7500 and the total supplied energy is roughly 90 GWh/a. In the case study, the whole network is modeled from the primary substation to the distribution transformers.

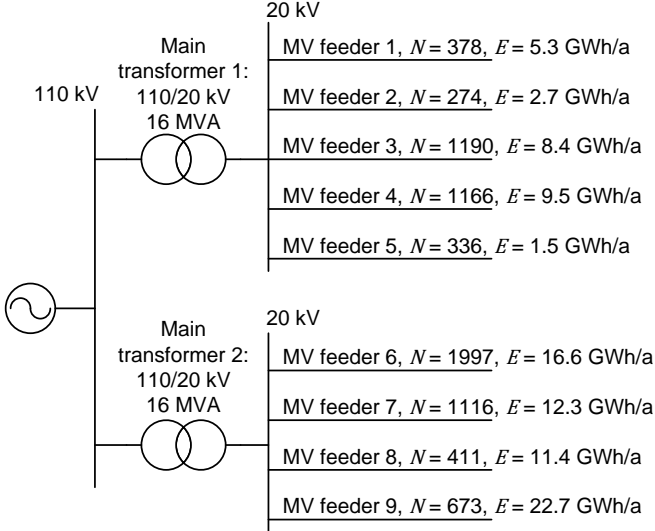

Fig. 1. Distribution network of the case study.  $N$  denotes number of LV customers in each MV feeder and  $E$  annual energy supplied by each of the MV feeders.

### C. Customer load profiles

As mentioned previously, the base of the customer load patterns is real AMI measurement data. For the simulations, we have selected the network customers with *the main fuse size of  $3 \times 25$  A*, which is the most common main fuse size in the case network. A certain group is selected because typically the distribution tariff pricing of a DNO depends on the main fuse size. Therefore, we wanted to select customers whose distribution tariffs are comparable to each other. To filter some erroneous data from the dataset, an additional criterion was set for the analyzed customer group: all hourly energies of the customers have to be less than or equal to 18 kWh. The errors may be in the measurement or in reality the main fuses might be something else than  $3 \times 25$  A as stored in the customer information system. For this customer group, in which the number of customers is 4195, we tuned the distribution tariffs in the way described in Section III.D. Out of this customer group we selected the customers living in detached houses with electric heating, often with electric storage water heaters, and these customers would control their loads to do some DR. The number of selected DR electric heater customers is 1553 and their average electricity consumption is about 13300 kWh/a.

### D. Distribution tariffs and energy costs in the case study

As mentioned above, the pricing of the new tariffs are based on current real tariffs of the users. The real customers of the case study use three different tariffs today: general tariff, time-of-day tariff and seasonal tariff, and their shares are 74.8%, 24.7% and 0.5%, respectively. In general tariff the basic charge is 13.61 €/month and the energy charge 5.72 cents/kWh. In time-of-day tariff the basic charge is 23.64 €/month and the energy charges for daytime and night time are 4.89 cents/kWh and 3.81 cents/kWh, respectively. For

seasonal tariff, the basic charge is 28.13 €/month and energy charges for winter workdays and other times are 5.52 cents/kWh and 3.81 cents/kWh, respectively. These are the prices for 2013. In the case studies, three new distribution tariffs including a power component are investigated, and the tariffs are based on Section II.B. Next, the parameters of the new simulated power tariffs (PT) are presented in detail.

#### 1) Power fee tariff (PT1)

The power fee tariff (PT1) represents the tariff structure of (2). In the tariff, there is a basic charge of 10 €/month, an energy charge of 2 cent/kWh and a *monthly* power fee which is a function of the peak power of the *month*. The power fee is plotted in Fig. 2.

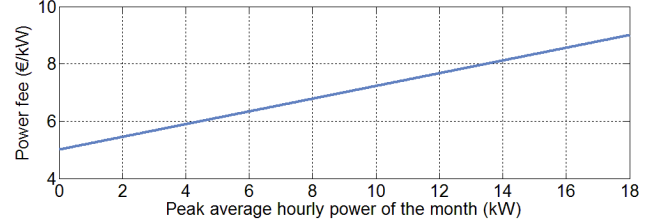

Fig. 2. The power fee of tariff 1.

#### 2) Monthly peak power based energy charge tariff (PT2)

The second tariff structure is the peak power based energy charge (PT2) which is presented in (3). In this case, there is a basic charge of 10 €/month and an energy charge for the whole month which is a function of the monthly peak power. The function is presented in Fig. 3. This means that the peak power of the month determines the energy charge (€/kWh) for all the energy used that month. In this structure, the peak power dependent energy charge includes both the “power” and “energy” components of the distribution fee.

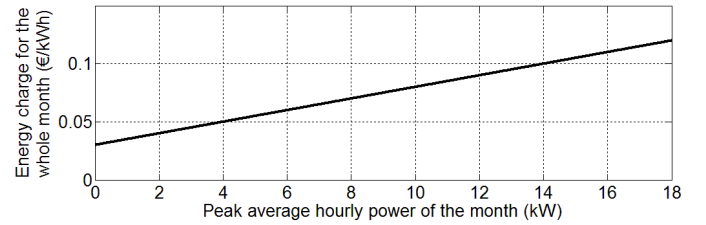

Fig. 3. The peak power dependent energy charge for the whole month.

#### 3) Hourly power based energy charge for every hour, continuous version (PT3)

The third tariff structure (PT3) is based on (4) and is presented in Fig. 4. The “price curve” of Fig. 3 is fixed in time. The idea is that there is an energy charge (€/kWh) for every hour depending on the average power of the hour. Another practical option could be to have a step-like charge function which would correspond to a “low price” under a certain threshold power and a “high price” above the threshold power. This is however, excluded from the case study.

There are many ways to determine the parameters of distribution tariffs (cf. for example [21]), and in this paper the main point is not the selection of the parameters but the tariff structures and their properties. Of course, the parameter selection impacts on the efficacy of the tariffs. In this case, the parameters of the tariffs are selected simply using two different criteria: the total income for the DNO has to remain roughly on the same level as with the current real tariffs and the tariffs have to include some incentive for peak power decrease. The basic charges have been chosen to be smaller

compared to the original tariffs, as there is a power component in the tariff (cf. Section II.B.1). The average annual distribution fees with different tariff types are presented in Fig. 5. The first value (“Real”) represents the real distribution costs (644 €) of the customers. “PT1”, “PT2” and “PT3” represent the three power based tariffs presented above. The fees are calculated with the real AMI load profiles of all the relevant customers with tariff information.

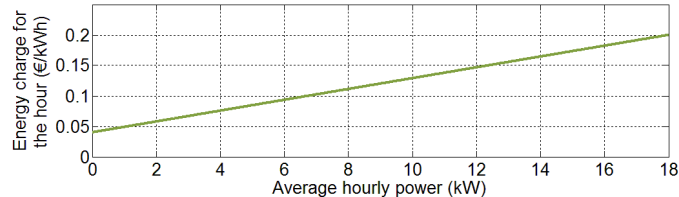

Fig. 4. Continuous version of the average hourly power dependent energy charge for the corresponding hour.

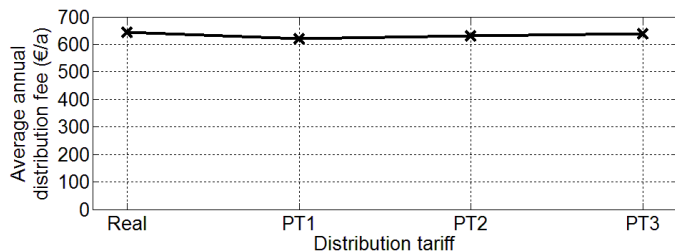

Fig. 5. The average annual distribution fees with different types of distribution tariffs with the original real AMI data of all 3×25 A customers. “Real” stands for real distribution costs of the customers. PT stands for power tariff. PT1...PT3 represent the three power based distribution tariffs presented above.

#### 4) Energy pricing

In some parts of the case study, spot price based energy fees were modeled for the customers. These fees are paid to the electricity retailer and not to the DNO. In Fig. 6, hourly spot price data for the whole year is presented. It is assumed that these prices with an additional 0.005 €/kWh marginal and 24% VAT would represent the final prices for the customers in the case study. In the studies an assumption was made: DR does not have a significant impact on the spot prices. This causes some error to the results because if DR were to be applied on a large scale, it would probably have some an impact on the energy spot prices.

### IV. LOAD CONTROL ALGORITHM OF HA

#### A. General principle

There are many types of load control modeling methods and principles. One branch of modeling is to look at a single electricity customer, model their loads accurately and simulate the control of each load separately. In this way, a good understanding and accuracy of load control possibilities of a customer are obtained. However, the drawback of this approach is that it is very hard in practice to obtain DR models for a very large amount, say thousands, of real customers. Another load control modeling possibility is to make some assumptions and carefully define a generally applicable “hypothetical” load control model, which of course includes some more uncertainty compared to detailed modeling, but this approach could be applied to a large amount of electricity

customers. As we use a large amount of real AMI data in our studies, we use the “hypothetical” DR modeling methodology.

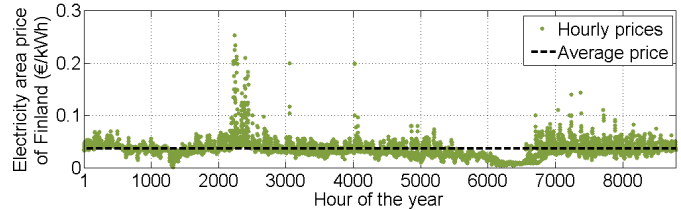

Fig. 6. The NordPool’s hourly electricity area price of Finland 1.11.2011-31.10.2012. The average price is also presented.

In the simulations it is assumed that the customers have a sophisticated but “hypothetical” load control systems embedded in home automation systems, see for example [22], which can forecast and control customers’ electricity consumption. In the approach of the paper, the load forecast and control is made within “control periods” of constant length. A simple and heuristic load control principle is used and works as follows. It is assumed that some parts of the hourly energies during the control period are “flexible” and can be divided and shifted freely to any hours of the control period. The amount of flexible energy is calculated by using a simple rule. For those hours whose energies are more than the average hourly energy of the customer during the whole year have flexible energy, and the amount of the flexible energy is 50% of the energy above the average hourly energy of the customer for the whole year. Figure 7 illustrates this principle in the case of a 24 h long control period. In Fig. 7a, the original hourly energies of a real electricity customer are presented. The red parts of the hourly energies represent the flexible parts that can be freely shifted to any hour(s) within the 24 h long load control period. The horizontal dash line presents the average hourly energy of the customer for the whole year (i.e. minimum level of hourly energy including flexible energy). In fig. 7b, a load profile “as flat as possible” is made using the load control possibilities. Fig. 7c presents a case where all the “flexible energy” is shifted to a single hour. This represent a case where the last hour is the cheapest one and all the flexible energy would be shifted to that hour.

The amount of flexible energy that can be shifted to a certain hour is highly dependent on the nominal powers of customers’ appliances. Theoretically the maximum hourly energy is limited by the fuse size at customer connection point. As discussed in Section III.B, the customers selected for optimization have 3×25 A primary fuse. This limits the hourly energy to roughly 18 kWh. In practice, however, the sum of the nominal powers of customer’s appliances might be less than 18 kW. Therefore, customer’s maximum hourly energy is heuristically restricted to 1.2 times the highest hourly energy measured on the examined year. The load control principle, which is very hypothetical, is expected to emulate the real load control possibilities only in a rough manner. The possibility to realize this kind of control in reality depends on many things such as the types of the customers’ loads, outdoor temperature etc. In the simulations of the paper, a control period of 24 h is used. However, due to the uncertainties of the model, some sensitivity studies were made and are presented in Section V.

It can be noticed that it is easier to increase the loads than to decrease them in the load control system, and this can be easily understood in practice as well. Let us consider a single

customer with a certain number of controllable loads such as electric heaters and storage water heater. In many cases it is quite rare that all of these loads are *on* simultaneously so that a large amount of load could be simultaneously switched *off*. On the other hand it is much easier to switch all of the controllable loads simultaneously *on*.

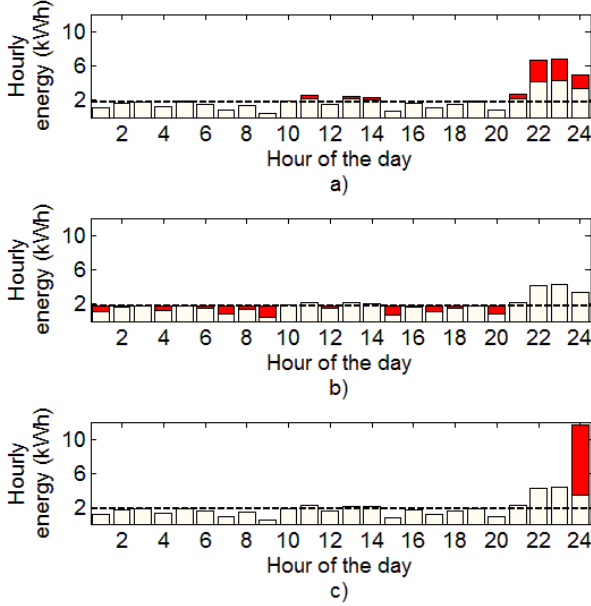

Fig. 7. a) Original hourly energies. The red parts can be shifted within the day. b) A flattened load profile which minimizes the peak hourly energy. c) All the flexible energy shifted to a cheap hour. The black dash line in every subfigure presents the average load level of the consumer for the whole year.

In this kind of system, the length of the load control period is a tradeoff between many things. The longer the interval, the better the potential advantage of the control for the customer. On the other hand, the longer the control period, the harder the load forecasting and the larger the possible decrease in customer comfort such as decrease in indoor temperature.

### B. Optimization problem

In the simulations, three different types of customer-driven optimizations were made: minimization of the distribution fee, minimization of the energy fee and minimization of the total cost comprising both distribution and energy fee.

The cost optimization problem in this study is the minimization of electricity cost for the examined optimization period. The optimization is run separately for each optimization period of 24 hours over the whole examined year. The target of the optimization is to solve the sequence of hourly energies  $E_k$  which give the minimum total cost of electricity  $C_{Tot,k}$  for optimization period  $k$ :

$$\min (C_{Tot,k}(E_k)) \quad (5a)$$

$$E_k = \{E_1, E_2, \dots, E_{24}\}. \quad (5b)$$

#### 1) Constraints

The hourly energies in the optimization task are limited by the “flexible energy” on the optimization period. In short, the optimal sequence of energies must be lower than the defined maximum limit (120% of highest measured hourly energy on measured year  $E_{peak,y}$ ) presented in Section IV.A, giving the upper limit for an hour  $i$  presented in (6).

$$E_{lim,high,i} = \begin{cases} 1.2 \times E_{peak,y} & \text{if } 1.2 \times E_{peak,y} \leq 18 \\ 18 & \text{if } 1.2 \times E_{peak,y} > 18 \end{cases} \quad (6)$$

Also, every optimal hourly energy must be equal to or higher than the fixed part of the original energy of the hour  $i$  (defined in Section IV.A):  $E_{F,i}$  as presented in (7).

$$E_{F,i} = \begin{cases} E_i & , E_i \leq E_{av} \\ E_i - 0.5(E_i - E_{av}) & , E_i > E_{av} \end{cases} \quad (7)$$

In (7)  $E_i$  is the original hourly energy of hour  $i$ , and  $E_{av}$  is the average hourly energy of the customer over the whole year. Also the sum of the optimal energies  $E_k$  must be same as the sum of the original measured energies  $E_{k,0}$  during the optimization period, giving the equity constraint of energies:

$$\sum E_k = \sum E_{k,0}. \quad (8)$$

#### 2) Objective functions

The objective function depends on the type of optimization.

##### a) The case including energy fee minimization only

In this optimization case, the target is to solve the sequence of hourly energies which give the minimum total energy cost. The distribution fee is not considered here and therefore the total cost of electricity is composed only of energy prices  $C_{E,i}$ . The objective function is given by (9), where  $E_i$  is the energy of hour  $i$ .

$$C_{Tot,k}(E_k) = \sum_{i=1}^{24} (C_{E,i} \cdot E_i) \quad (9)$$

##### b) Cases including distribution tariff PT1

The total cost of electricity in this case is composed of energy price and the power based distribution fee (10). The constant part of the distribution energy fee is not considered as it has no influence in the outcome of the optimization. If only distribution fee is considered, the energy price based part of the equation is omitted. In (10) the power based fee  $C_{dist,PT1}(E_{peak,m})$  is calculated (presented in (11)) from the highest peak hourly demand of the month  $E_{peak,m}$  which is then divided evenly for all the optimization periods on the month ( $K$  is the number of optimization periods, 31, 30 or 28 depending on the month in question) as presented in (10). This means that the cost of the optimization period is defined not only by the hourly energies of the current optimization but also by the previous and following optimizations in the current month.

$$C_{Tot,k}(E_k) = \sum_{i=1}^{24} (C_{E,i} \times E_i) + \frac{C_{dist,PT1}(E_{peak,M})}{K} \quad (10)$$

$$C_{dist,PT1}(E_{peak,M}) = a_{PT1} \times E_{peak,M}^2 + b_{PT1} \times E_{peak,M} \quad (11)$$

The cost parameters  $a_{PT1}$  and  $b_{PT1}$  of (11) are the coefficients of the polynomial of the first degree of fig. 1.

The problem described in 10 is hard to solve as the part of  $C_{Tot}(E)$  is dependent on previous optimizations. In order to simplify this problem, the customers’ behavior is modelled in

two different ways: high risk (HR) and low risk (LR) optimization. The difference comes from the idea that the customer could theoretically “select” a peak hourly demand for the month pre-hand which would maximize the customer’s savings on energy fee while deliberately paying a higher distribution fee. This kind of behavior carries some risk, because the customer would have to have a very accurate idea of his consumption and energy prices during the month in the beginning of the month and this includes uncertainties.

The high risk optimization begins by identifying that the total cost of electricity in month  $M$  is dependent on the energy charge and distribution fee. Energy charge can be reduced by allowing higher peak demand during month  $M$  but this would, on the other hand, cause an increase in the distribution fee. The problem becomes finding the peak demand for  $M$  which would give the highest total savings (combined energy charge and distribution charge) for the billing period. This information is needed in order to estimate *the saving potential in energy fees*  $S_{en}(E_{peak,M}, E_M)$  with different peak demands (12b).  $E_M$  denotes the sequence of the hourly energies of the month  $M$ .

As a solution we get the peak demand of month  $E_{peak,M}$  which would give the *highest saving in total cost*  $S_{tot}(E_{peak,m})$  presented in (12c).  $E_{peak,M,0}$  is the peak hourly energy of the original load for the current month.

$$\Delta C_{dist}(E_{peak,M}) = C_{dist,PT1}(E_{peak,M,0}) - C_{dist,PT1}(E_{peak,M}) \quad (12a)$$

$$S_{en}(E_{peak,M}, E_M) = \sum_{k=1}^K \sum_{i=1}^{24} (C_{E,i} \times E_{i,0}) - \sum_{k=1}^K \min \left( \sum_{i=1}^{24} (C_{E,i} \times E_i) \right) \quad (12b)$$

$$S_{tot}(E_{peak,M}) = \max(S_{en}(E_{peak,M}, E_M) + \Delta C_{dist}(E_{peak,M})) \quad (12c)$$

so that

$$E_i \leq E_{peak,M} \quad \forall E_i \in E_M$$

where  $E_i$  denotes an hourly energy. Then the objective function (10) is optimized with new high limit sequence (13).

$$E_{lim,high} = E_{peak,M} \quad , \quad \forall E_{lim,high,i} \in E_{lim,high}. \quad (13)$$

The low risk optimization assumes that the customers do not want to increase the distribution fee unless necessary. This means that in the energy price optimization the existing peak demand is considered to be the upper limit for hourly demands in the optimization. If there is no solution to the optimization problem of period  $k$  with the given peak demand, a new peak demand is defined by (14).

$$\begin{aligned} \text{if: } \sum E_k > E_{peak,M} \times 24 \\ \rightarrow E_{peak,M} &= \frac{\sum E_k}{24} \end{aligned} \quad (14)$$

c) *Cases including distribution tariff PT2*

The objective function in this case is quite similar to the objective function of the previous case. Only now the peak

demand dictates the energy based fee of the distribution tariff  $C_{dist,PT2}(E_{tot,M}, E_{peak,M})$ , giving the objective function (15).

$$C_{Tot,k}(E_k) = \sum_{i=1}^{24} (C_{E,i} \times E_i) + \frac{C_{dist,PT2}(E_{tot,M}, E_{peak,M})}{K} \quad (15a)$$

$$\begin{aligned} C_{dist,PT2}(E_{tot,M}, E_{peak,M}) \\ = (a_{PT2} \times E_{peak,M} + b_{PT2}) \times E_{tot,M} \end{aligned} \quad (15b)$$

The cost parameters  $a_{PT2}$  and  $b_{PT2}$  are the slope and vertical axis intersection point of the cost curve on fig. 2, and the  $E_{tot,M}$  is the sum of consumed energy on month  $M$ .

The optimization problem is again divided in to high risk behavior and low risk behavior. The methodology in defining the high limits for optimal energy sequence is same as in the case of PT1 only now the cost function of distribution fee in (12a) is replaced with (15b).

d) *Cases including distribution tariff PT3*

In this final optimization the energy based fee for distribution tariff for any hour is dictated by the hourly energy of the hour  $C_{dist,PT3}(E_i)$ . This gives objective function (16).

$$C_{Tot,k}(E_k) = \sum_{i=1}^{24} \left( (C_{E,i} + C_{dist,PT3}(E_i)) \times E_i \right) \quad (16a)$$

$$C_{dist,PT3}(E_i) = a_{PT3} \times E_i + b_{PT3} \quad (16b)$$

The cost parameters  $a_{PT3}$  and  $b_{PT3}$  are the slope and vertical axis intersection point of the cost curve on Fig. 3.

3) *Implementation of the optimization algorithm*

Optimization tasks were calculated using the Optimization Toolbox of Matlab. The linear programming tool (linprog) was used to solve the optimum for energy fee optimization (case E) and power tariffs PT1 and PT2. Linear programming tool was set to use active set-method algorithm. The last of the optimization tasks were not solvable by linear programming so the tool for solving nonlinear problems was used (fmincon). The tool was set to use sequential quadratic programming algorithm for solving the optimum.

## V. RESULTS OF THE CASE STUDY

In the case study, customer costs, customer peak powers and the peak powers in the distribution network are investigated.

### A. Customer costs

In Fig. 8, average annual distribution fees for all of the simulated DR customers are presented. Fig. 9 presents the average annual total costs of the customers. In the figures there are two parameters: the type of distribution tariff and the simulation case. The average annual distribution fees and total costs with the original AMI load profiles (cf. Fig. 5) are presented for a baseline in both pictures (the case “Original”). In addition to this, there are five other simulation cases: energy fee minimization, distribution fee minimization and the total cost (energy fee and distribution fee) minimization of PT1 and PT2 using low risk (LR) and high risk (HR) approaches and total cost minimization in the case of PT3. The first observation from the results is that on average customers

could decrease their total costs by about 70–240 € (about 4–15%) per year on average using DR. The savings of course depend on the parameters of the distribution tariffs. The second observation is that the average annual distribution fee is pretty much the same with the distribution fee and total cost minimizations. This is because the changes in the energy spot prices are quite small in the 24 h long time windows and there is only a quite modest possibility to save in energy fees. As the energy price changes are small, the distribution tariff dominates the total cost minimization DR. The third observation is that if only the energy fee was minimized, it would lead to high distribution fees. If large amounts of flexible energy were transferred to the hours with low energy spot prices, it would lead to high hourly energies and higher distribution fees. It can also be seen that there are no significant difference between LR and HR approaches.

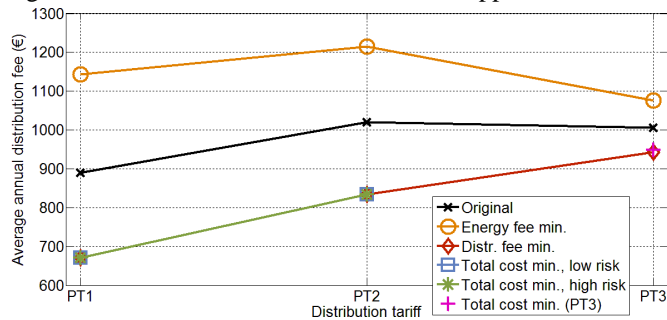

Fig. 8. Average annual distribution fees of the customers with different types of distribution tariffs and different types of load profiles.

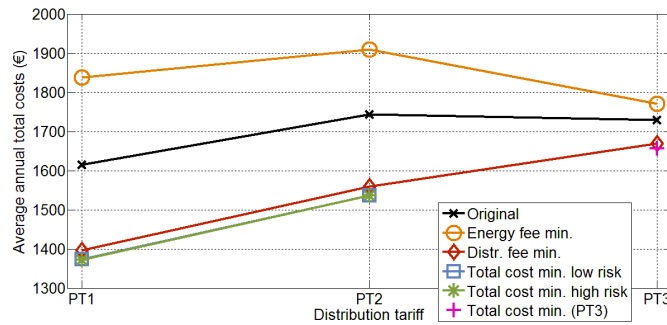

Fig. 9. Average annual total costs of the customers with different types of distribution tariffs and different types of load profiles.

In Figs. 8 and 9, only average values are presented. In different DR cases the deviations of annual costs are typically such that for most of the customers the fees changed quite moderately and for a few customers changes were quite large. For example, in different DR cases the standard deviations of changes of the annual distribution fees were between 11% and 37% of the average distribution fee caused by the real distribution tariffs (case “Original”).

#### A. Customer peak powers

Fig. 10 presents the average peak power of the customers over the whole year in different simulation cases. It can be seen that the largest peak powers are in the case where only the energy fee (“E” in Fig. 10) is minimized. This result is as expected as explained above. The average peak power rose about 1.7 kW which is about 19% compared the original load profiles. When only distribution fees PT1, PT2 and PT3 are minimized, the average peak powers decrease about 3.5 kW which is about 39% of the original load profile’s case and the

decrease is quite large. In Fig. 10, also in the cases where both energy and distribution fees with high risk and low risk approaches (i.e. EPT1LR, EPT1HR, EPT2LR, EPTHR and EPT3) are minimized, the peak powers are smaller than in the “original” case. From the customer specific peak power point-of-view there is no difference between low and high risk options.

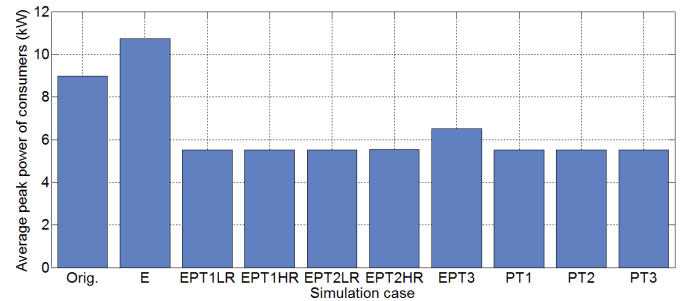

Fig. 10. Average peak powers of the whole year of all customers in different simulation cases. LR denotes low risk and HR high risk.

#### B. Peak powers in the network

A very interesting and essential issue is that how the changes in the peak powers of individual customers would affect the load levels of the distribution network. In Fig. 11, histograms of the peak powers of the distribution transformers, in percentages of the transformers’ ratings, are presented in different simulation cases. In the figure, orange vertical dash lines represent the average values in different cases and red vertical line represents the value of 100%. When the energy fee only is minimized, it raises the peak powers of the transformers the most, about 13 % on average (orange dash line in the figure). It can be seen that in cases where customers are encouraged to decrease the peak powers with power based distribution tariffs the average decreases in peak powers were about 3% percent at the highest. It should be, however, remembered that only about 20% of the customers (consuming about 23% of all consumed electrical energy in the network) of the network participated to DR, and in this sense the 3% is not as small as it might first appear. Power based tariffs could also help to prevent the increase of the peak loads caused by customers’ reactions to spot price based energy contracts. As only part of the customers utilized DR, some transformers have proportionally more DR customers than others.

Load levels of the medium voltage (MV) feeders in the network are also studied. The proportions of the customers participating to DR in different feeders vary and are presented in Table I. The peak powers can be seen in Table II. The results are mostly quite the same as with the distribution transformers. If only the energy fee is minimized, peak powers rise quite significantly. On the other hand, with distribution fee minimization, a peak power decrease of a few percent at the maximum can be obtained. However, interesting phenomena can be seen. For example, the peak power of feeder 9 is increased in case “PT3” compared to the case “Original”. It turns out that although the electric heater customers decrease their peak powers and shift their consumption to non-peak times of their own consumption profile, the load is shifted to the peak time of the non-DR customers in the network. Another interesting thing is that the peak power of feeder 6 in the case “E&PT3” is lower than in

the case of “PT3”. High spot prices often correlate with the peak load times of the distribution network under investigation, and therefore in the case “E&PT3” would decrease the peak load more than the case “PT3”. These phenomena are important to understand when designing new distribution tariffs.

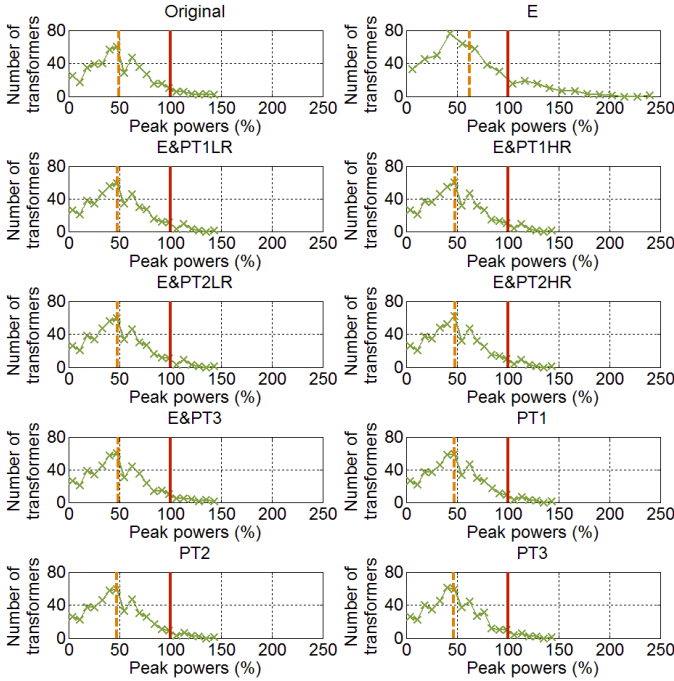

Fig. 11. The peak powers of distribution transformers in different simulation cases. Peak powers are presented in percentages of the transformers’ ratings. The vertical orange dash lines represent the average peak power level and the vertical red line the more or less critical limit 100%.

TABLE I  
PROPORTION OF DR CUSTOMERS IN DIFFERENT MV FEEDERS.

Feeder	1	2	3	4	5	6	7	8	9
Prop. (%)	32	24	13	18	17	11	33	36	31

TABLE II  
PEAK POWERS (IN MW) OF THE NINE MEDIUM VOLTAGE FEEDERS IN DIFFERENT SIMULATION CASES.

	1	2	3	4	5	6	7	8	9
Original	1.4	0.9	2.6	3.0	0.5	4.0	3.6	2.7	4.5
E	1.9	1.2	3.4	4.2	0.8	4.6	5.6	2.9	5.6
E&PT1LR	1.3	0.9	2.6	3.0	0.5	3.8	3.6	2.7	4.5
E&PT1HR	1.3	0.9	2.6	3.1	0.5	3.8	3.6	2.7	4.5
E&PT2LR	1.3	0.9	2.6	3.0	0.5	3.8	3.6	2.7	4.5
E&PT2HR	1.3	0.9	2.6	3.1	0.5	3.7	3.6	2.7	4.6
E&PT3	1.4	0.9	2.7	3.1	0.5	3.6	3.7	2.7	4.7
PT1	1.4	0.9	2.6	3.0	0.5	4.0	3.4	2.7	4.6
PT2	1.4	0.9	2.6	3.0	0.5	4.0	3.4	2.7	4.6
PT3	1.3	0.9	2.6	3.0	0.5	3.9	3.4	2.8	4.6

The characteristics of the load control modeling can have a significant impact on the simulation results. As the applied “hypothetical” load control modeling methodology includes many uncertainties, a sensitivity study was made. In the sensitivity study all the case study simulations were carried out using 11 combinations of the values of two fundamental simulation parameters: *the length of the optimization period* and *the minimum level of hourly energy including “flexible energy”*. As explained in Section IV, the control period of the previous simulations was 24 h and the minimum level of the hourly energies including flexible energy was the average

hourly power of the year (cf. Fig. 7). Concerning the minimum level of the hourly energy including flexible energy, the limits of 0.5, 1.0 and 1.5 times the annual average power correspond to average annual total flexible energies of all the customers are 3800 kWh, 2100 kWh and 1100 kWh, respectively. On average among the customers, corresponding numbers of hours in the year which included flexible energy are roughly 5900, 3400 and 1800, respectively. In the sensitivity studies all the simulations were made also with the parameter combinations of Table III. It is not possible to present the results in detail in this paper, but average load levels of distribution transformers in three simulation cases (“E”, “E&PT3”, “PT3”) are presented in Table III. Also the differences of the load levels to the “Base” case (with the sensitivity study parameters *24 h* and *1.0 × average power*) are presented. As an overview, it can be said that the results deviated from the results of the “Base” case quite moderately. It can be strongly stated that the outcome and the conclusions made in accordance with the results above can also be made in all of the sensitivity study cases.

TABLE III  
PARAMETERS IN DIFFERENT SENSITIVITY STUDY CASES AND CORRESPONDING, AVERAGE LOAD LEVELS OF DISTRIBUTION TRANSFORMERS AND THEIR CHANGES COMPARED TO THE “BASE” CASE

Sensitivity study case	Length of the opt. prd. (h)	Min. level of the hourly en. Including flex. en.	Av. distr. trans. load level in case “E” and $\Delta$ to case “Base” (%)	Av. distr. trans. load level in case “E&PT3” and $\Delta$ to “Base” (%)	Av. distr. trans. load level in case “PT3” and $\Delta$ to “Base” (%)
“Base”	24	$1.0 \times E_{h,av}$	62.5	48.6	47.1
1	4	$0.5 \times E_{h,av}$	60.0 (−2.5)	53.2 (+4.6)	48.3 (+1.2)
2	4	$1.0 \times E_{h,av}$	58.5 (−4.0)	52.1 (+3.5)	48.3 (+1.2)
3	4	$1.5 \times E_{h,av}$	56.8 (−5.7)	51.1 (+2.4)	48.3 (+1.2)
4	8	$0.5 \times E_{h,av}$	62.7 (+0.2)	51.0 (+2.4)	47.7 (+0.6)
5	8	$1.0 \times E_{h,av}$	61.6 (−0.9)	50.3 (+1.7)	47.8 (+0.7)
6	8	$1.5 \times E_{h,av}$	60.1 (−2.4)	49.6 (+1.0)	47.8 (+0.7)
7	12	$0.5 \times E_{h,av}$	63.1 (+0.6)	50.6 (+2.0)	47.2 (+0.2)
8	12	$1.0 \times E_{h,av}$	62.2 (−0.3)	50.1 (+1.4)	47.3 (+0.2)
9	12	$1.5 \times E_{h,av}$	61.1 (−1.4)	49.4 (+0.7)	47.5 (+0.4)
10	24	$0.5 \times E_{h,av}$	63.2 (+0.7)	49.1 (+0.5)	47.0 (−0.1)
11	24	$1.5 \times E_{h,av}$	61.6 (−0.9)	48.2 (−0.4)	47.3 (+0.2)

## VI. DISCUSSION AND CONCLUSIONS

In this paper, the concept of DR is discussed from the electricity customers’ and DNOs’ points of view. Different types of novel distribution tariff structures with power based components are presented and discussed. Also, the effects of distribution tariff and electricity spot price based DR on the load levels of a distribution network are simulated with real electricity consumption, electricity price and network data. These are the main contributions of the paper.

Power based distribution tariffs would encourage the customers to reduce their peak powers which could lead to a reduction of peak powers in the components of the electricity networks. With the load control principle of the simulations, peak powers of distribution transformers and MV feeders could be decreased to some extent, but in a case where only a small proportion of the customers flatten their consumption profiles, they might shift part of their consumption to the peak time caused by other customers of the network, and this might increase the real peak powers of the network components.

Also, in this kind of situation, the impact of positive correlation of spot prices and peaks in the distribution network might cause spot price based DR to decrease the peak loads. When DR is implemented to minimize only the spot price based electricity fees of the consumers, it can increase the network load levels significantly. In this sense, it seems that DR driven by electricity retailers and other non-DNO actors might be more of a threat than an opportunity to the distribution networks. Power based tariffs could be useful in the sense that they could mitigate the increase of the peak loads caused by e.g. spot price based control. All of this implies that in order to have a reasonable system from a holistic point-of-view, new distribution tariffs should be carefully designed.

In the studies of the paper there are many uncertainties which would suggest topics for future studies. One uncertainty is the modeled HA load control algorithm. Although some sensitivity studies are carried out in this paper, there is a need to develop the modeling further. In different simulations of the paper, all DR customers were assumed to be using the same distribution tariff. In future tariffs, we could investigate which tariff type would be suitable for each customer with different size of the main fuses of their network connection. Also, the tariff parameters were set in a very simple way in the studies. In future studies, DNO cost based tariff pricing should be investigated. Practical ways to implement power based distribution tariffs and assessment of the economic consequences of the changes in the network load levels in long term should also be made.

#### REFERENCES

- [1] Finnish Electricity market decree 66/2009.
  - [2] M. H. Albadi, and E.F. El-Saadany, "A Summary of demand response in electricity markets," in *Electric Pow. Syst. Research*, vol. 78, no. 11, pp.1989–1996, Nov. 2008.
  - [3] P. Bartholomew *et al.*, "Demand Response Measurement & Verification - Applications for Load Research," AEIC Load Research Committee, 2009.
  - [4] P. Palensky and D. Dietrich, "Demand Side Management: Demand Response, Intelligent Energy Systems, and Smart Loads," in *IEEE Trans. Ind. Informat.* vol.7, pp.381–388, Aug. 2011.
  - [5] A. Rautiainen *et al.*, "Requirements for an interface between a plug-in vehicle and an energy system," in *Proc. IEEE Powertech 2011*, Trondheim, Norway.
  - [6] M.P. Rodríguez Ortega *et al.*, "Distribution network tariffs: a closed question?," in *Energy Policy*, vol. 36, pp. 1712–1725, 2008.
  - [7] Eurelectric, "Network tariff structure for a smart energy system," Eurelectric, 2013.
  - [8] L. Similä *et al.*, "Network tariff structures in Smart Grid environment," VTT Research report, VTTR0317311, Espoo, 2011.
  - [9] J. Partanen *et al.*, "Tariff scheme options for distribution system operators," Laboratory of electricity market, Lappeenranta, 2012.
  - [10] A. J. Conejo *et al.*, "Real-Time Demand Response Model," *IEEE Trans Smart Grid*, vol. 1, pp. 236–242, Dec. 2010.
  - [11] Y. Guo *et al.*, "Decentralized Coordination of Energy Utilization for Residential Households in the Smart Grid," *IEEE Trans Smart Grid*, vol. 4, pp. 1341–1350, Sep. 2013.
  - [12] A-H. Mohsenian-Rad *et al.*, "Optimal Residential Load Control With Price Prediction in Real-Time Electricity Pricing Environments," *IEEE Trans Smart Grid*, vol. 1, pp. 120–133, Sep. 2010.
  - [13] Hanne Sæle and Ove S. Grande, "Demand Response from Household Customers: Experiences from a Pilot Study in Norway," *IEEE Trans Smart Grid*, vol. 3, pp. 102–109, Mar. 2010.
  - [14] G. C. Heffner *et al.*, "Innovative Approaches to Verifying Demand Response of Water Heater Load Control," *IEEE Trans. Pow. Del.*, vol. 21, pp. 388–397, Jan. 2006.
  - [15] H.S.V.S. Kumar Nunna, S. Doolla, "Energy Management in Microgrids Using Demand Response and Distributed Storage-A Multiagent Approach," *IEEE Trans. Pow. Del.*, vol. 28, pp. 939–947, Apr. 2013.
  - [16] Accenture. "Understanding Consumer Preferences in Energy Efficiency," Accenture end-consumer observatory on electricity management, 2010.
  - [17] Finnish Electricity Market Act 588/2013.
  - [18] S. Honkapuro, "Performance benchmarking and incentive regulation – considerations of directing signals for electricity distribution companies," PhD dissertation, LUT, Lappeenranta, 2008.
  - [19] K. Tahvanainen *et al.*, "Experiences of modern rate of return regulation in Finland," in *Utility Policy*, vol. 21, pp. 32–39, 2012.
  - [20] J-P. Mutanen and R. Norblad, "Renewed Regulation of Finnish Electricity Distribution Networks," D&I Focus, Jul. 2013.
  - [21] K. Lummi, A. Mäkinen, A. Mutanen, P. Järventausta, "Electricity Distribution Pricing Methodology In Finnish Regulation Framework - A Case Study of Matching Principle," in *Proc. 11th Nordic Conference on Electricity Distribution System Management and Development (NORDAC 2014)*, Stockholm, Sweden.
  - [22] K. Grip, A. Mutanen, P. Järventausta, "Effects of demand response on load profiling of small-scale customers," in *Proc. 11th Nordic Conference on Electricity Distribution System Management and Development (NORDAC 2014)*, Stockholm, Sweden.
- A. Rautiainen** received his M.Sc degree from Tampere University of Technology in 2008. He is now working as a researcher towards doctoral degree at Tampere University of Technology. His main interest focuses on demand response and electric vehicles in smart grids.
- A. Supponen** received his B.Sc degree from Tampere University of Technology in 2013. Currently he is working as a research assistant towards master's degree at Tampere University of Technology. His main research interest is impact evaluation of distributed energy resources on network planning.
- A. Mutanen** received his Master's degree in electrical engineering from Tampere University of Technology in 2008. At present, he is a post-graduate student at the Department of Electrical Engineering of Tampere University of Technology. His main research interests are load research and distribution network state estimation.
- K. Lummi** received his M.Sc degree in Electrical Engineering from Tampere University of Technology in 2013. At present he is working as a doctoral student at the Department of Electrical Engineering of Tampere University of Technology. His main interest focuses on electricity distribution pricing.
- J. Markkula** received his M.Sc degree from Tampere University of Technology in 2013. He is now working as a researcher at Tampere University of Technology. His main interest focuses on business logic and business models in power system context.
- M. Mononen** received his M.Sc degree from University of Eastern Finland in 2012, and has worked as a project researcher at University of Eastern Finland. His research interests have included the role of households in the emerging smart grid systems.
- S. Repo** received his M.Sc. and Dr.Tech. degrees in Electrical Engineering from Tampere University of Technology in 1996 and 2001 respectively. At the present he is a professor at the Department of Electrical Engineering of Tampere University of Technology. His main interest is the management of active distribution network including distributed energy resources.
- P. Järventausta** received his M.Sc. and Licentiate of Technology degrees in Electrical Engineering from Tampere University of Technology in 1990 and 1992 respectively. He received the Dr.Tech. degree in Electrical Engineering from Lappeenranta University of Technology in 1995. At present he is a professor at the Department of Electrical Engineering of Tampere University of Technology. The main interest focuses on the electricity distribution and electricity market.

### **Publication 3**

A. Rautiainen, S. Repo, P. Järventausta, A. Mutanen, K. Vuorilehto, and K. Jalkanen, "Statistical charging load modeling of PHEVs in electricity distribution networks using national travel survey data", *IEEE Trans. on Smart Grid*, vol. 3, no. 4, Dec. 2012, pp. 1650-1659. *The approved version.*

In reference to IEEE copyrighted material which is used with permission in this thesis, the IEEE does not endorse any of Tampere University of Technology's products or services. Internal or personal use of this material is permitted. If interested in reprinting/republishing IEEE copyrighted material for advertising or promotional purposes or for creating new collective works for resale or redistribution, please go to

[http://www.ieee.org/publications\\_standards/publications/rights/rights\\_link.html](http://www.ieee.org/publications_standards/publications/rights/rights_link.html)  
to learn how to obtain a License from RightsLink.





# Statistical charging load modeling of PHEVs in electricity distribution networks using National Travel Survey data

A. Rautiainen<sup>1</sup>, S. Repo<sup>1</sup>, P. Järventausta<sup>1</sup>, A. Mutanen<sup>1</sup>, K. Vuorilehto<sup>2</sup>, K. Jalkanen<sup>2</sup>

**Abstract**— In this paper, statistical charging load modeling of plug-in hybrid electric vehicles (PHEVs) in electricity distribution networks is studied. Usefulness of National Travel Survey data in the modeling is investigated, and a novel modeling methodology is proposed where detailed car use habits are taken into account and statistical distributions of charging energies can be produced. Using the modeling methodology some example calculation results of a Finnish case study are presented with further analysis and sensitivity studies. The example calculations are made mostly from viewpoint of the Finnish distribution networks and their modeling traditions but the method can be applied internationally when relevant travel survey data is available. Example calculations are analyzed in order to assess reasonability and practical usability of the models. The models produced by the methodology can easily be used in network calculation tools commonly used by distribution network operators.

**Index Terms**—PHEV, plug-in hybrid electric vehicle, electric vehicle, load modeling, electricity distribution networks, travel survey

## I. INTRODUCTION

TRANSPORTATION has a very important function in today's society. Globally, the energy production of transportation systems is highly dependent on oil, and there are strong expectations that the price as well as the volatility of the price of oil will increase in the future. The transportation sector is also a significant consumer of energy and a significant source of greenhouse gases and other emissions [1]. Today's climate and energy policies imply strongly towards diversification of transportation fuels, improving energy efficiency and reducing emissions. The use of electrical energy in a broader manner by means of plug-in hybrid electric vehicles (PHEV) and full electric vehicles (EV) offers the potential to partly fulfill these challenging requirements. Emission reductions and the amount of primary energy conservation due to plug-in vehicles are, however, highly dependent on the energy system.

There are some barriers related to the high penetration of

plug-in vehicles (PHEV and EV). The most important barrier is the battery technology. Technologically speaking batteries are fairly good at the moment, but batteries suitable for transportation appliances are very expensive. However, the prices are expected to go down in the future [2]. Secondly, a lack of adequate charging infrastructure is a major barrier. It is fairly expensive to construct extensive charging infrastructure especially in the existing densely populated areas.

Vehicle chargers affect the power system in many ways. In Finnish medium voltage and low voltage networks the impacts of plug-in vehicles might be, without counter actions, a rise of peak load levels in some parts of the network, see for example [3] in the case of full EVs, and this has impact on the design of the networks.

Many Finnish utilities have shown their interest on modeling of charging load of plug-in hybrid electric vehicles and full EVs. The distribution networks of Finnish distribution system operators (DSO) are generally fairly old, and remarkable network renovation work will be made in many companies in the following years. As the construction of distribution networks are long-term investments, i.e. the lines and other components will probably be in use for many decades, in planning process the DSOs have to assess or approximate somehow the development of the loads in the networks in a long-term. Thus, there are practical needs for PHEV load models already today.

To assess the impacts of plug-in vehicles on a power system, the effect on the electrical load of a plug-in vehicle fleet in a power system has to be modeled. In this paper, a method for constructing statistical load models for plug-in hybrid electric vehicles especially in the Finnish transportation system is proposed. In addition to the contribution to the discussion around this topic, this study offers tools for network companies to carry out rough practical studies. Modeling could be used to assess the impact of different PHEV penetration levels on the existing networks and as a tool for future network planning. The methodology can be used to construct statistical charging load model for a single PHEV with certain characteristics. When such models exist, one can embed freely selectable amount of cars to a distribution network model into freely selectable locations and carry out studies of an individual area or network.

The modeling in this paper is restricted only to charging of PHEVs. Using PHEVs, a fairly high portion of driving can be done using electrical energy. According to Finnish National

Manuscript received June 22, 2011.

<sup>1</sup>Authors are with the Department of Electrical Energy Engineering, Tampere University of Technology, P.O. Box 692, FI-33101 Tampere, Finland (e-mail: antti.rautiainen@tut.fi).

<sup>2</sup>Authors are with Aalto University, School of Chemical Technology, (kai.vuorilehto@iki.fi).

Travel Survey (NTS) 2004–2005 [4] about half of the driven mileages are driven as trips shorter than 50 km. Depending on the charging opportunities, PHEVs with an electrical range of fewer than 100 km can reach a very high proportion of mileages driven using mainly electrical energy. Vehicle-to-grid (V2G) [5] and Vehicle-to-home (V2H) [6] functionalities of plug-in vehicles are interesting, but this paper excludes them and concerns only regular charging, i.e. a situation where chargers only draw active power from the grid.

The paper is organized as follows. In chapter II the principles of the statistical load modeling and the corresponding network calculations are briefly presented. In chapter III issues affecting PHEV load are presented and discussed. In chapter IV the modeling of PHEV load using NTS data is discussed and a simple method for building up load models is presented. In chapter V the parameters of the example results are presented and discussed. In chapter VI some example results with simple sensitivity studies are presented. In chapter VII conclusions are made and future work is proposed.

## II. LOAD MODELING IN DISTRIBUTION NETWORK CALCULATIONS

Today's network planning in Finnish distribution network companies is strongly based on customer class based hourly load curves. Each customer is modeled with a customer class specific load curve which contains mean and standard deviation values for electrical energy consumption in all hours of the year [7]. Customers are typically grouped into 20–50 customer classes. To model a certain customer, the customer class load curve is scaled in accordance with the customer's annual electricity consumption. It is also possible to make an outdoor temperature correction. These curves present the total consumption of a large amount of customers fairly well. In addition to these load curves, the rapid increase in automatic metering infrastructure has brought on lots of data on the electricity consumption of different consumers, and this data is also used today and in the future will be used more in load modeling [7]. For practical reasons, it would be desirable to model PHEV load in such way that the models could be used as easily as possible in existing network information systems (NIS) and other related calculation software.

The load curves used in network planning nearly always include an assumption that the hourly energies of different consumers are normally distributed. In the power flow calculations of NISs different confidence levels can be used. In this application a certain confidence level is defined so that by a certain probability a value of a real load is equal to or below the value used in the modeling. If the load is assumed to be normally distributed, the value of load in a calculation which is carried out with a certain confidence level is quantified using the cumulative probability density function of normal distribution. Typical confidence levels used are 99%, 95%, 90% and 50%. 99% and 95% values are used typically for example in maximum capacity calculations of lines, 90% is used for example in voltage reduction calculations, and 50% is used for example in loss calculations.

When using such statistical load models, network calculations are made in a certain way. In the following description a certain backward-forward-sweep load flow calculation algorithm is illustrated. Fig. 1 presents a part of a simple example network of which four network nodes A, B, C and D are presented. Nodes C and D include loads  $P_C + jQ_C$  and  $P_D + jQ_D$ , respectively. The loads are modeled statistically, and in both loads active and reactive powers obey normal distribution with certain mean values (denoted with  $\mu$ ) and standard deviations (denoted by  $\sigma$ ). When applying load flow calculations with statistical load models presented above, the following principles are obeyed in network computations. When branch currents  $I_{BC}$  and  $I_{BD}$  are computed the loads in points C and D are treated to be

$$P_C = \mu_{PC} + z\sigma_{PC}, \quad (1)$$

$$Q_C = \mu_{QC} + z\sigma_{QC}, \quad (2)$$

$$P_D = \mu_{PD} + z\sigma_{PD} \text{ and} \quad (3)$$

$$Q_D = \mu_{QD} + z\sigma_{QD}, \quad (4)$$

where  $z$  is a coefficient determined by the applied confidence level. When the branch current  $I_{AB}$  is computed, the sum load of nodes C and D is computed from the sum distribution as follows:

$$P_{CD} = \mu_{PC} + \mu_{PD} + z\sqrt{\sigma_{PC}^2 + \sigma_{PD}^2} \text{ and} \quad (5)$$

$$Q_{CD} = \mu_{QC} + \mu_{QD} + z\sqrt{\sigma_{QC}^2 + \sigma_{QD}^2}. \quad (6)$$

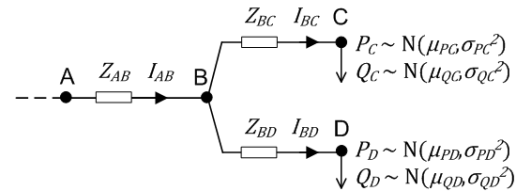

Fig. 1. A simple example network which is used to illustrate the principle of the statistical load flow computation

This means that when proceeding towards higher voltage levels in a radially operated network, the load “below” the node under calculations is computed from the sum distribution of the loads. Of course, losses in  $Z_{BC}$  and  $Z_{BD}$  are also taken into account. In this method, Kirchhoff's current law does not hold in all network nodes, but this method is used to assess the maximum loading levels of different line branches and other network components at a certain probability. The principle presented above is the main principle of the typical statistical load flow calculations in network information systems which are in daily use in Finland. However, different approximations may have been made depending on the NIS.

## III. THE USE OF NTS DATA TO MODEL PHEV CHARGING

### A. The content and usefulness of NTS data

To model PHEV load, it would be ideal if long lasting measurements of the charging of a large number of real PHEVs could be carried out in a large number of different types of charging spots around Finland. This kind of research would be expensive and it would take lots of time and effort. At this time, the results of such a research are not available. Also there are no guarantees that today's PHEVs and charging

infrastructure, or our today's visions of them, will be similar with the ones which are really available in the market and in use at the time when (possibly) the penetration level of PHEVs is high. Therefore it could be useful to have a simulation tool for carrying out simulations with different parameters. Then comparing the outcomes of these scenario studies, decisions would be easier to make.

Car use habits are a very crucial issue affecting to PHEV load. For example, in different European countries the driving habits of people are investigated in the form of different types of national travel surveys [8]. As different types of travel survey information are available, it is interesting to investigate the usability of this type of data to model possible charging habits of people. In this paper, National Travel Survey (NTS) conducted during the years 2004–2005 is used. NTS includes very specific data regarding the car use habits of Finns. The use of this kind of data to model PHEV load in electricity distribution networks is the central content of this paper.

NTS [4] gives plenty of information about the travelling habits of Finns. NTS 04–05 data was collected by means of telephone interviews during a time interval of 1.6.2004–31.5.2005, and there were about 13000 people answering the survey. The survey is a random survey and covers the whole country. Fig. 2 presents the data structure of the NTS relational database for those parts which are essential for construction of load curves in this paper.

Three different data tables and their relations to each other are shown in the figure: background information, daily trips and cars. The Background information table includes the information about the respondent of the survey. In addition to the ID identifying the respondent, data regarding for example the survey date, type of dwelling place (for example detached house, row house and apartment building), existence of driving license, driven kilometers during the last year and the residential city/town of the respondents is included in the table. The Daily trips table includes all the trips made by a respondent during a 24 h period. Period begins at 04:00 on the date of survey and ends at 04:00 the next day. Data regarding for example departure time, duration of trip, type of starting place of the trip (18 different options, for example home and workplace), type of destination place (the same options as in starting place), length of the trip and the way of travel (for example driving a passenger car) are included in the table. The Cars table includes information about the cars in respondents' households. The table includes data about each cars' driven kilometers during the past year.

National Travel Survey includes data which can be used to sketch PHEV load models, especially if it is assumed that the PHEVs would be used in the same way as present internal combustion engine based cars. Conventional ICE based vehicles are very user-friendly because it takes only a few minutes to refuel them and their range can be over 1000 kilometers. This is why today people can generally use their cars in a way that corresponds to their travelling needs very well. Thus, NTS data can be interpreted to represent the driving needs of Finns.

When PHEVs are modeled to investigate their impacts on a

certain network, the car use habit data should represent the case network's area's car use habits as well as possible. Thus, the geographical information of the travel survey data should be used to make the models as localized as possible.

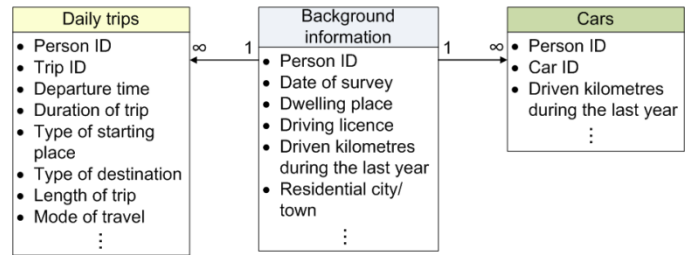

Fig. 2. Structure of the essential parts of the NTS relational data base.

As PHEVs do not have such strict range limitations as for example full EVs, it can be thought to be fairly justified to assume that PHEVs will be used pretty much the same way as conventional cars. If the state of charge of the PHEV's battery drops too low, driving can continue using the ICE, and the vehicle can be refueled very quickly in a conventional gas station or maybe in high power fast charging spots in the future. Of course, there are many psychological factors in customers' behavior which are hard to predict, and changes in the way of living, prices of electricity and liquid fuels and use of public transport etc. also have an effect on the driving needs.

In NTS, all the car trips of the respondents are documented in a detailed manner. However, the use of NTS data is also somewhat problematic. One problem is that NTS data describes the driving behavior and driving patterns of individual people, and does not describe the driving patterns of individual cars. NTS includes no information about the driving of the other members of the respondent's family during the survey or neither data concerning the use of the cars of the respondent's family during the survey. A respondent can drive more than one car during the day, and a car can be driven by more than one driver. This is a fundamental problem as the use of the cars is the essential issue here, not the driving of the people. To apply NTS data in the assessment of PHEV load some assumptions and simplifications have to be made.

A way to overcome the problem is simply to assume that an individual driver uses the same car for the whole day, and that individual cars are driven only by single drivers during the day. These assumptions bring some error to the results because, to some extent, people do drive different cars along the day and the cars are driven by many drivers during a day. According to NTS, people with a driving license drive about 13000 km/a on average. On the other hand, a typical Finnish car is driven about 18000 km/a. Thus, if people's driving patterns are extended to driving patterns of cars, some kind of scaling is needed to obtain a high enough average daily mileage of cars. This can be reached by for example simply removing a suitable amount of people with driving licenses who do not drive at all during the day from the database to obtain proper average daily mileage (km/d). This method is

very simple, but it is a heuristic one, and increases the uncertainty of the results.

The driving habits of people vary to some extent according to day of week and season. It is therefore reasonable to divide the investigation of driving habits and hence charging habits into different time windows. In the following calculation examples of chapter V, driving patterns are divided into summer (May–August) and winter (September–April) profiles, and both summer and winter profiles are further divided in three parts: work days (Monday–Friday), Saturday, and Sunday. Day types differ from each other in several ways such as average mileage (km/day) of people, lengths of trips, nature of trips (start and destination places) and timing of trips. These day types are also used very generally in load models used in NISs of Finnish distribution network operators.

Using NTS’s information about Finnish cars the average daily mileage of cars could be calculated in different respondent groups and this average mileage should be taken into account when extending the driving patterns of the respondents into the driving patterns of cars. Also, variation of car use habits in accordance with day of week and season should also be taken into account in the extension process. This could be made by assuming that variations in daily mileage (km/day) of cars correlate with variations in daily mileage of people with driving licenses. This assumption is hypothetical, but we think that it gives fair results. In practice, this could be carried out for a respondent group as follows.

1. Calculate the average daily mileage (km/d) *of the cars* (calculated from the yearly mileages) of the people’s households:  $M_c$
2. Calculate the average daily mileage (km/d) *of people* with driving licenses:  $M_p$
3. Calculate the average daily mileage *of people* in
  - winter:  $M_{pw}$
  - summer:  $M_{ps}$
4. Calculate the estimates for the average daily mileage *of cars* (km/d) for
  - winter:  $M_{cw} = \frac{M_{pw}}{M_p} M_c$
  - summer:  $M_{cs} = \frac{M_{ps}}{M_p} M_c$
5. Calculate the average daily mileage *of people* for different types of weekdays, workdays (WD), Saturday and Sunday for
  - winter:  $M_{pwWD}, M_{pwSat}$  and  $M_{pwSu}$
  - summer:  $M_{psWD}, M_{psSat}$  and  $M_{psSu}$
6. Calculate the *estimates for the average daily mileage of cars* (km/d) for different weekday types for winter and summer:
  - winter:
    - $M_{cwWD} = \frac{M_{pwWD}}{M_{pw}} M_{cw}$
    - $M_{cwSa} = \frac{M_{pwSa}}{M_{pw}} M_{cw}$
    - $M_{cwSu} = \frac{M_{pwSu}}{M_{pw}} M_{cw}$
  - summer:

- $M_{csWD} = \frac{M_{psWD}}{M_{ps}} M_{cs}$
- $M_{csSa} = \frac{M_{psSa}}{M_{ps}} M_{cs}$
- $M_{csSu} = \frac{M_{psSu}}{M_{ps}} M_{cs}$

In this way the average daily mileage of cars can be assessed in a very simple way. For example, if the weighted average of average mileages of winter weekdays is calculated, the average daily mileage of winter days is obtained. These figures can be then used when extending the driving patterns of the respondents into the driving patterns of cars. In this paper, the following calculation examples of chapter V uses the extension method presented previously. Thus, an appropriate proportion of the people with driving licenses who do not drive at all during the survey will be removed from the database to obtain the appropriate mean daily mileage of cars. Also, the previous method with six steps for estimation of seasonal and week day based division of daily mileage is applied in the following example calculations.

### B. Converting driving patterns into charging patterns

When driving patterns of cars are modeled, the next step is to convert this to charging patterns. In this paper, a case in which charging is started immediately when the vehicle is parked at a charging place is considered. This concept is sometimes called as “dumb charging”. From the car usability point-of-view, “dumb charging” represents the most favorable charging principle, as the state-of-charge of the batteries would be as high as possible at every moment. Different “smart charging” schemes, see for example [6],[9]–[13], in which the charging of plug-in vehicles would be coordinated in different ways, are excluded from the studies. In this work, although cars are modeled, the target is to model the charging of cars which takes place at some kind of charging spots. It is therefore convenient to model the charging spots located in different places. The main interest of this work is home charging.

We developed an algorithm for converting the driving patterns into the charging patterns. The main idea of the algorithm is to track the trips of a car and calculate the electricity use and SOC of the battery pack and then calculate the related charging events during the day. Then the algorithm calculates the hourly charged energies of the car. It is assumed that the battery pack of the vehicle is fully charged at the beginning of the first trip. This is a relevant assumption, because usually there would have been time to fully charge the battery during the late evening and night. Thus, it is also assumed that the battery is charged full after the last trip of the day. Using the algorithm, charged energies of different cars at different hours of the day are calculated.

To illustrate the main principle of the algorithm, a simple example is presented in table 1 and fig. 3. The table presents the driving trips of a respondent of NTS. The driver makes six car trips during the day. Fig. 3 presents the driving trips of table 1 (1 means that the respondent is driving and 0 means that he is not driving) and corresponding charging of the car with a constant charging power of 3 kW at workplace and

home and having average 0.2 kWh/km specific electrical energy consumption. The first charging period starts at 06:55 when the driver arrives at the workplace and charging lasts until the battery is full again at 08:47. The second charging event begins when the driver arrives home at 15:20. The battery is again charged to a full charge. After this, the driver very shortly visits his friends or relatives (type 15) and returns home for five minutes. During these five minutes some charging is again made. The final visit in the example is made to a summer cottage (type 17) and the arrival at home is at 19:27. After this, the battery is charged to a full charge.

When the charging of a set of cars is determined, different types of mathematical models can be formed. For example different statistical figures such as mean values and standard deviations can be calculated and the statistical distributions can be investigated.

TABLE I  
CAR TRIPS OF AN INDIVIDUAL RESPONDENT OF NTS

Departure time	Duration of trip (min)	Length of trip (km)	Type of starting place	Type of destination
06:35	20	28	1	3
15:00	20	28	3	1
18:00	10	12	1	15
18:20	10	12	15	1
18:35	2	2	1	17
19:25	2	2	17	1

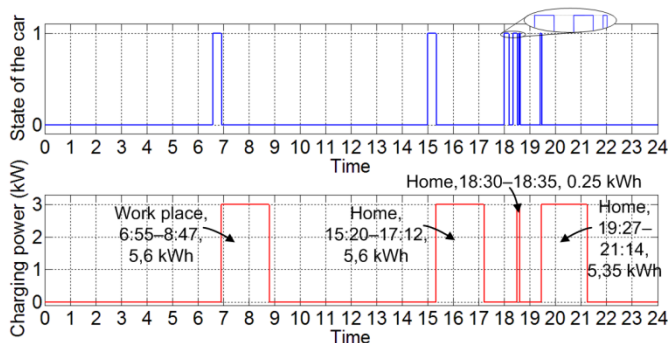

Fig. 3. State of the car (1 refers to driving and 0 to parking) and computed charging behavior of an individual respondent of NTS.

#### IV. THE PARAMETERS AND THE ASSUMPTION OF THE EXAMPLE CALCULATIONS

There are high uncertainties in the characteristics of the future's PHEV fleet and charging infrastructure. When modeling charging patterns and further constructing PHEV charging load curves, many parameters have to be specified and assumptions have to be made. In this chapter we discuss the significance of different characteristics of a PHEV fleet and charging infrastructure on the PHEV charging load and how we have modeled these issues in our example calculations. The example calculations are a case study of a possible lumped model of a PHEV in a Finnish system.

##### A. Battery capacities

Battery capacities impact the PHEV load. The bigger battery capacities the bigger proportion of the energy use of

the cars can be fulfilled using electricity. Bigger battery capacities can also be thought of as a substitute for more extensive charging infrastructure and vice versa.

The battery capacity distribution of the PHEV fleet is an important assumption. In the future there will be different types of PHEVs with different battery capacities. A unimodal distribution such as normal distribution could model the capacities of the batteries which originally had equal nominal capacities and due to different degradation and aging processes have lost parts of their capacities. These capacities would then be spread to an interval with some distribution. In reality the case would probably be that different types of PHEVs with different battery capacities would be in use and available in the market. There are at least two options to model different types of PHEVs: to form a number of models for a number of types of PHEVs or include all types in a lumped model. The latter case is more easy to use in the practical calculations, but it brings more uncertainty to the results. In the latter case some kind of a multi-modal distribution should be used.

In the examples of this chapter we used the following simple battery capacity distribution which represents a lumped charging load model. The PHEV fleet is divided in three equal sized groups which obey normal distributions  $N(5 \text{ kWh}, (0.5 \text{ kWh})^2)$ ,  $N(10 \text{ kWh}, (1.0 \text{ kWh})^2)$  and  $N(15 \text{ kWh}, (1.5 \text{ kWh})^2)$ . Thus, in each sub fleets vehicles have battery packs whose useable capacities are formed randomly and are normally distributed with 10 % (of the mean value) standard deviation. This distribution assumes that there are mainly three different categories of cars, for example small "city cars", mid-sized passenger cars and bigger family cars or SUVs. Here we have chosen normal distribution to describe the battery capacities or the subgroups, because we do not have better information. The capacities of the examples present the "usable" capacities, i.e. the capacities which are really in use for the electricity needs of the car.

##### B. Specific electricity consumptions

The specific electricity needs of the vehicles are also important for the load modeling. Specific electricity consumption of a PHEV is dependent on many things. Specific electricity consumption is defined as the electrical energy need per driving distance, typically in kWh/km. Typical value of a regular passenger car is of the order of 0.15–0.30 kWh/km, but the consumption is dependent on the drive cycle, need for electrical energy for cooling or heating purposes etc and design of the energy management system of a PHEV [14]–[15].

It can be assumed, that there will be different types of PHEVs available which differ from each other in many ways which affect the specific electricity needs. PHEVs can be of different sizes and their internal energy management systems could be different from each other. All PHEVs are not necessarily designed to be able to operate in full all-electric mode, but for example during high driving speeds ICE will start and produce mechanical propulsion [15]. Specific energy need is dependent on the nature of the drive cycle, i.e. driving

speed, stops, starts, acceleration and decelerations etc. As the average velocity of the trips could be calculated using NTS data, the specific energy need could be approximated in accordance with that data, if there was an appropriate relation available. Also, the need of heating or cooling energy can be assessed in accordance with the season.

In our example calculations we used the same type of distribution as with the battery capacities. The cars were again divided in three equal sized sub fleets whose specific electricity consumptions obeyed normal distribution with mean values of 0.15 kWh/km, 0.20 kWh/km and 0.25 kWh/km and 10 % (of the mean value) standard deviations. The sub fleets correspond with the ones of the battery capacities. Thus, the cars with the smallest battery packs have also on average the smallest specific electricity consumptions.

### C. Charging spot locations

Availability and characteristics of charging spots have major impact on the PHEV load and the use of PHEVs. If charging spots were available in many places such as homes, workplaces, public parking places, shopping centers etc., charging could be carried out in many places and a greater portion of driving could be done using electrical energy.

Nowadays, sockets for the pre-heating of the car engines at winter are very widely available in Finland in all types of houses and also in workplaces. These sockets could be used to some extent to charge plug-in vehicles. It was noticed in the case studies presented in [16] that on average approximately 50 % of the pre-heater sockets of different parking places could be used for charging with 3 kW charging powers without overloading the feeders feeding the sockets. Thus, in high penetration levels of plug-in vehicles, the feeders of the parking areas should be enforced.

In the following examples we assume that charging can take place in two different locations: at home and at the workplace. This is relevant assumption as most of the charging would be made at homes and the workplaces, because the cars are parked to these places for very long times and we already have some “charging infrastructure” ready in Finland in these locations. In the methodology it is possible to take other types of charging locations into account if wanted.

### D. Charging powers

Available charging power in charging spots is also an important factor. We assume that people would like to charge their PHEVs as fast as possible. Lithium-ion batteries can be charged using different charging rates which are usually expressed as C values. A rate of  $n$  C corresponds to a full charge in approximately  $1/n$  h starting from empty state. A certain charging rate with a certain battery energy capacity corresponds to a certain average charging power. Available maximum charging power in different places can vary significantly especially in the future. It is expected that in Finland charging powers used in domestic environment would be between 2...11 kW. These limits correspond approximately to one-phase 10 A and three-phase 16 A fuses in a 230 V network, respectively. These circuits are widely available in

Finnish real estates and practically in all detached houses powers from the upper end of the previous interval are realistic to obtain. In the future, there might be opportunities for fast charging with a maximum power of some dozens of kW and above which would enable the charging of a battery pack in a few minutes. This requires a high power electricity network connection, and it sets high requirements for battery materials, battery design and heat management systems [17]–[18].

In the example calculations we considered two different cases. In the first one charging powers were assumed to be 3 kW in every charging spot, and in another one 10 kW power was assumed to be available in detached houses and semi-detached houses and 3 kW elsewhere. When considering 10 kW charging power, it should be noted that if such power would be used, some kind of peak load reduction systems would be used at least in houses with electric heating systems or electric sauna stoves (typically 6...10 kW). These peak load reduction systems are very general in Finland. If peak load reduction methods would be used, this should also be taken into account in load modeling.

The behavior of charging power during the charging process depends on battery chemistry. It is still an open issue, which of the lithium-ion chemistries will be successful in the PHEV market. Toyota Prius PHEV is using a lithium nickel-cobalt-aluminum oxide (NCA) based positive electrode, as it gives a high energy density. Chevrolet Volt is using a mixture of lithium manganese oxide (LMO) and lithium nickel-cobalt-manganese oxide (NCM). This combination is cheaper and safer than NCA. The choice for Fisker Karma is lithium iron phosphate (LFP), as the LFP chemistry offers very good safety properties and a good cycle life. [19]

Fig. 4 presents the behavior of charging power, measured by the authors of this paper, of two different lithium-ion battery cells with charging rates of 0.2 C and 0.5 C. Additionally, charging power of a 1 kWh battery pack with 0.2 C charging rate was measured. The cells have different capacities and the capacity of the battery pack is much higher than that of the cells. Therefore, charging power in fig. 4 is presented as a percentage of the maximum power of each charging process. In this way we can compare the forms of the charging profiles of different cases. The first cell, by Samsung, has a NCA positive electrode, and the second cell, by European Batteries Ltd, has a LFP positive electrode. Both cells have graphite negative electrodes. The 1 kWh battery pack includes similar cells as the individual LFP cell.

It can be seen that the power profiles are fairly flat especially with the iron-phosphate chemistry. If the power is assumed to be constant during the charging processes, the error is fairly small with both chemistries. As the whole nominal capacity of the battery pack is not used in practical applications, the charging is limited only to a certain part of the charging curves of fig. 4, and this makes the error of the constant power approximation even smaller. The charging profile of the battery pack is very similar to the charging profile of an individual cell with same chemistry.

In the example studies, charging powers are assumed to be

constant during the charging process. It would be possible to take the variable charging power into account as we model the SOC of the battery packs of every car. However, modeling this would make the choice of the battery chemistries etc. mandatory, and the battery chemistries of the future's PHEVs is an open question today.

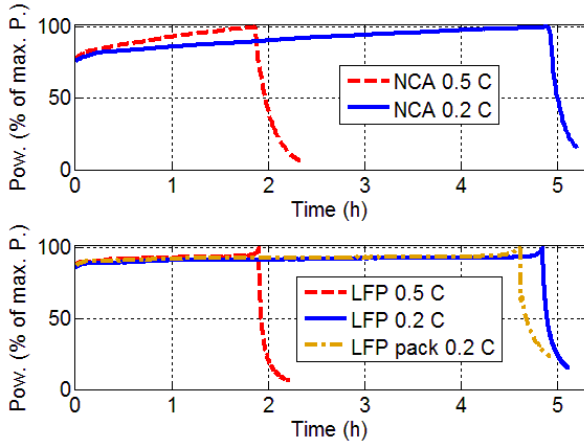

Fig. 4. The behavior of the proportional charging powers of two different lithium-ion battery cells and a battery pack.

### E. Customer classification

In Finnish load modeling, as mentioned in chapter II, customers are divided into classes. When considering the assessment of the PHEV load DNOs do not have information about the car use habits of the network customers. However, Finnish DNOs usually know the types of the houses of their customers. People living in same types of households may often share the same situation in life and there may be similarities in the way of life which affect the car use habits. Also, if there are different charging powers available in different types of houses this would definitely have impact on the charging needs and habits. Because of the two issues mentioned above, it is reasonable to form different load models for different types of households in accordance of dwelling places. Thus, a generalization was made: people in different groups were assumed to present more or less similar charging behavior.

### F. Summary of the parameters and the assumptions

In table II the assumptions and parameters of the previous example calculations are summarized. The assumptions and parameters represent realistic scenario, but include uncertainties.

## V. RESULTS OF THE EXAMPLE CALCULATIONS AND THEIR FURTHER ANALYSIS

We made some example calculations with previous parameters using our NTS data processing methodology. Some of the results with their further analysis are presented next.

Figure 5 presents an example of a calculation result. It presents hourly mean values and standard deviations of charged energies of winter workdays (WD), Saturdays and Sundays concerning the cars of the people living in detached houses or semi-detached houses with a charging power of 3

kW. The figure only presents the charging made in home. Some charging is also carried out at workplace. It can be seen that the standard deviations are very big when compared to mean values.

TABLE II  
THE PARAMETERS AND THE ASSUMPTIONS OF THE EXAMPLE CALCULATIONS

Assumption or parameter	Description or value
Battery capacities	Multimodal distributions presenting roughly three different types of PHEVs.
Specific electricity consumption	Multimodal distributions presenting roughly three different types of PHEVs.
Charging spot locations	Homes and the workplaces. This fits especially well to Finnish electricity system.
Charging powers	3 kW or 10 kW in some charging spots. These powers fit especially well in Nordic countries.
Customer classification	In accordance of the type of the dwelling place. This is sort of information which Finnish DNOs have in their customer information system.

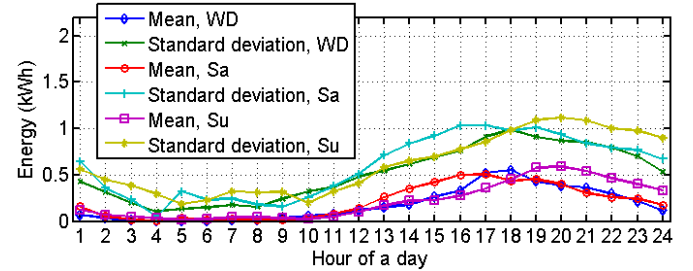

Fig. 5. Mean values and standard deviations of cars which are owned by people living in detached houses or semi-detached houses with a 3 kW charging power for winter workdays, Saturdays and Sundays.

Fig. 6 presents a histogram of charged energies at the peak hour 18 (time interval 17:00–18:00) of the workday curve of fig 5. The mean value of charged energies is about 0.55 kWh, and standard deviation is 0.99 kWh. Most of the people, approximately 70 % of them, do not charge their vehicles during this hour. Also, there is another clear peak, 9% of all values, in the histogram at interval [2.85 kWh, 3.0 kWh]. This is due to plentitude of people who have started the charging process in the previous hours and continue charging after the hour under inspection. Because of this, these cars draw the maximum charging energy 3 kWh from the network. When investigating the distributions of some other hours around hour 18 it was noticed that the forms of the distributions seem to be very similar to the form of the distribution of fig. 6.

Previous results included an assumption that the maximum charging power was 3 kW. Fig. 7 presents a case similar to the previous case, but with the charging power now being 10 kW. It can be seen that when compared to fig. 5, most of the charging is spread out on a somewhat narrower time slot. Standard deviations have increased dramatically and some increase can be seen in the mean values of the peak hours. These results are pretty much as expected.



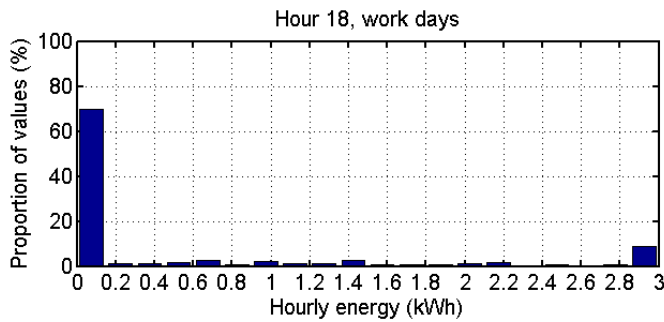

Fig. 6. Winter workdays' charged energies of cars which are owned by people living in detached houses or semi-detached houses with 3 kW charging power regarding hour 18

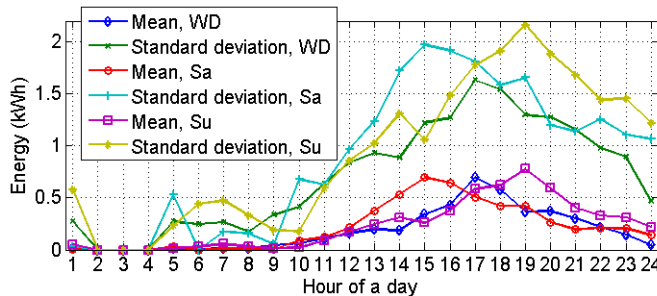

Fig. 7. Mean values and standard deviations of winter workdays, Saturdays and Sundays of individual cars of detached houses or semi-detached houses with 10 kW charging power.

Fig. 8 presents a histogram for the hour 17 (16:00–17:00), which is now the hour of the highest WD hourly mean of the data of fig. 7. The mean value is 0.70 kWh, and standard deviation is 1.63 kWh. It can be seen that there is no peak as clear in the upper end of the distribution as in the case of 3 kW charging power. Other high mean hours obey very similar distribution as in fig. 8.

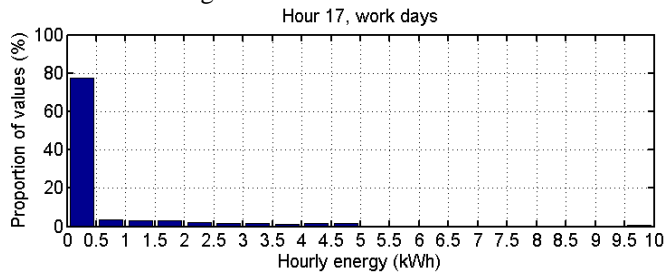

Fig. 8. Charged energies of winter workdays of cars of detached houses or semi-detached houses with 10 kW charging power regarding hour 17.

It can be seen that these hourly distributions do not seem to resemble the normal distribution or any of the other common distributions. The form of the load distribution can be a non-negligible factor especially in LV network calculations where there is a small amount of customers. When modeling a domestic electricity consumer with a PHEV, the electricity use can be divided into two parts: the regular domestic consumption and the PHEV consumption. Fig. 9 presents examples of this. Fig. 9a presents histograms, plotted as bars, of sum distributions formed by two independent distributions:  $L_{PHEV}$  and  $L_1 \sim N(2 \text{ kWh}, (0.5 \text{ kWh})^2)$  and in fig. 9b sum distributions formed by the  $L_{PHEV}$  and  $L_2 \sim N(1 \text{ kWh}, (0.25 \text{ kWh})^2)$  are presented.  $L_{PHEV}$  represents the PHEV load distribution of fig. 6 and  $L_1$  and  $L_2$  represent conventional

domestic loads of the same hour. The uppermost subfigure in both figures 9a and 9b presents the sum distribution of single PHEV and single domestic loads. The lower subfigures present the sum distributions of  $m$  independent distributions similar to the uppermost subfigures.

In addition to the histograms of the original data, each subfigure in fig. 9 presents the histograms, plotted as lines with spheres, calculated from *normal distributions* whose parameters are calculated from the *original non-normal sum distributions*. In all subfigures of fig 9, two vertical lines are also plotted. The red dashed lines represent load values corresponding to 95% confidence level of the normal distributions, and the blue solid lines represent similar values of the original non-normal distributions. In most of the cases, the normal approximation gives values very close to the non-normal case. Thus, in a great majority of the network normal distribution approximation would give good results. However, the goodness of the normal distribution approximation also depends on the size of the domestic load.

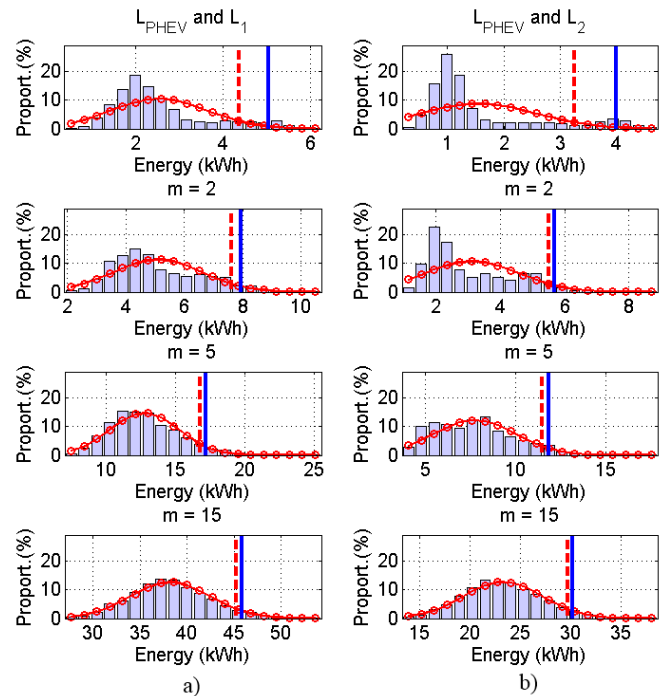

Fig. 9. An example of summing independent load distributions.

In previous examples, it was assumed that PHEV and other loads of the households are independent loads. However, this could not necessarily be the case in reality. It is easy to consider that often when charging is made at home, people are at home and use electricity. On the other hand, electricity is used a lot during the times when charging is not typically carried out. The data of these studies did not offer possibilities to investigate the correlation of PHEV and other loads of the households.

Previous graphs presented charging behavior at home. However, it is interesting to know how much charging is carried out at workplaces and when the charging takes place. Fig. 10 presents workplace charging for the same respondent group as in fig. 5. It can be seen that most of the work place

charging is made during workdays concentrating mostly on hours in the morning and before noon, which is not a surprise. General modeling of workplaces is more difficult than the modeling of homes. This is because workplaces are pretty much point loads and the behavior of the employees in a workplace is fairly homogenous, and the behaviors of different workplaces are fairly different from each other.

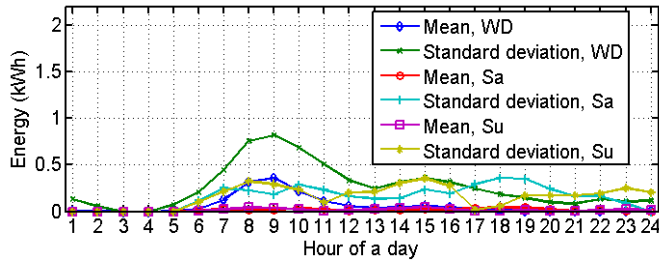

Fig. 10. Mean values and standard deviations for workplace charging on winter workdays, Saturdays and Sundays for individual cars of detached houses and semi-detached houses with 3 kW charging power at home and at the workplace.

Many assumptions are made in our example calculations. From the car users' and the society's point-of-view one of the key questions is that how big proportion of the PHEVs mileages can be driven using electrical energy instead of liquid fuels. The most important characteristic affecting this is "electric ranges" (ER) of the PHEVs. There are mainly two factors affecting ER: the energy capacity of the battery pack and the average specific electricity consumption. There are remarkable uncertainties concerning for example the sizes of the battery packs of the PHEVs of the future. We made some sensitivity calculations of the impact of the useable battery capacities and specific electricity consumptions on the load models.

We investigated the mean value of charged energies of the peak hour of the work day curves similar to one in fig 5 as a function of the mean useable battery capacity and the mean specific electricity. We selected the same customer group as in fig. 5 with 3 kW charging power everywhere. The investigations were made varying the two variables within certain intervals, and then computing the mean energies of the peak hour. The useable battery capacities were varied having mean values of 1, 2, ..., 30 kWh, being normally distributed and having 10 % (of the mean value) standard deviation. It should be noticed that when smaller nominal capacities than 6 kWh are used, the 3 kW charging power lead to higher charging rate than illustrated in fig. 4. This increases the uncertainty of these results. Also, in these sensitivity studies the biggest battery capacities are very much overestimated for PHEV use when compared to the today's state-of-the-art battery technology. The specific electricity consumptions were varied having mean values of 0.15, 0.16, ..., 0.30 kWh/km, being normally distributed and having 10 % standard deviation. The unimodal normal distribution represents fleet of cars which have roughly the same nominal battery capacity as explained in chapter V.A.

The result of the sensitivity study is presented in fig. 11. The figure presents the "peak mean energy" as a function of the two variables. The peak hour was hour 18 except most of the cases in which the battery capacities were smaller than 5 kWh. In those cases the peak hour was hour 17. If the specific

electricity consumption is kept constant, the peak mean energy increases in highly non-linear fashion as the mean battery capacity increases, until a certain saturation point is attained. After the saturation point the peak mean energy remains at a constant level. Also, if the mean battery capacity is kept constant, the peak mean energy increases in a fairly affine manner as the mean specific electricity consumption increases. It can be concluded that the peak mean energy is very stable with respect to battery capacities if the capacities are in the saturated region. Also, the changes in peak mean energy are at fairly moderate level with small changes in mean specific electricity consumptions.

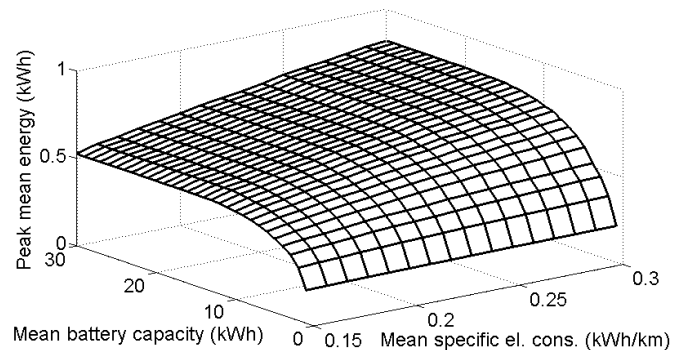

Fig. 11. The mean energies of the peak hour as a function of the mean battery capacity and mean specific electricity consumption.

We made another sensitivity study in which we investigated the average daily electricity need as a function of the same variables as in previous study. Now all the cars modeled by NTS are included in the study and not only a certain customer group's cars as above. Charging power was assumed to be 3 kW in every charging spot. The daily electricity need represents in a certain way all the hours of the day and not only the peak hour. The result is illustrated in fig. 12. It can be seen that the electricity need rises rapidly when battery capacities is increased from the lowest values. It can be interpreted that the first kilowatt-hours in battery capacity bring most of the electricity consumption. From this one can deduce that most of the benefits of PHEVs, i.e. replacing the use of liquid fuels with the use of electricity, can be achieved even with moderate battery capacities.

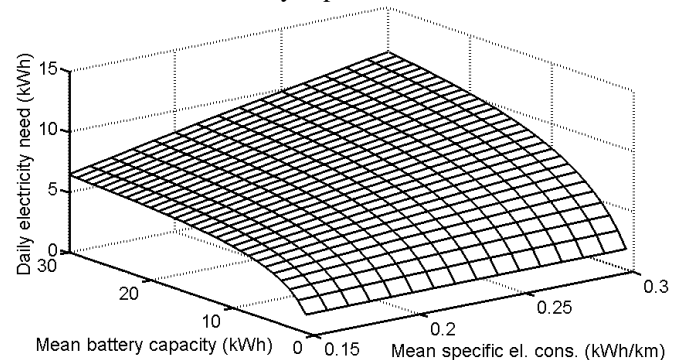

Fig. 12. Average daily electricity need as a function of the mean battery capacity and mean specific electricity consumption.

## VI. CONCLUSIONS AND FUTURE WORK

In this paper, the use of the National Travel Survey of Finland in the assessment of the impacts of PHEVs on the

loads of the electricity distribution network was investigated. NTS provides lots of useful information for load assessment but presents some problems. To overcome these problems, assumptions have to be made. It should also be noted that the assessment of the load impact of PHEVs is always more or less an “educated guess” in this type of situation where a large amount of PHEVs are not yet in use in real life. In the example studies, national level modeling was investigated. When a real network is studied, local load models based for example on NTS geographical data should be used.

The most important results and contributions of this paper are

1. A generic method to model charging loads of PHEVs using the travel survey data
2. Example results, their analysis and related sensitivity studies.

Many topics and issues for future work arose in this study. The impacts of different intelligent charging scenarios on the load curves also present a relevant topic for future work. Conducting more case study example calculations with different types of assumptions is also needed. Also, different selection and clustering methods of NTS respondents to model car use habits of a certain real network’s area should be investigated.

#### ACKNOWLEDGMENT

The authors thank B.Sc. Turo Valavaara from the Department of Electrical Energy Engineering of Tampere University of Technology for conducting the battery pack measurement of fig. 4.

#### REFERENCES

- [1] S. C. Davis *et al.*, *Transportation energy data book: Edition 30*. Oak Ridge National Laboratory, Oak Ridge, 2011.
  - [2] R. Lache *et al.*, “Vehicle Electrification, More rapid growth; steeper price declines for batteries,” Deutsche Bank Global Markets Research, Frankfurt am Main, Germany, 2010.
  - [3] J. Lassila *et al.*, “Electric cars – challenge or opportunity for the electricity distribution infrastructure?,” in *Proc. European Conf. SmartGrids and Mobility*, Würzburg, Germany, 2009, pp. 85–92.
  - [4] Finnish transport agency (2011 May 13), *National Travel Survey*. [Online]. Available: [http://portal.liikennevirasto.fi/sivu/www/e/fta/research\\_development/national\\_travel\\_survey](http://portal.liikennevirasto.fi/sivu/www/e/fta/research_development/national_travel_survey)
  - [5] J. Kiviluoma, P. Meibom, “Methodology for modeling plug-in electric vehicles in the power system and cost estimates for a system with either smart or dumb electric vehicles,” *Energy*, vol. 36, no. 3, pp. 1758–1767, Mar. 2011.
  - [6] A. Rautiainen *et al.*, “Requirements for an interface between a plug-in vehicle and an energy system,” in *Proc. IEEE Powertech 2011*, Trondheim, Norway, 2011.
  - [7] A. Mutanen *et al.*, “Customer classification and load profiling method for distribution systems,” *IEEE Trans. on Power Del.*, vol. 26, pp. 1755–1763, Jul. 2011.
  - [8] D. Marconi *et al.*, “The Swiss Microcensus 2005: An International Comparison on Travel Behaviour,” in *Proc. Swiss Transport Research Conf.*, Ascona, Switzerland, 2004.
  - [9] A. Rautiainen *et al.*, “Intelligent charging of plug-in vehicles,” in *Proc. NORDAC 2010, The 9th Nordic electricity distribution and asset management conf.*, Aalborg, Denmark, 2010.
  - [10] E. Sortomme *et al.*, “Coordinated Charging of Plug-In Hybrid Electric Vehicles to Minimize Distribution System Losses,” *IEEE Trans. Smart Grids*, vol. 2, pp. 198–205, Mar. 2011.
  - [11] E. Sortomme, M. A. El-Sharkawi. “Optimal Charging Strategies for Unidirectional Vehicle-to-Grid,” *IEEE Trans. Smart Grids*, vol. 2, pp. 131–138, Mar. 2011.
  - [12] K. Clement-Nyns *et al.*, “The Impact of Charging Plug-In Hybrid Electric Vehicles on a Residential Distribution Grid,” *IEEE Trans. Power Syst.*, vol. 25, pp. 371–380, Feb. 2010.
  - [13] M. D. Galus, G. Andersson. “Demand Management of Grid Connected Plug-In Hybrid Electric Vehicles (PHEV),” in *Proc. IEEE Energy2030*, Atlanta, USA, 2008.
  - [14] J. Axsen *et al.*, “Batteries for Plug-in Hybrid Electric Vehicles (PHEVs): Goals and the State of Technology circa 2008,” University of California, Inst. of Transportation Studies, Davis, 2008.
  - [15] M. A. Kromer, J. B. Heywood. “Electric Powertrains: Opportunities and Challenges in the U.S. Light-Duty Vehicle Fleet,” Massachusetts Inst. of Technology, Laboratory for Energy and the Environment, Sloan Automotive Laboratory, Cambridge, rep. LFEE 2007-03 RP, 2007.
  - [16] Fortum Oyj. (2011 May 15) “*Recommendation to plug-in vehicles in internal networks of real estates*”, (In Finnish) [Online] Available: <http://verkkojulkaisu.viivamedia.fi/fortumesfi/ladattavatoutsuositus/2>
  - [17] K. Zaghib *et al.*, “Unsupported claims of ultrafast charging of LiFePO<sub>4</sub> Li-ion batteries,” *J. of Power Sources*, vol. 194, no. 2, pp. 1021–1023, Jul. 2009.
  - [18] G. Ceder, B. Kang. ‘Response to “unsupported claims of ultrafast charging of Li-ion batteries,”’ *J. of Power Sources*, vol. 194, no. 2, pp. 1024–1028, Jul. 2009.
  - [19] M. Yoshio *et al.*, “A Review of Positive electrode Materials for Lithium-ion batteries” in *Lithium-Ion Batteries, Science and Technologies*, New York, Springer, 2009.
- A. Rautiainen** received his M.Sc degree from Tampere University of Technology in 2008. He is now working as a researcher towards doctoral degree at Tampere University of Technology. His main interest focuses on the effects of plug-in vehicles to electric power systems, ancillary service possibilities of plug-in vehicles and new load control schemes.
- S. Repo** received his M.Sc. and Dr.Tech. degrees in Electrical Engineering from Tampere University of Technology in 1996 and 2001 respectively. At the present he is an associate professor at the Department of Electrical Energy Engineering of Tampere University of Technology. His main interest is the management of active distribution network including distributed energy resources.
- P. Järventausta** received his M.Sc. and Licentiate of Technology degrees in Electrical Engineering from Tampere University of Technology in 1990 and 1992 respectively. He received the Dr.Tech. degree in Electrical Engineering from Lappeenranta University of Technology in 1995. At present he is a professor at the Department of Electrical Energy Engineering of Tampere University of Technology. The main interest focuses on the electricity distribution and electricity market.
- A. Mutanen** received his Master’s degree in electrical engineering from Tampere University of Technology in 2008. At present, he is a Researcher and a post-graduate student at the Department of Electrical Energy Engineering of Tampere University of Technology. His main research interests are load research and distribution network state estimation.
- K. Vuorilehto** received his M.Sc. and Dr.Tech. degrees in Electrochemistry from Helsinki University of Technology in 1990 and 1997 respectively. At present he is an adjunct professor for Electrochemical Energy Solutions at Aalto University (formerly Helsinki University of Technology), Helsinki. Additionally, he works as a battery consultant for the industry. His main interest is the electrochemistry of lithium ion batteries.
- K. Jalkanen** received her Master’s degree in Electrochemistry from Aalto University School of Science and Technology (formerly Helsinki University of Technology) in 2010. She is now studying towards doctoral degree at Aalto University and working as research engineer for the industry. Her main interests are lithium ion batteries and their electrochemistry

#### **Publication 4**

A. Rautiainen, A. Mutanen, S. Repo, P. Järventausta, R. Ryymin and J. Helin, A. Tammi, A. Unkuri and M. Pekkinen, “Case studies on impacts of plug-in vehicle charging load on the planning of urban electricity distribution networks,” *in proc. EVER '13*, 2013, Monaco, 7 p. ***The approved version.***

In reference to IEEE copyrighted material which is used with permission in this thesis, the IEEE does not endorse any of Tampere University of Technology's products or services. Internal or personal use of this material is permitted. If interested in reprinting/republishing IEEE copyrighted material for advertising or promotional purposes or for creating new collective works for resale or redistribution, please go to

[http://www.ieee.org/publications\\_standards/publications/rights/rights\\_link.html](http://www.ieee.org/publications_standards/publications/rights/rights_link.html)

to learn how to obtain a License from RightsLink.



# Case studies on impacts of plug-in vehicle charging load on the planning of urban electricity distribution networks

Antti Rautiainen, Antti Mutanen, Sami Repo and Pertti

Järventausta

Department of Electrical Engineering

Tampere University of Technology

Tampere, Finland

antti.rautiainen@tut.fi

Antti Tammi

Suur-Savon Sähkö Inc.

Mikkeli, Finland

antti.tammi@sssoy.fi

Risto Ryymin and Jari Helin

J-E Siirto Inc.

Jyväskylä, Finland

risto.ryymin@jenergia.fi

Ari Unkuri and Mika Pekkinen

Tampereen sähkölaitos Inc.

Tampere, Finland

mika.pekkinen@sahkolaitos.fi

*Abstract*— In this paper, the impact of plug-in vehicle charging load on electricity network planning is investigated by means of case studies which are based on statistical PHEV charging load modeling work and co-operation with two Finnish distribution network companies. According to the case studies, the impacts of plug-in vehicle charging load on Finnish urban distribution networks are modest with low penetration levels, but with high penetration levels plug-in vehicles should be taken into account in long-term network planning. Also, needs and possibilities of “smart charging” were acknowledged from the calculation results.

*Keywords*— PHEV, plug-in hybrid electric vehicle, electric vehicle, charging load, network impacts, distribution network planning

## I. INTRODUCTION

Transportation has a very important function in today's society. Globally, the energy production of transportation systems is highly dependent on oil, and there are strong expectations that the price as well as the volatility of the price of oil will increase in the future. The transportation sector is also a significant consumer of energy and a significant source of greenhouse gases and other emissions [1]. Today's climate and energy policies imply strongly towards diversification of transportation fuels, improving energy efficiency and reducing emissions. The use of electrical energy in a broader manner by means of plug-in hybrid electric vehicles (PHEV) and full electric vehicles (EV) offers the potential to partly fulfill these challenging requirements. Emission reductions and the amount of primary energy conservation due to plug-in vehicles are, however, highly dependent on the energy system.

There are some barriers related to the high penetration of

plug-in vehicles (PHEV and EV). It is widely believed that PHEVs and EVs will become common within some time frame, but there are differences of opinion about when and at what rate the market penetration will happen. The most important barrier is the battery technology. Technologically speaking batteries are fairly good at the moment, but batteries suitable for transportation appliances are very expensive. However, the prices are expected to go down remarkably in the future [2]–[3]. Secondly, a lack of adequate charging infrastructure is a major barrier. It is fairly expensive to construct extensive charging infrastructure especially in the existing densely populated areas.

Many Finnish utilities have shown interest in the investigation of the impacts of charging of plug-in hybrid electric vehicles and full EVs on their networks. The distribution networks of Finnish distribution system operators (DSO) are generally fairly old, and significant network renovation work will be carried out by many companies in the following years. As the construction of distribution networks is a long-term investment, i.e. the lines and other components will probably be in use for many decades, the DSOs have to somehow assess or approximate the long-term changes in the loads of the networks in the planning process. Thus, there is a practical demand for PHEV load modeling already today.

To assess the impacts of plug-in vehicles on a power system, the effect on the electrical load of a plug-in vehicle fleet in a power system has to be modeled. The studies of this paper are based on the modeling methodology of the charging load profiling presented in [4]. The methodology is strongly based on the use of National Travel Survey (NTS) [5] data. NTS is used to model the car use habits of people. The main idea of the methodology is to track the trips of a car and

calculate the electricity use and state-of-charge (SOC) of the battery pack and then calculate the related charging events during the day. Then the algorithm calculates the hourly charged energies of the car.

In this paper, the network impacts of charging load of plug-in vehicles on two real Finnish distribution networks is investigated. The networks are owned and managed by two DSOs: JE-Siirto Inc. and Tampereen Sähköverkko Inc. The calculations were made by the DSOs' staff and two M.Sc. theses [6], [7] were done during the studies. This paper is based mainly on these theses. As the two different studies were made independently from each other, their modeling and calculation principles were partly based on the possibilities of the used calculation tool (i.e. network information system, NIS), assumptions and the way of presenting the results differ from each other in some ways. However, the main statistical network power flow calculation principles (short description is presented in [4]) were the same in both cases. The whole distribution network was modeled: primary substations, medium voltage networks, secondary substations and low voltage networks. Distribution systems are different in different countries, and to our knowledge the paper presents the first network calculations made in Finland with statistical charging load models similar to regular statistical load models used today by every DSO in Finland.

During the last few years, different kinds of “smart” charging schemes have received a lot of attention from the scientific community and plenty of different results and ideas have been published, cf. for example [8]–[17]. In the calculations of this paper, a case in which charging is started immediately when the vehicle is parked at a charging place is considered. This concept is sometimes called “dumb” charging. From the car usability point of view, dumb charging represents the most favorable charging principle, as the state-of-charge of the batteries would be as high as possible at every moment. This kind of charging case offers a good reference point in order to see the possible *needs* for charging control, the worst case scenarios for network planning purposes, and also the *possibilities* of plug-in vehicles to produce different kinds of ancillary services for the electricity system [8]–[9]. This is because in order to control plug-in vehicles one must know when the resource (controllable load or energy storage) is available in the network. This paper's main scientific contribution is the use of statistical charging load models in real DSOs' NISs and to get an overall view of the impacts of EVs from network capacity and planning perspective in real urban networks.

The paper is organized as follows. In section II, the case networks and the case scenarios are presented and charging load modeling is discussed. In section III, the results of the calculations are presented and discussed. In section IV, conclusions are made and future work is proposed.

## II. CASE NETWORKS, SCENARIOS AND CHARGING LOAD MODELLING

### A. The case networks

#### 1) JE-Siirto

JE-Siirto Inc. operates as a DSO in the city of Jyväskylä in Central Finland. In 2011, the yearly transferred energy was about 0.64 TWh. In the area there are five primary substations, 367 km of medium voltage lines, almost 500 distribution transformers and 980 km of low voltage lines. As the network is a city area network the cabling degree is high. The cabling degrees (proportion of cable kilometers of all line kilometers) of the medium voltage network and low voltage network are 78 % and 95 %, respectively.

#### 2) Tampereen sähköverkko

Tampereen Sähköverkko Inc. operates as a DSO in the city of Tampere and some surrounding areas, but in this paper only the load flow calculations of the city area are investigated. The city area covers roughly about 1/3 of the whole distribution area. The whole distribution area is showed in fig. 1, and the network area under investigation is circled. In 2011, the total transferred energy was 1.8 TWh. In the city area, which is under investigation in this paper, there are 10 primary substations which comprise 15 main transformers, 750 km of medium voltage lines, 1150 distribution transformers and 2000 km of low voltage lines. The number of medium voltage and low voltage feeders in the city are 109 and 8212, respectively.

### B. Penetration levels and electricity use of vehicles

In order to assess the impact of charging load on the electricity grid, it is necessary to define the penetration levels and the electricity use of the vehicles.

#### 1) JE-Siirto

A rough assessment of future traffic flows inside the distribution area and through its boundaries was made based

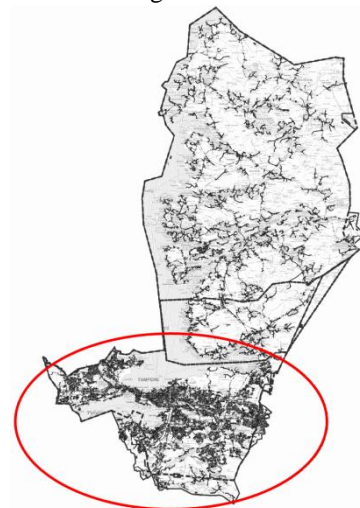

Figure 1. The distribution area of Tampereen sähkösiirto Inc. The part of the network under investigation is circled.

on local traffic data. Fig. 2 presents the assessed traffic flows during work days. It is estimated that about 48,500 cars are located inside the distribution area (DA) of JE-siirto in 2030. About 20,000 cars are travelling daily between homes and workplaces inside the DA. Also about 5,000 cars travel between homes inside the DA and workplaces outside DA, and in addition to that about 12,000 cars travel between homes outside the DA and workplaces inside the DA. This allows rough approximations for the amounts of cars in workplaces and homes inside the DA during work days to be calculated.

It is useful to assess the average yearly electricity need of the cars. According to NTS, in the central part of Finland passenger cars are driven about 19,000 km/a on average. If it is assumed that all the kilometers can be driven using electricity and a specific electricity consumption of the EVs was 0.2 kWh/km, the electricity use of a regular car would be 3.8 MWh/a. It is assumed that about 70 % of the driven kilometers of PHEVs would be driven using electricity, and the corresponding electricity need would be about 2.7 MWh/a.

In the calculations of this paper, five different scenarios are presented which differ from each other in the penetration levels. Penetration levels of PHEVs and full EVs are quantified separately. Different penetration levels also correspond to different levels of yearly total charging energy. These scenario parameters are presented in Table I. The last scenario, 100 % of full EVs, is mostly a theoretical one. It, however, works well as an interesting baseline to which other results can be compared.

TABLE I. THE SCENARIOS OF JE-SIIRTO'S CALCULATIONS.

Scenario	PHEV penetration level (%)	Full EV penetration level (%)	Yearly total energy (GWh)	Yearly total energy (% of the total transfer in 2011)
1	2	1	5	1
2	15	5	30	5
3	40	15	82	13
4	50	30	125	19
5	0	100	192	29

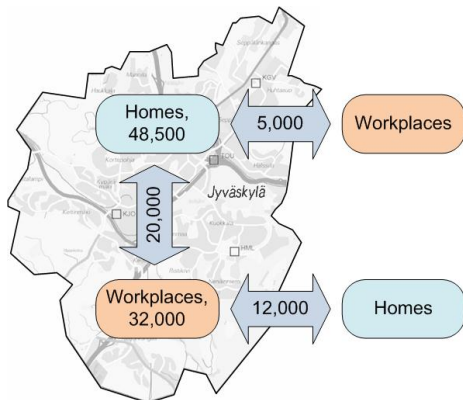

Figure 2. The daily traffic flows of the distribution area of JE-siirto Inc. during the work days.

## 2) Tampereen sähköverkko

It was assessed that there would be about 110,000 cars in the distribution area in 2030. In the study one PHEV type and two different types of full EVs (EV1 and EV2) were modeled. The average yearly mileages of PHEVs, EV1s and EV2s were 15,000 km/a, 10,000 km/a and 5000 km/a, respectively, and the corresponding average specific electricity consumptions including all the losses were 0.20 kWh/km, 0.20 kWh/km and 0.15 kWh/km, respectively. Using these figures, the average yearly electricity consumptions of the cars can be calculated.

In Tampereen Sähköverkko's (TS) calculations two different scenarios were covered. These scenarios differed from each other in penetration levels. Table II presents the penetration levels and the total electricity consumption of the plug-in vehicles in the scenario calculations.

TABLE II. THE SCENARIOS OF TS'S CALCULATIONS.

Scenario	PHEV pen. level (%)	Full EV (EV1 + EV2) pen. level (%)	Yearly total energy (GWh)	Yearly total energy (% of the total transfer in 2011)
1	20	11 + 6	76	4
2	31	16 + 9	115	6

## C. Load curves

### 1) JE-Siirto

In addition to yearly energies of the vehicles, the distribution of the charging energy during the year has to be modeled. Network planning in Finnish distribution network companies is at present strongly based on customer class based hourly load curves. Each customer is modeled with a customer class specific load curve which contains mean and standard deviation values for electrical energy consumption in all hours of the year [18]. To apply these models the following data is needed: the class of the customer, the customer's yearly energy and the location of the customer in the grid. All this is stored in the information systems of the DSO. Customers are typically grouped into 20–50 customer classes. To model a certain customer, the customer class load curve is scaled in accordance with the customer's annual electricity consumption. It is also possible to make an outdoor temperature correction. These curves present the total consumption of a large amount of customers fairly well. The scaling principle mentioned above is also applied in the plug-in vehicle load models of this work, although its applicability is not verified [3]. However, we think that this approach gives fair results.

In this paper, simple load curves based on the algorithm presented in [4] are used. Only PHEVs are investigated in [4], but we think that PHEV load models can also be used to roughly model full EVs. In our studies different curves were used for workdays, Saturdays and Sundays. This corresponds to the daily load modeling principles of Finnish distribution network companies. As car use habits depend on the season, the year was also divided into two different parts, summer and



winter, for which curves for different day types were formed. Also, network customers were divided into two different groups. The first group includes network customers with detached houses and semi-detached houses, and the second one includes other dwelling types.

Fig. 3 presents an example of the curves for the first mentioned customer group for winter time. The curves present the charging of a typical car during different types of days. Curves include mean and standard deviation values of the charged energy during all hours of the day. When the load curves were formed, a stack of assumptions had to be made. Average usable battery capacity of the cars was chosen to be 18 kWh and the average specific electricity consumption of the cars was 0.2 kWh/km. It is assumed that charging is carried out only at homes and workplaces. In both places the charging power was assumed to be 3 kW. Nowadays, sockets for pre-heating car engines in winter are very widely available in Finland in all types of houses and also in workplaces. These sockets could be used to some extent to charge plug-in vehicles. It is assumed that most of the charging would be made at homes and workplaces because the cars are parked in these places for long times and we already have some “charging”, i.e. preheating, infrastructure ready in Finland in these locations. Also, it is assumed that roughly fourth of the electricity need would be charged at the workplace [19]. The confidence level [4] of the calculations was 95 %. At the workplaces, it is simply assumed that on average the charging is carried out evenly during the hours 7, 8 and 9 of work days with a yearly energy of 0.9 MWh.

#### 2) Tampereen sähköverkko

The load curves of plug-in vehicles were pretty much the same as in JE-siirto’s calculations. However, there are some non-negligible differences in their use. These are briefly discussed in the following.

Firstly, in TS’s calculations only the mean value curves were used in MV and LV network calculations, and standard deviation curves were pressed down to zero. However, this simplification does not cause that big of an “error” because the currents in most of the lines and components consist of so

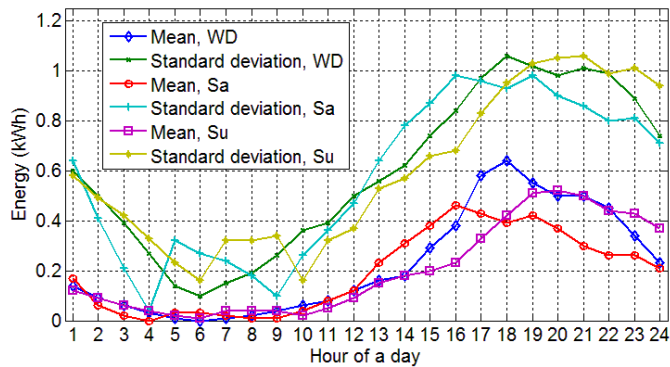

Figure 3. Curves for winter for a typical PHEV of the network customers living in detached houses and semi-detached houses.

many customers’ load currents that the significance of the standard deviation is fairly low. However, in the parts of the network where there is a small amount of customers, the error can be non-negligible. Also, the confidence level of the TS’s calculations for other loads than plug-in vehicles was 85 % (in JE-siirto’s case the confidence level was 95 %), and this decreases the significance of standard deviations in the calculations [4].

Secondly, in TS’s calculations it was assumed that in addition to homes and workplaces some charging takes place also in department stores and public car parks. In JE-siirto’s calculations, charging was assumed to be carried out only at homes and workplaces, and also in the load curves produced by the methodology of [4], only home and workplace charging was assumed. In the modeling of department stores and public parking lots, certain home curves were used as it was assumed that as shopping is done mostly in the early evenings and during weekends, it resembles to some extent charging at homes. This is, however, a rough approximation.

The charging energy is divided so that 15% of the total charged energy is set for workplaces, 10% for the public parking and the rest for homes. In TS’s distribution area there are 25 large department stores, shopping centers and public car parks, and the charging energy is divided evenly between these places. In scenarios 1 and 2, the yearly charging energies per spot for these places are 304 MWh and 480 MWh, respectively. For example scenario 1’s energy corresponds to 185 cars charging 1.5 h at a 3 kW rate every day on average.

#### D. Placing the plug-in vehicle loads to the network

##### 1) JE-Siirto

Vehicle loads were added to the homes and workplaces. In each scenario, plug-in vehicles were added randomly to the network customers until the assessed amount of plug-in vehicles was reached. The maximum number of plug-in vehicles in a household was restricted to one. It was noticed that when one car is added to all the households, the amount of cars corresponds with sufficient accuracy with the number of all cars in the distribution area. The number of cars in workplaces is a more challenging thing to assess. In this work, a rough assessment of the maximum number of cars for 45 different types of industrial or service sector customers of the network was made.

A simplification was made in the studies. It was mentioned previously that with plug-in hybrids 70 % of the kilometers could be driven using electricity. In practical studies this was taken into account so that  $N$  plug-in hybrids were modeled as  $0.7N$  full EVs. In this way the practical calculation work could be simplified. This simplification, however, decreases the geographical diversity of the load and slightly increases the uncertainty of the results.

##### 2) Tampereen sähköverkko

In TS’s calculations the vehicle loads of homes were placed into the network pretty much the same way than in JE-siirto’s calculations. Workplaces were divided into two

different groups: industrial and non-industrial. In scenario 1 the yearly charging energies of these two customer groups per customer were 11.7 MWh and 0.9 MWh, respectively, and in scenario 2 the corresponding energies were 16.8 MWh and 0.9 MWh, respectively. In scenario 1 industrial charging load is set for every industrial customer and for non-industrial workplace customers the charging load was set for every third customer. Scenario 2 differs from scenario 1 in the way that for non-industrial customers the charging load was set for every second customer. This division between industrial and non-industrial workplaces is rough, but we think it leads to results with a reasonable order of magnitude.

### III. THE RESULTS OF THE CASE SCENARIOS

#### A. The goal of the case study

The main goal of this paper is to assess the impacts of plug-in vehicles on the planning of electricity distribution networks. Planning is always a techno-economic process and the aim of the planning is to find technologically feasible solutions which have as low costs as possible within the planning period. In general, the aim of the network planning tasks can be presented as the following minimization task:

$$\min \sum_{t=t_1}^{t_n} (C_{inv}(t) + C_{loss}(t) + C_{out}(t) + C_{maint}(t)), \quad (1)$$

where  $C_{inv}$ ,  $C_{loss}$ ,  $C_{out}$  and  $C_{maint}$  represent the present values of investment, loss, outage and maintenance costs, respectively, of the sub periods ( $t_1, t_2, \dots, t_n$ ) of the planning period with a length of  $T$ . Of course, different technical boundary conditions such as electrical safety regulations have to be fulfilled. In principle, increasing the network load can increase all the cost components of (1).

In this paper the impact of plug-in vehicle load on (1) is not investigated in detail, but we simply study the impact of the load changes on the load levels and overloading of the network components and network voltages in different scenarios. This is a very restricted approach but it gives a rough overview of the impacts of plug-in vehicles on the network. In this paper, only the impact of the increasing plug-in vehicle charging load is considered and other possible changes in the network and its load are excluded from the studies. In other words the plug-in vehicle load is simulated in today's network.

#### B. Calculation results

##### 1) JE-Siirto

Plug-in vehicle charging load can increase the peak power of the whole network. Table III presents the changes in the peak loads of the network in different scenarios. The peak loads are calculated by summing up the peak loads of the five primary substations. Change in energy losses is also presented in the table. It can be seen that in scenarios 1 and 2 the peak load rise is negligible. In scenarios 3, 4 and 5 the increase in peak load rises to a non-negligible level.

The most remarkable network impact of plug-in vehicle charging load is observed in distribution transformers (21kV/0.4kV). Table IV presents the sums of the need for additional transformer capacity, the number of overloaded transformers and the proportion of overloaded transformers of all transformers in different scenarios. Again, in scenarios 1 and 2 the need for new investments are very small, but the last three scenarios imply a need to replace at least some dozens of transformers with ones with bigger capacity. However, when compared to the total amount of distribution transformers in the network, the amounts are typically fairly modest. It was noticed that in some cases by shifting the time of charging to night, the overloading situations could be avoided. It should however be noticed that due to the electric heating systems of households, the total peak loads usually take place during very cold weather. During cold weather a moderate overloading of the transformers placed outside can be allowed.

TABLE III. CHANGES IN PEAK LOAD AND LOSSES IN DIFFERENT SCENARIOS

Scenario	Change in peak load (MW)	Change in peak load (%)	Change in energy losses (GWh/a)
1	0	0	0.4
2	1	1	1.2
3	10	8	4.1
4	18	15	6.5
5	31	26	11.0

TABLE IV. ADDITIONAL CAPACITY NEED AND OVERLOADING OF DISTRIBUTION TRANSFORMERS.

Scenario	Total need for additional capacity (MVA)	Number of overloaded distribution transformers	Proportion of overloaded distribution transformers (%)
1	0	0	0
2	0.7	7	1
3	3.2	28	6
4	6.5	55	11
5	16.2	100	20

The impact of the charging load on low voltage (LV) and medium voltage (MV) lines was also investigated. It was noticed that the overloading of LV and MV lines is practically negligible. There were a few overloading cases, but those could perhaps be managed by changing the configuration of the network.

The voltage levels of the customers' LV network connections were also studied. It was noticed that the voltages of the network customers remained at permissible levels very well even with the highest penetration levels. In scenario 5 there were only some dozens of network connections (out of 9340) with too low voltage.

##### 2) Tampereen sähköverkko

In TS's calculations the impacts on primary substations' main transformers, MV feeders, distribution transformers and LV feeders were studied. The results are briefly summarized

in the following.

Peak load levels of the 15 primary substations' main transformers increased only a little. Average increases in scenarios 1 and 2 were 2.4 % and 3.8 %, respectively. Maximum and minimum increases in scenario 1 were 4.3 % and 0.4 %, respectively. Corresponding figures for scenario 2 are 7.9 % and 0.6 %. These changes do not cause any problems.

The average increases of peak load levels of MV feeders in scenarios 1 and 2 are 2.3 % and 3.6 %, respectively. Also 86 % of the feeders have an increase of under 4 % in scenario 1. For scenario 2 the corresponding proportion is 58 %. In both scenarios the voltage drop in MV feeders is under 3 % apart from three feeders. However, in these three feeders the voltage decline is still under 5 %. According to TS's network design principles, the voltage decline of MV urban cable networks should be restricted to 3 %. This allows for a high enough transfer capacity marginal for back-up connection use to be ensured.

Changes in the peak load levels of distribution transformers were also studied. In scenario 1 the average increase in the load level of the distribution transformers was about 3.1 %, and in 91 % of the transformers the increase was under 6 %. In scenario 2 the average increase was about 4.8 % and in 80 % of the transformers the increase was under 6 %. However, in both scenarios there were dozens of transformers whose proportional load level increases were greater than or equal to 12 %. When these transformers were investigated, it was noticed that most of them are feeding industrial customers. In these transformers the absolute load level is often fairly low which partly explains the large proportional increase.

These industrial customers typically have a large "charging peak" in the morning as employees arrive in their workplaces. By dividing the cars of the workplaces into subgroups which charge their battery packs in different time windows, the peak load increase could be avoided.

The average increases of peak load levels of LV feeders in scenarios 1 and 2 are 3.0 % and 5.3 %, respectively. Also 89 % of the feeders have an increase of under 6 % in scenario 1. For scenario 2 the corresponding proportion is 80 %. In scenarios 1 and 2 a peak load level increase of greater than or equal to 12 % was noticed in 5.5 % and 9.8 % of the LV feeders, respectively. The changes in voltage declines are very small.

#### IV. CONCLUSIONS AND FUTURE WORK

In this paper, load flow calculations were made to assess the impacts of plug-in vehicles on the network with two case studies. Five different scenarios with different plug-in vehicle penetration levels were defined and calculated in the first case study and two scenarios in the second one. The studies concentrated mainly on the load rates of different components. As a conclusion it can be said that plug-in vehicles would not cause serious problems in the case networks which are quite strong, i.e. it is possible to increase the loading of network

components and line sections without violating any voltage limits etc. The networks are strong partly because there has to be some marginal in the network components for the possible back-up connection use. Generally, Finnish distribution networks are fairly strong because of the wide use of high power and energy loads such as electric heating and electric sauna stoves. However, in these two network areas, district heating covers some 90 % market share. In the studies of this paper many approximations and simplifications were made, but we think that the results are fair and give a proper overview of the impact of the charging load on the distribution networks. Also, the calculations showed in a preliminary manner that it could be beneficial to control the real charging loads or other resources in order to reduce the network impacts in some cases. Also, using the methodology of this paper, one can assess the availability of plug-in vehicles to be used as controllable loads and energy storages. Many topics and issues for future work arose in this study.

It would be useful to conduct a more holistic study on the impacts possible changes of the loads can have on network planning. In such studies other types of new loads besides plug-in vehicles should also be taken into account. In Finland there are a lot of households with direct electrical heating, and in the future some proportion of them will be totally or partly replaced by heat pumps. In long term this can cause a remarkable decrease in electricity consumption in some network areas. There are also plenty of houses today in Finland which are heated by heating oil. Some proportion of these households will probably replace the oil heating system with a system which consumes remarkable amounts of electricity, for example heat pumps. This load change can increase network loads in some parts of the network.

In future studies, financial factors concerning network planning presented in (1) should also be taken into account to some extent. In the calculations of this paper, mostly the loading levels or possible overloadings of network components were investigated. However, replacing for example a line with one with a larger cross-section might be economically feasible before possible overloading of the line.

In this paper it was mentioned that charging load curves could be improved in many ways. This could also be realized in future studies. Also, different types of investigations concerning the use of plug-in vehicles and controllable loads or energy storages could be made by means of network calculations.

#### REFERENCES

- [1] S. C. Davis, S. W. Diegel and R. G. Boundy, "Transportation energy data book: Edition 31". Oak Ridge National Laboratory, 2012, 423 p.
- [2] R. Lache, D. Galves and P. Nolan, "Vehicle Electrification, More rapid growth; steeper price declines for batteries". Deutsche Bank, Global Markets Research, 2010.
- [3] R. Hensley, J. Newman and M. Rogers, "Battery technology charges ahead", McKinsey Quarterly, Jun. 2012, 4 p.
- [4] A. Rautiainen, S. Repo, P. Järventausta, A. Mutanen, K. Vuorilehto, and K. Jalkanen, "Statistical Charging Load Modeling of PHEVs in

- Electricity Distribution networks Using National Travel Survey data", *IEEE Trans on Smart Grid*, vol. 3, no. 4, Dec. 2012, pp. 1650-1659.
- [5] National Travel Survey. [Online] Available : <http://www.hlt.fi/english/index.htm>
- [6] A. Tammi, "Effects of plug-in vehicles in distribution network and business", MSc. Thesis, 2011, 74 p. (In Finnish)
- [7] A. Unkuri. "Consequences of Electric Cars to the City Distribution Network", MSc. Thesis, 2011, 56 p. (In Finnish)
- [8] A. Rautiainen, C. Evens, S. Repo and P. Järventausta, "Requirements for an interface between a plug-in vehicle and an energy system", in Proc. of IEEE Powertech 2011, Trondheim, Norway, 8 p.
- [9] A. Rautiainen, S. Repo and P. Järventausta, "Intelligent charging of plug-in vehicles," in Proc. NORDAC 2010 9th Nordic Electr. Distrib. Asset Manage. Conf., Aalborg, Denmark.
- [10] E. Sortomme, M. M. Hindi, S. D. J. MacPherson and S. S. Venkata, "Coordinated charging of plug-in hybrid electric vehicles to minimize distribution system losses," *IEEE Trans. Smart Grid*, vol. 2, pp. 198–205, Mar. 2011.
- [11] E. Sortomme and M. A. El-Sharkawi, "Optimal charging strategies for unidirectional vehicle-to-grid," *IEEE Trans. Smart Grid*, vol. 2, pp. 131–138, Mar. 2011.
- [12] K. Clement-Nyns, E. Haesen, J. Driesen, "The impact of charging plug-in hybrid electric vehicles on a residential distribution grid," *IEEE Trans. Power Syst.*, vol. 25, pp. 371–380, Feb. 2010.
- [13] R.A. Verzijlbergh, M. O. W. Grond, Z. Lukszo, J. G. Sloopweg and M. D. Ilić, "Network Impacts and Cost Savings of Controlled EV Charging," *IEEE Trans. Smart Grid*, vol.3, pp.1203-1212, Sep. 2012
- [14] C.-K. Wen, J.-C. Chen, J.-H. Teng, and P. Ting, "Decentralized Plug-in Electric Vehicle Charging Selection Algorithm in Power Systems," *IEEE Trans. Smart Grid*, vol.3, no.4, pp.1779-1789, Dec. 2012
- [15] O. Sundstrom and C. Binding, "Flexible Charging Optimization for Electric Vehicles Considering Distribution Grid Constraints," *IEEE Trans. Smart Grid*, vol.3, no.1, pp.26-37, March 2012
- [16] P. Richardson D. Flynn, and A. Keane, "Local Versus Centralized Charging Strategies for Electric Vehicles in Low Voltage Distribution Systems," *IEEE Trans. Smart Grid*, vol.3, no.2, pp.1020-1028, June 2012
- [17] P. Sánchez-Martín, G. Sánchez, and G. Morales-España, "Direct Load Control Decision Model for Aggregated EV Charging Points," *IEEE Trans. Power Systems*, vol.27, no.3, pp.1577-1584, Aug. 2012
- [18] A. Mutanen, M. Ruska, S. Repo, P. Järventausta. "Customer classification and load profiling method for distribution systems", in *IEEE Trans. Power Delivery*, vol. 26, no. 3, July 2011, pp. 1755-1763.
- [19] A. Rautiainen,, K. Vuorilehto, S. Repo, A. Mutanen, P. Järventausta. "Impacts of battery capacities and specific electricity consumptions on charging needs of PHEVs". Unpublished. 2011. 6 p.



## **Publication 5**

Rautiainen A., Repo S., Järventausta P., Evens C., “Requirements for an interface between a plug-in vehicle and an energy management system,” *in proc. IEEE Powertech 2011*, Trondheim, Norway, 8 p. ***The approved version.***

In reference to IEEE copyrighted material which is used with permission in this thesis, the IEEE does not endorse any of Tampere University of Technology's products or services. Internal or personal use of this material is permitted. If interested in reprinting/republishing IEEE copyrighted material for advertising or promotional purposes or for creating new collective works for resale or redistribution, please go to

[http://www.ieee.org/publications\\_standards/publications/rights/rights\\_link.html](http://www.ieee.org/publications_standards/publications/rights/rights_link.html)

to learn how to obtain a License from RightsLink.



# Requirements for an interface between a plug-in vehicle and an energy system

A. Rautiainen, C. Evens, S. Repo, P. Järventausta

**Abstract--** In this paper, requirements for an interface between a plug-in vehicle and an energy management system are discussed. A case where there is a service provider aggregating large amount of small resources was considered. Requirements were set for electrical and ICT interfaces and some related standardization work was briefly presented. Four different types of interfaces were presented: passive load (type 1), dynamic load (type 2), V2G (vehicle-to-grid – type 3) and V2H (vehicle-to-home – type 4).

**Index Terms--** Plug-in hybrid electric vehicle, electric vehicle, interface, power system, electricity network, ICT

## I. INTRODUCTION

Transportation has a very important function in today's society. Globally, the energy production of transportation systems is highly dependent on oil, and there are strong expectations that the price of oil as well as its volatility will increase in the future. The transportation sector is also a significant consumer of energy and a significant source of greenhouse gases and of other emissions [1]. Today's climate and energy policies push increasingly towards a diversification of transportation fuels, an improvement in energy efficiency and a decrease in emissions. The use of electrical energy for plug-in hybrid electric vehicles (PHEV) and electric vehicles (EV) offers the potential to partly fulfill these challenging requirements. Emission reductions and the amount of primary energy conservation due to plug-in vehicles are, however, highly dependent on the energy system.

There are some barriers related to high penetration of plug-in vehicles (PHEV and EV). The most important barrier is the battery technology. Batteries suitable for transportation appliances are very expensive at the moment, but the technology is continuously evolving and prices are expected to go down [2]. Secondly, a lack of adequate charging infrastructure is a major barrier. A massive installation of charging infrastructure would probably be fairly expensive

especially in densely populated areas.

Vehicle battery chargers affect the power system. Plug-in vehicles are not very big loads when considering the amount of energy absorbed. For example, there are about 2.5 million registered passenger vehicles in Finland today. If all of them were full EVs, their total energy need would be roughly about 10 % of the total electricity consumption of Finland. Plug-in vehicles can however cause challenges when considering instantaneous power. A great penetration level of plug-in vehicles can increase dramatically the peak powers of different parts of an electricity distribution network [3].

A plug-in vehicle can include different kinds of functionalities other than being simply passive electrical loads [4]. They could be used smartly to mitigate their harmful impacts on the network (i.e. to avoid high cost grid investments) and to make electricity market operation more effective [4]. In the beginning of the market penetration process only the mandatory functionalities will probably be used, but when the penetration level increases, other functionalities and services might become economically attractive. Although plug-in vehicles are mostly discussed in this paper, it is very important to remember that they are only one of the many resources that could be used to provide different services.

In the context of power systems, plug-in vehicles can be used as controllable loads or as dischargeable energy storages. Efficient and cost effective energy storage capacity would offer many advantages and possibilities which are analyzed for example in [5]. Storages could be discharged to public distribution networks (Vehicle-to-grid – V2G) or to small isolated network islands such as single households (Vehicle-to-home – V2H). V2G and V2H functionalities are very interesting because of their ability to store relatively large amounts of electrical energy. In addition the cost of the storage itself can be viewed as fairly low because it comes as an ancillary service on top of the driving purposes. Storage and discharging of batteries however bring some new challenges. Additional charging-discharging cycles pose additional stress to batteries and decrease their cyclic lifetime causing additional costs for vehicle owners. As the cyclic lifetime of batteries lengthens and the prices go down, this issue will become less important. Also the users have to accept that the state-of-charge of the batteries of their vehicles can decrease while they are connected to the electricity

---

The authors are grateful to the partners of the INCA project "Interactive customer gateway" for the interesting research topic, comments, funding and research co-operation. The project is financed by Tekes and several Finnish network companies, manufacturers and service companies.

First, third and fourth author are with the Department of Electrical Energy Engineering, Tampere University of Technology, P.O. Box 692, FI-33101 Tampere, Finland (e-mail: antti.rautiainen@tut.fi). C. Evens is with VTT, Technical Research Centre of Finland.



network. These challenges will have to be tackled with relevant customer incentives.

This paper discusses the requirements for the interface between the “energy management system” and a plug-in vehicle. Energy management system refers to a unity including all the systems and parties related to power system and electricity markets.

## II. SERVICES OFFERED BY PLUG-IN VEHICLE FLEET AND OTHER SMALL RESOURCES

Figure 1 illustrates services and functionalities a plug-in vehicle fleet could offer to different parties in the future. In the figure, the links between different parties are represented along with the relevant services and processes. The charging spots are connected to a party called service provider (SP) who has an essential role in the system. The service provider aggregates a large number of vehicles and possibly other types of resources and offers services to different parties. Other common terms for service provider could be virtual power plant (VPP) or aggregator. For different parties it is necessary to allow the aggregation of small resources and treat the aggregated resources as a single, larger, unit. The connection between the charging point and the SP can range in complexity from a very simple situation to an “interactive customer gateway” [6] allowing interactions and communication in real-time.

Energy companies could use the aggregated resource for demand response (DR) based on electricity price or for balancing purposes. This means that the customers modify their energy consumption based on the electricity price [7] or on other signals. In the Nordic electricity market energy companies are responsible for two different balances: production balance and consumption balance. Using the aggregated resource an energy company could adjust its realized consumption and production in order to improve its balance positions. The difference between balance management and other DR functions is that balance management tries to change the real consumption closer to a value bought from the electricity market, and some other DR functions are used to modify the energy amounts that have to be bought from or sold on the market. Plug-in vehicles can be charged in many physical locations. There are many possible market mechanisms [4] offering the vehicle users different levels of freedom to choose the electricity product when charging in public charging spots. Information flows between different parties are needed and they could be managed by SP.

The service provider could also make bids directly on the day-ahead and intra-day markets in the power exchange (NordPool in the Nordic countries). In addition to these markets, the TSOs administrate separate balance power markets. In fig. 1 all of these markets are lumped under the term “power exchange”.

As mentioned earlier, distribution networks may experience dramatic load changes due to plug-in vehicle

charging. A SP could offer network management services to manage these changes, and these services could be treated as an alternative for network reinforcements. Different services provided by vehicles acting as loads are described in [4]. The range of services becomes wider if the batteries can also be discharged into the grid. If the services are based on communication, the DSO can monitor the state of the network (cf. fig. 1) using distribution management system (DMS) and advanced metering infrastructure (AMI) and send information to the vehicle chargers and other resources. Vehicle chargers could also be used to improve power quality in a local distribution network by for example mitigating voltage dips, harmonics and asymmetry. In some market mechanisms presented in [4], SP could offer services for balance settlement process.

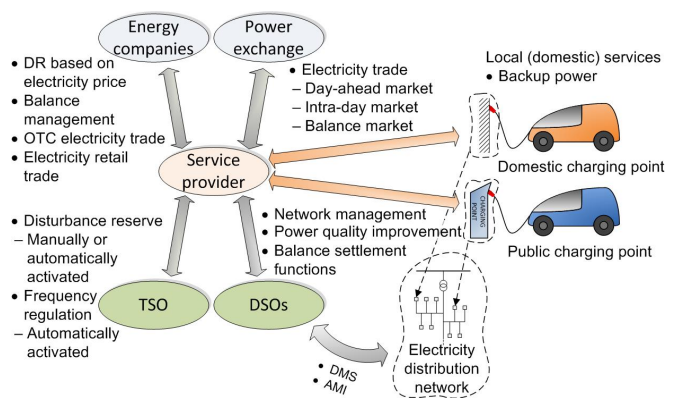

Fig. 1. Services and functionalities which plug-in vehicle fleet could offer for different parties

Plug-in vehicles can be used to provide different reserve services for the TSO. Making the charging dependent on local frequency measurement would be an easy way to realize automatically activating disturbance or frequency regulation reserves [8]. Such reserves could also be offered using many other types of loads [9;10]. Vehicles could also provide manually activated disturbance reserve which could be offered directly to the TSO.

An individual vehicle can also be used to provide some local services, such as backup power, at the charging site. During an electricity distribution outage the batteries of the vehicles could be used as energy storages to feed a small network island in a network, such as a single household. This is discussed in more detail in chapter III.D.

## III. INTERFACE REQUIREMENTS

An interface between an energy management system and a vehicle can be divided into two parts: an electrical interface and an ICT interface. The electrical interface links the vehicle to the physical power system. The ICT interface links the vehicle to the information systems which is needed to realize different services. One essential part of the ICT interface is the communication between the vehicles and the different parties of fig. 1. In this paper, the requirements for

communication are discussed from an operational point of view so that a network operator could design and define the communication system with satisfying characteristics.

A charger can be physically connected to an electricity network in two ways: through conductive and inductive coupling. In this paper conductive coupling is mostly covered. Inductive coupling, however, includes some features which could make it preferable for some special applications.

Different kinds of services set different requirements for an interface. Thus, in this paper the interfaces are divided into four different types: types 1, 2, 3 and 4. For each type, the electrical and ICT requirements are presented. The impacts of each interface types' functionalities on the power system and electricity market are also discussed. The presented interface type division is of course only an option, and it does not cover all the possible solutions. Different interfaces do not necessarily have to include all the functionalities which interface types make possible.

#### *A. Type 1 interface: "passive load"*

The type 1 interface, called passive load interface, is the simplest one. It presents only a simple and safe connection to an electricity network in order to draw electrical energy from the grid. Type 1 interface includes no vehicle specific measurement of electrical energy or any control possibilities by any parties presented in chapter 2. In this concept, when public charging spots are used to charge the vehicle, billing is not based on the amount of electrical energy drawn from the grid, but the billing can be included for example in a parking payment as a constant or parking time dependent payment.

#### *Functional requirements of the type 1 interface*

The electricity connection needs the regular electrical safety requirements for equipment designed for indoor or outdoor (depending on the location of the charging spot) usage. The physical connection to the electricity network can take the form of a "regular" one-phase or three-phase socket. In Finland there is a long history of using pre-heaters for the vehicle engines in outdoor environments in winter time, and there have been very little problems with electrical safety issues. If a high power three-phase charger is used, methods of local load coordination [4] can be applied for this type of interface to manage the peak power of a network connection.

#### *Type 1 interface and standardization*

An exhaustive list of the standards related to this type 1 interface is not given in this paper, but only a brief overview of some relevant issues. Related standards include rules for the design of the inlets, outlets, connecting cables as well as the insulation level (IP class), the required grounding system, residual current devices etc.

In Finland, electrical installations on a low-voltage network should be made according to the standard SFS 6000, based on the IEC and CENELEC 60364-series. The rules for working on low-voltage installations are given by regulations

in Finland. The regulations are considered to be fulfilled if the Finnish standard SFS 6002 is complied with [11].

The relevant Finnish laws and regulations are the following:

- Electrical safety act (410/1996, 634/1999, 893/2001, 913/2002, 220/2004)
- Electrical safety decree (498/1996, 323/2004)
- Decision/statute of the Ministry of Trade and Industry on electrical works (516/1996, 1194/1999, 28/2003, 1253/2003)
- Decision/statute of the Ministry of Trade and Industry on commissioning and use of electrical installations (517/1996, 30/2003, 335/2004)
- Decision of the Ministry of Trade and Industry on safety of electrical installations (1193/1999)

The Technical Committee IEC/TC69 dealing with 'Electric road vehicles and electric industrial trucks' has published the standard IEC 61851 [12] about electric vehicle conductive charging systems. It is currently being taken into account by SESKO, the Electrotechnical Standardization body in Finland, in order to form a Finnish standard [13]. Some additions (parts 21 and 22) have also been published regarding the specific measures for the vehicle charging systems and the AC charging stations. Their content is however very similar to part 1, and they just mostly complement it. The content of the standard covers the electrical and mechanical aspects of the connection between a vehicle and the grid. It thus includes issues such as protection against electric shocks (direct, indirect, capacitor discharge...), specific inlets and connectors' ratings, IP class, permissible temperatures and environmental conditions, and specifications for the charging cables. It also considers three different types of connections depending on where the charging cable is attached: to the car, to the charging point or if it can be disconnected from both sides. It is now assumed by SESKO that the existing outlets used for car heating will need to be replaced by new installations, although they could remain mounted on the same pole [13].

In addition to this standard, the IEC/TC69 is also working on charging installations based on inductive charging. That standard is not finalized yet, but it is announced to be based on the IEC 61980. However, some inductive charging installations do exist such as Magne Charge WM7200. In addition to the standards for conductive charging, inductive installations should be equipped with other protections such as overheating protections for the charger, detectors preventing the charging if the receiving battery is not adapted (for example if the vehicle requires ventilation for inductive charging which is not provided by the charger) or a protection against over-voltage faults at the battery level.

There are currently some existing outdoor conductive charging installations in Finland [13]. They follow the principles and use the same technologies as those encountered in building electrification.

Their characteristics are listed here:

- Nominal voltage: 400/230V
- Nominal current: 3x16A or 50A
- Thermal overcurrent rating: 10kA
- 1-phase outputs, 230V, 3,6kW
- 3-phase output, 400V, 10,8kW
- Residual current protection: 30mA
- Over current protection: 16A
- IP class 34
- Lock on the casing

### *B. Type 2 interface: “dynamic load”*

The second interface type is called a dynamic load interface. In addition to the functionalities and requirements of the passive load interface, the dynamic load interface includes a few additional features. One of these is a vehicle specific energy measurement, which is used for billing purposes. In such market mechanisms where the charged energy is bought from the same retailer as the one from which the user buys the domestic electrical energy [4], payment of the charging in public charging spots could be added to the user’s regular electricity bill. The dynamic load interface makes possible the use of the charger as a controllable load using communication or based on local logic or intelligence. In addition, monitoring of the state of the loads could be needed depending on the service. The use of a charger for frequency regulation or disturbance reserve capacity based on local frequency measurement is also supported by this interface. Local power quality improvement, such as harmonics or voltage asymmetry mitigation, could also be possible

#### *Functional requirements of the type 2 interface*

This interface type includes some additional requirements for the electrical interface when compared to the passive load interface. Vehicle specific energy measurement equipment should be included in the vehicle or in the charging spot. Frequency measurement and related technology for realization of frequency dependency is needed. For local power quality improvements, the charger should present relevant design and characteristics.

The dynamic load interface sets some requirements for the ICT interface. Communication is needed to send control signals, such as price data or direct instructions, to the chargers unless the control is based on local intelligence/logic. In some cases there could be a need to send information from the vehicles to the service provider in order to monitor the state of the distributed resources and assess the available resources. Many communication requirements can be set for the ICT interface. They can be quantified by investigating the needs of the different services.

If the energy meter is in the vehicle, it should be possible to read the meter remotely when the payment of electricity is carried out in a public charging spot. This communication should be very reliable and it should have such characteristics, that the user experience is of good quality.

One possible service is the participation in a regulating power market. In today’s Nordic electricity market the activation time between the order and the full volume delivery must be less than 15 minutes [14].

Another electricity market related service is balance management. For balance management the differences between scheduled and realized production and between estimated and realized consumption in a certain time interval are minimized within certain boundary conditions. The requirements set for the communication regarding this service are dependent on the moment when the short-term estimations of production and consumption are carried out. Estimations can be carried out before the time interval or during the time interval. In the first case, the time requirement for control actions depends on the time between the finalization of the estimation and the beginning of the time interval under manipulation. In the latter case, the control actions should be performed as soon as possible. Thus, if the estimation is conducted during a one-hour time interval, the control actions must have the ability to be realized within some minutes.

Another possible service is the manually activated disturbance reserve. Today in the Finnish power system, manually activated fast disturbance reserves must have the ability to be activated within 15 minutes [15]. It can be considered as the time response requirement for a load decrease of a plug-in vehicle fleet.

A type 2 interface vehicle fleet can also participate in the management of the electricity distribution network. The aim is to use lines and transformers nearer to their economic-physical limits. The services include avoiding the excessive overloading of network components. In the case of overloading time response requirements depend on the component under overload and weather conditions such as outdoor temperature. Depending on the system, the overcurrent protection of the network may or may not be set to trip because of overload. If overload situations are covered in the protection system, the electricity network management service should operate before the protection system. This type of service is based on state estimations of the network and may require a high level of coordination in order to operate extensively in different network states. This type of service can however be realized for different degrees of scale. One must not manage the whole distribution network but a part of it: for instance a single problematic medium voltage feeder can also be the target of this service.

Another possible service is frequency dependent reserve. The Finnish TSO’s grid code requires that the frequency controlled normal operation reserves have to be activated within two to three minutes after an appropriate frequency change. On the other hand, 50 % of a frequency controlled disturbance reserve’s capacity has to be activated within 5 seconds and 100 % has to be activated within 30 seconds in the case of a sudden 0.5 Hz frequency drop. [16]

In addition to these services communication can also be needed for many other services which include modest requirements for the time response of the communication system.

Many of these services can have a need to monitor the state of the vehicles. For some services it is important to have an accurate enough estimate concerning for example total power (MW) of controllable chargers. The level of monitoring need is the main attribute defining the requirements for the communication system.

Table 1 sums up the time response requirements for communication and control equipment for different services in the Finnish power system and presents information concerning the location of the measurement and control equipment needed in different services. Time ranges refer to the permitted delay between the time when the need is detected and the time when the control action is taken. "L" (local) in the table means that measurement or control equipment is located near the resource and "R" (remote) corresponds to remote location.

TABLE I  
APPROXIMATE TIME RESPONSE REQUIREMENTS AND LOCATION OF  
MEASUREMENT EQUIPMENT AND CONTROL INTELLIGENCE FOR DIFFERENT  
SERVICES

Service	Time range	Measur.	Control
Power quality improvement	Some $\mu$ s...some ms	L	L
Distribution network power flow management	Some min...some h	L/R	L/R
Frequency controlled disturbance reserve	5...30 s	L	L
Frequency controlled normal operation reserve	2...3 min	L	L
Balance management	5 min...1 h	–	R
Monitoring of reserves	Some minutes... 1 h	L	L/R
Balancing power market (realized bid)	15 min	–	R
Fast disturbance reserve	15 min	–	R
Intra-day market (Elbas market)	1 hour	–	R
Day-ahead market (Elsport market)	10...34 h	–	R

The amounts of data which should be transferred for the different services are not large. Data can comprise simple on/off type commands, starting and stopping times of some event, some simple numerical data such as electricity prices of different periods of time etc.

### *Type 2 interface and standardization*

The first new requirement for this type of an interface is a specific metering infrastructure for the vehicle. This infrastructure can be located inside the vehicle or inside the charging points.

The meters will most likely have to follow the existing regulations and standards as for household consumption meters. There are European and national regulations and standards detailing the precision required by the meters as well as for data protection and transmission. The EU Measurement Instrument Directive (MID) [Directive 2004/22/EC] for example provides the legal requirements to

ensure that trade based on measurements is accurate, reliable and fair.

Often the owner of the charging point is not the owner of the vehicle. There could then be a need for two different metering systems. The first would be at the connection point to the network. The DSO would use it to bill the owner of the charging point. The second would be used by the owner of the charging point to bill the vehicle user. There could be an additional meter inside the car. The system could be greatly simplified if a secure and reliable communication system was installed. In any case, it is important that the EV user pays for his charging and that the owner of the charging point pays for the electricity consumed, each of them paying once and only once.

New meters will most likely be "smart-meters" that can be read remotely. For the interface with the network in Finland, the electricity market decree 65/2009 [17] details the way that the DSOs should implement their smart-meter roll-out as well as minimum requirements for them (such as an hourly measurement and a daily meter reading).

In cases where the meter is installed inside the vehicle, they will have to comply with standards and regulations about on-board electric equipments for EV (under work standard IEC 61981), but also the reading of the meter may not need to be daily (the vehicle may be unable to transmit the information on a daily basis, e.g. in the case of a travel in another country) and the transmission of the information to the DSO would offer complications. If this solution is to be considered, a specific regulation should be drawn up in order to make it possible.

The communication standards between the meter and the electricity actors are the object of the report [18]. The meters, or the data concentrators should have a Wide Area communication Network (WAN) access such as a GSM/GPRS modem, an xDSL-modem or a satellite phone modem. If concentrators are used, the communication with the meter is made using some 'last kilometer' communication such as PLC, short range radio communication or some other local communication system. In the case of a specific EV measurement at the charging point, it would be likely that a concentrator is used. If the measurement is made onboard, either the meter communicates directly with the company responsible for the metering, or it should be able to communicate with the concentrators wherever the charging takes place.

In Europe, the series of standards IEC 62056 "Electricity metering – Data exchange for meter reading, tariff and load control", also called DLMS (Device Language Message Specification) are widely used for meter communication and cover most major aspects.

With this type of interface, the vehicle's load (the charger) can be used as a controllable load based on signals received or on local control. The electricity market decree 66/2009 states that the metered hourly data should be used in balance

settlement by 2014. It is therefore very likely that electricity retailers and/or network operators will submit electric vehicles to hourly metering and possibly to direct control signals or to price or price and volume signals. The exchange of these signals should follow the same standards as those used for metering with the additional constraint that the communication system must be fast enough for the vehicle's charger to react to the signals.

The possibilities based on local measurements are not currently being studied much because frequency and disturbance regulations are reserved for producers and large consumers. However, they could be introduced through the SP or if the TSO policies change. In a smart-grid context, with increased levels of interactivity between the network and the distributed resources and with a higher penetration of renewable energies, they would become of vital importance.

This type of interface would require a fast enough measurement system and probably some other elements such as can be found in the existing contracts between Fingrid and frequency control service providers [19]. They include such information as what types of disturbances the service should react to, how fast it should respond and prices for the utilization of the service.

The metering infrastructure should also in this case be faster in order to assess the provision of the frequency or disturbance control action. In other words the metering data should show if the service has been provided according to the contract. Currently, Fingrid requires "real time" measurement for its services. Collecting the data and sending it to the service buyer can however be done at a lower frequency (every hour or day for example).

Another aspect of the vehicle specific metering to be considered is data security. This is especially true when the meter is attached to the vehicle. Data security needs different sets of standards depending on the communication technologies and protocols used [18].

### C. Type 3 interface: "V2G"

Type 3 interface includes the vehicle-to-grid capability in addition to the functionalities of type 2.

#### *Functional requirements of the type 3 interface*

To operate in V2G mode, some additional features are necessary in the electrical interface. The most important additional feature is the bidirectional converter of the charger with appropriate protection equipment such as over current, over voltage and under voltage protections. Loss-of-mains (LOM) protection is also needed in the electrical interface. If a part of a network in which a vehicle operates in V2G mode is disconnected from the public distribution network due to for example an earth fault, the vehicle should also stop feeding energy to the grid for safety reasons. There are many different types of LOM protection methods. Some of them are discussed and extensively overviewed for example in [20]. Also, safety issues during network repair and maintenance

should be ensured to avoid the sudden start of V2G operation during such work. This could be carried out by designing the converters to be unable to operate in dead network or by using a remotely controllable switch that could be opened before network repair and maintenance work. Also, energy meters should be able to handle two-way energy flows. Interface of type 2 included a functionality of power quality improvement. This could be enhanced in V2G interface, because feeding real power back in a network offers new possibilities such as mitigating voltage dips.

V2G does not set very many new requirements for the ICT interface. The requirements of type 2 are valid when applied to V2G operation. Concerning the monitoring of resources, in V2G operation it is necessary to monitor the total amount of battery energy storage capacity (MWh), which could be used for V2G purposes. This requires that the information concerning the state of charge of the batteries should have the ability to be transferred from the battery controller equipment to the service provider.

#### *Type 3 interface and standardization*

A good basis for this type of interface in Finland would be to comply with the network guideline YA9:09 [21] from the Finnish energy industries. The recommendation is based on the European standard EN 50438: "Requirements for the connection of micro generators in parallel with public low-voltage distribution networks". The YA9:09 includes recommendations about:

- The disconnection of the generator (according to the standards SFS 6002 and SFS 6000)
- EMC requirements:
  - The standard EN 61000-3-15 is in preparation: Electromagnetic compatibility (EMC) Limits – Assessment of low frequency electromagnetic immunity and emission requirements for dispersed generation systems in LV network
  - Existing standards that can be applied to micro-generation:
    - Interference immunity: EN 61000-6-1
    - Electromagnetic emissions: EN 61000-6-3
    - Harmonic current emissions: EN 61000-3-2
    - Voltage fluctuation and flicker: EN 61000-3-3
- Quality of electricity: the quality of the voltage at the connection point must comply with the standard SFS-EN 50160 "Voltage characteristics of electricity supplied by public distribution systems"
  - Network connection and tripping in case of network fault situation (including limits in voltage deviation requiring a disconnection, Loss of mains situations and resynchronization after a disconnection)
  - Short-circuit current limitations to be fed into the network

Another related standardization work is standard draft ISO/IEC CD 15118-1 "Road Vehicles – Vehicle to grid communication interface – Part 1: General information and

use-case definition”.

#### D. Type 4 interface: “V2H”

The fourth interface type is called the V2H (Vehicle-to-home) interface. In addition to the functionalities of type 3, V2H interface has an ability to feed energy to a single household. This would offer the possibility to use the vehicle as a domestic back-up power. The V2H interface does not necessarily include all the functionalities of the V2G interface and thus all the same requirements do not necessarily have to be set for it. In addition to the requirements of the V2G interface or part of them, the V2H operation sets some new interface requirements.

#### Functional requirements of the type 4 interface

Type 4 interface includes some important new requirements. One requirement is a switch, which is used to disconnect the household (or another small network island) from the public distribution network (see fig. 2). This isolation has to be made, because a V2H capable vehicle has very limited power and energy capacities and thus cannot feed other households or customers connected in the public distribution network. It is also preferable that the connection to the electricity network is three-phased (see fig. 2). Otherwise it would be necessary to select the loads to be fed during an outage, and those should be connected to a certain phase. Some load reduction of non-critical loads may be necessary to ensure that the power capability of the converter, the line and the energy capability of the battery are sufficient. This requires some special equipment including some sort of a relay or home automation able to disconnect these loads. Assuming that the vehicle works as the only power source (unless there is some sort of small scale power production such as solar panels) during V2H operation, the feeding equipment has to include all necessary control and protection functions very similar to the ones found in conventional power plants. This comprises voltage control, big enough short circuit current capacity, short circuit protection etc. However, fulfillment of all the power quality requirements defined by standards is not necessarily mandatory. The switching equipment has to include a battery back-up or other type of back-up power to realize the necessary switching and communication actions during an outage.

V2H operation brings some new requirements for ICT interface. In addition to the relevant requirements of type 3, there is a requirement for an automatic operation of the isolation switch during an outage and automatic control of the converter. The transfer into back-up power mode could be made with a short interruption or voltage dip, or totally seamlessly. The transfer to V2H mode after an outage and returning on the basic mode (electricity transfer from distribution network) after the outage is carried out as follows.

1. When an outage is detected in the network, the isolation switch has to be opened automatically.

2. After the isolation, necessary load reductions have to be made.

3. “Start back-up power operation” command has to be sent to the converter of the vehicle. Converter starts to feed the loads.

4. When the end of the outage is detected, a “stop back-up power operation” command has to be sent to the vehicle converter.

5. The isolation switch has to be closed.

6. Loads which were disconnected have to be reconnected to the network.

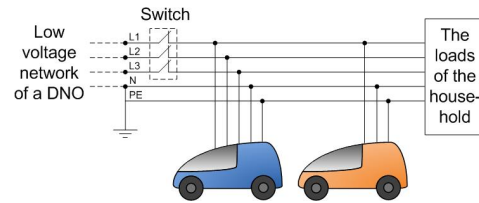

Fig. 2. Realization of the vehicle-to-home service.

#### Type 4 interface and standardization

The Finnish guideline YA9:09 (ET 2009) states: "If a consumer wants to use a micro-generator as reserve power in parallel with the network it is of utmost importance that the installation may under no circumstances concurrently feed both the network and the isolated network" and that it requires a separate switch and additional devices.

This situation brings up new requirements that are not included in current standards. One is that the local system must keep a balance between production and consumption on the islanded network. For that purpose, some loads must be turned off or down in order to not exceed the battery capacity (for example sauna, water heaters, space heaters...). In the case where the vehicle is connected to a single phase, only the loads connected to that same phase can be fed. Another point is that the power quality on the local network does not need to fulfill the normal power delivery standards. However, some limitations should be put in place and the control capabilities of the converter must be able to respect them. Also, safety standards must still be fulfilled. That includes a possibility to disconnect the vehicle from the local network in situations of faults or of repairs. The short-circuit protection must also work during V2H operation.

## IV. CONCLUSIONS

A cost effective but still flexible and dynamic system is the target of the plug-in vehicle infrastructure development. In this report requirements for an interface between a plug-in vehicle and an energy management system were discussed. A case where there is a service provider aggregating large amounts of small resources was considered. Requirements were set for electrical and ICT interfaces and some related standardization work was briefly presented.

In this report, many different types of services were

discussed. However, these services were not discussed from an economical point-of-view. In this context, economical factors should be analyzed from the vehicle users', service provider's and different power system and electricity market related actors' point-of-views. It is very important that vehicle users have a reasonable economic incentive to participate in different service markets with their vehicles and other energy resources. Also, the service provider must have reasonable revenue possibilities for its operation. Different actors cooperating with the service provider, such as energy companies and network companies, must also have reasonable economical incentives to apply the services. For energy companies such incentives could be formed by means of more efficient electricity trade and for a distribution network company such incentive could be peak load reduction and avoidance of some network reinforcements.

## V. REFERENCES

- [1] Davis, S. C., Diegel, S. W., Boundy, R. G. (2009). Transportation energy data book: Edition 28, Oak Ridge National Laboratory, [Online] Available: <http://cta.ornl.gov/data/index.shtml>
- [2] Lache R., Galves, D., Nolan, P. (2010). Vehicle Electrification, More rapid growth; steeper price declines for batteries. Deutsche Bank, Global Markets Research, Available: <http://www.scribd.com/doc/28104500/Deutsche-Bank-Electric-Car-Analysis-Batteries>
- [3] Lassila, J., Kaipia, T., Haakana, J., Partanen, J., Järventausta, P., Rautiainen, A., Marttila, M. (2009). Electric cars – challenge or opportunity for the electricity distribution infrastructure?, European Conference SmartGrids and Mobility, Würzburg, Germany. 8 p.
- [4] Rautiainen, A., Repo, S., Järventausta, P. (2010). Intelligent charging of plug-in vehicles. NORDAC 2010, Ninth Conference on Electricity Distribution System Management and Development, Aalborg, Denmark, 6–7 September 2010, 11 p.
- [5] Jewell W., Gomatom P., Bam L., and Kharel R. (2004). Evaluation of Distributed Electric Energy Storage and Generation, Final Report for PSERC Project T-21. PSERC Publication 04–25, Power Systems Engineering Research Center.
- [6] Järventausta, P., Repo, S., Rautiainen, A., Partanen, J. Smart grid power system control in distributed generation environment, Annual Reviews in Control 34 (2010) pp. 276-285.
- [7] Albadi, M. H., El-Saadany, E. F. (2008) A Summary of demand response in electricity markets. Electric Power System Research 78 (2008) pp. 1989–1996.
- [8] Rautiainen, A., Repo, S., Järventausta, P. (2009). Using Frequency Dependent Charging of Plug-in Vehicles to Enhance Power System's Frequency Stability. European Conference SmartGrids and Mobility, Würzburg, Germany. 8 p.
- [9] Short, J. A., Infield, D. G. and Freris, L. L. (2007). Stabilization of Grid Frequency through Dynamic Demand Control. IEEE Transactions on Power Systems, vol. 22, 3, pp. 1284–1293.
- [10] Rautiainen, A., Repo, S., Järventausta, P. (2009b). Using Frequency Dependent Electric Space Heating Loads to Manage Frequency Disturbances in Power Systems. PowerTech 2009, IEEE PES, Bucharest, Romania, 6 p.
- [11] Tukes. 2010. Finnish safety technology authority (Turvatekniikan Keskus – Tukes) websites: <http://www.tukes.fi>, checked in April 2010.
- [12] IEC. 2010. IEC websites: <http://www.iec.ch>, checked in April 2010.
- [13] Vesa, J. 2009. Status of standardization of electric vehicles, presentation, available: [http://www.sesko.fi/attachments/sk69/sahkoauto\\_standardointi.pdf](http://www.sesko.fi/attachments/sk69/sahkoauto_standardointi.pdf) [in Finnish].
- [14] Fingrid Oyj. 2010. Balancing power market. Available: [http://www.fingrid.fi/portal/in\\_english/services/balance\\_services/balancing\\_power\\_market/](http://www.fingrid.fi/portal/in_english/services/balance_services/balancing_power_market/)
- [15] Fingrid Oyj. 2010. Maintenance of operational reliability. Available: [http://www.fingrid.fi/portal/in\\_english/services/system\\_services/maintenance\\_of\\_operational\\_reliability/](http://www.fingrid.fi/portal/in_english/services/system_services/maintenance_of_operational_reliability/)
- [16] Fingrid Oyj. 2010. Maintenance contract for frequency controlled normal operation and disturbance reserves. [In Finnish]. Available: [http://www.fingrid.fi/attachments/fi/palvelut/jarjestelmopalvelut/taajuuden\\_yllapito/taajuusohjatus\\_kaytto-ja\\_hairioreservin\\_yllapitosopimus.pdf](http://www.fingrid.fi/attachments/fi/palvelut/jarjestelmopalvelut/taajuuden_yllapito/taajuusohjatus_kaytto-ja_hairioreservin_yllapitosopimus.pdf)
- [17] Energy Market Authority. 2009. Electricity market decree 65/2009 (Sähkömarkkina-asetus 65/2009), Available: <http://www.energiamarkkinavirasto.fi/select.asp?gid=43> [in Finnish]
- [18] Koponen, P., Pykälä, M-L., Peltonen, J., Ahonen, P. 2010. Interfaces of consumption metering infrastructures with the energy consumers, review of standards. VTT Espoo, 105 p.
- [19] Fingrid Oyj. 2010. Maintenance of frequency. Available: [http://www.fingrid.fi/portal/in\\_english/services/system\\_services/maintenance\\_of\\_frequency/](http://www.fingrid.fi/portal/in_english/services/system_services/maintenance_of_frequency/)
- [20] Dyško, A. Booth, C., Anaya-Lara, O., Burt, G. M. 2007. Reducing unnecessary disconnection of renewable generation from the power system. IET Renewable Power Generation, 1, (1), pp. 41–48
- [21] ET. 2009. Network guideline YA9:09: Connection of micro-generation to the electricity distribution network. Finnish energy industries (ET). Available: <http://www.vsvoy.fi/attachment.asp?Section=5681&Item=13953> [in Finnish]

## VI. BIOGRAPHIES

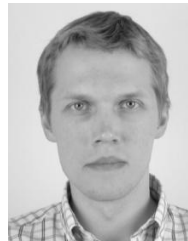

**A. Rautiainen** received his M.Sc degree from Tampere University of Technology in 2008. He is now working as a researcher towards doctoral degree at Tampere University of Technology. His main interest focuses on the effects of plug-in vehicles to electric power systems, ancillary service possibilities of plug-in vehicles and smart load control.



**C. Evens** received M.Sc. degrees in Electrical Engineering from the Helsinki University of Technology and from the University of Liège in 2007. He has since been working for VTT, Technical Research Center of Finland. His work focuses on demand response, the aggregator concept and the future interactions between electricity actors.



**S. Repo** received his M.Sc. and Dr.Tech. degrees in Electrical Engineering from Tampere University of Technology in 1996 and 2001 respectively. At the present he is a University Lecturer at the Department of Electrical Energy Engineering of Tampere University of Technology. His main interest is the management of active distribution network including distributed energy resources.

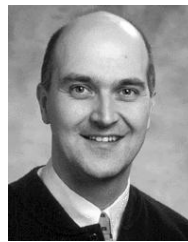

**P. Järventausta** received his M.Sc. and Licentiate of Technology degrees in Electrical Engineering from Tampere University of Technology in 1990 and 1992 respectively. He received the Dr.Tech. degree in Electrical Engineering from Lappeenranta University of Technology in 1995. At present he is a professor at the Department of Electrical Energy Engineering of Tampere University of Technology. The main interest focuses on the electricity distribution and electricity market.

## **Publication 6**

A. Rautiainen, J. Markkula, S. Repo, A. Kulmala, P. Järventausta, K. Vuorilehto, “Plug-in vehicle ancillary services for a distribution network,” *in proc. IEEE EVER '13*, 2013, Monaco, 7 p. ***The approved version.***

In reference to IEEE copyrighted material which is used with permission in this thesis, the IEEE does not endorse any of Tampere University of Technology's products or services. Internal or personal use of this material is permitted. If interested in reprinting/republishing IEEE copyrighted material for advertising or promotional purposes or for creating new collective works for resale or redistribution, please go to

[http://www.ieee.org/publications\\_standards/publications/rights/rights\\_link.html](http://www.ieee.org/publications_standards/publications/rights/rights_link.html)  
to learn how to obtain a License from RightsLink.





# Plug-in vehicle ancillary services for a distribution network

Antti Rautiainen, Joni Markkula, Sami Repo, Anna  
Kulmala and Pertti Järventauta  
Department of Electrical Engineering  
Tampere University of Technology  
Tampere, Finland  
antti.rautiainen@tut.fi

Kai Vuorilehto  
School of Chemical Technology  
Aalto University  
Espoo, Finland  
kai.vuorilehto@iki.fi

**Abstract**— In this paper, we have investigated the possibilities of plug-in vehicles to produce ancillary services for distribution networks. First, special features of plug-in vehicles as controllable resources are discussed and then motivation and methods of four different types of ancillary services are discussed. These services are peak load management, network power flow management, customer back-up power and power quality improvement. Finally some conclusions are made and future work is proposed.

**Keywords**— *Plug-in vehicles, PHEV, EV, ancillary services, electricity distribution networks*

## I. INTRODUCTION

Transportation has a very important function in today's society. Globally, the energy production of transportation systems is highly dependent on oil, and there are strong expectations that the price as well as the volatility of the price of oil will increase in the future. The transportation sector is also a significant consumer of energy and a significant source of greenhouse gases and other emissions [1]. Today's climate and energy policies imply strongly towards diversification of transportation fuels, improving energy efficiency and reducing emissions. The use of electrical energy in a broader manner by means of plug-in hybrid electric vehicles (PHEV) and full electric vehicles (EV) offers the potential to partly fulfill these challenging requirements. Emission reductions and the amount of primary energy conservation due to plug-in vehicles are, however, highly dependent on the energy system.

There are some barriers related to the high penetration of plug-in vehicles (PHEV and EV). The most important barrier is the battery technology and its relation to short operating distances. Technologically speaking, batteries are fairly good at the moment, but batteries suitable for transportation appliances are very expensive. However, the prices are expected to go down dozens of percentages over the course of the following years [2]–[3]. PHEVs are penetrating the market more potentially due to their long range and small and thus less expensive battery pack. Secondly, a lack of adequate charging infrastructure is a major barrier. It is often fairly expensive to construct extensive charging infrastructure

especially in the existing densely populated areas. However, constructing extensive charging infrastructure for full EVs in scarcely populated areas can also be challenging.

In addition to enabling sustainable passenger transportation, plug-in vehicles can also be used as controllable resources among other resources for the needs of different actors of the power system and energy market. These actors can be distribution network operators (DNO), energy companies and retailers, transmission system operator etc. In [4] these services are handled from the perspective of plug-in vehicle system interface requirements.

In general, the controlling of plug-in vehicle charging and discharging (vehicle-to-grid, V2G and vehicle-to-home, V2H) has been under intensive academic research for a few years and lot of different types of ideas and results have been published in different forums, cf. for example [4]–[13]. This paper concentrates on the services which plug-in vehicles with other resources could produce for electricity distribution networks. In this paper, we have been trying to emphasize the practical point-of-views for plug-in vehicle control. The services for distribution networks are presented in a generic manner, but special characteristics of Finnish distribution networks are highlighted.

The paper is organized as follows. In section II, the special characteristics of plug-in vehicles as a controllable resource are discussed. In section III, different services for distribution networks are presented and motivation and methods for different services are discussed. In section IV, conclusions and future work are presented.

## II. PLUG-IN VEHICLES AS CONTROLLABLE RESOURCES

In the context of power systems, plug-in vehicles can be used in at least two ways: as controllable loads or as dischargeable energy storages (bidirectional power flow). Controllable load operation is easier to realize, but energy storage operation offers a wider range of possibilities. Controlling plug-in vehicles alone does not necessarily offer high enough volume for economically attractive operation. Thus, plug-in vehicles should perhaps be controlled with other resources such as loads and small-scale power generation

plants. Other loads can be for example electric heaters, heat pumps and storage water heaters. A single term for distributed loads, storages and generation plants is “distributed energy resources” (DER), which is used hereafter in this paper.

Plug-in vehicles can be used as controllable load in at least two ways: by switching charging on/off or by restricting the charging current. On/off switching is simple to realize, but it has to be made in such a way that the control does not interfere the charging system of the car. For example, some models of mode 2 (defined in standard IEC 61851-1) charging related in-cable-control-boxes do not necessarily recover from voltage cut-offs. In mode 3 charging, a maximum charging current level is set for the car by the charging station, and the maximum level can be changed during the charging process. It should be noted that only the maximum current level can be set, and the charger itself decides the charging current.

Efficient and cost effective energy storage capacity would offer many advantages and possibilities which are analyzed for example in [14]. Car electricity storages could store relatively large amounts of electrical energy and the power capacity would be quite large. For example, if there were one million plug-in vehicles (there are about 2.7 million passenger cars in Finland today) in Finland and if 50 % of them would be available for energy storage use and if the vehicles would be simultaneously able to discharge 5 kWh per vehicle on average, the total energy capacity would be 2.5 GWh. If the discharging power was 3.7 kW per vehicle, the total discharge power capacity would be 1850 MW. These numbers are quite remarkable in the Finnish power system.

A question of its own is the use of internal combustion engine of a PHEV to produce power for the needs of the power system. In this case, the liquid fuel stored in the fuel tank would operate as energy storage and thus the energy capacity would be quite high. This concept is, however, mostly suitable for domestic back-up power applications, i.e. producing power for a single household during an outage. For other types of applications this concept is not perhaps very relevant. One must consider user acceptance: people would probably be less excited that their car engines would start and stop by themselves every now and then when parked. In this concept, one must ensure that the car would be parked outside in order to avoid a safety hazard with the exhaust gases.

The use of the car’s battery packs as energy storages for the power system inflicts costs for the car owners. Additional charging-discharging cycles pose additional stress to batteries and decrease their cyclic lifetime. When calculating the costs of the energy storage operation, the investment cost of the storage itself can be considered fairly low because the car is bought primarily for transportation purposes and the energy storage operation comes as an ancillary service on top of the driving. The battery degradation cost of discharging a certain amount of energy from a battery pack and recharging the same amount of energy back to the battery depends on the type of the battery pack.

Today, PHEVs and full EVs nearly always have lithium-

ion batteries which will be the energy storage solution also in the near future. The cyclic lifetime of a lithium-ion battery cell is dependent on the battery chemistry and especially the type of the negative electrode. In the case of graphite negative electrode the cyclic lifetime of the battery cells is limited to around 3,000 full cycles depending on battery chemistry and design. On the other hand, in the case of titanate negative electrode the cyclic lifetime is considerably higher. However, batteries with titanate negative electrode are more expensive and their specific energy (in Wh/kg) is much lower compared to the many graphite based batteries. Today’s investment costs of lithium-ion batteries are from some hundreds of EUR/kWh up to thousands of EUR/kWh depending on the battery chemistry and manufacturer. The cyclic lifetime was expressed above in full cycles. In practice, cycle depth (CD) of a charging-discharging cycle is often less than 100%. The impact of CD on the cyclic lifetime depends on the battery chemistry. For example, batteries with lithium-iron-phosphate (LFP) positive electrode are not so sensitive to CD. Thus, over the course of LFP batteries’ cyclic life the total amount of discharged energy from the battery is quite stable and independent from CD. For a battery with a cobalt based positive electrode, CD has non-negligible impact on the cyclic life: the smaller the average CD, the larger the total amount of discharged energy over the course of the cyclic life.

Fig. 1 presents simple calculations concerning battery degradation costs as a function of cyclic lifetime and battery investment cost. The battery degradation cost represents a cost per stored energy (in EUR/kWh) which is caused by cyclic lifetime loss when discharging a battery pack from a certain state by certain amount and then charging back to the initial state. Cyclic lifetime is presented as a number of a certain type of charge-discharge cycles (CD of 100% or something else). Battery investment cost is presented in EUR/kWh. The values of Fig. 1 are obtained by simply dividing the battery investment cost (in EUR/kWh) by the number of cycles which can be obtained from the battery before its lifetime has ended. It can be seen that to obtain a battery degradation cost of a few cents/kWh the cyclic lifetime must be very high and/or the investment cost has to be very low.

Fig. 2 presents a simple calculation about energy storage costs including battery degradation costs of Fig. 1 and electricity price of 0.15 EUR/kWh. The electricity price is in the order of typical present-day costs in Finland. In the figure, the energy cost of gasoline is also represented from two points of view: power and heat. The costs of gasoline mechanical energy and heat are calculated according to

$$C_{gm} = C_g / \rho_g / E_g / \eta_{ICE} \text{ and} \quad (1)$$

$$C_{gh} = C_g / \rho_g / E_g. \quad (2)$$

In (1)  $C_{gm}$  presents the cost of mechanical energy (EUR/kWh) produced by a gasoline internal combustion engine (ICE) and in (2)  $C_{gh}$  presents the cost of heat produced by gasoline. In (1) and (2)  $C_g$  is the price of the gasoline (EUR/l),  $\rho_g$  is the density of gasoline (kg/l) and  $E_g$  is the lower heating value of

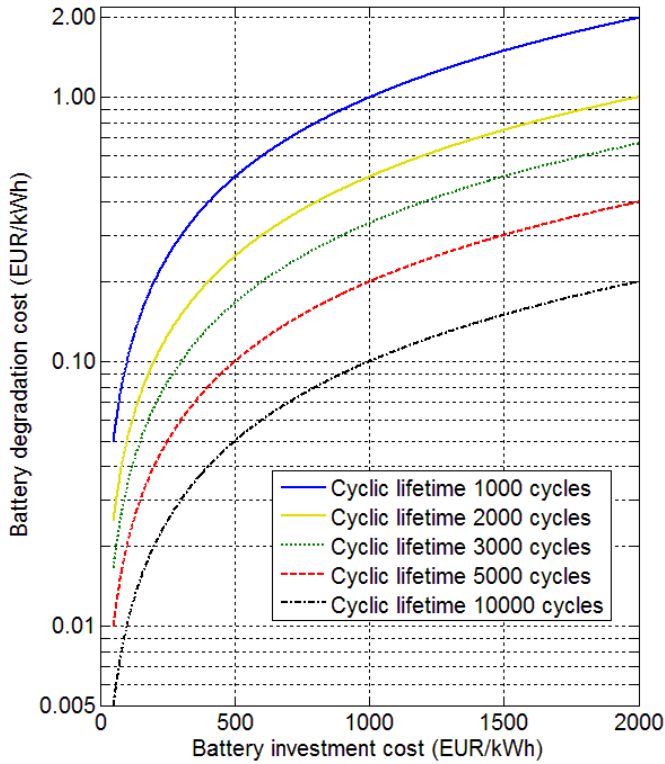

Figure 1. Battery degradation costs as a function of cyclic lifetime and battery investment cost.

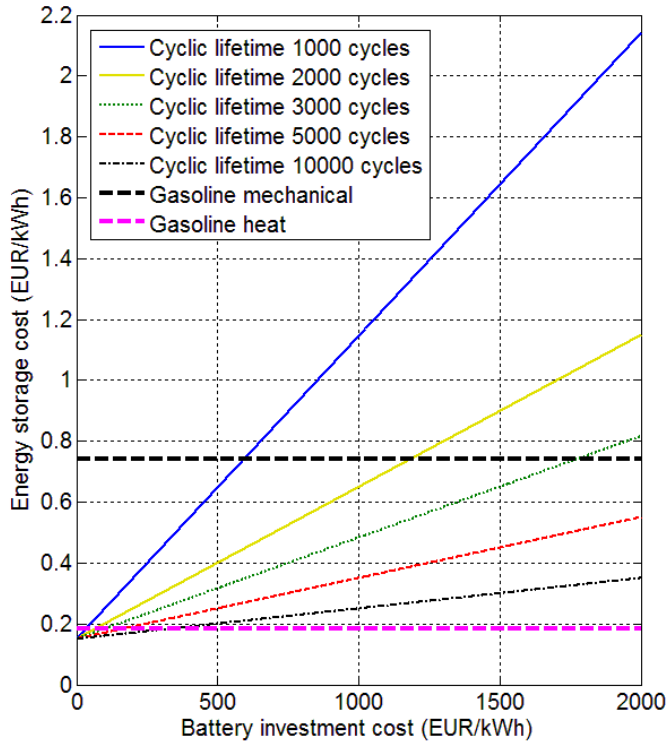

Figure 2. Energy storage costs as a function of batteries' cyclic lifetime and investment cost. Electricity cost is also included. Cost of gasoline mechanical energy and heat also are presented for comparison.

gasoline (kWh/kg), and in (1)  $\eta_{ICE}$  is the thermal efficiency of an ICE. In the calculated values of Fig. 2, the values of the previous parameters are presented in table I. It can be seen that when comparing the costs of gasoline and the degradation cost of the batteries together with the electricity price, some batteries might be competitive when compared to gasoline ICE. It should be noted that during cold weather the waste heat of the ICE is used to heat the car interior depending on the outside temperature and cabinet heating demand. In this case the real cost of the useful gasoline energy is somewhere between the cost levels of mechanical and thermal energies. It should be noted that previous calculations are simple, and the real cost structure is more complicated.

These types of theoretical marginal cost calculation principles have certain drawbacks. Let us consider life cycle costs by means of a simple example. A plug-in vehicle has an effective battery capacity of 20 kWh, which roughly corresponds to 100 km electric driving range. The battery pack has a cyclic lifetime of 3,000 full cycles which corresponds to total electric driving range of 300,000 km. The average daily driving distance of Finnish cars is about 50 km, which is roughly 18,000 km/a. If all of the driving would be made using electricity, which is very hard to realize in practice [15], the total electric driving range could be "consumed" in 17 years on average. The estimated calendar lifetimes of today's lithium-ion batteries and also plug-in vehicles are typically less than 17 years. This means that over the course of a plug-in vehicle's lifetime, part of the battery capacity will not be used. From this point of view, the battery degradation cost of a moderate amount of V2G use can be considered practically zero if there is no significant battery after-car-life market. There have been some ideas about the possible use of batteries in for example power system applications after having been used in cars, but safety and reliability characteristics of reused batteries may have been decreased significantly. Thus, the secondary battery market can be quite small also in the future.

TABLE I. THE PARAMETERS OF THE GASOLINE COSTS OF FIG. 2

Parameter	Value
$C_g$	1.7 EUR/l <sup>a</sup>
$\rho_g$	0.75 kg/l [16]
$E_g$	12.2 kWh/kg [16]
$\eta_{ICE}$	0.25 [16]

a. Typical gas station price in Finland in 2012

The owners or the users of the cars have certain preferences with relation to the use of the car. The vehicle should be charged to full charge at some stage. If the battery pack was "unexpectedly" discharged during the charging process, the state-of-charge (SOC) of the battery pack would temporarily be decreased and vehicle users would have to accept this. Of course it is possible to construct some kind of a charging system which optimizes the charging taking into

account car use preferences, dynamic energy pricing and ancillary service profits. Users may set the charging system to charge the battery pack to full charge at a certain time at the latest and within that time-frame some optimization could be made.

Using the batteries as power system storages sets some requirements for the car and its electrical interface. In order to use a vehicle as energy storage for the need of the power system, a bidirectional converter to the car or an external module with appropriate protection equipment is needed [4]. Also, energy meters should be able to handle two-way energy flows. Car storages could be discharged to public distribution networks (Vehicle-to-grid – V2G) or to small isolated network islands such as single households (Vehicle-to-home – V2H). These energy storage operation modes differ from each other in some ways. For example, the required protection and other requirements for the network interfaces are different [4].

### III. ANCILLARY SERVICES

As presented in [4] plug-in vehicles can be used to produce different services to several parties. A possible concept to realize this kind of flexible and versatile system is that there would be an aggregator or a service provider who would offer an interface between customers and different parties. The aggregator would make contracts with small and medium size energy users and it would lump the DERs into larger entities and offer services produced by these entities to different parties. The aggregator would also carry out the control actions and supervise and monitor the DERs and their use. In this concept the energy users would make the final decision concerning the use of their DERs in a form of contracts with the aggregator. Thus, in addition to asking energy contract bids from energy retailers, which is already done today, customers could also ask for bids from the “ancillary service market” through the aggregator to maximize the utilization rate of their DERs’ elasticity capability and thus minimizing their energy costs. The realization of different services would be as automated as possible to minimize the customer effort and maximize customer comfort.

In this paper we deal only with services produced for the needs of the electricity distribution networks. By electricity distribution networks we mean the networks owned by the distribution network operators and the private networks of the owners of the real estates or parking places.

Fig. 3 presents a concept which could provide different services for customers themselves and for the DNOs. Some services are also mentioned in the figure. The aggregator collects the DERs and can offer different services to different DNOs. DNOs monitor their networks using distribution management systems (DMS) and automatic metering infrastructure (AMI) and inform the aggregator about the need for a service. The aggregator makes sure that the service is provided in the energy users’ properties or premises. In domestic customers there is some kind of a Home Energy Management System (HEMS) which is comparable to a home automation system. It can control the DERs of the property.

There might also be small-scale distributed generation (DG) such as solar panels in the real estate. The control actions required to realize the services can be made locally near the DER or remotely using a communication system [5]. The first mentioned case can also include a possibility for the aggregator to pass setting values and parameters for the local controllers via a communication system [5]. In the following, the different services mentioned in Fig. 3 are discussed.

#### A. Peak load management

##### 1) Motivation

There might be several drivers for the network customers to restrict the powers in their networks.

The electricity grid connections of properties have limited current capacities which are determined by the rating of the main fuses. A common main fuse size in a Finnish detached house is 3×25 A. The maximum current capacity can be exceeded due to a charging load especially with high charging powers. In addition to exceeding the rating of the main fuses, plug-in vehicle charging can also cause exceeding of the maximum current levels of some parts of the internal network. Maximum current capacities can be exceeded in today’s preheating feeders in the parking places of row houses or apartment houses if a large number of slow chargers are connected simultaneously. The capacity of the network connection can be enhanced by enlarging the rating of the main fuses, but this brings additional costs and if applied broadly, it can lead to extra network enforcement investments for the DNO and hence to an increase in transfer tariffs. If the capacity of some parts of the internal network is not sufficient network upgrades are needed.

In addition to restricted current capacity a possible application of demand tariffs in electricity distribution may offer incentives to restrict the peak load of a network connection. If the transfer tariff is based totally or partly on the peak power, for example the highest hourly mean power of the network connection, some financial savings can be achieved by management of peak loads.

Another incentive for peak load restriction could come from the needs of other services. For example, the “network power flow management” service discussed in section III.B can be realized with a load restriction system. If the load level of some part of a network should be temporarily decreased, this could be achieved by using this kind of a load management method. Thus, a DNO could encourage households and other consumers to reduce load for a while.

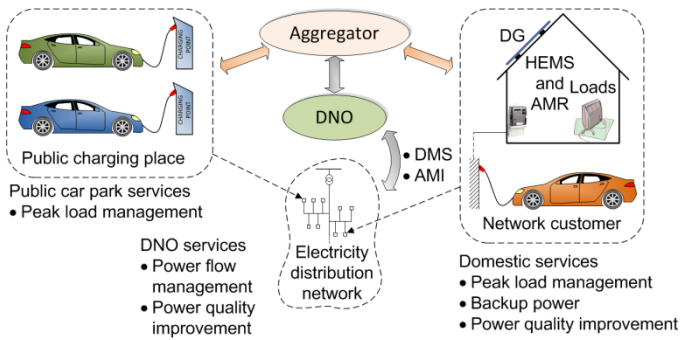

Figure 3. Aggregator driven DER service concept.

Public parking places which have plug-in vehicle charging spots might also be willing to apply some kind of peak load reduction methods. For example, there is a certain amount of charging spots in a parking area. If only a part of the charging spots are in use, it could be possible to allow these spots to use a higher charging power than in a situation where all the spots were in use. The highest allowed charging powers of different charging spots could be adjusted dynamically in accordance with the total power need of the parking area. In this way the customers could be served better and the utilization rate of the charging infrastructure could be increased.

## 2) Methods

There are several methods which could be used to manage peak loads. Today in Finnish detached houses, electric space heaters (total amount is usually some kilowatts depending on the size of the house etc.), electric sauna stoves (typically 4–11 kW), which are very common in Finland and storage water heaters (typically 1.5–6 kW) are often alternating with each other to restrict the peak power of a household. When for example a sauna stove is switched on, some space heaters are automatically switched off. These kinds of alternating systems could be extended and applied to the charging of a plug-in vehicle [5]. The simplified principle of this kind of a system is presented in Fig. 4 and Fig. 5. Also, it is possible to use a plug-in vehicle as a network's energy storage in order to manage peak load. This means that energy is stored in the vehicle battery pack and later this energy is fed back to the network during time when energy needs of other loads are high.

Peak load management methods can be divided into two types: load alternation and load adjustment. In alternation methods, loads can be switched off and on in accordance with different control principles. In load adjustment methods the load current of some loads is restricted instead of off-on-switching. It would be possible for example to switch the charging mode from semi-fast (~10 kW) to slow (~3 kW) or to modify charging current more freely. It is also possible to feed power from the vehicle to the network in order to manage peak load. This feeding current or power could also be freely adjusted. Load adjustment requires communication between a "peak load controller" and the chargers.

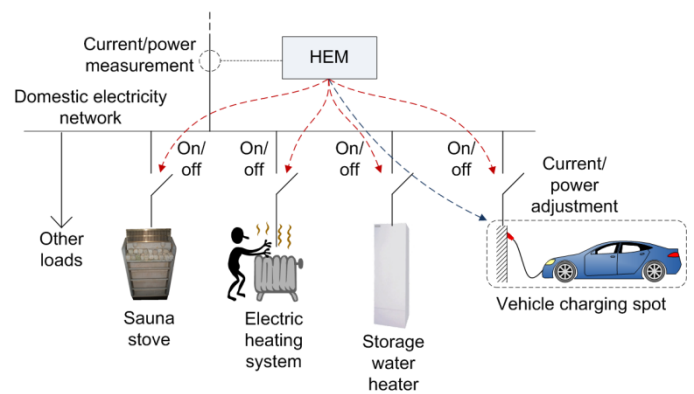

Figure 4. The simplified principle of a peak load management system of detached houses.

Peak load management methods can be divided into two different groups also from another point of view: methods in which the total current or power, for example the current or power of the connection point of a property or a parking place, is measured, and methods without the measurement. This is illustrated in Figures 4 and 5. If the total current/power is measured, loads can be controlled dynamically depending on the marginal between on the measured value and the maximum value.

There are many boundary conditions in peak load management methods which have to be taken into account. When loads are switched off or the energy they receive is restricted by some other way, the harm caused by the load control cannot be too severe. Also the battery packs of the plug-in vehicles cannot be strained too much. And of course, the expected financial savings caused by the current restriction system must be higher than the investment costs of the system.

## B. Network power flow management

### 1) Motivation

A possible ancillary service is network power flow management. The aim of this service is to manipulate the power flow of the distribution network in order to reach different goals. One goal could be to clip the power peaks in the networks in order to delay or avoid network investments. Network power flow management could also be used to manage special situations such as disturbances. During a network disturbance, the power flow of a network could be manipulated to ensure the sufficiency of a back-up connection's capacity. In this way power system reliability could be improved. Another temporary special situation might be such that there is lot of renewable DG in the network and it would be necessary to restrict the generation for short times due to voltage rise problems. An option for this could be to increase the network load for a while and thus maximize the power production of DG plants.

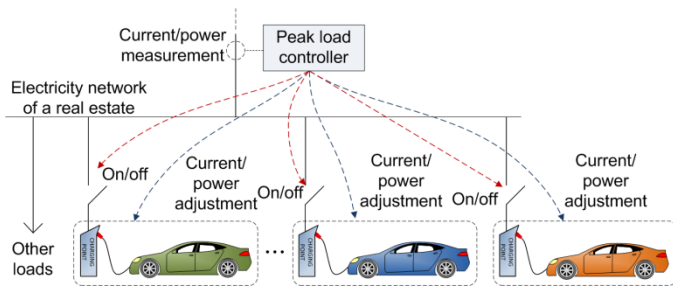

Figure 5. The simplified principle of a peak load management system of different types of parking places.

This type of service can be realized for different degrees of scale. The DNO does not have to manage the whole distribution network but it could be possible to manage only a part of it: for instance a single problematic medium voltage feeder or distribution transformer can also be the target of this service.

## 2) Methods

These types of services can be realized in different ways. One possibility is to use control based on local information. For example, load could be shifted rigidly in accordance with the time of day and type of day. In addition to pure time shift of the loads, load adjustment can be used. In this case the power drawn by the loads is controlled as a function of time to achieve a desired load profile. The timing of different loads can be different so that big power demand peaks are avoided. Time control, although based on local information, does not have to be static and rigid. The method can be dynamic and flexible in many ways. For example, it would be possible to adjust the timing process of plug-in vehicle charging in accordance with the state-of-charge of the battery packs. This would of course require an agreement between the car owners.

More sophisticated and flexible network power flow methods are based on state estimations of the network and can operate extensively in different network states. In [17] a real-time management of low voltage network using DERs controlled by HEMSs is studied. The algorithm, which gives a good view on the requirement of these kinds of systems, works roughly as follows.

First a state estimation of the distribution network is made. The state estimation of radial networks estimates currents and voltages in all phases and all parts of the target network and is based on static network data and the latest real-time measurements received from DMS and AMI. The DNO has the complete model of the distribution network up to the single final LV customer in the network information system. The calculation results of state estimation are compared to the operational limits of network components. If some thresholds are exceeded, the location of the problem is then found, the location of controllable resources capable to solve the problem are looked for and finally the operational commands (e.g. to reduce power flow) are sent to selected network customers. Load-flow algorithm is used to check the validity of control decisions from the electrical engineering viewpoint. The

control commands are sent to the network customers with controllable DERs. The control command includes the following information:

- What kind of control is expected (reduction or increase of demand/production).
- When control may be released or will the system also send the release command.
- How much control is needed (total control need is shared among the available and suitable control resources).
- Where the control should be realized (identification of correct control resources).

The location, availability, resource size, etc. information of DERs in network customers' properties is managed by HEMS. HEMS aggregates the DER information and sends it to the aggregator. The final decision of how the control need of a single HEMS is shared to individual DERs is made by HEMS because the customer may want to prioritize the utilization of resources and the most recent information about DER availability and controllability is in HEMS. The prioritization of DERs might also depend on external factors like outside temperature or predefined conditional situations like plug-in vehicle charging or the presence of high-consumption home appliances such as electrical sauna stove.

In this kind of a system the DNO must be sure that the resources can be used for many years for network management purposes. The system must be reliable enough and its performance must be credible.

## C. Customer back-up power

### 1) Motivation

Today's way of living is highly dependent on reliable electricity distribution. In recent years, there have been many serious storms in Finland which have caused long lasting outages for a large amount of electricity users. The reliability of electricity distribution is improved all the time, but outages will always be possible at least to some extent.

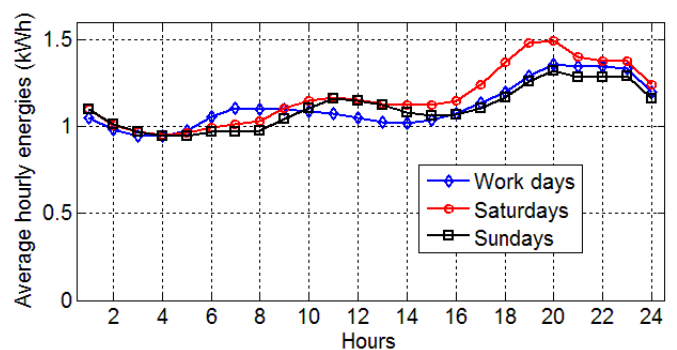

Figure 6. Average hourly energies during different types of days of a 1000 random customers with a  $3 \times 25$  A main fuses in the distribution network of Koillis-Satakunnan Sähkö Inc.

Plug-in vehicles could be used as a back-up power source during outages. The battery pack would be then used as an energy storage feeding a small network island such as a single household. Also, in the case of a PHEV, the internal combustion engine might also be used to produce electricity from a liquid fuel. The energy capacity of the battery pack is very limited which means that all the energy need of for example a detached house cannot be covered for a long time. However, if the largest loads such as electric heaters and storage water heater were switched off, the sufficiency of the battery capacity would be much higher. If only a very limited amount of loads such as some lighting and maybe cellular phone or laptop charging would be allowed, the battery capacity would offer back-up power capability for a fairly long time. Fig. 6 shows average hourly energies which are measured in 2010 during different types of days of a 1000 random customers with a  $3 \times 25$  A main fuses in the distribution network of Koillis-Satakunnan Sähkö Inc. The customers of the figure are of different types and also customers with electric heating are included. This simple illustrative example figure shows that with a battery pack from which a few kilo-watt-hours could be used for back-up power purposes, fairly long back-up power capability times could be achieved especially if some of the largest loads were disconnected from the network.

## 2) Methods

To realize the plug-in vehicle back-up power service, some special equipment and systems would be needed. Fig. 7 illustrates some features of such a system. One requirement is an isolation switch, which is used to disconnect the household or another small network island from the public distribution network. This isolation has to be made because the plug-in vehicle cannot feed other households or customers connected to the public distribution network. Depending on the preferences defined by the user of the back-up power service, it might also be preferable that the electricity connection of the vehicle to the electricity network is three-phased (cf. Fig. 7). Otherwise it would be necessary to connect the loads to be fed to a certain phase. Some load reduction may be necessary to ensure that the power capability of the converter, the line and the energy capability of the battery are sufficient. This requires load disconnection made by HEMS. Assuming that the vehicle works as the only power source (unless there is some sort of small scale power production) during back-up power operation, the feeding equipment has to include all necessary control and protection functions somewhat similar to the ones found in conventional power systems [4]. This comprises voltage control, high enough short circuit current capacity, short circuit protection etc. HEMS and the switching equipment have to include a small battery back-up or other type of back-up power to realize the necessary switching and communication actions during an outage.

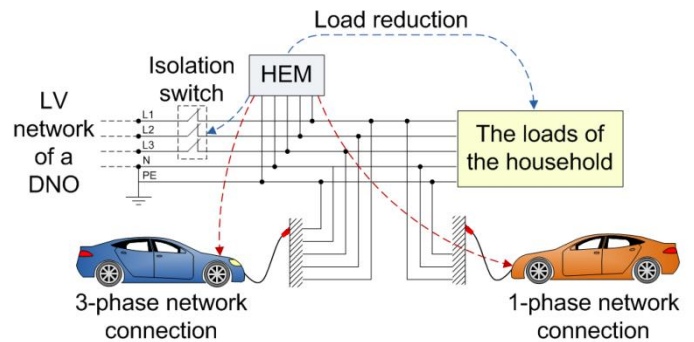

Figure 7. Realization of the customer back-up power service.

The back-up power operation could be automated, but even manually controlled systems can have a significant value during long outages. Automatic operation of the isolation switch and automatic control of the converters of the vehicle are needed. The transfer into back-up power mode could be made with a short interruption or voltage dip, or totally seamlessly. The transfer to back-up power mode after an outage and returning on the basic mode (electricity transfer from distribution network) after the outage could be carried out as follows (cf. also Fig. 7).

1. When an outage is detected in the network by HEMS, the isolation switch has to be opened automatically.
2. After the isolation, necessary load reductions have to be made.
3. “Start back-up power operation” command has to be sent to the converter of the vehicle. Converter starts to feed the loads.
4. When the end of the outage is detected, a “stop back-up power operation” command has to be sent to the vehicle converter.
5. The isolation switch has to be closed.
6. Loads which were disconnected have to be reconnected to the network.

## D. Power quality improvement

The importance of power quality issues increases all the time. The significance of good power quality and the amount of the sources of bad power quality increase. Plug-in vehicles could produce a power quality improving service either for an individual network customer or to a DNO. Power quality improvement may mean mitigation of voltage dips, harmonics, flicker and asymmetry in the network.

Using appropriate converter technology in a battery charger, it is possible to adjust the phase specific loading of a three-phase charger to participate in the mitigation of the asymmetry. This could be done based on locally measured voltages of different phases. Chargers would adjust their phase specific loads to mitigate negative sequence component of the voltages. Also, the use of the car converter as an active filter mitigating flicker and harmonics might also be possible. Individual households could use their vehicles to mitigate



voltage dips at their network connection. If a voltage dip occurs, the vehicle could feed energy to the network in order to mitigate the dip.

#### IV. CONCLUSIONS AND FUTURE WORK

In this paper, we have investigated possibilities of plug-in vehicles to produce ancillary services for distribution networks. First, special features of plug-in vehicles as a controllable resource were discussed and then motivation and methods of four different types of ancillary services were discussed. These services are peak load management, network power flow management, customer back-up power and power quality improvement. In the beginning of the plug-in vehicle market penetration many of the ancillary services are not reasonable due to low volume, but when penetration level increases, different ancillary services might become economically attractive.

However, working business models has to be created to realize these kinds of ancillary services. The owners of the vehicles and other controllable resources have to have high enough economic incentives to participate in the ancillary service market. Also, the flexibility and the volume of the resources have to be high enough to be used in ancillary services.

In this paper, the services are only generally overviewed. Deeper investigations with cost analyses, business models and control method developments as well as network simulations and analysis should be made. Also, demonstrations in laboratory environment and pilots in real environment should be carried out.

#### REFERENCES

- [1] S. C. Davis, S. W. Diegel and R. G. Boundy, "Transportation energy data book: Edition 31". Oak Ridge National Laboratory, 2012, 423 p.
- [2] R. Lache, D. Galves and P. Nolan, "Vehicle Electrification, More rapid growth; steeper price declines for batteries". Deutsche Bank, Global Markets Research, 2010.
- [3] R. Hensley, J. Newman and M. Rogers, "Battery technology charges ahead", McKinsey Quarterly, Jun. 2012, 4 p.
- [4] A. Rautiainen, C. Evens, S. Repo and P. Järventausta, "Requirements for an interface between a plug-in vehicle and an energy system", in Proc. of IEEE Powertech 2011, Trondheim, Norway, 8 p.
- [5] A. Rautiainen, S. Repo and P. Järventausta, "Intelligent charging of plug-in vehicles," in Proc. NORDAC 2010 9th Nordic Electr. Distrib. Asset Manage. Conf., Aalborg, Denmark.
- [6] E. Sortomme, M. M. Hindi, S. D. J. MacPherson and S. S. Venkata, "Coordinated charging of plug-in hybrid electric vehicles to minimize distribution system losses," IEEE Trans. Smart Grid, vol. 2, pp. 198–205, Mar. 2011.
- [7] E. Sortomme and M. A. El-Sharkawi, "Optimal charging strategies for unidirectional vehicle-to-grid," IEEE Trans. Smart Grid, vol. 2, pp. 131–138, Mar. 2011.
- [8] K. Clement-Nyns, E. Haesen, J. Driesen, "The impact of charging plug-in hybrid electric vehicles on a residential distribution grid," IEEE Trans. Power Syst., vol. 25, pp. 371–380, Feb. 2010.
- [9] R.A. Verzijlbergh, M. O. W. Grond, Z. Lukszo, J. G. Slootweg and M. D. Ilić, "Network Impacts and Cost Savings of Controlled EV Charging," IEEE Trans. Smart Grid, vol.3, pp.1203-1212, Sep. 2012
- [10] C.-K. Wen, J.-C. Chen, J.-H. Teng, and P. Ting, "Decentralized Plug-in Electric Vehicle Charging Selection Algorithm in Power Systems," IEEE Trans. Smart Grid, vol.3, no.4, pp.1779-1789, Dec. 2012
- [11] O. Sundstrom and C. Binding, "Flexible Charging Optimization for Electric Vehicles Considering Distribution Grid Constraints," IEEE Trans. Smart Grid, vol.3, no.1, pp.26-37, March 2012
- [12] P. Richardson D. Flynn, and A. Keane, "Local Versus Centralized Charging Strategies for Electric Vehicles in Low Voltage Distribution Systems," IEEE Trans. Smart Grid, vol.3, no.2, pp.1020-1028, June 2012
- [13] P. Sánchez-Martín, G. Sánchez, and G. Morales-España, "Direct Load Control Decision Model for Aggregated EV Charging Points," IEEE Trans. Power Systems, vol.27, no.3, pp.1577-1584, Aug. 2012
- [14] W. Jewell, P. Gomatam, L. Bam, R. Kharel, "Evaluation of Distributed Electric Energy Storage and Generation", Final Report for PSERC Project T-21. PSERC Publication 04–25, Power Systems Engineering Research Center.
- [15] A. Rautiainen, S. Repo, P. Järventausta, A. Mutanen, K. Vuorilehto, and K. Jalkanen, "Statistical Charging Load Modeling of PHEVs in Electricity Distribution networks Using National Travel Survey data", IEEE Trans on Smart Grid, vol. 3, no. 4, Dec. 2012, pp. 1650-1659.
- [16] Y. A. Cengel, M. A. Boles. "Thermodynamics, An Engineering Approach", fifth edition in SI units, McGraw-Hill, 2006, 946 p.
- [17] S. Repo et al., "Use Case Analysis of Real-Time Low Voltage Network Management", proceedings of the 2nd IEEE European conference and exhibition on Innovative Smart Grid Technologies (ISGT-EUROPE 2011), Manchester, UK, 8 p.

## **Publication 7**

A. Rautiainen, and P. Järventausta. "Load control system of an EV charging station group", *in proc. of Nordac 2014*, Stockholm, Sweden, 11 p. ***The approved version.***



## **Load Control System of an EV Charging Station Group**

**Antti Rautiainen and Pertti Järventausta**  
**Tampere University of Technology**  
**Department of Electrical Engineering**  
**antti.rautiainen@tut.fi**

### **SUMMARY**

When multiple AC electric vehicle charging stations are planned to be installed in a parking hall or other place, a certain issue always arises. If there are many EVs charging simultaneously using high powers/currents, the total peak powers/currents of the cables feeding the charging station group or in the network connection can rise to an extremely high level which leads to needs for very thick cables and/or large main fuse sizes. From the cost effectiveness point-of-view, this is not desirable. However, the widely respected standardized charging method “mode 3” (defined in IEC 61851-1) enables controlling the maximum charging current of an individual charging station, and a control system controlling the total load of a charging station group can be made. In this paper, corresponding control methods are discussed in general, and an example of a practical and generic control algorithm is presented and simulated in detail. The algorithm can be used also for other load control purposes besides management of the sizes of cables and main fuses. The simulation shows that the algorithm works efficiently and is flexible in different operational situations.

### **KEYWORDS**

Electric vehicles, plug-in hybrid electric vehicles, charging station, load control, demand response

## 1. INTRODUCTION

Today's society is too dependent on oil, and there might be "cheap oil" in the ground less than many people expect [1]. Also, there is a need to reduce the air quality related tail pipe emissions of cars especially in large cities [2]. In addition to these there is also a need to reduce the greenhouse gas emissions of the transportation system in order to participate in the climate change mitigation. Electric vehicles (EVs), both plug-in hybrid electric vehicles (PHEVs) and full electric vehicles (full EV), could be used to partly contribute to these challenges. In the last few years almost all car manufacturers have launched some kind of EVs to the market, and it is widely expected that these vehicles will be "permanently" part of the road transportation system at least to some extent. Of course there are still some challenges in the wide penetration of EVs to the road transportation system which has to be tackled [3].

An EV has to be charged using a charging station or at least a socket. The widely respected international standard IEC 61851-1 defines four different charging modes, and in practice three of them are used in commercial electric passenger vehicles today: mode 2, mode 3 and mode 4. In modes 2 and 3, the charger is in the vehicle and AC voltage and current are fed to the car. In mode 4 DC voltage and current are fed directly to the high voltage battery pack of the vehicle.

The first option is to use mode 2 charging. In Europe, this means that the regular "schuko" socket is used in the charging in most of the cases, and there is a so-called in-cable control and protection device (IC-CPD) in the charging cable. IC-CPD includes some safety functionalities such as a residual current device but it also restricts the charging current of the EV charger to a level (typically 6–10 A) which is safer to be used in domestic and other sockets. Typically every commercial EV is delivered to the consumer at least with a mode 2 charging cable.

The second option is to use mode 3 charging. In practice, this mode is preferred and recommended for the everyday use by the car manufacturers and different kinds of regulative and instructive organizations. Mode 3 enables charging currents from one-phase 6 A up to three-phase 63 A. Mode 3 charging includes many sophisticated, such as safety related, functionalities, but also a possibility to control the maximum current which the vehicle can draw from the socket. It should be noted that only the maximum current level can be set, and the charger itself decides the actual charging current below the limit. In addition to the normal power conductors, mode 3 sockets also include two additional conductors for control and protection purposes: control pilot (CP) and proximity pilot (PP) conductors. The control of the maximum current is made using an analog pulse width modulated (PWM) voltage signal between the control pilot and earth conductors. The maximum current level can be adjusted between 6A and 63 A, and the charger of the car obeys this limit. For mode 3 there are standardized sockets and plugs which are dedicated to EV charging. These sockets and plugs are standardized in IEC 62196 standard family. In Europe, the de facto standard is "type 2" ("Mennekes") socket.

The third charging option is mode 4. This means that the off-board charger feeds DC voltage and current directly to the battery pack of the car, and the car controls the charging voltage and current during the charging. When the charger is an off-board one, it is possible to use very high charging powers. Typically mode 4 charging powers have nominal powers up to 50 kW, but there are also 20 kW chargers available. DC charging is very useful in cases where the battery pack of the car is large and one needs to have battery charged within an hour. The charging current of the car can also be restricted with mode 4 charger by the charging station.

When multiple electric vehicle charging stations are planned to be installed in a parking hall or other place, a certain issue always arises. If there are many EVs charging simultaneously using high powers/currents, the total peak powers/currents of the cables feeding the charging station group or in the network connection can rise to an extremely high level which leads to needs for very thick cables and/or large main fuse sizes. From the cost effectiveness point-of-view, this is not desirable. It might be therefore reasonable to control the total currents of a charging station group. This paper focuses on these kinds of systems. In addition to the cable and main fuse optimization, there might also be some other types of needs for such a control system such as electricity contracts with dynamic pricing [4], distribution tariffs with a power based component [5] and ancillary service opportunities [6]. This

paper, however, focuses on the cable and main fuse optimization incentive. The paper is organized as follows. In section 2, some general basic principles and requirements of an EV charging station group's load control system are discussed and a practical and generic algorithm is described. In section 3, the results of the algorithm simulation are presented. In section 4, conclusions are made and future work is proposed.

## 2. LOAD CONTROL SYSTEM

### 2.1 General aspects and features

EV charging can be controlled at least in two ways: by switching charging on/off (typically the only option for mode 2 charging) or by restricting the mode 3 (or mode 4) charging current as explained in section 1. On/off switching is simple to realize, but it has to be made in such a way that the control does not interfere the charging system of the car. For example, some models of mode 2 charging related in-cable-control-boxes do not necessarily continue charging automatically after they have been switched on after an off-switching period, i.e. a period without any voltage in the charging socket.

A load control system can be made in many ways and with different features and properties. The main structure is, however, illustrated in fig. 1. There is a group of  $N$  charging stations and a load controller unit which controls all of the charging stations in some way to manage the total load of the charging station group. In the figure 1, there is also the total current measurement of the feeder feeding the charging station group. Also, it is possible to measure the phase currents of each of the charging stations and send the data to the controller. In principle, it would be possible to construct a control system where the total currents or the currents of individual charging stations would not be measured at all, but this may lead to an inefficient system.

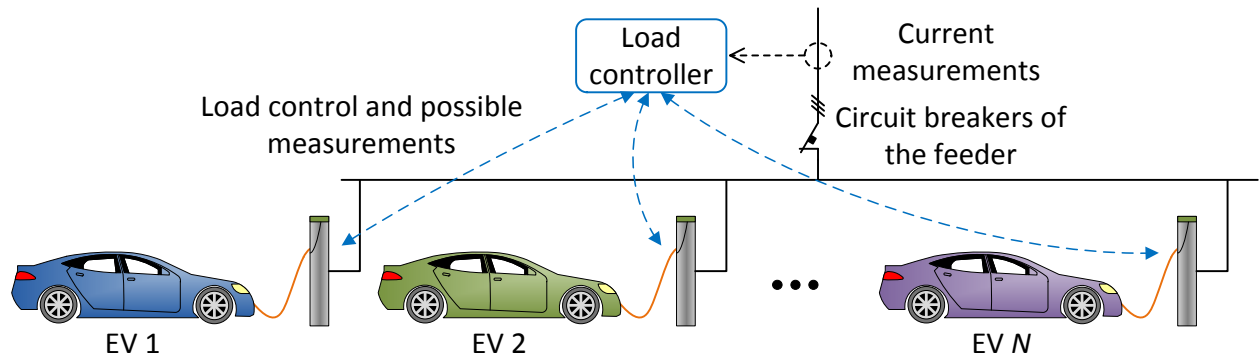

Fig. 1. The basic set-up of a load control system of charging station group.

How the electric circuits or feeders are constructed in very large parking and charging areas poses a question of its own. Typically a few charging stations are connected to a single cable and corresponding fuses and many of these kinds of subgroups exist in a parking area. In such cases the peak currents of the subgroups have to be managed separately in addition to the total current. Also, it is reasonable to circulate the phase sequences of three-phase stations and connection phases of one-phase stations in order to avoid "L1 syndrome", i.e. a situation where one of the phases is overloaded and two other phases carry a very low current. The risk might be realized as the commercial cars with one-phase chargers connect typically to the "L1 phase" of the vehicle inlet.

A real load control system should be fast enough to be able to handle all the situations where fast changes happen in a system. If one of the phase currents were to suddenly increase for some reason, the circuit breakers might open or fuses might blow if the load control system is not fast enough. Circuit breakers tolerate some overcurrent for a while, but the length of the overcurrent tolerant time depends on the amount of overcurrent and the protection device.

### 2.2 The simulated control algorithm

The purpose of the load control system simulated in the paper is to provide the chargers a very high current capacity as seamlessly as possible in every situation so that the total currents would still be

kept below a certain limit. It is assumed that the total current of the feeder and the currents of the individual charging stations are measured in real time and the measurement data is sent to the load controller. The simulated load control algorithm can control chargers using mode 2 and mode 3 charging. In mode 3 charging the pilot wire PWM communication is used to set the maximum current for the vehicle and in case of mode 2 charging is interrupted by disconnecting the charger from the grid. It is also possible to interrupt mode 3 charging using the communication. For mode 3 sockets, one-phase, two-phase or three-phase chargers can be used, and one-phase and two-phase chargers can be connected to any phase of the socket.

In brief, the main idea of the algorithm is as follows. Chargers are allowed to charge whenever needed even with the maximum current of the charging station, but if the total current of any of the feeding phases exceeds a certain predefined limit (the limit can be a parameter which can be changed in accordance of the situation), first restrict the currents of mode 3 chargers if it is possible to decrease the currents of the overloaded phases. If this is not possible or if it does not solve the problem, interrupt the charging of some of the chargers from the relevant phases. The interrupted chargers should be then circulated and alternated so that none of the chargers have to be interrupted for too long. The circulation time is a rigid 10 min.

The algorithm is designed to react to certain events. The essential events are as follows.

1. The current limit is exceeded in some phases.
2. The current capacity is freed in some phases.
3. An EV starts mode 3 charging.

The functions and procedures in the cases of the previous three events are described in more detail in the following flow charts (figures 2–4). The procedures triggered by the events also include some sub processes which are also introduced as flow charts. The flow charts do not describe all the details, but the essential ideas are covered.

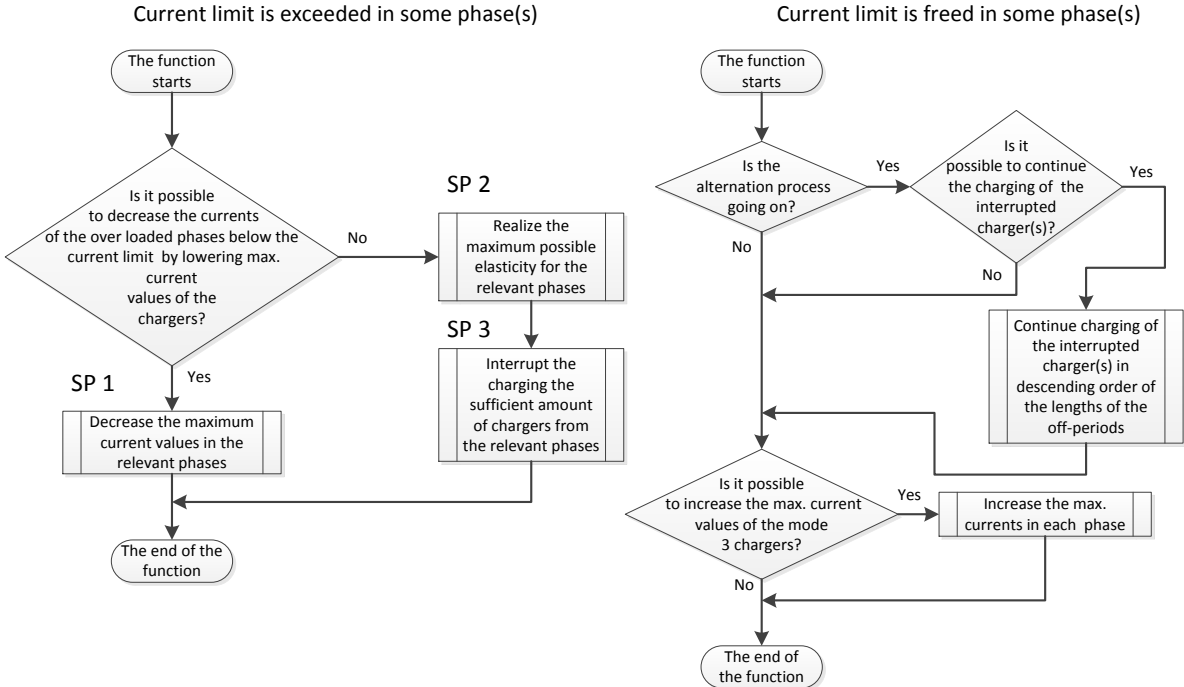

Fig. 2. Functions “Current limit exceeded in some phase(s) and “Current limit is freed in some phase(s)”.

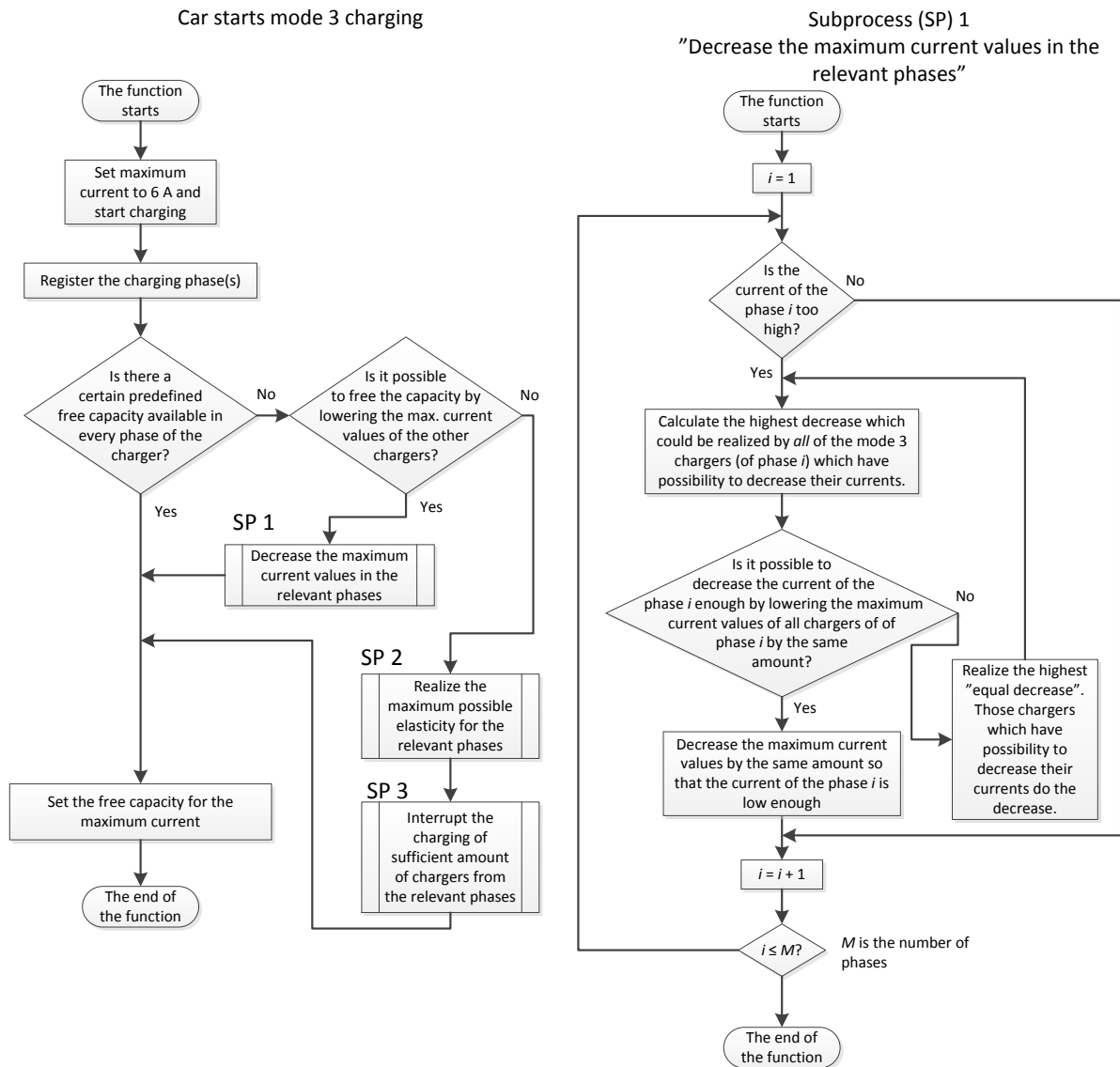
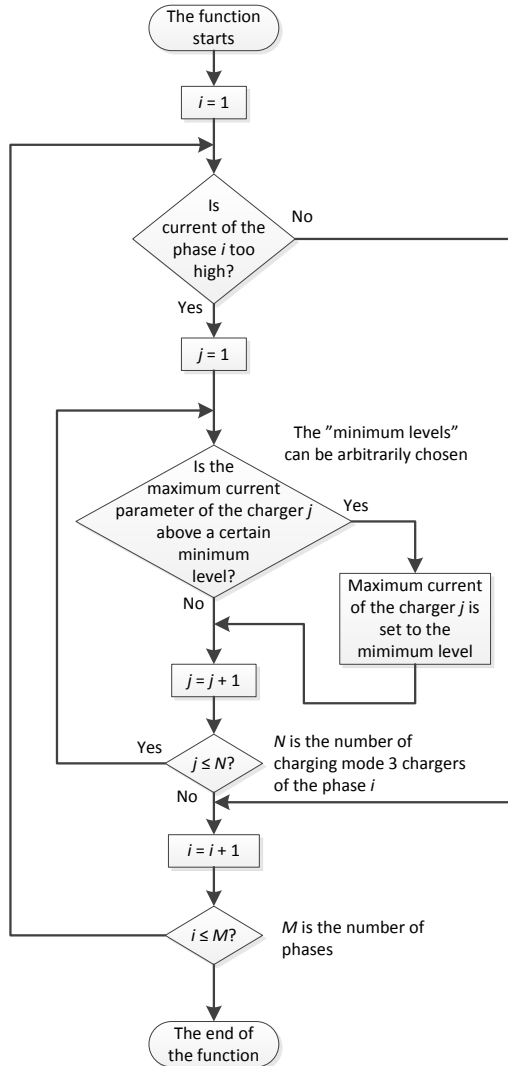

Fig. 3. Functions "Car starts mode 3 charging" and "Decrease the maximum current values in the relevant phases".



Subprocess (SP) 2  
 "Realize the maximum possible elasticity for the relevant phases"



Subprocess (SP) 3  
 "Interrupt the charging of sufficient amount of chargers from the relevant phases"

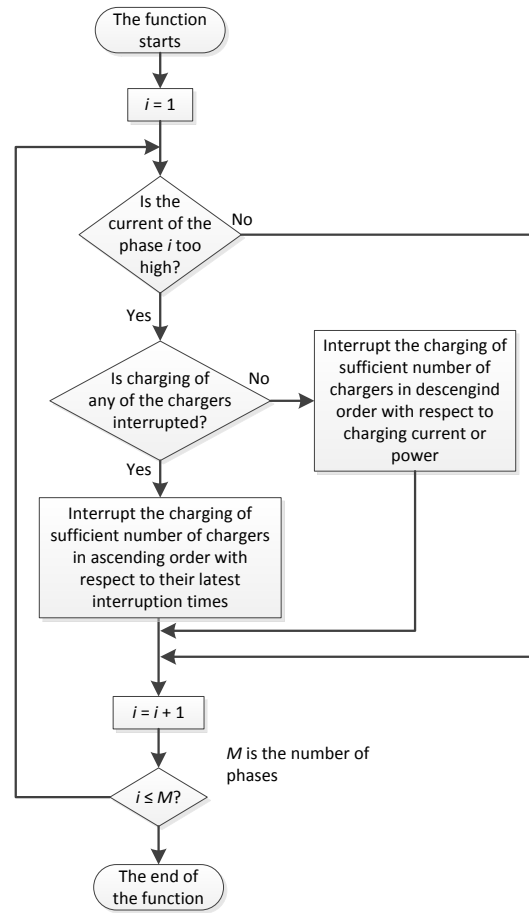

Fig. 4. Functions "Realize the maximum possible elasticity for the relevant phases" and "Interrupt the charging of a sufficient number of chargers from the relevant phases".

### 3. SIMULATIONS AND THEIR RESULTS

#### 3.1 Simulation case

The algorithm was simulated with a realistic use case. In the simulations the charging behaviors of 10 different EVs were modeled. Fig. 5 illustrates the charging station types and ratings of the EV chargers. There were 6 mode 3 charging stations and four Schuko plugs in which EVs were charged. The time in hours when the cars are plugged in to the charging station, the SOC of the battery pack (in red) at the first time of arrival and the decrease in SOC (in blue) in the beginning of the second charging session were illustrated in the figure. The simulations were made in 1 minute long time steps. Some "inter-minute" phenomena were also included in the simulation code, but the results were presented only on a minute level. In fig 14, also the circuit breakers for all of the phases are presented as the current limits.

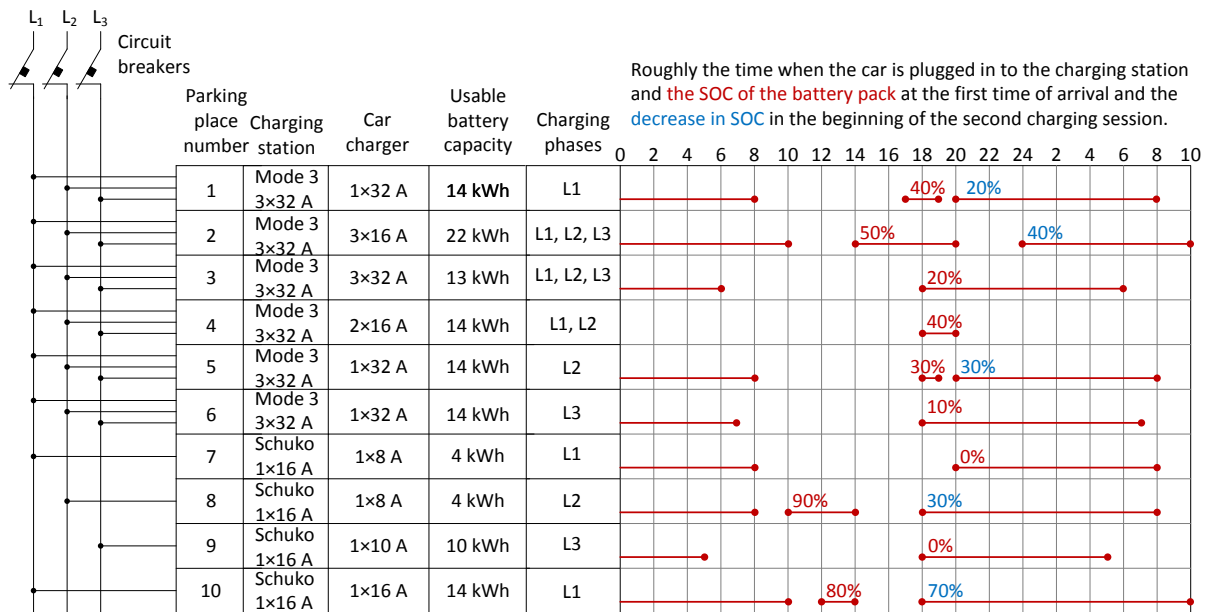

Fig. 5. The simulation case.

### 3.2 Simulation results

Four different simulations are presented in this paper. The simulations differ from each other in the current limit values. Current limits were “no limit”, 50 A, 32 A and 16 A. The results are presented in figures 6–11. From each current limit, two different figures are presented: phase currents and charging current of the cars. Charging currents of the cars are presented only for one phase, and if a charger is a multi-phase one, the same current is drawn from all of the phases.

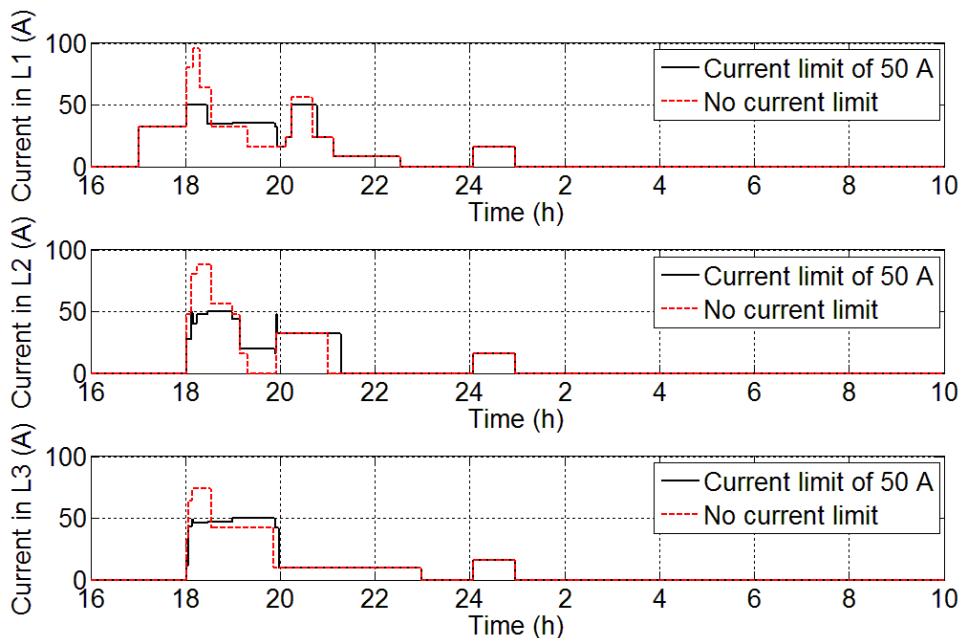

Fig. 6. Phase currents of the case “no current limit” and with a current limit of 50 A.

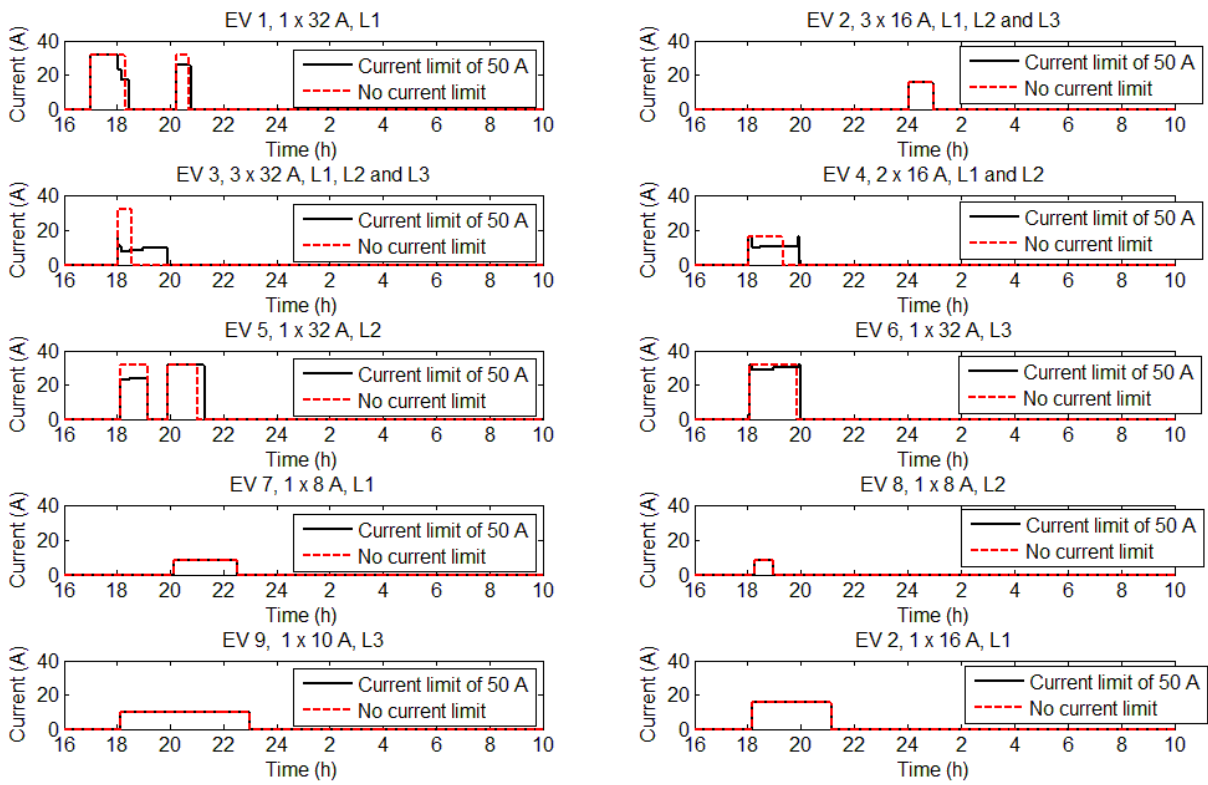

Fig. 7. Charging currents of the cars with no current limits and with a current limit of 50 A.

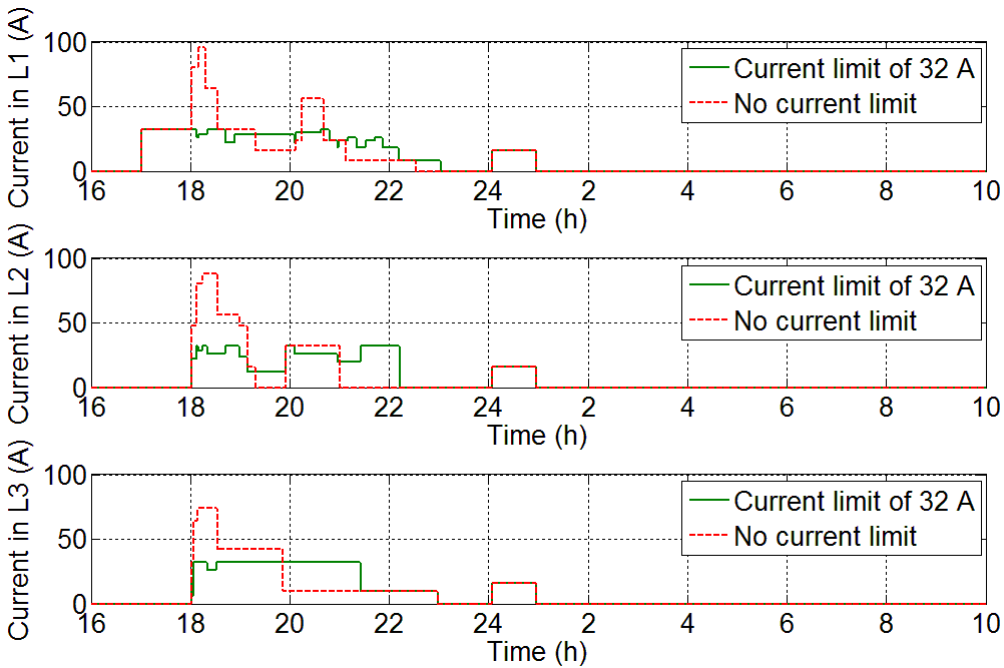

Fig. 8. Phase currents of the case “no current limit” and with a current limit of 32 A.

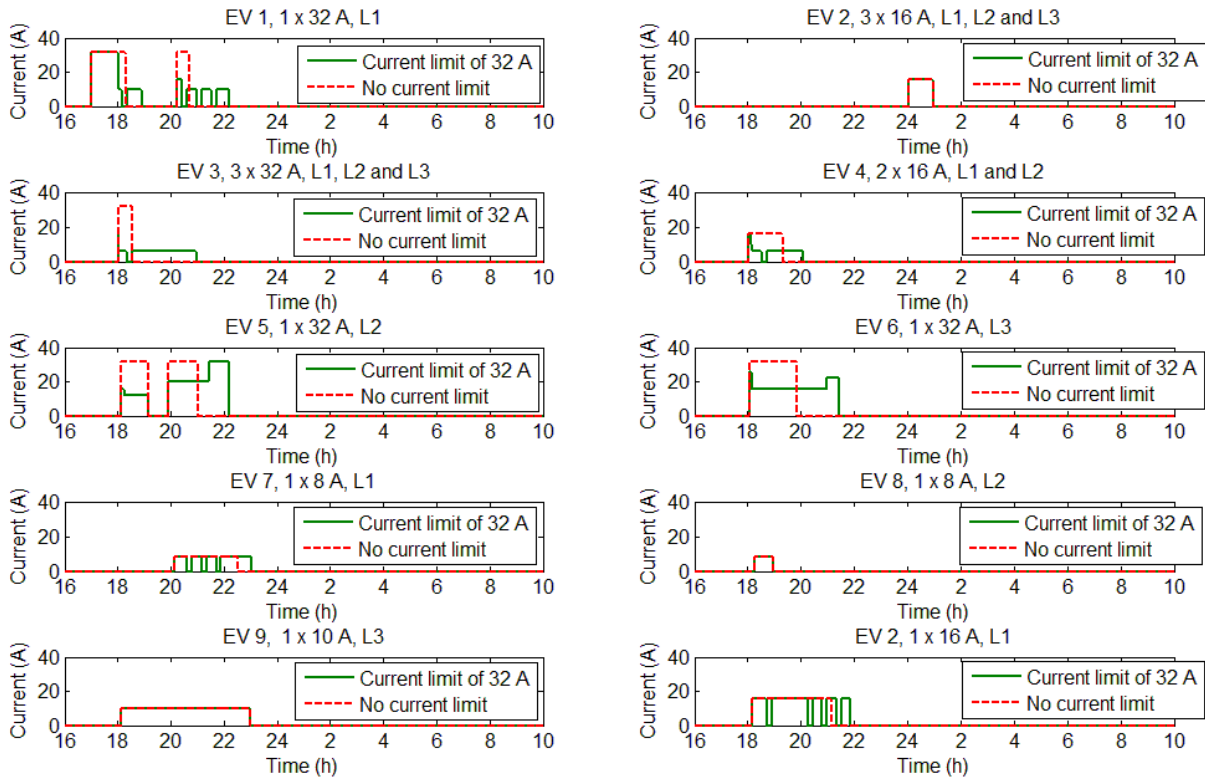

Fig. 9. Charging currents of the cars with no current limits and with a current limit of 32 A.

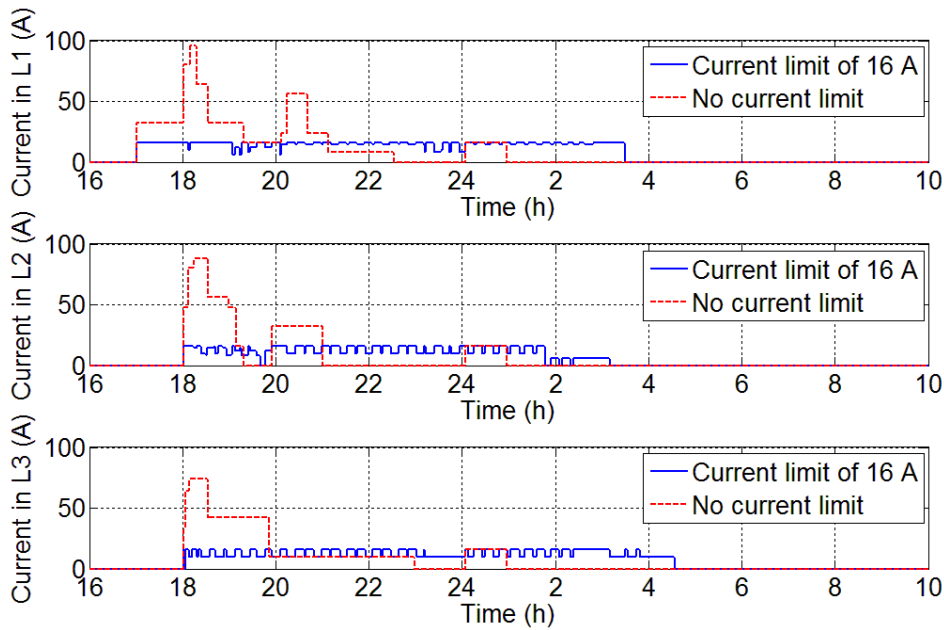

Fig. 10. Phase currents of the case “no current limit” and with a current limit of 16 A.

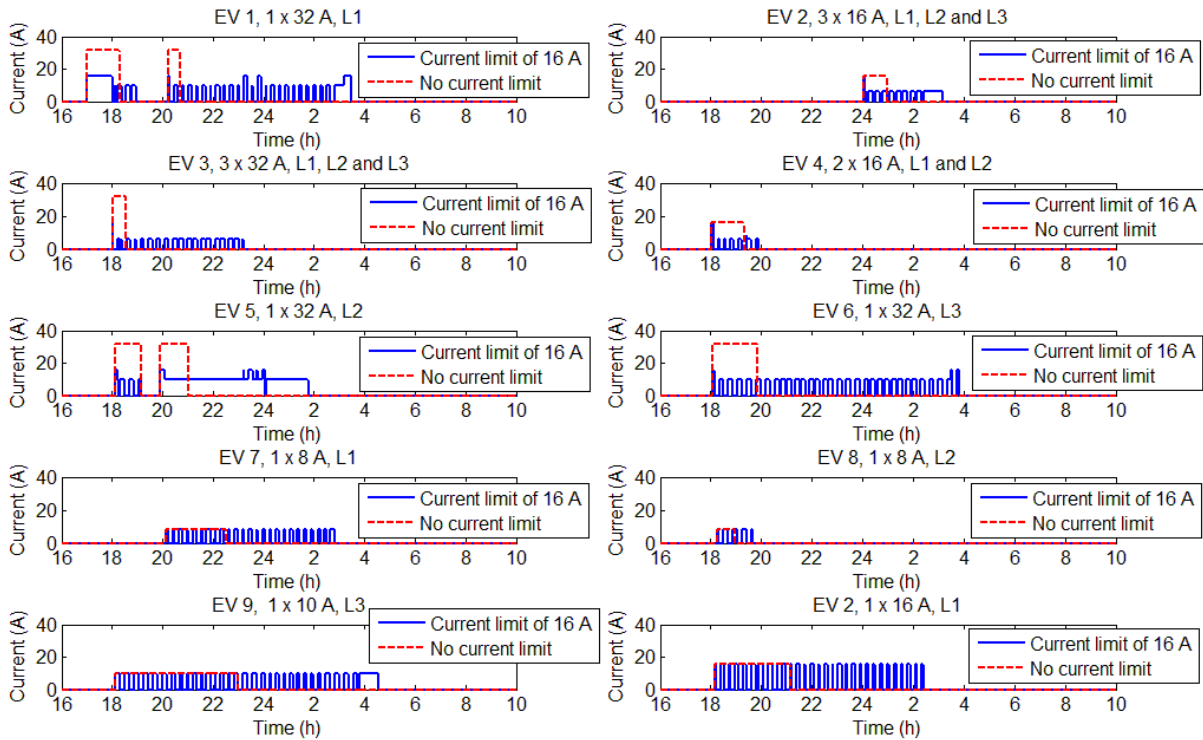

Fig. 11. Charging currents of the cars with no current limits and with a current limit of 16 A.

A few things can be noticed from the simulation results. When there is no current limit, the current of phase L1 rises to a value near 100 A. When a current limit of 50 A is set, some of the cars with mode 3 charging had to decrease their charging currents to keep the total phase currents below the current limit. However, the charging of any of the chargers was not interrupted. When the current limit is decreased to 32 A, the charging currents had to be decreased more and also some charging interruption had to be made. The final 16 A current limit is a sort of an extreme case. As it is allowed that a 16 A current can be taken from the Schuko socket, it is also the lowest possible theoretical current limit in order to make charging possible from all of the charging points. It can be seen that now a lot of charging interruption have to be made to keep the phase currents below 16 A. Also, the charged energies of the EVs do not change except for the EV 4, because it stays at the charging place only roughly two hours.

#### 4. CONCLUSION

In this paper, controlling of an EV charging station group is investigated. A load control algorithm is presented and simulated with a realistic use case. The algorithm is able to control mode 2 and mode 3 chargers, although it is somewhat uncertain whether controlling the mode 2 chargers is reasonable unless it was controlled by communicating directly to the car. It is expected that most of the charging system manufacturers will develop their load control systems for mode 3 charging only. The simulated algorithm seems to be very flexible with respect to different types of charging modes and charging load situations. Also, the mode 3 charging control needed in the system is already implemented in every commercial EV on the market.

The studies of the paper raised some topics for future work. The algorithm could be developed in many ways. If charging stations had information about the states of charge of the battery packs, the algorithm could be made to take that into account. Also, real demonstrations of the algorithms with real charging stations should be made. The possibilities of these kinds of systems realizing different energy related ancillary services should also be studied.

#### BIBLIOGRAPHY

- [1] Murray, J., King, D., "Oil's tipping point has passed", *Nature*, vol. 481, Jan. 2012.

- [2] Choi, W. et al. "Neighborhood-scale air quality impacts of emissions from motor vehicles and aircraft", *Atmospheric Environment*, vol. 80, pp. 310–321, Dec. 2013.
- [3] Steinhilber, S. et al., "Socio-technical inertia: Understanding the barriers to electric vehicles", *Energy Policy*, vol. 60, pp. 531–539, Sep. 2013.
- [4] Rautiainen, A. et al. "Requirements for an interface between a plug-in vehicle and an energy system", *Proc. of IEEE PowerTech*, Trondheim, 2011, 8 p.
- [5] Rautiainen A. et al., "Power-based Distribution Tariffs of Small Customers as Incentives for Demand Response – Case Study of a Real DNO's Network", Research report of SGEM (Smart Grid and Energy Market) project, 2014, 10 p.
- [6] Rautiainen, A. et al., "Plug-in vehicle ancillary services for a distribution network", *Proc. of EVER '13*, Monaco, 2013, 8 p.

Tampereen teknillinen yliopisto  
PL 527  
33101 Tampere

Tampere University of Technology  
P.O.B. 527  
FI-33101 Tampere, Finland

ISBN 978-952-15-3586-4  
ISSN 1459-2045