

0110
1001
0110
0101



Knowledge interaction between manufacturers and research organisations for building product innovations

An exploratory case study

Heli Koukkari

Knowledge interaction between manufacturers and research organisations for building product innovations

An exploratory case study

Heli Koukkari

VTT

Tampereen teknillinen yliopisto
Tampere University of Technology

Thesis for the degree of Doctor of Science in Technology to be presented with due permission for public examination and criticism in Festia Building, Small Auditorium 1, at Tampere University of Technology, on the 14th of November 2014, at 12 noon.



ISBN 978-951-38-8111-5 (Soft back ed.)
ISBN 978-951-38-8112-2 (URL: <http://www.vtt.fi/publications/index.jsp>)

VTT Science 49

ISSN-L 2242-119X
ISSN 2242-119X (Print)
ISSN 2242-1203 (Online)

Copyright © VTT 2014

JULKAISIJA – UTGIVARE – PUBLISHER

VTT
PL 1000 (Tekniikantie 4 A, Espoo)
02044 VTT
Puh. 020 722 111, faksi 020 722 7001

VTT
PB 1000 (Teknikvägen 4 A, Esbo)
FI-02044 VTT
Tfn. +358 20 722 111, telefax +358 20 722 7001

VTT Technical Research Centre of Finland
P.O. Box 1000 (Tekniikantie 4 A, Espoo)
FI-02044 VTT, Finland
Tel. +358 20 722 111, fax +358 20 722 7001

Photos on the cover by courtesy of

Peikko Group Oy (upper)

Paroc Panel System Oy Ab (lower)

Knowledge interaction between manufacturers and research organisations for building product innovations

An exploratory case study

Heli Koukkari. Espoo 2014. VTT Science 49. 189 p. + app. 4 p.

Abstract

This thesis adds to research on construction innovation through exploring and describing knowledge interaction between product manufacturers and research organizations. A few publications deal with manufacturers' innovation activities on their own terms, although products are broadly recognised to have major impacts on the performance of the entire built environment.

The research was conducted in a multilevel theoretical framework integrating the perspectives of systems of innovation, knowledge processes in manufacturing industries and knowledge interaction between companies and public research organizations. Ten product innovations were selected for a multiple case study. Cross-case synthesis was applied as the analysis technique of qualitative research data. The main themes in exploring and describing the knowledge interaction were found to be a) development and use of research-based knowledge in product innovations, b) accumulation and diffusion of research-based knowledge and c) context and forms of knowledge interaction.

The principal motivation for the knowledge interaction was found to be the need to know how a novel product would perform in its intended use in buildings, and how it should be designed and manufactured to meet the overall requirements. The regulations to design and use novel products were, however, often developed in parallel or after a technical invention. The objectives of joint innovation activities also reflected the market expectations and governmental strategies. The thesis thus emphasized the dynamics of relationships between various actors and institutions within a system of construction innovation.

A system of construction innovation is, however, not sufficient to uncover all the aspects of the knowledge interaction and even less the context of manufacturers' innovation activities. This is due to the division of the real estate and construction sector into competing value chains that exist in accord with basic framing materials. Manufacturers have ties to basic industries that are also important sources of product innovations. The industrial associations reflect this situation, as well as disciplines in research and education. As a conclusion, approaches to the technology innovation systems were proposed for further research.

The research identified similarities between the innovation processes of building product manufacturers and those of other manufacturing sectors. It is noteworthy, that innovation activities were organised in several case companies according to principles of concurrent engineering involving also research-based activities already decades ago.

Keywords Construction innovation, building product innovation, knowledge interaction, manufacturer, research organisation, system of innovation

Foreword

The innovation processes of construction product manufacturers are seldom investigated through approaches to innovation science although physical products are broadly recognised to have major impacts on the ways the entire built environment is constructed and performs. Even fewer studies concern manufacturers' interaction with research organisations enabling the technical invention of novel products and their launch onto the construction markets and use in buildings. The objective of this thesis was to respond to this apparent insufficiency and to explore phenomena related to the creation and use of research-based knowledge for building product innovations.

I thought that I had a good knowledge basis about the subject because I had worked at the national research centre almost my entire career. Instead, I faced a completely new research field of construction innovation which opened the gates to a broad field of innovation science and its various schools. My work also required my learning about qualitative research methods which I found surprisingly challenging. The research thus became a puzzle of various pieces that were sometimes difficult to connect. The outcome is now delivered as mapping descriptions with conclusions about research needs that would lead to deeper insights into the dynamics of interaction between building product manufacturers and research organisations.

It is time to address heartfelt thanks to those who supported the thesis research during the years it took, from the very vague first ideas to a structured publication. At Tampere University of Technology, Professor Kalle Kähkönen shared his excellent knowledge of the construction innovation and advised me wisely at critical moments. Professor Matti Kokkala was of invaluable help as a good listener and a great evaluator thanks to his global way of thinking. The reviewers Professor Emeritus Asko Sarja and Professor Luis Simoes da Silva from the Coimbra University, Portugal, are thanked for their strict reading and constructive evaluations.

The thesis was partly prepared in a national R&D project funded by the Finnish Funding Agency for Technology and Innovation Tekes and VTT Technical Research Centre of Finland. The Steering Group Members Professor Jukka Pekkanen, Mr. Jukka Huikari, Mr. Janne Jormalainen, Dr. Kimmo Järvinen, Mr. Olli

Korander, Mr. Jouko Kouhi, Mr. Mika Lautanala, Mr. Markku Lehtonen, Mr. Markku Vesa and Dr. Olli Vuola are cordially thanked for the guidance.

At VTT, Dr. Meri Viikari contributed to the planning, conducting and reporting of interviews; Dr. Guangyu Cao and Dr. Isabel Pinto Seppä were involved in some interviews and their reporting, Mr. Jarmo Vuorinen compiled the business reports on companies; Dr. Anne Tolman was available for inspiring discussions about analysing qualitative data; Dr. Markku Virtanen, Mr. Jari Shemeikka and Ms. Eila Lehmus were supportive managers. Dr. Sami Kazi also followed closely the evolution of the thesis. Thank you all so much!

I am most grateful to Professor Jos Lichtenberg and Dr. Emilia van Egmond-de Wilde De Ligny from the Technical University of Eindhoven, the Netherlands for their availability to scientific discourse. Ir. Rijk and Lian Blok will be remembered with gratitude for their caring hospitality during my visits to Eindhoven. Ing. Jan and Erja Brekelmans nearby in den Haag are thanked for many joyous moments.

Ms. Maini Manninen at VTT is appreciated for a good care of editing and publishing. Ms. Erja Schlesier is once again thanked for her skilled secretary help.

My warmest thanks are reserved for loyalty to my family Pertti, Tuomas and Tapio, to my mother Maija and to Soile, Matti, Päivi, Suvi, Urpo, Mirja, Meeri, Mauri, Leena and Risto.

Contents

Abstract	3
Foreword.....	4
1. Introduction.....	12
1.1 Scope of the research.....	12
1.1.1 Background.....	12
1.1.2 Building product manufacturers.....	14
1.1.3 Building product innovation.....	15
1.1.4 Knowledge interaction.....	17
1.1.5 Research problem.....	19
1.2 Structure of the thesis.....	20
2. Framework of the research.....	22
2.1 Research on innovation contexts.....	22
2.1.1 Approaches to innovation systems.....	22
2.1.2 Innovation systems in the construction sector.....	24
2.1.3 Research on construction product innovation.....	27
2.2 Research on knowledge processes.....	28
2.2.1 Organisational knowledge creation.....	28
2.2.2 Management of knowledge processes.....	31
2.2.3 Inter-organisational knowledge creation.....	34
2.3 Research on PRO-I interaction.....	36
2.4 Conclusions for the framework of research.....	38
2.4.1 Context of knowledge interaction.....	38
2.4.2 Knowledge creation processes.....	39
2.4.3 Channels and forms of knowledge interaction.....	41
2.4.4 Summary of the framework of thesis research.....	41
3. Research methods.....	43
3.1 Introduction.....	43
3.2 Design of multiple case study.....	44
3.2.1 Selection of innovation cases.....	44
3.2.2 Design for credibility.....	46

3.3	Interviews	47
3.3.1	Types of interviews.....	47
3.3.2	Interview topics	47
3.3.3	Interviewees	48
3.3.4	Conduct and reporting	50
3.4	Analysis procedure.....	50
4.	Research data: Case chronologies.....	52
4.1	Introduction	52
4.2	Case A: Product portfolio for the open building system.....	54
4.2.1	Background.....	54
4.2.2	Manufacturer A.....	54
4.2.3	Chronology of Case A.....	55
4.2.3.1	Basics of the 'bookcase' system.....	55
4.2.3.2	BES-adaptations to other types of building	57
4.2.3.3	Advancements in manufacturing, design and products.....	59
4.2.3.4	European R&D agendas and standardization	60
4.3	Case B: Products for industrial on-site concrete construction.....	62
4.3.1	Background.....	62
4.3.2	Manufacturer B.....	63
4.3.3	Chronology of Case B.....	64
4.3.3.1	Basics of the industrialised on-site concrete technology	64
4.3.3.2	Improvement of on-site technologies.....	65
4.3.3.3	Issues of holistic design.....	66
4.4	Case C: Composite slim floor beam	68
4.4.1	Background.....	68
4.4.2	Manufacturer C.....	68
4.4.3	Chronology of Case C.....	69
4.4.3.1	Development of a novel product.....	70
4.4.3.2	Product-specific approvals and export.....	71
4.5	Case D: Portfolio of thin-gauge steel products	72
4.5.1	Background.....	72
4.5.2	Manufacturer D.....	73
4.5.3	Chronology of Case D.....	75
4.5.3.1	Basics of structural use of thin-gauge steel.....	75
4.5.3.2	Development of systems and building technologies	77
4.5.3.3	Focus to ICT-based services and building concepts.....	80
4.6	Case F: Steel-framed energy-efficient commercial building	81
4.6.1	Manufacturer D in Case F	81
4.6.2	Chronology of Case F.....	81
4.7	Case G: Sandwich panel with a stone wool core.....	82
4.7.1	Background.....	82
4.7.2	Manufacturer G.....	83

4.7.3	Chronology of Case G.....	83
4.7.3.1	Product development.....	84
4.7.3.2	International networks and guidelines.....	84
4.7.3.3	Activities related to the European CE marking.....	85
4.8	Case H: ThermoWood® products.....	86
4.8.1	Background.....	86
4.8.2	Companies.....	87
4.8.3	Chronology of Case H.....	87
4.8.3.1	From science-based results to pilots.....	87
4.8.3.2	Co-ordinated joint efforts.....	89
4.9	Case J: LVL products.....	90
4.9.1	Background.....	90
4.9.2	Manufacturer J.....	91
4.9.3	Chronology of Case J.....	92
4.9.3.1	Feasibility projects and the pilot plant.....	92
4.9.3.2	Industrial development.....	93
4.10	Case K: Modular steel building.....	94
4.10.1	Manufacturer K.....	94
4.10.2	Chronology of Case K.....	95
4.11	Case L: Energy-efficient multi-storey building.....	96
4.11.1	Company L.....	96
4.11.2	Chronology of Case L.....	96
5.	Individual case descriptions.....	98
5.1	Description framework for knowledge interaction.....	98
5.1.1	Preparation of the uniform table of content.....	98
5.1.2	Theme of development and use of knowledge.....	99
5.1.3	Theme of diffusion and accumulation of knowledge.....	100
5.1.4	Theme of context of knowledge interaction.....	102
5.2	Case A: Product portfolio for the open building system.....	105
5.2.1	Vignette.....	105
5.2.2	Development and use of knowledge.....	106
5.2.2.1	Fuzzy front end.....	106
5.2.2.2	Invention phases.....	106
5.2.2.3	Commercialization phases.....	108
5.2.3	Diffusion and accumulation of knowledge.....	108
5.2.4	Channels and context of knowledge interaction.....	109
5.2.4.1	Channels of knowledge interaction.....	109
5.2.4.2	Context of knowledge interaction.....	110
5.3	Case B: Products for industrial on-site concrete construction.....	111
5.3.1	Vignette.....	111
5.3.2	Development and use of knowledge.....	111
5.3.2.1	Fuzzy front end.....	111
5.3.2.2	Invention phases.....	112
5.3.3	Diffusion and accumulation of knowledge.....	112

5.3.4	Channels and context of knowledge interaction.....	113
5.4	Case C: Composite slim floor beam	113
5.4.1	Vignette.....	113
5.4.2	Development and use of knowledge	114
5.4.3	Diffusion and accumulation of knowledge	115
5.4.4	Channels and context of knowledge interaction.....	115
5.4.4.1	Channels of knowledge interaction.....	115
5.4.4.2	Context of knowledge interaction	115
5.5	Case D: Portfolio of thin-gauge steel products	116
5.5.1	Vignette.....	116
5.5.2	Development and use of knowledge	117
5.5.2.1	Fuzzy front end	117
5.5.2.2	Invention phases	117
5.5.2.3	Commercialization phases.....	118
5.5.3	Diffusion and accumulation of knowledge	118
5.5.4	Channels and context of knowledge interaction.....	118
5.5.4.1	Channels of interaction.....	118
5.5.4.2	Context of interaction.....	119
5.6	Case F: Steel-framed energy-efficient commercial building	119
5.6.1	Vignette.....	119
5.6.2	Development and use of knowledge	120
5.6.3	Diffusion and accumulation of knowledge	120
5.7	Case G: Sandwich panel with a stone wool core.....	120
5.7.1	Vignette.....	120
5.7.2	Development and use of knowledge	121
5.7.3	Diffusion and accumulation of knowledge	122
5.7.4	Channels and context of knowledge interaction.....	122
5.8	Case H: ThermoWood® products.....	123
5.8.1	Vignette.....	123
5.8.2	Development and use of knowledge	123
5.8.3	Diffusion and accumulation of knowledge	124
5.8.4	Channels and context of knowledge interaction.....	124
5.9	Case J: LVL products.....	125
5.9.1	Vignette.....	125
5.9.2	Development and use of knowledge	125
5.9.2.1	Fuzzy front end	125
5.9.2.2	Invention phase.....	126
5.9.2.3	Commercialization.....	126
5.9.3	Diffusion and accumulation of knowledge	126
5.9.4	Channels and context of knowledge interaction.....	126
5.10	Case K: Modular steel building.....	127
5.10.1	Vignette.....	127
5.10.2	Development and use of knowledge	127
5.10.3	Diffusion and accumulation of knowledge	127
5.10.4	Channels and context of knowledge interaction.....	128

5.11	Case L: Energy-efficient multi-storey building	128
5.11.1	Vignette.....	128
5.11.2	Development and use of knowledge	128
5.11.3	Diffusion and accumulation of knowledge	129
5.11.4	Channels and context of knowledge interaction.....	129
6.	Cross-case synthesis.....	130
6.1	Introduction	130
6.2	Enabling conditions for knowledge interaction.....	130
6.2.1	R&D capabilities of manufacturers.....	130
6.2.2	Capabilities of research organisations	132
6.2.3	Initiation of knowledge interaction	133
6.2.4	Phases of knowledge interaction	135
6.3	Knowledge development and use.....	136
6.3.1	Knowledge development in the invention phase.....	136
6.3.2	Long-term knowledge development.....	138
6.3.3	Use of research-based knowledge.....	139
6.4	Diffusion and accumulation of knowledge	140
6.4.1	Diffusion of research-based knowledge	141
6.4.2	Knowledge assets.....	142
6.5	Context of knowledge interaction.....	143
6.5.1	National construction innovation system	143
6.5.1	Forms of knowledge interaction.....	144
7.	Discussion and conclusions.....	147
7.1	Introduction	147
7.2	Research approaches of the thesis	147
7.2.1	Scope and research problem.....	147
7.2.2	Research framework of the thesis.....	149
7.2.3	Case study approach	152
7.2.4	Representativeness of cases.....	153
7.2.5	Description framework	154
7.2.6	Influence of geography.....	155
7.3	Research findings of the thesis	156
7.3.1	Levels of knowledge interaction.....	156
7.3.2	Research-practice relationships.....	157
7.3.3	Knowledge contribution of the thesis.....	158
7.4	Conclusions.....	160
7.4.1	Introduction	160
7.4.2	Knowledge interaction in innovation processes	161
7.4.2.1	Actors	161
7.4.2.2	Knowledge development in joint activities.....	162
7.4.2.3	Knowledge diffusion and accumulation.....	164
7.4.3	Findings regarding the research problem	164
7.4.4	Future research needs	165

8. Summary	168
Acknowledgements	170
References.....	171
Appendices	
Appendix A: List of topics in semi-structured expert interviews	

1. Introduction

Building products as artefacts and figures look simple. A complex picture would, however, be needed in order to uncover the knowledge accumulated in them. The knowledge inputs originate from practical lessons over thousands of years and from science- and research-based achievements in several disciplines and technology fields. This thesis investigates the latter domain of knowledge development. Furthermore, it focuses onto relationships and knowledge flows between product manufacturers and research organisations.

This thesis concerns building products in the sense of the Construction Product Regulation of the European Union (CPR 2011): they are products to be used in a permanent manner in new buildings or buildings under renovation. Construction products for infrastructures such as bridges, roads, railways or supply networks were excluded from the thesis. Innovations in equipment and machines were also not dealt with.

1.1 Scope of the research

1.1.1 Background

The research on construction innovation has become more frequent, and the product manufacturing has also received more attention as a recognized part of the complex system of activities and actors. The focus of research has however been on the construction sector that is identified in accord with common trade classifications and thus comprises only site activities.

The innovation processes of construction product manufacturers are seldom investigated through approaches to innovation science although physical products are broadly recognised as having major impacts on the ways the entire built environment is constructed and performs. Even fewer studies concern manufacturers' interaction with research organisations enabling the technical invention of novel products and their launch on the construction markets and use in buildings. The objective of this thesis was to respond to this apparent insufficiency and to explore phenomena related to the creation and use of research-based knowledge for building product innovations – construction products for buildings.

The small number of scientific publications about the innovation processes of the construction product industry might be explained by the economics-oriented tradition of the innovation science that used to concern macro-level phenomena. The organisation-oriented tradition added an interest on actual industrial processes but still the various sectors are distinguished mostly based on trade classifications. According to Barrett (2005), the narrow definition given in trade classifications 'draws a line between these (activities) and intimately linked, value adding activities.' Abbott et al. (2007) agreed by stating that 'the official economic classification of construction activity caused bias in analysis of the level of innovation in the sector due to its omission of certain intrinsic elements of the industry, such as design and engineering activity'.

The construction-related activities of manufacturers and service providers are sometimes included in a definition of the construction sector either with an explanation or without. In Finland, it has been common to use the term 'construction trade' to cover construction activities, the manufacturing of construction products and various related services including for example design, public services, and rental of equipment (Pajakkala et al. 1992). The term 'construction sector' is used for example by Ecorys (2011) to cover 'on-site construction', 'manufacturing of construction materials' and 'professional construction services'.

Alternative terms for the sector are construction industries, construction cluster, property and construction sector, real estate and construction sector, and construction and property sectors (Barrett et al. 2007). Gann and Salter (2000) summarised that 'construction includes designing, maintaining and adapting the built environment, involving many organisations from a range of industrial sectors, temporarily working together on project-specific tasks'.

Barrett (2005) summarised the activities of Technical Group 31 of the International Council for Research and Innovation in Building and Construction CIB, and explained that the meso-economic framework for the construction sector system takes in the full building life cycle of new construction, management of the service provided by the built environment and demolition.

In the Finnish economy, 66% of investments are made in the construction sector, and its share in employment is 15% (including services for building design and property management and product manufacturing). In 2012 the number of man-years in the manufacturing industry was 80 000 when it was 145 000 in the site activities (Vainio 2013). The share of construction products in costs of a house building segment (including renovation) was 55%.

The construction product industry also has enormous impacts onto the use of natural resources and to greenhouse gas emissions. These global issues are especially prominent in the strategies of the European Union, but more and more the industrial research agendas also support resource-efficiency goals. In order to realize the ambitious goals of the construction sector and its stake-holders, the actual complex processes need to be understood.

1.1.2 Building product manufacturers

Anderson and Schaan (2001) described the difference between the construction sector and construction product manufacturing sectors in that ‘products (old or innovative) are produced in the manufacturing sector. These manufactured products flow from the manufacturing sector into the construction industries where they become components of sub-systems and these sub-systems become part of the final complex product system – the built structure’. Thus, the construction product manufacturers are suppliers of products and services to the construction sector, and their activities are a part of pre-production in the construction sector as shown in Figure 1.

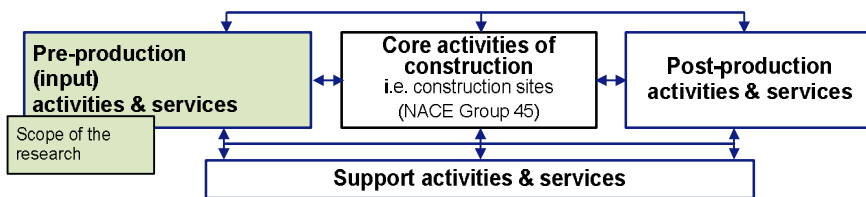

Figure 1. Manufacturing of the construction products is a part of pre-production activities and services of the construction sector (Asikainen and Squicciarini 2009, Squicciarini and Asikainen 2011).

Construction product manufacturers do not comprise an industry in the common trade classifications. Instead, they belong to various manufacturing subsectors. Ecorys (2010) identified the following sub-sectors clearly connected to the construction sector: manufacture of builder’s carpentry and joinery; bricks, tiles and construction products; cement, lime and plaster; articles of concrete, plaster and cement; cutting, shaping and finishing ornamental and building stone; and structural metal products. Sub-sectors like for example manufacturing of glass products or wooden boards were excluded because the share of construction-related products could not be found. Even though Ecorys and other project partners worked on the basis of the common trade classifications, they later called the product manufacturers ‘Manufacturing of construction materials subsector’ of the construction sector – including wholesalers (Ecorys 2011).

Based on the identified sub-sectors of manufacturing industries, the turnover of the European construction product manufacturers was estimated as 360 billion Euros in 2009, and the number of employees was 2.6 million (Ecorys 2011). The study noted that several other sub-sectors include construction-related manufacturing but its share could not reliably be distinguished.

To a product manufacturer, clients may be consumers, retailers, wholesalers, manufacturers of components, contractors or sub-contractors. Thus, the construction sector defined through site activities is a client sector of the product industry.

The construction product manufacturers are also connected to their own suppliers and various basic manufacturing industries. In this thesis, the construction product industry was studied as an intermediary industry between basic manufacturing industries and the construction sector (Figure 2).

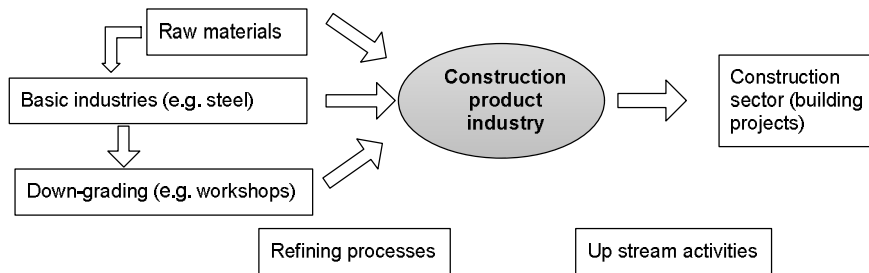

Figure 2. Schematic presentation of the intermediate position of construction product manufacturers between basic manufacturing industries and the construction sector.

Different definitions are also given for the construction product manufacturers. For example, Larsson et al. (2006) call them 'basic technology companies' whereas contractors are 'intermediate construction companies'.

1.1.3 Building product innovation

This thesis deals solely with construction products for buildings, thus 'building products'. Furthermore, the thesis excludes equipment and elevators, fixtures and finishes.

The first meaning of 'building product innovation' in the thesis is related to the product itself: in accordance with the Oslo Manual of the Organisation for Economic Co-operation and Development (OECD 2005), it is 'the introduction of a good or service that is new or significantly improved with respect to its characteristics or intended uses. This includes significant improvements in technical specifications, components and materials, incorporated software, user friendliness or other functional characteristics. More precisely, the thesis deals with product innovations that 'comprise implemented technologically new products ... and significant technological improvements in products'; implementation means that the product 'has been introduced on the market' (OECD 2005). Dosi (1982) also paid attention to implementation with a quotation from Freeman: 'An innovation in the economic sense is accomplished only with the first commercial transaction'. This definition is particularly significant for building product innovations because procedures for their implementation in building projects and launch onto markets are highly regulated at a national and European level.

The second meaning of the word 'innovation' is also used in this thesis to refer to innovation activities in general. According to OECD (2005), 'innovation activities

include all scientific, technological, organisational, financial and commercial steps which actually lead, or are intended to lead, to the implementation of innovations'.

A common agreement concerns the incremental innovations as minor changes in production, product or use of the product whereas the radical or disruptive innovation has been defined in different ways depending also on the level of consideration. Popadiuk and Choo (2006) cited Stamm who presented a list of nine factors that comprise the differences between incremental and radical innovation. These included time frame, development trajectory, idea generation and opportunity recognition, process, business case, players, development structure, resource and skill requirements, and operating unit.

A building product innovation is regarded in this thesis to be radical when it is a novel type of product on existing markets; thus, it may compete with alternatives for the same use. This definition implies that the novel product is also new as regards the scope of existing codes and standards and requires special procedures in order to become approved for use in buildings. In the construction market, this means that the 'first commercial transaction' requires special procedures and possibly the use of research-based knowledge.

A building product brought onto the European common market has to be CE marked according to the Construction Product Regulation (CPR 2011). The regulation defines a construction product as a product to be used in a permanent manner in 'works' that are buildings, bridges, roads etc.; a building product is defined in the thesis as a construction product to be used in buildings. The regulation concerns a great variety of products from cement and aggregates to log buildings or steel or concrete frame buildings. The procedures for various types of products are developed either by the European Standardization Organisation CEN or by the European Organisation for Technical Assessments EOTA. The situations in which a product should have a European product assessment are as follows:

- (a) It does not fall within the scope of any existing harmonised standard;
- (b) For at least one essential characteristic of that product, the assessment method provided for in the harmonised standard is not appropriate; or
- (c) The harmonised standard does not provide for any assessment method in relation to at least one essential characteristic of that product.

In most Member States CE marking has replaced national type approval or similar procedures. For example, until July, 2013 several procedures were in use for a novel product to enter the markets in Finland. The Ministry of the Environment (previously the Ministry of Internal Affairs) awarded type approvals until 2006, and since then VTT Expert Services Ltd has had the mandate to operate. New products could also be brought onto the market based on a case-by-case approval by a local authority or a certified product declaration of the Finnish Constructional Steelwork Association TRY or the Concrete Association BY. The various national approval procedures are currently under consideration in Finland as well as in other Member States.

A product innovation may or may not be patented. On the other hand, a patent does not mean that an invention has been implemented in any building project.

Bowley stated in 1960 that 'innovation in basic materials, originating from outside the building industry and with markets far wider, plays an important role in the evolution of construction' (according to Gann 2003). The importance of product innovations for building costs (Larsson et al. 2006), productivity (Nam and Tatum 1989, Goodrum et al. 2009, Jarkas 2010), the performance of a building project (Slaughter 1993), the performance of a completed building (Henderieckx et al. 2002) and environmental impacts (González and Navarro 2006; Sand et al. 2012) have been recognized in research. Furthermore, many researchers have concluded that most construction innovations originate from material and component producers whose investments in R&D are also the largest share in the construction industry (Pajakkala et al. 1992, Gann 1997, Koskela and Vrijhoef 2001, Pries and Doree 2005, Manley 2008, Ozorhon et al. 2010). According to Schartinger (2009), radical innovations are more likely in this segment of the sector than in others. Lim and Ofori (2007), Asikainen and Squicciarini (2009) and Squicciarini and Asikainen (2011) have also paid attention to the overlooked impacts of the construction product industry. Despite widely shared views on the importance of construction product innovations, few publications were found about the innovation processes of product manufacturers.

In the literature, other words are also used for building products such as construction materials and building materials, or a building is recognised as a product (end-product, complex product). For example, Shenhar et al. (1995) described buildings, constructions, roads, bridges and utility as typical products of sectors with low-tech innovations. Nam and Tatum (1989) also used the word 'product innovation' in relation to a building.

1.1.4 Knowledge interaction

This thesis is focused on the innovation co-operation between the building product manufacturers and technical research organisations as an important enabler of changes in products and building technology. The research organisations are here technical universities, universities of applied sciences, university centres or consortiums and national research centres which operate under ministries but may have substantial funding from the private sector. The OECD (2005) also includes the private non-profit research organisations in the public sector sources for transfers of knowledge and technology. It defines innovation co-operation as the active participation of a company in joint innovation projects with other companies or research organisations (OECD 2005). In the thesis, the concept 'knowledge interaction' is used as an alternative to 'co-operation' in order to underline the interest in such a co-operation which aims at the growth of knowledge and know-how of the participants involved.

The concept of 'technology' has two interrelated meanings in this thesis: 'First, technology refers to material and immaterial objects – both hardware (e.g.

products, tools and machines) and software (e.g. procedures/processes and digital protocols) – that can be used to solve real-world technical problems. Second, it refers to technical knowledge, either in general terms or in terms of knowledge embodied in the physical artefact (Bergek et al. 2008).

The scope of the thesis was restricted to the field of building engineering as a science and technology. The reasons were that the access of a novel type of building product to the construction market is not possible without reliable methods in this field. Secondly, the field is understood in similar ways in industrial R&D, research organisations and in the construction sector and related design services. The focus meant however that a large number of other disciplines and much know-how were eliminated that are a part of the innovation activities of manufacturers.

The term building engineering was adopted from Addis (2007) who explains it as a compilation of several professional disciplines such as structural, building services, acoustics, earthquake and fire safety engineering. With this integrated definition, he paid attention to the necessity of designers, understanding the performance of a completed building and developing integrated working methods. He also highlighted the fact that the science and practice of building engineering concentrate on methods for predicting the performance of building components and the entire building.

A dynamic relationship exists between building product manufacturers and research organisations but also between the other organisations and institutions. Theories based on an evolutionary economic approach and systems of innovation emphasise interaction between various actors and other factors. Malerba (2002) highlighted that the tradition of innovation and production systems ‘considers innovation as an interactive process among a wide variety of actors’. Edquist (1999) underlined that ‘interaction and interdependence is one of the most important characteristics of the SI, systems of innovation approach, where innovations are thought to be determined not only by the elements of the system but also by the relations between them’. The knowledge interaction involves close inter-personal working relationships that can provide codified and tacit knowledge and assist real-time problem solving (OECD 2005).

Interaction between an industry and research organisations is widely regarded as beneficial to innovation (Owen and Wood 1998, Kaufmann and Tödtling 2001, Broström and Lööf 2006, de Fuentes and Dutrénit 2010), and its drivers, channels, forms, benefits and risks have been studied extensively. A traditional view of the roles of industries and research organisations is that basic science is dedicated to academia, applied sciences to universities and research centres and the development of products, services and business to companies. In this view, universities and research organisations are regarded as sources of knowledge transfer to the practitioners. Among innovation researchers, linear models of knowledge transfer are, however, commonly considered to be outdated, and attention is paid more to co-operation, joint efforts and two-way communication. However, they are still used in policy making due to their obvious simplicity (Godin 2005).

Since the 1980s, the interest of national governments in construction and construction-related research has declined for reasons such as non-tradable goods, lack of industry lobbies and many regional and national barriers to trade (Seaden 1997). As a consequence, since the mid-1980s the privatisation of national research centres has taken place in many countries, and base funding has been reduced. Some papers deal with the potential consequences of this. Gann (1997) has argued that 'due to the nature of the construction sector and its innovation system, governmental investments should be increased and not decreased in order to facilitate a strong, coherent and co-operative research-base for construction'. He states that most industrial investments in the system are made by the manufacturing companies. He does not however mention the fact that the major part of public investments also serves manufacturers whose product innovations often need costly experimental facilities. According to Winch (1998), 'government-funded national construction research organisations ...also play a vital brokering role', and he wonders whether they will be able to retain this role in the conditions of reduced public funding.

The aforementioned publications leave unclear which kinds of companies and research units were actually involved in the co-operation. A similar situation also concerns Schartinger et al. (2002) who studied sectoral differences in university – industry interaction in Austria and concluded that the construction sector with low R&D ratios was among those sectors with the highest interaction intensity together with those with high R&D ratios: The data in their study was gathered among the heads of university departments through a survey without classification of co-operative companies. The same statement was made in Germany according to Beckers and Bodas Freitas (2008) in 1998 who referred to Meyer-Krahmer and Schmoch: 'The highest knowledge interaction is found in mechanical engineering and civil engineering, which however, had a lower science-intensity (measured by average level of scientific references per patent).'

1.1.5 Research problem

In the research field of construction innovation, manufacturers are recognised as a part of a cluster or of a broad sector or as a related sector of the construction sector. The importance of product innovations to costs, speed and quality of building projects and life-cycle performance of buildings is also recognised. The preliminary literature survey indicated however that the innovation activities of building product manufacturers have seldom been studied on their own terms.

This thesis is focused on the innovation co-operation between the building product manufacturers and research organisations as an important enabler of changes in products and building technology. The concept 'knowledge interaction' was used as an alternative to 'co-operation' in order to underline the focus on such a co-operation that aims at the growth of knowledge and know-how of involved participants and that is influenced by and influences the context in which interaction takes place. The scope was further limited to the innovation activities in

which research-based inputs concerned the technical performance of products or buildings. The research problem was thus

to explore knowledge interaction between product manufacturers and technical research organisations in the fields of building engineering science and technologies.

An integrated research approach was seen to be necessary in order to tackle the research problem which concerned on the other hand methods to create and use of new research-based knowledge and on the other hand types and ways to organise and manage joint activities.

1.2 Structure of the thesis

The thesis is organised according to the flowchart of the thesis work.

Chapter 1 introduces the background and objectives of the thesis and presents the research problem.

Chapter 2 summarises the literature survey on research in the fields that deal with innovation contexts and product innovation processes. Further research on approaches to technology innovation systems supported the finding that the context of knowledge interaction can be described through an innovation system. A framework of research was developed that combined perspectives of innovation systems, knowledge processes and knowledge interaction.

Chapter 3 describes the design of a multiple case study that was applied in order to explore the knowledge interaction between building product manufacturers and research organisations. The national construction innovation system was chosen as a common context for all the cases because the starting point in all the cases was the knowledge interaction between domestic actors and the products were first launched onto the national market. The design comprises methods for gathering qualitative research data, ascertaining its credibility and analysing it. The general strategy of the analysis was chosen as a descriptive framework.

Chapter 4 introduces data on knowledge interaction in ten historical (longitudinal) building product innovation cases based on several layers of working documents of the R&D project such as individual interview reports, company reports and interim working reports. The data was organised into a chronological order of 1–4 phases to be presented in the thesis.

Chapter 5 presents the cases according to a uniform table of content which was developed based on the research framework and the first iterative steps of analysis of the data. The themes of the description framework consisted of three main themes which were development and use of knowledge, diffusion and accumulation of knowledge and channels and context of knowledge interaction.

Chapter 6 presents a cross-case synthesis based on individual case descriptions in relation to the main themes of the description framework. The focus of analysis was on the type of knowledge inputs that were created and used in joint innovation processes and that were influenced by a wider sectoral and institutional context.

Chapter 7 includes a discussion that deals with the reliability and validity of the research, the suitability of the descriptive framework for analysis and the outcome with regard to exploratory objectives the research. Chapter 7 also presents conclusions and the need for future research. The technology innovation system approaches were found to be a fruitful perspective for further research on drivers and success factors of innovation activities of building product manufacturers.

Figure 3 summarizes the workflow of the research and the structure of the thesis.

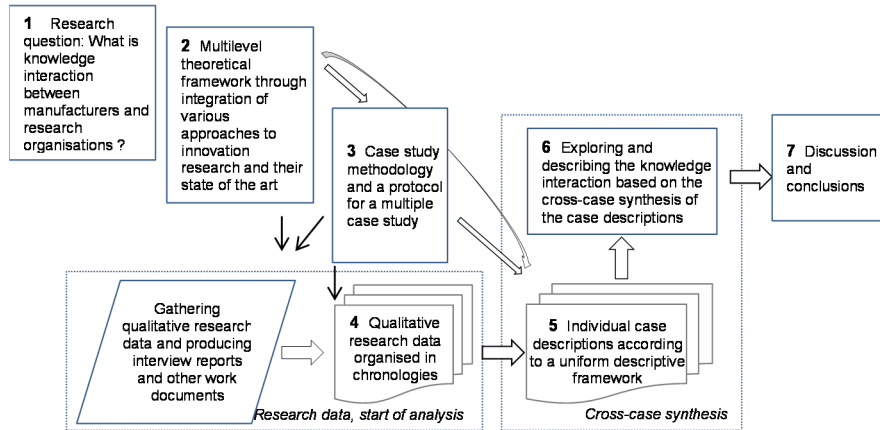

Figure 3. Structure of the thesis; numbering shows Chapters. Interview reports and other work documents were stored separately.

2. Framework of the research

The framework of the research was developed based on the state of the art of research fields that gave different perspectives on tackling the research problem. The literature survey was carried out in three phases: Firstly, a preliminary study aimed to identify relevant research fields, and these were identified as those dealing with innovation systems and processes. Secondly, a more thorough survey was performed in these fields focusing to research on construction innovation, knowledge processes and interaction between manufacturers and public research organisations. The third phase of the literature survey was conducted during the analysis and discussion stages of the research.

2.1 Research on innovation contexts

2.1.1 Approaches to innovation systems

Various approaches to explaining innovations have been developed in the economics-oriented tradition of research. Technology push- and demand pull-theories were born in the 1930s, and their 'clear-cut distinction... remains useful for the sake ... of the role attributed to market signals in directing innovative activities and technical changes' (Dosi 1982). Broader views take the role of institutions into account as the second main component in addition to organisations (Chaminade and Edquist 2005), such as technical standards, tax laws, environment and safety regulations, R&D investment routines, firm-specific rules and norms.

The systems of innovation approaches started to emerge in the 1980s. They see an 'innovation as a product of the interplay between actors (e.g. companies) and institutions' (Stendahl 2009). According to Edquist (1999), they point to the fact that innovation processes are evolutionary and also stress that firms innovate in interaction with other organisations within the framework of specific institutional rules. Furthermore, in a systems of innovation approach, 'a long term perspective is natural and important', 'because innovation processes take time, sometimes decades'. Edquist (1999) also pointed that 'the processes are often path-dependent over time and open ended'.

The OECD (2005) explains approaches to evolutionary economics and systems of innovation briefly as follows: 'Evolutionary approaches view innovation as a path-dependent process whereby knowledge and technology are developed through interaction between various actors and other factors. The structure of such interaction affects the future path of economic change.' The closely linked approach to systems of innovation investigates 'the influence of external institutions, broadly defined, on the innovative activities of firms and other actors. It emphasises the importance of the transfer and diffusion of ideas, skills, knowledge, information and signals of many kinds. The channels and networks through which this information circulates are embedded in a social, political and cultural background that guides and constrains innovation activities and capabilities. Innovation is viewed as a dynamic process in which knowledge is accumulated through learning and interaction'.

The systems of innovation are often considered at the national level. The other perspectives are for example regional, sectoral, international or technological. At the national level of analysis, R&D activities and the role played by universities, research institutes, government agencies, and government policies are viewed as components of a single national system (Carlsson et al. 2002). According to Malerba (2002), sectoral systems may provide a useful tool in various respects such as a descriptive analysis of sectors, for a full understanding of their working, dynamics and transformation, for the identification of the factors affecting the performance and competitiveness of firms and countries and finally for the development of new public policy proposals. Chaminade and Edquist (2005) pointed out that the narrow definition of an innovation system includes only the organizations and institutions involved in research activities (searching and exploring).

Hekkert et al. (2007) stated that the innovation systems approach has two shortcomings: Firstly, due to a focus on comparing the structure of different innovation systems, less emphasis is placed on the analysis of the dynamics of innovation systems. Secondly, the explanatory power of the framework lies mainly in the part of institutions (macro level), and less in the actions of the entrepreneur (micro level). The OECD's Oslo Manual (OECD 2005) agrees that systems approaches to innovation emphasise 'the role of governments in monitoring and seeking to fine tune this overall framework'.

Developers of approaches to technology innovation systems have aimed at the improved 'explanatory power' of the dynamics within an innovation system (for example Carlsson et al. 2002, Hekkert et al. 2007, Bergek et al. 2008 and Markard and Truffer 2008). Carlsson et al. (2002) stated that 'a technological innovation system is a set of networks of actors and institutions that jointly interact in a specific technological field and contribute to the generation, diffusion and utilization of variants of a new technology and/or a new product'. And, 'the approach may fruitfully be applied to at least three levels of analysis: to a technology in the sense of a knowledge field, to a product or an artefact, or finally to a set of related products and artefacts aimed at satisfying a particular function'. It overlaps parts of national and sectoral innovation systems (Figure 4). It may exist a certain period of time of development.

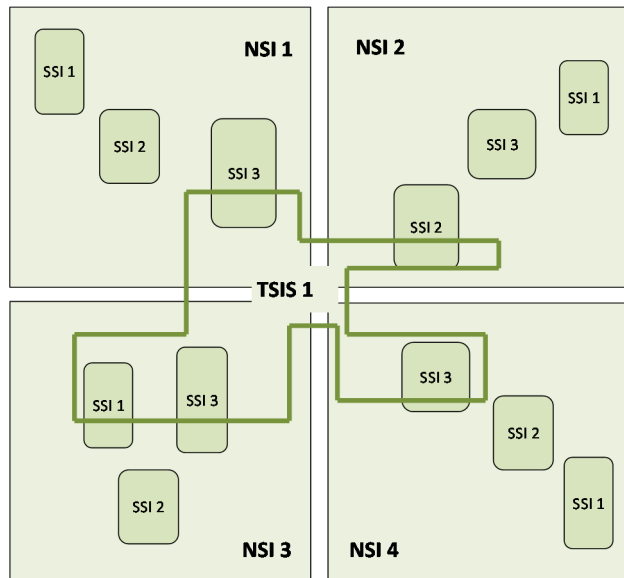

Figure 4. Technology-specific innovation system TSIS may cross national systems of innovation NSI, and sectoral systems of innovation SSI (Hekkert et al. 2007).

Hekkert et al. (2007) developed a systematic method for mapping processes within a technological system and resulting technical change. They called these processes functions and identified seven kinds as follows: entrepreneurial activities (F1); knowledge development (F2); knowledge diffusion (F3); guidance of the search (F4); market formation (F5); resources mobilization (F6); creation of legitimacy (F7).

Bergek et al. (2008) developed a scheme for analysis of technology innovation systems which they defined as 'socio-technical systems focused on the development, diffusion and use of a particular technology (in terms of knowledge, product or both)'. They proposed six steps for analysis including definition of the specific technology, identification of structure and functions, analysis of performance (through seven processes, including knowledge development and diffusion), identification of driving and blocking mechanisms and conclusions of policy.

2.1.2 Innovation systems in the construction sector

Several researchers were developing the innovation system approach for the construction sector at the end of the 1990s (Carassus 2004). According to Seaden and Manseau (2001), 'the innovation system approach, with its various options such as the firm-centred knowledge networks, the production systems or the complex product systems models appear to be relevant for the construction sector and a useful attempt to explain this very complex, multi-dimensional activity'.

Gann and Salter (2000) presented a construction innovation system around 'project-based firms' and knowledge flows between actors. Winch (1998) developed a variant system around innovation integrators with which he emphasised the phenomenon that each innovation needs to be implemented in a building project and that decision is made by an actor other than the innovator. The systems integrator role is shared between the principal architect and engineer at the design stage and the principal constructor at the construction stage. Anderson and Schaan (2001) used a similar approach. Later, Rutten et al. (2009) concluded that a company in charge of partial tasks in a system cannot be regarded as a system integrator.

The construction innovation systems presented in the literature recognise companies that belong to three different sectors in trade classifications. Voordijk et al. (2000) categorised them as 'three supply chains of the construction industry':

- Manufacturing of building materials and components.
- Construction that directly produces the end product.
- Design responsible for descriptions of the appearance, layout, functions of the building or engineering product.

Dubois and Gadde (2000) explained the difference between contractors operating through projects and product manufacturers, namely that the prevailing uncertainty of construction projects 'makes the use of standardised parts an appropriate strategy, which is further reinforced by the benefits gained from increasing economies of scale in the manufacturing of building materials'. Blayse and Manley (2004) refer to Marceau et al. (1999) in noting that construction innovations incorporate participants such as governments, building material suppliers, designers, general contractors, specialist contractors, the labour force, owners, professional associations, private capital providers, end users of public infrastructure, vendors and distributors, testing services companies, educational institutions, certification bodies, and others. Their proposal for a construction innovation system is shown in Figure 5.

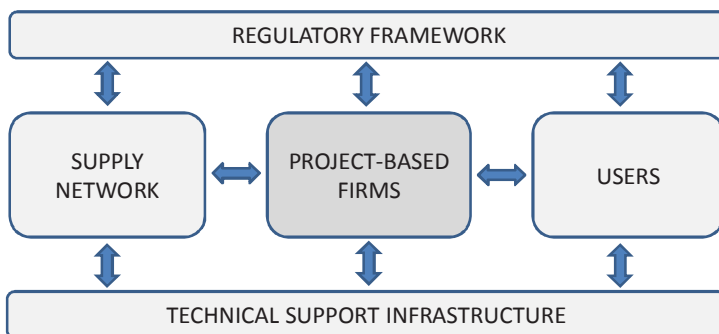

Figure 5. Participants in the building project system (Blayse and Manley 2004).

2. Framework of the research

Fernandez-Solis (2007) summarised the differences between building product manufacturing and building construction as shown in Table 1.

Table 1. Operational characteristics of building product manufacturing and building construction activities according to Fernandez-Solis (2007).

Product manufacturing	Building construction
Delays are not allowed or possible	The number of permutations and possible combinations is enormous;
Sequence of events is invariable	Generation of variations;
Alternative paths are tightly controlled or impossible;	Complex and insufficient operations
Little or no opportunity for substitution or repair (usually discarded or wasted)	Sub-optimization;
Slack is not desirable	Some tightly coupled, some time-sensitive specialized activities with in sequence interdependent activities with standard parts
Redundancies are designed or deliberate	Overlapping activities, long lead time and slack built into adaptive on-site changes and consequential changes;
	Self-determination, co-ordination with different firms each adding a measure of slack
	Work is redone when non-conforming

The centre of construction sector systems dominates the viewpoint of innovation research. Regarding building products, it concerns mostly diffusion or implementation of innovations in building projects or supply chain management e.g. by Akintoya et al. (2000), Dubois and Gadde (2000), Slaughter (2000), Anderson and Schaan (2001), Miozzo and Dewick (2002), Miozzo and Dewick (2004), Bayer and Gann (2006), Grey and Davies (2007), Harty (2008), Goodrum et al. (2009), and van der Vlies and Maas (2009). According to Anderson and Schaan (2001), 'the adoption and integration of innovative products can require considerable change on the construction or building site as these innovative products must be integrated into pre-existing sub-systems or complex product system. Methods and procedures of installation might have to change and the skills set of the workers might not be adequate to deal with the new innovative products.' Taylor and Levitt (2004) concluded that incremental innovations diffuse to the construction sector in normal trade but systemic innovations diffuse more slowly; a systemic innovation has several interfaces of traditional trade classifications. Manley (2008) studied determinants for how manufacturers can ensure implementation of innovations on construction projects. The building project is the context that has also been the starting point for studies concerning inter-firm relationships or partnering in the construction sector (Bossink 2002, Berente et al. 2010, Holmen et al. 2005, Hartmann and Bresnen 2011).

Aouad et al. (2010) concluded that an understanding of innovation from different perspectives and different levels of resolution is required in order to help stimulate the innovation that is sought by policy makers, industrialists, and academics.

2.1.3 Research on construction product innovation

Research in relation to the construction innovation systems has distinguished fundamental differences in the innovation activities of different companies in the construction sector and those related to it. Blayse and Manley (2004) quoted Anderson and Manseau who described the product industry's importance for the construction sector as follows: 'Manufacturing firms tend to operate in more stable and standardised markets than do contractors and consultants, allowing them to maintain R&D programmes. These programmes are key drivers of innovation in the industry. Manufacturing firms are also better able to build up knowledge bases and engage in virtuous cycles of learning because their activities are not project based, allowing them to avoid learning discontinuities. The original innovations developed by manufacturers are adopted by construction clients, contractors and consultants, improving the performance of the industry'.

Carassus (2004) concluded that the "construction sector system" approach identifies three kinds of firms and the methodologies to analyse innovation that should be tailored to each one: services firms, construction firms and manufacturing firms because they all have a very singular type of innovation (Table 2); he himself concentrated on service firms.

Table 2. Nature and main sources of innovation in different firms of the construction innovation system (slightly modified based on Carassus 2004).

Type of firms - trade classification	Nature of innovation	Main sources of innovation
Services firms dealing with the management of the built environment and construction projects - services sector	Mainly service and organizational innovations Design innovation	In-house projects groups and know-how, marketing department, coproduction with the clients, regulations, imitation of competitors Creativity, suppliers
Construction firms - construction sector	Mainly organizational Innovation, including site process. Tend to develop service innovation	Know-how of the technicians and workers on the sites, the clients, safety regulations
Manufacturing firms: Suppliers of materials and chemicals Manufacturers of components and systems - manufacturing sector	Mainly technological innovations (product and process) but commercial (material supplier) or service (component manufacturer) innovation can be a success factor	In-house R&D laboratories, scientific progress (materials), clients (components), regulations, competition in an oligopolistic market, the client

Differences are also observed among product manufacturers as regards size, turn-over, resources and innovativeness. The product industry is fragmented and

most companies are small or medium sized enterprises. Lichtenberg (2002) investigated 14 construction product development projects in order to identify key factors in success and failure. He concluded that most of the companies do not 'demonstrate any reaction at all' to the foreseen changes in the construction sector. Larsson et al. (2006) distinguished two types of component manufacturers in the Swedish timber industry: one group recognized the importance of information, knowledge, benchmarking and communication, demonstrating a balance between production and market needs; the other group concentrated primarily on production and largely ignored the market for their products.

Publications on product innovation activities are more frequent in the forest-based sector than in other construction-related value-chains. Mali et al. (1986a, 1986b) studied 'how product development projects should be prepared and realized in order that the projects were successful'. They analysed R&D (innovation) activities in Finland through nine factors that were business ideal, innovation structure, potential clientele, market dynamics, existing mind-sets, economy, entrepreneurship, manufacturing culture and alternative operational models. They also summarized the expectations of companies concerning the role of public research organisations as basic research, quick testing and official statements but wider co-operation could be more beneficial in their view. Kairi (2005) defended his doctoral thesis on the development and commercialization of the Kerto® LVL product. Hansen (2006) performed a survey among North American lumber and panel producers including structural panels in order to provide a description of the state-of-the-art of innovation and NPD (new product development) practices in the forest sector. His questions about innovation drivers also included academic/research institutions and sources included R&D; both of these aspects had a minor influence. Stendahl (2009) studied innovation management in the Swedish and Finnish wood industry aiming to understand the mechanisms of product innovation from a strategic and operational perspective and provide recommendations to practitioners. He conducted both a qualitative case study and a questionnaire among the manufacturers. One conclusion concerned co-operation with research organisations: 'Better knowledge about the properties and functionality of wood, better technology for wood processing and control of raw-material and production flow, and the development of proper product standards were all referred to by respondents as projects too large for a single company but well-suited for broad industry collaboration. Managers are therefore advised to promote such collaboration, for example through participation in research programs lead by universities or research institutes.'

2.2 Research on knowledge processes

2.2.1 Organisational knowledge creation

The definition of knowledge by Nonaka et al. (1996) is adopted as fundamental in this thesis: knowledge is 'a meaningful set of information that constitutes a justified

true belief and/or an embodied technical skill'. A hierarchical order is presented for data, information and knowledge for example by Bhatt (2001) and Jaspahara (2011). For Gielingh (2005), knowledge belongs to the conceptual domain, information to the communication domain and data to physical reality. Krogh et al. (2000) emphasized that, as opposed to information and data, all knowledge depends on its context.

Nonaka (1994) explored the idea that innovations are born in a continuous and dynamic interaction between tacit and explicit knowledge which happens at the individual, group, organizational, and inter-organizational levels. He concluded that there are four types of modes of knowledge conversion between tacit and explicit knowledge (Figure 6). Each of them can independently create new knowledge. Organizational knowledge creation means that each mode is organisationally managed so as to form a continual cycle. Schartinger et al. (2002) expressed the same thought by saying that 'what is considered as new knowledge, very often is the new combination of already existing pieces of knowledge. The combination occurs through personal interaction and communication processes between individuals.'

FROM	TO	Tacit knowledge	Explicit knowledge
Tacit knowledge		Socialization (S): Creating knowledge through shared experience (organizational cultures) Between individuals	Externalization (E): Creating knowledge through metaphors, analogies and models From individual to group
		Internalization (I): Creating knowledge through reflection and learning by doing; action-oriented (organisational learning) From organisation to individual	Combination (C): Use of social processes to combine explicit knowledge held by individual (information processing) From group to organisation
Explicit knowledge			

Figure 6. The spiral SECI process: four modes of knowledge conversion (Nonaka 1994).

Trott (2008) describes tacit knowledge as know-how that is difficult to understand and communicate. It can only be transferred through personal interaction and shared experience in the form of socialization (Nonaka et al. 1996). It may include a way of approaching and solving problems, imagination, continuous improvement techniques, or artisan like skills.

Tacit knowledge can either be held by individuals or collectively, in shared collaborative experiences and interpretations of events (Cavusgil et al. 2003). Because of its embedded nature within the firm, tacit knowledge tends to be what

2. Framework of the research

determines a particular firm's capabilities, its core competencies and hence its competitive advantage (Bergman 2005). Bhatt (2001) explained the core competence as interplay between background and foreground knowledge which he described as follows: 'Foreground knowledge is much easier to capture, codify, and imitate, while background knowledge is tacit and sticky, which makes it difficult to replicate and imitate. It is dependent on organizational history and its unique circumstances.'

Nonaka et al. (2000) proposed a model of knowledge creation consisting of three elements: (i) the SECI process, knowledge creation through the conversion of tacit and explicit knowledge (Figure 6); (ii) 'ba', the shared context for knowledge creation; and (iii) knowledge assets, the inputs, outputs and moderators of the knowledge-creating process (Figure 7). The 'ba' means a context in which knowledge is shared, created and utilized; it provides the energy, quality and place to perform individual conversions. It can be a mental, virtual or physical place. For example, members of a product development project share ideas and viewpoints on their product design in a 'ba' that allows a common interpretation of the technical data, evolving rules of thumb, an emerging sense of product quality, effective communication of hunches or concerns, and so on (Nonaka et al. 2006).

<p>Experiential Knowledge Assets</p> <p>Tacit knowledge shared through common experiences</p> <ul style="list-style-type: none"> - skills and knowhow of individuals - care, love, trust and security - energy, passion and tension 	<p>Conceptual Knowledge Assets</p> <p>Explicit knowledge articulated through images, symbols and language</p> <ul style="list-style-type: none"> - product concepts - design - brand equity
<p>Routine Knowledge Assets</p> <p>Tacit knowledge routinized and embedded in actions and practices</p> <ul style="list-style-type: none"> - know-how in daily routines - organisational routines - organisational culture 	<p>Systemic Knowledge Assets</p> <p>Systemised and packaged explicit knowledge</p> <ul style="list-style-type: none"> - documents, specifications, manuals - database - patents and licences

Figure 7. Four categories of Knowledge Assets (Nonaka et al. 2000).

Nonaka emphasized the responsibility of an organisation for establishing a nurturing environment of informal social interaction that might also span across the borders of the organisation. Whether organizational or inter-organizational, the critical step is to put the informal communities of interaction onto a formal basis. Brown and Duguid (2002) stated, that new knowledge usually emerges from communities of practice with a common set of habits, customs and priorities.

The knowledge creation theory is being developed further especially in areas of organisational learning and innovation management. According to Gielingh (2005),

its popularity can be explained to a great extent through internet technology because the theory focuses on interaction between human individuals and on the sharing of knowledge in an explicit form. On the other hand, potential limitations have also been identified. Peltonen (2009) refers to Jorna who writes that knowledge-creation theory lacks a theoretical foundation based on semiotics which would be needed since individuals treat and interpret knowledge in different ways.

Popadiuk and Choo (2006) compared the concepts of innovation and knowledge creation, and concluded that various types of innovations are related to various types of knowledge conversion modes (Figure 8).

Market knowledge	Knowledge creation	
	from tacit knowledge through socialization, externalization (exploration)	from explicit knowledge through internalization, combination (exploitation)
New market knowledge	Radical innovation Major product/service innovation	Niche innovation Modular innovation Major market breakthrough
Existing market knowledge	Major process innovation Technological breakthrough	Incremental product, service and process innovation

Figure 8. Classification of innovations in a knowledge creation perspective according to Popadiuk and Choo (2006).

2.2.2 Management of knowledge processes

Knowledge management is often labelled through its technology dimension, but according to Jaspahara (2011), it has been built on existing information systems. He defines the discipline from an interdisciplinary perspective so that it is 'the effective learning processes associated with exploration, exploitation and sharing human knowledge (tacit and explicit) that use appropriate technology and cultural elements to enhance an organisation's intellectual capital and performance'. He states that 'two dominant pillars of knowledge management are technology and human resource considerations'.

Although the interdisciplinary definition of knowledge management seems to be similar to an innovation as a knowledge process, the targets make the difference. An innovation process needs knowledge management for organisational performance but an innovation is the outcome of the process.

Several generic models for innovation processes are introduced in the literature. Their common feature is that a process is split into a number of phases that are distinguished based on the targeted results of a phase. Phases also involve different competences and expertise. Models may emphasise tasks and activities more than decision-making and vice-versa. According to Lin (2008), the functions typically in charge of the various phases are: marketing personnel for the concept phase and launch phase, design engineers for the design phase, test

2. Framework of the research

engineers for the prototype testing phase, and manufacturing personnel for the pilot production phase. Linear process models are still used to show the different activities, more for the sake of simplicity than reality.

According to Lin (2008), many industries have shifted from a sequential and functional development paradigm to a concurrent and cross-functional paradigm. Gielings (2005) defined 'concurrent' as referring to internal cross-functional activities and 'collaborative engineering' as referring to inter-organisational cross-functional activities. In the literature, the term co-NPD is also used for collaborative new product development. The more participants are involved and the more concurrent a process is, the more complex is the process model. Project-based business in particular uses multi-layered models that present a main process to which participants can develop their own organisation-level process models. Due to the rapid changes in companies, in the field of innovation management multi-functional processes inside a company, in a supply chain or in a networked activity are a continuous subject of research.

The processes are visualized in various ways depending on the weighting of activities and decision-making. The start and end phases may also differ; some models pay attention to the engineering phases and some pay attention to the forefront; one model is presented as an example in Figure 9 and a summary of some approaches is shown in Figure 10.

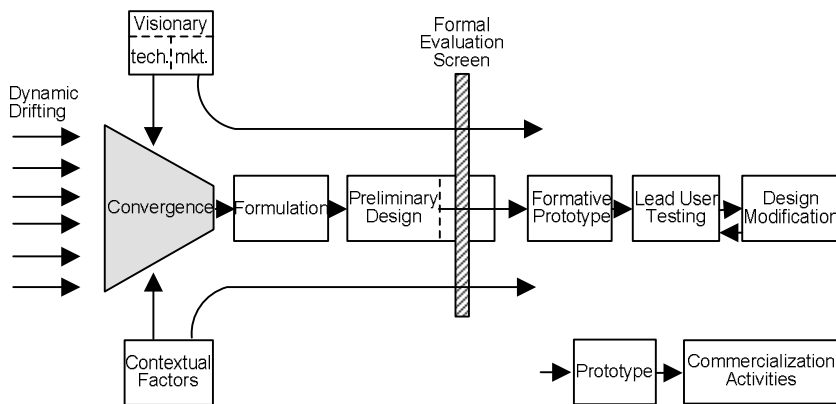

Figure 9. Schematic model of a product innovation process highlighting the front end activities (Veryzer 1998).

Ref		Division to various steps/actions/phases/stages										
1	Initiation	Information	Ideation (Concept)	Invention (tangible solution and marketing plan)			Implementation (Launch)					
2		Listening		Interpreting			Addressing					
3	Theoretical conception			Technical invention			Commercial exploitation					
4	Idea generation			Conversion			Diffusion					
5	Early phase			Mid-phase			Later phase					
6	Product ideas			Prototype development			Testing and validation			Launch		
7	Front end			Development projects			Product introductions					
8*	Requirements → Goals		Opportunities → Models	Studies → Options	Development → Fix	Manufacture and ITT (CE) → Product			Launch			
9	Scanning	Filtering	Acquiring resources			Implementing and commercialization			Reviewing and learning			
10*	Strategic phase	Creation phase	Development phase			Realization phase			Market diffusion			
11	Creating Concept	Justifying concept	Building prototype			Cross-leveling knowledge						
12	Dynamic drifting	Convergence Formulation	Preliminary design	Formative prototype Lead user testing			Commercialisation activities					
13	Concept development	Product Planning		Product/Process Engineering			Pilot Production/Ramp-Up					
14	Concept development	System-level design	Detail design		Testing and refinement			Production ramp-up				
15	Idea generation	Product definition	Project evaluation		Development stages			Marketing			Diffusion	
16			Invention									

*) presented in relation to building products

Figure 10. Schematic presentation of phases of an innovation process; 1 means Trias de Bes and Kotler (2011), 2 Verganti (2009), 3 Trott (2008), 4 Hansen and Birkinshaw (2007), 5 Frishammar (2005), 6 Vuola and Hameri (2006), 7 van Aken (2004), 8 Koukkari et al. (2004), Koukkari (2010), 9 Koivu and Björnsson 2003; 10 Lichtenberg (2002), 11 Nonaka et al. (2000); 12 Veryzer (1998), 13 Aldridge and Swamidass (1996), 14 Ulrich and Eppinger (1995), 15 Murphy and Kumar (1997), 16 Schumpeter (1934).

In the innovation processes of construction products, two knowledge management fields need to be considered, especially from software viewpoints. First, a manufacturer needs knowledge management in order to enhance its operational processes. The second area is knowledge management of building projects for which manufacturers provide information. The digital Building Information Modelling system, also called as Product Models, has been under development for decades, and implementation is expanding now.

2.2.3 Inter-organisational knowledge creation

In the 1980s, researchers summarized several types of inter-organisational co-operation activities, such as strategic alliances, partnerships, coalitions, franchises, research consortia, and various forms of network organisations. The types reflected 'rapid changes in technology, the competitive environment, firm strategies and other pressures' (Ring and Van De Ven 1992). Since then, the importance of inter-organisational co-operation has only grown. At the same time, 'the capability of a firm to absorb knowledge and information from external sources' has become 'one of the pillars in the process of transformation of knowledge and information into new knowledge and its conversion into new value' (Caloghirou et al. 2004).

The knowledge-creating view of companies has generated research that concerns internal and external knowledge interaction processes in such topics as acquisition, organisational learning, learning in networks, co-creation, co-innovation, innovation value chain, team working methods and trust building. Berente et al. (2010) divided the literature on inter-organisational knowledge creation into two streams. The first emphasises innovation and learning in projects and the second examines practices. They proposed to add use of information and communication tools (ICT) to practices that will probably allow less frequent physical interaction, for example in construction innovations. The potential of ICT is related to explicit knowledge. According to Yang and Lai (2006), the more 'valuable' the knowledge, the less sophisticated is the technology that supports it. Furthermore, 'to show its commitment for sharing knowledge, an organisation should foster the employee's willingness to share and contribute to the knowledge base'.

The inter-organisational knowledge creation through modes of knowledge conversion was depicted by Nonaka et al. (2000) as shown in Figure 11. The essential part of this model is collaborative working and shared experiences.

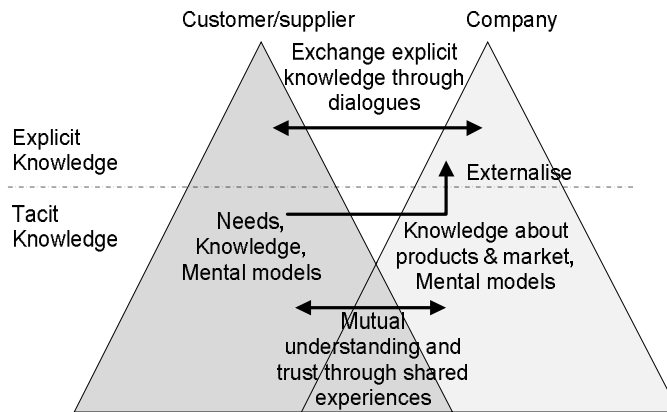

Figure 11. Knowledge conversion processes in inter-organisational interaction (Nonaka et al. 2000).

The concept of organizational knowledge creation through the SECI process has also been applied to interaction between universities and companies. Johnson and Johnston (2004) studied the relationship between enabling conditions and knowledge conversion processes as well as the effects of these processes on the achievement of technological objectives collaborative R&D projects. In their view, the entire cycle of conversion modes and the spiral of cycles are important, but individual processes are less relevant as such.

There are apparent obstacles to joint knowledge creation such as different backgrounds, personalities and interests (Bstieler and Hemmert 2010). The background of these differences is according to Bhatt (2001) that 'organizational knowledge is formed through unique patterns of interactions between technologies, techniques, and people, which cannot be easily imitated by other organizations, because these interactions are shaped by the organization's unique history and culture'. Similar cultural differences are also identified in industry-academia-research co-operation (Rynes et al. 2001).

At a sectoral level, innovation patterns are recognized to vary, and the interaction between research organisations and industry varies respectively. The role of interaction may also vary within a sector, depending on technology- and firm-related issues. Previous studies indicate that the construction products industry is heterogeneous in this respect (Lichtenberg 2002, Larsson et al. 2006). According to Rutten et al. (2009), literature on construction innovation concentrates on the process of innovation and discusses how specific industry characteristics affect this process. Researchers suggest that close and stable relations between the various organizations involved in the construction process, contribute to the development and adoption of innovations. In their study on learning in project networks, Taylor et al. (2009) concluded that project networks have been examined in design and construction from several perspectives including innovation but the role of learning has not been thoroughly investigated. In their view, knowledge

becomes an object to be exchanged at the boundary between firm dyads for the edification of one firm, presumably to be reciprocated in later knowledge exchanges.

2.3 Research on PRO-I interaction

The state of the art on public research organisation–industry (PRO-I) relationships is diverse, including the rich literature on relationships between universities and industries (Fontana et al. 2006, Salimi et al. 2013).

Schartinger et al. (2002) stated that knowledge interaction describes ‘all types of direct and indirect, personal and non-personal interactions between organisations and/or individuals from the firm side and the university side, directed at the exchange of knowledge within innovation processes’. In their view, a common feature of all knowledge interactions is that they involve a certain amount of knowledge flow, the exact extent, quality and effect of which is uncertain. According to Perkmann and Walsh (2007), the concepts of open, networked and interactive innovation would suggest that actual relationships between universities and industry – rather than generic links – play a stronger role in generating innovations.

Different concepts are developed in order to explain the knowledge interaction such as modes, forms, channels, mechanisms; according to Perkmann and Walsh (2009) though ‘some of the items refer to the media through which information is transferred between public research and industrial realms (publications, patents), others relate to social processes or configurations (collaborative research, informal networks)’. Tether and Tajar (2008) call universities and government research laboratories as specialist knowledge providers.

According to de Fuentes and Dutrénit (2010), the interaction develops in three linking phases that are the engagement in collaboration, the knowledge transfer during collaboration, and obtaining benefits from collaboration. This linking process can be different from the actual knowledge creation process of a company. Dutrénit et al. (2010) divided the forms of knowledge interaction into four channels: the traditional channel is defined by the conventional roles and forms such as publications, teaching, graduates; the services channel is motivated by the provision of scientific and technological services in exchange for money with forms such as consultancy and tests; the commercial channel means commercializing of scientific outcomes of PROs including forms such as licencing; and the bi-directional channel is motivated by long-term targets of knowledge creation by PROs and innovation by firms including forms such as joint R&D projects and research contracts.

The forms above are very similar to those recognized by Schartinger et al. (2002) as types of knowledge interaction between universities and companies. In their view, the channels used for transferring knowledge depend on the characteristics of knowledge, such as the degree of codification, the tacitness or the embeddedness in technological artefacts. They emphasised face-to-face-contacts and personal relations at least to some extent, because they are a precondition for transferring tacit, non-codified knowledge and also help to build up

trust. These relations can range from occasional and informal exchanges to permanent structures. Schartinger et al. (2002) also developed a metrics for the knowledge interaction that was based on the number of collaborative research projects with firms; joint scientific publications; researchers, who changed to firms for the purpose of R&D activities (either temporarily or permanently); technology-oriented firms founded by researchers; Ph.D. and Master theses jointly supervised with firm members or carried out at firms; lectures by firm members; number of training courses for firm members offered by their university department; research assistants employed at their department and financed by firms. A summary of identified forms of knowledge interaction between public research organisations and industries in common are shown in Table 3.

Table 3. Channels and forms of PRO-I interaction (Dutrénit et al. 2010).

Channel	Description	Forms
The traditional channel	knowledge flows mainly from PROs to firms; its content is defined by the conventional roles of PROs	Conferences and expos Publications Graduates recently employed in industry Teaching and research
The services channel	motivated by the provision of scientific and technological services in exchange for money; knowledge flows mainly from PRO to firms.	Staff mobility Consultancy and technical assistance Informal information exchange Use of equipment for quality control, tests Training staff
The commercial channel	is encouraged by an attempt to commercialize scientific outcomes that PROs have already achieved; knowledge flows mainly from PROs to firms	Patents Technology licenses Incubators Spin-off from PRO
The bi-directional channel	motivated by long-term targets of knowledge creation by PROs and innovation by firms; knowledge flows in both directions and both agents provide knowledge resources.	Networking with firms Joint R&D projects Research contract

Perkmann and Walsh (2009) identified four types of university-industry collaboration projects in their study that did not include construction-related projects: problem-solving projects addresses issues relating to products, processes or services close to market; technology development addresses design specifications or prototypes for new or improved products or processes; ideas testing is related to a high-risk concept on behalf of a firm which is outside the firm's mainstream activities; and knowledge generation projects making only very generic reference to market-ready products or services.

Research organisations are developing their networks and services proactively and actively. One role also identified in the construction sector is that of the broker. According to Winch (1998), the research organisations “play a vital brokering role” and do “much to fill the vacuum left by the competing professional institutions”. Davidson (2001) explained, that ‘the construction industry is one that can benefit greatly from the services of innovation brokers because the practice of technology watch within the industry is either impractical or simply non-existing’. This concept has also been applied by the Steel Research Institute FOSTA in Germany (Nuesse et al. 2012) and CRC CI in Australia (Kraatz and Hampson 2013). Processes inside research centres to respond to co-creation challenges are reported from Australia (Keist and Hampson 2007) and Finland (Koukkari 2010). The University of Salford in the UK has developed an innovation platform model that serves mainly as an internal framework to improve the engagement of potential end-users (Aouad et al. 2010).

Interaction between the contractors and research organisations has been investigated mainly from the points of view of universities and in relation to building projects (Bossink 2007, Aouad et al. 2010). Bossink’s work (2002) on co-innovation strategies in the Dutch construction sector in relation to sustainable buildings opens an interesting potential for studying co-innovative interaction patterns in stages that he defines as autonomous, co-operative, organisational co-operation and realization of innovations. Sexton and Lu (2009) based their research on the notion that ‘existing approaches are often producing knowledge that is not accessible and/or relevant for industry’ and ‘improved knowledge co-production designs and methods’ are needed.

2.4 Conclusions for the framework of research

A literature survey was conducted in order to identify suitable perspectives to investigate the innovation context and co-operative processes in building product innovation. The focus of the survey was on approaches that are usable for exploring the knowledge interaction between product manufacturers and technical research organisations.

2.4.1 Context of knowledge interaction

The innovation systems approaches include concepts that enable research on the context of knowledge interaction between manufacturers and research organisations in the field of building engineering. Their common feature is a recognition of actors and institutions and the principle that innovations are born through dynamic relationships within a system. For the actors involved, the structure and functions of a system should be such that they support development and diffusion of innovations. Building product manufacturers and research organisations are by definition actors in a system, and institutions in the construction sector comprising regulation, codes, and commonly accepted methods also concern product

manufacturers. From the viewpoints of the research problem of the thesis, various approaches have however uncertainties.

Innovation systems of the construction sector are centred on contractors and building projects. The research has recognized differences in operational and business models of product manufacturers as well as their R&D activities and knowledge bases from those of contractors but system approaches are so far not applied to investigate the innovation context of product manufacturers. Connections of product manufacturers to basic manufacturing industries in particular in the steel and forest sectors are also outside the system borders. The competition between the basic framing materials still exists which can be seen for example in the national, European and global industrial lobbying organisations and in the European Technology Platforms. Thus, the construction innovation systems do not cover all the factors that are essential for the innovation activities of product manufacturers.

The technology-specific systems of innovation seem to match well with the complex innovation context of manufacturers as they overlap national borders and sectors and deal with various levels. They would most likely help to explain the success stories or failures of single product innovations or technologies. The risk would be that the characteristics of the construction sector as an innovation system were not understood comprehensively. Furthermore, an integration process of all the activities of the construction and its related sectors has been taking place since the midst of 1980s due to the environmental and climate agendas on the other hand and the applications of information and communication technologies on the other hand. This development emphasises the importance to understand the characteristics of changes in the construction sector.

The approach to construction innovation systems as presented in Figure 5 was selected as the basis to investigate the context of knowledge interaction in the field of building engineering. This was concluded based in particular on the situation that institutions – rules of the game – are the same or overlapping for manufacturers, contractors and designers. Furthermore, the competences of research organisations are to a great extent based on knowledge of how to follow the procedures and rules of the construction sector and how to develop and use related institutions.

2.4.2 Knowledge creation processes

Several generic process models of product innovation are developed in research on manufacturing sectors. The activities are divided into slightly different main phases, but in general the models distinguish technical invention, commercialisation and diffusion. Greater emphasis has recently been given to strategic activities before any targeted programme or project, also called a fuzzy front end in the funnel type model (see Figure 9). Research-based inputs may be organised for various activities and in different forms of co-operation. The objectives of phases in a generic innovation process model are shown in Figure 12.

2. Framework of the research

<i>Phase in generic process model</i>	<i>Objectives</i>
Fuzzy front end	Strategic programmes and action plans
Invention	Ensuring compliance with objectives
Commercialization	Product-specific information in launch
Diffusion	Implementation of products in buildings

Figure 12. Objectives of joint innovation activities in building product innovations associated to the generic innovation process model.

The activities in various phases (categories) can be performed simultaneously.

Creation of new knowledge in the field of building engineering is the core of the scope of this thesis. The knowledge creation process (SECI) developed by Nonaka (1994) and Nonaka et al. (2000, 2006) is a popular approach to a diversity of research topics in the field of product innovation and organisational learning. Each knowledge conversion mode can generate new knowledge, for example through a combination of explicit knowledge. The theory has also been applied to inter-organisational knowledge creation.

In the thesis research, the knowledge creation theory was a basis to recognize common interest areas in joint activities and the content of knowledge assets of organisations. A model of collaborative knowledge creation process of a manufacturer and research organisation is shown in Figure 13.

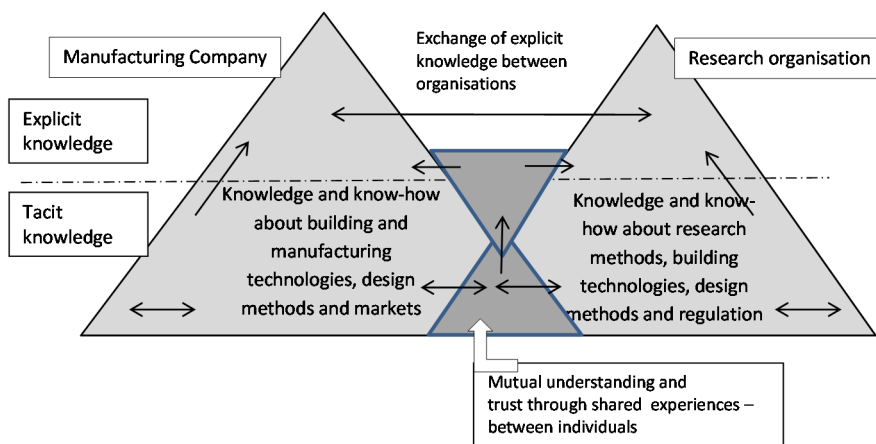

Figure 13. The approach to the knowledge conversion in joint innovation processes of building product manufacturers and research organisations.

The approach of innovation as a knowledge conversion process points to processes that need enabling conditions and caring management. In the thesis research, the aim was to deal with these issues.

2.4.3 Channels and forms of knowledge interaction

The knowledge interaction of industrial and research organisations is investigated through concepts that pay attention to ways in which knowledge flows between parties.

Co-operation between building product manufacturers and research organisations may be realised through several kinds of bi-lateral or multi-lateral form. In this thesis, the concept of 'knowledge interaction' is used for all kinds of co-operation independent of the actual form. The reasoning is that the co-operation is seldom an on-off effort but there are simultaneously many types of individual and organisational relationships, formal and informal. The forms of knowledge interaction as presented in the literature belong partly to the innovation process management (funding, project organisations, enabling conditions), partly to the knowledge creation process (working and communication methods).

The forms do not ask for causes or context of interaction, nor do they directly relate to any type of knowledge conversion modes. Identification of forms in actual processes does, however, provide first impressions about working methods and the intimacy of co-operation as Schartinger et al. (2002) concluded: collaborative research and joint research programmes are forms of 'transfer of tacit knowledge' in the university-industry interaction.

The forms recognized in the literature are common to various types of universities and disciplines. When the types of research organisation other than universities are considered, other forms of knowledge interaction may also appear than presented in the literature. There might also be differences in the accumulation of knowledge and organisational learning in various types of research organisation. It is also possible that other issues will deepen the analysis as for example types, rules and locations of funding organisations.

2.4.4 Summary of the framework of thesis research

The various research fields considered as potential approaches to studying the research problem are summarised in Table 4.

2. Framework of the research

Table 4. Perspectives to the research problem based on the literature survey.

Research field	Main concepts with relevance to the research problem	Topics related to the research problem
Innovation systems	An innovation takes place within an innovation system that may be national, sectoral or technology-specific. Two main components of a system are organisations and institutions ('rules of the game'). Innovations are path-dependent.	<ul style="list-style-type: none"> – Actors, institutions and their relations – Functions of an innovation system, including knowledge development and diffusion – Influence of the context on the interaction between organisations
PRO-I and U-I interaction	Forms and channels of knowledge interaction	<ul style="list-style-type: none"> – Acquisition of knowledge – Transfer of knowledge – Funding opportunities
Knowledge processes	<p>The innovation process is a spiral of knowledge conversions; each mode of SECI process creates new knowledge and knowledge assets. Sharing tacit knowledge between individuals is the primary source of radical innovations.</p> <p>SECI process requires enabling context, 'ba', in which new knowledge can be created, shared and used.</p>	<ul style="list-style-type: none"> – Spiral of the SECI process – Modes of knowledge conversion – Enabling conditions for new knowledge – Ways to communicate and work – Knowledge assets held by individuals and organisations – Diffusion ('cross-levelling') of the new knowledge
Product innovation and an innovation process	<p>An innovation results from an innovation process that essentially has activities of technical invention, commercialisation and diffusion, incl. implementation.</p> <p>An innovation process may be concurrent inside a company or collaborative between companies or various organisations.</p> <p>Co-operation (knowledge interaction) between research organisations and companies occurs through several forms.</p>	<ul style="list-style-type: none"> – Newness of the product innovation compared with existing solutions on the market. – Newness of the product innovation to existing institutions. – Types of new knowledge and research methods to create it. – Use of new knowledge inputs in various activities of an innovation process. – Participants in various activities. – Types of co-operation projects. – New research-based knowledge inputs for the product innovation. – Impacts of new research-based knowledge to institutions.

3. Research methods

3.1 Introduction

The case study approach was chosen due to the exploratory and descriptive purpose of the thesis. The aim was to “understand phenomena within their own context-specific settings” (Gray 2009). According to Eisenhardt (1989), “the case study is a research strategy which focuses on understanding the dynamics present within single settings“. According to Yin (2009), case study research is particularly suitable when there is a need to understand complex social phenomena such as organizational processes and when the boundaries between phenomenon and context are not clearly evident. The research methods were qualitative. The case study method was applied according to the instructions of Yin (2009). Any case study process has iterative phases which are not usually reported but are stored in working documents and the case study databank.

The type of approach in the thesis was “multiple case, embedded” as presented in Figure 14.

Extract from Yin (2009, p. 46) (Type: Multiple case, embedded)	Framework of research for the case study	Issues related to the research problem
	<p>Construction innovation system</p> <p>Product innovation as a process of activities</p> <p>PRO-I-knowledge interaction Product innovation as a joint knowledge process</p>	<p>Contexts of co-operation and knowledge interaction Relationships between various system components</p> <p>Progress from search to diffusion: manufacturer's and research organisations' activities</p> <p>Forms of knowledge interaction Areas of research-based knowledge inputs in different process phases Accumulation and diffusion of new knowledge</p>

Figure 14. Initial scheme of planning of the multiple-case study (embedded) based on Yin (2009) and the framework of research.

3. Research methods

The context of all the cases was chosen as the construction innovation system in Finland because the knowledge interaction was expected to be influenced by similar national institutions and actors. The research data was expected however to indicate that the other system approaches would give information about the overall innovation context of manufacturers.

The main reason to select several cases was the intention to acquire deeper insights into building product innovation processes in various value-chains and into various phases of an innovation system. Within a case, forms of interaction between a company and research organisations were studied as well as the steps in knowledge creation and accumulation. Causes and implications of knowledge interaction were of special interest, and they were associated with initiation of a co-operation and to shaping the institutions. Each case study was historical (longitudinal) tracing the evolution of companies and products.

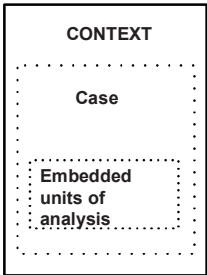
Research data was gathered through primary and secondary sources. Primary sources were interviews with the representatives of companies, industrial associations and research organisations. Secondary sources were background documents such as professional journals, R&D programmes and projects, national and European strategic research agendas, biographies, technology histories, histories of research organisations and companies as well as Business Intelligence (BI) reports prepared on companies and based on public information. The secondary sources were used mainly to gather qualitative data but they also included quantitative data. Document analysis was used for context description and to add depth to the cases (Simons 2009).

3.2 Design of multiple case study

3.2.1 Selection of innovation cases

The cases were selected according to a purposive strategy: The first criterion was that the product innovation had required research-based inputs before the market launch and implementation in buildings. This information was searched for through conversations in networks of researchers in different organisations and from publications in the field of building technologies. In total, 20 widely known products were selected preliminarily. The first interviews were also used to identify the innovation cases. Access to relevant and informative data was the second criterion: three companies did not wish to be involved. Finally, ten cases were selected for which the interviews could be arranged on both the industry and research side. Within these, the division into the traditional framing materials was such that concrete construction had two, steel construction three, and wood construction two cases. Two cases were about composite construction and one case dealt with building concepts that could be realised either through concrete or wood construction. Table 5 shows the cases.

Table 5. Product innovation cases.

Case	Company	Description	Additional information
A	A	Product portfolio for the open building system Prefabricated concrete products	Other manufacturers may compete with alternative products for the open building system
B	B	Products for industrialised on-site concrete construction Industrial reinforcement, composite slabs, green concrete	Technology concept developed by several companies manufacturing various products
C	C	Composite beam for slim floors Steel-concrete composite building system	Single product of one company Building system today
D	D	Portfolio of thin-gauge steel products	Several products; alternative products manufactured by other companies
F	D	Single-storey energy-efficient building	Building concept of one company, sub-contractors
G	G	Sandwich panel with mineral wool core Façade system made of panels	Single product, one company
H	H	Thermowood®	Single product type, several companies
J	J	LVL product Company-specific wooden building system	Single product, one company; a system today
K	K	Modular off-site building concept	Concept, system, one company
L	L	Energy-efficient multi-storey building and its components	Concept, system (concrete or wood frames)

The timeline of qualitative data was long. The reasoning behind this choice was that it was expected to have a more comprehensive picture of the system dynamics that influence building product innovations and relationships within a system. Furthermore, innovation activities are still continuing in some cases which began in the early 1970s. Cases A and B are connected to companies which played a leading role in the transition to prefabricated concrete construction in the 1970s and 1980s, Case D used to have a leading role in the emergence of the steel-based components and solutions in the 1980s and 1990s.

The cases were different as regard to product compositions or portfolios or the speed and duration of the process or the companies. There were cases, in which a new company and/or factory was established to produce one novel product (Cases C and G) or several companies were established to produce a novel product (Case H), or a case in fact was a product portfolio or a building system (Cases A, B and D).

3.2.2 Design for credibility

The design of the case study as regards credibility concerned the planning and conducting of interviews, the use of complementary literature and the interpretation of the qualitative research data. Some risks were identified associated with the qualitative research approach: At first, data gathering was to a great extent based on interviewees' memories and openness. Secondly, mixing personal opinions with data analysis was apparently too easy due to the career of the researcher. Measures were taken in order to ascertain the validity of data and analysis.

The validity of data was ascertained mainly through triangulation of data sources and methods: interviewees represented both manufacturers and research organisations, and designers and associations were also represented. The period of time of an interview covers the entire duration of consideration in some cases; in other cases the timeline was covered by several interviews. However, most product cases are covered by two interviews.

The background documents were used to deepen and cross-check the data acquired from interviews. Quantitative data was also gathered to a minor extent.

The reliability of the case study was based on a research plan including interview protocols, tables of content of company reports and a databank of documents. Preparation of the protocols for interviews was assisted by a colleague researcher. The topics were preliminarily selected based on a limited number of scientific papers that dealt with knowledge interaction, co-innovation and inter-organisational product innovation. Pilot interviews on steel-based construction products were used in order to assess the usability of selected topics, interviewers' ways of communicating and other practical issues.

A rather large number of cases was selected so as to strengthen the basis for analysis. The target was about ten that had been recommended as an upper limit by researchers Eisenhardt (1989) and Manley (2008), because a large amount of research data involves risks of losing the focus.

Interviews and their recording were conducted by two researchers in all the cases with only three exceptions; the assisting researchers were colleagues of the author of this work. The colleague involved in the preparation phase was present at half of the interviews. Two other colleagues were involved in other interviews at different times.

Data from each case was described as a stand-alone entity at first taking into account all the related interviews, the company reports and the background information. In the early-stage of analysis, a trial to apply the theory of Nonaka was made together with the colleague who was involved in the preparation of interviews. Another colleague was also available to organise data according to Nonaka's concepts and process model. It became obvious that another analysis technique was necessary. From this stage on, the analysis of data was developed and performed by the author of the thesis alone.

3.3 Interviews

3.3.1 Types of interviews

The primary sources of the qualitative research data were interviews. Two types of interviews were planned: the 'executive' interviewees represented industrial confederations and associations and the issues dealt with the national and sectoral systems of innovation but were also connected to the cases; the 'expert' interviews dealt with building product innovation cases from the viewpoint of a company's innovation processes and production and the use of research-based inputs. The first types of interview were non-directive although the main issues were listed beforehand. The expert interviews were semi-structured. The interview topics were introduced as open ended questions in semi-structured interviews, and a free flow of thoughts was allowed.

At the beginning of the research, an interview with a representative of the Finnish Constructional Steelwork Association was conducted as piloting in order to learn about the procedure; a new interview was conducted later.

3.3.2 Interview topics

The topics of interviews were identified and arranged based on the literature survey on knowledge and innovation processes focusing on inter-organisational co-operation. Thus, the headings of an interview plan were chosen as the main types of product innovation activities. The topics were also elaborated to match with the framework of research as concluded based on the literature survey (Chapter 2.4).

Detailed checklists (as an aide memoire for the interviewers) were prepared related to aspects of a knowledge process and knowledge interaction such as forms of interaction and research inputs to the product innovation.

Table 6 shows the interview topics that are presented in greater detail in Appendix A.

Table 6. Interview topics related to the product innovation processes.

<i>FUZZY FRONT END ACTIVITIES</i>
Strategic activities Identification of R&D needs Integrated research activities Networking Contribution to the development of institutions
<i>TECHNICAL INVENTION ACTIVITIES</i>
Co-operation partners Funding of joint activities Suppliers of research-based services Research areas and topics Use of research-based knowledge
<i>COMMERCIALISATION ACTIVITIES</i>
Co-operation partners Product-specific design methods Product-specific approval procedures Development of quality assurance Joint actions as regards market launch
<i>DIFFUSION</i>
Co-operation partners Development of technical services Demonstrations, pilots Export to Nordic, European and other countries

3.3.3 Interviewees

The following labels were for Finnish technical research organisations:

- PRO1: Helsinki Technical University HUT ('Aalto University' since 2009);
- PRO2: VTT Technical Research Centre of Finland;
- PRO3: Technical University of Tampere TUT
- PRO4: Technical Department of Oulu University OY
- PRO5: Any other Finnish university
- PRO6: Hämeenlinna University of Applied Sciences HAMK
- PRO7: Any other Finnish university of applied sciences
- PRO8: Any Finnish governmental research organisation
- PRO9: A foreign research organisation.

The interviewees were five 'executives' representing organisations that lobby, promote and co-ordinate R&D activities (Table 7) and 28 experts representing mostly the manufacturers and research organisations (Table 8).

Table 7. Executive interviews with representatives of lobbying and brokering organisations (associations and industrial research centres).

Lobbying/ Brokering Organisation	Interviewee and position
Finnish Confederation of Construction Industries RT	ER1: R&D Director, Dr., former Director at Tekes, Professor at PRO3
Finnish Concrete Association BY	EC2: Executive director, Dr., former Scientist at PRO3
Finnish Constructional Steelwork Association TRY	ES3: R&D director, former scientist and manager at PRO2; Manager of a national Technology Programme
Finnish Forest Industries Federation Wood Research Centre	EW4: Director, R&D and competitiveness EW5: Managing director, former R&D Director in a manufacturing company, international career

Table 8. Expert interviewees. I refers to industry, R to a research organisation.

Case	Interviewee	Position now; role in the innovation case	Links to cases
A	A1I A2R A3R	R&D Director; Director in RT Consultant; Professor at PRO2 Research scientist at PRO2; Research scientist	B, C
B	B4I C8R	R&D Director; R&D Director Teacher at PRO7; former Scientist at PRO2	A, C, D
C	C5I C6I C7I C8I C9R C10R	Marketing Manager; R&D Manager R&D Manager; project engineer Director, Foreign markets; project engineer Director, R&D; - Teacher at PRO7; Scientist at PRO2 Researcher at PRO4; Researcher at PRO4	A, B
D	D11I ES3	Project Manager; Customer Manager R&D Scientist at PRO2; Programme Manager	G, C, F
F	F12I F13I	Director, R&D, Dr.; Director, R&D R&D Architect; R&D Architect	D, G
G	G14I G15I G16R G17R	Consultant, Dr.; R&D Manager R&D Manager; Consultant Senior Designer; Scientist at PRO1 and PRO2 Expert in consultant firm; Scientist at PRO2	D, F
H	H18I H19R	Managing director, former expert Research Scientist at PRO2	J
J	J20I J21I EW4	Professor at PRO1, Dr.; R&D engineer Director, R&D; - Director; R&D Manager	
K	K22I ES3	Director, sales; a construction company Director, R&D; Programme Manager	D
L	L23I L24R	CEO; CEO Research Scientist at PRO2; Research Scientist at PRO2	
-	M25 M26	CEO; former researcher at PRO2 Director, steel design division	C, D, F
-	N27R	Professor at PRO3, Dr. former Director in a design office	D, F, K
-	O28R	Professor at PRO1; researcher at PRO1 and PRO2	A, D

All the experts were involved at least in the activities for technical invention except for O28. Several interviewees could provide information about more than one case as shown in Table 8 and also about the innovation context.

3.3.4 Conduct and reporting

The interviews were conducted mostly by two researchers between 7.9.2011 and 14.11.2012. Two complementary interviews were conducted by the author concerning Cases A and G in November 2013. The interviews took place either at the offices of the interviewees or at those of the researchers. The language used was Finnish except in four cases when it was English (F12, H19, J20 and J21). Interviews were recorded and notes were also made. The duration of an interview varied between 1.5 and 3 hours.

Interview reports were transcribed directly from recordings in Finnish and then translated into English by one researcher involved in the interviews and checked by another researcher. In total, 24 interview reports were prepared in English and Finnish reports were prepared from interviews with A3R, C6I, G17R, L24R and O28R. Data from Interviewees C4I, C6I and C7I were used directly in a conference paper. Interviewees M25 and M26 were present together. Each individual report had a length of between six and sixteen pages.

The English versions were communicated with the interviewees individually, and they made some minor technical modifications.

Working interim documents were prepared for the Steering Group of the national project based on individual interview reports and reports on companies (Business Intelligent reports). Written work documents were also prepared about lobbying and brokering organisations (see Table 7).

3.4 Analysis procedure

The analysis technique of the case study was a cross-case synthesis that was based on individual case descriptions in accordance with a uniform descriptive framework as explained by Yin (2009). Trials were also made to apply elements of the knowledge creation theory and process model of Nonaka and his colleagues but the conclusion was that the research data facilitated a more comprehensive approach through a combination of various perspectives as summarized in the framework of research in Chapter 2.

The research data was compiled case by case in chronological order and divided to 1–4 phases. Start and end years of phases in each case were identified based on changes that influenced the context of knowledge interaction, for example in the R&D strategy of manufacturer, public funding opportunities or regulation. The procedure of organising the research data further was iterative so that several trials were made to reorganise the data into word tables. The preparation of the uniform table of content is explained in Chapter 5.1.

The stepwise analysis process is summarised in Table 9.

Table 9. Analysis procedure of case descriptions and cross-case synthesis.

Phase	Steps	Methods
I: Trial to apply the approach and concepts of knowledge creation process		
One case write-up, Case C	First with-in case analysis (Case C)	A joint conference paper together with a colleague and all the interviewees of the company applying Nonaka's approach; the approach matched with data and analysis at inter-organisational level; the data also uncovered context issues (Koukkari et al. 2012).
Two-case comparison, Cases C and G	With-in case analysis of Case G Comparison of Cases C and G	Organising research data of Case G to a generic process model; application of the approach of Case C; data matched with the Nonaka's process model and also uncovered the context issues.
Application of Nonaka's approach to all the cases	Rearranging the data in interview reports to word tables Comparisons Conclusions	Data in each case organised according to Nonaka's process model and identifying the issues connected to the approach; Gaps observed in data based on interviews concerning working methods and three main elements of the theory (modes of knowledge conversion, 'ba' and knowledge assets)
II: Cross-case synthesis as the analysis technique of the thesis		
Research data: Chronologies of cases	Data in timetables Phases Data compilation	Arranging the data from interview and company reports into timetables; Identification of main phases; Complementing the data from the background literature.
→ Case chronologies in Chapter 4		
Iterative preparation of uniform table of content for the description framework	Concepts Topics Themes Structure	Compiling data of all the cases to word tables according to concepts and topics of the framework of the research; Rearrangements of topics and data; Themes for the description framework Table of content for the description framework
Individual case descriptions	Re-organising data Complementing data Descriptions	Organising data under the headings Complementary data Presentation of case descriptions according to the description framework.
→ Case descriptions in Chapter 5		
Cross-Case synthesis	Topics of all the cases	Compiling all the case descriptions topic by topic
	Synthesis of steel-related descriptions	All the steel-related product innovations were compiled and analysed in the framework
	Findings of all the cases	Combination of framework topics in all case descriptions
	Synthesis	Compilation of findings
→ Synthesis of the case descriptions in Chapter 6		

4. Research data: Case chronologies

4.1 Introduction

Research data on each case was gathered from interview reports, company reports and background literature and organised into chronologies. Chronologies were divided into 1–4 phases as follows:

- Case A: four phases since the beginning of the 1970s;
- Case B: three phases since the beginning of the 1980s;
- Case C: three phases since the end of the 1980s;
- Case D: three phases since the end of the 1970s;
- Case F: one phase in the 2010s;
- Case G: three phases since the themed-1980s;
- Case H: three phases since the mid-1980s;
- Case J: four phases since the beginning of the 1970s;
- Case K: one phase 2006–2014;
- Case L: two phases since 2001.

The first phase was dedicated to activities during the period of time before the novel products, product portfolios or building concepts were brought onto the national market for the first time either from pilot factories or based on a national product approval or a building permit.

Public research organisations operate under different ministries, perform their research tasks in various consortiums and acquire funding from many kinds of national, Nordic or European sources. Occasionally, private and public international funds are also used. Three types of technical public research organisations nowadays operate in the field of building and construction in Finland:

- Governmental research centre under the Ministry of Employment and the Economy;
- Technical universities under the Ministry of Education and Culture;
- Universities of Applied Sciences under the Ministry of Education and Culture.

The first technical university was established in Finland in 1908 by changing the status of the polytechnic institute of Helsinki. From the early years on, structural engineering was a part of the curricula. In 1933, the name of the department was changed to Civil Engineering. The number of teaching areas, professors and other employees and students grew steadily until the 1960s when the number of students doubled each year (Julkunen 2008). PRO4 started teaching in civil engineering in 1958. PRO1 established an affiliated unit in 1965, which became an independent technical university PRO3 in 1972. In 1971, all the technical educational institutes were moved to the responsibility of the Ministry of Education.

The laboratory for building technologies of the national research centre PRO2 was established in connection to PRO1 in 1937 (Michelsen 1993). The operations were merged or closed depending on the technology field until 1971 when PRO2 remained under the Ministry for Trade and Industry.

Technical universities have traditionally concentrated on thesis projects for which funding has been received in various ways. Companies and associations used to contract theses until the 1980s, but later most of the work has been done in joint research projects. In 2001 the law concerning universities of applied sciences included the obligation to include research and development in their activities. Several universities of applied sciences have subsequently been involved in joint research projects at regional, national or European level.

Many other research organisations, such as sectoral research organisations under various ministries, take part in R&D projects that deal with subjects concerning the performance of buildings and the built environment. The labels used in case descriptions for research organisations are explained in Chapter 4.3.3.

In chronologies, the funding opportunities are referred to by the following abbreviations:

- BY is the Concrete Association of Finland;
- CEN is the European Standardization Organisation;
- FA is the Academy of Finland under the Ministry of Education and Culture which administers funding opportunities for science-based research also in the fields related to technology development;
- RFCS is the European Research Fund for Coal and Steel (previous ECSC);
- RT is the Finnish Confederation of Construction Industries;
- RYM Ltd is the Finnish Strategic Centre for Science, Technology and Innovation, RYM for the built environment that was established by TEM in 2009;
- SBK is the Confederation of Finnish Concrete Industries;
- Tekes is the Finnish Funding Agency for Innovation (for Technology and Innovation until 2013) that was established in 1983 and is administered by the Ministry of Employment and the Economy TEM;

- TEM is the Ministry of Employment and the Economy (previously the Ministry of Trade and Industry) which administers funding opportunities of companies and joint activities in the fields of technology and innovations;
- TRY is the Finnish Association for Constructional Steelwork.

4.2 Case A: Product portfolio for the open building system

Case A concerns the development of the national open building system BES and prefabricated hollow-core slabs and concrete sandwich panels for façades fitting with the system. The BES system was an agreement of basic grids and their division into 3M modules (one M meaning 100 mm). Its fundamental principle was that components were suitable for competition between several manufacturers. In the basic system for residential buildings, transverse walls were load-bearing. BES became the winner of three alternative systems. Pilot buildings made of prefabricated components had already been constructed since the 1950s.

4.2.1 Background

The Housing Office in the Ministry for Internal Affairs and the concrete industry funded an initial R&D project in 1968–1970 that studied off-site manufacturing technologies and 25 building systems in detail in several countries. The General Manager of the Housing Office was one of the most influential individuals in launching the system on the markets (SBK 2009). Practically all the stakeholders of the construction sector were involved in the development of the national open building system BES: governmental offices, developers, contractors, designers, product manufacturers, industrial associations, research organisations, machine manufacturers; connections were also to investors, banks and urban planners (Hankonen 1994; Mäkiö et al. 1994; SBK 2009).

The emergence of an entirely new building technology based on prefabricated concrete components was also possible thanks to a change in higher education. The latest methods of structural analysis were brought from the United States to PRO1 through scientific visits in the 1960s. PRO1 had also acquired new experimental facilities in 1967 which facilitated an increase in research activities (Julkunen 2008). They were mostly related to diploma and doctoral projects. In PRO2, cement and concrete materials and concrete structures were studied since establishing the entire research centre in 1942. In 1958, the concrete laboratory acquired testing facilities for structural research (Michelsen 1993).

4.2.2 Manufacturer A

Manufacturer A produces prefabricated concrete building products at twelve sites in Finland which merged into an international concern in 2002. It is the leader on the domestic market. Its revenues in 2010 were 137.1 million euros, and the

number of employees was about 800. The concern has also had its central R&D unit with a good laboratory in Finland as a separate company for ten years.

The roots of Manufacturer A are in a company that used to be one of two leading cement and concrete companies in domestic markets and industrial organisations until 1992. It used to be one of two leading manufacturers of concrete components on the market and in SBK. Internationalisation of the previous Finnish company started in the late 1980s through acquisitions and merges. During the time of growth and internationalisation, the R&D resources of the company were generous thanks to the big volumes in building construction.

The product portfolio of the current Finnish company comprises prefabricated hollow-core slabs, concrete facades (concrete sandwiches, external insulation composite systems) with various surface treatments including rendering, composite slabs, fundament components, elevator shafts, various balcony structures, pre-stressed beams with various cross-sections and railway sleepers.

Manufacturer A continuously launches new products onto the markets. Since 2000 the number of their patents has been 83, half of them concerning products and the rest dealing with materials and production and construction methods. The newest building products comprise, for example, a symmetrically pre-stressed driven pile and a component for a light-weight hanging balcony that is made of glass fibre concrete and hung directly from the building frame, and optionally can have customised glass developed together with the producer of glass parts.

The individual products have been developed up to the present day such as hidden connectors, increasing the depths and spans of hollow-core slabs or supporting integration of various systems. Self-compacting concrete has also been taken into use in factories of pre-fabricated components. Panels for façades have been developed to cope with the requirements of energy-efficiency and long service-life. The R&D investments of Manufacturer A have been around 1% of its turnover in recent years, which is more than the average of the entire international concern; the annual allocation has been at the level of 1 million euros. However, its Tekes funding was about 50 000 euros in 2010.

Manufacturer A is a shareholder in RYM Ltd and actively involved in the development the Building Information Modelling BIM.

4.2.3 Chronology of Case A

The chronology of knowledge interaction between building product manufacturers and research organisations in Case A was divided into four phases.

4.2.3.1 Basics of the 'bookcase' system

The basics of the 'bookcase' system for residential buildings were established around the years from 1968 to 1978. Its main prefabricated components were hollow-core slabs, transversal load-bearing partition walls and concrete sandwich panels for façades. The design and product approval methods of the pre-stressed

4. Research data: Case chronologies

components of the BES system were not covered properly in the Building Code which was the primary driver of R&D activities (SBK 2009).

The new boom in the R&D activities of companies in the field of prefabricated construction was seen also at PRO1. In total, 34 theses were approved concerning the BES system in the 1970s, the first years of the decade being more productive – in 1972 alone the number was 9 (TKK 2013). A professorship of building technology at PRO1 concentrated on concrete materials and reinforced and prestressed concrete structures. In 1972, a course on the basics of prefabricated component construction was established (Julkunen 2008).

The knowledge interaction during the first phase of the BES system is introduced in Table 10.

Table 10. Knowledge interaction of Manufacturer A with research organisations related to the development of residential BES system in the 1970s (first phase).

Years	Description of knowledge interaction
1968–1972	The Confederation of Finnish Concrete Industries SBK: BES Recommendations for residential building prepared and published (the so-called 'bookcase system') First type of hollow-core slabs (depth 265 mm, 5 voids) Occasional contract projects
1974–1984	Formal PRO2-Contractors-co-operation group with representatives from contractors and various laboratories of PRO2 in the building sector. The scope was mainly on BES but also on in-situ construction and winter masonry. R&D focused on structural performance of hollow-core slabs and the load-bearing system of a building. Joint detailing was of importance.
around 1975	Hollow-core slabs of a depth of 200 mm (6 voids) and 150 mm (8 voids) on the market; the building permission authorities asked for verification and statements about their safety.
1975	The first PRO2 publication about the structural performance of the BES system (prevention of progressive collapse) in the Research Notes series (Concrete Technology No 36); the second publication dealt with production technology of prefabricated components (No 38) in the same year.
1975	The national product approval procedure was declared by the Ministry of Internal Affairs based on the preparation mandated to PRO2. It was based on Nordic and German models.

The first computing tools were developed for concrete structures at PRO2. The software was also sold to companies who used them for design tables and curves. The ADINA software was modified for analysis of reinforced concrete structures.

The prefabrication industry developed fast. At the end of the 1970s the share of prefabricated construction in multi-storey residential buildings was about 40%. The market also expanded to the Soviet Union where components were supplied to large construction projects of the Finnish contractors.

4.2.3.2 BES-adaptations to other types of building

Expansion and adaptation of the structural BES system to office and other types of building and incorporation of technical systems took place from 1979 to 1989. The closer co-operation between concrete product manufacturers and research organisations started when an agreement was signed between SBK and PRO2 based on the initiative of the association. Its general aims were to 'develop product ideas and industrial applications from the fruits of basic research' (SBK 2009). Two large manufacturers were involved, but also smaller manufacturers saw it as an important channel to gain access to research results. The common agenda was for 3–5 years, and implementation plans were made annually with budgets starting from one million Finnish Marks, which was a remarkable sum at that time. The chair of the group had a fundamental role in the success.

The research activities became a more important part of the professorship of building technology at PRO1 in the 1980s and 1990s when the new professor nominated in 1978 started a new period and organised an efficient utilisation of funding opportunities of the Finnish Academy and Tekes (Leppävuori et al. 2009).

The number of researchers of PRO2's laboratory for concrete technology grew from six in 1970 by almost ten times in twenty years, and the total number of employees was then 130 including technicians, engineers and administrative personnel.

By the end of the 1980s, the share of prefabricated residential buildings was about 85%. The Finnish hollow-core-slab technology also grew very competitive globally, and became the world leader during the 1980s. The key enabler of success was the combined development of machinery, products, structural design, construction technology, know-how and training. PRO2 had a role in the preparation of product specifications and guidance for design and use. Some of the documents were widely referred to in foreign publications, e.g. concerning the diagram action. PRO's researchers were also teaching on training courses abroad.

A summary of the observations during the second phase of innovation activities in relation to the BES system is presented in Table 11.

4. Research data: Case chronologies

Table 11. Knowledge interaction of Company A with research organisations related to the development of BES for office and other buildings (phase 2).

Year	Description of knowledge interaction
1979–1993	<p>The PRO2-SBK-research co-operation group based on the proposal of the SBK representing mainly the component manufacturers.</p> <p>PRO2 research created the knowledge and guidelines of new products and concepts, and companies concentrated on applications and business development. The outcome was published in the PRO2's "Research Notes" series about small houses, prefabricated facades, agricultural construction at the beginning of the 1980s.</p>
1980s	Several recruitments from PRO2 to companies and associations
1982–1985	<p>'Frame-BES' project of PRO2 and SBK produced basics for a building system for offices with standardized components and their connections; both parties published results.</p> <p>The shear resistance of hollow-core slabs became an issue when the hollow-core slab with a thickness of 400 mm (3 voids) was under development. A new research area in structural mechanics of hollow-cores slab fields began. Performance was also studied in co-operation with Swedes.</p>
1982–1995	The national Committee for Computer-aided Design was established based on the initiative of PRO2 and PRO3. The Committee prepared a long-term R&D plan. The Finnish Foundation of Building Information RTS established the RATAS Committee in 1984. The Committee produced several guidelines for Computer Aided Design and Construction in several projects which were funded by companies and Tekes.
1984	The large companies recognised the potential of the new Tekes funding to support the implementation programmes of PRO2-SBK co-operation group. The companies proposed the projects to which they allocated their own resources as well, and then sub-contracted PRO2. The long-term R&D co-operation in industrialised building started when the other large manufacturer announced its plan to start a new phase in off-site technology based on BES and engage designers and contractors to R&D as well. It had also reserved a substantial sum of funding.
around 1985	PRO2 started co-ordinate strategic Tekes projects. PRO2 needed financial contribution from companies and also a Steering Group of stake-holders.
1987	PRO2 received world-class research facilities suitable for large-scale structural experiments. Digital measurement and data handling were in use. Guidelines for experimental research were developed in study circles and published as in-house guidelines and to R&D personnel of companies (Jokela et al. 1987).
1986–1991	<p>The large-scale technology programme of Tekes for Industrialised Building Construction concerned all basic framing materials and the construction processes from planning to execution. Company A was involved in particular in the project Product Development of Office and Residential buildings TAT, and in the RATAS project on computer-aided design. In addition, R&D on construction processes and automation and technical systems was included. Its size was about 100 person-years. Several PRO2 laboratories were involved but the concrete laboratory kept the leading role. The head of the PRO2 laboratory arranged a sabbatical year and funding from the Finnish Academy to develop the systematic basis of the industrial building construction.</p> <p>TAT project was co-funded by four big contractors, two large component manufacturers, Tekes and PRO2. PRO2 reported about fast erection and stiffening of a frame of an office building in its Research Notes Series (no 850) in 1988.</p> <p>The Publication 'TAT – the new component system building technology' (TAT 1990).</p>

The open building system was studied theoretically in the joint projects both from the viewpoints of physical products and as an information system (FAT 1989). A design system was developed for the precast concrete construction based on the joint efforts around the mid-1980s (Figure 15).

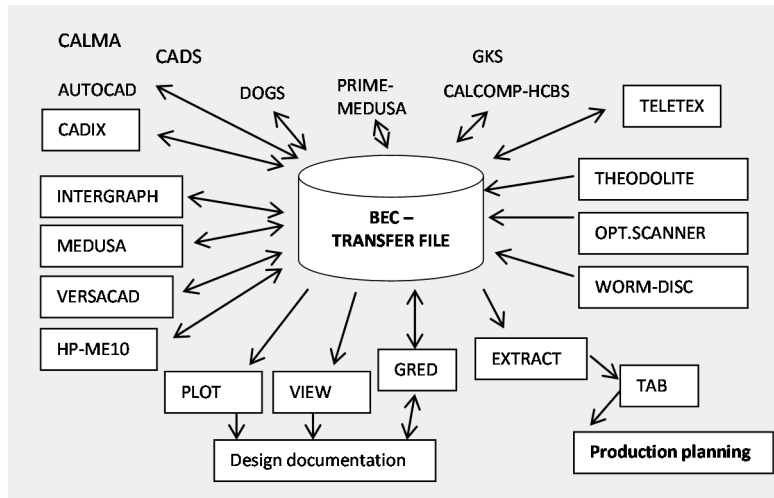

Figure 15. CAD data exchange based on the neutral BEC file according to the Finnish Academy of Technology (FAT 1989).

The project RATAS that was initiated as a construction IT roadmap project in 1985 began the development that is nowadays called Building Information Modelling BIM (Björk 2009). It relied on the BEC project.

4.2.3.3 Advancements in manufacturing, design and products

The BES framing system had become the most competitive solution in multi-storey buildings, and the product innovations became incremental, thus modifications in manufacturing or in products. However, design of the slim floor structures made from embedded beams and hollow-core slabs became an issue of great importance also internationally. Another area in which new research problems emerged was the long-term performance of façades made of concrete sandwich panels. Activities for advanced flooring design, modifications of products and manufacturing and advancements in services utilizing information and communication technology from 1990 to 2001 are introduced in Table 12.

4. Research data: Case chronologies

Table 12. Knowledge interaction between companies and research organisations concerning advancements in design and technologies (phase 3).

Years	Description of knowledge interaction
1990–1996	Flexible Support I and II on design of hollow-core slab floor supported on beams. The project was successful because it could combine strong Nordic players bringing expertise and excellence in FEM, theory and facilities; PRO2 used to have best experimental facilities in Europe. (Scientific papers Pajari and Koukkari 1998, Pajari 1998)
1992–1997	Technology Programme of the Concrete Industries for both on-site and off-site technologies co-ordinated by SBK. Research on slim floors was at the forefront in Finland, and the FIP Guidelines were produced by PRO2 and other Finns.
1996–1997	Façade 2000 – development project of the Finnish Association of Construction Product Manufacturers RTT. Several guidelines on materials, manufacturing and components in which the inner shell is made of concrete. PRO1 involved.
1997–1999	Microbiological behaviour of concrete façades. Project funded by Tekes in the Healthy buildings Programme, Company A involved; PRO 3 + PRO8 (Pessi et al. 1999)

The outcome of the first two projects on slim floors were published by the Concrete Association of Finland BY ry as recommendations and then modified to a semi-experimental approach published as a certified code of the association ('Betoninormikortti 18', updated in 2006).

4.2.3.4 European R&D agendas and standardization

The knowledge interaction between Manufacturer A and research organisations became more European in the 2000s despite the internationalisation and restructuring of the concrete industry since the end of the 1980s. The joint domestic activities continued but their budgets became smaller. The activities are introduced in Table 13.

Table 13. Knowledge interaction between companies and research organisations related to the European common market and BIM technologies (phase 4).

Years	Description of knowledge interaction
2002–2005	Tekes Technology Programme for Concrete Construction.
2002–2006	Large-scale European project Manubuild, 6 th Framework Programme on industrialised off-site construction, co-ordinated by a UK-led consortium. Major research organisations (PRO9), steel manufacturer, contractors and Company A involved, a Finnish contractor and PRO2 included. The project aimed at an Open Building Manufacturing System, a new paradigm for building production by combining ultra-efficient manufacturing in factories and at construction sites, and an open system for products and components offering diversity of supply in the open European market.
2002–2004	European project “Shear and torsion interaction of hollow-core slabs, Holcotors” was a pre-normative project directly connected to the CEN product standard prEN 1168. Partners from Belgium, Sweden, the Netherlands, the UK and two sub-contracted research organisations (PRO2, PRO9) were involved. The research organisations also worked independently looking for solutions but the companies were the decision-makers. The size of the project was about one million euros.
	The methodology developed in Finland was incorporated to developments of Eurocode for concrete structures and to the European harmonized product standard EN1168. The national application standard refers to the code. The approach is further adopted in Sweden and the Netherlands.
2002–2003	Recpro – Re-engineering of site technologies. Tekes funded. Co-ordinated by PRO2.
2002–2005	TERA2002 (industrial concrete construction), PRO2 co-ordinated; in cases two products of Company A: a new type of ventilated façade and hollow-core slab for wet rooms.
2002–2005	PRO-IT programme (Product Model Data in the Construction Process): the aim was to develop a digital library about the product information to be used in software of designers and to replace the brochures and handbooks. Product modelling was fully exploited in design and production of hollow-core slabs but modelling of façades was under development. (Saarinen 2007)
2003–2007	Engineering and Construction Project Information Platform Finland (ECHIP). Joint co-ordination by PRO1 and PRO2 aiming at software tools. Tekes SARA Programme.
2004–2006	TERMA project on use thermal capacity of hollow-core slabs in design, PRO2 as a sub-contractor; Tekes Programme CUBE.
2004–2009	Eurekabuild project “Nanocrete – photo catalytic concrete surfaces”, PRO2.
2000–2005	Integration of HVAC systems to frame and hollow-core slabs, PRO2 engaged e.g. in surface treatments.
2006–2008	Composite action between a hollow core slab and the concrete topping, and its influence on the shear capacity of the composite slab through experimental and theoretical studies. PRO2 and PRO9. Funded by NCC Prefab AB, Stombyggarna AB, Cembygg AB, Cementa AB, and the County Administration Board in Gävleborg, Sweden (Girhammar and Pajari 2008).
2010–2013	BIMCON (Building information model-based product data management in industrialized construction supply chain) part of a Programme of RYM, PRO1 and PRO2, other companies (e.g. Company D).

Company A was one of industrial financiers of the Tekes project “Future Envelope Assemblies and HVAC Solutions – FRAME” in 2009–2013 that was co-ordinated by PRO3 and also PRO1 was involved. The project was focused on the moisture behaviour of envelope structures and energy consumption of buildings. It influenced the renewal of Part C4 of the national Building Code.

The R&D company in the same international concern as Manufacturer A represented the concern in a European project of 20 million euros concerning modular construction, but the benefits were evaluated negatively. Instead, the joint Nordic and smaller European efforts with a clear focus, a limited number of excellent partners and a minor budget have led to good results from the viewpoint of the concern.

4.3 Case B: Products for industrial on-site concrete construction

4.3.1 Background

The Concrete Association of Finland BY ry was founded in 1925 and it is one of the oldest Finnish associations in the field of construction. The association is an expert organization that promotes the correct use of concrete in construction; it does not have lobbying activities. The members represent plants of ready-mixed concrete, cement manufacturers and manufacturers of various products and materials for concrete construction. Its journal *Betoni* (Concrete) publishes research news now and then; the journal has been published since 1930. Its editorial board has members from several organisations and associations as well as from the Ministry of Environment. Main areas of activities are training courses on design methods and new technologies and conducting procedures for product declarations mandated by the Ministry of Environment. The association produced the first national design codes for concrete and reinforced concrete structures in 1929 and has been involved in their continuous development as well as codes for composite structures. The first models were brought from Germany.

Cement and concrete materials research started in Finland in the 1940s as explained in connection with Case A. Previously, the theoretical knowledge was transferred from abroad, especially from Germany (Julkunen 2008). The technology was in frequent use in the 1910s when the first structural engineering office was also established. Concrete became the most commonly used building material in the 1930s (SBK 2009).

Nordic co-operation has a long tradition. It was of great importance at the time when the national regulation was under development. There are still some common interests in the preparation of European level regulations; according to Söderlund (2005), this co-operation has even been called the Nordic Mafia. The Committee publishes *Nordic Concrete Research* twice a year. Two Nordic networks are also active. The other one is among researchers, and it concerns self-compacting concrete. The Nordic Mini-seminar is a regular event that has run

for some years among researchers and R&D experts – the subject areas are very specific, like spearheads. The seminars are also arranged on a voluntary basis.

BY is a member of the International Federation for Structural Concrete (fib), but its contribution has been small. The European Concrete Societies Network ECSN means nowadays only an annual meeting for updating the status, but there were common projects a decade ago thanks to less competition and bureaucracy in the EU. The industrial members contribute to the development of common marketing material. The concrete industry participates to BIBM (Bureau International du Béton Manufacturé) and ERMCO (European Ready Mixed Concrete Organisation).

4.3.2 Manufacturer B

Manufacturer B has focused on promotion of on-site concrete technology. It is a Finnish manufacturer of mineral-based building materials and components that has belonged to an international group since 1999; the group is the third or fourth biggest producer of rock-based construction materials in the world. The history of Manufacturer B is linked to the restructuring of the Finnish concrete industries in the 1990s when the concrete and mineral business of the two largest companies was merged.

Manufacturer B operates in Finland, the Baltic countries and Russia. Its turnover in 2012 was 338 million euros, and the number of its employees was around 1,000. It has about 70 plants producing ready-mixed concrete and concrete products and almost 150 fields for refining aggregates. The investments in R&D have been about 0.1% of turn-over in recent years.

The position of the company between the cement and chemical industry and the construction sector is shown in Figure 16.

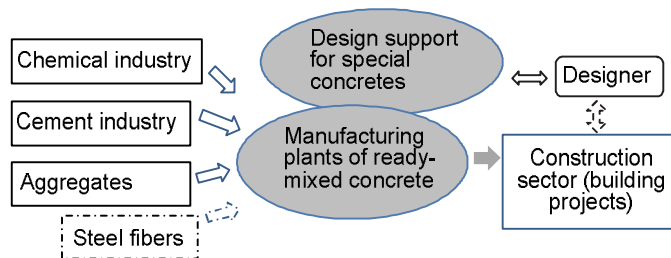

Figure 16. Position of Manufacturer B as a supplier of ready-mixed concrete to the construction sector.

Manufacturer B has been involved in several domestic R&D projects and programmes in which it has been able to track the state of the art and develop its processes. It has also continuously collaborated with major chemical companies. As an example, it started to apply the approach of self-compacting concrete SCC in the 2000s. The breakthrough had been made in Japan in 1985, but the origin

back dates to developments of additives and other concrete concepts in Germany in the 1970s (Hunger 2010).

The organisation of R&D activities of Manufacturer B has changed since the 1980s when economic and industrial activities were booming in Finland, groups were large and resources were bigger than today. The company does not have an R&D unit any more, and activities are closer to technical support and customer relationships. Manufacturer B has a laboratory mainly for quality assurance purposes but it is used in some R&D projects because all the basic tests on concrete specimens can be performed and there are skilled employees.

Manufacturer joined RYM Ltd with the smallest Category C fee, and in this way has access to meetings and follow-up of activities.

The informal group 'Resilient Stone Building' was established in 1994, and it has been co-ordinated by Manufacturer B since the outset. Its objective is to develop industrialised on-site building technologies in Finland and promote traditional and familiar construction methods. It comprises manufacturers of cement, concrete, reinforcement, bricks and moulds. In addition, the Finnish Confederation of Construction Industries RT and the Concrete Association are involved. The company Humit-test (later Humit-Group) also worked closely with the Group and specialised in moisture measurements on sites (1995–2006).

4.3.3 Chronology of Case B

Industrialised on-site concrete construction has been developed since the 1970s when the first steps were taken in manufacturing reinforcement mesh in factories. Simultaneously, hardening processes for concrete were investigated in particular at PRO1 and PRO2. The first professorship in concrete technology was established at PRO1 in 1983 for which the industry donated funding (for the first five years). The companies involved were the two large concrete companies and a manufacturer of reinforcement (Julkunen 2008). The chronology of knowledge development and interaction between the companies and research organisations in this field is divided to three phases.

4.3.3.1 Basics of the industrialised on-site concrete technology

Activities to develop products and related design and construction methods for the industrialised on-site concrete technology are introduced in Table 14.

Table 14. Research on the basis of industrialised on-site concrete construction (phase 1).

Year	Scope of R&D activities	Forms and areas of knowledge interaction
Midst of 1970s	Industrially manufactured reinforcement for on-site concrete construction.	PRO2 was in charge of the experimental research and design of welded cross-joints of rebars based on a co-operation contract signed in 1978; PRO1 concentrated on the impacts of the shift from steel quality A400 to A500. Diploma theses were also produced at PRO4. Funding came from a manufacturer of rebars and from one department in Ministry of Trade and Industry.
1985–1988	Selection of concrete, planning of moulding Modelling of concrete hardening based on temperature development	PRO2 in-house projects, Co-operative projects with the industry for winter concreting and massive structures

On-site processes became an important research topic at the end of the 1980s, and Master's theses were also published both at PRO1 and PRO3 in the 1990s (RTT 1995, Part 7). Another research area related to the development of on-site concrete construction was prestressed floors with unbonded tendons for which the national design codes were approved already in the 1970s and for which the Concrete Association published design guidance in 1988 (RTT 1995, Part 3).

4.3.3.2 Improvement of on-site technologies

The national technology programme 'Concrete Industry' was the first industrial programme of Tekes. It was focused to on-site technologies and CAD-based design. The second phase from 1994 to 2003 is introduced in Table 15.

4. Research data: Case chronologies

Table 15. Research on building processes of industrialised on-site concrete construction (phase 2).

Year	Scope of R&D activities	Forms and areas of knowledge interaction
1992–1995	Architecture, design and processes of on-site concrete construction Fast on-site production processes	Tekes Technology programme for the Concrete Industry. PRO1, PRO2, PRO3, RTT, contractors, architectural and structural design consultants; RTT also used sub-contracts e.g. with PRO1. The folder including several guidelines and booklets prepared by working groups and researchers in particular at PRO1 (RTT 1995)
1994–1996	Processes of industrialised on-site concrete construction	Tekes-funded industrial project of the Resilient Stone House Group. Diploma thesis on drying phenomenon at PRO1.
1998	The programme concerned composite structures comprising thin-gauge steel components or shell concrete slabs, and in general there were studies on combining off-site and on-site technologies.	Technology programme for steel-concrete and concrete-concrete composite construction. Tekes co-funded programme was prepared together with Company D over a long period of time. Two research scientists worked at PRO1
1996–2001	Indoor air quality of the Allergy House	Joint Tekes project of PRO1, PRO2 and companies
1997–1999	Recycling of contaminated soil	EU funded CONLIFE: industrial A national simultaneous project on environmentally friendly and durable concrete. PRO2, PRO3
2000–2003	Project on self-compacting concrete	Tekes Programme on Concrete Construction, co-ordinated by RTT. Companies, PRO1, PRO2, Road administration, Quality Association BLT

4.3.3.3 Issues of holistic design

The third period from around 2003 deepened the approach to holistic design and dealt with several problems associated with the overall and life time performance of buildings as introduced in Table 16. Advanced software tools and their use in technical support and planning of manufacturing were also developed.

Table 16. Knowledge interaction in expanding the concept of industrialised on-site concrete construction (phase 3).

Year	Scope of R&D activities	Forms and areas of knowledge interaction
2000–2005	Acoustics and vibration, product development	Tekes Programme on vibration and noise, in total 60 companies.
2000–2005	Moisture detecting system (Humi-Control-System)	Tekes Programme Healthy Buildings, several companies, PRO1 and PRO4
2004–2008	Modelling mould development in concrete structures	Tekes Programme Healthy Buildings, jointly funded by companies, co-ordinated by PRO2 and PRO3
2006–2008	Technology to use of fly ash in concrete	Environmental Cluster Programme of the Ministry of Environment and companies. PRO2 co-ordinated. Company B involved.
2006–2009	Durability and service life of concrete	Monitoring of various concrete specimens in real conditions and benchmarking with laboratory results for modelling. Aimed at influencing the European standard. Several companies and SBK Fund contracted PRO2.
2006–2010	Knowledge management, process management	EUREKA project INDUCO: An industrial concreting process – tools for monitoring, process control, product identification and data storage. PRO2 co-ordinated. Companies A and B involved.
2002–2005	Indoor air quality of buildings	Tekes Programme Concrete Construction; PRO2, PRO5 and PRO8 co-operated. Field measurements inside flats and on various concrete parts on ten different building sites during construction, in commissioning phase and one year later. Doctoral thesis at PRO1 (Merikallio 2009)
2011–2013	Room acoustics, metrics based on subjective experience	Finnish joint project on room acoustics (ÄKK) in which e.g. PRO8 and PRO3 are involved; the project is also connected to the European R&D Action of COST.
2012–2013	Permeable surfacing solutions for urban storm water management	Co-ordinated by PRO2, co-funded by Tekes; Company D co-funding
2012	Continuous slabs made of steel-fibre concrete	Contract about testing a two-span slab from PRO2 because it is important to instruct people in now how fibre concrete can be used

“Green concrete” was developed as a comprehensive model of operation including eco-efficiently produced material (Betoni 2012). Several ready-mixed concrete plants close to clients allow short transport distances. In the development of the “green concrete” product, the first thing was to select a type of cement that would have a smaller carbon footprint than the usual types: the Plus cement already developed by the sister company was selected. The company also reduces the

amount of clinker through its own mixing technology. Each purchase is custom-made because the structures are all different: Manufacturer B has a design service so that reduction in the carbon footprint is planned together with a structural designer and contractor. “Green concrete” has been on the market since 2011, and the first major on-site building project is under construction.

4.4 Case C: Composite slim floor beam

4.4.1 Background

The steel-concrete composite construction was not widely known in Finland in the 1980s, partly because the consumption of steel in construction was still small (Leskelä 1986). However, the technology was a popular research area, and steel manufacturers were also developing new solutions. The Codes of Practice had been published by the European Convention for Constructional Steelwork ECCS in 1981, which resulted from co-operation between several international organisations. ECCS also contributed to development of the European design standard Eurocode 4 for composite structures. Finnish researchers were involved in the technical committees of ECCS in the field.

New design codes for steel-concrete composite structures were under preparation in Finland in the 1980s as a voluntary project of the associations BY and TRY involving also researchers; they were published in 1988. The Ministry of Environment had initiated the preparation but preferred the status of the code to be at the level of a commonly accepted approach. PRO2 conducted an in-house state of the art project (Kouhi and Koukkari 1989).

The steel-concrete composite beam for slim floors was, however, a novel type of solution different from all the preceding types of solution.

4.4.2 Manufacturer C

Manufacturer C was established in 1965 to produce industrial steel trusses that connect the two shells of concrete sandwich panels. It had long been a supplier of steel ties to manufacturers of prefabricated concrete components, but the business remained small. It is family-owned and managed by the next generation since 2007. The company still focuses on the fastening technologies of concrete structures. The main products are fixing plates, bolts, column bases, consoles, bearing plates, trusses, web and bar reinforcements, stainless rebars, slices, lifting systems and anchors, balcony connections. Manufacturer C’s other strength is composite construction that originated with the steel-concrete beam for slim floors. The product portfolio makes an entire composite building system today, including steel tubes for composite columns and beam-column-connections.

The business volume has grown steadily over the years. The growth has been organic with no major acquisitions. It operates in 30 countries and production

facilities are located in Finland, Canada, China, Germany, Lithuania, Russia, Slovakia, United Arab Emirates, and United Kingdom. It employs more than 700 people, of whom about one third are in Finland.

The sales of the composite beam have increased remarkably year after year. The number of reference building projects is now about 6,000, mainly in the Nordic countries. A major expansion of production took place in Finland in 2005. Production in Slovakia began in 2008. At present each beam is modelled individually and production is totally automatized.

Manufacturer C aims to create value for its customers through a full control of supply chains. This means that steel materials are mainly purchased directly from steel mills, all key products are manufactured in-house factories and relevant storages are near customers. Building designers have been highly valued as an influential expert group in the selection of framing solutions, and thus design services and communication have been prioritized. The intermediate position between the steel industry and the construction sector is shown in Figure 17.

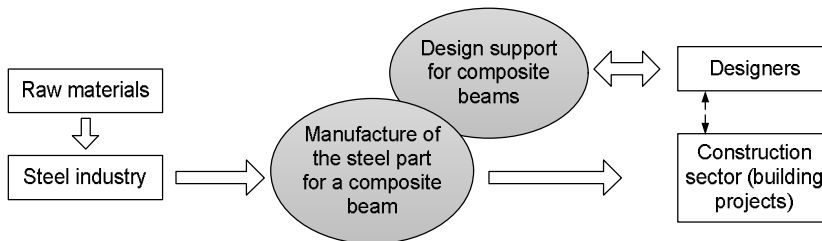

Figure 17. Company C as an intermediate manufacturer.

The major part of the development of knowledge and know-how has been realized through the company's own R&D investments. The investments in R&D were 1.6 million euros in 2009 which is among the highest in the field. The Group has 72 patents. The multi-national R&D function is managed at its headquarters in Finland, but the operations are carried out locally. A research partner is usually appointed from the country in which a project for a European Technical Assessment/Approval is established.

The company is a member of the Concrete Association of Finland BY and the Finnish Constructional Steelwork Association FCSA through which information about European standardization is available. The company also participates in national and European standardization. It has not joined RYM Ltd.

4.4.3 Chronology of Case C

The chronology of Case C had three main phases from viewpoints of knowledge interaction.

4.4.3.1 Development of a novel product

A 'composite beam' was mentioned at an internal meeting in the spring of 1988 (Seppälä 2009). A team was established to develop the first ideas in August 1988. All the members were trained in structural engineering, but their professional expertise was complementary, covering commercializing, research methods and building regulation.

The concept of a composite beam inside the depth of a slab soon emerged. It was about the newest technologies, but also a response to the needs of open space and flexibility in office buildings: The goal was to compete with a very thin ledge of steel beam against pre-stressed concrete beams that were developed for slim floors. The shape of the beam had to fit with structural and on-site concreting requirements. In particular, the joint between hollow-core slab ends and the beam web was under consideration. Development of a novel product in 1988–1990 is shown in Figure 18.

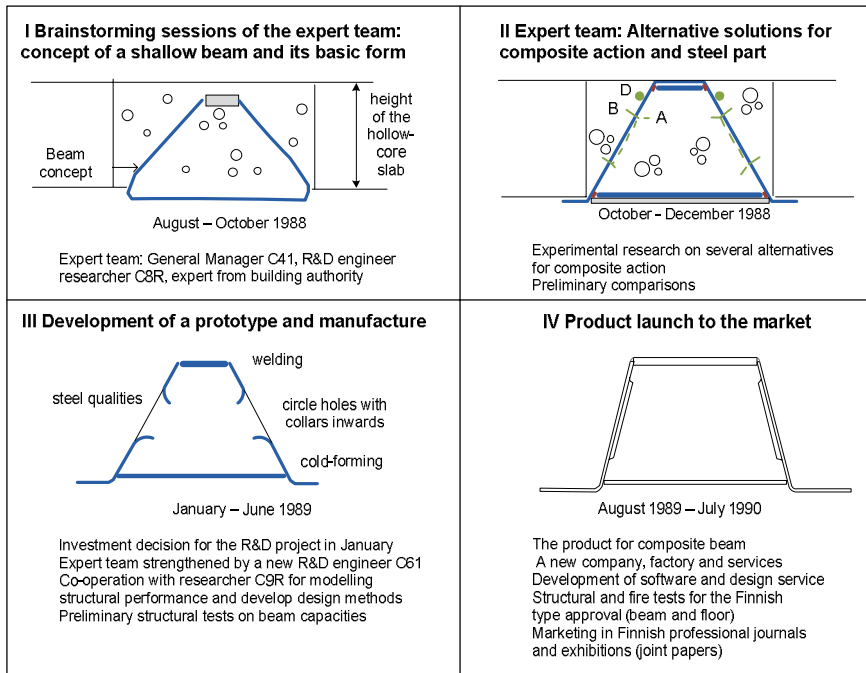

Figure 18. Knowledge interaction in Case C from idea to market (based on Koukkari et al. 2012 and communication with all the interviewees related to innovation).

The project manager in the company played a decisive role in the success of the technical intervention (Seppälä 2009). The team could also work closely together.

The major marketing arguments for the composite beam were its hidden position within the slab height and its fire resistance. Composite action was also claimed to result in about 30% saving in the steel material use compared to a plain steel beam of the same height. Furthermore, the solution allowed for a flexible layout (Kyckling et al. 1990, Nykyri et al. 1990). The national patent was published in 1990, the European patent in 1994. National type approval was received in 1990.

4.4.3.2 Product-specific approvals and export

A new company was established for marketing and manufacturing the composite beam solution. It participated in the Finnsteel Technology Programme of the national funding agency Tekes in 1995–1999. For Manufacturer C, R&D on the performance and design of slim floors was of vital importance because the beam was developed to be used in such floors together with hollow-core slabs.

The expanding export markets were based on product-specific approvals or local building permits. New load-bearing tests were made for the preparation of official approvals e.g. in the United Kingdom, the Netherlands and in Austria.

The knowledge interaction in phases to develop the design basics and services from 1990–2005 through domestic activities and since 2005 in the international company are summarized in Table 17.

Table 17. R&D of the slim floor beam solution after the first launch. “Scientist” is an employee of any PRO having permission from the company. “Joint paper” means that the representative of the company was the co-author.

Subject	Publication in theses or scientific or professional papers	Schedule	Contributions	
			Company	PROs
Fire tests				PRO2
Design methods, phase 1	Scientist, 1991–1992	1990–1992	x	PRO4
Floor with hollow-core slabs, tests (joint effort)	Scientists, 1998	1990–1994		PRO2
Composite action*	Doctoral thesis 1995	1992–1995		PRO1
Floor with big beams **	Scientists	1995–1999		PRO2 PRO4
Design methods, phase 2**	Scientist, 1997–2002	1995–1999	x	PRO4
Fire tests**		1995		PRO9
Push-out tests	Joint paper, 2006	2002–2003	x	PRO4
Design methods, phase 3	Joint paper, 2010		x	PRO4
Fire tests	Joint paper 2009	2008	x	PRO9
Manufacturing	Theses 2009, 2010	2008–2010		PRO7

* refers to funding from the Academy of Finland, ** refers to the national FinnSteel Programme of Tekes.

4.5 Case D: Portfolio of thin-gauge steel products

4.5.1 Background

The design codes and standards were the key for thin-gauge steel sheets and other profiled products to be launched and used as load-bearing structures. Part B7 of the national Building Code for heavier steel structures had already been published in 1974. The thin-gauge steel construction was then the focus of interest, and preparation of the new Part B6 with design methods started. It was published in 1976. Both of them benefited from the Swedish models. The preparation of the codes was mandated to the Finnish Constructional Steelwork Association TRY ry by the Ministry of Internal Affairs.

TRY was established in 1971. Its members comprise manufacturers of structural steel, stainless steel, copper and galvanizing zinc; manufacturers, workshops and contractors of metal structures; architectural and structural consultants; retailers of hardware; service companies; and research and educational organisations. The association is a part of the Finnish Confederation of the Construction Industries RT. The association is also a member of the European Convention for Constructional Steelwork ECCS.

Its tasks include lobbying the Ministry of Environment concerning the national Building Code and product approval procedures, dissemination of research results through the journal 'Teräsraenne' (Steel Structures), organisation of Steel R&D Days for all the researchers at a 2–3 years interval and Steel Construction Day annually, foreign excursions especially to architectural destinations, arrangement of the Training Day (TeräsMies), contributing to training courses and educational material, participation to standardization and regulation and lobbying with the educational organisations (e.g. for steel professorships). The Board of the Association usually has a member from research organisations. TRY's representatives in the ECCS Technical Committees meet once a year and they are from industry and research organisations.

In the past a great proportion of national R&D projects were organised and co-ordinated by TRY. The new project "European rules of game for steel structures – design and execution, TEP" is the most important joint effort at the moment. The co-ordinator is TRY, and 33 members of the association are partners and funding organisations.

Networking with international and European associations has been and still is important for knowledge transfer. The Nordic Steelwork Associations still meet on an annual basis. The committees of ECCS and the joint European projects partly funded by RFCS have been important especially during the most intensive ten years of national programmes.

4.5.2 Manufacturer D

Manufacturer D was established in 1960 as a state-owned company for steel manufacturing and mining. At the time of data collection the state still owned about 40% through its investment company. The company delivers metal-based components, systems and turnkeys to construction and engineering industry. It has 11,800 employees in 30 countries, e.g. in the Nordic countries, the Baltic countries, Russia, Ukraine and Eastern Central Europe. Its net sales in 2011 were 2.8 billion euros. Construction is one of its three business areas with net sales in 2011 of 757 million euros. It currently has 3,500 employees.

Company D played a leading role in the emergence of steel-based construction in the 1980s and 1990s (Gustafsson 2010). There were several manufacturers (workshops) of profiled steel sheets in Finland in 1980s and up to the beginning of 1990s. Most manufacturers were small- and medium-size companies, but they were active in product development and they frequently co-operated with research organisations. Company D bought three workshops at the beginning of 1990s, which was one event in restructuring the Finnish construction product industry. The growth of down-grading was set as an objective at the group level and the construction sector was regarded as a promising market segment.

The product portfolio of Manufacturer D nowadays is versatile including steel piles, composite columns, structural pipes, WQ- and CWQ-beam systems, trusses and welded profiles, sandwich panels, external and internal walls, ceilings, curtain walls, facade lamellas, design profiles and shallow corrugated sheets, prefabricated components for facades, prefabricated roof components, light-weight roof purlins, load-bearing steel sheets, steel roofs of small houses including drainage systems, roof safety products and protecting sheets and accessories, customised solutions for various building types. The production lines of these products are shown in Figure 19.

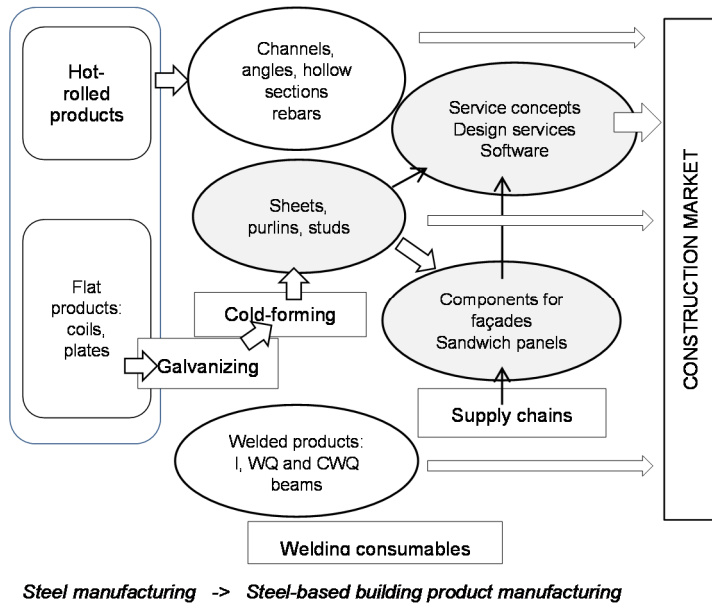

Figure 19. Production lines from steel manufacturing to building products.

Manufacturer D established also the company “Steel Building Systems” that was a developer and contractor, and it managed construction sites as a project co-ordinator. The channel to commercialisation was easy for R&D people at that time as regards speed and actions. These companies were, however, not so successful in business, and could never become really profitable. For this reason, they were closed down in 1995. The global economic situation was naturally one background reason.

In manufacturing technology of thin-gauge steel structures, the major achievement was made in 2007, when the company established the most modern and efficient production lines; the plant has one of the highest production capacities in Europe.

Today, the R&D on building and construction products and concepts is managed at the top level of the group to which Company D belongs. Relationships with research organisations are categorized according to different time-scales of perspectives and prospects in commercialisation; they can be seen as three horizons. The shortest horizon means a quick customer development project and problem-solving projects whose commercialisation takes place within 3 years. The next horizon of 3–6 years means that a company sets a focus to its strategy – which means energy-efficiency for many companies at the moment – and prepares, for example, roadmaps. The long-term horizon is such that trends and renewal are sought. The longer-term strategy of Company is developed at the group level. The construction R&D is closer to the 3–6 years horizon.

Manufacturer D is involved in RYM Ltd, with a focus on the BIM-centred programme that is important for the company. The horizon of RYM is more in the second horizon than in the commercialisation.

4.5.3 Chronology of Case D

The steps of research activities and product developments of the portfolio of thin-gauge steel products were divided into three phases.

The chronology of Case D had three main phases from the viewpoints of knowledge interaction.

4.5.3.1 Basics of structural use of thin-gauge steel

During the first phase, single products and single research topics were in focus in 1975–1989. Knowledge interaction in this phase is summarized in Table 18.

Table 18. R&D steps of the single products and components based on structural use of thin-gauge steel (phase 1).

Year	Scope of R&D activities	Knowledge interaction
1970–1976	Preparation of Part B6 to the National Building Code, mandated by the Ministry of Internal Affairs	Working group of TRY Diploma theses at PRO1 and loading test series at PRO2
Around 1975	High profiled steel sheets in roofs and upper floors of industrial halls and storage buildings.	Design formulae could usually be found in codes but they erred on the side of safety. Manufacturers ordered plenty of tests – almost solely from PRO2 – to achieve higher resistances for design. PRO3 was also used to some extent. The tendency was that everyone aimed at the tested characteristic values of resistances. The activities also supported improvements in the design code.
Around 1975	Two domestic types of composite slabs	Three diploma theses at PRO1 (1974, 1976, 1977; TKK 2013)
1974–1979	Design basics of sandwich panels with plastic cores	Seven diploma theses at PRO1 (1974, -75, -76, -77, three in 1979); article in a professional journal by researchers -76
1985–1990	The load-bearing solution for external walls of halls that had steel sheets on both sides and thermal insulation and wall rails between.	A boom in fire tests began, and again PRO2 was the dominant research organisation, as it had the only test oven in Finland at that time. The tests were contracted. Some tests were carried out in Sweden but they were more used for comparisons
1980s	Holorib based on a German solution by one workshop.	Structural performance of concrete and steel joined together was studied at PRO1, PRO2,

4. Research data: Case chronologies

Year	Scope of R&D activities	Knowledge interaction
	The design formulae were semi-empirical, and in the beginning they were product-specific.	PRO3 and PRO4. Company D both the workshop at the beginning of the 1990s and developed the Holorib-based slab to SteelComp together with PRO3. The issues concerned efficient joining technology and reliable design formulae. Test arrangements were also developed: design methods were urgently needed to support commercialisation.
Latter part of 1980s	A sandwich panel with a mineral wool core	Company D applied a sandwich technology that was developed by Company G that had also promoted development of design methods. The performance of the panel was experimentally verified at PRO2 (contract work).
1989	Studies on resources needed for the steel construction	Company D, TRY, Master thesis at PRO3
1990	Studies on needs to develop resources for the steel construction	Company D, TRY, PRO2 (VTT 1990)
1988–1990	Load-bearing frame made of thin-gauge steel to be used in halls and commercial buildings. The result was a frame system, and the external walls were made with common thin-gauge steel products such as sheets or sandwich panels.	Tekes funded project of Company; PRO1 was engaged, and at least one licentiate of science thesis and one Master's thesis were prepared. PRO2 was also involved on development of design methods for open profiles and purlins; it was internationally valuable, too. Company D got good methods for its software.
1987–1997	The pre-competitive CIMSteel project for definition, applied research and subsequent system evaluation for a modular computer integrated manufacturing (CIM) system	European network, more than 70 partners incl. foreign companies and research centres PRO9; TRY and software company from Finland

The Finnish Constructional Steelwork Association TRY ry proposed in 1981 that a professorship should be established at PRO1, and donated funding for it. In 1989, the first professor was finally nominated (Julkunen 2008).

The design methods of composite structures and in particular those of composite slabs were under development internationally in the 1980s and still in the 1990s, and researchers did not come to unanimous agreements. This situation caused a record-long process of several years before the composite slab of Manufacturer D was approved for the German market.

4.5.3.2 Development of systems and building technologies

At the end of the 1980s, on average the steel construction sector had more optimistic expectations than the construction sector based on surveys among manufacturers, developers, contractors. Among several conclusions concerning needs to develop resources of the sector in the 1990s, the following proposals were made in a project funded by Manufacturer D and the association TRY (VTT 1990):

- Share of R&D from the turn-over of companies to the level of 3%;
- Post-graduate programmes in technical universities;
- Research Professor;
- R&D units to the largest companies;
- Active participation in international R&D projects;
- Use of results of foreign experiments and test (e.g. fire);
- Product development to companies, common R&D to be led by a co-operation organisation;
- Dissemination of R&D results to be included in the planning of projects.

In the second phase, the aim was to develop and promote the 'dry construction system'. In the 1990s, co-operation between PRO2 and Manufacturer D was buffered through a bilateral contract. The number of researchers at PRO2 increased, and it plays an influential role in the FinnSteel Programme of Tekes 1995–2000.

The Finnsteel Technology Programme (1995–2000) was prepared and implemented by the national R&D funding organisation Tekes, a producer of steel products and a machine manufacturer and the Finnish Constructional Steelwork Association FCSA (TRY). Two representatives of PRO2 belonged to the six-person Steering Group during the preparation of the programme, and a researcher from PRO2 was nominated as Programme Manager. All Finnish technical universities and PRO2 participated to the programme. The number of public reports, articles and papers was 168. The programme aimed at improving the international competitiveness of the Finnish steel construction sector through new structural systems and components based on these. Towards the end of the programme, a slight shift took place and more emphasis was put on data management in product and delivery chains of materials supplier, steel structure manufacturers, designers, contractors and developers (Tekes 2001^b).

The evaluation report of the programme summarizes essential data (Tekes 2001^a): Share of product/ system development projects of all projects was 35%. On the other hand, in all projects managed by the steel producer, this category was 50%, and 42% of projects managed by PRO2 and 26% managed by FCSA.

A summary of the R&D activities for systems and building technologies in 1990–2000 is given in Table 19.

4. Research data: Case chronologies

Table 19. R&D activities on systems and building technologies based on thin-gauge steel products (phase 2).

Year	Scope of R&D activities	Knowledge interaction
1990s	<p>Composite construction solutions were investigated especially from viewpoints of the concrete flooring technology; even the drying problem was solved. Analysis and design methods were developed more accurate in issues like deflections and cracking. The model of fast production was applied to the composite construction technology in the mid-1990s.</p>	<p>An industry-led Tekes technology programme mainly as a joint effort of Companies B and D. There were several projects on composite slabs. All the national research organisations were deeply involved and two major companies had their R&D projects. Several diploma and doctoral dissertations were prepared.</p> <p>The co-operation with PRO1 was fundamental, especially with the laboratory of "construction economics".</p>
1990	<p>Thin-gauge steel construction and new products. The focus areas were external walls and load-bearing structures made of thin-gauge steel; structural design and building physics were cross-cutting topics.</p>	<p>The contract between Company D and PRO2 was bilateral for 5 years. PRO2 also invested those funds that came from the state budget. Probably some Tekes funding was also used. The programme defined focus areas and objectives but no projects. The programme resulted in numerous projects and the number of Master's dissertations was remarkable.</p>
1991	<p>The project aimed at</p> <ul style="list-style-type: none"> - improving know-how in structural analysis - development of design guidance for thin-gauge steel structures - development of design tools - new thin-gauge steel products 	<p>Company D-PRO2 joint project as a part of the joint programme</p> <p>The project had a joint steering group, incl. representatives of PRO1, PRO2, PRO3, PRO4, PRO5, companies and the building permit authorities (Talja et al. 1991)</p>
1990–1995	<p>Promotion of thin-gauge steel construction.</p> <p>Thermal stud for external walls of small houses and wall components for multi-storey buildings. Its competitive edge relied on holes in webs of studs that improved the thermal performance of steel structures so much that the U-value requirement of 0.24 could be achieved with only one row of studs, whereas two separate rows such as in cross-frames were needed in previous times.</p>	<p>In research, building physics and the climate chambers were new issues. The tests showed that the heat flow through a thermal stud was one ninth of that one through a wooden stud with the same depth of 175 mm and width of 45 mm that were common dimensions in small houses. Various structural tests were carried out at PRO2. At PRO1, some projects were also done. The current head of R&D for the construction sector in Company D presented his doctoral thesis on performance of a thermal stud wall focusing especially on the influence of a gypsum board on the stability of a flange when the web is not supportive. The outcome of all these projects was that design curves and software could be made</p>

4. Research data: Case chronologies

Year	Scope of R&D activities	Knowledge interaction
		available to structural designers. All in all, simple and quick design aids were developed for the practice. ‘Steel in residential building’ seminar was organised by Company D to a large audience 8–10.5.1995.
1995–2000	Finnsteel Technology Programme	Joint programme to promote steel-based construction, thin-gauge steel applications of special interest. See above.
1995–2002	Finland joined the European Coal and Steel Community in 1995	Company D was involved in several joint European projects partly funded by the European Coal and Steel Community ECSC (the activities continue under RFCS today, Kouhi 2005). In several projects, PRO2 was also involved. Other partners were companies and PRO9.
1996	‘Dry construction’ system, Finnish approach, focus to solutions for cold climate External and internal walls, frames. Design aids, software Service life of galvanized thin-gauge steel studs in external walls.	The European joint project co-funded by ECSC. State of the art, requirements management, design methods and tests on structural and fire performance, acoustics and building physics at PRO2. The demonstration building was connected to this project; moisture measurements inside the wall and methods for service-life design of a stud, monitoring about 1.5 year. Test specimens of joints and other details at PRO2’s field testing facilities in Espoo – it was maybe 2.5 years. Simulation models were developed at PRO2. Validation of the software; a tool to predict long-term performance of a wall in various climatic conditions (Nieminen and Salovaara 2000). In this way, authorities and customers could be convinced, too. PRO2’s reports and statements were then used to convince customers. PRO9’s involved.
Latter part of the 1990s–2000	Acoustic performance all kinds of solutions based on thin-gauge steel structures. Acoustic partition wall based on ASW thin-gauge steel stud	Many tests at PRO2 which also developed calculation methods. The attenuation capacity of external walls with thermal studs were studied and tested against traffic-induced noise. Flanking transmission tests were made on some typical connection details, and values were acquired in order to consider decibels. Both light and heavy external walls were tested. CTR correction values were also acquired to be applied in different conditions. The acoustic design principles of external walls were completed in about five years, at the beginning of the 2000s. The AWS was developed in close co-operation between the Company and PRO2, and all the regulated requirements were investigated and managed (Möttönen et al. 2000).

4. Research data: Case chronologies

4.5.3.3 Focus to ICT-based services and building concepts

Manufacturer D contributed to the preparation and implementation of the new joint programme NiceSteel in 2000–2004 whose projects were co-funded by Tekes. The aim was to promote client-oriented steel construction and develop networked business models and services. Development and implementation of the information and communication technologies in design and services were also focus areas (RT 2004^a). PRO2 established an internal co-operation network to strengthen its multi-technology approach; the network consists of the previous two units mostly involved in the FinnSteel Programme – manufacturing technologies and real estate and construction – and the unit for communal planning.

Manufacturer D aimed at fast commercialization of new types of products. Two light-weight buildings were designed and built for the 2000 and 2002 annual Housing Fairs in Finland as a part of European joint project (Lawson et al. 2005). Both buildings were conceived by Manufacturer D and the Finnish contractor YIT. New energy-saving technologies were also applied. A series of short-term and in-service tests were carried out.

Manufacturer D was also involved in the PRO IT programme in 2002–2005 that aimed at a national data management approach and guidelines for the construction process based on product modelling (Figure 20).

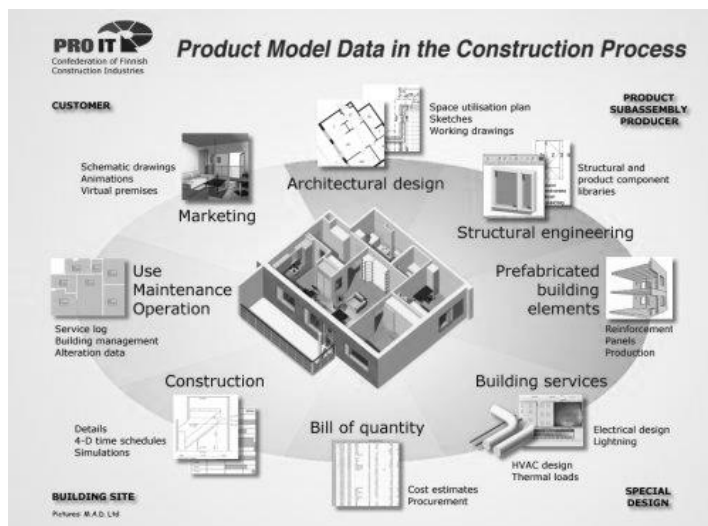

Figure 20. Introduction to the opportunities opened by BIM. http://virtual.vtt.fi/virtual/proj6/proit_eng/indexe.htm.

The programme was initiated and led by the Confederation of Finnish Construction Industries RT and supported by Association of Finnish Architects' Offices (ATL), Building Information Foundation RTS, Finnish Association of Consulting Firms

SKOL, the Ministry of the Environment, Sato Corporation plc, Senate Properties, Tekes and Wood Focus Oy. Several companies and PRO2 were performing the R&D tasks. Company D's activities concerned e.g. the thermal stud and steel frame components (RT^b 2004).

4.6 Case F: Steel-framed energy-efficient commercial building

4.6.1 Manufacturer D in Case F

The new energy-efficiency concept is one example of Manufacturer D's efforts to develop building level solutions for customer segments of industrial and commercial buildings. In the company's strategy, energy-efficiency had already been recognised as a global driver, and its impacts on building technologies were expected to grow. Consequently, a decision was made that the energy-efficiency of buildings would be a focus area for the company.

Manufacturer D has produced sandwich panels with a mineral wool core since the beginning of the 1990s. It had also been involved in several projects in which building-level performance was studied. The thermal properties of the panel were well known, and information was also available about detailing and thermal bridges of an external wall.

The marketing area of the energy-efficient building concept is Finland and other Nordic countries. The first client came from Norway, which has many similarities with Finland. Sweden is a little different as the clients have already been more demanding concerning e.g. airtightness.

4.6.2 Chronology of Case F

A decision was made in Company D to join the project 'Sustainable energy, KES-EN' in 2007–2010 funded by Tekes together with several companies and coordinated and mainly carried out by PRO1. The company's strategic aim was to investigate the potential of its own products in this area.

Company D prepared a case for the project that concerned a steel-framed building for a hardware store with external walls made of sandwich panels. The objectives of the case were to learn about factors influencing the energy consumption of such a building. All the design data and drawings could be compiled from the real building of a client. They were used for the energy calculation, and later, measured values were available for comparison. Simulation software was developed, and this could be validated through measurements. The programme was then used for parametric studies. The results were used to identify the areas in which improvements could be gain, and also to select more efficient measures. The air-tightness of an external wall was one of the major issues.

The product development was moved to the R&D unit. Measurements and calculations pointed to joints between individual panels and also to connections of various structural parts such as walls and roofs. The importance of assembly was concluded based on the great variation of measured values. A decision was made that all three areas having a great influence on energy-efficiency will be dealt with, namely the panel, the connections and the assembly.

A link was developed between two software programmes already available in the company. This means that the company commits to considering an entire building as being beyond its own trade limits. The company makes correcting measures free of charge in the case where the airtightness does not agree with that was promised. In an extreme case, a contract can be cancelled. As a bonus, extra credits are gained from the sustainability rating system BREEAM.

At the moment Manufacturer D is involved in the RFCS project together with PRO2 because it is interested in the implementation of renewable energy sources in buildings. The company aims to make findings that would help to prioritise development efforts.

4.7 Case G: Sandwich panel with a stone wool core

4.7.1 Background

Industrial manufacture of various sandwich panels started at Finland at the beginning of the 1970s with plastic cores made of polyurethane or polystyrene. Steel sheets became the dominant material by the middle of the decade. Several researchers were involved in the R&D projects of companies at PRO1 and PRO3. A major part of the outcomes was presented in diploma and doctoral theses. There were also technical studies and reports. The director of the laboratory at PRO2 involved in Case G had supervised theses as a professor at PRO1. In 1980, PRO2 published a document concerning sandwich panels with polystyrene core as an outcome from an in-house project on the state of the art (Tolva and Jumppanen 1980).

Various design guidelines started to be available in the 1980s. The new knowledge was filtered to Finland, and especially the German Stahlbau Journal was important. The required safety level in design was a topical issue. The manufacturers of polyurethane sandwich panels compiled folder type guidance for design in the 1980s.

PRO2 was involved in the Technical Working Group of European Convention for Constructional Steelwork ECCS since 1984 which published new guidelines in 1990 and in 1991 based on experimental data in several countries.

4.7.2 Manufacturer G

Manufacturer G that produces sandwich panels belongs to a group of companies that also produces insulation and acoustic products from stone wool. The company's turnover was about 40 million euros in 2010, and the number of employees was about 100.

The sandwich panels are only produced in Finland, but other products are also manufactured in Sweden, Lithuania and Poland. The Nordic countries constitute the main market area. The sales network covers 13 countries in Europe. Figure 21 shows the position of the panel manufacturer as a supplier to the construction sector.

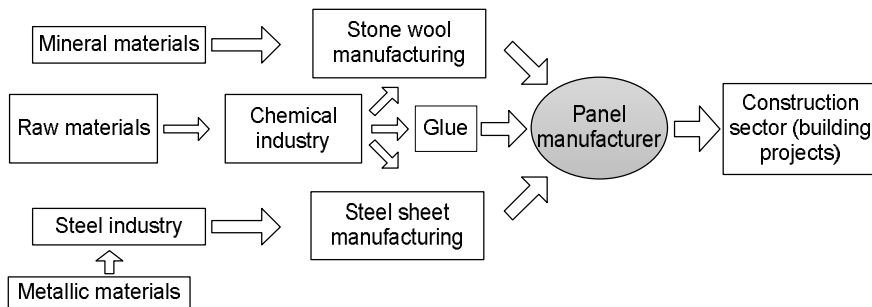

Figure 21. Panel manufacturer as an intermediate company.

The operational history of Company G dates back to a large Finnish producer of mineral and concrete products. The insulation products were one division in the company. The company had an advanced R&D centre with multidisciplinary staff and excellent laboratories. The R&D centre searched continuously new ideas and communicated with research organisations.

4.7.3 Chronology of Case G

Knowledge interaction in Case G started in 1985 when the head of the insulation division of Manufacturer G's preceding company invited PRO2 to join the idea searching stage for new products. PRO2 had knowledge of state of the art of thin-gauge steel structures and sandwich technology which were outside the competences of the company. There were also facilities available for experimental research.

A company-led ideation team had the task of studying trends and freely generating new product proposals. Quite soon, the talks were focused on light-weight solutions, a growing market in Finland. Another important factor was that markets in the Soviet Union required building solutions with good fire properties. A sudden opportunity opened up as regards incombustible stone wool because

4. Research data: Case chronologies

polyurethane sandwich panels were unexpectedly banned in many applications there. The team soon agreed on three objectives for the new product: light-weight, panel and fireproof.

4.7.3.1 Product development

The true product development project of a novel type of sandwich panel for external walls started at the beginning of 1986. Two market segments were considered at first, but it soon became obvious that industrial manufacturing was more appropriate for commercial and industrial buildings than for residential buildings, and it also opened a realisation potential for the strategy of economy of scale. The company's R&D centre had two challenging projects, the first to develop a special stone wool material for a core with improved strength properties and durability, and the second to develop manufacturing techniques including glueing. The structural performance and design methods were studied by Manufacturer G and PRO2. The first phase of knowledge interaction from idea to the domestic market in 1985–1987 is shown in Figure 22.

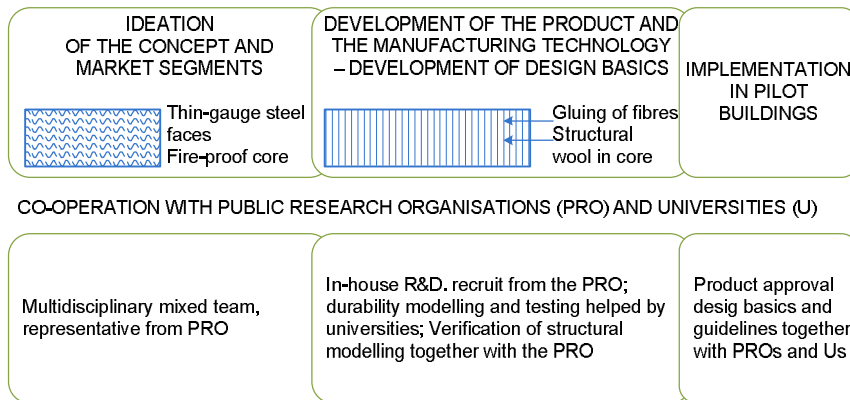

Figure 22. Knowledge interaction in Case G in the product development from idea to market in 1985–1987 (data organised together with Interviewees).

Funding from TEKES was critical; the project was under threat even with this support. The product development resulted to a competitive technical solution but commercially it was not that successful at first – the return on all the investments took seven years.

4.7.3.2 International networks and guidelines

Manufacturer G started to support the international activities aiming at generally approved design methods and guidelines in order to include panels with a woollen core to the international design guidelines already available for the panels with

plastic core (ECCS 1990 and 1991). The motivation was that the export of novel panels began immediately after the launch onto the domestic market. The phase of networked activities from around 1987 to 2000 is introduced in Table 20.

Table 20. Knowledge interaction between Company G and research organisations since the launch of the panel to the Finnish market in phase 2.

Years	Scope of R&D activities	Knowledge interaction
1990–2000	One research topic was related to the use of a panel face for fixings.	Several Master's theses were prepared at PRO1 in jointly funded projects in the 1990s and 2000s.
1990–1992	State of the art Guidelines for the design and use of panels incl. mineral wool core	Joint committee between CIB and ECCS, Company and PRO2 involved (CIB 1992)
1989–1999	Aging test methods for sandwich panels and their core materials; Lifetime predictions under different actual exposure conditions	Several projects at PRO3 (Tiainen and Kerkanen 1999)
1992–2001	State of the art Durability	CIB (2000) and ECCS (2001) published new versions of recommendations. The ECCS Publication No 115 became the basis of the harmonised product standard
1988–	European fire regulation - development of test methods - connections to harmonised product standards - development of performance based approach since 2004	CEN TC127 (Fire safety in buildings) mandated by EU Commission – other Members from PRO2 and the Ministry of Environment Company G in the Expert Group of the Council of European Producers of Materials for Construction (Construction Products Europe 2013) National Mirror Groups involving producers and researchers

4.7.3.3 Activities related to the European CE marking

Manufacturer G regarded the commonly approved design methods so important that its joint R&D activities were harnessed development of the harmonized product standard in the 2000s. The activities to develop the European fire regulation were connected to this line that had started a decade earlier. The activities since 2001 are introduced in Table 21.

Table 21. European harmonisation activities in Case G (phase 3).

2002–2004	Preliminary work for the harmonised European product standard for sandwich panels	R&D project was ordered by the European Standardization Organisation CEN; companies and PRO9 and PRO1
2008–2011	The co-operative European Framework project EASIE; aimed to improve the standard	European companies and research organisations, PRO1. Company G supported its consortium through access to panels from first pilot buildings for durability tests.
2009	Testing and design of fastenings of sandwich panels (ECCS 2009). These are excluded from the harmonised product standard	Co-operation between Working Groups of ECCS and CIB. Representatives of Company G, PRO1 and PRO2

4.8 Case H: ThermoWood® products

Case H was born in research on wood chemistry. New needs for wood treatments appeared in the 1980s because environmentally less harmful products were needed. Thus, the traditional preservation technique (CCA) was coming to an end. Different thermal treatments had already been investigated and developed in several countries but an associated problem existed due to the reduced dimensional stability of wood. Commercialization of alternative treatments had also been difficult because of increased costs.

4.8.1 Background

The various wood treatment techniques were common bioscience trends in the 1980s. One reason was that the wood treated with CCA was coming to an end and environmentally less harmful products were needed. Many modifications had been tried for many years but commercialization was always difficult because they were more costly than the traditional processes. Some experiments had also been done, for example in Germany, on treating wood at high temperatures, in the 1950s. These were only trials with small specimens.

PRO2 established an internal strategic research programme to investigate various treatment techniques. The first small-scale tests showed that a drying process at higher temperature not improved only the stability properties of wood but also resulted in a decay-resistant wood. A series of various drying experiments followed. The breakthrough was achieved through increasing both temperature and steam in an oven. Specimens became completely coloured in dark brown and dimensional stability and decay resistance were also achieved. PRO2 got a Tekes funded project with several industry partners after the first findings. The input of Suomen Puututkimus SPT was very significant. The project facilitated systematic

studies on the problems of how temperature, time and other variables affect the wood properties.

Suomen Puututkimus SPT was one of the broker organisations established by the Finnish Federation of Forest Industries FFFI ry in the past which operated in 1989–2000. It became WoodFocus through a merge with the communication centre Puuinfo, which stopped operating in 2006. These broker organisations had a central role in initiating and organising research projects together with companies and research organisations and negotiating about funding opportunities.

4.8.2 Companies

The ThermoWood Association was established in 2000 to promote the use of the ThermoWood® products. It represents manufacturers who apply similar principles in their wood treatment process although there are variations in end products depending on species and details of the process. The right to the registered trademark of ThermoWood® is limited to members of the Association. Their current number is 13, and two of them are kiln manufacturers. The members are mainly Finnish, and one is from Japan and one from Turkey.

The association aims at a continuous involvement in research and product development.

4.8.3 Chronology of Case H

4.8.3.1 From science-based results to pilots

PRO2 initiated an in-house research programme on advanced wood treatment techniques in 1988 in which one stream concerned thermal treatment. The main research findings initiated a series of process and product development projects whose first phase concerned industrial up-scaling of laboratory results to a first industrial oven in 1994. Industrial up-scaling continued with full-scale ovens which brought products to markets, but there was still a need for research on processes and properties of products as introduced in Table 22.

4. Research data: Case chronologies

Table 22. Knowledge interaction between PRO2 and companies in the forest-sector from science to the market (phases 1 and 2).

Year	Scope of R&D activities	Knowledge interaction
Around 1988–1990	Chemistry of wood under thermal and moisture treatment; correlations between treatment factors and wood properties	PRO2, in-house programme Results were communicated openly with the forest-sector companies; Master's and doctoral theses Conference papers
1990–1994	Systematic studies on problems how temperature, time and other variables affect the wood properties	Tekes funded a joint project; several industrial partners and PRO2; Suomen Puututkimus SPT involved; small-scale experimental work theoretical work; PRO2 submitted several patent applications in 1994
1994–1997	Industrial up-scaling of the process: combined process and product development; still under research	The first industrial oven. R&D director of one major company was a central person in supporting the R&D Conference presentations. PRO2's first publications in 1996 (e.g. Viitaniemi and Jämsä 1996)
1998–2001	Reaction mechanisms of modified wood: influence of thermal treatment on chemical, morphological and physical properties	Science-based projects of PRO1, PRO2 and PRO9. Experimental research and statistical analysis Doctoral theses.

The research on wood chemistry was conducted in parallel with industrial up-scaling and the start of commercial manufacturing for some years. The correlation scheme of factors influencing on the properties in use are shown in Figure 23.

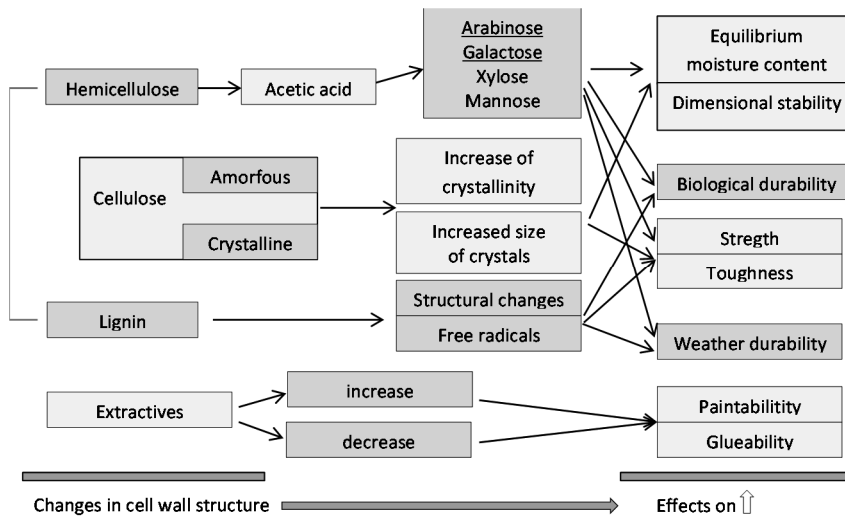

Figure 23. Factors affecting the properties of thermally modified wood (Viitaniemi et al. 2002).

4.8.3.2 Co-ordinated joint efforts

The new phase in R&D started in 2000 when the association was established. The gaps in knowledge and know-how have been corrected through activities of the association as, for example, concerning classification. The product classes Thermo-S and Thermo-D are based on the process temperature. The association has developed an overall concept with quality, research and service dimensions.

The association has continuously been involved in research. It has also inherited some activities from other organisations such as the follow-up of long-term test specimens for which the R&D broker organisation Wood Focus Oy helped to create a test field in 2004. A similar test field was established by PRO9 in the UK. The specimens are façade products, and the assessment is being carried out now after ten years. The test fields are also a part of a larger new project. In this project, there are several partners, one of them being PRO2.

The relationships between PRO2 and companies were quite close in the early phases of basic research. However, at some stage the companies had created their know-how and knew what to do for product development. They started involving other research organizations. A new umbrella project started a year ago, and many of the important tasks are included. The initiative came from the industry.

A technical specification for CEN came into force in 2008.

4.9 Case J: LVL products

Case J concerns LVL wooden engineered products that are made of 3 mm thick veneers glued together.

4.9.1 Background

The forest sector is one of the major branches in the Finnish economy. The companies are organized in the Finnish Federation of Forest Industries FFFI ry having the role of lobbyist including issues of research and development. Its tasks are knowledge sharing and communication with Tekes and the Ministry of Employment and the Economy in order to ascertain public funding and programmes for the entire sector. The three largest companies are major companies also on the European scale. Their main field of operations is pulp and paper making. Each of them is also a manufacturer of building products. The flow of wood from forests to the manufacturing is shown in Figure 24.

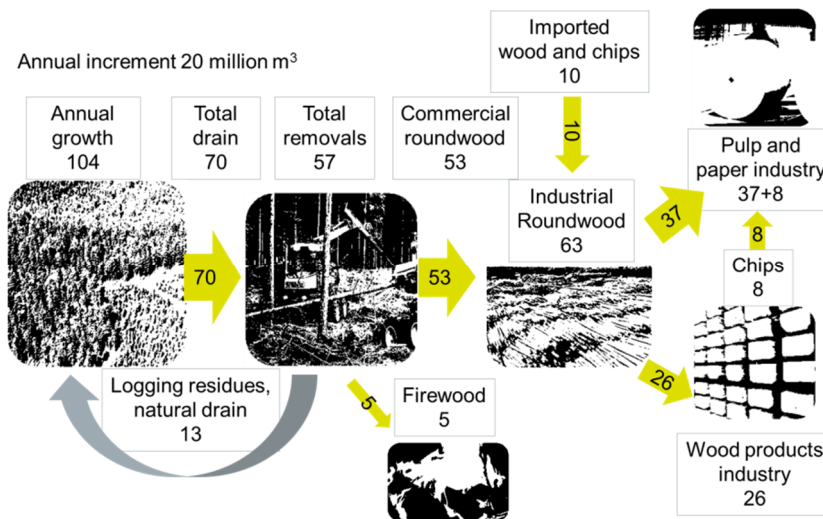

Figure 24. Wood flow from forest to mill in Finland 2013 (FFFI 2013).

Research on wooden structures and wood construction started in the 1930s when the laboratory at PRO1 studied small houses. The research area related to the woodworking industries was moved to two laboratories of PRO2 in 1942. The activities of PRO1 and PRO2 were mixed until 1972 when the organisations were separated under two different ministries. However, the volume of research in the field of building technologies remained at a modest level until the 1980s (Julkunen 2008). There was a peak of research at PRO2 during the latter part of the 1980s. PRO2 acquired the first professorship in wooden construction in 1996 which was

donated by the forest sector through PuulInfo for five years (Julkunen 2008). After this period, the position was vacant until 2010 (Heino 2011).

The R&D of the forest sector on construction and building products has been organised through several broker centres in the past as follows:

- Suomen Puututkimus Oy SPT operated in 1989–2000;
- WoodFocus around 2000–2006 (merge of SPT and Puuinfo);
- The Finnish Wood Research Centre WRC Ltd 2009–.

The largest companies have been involved in the joint efforts of the broker centres for a common good such as national and European design methods and fire issues. At the same time, their own R&D units have concentrated on product development.

The very first idea of laminated veneer lumber LVL was invented in the United States as an idea that aimed at new types of product and production (Mali et al. 1986a). In fact, the very first applications were in aeroplanes. The important difference between LVL and plywood is that the plies are parallel and thus the longitudinal direction is the longest one. The idea was learnt on a visit to a forest laboratory in the USA and brought to Manufacturer J.

4.9.2 Manufacturer J

Manufacturer J belongs to a large Finnish group in the forest sector which also includes a co-operative of forest owners. The group operates globally and its turnover in 2012 was 5 billion euros. The company itself has three business lines: timber and sawn goods, plywood business and building product business. LVL products belong to the building product business. Company J has a turnover of about 900 million euros and the number of employees is about 2,700. The structure of the group has changed frequently but the first factory of LVL has stayed in the same location since 1981.

The R&D budget for the LVL was around 1.5% of the turnover of its business in the early years, and 1.6–1.8% in the 1990s which is a good figure compared, for example, with plywood or sawn timber that have shown around 0.5%.

The strategic core of innovation processes of Manufacturer J is to provide added value systems and solutions to contractors. The company has also operated as a contractor in Germany, Finland, the UK and France. However, this is not regarded as its ultimate purpose but as a means of influencing the speed of growth of wood-based construction.

R&D of Company J is managed and conducted in its business lines but coordinated at company level. Decisions involving large investments are also made at company level – new manufacturing lines or factories cost more than 50 million euros. Three types of R&D projects are listed at the business line level:

1. R&D planned and approved to be run all the way to the market (time schedule, budget, resources and marketing and launching plan).

2. Feasibility studies collecting and analysing market and technology information.
3. R&D of longer-term objectives.

When a project is being decided, the project manager, internal resources and outsourcing is determined at the same time. Research organisations can be selected in many countries like, for example, Germany or France.

The company has had a strategy of first products for a long time. This means that one product is a basis on which a product family or portfolio is enlarged, and then a system and more completed solutions are created through combining product families together. The main systems are developed for roofing, flooring, framing and walls. In parallel with this process, the company develops its services for designers and contractors such as software tools and dimensioning and structural calculation tools. Also, Building Information Modelling is of interest.

Manufacturer J is a shareholder in the Finnish Wood Research Centre FWR and participates in the European activity Building with Wood and CEI-Bois. The company has also been a member of the Finnish Confederation of Construction Industries RT for two years through its member organization of construction product manufacturers, RTT. This move was made because of the new strategy of the company that it will transfer most of its activities from the Finnish Federation of Forest Industries (Metsäteollisuus) to RTT.

4.9.3 Chronology of Case J

Company J has been in charge of all the various phases of R&D on LVL, and it acquired the research inputs mostly from domestic PROs in the first phases of the innovation process. Knowledge interaction in Case J was divided in four main phases.

4.9.3.1 Feasibility projects and the pilot plant

Company J organized a series of Master's thesis together with PRO2's laboratory for wooden products and technology at the beginning of the 1970s. In addition, one study was organized together with the School of Economics. The first two phases concern feasibility projects and a pilot plant that was also used as a test bed. Tables 23 and 24 summarize knowledge interaction during these phases.

Table 23. Knowledge interaction between Company J and research organisations from the idea to the pilot phase (1970–1974).

Year	Scope of R&D activities	Knowledge interaction
1970–1974	Peeling thick veneer from conifer Drying thick veneer Curing time: gluing	Master's theses at PRO1, work done at PRO2 Technical part of feasibility studies of Company J
1972–1974	Yield in wood processing	PRO5 (business)

Table 24. Knowledge interaction between Company J and research organisations from the idea to the pilot phase (1974–1979).

1974	Up-scaling project with pine Pilot plant, start in 1975	Company's own project Ministry of trade and industry (KTM), and some funding could be received from it
1974–1975	Optimisation of wood use (sap/heart) Manufacturing veneer from dry spruce (soaking) Move to spruce in pilot plant	PRO2 as an expert organization Soaking tests at PRO2 and factory Fund for Developing Areas in Finland, Kera. This was a fund to promote industrial and economic development in some regions in Finland
1975–1978	Glueing technology	Tests with the one-side glueing extruder at factory, co-operation with PRO2 about performance of beams PRO2's statement about quality and strength
1979–1980	Type approvals	Finland and Sweden 1979 Discussions in Germany started in 1978 France 1982 PRO2's networks helpful Discussion in the States

4.9.3.2 Industrial development

The first pilot line was closed in August 1979 as a decision was made to establish large-scale manufacturing closer to the capital. A new line was designed together with a Finnish machine manufacturer. For the new line, joining of plies was developed further. A decision was made to make scarf-jointing online, not separated, as it is now done in a plywood factory. This implied a major technical leap forward compared with other products. Since the LVL reached the industrial stage in 1981, development efforts have been focused on responding to market needs. The I-joists were developed with an OSB (or plywood) web and flanges made of LVL. Development of connections was vital for the implementation of LVL-based solutions in multi-storey buildings (Kairi 2011).

Table 25 introduces the joint R&D activities in 1980–2004.

Table 25. Knowledge interaction after the launch onto markets.

Year	Scope of R&D activities	Knowledge interaction
1982–1988	Creep and long-term performance of wood	PRO1, several tests; doctoral thesis
1992–1993	Optical quality control of veneer in the production line	PRO1, radio laboratory
1990s	Kerto-LVL-trusses Joints in LVL structures	Experimental and theoretical studies at PRO1, building technology, publications and dissertations
1990s	VOCs	PRO2, measurements
1994–2000	Acoustics and vibrations of structures of Sibelius Hall Glueing with polyurethane	Nine projects with PRO1 and PRO2. Large scale and long-term tests at PRO2 Tekes funding. co-ordinated by Suomen Puututkimus SPT
1997–2004	CEN standardization for CE marking (EN 14374); for structural use, AoC (AVCP today) Class 1	
2004–2006	Design values according to European rules	PRO2; product certificate
	CE marking via EOTA route for the I joists	PRO9 (the UK)

4.10 Case K: Modular steel building

The concept of turn-key modular steel building was transferred from ship-building technology. The structural load-bearing box was made of sandwich panels with a corrugated steel core whose original idea was developed for the US Navy in the 1950s. Since the 1980s, a considerable number of studies and research projects dealing with metallic sandwich panels have been conducted in Europe; research was initiated particularly in the UK, Germany and Finland (Laiterä 2010). A project was conducted within the FinnSteel programme of Tekes concerning new manufacturing technology in 1995–2000 in which a company other than Company K took part, but which enabled knowledge transfer.

4.10.1 Manufacturer K

Manufacturer K was established in 2007 to produce steel-based modules and deliver customized turnkey service that consisted of completed buildings or parts of buildings and various compilations of design and construction services. The services were produced by a network of sub-contractors. The company had ten employees at the end of 2010.

Several applications were developed, such as apartment buildings, nurseries and day-care centres, lift towers and building extensions. Modules may have all

technical installations and indoor and outdoor finishes. The lift towers may have elevator lift installed before delivery. The apartment modules may contain four bedrooms.

The company offered to join to a building project as early as possible, or even earlier in the portfolio planning or area planning of developers together with the local authorities. The company was also operating as a contractor.

The principle of fast erection on site did not, however, mean fast production in the factory. Instead, the off-site production resembled on-site building under a roof (Peltonen 2013).

4.10.2 Chronology of Case K

The knowledge interaction between Company K and research organisations is shown in Table 26.

Table 26. Knowledge interaction between Company K and research organisations.

Years	Scope of R&D activities	Knowledge interaction
2006–2010	Joining techniques, materials, modification methods, design parameters Structural and fire safety and acoustics of a module	Fire tests on floors, roofs, walls and staircases at PRO2, acoustic measurements and structural design basics at PRO3; Master's theses at PRO3 Co-operation with PRO1
2009–2011	Business models Basics of B1-class for an 8-storey modular building	Pilot building projects. Tekes funding in the Built Environment Programme
2008–2009	Carbon footprint	Programme in carbon neutral communes, HINKU, of the Sectoral Research Centre of the Ministry of Environment; Company contributed to local activities
2012	Basis for applying metal core panel technology in bridge and bay structures opening up new opportunities for architecture	Master's thesis at PRO3; the supervisor from Company K; TRY's award for an excellent thesis (TRY 2013)
2011–2013	Architectural and structural design, software for BIM; Building process development	Multidisciplinary project 'Concells' funded by Tekes Programme 'The Built Environment', companies and PRO3
2013	Production system for modular housebuilding	Master of Science project (Peltola 2013)

Company K had three patents (by the end of 2010) that deal with “manufacturing of cellular board”, “room arrangement” of at least two superposed prefabricated load-bearing room units, and “method of renovating a building”. The company for ship's cabins has several patents even from the 1990s dealing with buildings (class EO4 in patent register).

The product approvals were given case-by-case in building projects by the local building surveyors, and the building solutions do not have a common product approval or European Technical Assessment. Each building project was used as a pilot at the time of the thesis project. The company had a quality inspection contract with a Finnish certification body.

4.11 Case L: Energy-efficient multi-storey building

Company L has developed manufacturing of components and building technology and processes for energy-efficient and nearly zero-energy buildings for a decade and has implemented novel solutions for the new buildings it has constructed. In the first phase, the energy demand was about 30% of the average consumption in multi-storey residential buildings (Tekes 2008).

4.11.1 Company L

Company L is a contractor established in 1952 and is nowadays owned by five operative managers. The number of its employees is 60. It delivers completed buildings either with a concrete or wooden frame, mostly around the capital. The company owns a factory for prefabricated concrete components.

The company is not a member of RYM Ltd or engaged in any of its programmes, although its CEO was promoting the establishment of RYM on the board of RT.

The company does not have full-time R&D personnel, but the CEO and other managers are active as well as 3–5 employees according to actual needs. The annual R&D investment of Company L is around 200 000 euros. In addition, the funding from Tekes doubles the budget. The factory has its own experts involved in R&D projects.

4.11.2 Chronology of Case L

The innovation process of Case L started at the beginning of the 2000s based on an insight that consumers' energy bills will not be reduced without savings in consumption. The first phase of concept development aimed at continuous improvements in the energy-efficiency of a multi-storey residential building with a concrete frame, and nowadays the objective is approaching a nearly zero-energy building (Table 27). Recently, solutions for a wooden multi-storey residential building have been studied and developed.

Table 27. Knowledge interaction between Company L and research organisations.

Year	Scope of R&D activities	Knowledge interaction
2001	Basics of the concept for energy-efficient multi-storey residential building: all components and systems need improvements; U-value targets Building physics, especially moisture	A team of contractors involving a design office, suppliers of thermal insulation, windows and heating systems and PRO2
2004–2005	Design and construction of the pilot apartment without separate heating and with low-energy wall components, excellent air tightness	R&D project in Tekes programme Sara Dynamic simulation of energy consumption taking all systems into account; PRO2, PRO9
2005–2007	Performance of the pilot apartment: indoor air and energy consumption	Thermal camera plus 80 monitoring points including moisture; PRO2
2009	First demonstration building was completed with a concrete frame	
2010–2011	Wooden multi-storey building as an in-house project; vibrations, acoustics	Funding partly from Lahti Science and Business Park which belongs to the national Programme of Centres of Expertise OSKE (under TEM); PRO2 involved

5. Individual case descriptions

The analysis procedure of the case study comprised preparation of individual case descriptions according to a uniform description framework and a cross-case synthesis of the individual case descriptions.

The uniform table of content of case descriptions was prepared through an iterative process in which the research data and concepts and approaches of the research framework were studied.

5.1 Description framework for knowledge interaction

5.1.1 Preparation of the uniform table of content

The iterative preparation of the uniform table of contents for individual case descriptions is shown in Table 28.

Table 28. Preparation of the uniform descriptive framework for the cases.

Stage	Description
Preliminary topical tables	Data from all the chronologies were gathered into preliminary topical tables (without reference to a case). The aim was to compile data that would provide information about research needs, research methods, use of new knowledge, types of projects and funding and use of research-based knowledge. The data was aggregated according to these topics.
Thematic tables	The topical tables were compared with the concepts of the framework of the research. Conclusions about a match of research data with the research framework were also made. Topics were adjusted to fit with the framework of the research. Themes were chosen and data was rearranged.
Structure of the uniform description framework	The themes became headings and their content was described in generic terms.

During the iteration process, it was noted that the knowledge creation and the knowledge development pointed to the same phenomenon from a different perspective – i.e. at organisational or personal level and at a level of economy or sector, respectively. As the term ‘knowledge creation’ is intimately connected to relationships between people and management of innovation processes inside and between organisations and to modes of knowledge conversion, the term ‘knowledge development’ was chosen as a more appropriate concept usable both at organisational and systems level.

It was concluded that the knowledge interaction would best be explored through themes that describe development, use, diffusion and accumulation of the research-based knowledge, but the context of interaction needs to be described, too. Data uncovered that in true processes, various innovation activities were carried out in parallel, and also that various projects were in practice mixed. Research inputs were used rather simultaneously to develop the physical product and methods, software and guidelines for its design.

Thus, the preliminary reading and organising of data showed that activities of research, technical invention, commercialization, implementation in buildings and diffusion to new markets were intertwined. Three main themes were however defined for a common table of content of case descriptions in order to explore the knowledge interaction. These were development and use of knowledge, accumulation and diffusion of knowledge and context of knowledge interaction. The content of the themes were organised with codes, too.

5.1.2 Theme of development and use of knowledge

The theme concerning development and use of research-based knowledge directly in product innovation was selected to describe research topics and areas in building engineering that were keys to advancing product development and entrance onto the construction market. The data was collected from all the reports and connected to the generic process model, but development of technical services was also identified as an essential activity. Topics connected to this theme are shown in Table 29.

5. Individual case descriptions

Table 29. Topics in the theme of development and use of research-based knowledge in innovation cases.

<i>Process phase</i>	<i>Areas of research Use of research-based inputs</i>
Fuzzy front end	State of the art of a new R&D field Basic research on materials
Invention phase: product-specific knowledge, know-how	Knowledge about structural performance under various loading situations and fire Knowledge about building physical phenomenon Knowledge about ageing and service life Experimental and analytic research methods Composition of a product Interaction of manufacturing and product performance Quality assurance at factory Environmental impact assessment Simulation of overall energy consumption of a building Energy-efficiency assessment
Commercialization, marketing and product approvals	Research-based evidence for market entrance Product-specific approval procedure, domestic Product-specific approval procedure, foreign Product-specific approval procedure, CE marking European standardisation Environmental product declarations
Companies' services	Design recommendations and guidelines Design tables Design software Voluntary product certificates Building Information Modelling data Environmental product declarations Service for contractors and designers for concreting (BetoPlus) Service for energy-efficient halls Service for design of panel walls

5.1.3 Theme of diffusion and accumulation of knowledge

The theme of diffusion and accumulation of research-based knowledge was compiled based on the concepts of knowledge assets by Nonaka et al. (2000), the generic model of innovation processes (Figure 13) and the functions of an innovation system as defined by Hekkert et al. (2007) and Bergeck et al. (2008).

The case study was limited to the activities of manufacturers during innovation processes, and the diffusion of new knowledge to the construction sector (contractors) or implementation of novel products to building projects were not considered. Diffusion was, thus, considered to be activities to publish the results, for example, in journals, theses, guidelines, training materials and conferences.

Thus, it was overlapping with the use of new knowledge. A conclusion was made that diffusion of the research-based knowledge was first of all considered through strengthening and establishing of knowledge assets as shown in Table 30.

Table 30. Topics in the theme of diffusion and accumulation of research-based knowledge in innovation cases.

Type of knowledge asset	Related topics identified in research data
The industrial knowledge base	Product declarations, product approval procedures Basic properties of materials (strength, long-term, ageing, fire, emissions, treatments, quality assurance) Performance of components and systems (fire, service life, recycling, safety) Performance of buildings (acoustics, indoor air) State-of-the-art in foreign countries Forecasts on markets and technologies, strategies National design codes National open system, principles Design codes in foreign countries Implementation of the European regulations Common rules for uptake of ICT in design, BIM Building technologies (off-site, on-site) Renovation technologies Know-how of testing methods related to quality control at factory European standardisation, Eurocodes International standardisation, e.g. ISO International emerging design methods Design basics for structural safety Design basics for safety in fire Design of indoor environment Design of healthy buildings Ageing and service life of materials and structures Building construction technology Production of concrete materials State-of-the-art of materials Product approval procedures in foreign countries Manufacturing technology, CAD-CAM Implementation of Building Information Modelling European standardisation
The national knowledge base	National Building Code National standardization Implementation of the European regulation Product approval procedures

5. Individual case descriptions

The knowledge assets of research organisations	Competences on research methods, software Development and use of experimental facilities Publications, papers, scientific records Know-how on research management Research funding opportunities Research proposals Competences on research methods Development and use of experimental facilities Know-how on research management Research agendas at various levels Forecasting technology development Research-based services
--	---

The data of cases in chronologies indicated that product- and technology-related knowledge assets developed in companies and research organisations parallel, and the products also were developed parallel with research. Thus, a difference between the theme of development and use of knowledge above and the theme of accumulation and diffusion of knowledge was not based on timing.

5.1.4 Theme of context of knowledge interaction

The theme of context of knowledge interaction included the issues of channels and forms of interaction and the approaches to innovation systems. In addition, the state of the art of the particular field in building engineering science related to case studies was described when the research data received from interviews referred to it.

The forms of knowledge interaction are by definition ways of transferring knowledge. The similar forms as introduced in the channel mode of Dutrénit et al. (2010) were identified in the research data with the following modifications:

- The traditional channel was dedicated to activities which might have been performed without funding from companies;
- The service channel was dedicated to ‘free’ and voluntary services, and for this reason ‘use of equipment for quality control or tests’ was moved to the commercial channel;
- The commercial channel was focused onto all kinds of business services of public research organisations such as statements and certificates and it was divided into IPR and other services including consultation and technical assistance;
- It was considered as reasonable to sub-divide the bi-directional channel as the observed forms were more numerous than in the original list; also funding of co-operation and structure of consortiums were considered;

- An additional networked channel was included in the thesis that reflects the changes to more international and networked innovation processes.

The data was not detailed enough for the service and commercial channels to be clearly distinguished. For example, training of the staff of companies could be a free service, especially a couple of decades ago, or it can be a commercial service. Voluntary work of associations can also be connected to technical assistance, and for this reason belongs to two channels. The sub-sectors of the extended construction innovation system were very similar in their forms of interaction historically and also in their current operations, which justified an aggregation of forms. Table 31 shows the lists of forms as observed in the research data and their aggregation to channels of interaction.

Table 31. Topics related to the channels and forms of knowledge interaction from the viewpoints of research organisations in innovation cases.

Channel	Forms identified in the research data
The traditional channel: in-house work and public communication	Nordic mini-seminars, meetings, conferences In-house research of a research organization Nordic Concrete Publications, Nordic Concrete Day Domestic R&D Day on steel construction Teaching in training courses of associations Research publications of PROs Diploma and doctoral theses, funding, supervision Informal information exchange, networks of individuals (national, Nordic, European, COST)
The services channel: free and voluntary services	Researchers hired by associations/companies Training staff of companies by researchers Guidance for design and use of novel solutions Presentations at events Advisory groups of industrial organisations Editorial Boards of professional journals Teams for product declarations
The commercial channel: IPR and contract work	Patents Technology licenses Consultancy and technical assistance Product-specific or solution-specific modelling Standard tests for design values Experimental research, outside existing standards Quality control agreements, control tests Statements, certificates Sub-contracts in a joint or company's project

5. Individual case descriptions

Channel	Forms identified in the research data
<p>The bi-directional PRO-I channel,</p> <p>including bilateral and multilateral co-operation and joint efforts as well as co-operation between associations and research organisations</p>	<p>Joint national or Nordic project co-ordinated by any PRO or government institute, jointly funded by a public source (ministry, Tekes, Nordic funds) and related to common objectives</p> <p>Joint European project, partners from PROs or government institute and companies or associations, jointly funded by a public source</p> <p>Preparation of International Guidelines on a special technology (CIB, FIP, ECCS)</p> <p>Steering Groups of a joint research project</p>
	<p>Working groups of associations (national, European)</p> <p>European Technology Platforms (steel, wood)</p> <p>National Mirror group or a committee related to European activities</p> <p>European joint research group of companies</p>
	<p>Joint project co-ordinated by an association or a broker centre</p> <p>Joint project funded from a source connected to the sub-sectoral system (steel and wood)</p> <p>Product development projects within joint projects</p> <p>Eurocodes</p> <p>Voluntary industrial standards</p>
	<p>PRO-companies contract</p> <p>PROs-company contract</p> <p>Team work in one or more phases of a product development project</p> <p>Participation in negotiations of a company</p> <p>CEN standardization, harmonised product standard (for CE marking)</p> <p>Joint scientific and professional papers</p>
<p>The multiple channel</p>	<p>Technology roadmaps, inter-ETPs</p> <p>Multi-disciplinary project involving many kinds of PROs</p> <p>Cluster-wide multi-level technology programme</p> <p>Promotion of new ICT technology</p> <p>Local network of communes and companies</p> <p>Large-scale multi-technological European project</p> <p>Value-chain project</p> <p>Workshops for national industrial visions and research agendas or public-private agendas</p> <p>Public-private company and its programmes</p> <p>Construction Sector Technology Platform</p>

Forms of knowledge interaction in Table 31 comprise types of co-operation projects as defined by Perkmann and Walsh (2009) as follows:

- Problem-solving projects address issues relating to products, processes or services close to market – Commercial channel

- Technology development address design specifications or prototypes for new or improved products or processes – Commercial or bi-directional channel;
- Ideas testing was related to a high-risk concept on behalf of a firm which was outside the firm's mainstream activities – bi-directional channel; and
- Knowledge generation projects making only very generic reference to market-ready products or services – bi-directional or multiple channel.

Innovation systems approaches were considered in relation to each case in order to enhance the understanding of the context in which the knowledge interaction takes place and also the overall innovation context of product manufacturers.

5.2 Case A: Product portfolio for the open building system

5.2.1 Vignette

The national BES system was developed through joint efforts of all the stakeholder at the end of the 1960s. The process involved R&D activities that were organised by the Ministry of Internal Affairs. The first phase of the innovation processes concerned multi-storey residential buildings. Novel types of building product led to the creation of national product approval procedures in 1975.

In the 1980s and still in the 1990s, the focus was on the expansion of the system to office and other types of buildings and improvement of the technical function of components. The system was also developed to better fit with flexibility and architectural requirements. The knowledge interaction between Manufacturer A and research organisations was dynamic and active, which was facilitated by the growing numbers of researchers on both sides and the new funding opportunities of Tekes since 1983.

The uptake of information and communication technology started in the 1970s when the first analysis software was acquired and used for the planning of manufacturing. Computer-aided design and manufacturing of prefabricated concrete components was developed further as CAD-CAM applications in 1985–1990. In the 2000s, manufacturers have invested to the development of Building Information Modelling BIM.

Manufacturer A had a leading role together with another large manufacturer of cement and concrete products in the development of the structural system and its prefabricated components. Competition between these companies was a strong driver for their in-house R&D and co-operation with research organisations until the re-structuring of the industry in the beginning of the 1990s.

The domestic co-operation between the Finnish companies of Manufacturer A and research organizations has declined since 1995. Internationalization led to co-operation with foreign organizations, and gradually the group has also changed the balance between centralized and company-based innovation activities. This

5. Individual case descriptions

has also led to decline of the concrete laboratory in Finland that used to serve the international concern. The relationships of Manufacturer A with research organisations as observed in research data are summarized in Table 32.

Table 32. Collaborative research organisations of Manufacturer A.

<i>PRO</i> <i>Period</i>	1	2	3	4	5	6	7	8	9
1968–1978	x	x							
1979–1989	x	x	x	x					
1990–2001	x	x	x	x	x				x
2002–		x	x	x				x	x

5.2.2 Development and use of knowledge

5.2.2.1 Fuzzy front end

International building systems and technologies were studied in detail in joint activities which involved representatives of all stakeholders of the construction sector. Before this stage, individual manufacturers and contractors had had pilot building projects of prefabricated solutions since the 1950s. The projects converged into three alternative systems from which the BES evolved the most competitive one.

The research organisations were capable of educating and investigating in the field of concrete materials and structures.

5.2.2.2 Invention phases

The chronology of Case A was divided into four main phases from viewpoints of knowledge interaction and innovation process. The first two phases can be distinguished as periods of time when novel types of solutions were brought to construction markets, namely

- Products for the ‘Bookcase’ system (components, connections);
- Products for the office buildings, in particular those for slim floors.

The first phase of knowledge interaction between Manufacturer A and research organisations was characterized by the need for basic knowledge of structural and fire performance of pre-stressed and prefabricated components and the ‘bookcase system’ these comprised. Studies on progressive collapse and diaphragm action established a theoretical basis for the safety and rigidity of a building.

The first wave of knowledge development of hollow-core slab technology concerned one-way slabs supported on walls as used in residential buildings. Experimental research of structures became an important research area. The demand came from the manufacturer, but the building permit authorities also

started to require verification of the properties. Research, analysis and design methods of prefabricated components were developed simultaneously, and published in theses, technical notes and national professional journals.

The second phase of knowledge interaction in the 1980s was a period of time when the system approach was applied to various building typologies. The new phase of research on hollow-core slabs started when slim floor structures became popular in office buildings where slabs were supported on beams instead of walls in order to improve flexibility of spaces.

Façade technology, in particular concrete sandwich components were continuously developed to respond to the architectural demands but also to comply with tightening energy-efficiency regulation. A new research field was born in the mid-1990s concerning microbiological performance of façades; this area is still topical.

Figure 25 summarizes the knowledge development in design of hollow-core slab fields and façade technology.

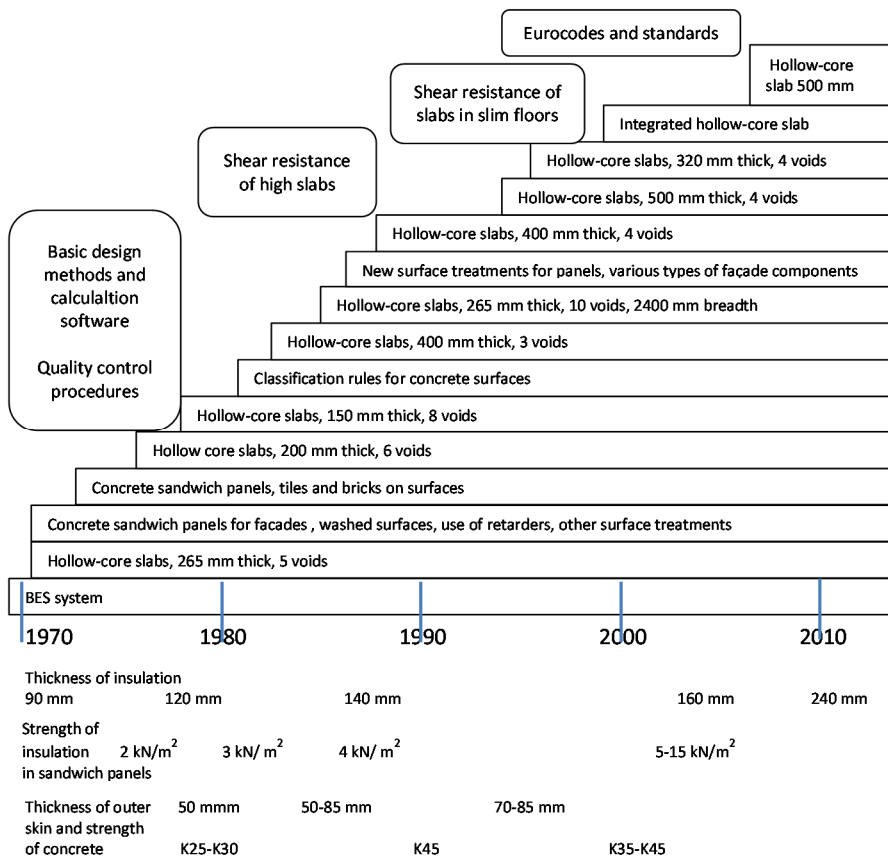

Figure 25. Knowledge creation steps of prefabricated concrete hollow-core slabs and concrete components for façades (based on research data, Betonikeskus 2007 and SBK 2009).

5. Individual case descriptions

Application of the system thinking to space and technical systems of a building was investigated in the joint projects of contractors, product manufacturers and research organisations at the end of the 1980s. The open building system was studied theoretically in the joint projects also as an information system. Product portfolios were expanded and software applications were developed and integrated in design and manufacturing.

Recently, issues related to energy-efficiency of buildings have also been of importance. Joint activities have included measurements on heat losses of real buildings.

5.2.2.3 Commercialization phases

Entrance to the market was a major driver for the R&D on pre-stressed concrete components because their design and approval methods were not sufficiently covered in the national regulations. The design of hollow-core slabs and pre-stressed beams was product-specific and based on verification through experimental research and continuous quality control. The national product approval procedure was one outcome of the activities and declared by the Ministry of Internal Affairs (predecessor of the Ministry of Environment) in 1975.

The first computing tools were developed in the mid-1970s, and sold to companies that used them for design tables and curves. These were an essential part of technical brochures used in structural design offices.

The Finnish hollow-core slab technology grew globally very competitive, and became the leader in the world during the 1980s. Product specifications and guidance for design and use were typically prepared by research organisations. Some of the documents were widely referred to in foreign publications, e.g. concerning the diaphragm action. Researchers were also teaching on training courses abroad. This period of time ended during the restructuring of the entire industry.

Research-based knowledge and know-how was also developed for understanding the interaction between space, structural and technical systems. The development of software for design and Building Information Modelling BIM has become an essential part of everyday business. The history of integrated tools started already in the mid-1980s, and several joint projects have been undertaken.

5.2.3 Diffusion and accumulation of knowledge

The first nationally supported projects had an objective of learning from foreign experiences. Research methods were at first studied from Nordic and German practices, but the Finnish knowledge and know-how could be transferred back to international guidelines and standards in the 1980s.

The Ministry of Internal Affairs (the Ministry of Environment today) was responsible for the regulation concerning safety of structures that has been in the form of obligatory and advisory Parts of the national Building Code since 1976. A

year before, the Ministry had declared the procedures of national product approval. Since the mid-1980s, design principles of single hollow-core slabs but especially those of slabs of slim floors, have been developed in experimental and theoretical projects. The new knowledge and knowhow were utilised in product approvals, quality assurance procedures and in design guidelines.

The knowledge and know-how on experimental and theoretical research grew in research organisations in particular in the 1980s when the number of researchers also grew rapidly. Guidelines to perform experimental research were studied and published.

The Finnish technology was exported to several countries in the 1980s. Training courses were organised by the research organisations abroad and for foreign visitors. Mobility of researchers and industrial representatives were supported through several technical guidelines and the first pieces of software for design.

Standardization has taken place at the European level since 1995, but the national standards are still developed for national applications. There are still some common Nordic interests in the preparation of European level regulation, but their importance has gradually declined.

5.2.4 Channels and context of knowledge interaction

5.2.4.1 Channels of knowledge interaction

Practically all the stakeholders of the construction sector were involved in the development of the BES system. In particular, two major cement and concrete companies and the industrial lobbying organisation SBK (the Confederation of Finnish Concrete Industries) were active in product innovation processes, and SBK co-ordinated several research projects. The first industrial product-related projects received funding from the Ministry of Trade and Industry (predecessor of the Ministry for Employment and Economy).

The establishment of the national funding organisation for technology development Tekes under the Ministry of Trade and Industry in 1983 opened new opportunities for manufacturers which were used for confidential product development projects and for public efforts for the common good of the concrete construction sector. Manufacturer A was involved in joint R&D activities with research organisations alone, with other manufacturers and other companies, and thorough industrial associations.

PRO2 grew from a provider of R&D services also to a broker in the 1980s that initiated and co-ordinated large national programmes involving a great number of companies. The peak of this evolution was reached by the turn of the decade when the programme for Industrialised Building Construction integrated R&D activities of major contractors, manufacturers and software houses. Joint innovation activities took continuously place between PRO2 and companies based on formal co-operation agreements from 1974 to 1993. Representatives of companies were sometimes hired by PRO2 for a couple of years. On the other hand, Manufacturer

A recruited several researchers to its R&D units; the Finns managed the R&D of the international companies and the current group until 2010.

PRO1 also increased the number of researchers in jointly funded Tekes projects in particular in the professorship for building technology which focused on concrete and wooden structures and building physics in the 1980s and 1990s. The outcomes of research projects were public Master's and Doctoral theses.

Manufacturer A was involved in European activities in 2002–2009 which dealt with industrialized construction, shear resistance of hollow-core slabs and surface treatments. In all these projects, PRO2 was also involved.

The Concrete Association of Finland has been an activator and co-ordinator of voluntary and informal joint activities since 1925. The research organisations have been involved, for example, in the preparation of national design codes and recommendations, in the national and Nordic R&D co-operation, in the preparation of the international guidelines and in the procedures of product declarations. The product declarations were one important way onto the Finnish markets for domestic manufacturers but also for imported products, and their role was mandated by the Ministry of Internal Affairs and then by the Ministry of Environment to the association.

5.2.4.2 Context of knowledge interaction

The background facilitating development of new knowledge and technologies was established during the years when newest methods of structural analysis were brought from the United States to PRO1 in the 1960s. Knowledge and technology transfer from foreign countries also took place in the first phase of the development of the national building system when the building systems and technologies were studied in joint efforts.

However, the knowledge interaction considered in this thesis was connected to the further development of the new knowledge and to implementing it into the national open building system and its products and procedures of national approvals. Thus, the innovation system in relation to knowledge interaction was a national construction innovation system at the time of transition from traditional building technologies to prefabricated concrete construction.

PRO2 received new experimental facilities in 1987 which were vital for the development of design methods of slim floors thanks to the possibility of large specimens.

The policy intervention was an important factor for the systemic change, and it happened at the governmental level but also at the level of urban planning.

5.3 Case B: Products for industrial on-site concrete construction

5.3.1 Vignette

Case B concerns the development of the concept and products for industrial on-site concrete construction. The purpose was to simplify and hasten on-site work and compete with quality and durability aspects against prefabricated concrete construction. Companies involved in off-site and on-site concrete construction were also co-operating in development of concrete research and technology.

The concept of industrialised on-site construction is based on advances in prefabricated reinforcement, concrete technology (additives, self-compacting concrete), steel fibres, steel-concrete composite construction and moulding technology as well as efficient on-site process management. As a multi-technology concept, it has been developed and promoted by several companies.

The industrialized reinforcement technology was developed in Finland by the reinforcement industry starting in the mid-1970s. Implementation of new products in building projects was, however, a long-lasting change of 15 years although use requirements and logistics were also considered. Industrial reinforcement is predominantly used on building sites nowadays.

Development of additives facilitated changes in concrete technology. The most recent achievement since the end of the 1990s is self-compacting concrete SCC which was realized through components of grading curve and additives. 'Green concrete' was developed as a comprehensive model of operation including the eco-efficiently produced material. It has been on the market since 2011, and the first major on-site building project is under construction.

Relationships of Manufacturer B with research organisations as observed in research data are summarized in Table 33.

Table 33. Joint activities of manufacturer B with technical research organisations.

PRO Period	1	2	3	4	5	6	7	8	9
1980–1995	x	x		x					
1995–2003	x	x	x						
2003–	x	x	x	x	x			x	

5.3.2 Development and use of knowledge

5.3.2.1 Fuzzy front end

Knowledge development on industrialised on-site construction began in issues that concerned prefabricated reinforcement including structural performance,

5. Individual case descriptions

manufacturing technology, logistics and costs of mesh for floors. The idea of welding grids from ribbed bars for load-bearing structures was imported in the 1980s, but the differences in surface treatments, steel qualities (move to a higher strength class) and welding techniques made it necessary to develop a national approach for the development of manufacturing technology and the verification of properties. The project involved a manufacturer of rebars and two research organisations.

5.3.2.2 Invention phases

Manufacturer B has developed processes for ready-mixed concrete and on-site concrete technology throughout its history. The activities have concerned grading and manufacturing of concrete, properties of fresh concrete and phenomena in the hardening processes and properties of concrete such as drying.

Knowledge of hardening processes and grading schemes was developed both by industrial and science-based research organisations. The achievements in additives were implemented to company-specific conditions and products in partnerships between various companies, in the joint projects of companies and research organisations or as contracted work. Modelling and development of planning software came as early as the 1980s, and the current BetoPlus-based customer service resulted from several R&D projects.

Manufacturer B promoted on-site technology also in the technology area of steel-concrete composite construction together with Manufacturer D. Hardening and drying phenomena were studied extensively through on-site monitoring and modelling in various projects until 2009. The subject was also related to research on indoor air quality which in turn was a part of research on healthy buildings.

At the end of the 1990s, Manufacturer B was involved in joint projects to develop environmentally friendly and durable concrete. Around the same period of time, self-compacting concrete SCC started to gain attention. Studies were localized in Finland in the 2000s. SCC was realized through components of grading curve and special additives. "Green concrete" was developed as a comprehensive model of operation including eco-efficiently produced material. Its core is also the management of the grading curve and additives, but essentially it is also a service concept developed by the company itself.

5.3.3 Diffusion and accumulation of knowledge

Manufacturer B has disseminated research-based knowledge through networks, professional and scientific publications and events and guidelines. Its representatives have been involved in a great number of steering groups of joint projects.

The activity 'Resilient stone building' has been important for Manufacturer B in the promotion of industrial on-site construction together with other suppliers of products and solutions connected to the concept. The co-operation group organises dissemination of on-site technology through publications as well as related

promotional events and international excursions. It has also been one way to publish research-based knowledge about the newest design and construction technologies in the field.

Representatives of research organisations were authors of codes and guidelines for design and best practices together with representatives of companies and associations.

5.3.4 Channels and context of knowledge interaction

The knowledge interaction in Case B took place in various national research projects and programmes mostly jointly funded by Tekes. The domestic channels have been similar during the entire case, but the number of joint projects has declined since the beginning of the 1990s.

The context of knowledge interaction in Case B was influenced by domestic markets and regulated requirements in Finland, and thus it can be studied as a national construction innovation system. The relationships of Company B with contractors and other manufacturers, supply networks and governmental organisations have been rather stable. The system has also had supportive features such as a professorship specialised in concrete technology, higher education on the design of on-site cast concrete structures and funding opportunities. The national association has also had a long-term co-operation with the ministries in charge of the national building code, which became evident through mandates to prepare the Parts of the Building Code and to award certified product declarations.

A potential innovation system to study the success of the various products of the on-site building concept could however be closer to a technology-specific approach as the concrete research is international and similar technologies are in use world-wide.

5.4 Case C: Composite slim floor beam

5.4.1 Vignette

Case C concerns a cutting-edge steel-concrete composite beam solution for slim floors launched to the domestic market in July 1990. Its original purpose was to support hollow-core slab floors but it also suits other types of floor structures. The solution comprises a steel beam and concrete cast inside the steel part and to the void between the slab ends and the beam. A new factory was established.

Case C was a combination of the latest knowledge about steel-concrete structures developed internationally and slim floors developed especially in Nordic countries. However, no commonly approved or standard design method was available.

5. Individual case descriptions

The major marketing arguments for the composite beam were its hidden position within the slab height and fire resistance. National type approval was received in 1990.

The innovation process of the solution has continued until today. The main cause has been the long tradition of national type approvals in export countries because they relied on the product-related design methodology and experimental verification. At the same time, research-based efforts are made to develop universally approved methods and incorporate them into standards.

The shape of the steel beam was slightly modified in 2005 so as to suit to the automated production line. The beam, its connectors to columns and composite columns are also marketed as a system today.

Relationships of Manufacturer C with research organisations as observed in research data are summarized in Table 34.

Table 34. Joint activities of Manufacturer C with technical research organisations.

PRO Period	1	2	3	4	5	6	7	8	9
1988–1990		x		x					
1990–2005	x	x		x					x
2005–	x	x	x	x		x	x		x

5.4.2 Development and use of knowledge

The type of a steel-concrete composite beam was such that there was no standard research or design method available. For this reason, Manufacturer C not only invited researchers to the idea team but relied on research-based knowledge throughout the process from an idea to the market. At first, the performance of the joint between the steel part and in-situ cast concrete was studied in a comparative test series. Full-scale loading experiments were conducted on beam specimens and beam-hollow-core slab specimens. An experimental research method was also developed for a large-scale slim floor specimen on flexible supports. The state of the art on computational methods was the other pillar of the successful innovation process. The new knowledge and knowhow were utilised in product approval procedures and in design software and guidelines. The technical service of the company has been available from the very beginning, and it has been continuously developed.

Analysis and design methods of the composite beam for a slim floor have been developed and experimentally validated in several research projects since the launch on the Finnish market. In particular two areas of research have been important, namely the performance of an entire floor made of hollow-core slabs and the performance of the beam and a floor in a fire.

5.4.3 Diffusion and accumulation of knowledge

Development of universal design methods has been a strong motivation for the co-operation with PRO4, and this has also been buffered with a long-term contract. This co-operation enabled European networking and contribution to European standardization.

Manufacturer C regards joint research projects as important for improving the state of the art of special types of products and for strengthening the basis of design methods in Eurocodes, and furthermore for facilitating product approval procedures.

5.4.4 Channels and context of knowledge interaction

5.4.4.1 Channels of knowledge interaction

During the product development phase, knowledge of design methods and software and manufacturing was acquired through recruitments and joint projects. External R&D services have been acquired through contracts in issues for which there are no standardized methods or when experimental verification is needed, e.g. seismic, fire, vibration, and concrete anchoring strength.

The knowledge interaction in Case C was focused on experimental research and performance verification of the beam itself and its use in a hollow-core floor slab. It took place with domestic and foreign research organisations that had facilities and competences.

Manufacturer C supported open communication about the design of slim floors and development of universal methods in domestic associations (BY and TRY) as well as in the European arena (ECCS).

5.4.4.2 Context of knowledge interaction

The knowledge interaction during the first phase of product development and in succeeding phases was connected to the regulated first entrance of a novel product onto national construction markets. Thus, the context of knowledge interaction can be described through the concepts of a construction innovation system. Furthermore, the ideas of composition and dimensions of a novel solution were matured in relation to existing national R&D on concrete and composite construction and the shift of the concentration of construction from residential buildings to offices.

However, a technology-specific innovation system approach in the field of steel-concrete composite construction could also be regarded as a potential approach. This kind of system can be considered as embedded in the larger construction or sub-construction system depending on the purpose under consideration. The manufacturers – especially those of steel products – and research organisations

were developing universal design and verification methods at the European level to be included in the series of Eurocodes, and the Ministry of Environment had given a mandate for two associations to prepare national guidelines. The composite building system as developed by Company C is a niche technology both on the domestic and export markets.

5.5 Case D: Portfolio of thin-gauge steel products

5.5.1 Vignette

The use of thin-gauge steel changed in the 1970s when various cold-formed profiles and sheets were developed for load-bearing purposes. Non-load-bearing roofing and façade products were used in Finland as early as the 1950s.

Three different application areas for thin-gauge steel sheets started to develop almost simultaneously. At first, high profiles were developed to be used as load-bearing structures in roofs and upper floors of industrial halls and storages. Typically, span lengths were around 5–6 m, and thermal insulations were laid above the profiled sheets. Secondly, sandwich panels with polyurethane or polystyrene cores were developed. These kinds of product were on the market even before their design basics were thoroughly investigated, in particular concerning their long-term behaviour. The third area was composite slabs.

The next applications of load-bearing sheets were the external walls of halls. The solution had steel sheets on both sides and thermal insulation and wall rails in-between. Durability was usually achieved through galvanisation and sometimes painting in the factory. In the beginning, the walls were usually built on site.

A new phase took place in the 1990s with the aim of producing a portfolio of products for a small house and a number of components for multi-storey buildings. A steel-intensive building system was developed as a concept of 'dry construction'. The thermal stud for external walls was launched in 1994. Its competitiveness was based on the one row of studs allowing material and labour savings. Composite construction technology was also promoted as a part of industrialised on-site construction.

A sandwich panel with mineral wool core was one step forward in products that have several functions: A load-bearing product had thermal insulation and a finished external surface in one package. Manufacturing technology was also very advanced. It is one of the really rare commercially successful products that have survived for a long time, and its market potential is still promising.

The opposite development took place concerning the use of composite slabs in Finland. A modest level was achieved, but growth then stopped. R&D on Manufacturer D's own composite slab solution resulted in superb joint strength, but it was only a good addition to technical performance, and marketing efforts were stopped after a while.

The story of 'dry construction' concept was short-lived in the sense that the major product manufacturer has stopped production of several components. There

are small- and medium-size enterprises today which, for example, produce various steel studs. Table 35 summarizes the relationships of Manufacturer D with research organisations.

Table 35. Joint activities of Manufacturer D with technical research organisations.

PRO Period	1	2	3	4	5	6	7	8	9
1975–1989	x	x	x	x					x
1990–2000	x	x	x	x					x
2001–	x	x	x	x		x			x

5.5.2 Development and use of knowledge

5.5.2.1 Fuzzy front end

The industrialization and domestic manufacture of thin-gauge steel opened new opportunities for workshops that manufactured profiled sheets for non-load bearing use. At first the market was load-bearing roofs and façades. For this change, new design codes were necessary, and models were studied especially from Sweden. The Finnish Constructional Steelwork Association TRY ry was established in 1971, and preparation of the Parts B6 and B7 of the national Building Code was among its first activities; companies and research organisations were involved.

5.5.2.2 Invention phases

The portfolio of thin-gauge steel structures developed stepwise. At first, research-based inputs were needed so as to explain the structural performance of thin-gauge steel sheets which was based on exported calculation models and domestic test series. Manufacturers ordered experimental design values because the code formula underestimated the capacities. Next, components for external walls were developed which directed attention to fire safety.

The focus of R&D shifted from structural performance of single components to overall performance of buildings with thin-gauge steel frames and components taking into account user comfort (acoustics, vibration, indoor air), costs (also life-cycle costs) and environmental impacts. Development of design software has also been addressed, starting in the mid-1980s.

Manufacturer D developed a portfolio of building components for envelopes and partition walls whose performance was studied experimentally and theoretically as regards various the technical properties and durability essential for use in buildings. Components were combined with load-bearing frame structures to form a system of dry construction. Pilot and demonstration building projects were conducted and phenomena related to building physics were monitored. The

5. Individual case descriptions

summary of R&D and monitoring of demonstration buildings were published internationally.

Manufacturer D also developed a composite building system together with Manufacturer B focusing on high-performance composite slab. The design values were based on semi-experimental calculation model.

5.5.2.3 Commercialization phases

The research-based knowledge and knowhow were utilised parallel with product development, product approvals, quality assurance procedures, design guidelines and development of the technical service of Manufacturer D. The aim was to commercialize the novel solutions as soon as possible, and for this reason Manufacturer D had also established their own contracting company.

5.5.3 Diffusion and accumulation of knowledge

Diffusion of new knowledge took place simultaneously at the organisational and national level, and it concerned quality assurance procedures, product approvals, design guidelines and the preparation of Part B6 to the national Building Code published in 1975. At European level, the series of Eurocodes concerning structural design was under development mandated by the Commission of EU, and European standards were also developed to parallel domestic activities. The joint domestic activities facilitated a contribution to these developments by representatives of industry and research organisations.

Manufacturer D aimed at rapid commercialization of new types of products. Typically, pilot buildings were used for in-service tests.

5.5.4 Channels and context of knowledge interaction

5.5.4.1 Channels of interaction

The channels of knowledge interaction comprise a great number of the forms from informal professional clubs to voluntary technical committees and from bilateral contract work to a large international joint project. The Finnish Constructional Steelwork Association TRY has also played a central role as co-ordinator of various activities and as a broker organisation for joint efforts for the Building Code, FinnSteel and NiceSteel Programmes. TRY has also hosted joint working groups, informal meetings, training courses and Research Days and Nordic conferences.

5.5.4.2 Context of interaction

The knowledge interaction between various organisations was connected to development of the national steel construction sector and institutions for it in the first place. In this sense, the Finnish construction innovation system was a justified choice for the context of the case study for Case D.

However, Manufacturer D, the TRY association and research organisations have had close co-operation with Nordic, European and international networks in the constructional steelwork. Nordic and European models were important from the beginning of R&D activities.

The technology innovation system could also be regarded as a potential approach to investigate determinants that influence the success of novel products. The connections of industrial associations, companies and research organisations crossed borders and represented a value chain of the steel industry to the construction sector.

5.6 Case F: Steel-framed energy-efficient commercial building

5.6.1 Vignette

Case F concerns a steel-based building concept for an energy-efficient commercial building developed by Manufacturer D. The concept is a comprehensive service model that is based on external walls made of sandwich panels. The concept has three pillars: the air-tight envelope solutions, certified assemblers and simulation-based guarantee of savings in energy bills.

The airtightness of a panel wall was achieved through gaskets in joints between panels and by improving all the details. Detailing includes all connections between structural parts such as roofs, upper floors, foundations, windows and external walls. Assemblers are not employees of the company, but they can be trained by the company at its training centre close to the main factory, and a certification procedure for individuals was also adopted. A guarantee will be given to a client that the airtightness of the entire building will be at the level of a passive house. The concept combines minor changes in physical solutions and an advance in service development. The fundamental features of the service are reliance on advanced software, relevance with the decision-making in the early design phase of a building project, dealing with an entire building and a focus on economic benefits. The energy-efficient commercial hall has been very successful. The situation that an investor, user and owner are often the same company in commercial halls, has also helped.

The eco-efficiency of the concept has been improved through implementation of a new type of glass wool as the core material which contains a high percentage of recycled glass. The manufacturer of the insulation developed technical properties to be at the level of those of the structural stone wool insulation that is

also used. The essential argument from sustainability viewpoints is changing insulation of external walls influences on environmental loads of a building more than changing the framing material from concrete to wood. This new insulation is included in the service package of energy-efficient halls.

5.6.2 Development and use of knowledge

Manufacturer D joined a national R&D project in order to learn about factors that influence the energy consumption of a commercial building. The results were used to identify the areas in which improvements in energy-efficiency could be gained. A decision was made that all three areas having a great influence on energy-efficiency will be dealt with, namely the panel, the connections and the assembly.

A link was developed between two software programmes already available in the company. This means that the company commits to considering an entire building beyond its own trade limits. The company makes correcting measures free of charge in the case where the airtightness does not agree with that was promised.

Manufacturer D is involved in the RFCS project together with PRO2 because it is interested in the implementation of renewable energy sources in buildings.

5.6.3 Diffusion and accumulation of knowledge

Service development was the cornerstone of the energy-efficient hall concept. A voluntary product certificate of PRO2 will define design values, and this way it is possible to ignore measurements in real buildings required by the National Building Code as an alternative. Gathering measured data has also been included in the service for the reason that the energy performance needs to be verified through measurements in the completed building according to the Code.

5.7 Case G: Sandwich panel with a stone wool core

5.7.1 Vignette

Case G concerns a novel type of sandwich panel with a stone wool core launched on the market at the beginning of 1987. The core is made of so-called structural wool developed by Manufacturer G. The wool lamellas are cut from insulation sheet and turned vertically so that the fibres are perpendicular to the thin-gauge steel faces. The core and faces are glued together to perform structurally together. The core solution and the panel type were new world-wide.

Innovation activities are still continuing. The main reasons have been changes in use (for example continuous panels) and willingness to improve generic design and testing methods. Foreign product approvals have also been a challenge. Architectural design has been addressed in special building projects, and more

emphasis has been given recently to customized surface treatments. Tightening energy-efficiency requirements are also influencing on activities today.

The co-operation between Company G and research organisations has continued at the domestic and international level up to the present day as summarised in Table 36.

Table 36. Joint activities of Manufacturer G with research organisations.

PRO Period	1	2	3	4	5	6	7	8	9
1985–1987		x	x						
1987–2000	x	x	x						
2001–		(x)							x

(x) refers to a service company inside PRO2

5.7.2 Development and use of knowledge

Case G resulted from the state of the art of several areas that were held in companies and research organisations such as sandwich technology with plastic cores, manufacturing of stone fibre insulation, gluing technologies, experimental research on materials and structures and procedures of design codes and standards. Manufacturer G managed R&D in different areas and its own R&D unit was well-equipped and resourced at the time of product development. Its competences were complemented through acquiring research-based inputs in particular in areas of long-term performance of materials and structures.

The research-based knowledge inputs facilitated the development and market launch of a novel type of sandwich panel for which no universal design or verification methods were available. Finnish type approval of the panel was based on product-specific data obtained from experimental verification. It presents all the product details, product-related design rules and safety factors.

The most important achievement of the new sandwich technology was that the structural performance was predictable as reliably as, for example, that of steel structures. This was a completely new and seminal outcome that was the key that opened the markets.

Knowledge interaction in joint R&D projects in the 2000s and 2010s was focused on structural applications that are beyond the original type approvals concerning, for example, continuous structures and use of steel faces for hanging loads.

A new R&D field is optimization of the properties of the mineral wool core. The eco- and energy-efficient agendas highlight better insulation properties when the original targets focused on the strength properties of stone wool. Architectural appearance is also a topical area of continuous developments.

5.7.3 Diffusion and accumulation of knowledge

Manufacturer G promoted development of universal design and verification methods especially on safety and fire safety issues since the first launch to the domestic market. The first launch and exports to the Nordic countries benefited from the national product approval that was based on product-specific data and methods.

Manufacturer G regarded domestic and international guidelines as a gateway to the building projects whereas product approvals were the gateway to marketing. Design software was also developed as a core of service for designers, owners and contractors. The representatives of research organisations have contributed to the dissemination of research knowledge in training courses and meetings with representatives of companies.

The R&D projects supported Manufacturer G's focused efforts to develop a harmonised product standard for light-weight sandwich structures that would present rules for CE marking. It was approved in 2006 but came into force four years later. Another field of standardisation to which Manufacturer G contributed was fire safety. Foreign official approvals have been and still will be a challenge because in Europe the Member States are allowed to regulate preconditions of use.

5.7.4 Channels and context of knowledge interaction

Manufacturer G organised knowledge interaction with research organisations through contracted projects in the product development phase, but the company received funding support from Tekes. The third party quality assurance and test services were also contracted.

Several joint projects were organised that helped to extend the areas of application of panels and facilitated theses at universities. These were conducted both at the domestic and European level. The activities for international design guidelines were partly contracted, partly based on voluntary contributions and allocations of research organisations.

The overall context of knowledge interaction in Case G has been international since the launch on the domestic market. Manufacturer G initiated a joint international working group to complement the existing guidelines with its special solution. On the other hand, the knowledge interaction considered in the thesis research comprised the product development phase that was characterized through domestic co-operation and launch to the domestic market. Manufacturer G's customers were at that time mostly Finnish contractors. National projects have also connected joint activities to the national innovation system. A cross-border technology innovation system approach could, however, be more usable in order to study the determinants of the success of the novel panel on export markets.

5.8 Case H: ThermoWood® products

5.8.1 Vignette

ThermoWood® products are made of sawn timber that has been treated in an oven under controlled moisture and temperatures above 180 °C. The registered trademark is a concept that comprises patented thermal modification process, audited quality control system, life cycle assessment (LCA); certified raw material; standardisation; and continuous research and development activities.

The background of the product portfolio is in the science-based research that was taking place in several countries in order to replace the traditional preservation technique (CCA). Promising findings were made in an in-house project of PRO2 on thermal treatment, and a series of process and product development projects followed. The first industrial oven was established in 1994.

ThermoWood® product classification was completed in 2003. Two standard treatment classes were introduced. The classes are called Thermo-S and Thermo-D where S refers to product use where stability is emphasised, and D to use when durability is prioritised. The process can also be customised.

A summary of research organisations involved in Case H is shown in Table 37.

Table 37. Knowledge interaction between companies and research organisations in Case H.

PRO Period	1	2	3	4	5	6	7	8	9
1988–1994		x							
1995–2000	x	x			x				
2001–	x	x							x

5.8.2 Development and use of knowledge

Case H was born in research on wood chemistry. After the first promising small-scale experimental series when correlations between desired properties (colour, dimensional stability and durability) and treatment with high temperatures and steam were observed, a joint project with the broker centre and companies was established. Industrial up-scaling followed rapidly, but the research on wood chemistry was conducted in parallel for some years still.

The pilot plants were used as a method of product development, which on the other hand helped to gather data on properties of the product. More information about the application areas should also have been gathered at the time when the industrial up-scaling of the process took place. Thus, industrialization started in parallel with the basic research.

The R&D has focused on factors in processes and species that influence the quality of the treated wood. The long-term durability was investigated in field tests that were established in Finland and the UK.

5.8.3 Diffusion and accumulation of knowledge

New wood treatment methods were researched in PRO2's in-house programme and communicated openly with companies. The first industrial oven was established by one of the largest Finnish companies in the forest sector in 1994. In a few years, several ovens were established. There were practical problems at the beginning of the industrial phase. A commonly held view is nowadays that the product was launched too early onto the market. More experimental investigation should have been done in order to verify the properties more comprehensively, but some companies were eager to start and implemented the new process in small ovens.

The association has promoted the concept of Thermowood with a trademark internationally and in the European markets. A technical specification of CEN came into force in 2008.

5.8.4 Channels and context of knowledge interaction

The knowledge interaction in Case H was organised as joint projects in the phase of pilot plants by the brokering centres Suomen Puututkimus and WoodFocus Oy. The joint projects were partly funded by Tekes. Previously PRO2 allocated its base funding for science-based work and submitted several patent applications. The relationships between PRO2 and companies were quite close in the early phases of basic research. However, at some stage the companies had created their know-how and knew what to do for product development. They started involving other research organizations.

Since 2000, the association has continuously been involved in research initiated by itself or companies. Public funding opportunities are used, and the types of projects can be co-operative or research inputs can be acquired as sub-contracted or contracted work.

The context of knowledge interaction in Case H was considered to have been the same as for the other cases for the reason that the invention was made in the national research centre and investigated mostly in domestic, projects and products were first used in the domestic market.

However, the innovation context could also be regarded as technology-specific for the following reasons: the new technology was developed as originally science-based and implemented by a number of companies without first-hand institutional influence. The regulation concerning wood treatments was, however, expected to change, which was one driver of the research activities. The innovation was also connected to the pursuits of the sub-sectoral innovation system of wooden construction, and the large companies in the forest sector were among the first to

scale-up the research-based invention. The sub-sectoral innovation system of wood construction is based on value chains of the forest-sector from sawn timber to a building.

5.9 Case J: LVL products

5.9.1 Vignette

Case J concerns LVL wooden engineered products that are made of 3 mm thick spruce veneers glued together. The first application was a beam in which the laminates are vertical. The product and manufacturing technology was studied in several focused projects before and during the pilot plant that was established in 1975. It was a full scale LVL line that could produce all the dimensions that exist today. The first year's production was 500 m³ and the maximum of 2,500 m³ was achieved in four years. The beam was on the market in 1979 when national type approval was awarded. The right market segment of small houses was found with a 300 mm high beam. A new full-scale factory was established closer to the capital in 1981. It is still operating and in addition several lines are established there and also on the site of the pilot plant.

The LVL applications were developed together with client contractors and upgraders who offered structural solutions such as frames and trusses. I-joists were also developed. Today, the basic product is classified in three types (S, Q and T) which have different recommended applications. The properties are controlled with the quality of raw material and orientation of veneer.

Relationships of Manufacturer J with research organisations as observed in research data are summarized in Table 38.

Table 38. Joint activities of Manufacturer J with research organisations.

PRO Period	1	2	3	4	5	6	7	8	9
1970–1974	x	x							
1975–1981		x							
1982–2003	x	x							x
2004–	x	x							x

5.9.2 Development and use of knowledge

5.9.2.1 Fuzzy front end

The idea of the LVL product was brought from the United States. The feasibility studies concerned wood treatment, manufacturing technology and product properties that would suit the local resources and markets.

5. Individual case descriptions

5.9.2.2 Invention phase

Several joint projects between the company and research organisations were conducted in order to develop manufacturing technology that would match with the properties of the local wood material in the first phase of knowledge interaction. The research projects aimed at optimization of wood processing, product manufacture and product properties. Manufacturing of the new product started in a pilot plant, and basic properties and quality were developed mostly by the manufacturer, but verified by a research organisation (PRO2).

Long-term properties and design basics were studied in joint efforts during the period of time when the variety of use applications and LVL-based system solutions were developed. The major building project Sibelius Hall boosted research in the acoustics and vibration of wooden structures.

5.9.2.3 Commercialization

The networks of researchers with national and foreign type approval bodies in export countries were of assistance in the market expansion. Research organisations provided with statements and certificates and reliable design values.

5.9.3 Diffusion and accumulation of knowledge

Research-based inputs have been used by the manufacturer from the first phase of the combined product and process development in order to ascertain reliable structural design including design values of the various cross-sections and quality control procedures. The knowledge assets have mainly been developed inside the company but also through joint standardisation efforts with PRO2.

5.9.4 Channels and context of knowledge interaction

The knowledge interaction in Case H was organised as contract work and joint projects in the feasibility studies and the phase of pilot manufacturing by Manufacturer J. The research organisations PRO1 and PRO2 were involved in joint projects also in the phase when new research areas of acoustics and vibrations were investigated.

The innovation system of LVL building products was a technology-specific system that was included in the subsectoral innovation system of wooden construction based on value chain from forest to building and crosses borders in particular in Europe. The Finnish forest-sector companies are among the largest in Europe, and the wood-working industry including building products has been a part of the lobbying organisation. The forest sector has been active in lobbying with governmental organisations.

5.10 Case K: Modular steel building

5.10.1 Vignette

Case K concerns an off-site building concept based on finished modules and turn-key service which was developed at the end of the 1980s by a company that delivers rooms for ships. A new company was established to elaborate a new building concept and diffuse it to the construction market.

The modules are spacy boxes which can be stacked up to eight floors without a separate framing structure. The main structural component of a module is a honeycomb panel that is a registered trademark and patented. The panel is made entirely of galvanized thin-gauge steel sheets that are rolled together (no welding). The core sheets are cold-formed to u-shapes.

The company was top-ranked among the innovative companies in Finland, but the business was troublesome. It went bankrupt in 2013.

The research organisations with which Manufacturer K had joint activities are summarized in Table 39.

Table 39. Joint activities of Manufacturer K with research organisations.

PRO \ Period	1	2	3	4	5	6	7	8	9
2007–	x	x	x						

5.10.2 Development and use of knowledge

The modular building concept was developed for the construction sector based on ship building technology. The new company established for the customized building solutions developed both off-site manufacturing and on-site building technologies together with a networked service model. Each building was customized, and new solutions could be developed and verified for each building. The R&D tasks were identified, and performed before the building permission phase. The building design and the R&D were thus intertwined. The financing of R&D tasks was partly done during a pilot project. Gradually, the building surveyors have also learned to understand and accept the new building system. R&D activities are partly carried out and financed in individual building projects.

5.10.3 Diffusion and accumulation of knowledge

The diffusion of knowledge took place in pilot building projects. The knowledge assets of Manufacturer K were in its patent portfolio.

5.10.4 Channels and context of knowledge interaction

The company utilized different national funding sources for R&D projects and cooperated in particular with one technical university (PRO3). It was also involved in a European R&D project that was about to begin at the time of the bankruptcy.

The implementation of the idea to buildings and the development of related services and technologies were conducted in the context of the national construction innovation system.

5.11 Case L: Energy-efficient multi-storey building

5.11.1 Vignette

Case L concerns an energy-efficient building concept that was developed by a contractor for a multi-storey residential building in 2001. The original aim was to radically reduce energy consumption, but the aims nowadays are developing towards a nearly zero-energy building.

The concept is realised through several solutions starting from improved energy-efficiency of the envelope. A building does not usually have a separate heating system and the small demand is taken care of by ventilation. The framing structures were made of concrete in the first applications, and wooden buildings have been promoted recently. LED lighting is pre-installed in some spaces such as kitchens and bathrooms.

The contractor has co-ordinated the activities of a team of product suppliers and research organisations. Logistics has also been advanced together with a retailer so that storing on site is short-term. The concept has received several national awards, for example from the Finnish Association of Civil Engineers RIL ry.

The relationships of Company L with research organisations as observed in research data are summarized in Table 40.

Table 40. Joint activities of Company L with research organisations.

<i>PRO</i>	1	2	3	4	5	6	7	8	9
<i>Period</i>		x					x		

5.11.2 Development and use of knowledge

The fundamentals of the energy-efficient building concept were established through modelling and simulation of entire buildings at PRO2 using dynamic software that was not available as commonly as today. The calculations were used to identify the potential of savings and the need to improve solutions. The pilot flat and pilot

buildings were used to verify the results and further study the phenomena influencing the energy consumption.

Company L has used the new knowledge in its process of setting requirements for the energy performance of a multi-storey residential building and communicating them with its suppliers. The R&D activities have been carried out in networks and through teamwork.

5.11.3 Diffusion and accumulation of knowledge

The outcomes of the R&D activities are widely disseminated in professional journals and domestic events. Company L evaluates each building project and organises internal training courses.

5.11.4 Channels and context of knowledge interaction

Company L and research organisations were co-operating in company-led R&D projects that were funded by technology programmes of Tekes. For a research organisation, this meant a contract work.

The knowledge interaction has taken place in the national context but it is strongly influenced by the European strategies and regulation.

6. Cross-case synthesis

6.1 Introduction

The analysis technique applied in the thesis was a cross-case synthesis that was based on individual case study descriptions.

The descriptions of individual cases were based on chronologies that were divided into 1–4 main phases. The first phase was usually dedicated to the period of time from first ideas to the launch of a novel product to the Finnish market. The following phases dealt with knowledge development needed to expand the market and application areas of a product or product portfolio.

6.2 Enabling conditions for knowledge interaction

6.2.1 R&D capabilities of manufacturers

The manufacturers in the case study are known in the Finnish construction market for their innovations. The research data showed that they have also been continuously involved in knowledge interaction with research organisations.

In the first decades of the long period of time considered in the case study, the large companies were innovation champions bringing such novel building products to the Finnish markets that it was necessary to simultaneously develop research-based knowledge. They also had a leading role in developing knowledge and know-how in other companies through joint efforts often organised by industrial and professional associations. In the growth of a new building technology, wide and fast dissemination of research outcomes was regarded as a marketing support. These companies were present in cement and concrete related manufacturing (cases A and B), steel related manufacturing (Case D) and in the forest sector (Cases H and J).

The supply networks of large companies benefited also from their open communication and joint activities: Case C was weakly connected to large building product manufacturers as it started as a supplier of reinforcement ties to concrete sandwich panels. On the other hand, it was also essential for the product innovation that the owner family was able to invest its own funding in the product

invention. Another example of funding opportunities coming from a field other than the construction sector is Case K.

Different ways existed, however, of how R&D and interaction with research organisations were organised in the large companies: The companies related to cement and concrete used to have their own personnel and facilities for R&D and they actively hired graduates and researchers. The rise of steel-based construction was strongly connected to one company that also had its own R&D personnel and recruits from research organisations. The forest sector instead oriented itself more towards smaller R&D units, industrial brokerage centres and active networking with research organisations.

The concrete construction sector was especially affected by the industrial restructuring in the beginning of the 1990s but parts of the former large companies (Cases A and B) continue as domestic manufacturers. In the steel construction sector, Company D has been reorganised several times, and it has reduced the range of its product portfolio. Company G separated from Company A at the beginning of the 1990s, and its growth was fast during the first decades, when it was practically the only manufacturer of its kind of product also in international markets. Companies A, B and G are nowadays owned by foreign companies or investors. The joint activities with domestic research organisations have become less frequent, and the number of R&D employees has also been reduced.

Companies D and J have innovation strategies that are led at the group level. They also have R&D managers and personnel for the construction sector.

Company C has grown steadily and operates internationally today. Its R&D unit is also international but directed from Finland.

Domestic funding opportunities have been important for all of the cases. They are summarized in the Chapter dealing with the channels and context of interaction.

Many changes have taken place in industrial R&D since the first product innovation launches. The Finnish R&D has gradually decreased in concrete related companies that have been reorganised and internationalized since 1992. In Case A, reliance on the company's own core competences became more important leading to a reduced willingness to engage in joint activities. In Case B, the Finnish R&D relies on a small number of experts today. In Company D, R&D on building products has a unit and strategic planning as a part of an innovation strategy of the concern. The role of large companies as innovation champions and as leaders of joint innovation pursuits of industrial associations has also become smaller.

The four succeeding companies are among the shareholders of RYM Ltd today (A, B, D, G); among 53 shareholders the number of product manufacturers is nine.

In the wood construction sector, the case company belongs to the three largest companies in the forest sector in Finland; Cases H and J were connected to two of them. In addition to their own innovation activities, these companies used to have a leading role in innovation activities through their own action but also through activities of industrial associations and brokering centres. Company J is a shareholder in the centre FIBIC, which is RYM's equivalent in the forest sector.

As a summary on the capabilities of the companies, it can be concluded that the large companies used to have R&D units in the early phases of product

innovation processes when physical product innovations were made and the national building codes or codes of an association were also under development. Today, the companies owned by global manufacturers have small domestic investments in joint activities. Finnish Manufacturer A does have a small number of employees involved in R&D but the group closed its central Finnish technology development unit in 2012. Company B does not have full-time R&D employees any more. The two other large Finnish companies owned mostly by Finns (D and J) have R&D units, whose internal co-operation with business operations is closer today than in the earlier phases of the longitudinal cases.

6.2.2 Capabilities of research organisations

Research in the field of building engineering science started in the 1940s at the first technical university (a professorship in 1944) and the national research centre (1942). The educational and research needs were at first related to the increased use of concrete in construction and the exceptional period of war time. The university network was expanded in 1959 and 1972 (starting as a filial in 1965). Facilities for experimental research on building materials and structures were established in all of these organisations. The fire laboratory has served building product manufacturers since 1942. In particular, the structures research laboratory of PRO2 acquired in 1987 used to be among the most advanced and versatile in Europe. The experimental research methods were developed in parallel with the research needs through trials and transfer of foreign know-how.

Digitalisation of the research started in the 1970s when the first structural analysis programmes were developed at the research centre. Since then, the modelling techniques and software tools have become more comprehensive, dealing with all areas of building engineering science.

In 2001, the law on universities of applied sciences was changed so that they are entitled to organise research activities in particular to support regional development. The number of employees has also grown in governmental (so called 'sectoral') research organizations, and especially in the area of environmental impacts of products and buildings, there is overlapping expertise with other research organisations.

Most Finnish research organisations are governed by the Ministry of Education, which is in charge of higher education. The funding of universities and universities of applied sciences comes mainly from the state budget. However, manufacturers have influenced the structure of higher education through donations of temporary professorships, which usually were changed into permanent office posts. In connection to the case study, the Finnish Constructional Steelwork Association donated funding for a professorship in steel construction at PRO1 in 1981, but the process was concluded only in 1989. In 1983, the professorship for concrete technology was donated to PRO1 by the two large companies for cement and concrete products and by one for reinforcement. In 1995, PRO1 received a donation from Puuinfo to establish a professorship in wood construction, and it

was established in the architectural department. PRO3 received a donation from companies and municipalities to establish a professorship in metal structures in 2003, and funding for the second term from 2010 has received additional support from another municipality than originally. PRO1 and PRO3 are owned by foundations nowadays but the state is the main shareholder.

The research organisations underwent changes during the decades that are covered by the longitudinal cases. PRO2 used to have a dominant position in research until around the year 2000 thanks to its excellent laboratories and permanent staff (Cases A, B, C, D, G, H and J). Its position was also strengthened by the product approval procedures and quality control assignments stated in the National Building Code. Technical universities PRO1 and PRO3 and the faculty of technical sciences of PRO4 acquired several Master's thesis projects directly from companies or from associations that were connected to product innovations. PRO2 also had R&D projects in which Master's theses were prepared. Higher education in building technology was discontinued at PRO4 in 2001 but Manufacturer C could continue its co-operation through a new contract with another department.

PRO3 especially has strengthened its co-operation with building product manufacturers during the last two decades. The opposite development concerns PRO2 in which the number of researchers specialized in the construction and real estate sector has decreased.

The companies were used to co-operate with foreign research organisations each time the authorities of a new export country required local test results according to local standards. However, internationalisation of large concrete and cement companies started a new era of international competition between research organisations in the 1980s. The co-operation with foreign research organisations has become more frequent as Finnish companies have grown more international and on the other hand, the harmonisation of European standards and CE marking have formally equalised European research organisations.

6.2.3 Initiation of knowledge interaction

The case study covered a long history: Technical inventions in Cases A and J were mostly developed in the 1970s and Cases B, C, D, G and H in the 1980s.

Knowledge interaction between manufacturing companies and research organisations started in the early stages of product-related innovation processes (Cases A, B, C, D, G, H, J and L) or there had been preceding joint activities (F, K). Before activities that were connected to the specific innovation case of the thesis research, the knowledge interaction took place in the forms of Master's theses (diploma theses), contract work (PRO2) and common activities of associations. Text books, guidelines, recommendations and Parts of the national Building Code were joint efforts that engaged representatives of various organisations.

The knowledge interaction was initiated by manufacturers in all those cases in which a novel type of product was set as a target by a manufacturer because there was a need to ascertain a reliable basis for design of products in buildings.

Data on innovation cases A, B, C, D, G, H and J indicate that manufacturing companies were enthusiastic to start developing novel types of solutions for the markets soon after they discovered new opportunities or needs although they did not have their own capabilities in the relevant R&D field such as experimental facilities and state of the art knowledge in the type of a product or solution.

In one case, the very first initiator was a ministry in the fuzzy-front end phase, in two cases the initiator was a research organisation and in other cases companies were the most active actors as shown in the following:

- In Case A, the joint effort of studying various foreign off-site solutions was initiated and partly funded by the Ministry of Internal Affairs; the leading product manufacturers, leading construction companies and lobbying organisations made later bi-lateral and multi-lateral contracts with research organisations for technical inventions because the types of components and building systems were new to manufacturers and new to the market;
- In Case B, the cement and concrete industries and a producer of reinforcement established an R&D team and organised co-operation with research organisations because the solutions were new to the domestic market and required changes to design and construction methods ;
- In Case C, the company invited and funded the participation of research organisations in the ideation and invention phase to select and develop a technically feasible solution with a competitive edge in slim floor structures;
- In Case D, the companies and the lobbying association were active in initiating the co-operation with research organisations in order to ensure and promote emergence of new types of steel-based components and prepare new design and verification methods and Parts to the national Building Code based partly onto Swedish models;
- In Case F, the company joined a project that was under preparation by a research organisation in order to identify potential pathways to develop a new building concept based on the existing product portfolio of the company;
- In Case G, the company invited and funded the participation of research organisations in the ideation and invention phases in order to develop a technically and commercially feasible product for light-weight construction because the product type was new to the company;
- In Case H, the research organisations and companies were continuously co-operating, and a science-based invention in an in-house project was openly communicated and transferred to the up-scaling processes of the companies;
- In Case J, the company initiated co-operation with research organisations in order to adjust an American invention to the local wood species and technology;
- In Case K, the company initiated co-operation with research organisations in order to adapt a technique of ship's cabins to multi-storey buildings but there had been previous joint activities in development of cabin structures;

- In Case L, the company initiated co-operation with research organisations in order to identify all the potential factors influencing the energy consumption of a building through advanced simulation and monitoring.

The invention phase from the first practice-oriented ideas to implementation in the building market in Finland lasted from two to three years as, for example, in Cases C, G, H, J, K and L. On the other hand, the true market penetration of industrialised reinforcement in Case B took more than a decade.

6.2.4 Phases of knowledge interaction

The knowledge interaction between manufacturers and research organisations has commonly taken place until today. The relationships between building product manufacturers and technical research organisations is summarised in Table 41.

Table 41. Relationships of building product manufacturers and research organisations observed in Cases A–L.

Case	PRO	1	2	3	4	5	6	7	8	9
	Period									
A	1968–1978	x	x							
	1979–1990	x	x	x						
	1991–2001	x	x	x						x
	2002–	x	x	x		x				x
B	1980–1995	x	x		x					
	1995–2003	x	x	x						
	2003–	x	x	x	x	x			x	
C	1988–1990		x		x					
	1990–2005	x	x		x					x
	2005–	x	x	x	x		x	x		x
D	1975–1989	x	x	x	x					x
	1990–2000	x	x	x	x					x
	2001–	x	x	x	x		x			x
F	2007–	x	(x)							
G	1985–1990		x	x						
	1990–2000	x	x	x						x
	2001–		(x)							x
H	1988–1994		x							
	1995–2000		x							
	2001–	x	x							x
J	1970–1974	x	x			x				
	1975–1981		x							
	1982–2003	x	x							
	2004–	x	x							x
K	2007–	x	x	x						
L	2001–		x					x		

(x) refers to a company inside PRO2.

Three types of reason were identified for the long duration of the joint innovation activities. At first, each new export country used to demand new results and statements. Secondly, the application area of the novel product was extended which produced the need for true research-based inputs as for example in Cases A, C, D and G. The development of product-related services including design recommendation and software has however been the most visible reason for long-lasting co-operation which has influenced European standardization, too. In Cases C, D and G, international relationships also became a close personal network.

In Cases C and G, the product became successful in Nordic and other foreign markets, too. Hollow-core slab technology in Case A became internationally successful in ten years. The domestic research organisations had played a supportive role and provided research reports, statements, certificates, guidelines and training courses. Companies were also obliged to acquire verification tests and research reports from foreign research organisations.

The domestic knowledge interaction has become smaller or has ceased in some cases: Companies A and B have received only a small support from Tekes in recent years, and the number of R&D employees is very small. The change is dramatic although not sudden because their preceding companies used to be the leading innovators in the concrete industry. In these cases, the Finnish company is a part of a large international group. Company K, which had launched and implemented a new modular construction technology ceased operations in the summer of 2013.

6.3 Knowledge development and use

The theme of development and use of knowledge had two facets but due to the concurrence of various activities particularly in an invention phase (or product development), they are dealt with under one heading.

6.3.1 Knowledge development in the invention phase

The process of developing and using research-based knowledge for building product innovations started in the majority of cases from foreign ideas imported through networks of manufacturers or researchers. The ideas could have had an explicit form written in guidelines, codes, papers or contributions to various working reports or they were shown in drawings and photos or the information was exchanged orally (Cases A, B, D, J). On the other hand, the ideas could have been rather fuzzy as in Cases C and G although they had visible links to existing but not fully implemented technologies.

The case descriptions do not clearly present whether the very first product idea was originally invented in research or in industry or through joint activities, partly because many ideas were exported. Case H was an example of a truly domestic science-based invention; it was however also connected to an international research field on thermal treatment of wood. Case J was picked from a research

organisation but similar products were already on the American market. In Case B and to some extent in Case A concerning material technology, the advancements were achieved through the uptake of new outcomes of industrial (mostly in the chemical sector) and science-based research (for example in Germany and Japan).

The domestic knowledge interaction concerned further elaboration and modification of an idea, application to local materials, design conditions and building technologies or inventing a new idea based on a combination of many opportunities. The common pattern in invention activities – from an idea towards a product - was that the research was planned together (A, B, C, D, G, H) but the product development was planned and managed by companies (A, C, D, G, H, J, K, L). The tacit knowledge developed in companies and research organisations was partly overlapping thanks to collaboration in conducting product-related activities and also in preparation of national and international documents. This was obvious particularly in the portfolio Cases A and D and novel types of products in Cases C and G in which contracts were made and co-operation included closer personal co-operation and exchange of employees.

The following common steps can be traced about knowledge processes in regards to a product innovation after the concept or idea has been expressed in sketches and words (based on Cases A, C, D, G, J and K):

- Analysis of the product requirements in respect of known regulations and commonly accepted methods (e.g. recommendations of associations);
- Recognition of the need for product-specific knowledge;
- Creation of first pieces of knowledge through literature surveys, mathematical analysis, expert assessment and material and small-scale tests and in order to ascertain basics of a new solution;
- Knowledge inputs for the technical invention through experimental and analytical methods and modelling and its validation (e.g. structural safety, fire safety, health issues);
- Proposals for design methods and their verification;
- Preparation of design guidelines and software;
- Quality assurance procedures connected to design methods and values;
- Product-specific approval procedures, national or European;

The safety of a product or component under various loading situations and fire was a fundamental area of research. Thermal and moisture behaviour were the typically the next area of interest. Acoustic performance followed. These areas were obvious also because manufacturers of novel types of products needed product-specific knowledge for the design basics. The building level concepts in Cases F, K and L dealt not only with energy consumption of a building but other performance issues were studied as well. The new buildings were also pilots that were monitored.

6.3.2 Long-term knowledge development

The knowledge development took place in research, manufacturing, governmental, lobbying and professional organisations as follows:

- Research organisations concentrated on methods to investigate, analyse, model, design and verify the properties of products;
- Manufacturing companies concentrated onto production, marketing and technical services;
- Associations were often in charge of the preparation of design guidelines and codes and they lobbied and co-ordinated public research programmes and project;
- The authorities prepared regulations and procedures of product and building approvals.

Research-based knowledge was developed in various disciplines summarized as follows:

- Basic material properties and their control in manufacture and impacts on structural performance (Cases A, B, G, H, J);
- The safety of products in different loading situations and fire were the first research issues (e.g. in Cases A, B, C, D, G and J); these fields involved on the other hand the development of experimental and theoretical research methods and on the other hand, the development of generally approved design methods;
- Product approval and quality assurance procedures based on statistical assessments (Cases A, B, C, D, G, J);
- Approaches to complex building systems and their application to product development (e.g. in Cases A, C, D, J, K and L);
- Application of information and communication technology to the design of products and buildings including developments from simple calculation tools to dynamic simulation software and from CAD-CAM to BIM (Cases A, B, C, D, F, G, J, K, L);
- Theories and research methods on multi-material products related to internationally prioritized and popular fields (Cases C and G);
- Glueing technology (Cases G and J);
- The impacts of building products on construction processes (Cases A, B, D, K, L);
- The impacts of building products on energy consumption (Cases A, D, F, G, K, L);
- The impacts of building products on indoor air (Cases A, B, D, K, L);
- The environmental impacts of building products (Cases A, B, D, F, G, K);

- A holistic approach to overall performance of a building during its life cycle incl. acoustics, vibrations and indoor air quality (Cases A, B, D, J, K, L).

The cases show that the definition of 'building engineering' based on the traditional building-related knowledge areas such basic material properties, structural and fire safety, acoustics and indoor air has become broader. Product development has involved the development of applications of information and communication technologies for design and manufacturing since the mid of the 1980s and manufacturers are involved in development of Building Information Modelling together with designers and contractors. Product innovations also incorporate knowledge about energy technologies and require building level modelling and simulation tools (Cases F and L).

6.3.3 Use of research-based knowledge

The overarching cause of the knowledge interaction was a reliable design approach in all the cases, to some extent also in Case H that had a science-based source. Use of research-based knowledge was, thus, as a matter of course connected to the technical properties of an invention. First they were studied, then verified for design and controlled in manufacturing.

The two fundamental safety aspects – structural safety and safety in fire - were the key to the construction market and the national product approvals were limited to these at first. In the cases of a novel product new to the markets, usable universal methodology was not available although the similar technologies were under development in other countries. The other cases either benefited from the work carried out in the preceding cases or they represented building level concepts. The regulated characteristics of building products are broader nowadays, but structural and fire safety are the first two characteristics also in the European Construction Product regulation. Environmental properties have gradually become more important, and in particular the energy-efficiency objectives started to influence the order of importance of objectives in the 2000s.

Use of knowledge also depended on the actor initiating the interaction as summarized in the following:

- A ministry as an initiator aimed at outcomes with sector-wide impacts in the forms of common strategies and principal agreements; this was shown in Case A in which the role of the Ministry for Internal Affairs was vital for establishing the national building system and later establishing of the national product approval procedures;
- An association as an initiator aimed at outcomes with benefits to the entire cluster/real estate and construction sector or a sub-sector in the forms of design guidelines, standards, codes and product approval procedures; this was seen for example in the preparation and modification of Parts of the national Building Code and guidelines of best practices;

- A group of companies as an initiator aimed at outcomes with similar benefits as in the case of an association but also including aspects of problem solving in the interest of initiators themselves; this was a case for example in the development of design principles for slim floors with hollow-core slabs;
- A company as an initiator aimed at outcomes that would be usable in particular in its own innovation activities but could also be beneficial to the competitors to some extent.

At the same time when the performance of the novel solution was under investigations, technical services were developed in order to support marketing and selling and assure the credibility of design methods.

During the first product invention phase when a novel type of product or solution was under development, experimental research methods were often developed in parallel. Small-scale experiments in search of structural solutions were carried out for example in Cases C (interaction between steel and concrete parts) and G (strength of glued joint between stone wool fibres and steel).

In cases in which the launch onto the markets depended on a product-specific approval, research reports and statements were used for approvals at first in Finland but also in Nordic and international markets. The Nordic markets were mostly open solely based on the Finnish type approval and the domestic co-operation in quality assurance procedures (for example Cases C, G and J). Researcher's networks were helpful in export also to some other countries like for example in Germany (Cases G and J) but sometimes the approvals were only partial.

It was common that design and good practice guidelines were prepared in co-operation between researchers and industrial experts like in Cases A, C, D and G. In Cases A, D and G, the guidelines were regarded as a gateway to foreign markets, too.

Research inputs were used for the development of design software already in the mid of the 1980s in Case A. In Case C, the software was an integral part of the technical supporting service of the manufacturer that in turn was an essential part of the marketing that considered structural designers as to be an influential profession. In Case B, the software has also been developed to support a technical service that assisted in the planning of grading of concrete and sequence of works on sites.

For research organisations, sharing of research-based achievements in publications is an essential part of being a member in a research community. It was common that the joint projects that were established by associations or groups of companies facilitated the preparation of publications.

6.4 Diffusion and accumulation of knowledge

Diffusion and accumulation of research-based knowledge took place simultaneously with activities of development and the use of knowledge in particular in the invention phase of a novel product. However, a distinction can be made based on

the first launch onto the domestic market: during the growth of domestic and international markets, diffusion activities became more independent from the technical development.

6.4.1 Diffusion of research-based knowledge

Companies and research organisations were in charge of the diffusion of research-based knowledge in their own operational context mostly independently. At the same time, the activities of associations were often shared.

The association's role in diffusion was of great importance in Cases A, B, C, D and G. In particular, Concrete Association BY and Association of Constructional Steelwork TRY were active. Their professional journals introduced new research-based findings for decades. They were engines for domestic and Nordic symposiums and conferences involving companies and research organisations. Training courses were organised by associations and companies, and lecturers came from both sides. Both these associations used to be a part of national product approval procedures through the mechanism of product declarations that was mandated by the Ministry of Internal Affairs (later, the Ministry of Environment). In Case H, a new association was established in order to lobby for the new solution and its manufacturers and disseminate the research-based inputs and best practices.

Associations opened gates to contribute to the preparation of European and international guidelines to which representatives were nominated from companies and research organisations (Cases A, C, D and G in particular). The European harmonisation process engaged representatives from both sides and associations as well since 1995.

On the manufacturer's side, diffusion took place in connection with trade and the implementation of physical products in building projects. Manufacturer's product-related guidelines (like in Cases A, B, C, D, G, H and J) explained basic properties and features of performance as well as design formulae that were based on research outcomes. In Case A, PRO2 had an important supportive role in exporting the hollow-core slab technology through training courses and exchange of researchers.

Manufacturer's technical support service to designers and contractors was supported by product-specific software and given by trained personnel (as in Cases A, B, C, D, G and J). In Cases F, K and L, the technical service dealt with the performance of an entire building, in Cases F and L with an emphasis on energy consumption and in Case K on spaces and architecture. Training courses were also organised internally, and sometimes with representatives of research organisations. Research organisations were also involved in quality assurance activities and for this reason visited manufacturing sites on regular basis.

Diffusion of research-based knowledge took also place through joint scientific papers (for example in Case C).

6.4.2 Knowledge assets

Diffusion of research-based inputs facilitated the strengthening of existing knowledge bases and establishment of new ones. The creation of both a national knowledge base and of a domestic sub-sectoral knowledge base was of great importance for the growth of innovation activities in companies (in particular Cases A and D). These were connected on the one hand to the need to develop national design and verification methods and on the other hand to practical needs of manufacturers to understand and explain the phenomena that influenced the technical performance of a new building product. Joint product development activities (invention, commercialisation, diffusion) helped to simultaneously establish the various knowledge bases.

The knowledge assets identified and categorised in the preliminary step of analysis (Chapter 5.1) could be divided to various knowledge assets as shown in Table 42.

Table 42. Research-based knowledge assets developed through knowledge interaction.

Type of knowledge asset	Sub-division of assets	Reasoning for the category
The industrial knowledge base	Sub-sectoral knowledge base	Several product innovations were born in the context that refers to a competition between basic building materials (Cases A, B, D, F, H, J); multimaterial product technology were promoted by the steel sector (C and G)
	Company's knowledge base	The product manufacturer's knowledge bases comprised knowledge on manufacturing technology, on design methods, building technology and product approvals in each case. Patents and trademarks (for example Cases A, C, G,H, J, K)
The national knowledge base	Governmental knowledge base	Governmental strategies and programmes National regulation Implementation of the European regulation Product approval procedures
	Research community	Knowledge and know-how about research methods (experimental, theoretical, simulation and modelling) were developed parallel with innovation activities of companies in Cases A, B, C, D, F, G, H Commercial services like certificates and third party quality assurance (Cases A, C, D, G) IP (patent) in Case H
The European knowledge base	European innovation system	Cases were influencing the European co-operation and European research programmes
	European research community	In Cases, several joint research projects were established involving research organizations from various countries

The national knowledge base concerning the safety, health, comfort, usability and energy-efficiency of buildings has been created in close collaboration between the Ministry of Environment (previously the Ministry of Internal Affairs), industrial associations, companies and public research organisations. The public need to ascertain the safety of structures was the primary driver of development of various parts of the National Building Code. The Ministry handed over the preparatory work on safety issues to associations as observable in Cases C and D. The national procedures of product approvals for such solutions that are outside the standardised or commonly approved design methods were also developed in co-operation between the Ministry, associations and PRO2.

6.5 Context of knowledge interaction

Context of knowledge interaction was studied through concepts of construction innovation system and channels of knowledge interaction. Channels were further analysed through the identification of various forms of interaction.

6.5.1 National construction innovation system

The context of knowledge interaction was considered as a national construction innovation system. The approach was used as a basis to identify the actors and institutions influencing the interaction. The cases showed similar patterns that were related to this system such as procedures to launch a novel product onto the markets, development of the National Building Code and influences of the governmental innovation system.

The governmental innovation system was observed as the facilitator of the knowledge interaction through the funding of research organisations. Professionals and researchers received a similar education at universities especially in the fields of building engineering. However, the higher education system seemed to react slowly to changes in product and building technologies, and the industrial associations and companies promoted the establishment of new professorships (Cases A, B, D and J).

The governmental innovation system has also influenced the knowledge interaction through the strategies and related funding opportunities for R&D projects. In all the cases, national funding opportunities were used. Their importance for the technical invention and new factories varied. The national R&D programmes of Tekes were particularly important for the portfolio cases A, B and D that incorporated development and implementation of emerging building technologies. The national funding was not so important for the first phase of Cases C, K and L although it was used. Case G was initiated by the company but later the support became vital. Case J used very much of its own resources in the R&D but the pilot plant and later activities were co-funded by governmental sources. In Case H, the in-house funding of the research organisation was vital.

The national construction innovation system has since 1995 been influenced by the directives and regulation of the European Union and also by the various funding opportunities. However, institutions are still developed on a national basis and through national knowledge interaction.

Although the construction innovation system was found to be a common context to describe the initiation and continuation of knowledge interaction between manufacturers and technical research organisations, the case study showed that it is not sufficient to describe innovation drivers or the overall context in which manufacturers operate.

6.5.1 Forms of knowledge interaction

Knowledge interaction between building product manufacturers and research organisations has taken place in different arrangements so that the number of organisations has varied as shown in Table 43.

Table 43. Basic types of arrangements in co-operation from viewpoints of one company. Broker means an association or the industrial research centre.

Case \ Arrangement	A	B	C	D	F	G	H	J	K	L
Bi-lateral product development, contracts Co-innovation	x		x	x		x		x		
Multi-lateral product development with a broker, PROs and other companies							x			
Applied research with 1–2 PRO and other companies	x	x	x	x	x	x	x	x	x	x
Applied research with a broker (association or a centre), PROs and other companies	x	x	x	x			x			

Different variations have taken place depending on companies' own objectives but also on the preconditions of funding organisations and the planned use of research inputs. In common, the early stages of an emerging technology field tend to favour a wider co-operation, especially in the cases where the new technology is growing within a sub-sectoral or sectoral innovation system. This was the situation in Case A and Case D. The sub-sector of wooden construction was not covered by similar cases but the interviews of representatives from the Finnish Confederation of Forest Industries and the industrial research centres indicate that the sub-sector exists in a similar way as in concrete and steel construction sub-sectors.

The forms of knowledge interaction were identified as being similar to the forms observed in the literature survey, although the number of actual forms was larger: The research data about the cases showed that in addition to bi-lateral forms, the multilateral forms were important. Furthermore, a part of multilateral forms were involving several companies and research organisations and aimed at joint strategies.

The following forms were observed (examples in parenthesis):

- Company – research centre (contracted test, quality assurance contract);
- Group of companies – research centre (contracted large-scale tests);
- Company – university (contracted test, paid diploma thesis, supervision);
- Company-university-research centre (equal partners in an R&D project);
- Association – research centre (contracted project, teaching);
- Association- university (diploma or doctoral thesis);
- Association- university – research centre (uptake of new technology);
- Broker centre – research organisation (companies involved through centre);
- Jointly funded R&D project co-ordinated by a research centre or a university; funding organisation mostly Tekes but ministries or other funding organisations may also be involved.
- Jointly funded R&D project co-ordinated by a company (RYM programmes)

Typically, companies and research organisations were engaged in various forms of knowledge interaction simultaneously.

Forms of knowledge interaction reflected the phase of an innovation process, too. The technical invention phase of an emerging technology was carried out through parallel activities for the common good such as design basics for codes and companies' own activities for own product innovations (Cases A and D in particular representing product portfolios, too).

Cases A, B and D were led by large companies and several small and medium-sized companies were involved in joint projects, often together with other kinds of stake-holders such as associations and design offices. The knowledge interaction was thus bi- and multilateral with co-operation agreements and joint research programmes. Case J was managed by one large company that acquired research-based inputs to directly fit with its own needs.

The small and medium-sized companies were involved in co-operation agreements and research programmes often organised by industrial associations and jointly funded by the governmental funding agency Tekes. This was in particular the situation in Cases A and B but also Cases D had phases that involved several companies and research organisations. Case H was industrialized in several companies of many different sizes.

A summary of channels and forms of knowledge interaction are shown in Table 44.

Table 44. Channels and forms of knowledge interaction observed in the case study.

Type of channel of knowledge interaction	Observed in the case study
The traditional channel: in-house work of a research organisations and public communication	Cases A, B, D, G, H
The services channel: free and voluntary services	Cases A, B, D, G
The commercial channel (PRO's services) IPR Contract work, sub-contracted work	Case H
	Cases A, B, C, D, G, H Contracted work received funding support from Tekes in most cases and it was connected to the establishment of a product-specific knowledge base of a company
The bi-directional PRO-I channel, including bilateral and multilateral co-operation and joint efforts as well as co-operation between associations and research organizations	In all the cases, two-directional research-industry-projects were conducted. Industrial associations or a broker centre could be the co-ordinator but companies were involved at least in Steering Groups This channel dominated the establishment and strengthening of sub-sectoral and national knowledge bases as well as the knowledge assets of research organisations
The multiple channel	Cases A, D, J The channel refers to multi-disciplinary and multi-technology cross-cutting co-operation and ppp-activities related to R&D like the European Construction Technology Platform

7. Discussion and conclusions

7.1 Introduction

This thesis aimed to explore knowledge interaction between building product manufacturers and technical research organisations. The concept of 'knowledge interaction' was used to reflect the various types of co-operation between organisations and their employees considering also the context of interaction.

The research framework was summarized, based on a literature survey on research areas that deal with innovation processes and systems (Chapter 2).

A multiple case study was chosen as the research approach for which qualitative data was gathered through interviews and background literature. Ten longitudinal cases were investigated, whose data was at first arranged in chronologies (Chapter 4) and then presented according to a uniform table of content (Chapter 5). This descriptive framework was developed based on the research framework as presented in Chapter 2 and iterative steps to categorize the data.

The synthesis of case descriptions was presented in Chapter 6. The knowledge interaction was described through three major themes which were the development and use of knowledge, diffusion and accumulation of knowledge and channels and context of knowledge interaction.

The purpose of this Chapter is to assess how the thesis responded to the research problem.

7.2 Research approaches of the thesis

7.2.1 Scope and research problem

The scope of the thesis focused on knowledge interaction between building product manufacturers and research organisations which could have been investigated from several perspectives and at many levels. The literature survey was conducted on many areas in order to identify potential approaches to explore essential phenomena that would uncover the interaction.

The thesis was focused preliminarily on such innovation cases in which product innovations were new to the market and new to the manufacturer. Furthermore, such innovations were defined radical. One criterion for a radical product innovation was that its entrance to the markets required product-specific procedures which used to be national in Finland until 1995 and a mixture of national and European procedures since then. The assumption was research inputs were needed for such innovations. The cases showed that this assumption was right. However, the thesis research uncovered the fact that research inputs are also needed for product innovation processes that are connected to the development of building concepts.

The primary empirical data gathered through interviews showed that the relationships between individuals, companies, research organisations, governmental organisations and associations are multitude, and many types of activity are running in parallel. Even the strictly bilateral product development projects were connected not only to the accumulated knowledge on both sides but also to accumulated commonly shared knowledge such as codes and standards. It was thus obvious that the context of interaction influences the types of co-operation and needs to be considered.

The innovation cases were historical (longitudinal), which was another reason to emphasise knowledge interaction at organisational level instead of studying working methods or enabling conditions in the sense that the research streams on co-innovation or co-creation focus on their subjects. The interviewees recalled steps of new knowledge and new product innovations, but daily working methods or frequency of meetings were only mentioned briefly if at all. There were indications, though, that in many cases personal relationships have been close over the years and not only during the hectic product development phase. This area could be revealed further based on confidential memos and sketches, but the risk is that they are not stored systematically.

The scope of the thesis was restricted to the field of building engineering. Thus, a large number of other fields of knowledge and know-how necessary in innovation processes were eliminated, such as innovation management or customer management. Two reasons were given. At first, the access of a novel type of building product on the construction market is not possible without a reliable basis in this field which emphasises the need for research-based knowledge. Secondly, the field is consistent and understood in similar ways on both the industrial and research sides, which reduces the risks of misinterpretation. These arguments stay valid also for eco- and resource-efficient materials and products, as all the standards and codes have a limited scope usually based on experimental validation, and novel types of solutions might not be within this scope. On the other hand, the novel concepts of energy-efficient buildings showed that the area of 'building engineering' might become broader, so that functioning of machines and technical networks needs to be included to the area.

The thesis did not investigate knowledge interaction as a success factor for innovation processes or products innovations on markets. On the contrary,

practical examples were given showing that unfinished research topics may cause serious delays for the entrance onto markets. There were also examples in the research data that manufacturers have ceased production of technically polished products due to limited success.

The limitations of the scope leave thus several research questions open for future research.

7.2.2 Research framework of the thesis

The theoretical research framework of the thesis resulted from a literature survey on various research streams of innovation science, which was produced in two phases. A preliminary survey was conducted in order to find publications related to the scope of the thesis. It was obvious that the innovation processes of building product manufacturers were seldom studied, and less was published about knowledge interaction with public research organisations. It was also obvious that there were different definitions for the building product manufacturers and the construction sector used in innovation research dealing with the construction, and related sectors. A background to the differences was found to be dependent on the economics-oriented start of the innovation research that identified industrial sectors in accord with the common trade classifications.

The new phase of the literature survey was carried out in three research fields of innovation science that were identified as opening promising perspectives on the research problem. They were approaches to systems of innovation, innovation as knowledge processes and interaction between industries and public research organisations (PRO-I). The outcome of the survey and conclusions for the integrated research framework of the thesis are presented in Chapter 2.

An innovation process defined as a process of knowledge creation and conversion was studied first. The related concepts were found also to be suitable for joint activities between various organisations. The theory was successfully applied to two cases including enabling conditions and steps, knowledge conversion and accumulation of knowledge assets, but the research data of the other cases were not comprehensive enough concerning, for example, the modes of knowledge transformation and enabling conditions for the knowledge creation. The knowledge theory was, however, not completely rejected because its core concept, 'knowledge creation', was the core of the thesis, too. The thesis replaced the concept with the concept of 'knowledge development' used in the approaches to technology innovation systems. The thesis presented empirical evidence of how the knowledge was developed through interaction between different actors.

The literature survey also consisted innovation management approaches, and several process models were compared. Based on these, the generic model of three different types of activities was adopted for organisation of the interview issues: technical intervention, commercialization and diffusion. They are called phases and are often presented with a linear model, but in practice they are partly or completely parallel. In addition, activities before a process with set objectives

were included in the case study, called fuzzy front end in the process models. The research data showed that knowledge interaction took place in various types of activities, but with a focus on technical performance of products or buildings. It was also observed that research-based knowledge and industrial processes fed each other, particularly in cases where a technology transition took place.

Innovation systems were studied in order to identify the concepts for exploring the context of knowledge interaction. The sectoral construction innovation systems have a structure that incorporates building product manufacturers, their clients (owners, contractors, developers) and the institutions and research infrastructure that is common to manufacturers and their clients. Thus, a national construction innovation system was adopted as the common context in which co-operation between building product manufacturers and technical research organisations takes place.

The approaches to construction innovation systems have also recognized differences in the innovation processes and operational models of manufacturers and the construction sector. It was obvious that manufacturers were also connected to basic manufacturing sectors such as the chemical, cement, steel and forest sectors. For this reason, other potential innovation system approaches were also reviewed.

Technology-specific systems are approaches that are used to analyse the growth and diffusion of product, technology and knowledge fields. They also present concepts and methods for this analysis. They reside within other innovation systems and may cross borders like sub-sectoral and sectoral systems. A potential technology innovation system is shown in Figure 26.

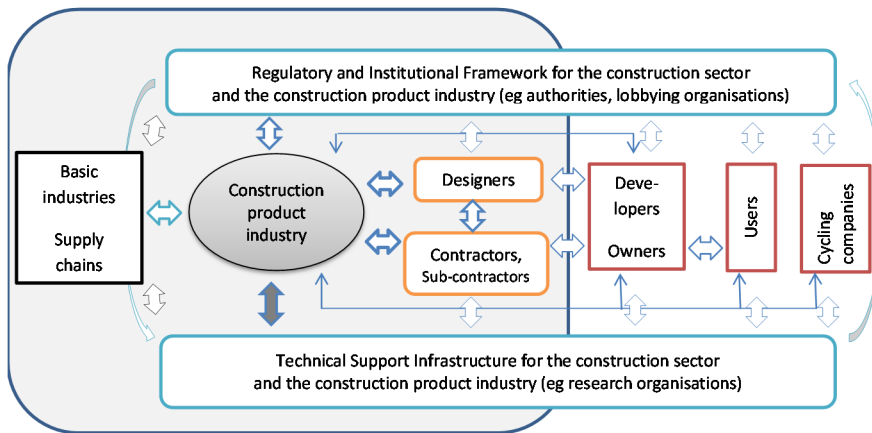

Figure 26. Framework of an extended innovation system of the construction sector to study the knowledge and information flows between various actors from the viewpoint of the construction product industry.

It is based on the notes of Gann and Salter (2000), Blayse and Manley (2004), Winch (1998) and Barrett (2005). The modifications were as follows:

- The construction product industry was located between basic industries and the construction sector;
- ‘Technical support infrastructure’ and ‘regulatory and institutional framework’ were defined as including the construction product industry because firstly, national building codes deal with both products and buildings, and secondly, the facilities of universities and research organisations are mostly built up to serve the product level R&D (e.g. experiments on materials, components, joints, frames, kits);
- The top box including regulation and bottom box including research organisations were also shown to have direct communication;
- Links between the construction product manufacturing and firms connected to the end of life of buildings.

The benefit of an extended construction innovation system is that it gives an overall picture of the complex relationships between actors. Its usefulness, may however, be limited to this point. The manufacturers’ relationships with their suppliers and basic industries are many and varied and in fact, competing value chains can be identified. The value chains span from basic manufacturing industries to suppliers of construction product manufacturers, and from product manufacturers to specialized contractors and designers. This situation has been underlined recently by the steel and forest industries in their respective European Research Agendas (ESTEP 2005, FTP 2006). It is also common to speak about the concrete, wood and steel construction sectors reflecting the value chains that are related to the basic framing materials of buildings.

The role of ‘construction sub-sectors’ in product innovations is a question to which the technology innovation systems approach may be applicable, because they may typically identify an ‘innovation value chain’ or rather innovation networks according to Hekkert et al. (2007). The method for mapping functions in a technology innovation system developed by Hekkert et al. (2007) and the scheme to analyse a system developed by Bergek et al. (2008) summarize a framework for analysing technology changes systematically. They also include proposals for relating the various functions that are usable to explain relationships between knowledge development and other functions. Functions incorporate concepts of niches and technology regimes that are used in approaches to evolutionary economics in order to analyse technology changes.

Approaches to the construction innovation system and technology innovation systems were regarded as complementary from the viewpoint of the thesis because the institutions and research infrastructure were observed to be the same. Thus, for the purpose of the thesis, the construction innovation system was justified. However, the case descriptions were prepared using concepts for technology innovation systems: Two functions (also called sub-functions) of

technology systems were found to have relevance for the scope of the thesis, namely knowledge development and knowledge diffusion. These functions were interpreted as links to micro-level theories on knowledge processes and innovation co-operation.

The PRO-I research field was also found to be a link between the organisational and system level because the forms and channels are connected to funding opportunities. The identification of this field as a perspective on the thesis research was successful because its concepts were usable for the data and findings brought added value to the state of the art.

7.2.3 Case study approach

The case study approach was chosen due to the limited number of publications on innovation processes of building product manufacturers on their own terms. Furthermore, no publication was found with the same objectives as the thesis.

Ten longitudinal cases were selected that were known to have research input during their history. The individual case descriptions were prepared based on qualitative data that was gathered in two sets of interim working documents of the thesis project: They were the original interview reports and so called Business Intelligent reports on companies. Supportive data was added from the background documents, especially in relation to the portfolio cases. The descriptions were presented in text and chronological tables. The years separating the phases were case-specific and chosen based on changes in the context, forms or areas of knowledge interaction including major changes in the ownership of companies.

The descriptive framework was complemented based on the first iterative steps of the analysis procedure. The amount of research data from interviews and related documents was so large that it was necessary to summarise it. The descriptions were focused on data that provided information about the creation and use of research-based inputs during innovation processes and forms of knowledge interaction.

The cases were historical (longitudinal) and their lessons for today can be questioned because of a number of changes in markets, companies, building technologies and institutions. The technology transition to prefabricated concrete construction took place in a major societal change in Finland, and so visible change has not happened later.

The cases concerned structural building products and components. This restriction was justified because of available data. Innovation processes of manufacturers of technical systems remain open for future studies. Such studies are of great importance because structural, space and technical systems together establish the indoor environment that should satisfy the user's needs and aspirations.

A qualitative case study approach that has interviews as a primary source of data may have its weaknesses. The memory of individual interviewees or the biased attitude of a group is a possible source of insufficient data. In order to

increase the reliability of the data, most cases were studied through two or more interviews, company reports and related background documents.

The selection of interview topics was another area where the research plan may have been misleading due to the researchers' own views. This risk was reduced through a collaborative plan of interview topics and procedure. The findings based on analysis show that the topics were successfully selected for the purpose of the thesis: they guided the interviewees to describe the knowledge interaction in a way that justified answers to the research problem. Colleagues were also available for the first discussions about approaches to categorising the data.

The origin of cases was in Finnish companies and they were first brought to the Finnish markets. The regional dimension was however a Nordic one in several cases practically at the same time as the product was launched on the domestic market, and export to other European countries followed soon. In the case of off-site concrete construction and composite slim floor beams, export reached the Asian countries as well. Nowadays the construction product market is European, and the national systems of innovation have less impact than before 1995 when Finland joined the European Union. The technical systems of buildings have developed during the period of time that was considered in the research. The data did not include any case in this field on its own terms, but some aspects were considered in relation to the building system and building level concepts for energy-efficient buildings.

7.2.4 Representativeness of cases

The cases represented an emergence of new building technologies in Finland but their range of implementation was different: Prefabricated concrete construction became a mainstream technology for which several manufacturers developed product portfolios in the 1970s and 1980s. The steel construction sector emerged in the 1980s and 1990s. Small-and medium-size companies joined the R&D projects that were initiated by large companies. The large product manufacturers involved in these cases were leading companies in the R&D activities, and they are shareholders of RYM LTd today.

Two cases represented multi-material products which were novel types of applications – and became internationally successful. The sandwich panel manufacturer is a shareholder in RYM Ltd. One case was born in a science-based material research that was up-scaled successfully in Finland.

The other cases represent a novel wood-based solution on the market and to the Finnish company although similar products were found in foreign countries or in a sector other than construction. The manufacturer is a large internationally operating company that is a shareholder in the Strategic Centre for Science, Technology and Innovation of the forest sector.

One case was connected to a manufacturer that developed a modular building concept and supporting holistic service concept. The parent company manufactures

cabins for ships. Two cases represented energy-efficient building concepts for which products and components were also modified to fit with the requirements. This area of innovation activities has been strongly supported at national and European level thanks to the tightening European law.

It can be concluded that the cases were truly representative of the innovative product manufacturers and particularly their joint efforts with research organisations in Finland. Consequently, they also were representative of the research problem as exploration of the knowledge interaction between manufacturers and research organisations.

The research organisations mostly involved in the cases were all three technical universities in Finland and the national technical research centre. These had the major experimental facilities, computational capacities and competences in different areas of building engineering needed for technical inventions of building products. The changed role of universities of applied sciences from purely educational to research organisations could also be observed.

7.2.5 Description framework

The outcome of the research depended on the description framework, which in turn was developed based on selected theoretical approaches. The description framework was further complemented based on the first iterative steps of data analysis. Each case description was then organised according to the framework. Cross-case synthesis was the method used to respond to the research questions and to explore and describe causes and implications of knowledge interaction between building product manufacturers and research organisations.

The description framework was developed in two stages: first based on the literature survey, and then complemented based on first stages of data analysis. Two of the themes concerned joint innovation processes and the third the context of knowledge interaction. Because the themes were selected based on the first iterative steps of data analysis, it was logical that the data of each case could be reorganised under the themes. The data concerning the creation of research-based knowledge and its implementation to the technical invention and related services were also detailed enough for a comprehensive description. The first phase of innovation activities in product or product portfolio cases could be distinguished from idea onto market as the basis on which the following phases were built on. The next phases were usually related to expansion of the markets or application areas or modifications of a product when the research needs concerned adaptation to foreign requirements or adding new disciplines to the research. Expansion of application areas of existing products could also result in a totally new research area, as in the case of slim floors.

The descriptive framework helped to reduce the influence of the different timeframes and show similarities of the research-based achievements. The cases also had interrelations that opened opportunities for knowledge sharing, technology transfer and organisational learning. The knowledge development in different

cases could also benefit from the accumulated knowledge in previous phases of other cases which could be seen, for example, in the development of different sub-sectors (concrete, steel and wood). In Finland, thinking of a building as a modular and holistic system of sub-systems and components started in connection with concrete construction, and the approach has been a fruitful basis also for the development of other building systems (composite and wooden construction) and the Building Information Modelling BIM.

The theme of diffusion and accumulation of knowledge was merged with the creation and use of knowledge mainly due to concurrence of activities. The third theme concerning the channels and context of knowledge interaction was also merged with the two other themes as the actual co-operation was usually related to funding opportunities and overall industrial or governmental strategies.

7.2.6 Influence of geography

The building products are goods for export with some exceptions such as heavy concrete components, ready-mixed concrete or voluminous products like aggregates. The differences in building cultures between regions and countries are well known, but on the other hand, principles of building permits and surveillance and building codes are similar all over. Test and classification standards and product specifications have long been developed internationally, and national standards have often been applications with minor differences. As a consequence, export of building products has been common despite the apparent obstacles of free markets that used also to be the situation in Europe.

For the Finnish manufacturers, the Nordic market used to be almost the same as the domestic market. Several novel products were exported to Nordic and European countries as soon as local product approvals were received. In the Nordic countries, the national approvals were usually accepted without additional requirements.

All the cases were connected to research, technology or market developments in foreign countries. Several manufacturing companies operate internationally. Some of them are also owned by large international companies. The forms of knowledge interaction have evolved and incorporate working groups and committees, jointly funded projects and international contracts. Companies operating internationally acquire research-based services on the international market today.

However, the governmental innovation system was shown to be influential in the initiation and continuation of the knowledge interaction. In particular, the funding programmes of Tekes have been important for the development of physical products and related design services. For this reason, further research can uncover differences between countries and regions concerning the innovation activities of building product manufacturers and their interaction with research organisations.

7.3 Research findings of the thesis

7.3.1 Levels of knowledge interaction

The knowledge interaction between building product manufacturers and research organizations appeared to happen at individual, organizational, sub-sectoral, sectoral, national and international levels. The various levels were not isolated but many relationships crisscrossed them. For example, Chapters of the national Building Code were prepared by associations mandated by the Ministry of Environment (the Ministry of Internal Affairs) and the actual preparation was taken care of through joint efforts of representatives of manufacturers, research organizations and other stake-holders.

The multiple case study covered a period of time of about six decades. The first technical inventions were made in many cases at a time when related national institutions were under development. The domestic construction markets were rather closed. The number of players was big but the number of big players was small – all of them being owned by Finns. Today, the markets and manufacturers are international and European law is influencing the National Building Code, product approval procedures and standardization.

At the system level, historical cases showed that relationships between various components of an innovation system develop continuously and their changes take place concurrently. It was also obvious that the more radical a technology change was, the more stakeholders were needed for its realization. Comparing the growth of prefabricated concrete construction and steel-based construction which were both new on the domestic market and expanded through support of public funding, the essential difference was, however, that the markets were different.

The importance of the national context was uncovered as a cause of interaction but also as its facilitator. The role of the governmental innovation system was significant in all cases, in most cases, as the immediate and vital enabler of an actual invention and its industrialization. The main body of joint activities was organized in various types of collaborative projects receiving public funding. Tekes has been a major funding organization since 1973. Before that, funding was received from ministries or governmental programmes. The contract work to research organizations has often had the public support of a company.

The national context of knowledge interaction and the basic components of the national innovation system still exist. The Building Code and national strategies for the construction sector are developed in a similar domestic context, but it is apparent that subjects are often determined by European law. The product-approval procedures are still domestic although European CE marking became mandatory in 2010. RYM Ltd is operating for strategic R&D programmes which are co-funded by Tekes. What would be an interesting research topic is how the global and European impacts will influence the domestic construction innovation system in the future.

The case study showed that the innovation processes of building product manufacturers are similar to other industrial sectors of manufacturing. They consist of various activities as presented in a generic simplified process model divided into phases; typically, invention, commercialization and diffusion were distinguished. The activities were, however, mostly conducted concurrently.

In some cases, data was also available about joint activities at the fuzzy front end and enabling conditions of the interaction. More research would, however, be needed to explain the knowledge creation and conversion processes.

The national research centre and technical universities existed by the time when the major changes began in building technologies in the 1970s. Their role was decisive in providing research-based inputs to product innovations in particular in the transition from the traditional on-site building technologies to prefabricated concrete building technology and in establishing steel-based construction technology. Today, the number of research organizations is bigger thanks to the universities of applied sciences. Organizations are also increasingly involved in international research activities and alliances. The European research area is being developed in parallel with national innovation systems.

The case study showed the shift to a more competitive research market due to internationalisation of companies and an increase in the number of domestic research organisations when universities of applied sciences started to offer research services. Multidiscipline and integrated research projects involving new research organisations are also common nowadays.

7.3.2 Research-practice relationships

The research problem of the thesis was tackled through a division of the case descriptions into three themes that highlighted the development, use, accumulation and diffusion of knowledge from different perspectives. Two of the themes were focused on concepts of innovation processes and one theme was dedicated to the context of the interaction. The case study showed that the various phases of innovation processes were in fact concurrent activities, and that the research for technical invention was concurrent with activities inside a company or companies.

The research-based knowledge developed in waves related to types of product inventions and the capabilities of organizations. In cases concerning an entirely new product and building technology, a basis of national knowledge was established concurrently with the development of knowledge and know-how in companies and research organizations.

Research topics in the long history of the case study concerned phenomena and design basics related to the performance of products, product systems and entire buildings. The topics were identified from the international state of the art or standards but also from practical experience, particularly when the application area of an existing product was expanded.

The thesis showed that, in product innovations, product-specific methods and technical support services directed to design offices were essential and also that

the National Building Code was developed in co-operation within designers, manufacturers, researchers and associations. Gradually, the accumulated knowledge was used for commonly accepted methods and guidance and standards, also in international forums. Today, large international design offices are operating in Finland. The BIM technology is connecting various parts of the broad construction sector and life cycle of the buildings which started in stand-alone tools.

The case study did not uncover research needs of the same magnitude as in relation to the cases when an entirely new building technology was developed and implemented. The product inventions of several manufacturers involved in cases tend to be modifications in manufacturing processes, products, use of products and technical services. The observation can, however, be questionable. At first, recent novel inventions in physical products were not included in the study. The most radical invention was the modular technology based on modules, but the invention as such was made in shipbuilding. Secondly, new research needs related to technical inventions are expected to emerge due to the objectives to reduce environmental impacts of building products and use more recycled materials. In relation to the move toward zero energy buildings, completely new materials and products are also under development and they would most likely need product-specific methods and approvals before implementation in buildings.

7.3.3 Knowledge contribution of the thesis

The thesis contributed particularly to the research on construction innovation through empirical evidence about

- Building product innovations from viewpoints of manufacturers;
- Joint processes to create and use research-based knowledge;
- Development of knowledge assets in the field of building engineering science and technologies.

It also included theoretical studies on methodology to investigate knowledge interaction between product manufacturers and research organizations related to the construction sector.

The research showed that the construction sector as the clientele of manufacturers determines the objectives of actual product innovation activities and also objectives of the knowledge interaction between research organizations related to product innovations. Furthermore, the institutions of the construction sector are of great importance to the subject matter issues of the knowledge interaction between manufacturers and research organizations.

The needs of society and the governmental innovation strategies were of decisive importance for most innovation cases. The product manufacturers were in all the cases involved in the public R&D programmes and many had used public support for investments. This was not a surprise because the cases were selected to explore knowledge interaction involving public research organizations. Whether

the argument of the importance of public support is valid in all the product innovation cases cannot be assessed, but in the domestic market, the companies and cases are representative and in them.

Other theories dealing more with relationships between society, industry and research than innovation systems could have added perspectives to the research problem, but the scope of the thesis was limited to the level of organizations. It was, however, apparent that the context of knowledge interaction cannot be ignored because the research data showed relationships between the national governmental innovation system, national institutions, companies, research organisations and associations.

Considering the manufacturer's innovation processes, different directions were observed. In the internationally owned companies, domestic activities have been reduced. Reasons were not studied but, concerning knowledge interaction, the international research offerings and easy access to the state of the art were reported. On the other hand, in the large and medium-size companies operating internationally but owned by Finns, R&D operations were more systematically and strategically organised than in the first phase of technical invention. Indications were also observed that there has been a transition to greater secrecy related to core competences.

It is worth noting that patent statistics do not give a fair picture about achievements: technical services, European standards and Building Information Modelling BIM are a part of commercialization and diffusion activities. Development of basics of BIM started already in the mid-1980s but manufacturers are implementing the technology today. One of the important issues to be investigated in the future is how BIM, as an enormous asset of the accumulated knowledge of products and their design, will influence the innovation processes.

The thesis showed that competing value chains have grown based on basic framing materials (steel, wood and concrete) in the construction sector. Despite the fact that the share of framing in construction costs has fallen parallel with the increased complexity of technical systems, the value chain thinking is still strong involving technology-based innovation strategies. For this reason, further research on innovation activities of product manufactures is needed to explore all the relationships and their impacts. If the analysis were to follow the approaches of Hekkert et al. (2007) and Bergek et al. (2008) would be a potential approach. Thus, the research questions could be reformulated so as to fit with the approach as follows:

- I What innovation systems suit studies on building product innovations?
- II What system functions are related to knowledge interaction between manufacturers and research organisations?
- III What relationships do functions, including knowledge interaction between manufacturers and research organisations, have with other functions?

The thesis also adds empirical evidence to the research on knowledge interaction between industries and public research organisations. Summarizing the case study, the following observations can be made:

- Division to Channels of interaction based on the literature survey were applicable to cases when the bilateral channel is extended and a multiple channel is introduced;
- Channels give only an overview of knowledge interaction and show that it has happened in one form or another in all cases;
- Channels and forms do not explore the details of joint activities such as drivers, objectives, working methods or importance of knowledge inputs;
- Preliminary connections between Channels and funding allocations as well as Channels and closeness of co-operation can be made because the more a company is allocating funding and resources, the more interactive is a co-operation;

Further research would be needed in order to identify connections between different channels and outcomes of research. The thesis showed that there is a rationale for considering the forms involving several kinds of actors outside the traditional real estate and construction sector ('multiple channel').

7.4 Conclusions

7.4.1 Introduction

A multiple case study was performed including ten historical (longitudinal) building product innovations in order to explore knowledge interaction between building product manufacturers and technical research organisations.

A theoretical framework was developed and associated with the case study approach, so that the national construction innovation system was first regarded as the common context for the different cases. Each innovation case was a co-operative process in which new knowledge was developed and diffused.

From various models of innovation processes, a simplified division of activities was adopted as an approach in order to structure the topics for interviews: the technical intervention, commercialization and diffusion were preliminarily regarded as product-related activities in which research-based inputs were necessary. In addition, various common activities were expected to surface before product-related activities. The forms of knowledge interaction as developed in research on relationships between private companies and public research organisations were taken as a basis in order to describe the interaction in greater detail. The variety of forms observed was wider than presented in previous studies.

The cases were described under three main headings: Development and use of knowledge; Diffusion and accumulation of knowledge; and Channels and context

of knowledge interaction. The descriptions were based on research data that was organised in chronologies.

Various aspects of knowledge processes were intertwined. Firstly, forms of knowledge interaction had similarities with types of interaction and included governmental influence through funding opportunities. Secondly, knowledge assets were developed at various levels and used for various purposes such as commercializing and service development by a company, the development of national building code or the development of design recommendations by associations.

7.4.2 Knowledge interaction in innovation processes

7.4.2.1 Actors

Co-operation between building product manufacturers and technical research organisations has a history of several decades. It has been organised in a variety of bi-lateral and multi-lateral activities. Since 1983, the funding opportunities of the national funding agency have been essential to the innovation activities of companies and to long-term development of the knowledge field of building engineering. Before this, other public funding opportunities were available and used.

The industrial associations have been lobbyist and broker organisations in particular in the cases when a totally new building technology has been under development. They have initiated and co-ordinated joint programmes and projects, and have also sought funding for new professorships in the emerging technology area. Multi-lateral co-operation has been organised for R&D on topics which are common to all the companies, such as the development of design methods for national and European building codes. The Confederation of the Finnish Concrete Industries SBK played a central role when a technology transition from traditional on-site technologies to prefabricated concrete components was developed by several companies and research organisations. The activities of the Finnish Concrete Association BY have supported this transition through the preparation of relevant parts of the National Building Code and certifications for a number of novel products. The Finnish Constructional Steelwork Association TRY co-ordinated the national technology programme that aimed at improving the international competitiveness of the Finnish steel construction sector through new structural systems and components.

Since the 1990s, building product manufacturers in the concrete sector have been restructured, and the former large companies that were influential on the technology transition toward industrial concrete construction do not exist anymore. Product innovations in the sector concentrate nowadays on modifications of existing portfolios and development of services that utilise information and communication technology. The steel construction sector was also restructured in the 1990s, and several small companies were acquired by the large company in the sector. The variety of thin-gauge steel products that were developed before 2000

has been limited, and the focus is on the successful products and service concepts that utilise advanced software. In the companies that have an R&D function, the processes are structured and the employees also have post-graduate degrees.

The Ministry of Environment (and its predecessor the Ministry of Internal Affairs) was responsible for the development of an institutional framework for the construction sector. However, its approach was based on tripartite co-operation involving industrial associations and research organisations. It also communicates with other stake-holders in the sector. It used to deal with building product approvals but gave up this activity in 2006. The European Union's influence on the activities of the Ministry has increased since 1995, and its directives and action plans are implemented in the national regulations. A new structure of notified bodies for testing, certificates and quality assurance and assessment operates for implementation of the Building Product Regulation. The Eurocodes were taken into use in 2010.

The research organisations have undergone several changes during the long period of time of consideration. The number of research organisations multiplied in 2001 when the universities of applied sciences started to offer R&D services. The national research organisation moved the major part of its experimental facilities and expert services to a company that does not receive governmental funding. For the companies, one of the technical universities has developed a closer co-operation organisation while the other focuses on science-based advancements.

The Ministry of Employment and the Economy established a programme of Strategic Centres for Science, Technology and Innovation in 2008 which is a new public-private partnership model for speeding up innovation processes. RYM Ltd operates in the field of the built environment. The principle of parallel R&D activities with a great number of different participants and focused innovation activities of companies was adopted from the experiences in shifting the building technologies to prefabricated concrete construction.

To summarize, in forty years the number of research organisations and brokers in the field of building engineering has increased at the same time as the number of companies searching for radical product innovations has become smaller. The resources of companies have declined, and often they have to be used for tasks that are regulated at the European level. Development of the applications of information and communication technology such as Building Information Modelling and simulation tools is connected to building products and is also prioritized as more topical than the development of physical products. This reflects a change in the order of importance of objectives in product development so that building processes and also environmental aspects have become more topical than physical products.

7.4.2.2 Knowledge development in joint activities

Several professional areas of building engineering were developed through knowledge interaction between manufacturers and research organisations. It can be concluded that the innovations were not possible without research-based inputs, which in turn were facilitated through long-term investments in research

facilities and competences. On the other hand, research organisations also learnt from the manufacturing and building technologies through interaction.

The research-based inputs were needed in the first place to explain the performance of novel types of solutions and then used for product development projects. Simultaneously, product-specific design methods were developed that were a prerequisite for product approvals and thus the commercialization of products. In the case of reliance on a building permit, a certificate or a statement from a research organisation was usually required.

Novel products also entailed a need to develop research methods. Concerning building products, they involve experimental methods where safety issues are concerned at least as verification methods (initial type testing). The experimental research has benefited from the development of analysis tools that could be used to model and simulate the performance of a product and to plan the research assembly. Sometimes devices were also developed.

The building concepts were investigated through different procedures than were physical components. They were at first modelled and simulated, then built, and measurements were conducted in completed buildings.

The cases with a long history were divided into 2–4 phases, and the first phase represented the innovation process from idea or concept generation to the launch onto the market. The national market is a part of a European and global market today, and CE marking has replaced national product approval procedures. The national building code implements more and more European regulations. The original drivers of knowledge interaction have, however, not changed: to know how a novel product performs and to ascertain beforehand in design that its performance in use conditions is safe and harmless. The causes of engaging in knowledge interaction at the level of organisations can be summarised as follows:

- State of the art in foreign countries;
- Market information especially in foreign countries;
- Knowledge on structural, physical or chemical phenomena;
- Research methods and equipment to study phenomena;
- Product-specific design methods;
- Research-based evidence for market entrance;
- Product-specific approval procedure;
- Quality assurance procedures and methods;
- Guidance on design and use;
- Methods of environmental/sustainability assessment;
- Contribution to standardisation;
- Development of R&D strategies;
- Implementation of research findings in buildings and practical know-how.

7.4.2.3 Knowledge diffusion and accumulation

Knowledge diffusion included information about the accumulation of knowledge assets and forms of knowledge interaction.

The fundamental aim of knowledge interaction is to develop knowledge assets on which competitiveness of a product, a company, a sub-sector or a nation is built. They were divided in the thesis according to assets that are product-specific (for invention, commercialization and service development of a novel product), company level, sub-sectoral or national.

Diffusion of new knowledge to product development started immediately when results were available from a research organisation. In some cases when a company's representatives were present in the experimental research, the research inputs were used before any formal report was made. Also in cases when a team was established, results were quickly adopted.

Parallel with product development, development of design methods and tools took place in cases which could not rely on codes or standards. Software developments started in research organisations as early as in the 1970s, and they were purchased by companies either as ready tools or as a development project. New companies started to offer software development for structural engineering.

In national projects that involved several companies directly or through associations, the co-operation facilitated the diffusion of knowledge to all participating organisations. The projects had Steering Groups and organised seminars and workshops. Associations also organised national or Nordic R&D Days which have representatives from companies and research organisations. In the era of European joint projects, the diffusion of research-based knowledge also takes place.

Preparation of parts of the National Building Code or international recommendations have been a regular joint activity between companies and research organisations through which most recent research-based knowledge has been diffused to a wider use.

Knowledge diffusion was described through development and accumulation of knowledge assets at different levels and for various purposes. This approach was regarded as sensible as it linked the causes and implications to companies' needs and to institutions.

7.4.3 Findings regarding the research problem

The following conclusions were made with respect to the research problem:

- Building product innovations take place in a context that has impacts on the basic manufacturing sectors but is closely connected to the construction innovation system; this conclusion facilitates the overall picture of actors and relationships influencing knowledge interaction;

- The sub-systems of the construction sector are influential for knowledge interaction, and they are based on value chains from the basic manufacturing sectors to specialised designers and contractors; this conclusion facilitates explanations of the sources and drivers of innovations;
- Joint innovation activities can be divided into various progressive phases which are run partly or totally simultaneously; this conclusion facilitates the identification of areas and forms of knowledge interaction and also research-based methods to create new knowledge;
- National and sub-system knowledge bases were developed through the export of knowledge and know-how and joint domestic efforts, which in the 1990s led to partly overlapping and partly separate engineering cultures for concrete, steel and wood construction;
- In a small country like Finland, knowledge assets are often developed jointly, as the resources are distributed and sometimes scarce. Nowadays the national knowledge base is to a great extent merging with European methods and procedures.
- Associations have been important innovation brokers in building up opportunities for knowledge interaction;
- A versatile selection of forms is in use, and especially larger companies are engaged in many forms simultaneously;
- The number of R&D service providers has increased, and the competition is international; domestic R&D services are however valued and needed;
- The national knowledge assets are well distributed nowadays. The network of science parks, university centres and universities of applied sciences is close-knit, and various stakeholders work together especially in regional contexts;
- The funding opportunities are distributed to regional, national and European sources;
- The 1980s and 1990s were very productive and innovative periods when several new types of products emerged onto the markets. Some of them became successful in international markets as well, like the sandwich panel with a mineral wool core and the composite slim floor beam.

7.4.4 Future research needs

The purpose of the thesis was to explore knowledge interaction between building product manufacturers and research organisations. The research method was a qualitative case study in which a primary source of information was interviews on both sides.

The cases were selected purposefully so that research inputs were known beforehand to have been developed and used in the innovation processes. Furthermore, the research inputs and knowledge accumulation focused on the field of building engineering. The delineation was for practical reasons because of the availability of various data sources but also for the importance of the field to the launch of products onto markets. Although the research did answer the specific research questions of the thesis, several issues remain open for future research especially concerning the innovation activities of building product manufacturers. Some dissertations, theses and conference papers are available on the subject, but the number of journal papers is small.

A more comprehensive picture of collaborative methods of knowledge development and diffusion is needed. The associated topics deal with innovation processes, working methods, organisational learning and innovation management. The various research streams applied to studying everyday processes inside companies and between companies and research organisations would give more causal explanations for a company's innovativeness, knowledge acquisition and the success of its products on markets.

The drivers of building product innovations should be studied further. The past examples indicate that the technology push has been of great importance especially in relation to steel-based and steel-concrete composite structures, but market needs have also influenced the search for new ideas. The importance of market needs was in particular visible in the case of the transition from traditional on-site technologies to the use of prefabricated concrete components. Recently, signs of more regulation-driven innovation activities were observed due to increasing efforts for energy-efficiency and resource-efficiency. How a change can be realised and how it influences the innovation activities of manufacturers is an interesting topic that also has social relevance.

The building product manufacturers are heterogeneous in size, in R&D, in products, in markets and in the manufacturing sectors to which they are connected in common trade classifications. The proportion of small and medium-sized companies is high. These differences alone call for more research on the innovativeness, innovation capabilities and innovation processes of manufacturers in order to acquire greater insights into how building product innovations are made.

The influence of governmental organisations and interplay between institutions and actors were explored as essential for initiating and maintaining innovation activities and particularly for initiating and maintaining innovation co-operation between various organisations. Regulated procedures concerning access to the markets were an important motivation in acquiring and using research-based knowledge in all the cases that dealt with building products. In cases that dealt with building concepts, the novel solutions can be approved as a part of a building permit. The cases showed that the context in which the innovation co-operation between building product manufacturers and technical research organisations takes place can be explained through concepts of the construction innovation system, because the institutions and the governmental innovation system are the same for manufacturers and contractors. However, more research is needed in

order to describe in greater depth the influence of value chains for which an extended construction innovation system was introduced. This kind of approach can be further developed through approaches to technology innovation systems. All in all, approaches to innovation systems are an interesting field of research that has a great deal of potential for explaining the success factors of building product innovations.

Differences between countries and regions are also a topic for further research which is essential in order to identify the potential barriers of changes that are regarded necessary in societal strategies such as the goal of sustainable construction.

8. Summary

The purpose of this thesis was to explore the knowledge interaction between manufacturers and technical research organisations pursuing product innovations, particularly in the fields of building engineering science and technology.

A theoretical framework was derived from the literature survey on innovation systems, knowledge processes and knowledge interaction between companies and public research organisations. Research on various potential research streams showed that the approaches to construction innovation systems were likely to be suitable to investigate the development and utilisation of new research-based knowledge. On the other hand, the research approaches to product innovations and knowledge processes in the manufacturing sectors were likely to be applicable to the study of knowledge interaction at organisational and individual level.

The case study of ten joint innovation processes was chosen as a research method. Interviews on both sides were the primary source of qualitative research data. Secondary sources comprised professional journals, published data on companies and the histories of organisations and persons.

The theoretical framework was further developed toward a descriptive framework that was applied to analysis of the research data. The common themes under which the chronological data was reorganised were the development and use of knowledge, diffusion and accumulation of knowledge and channels and context of knowledge interaction. The themes were further elaborated in the cross-case synthesis.

The following conclusions were made with respect to the research problem:

- The approaches to construction innovation systems are suitable in exploring the knowledge interaction between building product manufacturers and technical research organisations as both types of organisation are connected to the same institutions.
- The principal driver for the knowledge interaction between building product manufacturers and research organisations is the need to know how a novel product would perform in its intended use.

- The need to develop reliable design (prediction) methods may lead to long-lasting knowledge interaction taking different forms and aiming at the international acceptance of universal methods and standards.
- Generally perceived methods and standardization may also be a motive for knowledge interaction in innovation cases that do not require product approvals by authorities but are regarded as beneficial for marketing purposes.
- The research-based knowledge can be developed and used in parallel for the technical invention, development of product-specific design methods and software as well as for product-specific documentation and certification, which are the key to the construction markets. Furthermore, research methods can also be developed parallel with product-related activities.
- Building product innovations are driven by a combination of technology achievements in basic manufacturing industries, machinery and building technologies, information and communication technologies, the needs of society and users and owners of buildings, competition on markets and changes in regulation. The priority of drivers may change.
- Associations have been important innovation brokers in building up opportunities for knowledge interaction.
- Competition between basic manufacturing industries concerning the construction sector as a client sector has been a strong driver for product innovation activities particularly concerning basic framing materials but connected with them also multi-material components and related systems;
- Analysis of drivers and a broader innovation context from the viewpoint of product manufacturers would need approaches to technology innovation systems that may possibly benefit from the construction innovation systems as introduced in the thesis as an extended system or technology innovation systems.
- In a small country like Finland, various knowledge assets are developed jointly, as the resources are distributed and sometimes scarce. The national knowledge base is closely blended with European methods and procedures nowadays.
- The number of R&D service providers has increased, and the competition is international.

The thesis was planned so as to explore the various aspects of knowledge interaction between building product manufacturers and technical research organisations. Further research is needed in order to explore the collaborative processes in depth and to identify factors that support successful innovations. Impacts of globalisation and European Union to the national construction innovation system also need more research.

Acknowledgements

The research was partly performed in a project funded by the Finnish Funding Agency for Technology and Innovation Tekes (project no. 40479/20) and VTT (1.2.2010–31.6.2013).

For sharing her/his knowledge: Mr Tapio Aho, Mr Mika Airaksela, Mr Jukka Ala-Viikari, Dr Anna-Leena Asikainen, Dr. Wim Bakens, Professor Luis Braganca, Professor Joop Halman, Mr Paavo Hassinen, Professor Markku Heinisuo, Mr Antti Helenius, Dr Lars-Henrik Heselius, Ms Saira Jämsä, Dr Kimmo Järvinen, Professor Matti Kairi, Mr Dick Karlsson, Mr Olli Korander, Mr Jouko Kouhi, Mr Jorma Kyckling, Mr Petteri Lautso, Mr Raimo Lehtinen, Mr Markku Lehtonen, Ms Taru Leinonen, Dr Matti Leskelä, Mr Pentti Lumme, Dr Jussi Mattila, Mr Tarmo Mononen, Mr Pekka Nykyri, Dr Finn Orstavik, Professor Juha Paavola, Dr Matti Pajari, Professor Jukka Pekkanen, Mr Simo Peltonen, Dr Arto Ranta-Eskola, Mr Mikko Saari, Dr Bert Sadowski, Professor Asko Sarja, Professor Chris Snijders, Mr Juhani Syrjä, Mr Ari Tiukkanen, Mr Markku Vesa and Mr Petri Wegelius.

References

- Abbott, C., Ruddock, L. & Sexton, M. 2007. Hidden Innovation in the Construction & Property Sectors. RICS Research paper series. Vol. 7, No 20. ISBN 978-1-84219-359-4.
- Addis, B. 2007. Building: 3000 years of design engineering and construction. Phaidon Press Limited. New York. ISBN 978-0-714841465. 608 p. + app. 30 p.
- Aken, van J.E. 2004. Organising and managing the fuzzy front end of new product development. Eindhoven Centre for Innovation Studies, Working Paper 04.12. Eindhoven, The Netherlands. 13 p.
- Akintoya, A., McIntosh, G. & Fitzgerald, E. 2000. A survey of supply chain collaboration and management in the UK construction industry. *European Journal of Purchasing & Supply Management* 6, pp. 159–168.
- Aldridge, M.D. & Swamidass, P.M. 1996. Cross-functional management of technology. Cases and Readings. Irwin Book Team, Times Mirror Books. ISBN 0-256-19429-7.
- Anderson, F. & Schaan, S. 2001. Innovation, Advanced Technologies and Practices in the Construction and Related Industries. Working paper No. 88F0006XIB01004. Statistics Canada. 56 p.
- Aouad, G., Ozorhon, B. & Abbott, C. 2010. Facilitating innovation in construction, Directions and implications for research and policy. *Construction Innovation* 10, 4, pp. 374–394.
- Asikainen, A.-L. & Squicciarini, M. 2009. Innovation and the Construction Sector: A Value-Chain Based Definition of the Sector. Global Innovation in Construction Conference, 13–16 Sept 2009, Loughborough, UK.
- Barrett, P. 2005. Revaluing Construction – A Global CIB Agenda. International Council for Research and Innovation in Building and Construction.
- Barrett, P., Abbott, C., Ruddock, L. & Sexton, M. 2007. Hidden innovation in construction and property sectors, RICS Research Paper Series, Vol. 7 No. 20. RICS, London. pp. 1–21.

- Bayer, S. & Gann, D. 2006. Innovation and the Dynamics of Capability Accumulation in Project-based Organisations. Innovation Studies Centre, Tanaka Business School, Imperial College London. Manuscript 28.6.2006.
- Beckers, R. & Bodas Freitas, I.M. 2008. Analysing knowledge transfer channels between universities and industry: To what degree do sectors also matter? *Research Policy* 37, pp. 1837–1853.
- Berente, N., Baxter, R. & Lyytinen, K. 2010. Dynamics of inter-organizational knowledge creation and information technology use across object worlds: the case of an innovative construction project. *Construction Management and Economics* 28, pp. 569–588.
- Bergek, A., Jacobsson, S., Carlsson, B., Lindmark, S. & Rickne, A. 2008. Analyzing the functional dynamics of technological innovation systems: A scheme of analysis. *Research Policy* 37, pp. 407–429.
- Bergman, J.-P. 2005. Supporting knowledge creation and sharing in the early phases of the strategic innovation process. *Acta Universitatis Lappeenrantaensis* 212. Diss. Lappeenranta University of Technology. 180 p. ISBN 952-214-060-0.
- Betoni. 2012. Green concrete can reduce carbon dioxide emissions from concrete to half. *Betoni* 82, 4, pp. 54–55. (Editorial, in Finnish)
- Betonikeskus. 2007. Concrete façades. Forssan Kirjapaino. ISBN 978-052-5075-91-5. 95 p. (In Finnish)
- Bhatt, G.D. 2001. Knowledge management in organizations: examining the interaction between technologies, techniques, and people. *Journal of Knowledge Management* 5, 1, pp. 68–75.
- Björk, B.-C. 2009. RATAS, a longitudinal case study of an early construction IT roadmap project. *Journal of Information Technology in Construction (ITcon)*, Special Issue Next Generation Construction IT: Technology Foresight, Future Studies, Roadmapping, and Scenario Planning, 14, pp. 385–399.
- Blayse, A.M. & Manley, K. 2004. Key influences on construction innovation. *Construction Innovation*, 4, pp. 143–154.
- Bossink, B.A.G. 2002. The development of co-innovation strategies: stages and interaction patterns in interfirm innovation. *R&D Management* 32, 4, pp. 311–320.

- Bossink, B.A.G. 2007. The interorganizational innovation processes of sustainable building: A Dutch case of joint building innovation in sustainability. *Building and Environment* 42, pp. 4086–4092.
- Broström, A. & Löf, H. 2006. What do we know about Firms' Research Collaboration with Universities? New Quantitative and Qualitative Evidence. Working Paper 2006-08-28. The Royal Institute of Technology, Centre of Excellence for Science and Innovation Studies, Stockholm, Sweden. Available at www.infra.kth.se/cesis/research/publications/working_papers
- Brown, J.S. & Duguid, P. 2002. Creativity versus structure: a useful tension. In: *Innovation – Driving Product, Process, and Market Change*. Roberts, E.B. (ed). MIT Sloan Management Review. Massachusetts Institute of Technology. Pp. 41–45. ISBN 0-7879-6213-9.
- Bstieler, L. & Hemmert, M. 2010. Increasing Learning and Time Efficiency in Interorganizational New Product Development Teams *Journal of Product Innovation Management* 27, 4, pp. 485–499.
- Caloghirou, Y., Kastelli, I. & Tsakanikas, A. 2004. Internal capabilities and external knowledge sources: complements or substitutes for innovative performance. *Technovation* 24, pp. 29–39.
- Carassus, J. 2004. Construction Sector System, Innovation, Services. CIB – Conseil International du Batiment, Congress on Construction, innovation and services. 2.–7. May, 2004. Toronto, Canada.
- Carlsson, B., Jacobsson, S., Holmén, M., Rickne, A. 2002. Innovation systems: analytical and methodological issues. *Research Policy* 31, pp. 233–245.
- Cavusgil, S.G., Calantone, R.J. & Zhao, Y. 2003. Tacit knowledge transfer and firm innovation capability. *Journal of Business and Industrial Marketing* 18, 1, pp. 6–21.
- Chaminade, C. & Edquist, C. 2005. From theory to practice: the use of systems of innovation approach in innovation policy. CIRCLE Electronic Working Paper Series, Paper no. 2005/02. Center for Innovation, Research and Competence in the Learning Economy, Lund University. 43 p. Available at www.circle.lu.se/publications
- CIB. 1992. Preliminary European Recommendations for Sandwich Panels with additional Recommendations for Panels with Mineral Wool Core Material,

Part 1: Design. International Council for Research and Innovation in Building and Construction. CIB Publication No. 148.

CIB. 2000. The European Recommendations for Sandwich Panels, Part 1: Design. International Council for Research and Innovation in Building and Construction. CIB Publication No. 257.

CPR. 2011. Construction Product Regulation. Regulation (EU) No 305/2011 of the European Parliament and of the Council of 9 March 2011 laying down harmonised conditions for the marketing of construction products and repealing Council Directive 89/106/EEC. Official Journal of the European Union L88/5, 4.4.2011. Available at <http://eur-lex.europa.eu/LexUriServ/LexUriServ.do?uri=OJ:L:2011:088:0005:0043:EN:PDF>.

Davidson, C.H. 2001, Technology watch in the construction industry: why and how? *Building Research and Information*, 29, 3, pp. 233–41.

Dosi, G. 1982. Technological paradigms and technological trajectories, a suggested interpretation of the determinants and directions of technical change. *Research Policy* 11, pp. 147–162.

Dubois, A. & Gadde, L-E. 2000. Supply strategy and network effects – purchasing behaviour in the construction industry. *European Journal of Purchasing & Supply Management* 6, 207–215.

Dutrénit, G., De Fuentes, C. & Arturo Torres, A. 2010. Channels of interaction between public research organisations and industry and their benefits: evidence from Mexico. *Science and Public Policy*, 37(7), August 2010, pp. 513–526.

ECCS. 1990. Preliminary European Recommendations for Sandwich Panels, Part II: Good Practice. European Convention for Constructional Steelwork. ECCS Publication No. 62.

ECCS. 1991. Preliminary European Recommendations for Sandwich Panels, Part I: Design. European Convention for Constructional Steelwork. ECCS Publication No. 66. 120 p.

ECCS. 2001. European Recommendations for Sandwich Panels. European Convention for Constructional Steelwork. ECCS Publication No 115. 161 p.

- ECCS. 2009. Preliminary European Recommendations for the Testing and Design of Fastenings for Sandwich Panels. ECCS/CIB Joint Committee. ECCS – European Convention for Constructional Steelwork. ISBN: 92-9147-000-93.
- Ecorys. 2010. FWC Sector Competitiveness Studies – Sustainable Competitiveness of the construction Sector. Draft Final Report. At http://ec.europa.eu/enterprise/sectors/construction/files/compet/sustainable_competitiveness/fwc-draft-final-report_en.pdf.
- Ecorys. 2011. FWC Sector Competitiveness Studies – Sustainable Competitiveness of the Construction Sector. Final report N° B1/ENTR/06/054. Available at http://ec.europa.eu/enterprise/sectors/construction/studies/sustainable-competitiveness_en.htm.
- Edquist, C. 1999. Innovation Policy – A Systemic Approach. Incomplete Draft of May 9, 1999. Paper presented at the DRUID's Summer Conference on National Innovation Systems, Industrial Dynamics and Innovation Policy, Rebild, June 9–12, 1999. Danish Research Unit for Industrial Dynamics. 18 p. Available at <http://www.druid.dk/conferences/summer1999/conf-papers/edquist.pdf>.
- Eisenhardt, K. 1989. Building Theories from Case Study Research. *The Academy of Management Review* 14, 4, pp. 532–550.
- ESTEP. 2005. Strategic Research Agenda. European Steel Technology Platform. European Communities. ISBN 92-894-8967-7.
- FAT. 1989. High Technology from Finland. The Finnish Academy of Technology. Gummerus Kirjapaino Oy: Jyväskylä. 124 p. ISBN 951-666-279-X.
- Fernandez-Solis, J.L. 2007. The systemic nature of the construction industry. Proceedings of CIB World Building Congress Construction for Development, 14–17 May 2007, Cape Town, South Africa. The International Council for Research and Innovation in Building and Design CIB and South African Institution of Civil Engineers SAICE. Pp. 1598–1625.
- FFFI. 2013. Forest Industries Statistics Service Tilda. Statistics Figures. Available: <http://www2.forestindustries.fi/statistics/tilastokuviot/Forestreresource/Form s/AllItems.aspx>.
- Fontana, R., Geuna, A. & Matt, M. 2006. Factors affecting university–industry R&D projects: The importance of searching, screening and signalling. *Research Policy* 35), pp. 309–323.

- Frishammar, J. 2005. Towards a Theory of Managing Information in New Product Development. Doctoral Dissertation. Luleå University of Technology. Department of Business Administration and Social Sciences, Division of Industrial Management 2005:54. ISSN 1402-1544. ISRN: LTU-DT-05/54-SE.
- FTP. 2006. A strategic research agenda for innovation, competitiveness and quality of life. Forest-based sector technology platform. European Commission. ISBN 92-79-01027-1.
- Fuentes, C. de & Dutrénit, G. 2010. A three-stage model of the academy-Industry linking process: the perspective of both agents. Paper no. 2010/06. Centre for Innovation, Research and Competence in the Learning Economy (CIRCLE), Lund University, Sweden. ISSN 1654-3149. Available at <http://www.circle.lu.se/publications>.
- Gann, D.M. 1997. Should governments fund construction research? *Building Research and Information* 25, 5, pp. 257–267.
- Gann, D.M. 2003. Guest editorial: innovation in the built environment. *Construction Management and Economics*, 21, 6, pp. 553–555.
- Gann, D.M. & Salter, A.J. 2000. Innovation in project-based, service-enhanced firms: the construction of complex products and systems. *Research Policy* 29, pp. 955–972.
- Gielingh, W. 2005. Improving the performance of construction by the acquisition, organisation and use of knowledge. A theory and method for cognitive engineering, construction and lifecycle management. Doctoral thesis. Technical University of Delft, The Netherlands. ISBN 978-90-810001-1-6. 372 p.
- Girhammar, U.A. & Pajari, M. 2008. Tests and analysis on shear strength of composite slabs of hollow core units and concrete topping. *Construction and Building Materials* 22, pp. 1708–1722.
- Godin, B. 2005. The linear model of innovation. The historical construction of an analytical framework. Project on the history and sociology of the S/T statistics, Working document 30. Montreal, Canada. Available at http://www.csiic.ca/PDF/Godin_30.pdf. Document downloaded on 3.4.2011.
- González, M.J. & Navarro, J.G. 2006. Assessment of the decrease of CO₂ emissions in the construction field through the selection of materials:

- Practical case study of three houses of low environmental impact. *Building and Environment* 41, pp. 902–909.
- Goodrum, P.M., Zhai, D., Mohammed F. & Yasin, M.F. 2009. Relationship between Changes in Material Technology and Construction Productivity. *ASCE Journal of Construction Engineering and Management* April 2009, pp. 278–287.
- Gray, D.E. 2009. *Doing Research in the Real Worlds*. 2nd Edition. Sage Publications Ltd. ISBN 978-1-84787-337-8.
- Grey, C. & Davies, R.J. 2007. Perspectives on experiences of innovation: the development of an assessment methodology appropriate to construction project organizations. *Construction Management and Economics* 25, 12, pp. 1251–1268.
- Gustafsson, R. 2010. Awareness, institutional entrepreneurship, and contradictions in emerging technological fields. Doctoral dissertation. Helsinki University of Technology, Industrial Engineering and Management. Yliopistopaino. 221 p. + app. 2 p. ISBN 978-952-248-258-7.
- Hankonen, J. 1994. Suburbs and the society of effectiveness. Doctoral thesis. Helsinki University of Technology, Dept. of Architecture. Tampere: Tammer-Paino Oy. 539 p. ISBN 951-672-187-7. (In Finnish)
- Hansen, E. 2006. The state of innovation and new product development in the North American lumber and panel industry. *Wood and Fiber Science*, 38, 2, pp. 325–333.
- Hansen, M.T. & Birkinshaw, J. 2007. The innovation value chain. *Harvard Business Review*, 85, 6, pp. 121-130.
- Hartmann, A. & Bresnen, M. 2011. The emergence of partnering in construction practice: an activity theory perspective. *Engineering Project Organization Journal* 1, 1, pp. 41–52.
- Harty, C. 2008. Implementing innovation in construction: contexts, relative boundedness and actor-network theory. *Construction Management and Economics* 26, 10, pp. 1029–1041.
- Heino, P. 2011. Know-how and experts in the wooden construction: national mapping (In Finnish). *Metsäalan ennakointiyksikkö (Itä-Suomen yliopisto) ja Joensuu Tiedepuisto Oy*. 87 p. + app. 1 p. ISBN 978-952-61-0432-4 (pdf).

- Hekkert, M.P., Suurs, R.A.A., Negro, S.O., Kuhlmann, S. & Smits, R.E.H.M. 2007. Functions of innovation systems: A new approach for analysing technological change. *Technological Forecasting & Social Change* 74, pp. 413–432.
- Henderieckx, F., Koos, J., van Gassel, F.J.M., Scheublin, F.J.M. & Winch, G.M. 2002. Building and Construction Process Innovation: A Framework for Measuring Innovation Performance. Topic Paper in Domain 8, PeBBu Thematic Network (Performance Based Building). 9 p. Available: <http://www.docstoc.com/docs/26270366/Process-innovation-in-the-construction-industry> [25.2.2014].
- Holmen, E., Pedersen, A.-C. & Torvatn, T. 2005. Building relationships for technological innovation. *Journal of Business Research* 58, pp. 1240–1250.
- Hunger, M. 2010. An integral design concept for ecological Self-Compacting Concrete. A doctoral thesis at Technical University of Eindhoven, The Netherlands. *Bouwstenen* 146. 240p. ISBN 978-90-6814-628-8.
- Jarkas, A.M. 2010. The influence of buildability factors on rebar fixing labour productivity of beams. *Construction Management and Economics* 28, pp. 527–543.
- Jaspahara, A. 2011. Knowledge management. An integrated approach. 2nd ed. Pearson Education Limited. ISBN 978-0-273-72685-2. 356 p.
- Johnson, W.H.A. & Johnston, D.A. 2004. Organisational knowledge creating processes and the performance of university-industry collaborative R&D projects. *Int. Journal of Technology Management* 27, 1, pp. 93–114.
- Jokela, J., Koukkari H., Pitkänen P. & Rae R. 1987. Experimental methods of the concrete structures. Espoo: VTT Research Notes 662. 62 p. (In Finnish)
- Julkunen, J. 2008. Civil engineering department of Helsinki University of Technology 1861–2007 (Kyhäysopista rakennus- ja ympäristötekniikkaan, in Finnish). Teknillinen korkeakoulu, rakennus- ja ympäristötekniikan osasto. Gummerus Oy: Jyväskylä. 178 p. + app. 20 p. ISBN 978-951-22-9250-9.
- Kairi, M. 2005. Interaction of R&D and business development in the wood products industry, case Kerto® - laminated veneer lumber (LVL). Doctoral dissertation. Helsinki University of Technology, Department of Forest Products Technology, Laboratory of Wood Technology. Picaset Oy: Helsinki. 225 p. + app. 15 p. ISBN 951-22-7705-0.

- Kairi, M. 2011. Developing competitive wood product, Case Kerto-LVL. Lecture in the course Fibre Product Development Practices. School of Chemical Technology at Aalto University. 76 p. Available https://noppa.aalto.fi/noppa/...0.../Puu-0_3200_kertopuu.pdf.
- Kaufmann, A. & Tödtling, F. 2001. Science Industry Interaction in the Process of Innovation: The Importance of Boundary-Crossing between Systems. *Research Policy* 30, pp. 791–804.
- Keist, R. & Hampson, K. 2007. Building Constructive Innovation Networks: Role of Relationship Management. *ASCE Journal of Construction Engineering and Management* 133, 5, pp. 364–373.
- Koivu, T. & Björnsson, H. 2003. Towards value networks in construction. Outlining internationalisation for the Building Cluster Technology Programme. The National Technology Agency Tekes. 25 p. ISBN 952-457-105-6. (In Finnish and English)
- Koskela, L. & Vrijhoef, R. 2001, “Is the current theory of construction a hindrance to innovation?” *Building Research and Information* 29, 3, pp. 197–207.
- Kouhi, J. 2005. The European Coal and Steel Community ECSC. *Teräsrakenne* 28, 1, pp. 30–31. (In Finnish)
- Kouhi J. & Koukkari H. 1989. Steel-concrete composite structures. Espoo 1989. VTT Publications 614. 174 p. (In Finnish)
- Koukkari, H. 1998. Industrialized building methods in Finland. Presentation to Danish visitors at VTT Building Technology on 9.2.1998. 22 p. Slide set available from the author.
- Koukkari, H. 2010. Transformation of a research centre toward an innovation partner in the construction sector. *Engineering, Construction and Architectural Management* 17, 1, pp. 89–98.
- Koukkari, H., Ala-Outinen, T., Salmi, P. & Sipari, P. 2004. Customer-oriented product development in the steel construction – competitiveness through the PD methodology. Finnish Steel Structures R&D Days, Seinäjoki, 2.–3.9.2004. Seinäjoki Polytechnic, technology unit & Finnish Constructional Steelwork Association TRY. 7 s. (In Finnish)
- Koukkari, H., Kyckling, J., Peltonen, S., & Viikari, M. 2012. Managing construction product innovations. Paper presented at 7th Int. Conf. on Innovation in

- Architecture, Engineering & Construction, AEC2012, Sao Paolo, Brazil, 15–17 August, 2012. Loughborough University & University of Sao Paolo. Paper no 85, 10 p. Retrieved from <http://innovationinaec2012.pcc.usp.br/>.
- Kraatz, J., & Hampson, K. 2013. Brokering innovation to better leverage R&D investment. *Building Research and Information*, 41, 2, pp. 187–197. ISSN 0961-3218. Doi: 10.1080/09613218.2013.749771.
- Krogh, G. von, Ichijo, K. & Nonaka, I. 2000. *Enabling Knowledge Creation. How to unlock the Mystery of Tacit Knowledge and Release the Power of Innovation*. Oxford University Press, Inc. New York. ISBN 0-19-512616-5. 292 p.
- Kyckling, J., Koukkari, H. & Nykyri, P. 1990. Competitive Delta-beam (In Finnish). *Rakennustaito* 85, 5, pp. 18–20, 23.
- Laiterä, J. 2010. Novel Modular Accommodation Solution, Applying Steel Sandwich Panel. *Schiffbauforschung* 49, 1, pp. 79–92.
- Larsson, B., Sundqvist, J. & Emmitt, S. 2006. Component manufacturers' perceptions of managing innovation. *Building Research & Information*, 34, 6, pp. 552–564.
- Lawson, R.M., Ogden, R.G., Pedreschi, R., et al. 2005. Pre-fabricated systems in housing using light steel and modular construction, *International Journal of Steel Structures*, 5, pp. 477–483.
- Leppävuori, E.K.M., Nordlund O.P. & Absetz, I. 2009. Pekka Kanerva, the honorary member of the Association for Structural Mechanics in Finland, 70 years. *Rakenteiden Mekaniikka* 42, 4, pp. iii–iv. (In Finnish)
- Leskelä, M. 1986. Calculation models for concrete-steel composite beams, considering partial interaction. Doctoral Thesis. *Acta Universitatis Ouluensis, Series C, Technica No 36, Artes Constructionum No 8*. University of Oulu Printing Center. Oulu 1986. 138 p. + app. 20 p. ISBN 951-42-2224-5.
- Lichtenberg, J. 2002. *Ontwikkelen van Projectgebonden Bouwproducten. Datawysse Boekproducties*, Maastricht, The Netherlands. ISBN 90-9015599-6.
- Lim, J.N. & Ofori, G. 2007. Classification of innovation for strategic decision making in construction businesses. *Construction Management and Economics*, 25, 9, pp. 963–978.

- Lin, J. 2008. Modeling and Analyzing Concurrent Processes for Project Performance Improvement. Doctoral thesis. Technical University of Eindhoven. 154 p. + app. 22 p. ISBN 978-90-386-1380-2.
- Malerba, F. 2002. Sectoral systems of innovation and production. *Research Policy* 31, pp. 247–264.
- Mali, J., Tarvainen, V., Saarelainen, U., Vihavainen, T. & Hirvensalo, R. 1986^a. Product development in the Finnish mechanical forest industry. Part I. How to success in product development. Technical Research Centre of Finland, Research report 394. Valtion teknillinen tutkimuskeskus (VTT). ISBN 951-38-2510-8. 110 p. (In Finnish)
- Mali, J., Tarvainen, V., Saarelainen, U., Vihavainen, T. & Hirvensalo, R. 1986^b. Product development in the Finnish mechanical forest industry. Part II. How to success in product development. Technical Research Centre of Finland, Research report 401. Valtion teknillinen tutkimuskeskus (VTT). ISBN 951-38-2567-1. 117 p. + app. 74 p. (In Finnish)
- Manley, K. 2008. Implementation of innovation by manufacturers subcontracting to construction projects. *Engineering, Construction and Architectural Management* 15, 3, pp. 230–245.
- Markard, J. & Truffer, B. 2008. Technological innovation systems and the multi-level perspective: Towards an integrated framework. *Research Policy* 37. pp. 596–615.
- Marceau, J., Manley, K., Hampson, K.D., Toner, P., Gerasimou, E. & Cook, N. 1999. Mapping the building and construction product system : preliminary report. Queensland University of Technology, Department of Industry, Science and Resources, Canberra, ACT. Downloaded from: <http://eprints.qut.edu.au/41288/> (only the concept 'product system' cited).
- Merikallio, T. 2009. Evaluation of adequate drying of a concrete floor during construction process (In Finnish). Doctoral thesis. Helsinki University of Technology, TKK Structural Engineering and Building Technology. 136 p. ISBN (printed) 978-951-22-9956-0.
- Michelsen, K.-E. 1993. State, technology and research. VTT and born of the national research system. VTT, Valtion teknillinen tutkimuskeskus. 429 p. (In Finnish). ISBN 951-38-4271-1.

- Miozzo, M. & Dewick, P. 2002. Building competitive advantage: innovation and corporate governance in European construction. *Research Policy* 31, pp. 989–1008.
- Miozzo, M. & Dewick, P. 2004. Networks and innovation in European construction: benefits from inter-organisational cooperation in a fragmented industry. *Int. J. Technology Management* 27, 1, pp. 68–91.
- Murphy, S.A. & Kumar, V. 1997. The front end of new product development: a Canadian survey. *R&D Management* 27, 1, pp. 5–15.
- Mäkiö, E., Malinen, M., Neuvonen, P., Vikström, K., Mäenpää, R., Saarenpää, J. & Tähti, E. 1994. *Multistorey buildings 1960–1975. Rakennustietosäätiö & Rakennustieto Oy. Tammer-Paino. 271 p. (In Finnish). ISBN 951-682-279-7.*
- Möttönen, H., Hirviniemi, J., Salmi, P., Koukkari, H., Sipari, P., Myllymäki, J., Oksanen, T., Ptchelintsev, A. & Hieta, J. 2000. Load-bearing partition wall with new RAN AWS steel stud. The 5th. Finnish Steel Structures R&D Days. Espoo, FI, 18–19 Jan. 2000. Helsinki University of Technology & Constructional Steelwork Association TRY. Pp. 154–162. ISBN 951-22-4840-9.
- Nam, C.H. & Tatum, C.B. 1989. Toward Understanding of Product Innovation Process in Construction. *ASCE Journal of Construction Engineering and Management*, 115, 4, pp. 517–534. ISSN 0733-9364/89/0004-0517.
- Nieminen, J. & Salonvaara, M. 2000. Hygrothermal performance of light steel-framed buildings. Technical Research Centre of Finland, VTT Tiedotteita-Meddelanden – Reserch Notes 2070. 26 p. ISBN 951-38-5772-7.
- Nonaka, I. 1994. A Dynamic Theory of Organizational Knowledge Creation. *Organization Science* 5, 1, pp. 14–37.
- Nonaka, I., von Krogh, G. & Voelpel, S. 2006. Organizational Knowledge Creation Theory: Evolutionary Paths and Future Advances. *Organization Studies* 27, 8, pp.1179–1208.
- Nonaka, I., Toyama, R. & Konno, N. 2000. SECI, Ba and Leadership: a Unified Model of Dynamic Knowledge Creation. *Long Range Planning* 33, pp. 5–34.

- Nonaka, I., Umemoto, K. & Senoo, D. 1996. From information processing to knowledge creation: a paradigm shift in business management. *Technology In Society* 18, 2, pp. 203–218.
- Nuesse, G., Limbachiya, M., Herr, R., & Ellis, A. 2012. Managing interdisciplinary applied research on sustainability in construction with the help of an innovation broker. *Steel Construction*, 5, 1, pp. 41–52.
- Nykyri, P., Koukkari H. & Kyckling J. 1990. Deltapalkki- fireproof composite beam embedded in a floor slab (In Finnish). *Rakennustekniikka* 46, 2, pp. 47–50.
- OECD. 2005. Oslo Manual. Guidelines for Collecting and Interpreting Innovation Data, 3rd edition. OECD/European Communities 2005. ISBN 92-64-01308-3. At <http://browse.oecdbookshop.org/oecd/pdfs/browseit/9205111E.PDF>.
- Ozorhon, B., Abbott, C., Aouad, G. & Powell J. 2010. Innovation in construction. A project life cycle approach. Salford Centre for Research and Innovation in the built and human environment (SCRI). University of Salford. 46 p. ISBN 978-1905732869. http://www.salford.ac.uk/__data/assets/pdf_file/0003/297228/SCRIResearchReport4Innovation.pdf.
- Owen, G. & Wood, A. 1998. Worldwide Use of Steel in Construction: Strategies for Growth. *J. Construct. Steel Research* 46, 1–3, pp. 32–33. Paper number 422.
- Pajari, M. 1998. Shear resistance of PHC slabs supported on beams, II: Analysis. *ASCE J. of Structural Engineering* 124, 9, pp. 1062–1073.
- Pajakkala, P., Perälä, A.-L. & Matilainen, J. 1992. Developing construction industry. General view of the sector – R&D activities of the sector. *Rakennustieto Oy: Helsinki*. 81 p. + app. 13 p. ISBN 951-682-253-3. (In Finnish)
- Pajari, M. 1998. Shear resistance of PHC slabs supported on beams, II: Analysis. *ASCE J. of Structural Engineering* 124, 9, pp. 1062–1073.
- Pajari, M. & Koukkari, H. 1998. Shear resistance of PHC slabs supported on beams, I: Tests. *ASCE J. of Structural Engineering* 124, 9, pp. 1050–1061.
- Peltola, S.-M. 2013. Planning of Production System for Modular Housebuilding, Master of Science Thesis. Tampere University of Technology, Industrial Engineering and Management. 107 p. + app. 32 p. (In Finnish)
- Peltonen, M. 2009. Nonaka's knowledge creation theory revisited: A semiotic analysis of Communicating Knowledge in a Geographically Dispersed

Team. Master Thesis. Helsinki School of Economics, International Business Communication. 111 p. + app. 2 p.

Perkmann, M. & Walsh, K. 2007. University-industry relationships and open innovation: towards a research agenda. *International Journal of Management Reviews* 9, 4, pp. 259–280.

Perkmann, M. & Walsh, K. 2009. The two faces of collaboration: Impacts of university-industry relations on public research. Paper in the summer conference 2009, Danish Research Unit for Industrial Dynamics (DRUID) Summer Conference, Copenhagen, 18–20 June. CBS – Copenhagen Business School, Denmark. 43 p.

Pessi, A.-M., Suonketo, J., Pentti, M. & Rantio-Lentimäki, A. 1999. Betoni-elementtijulkisivujen mikrobiologinen toimivuus. Tampereen teknillinen korkeakoulu ja Turun yliopisto. TTKK Talonrakennustekniikka, julkaisu 101. 88 p. + app. 6 p. ISBN 952-15-0337-8.

Popadiuk, S. & Choo, C.W. 2006. Innovation and knowledge creation: How are these concepts related? *Int. J. of Information Management* 26 (2006), pp. 302–312.

Pries, F. & Doree, A. 2005. A century of innovation in the Dutch construction industry. *Construction Management and Economics*, 23, pp. 561–564.

Ring, P.S. & Ven, A.H. van de. 1992. Structuring Cooperative Relationships between Organizations. *Strategic Management Journal*, Vol. 13, No.7, pp. 483–498.

RT^a. 2004. Advancing construction industry – practical results from visions and strategies. The Finnish Confederation of Construction Industries. Rakennusteollisuuden Viestintäkeskus Oy/Libris Oy 2004. 18 p. <http://www.asuntotieto.com/asuntotietokeskus/esittely/Kehitt%E4v%E4%20rak.teollisuus.pdf>. (In Finnish)

RT^b. 2004. PRO IT, product model data in construction processes (tuotemallitieto rakennusprosessissa). PRO IT News September 2004. The Finnish Confederation of Construction Industries.

RTT. 1995. Construction with cast-in-situ concrete. Guidelines for architecture, structural design, design of industrial reinforcement, detailing, acoustics, planning of production and building technology. Lahden Kirjapaino ja

- Sanomalehti Oy. 431 p. + app. 227 p. ISBN 951-9365-8X-Y and ISBN 951-9365-9X-Y.
- Rutten, M.E.J., Dorée, A.G. & Halman, J.I.M. 2009. Innovation and inter-organizational cooperation: a synthesis of literature. *Construction Innovation* 9, 3, pp. 285–297.
- Rynes, S.L., Bartunek, J.M. & Daft, R.L. 2001. Across the Great Divide: Knowledge Creation and Transfer between Practitioners and Academics. *The Academy of Management Journal*, Vol. 44, No. 2, pp. 340–355.
- Saarinen, S. 2007. PRO IT project promoted breakthrough of product modelling. *Betoni* 77, 2, pp. 93–97.
- Salimi, N., Bekkers, R. & Frenken, K. 2013. Governance and success of university-industry collaborations on the basis of Ph.D. projects – an explorative study. Working Paper 13.05. Eindhoven Centre for Innovation Studies (ECIS), School of Innovation Sciences, Eindhoven University of Technology, The Netherlands.
- Sand, H., Hjorth Lorenzen, K. & Burgos Nittegaard, C. 2012. Survey of green legislation and standards in the construction area in the Nordic countries. Background Note. Nordic Innovation Publication 2012:10. Nordic Innovation, Oslo. ISBN 978-82-8277-026-2.
- SBK 2009. Building with prefab components. Tehdään elementeistä. SBK Säätiö. Betonitieto Oy. Gummerus: Jyväskylä. 322 p. ISBN 978-952-92-5772-0.
- Schartinger, D. 2009. Sectoral Innovation Foresight, Construction. Europe Innova – Innovation Watch Project, Interim Report. Competitiveness and Innovation Framework Programme (CIP). 26 p. Available at <http://rtd-sectors.eu/files/assets/WP1/Services/Construction.pdf>.
- Schartinger, D., Rammer, C., Fisher, M.M. & Fröhlich, J. 2002. Knowledge interactions between universities and industry in Austria: sectoral patterns and determinants. *Research Policy* 31, pp. 303–328.
- Schumpeter, J. 1934. *The Theory of Economic Development*, Cambridge, Mass: Harvard University Press.
- Seaden, G. 1997. The future of national construction research organizations, *Building Research & Information* 25, 5, pp. 250–256.

- Seaden, G. & Manseau, A. 2001. Public policy and construction innovation. *Building Research & Information* 29, 3, p. 182–196.
- Seppälä, R. 2009. Jalo Paananen, yrittäjä. Keuruu: Otavan kirjapaino Oy. ISBN 978-951-1-23515-6. 254 p.
- Sexton, M. & Lu, S.-L. 2009. The challenges of creating actionable knowledge: an action research perspective. *Construction Management and Economics* 27, pp. 683–694.
- Shenhar, A.J., Dvir, D. & Yechiel Shulman, Y. 1995. A two-dimensional taxonomy of products and innovations. *J. Eng. Technol. Management* 12, pp. 175–200.
- Simons, H. 2009. *Case Study Research in Practice*. Sage Publications Ltd. 189 p. ISBN 978-0-7619-6424-7.
- Slaughter, S. 1993. Builders as sources of construction innovations. *Journal of Construction Engineering and Management* 119, 3, pp. 532–549.
- Slaughter, S. 2000. Implementation of construction innovations. *Building Research & Information*, 281, pp. 2–17.
- Squicciarini, M. & Asikainen, A.-L. 2011. A value chain statistical definition of construction and the performance of the sector. *Construction Management and Economics*, 29, 7, pp. 671–693.
- Stendahl, M. 2009. *Product Development in the Wood Industry – Breaking Gresham’s Law*. Doctoral Thesis. Swedish University of Agricultural Sciences. Uppsala, Sweden. 112 p.
- Söderlund, K. 2005. The Nordic concrete research. *Betoni* 75, 3, pp. 72–73. (In Finnish)
- Talja, A., Salmi, P. & Vähä-Pietilä, K. 1991. The use of finite element method in the determination of the strength of cold-formed sheetings and columns for concentrated load or compression. Technical Research Centre of Finland, Research Notes 1257. 58 p. + app. 40 p. ISBN 951-38-3889-7. (In Finnish)
- TAT. 1990. TAT, the new component system building technology. Kustannusosakeyhtiö Tietopuu ja Juhani Keppo. SP-Paino: Hyvinkää. 112 p. + app. 1 p. ISBN 951-869-031-6.

- Taylor, J.E. & Levitt, R.E. 2004. Understanding and managing systemic innovation in project-based industries. Stanford University. Available at <http://crgp.stanford.edu/publications/bookchapters/TaylorLevitt.pdf>.
- Taylor, J.E., Levitt, R. & Villarroel, J.A. 2009. Simulating Learning Dynamics in Project Networks. *ASCE Journal of Construction Engineering and Management* 135, 10, pp. 1009–1015.
- Tekes. 1991. Industrialized Building Construction 1986-1991. The Centre for Technology Development Tekes. Brochure. 7 p. (In Finnish)
- Tekes. 2001a. Finnsteel Technology Programme 1995-2000. Evaluation Report by Lawson, M. & Burgan, B. National Technology Agency Tekes. Technology Programme Report 6/2001.
- Tekes. 2001b. Finnsteel Technology Programme 1995-2000. Final Report. National Technology Agency Tekes. Technology Programme Report 7/2001. 63 p. ISBN 952-457-024-6.
- Tekes. 2008. Towards construction in value networks. Newsletters of the Sara technology programme 2002-2007. 20 p. (In Finnish)
- Tether, B.S. & Tajar, A. 2008. Beyond industry–university links: Sourcing knowledge for innovation from consultants, private research organisations and the public science-base. *Research Policy* 37, pp. 1079–1095.
- Tiainen, T. & Kerkkänen, T. 1999. Durability of sandwich panels and their core materials. *Finnish Civil Engineering* 55, 4, pp. 47–50.
- TKK 2013. Diploma theses of the civil engineering department 1970–1979. Memo prepared by Soile Koukkari.
- Tolva, I. & Jumppanen, P. 1980. A sandwich structure with a polystyrene core. VTT Valtion teknillinen tutkimuskeskus, rakennetekniikan laboratorio, Tiedonanto 10. Espoo. 135 p. + app. 4 p. ISBN 951-38-1049-6. (In Finnish)
- Trias de Bes, F. & Kotler, P. 2011. *Winning at innovation. The A-to-F-Model*. Palgrave MacMillan. ISBN-13: 978-0-230-34343-6. 252 p.
- Trott, P. 2008. *Innovation management and new product development*. 4th ed. Pearson Education Ltd. Printed in Malaysia. ISBN 978-0-273-71315-9. 581 p.

- TRY. 2013. Press release 21.11.2012. The Finnish Constructional Steelwork Association.
- Ulrich, K.T. & Eppinger, S.D. 1995. Product design and development. McGraw-Hill, Inc. 289 p. ISBN 0-07-065811-0.
- Vainio, T. 2013. Societal impacts of the construction industries. Report to the Confederation of the Finnish Construction Industries. VTT Technical Research Centre of Finland, 14.8.2013. (In Finnish) Available at <http://www.rakennusteollisuus.fi/Documents/Suhdanteet%20ja%20tilastot/Rakentamisen%20yhteiskunnalliset%20vaikutukset%202012.pdf>.
- Verganti, R. 2009. Design-driven Innovation. Changing the rules of competition by radically innovating what things mean. Harvard Business School Publishing Corporation. 229 p. ISBN 978-1-4221-2482-6.
- Veryzer, R.W. 1998. Discontinuous Innovation and the New Product Development Process. *Journal of Product Innovation Management* 15, pp. 304–321.
- Viitaniemi, P. & Jämsä, S. 1996. Modification of wood through heat treatment. VTT Julkaisut-Publikationer 814, Valtion teknillinen tutkimuskeskus, Espoo. 57 p. (In Finnish) <http://www.vtt.fi/inf/pdf/julkaisut/1996/J814.pdf>.
- Viitaniemi, P., Jämsä, S., Koskela, K. Paajanen, L. Vuorinen, T., Maunu, S. & Paakkari, P. 2002. Reaction mechanisms of modified wood and pine oil. In: Paavilainen, L. (ed.), Finnish Forest Cluster Research Programme Wood Wisdom (1998-2001), Final report. Helsinki (2002), pp. 185–192. (In Finnish)
- van der Vlies, R.D. & Maas, G.J. 2009. A social capital perspective to innovation management in construction. 26th International Symposium on Automation and Robotics in Construction (ISARC 2009).
- Voordijk, H., de Haan, J. & Joosten, G.-J. 2000. Changing governance of supply chains in the building industry: a multiple case study, *European Journal of Purchasing and Supply Management*, Vol. 6, Special Issue, pp. 217–225.
- VTT. 1990. Steel Construction 2000 – needs and opportunities to develop resources. VTT Laboratory of building production. Tampere: Tehokopiointi Oy. 50 p. + app. 3 p. (In Finnish)
- Vuola, O., Hameri, A.P. 2006. Mutually benefiting joint innovation process between industry and bigscience. *Technovation*, 26, 1, pp. 3–12.

- Winch, G. 1998. Zephyrs of creative destruction: understanding the management of innovation in construction. *Building Research & Information* 26, 4, pp. 268–279.
- Yang, J. & Lai, F. 2006. Harnessing value in knowledge acquisition and dissemination: strategic sourcing in product development. *Int. J. Technology Management* 33, 2/3, pp. 299-317.
- Yin, R.K. 2009. *Case Study Research. Design and Methods*. 4th Ed. Applied Social Research methods Series. Volume 5. SAGE Publications, Inc. 218 p. ISBN 978-1-4129-6099-1.

Appendix A: List of topics for semi-structured expert interviews

The topics of expert interviews were listed for the use of interviewees to guide the conversation, and they were not questions for the interviewee. The interview usually proceeded in a chronological order, but a freedom to follow thoughts was allowed. Many topics were also not dealt with at all.

The topics were arranged according to the generic process model comprising the following four phases of the main activities:

- Before product-specific activities (called e.g. the fuzzy front end)
- Invention: product development and pilot manufacturing
- Industrial up-scaling and commercialization
- Diffusion, services, buildings, expansion of markets and use.

Additional topics for the interviews included current practices in networking and organising joint projects and programmes.

PHASE PRIOR PRODUCT-SPECIFIC ACTIVITIES

HOW DID YOU/ YOUR ORGANISATION NOTICE THAT THE FINDINGS HAD INDUSTRIAL POTENTIAL?

(Ad-hoc teams, industry-research co-operation, joint research projects, international/national co-operation with industrial R&D units or research organisations, intensity of any communication, special team work procedures, time scale, co-operation with different functions of companies – marketing, manufacture, R&D units, upper management etc.)

CONCEPTUALIZATION OF A PRODUCT IDEA

(How were different approaches compiled and integrated, working methods?)

IDENTIFICATION AND PRIORITIZATION OF RESEARCH NEEDS

ORGANISATION OF RESEARCH PROJECTS

(How were the research agendas established and agreed before any industrial pilot, what role did regulations and standards play in R&R planning?)

ENGAGEMENT OF INDUSTRIES

(How was knowledge sharing and transfer organised in practice – professional journals, conferences, associations, workshops, visits, personal networks, informal meetings); assess importance of face-to-face-meetings and personal relationships; assess importance of strategic alliances if any – joint research projects, co-operation contracts, contract research)?

MILESTONES LEADING TO INVESTMENTS IN PRODUCT DEVELOPMENT

(Steps towards the industrial commitment, argumentation, issues of negotiation, issues that supported and prolonged the progress, IPR issues, who were the collaborators, how was industrial communication organised, identification of potential market segments etc.)

INVENTION: PRODUCT DEVELOPMENT AND PILOT MANUFACTURE

RESEARCH-BASED PROBLEM SOLVING, ROLES AND RESPONSIBILITIES

(Needs, phases, small-scale tests, full-scale tests, theoretical basis for design, reliability, safety etc.)

CREATION AND IMPLEMENTATION RESEARCH-BASED KNOWLEDGE

(What research organisations, what companies and associations, types of projects, funding of projects, co-operation between parties, milestone issues, communication intensity, type of communication, content of knowledge in various phases of product development and pilot manufacture, exchange of personnel, places of meetings, common excursions etc.)

TRANSFER OF INDUSTRIAL KNOWLEDGE

(Assess importance of industrial know-how to research problems and methods; what kind of knowledge was gained – what should have been understood better?)

EXPERIENCES ABOUT KNOWLEDGE CREATION AND SHARING WITH INDUSTRY

(Match of capabilities, use of resources, openness, atmosphere, reasons for success, working and communication methods, intensity of communication, cultural differences, common beliefs, shared strategies of various organisations, funding opportunities, informal communication, co-operation in associations etc.)

LESSONS LEARNT FROM PILOT MANUFACTURING

(Sharing experiences, co-operative action plans, submission of research-based information)

INDUSTRIAL UPSCALING AND COMMERCIALIZATION

RESEARCH-INDUSTRY CO-OPERATION

(How did research-based knowledge influence on the process development, did product objectives influence on process control, research agenda on products from manufacturing lines, how was the co-operation organised, joint projects, partnerships between companies etc.?)

RESEARCH FINDINGS THAT WERE IMPLEMENTED IN GENERAL

(Manufacturing machinery, cad-cam, bim, structural simulation, building physics simulation, energy simulation, service-life simulation, decision-making methods, sustainability assessment methods, environmental assessment methods)

R&D PARTNERSHIPS

(Industrial partnerships, supply chain partnerships, knowledge management arrangements)

EXPERIENCES ABOUT THE INDUSTRIAL CO-OPERATION

(Personal competition, organisational competition, sharing of responsibilities, working methods, cultures, timetables, resources, jealousy, IPR, openness etc.)

DIFFUSION: SERVICES, BUILDINGS, EXPANSION OF MARKETS AND USE

USE OF PRODUCT-SPECIFIC KNOWLEDGE

(Product approvals in different markets, needs of new knowledge)

NEEDS TO CONTINUE CO-OPERATION WITH RESEARCH ORGANISATIONS

GENERAL TOPICS

NATIONAL RESEARCH CO-OPERATION AND NETWORKS

(Distribution of R&D activities geographically, co-operation with local actors, joint national Tekes projects, ownership in RYM, participation in RYM Programmes, preparation of RYM programmes, partnerships. alliances, co-operation in national strategies, contribution to training and education)

How the organization is networked with the international RD activities?

(Direct networks to R&D centres and universities, memberships in international organisations with R&D strategies such as ETPs, ppp alliances like E2B, CIB??, AERTO??, EERA etc.)

COMMUNICATION NETWORKS Communication networking of the personnel at home and abroad?

(Individual memberships of personnel in professional organisations, teaching and research co-operation with local schools and universities, personal engagements in education, alumni-activities, invited lectures, invited speakers, mutual help in providing material e.g. for case studies, free information, participation in open idea gathering, brainstorming etc.)

What kinds of journals and conferences are interesting and followed?

(Relevant review-papers, topics of conferences, typical organisers of conferences, own contributions in journals/ conferences, joint efforts in publication, joint efforts in R&D workshops)

Title	Knowledge interaction between manufacturers and research organisations for building product innovations An explorative case study
Author	Heli Koukkari
Abstract	<p>This thesis adds to research on construction innovation through exploring and describing knowledge interaction between product manufacturers and research organizations. A few publications deals with manufacturers' innovation activities on their own terms, although products are broadly recognised to have major impacts on the performance of the entire built environment.</p> <p>The research was conducted in a multilevel theoretical framework integrating the perspectives of systems of innovation, knowledge processes in manufacturing industries and knowledge interaction between companies and public research organizations. Ten product innovations were selected for a multiple case study. Cross-case synthesis was applied as the analysis technique of qualitative research data. The main themes in exploring and describing the knowledge interaction were found as to be a) development and use of research-based knowledge in product innovations, b) accumulation and diffusion of research-based knowledge and b) context and channels of knowledge interaction.</p> <p>The principal motivation for the knowledge interaction was found to be the need to know how a novel product would perform in its intended use in buildings, and how it should be designed and manufactured to meet the overall requirements. The regulations to design and use novel products were, however, often developed in parallel or after a technical invention. The objectives of joint innovation activities also reflected also the market expectations and governmental strategies. The thesis thus emphasized the dynamics of relationships between institutions and various actors within a system of construction innovation.</p> <p>A system of construction innovation is, however, not sufficient to uncover all the aspects of the knowledge interaction and even less the context of manufacturers' innovation activities. This is due to the division of the real estate and construction sector into competing value chains that exist in accord with basic framing materials. Manufacturers have ties to basic industries that are also important sources of product innovations. The industrial associations reflect this situation, as well as specialization of research and education. As a conclusion, approaches to the technology innovation systems were proposed for further research.</p> <p>The research identified similarities between the innovation processes of building product manufacturers and those of other manufacturing sectors. It is noteworthy however, that innovation activities were organised in several cases according to principles of concurrent engineering already decades ago. It was also observed that relationships between research and practice are of mutual benefit.</p>
ISBN, ISSN	ISBN 978-951-38-8111-5 (Soft back ed.) ISBN 978-951-38- 8112-2 (URL: http://www.vtt.fi/publications/index.jsp) ISSN-L 2242-119X ISSN 2242-119X (Print) ISSN 2242-1203 (Online)
Date	October 2014
Language	English
Pages	189 p. + app. 4 p.
Keywords	Knowledge interaction, building product, building, manufacturer, research organisation, product innovation, system of innovation
Publisher	VTT Technical Research Centre of Finland P.O. Box 1000, FI-02044 VTT, Finland, Tel. +358 20 722 111

Knowledge interaction between manufacturers and research organisations for building product innovations

An exploratory case study

This thesis explores the knowledge interaction between manufacturers and research organizations pursuing building product innovations. It contributes particularly to research on construction innovation through its emphasis on the suppliers who rarely have been investigated on their own terms. In addition, the focus on creative knowledge processes presents empirical evidence of the joint innovation activities.

The multilevel theoretical framework has been a mix of perspectives including systems of innovation, knowledge processes in manufacturing industries and knowledge interaction between companies and public research organizations. Ten product innovations were selected for a qualitative case study. Three main themes were found to answer the research problem: the development and use of research-based knowledge in product innovations, accumulation and diffusion of research-based knowledge among all stakeholders and finally the context and channels of the knowledge interaction.

ISBN 978-951-38-8111-5 (Soft back ed.)
ISBN 978-951-38-8112-2 (URL: <http://www.vtt.fi/publications/index.jsp>)
ISSN-L 2242-119X
ISSN 2242-119X (Print)
ISSN 2242-1203 (Online)

