



TAMPEREEN TEKNILLINEN YLIOPISTO
TAMPERE UNIVERSITY OF TECHNOLOGY

HASIB KHURSHID
AUTOMATIC TRAFFIC CLEARANCE DURING EMERGENCY

Master of Science Thesis

Examiners : Dr Andrei Lobov
Prof Jose L. Martinez Lastra
Topic approved by Faculty
Council of Engineering sciences
6th October 2015

ABSTRACT

Tampere University of technology

HASIB KHURSHID: Automatic Traffic Clearance during Emergency

Master of Science Thesis, 44 pages

September 2017

Master's Degree Programme in Machine Automation

Major: Factory Automation

Examiner: Dr Andrei Lobov and Professor. Jose L. Martinez Lastra

Keywords: Emergency Vehicle, Travel time, congestion, Queue time,

Emergency Vehicle plays an important role when there is emergency situation in the area. And it is necessary to reach destination as soon as possible to save lives. Preemption techniques for emergency vehicles in high volume traffic were examined and it was found out that there is no tool for signal controller for Emergency Vehicle preemption. So the goal was to design signal controller which helps Emergency Vehicle to get green light throughout its travel time.

This thesis solves the problem of selecting appropriate preemption technique and designing algorithm for preemption of Emergency Vehicle in high traffic volumes. Tool was created using PTV VISSIM for optimized traffic signal controller. Results can be saved as a text file which can be imported to excel for measurements and plotting graph values.

The tool was tested providing different road and environment conditions and results were collected. The average travel time of Emergency Vehicle in network is improved up to 2 seconds per signal using optimized traffic signals. In this thesis, Emergency vehicles can reach their final stop 8.1 seconds early using this setup. As in emergency situations every second counts so 2 seconds per traffic light is a huge improvement and it means, a lot of time can be saved by implementing this method in normal traffic on roads. Furthermore results were collected for total travel time, queue length and queue counter, speed and acceleration of vehicles in network, delay and stop time of vehicles. The tool was tested for challenging environment like peak road traffic, congestion at intersection and it succeeded in finding the solution for preemption of Emergency Vehicle.

PREFACE

“If something is important enough, you should do it Even if the probable outcome is failure.”

Elon Musk

First of all I am really thankful to Professor Dr Joe Luis Martinez Lastra for giving me the opportunity to select this interesting topic as my thesis. Next, especially thanks to my supervisor and mentor Dr Andrei Lobov for his continuous support, help and feedback throughout the time period.

Last but not least thanks to all my friends for their love, support and encouragement to complete my thesis. Loads of love to my wife Thabusam for motivating and pushing me and always sticking to my side in every thick and thin. Those sleepless nights are finally paid off.

Credit goes to my lovely family Ammi and Abbu whose prayers, time and advices helped me in fulfilling my dream. They were there in my whole journey.

I would like to dedicate this thesis to my nephews Azan, Muhammad Ahmed and Mahad and my nieces Samavia and Afreen.

Hasib Khurshid

26th August 2017

CONTENTS

1	INTRODUCTION	1
1.1	Motivation	1
1.2	Problem Statement	2
1.3	Hypothesis for Research.....	2
1.4	Objective	2
1.5	Limitations	2
2	BACKGROUND	3
2.1	Background	3
2.2	Emergency vehicle preemption (EVP).....	4
2.3	EVP systems and their working	4
2.4	Available Preemption Technologies	5
2.4.1	Wireless Sensor Network (WSN)	6
2.4.2	GPS Based Preemption Control System	7
2.4.3	Fast Emergency Preemption Systems (FAST).....	8
2.4.4	Infrared Receiver System.....	9
2.4.5	Differential GPS System.....	10
2.4.6	Warning System.....	11
2.4.7	GIS Based System.....	12
2.4.8	Collision Avoidance System.....	14
2.4.9	Improved Warning Signals System.....	15
2.5	Other Approaches.....	15
2.5.1	Fuzzy Control.....	15
2.5.2	Emergency Vehicle Signaling Using VANETS	15
2.5.3	Simulation and Modeling Using CORSIM.....	16
2.5.4	Agent Based Simulations for Designing Control Systems	16
2.5.5	Multimode Traffic Flow Using VISSIM	17
2.6	Summary	18
3	APPROACH	19
3.1	Traffic management for emergency vehicles	19
3.2	Emergency vehicle priority strategy	19
3.3	Work flow	19
3.4	Traffic Model	22
3.5	Modeling Tool: PTV Vissim.....	22
3.5.1	VisVap Module.....	23
3.6	Input Data.....	24
3.7	Speed, Acceleration and other parameters	25
3.8	Road Accidents in previous years	25
4	IMPLEMENTATION	27
4.1	Building Intersection Model.....	27

4.2	Tool for Traffic signals	28
4.3	Vehicles in Network.....	30
4.4	Various other parameters	30
5	RESULTS	31
5.1	Input values	31
5.2	Results for Travel Time.....	31
5.2.1	Result for Total Emergency Vehicles in Network	32
5.3	Results for Vehicles speed in Network	34
5.4	Results for Average Stop Time	35
5.5	Results for Delay stop	37
5.6	Results for safe Distance	37
5.7	Results for Queue time	38
6	DISCUSSION	40
7	CONCLUSIONS.....	41

LIST OF FIGURES

<i>Figure 1: Sensor node Architecture [11]</i>	6
<i>Figure 2: Vehicle passing by sensor [11]</i>	7
<i>Figure 3: Function design flow chart [12]</i>	8
<i>Figure 4: System Structure [13]</i>	9
<i>Figure 5: Preemption Components [14]</i>	10
<i>Figure 6: working sequence [16]</i>	11
<i>Figure 7: Intersection with approaching EV [17]</i>	12
<i>Figure 8: working System [18]</i>	13
<i>Figure 9: Intersection Environment [19]</i>	14
<i>Figure 10: TMS structure for Emergency vehicle [22]</i>	15
<i>Figure 11: EV related system Enhancement [24]</i>	16
<i>Figure 12: ABMS view [25]</i>	17
<i>Figure 13: Vissim software [26]</i>	17
<i>Figure 14 Work Flow</i>	20
<i>Figure 15: Path selection for EV in Hervanta region</i>	22
<i>Figure 16: Intersection traffic in Vissim [32]</i>	23
<i>Figure 17: Algorithm implementation in model [35]</i>	24
<i>Figure 18: Traffic accident data for pirkanmaa [33]</i>	26
<i>Figure 19: PTV Vissim working Environment</i>	27
<i>Figure 20: Model built in Vissim</i>	28
<i>Figure 21: Flowchart in VisVap for EV preemption</i>	29
<i>Figure 22: Different traffic signals in network</i>	29
<i>Figure 23: Vehicles in Network</i>	30
<i>Figure 24: Travel Time for EV</i>	32
<i>Figure 25: EV in Network and their travel time</i>	33
<i>Figure 26: Travel Time of Normal Traffic Vs EV</i>	33
<i>Figure 27: Speed with other parameters of vehicle in network</i>	34
<i>Figure 28: Vehicles type Vs Speed</i>	35
<i>Figure 29: Vehicle Network performance Results</i>	36
<i>Figure 30: Average stop time graph</i>	36
<i>Figure 31: Delay stop data comparison</i>	37
<i>Figure 32: Safe distance from vehicle ahead</i>	38
<i>Figure 33: vehicles vs. Queue time</i>	39

LIST OF TABLES

<i>Table 1 Comparison of different preemption technologies.....</i>	<i>5</i>
<i>Table 2 Extracted Data from input</i>	<i>24</i>
<i>Table 3 input values</i>	<i>31</i>

LIST OF SYMBOLS AND ABBREVIATIONS

EV	Emergency Vehicle
ITS	Intelligent Transport System
EVP	Emergency Vehicle Preemption
GPS	Global Positioning System
WSN	Wireless Sensor Network
TTA	Time to Arrive
CT	Critical Time
UTMS	Universal Traffic Management System
GIS	Geographic Information System
EMS	Emergency Medical Service
SUMO	Simulation of Urban Mobility
TraCI	Traffic Control Interface
TMS	Traffic Management System
CV	Congestion value
CL	Congestion level
ERP	Emergency Response Plans
VANET	Vehicular Ad Hoc Network
ABSM	Agent Based Simulation Model
POV	Private Owned Vehicles

1 INTRODUCTION

The Thesis is divided into different chapters like introduction of thesis and problem, its background and various methods used in solving this problem that is road clearance for Emergency Vehicles. Many already existing methods will be discussed and the most suitable one is to be selected and extended with some modifications. This will be the part of chapter approach. In implementation, there will be explanation regarding approach implementation using different techniques and related methods for problem solving. After implementation, results and simulations are discussed. There will be a small general discussion about results, simulations and implementation. The last chapter will cover conclusions with possible future opportunities.

1.1 Motivation

Modern road networks ensure safety for motorists and pedestrians. However, around 30% to 60% of all injury accidents occur at intersection [34]. Road accidents and emergency situations have made emergency vehicles important subjects in daily life. There are several incidents occurring every day and EV has to respond and reach in time with minimal delay. The path and route they follow must be clear so that they do not have to stay in lane and wait for the traffic. There are various existing preemption techniques, but most of them have some limitations in implementation. Some have very short range to cover traffic flow data at congestion, some components get damage due to environmental conditions. The best available preemption method can be selected and then connected with fastest communication module like GPS. This will improve the smooth flow and update information availability for EV to follow. And if some accident happens on the way to destination, an alternate path can be selected with low traffic flow.

The working environment of this thesis is PTC Vissim [27]. Since Vissim is the simplest microscopic simulation tool for city traffic modeling and it requires two inputs, Street Network (Maps) and Traffic demand. Vissim is able to connect to other softwares and it is possible to import and export it to connect to different traffic simulation modules. Other simulation tools utilize vehicle speed to obtain exact location and create coordinates accordingly while Vissim uses driver behavior model for data collection. The vehicles in the network are assigned a driver whose characteristics can be changed according to need [26].

1.2 Problem Statement

Traffic and road accidents are one of the most crucial problems the world is facing now days. Over speeding, negligence while driving and high congestion on the road results in loss of precious human lives. Emergency vehicles are responsible to respond and reach at accident sight. The main problem for this thesis work is to find the best preemption technique and develop an algorithm that can minimize traveling time for Emergency vehicles and provide information to select shortest path to avoid traffic.

Traffic lights at road intersections are the main obstacles for EV at time of congestion on roads. An algorithm is required, that provides information about vehicles at intersection, congestion on the road and number of traffic lights. Then allocate emergency vehicle a green light to reach its final point in shortest possible interval.

1.3 Hypothesis for Research

By selecting efficient and optimized preemption method and developing an algorithm for EV preemption in congestion areas, it is possible to solve the traffic congestion problem for EV. When this problem is solved, the EV can perform better and can correspond to emergency calls more efficiently. By selecting the best preemption method, it is possible to avoid time consuming routes and by selecting variable traffic signal algorithm, it is possible to respond to emergency situations more quickly. Creating and sharing the solution built in PTV VISSIM and Net Logo, it is possible to make EV travel path simpler, efficient and time friendly.

1.4 Objective

The main goal of this thesis is to solve traffic congestion problem and develop optimized algorithm which can provide green light for EV in need of emergency. The solutions should be general and easy to use so that it can be used for further development. The final result may end up in producing different source codes, algorithm, simulations and most efficient preemption method.

1.5 Limitations

There is no limitation of programming language in this thesis. Some algorithm in this thesis is written using VisVap logic and some are implemented using Vissim built in functions.

2 BACKGROUND

This chapter focuses on emergency vehicles, their types and technologies being used. This chapter highlights selecting best preemption technique and methods. Technology has always played an important role in development of many systems. With the passage of time, new methods and technologies were invented to benefit human beings. With new technology, safety is becoming one of the most important concerns. When it comes to safety, Emergency vehicles are known as one of the most important elements. It includes ambulance, police vehicles and fire trucks. They are mostly operated in high congestion levels which result in delay to reach in scene of incident or fire.

As vehicles on the roads are increasing worldwide, traffic density and delay times are emerging as one of the biggest problem [1]. Considering the traffic issues, a lot of research work is going on in Intelligent Transportation system (ITS). Another concern is avoiding the crowded place in the path which can cause delay in reaching destiny. The efficient solution developed to avoid these problems is preemption technique. In preemption, vehicles are detected by sensors which are installed at intersections. And they transmit the data to provide Emergency Vehicle green light until the vehicle is passed through traffic [2]. Due to high traffic on the roads there are a lot of accidents and delay so the safety of emergency vehicles can be make possible using Emergency vehicle preemption (EVP) technique [3].

2.1 Background

Emergency vehicles have to do tough job in emergency incidents. They have to respond to emergency call and reach their destination as soon as possible. Fire trucks, ambulances and police vehicles are typical examples of emergency vehicles. Advancements and research to reduce traffic incidents lead to various useful techniques which are considered one of the latest technologies. Intelligent transportation system (ITS) is one example of modern technology and signalized preemption technique is the result of advancement in ITS. Intelligent transport system is road management system, which is responsible for all kind of traffic safety and investing in methods which help in minimizing energy consumption by on road traffic.

2.2 Emergency vehicle preemption (EVP)

EVP is specially designed for emergency vehicles by prioritizing and providing green light when they approach traffic signal and red light to other traffic [4]. There are many EVP technologies which are being used and implemented like light based, sound based, infrared based, GPS based and radio based. A signal preemption system can decrease the response time of EV once it approaches. Preemption at signal helps emergency vehicles to pass through congestive intersection quickly to act faster to emergency call. Preemption is applicable only when emergency vehicle have to reach far place and cover some distance [5]. Preemption signal provides priority and safety on high speed roadways where EV wants to enter intersection from normal road.

The main focus of preemption signal is fire trucks and ambulance. The preference to emergency vehicles is given by interrupting the normal traffic, so sometimes it takes much time or delay the normal recovery time for the traffic in peak hours. The majority of traffic signal preemption system for emergency vehicles use transmit device which is mounted on vehicle and receiver at traffic signal [6]. The receiver receives the transmitted signals from approaching EV and forwards it to controller to favor the signal for emergency vehicle. The receiving technique includes siren, strobe light, radio signals and GPS system. So adopting the preemption technology can create a huge difference in safety, road traffic control and quick response to emergency conditions.

2.3 EVP systems and their working

Emergency vehicle preemption interrupts regular signal system and gives priority to emergency vehicle with minimum delay [7]. A signal from emergency vehicle is sent to the detector which interacts with the controller of traffic system so that the traffic lights can be changed for emergency vehicle. There are various approaches of implementing preemption systems which include

- a) Line of sight systems uses infrared signal which acts as warning light [8]. Then emergency vehicle emits visible light flashes at specified frequency which is compatible with traffic light receiver. Signal is received by traffic light and preemption request is forward to signal controller and the lights are changed accordingly.
- b) In systems based on sound, the siren of approaching vehicle acts as emitter [9]. The traffic light has microphone and processing unit which captures waveform. It can detect the siren. The microphone can detect the siren waveform and once it is detectible, it is sent to controller as preemption request and the action is taken accordingly.
- c) GPS based system requires communication and different equipments to trace location, approaching direction and velocity of emergency vehicle. This infor-

mation can be used in deciding which traffic light to be considered for preemption.

- d) Radio based preempted technique is suitable for short ranges. It uses directional antennas which are mounted on both emergency vehicle and traffic light receivers. As soon as the radio signal and approaching direction of travel is recorded, preemption request is being sent to controller and the action is taken accordingly giving preference to emergency vehicle.
- e) System based on Sensor controls switching operation of light using some algorithm. The vehicle is equipped with sensors which perform the preemption operation for emergency vehicle.

Below is the *Table 1* defining the difference and properties of each preemption techniques [10].

Table 1 Comparison of different preemption technologies

Consideration	Optical system	Line of sight system	Radio system	GPS	Sensor system	Acoustic system
Emitter required	Yes	Yes	Yes	No	Yes	No
Noise interference	No	No	Yes	No	Yes	No
Clear line of sight required	Yes	No	No	No	Yes	Yes
Weather interference	Yes	Yes	No	No	Yes	No
Preemption of other vehicles	No	No	Yes	No	Yes	Yes
Illegal triggering of preemption	Low	High	High	Low	High	High
Traffic signal monitoring	No	No	No	Yes	No	No

There are different factors which can affect the preemption systems so they should be considered while implementing.

2.4 Available Preemption Technologies

There is much research going on how to make preemption technologies more efficient and better so some of the important methodologies and solutions are discussed below.

2.4.1 Wireless Sensor Network (WSN)

WSN has many application areas like health care monitoring, weather monitoring, military automation etc [11]. It can be used in traffic monitoring system to collect information about incoming traffic, traffic volume on that specific road and traffic volume during hours. The sensor network has two types of sensors in it

- Intrusive type
- Non intrusive type

Intrusive sensors are placed under the road surface to record traffic volume at signal and they work like metal detectors. The non intrusive ones are used along the roads and include acoustic sensor and video image processing sensors. Their main purpose is to record the exact amount of vehicles waiting at intersection.

These sensors are small in size and works on low energy consumption. They work on solar energy for the day time and in fog and cloudy season, they work on battery.

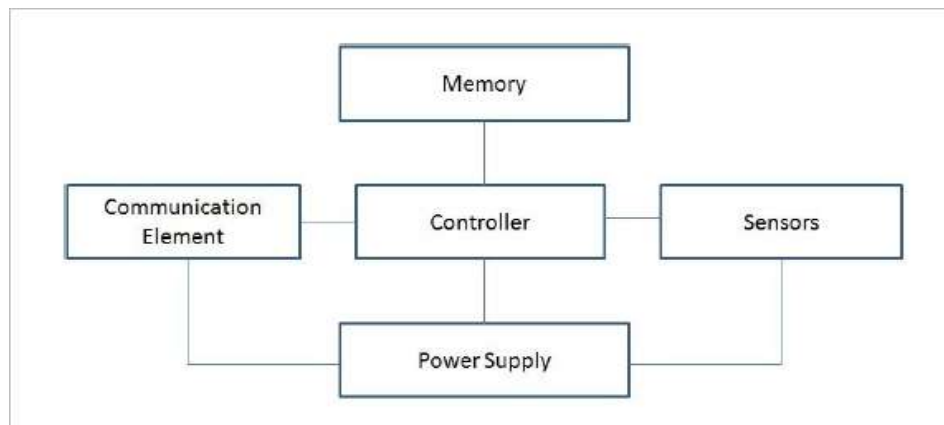

Figure 1: Sensor node Architecture [11]

When the emergency vehicle passes by, the sensors which are installed along the road detect approaching vehicle, it passes the information to next intersection that the emergency vehicle is approaching so clear the traffic signal. Sensors which are placed at Road side have variable sound detection capability to differentiate between the sounds coming from many emergency vehicles. This property helps to differentiate emergency vehicles from ordinary vehicles and then the sensors trigger event.

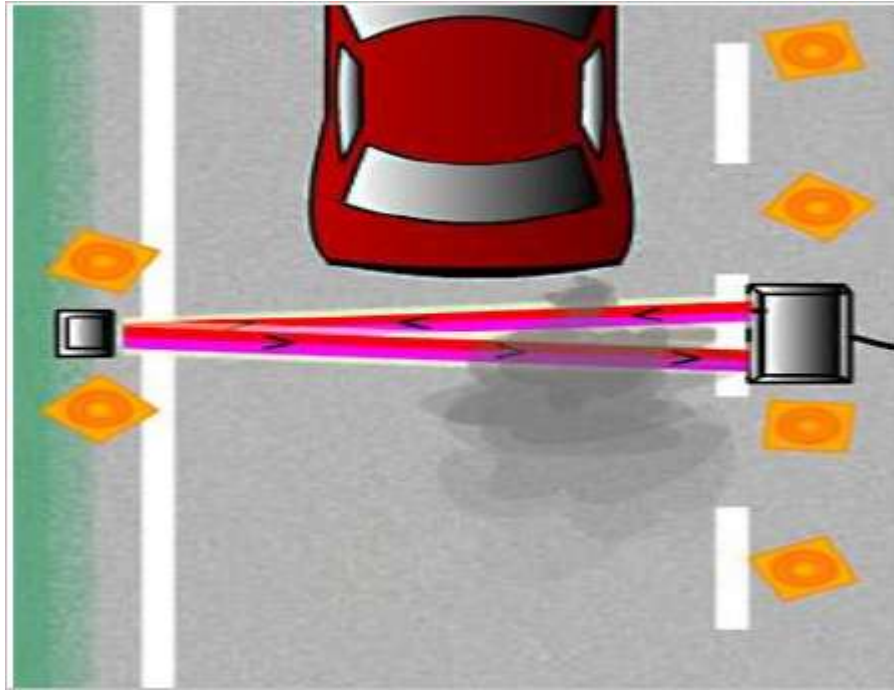

Figure 2: Vehicle passing by sensor [11]

Now if there are many emergency vehicles at intersection, the preference will be given according to first come first serve basis. The side from where the first trigger event is received will be given priority.

2.4.2 GPS Based Preemption Control System

The main components being used in the system are transmitter, receiver, controller, road routing system and pressure sensors. In case of emergency the preemption system is activated and the position of EV is detected when the driver inputs the destination address. The shortest path is selected for the particular route and traffic lights are being controlled.

The messages are transferred and they contain the information about the EV velocity, its longitude and latitude. There is also information about the traffic lights in the way and their longitude and latitude. The message is encapsulated in to text form and the message is sent to the desired traffic lights for the action.

A microcontroller and GSM modem is connected to traffic light that receives exact position information and responds accordingly. To do that, traffic light calculates two quantities which are Time to arrive (TTA) and critical time (CT).

Main flowchart of the system is given below.

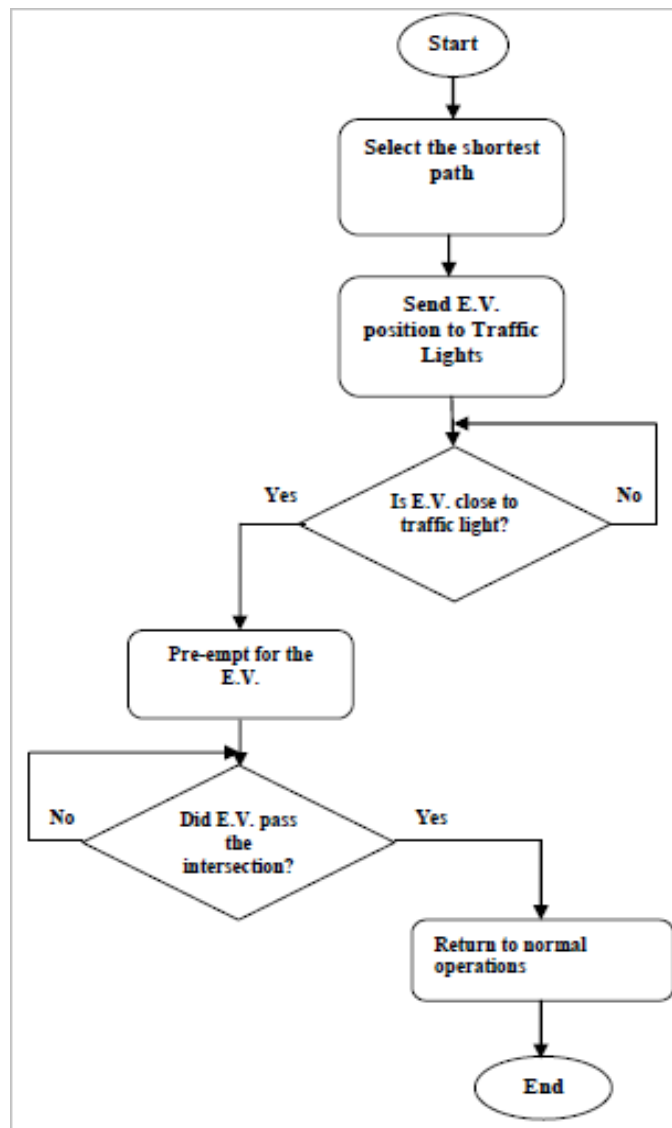

Figure 3: Function design flow chart [12]

The TTA and CT are calculated and compared. Then the action is taken according to the situation. The traffic lights have various amount of sensors at intersection to calculate total number of vehicles, this information helps vehicles to change their state from ready to moving state. As soon as the path is selected, the address of EV is sent to traffic lights and its position is being checked. If EV is close by then preemption is done unless it passes intersection and after its passage, normal traffic routine is returned.

2.4.3 Fast Emergency Preemption Systems (FAST)

Fast emergency preemption system operates emergency vehicles by using two way communicating characteristic of infrared beams. The system allows smooth and safe operation of emergency vehicles using signal priority for emergency vehicle. Safety Messages to alert other vehicles which are approaching and guiding the emergency vehicles for the routes they follow it is one of the important structures which can com-

municate in both ways. These are basically installed at the road corner and its salient features are

1. It has multifunction capability for collecting and providing traffic information
2. It has size of 3.5 meter * 3.7 meters for two way communications between vehicle and beacon.
3. It permits per lane communication too like straight, left and right.

The figure for the system described above is represented below.

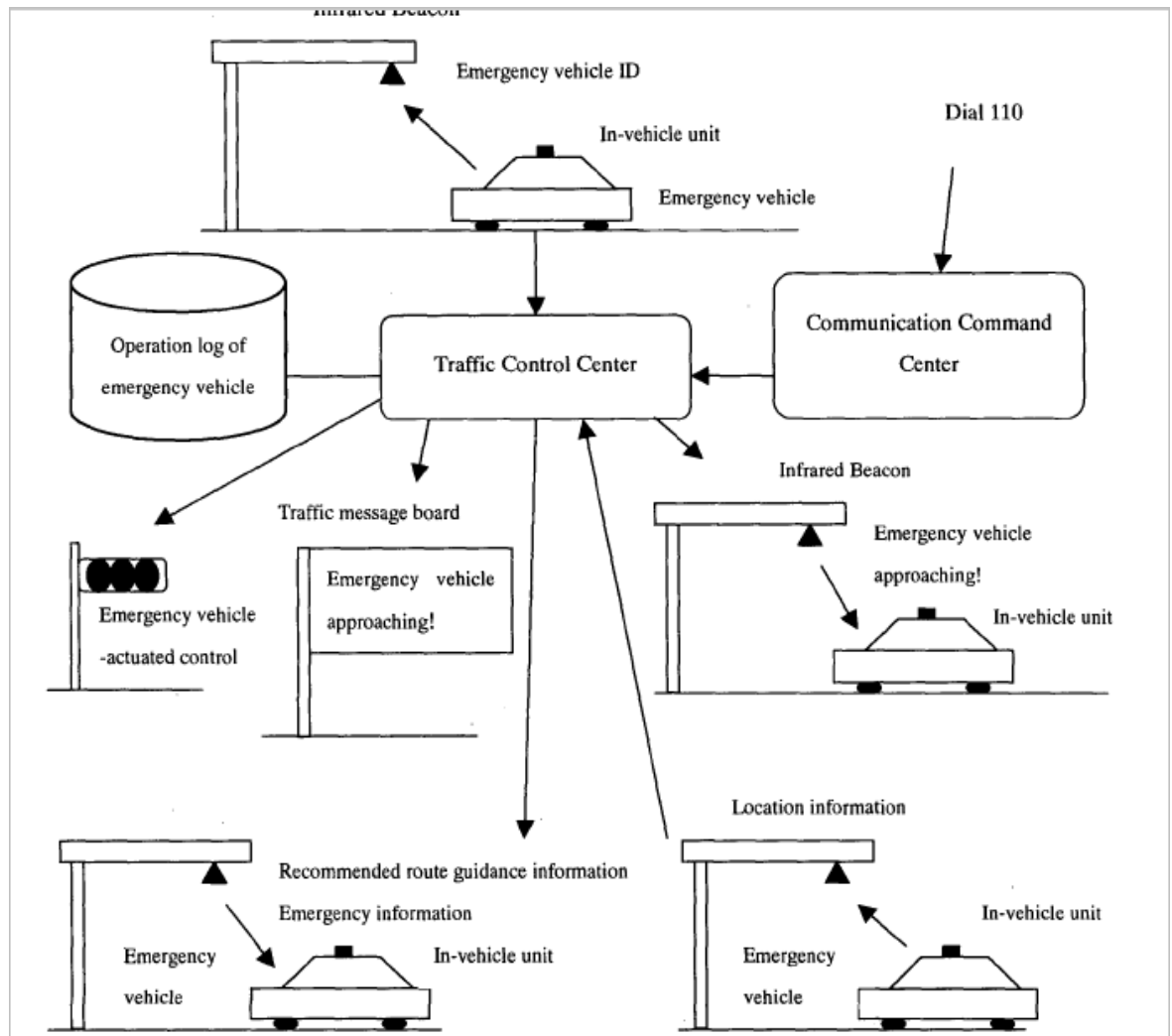

Figure 4: System Structure [13]

2.4.4 Infrared Receiver System

Emergency vehicles preemption (EVP) devices help EV in reducing response time and increasing safety [14]. In collier, all the traffic is following ITS. EVP device consists of two main parts the infrared receiver and confirmation beacon (white light). It can be seen in figure below

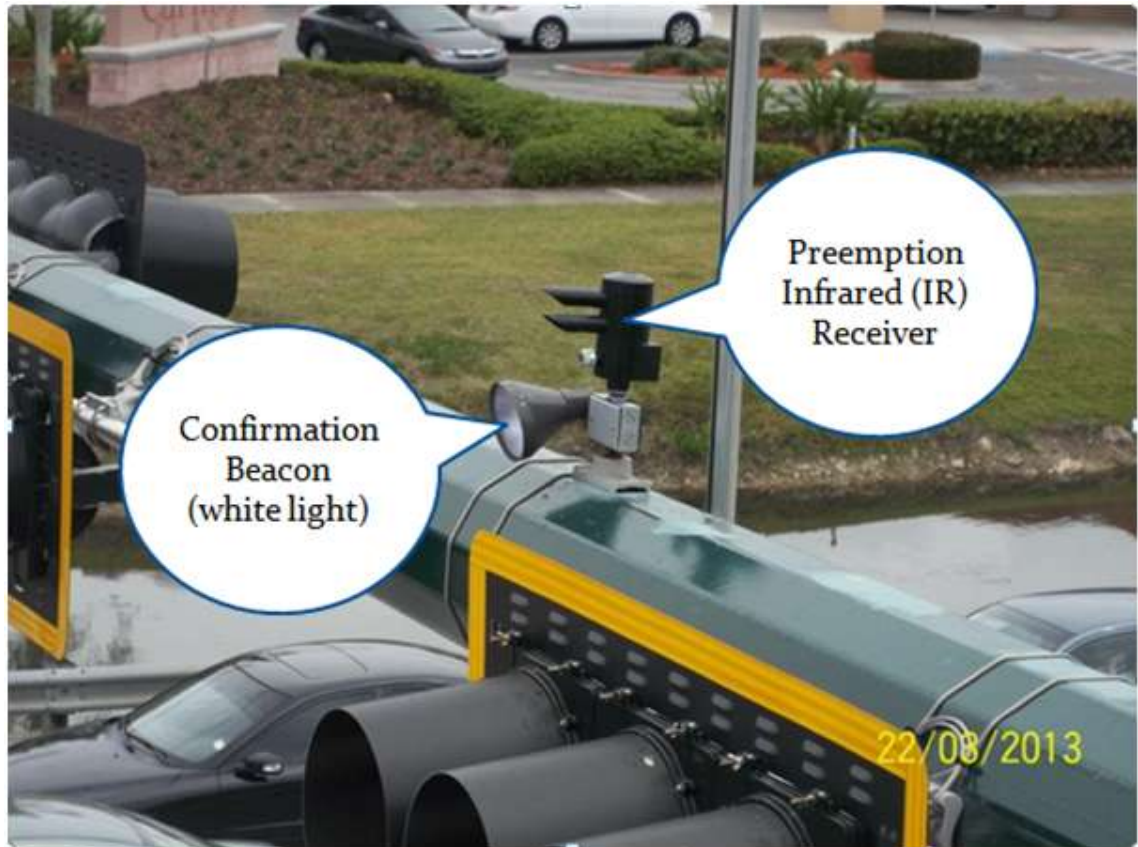

Figure 5: Preemption Components [14]

Fire and ambulance vehicles are equipped with infrared emitter and emergency response teams control the traffic lights accordingly. This preemption technique can affect the remaining traffic but thanks to intelligent transportation system (ITS), which helps traffic operation to its normal routine with no delay.

2.4.5 Differential GPS System

Common approach is to provide the apparatus on EV which transmits emergency signal and is received by receiver installed at traffic signals. It acts accordingly and preemption signal is activated upon request. These systems require installation of sensors to determine traffic flow and congestion at intersections which are expensive to maintain. The main difficulty is determining the arrival of EV at intersection because preemption cannot be activated earlier or later.

So the new system is designed to accurately inform about EV arrival and control of traffic signals accordingly [16]. The system includes traffic signal subsystem and a vehicle subsystem. The working of differential GPS is most important here. It receives the signals from vehicle and transmits. While again receives the real time signals of approaching vehicle and transmits to intersection computer to preempt request. It is known for more accuracy and better result as compared to normal GPS.

The schematic figure of the process is shown below

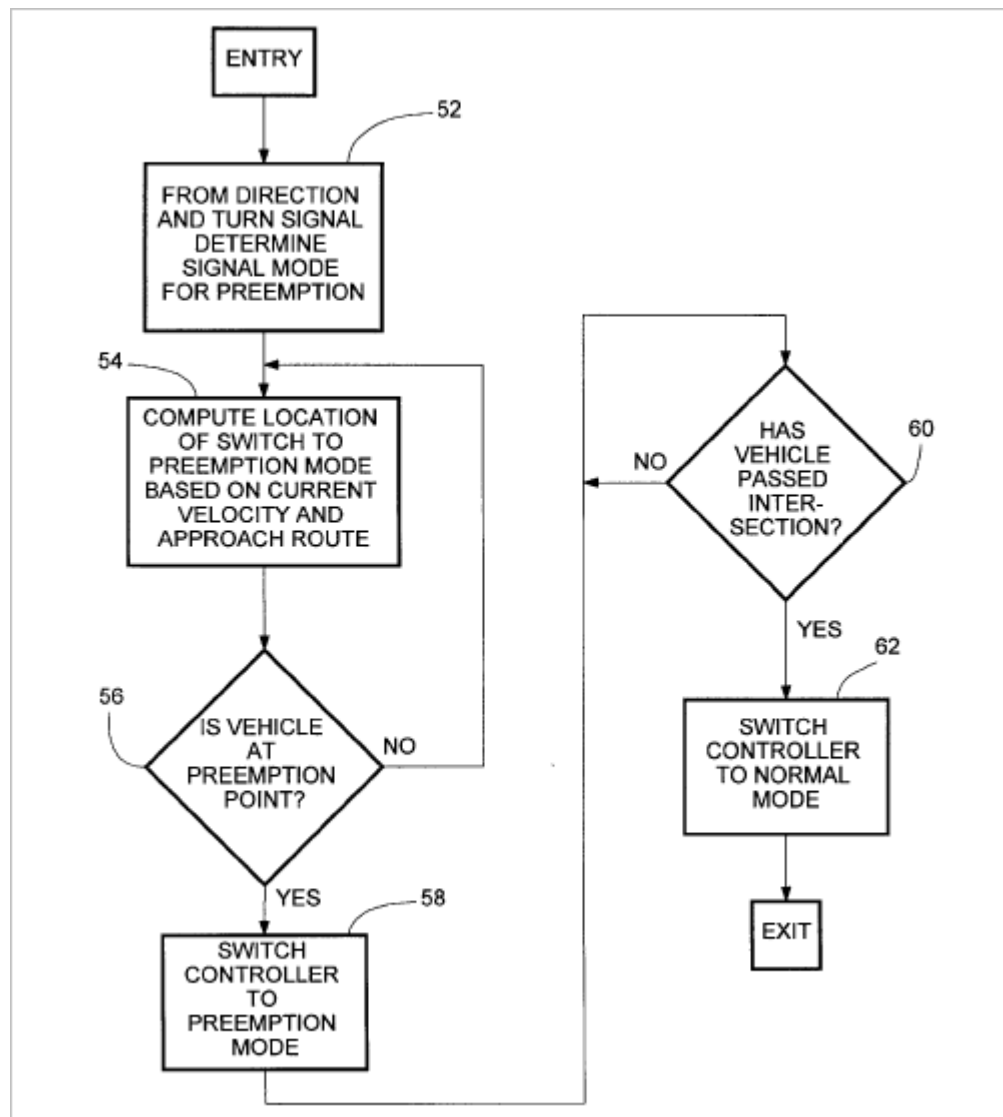

Figure 6: working sequence [16]

When the vehicle is approaching, the velocity and travelling route is calculated and as soon as the vehicle is at preemption point, the controllers are switched to preemption mode. As vehicle pass through intersection, the normal mode is activated.

2.4.6 Warning System

One of the problems is that surrounding vehicles are not aware of EV arrival. They slowed down and stuck in traffic at street intersections which causes delay. Another issue is people listening to high volume radio in car and cannot hear EV.

Considering the above problems, the following system is designed to reduce delay and informing surrounding vehicles on possibly arrival of EV.

A system on approaching emergency vehicle with following equipments

- i. Transmitter
- ii. Receiver
- iii. An audio and visual indicator.

The transmitter is used to activate receiver which is affixed near traffic signals to audibly and visually warn vehicles that EV is arriving and clear the path. Additionally a radio signal transmitter is also adopted in EV to broadcast an emergency siren signal over receiver. The transmit broadband is of AM and FM frequencies which will broadcast on radios to give warning.

The receiver also activates and deactivates audible and visual indicator. It also deactivates indicator when EV is moving away.

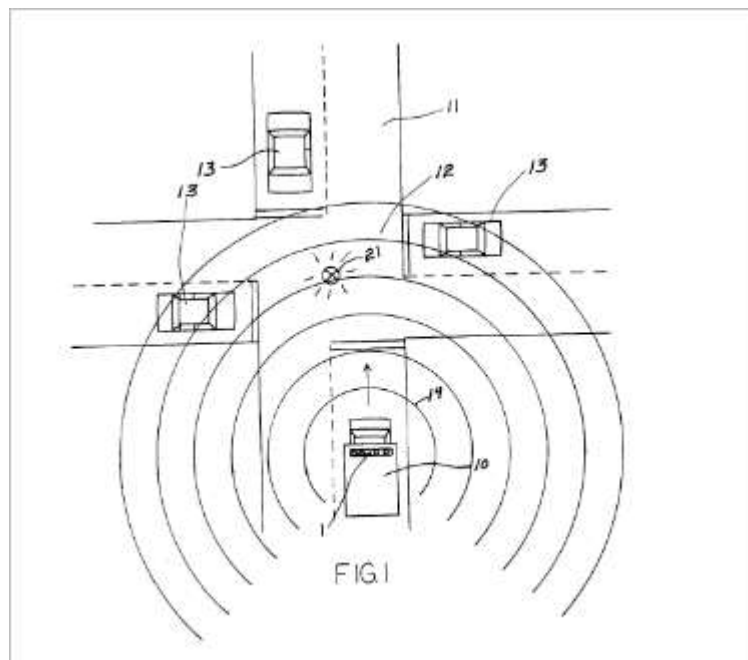

Figure 7: Intersection with approaching EV [17]

2.4.7 GIS Based System

The details of this system are explained as below

GIS subsystem

It is a computer based information system which enables modeling, analysis and presentation of geographic data. GIS provides integration of various applications like displaying map, attribute data and perform spatial task. It also offers tools to find shortest path. GIS helps emergency response considering the following situations [18]

- Identifying emergency call location
- Provide dispatchers all information
- Determine the quickest route
- Analyzing incident volumes

Positioning system

GPS is the most reliable tool to determine position. It is important to determine the position of incident so that EV can reach to exact location without any problem. It provides approximate information about time to reach destination.

Communication system

This unique system helps in establishing communication link between vehicle and dispatcher. It includes sending and receiving data to/from vehicle. The vehicle data transmitted through communication system includes current position, progress along planned route and all necessary information.

The above system can be explained using following figure

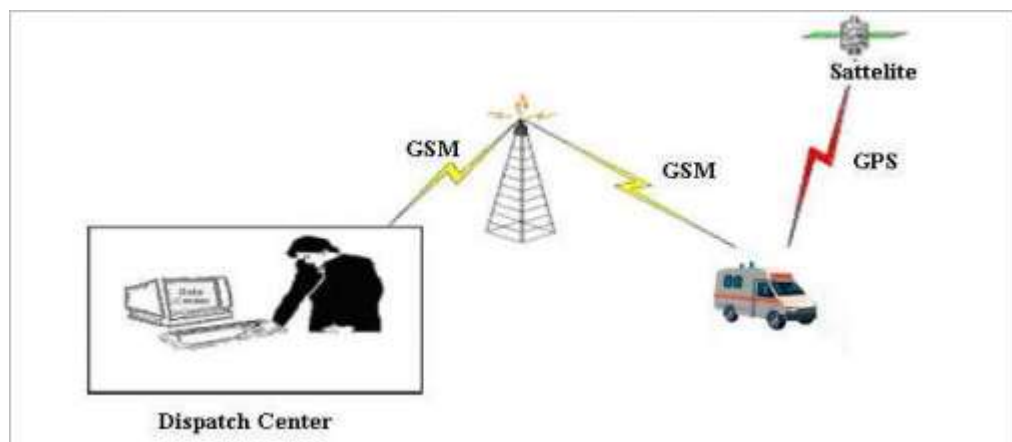

Figure 8: working System [18]

2.4.8 Collision Avoidance System

There are many ways to inform the arrival of EV like sirens, horns [19] and audible signals etc. when there are two or more vehicles are at intersections, these techniques are not efficient and reliable. To resolve this issue, traffic collision avoidance system is introduced to make working of EV more efficient and useful.

This system includes plural Emergency Vehicles and each vehicle has device to determine direction of travel. EV is also equipped with transceivers to transmit the direction signals and receive the direction signals of other EV around. Each vehicle has direction vectors for their path which helps to avoid collision.

Following figure explains the situation well.

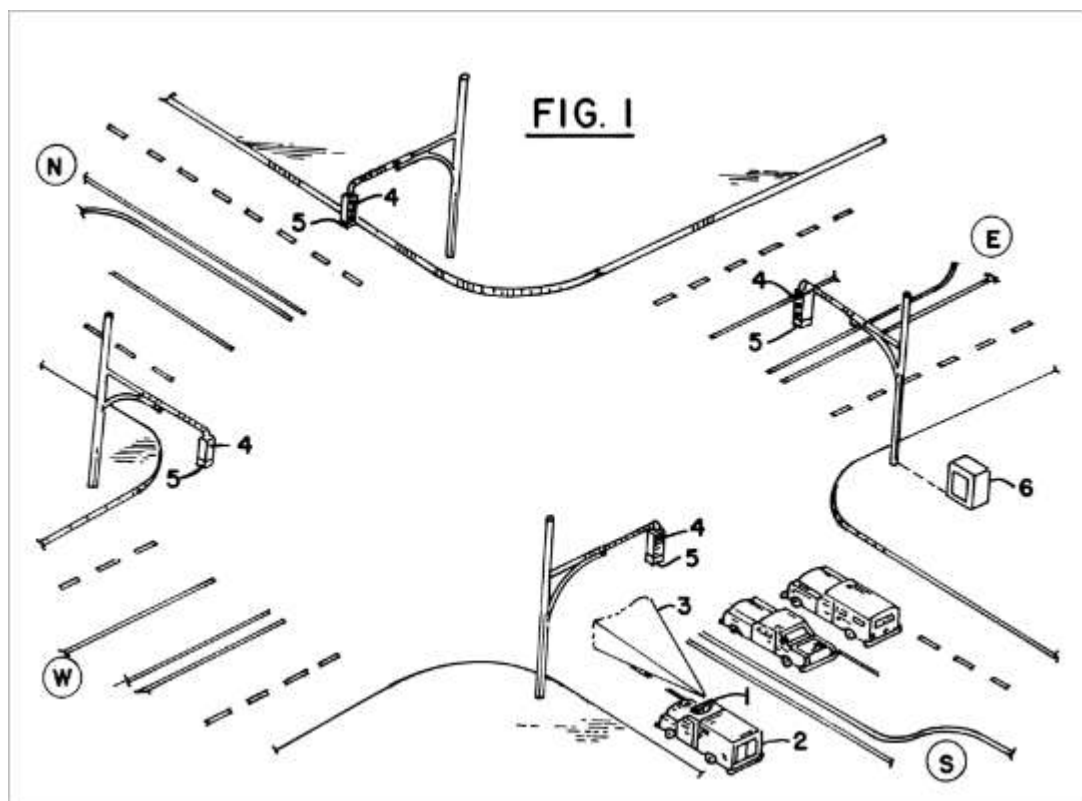

Figure 9: Intersection Environment [19]

The equipment is installed in EV and each EV can interact with another EV nearby to inform about the preempt traffic signal. The directional vectors are displayed on screen of EV which helps in locating nearby EV and interact with it if necessary.

2.4.9 Improved Warning Signals System

The warning signals or signs in EV can be improved to make Vehicle more visible to passengers and surrounding people [20]. The light colors include lime and yellow can be more helpful in visibility of EV. It was studied and the results proved that lime yellow has more visibility effect then red or any other. And secondly to overcome the noise, the sound system must be loud so that it can be heard inside the vehicle too.

2.5 Other Approaches

There are many other methods and technologies which are implemented to reduce the travel time for EV in road traffic congestion. They are discussed below

2.5.1 Fuzzy Control

One approach is using fuzzy control with TMS (Traffic Management System) to speed up EV by avoiding maximum obstacles in their way. Output of fuzzy control and emergency response plane by EV are two critical factors that need to be considered. The simulations are carried out to show the improved less travel time for EV while keeping the non emergency vehicle load steady on road. The traffic conditions are acquired from road network and passed to fuzzy controller which gives a value which is sent to ERP to plan action for EV [22].

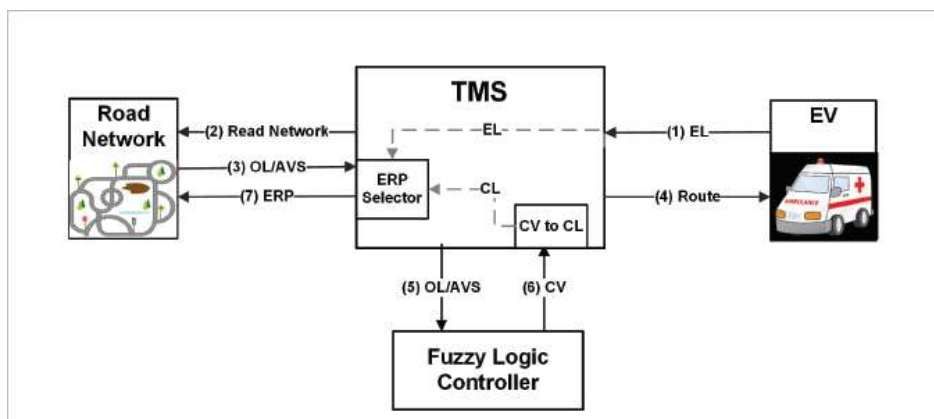

Figure 10: TMS structure for Emergency vehicle [22]

2.5.2 Emergency Vehicle Signaling Using VANETS

VANET (Vehicular ad hoc network) is used for communication and it is advance application which can improve safety and optimize road traffic to provide intelligent transport system. Main criteria are signaling to nearest traffic light so that green signal is achieved. Information like GPS position and so on can also be sent to other vehicles

to establish Vehicle to Vehicle communication. The main aim is to provide green signal to EV throughout route [23].

2.5.3 Simulation and Modeling Using CORSIM

Due to development in technology, many new softwares and modules are used to monitor traffic congestion, EV travel route and emergency responses. The unique quality of this software is building information transfer between Emergency Vehicle and POV (private owned vehicles). Driving behavior and control systems are simulated and it is successfully implemented in London and Virginia. The main finding is improving the travel time of EV in critical situations [24]. The figure below represents the values used in this technology

sub-system	New Attributes or Characters	Instances or Variables
Vehicle*	New Fleet Type: EV	Police car, fire truck, ambulance
	Preempt emitter	Effective distance
	Free flow speed	
Driver	Auditory Detection parameters	POV's awareness of EV
	Visual Detection parameters	
	Reaction Time	POV's Reaction of EV
Road	Motivation factor	Median Availability
		Shoulder Availability
Signal	Preempt receiver	Distance
	Preemption function	

* Combining with existing vehicle type

Figure 11: EV related system Enhancement [24]

2.5.4 Agent Based Simulations for Designing Control Systems

This is the approach which can be used as extending work in this thesis. The platform used in this technique is Net Logo with multi agents. The distributed control system is designed to facilitate the arrival of emergency vehicles at accident sights. The software Net Logo has simple programming language and graphic interface to use and simulate the results to see real time traffic at intersections and planning the routes of EV accordingly. Many emergency vehicles like police, fire brigade and ambulance can be operated through this network and priority can be selected by considering the type of emergency situation. The figure of network with multi agents is given below [25].

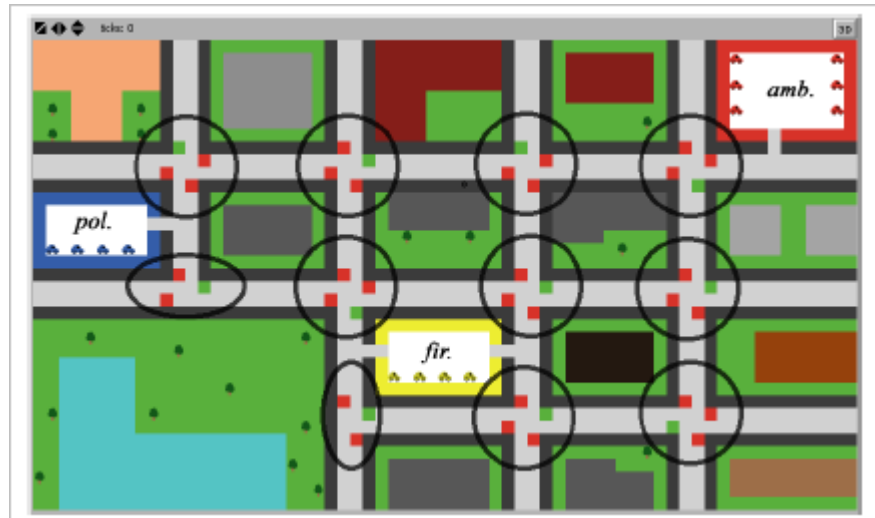

Figure 12: ABMS view [25]

2.5.5 Multimode Traffic Flow Using VISSIM

Vissim traffic simulation is developed by PTV group [26], a German group to improve the transportation, analyzing transportation priority schemes and data collection from different vehicles. The complex geometries can be developed easily using links and connectors. Vehicle characteristics and driver attributes makes it more interesting. Furthermore it provides large number of interfaces, which can be integrated with other systems for signal controlling, traffic volume management and carbon emission models. This is considered as one of the powerful tools for evaluation and planning of urban and non urban vehicles. It can generate detailed 3D simulations of even a complex design.



Figure 13: Vissim software [26]

Now it is easy to think of any complex design and implement it using Vissim. Its fast compilation and most advanced built in features help in development of models easily. This tool is used in this thesis because of its vast interfaces, geometry building and traffic simulation capabilities.

2.6 Summary

In this chapter, different preemption methods are discussed in depth with their properties and limitations. Every method has some salient features which other method lacks. Thus, it helps in deciding which method is suitable for this thesis considering different parameters like cost of implementation, long term advantages, future development and competitiveness. So after background research, GPS based preemption method is selected for this thesis. It is efficient to use, cannot be affected by weather conditions and low cost module to be implement with high accuracy rate. Background research also helped in discovering new dimensions and scope for future work.

3 APPROACH

Before going in to implementation phase, it is necessary to define working atmosphere, methodologies and tools to be used. This chapter focuses on the methods and approaches in solving problem. There are several tasks to do before starting implementation like Traffic signal control design for emergency vehicles, Data collection for traffic congestion at various selected routes using appropriate tools and algorithm design for signal controls. So in this chapter, there is detail description for approach used for problem solving.

3.1 Traffic management for emergency vehicles

Getting traffic solution from real time traffic data is nearly impossible. The real time situations and complex network are those critical factors which make it impossible. There is always traffic on the road so we have to construct model to analyze an idea. In this chapter, model having intersections and traffic is introduced. The model is constructed using tool and later on evaluated and analyzed. Due to vast amount of data, particular intersections were selected for data collection and research.

3.2 Emergency vehicle priority strategy

The aim in this case is to provide EV green lights throughout its journey. Simple logic is used to create an algorithm for emergency vehicles.

Design the variable type traffic control signal and place the detectors on the road just before the stop sign. As long as the detectors do not have any emergency vehicle detected, the normal traffic flow will continue. But as soon as the emergency vehicle is detected by detectors, it will prioritize it and change the traffic light to green unless the vehicle is passed through intersection.

This is a balanced algorithm which helps both normal traffic and emergency vehicles. If more than one emergency vehicle is detected, they both will get the green light and as soon as they pass through safe intersection distance, the red light for normal traffic is triggered.

3.3 Work flow

There are various steps which should be carried out to implement this preemption method and the flow chart below explains them with details.

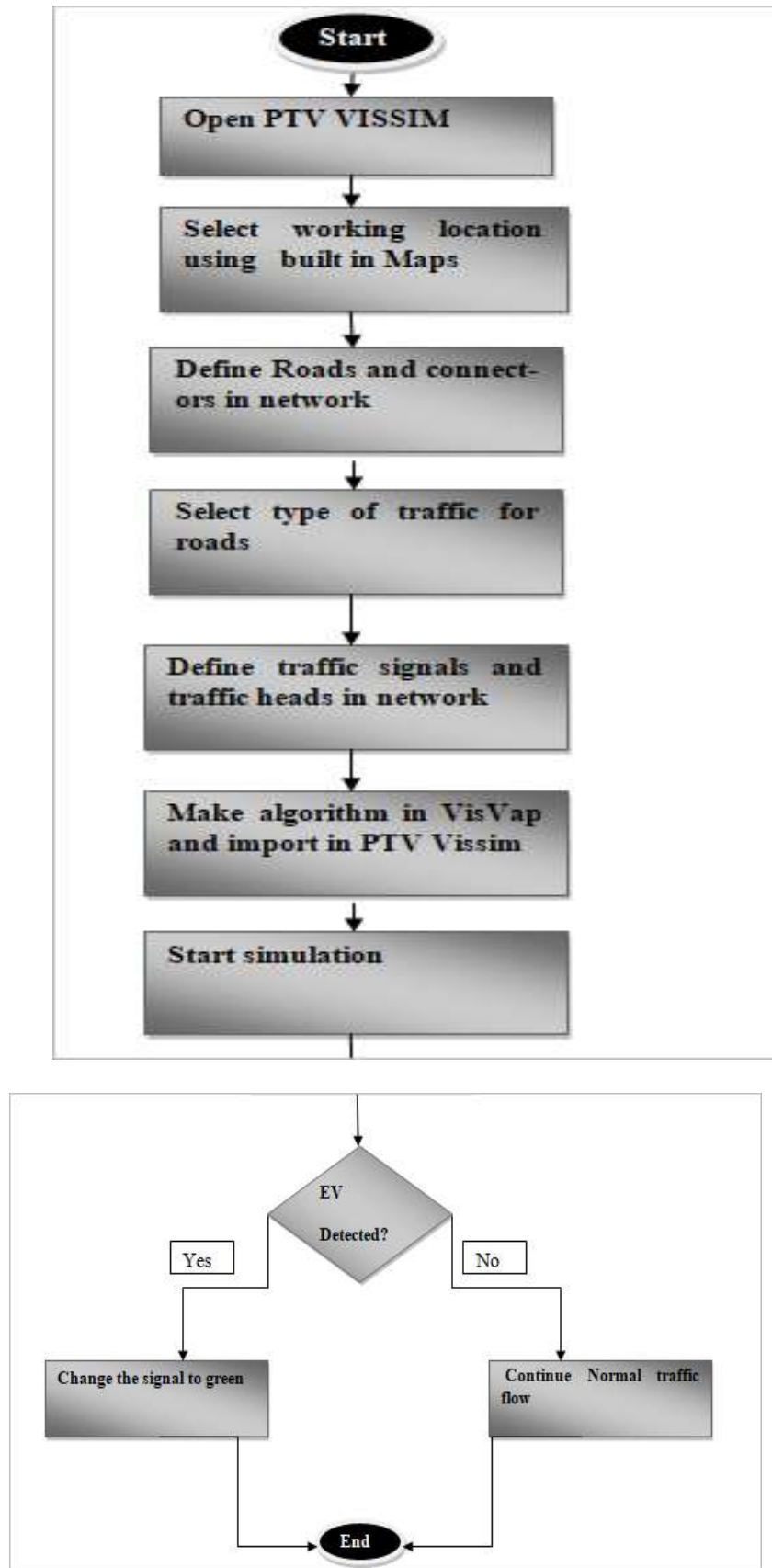

Figure 14 Work Flow

This workflow helps in understanding the steps to build the model from scratch. First of all the working environment is selected which in this thesis is PTV VISSIM. After that, define the location which is going to be used for implementation preemption. Vissim has default map options like Bing maps and street view maps. The location can be selected from the map and street view can be the best option to view details around selected location. Then define the starting point, end point in the network and build Roads and connectors. The roads are simply built using Link function and connectors are used as joints in building and extending roads.

After that the next step is to define the traffic on these roads. The vehicle composition can be defined in the network, it defaults has bus, car, tram, bicycles and vans as default traffic. As we need to use emergency vehicles in the network, so the models can be download from (V3d.ptvamerica.com) and import in network. Then define the type of these imported vehicles. We defined these vehicles as emergency vehicles in the network. After defining vehicles types, we have two classes of traffic one is normal and second is emergency vehicles. Now define the volume of traffic on each built road which means the number of vehicles passing in an hour.

The next thing is defining the traffic signals in network. There are two types of signals fixed time and variable. Fixed time signals can be built in Vissim while variable time signals can be built using VISVAP module and can be imported to Vissim. Variable type signals work for both emergency and normal vehicles while fixed time signal only works for normal traffic. After defining the fixed type signal, define the signal heads which contain information about stop time, start time and duration of red and green light etc. Then write the algorithm in VisVap which is found in Vissim and it is basically a logical program like in this thesis it can be detectors detecting EV and changing signals accordingly. The VisVap file can be imported to Vissim and it will correspond to variable type signal.

Then start the simulation and let it run for couple of minutes so that there are plenty of vehicles in the network. Then if the Emergency vehicles are detected in the detectors which are placed near the traffic signal, the preemption is activated till the vehicle is passed through intersection safely. And if there is no EV detected, the normal traffic operation will be carried out.

The different results can be calculated like travel time, Queue length time, waiting time and other parameters. The speed of the vehicles can be defined and controlled too. So this is the workflow which is going to be used in the next chapter for implementation. It is really flexible and can be extended for further observations and functions.

3.4 Traffic Model

Traffic models are used to define actions that can influence traffic system for analysis of efficient methods. They provide insight of complex interactions and help in detection of key elements of system. Traffic models use what if logic to analyze output. Simulation model for the priority of EV can be made with real traffic data. There is possibility to design algorithm for EV which will give priority to it and compare it with normal model. For Example the model used below consist of different intersections with congestion traffic in Hervanta region and it has hospital, emergency centers, start point and end points nearby.

So the traffic model with priority to EV is build, analyzed and compared with normal model to see the difference in travel time, delay and route timings of vehicle.

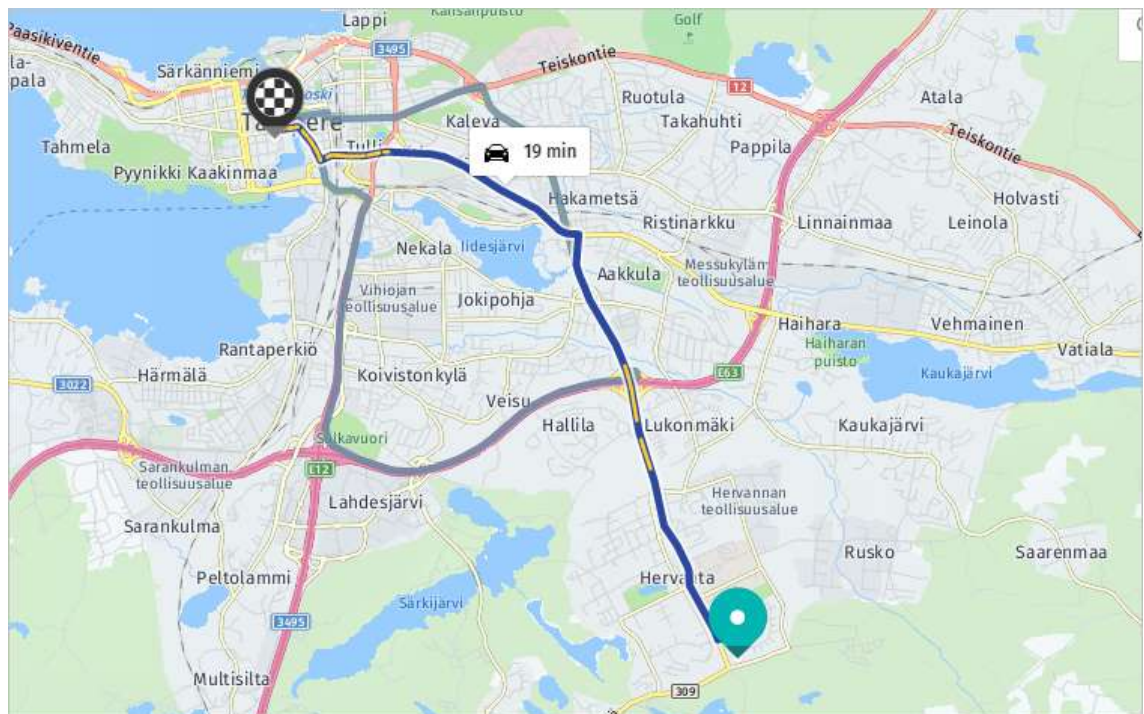

Figure 15: Path selection for EV in Hervanta region

3.5 Modeling Tool: PTV Vissim

Vissim is multimode traffic simulation software which is developed by PTV in Germany [27]. It is well known for its microscopic simulation capability. Many interactions like pedestrians, all kind of traffic and vehicles are simulated in one model. It is one of the best tools which provide realistic modeling for all users [27].

It has various application domains like traffic control, signal controlling and optimization, transportation planning and urban planning. It provides high accuracy in terms of designing. Links and connectors concept helps in mapping a network and model com-

plex geometries it also allows testing of behavior of autonomous vehicles as cost effective alternate [26]. The driver behavior and vehicle properties can be changed according to real time driving conditions. It allows 2D animations and 3D visualizations to easily understand the real time environment. It has various interfaces and can be connected to external signal controller like SCOOT, VS plus Lisa+ etc [26].

It also allows mapping capability with aerial photographs. It is extendable and suitable to pair with different interfaces according to user requirements. In our case, it is useful in getting traffic volume information on particular road, intersection and to examine the travel time for EV on these roads. It provides detailed geometry of road which others lack.



Figure 16: Intersection traffic in Vissim [32]

Vissim can simulate all complex intersections and signal control systems. The main focus is on signalized intersections but it can also be used for unsignalized intersections with signs like stop, speed limit and vehicle priority. For EV, it calculates traffic flow, vehicles in queue, vehicles volume and travel time for vehicles in network. Data can be reported for any point location in network for any intersection, path or entire network. It can also be reported for individual vehicle like EV [32].

3.5.1 VisVap Module

VisVap module is used to create algorithm for signalized intersection for EV. VisVap is easily usable tool for defining program logic for VAP (vehicle actuated programming) signal. During running of PTV Vissim, VAP interprets the logic commands and creates signal control commands for PTV Vissim. The control logic for VAP is described in text file (.VAP) using simple programming language. The signal data for VAP (.PUA) can be exported from Vissim or can be written in txt file.

Algorithm for priority of EV is built in PTV VisVap. It is basically a flow chart with logics which is then compiled and checked for any possible logic errors. PTV provided the thesis license for using this module.

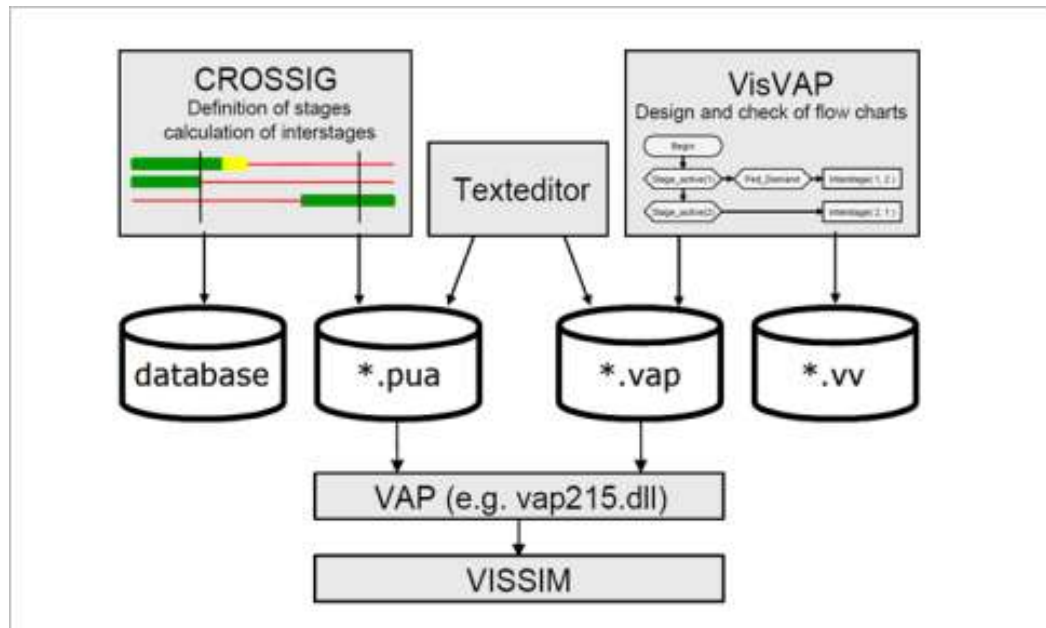

Figure 17: Algorithm implementation in model [35]

3.6 Input Data

The traffic flow, peak hour traffic data are the main required inputs in Vissim. The following data is obtained from Vissim to be used in results during model simulation.

1	Simulation run time (SIMRUN)
2	Time interval (TIMEINT)
3	Vehicle travel time measurement (VEHTRVELTIMEMEASUREMENT)
4	Number of vehicles recorded (VEHS)
5	Average travel time of vehicles in network (TravTm)
6	Type of vehicles in network (Vehtype)
7	Distance Travelled (DISTTRAV)
8	Delay in network (DELTm)
9	Vehicles stop at signal (VEHSTP)

Table 2 Extracted Data from input

During peak hour, the traffic flow and queue counter for vehicles in network is different as compared to normal timings. The main concern is number of emergency vehicles in the network in peak and off peak hours.

3.7 Speed, Acceleration and other parameters

PTV Vissim tool uses functions to simulate real time driver behavior and do not rely on single acceleration value. These are the real time values for every vehicle travelling in network. Every vehicle has acceleration and deceleration values. Maximum acceleration is the value which is used when vehicle is traveling on steep areas. Similarly the maximum deceleration is value for every positive and negative slope.

Desired speed is also one important parameter which is observed during simulation. It is important when the simulation is done at street level and every vehicle can be assigned the particular speed which they follow throughout their travel time. If other vehicle in network is stopping driver, the speed will be still as described for vehicle but with small oscillations.

One of the important features of PTV Vissim is Driving behavior which can be defined for each link. Based on traffic link, they can be categorized as pedestrian lane, highway lane, city grid and bike lane. Driving behavior impacts on pedestrians in the network and can be adjusted according to traffic congestion in network. There are four state of driving which are free driving, following, approaching and braking.

In free driving state, driver is moving on the defined lane and following the speed limit defined for the vehicle. In following approach, driver follows the vehicle in front of it but keeping safe distance from it. In approaching technique, driver adjusts the vehicle speed to slow down the vehicles in front and keeping safe distance. While in braking, the deceleration is done when safety distance is low.

3.8 Road Accidents in previous years

According to [33] the data shows that so far in 2017, the total accidents are 871 till August, while it was 1285 in 2015 and 1410 in 2016. This stats show how important is it to have smart and intelligent transport design so that the emergency vehicles can reach the accident sight in time. The average response time is 10.35 to 12 minutes [33]

Below is the data for the accidents happened from year 2013 to 2017.

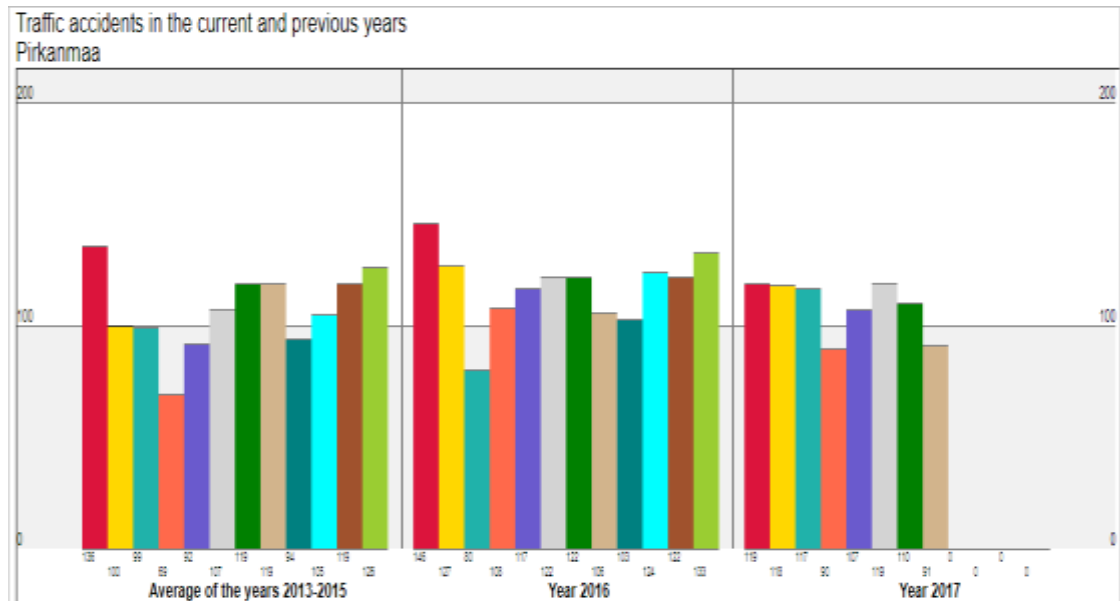

Figure 18: Traffic accident data for pirkanmaa [33]

Data in [33] shows that it take approximately 10 minutes for EV to reach at the sight of accident. This time can be further improved by implementing smart preemption technique and designing intelligent traffic signals for vehicles.

4 IMPLEMENTATION

This chapter focuses on implementation phase used for problem solving. PTV Vissim is used to build intersection models, geometries and structures of network. VisVap tool is used to build fixed time and variable time traffic signals which are compatible with EV.

4.1 Building Intersection Model

PTV Vissim is useful tool in constructing traffic models. Links define the streets and connectors define the intersection on the model. There are built in maps through which the working area can be selected and worked on. Speed limit is defined for each link after that, the signal heads are created with detectors on the road. The types of the signal heads can be defined while detectors help in recording the vehicle approaching. Then vehicle inputs and their types are defined on particular.

The working environment of Vissim looks as below.

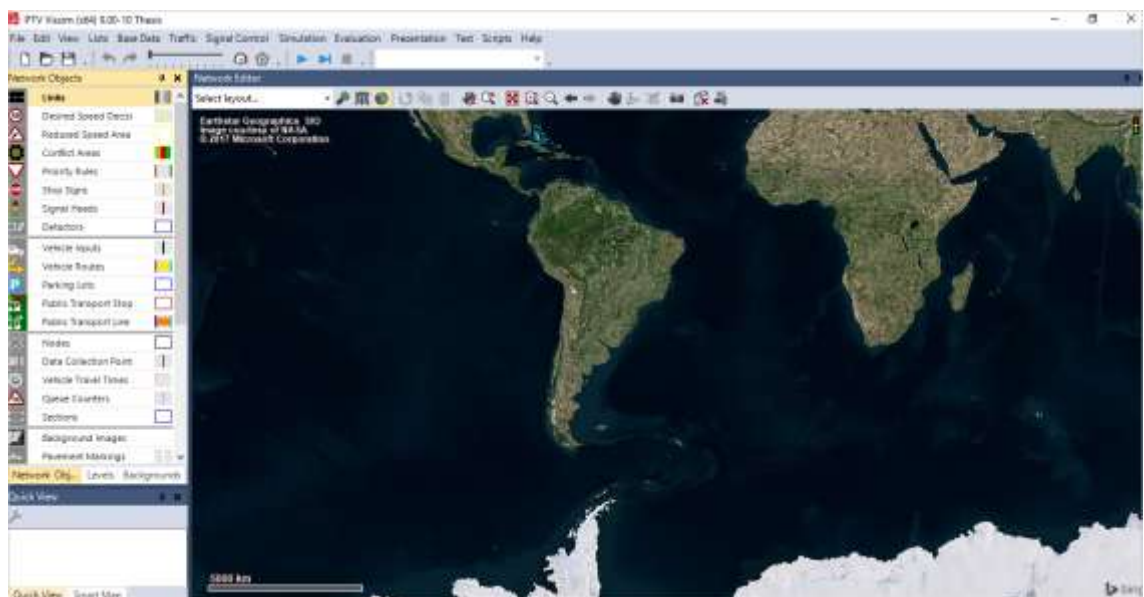

Figure 19: PTV Vissim working Environment

Several points are defined on the route like start point from which the traffic starts and spreads in the whole network till end point. Then there are two hospitals and emergency centre from which EV start and reach the hospitals. The main focus is calculating travel time, vehicle congestion, and Queue counters during traffic. There are two types of signals which are used in whole network. One is fixed time which is used for all traffic and other is variable type which is used for Emergency Vehicles.

The following figure shows the model built in Vissim

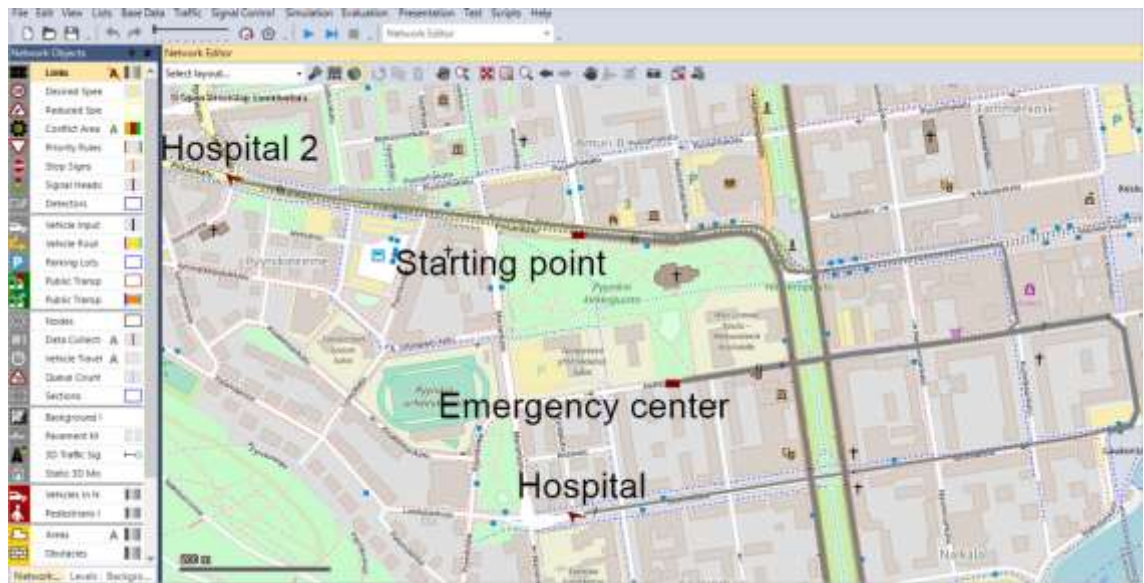

Figure 20: Model built in Vissim

The gray line represents roads for traffic flow in the network and other points are for result collection for traffic and EV flow in network.

4.2 Tool for Traffic signals

There is another tool which is used to develop the traffic signals for Emergency Vehicles like ambulance, police van, fire trucks etc. Normal traffic signal cannot be used for EV because it does not synchronize with EV. So this tool is really helpful in creating signal.

Simple technique is used in creating algorithm for EV preemption signal. The detectors are placed besides the traffic signals and whenever detector detects EV, green light is requested unless vehicle passes through the intersection. As soon as EV is at safe distance the traffic lights are immediately changed for normal traffic. So there is no delay and waiting time for normal vehicles and

The algorithm is written in VisVap and is modeled in Vissim. VisVap is easily usable tool for defining program logic for VAP (vehicle actuated programming) signal. During running of PTV Vissim, VAP interprets the logic commands and creates signal control commands for PTV Vissim. The control logic for VAP is described in text file (.VAP) using simple programming language. The signal data for VAP (.PUA) can be exported from Vissim or can be written in txt file.

The signal head is designed so that the EV has to stop for 2 seconds at the busy intersection till it gets green light. While currently, it takes more than 6 seconds to give EV green light during its journey through busy intersections.

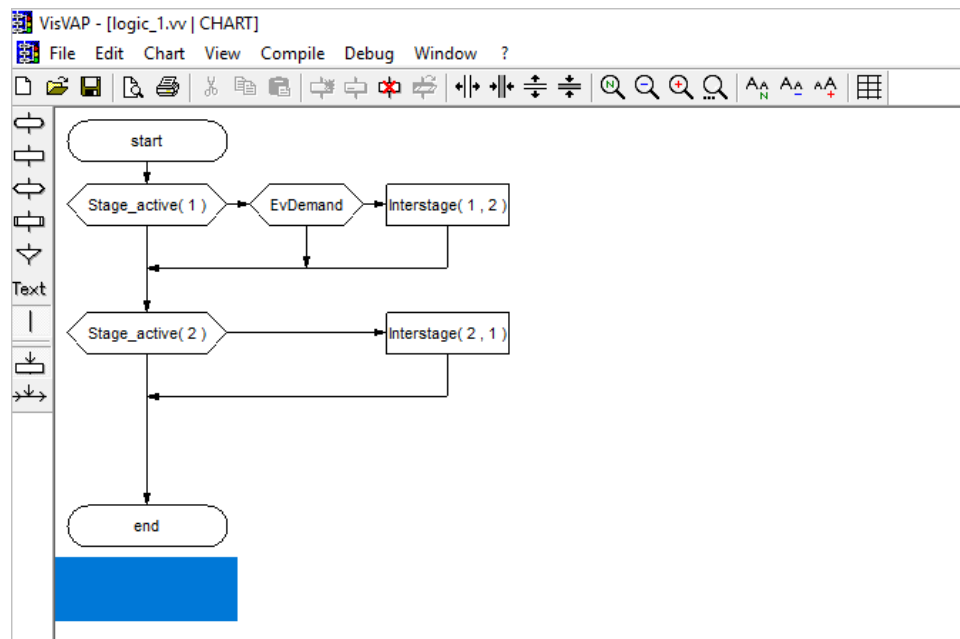

Figure 21: Flowchart in VisVap for EV preemption

The traffic signals are placed on different routes for Emergency Vehicles and for normal traffic. Their position, lane number and type can be observed as below.



Figure 22: Different traffic signals in network

4.3 Vehicles in Network

There are number of vehicles which can be included in network. By default there is bus, car, tram, bicycle, motorcycle and pedestrian. We can select the type and their volume on any link in network. But for Emergency vehicles, the models need to be imported in working directory and then they need to be defined like what type of vehicle it is and then they are assigned some value like in this case 630 was assigned for all the emergency vehicles in this network. All the vehicles can be recorded along with their position, type, speed and acceleration. In this thesis, we defined two classes of vehicles one is normal vehicles which are already there by default and second class is emergency vehicles which is imported and then defined. The volume of the vehicles can be selected on particular link so that the vehicles can flow there for result analysis.

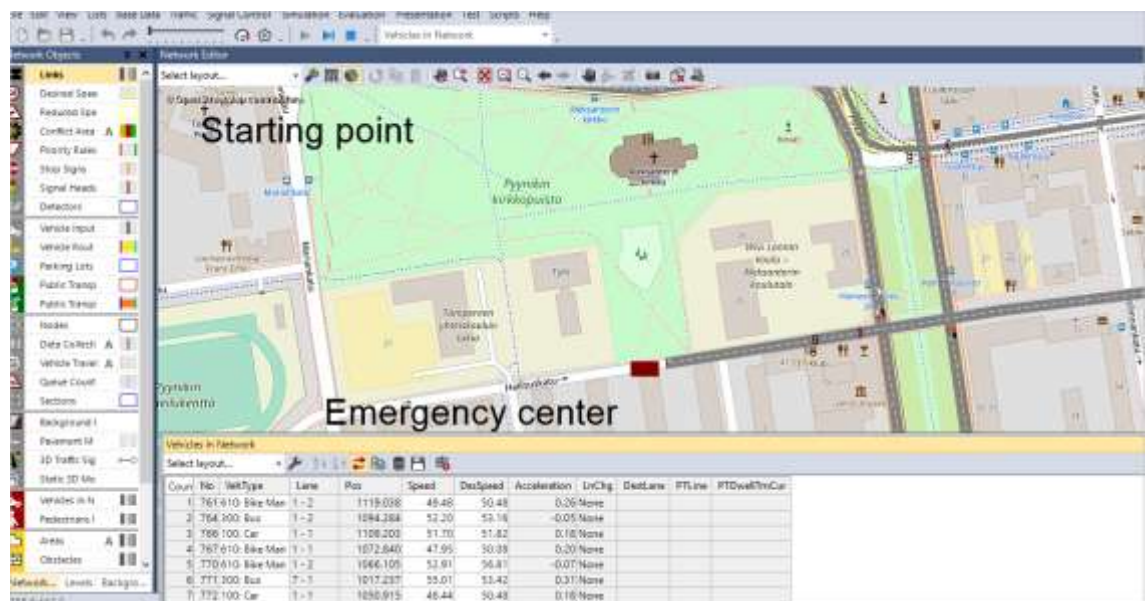

Figure 23: Vehicles in Network

4.4 Various other parameters

There are many other important parameters which are helpful in measuring the travel time of EV. This includes vehicles travel time, their delay times which mean for how much time the vehicle stayed at signal. Queue counter which helps in determining the number of vehicles ahead of Emergency Vehicles at signal. It also gives information about the number of vehicles which have passed through the particular link.

5 RESULTS

Deigned algorithm was tested and Conclusion is made after simulation model was tested several times. Emergency vehicle was placed in a model and run through adaptive traffic signals, which prioritize it. Whenever EV approach the traffic signal, the duration of current phase was reduced and green light was given to pass through traffic.

Different real time environments were created and results were collected in those real time situations. The main goal was to create real road conditions and get results.

5.1 Input values

There are many input parameters which are required to get results. The following values and parameters are used in result collection.

No	Input parameter name	values
1	Vehicle input (peak hours)	1900 vehicles/ hour
2	Vehicle input (off peak hours)	1200 vehicles/ hour
3	Vehicle class	Normal or Emergency
4	Number of pedestrians	150/ hour
5	Traffic Signal type	Fixed or Variable
6	Desired speed of vehicles	50km/h for EV Default for others

Table 3 input values

5.2 Results for Travel Time

So the emergency vehicles were imported in network to find out the average travel time in congestion intersection. The simulation was run for 20 minutes with 5 minutes interval to record data. First, EV was tested without variable signal control which gives priority to EV and travel time values were recorded. The average time of travel came out to be 139.91 seconds.

Then preemption algorithm was implemented and analyzed to calculate average travel time. The value calculated was 131.10 seconds which was 8.81 seconds less than the normal one. So implementing preemption algorithm, Emergency vehicles could reach their final destination 8.81 seconds faster. As there were 4 traffic signals on that route, so it means there is improvement of 2 second per traffic signal using variable type signal controller.

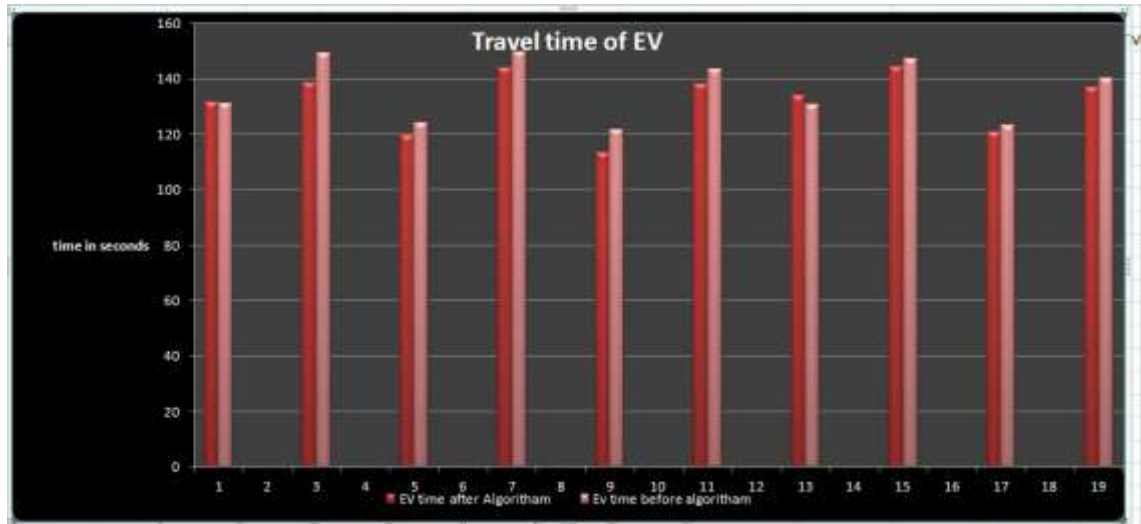

Figure 24: Travel Time for EV

5.2.1 Result for Total Emergency Vehicles in Network

The result in 5.2 was about total travel time of EV in network. In this case, the routes were defined and detectors were placed on the roads to analyze the number of Emergency Vehicles passing through that particular route. As in one hour, there are many numbers of Emergency Vehicles which gets call for operation. So this environment was created to record number of Emergency Vehicles in an hour and their travel time.

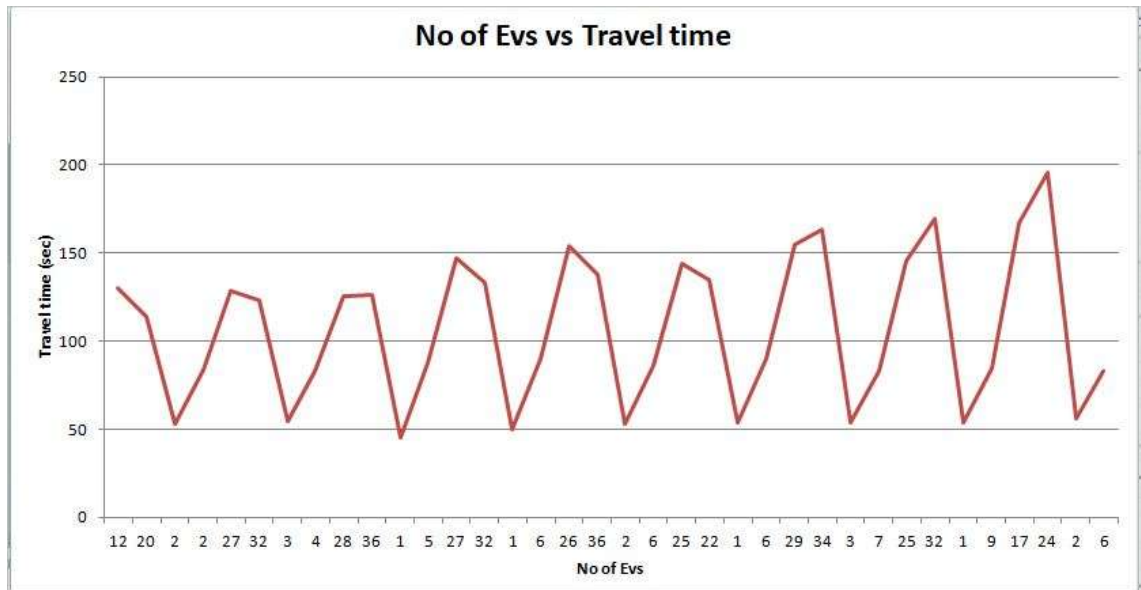

Figure 25: EV in Network and their travel time

In Figure, the horizontal axis represents the total vehicles involved in operation on different routes in network and vertical axis represents their travel time. The algorithm was implemented to traffic signals for preemption and results were recorded.

The next environment was to record the normal traffic passing through different routes using fixed time signals. In Figure 26, the travel time of vehicles were calculated, analyzed and compared with Emergency Vehicles. It was observed that EV travel time was less as compared to normal traffic. And it solved the traffic congestion problem.

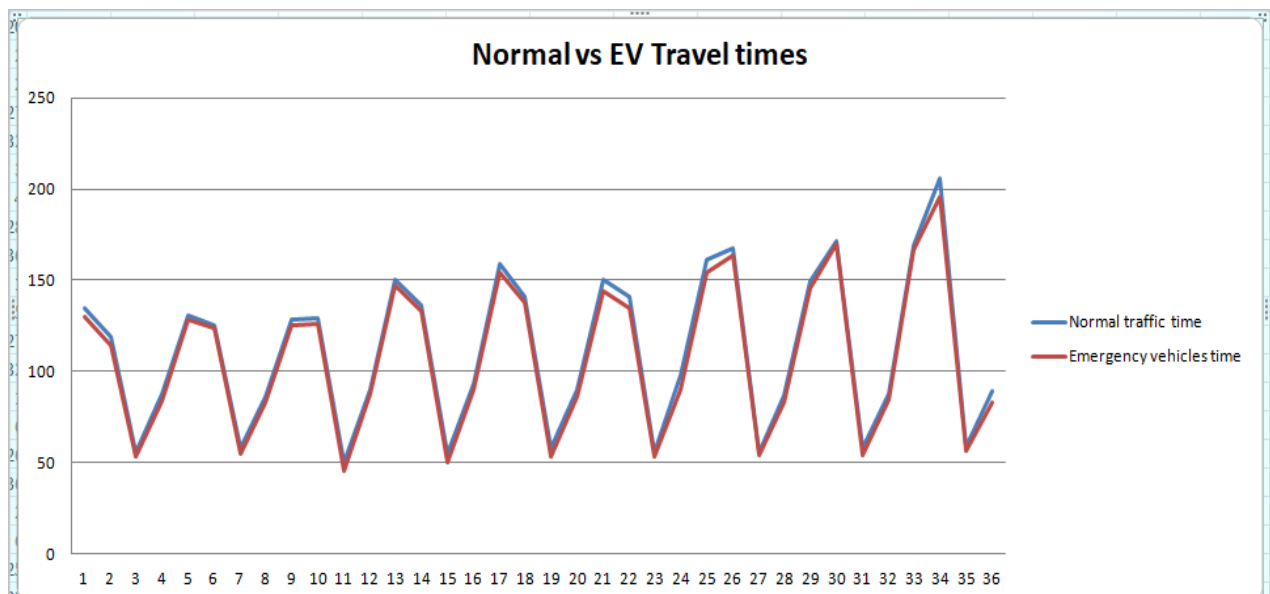
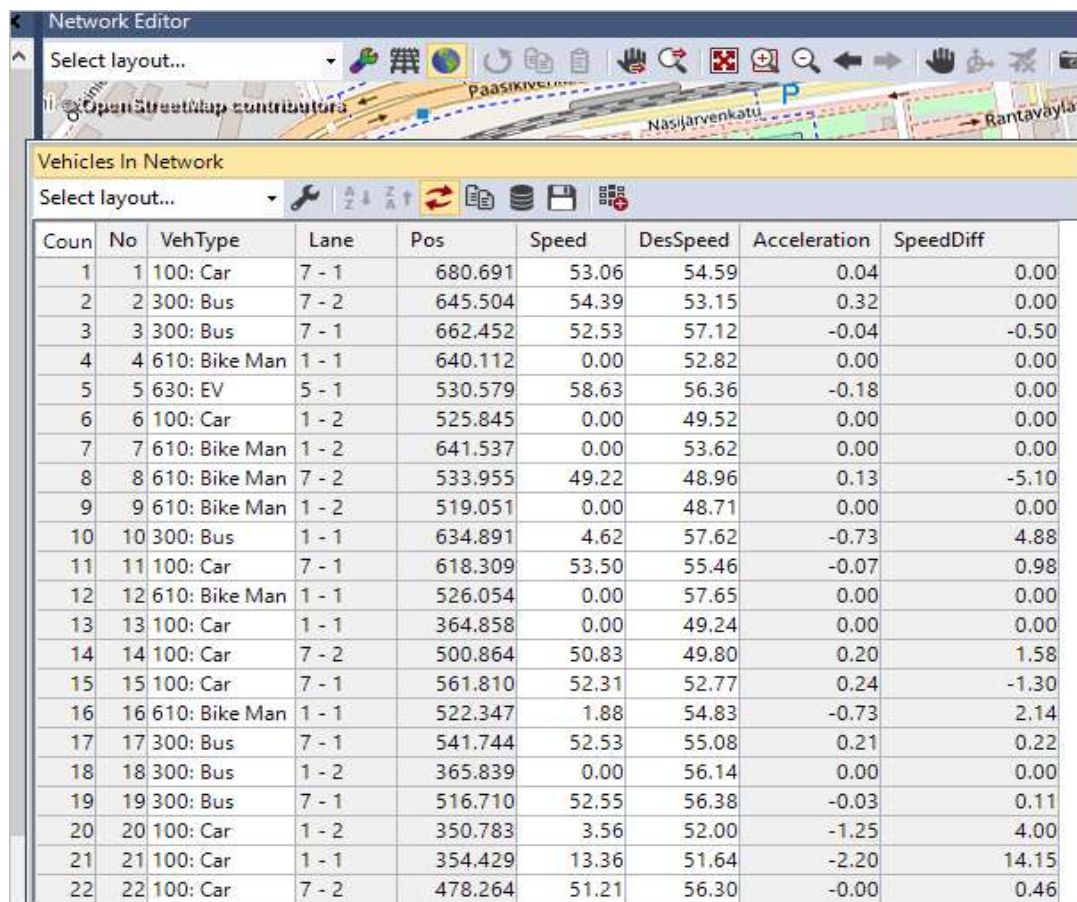

Figure 26: Travel Time of Normal Traffic Vs EV

5.3 Results for Vehicles speed in Network

When network is modeled, it is possible to measure speed, desired speed, acceleration, position and speed difference of vehicles in network. There are many types of vehicles in the network which consist of cars, buses, motorcycles, emergency vehicles and pedestrians. This data helped in determining traffic congestion, peak and off peak traffic and vehicle behavior in rush hours. If EV has to pass through some intersection, it is possible to get information of the traffic ahead using this algorithm with GPS controlled preemption.

In Figure 27, results were recorded. The simulation was run for 20 minutes with 5 minutes time interval to get as much data as possible for observation. The result values of different vehicles in network were recorded and analyzed. The traffic was operated with both fixed and algorithm controlled traffic signals.



Coun	No	VehType	Lane	Pos	Speed	DesSpeed	Acceleration	SpeedDiff
1	1	100: Car	7 - 1	680.691	53.06	54.59	0.04	0.00
2	2	300: Bus	7 - 2	645.504	54.39	53.15	0.32	0.00
3	3	300: Bus	7 - 1	662.452	52.53	57.12	-0.04	-0.50
4	4	610: Bike Man	1 - 1	640.112	0.00	52.82	0.00	0.00
5	5	630: EV	5 - 1	530.579	58.63	56.36	-0.18	0.00
6	6	100: Car	1 - 2	525.845	0.00	49.52	0.00	0.00
7	7	610: Bike Man	1 - 2	641.537	0.00	53.62	0.00	0.00
8	8	610: Bike Man	7 - 2	533.955	49.22	48.96	0.13	-5.10
9	9	610: Bike Man	1 - 2	519.051	0.00	48.71	0.00	0.00
10	10	300: Bus	1 - 1	634.891	4.62	57.62	-0.73	4.88
11	11	100: Car	7 - 1	618.309	53.50	55.46	-0.07	0.98
12	12	610: Bike Man	1 - 1	526.054	0.00	57.65	0.00	0.00
13	13	100: Car	1 - 1	364.858	0.00	49.24	0.00	0.00
14	14	100: Car	7 - 2	500.864	50.83	49.80	0.20	1.58
15	15	100: Car	7 - 1	561.810	52.31	52.77	0.24	-1.30
16	16	610: Bike Man	1 - 1	522.347	1.88	54.83	-0.73	2.14
17	17	300: Bus	7 - 1	541.744	52.53	55.08	0.21	0.22
18	18	300: Bus	1 - 2	365.839	0.00	56.14	0.00	0.00
19	19	300: Bus	7 - 1	516.710	52.55	56.38	-0.03	0.11
20	20	100: Car	1 - 2	350.783	3.56	52.00	-1.25	4.00
21	21	100: Car	1 - 1	354.429	13.36	51.64	-2.20	14.15
22	22	100: Car	7 - 2	478.264	51.21	56.30	-0.00	0.46

Figure 27: Speed with other parameters of vehicle in network

Several data collection points were placed on different lanes in network. They record values for vehicles passed, their average speed and time of travel. This result was real time implementation for determining the speed of EV while passing through high volume traffic. The speed of Emergency Vehicles varies according to different traffic con-

ditions. When traffic volume is high on the road, speed decreases. And when vehicle is at low volume traffic lane, the speed increases and hence travel time decreases.

Figure 28 shows results for different vehicle types in network and their speed which are good. Horizontal axis has information about the types of vehicles and vertical axis represents time in seconds.

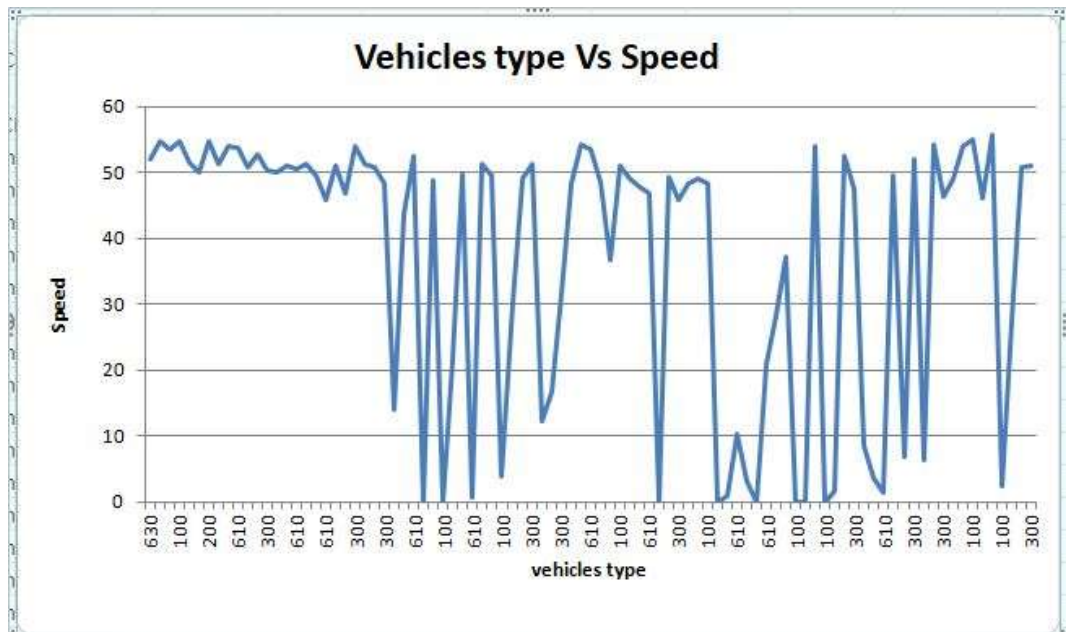

Figure 28: Vehicles type Vs Speed

5.4 Results for Average Stop Time

Besides other parameters, it was important to know how long emergency vehicle has to wait at intersection for passage. Average stop time recorded on intersection was 3.88 seconds and average stop time using adaptive control signalized intersection was around 1.1 seconds. This was a very good result for stop time because less stop means improvement in reaching destination point more quick.

The simulation run time was 30 minutes and results were recorded and analyzed. Vehicle performance contains many elements which could be observed during simulation. In Figure 28, the information was recorded for each vehicle class in network like cars, buses, heavy vehicles, pedestrians, motorcycles and emergency vehicles. The average values were recorded for all vehicles and emergency vehicles.

Vehicle Network Performance Evaluation Results											
Count	SpeedAvg(20)	SpeedAvg(30)	SpeedAvg(50)	SpeedAvg(60)	SpeedAvg(70)	DelayStopAvg(All)	DelayStopAvg(10)	DelayStopAvg(20)	DelayStopAvg(30)	DelayStopAvg(50)	DelayStopAvg(60)
25	49.61				49.41	2.37	2.55				
26											
27	46.62	51.32	46.27		47.36	48.38	3.64	3.48	0.00	3.20	4.18
28											
29	47.27	47.75	45.64		46.44	46.97	4.12	4.07	2.98	3.33	4.83
30											
31	47.99	48.56	46.72		47.15	47.78	3.91	4.01	2.02	2.78	4.82
32											
33	46.45	46.10	44.72		45.62	46.15	4.48	4.17	3.72	3.59	5.64
34											
35	47.25	47.63	46.27		46.70	47.06	4.74	5.14	3.36	3.52	5.41
36	42.86		44.28		47.26	42.13	1.64	2.45	0.90		1.22
37	47.93	48.50	46.55		47.18	47.73	3.92	4.03	2.24	2.92	4.60
38											
39	47.42	47.95	45.95		46.72	47.15	4.00	4.20	2.98	3.08	4.63
40											
41	48.22	48.31	46.03		46.74	47.99	4.59	3.67	2.39	3.22	4.91
42	47.01		44.28		47.26	46.62	9.38	2.43	0.90		1.22
43	1.12	1.72	0.74		0.65	1.15	4.20	0.84	1.34	0.32	0.53
44	3.59					3.88	9.71	0.02			
45	46.45	46.10	44.72		45.62	46.15	0.43	2.55	0.00	2.78	4.18
46	42.86		44.28		47.26	42.13	1.64	2.42	0.90		1.22
47	49.61	51.32	46.72		47.36	49.41	14.75	5.14	3.72	3.59	5.64
48	49.08		44.28		47.26	48.86	20.00	2.45	0.90		1.22

Figure 29: Vehicle Network performance Results

With the help of signalized intersection, the average stop time of EV was cut in to half. As this stop time was calculated for two routes (starting point to hospital and emergency center to hospital) having high volume traffic at intersection. So implementing the signalized intersection on whole network could reduce waiting time greatly on whole. The figure below represents the data recorded for stop time.

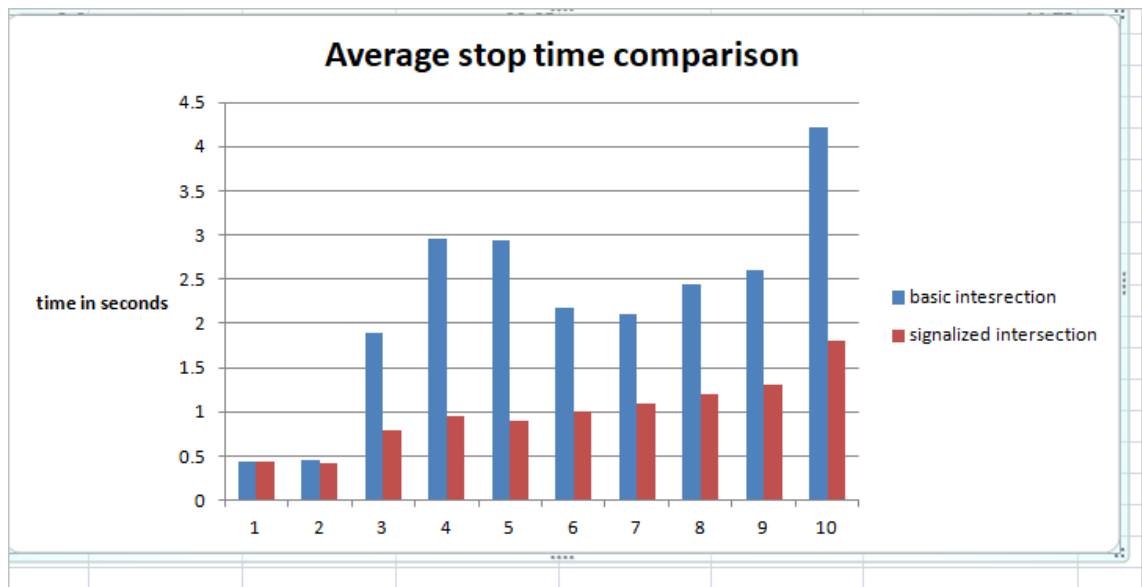

Figure 30: Average stop time graph

5.5 Results for Delay stop

Delay stop is defined as the delay time due to obstacles like several traffic signals, accident sight, construction or any other circumstances. This is the most challenging environment for Emergency Vehicles in real time situation when it has to deal with obstacles to reach at sight of emergency. The values of delay stop vary in traffic peak hours. The more efficient signals, the less will be delay and vice versa. It is calculated by subtracting ideal time from actual travel time.

EV takes around 2.3-3 seconds in delay stops due to variable (algorithm controlled) signal head and the normal traffic takes 5-13 seconds at delay stop. The traffic lights switch to green for Emergency Vehicles and after 2.3 seconds, they switch back to normal for other traffic. This test was conducted at two high volume sights and data was recorded. There were both fixed and variable (algorithm controlled) traffic signals.

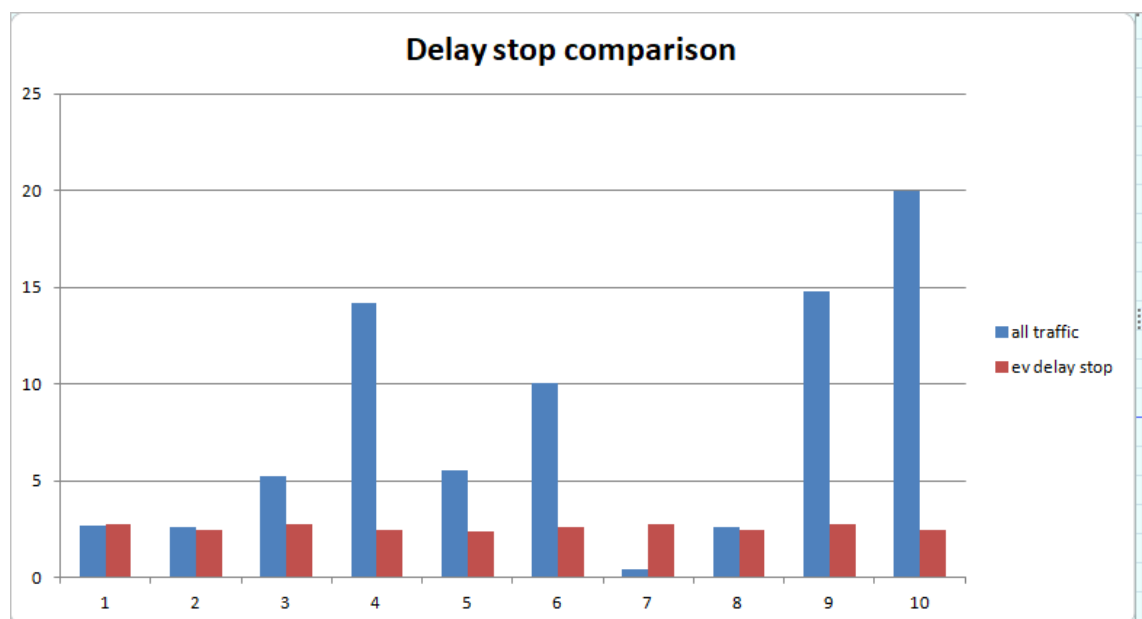

Figure 31: Delay stop data comparison

5.6 Results for safe Distance

When vehicles are in high volume traffic, they keep a safe distance from the vehicle ahead to avoid any accident. In this experiment, the volume of the vehicles was increased on the lanes to analyze the safe distance vehicles keep to avoid congestion. Both fixed and variable traffic signals were used in this experiment and results were good. The traffic moved smoothly without any congestion and accident.

In Figure 31, the result can be observed. The distance from the vehicle ahead is in meters and on horizontal axis, there are vehicle types which were recorded during experi-

ment. This result shows that by implementing variable type traffic control signal, the distances between the vehicles on the roads can be made safe to avoid accidents.

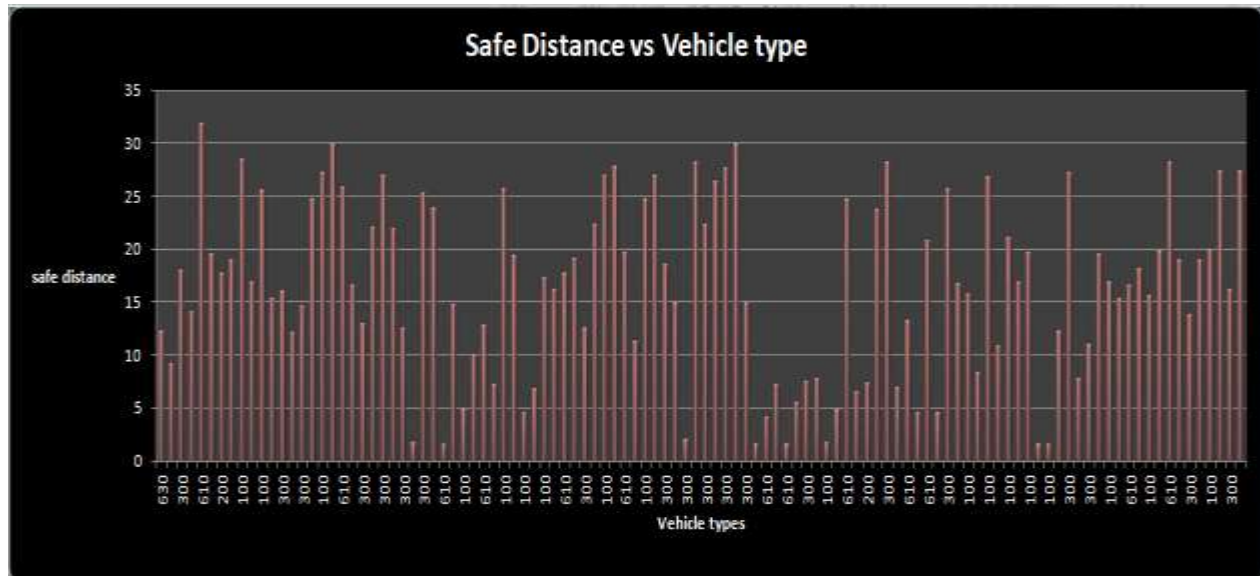

Figure 32: Safe distance from vehicle ahead

5.7 Results for Queue time

The last experiment was to calculate the Queue time when the vehicles stop at traffic signals and are in queue. Detectors were placed at the traffic signals to record the data for Queue, their length and time. It helped EV to decide their travel routes. If there is too much traffic on the road, it could be avoided and alternate route could be selected to avoid congestion. PTV Vissim has options to define road conditions so that the environment to be created is more real time and results are more accurate.

When vehicle starts moving, the queue value becomes zero and as soon as vehicles stop at traffic signal and queue is formed, the values are recorded. The results were recorded in Figure 33 and their analysis shows that the queue time information can be extracted using this approach. Queue time data collection can help the driver to select its path to avoid heavy traffic and using GPS based preemption method, which was selected as the most efficient method EV can perform really well in congestion situations.

6 DISCUSSION

The aim of thesis is accomplished and the tools which were created for preemption problem work perfectly in preemption of EV in traffic situations. The traffic congestion problem at intersection is solved and produced results are good. Variable signal controller succeeded to find a solution for Emergency Vehicles and priority to EV is obtained in every experiment performed.

Many tools were under consideration when starting this thesis. But PTV Vissim is selected due to its functionality and availability. It was very difficult to find the trial version of this software because the student version has limited functionality and it does not offer modules which were required in thesis. After couple of emails and wait finally the student license was granted for one year to work on. Another reason for selecting this software is built in functions and libraries which are easy to use and implement. It solved most of the issues related to thesis like Queue time calculation, traffic at intersection, vehicles in network and their travel time. These features of Vissim were really helpful in performing different experiments and collecting results.

There are many statically information which were not available in Google or any other search engines. So the interior ministry was contacted and it was so kind of them for providing all the relevant information needed for this thesis. Like accidents data for the past couple of years, number of operations carried out in emergency situations, number of Emergency Vehicles dispatched for help. All these stats helped in using input for creating experiment scenario in thesis for result collection.

This tool can be used for preemption purposes and can be extended further but the main problem maybe the fact that user has to build the algorithm in VisVap and it requires some basic knowledge of logic implementation and program interface. Secondly Vissim itself requires deeper knowledge of link creation, intersection construction, signals controllers, vehicle input data and many other parameters. Before using this tool, it is highly recommended to give at least good couple of days in understanding basic modules then start constructing model. The main advantage is that the results can be saved as text file which can be imported to excel for data generation and graph construction. It can be import and export to many compatible formats which can be used in many other types of software.

Overall the tools created are successful. They provide a comprehensive solution for traffic congestion problem and this work has many potential opportunities for further extension and research.

7 CONCLUSIONS

Preemption techniques for emergency vehicles in high volume traffic were examined and it was found out that there is no tool for designing traffic signal controller for EV preemption at intersection. All the tools are available for best preemption techniques, methods and technologies. So the environment for Emergency Vehicles has to be simulated providing real time traffic conditions.

To solve the preemption problem, a tool for variable traffic controller was designed. This tool helped EV to pass through the traffic using preemption technique. Before creating tool, the main issue was selecting a suitable preemption technique compatible with tool designing. Different methods were reviewed to solve this problem using literature.

The best preemption method selection problem was solved using GSP based preemption technique. The solution selected has various characteristics which were compared with other available methods like price to implement, external interference, capacity, working range etc.

Now the next step was to create the tool for implementing this preemption technique. So this problem was solved using PTV VISSIM. There were different modules in Vissim which have their own functionality. For preemption of Emergency Vehicles, VISVAP module was utilized. Vissim already has built in function (fixed time) for normal traffic control but it lacks the function which can be used as preemption tool. So algorithm was designed in VISVAP and implemented using Vissim. This algorithm utilizes detectors at signals and when EV is detected in these detectors the traffic light priority is given to EV. And as soon as EV reaches at safe distance, traffic lights return to normal schedule.

Through simulation, it is proven that travel time of Emergency vehicle in traffic becomes shorter using optimized traffic signals. The results of simulation can be saved as text file and can be imported to excel for plotting and observing results. The tool was tested providing different road and environment conditions and results were collected. The average travel time of Emergency Vehicle is improved up to 2 seconds/ traffic signal using optimized traffic signals. Furthermore results were collected for total travel time, queue length and queue counter, speed and acceleration of vehicles in network, delay and stop time of vehicles. The tool was tested for challenging environment like peak road traffic, congestion at intersection and it succeeded in finding the solution for EV preemption.

There is plenty of space for future work in this project. The tool can be converted to java or C++ to implement it to another module which might be compatible to many other traffic controlled software. As this tool is developed using maps and locations of Tampere region, so it can be distributed to Tampere traffic city as proposed solution for traffic congestion at intersection. The algorithm can be further improved for more efficient working of Emergency Vehicles in high traffic volumes. As it is very difficult to find the module in PTV VISSIM so some other working environment can be selected with same implementation conditions.

This thesis solves the problem of selecting appropriate preemption technique and designing algorithm for preemption of EV in high traffic volumes. Tool was created for optimized traffic signal controller and also leaving plenty of opportunities for future work.

REFERENCES

- [1] Weng, Y.-S., Huang, Y.-S., Su, S.-F., & Yu, C.-S. (2011). Modelling of emergency vehicle preemption systems using statecharts. In 2011 IEEE International Conference on Systems, Man, and Cybernetics (SMC) (pp. 556–561).
<http://doi.org/10.1109/ICSMC.2011.6083742>
- [2] Signalcontrol.com, 'Signal Control Products, Inc. - Preemption Systems', 2015. [Online]. Available: http://www.signalcontrol.com/products_preemption.asp. [Accessed: 07- Oct- 2015].
- [3] I. Yun, B. Park, C. Lee and Y. Oh, 'Comparison of Emergency Vehicle Preemption methods using a Hardware-In-The-Loop simulation', *KSCE Journal of Civil Engineering*, vol. 16, no. 6, pp. 1057-1063, 2012.
- [4] Ntl.bts.gov, 'Traffic Signal Preemption for Emergency Vehicles: A Cross-Cutting Study - ITS Report', 2015. [Online]. Available: http://ntl.bts.gov/lib/jpodocs/repts_te/14097.htm. [Accessed: 07- Oct- 2015].
- [5] Safety.fhwa.dot.gov, 'Strategy A5. Employ Emergency Vehicle Preemption - Safety | Federal Highway Administration', 2015. [Online]. Available: <http://safety.fhwa.dot.gov/intersection/resources/intsafestratbro/sa5.cfm>. [Accessed: 07- Oct- 2015].
- [6] J. BYCRAFT, *Green Light Pre-emption of Traffic Signals for Emergency Vehicles Richmond, British Columbia's Approach*, 1st ed. 2015.
- [7] H. Teng, V. Kwigizile and M. Kaseko, *Digitalscholarship.unlv.edu*, 2015. [Online]. Available: http://digitalscholarship.unlv.edu/cgi/viewcontent.cgi?article=1301&context=fac_articles. [Accessed: 15- Oct- 2015].
- [8] G. Unibaso, J. Del Ser, S. Gil-Lopez and B. Molinete, 'A novel CAM-based traffic light preemption algorithm for efficient guidance of emergency vehicles', *13th International IEEE Conference on Intelligent Transportation Systems*, 2010.
- [9] J. Collura, E. W. Willhaus, J. Gifford, "Traffic Signal Preemption and Priority: Technologies, Past Deployments, and System Requirements", in Proceedings of ITS America 11th Annual Meeting, Miami Beach, Florida, 2001.
- [10] M. Priya and M. Jose, *Traffic Light Pre - emption control System for Emergency Vehicles*, 1st ed. 2015.

- [11] Goel, Amnesh, Sukanya Ray, and Nidhi Chandra. 'Intelligent Traffic Light System to Prioritized Emergency Purpose Vehicles Based On Wireless Sensor Network'. *International Journal of Computer Applications* 40.12 (2012): 36-39. Web.
- [12] S. Eltayeb, Abubakr, Halla O Almubarak, and Tahani Abdalla Attia. 'A GPS Based Traffic Light Pre-Emption Control System For Emergency Vehicles'. *Computing, Electrical And Electronics Engineering (ICCEEE), 2013 International Conference*. 2013. 724 - 729. Print.
- [13] Miyawaki, M., Z. Yamashiro, and T. Yoshida. 'Fast Emergency Pre-Emption Systems (FAST)'. *Proceedings 199 IEEE/IEEJ/JSAI International Conference on Intelligent Transportation Systems (Cat. No.99TH8383)* (1999): n. page. Web. 3 Dec. 2015.
- [14] "Collier County, FL : Emergency Vehicle Preemption". *Colliergov.net*. N.p., 2016. Web. 15 Sept. 2016.
- [15] J. Hall, Timothy, Mark A. Schwartz, and Steven M. Hamer. "GPS-Based Traffic Control Preemption System". 1996: n. page. Print.
- [16] L & H Company, Inc» Oak Brook, 111,. (1999). AUTOMATIC DETERMINATION OF TRAFFIC SIGNAL PREEMPTION USING DIFFERENTIAL GPS. US.
- [17] Klosinski, S. & Fuller, D. (1999). Warning system for emergency vehicles. US.
- [18] S. Panahi and M. Delavar, "A GIS-based Dynamic Shortest Path Determination in Emergency Vehicles", *World Applied Sciences Journal 3 (Supple 1): 88-94, 2008 ISSN 1818-4952 © IDOSI Publications, 2008*, pp. 6-7, 2008.
- [19] D. Gross and J. Gross, "Emergency vehicle traffic signal pre-emption and collision avoidance system", US6326903 B1, 2001.
- [20] R. A. De Lorenzo and M. A. Eilers, *Lights and Siren: A Review of Emergency Vehicle Warning Systems*, 1999, pp. 2-6.
- [21] B. Pattberg, "DLR - Institute of Transportation Systems - SUMO – Simulation of Urban MObility", Dlr.de, 2017. [Online]. Available: http://www.dlr.de/ts/en/desktopdefault.aspx/tabid-9883/16931_read-41000/. [Accessed: 22- May- 2017].
- [22] S. Djahel, N. Smith, s. Wang and j. Murphy, Reducing Emergency Services Response Time in Smart Cities: An Advanced Adaptive and Fuzzy Approach, 2000.

- [23] V. Jayaraj and H. C, "Emergency Vehicle Signaling using VANETS", in IEEE 17th International Conference on High Performance Computing and Communications (HPCC), 2015, pp. 1-6.
- [24] L. Zhang, J. Gou, K. Liu, G. McHale, R. Ghaman and L. Li, *Simulation Modeling and Application with Emergency Vehicle Presence in CORSIM*, 2009, pp. 1-7.
- [25] M. Patrascu, A. Ion and V. Constantinescu, "Agent Based Simulation Applied to the Design of Control Systems for Emergency Vehicles Access", in *14th International conference on ITS communication*, Copenhagen, Denmark, 2015, pp. 1-5.
- [26] "Traffic simulation with PTV Vissim for efficient junction design", *Vision-traffic.ptvgroup.com*, 2017. [Online]. Available: <http://vision-traffic.ptvgroup.com/en-uk/products/ptv-vissim/>. [Accessed: 04- Jul- 2017].
- [27] "PTV VISSIM", *En.wikipedia.org*, 2017. [Online]. Available: https://en.wikipedia.org/wiki/PTV_VISSIM. [Accessed: 05- Jul- 2017].
- [28] "Opticom GPS for Emergency responders - GTT", *GTT*, 2017. [Online]. Available: <http://www.gtt.com/opticom-emergency-response/opticom-gps-system/>. [Accessed: 19- Jul- 2017].
- [29] "Emergency Response | Transportation Control Systems", *Tcstraffic.com*, 2017. [Online]. Available: <http://tcstraffic.com/emergency-response/>. [Accessed: 19- Jul- 2017].
- [30] "ITS International - Priority management saves time, money and lives", *Itsinternational.com*, 2017. [Online]. Available: <http://www.itsinternational.com/categories/utc/features/priority-management-saves-time-money-and-lives/>. [Accessed: 19- Jul- 2017].
- [31] "About ArcGIS Pro—ArcGIS Pro | ArcGIS Desktop", *Pro.arcgis.com*, 2017. [Online]. Available: <http://pro.arcgis.com/en/pro-app/get-started/overview-of-arcgis-pro.htm>. [Accessed: 21- Jul- 2017].
- [32] Microscopic traffic simulation with *VISSIM*. 2012, pp. 1-8.
- [33] "Traffic accidents in the current and previous years", *Prontonet.fi*, 2017. [Online]. Available: <https://prontonet.fi/Pronto3/online3/Tp30P12.htm>. [Accessed: 26- Aug- 2017].
- [34] R. Tay and S. Rifaat, "Factors contributing to the severity of intersection crashes", *Journal of Advanced Transportation*, vol. 41, no. 3, pp. 245-265, 2007.
- [35] PTV VisVap 2.16 user manual, 2007