



REPORT SNO 5305-2007



The Benthic Chamber experiment in Storfjorden (Norway) 2005 – effects of CO₂ on microbes, nanobenthos and meiofauna



Runde miljøsententer

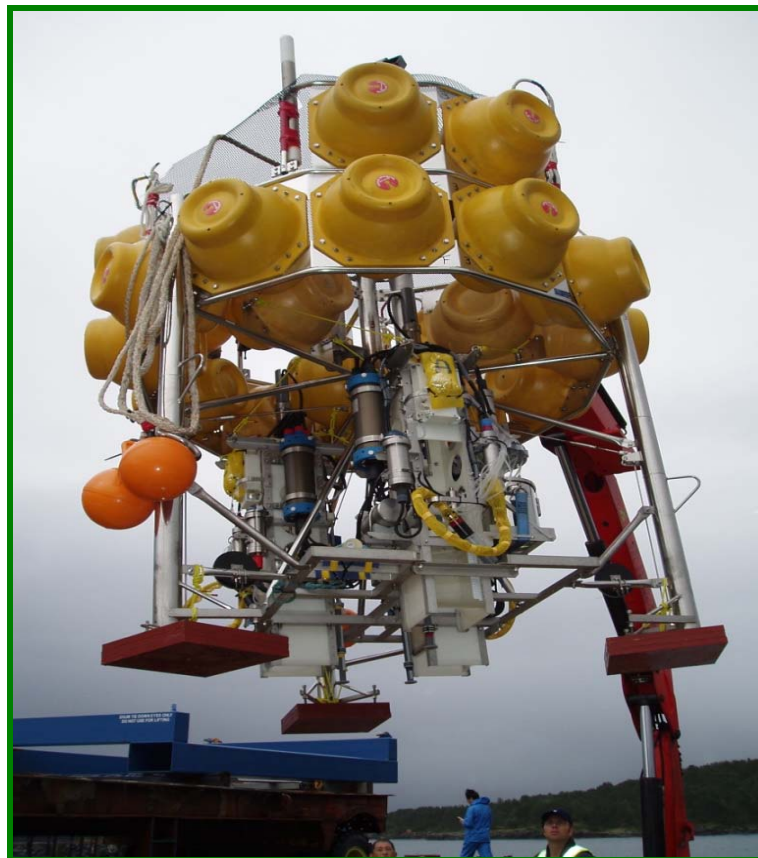

Main Office

Gaustadalleen 21
 N-0349 Oslo, Norway
 Phone (47) 22 18 51 00
 Telefax (47) 22 18 52 00
 Internet: www.niva.no

**Regional Office,
Sørlandet**

Televeien 3
 N-4879 Grimstad, Norway
 Phone (47) 37 29 50 55
 Telefax (47) 37 04 45 13

**Regional Office,
Østlandet**

Sandvikaveien 41
 N-2312 Ottestad, Norway
 Phone (47) 62 57 64 00
 Telefax (47) 62 57 66 53

**Regional Office,
Vestlandet**

Nordnesboder 5
 N-5008 Bergen, Norway
 Phone (47) 55 30 22 50
 Telefax (47) 55 30 22 51

**Regional Office
Midt-Norge**

P.O. Box 1266
 N-7462, Norway
 Phone (47) 73 54 63 85 / 86
 Telefax (47) 73 54 63 87

| | | |
|--|-----------------------------|----------------------|
| Title The Benthic Chamber experiment in Storfjorden (Norway) 2005 – effects of CO₂ on microbes, nanobenthos and meiofauna | Serial No. O-24052 | Date March, 2007 |
| | Report No. Sub-No. 5305 | Pages Price 75 |
| Author(s) John Arthur Berge, Hiroshi Ishida, Julia West, Knut Sjøstad, Martin Krüger, Patricia Coombs, Tatsuo Fukuhara, Lars Golmen, Nils Roar Hareide, Michimasa Magi, Jonathan M. Pearce, Anne Stene, Yuji Watanabe, Jun Kita | Topic group Oceanography | Distribution Open |
| | Geographical area Norway | Printed NIVA |

| | |
|--|-------------|
| Client(s) RITE, EU-NoE 'CO2GEONET' and the Norwegian Research Council | Client ref. |
|--|-------------|

Abstract (Japanese abstract and summary is inside the report)

Carbon capture and storage (CCS) either sub-seabed or in the ocean is considered among the options for reducing future emissions of CO₂ to the atmosphere. Such storage does, however, introduce the possibility of CO₂ leakage and interaction with marine fauna. It is therefore important to obtain knowledge on possible effects of CO₂ that is introduced to the sea floor. Results from experiments on environmental effects of enhanced concentrations of CO₂ at the sediment/water interface are presented. The key part of the project was the Japanese Benthic Chamber system (BC) developed to perform experiments with CO₂ in sedimentary environments *in situ*. The BC is equipped with chambers which enclose sections of the sea floor. Two similar experiments were carried out at 400 m depth in Storfjorden, Norway in September, 2005. The pCO₂ exposures in the water above the sediment in the chambers were programmed to maintain levels of approximately 5,000 µatm (pH=7.0) and 20,000 µatm (pH=6.3) respectively in two experimental chambers. The pCO₂ in the third control chamber was 500 µatm (pH=7.8). This report gives a description of the experiment and the results from measured physical and chemical parameters (pH, NO₃, NH₄, SiO₂ and oxygen) in the water overlying the sediment in the experimental chambers and biological responses (meiobenthos, nanobenthos, bacteria, Archaea, bacterial DNA and ATP, methane production, sulphate reduction) in the chamber sediments. The results from the different research groups and methods clearly show effects of elevated CO₂ concentrations on biological processes such as reduced bacterial density and increased nanobenthos densities. Methane formation and sulphate reduction was favoured by the condition in the 5,000 µatm chamber.

| | |
|--|---|
| 4 keywords, Norwegian 1. Klimaendringar 2. CO ₂ lagring 3. Feltforsøk 4. Sediment | 4 keywords, English 1. Climatic change 2. CO ₂ Storage 3. Field experiments 4. Sediments |
|--|---|



Lars Golmen
 Project manager



Dominique Durand
 Research manager
 ISBN 82-577-5036-0

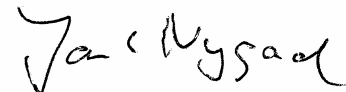

Jarle Nygaard
 Strategy Director

The Benthic Chamber experiment

in

Storfjorden (Norway) 2005

Effects of CO₂ on microbes, nanobenthos
and meiofauna

Preface

The project came about as part of the joint international cooperation agreement 2003-2005 between RITE (Research institute of the innovative Technologies of the Earth), Japan, and NIVA (Norwegian Institute for Water Research), Norway. Through NIVA's participation in the EU NoE "CO2GEONET", two partners, namely the British Geological Survey (BGS) in Nottingham, UK, and the Bundesanstalt für Geowissenschaften und Rohstoffe (BGR), in Hannover, Germany, were invited to join the project.

With the experiment located at Storfjorden in Norway the regional Aalesund University College were a natural partner to contribute with logistics and analyses. Co-ordination assistance was provided by the local Runde Environmental Centre.

The key part of the project was applying the Japanese Benthic Chamber, which was provided by General Environmental Technos Co., Ltd. (KANSO Technos) of Japan. The Japanese contribution was supported by the Japanese Ministry of Economy, Trade and Industry (METI). NIVA's work was supported partly by the NoE CO2GEONET and partly by NIVA through an internal research grant. The Norwegian Research Council provided 100,000 NOK to support an open workshop on CO₂ storage held in Aalesund on September 1, 2005, and remaining funding was allocated to cover some expenses for the following CO₂ experiments.

We gratefully acknowledge Dr. Olaf Pfannkuche of GEOMAR, Dr. Gerb Schriever of BioLab and Mr. Volker Nuppenau of Oktopus who generously permitted RITE/KANSO to apply their design ideas of the GEOMAR benthic chamber. We also acknowledge the company ODIM ASA at Hjørungavaag for its support of workspace and logistics and to Pan-Fish ASA for the vessel support.

Many persons contributed in the different work tasks in the project. The following were the key persons in the scientific parts.

| Institute | Name |
|--|---|
| NIVA, Norway: | John Arthur Berge, Lars G. Golmen and Morten Schaanning |
| RITE, Japan: | Michimasa Magi |
| Marine Ecology Research Institute (MERI) , Japan: | Jun Kita |
| KANSO/Japan: | Tatsuo Fukuhara, Hiroshi Ishida and Yuji Watanabe |
| Aalesund Univ. College: | Knut Sjøstad and Anne Stene |
| BGR, Germany: | Martin Krüger and Hans-Martin Schulz |
| BGS, UK: | Patricia Combs, Jonathan M. Pearce and Julia West |
| Runde Environmental Centre: | Nils Roar Hareide and Greta Garnes |

Thanks to those, and to all other personnel involved in the project.

Bergen/Oslo, January/March, 2007

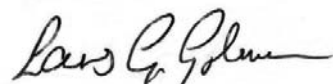

Lars G. Golmen

Cover photo: The Benthic Chamber system about to be lowered onto the deck of the vessel at ODIM, prior to deployment. Photo: John Arthur Berge.

Contents

| | |
|--|-----------|
| Summary | 6 |
| Japanese Summary | 10 |
| 1. Introduction | 14 |
| 1.1 Background of the study | 14 |
| 1.2 The way towards implementing Carbon Capture and Storage (CCS) | 14 |
| 1.3 Impact of CO ₂ on marine life | 15 |
| 1.4 Why an experiment in Norway? | 16 |
| 2. Description of the experimental site | 17 |
| 2.1 Sediments | 17 |
| 2.2 Hydrography and currents | 19 |
| 2.3 Marine biology of Storfjorden | 20 |
| 2.3.1 Plankton | 20 |
| 2.3.2 Benthos | 21 |
| 2.4 Fish and fisheries | 21 |
| 2.5 Aquaculture | 22 |
| 2.6 The deployment site and the pre-survey | 22 |
| 3. Experimental setup | 24 |
| 3.1 Description of the Benthic Chamber (BC) system | 24 |
| 3.2 Experimental design (first and second experiment) | 26 |
| 3.2.1 Sampling of sediment and water from the BC at ODIM | 27 |
| 3.2.2 Hydrography and current measurements | 28 |
| 3.2.3 Analysis of nutrients and oxygen in the water inside the chambers | 29 |
| 3.2.4 Analysis of total carbon and nitrogen in the sediment by NIVA | 29 |
| 3.2.5 Treatment of sediment and analytic methods for the RITE/Kanso analyses | 30 |
| 3.2.6 Analytic methods used by BGS for geochemical analysis of sediment | 30 |
| 3.2.7 Treatment of sediment and analytic methods for the BGR analyses | 32 |
| 3.2.8 Analytic methods used by BGS for analyses of ATP in sediment | 33 |
| 3.2.9 Denaturing gradient gel electrophoresis (DGGE) of sediment samples | 35 |
| 4. Results | 36 |
| 4.1 Ambient conditions at the experiment site | 36 |
| 4.1.1 Hydrography and oxygen time series | 36 |
| 4.1.2 Currents near the bottom | 36 |
| 4.2 Nutrients and oxygen in the water inside the chambers | 39 |
| 4.2.1 Oxygen | 39 |

| | |
|--|-----------|
| 4.2.2 Nutrients | 39 |
| 4.2.3 Measurements of fluxes through the sediment/water interface | 43 |
| 4.3 Physical and chemical measurements and sampling in the chambers during the experiments | 44 |
| 4.3.1 pH, T-CO ₂ and pCO ₂ in the chamber water | 44 |
| 4.3.2 Dissolved oxygen (DO) in the chamber water | 45 |
| 4.3.3 Water content and total carbon and nitrogen in the sediment | 46 |
| 4.3.4 Particle size distribution of the sediments | 46 |
| 4.3.5 Results from geochemical analyses of the sediment | 48 |
| 4.4 Bacterial responses | 49 |
| 4.4.1 Results from RITE/Kanso analyses | 49 |
| 4.4.2 Results from microbial analyses by BGR | 50 |
| 4.4.3 Results from ATP analyses by BGS | 53 |
| 4.4.4 Results from DGGE-analyses by Aalesund University College | 56 |
| 4.5 Responses in meiobenthos and nanobenthos | 61 |
| 4.5.1 Nanobenthos | 61 |
| 4.5.2 Meiobenthos | 62 |
| 5. Discussion | 66 |
| 5.1 Water quality in head space | 66 |
| 5.2 Microbial analyses, ATP and DNA | 66 |
| 5.3 Meiofauna/nanobenthos/bacteria analyses RITE | 68 |
| 5.4 Representatively of the conditions in the chambers | 70 |
| 5.5 Final remarks | 71 |
| 5.5.1 Equipment and logistics | 71 |
| 5.5.2 Possible reasons for inconsistencies | 72 |
| 5.5.3 Some suggestions for follow-up | 72 |
| 6. References | 74 |

Summary

摘要

海底における CO₂ 濃度上昇の環境影響について実験を行った結果報告である。このプロジェクトの特徴は、現場海底環境で CO₂ 影響実験を行うために開発された日本のベンチック・チャンバー装置 (BC) を用いたことである。この BC は海底の一部分を囲うことができる 3 つのチャンバーを備えている。2 回の繰返し実験をノルウェーのストルフィヨルドの水深 400m で行った。2 つのチャンバー内の底質直上水の CO₂ 濃度設定は、それぞれ約 5,000 μatm (pH=7.0) および 20,000 μatm (pH=6.3) とした。3 番目のチャンバーは対照区で、500 μatm (pH=7.8) であった。この報告書は、実験サイトの一般的な特性、チャンバー内の底質直上水の物理・化学パラメータ (pH, O₂, NO₃, NH₄, SiO₂) 測定の結果、およびチャンバー内の生物反応 (メイオベントス, ナノベントス, バクテリア, 古細菌, バクテリア DNA と ATP, メタン生成, 硫酸塩減少) について記載している。個々の研究グループによる結果は、高濃度の CO₂ がストルフィヨルドの生物学的プロセスおよび微生物やナノベントスの密度に影響を及ぼすことを示していた。しかし、CO₂ に対する反応という面ではある場合には一貫した結果ではなく、この反応をより詳細に理解するためには更なる実験が必要と考えられた。

Emissions of anthropogenic carbon dioxide (CO₂) to the atmosphere constitute an important factor in global warming. One option to mitigate the situation is to capture and store CO₂ from large point-sources underground, under the seabed or in deep sea water. However, the environmental consequences of such storage are still not fully resolved. One scenario for sub-seabed storage is that the CO₂ under certain conditions may reach the sediment/water interface. Another is that a plume of highly CO₂-enriched seawater induced by deep-sea storage of CO₂ may reach the sediment/water interface. These scenarios formed the perspective of the present study, i.e. what consequences may high concentration of CO₂ at the sediment/water interface imply for organisms? To understand such ecosystems require detailed knowledge of the abundance and functional diversity of micro organisms, nanobenthos and meiofauna and is an important requirement in order to establish safe sequestration of CO₂.

Experiments were therefore performed in order to mimic a condition of enhanced CO₂ in a marine sedimentary environment. The participants in the project were RITE (Research Institute of the Innovative Technologies for the Earth in Japan), General Environmental Technos Co., Ltd. (KANSO Technos), NIVA (Norwegian Institute for Water Research), BGR (Bundesanstalt für Geowissenschaften und Rohstoffe), BGS (British Geological Survey), Aalesund University College, Runde Environmental Centre and the company ODIM.

The key part of the project was the Japanese Benthic Chamber system, which was provided by KANSO Technos. This system was developed for studying effects of CO₂ on benthic communities on the deep-sea floor. The Japanese contribution was supported by the Japanese Ministry of Economy, Trade and Industry (METI). NIVA's work was supported by a grant from the European Network of Excellence, CO₂GEOINET, a small grant from the Norwegian Research Council and an internal research grant from NIVA.

The Benthic Chamber is a free float system which is deployed and brought to the surface without using wires etc. for deployment and retrieval. The benthic chamber system is equipped with three chambers which all enclose a section of the *in situ* sediment. Two chambers were used for the addition of CO₂ and the third chamber was used as a control with no addition of CO₂. The enclosed area in each chamber was 200 mm x 200 mm and the height was 280 mm. All chamber operations were pre-programmed prior to deployment.

Experiments were successfully carried out twice (exposure time was 217 and 226 hours, respectively) at 400 m depth in Storfjorden, Norway during September 2005. The underwater topography at this site indicates a homogenous sedimentary environment, as was documented in a pre-survey in June, 2005. The results from particle size distribution indicate that there was little difference in this parameter in the sediment within the experimental chambers.

The ambient environmental condition (temperature, oxygen, salinity and bottom currents) at the experimental site was monitored during the experiments. Waters below 100-150 m depth at the experimental site showed uniform distribution of salinity (35.2) and temperature (8 °C), and even the bottom water was well oxygenated. The deep water values show the characteristics of the Atlantic Water offshore, illustrating the efficient communication across the shelf between the shelf slope regions and the fjord proper. In general, the bottom currents at the site remained weak most of the time during the experiments, and below 0.1 m/s.

During the two experiments measurements were performed by sensors in each chamber (pH, oxygen, temperature). Samples for later analyses (nutrients like NO₃, NH₄, SiO₂ and oxygen) were collected autonomously several times from the water overlying the sediment in the chambers. The pCO₂ exposures were intended to be the same for both experiments, in which the average pCO₂ was programmed to maintain levels of approximately 20,000 µatm (pH=6.3) and 5,000 µatm (pH=7.0) in the chambers A and B, respectively. The pCO₂ in the control chamber (C) was to be maintained at 500 µatm (around the normal ocean concentration at pH=7.8). In order to maintain the high levels in A and B, seawater with a high pCO₂ (CO₂ SW) was injected 3 times into the headspace of these chambers during the experiments.

At the end of each experiment cores for enumerating the abundance of meiobenthos, nanobenthos and bacteria, Archaea, bacterial DNA, ATP and sediment characteristics were collected at random from the sediments in each chamber using polyethylene piston syringes. The samples were subsequently split up and distributed among the different partners for later analyses.

Headspace water in the chambers

The water above the sediment in all chambers experienced an almost linear decline in oxygen over time. This was seen both from the data obtained from sensors in the chamber and water samples analysed by Winkler titration. At the end of the experiments the oxygen concentration in the headspace water was approximately 2 ml/l in all chambers. There were only minor differences in the oxygen level and consumption rate among the chambers so that the different chambers experienced quite similar experimental conditions for this parameter.

Silicate (SiO₂) was the parameter showing the most pronounced response, with values increasing from around 500 µg/L at the start of the experiments to 4000-6000 µg/L at the end. The response in silicate was fairly similar in all chambers except for B1 (low CO₂ in the first experiment) where the release was somewhat higher.

There was no pronounced effect of the CO₂ treatment on the concentration of ammonium in the first experiment. The ammonium data were more variable in the second experiment and an increase in

concentrations was observed towards the end of the incubation period (especially in chamber B -low CO₂). The increase in ammonium was accompanied by a decrease in NO₃.

Sediments:

Bacterial response to the CO₂ exposure was enumerated by several methods and by different institutions.

The results from BGR show that cell numbers of *Bacteria* generally were highest in the control chamber and gradually lower after the addition of low or high CO₂. *Archaea* (a prokaryote group different from *Bacteria*), in contrast, seemed to be stimulated by low CO₂ and only died off with high CO₂. Generally, cell numbers of *Bacteria* was higher than those of *Archaea*.

The effect of the CO₂ treatment on bacterial biomass was determined by ATP analysis by BGS. The first experiment showed that bacterial biomass in the surface sediment increased compared to the control both in the low and the high dose treatment. The same trend was also indicated in the second experiment, but only after excluding two outliers from the data set.

The denaturing gradient gel electrophoresis (DGGE) as performed by Aalesund University College of sediment samples showed high diversity in the microbial population, but the results were not clear enough to observe differences between samples from different benthic chambers, or to observe significant changes due to different CO₂-treatments.

Microbial methane formation in the first experiment was slightly stimulated by low CO₂ addition. In the second experiment the increase from the control to the low CO₂ chamber was even more pronounced, but decreased at the highest CO₂ concentrations. The growing *Archaea* might well also be methane producers.

Also **sulphate reduction** was stimulated by low CO₂ addition in both sets of experiments. In the second experiment sulphate reduction rates increased further from low to high CO₂ concentration. This was interpreted as sulphate reducing bacteria that can tolerate changes in CO₂ concentrations and/or pH in their surroundings, and that also thrive on degradation products of other organisms which could have died as a consequence of CO₂ exposure.

Nanobenthos (cells or individuals having a length of 2 to 32 µm) includes unicellular microorganisms such as flagellates, ciliates, and amoeba. These microbes are important prey for meiobenthos (organisms that pass through a 300 µm sieve and are retained by a 32 µm sieve) and predators for bacteria. The highest densities of both the small sized and the large sized nanobenthos was observed in the surface sediment. For these size groups the densities increased in the chambers exposed to CO₂ compared to the control. The results were therefore consistent in terms to the response to CO₂.

The **meiobenthos** consisted mostly of *Foraminifera*, *Ciliophora*, *Cnidaria*, *Nematoda*, *Kinorhyncha*, *Bivalvia*, *Polychaeta*, *Ostracoda*, *Harpacticoida* and nauplius larvae. In particular, *Foraminifera* and *Nematoda* predominated over the other taxa, and accounted for 80% or more of the total meiobenthos in both experiments.

Possible effects of the treatment were evaluated for total meiofauna, *Foraminifera*, *Nematoda* and *Crustacea*. In general the meiofauna responses were unclear and much less consistent in terms of response compared to the nanobenthos. Total meiobenthos decreased with depth in the sediment. However, the abundance varied greatly and no significant differences between chambers/treatments were therefore observed in any of the two experiments. Neither for *Foraminifera* in particular were there any significant differences among chambers.

The number of nematodes did not decrease with depth as observed for *Foraminifera*. In the first experiment the numbers of nematodes in the 5,000 μatm chamber were significantly higher than in the two other chambers. In contrast the abundance in the 0.5 – 1 cm layer of the 5,000 μatm chamber in the second experiment was significantly lower compared with the control. Apart from this no significant differences related to CO_2 were observed.

For *Crustacea* the abundance in the 0 – 0.5 cm layer of the 5,000 μatm treatment in the first experiment and the 1–2 cm layer of both exposure chambers in the second experiment were significantly higher compared with the control. On the other hand other 5,000 μatm treatments showed lower abundance compared to the control and consistent responses to CO_2 in *Crustacea* were difficult to identify.

Benthic organisms such as meiobenthos, nanobenthos and bacteria interact as a community. Such interactions require that change in one group of organism in the experiment has to be compared with those of the other groups. The results from the experiments show a stimulation of microbial methane formation and sulphate reduction following CO_2 exposure.

Significant effects of high CO_2 concentrations were also observed on cell numbers, indicating the stimulation (*Archaea*) or inhibition (most results on *Bacteria*) of distinct groups of micro organisms as a consequence of the exposure of the sedimentary environment to elevated CO_2 concentrations.

The abundance of nanobenthos also increased as consequence of the CO_2 exposure and thus resembles the response of *Archaea* but was opposite to the reduction in numbers which seemed to be the case for *Bacteria*. The results may be used to identify candidates in the microbial flora/fauna, whose presence, absence or ratios of abundance could provide indicators for exposure to CO_2 in marine sediment.

The combination of methods applied simultaneously by the different research groups on the same sediment has provided a comprehensive and complimentary picture of the ecosystem and has already shown effects of high CO_2 concentrations on a previously undisturbed environment such as in Storfjorden.

Japanese Summary

要約

大気中への人為起源二酸化炭素排出は地球温暖化の重大な要因となっている。CO₂の地中貯留、海底下地中貯留、深海貯留の長期影響は未解明である。ある場合には、地中に貯留されたCO₂が底質と海水の境界面に達し、また、別の場合には、CO₂深海隔離（中層放流）による高CO₂プルームが底質と海水の境界面に達するかも知れない。これらを想定して本実験を行った。すなわち、底質と海水境界面に達したCO₂が生物に及ぼす影響を明らかにすることである。このような生態系を理解するためには、微小生物、ナノベントス、メイオファウナの数度（出現個体数）および機能の多様性に関する詳細な知見が不可欠であり、これは安全なCO₂隔離を確立するためにも重要である。

そこで、海底環境における高CO₂状態を模擬した実験を行った。このプロジェクトの参加者は、RITE（（財）地球環境産業技術研究機構、日本）、KANSOテクノス（（株）環境総合テクノス）、NIVA（Norwegian Institute for Water Research、ノルウエー）、BGR（Bundesanstalt für Geowissenschaften und Rohstoffe、ドイツ）、BGS（British Geological Survey、英国）、Aalesund University College（ノルウエー）、Runde Environmental Center（ノルウエー）およびODIM（ノルウエー）であった。

このプロジェクトの特徴は、KANSOテクノスによって準備された日本のベンチックチャンバー装置を用いたことである。このベンチックチャンバー装置は、海底のベントス群集に及ぼすCO₂の影響を調べるために開発されたものである。日本の参加は経済産業省、NIVAの参加はEuropean Network of Excellence, CO₂GEONET および NIVA 研究費、からの助成による。

ベンチックチャンバーは、自立フロート装置であり、ワイヤー等を用いずに設置および海面に浮上することができる。ベンチックチャンバー装置は、3つのチャンバーをもち、実際の底質の一部を囲うことができる。2つのチャンバーはCO₂を添加する区として、別の1つはCO₂を添加しない対照区として用いる。チャンバーによって囲われる部分は、200mm×200mmで高さ280mmである。すべてのチャンバーの操作は、設置に先立って事前にプログラムで設定されている。

実験は、2005年9月にノルウエーのStorfjordenの水深400mにおいて2回（曝露時間はそれぞれ217時間および226時間）実施された。実験サイトの地形図は均質な底質環境を示していた。実験チャンバー内の底質の粒度分布には大きな差異は認められなかった。実験期間中のサイトの環境状況（温度、酸素、塩分および底流）を記録した。実験サイトの水深100-150mより深いところでは、均一な塩分（35.2）、温度（8°C）であり、海水には酸素がよく溶存していた。これら

深層水の値は、沖合の大陸棚に到達する大西洋の深層水と似ており、大陸棚斜面とフィヨルドの間に海水の交流があることを示している。底流は実験期間中には概ね弱く、0.1m/s 以下であった。

2回の実験中にはセンサー（pH、酸素、温度）による測定、あるいはチャンパー内の底質直上水を採取して後に分析（NO₃、NH₄、SiO₂等の栄養塩および酸素）を行った。CO₂曝露は2回の実験ともに同様であり、それぞれ2つのチャンパー（AとB）でpCO₂平均値がおよそ20,000µatm（pH=6.3）および5,000µatm（pH=7.0）のレベルを維持するようにプログラム設定された。対照区のチャンパー（C）のpCO₂は、500µatm（pH=7.8）であった。このようなpCO₂レベルを維持するために、実験期間中に3回、チャンパーAとBの海水に高CO₂海水（CO₂SW）を注入した。

実験終了時には、メイオVENTス、ナノVENTス、バクテリアおよび古細菌（archaea）の数度、またバクテリアDNAとATP、さらに底質特性を計数するために、ポリエチレン製の注射器を用いてそれぞれのチャンパーから無作為にコアサンプルを採取した。サンプルは後に各研究機関で分析するために分割された。

2回の現場実験は、顕著な技術的問題もなく完遂された。

すべてのチャンパーにおいて、底質直上水の酸素は時間とともに直線的に減少した。このことは、チャンパーに設置したセンサーによるデータおよび海水サンプルをウィンクラー法によって分析したデータの両方から確認された。実験終了時には、全てのチャンパー内で海水の溶存酸素量はおよそ2ml/Lあった。チャンパー間では、酸素減少速度に若干の異なりが認められた。しかし主要な傾向としてそれぞれのチャンパーはほぼ同様の酸素消費を示していたので、CO₂影響の結果には酸素消費は影響していないと考えられる。

珪酸(SiO₂)は実験開始時の値およそ500µg/Lから終了時の値4000-6000µg/Lに増加しており、栄養塩の中では最も大きな変化を示した。珪酸の反応は全てのチャンパーでほぼ同様であったが、B1（第1回目実験の低CO₂区）チャンパーでは他よりも若干高い値であった。

アンモニア濃度はCO₂添加によって、第1回目実験では顕著な変化を示さなかった。第2回目実験ではより大きな変化を示し、経過時間とともに増加する傾向が見られた（特にチャンパーBの低CO₂区）。アンモニア濃度の上昇と同時に、NO₃は減少した。

CO₂曝露に対するバクテリアの反応は、各研究所による様々な方法で測定され、結果は必ずしも一致しなかった。例えば第1回目実験（RITEによる実施）では、バクテリア細胞数は、0-0.5cm層を除いて20,000µatmチャンパーのほうが対照区よりも有意に少なかった。しかし、第2回目実験ではチャンパー間で有意な差は認められなかった。

BGRによる結果では、バクテリアの細胞数は、通常では対照区で最も多く、低CO₂または高CO₂の添加後に徐々に減少することが示された。対照的に古細菌（原核生物でありバクテリアとは異なる分類群）は、低CO₂区で多くなり、高CO₂区で死滅した。一般的に、バクテリアの細胞数は、古細菌よりも多かった。

バクテリア現存量 (BGS による ATP 分析に基づく) に対する CO₂ の影響は、データが大きく変動しており、一貫した結果を示さなかった。第 1 回目の実験では、底質表層のバクテリア現存量は、低 CO₂ 区および高 CO₂ 区ともに対照区と比較して増加していた。データから 2 つの異常値を除いた場合には、同様の傾向が第 2 回目実験でも示された。

変性剤濃度勾配ゲル電気泳動法 (DGGE) による底質の分析は、微生物多様性が一般的に高いことを示していたが、各チャンバー間すなわち CO₂ 影響の有意な差を検出できるほど明確な結果を示さなかった。

微生物によるメタン生成は、第 1 回目実験では低 CO₂ 添加によって促進された。第 2 回目の実験では、対照区と比較した低 CO₂ 区のメタン生成促進はより顕著であったが、しかし高 CO₂ 区ではメタン生成が減少した。メタン生成がバクテリアによるものか古細菌によるものが、メタン生成の結果からは判断することができなかった。増殖中の古細菌がメタン生成者である可能性もある。

メタン生成で観察されたように、低 CO₂ 添加によって硫酸塩が減少することが両実験で示された。実際に第 2 回目の実験では、硫酸塩の減少速度は低 CO₂ 区よりも高 CO₂ 区で増加した。おそらく、硫酸塩を消費するバクテリアは CO₂ 濃度あるいは pH の変化に耐えることができ、また CO₂ 曝露によって死亡した他の生物の分解物にも耐性を有するためであろう。

ナノベントス (細胞または個体の大きさが 2-32 μ m) は、繊毛虫、鞭毛虫およびアメーバのような単細胞生物を含んでいる。これらの微生物はメイオベントス (300 μ m の網目を通過し、32 μ m の網目に留まる生物) の重要な餌であり、バクテリアの捕食者である。ナノベントスの小サイズ (<10 μ m) と大サイズ (10-32 μ m) 両方の最高密度は底質表層で観察された。両サイズグループおよび両実験で、密度は、対照区よりも CO₂ 曝露区で増加した。したがって、CO₂ 影響という観点からは、一貫した結果であると言える。

メイオベントスは主に、有孔虫類、有毛虫類、刺胞動物、線虫類、動吻類、二枚貝類、多毛類、介形類、ソコミジンコ類、ノープリウス幼生から成っている。特に、有孔虫類と線虫類は、他の分類群よりも卓越しており、両実験において全メイオベントス数の 80% 以上を占めた。CO₂ 影響の解析は、全メイオベントス、有孔虫類、線虫類および甲殻類について行った。全体的に、メイオベントス相の反応は明確ではなく、ナノベントスの結果に較べてあまり一貫性が認められなかった。全メイオベントスは底質の深さにしたがって減少した。しかし、全メイオベントスの数度は大きく変動しており、したがって両実験ではチャンバーあるいは CO₂ 処理区の間には明確な差は認められなかった。また、有孔虫類についてもチャンバー間で明確な差は認められなかった。

線虫類の数は、有孔虫類で観察されたように底質の深さにしたがって減少することはなかった。第 1 回目の実験では、線虫類の数は 5,000 μ atmCO₂ 区のチャンバーで他の区よりも有意に多かった。対照的に、第 2 回目の実験では、5,000 μ atmCO₂ 区の 0.5 - 1cm 層の線虫類の数度は対照区よりも有意に少なかった。この他には、CO₂ 影響による有意な差は認められなかった。

甲殻類の数は、第1回目実験の5,000 μ atm処理区の0 - 0.5cm層および第2回目実験の両曝露区の1 - 2cm層において、対照区より有意に多かった。一方、他の5,000 μ atm処理区では対照区と比較して数が減少し、一貫したCO₂影響を認めることは困難であった。

メイオベントス、ナノベントスおよびバクテリアのような底生生物は群集として相互作用している。このような相互作用を調べるためには、実験におけるある1つのグループの変化を他のグループの変化と比較しなければならない。本実験の結果では、CO₂曝露による微生物のメタン生成の増加と硫酸塩の減少が認められた。また、高CO₂区における細胞数には有意差が認められ、これは底質環境が高CO₂に曝された結果として、微生物群集の特徴的なグループの活性化（古細菌）と抑制化（多くはバクテリア）を示していた。また、ナノベントスもCO₂曝露によって数が増加したことから、古細菌の反応と共通であるが、数の減少を示すバクテリアの場合とは反対であった。

同じ底質サンプルについていくつかの研究機関によって同時に適用された分析方法の組み合わせは、生態系の大局的かつ相補的な姿、そしてこれまで攪乱されていない Storfjorden の環境に高CO₂濃度が与えるであろう影響を明らかにした。

各研究機関のあるは実施した2回の実験の結果は、CO₂に対する反応という面では、ある場合には一貫しておらず、反応をより詳細に理解するためにはさらに実験が必要と考えられた。

1. Introduction

1.1 Background of the study

Emissions of anthropogenic carbon dioxide (CO₂) to the atmosphere constitute an important factor in global warming. Several approaches have been suggested to reduce the CO₂ emissions. Geological storage is one such, with a large capacity and potential (Marlek et al., 2004). Such storage (or analogies) are already being performed at various locations around the world, mostly as demonstration projects or in connection with EOR (Enhanced Oil Recovery), and the technical feasibility seems to have been mostly proven. Another approach is ocean sequestration which enhances the natural process of CO₂ absorption by the ocean. Ocean sequestration is still in conceptual research phase but it could be a favouring option for regions or countries without available geological formations for CO₂ storage.

However, the long-term consequences of storing CO₂ underground, under the seabed or in deep sea water are still not resolved. One scenario is that the stored CO₂ into the geological formation gradually may penetrate the cap-rock and overburden (through fractures, defect wells or old boreholes) and enter into the soil, air or ocean above. Another scenario is that the plume of high CO₂ concentration sea water induced by deep sea (water column, 1,000m to 2,500m depth) CO₂ sequestration may reach the sediment/water interface at high rise such as seamount. These scenarios formed the perspectives of the present study, i.e. what consequences may high concentration of CO₂ at the sediment/water interface imply for micro organisms and meiofauna? To understand such ecosystems, detailed knowledge on the abundance and functional diversity of micro organisms and meiofauna is essential. Changes in such communities may also turn out to be important as indicators in future monitoring and early-warning systems for CO₂ migrating out of the storage reservoir (geological storage) or site (ocean sequestration) and towards the ocean floor.

Consequently, an inventory of dominant microbial communities and their response to CO₂ is important. These and similar topics must be understood in order to establish official European and Japanese requirements for the safe sequestration of CO₂ in the deep subsurface.

This report describes the results from 2 deployments of a benthic chamber system with a CO₂ injection system in Storfjorden, Norway. The main aim of the experiment was to elucidate how the addition of CO₂ to marine sediments would influence the physical/chemical conditions, microbes and meiofauna during an experimental period of about 10 days.

1.2 The way towards implementing Carbon Capture and Storage (CCS)

The successful implementation of CO₂ storage as a large scale international option for reducing emissions will depend on several issues being resolved, which include: (i) the ability to demonstrate that CO₂ storage is safe, over timeframes of at least several thousand years; and (ii) creating an economic and regulatory environment that provide financial markets with the necessary incentives.

Point (i) requires two approaches. The first is through industrial (e.g. Sleipner, Weyburn and In Salah) and research (CO₂Sink, Frio, Nagaoka etc) demonstration projects. In these projects, efforts are particularly focused on demonstrating that CO₂ can be stored safely in target reservoirs and that it can be appropriately monitored to ensure migration is limited to that predicted in reservoir modelling.

However, these projects cannot directly address the second approach, which is to demonstrate that the long term CO₂ storage and behaviour can be predicted with some confidence. This not only requires knowledge of processes at depth but also relevant near-surface processes, including ecosystem responses to possible leaks from depth.

Within Europe, the Emission Trading Scheme (ETS) may provide the economic incentive for future CO₂ storage, if the value of CO₂ can be driven upwards through tightening national allocations. However, to encourage investment financial markets will need confidence in the long-term viability of storage. Furthermore, effects of significant leaks will need to be accounted for in national allocation plans and possibly within the ETS, requiring verifiable monitoring technologies that may include chemical and biological indicators.

The experiments reported herein focus on the biological impacts in the case where CO₂ from sub-seabed storage may leak through the sealing cap-rock and into sediments or overlying water, thus covering both monitoring and regulatory aspects. The experiments are also relevant for verifying impacts from ocean storage of CO₂ at locations where the CO₂ plume may interact with the sea bottom.

1.3 Impact of CO₂ on marine life

Increased CO₂ concentrations in sea water may have consequences for marine life. Observed accumulation of CO₂ in the surface water due to the increase of atmospheric CO₂ from pre-industrial times has probably already caused a decrease of almost 0.1 pH-units (Haugan and Drange, 1996). Estimates of future atmospheric and oceanic CO₂ concentrations suggest that pH by the end of this century will drop by about 0.4 pH units in surface waters and that unabated CO₂ emissions may produce pH changes in the ocean over the coming centuries that are greater than experienced in the past 300 million years (Caldeira and Wickett, 2003).

Similarly, acidification of seawater may occur as a consequence of CO₂ leaking from sub-seabed reservoirs. It may then directly affect water and sediment chemistry and marine life in the surroundings (**Figure 1**). Such effects will probably be related to the large changes in seawater chemistry (i.e. pH reductions) near the CO₂ leak point and may cause mortality for nearby infaunal deep-sea communities (Barry et al., 2004) or effect marine plankton in various ways if the CO₂ escapes upward towards the sea surface (Riebsell, 2004, Kurihara et al. 2004).

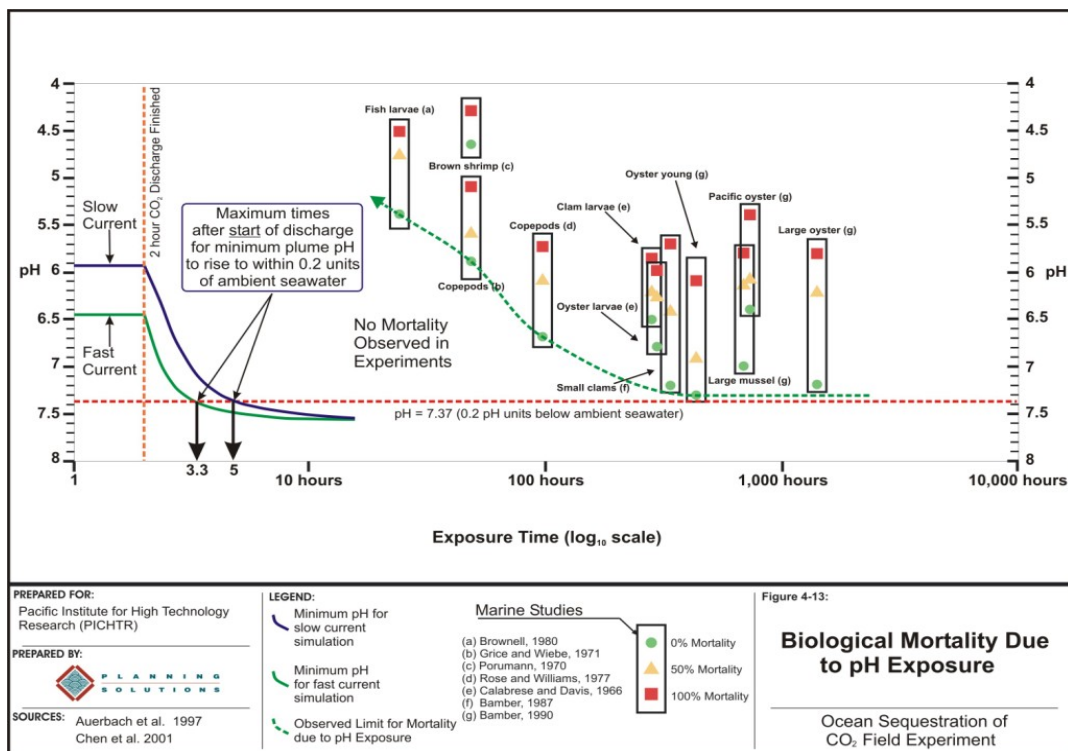

Figure 1. Lethality of some marine organisms based on previous studies from experiments with acids (not CO₂). The figure is from the EIA prepared for the permit to perform an ocean sequestration experiment in Hawaii and Norway in 2002 (the permit was withdrawn for political reasons (Golmen 2002)).

1.4 Why an experiment in Norway?

Norway is presently considering several sub-seabed storage projects. The Norwegian government has recently announced they will invest significant resources into CCS R&D, while the Norwegian oil company Statoil has performed sub-seabed reinjection of CO₂ at the Sleipner field in the North Sea for more than 10 years. While there was significant domestic focus on the CCS issue at the time when our experiments were planned, the work actually received very little Norwegian support and funding.

Japan has a strong strategy for CCS R&D and a portfolio of many projects, and in 2003, NIVA made an agreement with RITE, Japan to perform research and technical cooperation in the area of carbon dioxide impact on marine ecosystem. Within this agreement RITE and NIVA explicitly planned an experiment to be performed at 400 m depth in Storfjorden on the western coast of Norway. In the experiment sections of the sediment were to be dosed with different concentrations of CO₂ using a benthic chamber system owned by RITE.

The experiment was successfully performed in June-September 2005 with RITE and KANSO taking the main burden of assembling and preparing the benthic chamber system. The presence of the Japanese scientists formed a good basis for expanding the cooperation with the introduction of BGS, BGR, Aalesund Univ. College and others. The experiment was also foreseen to become a contribution to the EU network of excellence on geological storage of CO₂ (CO₂GeoNet, <http://www.co2geonet.com/>), in which NIVA, BGS and BGR are partners.

2. Description of the experimental site

Storfjorden on the Western coast of Norway (**Figure 2**) may be considered as a system of fjords with several entrances and branches. The main part stretches in SW-NE direction. The main opening to the ocean (Norwegian Sea) is through Breisundet between Aalesund and Hareidlandet.

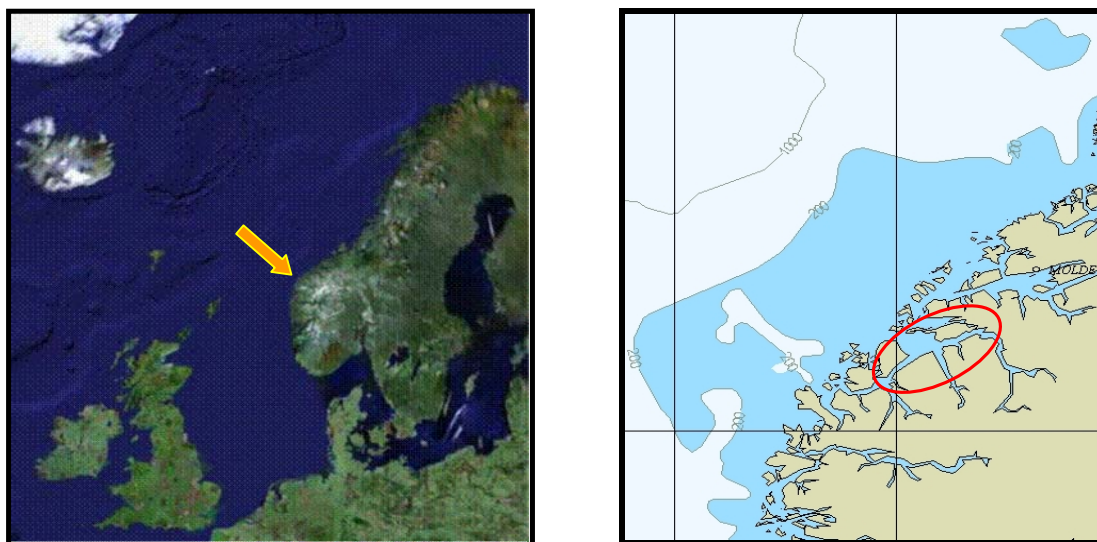

Figure 2. Maps showing the North Sea and Norwegian Sea (left) and a closeup of the Norwegian NW coast, with Storfjorden inside the oval.

The width of the fjord varies from less than 1 km in the inner parts, to several km in the outer parts. Main topographic features are shown in **Figure 3**.

The U-shaped glacial eroded Storfjord has a maximum water depth of 650 m. The bottom is relatively flat with large sediment thickness. There are relatively steep rocky slopes. Cold water corals are found in some patches on the slopes. Some shallow side fjords are connected to the main fjord. These fjords have water depths of 50 – 150 meters.

2.1 Sediments

Sediment deposits in the Storfjord have probably a thickness of 150 m or more. The upper 10-20 meters are typically silty clay. **Figure 4** shows some details from the upper meters, with dating back 8-9000 years.

The Storfjorden region has been, and still is, exposed to massive rockslides (Blikra et al., 2006). Remains from the Storegga slide tsunami 8.200 BP are found at ca 3.5 m depth. Swath bathymetry and seismic data by the Geological Survey of Norway (NGU) show several debris-flow wedges along the margins of Sulafjorden. All the wedges appear to occur at the same stratigraphic level and extend up to ca. 1 km out from the fjord margins. A pronounced set of reflectors extends out from the wedges across the fjord basin.



Figure 3. Bathymetric map of Søre Sunnmøre, with Storfjorden and the adjacent coastal waters. The rectangle shows the location of the map in **Figure 7** with the detailed position of the site where the experiments were performed.

A core from the central part of the fjord comprised, in its upper part (0-3.15 m) olive grey, homogeneous, strongly bioturbated clayey silt/silty clay with many shells and shell fragments (**Figure 4**). Seismic data indicate homogeneous sediments over this interval. Samples at 0.10 m, 1.84 m and 3.08 m depth gave ages of 614 cal. BP, 4851 cal. BP and 8111 cal. BP, respectively. No major tsunami event younger than 8111 cal. BP was recorded in the core (Bøe et al. 2004). Parts of the seabed of the inner fjord are however covered by rocks and debris from rock avalanches.

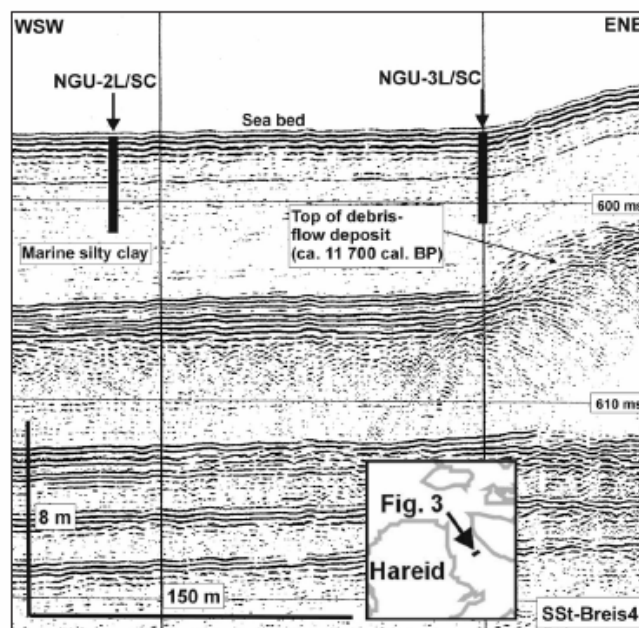
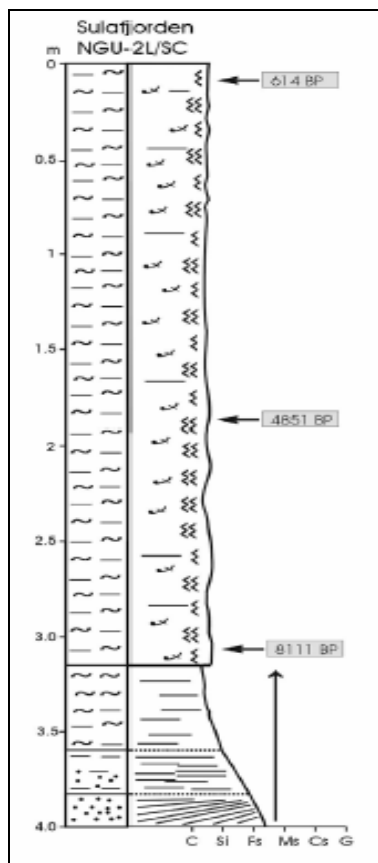

Fig. 3. Seismic profile (Sparker) with core locations, Sulafjorden. A sound velocity of 1600 m/s was used for conversion of milliseconds to meters. Vertical exaggeration ca. $\times 10$. See inset map and Fig. 1 for location.

Figure 4. Left: Lithology of a sediment core from Storjfjorden (Sulafjorden). Right: Sediment profile from same location. From Bøe et al. 2004.

2.2 Hydrography and currents

The hydrography (water stratification, temperature etc) of Storjfjorden is monitored on an in-frequent basis by the Norwegian Institute of Marine Research (IMR), and also by other institutions on an ad-hoc basis. In June and August 2005 the measurements by NIVA and RITE showed that waters below 100-150 m depth had a quite uniform distribution of salinity and temperature (**Figure 5**), still remaining well oxygenated. The deep water values mimic those of the Atlantic Water that touches the shelf offshore Møre on its way further north, illustrating the communication between the shelf slope regions and the fjord proper.

Currents have only been sparsely measured previously in Storjfjorden, and then primarily in upper layers. It was anticipated that deep water currents are weak or moderate, thus posing no serious challenge to the deployments or recovery of the benthic chamber.

The CO₂ experiments actually provided some data on currents near the bottom, and the report provides a brief description of those.

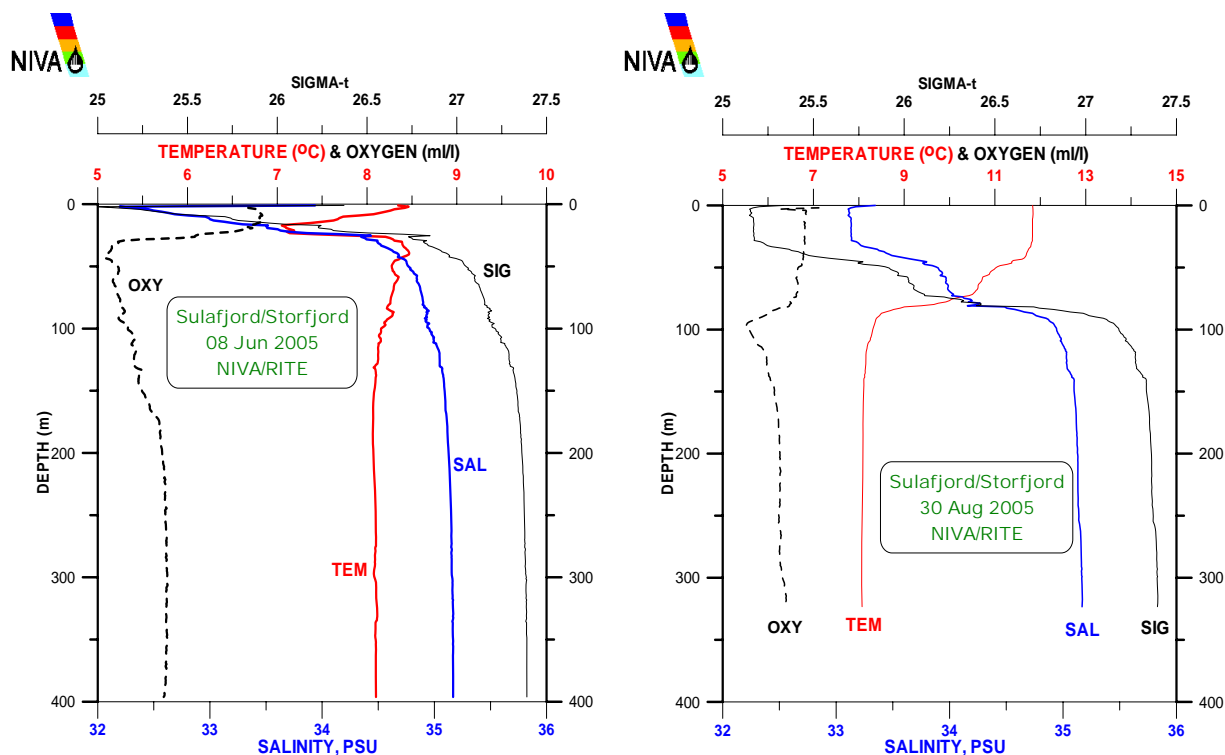

Figure 5. Hydrographic profiles by NIVA from Stor fjorden, June and August, 2005, prior to the experiments. The measurements were taken with a SBE-19 STD that was calibrated at the factory in December 2004.

2.3 Marine biology of Stor fjorden

According to existing information and publications the sediments and biology of Stor fjorden in many respects seems to resemble some of the deeper offshore (North Sea) locations that may be used for CO₂ storage. Therefore using Stor fjorden for well managed and controlled marine impact studies may provide an easier and safer way to assess possible impacts from CO₂ leaks than by running experiments offshore. Below we give a brief review of the existing information on Stor fjorden, that still has knowledge gaps in several aspects of the biology.

2.3.1 Plankton

The relative abundance of the zooplankton species in Stor fjorden is consistent with descriptions from several other Norwegian fjords (Halliday et al. 2001). *Evadne spp* is often the most abundant zooplankton species in the upper layers (**Figure 6**) and some species show a bimodal distribution (e.g. *Oithona spp.*, *Oncaea spp.*, *Calanus finmarchicus*, and *Metridia spp.*) which may be a reflection of generational or physiological differences not distinguished in the analysis.

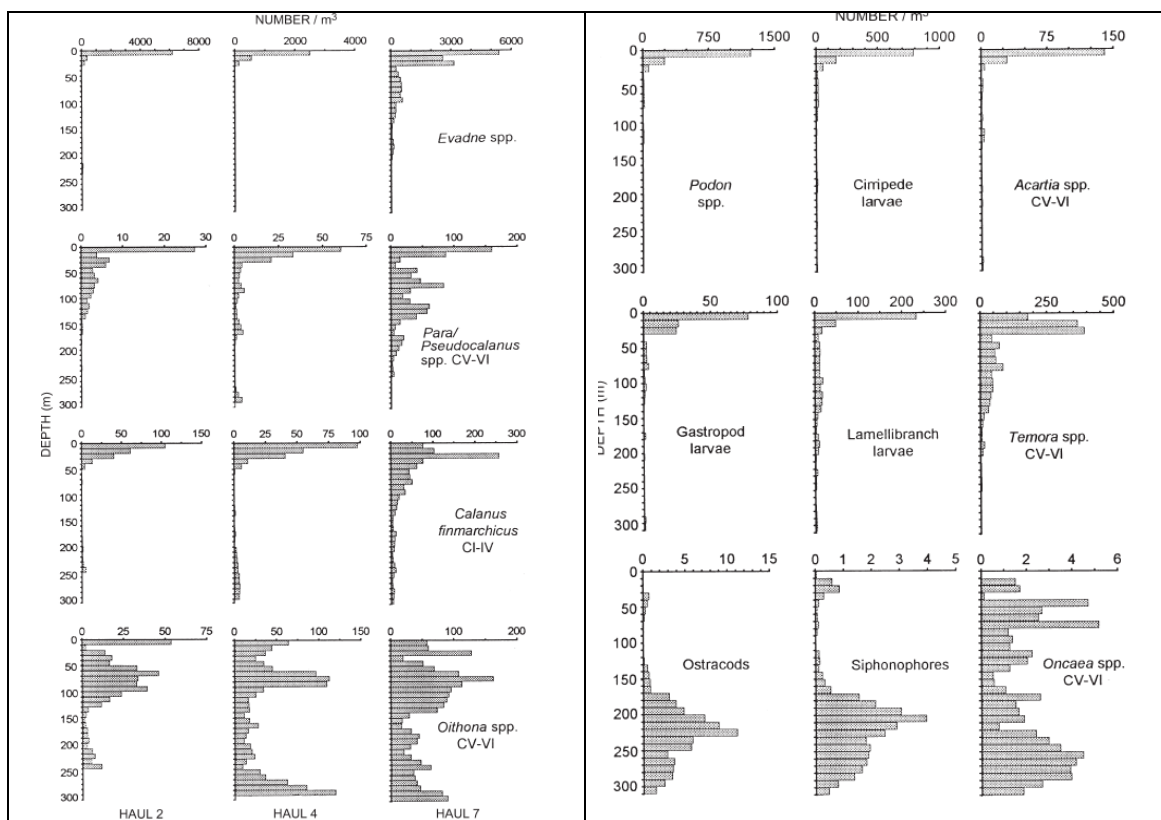

Figure 6. Vertical distribution of selected crustacea from 200 µm net samples (3 hauls) in Storjfjorden in June 1993. Each haul is plotted to the maximum depth sampled on that haul (figure from Halliday et al. 2001).

2.3.2 Benthos

Little is known about the macro benthos (animals retained on a 1 mm sieve) in the soft bottom sediments in Storjfjorden. The well oxygenated bottom water indicates a condition that can support a rich benthic fauna in the fjord. The results from the present study indicate that the site actually was well suited both in terms of sediment characteristics and abundance of meiofauna and microbes for exposure experiments (larger animals were not tested in the project).

2.4 Fish and fisheries

The deep flat areas in the fjord have depths between 200 and 650 meters. The main fish species found on these areas are deep water species such as Roundnose grenadier (*Coryphaenoides rupestris*), blue ling (*Molva dypterygia*), rabbitfish (*Chimaera monstrosa*) and some deep water sharks. Other important species are the tusk (*Brosme brosme*). These are species commonly found offshore. In the slopes the species composition changes by depth. In the upper part of the slope shallow water species are dominating such as Pollack (*Pollachius pollachius*), Cod (*Gadus morhua*). In the deeper part of the slope the ling is becoming one of the most common species.

Most probably some of the deep water species of Storfjorden, such as the Roundnose grenadier and the Greater fork beard are isolated stocks. Others may have migrations out and back into the fjord.

As example it can be mentioned that some of the side fjords are spawning areas for migrating cod, herring and hake.

In the Storfjord there are coastal gill-netters targeting, hake, saith, and monkfish. A trawl fishery for deep water shrimps are conducted along the deeper parts of the fjords. There has traditionally been a long-line fishery targeting tusk and blue ling and Atlantic halibut, but this activity is declining.

Trawling is restricted to testing of gear only and was therefore not considered an obstacle for the BC experiments.

2.5 Aquaculture

Salmon farms are not allowed in the inner parts of Storfjorden, as a means to protect the wild salmon. However, significant production of rainbow trout is taking place in the fjord (in floating net cages/pens). More recently, farms for cod production is also emerging. This activity is restricted to the upper part of the water column only and did not represent any conflict for the CO₂ experiments.

2.6 The deployment site and the pre-survey

In June, 2005, a pre survey to the site was done by NIVA and RITE/KANSO, mainly to study the bottom conditions and the sediment quality in order to insure that the physical characteristics (especially softness) were compatible with the use of the benthic chamber. If the sediments were too soft, the chamber might sink too deep in. The testing of the sediment was done by means of taking grab samples of the surface sediment and subsequent inspection of the sediment on deck.

Sediments in the central part of the fjord were observed to be a bit too soft, while at the foot of the slope the sediments were sufficiently hard to fulfil the requirements for a successful deployment of the benthic chamber system.

The location of the chosen deployment site is shown in **Figure 7**. The site is located ca. 3 km from the ODIM factory at Hjørungavåg (near Hareid) where the benthic chamber was assembled and prepared. The depth at the deployment location was around 400 m in an area with a relatively flat bottom as confirmed by the echosounder.

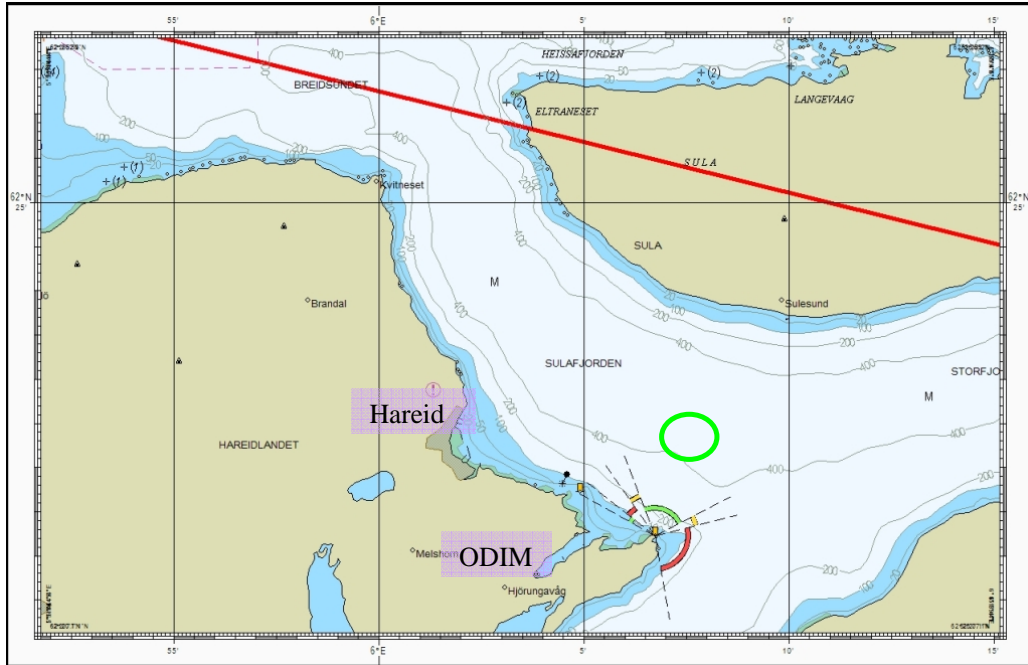

Figure 7. Map of the Storfjorden south of Aalesund, between Hareid and Sula. The circle denotes the location for the two deployments of the benthic chamber.

3. Experimental setup

3.1 Description of the Benthic Chamber (BC) system

Various experiments, such as measuring the metabolism of benthos populations, have been conducted using benthic chambers (Tengberg et al., 1995), but this technique has not been used for CO₂ exposure experiments before Ishida and Shirayama (1999) developed a benthic experimental chamber specialized for studying effects of CO₂ on benthic communities on the deep-sea floor. This benthic chamber system (**Figure 8**) was a modification of the design of the German IFM-GEOMAR Research Institute (Witte and Pfannkuche, 2000, Pfannkuche and Linke, 2003). A sensor was added to the chamber to regulate its penetration depth in order to make the headspace water volume equal for each chamber during the experiment. This secures that the partial pressure of CO₂ ($p\text{CO}_2$) in each chamber is maintained at the required level. The water injection and sampling system was also modified.

The benthic chamber system (**Figure 8**) was equipped with three chambers, two (A and B) were used as the experimental chambers with the addition of CO₂ and the third chamber (C) was used as a control with no addition of CO₂. The enclosed area was 200 mm x 200 mm and the height was 280 mm (**Figure 9b**). Each chamber was closed by a bottom shutter before the CO₂ were released into the water overlying the sediment. This prevents the benthos from escaping. All chamber operations were pre programmed prior to deployment.

The benthic chamber equipment is a free float system which is deployed and brought to the surface without using wires etc. At the end of each experiment the BC was brought to the surface after releasing ballasts on response to an acoustic signal from the ship.

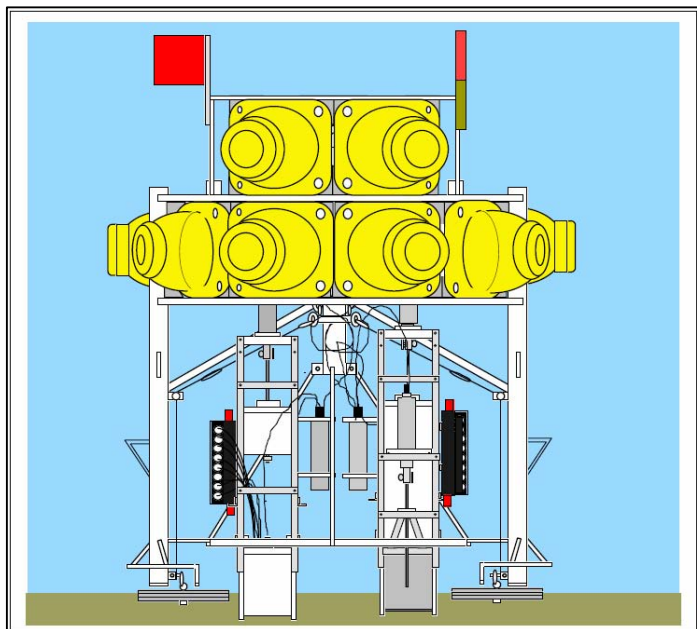

Figure 8. Schematic of the benthic chamber system (figure made by Hiroshi Ishida).

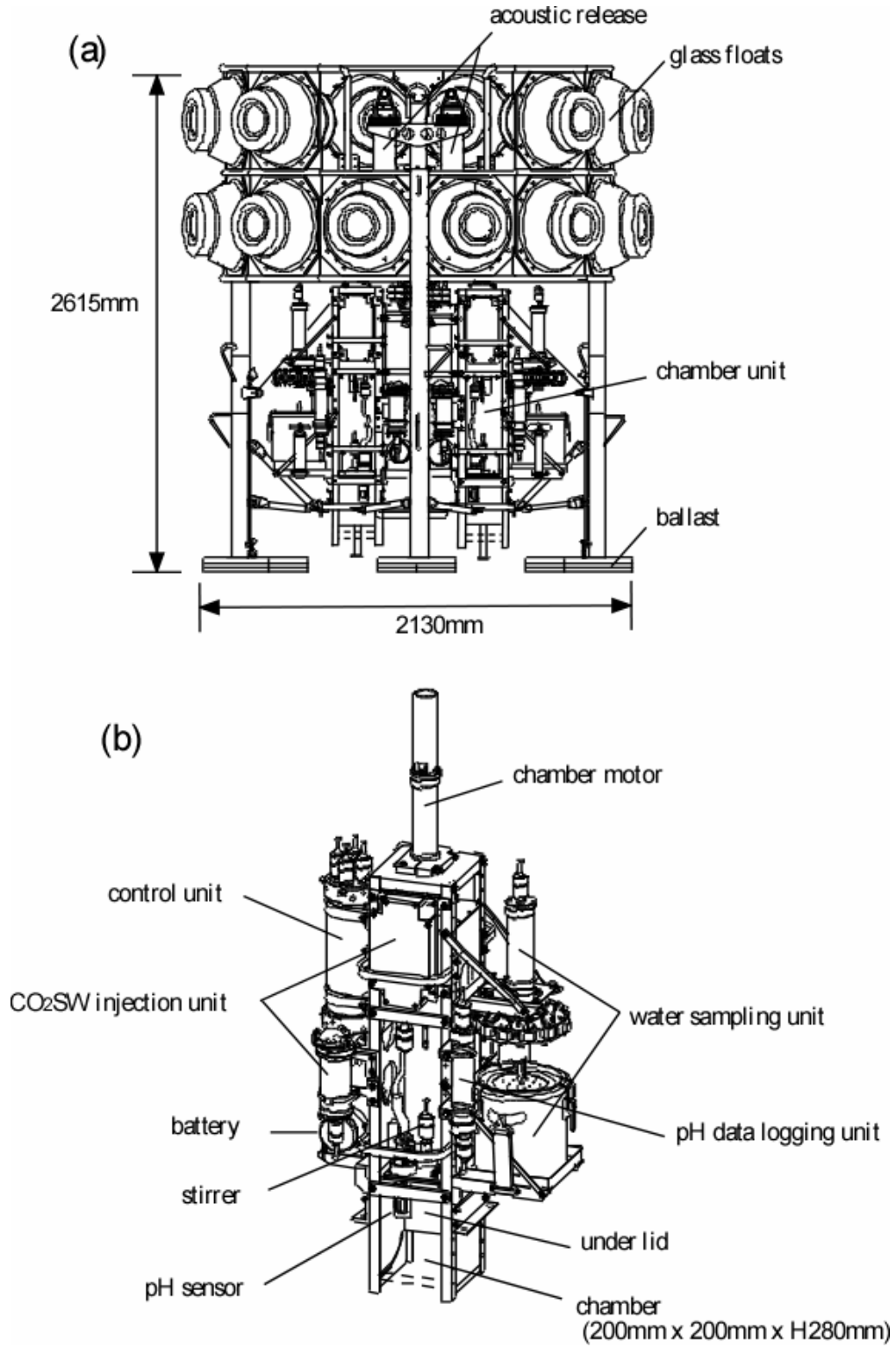

Figure 9. *The benthic chamber system, with explanation of vital parts.*

Seawater with an elevated $p\text{CO}_2$ (CO_2 SW) was injected periodically into the headspace of experimental chamber A and B according to a pre set schedule (electronically programmed) in order to control $p\text{CO}_2$ in each chamber. In chamber C only normal seawater was injected. The injected water was prepared prior to the deployment of the equipment and stored in a sealed bag of aluminium.

The pH in the headspace water of each chamber was monitored by a pH sensor (HORIBA pH/ORP sensor 6280) during the experiment. Dissolved oxygen (DO) was also monitored by means of a DO sensor (ALEC COMPACT-OPTODE). Seawater samples were collected 6 times during each experiment (each of a duration of 9 days) and preserved in 500 ml aluminium sealed bags (GL Science AA1) up to the end of the experiment to calibrate the data obtained by the sensors.

Volume compensation following injection and sampling are done through a special tube connecting the chamber to the outside water. Some compensation may however also take place through the sediment water interface.

3.2 Experimental design (first and second experiment)

Experiments were carried out twice in September 2005. The exposure time of the first and the second experiment was 217 and 226 hours, respectively. The $p\text{CO}_2$ exposures were the same for both experiments, in which the average $p\text{CO}_2$ during experiments was programmed to maintain levels of approximately 5,000 μatm and 20,000 μatm in each of the two experimental chambers A and B. The levels were chosen in order to be able to compare with previous BC experiments in the Pacific where these $p\text{CO}_2$ levels were found to cause some specific biological effects (Ishida *et al.*, 2005).

Details of each of the experiments in Storfjorden are shown in **Table 1**.

Table 1. *Experimental details. The values shown in B are target (design) values.*

A

| Experiment | Date of deployment | Position | Exposure time | Exposure time (hr) |
|------------|---------------------|--------------------------|-------------------------|--------------------|
| 1st | 2005/09/02 12:00 | 62°21.99'N 06°08.07'E | 9/3 10:30 – 9/12 11:30 | 217 |
| 2nd | 2005/09/17 13:00 | 62°22.03'N 06°08.10'E | 9/17 22:30 – 9/27 08:30 | 226 |

B

| Experiment | Exposure $p\text{CO}_2$ (μatm) | pH | Chamber name | Chamber label |
|------------|---|-----|--------------------|---------------|
| 1st | Control | 7.9 | Control | C |
| | 5,000 | 7.0 | Low CO_2 | B |
| | 20,000 | 6.3 | High CO_2 | A |
| 2nd | Control | 7.8 | Control | C |
| | 5,000 | 7.0 | Low CO_2 | B |
| | 20,000 | 6.3 | High CO_2 | A |

The seawater used for the experiments was collected from 100 m depth at the experimental site in the Storfjorden and was filtered using a Millipore HA membrane filter (0.45µm pore size) before CO₂ addition. This water was used as basis for producing the CO₂SW to adjust the *p*CO₂ in the chamber to the planned levels. The water for the 20,000 µatm treatment was prepared by bubbling with 100% CO₂. The CO₂SW for 5,000 µatm treatment was prepared by mixing seawater bubbled with pure nitrogen with the seawater bubbled with 100% CO₂. **Table 2** shows the conditions of pH, total carbon dioxide (T-CO₂) and estimated *p*CO₂ of the CO₂SW used in each chamber. Seawater bubbled with pure nitrogen gas was injected in the control chamber to standardize the experimental conditions against the exposure chambers.

Table 2. Data on the seawater prepared for injection into the chambers headspace during the experiments.

| Experiment | Chamber | pH | T-CO ₂ (mM) | <i>p</i> CO ₂ (µatm) |
|------------|-----------|-----|------------------------|---------------------------------|
| | control | 7.8 | 2.3 | 930 |
| 1st | 5000µatm | 5.9 | 5.8 | 90000 |
| | 20000µatm | 4.9 | 30 | 841000 |
| | control | 7.8 | 2.4 | 860 |
| 2nd | 5000µatm | 5.9 | 6.1 | 89000 |
| | 20000µatm | 5.0 | 29 | 783000 |

The injected seawater to adjust *p*CO₂ (CO₂SW) was oxygen-free in order to avoid any fluctuations of dissolved oxygen resulting from the CO₂SW injections, because we aimed to measure the oxygen consumption rate from the changes of the dissolved oxygen. 300 ml of CO₂SW was injected into the headspace of the chamber at each injection. This amount corresponds to 5 % of the headspace volume. A similar volume of water pre bubbled with nitrogen was injected into chamber C.

3.2.1 Sampling of sediment and water from the BC at ODIM

All chamber operations followed a preset program (**Table 3**). The penetration of the chamber into the sediment started half or 1 day after the benthic chamber system had landed on the seabed in order to avoid the effects of disturbance by the landing. The chamber penetrated slowly at a rate of 17 mm/min in order to minimize disturbance to the sediment surface. When the chamber had penetrated to 15 – 16 cm depth, the shutter of the lower part of the chamber was closed and thereby enclosing the sediment with the bottom water in each chamber as a unit. The first water sample was collected 12 minutes after the enclosing operation was finished. The first CO₂SW injection was performed 30 minutes after the enclosing operation. The second water sample was taken 30 minutes after the first injection of CO₂SW. Subsequently, CO₂SW injection and water sampling were operated at regular intervals (**Table 3**). The exposure period was defined as the time from the initial injection to the ballast release.

Table 3. Chamber operations program. Seawater samples collected in bags were analyzed for dissolved oxygen concentration (DO), T-CO₂ and pH immediately after the benthic chamber was recovered.

| Deployment | 1st Experiment | | 2nd Experiment | |
|------------|--------------------|-------------|--------------------|-------------|
| | 9/2 10:00 | amount (ml) | 9/17 13:00 | amount (ml) |
| sampling | 9/3 10:00 - 10:20 | 300 | 9/17 22:00 - 22:20 | 400 |
| injecting | 9/3 10:30 - 10:50 | 300 | 9/17 22:30 - 22:50 | 300 |
| sampling | 9/3 11:00 - 11:20 | 300 | 9/17 23:00 - 23:20 | 400 |
| sampling | 9/7 10:00 - 10:20 | 300 | 9/21 22:00 - 22:20 | 400 |
| injecting | 9/7 10:30 - 10:50 | 300 | 9/21 22:30 - 22:50 | 300 |
| sampling | 9/7 11:00 - 11:20 | 300 | 9/21 23:00 - 23:20 | 400 |
| sampling | 9/11 10:00 - 10:20 | 300 | 9/25 22:00 - 22:20 | 400 |
| injecting | 9/11 10:30 - 10:50 | 300 | 9/25 22:30 - 23:50 | 300 |
| sampling | 9/11 11:00 - 11:20 | 300 | 9/25 23:00 - 23:20 | 400 |
| Recovery | 9/12 09:00 | | 9/27 09:00 | |

The Winkler method was used to measure DO using 100 ml samples. Total CO₂ (T-CO₂) was measured by a Capni-Con 5s Total CO₂ Analyzer (Cameron Instrument Company, Inc.) and pH was measured by a pH sensor (ORION). The value of *p*CO₂ was calculated from pH and T-CO₂ using the CO2SYS program (Lewis and Wallace, 1998).

3.2.2 Hydrography and current measurements

A CTD of type SAIV SD204 with a Royce dissolved oxygen sensor was fixed to the chamber about 1 m above the bottom of the legs, logging data at 30 minute intervals. A NORTEK Aquadopp acoustic current meter was mounted at the top of the chamber, about 4 m above the bottom. The logging interval was set to 5 minutes.

An overview of some of the equipment used to describe chemical and physical characteristics at the experimental site and experimental chambers are shown in **Table 4**. In addition sensors for pH monitoring and calculation of *p*CO₂ were incorporated in the system (see Para. 3.1).

Table 4. Overview of the data and samples provided by NIVA.

| Item | First Exposure | Second exposure | |
|--|----------------|-----------------|--|
| Ambient STD-logging near bottom | OK | OK | Raw data files processed and saved |
| Ambient O ₂ near bottom | OK | OK | Raw data files processed and saved |
| Ambient currents near bottom | OK | OK | Raw data files saved, data processed |
| Water samples from chambers: Nutrients | OK | OK | Values obtained for PO ₄ -P, NH ₄ -N, NO ₃ -N, SiO ₂ , 36 samples |
| Oxygen in seawater, in chambers | OK | OK | Winkler analyses, 36 samples |
| Sediments: C/N | OK | OK | 12 samples for analysis of % dry weight (TTS%), total carbon (TC) and total nitrogen (TN) |
| Hydrographic profiles in the fjord | OK | - | A couple of new profiles obtained, before/during experiment, plus several older profiles obtained from Inst. Mar. Res. |

3.2.3 Analysis of nutrients and oxygen in the water inside the chambers

Seawater collected in the headspace 6 times during each experiment were analysed (see **Table 3** for sampling time and date). Oxygen content were analysed by Winkler titration. Nutrients were analysed according to standard NIVA procedures (**Table 5**).

Table 5. Methods used for analysis of nutrients in seawater samples from the chamber.

| Nutrient | Code for NIVA method | Units | Reference |
|---------------------------|--|-----------------------|---|
| NH ₄ -Nitrogen | D 5-1 | µg/l nitrogen | NS ¹ 4746 |
| NO ₃ | D 3 (+any NO ₂ ⁻ present in the sample will also be included in the result) | µg/l nitrogen | NS ¹ 4745 (modified) |
| SiO ₂ | C 7-2 | mg/l SiO ₂ | K. Grasshoff, M. Erhardt, K. Kremling: Methods of seawater analysis. F. Koroleff: Determination of silicon, pp 174 – 185, 1985. |

¹Norwegian Standard.

3.2.4 Analysis of total carbon and nitrogen in the sediment by NIVA

Sediments were analysed according to standard NIVA procedures (**Table 6**).

Table 6. *Methods used for analysis of % dry weigh (TTS), total carbon (TC) and total nitrogen (TN) in sediment samples collected in the chambers after the 2nd experiment.*

| Parameter | Code for NIVA method | Units | Method |
|-----------|----------------------|------------------------------------|---|
| TTS | B-3 | % | Drying at 105 °C, gravimetric determination of weight |
| TC | G-6 | µg carbon /mg dry weight sediment | Catalytic combustion, CO ₂ are detected by use of Carlo Erba Element analyser 1106 equipped with AS 400 LS sampler |
| TN | G-F | µg nitrogen/mg dry weight sediment | Catalytic combustion, N ₂ are by use of Carlo Erba Elementanalyser 1106 equipped with AS 400 LS sampler |

3.2.5 Treatment of sediment and analytic methods for the RITE/Kanso analyses

Nine sub-cores to measure the abundance of meiobenthos, nanobenthos and bacteria were collected at random from the sediment in each chamber using polyethylene piston syringes. Each sub-core was sliced into 0-0.5, 0.5-1, 1-2 and 2-3 cm layers to take a vertical profile of the benthos. One subcore was collected after the second experiment to measure particle size distribution of the sediment. Each sub-core was sliced into 0-0.5, 0.5-1, 1-2, 2-3, 3-4 and 4-5 cm layers.

The samples for meiobenthos were fixed with neutralized seawater formalin containing rose bengal at a final concentration of 10 % of formalin, and stored at room temperature until analysis. The nanobenthos and bacterial samples were fixed with 1 % glutaraldehyde and kept cool until analysis. In this study, meiobenthos was defined as those organisms that passed through a 300 µm sieve and were retained by a 32 µm sieve. The individuals or shells having protoplasm which were stained red by rose bengal were counted under a binocular microscope (Higgins and Thiel, 1988).

Cells or individuals having a length of 2 to 32 µm were assumed to be nanobenthos and were divided into small size nanobenthos of less than 10 µm and large size nanobenthos of more than 10 µm, respectively. To count them, sediments were double stained by DAPI and proflavine, and filtered using a nucleopore filter of 1.0 µm pore size. Only those cells having nuclei, fimbriae and flagellae, and those fluorescence-stained under UV excitation light and B excitation light using an epifluorescence microscope were counted. Bacteria were separated ultrasonically from sediment particles, stained by DAPI, and filtered using a 0.2 µm nucleopore filter (Epstein and Rossel, 1995). Particulate composition was analyzed by the Microtrack method using laser light beam (NIKKISO COMPANY MT3300EX) (Yamashita and Kawada, 1997).

3.2.6 Analytic methods used by BGS for geochemical analysis of sediment

Analysis were performed on core samples (0-10 cm deep) collected from each chamber at the end of both experiments (**Table 7**).

Table 7. *Samples analysed for geochemical parameters.*

| Experiment | Chamber name | Sample label |
|------------|----------------------|-----------------|
| 1st | Control | NIVA C/1 0 - 10 |
| | Low CO ₂ | NIVA B/1 0 - 10 |
| | High CO ₂ | NIVA A/1 0 - 10 |
| 2nd | Control | NIVA C/2 0 - 10 |
| | Low CO ₂ | NIVA B/2 0 - 10 |
| | High CO ₂ | NIVA A/2 0 - 10 |

Total Organic carbon

Non-volatile total carbon (TC) and total organic carbon (TOC) in solid geological materials (e.g. soil, rock, sediment, coal, etc.) was determined by combustion to carbon dioxide, which is measured using a thermal conductivity detector (TCD). Determination of TOC was performed by removal of carbonate by acidification prior to analysis, (losses of volatile or semi-volatile organic compounds are not measured). Total inorganic carbon (TIC) is calculated by difference, $TC - TOC = TIC$. All data is reported as % carbon.

The determination of non-volatile total carbon and TOC content of solid samples was carried out using an Elementar VarioMax analyser. The instrument is controlled by a computer using the 'VarioMax' software supplied by the manufacturer. The results are also calculated on the instrument's software. The sample (100-1,000mg) is placed in a pre-weighed silver-foil cup and oven dried at 100-105°C for at least 1.5 hours and reweighed to obtain a 'dry-weight'. Next the sample is treated with excess acid (HCl, 50% v/v) until all effervescing stops and oven dried at 100-105°C (at least 1.5 hours). The sample is put in a ceramic crucible and placed on the auto-sampler of the instrument ('Elementar Vario Max' C/N analyser). The sample crucible is mechanically lowered into a vertical tubular quartz combustion furnace (1050°C), through which helium carrier gas is constantly flowing. Once in the combustion furnace a stream of oxygen is introduced to the sample until combustion is complete, the carrier gas conveys the combustion products via cerium dioxide granules (a catalyst) within combustion furnace to the detector where carbon dioxide is measured as a function of time.

Wavelength-Dispersive X-Ray Fluorescence Analysis (XRF)

Samples were analysed for Loss on Ignition (LOI) by gravimetry, major and minor oxides by fusion and X-Ray Fluorescence Spectrometry (XRFS) and minor and trace elements by pressed powder pellet and XRFS. This work is covered under UKAS accreditation. The laboratory is a UKAS accredited testing laboratory, No. 1816.

Loss on Ignition The samples were dried overnight at 105°C before LOI and fusion. Loss on ignition was determined after 1 hour at 1050°C. Approximately 1 g of sample was weighed accurately into a porcelain crucible. The crucible was weighed before and after heating and the two weights compared. The resulting relative loss or gain in sample weight was reported as the LOI. Quality Control (QC) was monitored by the regular analysis of three materials covering the range of LOI values found in most geological and related materials.

Fused bead major and minor oxide WD-XRFS Analysis

Fused beads were prepared by fusing 0.9000 g sample plus 9.000 g flux (66/34 Li₂B₄O₇ and LiBO₂) at 1200 °C. After fusion the melt was cast into a 40 mm glass bead which was then analysed by WD-XRFS. The XRFS Spectrometer used was a Philips MagiX-PRO with a 60 kV generator and 4 kW rhodium (Super Sharp) end-window X-ray tube controlled via PC running PANalytical SuperQ XRF application package. The PANalytical calibration algorithm is used to fit calibration curves and inter-element effects are corrected by theoretical alpha coefficients, calculated by the PANalytical method. All spectral backgrounds and peaks are corrected for instrument drift using two external ratio monitors. Routine calibrations cater for a wide variety of environmental and geological matrices; the application quantifies 19 elements on fused beads, calibrated as oxides shown with reporting limits in **Table 8**.

The lower limits of detection (LLD) were calculated from instrument sensitivity at calibration and lower limits of reporting (LLR) were calculated from the LLDs. The upper reporting limits (URL) were determined from the highest concentration standard used on calibration. Fused bead QC was monitored by the analysis of two bulk rock materials chosen for their variety of type and analyte values. The results were entered into run charts for statistical analysis using a SPC package.

Table 8. Fused Bead Major Element Lower Limits of Detection (LLD), Lower and Upper Limits of Reporting.

| Oxide | LLD (%) 3 σ | LLR (%) | ULR (%) | Oxide | LLD (%) 3 σ | LLR (%) | ULR (%) |
|--------------------------------|--------------------|---------|---------|----------------------------------|--------------------|---------|---------|
| Na ₂ O | 0.009 | 0.05 | 50 | Mn ₃ O ₄ | 0.002 | 0.01 | 100 |
| MgO | 0.006 | 0.05 | 100 | Fe ₂ O _{3-t} | 0.003 | 0.01 | 100 |
| Al ₂ O ₃ | 0.002 | 0.01 | 100 | NiO* | n.d. | 0.01e | 25 |
| SiO ₂ | 0.002 | 0.01 | 100 | CuO* | n.d. | 0.01e | 25 |
| P ₂ O ₅ | 0.002 | 0.01 | 50 | ZnO* | n.d. | 0.01e | 25 |
| SO ₃ * | 0.004 | 0.1 | 75 | SrO | 0.003 | 0.01 | 1 |
| K ₂ O | 0.002 | 0.01 | 50 | ZrO ₂ | 0.004 | 0.02 | 100 |
| CaO | 0.002 | 0.01 | 100 | BaO | 0.005 | 0.02 | 100 |
| TiO ₂ | 0.002 | 0.01 | 100 | PbO* | n.d. | 0.02e | 10 |
| Cr ₂ O ₃ | 0.003 | 0.01 | 25 | | | | |

Fe₂O_{3t} represents total iron expressed as Fe₂O₃. SO₃ represents sulphur retained in the fused bead after fusion at 1200°C.

SO₃, NiO, CuO, ZnO, PbO are not included in the UKAS Accreditation Schedule

n.d. not determined

e estimated

3.2.7 Treatment of sediment and analytic methods for the BGR analyses

Sampling and treatment in Norway

At the end of both experiments 6 cores were collected in each chamber and allocated for bacterial counts, DNA extraction and determination of sulphate reduction rates (SRR). Each core was sliced into two depth intervals (0-2.5 and 2.5-5 cm). 3 of the cores (core 1-3) were used for bacterial counts and the other 3 (core 4-6) for DNA extraction and measurements of sulphate reduction and methane production rates. The slicing of the cores was performed at the ODIM site within approximately 6 hours after retrieval of the BC. The different samples (slices) of sediment were stored in aseptic glass containers until further subsampling were performed at the microbiology laboratory at Aalesund Univ. College the same day.

Fixation of the sediment samples (2 ml) for bacterial counts were performed within 18 hours after retrieval according to a method which involves fixation in 4 % formalin, centrifugation, treatment with washing buffer and storage in a buffer/ethanol solution (Eller et al. 2001). The treated samples were stored and transported to BGR in a frozen condition (mostly at -20 °C). The subsamples for DNA analysed were stored in Eppendorf cups (in duplicate) at -80 °C until transported to BGR. The amount of sediment available was limited and priority was given to the samples for bacterial counts and DNA work. Therefore, a limited amount of sediment for determination of sulphate reduction rates and the sediment used for these analyses represent a depth distribution of 0-5 cm in the sediment. The sediment for these analyses was stored in glass tubes with butyl septa and screw cap. Care was taken to fill the tubes 100% with sediment and avoiding air bubbles. The samples were stored and transported to BGR at approximately 4°C. One sample was lost during transport.

Sediment samples were collected during two subsequent chamber experiments. According to the CO₂ concentrations applied in the chambers samples were either labelled "control" for background CO₂ concentrations, or "low CO₂" for 5,000 ppm_v in the gasphase, and "high CO₂" with 20,000 ppm_v. From the first set of experiments the living sample from the "high CO₂" treatment was lost during transport.

Treatment at BGR

Sediment was filled aseptically into sterile glass bottles (100 ml), which were sealed with butyl septa and screw caps. Further subsamples (2 ml) were taken for DNA extraction (stored at -20°C), and for microscopy (fixed with 4 % p-formaldehyde (Eller et al. 2001)).

Sediments were converted into slurries by the addition of artificial seawater medium in a ratio of 1:1 (w/w). All manipulations were performed under an atmosphere of N₂/CO₂ (90/10 [v/v]) in an anoxic glove chamber (Mecaplex). Three replicates of 3 ml slurry from each sample were flushed with N₂ and incubated in Hungate tubes with a total volume of 5 ml to determine the initial potential methane production rates (MPR) (Krüger et al. 2001). All tubes were sealed with butyl stoppers and repeatedly flushed with N₂ to remove residual O₂. Headspace gas samples were taken daily after heavy shaking of the tubes by hand, and analyzed for methane on a gas chromatograph equipped with a flame ionization detector.

For the determination of sulphate reduction rates (SRR), incubations were set up as described above for MPR but this time additionally sulphate was added from an anoxic stock solution to a final concentration of 10 mM. Samples for chemical analysis were withdrawn with hypodermic needles and plastic syringes pre-flushed with N₂ through the butyl stoppers. Sulphide was determined photometrically using the formation of copper sulphide (Cord-Ruwisch, 1985).

Microbial activities were calculated by linear regression of the product increase with incubation time, and expressed in $\mu\text{mol g}_{\text{dw}}^{-1} \text{h}^{-1}$ of soil.

DNA extraction and quantification of 16S rRNA genes.

Archaea are similar to other prokaryotes (*Bacteria*) in most aspects of cell structure and metabolism. However central processes do not show typical bacterial features, and are in many aspects similar to those of eukaryotes. Several other characteristics also set the *Archaea* apart from bacteria and therefore render this group of organisms of interest in terms of possible difference in response to CO₂ compared to bacteria

For quantitative PCR analysis (qPCR), high molecular weight DNA was extracted from the sediment samples stored at -20°C. The DNA extraction was based on cell lysis with 10% lauryl-sulphate solution and horizontal shaking for 45 s after addition of zirconium-silica beads, followed by DNA purification using NH₄-acetate and isopropanol precipitations as described in detail by Henckel et al. (1999).

Nucleic acids of *Eubacteria* and *Archaea* were quantified by real-time qPCR using an ABI Prism 7000 Sequence detection system (Applied Biosystems, Germany), following the protocol of Lüders et al. (2004) with the primer sets Ba519f / Ba907r and Ar109f/Ar912r, respectively. The gene copy numbers were converted into cell numbers using a conversion factor of 3.6 and 1 for *Eubacteria* and *Archaea*, respectively (Klappenbach et al., 2001). Due to the lack of significant differences the results for the layers 0-2,5 and 2,5 to 5 cm were combined for statistical analysis.

3.2.8 Analytic methods used by BGS for analyses of ATP in sediment

The measurement of Adenosine 5'-Triphosphate (ATP) was used as an indicator of living biomass in the marine sediments in this study. A total of 30 sediment sample tubes from the BC experiment were received at the BGS laboratory in the UK. They had previously been frozen in liquid nitrogen soon after collection in Norway and were transported, packed under dry ice, in this frozen state. On arrival they were immediately placed in the laboratory freezer to prevent any deterioration of the samples until the analyses could be carried out. This method of freezing to preserve the ATP was recommended in literature from previous ATP sampling studies of ocean sediments (Egeberg, 2000).

The samples received included: 5 control samples, 5 low dose samples and 5 high dose samples collected at the end of both experiments (12/09/05 and 27/09/05).

Four of each of the groups of samples were processed for ATP and geochemical parameters.

Method

The samples tubes were removed from the freezer and, using aseptic techniques, a sample of sediment was removed from the following depth interval: 0 -1.5 cm, 3 -4.5 cm (in one set of samples only) and 5.5-6.5 cm. The analysis on these samples was carried out using the Deltatox analyser and is detailed below.

Deltatox ATP Procedure: This procedure details the use of the Deltatox analyser in conjunction with ATP reagents supplied by Strategic Diagnostics, Inc. and are specific to this equipment.

A sub sample was taken from the original sample using aseptic technique. This was transferred to a small sterile bottle (bijou) and weighed. A known volume of sterile deionised water was then added to the bijou and this was vortex mixed for a few seconds to homogenise the sample. A 100 µl sample of the supernatant was removed and the Deltatox procedure was then followed.

Required materials:

- Deltatox Analyser
- Glass Cuvettes
- Cuvette Rack
- 100µL Pipette
- 50-200µL Pipette Tips (Biopur ATP free)
- Stopwatch
- ATP Reagent
- ATP Diluent
- ATP Extractant

Procedure:

1. The entire content of a vial of the ATP diluent was poured into the dried ATP reagent vial. The ATP reagent vial was capped with the stopper and gently swirled to mix whilst the bottom of the vial rests on a work surface.
2. After 10 minutes the dried reagent has rehydrated and come to ambient temperature. Occasionally the vial is swirled to ensure thorough mixing.
3. The Deltatox analyser performs a self-test after 1 minute from switching on.
4. The MODE key was then pressed to convert the instrument to ATP measurements. The start key was then pressed and the analyser was ready to take measurements.
5. A cuvette for each sample was placed in the cuvette rack. (Up to ten samples can be tested at one time)
6. Using 100ul pipette 100ul of each sample was dispensed into corresponding cuvettes using a fresh tip for each sample.
7. Using 100ul pipette 100ul of ATP extractant was added to one sample cuvette. (The extractant can not be added to more than one sample at a time as it is not possible to run the samples concurrently). The cuvette was gently swirled for 2 seconds and let stand for 1 minute.
8. Using the 100 µl pipette 100 µl of reconstituted ATP reagent was added to the cuvette containing the sample and extractant. This was gently swirled for 2 seconds.
9. Immediately the cuvette was inserted into the analyser. The sample chamber lid was closed and locked by pulling the latch forward.
10. After pressing the read button the ATP measurement was displayed on the screen.

3.2.9 Denaturing gradient gel electrophoresis (DGGE) of sediment samples

These analyses were performed by the Aalesund University college.

DGGE analysis can give a genetic fingerprint of the bacterial population in a sample.

The following depth intervals of the sediment were analysed: 0.0 – 0.5 cm, 0.5 – 1.0 cm, 1.0 – 2.0 cm, 2.0 – 3.0 cm (one replicate for each treatment).

All equipment and solutions were sterilized and pre-filtered (0.2 µm) in advance.

Template preparation

0.5 ml sediment suspension was added 0.5 ml NSS (nine-salt-solution) and mixed for 30 sec on the whirl-mixer (speed 2,200 r/min) in a 2.0 ml safe lock tube. The suspension then was filtered through a 5.0 µm filter. The bacteria pass through, while most of the sediment particles remain on the filter. The clear solution (template in the PCR-reaction) was kept at – 20 °C. The filtration procedure is important because clay particles restrain the PCR-reaction. The templates were concentrated by centrifugation (6,000 g, 4 °C, 10 min). 90 % of the supernatant was removed before the pellet was resuspended (30 sec on the whirl-mixer).

Polymerase Chain Reaction (PCR)

1: PCR-mix: 2 x PCR mix (Red'y Gold Mix PK-0064-02R), 25 µl; **2:** BSA (Sigma-Aldrich B8667), 2.5 µl; **3:** primer F with GC-clamp (100 pmol/µl), 0.25 µl, **4:** primer R (100 pmol/µl), 0.25 µl; **5:** ddH₂O, 17 µl; template, **6:** 5 µl bacterial cell suspension. Final volume: 50 µl.

Primers: The primers were purchased from MWG.

The following 16s rDNA primers were used:

Forward: 5' -ACT CCT ACG GGA GGC AGC AG – 3'

Reverse: 5' – ATT ACC GCG GCT GCT GG – 3'

The forward primer was supplied with a GC-clamp at the 5'-end

GC-clamp:

5' - CGC CCG CCG CGC GCG GCG GGC GGG GCG GGG GCA CGG GGG G – 3'

PCR-program

1: 95 °C for 10 min, 1 cycle; **2:** 92 °C for 2 min, 1 cycle; **3:** 92 °C for 1 min, 55 °C for 30 sec, 72 °C for 1 min, 30 cycles; **4:** 72 °C for 6 min, 1 cycle; **5:** hold at 4 °C.

NSS – nine-salt-solution (1000 ml)

1: 17.6 g NaCl, **2:** 1.47 g Na₂SO₄, **3:** 0.08 g NaHCO₃, **4:** 0.25 g KCl, **5:** 0.04 g KBr, **6:** 0.04 g MgCl₂•H₂O, **7:** 0.41 g CaCl₂•H₂O, **8:** 0.008 g SrCl₂•6H₂O, **9:** 0.08 g H₃BO₃. The pH was adjusted to 7.0 with 0.1 M HCl and the solution was filtered twice (0.2 µm) before autoclaving.

VNSS –agar (1,000 ml)

1:1,000 ml NSS, 2: 1.0 g peptone, 3: 0.5 g yeast extract, 4: 0.8 g glucose, 5: 0.01 FeSO₄•7H₂O, 6: 0.01 g NaHPO₄, 7: 15 g agar, The agar plates were grown for 6 days at 15 °C before counting the colonies. NSS-solution was used to dilute the samples.

Agarose electrophoresis

The PCR-reactions were controlled on a 1x TAE-agarose (2 %) horizontal gel to verify the 234 bp 16S rDNA products. 5 µl of the PCR-mixture was applied to each well. The size of the PCR-products (app. 234 bp) was controlled with a 123 DNA-ladder (Sigma).

4. Results

4.1 Ambient conditions at the experiment site

4.1.1 Hydrography and oxygen time series

Results from measurements of temperature, salinity and dissolved oxygen during the first experiment (02 – 12 September 2005) are shown in **Figure 10**. All parameters remained stable, with only minor fluctuations. Salinity was around 35.37, temperature prevailed around 8.04°C, and dissolved oxygen varied between 70 and 80 % saturation (ca 7 ml/l). Some short-term “dips” in oxygen occurred intermittently, probably connected to fluctuations in benthic layer currents. Data from the second deployment were similar.

4.1.2 Currents near the bottom

Results from current speed measurements during both deployments are shown in **Figure 11**. No extended period with complete stagnation was observed, but currents remained weak most of the time, and below 0.1 m/s. At some instances currents exceeded 0.15 m/s, with maximum recorded speed of ca 0.45 m/s (26 September). The direction (not shown) was mainly along the SE-NW axis.

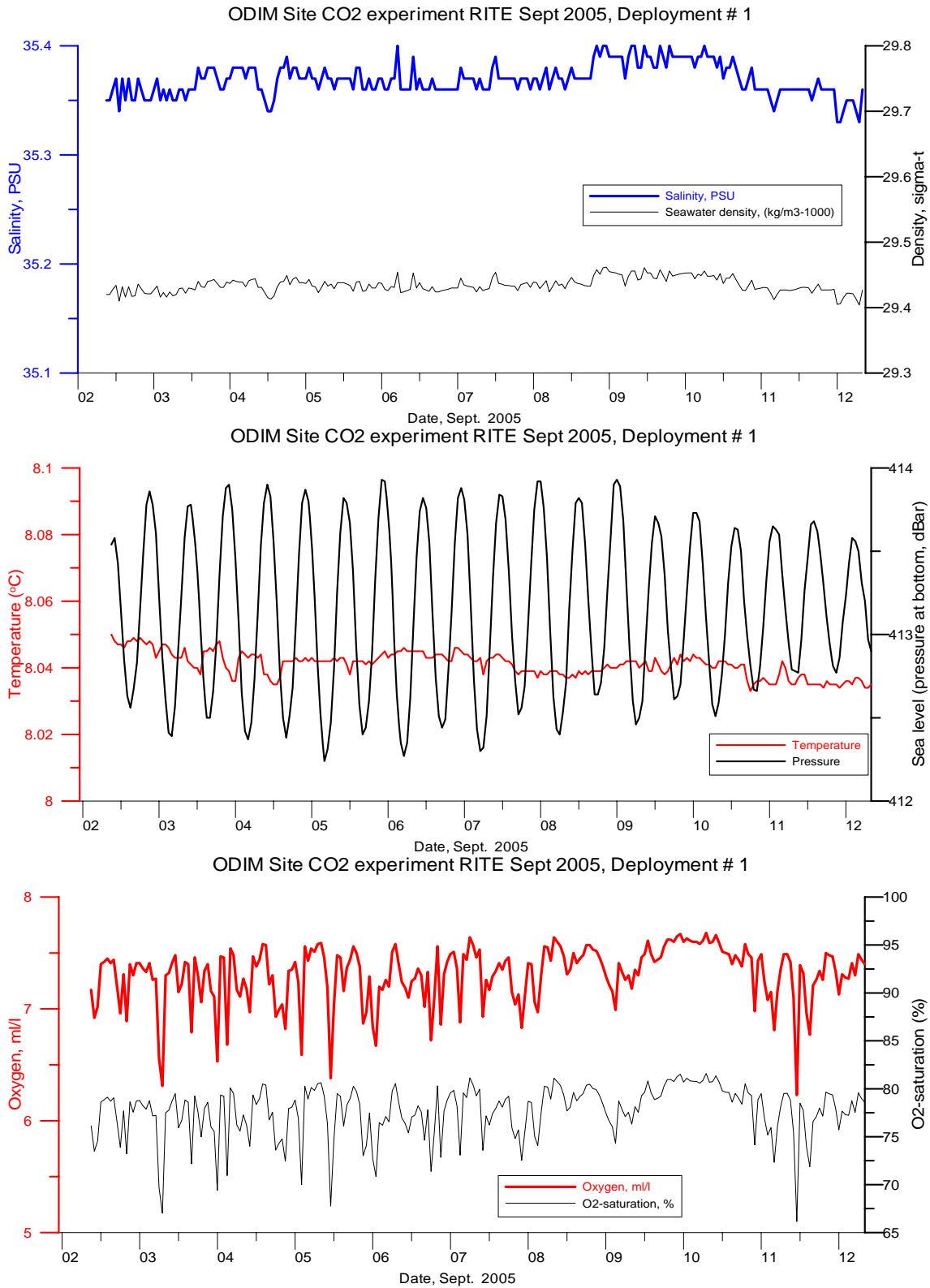

Figure 10. Time series of hydrographic data from 400 m depth at Storfjorden during 02-12 September, 2005.

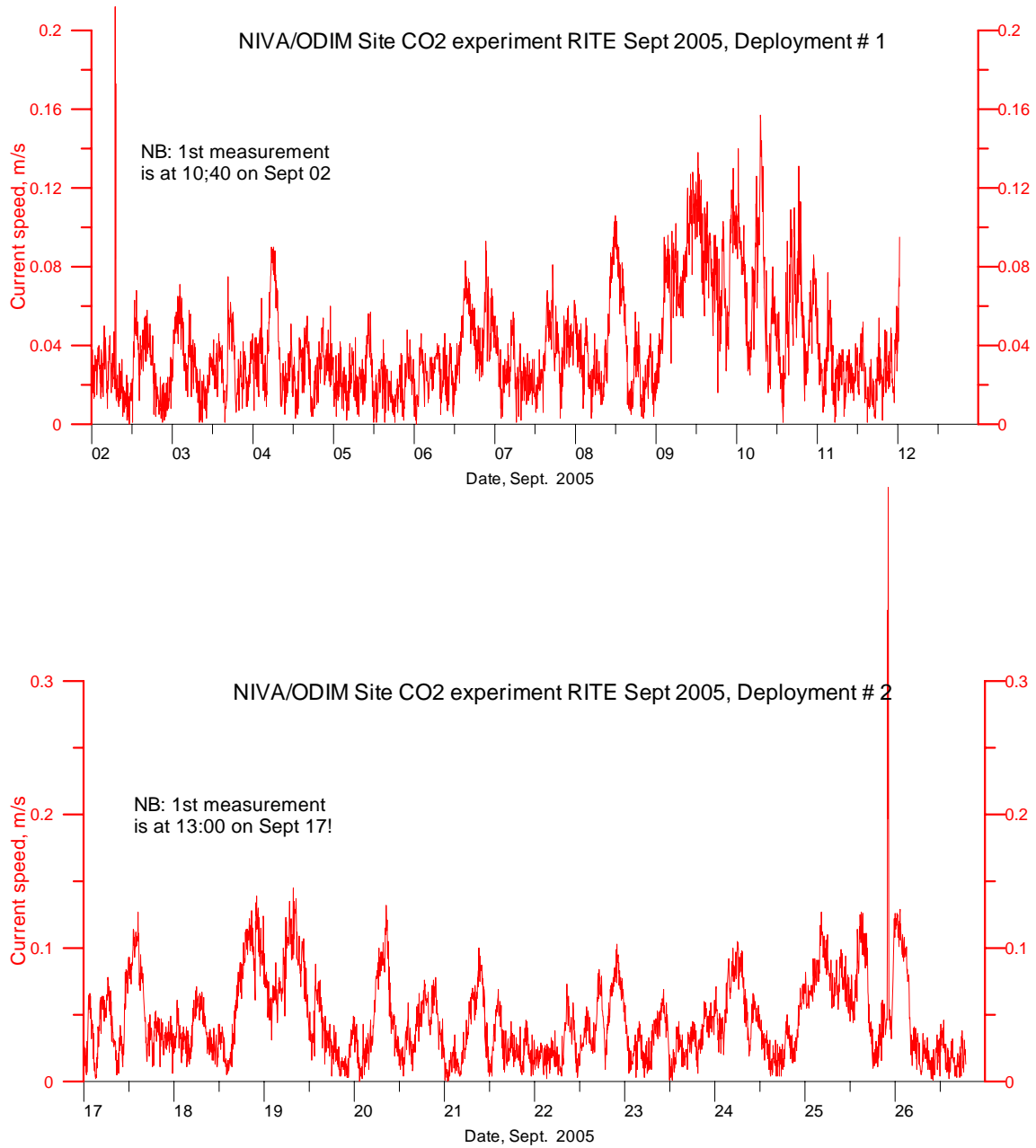

Figure 11. Measured current speed 3 m above the bottom at 400 m depth in Storffjorden, 17-27 September 2005.

4.2 Nutrients and oxygen in the water inside the chambers

4.2.1 Oxygen

Results from the Winkler analyses of discrete water samples collected inside the chambers are shown in **Figure 12**. All chambers experienced a long-term decline in oxygen over time. In experiment 1, Chamber B showed lower end values than the other two chambers. During experiment 2, the trend was quite similar in all chambers, indicating that most of the decay was due to natural consumption of oxygen due to respiration and chemical oxidation as only oxygen-free water was added to the chambers, see **Table 3** and Para. 3.2).

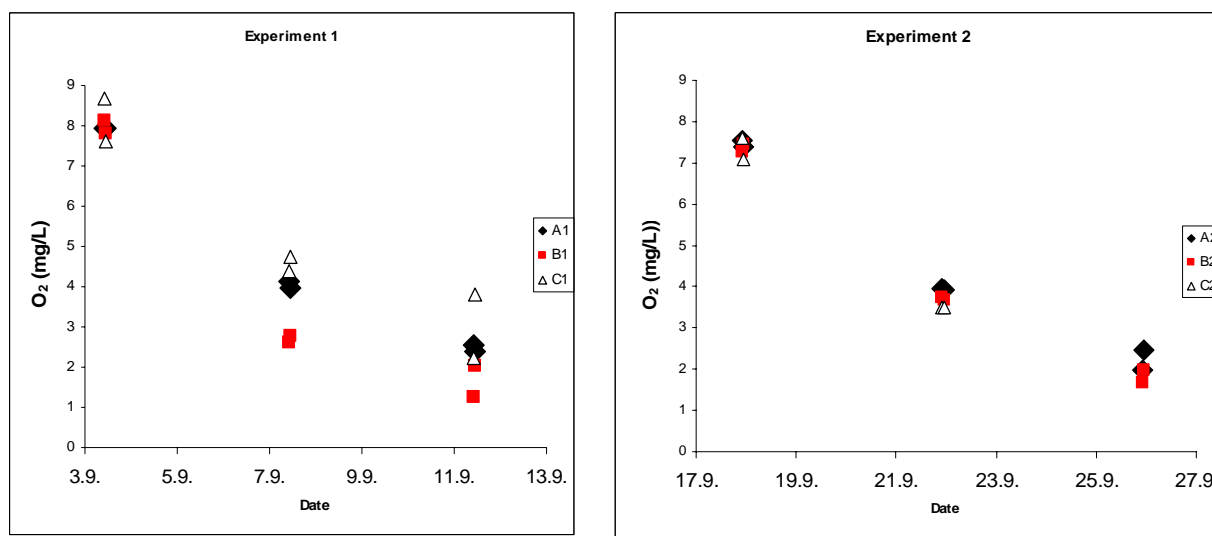

Figure 12. Results from oxygen analyses of the seawater remaining inside the chambers during first and second experiment respectively. Chamber A= High CO₂, Chamber B=Low CO₂, Chamber C=Control. See Table 3 for sampling times.

4.2.2 Nutrients

The results of water sample analyses for NO₃, NH₄-Nitrogen and SiO₂ for Chamber A, B and C, first and second experiment are shown in **Figure 13-Figure 15**. The results are plotted with respect to time of sampling (time and date), giving a time series within each chamber. Silicate is the parameter showing the most pronounced response, with values increasing 4-5 fold during the exposures, and also in the control chambers (**Figure 13**). This must be due to a release from the sediments into the enclosed and oxygen depleted water. The response in silicate seems to be fairly similar in all chambers except for B1 (low CO₂ in the first experiment) where the release were somewhat higher than in the two other chambers.

There was a trend with slightly increasing ammonium values during all exposures, and also in the controls. A more pronounced increase occurred in chamber B at the end of both experiments (**Figure 14**). The ammonium values were generally higher and more variable in the second experiment.

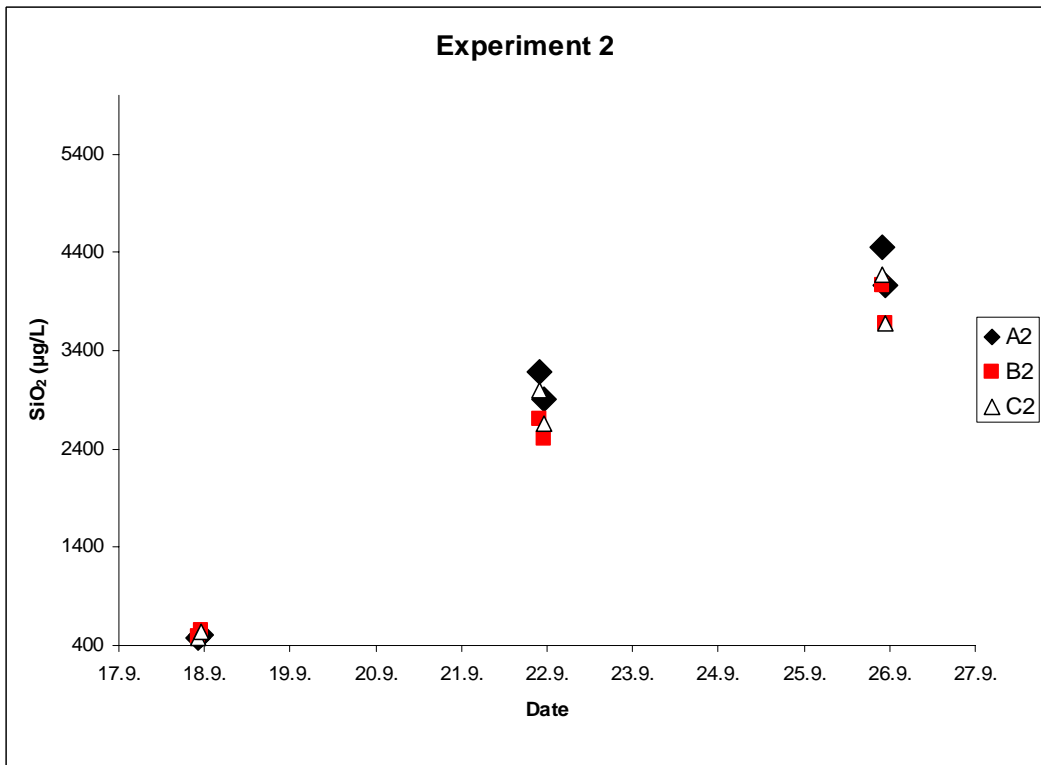
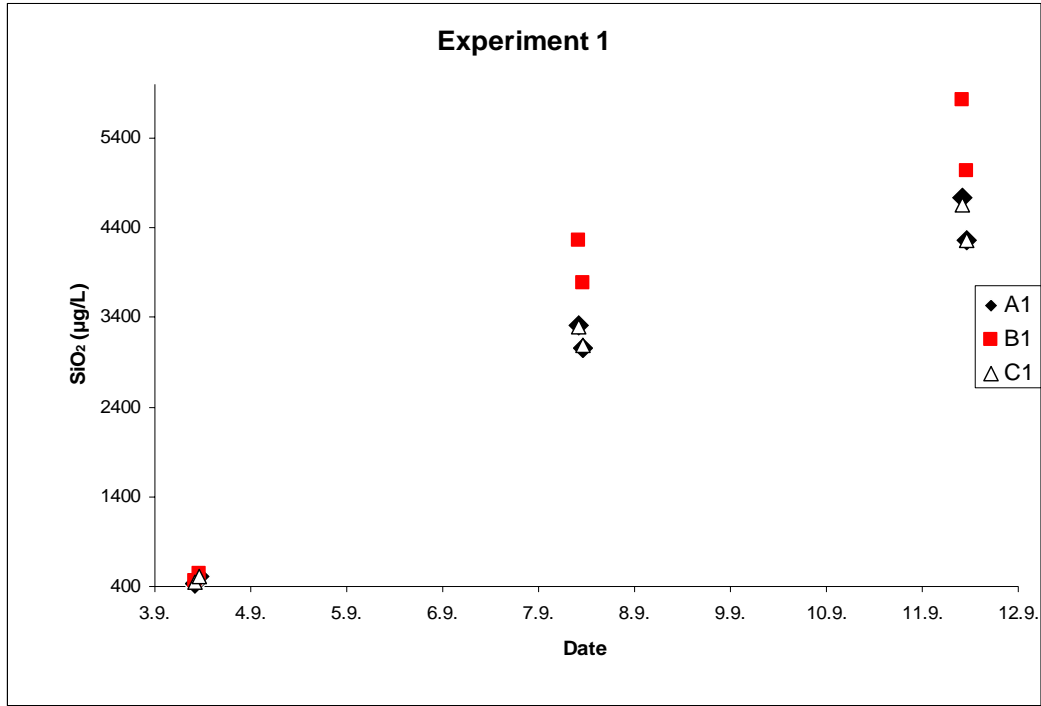

Figure 13. Results of water sample analyses for SiO₂ for Chamber A, B and C, first and second experiment. A= High CO₂, Chamber B=Low CO₂, Chamber C=Control.

The marked increase in ammonium in chamber B at the end of the first experiment and also during the second experiment (Figure 14) was concurrent with a decrease in nitrate concentration in the same chamber (Figure 15). The increase in ammonium was possibly caused by degradation of dead animals. Reduction of nitrate to ammonium at the sediment/water interface, which probably experienced low oxygen concentration, may also have contributed to the increase in ammonium.

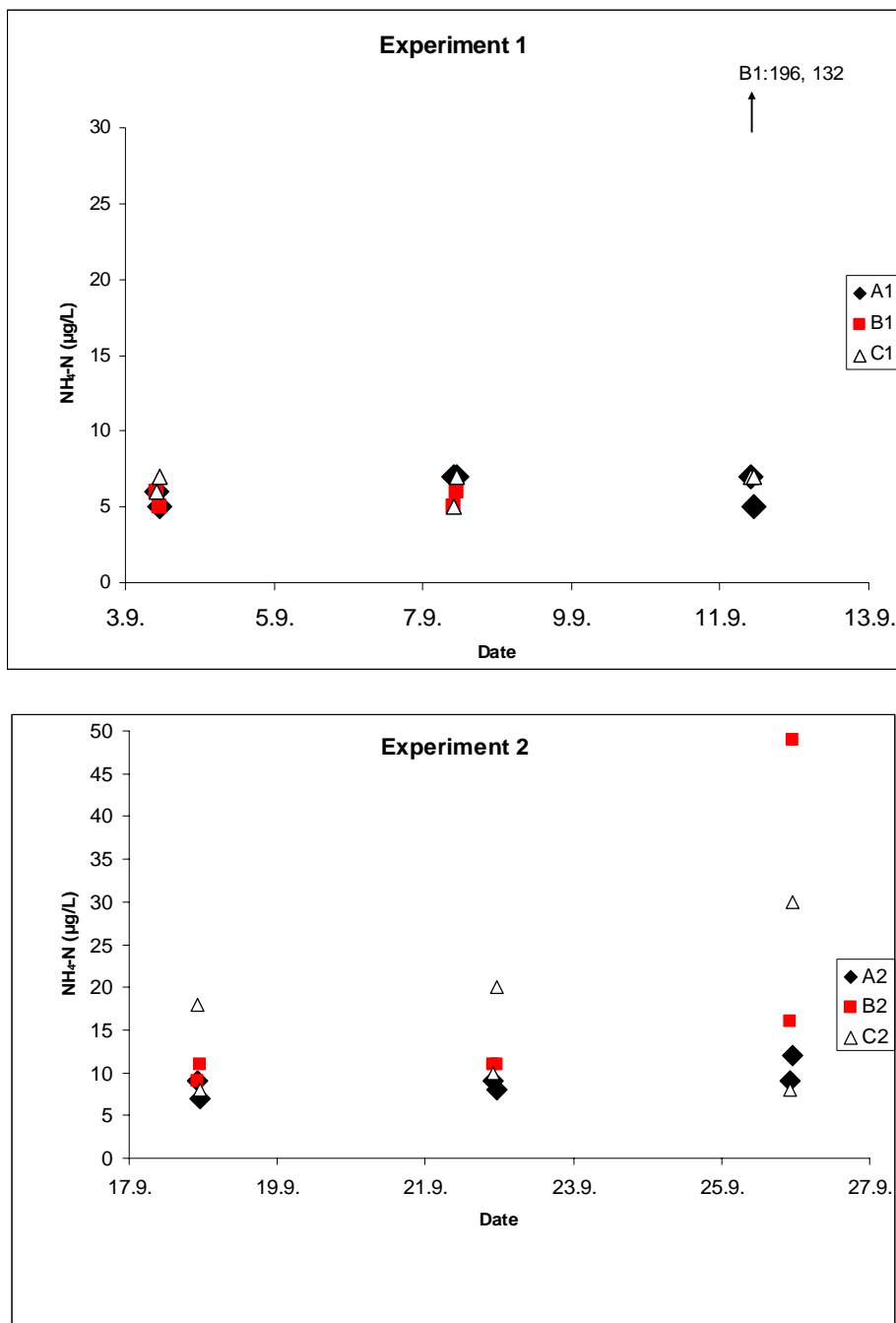

Figure 14. Results of water sample analyses for NH_4 related nitrogen for Chamber A, B and C, first and second experiment. Chamber A= High CO_2 , Chamber B=Low CO_2 , Chamber C=Control. NB: Values from samples collected 11. September in chamber B are indicated as numbers in the figure.

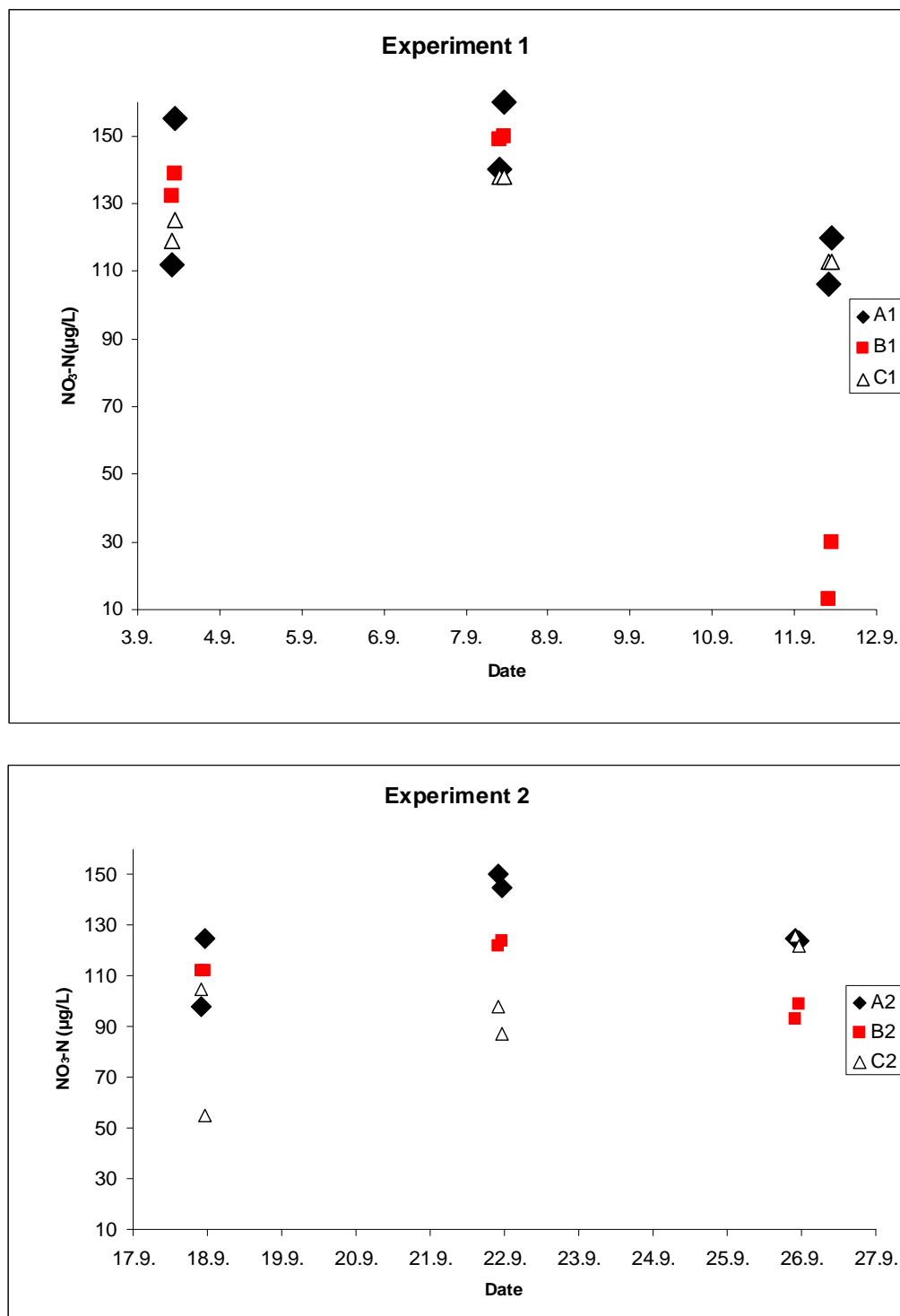

Figure 15. Results of analyses of NO_3^- in water samples from Chamber A, B and C, first and second deployment. Chamber A= High CO_2 , Chamber B=Low CO_2 , Chamber C=Control. Please note that any NO_2^- present in the water sample is included in the result.

4.2.3 Measurements of fluxes through the sediment/water interface

The analyses of nutrients and oxygen in the headspace water during the experiments have been used to calculate fluxes through the sediment/water interface. Each of the two experimental periods was divided in two 95 hour intervals and calculations were performed for each (**Table 9**).

It was generally difficult to identify clear consistent effects of the CO₂ on the fluxes of oxygen and SiO₂. For both parameters the fluxes were clearly different in the first half of the experiment compared to the last half (**Table 9**). The oxygen consumption varied from 3.4 to 5.5 mg h⁻¹m⁻² during the first part of each experimental period (period I and III) and from 1.1 to 2.9 mg h⁻¹m⁻² during the second part of each experiment (period II and IV).

Table 9. Results for calculation of fluxes through the sediment/water interface. The results are based on the analyses presented in Chapters 4.2.1 and 4.2.2, headspace volume in litres (A1: 4.8, B1:2.8, C1:4.0, A2: 4.4, B2: 5.6, C2:4.8), an experimental period of 96 hours and a sediment surface area of 0.04m² in each chamber. Positive values indicate a flux from the sediment into the headspace water. Negative values indicate consumption by the sediment.

Experiment 1

I: 03.09.2005, 11:00 to 07.09.2005, 10:00

II: 07.09.2005, 11:00 to 11.09.2005, 10:00

Experiment 2

III: 17.09.2005, 23:00 to 21.09.2005, 22:00

IV: 21.09.2005, 23:00 to 25.09.2005, 22:00

| Compound | Period | unit | Flux calculations for experiment 1 | | |
|--------------------|--------|------------------------------------|------------------------------------|-------|-------|
| | | | A1 | B1 | C1 |
| NH ₄ -N | I | µg h ⁻¹ m ⁻² | 3 | 0 | -2 |
| NH ₄ -N | II | µg h ⁻¹ m ⁻² | 0 | 140 | 0 |
| NO ₃ | I | µg h ⁻¹ m ⁻² | -19 | 7 | 14 |
| NO ₃ | II | µg h ⁻¹ m ⁻² | -68 | -101 | -26 |
| SiO ₂ | I | µg h ⁻¹ m ⁻² | 3,532 | 2,737 | 2,932 |
| SiO ₂ | II | µg h ⁻¹ m ⁻² | 2,135 | 1,511 | 1,642 |
| O ₂ | I | mg h ⁻¹ m ⁻² | -4,9 | -3,9 | -3,4 |
| O ₂ | II | mg h ⁻¹ m ⁻² | -1,8 | -1,1 | -2,7 |

| Compound | Period | unit | Flux calculations for experiment 2 | | |
|--------------------|--------|------------------------------------|------------------------------------|-------|-------|
| | | | A2 | B2 | C2 |
| NH ₄ -N | III | µg h ⁻¹ m ⁻² | 2 | 0 | 3 |
| NH ₄ -N | IV | µg h ⁻¹ m ⁻² | 1 | 7 | -15 |
| NO ₃ | III | µg h ⁻¹ m ⁻² | 29 | 15 | 54 |
| NO ₃ | IV | µg h ⁻¹ m ⁻² | -23 | -46 | 49 |
| SiO ₂ | III | µg h ⁻¹ m ⁻² | 3,100 | 3,165 | 3,115 |
| SiO ₂ | IV | µg h ⁻¹ m ⁻² | 1,806 | 2,299 | 1,907 |
| O ₂ | III | mg h ⁻¹ m ⁻² | -4,0 | -5,5 | -4,5 |
| O ₂ | IV | mg h ⁻¹ m ⁻² | -2,2 | -2,9 | -1,8 |

Similarly, values for SiO₂ were 2,737 to 3,532 µg h⁻¹m⁻² during the first period and 1,511 to 2,135 µg h⁻¹m⁻² during the second period.

The oxygen consumption in the three chambers was in both experiments higher during the first half of the experiments than during the last period (**Table 9**). The reduced oxygen consumption during the last half of the experiments indicates a reduced respiration towards the end.

The oxygen and SiO₂ fluxes calculated for the first half of both experiments represent the in situ processes.

The difference between the flux of NO₃ from the first period to the second period were generally higher in the chambers treated with CO₂ (A1, A2, B1 B2) compared with the control chamber (C1, C2) (**Table 9**). This was particularly clear in the results from the second experiment where the fluxes changed from positive to negative in the CO₂ treated chambers but remained positive and approximately the same in the control chamber (C2).

It was not possible to identify clear effects of the CO₂ treatment on the fluxes of NH₄-N. However, a clear increase in the flux of NH₄-N in B1 from the first to the second half of the first experiment was observed. It is interesting to note that the flux of NO₃ also changed clearly at the same time in this chamber.

4.3 Physical and chemical measurements and sampling in the chambers during the experiments

4.3.1 pH, T-CO₂ and pCO₂ in the chamber water

The pH logged in the headspace water of each chamber during the experiments is shown in **Figure 16**. The pH before the start of exposure was identical in all chambers. When CO₂SW was injected into each chamber, pH of each chamber decreased rapidly. However, the pH increased gradually with elapsed time thereafter. We were not able to monitor the 5,000 µatm chamber in the first experiment, because the top of the pH sensor had been buried in the sediment. It seems that the sediment was softer than we expected, so that the benthic chamber had penetrated deeper into the sediment than intended. We also had problems in monitoring pH in the control chamber during the last part of the second experiment, but the cause was uncertain.

Total carbon dioxide (T-CO₂), pH and pCO₂ just before the initial injection of CO₂SW were identical among all chambers (T-CO₂ 2,300 µmol L⁻¹, pH 7.9, pCO₂ 230 µatm).

During the experiments T-CO₂, pH and pCO₂ in the high CO₂ chamber ranged 2,280 – 7,940 µmol L⁻¹, 7.98 – 6.29 and 226 – 29,982 µatm. Similarly the ranges were 2,260 – 3,790 µmol L⁻¹, 7.98 – 6.96 and 228 – 4,669 µatm in the low CO₂ chamber and 2,270 – 2,600 µmol L⁻¹, 7.98 – 7.61 and 220 – 670 µatm in the control chamber.

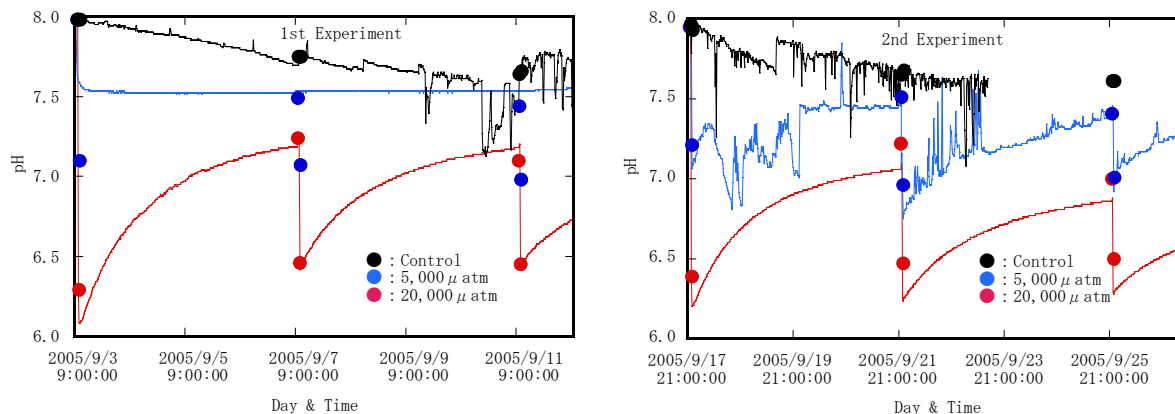

Figure 16. pH in the headspace water in each chamber during the experiments. Left: first experiment Right: second experiment. Lines show pH monitored by sensors placed in the different chambers. The circular points show results from analysis on water samples taken during the experiment. Black, red and blue show the results of the control chamber, 20,000 μatm chamber (high CO_2) and 5,000 μatm chamber (low CO_2) respectively. Please note that the readings shown for the 5,000 μatm chamber in the first experiment do not represent pH in the water.

4.3.2 Dissolved oxygen (DO) in the chamber water

The logged dissolved oxygen (DO) saturation in the headspace water during the experiments is shown in **Figure 17**. We could not monitor DO in the 5,000 μatm chamber during the last 2/3 of the first experiment. The results from analyses of water samples (**Figure 12**) do however indicate that the oxygen concentration during this period were slightly lower in the 5,000 μatm chamber than in the other chambers. The general picture is that DO saturation decreased almost linearly in different treatments during the experiments. However, there were some minor differences in the rate of decrease among the chambers. Decreasing rate in the 20,000 μatm chamber seems to be somewhat less during the last half of the experimental period than in the initial phase, and smaller than in the control chamber during the last part. Especially, DO consumption in the chambers exposed to CO_2 were higher during the first day than in the controls and after that became lower than the control. DO saturation in the control chamber of the second experiment increased initially, but we could not find the cause. DO saturation rate increased slightly on each of the two water samplings performed during each experiment and could be caused by some ambient seawater leaking into the chambers. The oxygen analyses performed by Winkler titration do however not give much support for such a leak apart for perhaps in B1 (see **Figure 12**).

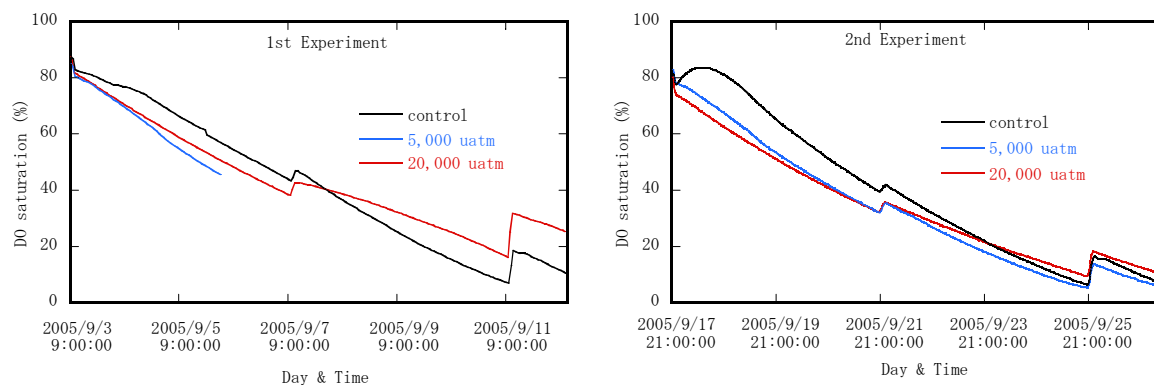

Figure 17. Dissolved oxygen (DO) saturation in the headspace water in each chamber during the experiments. Left: first experiment. Right: second experiment. Black, red and blue show the results of the control, 20,000 μatm chamber and 5,000 μatm chamber, respectively. Measurements were taken by use of a DO-sensor.

4.3.3 Water content and total carbon and nitrogen in the sediment

Sediment samples from the 2nd experiment were analysed by NIVA for the determination of water content, total carbon and total nitrogen. Results are shown in **Table 10**.

The results show very similar conditions in all 3 chambers, but with somewhat lower nitrogen values in the two topmost layers in the exposed chambers, possibly caused by N-mobilization to the overlying water, which was indicated by the observed increase in ammonium both in chamber A and B during the 2nd experiment (**Figure 14**, **Figure 15**).

Table 10. Results of analyses by NIVA of sediment samples from after the 2nd experiment. The table shows water contents (%), total amount of carbon (TC) and total amount of nitrogen (TN) in $\mu\text{g}/\text{mg}$ dry weight sediment at 4 depth intervals of the sediment in each chamber.

| Sediment depth | Chamber A, highCO ₂ | | | Chamber B, midCO ₂ | | | Chamber C, control | | |
|----------------|--------------------------------|------|-----|-------------------------------|------|-----|--------------------|------|-----|
| | % water | TC | TN | % water | TC | TN | % water | TC | TN |
| 0 – 0.5 cm | 69.8 | 49.5 | 2.7 | 66.3 | 47.7 | 2.5 | 70.1 | 48.8 | 3.0 |
| 0.5 – 1 cm | 66.5 | 49.0 | 2.5 | 66.5 | 48.6 | 2.4 | 65.5 | 49.0 | 3.0 |
| 1 – 2 cm | 66.6 | 49.3 | 2.5 | 64.2 | 49.2 | 2.2 | 67.9 | 47.0 | 2.4 |
| 2 – 3 cm | 63.6 | 49.4 | 2.2 | 60.8 | 47.6 | 1.9 | 64.2 | 47.0 | 2.5 |

4.3.4 Particle size distribution of the sediments

The particle size distribution of the sediments from the second experiment is shown in **Figure 18**. The particle composition showed a similar distribution among each sediment layer in each chamber as expected. The main particle size was 150 μm that is classified as very fine sand.

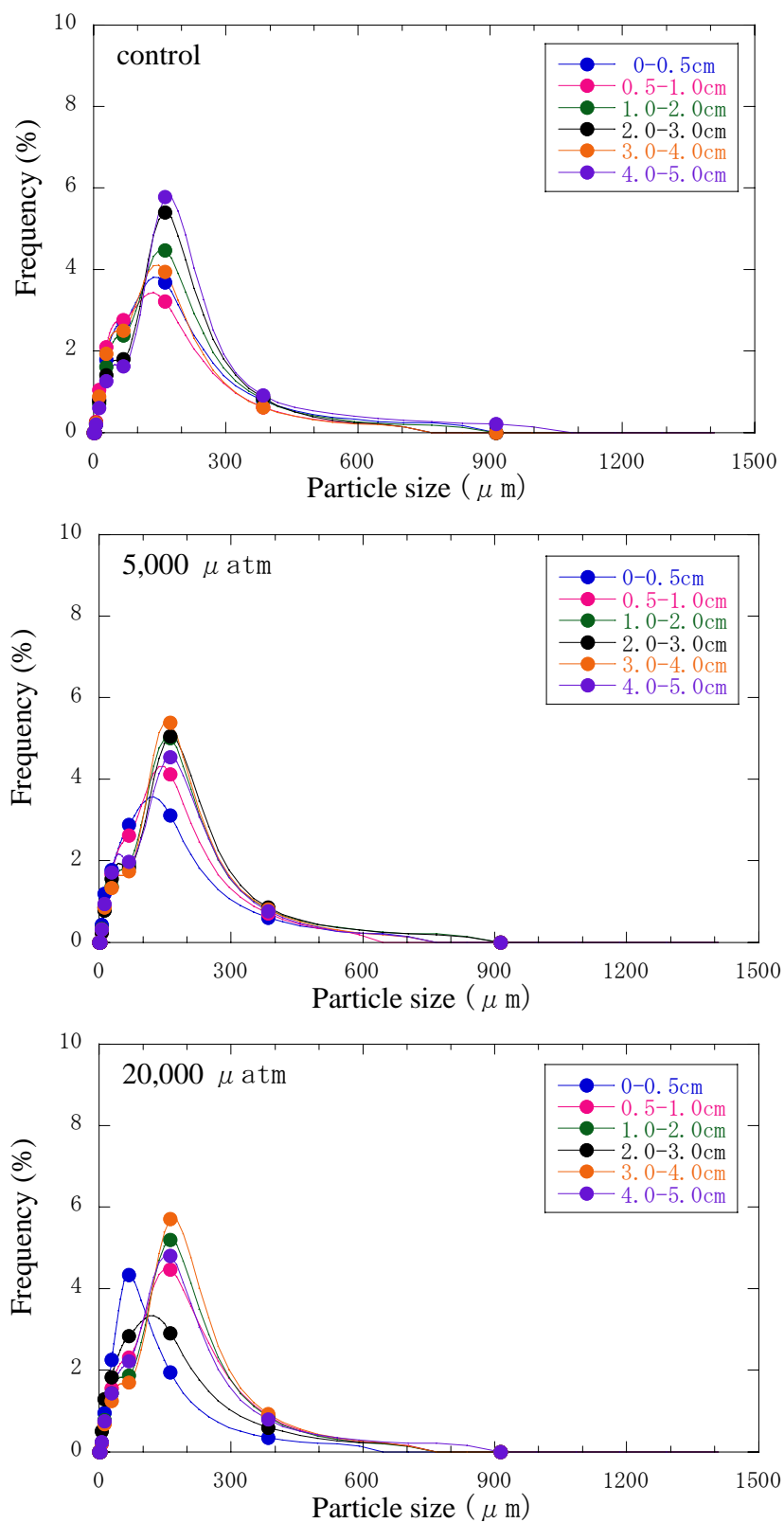

Figure 18. Particle size distribution of the sediment in the chambers during the second experiment.

4.3.5 Results from geochemical analyses of the sediment

High SiO₂ concentrations in all major element geochemical analyses by XRF (**Table 11**) indicate that samples are dominated by sand, while Al₂O₃ and K₂O concentrations reflect minor clay contents. The high loss in ignition (LOI) values and high CaO concentrations indicate high carbonate content, most likely in the form of shell debris. The TOC content was near 2.5% (**Table 11**) whereas the total carbon content (TC) was around 5 % (**Table 10**). The difference between TC and TOC is most likely related to the carbonate content which can be calculated to be roughly 10 % (CaCO₃).

Whole major element geochemical analyses by XRF () indicate that no significant differences are observed between the control samples and those exposed to elevated CO₂ concentrations. Those minerals most likely to react are carbonates – in these sediments, this would be the shell debris. However, CaO and LOI concentrations remain constant within a very narrow range, indicating that this component has not decreased significantly at the CO₂ concentrations/pH developed in the overlying water column. All other major elements analysed do not show significant variations.

Trace element analyses were also performed on these samples (not reported). However, within the detection limits of the analytical routines used, all trace elements that were analysed were below detection limits. Preliminary results from experiments performed elsewhere by NIVA do, however, indicate that lowering of pH by adding CO₂ will modify porewater content of some metal species.

Table 11. Major element and total organic carbon (TOC) contents for samples analysed from the benthic chamber experiments. The whole core (0-10 cm depth) was analysed as a homogenised sample.

| Sample name | BGS LIMS ID | SiO ₂ | TiO ₂ | Al ₂ O ₃ | Fe ₂ O ₃ t | Mn ₃ O ₄ | MgO | CaO |
|-----------------|-------------|------------------|------------------|--------------------------------|----------------------------------|--------------------------------|------|-------|
| | | % | % | % | % | % | % | % |
| NIVA A/1 0 - 10 | 11487-0021 | 41.31 | 0.58 | 10.92 | 4.58 | 0.11 | 2.51 | 13.67 |
| NIVA B/1 0 - 10 | 11487-0022 | 41.64 | 0.58 | 10.96 | 4.63 | 0.11 | 2.48 | 13.54 |
| NIVA C/1 0 - 10 | 11487-0023 | 41.29 | 0.57 | 10.85 | 4.54 | 0.12 | 2.49 | 13.65 |
| NIVA A/2 0 - 10 | 11487-0024 | 40.38 | 0.56 | 10.76 | 4.64 | 0.13 | 2.54 | 13.24 |
| NIVA B/2 0 - 10 | 11487-0025 | 42.00 | 0.59 | 11.14 | 4.75 | 0.12 | 2.55 | 13.07 |
| NIVA C/2 0 - 10 | 11487-0026 | 41.71 | 0.58 | 11.08 | 4.71 | 0.11 | 2.56 | 13.25 |

| Sample name | BGS LIMS ID | Na ₂ O | K ₂ O | P ₂ O ₅ | SO ₃ | Cr ₂ O ₃ | SrO | ZrO ₂ |
|-----------------|-------------|-------------------|------------------|-------------------------------|-----------------|--------------------------------|------|------------------|
| | | % | % | % | % | % | % | % |
| NIVA A/1 0 - 10 | 11487-0021 | 4.41 | 2.18 | 0.26 | 0.1 | 0.01 | 0.08 | <0.02 |
| NIVA B/1 0 - 10 | 11487-0022 | 4.15 | 2.19 | 0.27 | <0.1 | 0.01 | 0.08 | 0.02 |
| NIVA C/1 0 - 10 | 11487-0023 | 4.51 | 2.15 | 0.26 | 0.1 | 0.01 | 0.08 | 0.02 |
| NIVA A/2 0 - 10 | 11487-0024 | 4.72 | 2.18 | 0.27 | 0.1 | 0.01 | 0.07 | <0.02 |
| NIVA B/2 0 - 10 | 11487-0025 | 4.44 | 2.22 | 0.27 | 0.1 | 0.01 | 0.07 | <0.02 |
| NIVA C/2 0 - 10 | 11487-0026 | 4.48 | 2.22 | 0.26 | 0.1 | 0.01 | 0.07 | 0.02 |

Table 11 (Continued)

| Sample name | BGS LIMS ID | BaO | NiO | CuO | ZnO | PbO | LOI | TOC |
|-----------------|-------------|------|-------|-------|------|-------|-------|------|
| | | % | % | % | % | % | % | % |
| NIVA A/1 0 - 10 | 11487-0021 | 0.06 | <0.01 | <0.01 | 0.01 | <0.01 | 21.03 | 2.48 |
| NIVA B/1 0 - 10 | 11487-0022 | 0.06 | <0.01 | <0.01 | 0.01 | <0.01 | 20.55 | 2.46 |
| NIVA C/1 0 - 10 | 11487-0023 | 0.06 | <0.01 | <0.01 | 0.01 | <0.01 | 21.20 | 2.45 |
| NIVA A/2 0 - 10 | 11487-0024 | 0.06 | <0.01 | <0.01 | 0.01 | <0.01 | 22.15 | 2.63 |
| NIVA B/2 0 - 10 | 11487-0025 | 0.06 | <0.01 | <0.01 | 0.01 | <0.01 | 20.55 | 2.49 |
| NIVA C/2 0 - 10 | 11487-0026 | 0.06 | <0.01 | <0.01 | 0.01 | <0.01 | 21.01 | 2.51 |

4.4 Bacterial responses

4.4.1 Results from RITE/Kanso analyses

The vertical distribution of bacteria in the sediment is shown in **Figure 19**. In both experiments the number of bacteria cells ranged from 1 to 3 x 10⁸ cells/cm² irrespective of the depth. In the first experiment, the number of bacteria cells in the 20,000 μ atm chamber was significantly lower than the control except for the 0 – 0.5 cm layer. However, there were no significant differences among the chambers in the second experiment.

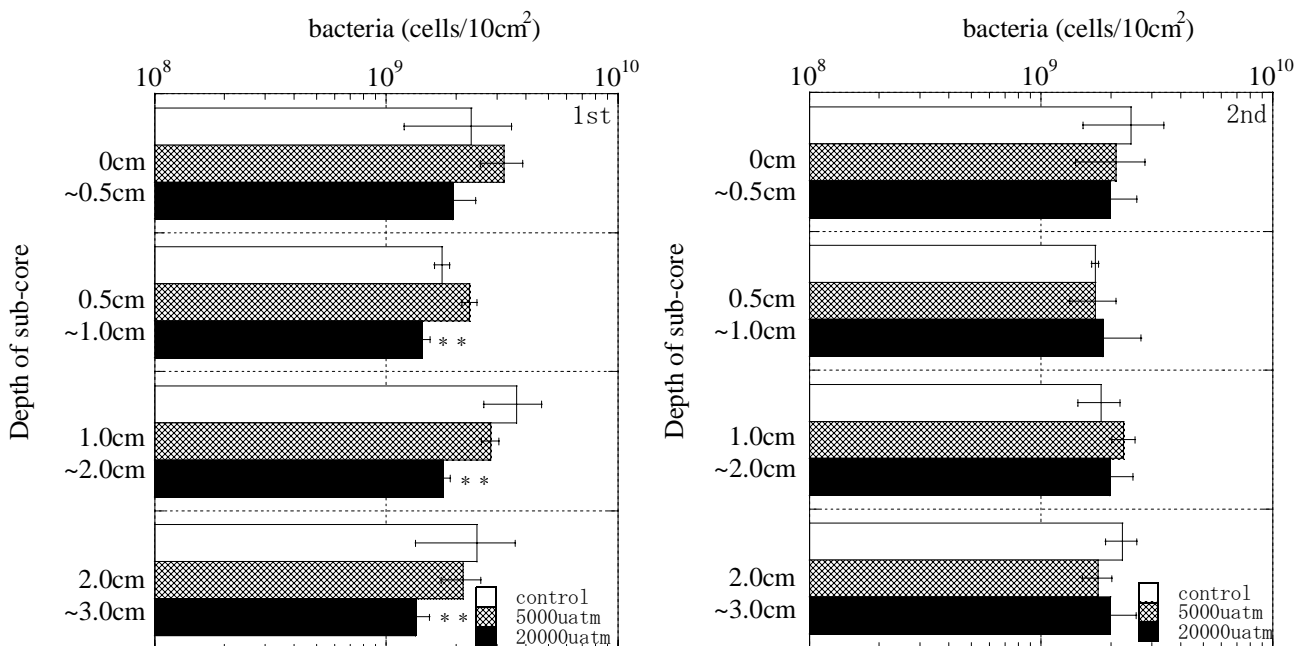

Figure 19. Vertical distribution of bacteria in the sediment. Left: first experiment. Right: second experiment. ** significant difference (Wilcoxon's rank test) $p < 0.05$.

4.4.2 Results from microbial analyses by BGR

Microbial activities and cell numbers of important groups

The results from analysis of environmentally important microbial activities in the sediment samples showed significant differences between the CO₂ enriched “high CO₂” and “low CO₂” sites and the “control” with background CO₂ concentrations. Methane production is an important anaerobic microbial process in organic matter degradation. Microbial methane formation was in the first experiment slightly stimulated by low CO₂ addition (**Figure 20**), with daily production rates increasing from 0.0097 ± 0.0001 to 0.018 ± 0.0007 $\mu\text{mol CH}_4/\text{g}$ dry weight sediment. In the second chamber experiment the increase of rates from the control to low CO₂ was even more pronounced, but then a decrease occurred at the highest CO₂ concentrations (**Figure 20**).

The stimulation of methane production rates is in good accordance with the increase in archaeal cell numbers detected by qPCR (**Figure 21**). Maybe the methanogenic micro-organisms benefited from the death of other bacteria due to less competition for substrates or by eating the products of their degradation.

Sulphate is an important electron acceptor and sulphate reduction is also the most important anaerobic microbial process in the degradation of organic matter in marine sediments. As was already observed for methane production, also sulphate reduction was stimulated by low CO₂ addition in both sets of experiments (**Figure 22**). In the second experiment sulphate reduction rates even increased further from low to high CO₂ concentrations (**Figure 22**). Presumably, sulphate reducing bacteria can tolerate changes in CO₂ concentrations and/or pH in their surroundings, and are also thriving on degradation products of other organisms which died as consequence of CO₂ addition.

In accordance with the microbial activities, also total numbers of microorganisms in the top sediment layer (0-5 cm), determined via quantitative PCR (qPCR), showed significant differences between the control chamber and the sediments exposed to CO₂ (**Figure 21**). Cell numbers of *Bacteria* generally were highest in the control chamber, and gradually lower after the addition of low or high CO₂. Archaea, in contrast, seemed to be stimulated by low CO₂ and only died off with high CO₂. The growing archaea might well be methane producers (methanogens), since their numbers are also stimulated (**Figure 21**). Generally, cell numbers of *Bacteria* were higher than those of *Archaea*. In conclusion, for this marine site these still preliminary microbiological experiments show a beneficial effect of moderately elevated CO₂ concentrations on specific groups of the sediment microflora.

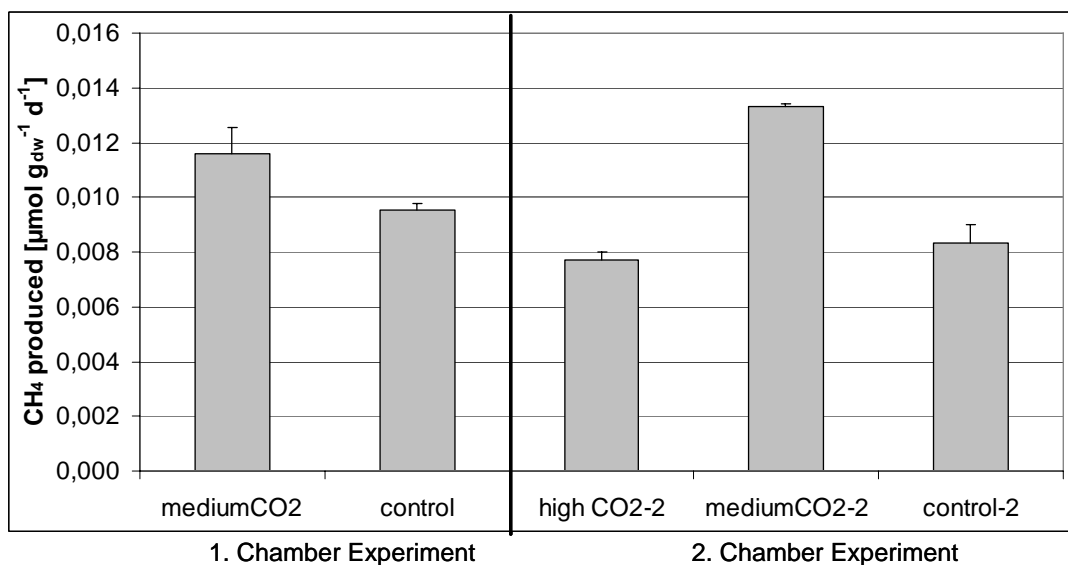

Figure 20. Potential rates of methane production in different sediment samples (0- 5 cm) determined in- vitro (mean ± SD, n = 3-5). NB: medium CO₂=camber B (see Table 1.).

| | |
|----------------------|---|
| Low CO ₂ | B |
| High CO ₂ | A |

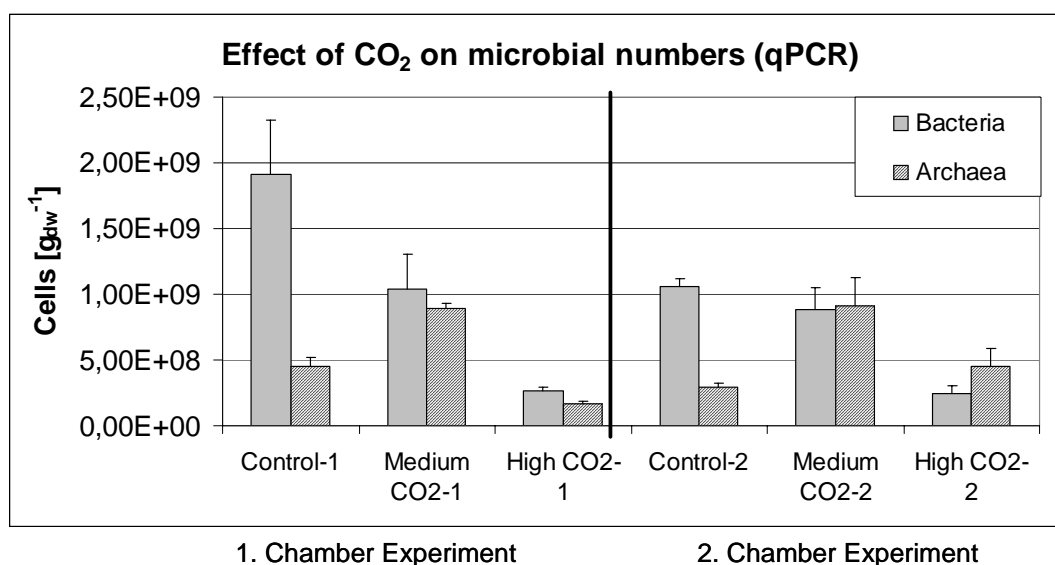

Figure 21. Cell numbers of archaea and bacteria determined via qPCR in different sediment samples (mean ± SD, n = 8-12). The analysed sediment was from the 0-5 cm layer. NB: medium CO₂=camber B (see Table 1.).

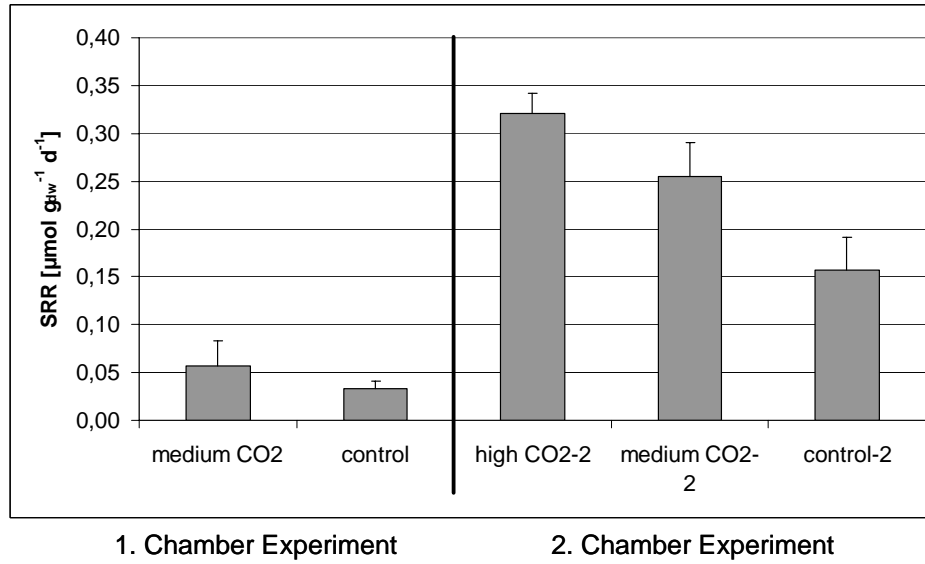

Figure 22. Potential rates of sulphate reduction in different sediment samples (0- 5 cm) determined *in-vitro* (mean \pm SD, n = 3-5). NB: medium CO2=camber B (see Table 1.).

4.4.3 Results from ATP analyses by BGS

ATP is a parameter reflecting bacterial activity/biomass. The results of the ATP analysis are shown in **Table 12** and **Figure 23**. ATP was highest at the surface (0 -1.5 cm) and then reduced with sediment depth in all treatments except for the control (**Figure 24**).

It is difficult to identify a clear effect of the CO₂ treatment on bacterial biomass due to large variability in the data, especially in the surface sediment (0-1.5 cm) from the control chamber in the second experiment (**Figure 23**).

In the first experiment there are indications that bacterial biomass in the surface sediment increases when compared to the control both in the low and the high dose treatment **Figure 24**. However, the opposite is the case in the second experiment (**Figure 24**) when mean values based on all the data are considered, but still shows the same trend if the two possible outliers (6367340 and 12497 pmol/gram, **Table 12**) in the control are excluded (also supported by rank test). Differences between the two experiments were also observed in results from 5.5-6.5 cm depth, but in this case ATP/biomass was reduced on CO₂ exposure in the first experiment and increased in the second **Figure 24**.

Table 12. Results from ATP analyses (pmol/g of sediment) performed on sediment samples collected by NIVA and analysed by BGS. Results from 4 replicate samples are shown for 1-1.5 and 5.5-5.6 cm depth interval and 1 replicate for the 3.0-4.0 cm interval.

| Depth (cm) | Control | | Low dose | | High Dose | |
|------------|---------|-------------------------|----------|---------|-----------|---------|
| | Exp. 1 | Exp. 2 | Exp. 1 | Exp. 2 | Exp.1 | Exp. 2 |
| 0 - 1.5 | 19,220 | 81,440 | 297,470 | 362,950 | 195,350 | 848,380 |
| 3.0 - 4.0 | 101,870 | 134,650 | 110,890 | 206,140 | 184,500 | 305,400 |
| 5.5 - 6.5 | 256,280 | 61,700 | 39,570 | 116,190 | 166,270 | 92,820 |
| | | | | | | |
| 0 - 1.5 | 100,553 | 105,620 | 190,753 | 148,467 | 119,607 | 163,047 |
| 5.5 - 6.5 | 21,720 | 17,427 | 9,027 | 34,267 | 27,053 | 13,767 |
| | | | | | | |
| 0 - 1.5 | 96,713 | 12,497 ¹⁾ | 452,947 | 76,527 | 85,627 | 158,613 |
| 5.5 - 6.5 | 186,220 | 31,173 | 9,320 | 19,953 | 11,560 | 45,213 |
| | | | | | | |
| 0 - 1.5 | 251,733 | 6,367,340 ¹⁾ | 231,820 | 869,260 | 373,933 | 425,980 |
| 5.5 - 6.5 | 86,920 | 37,407 | 36,253 | 65,533 | 124,140 | 162,113 |

¹⁾Outlier

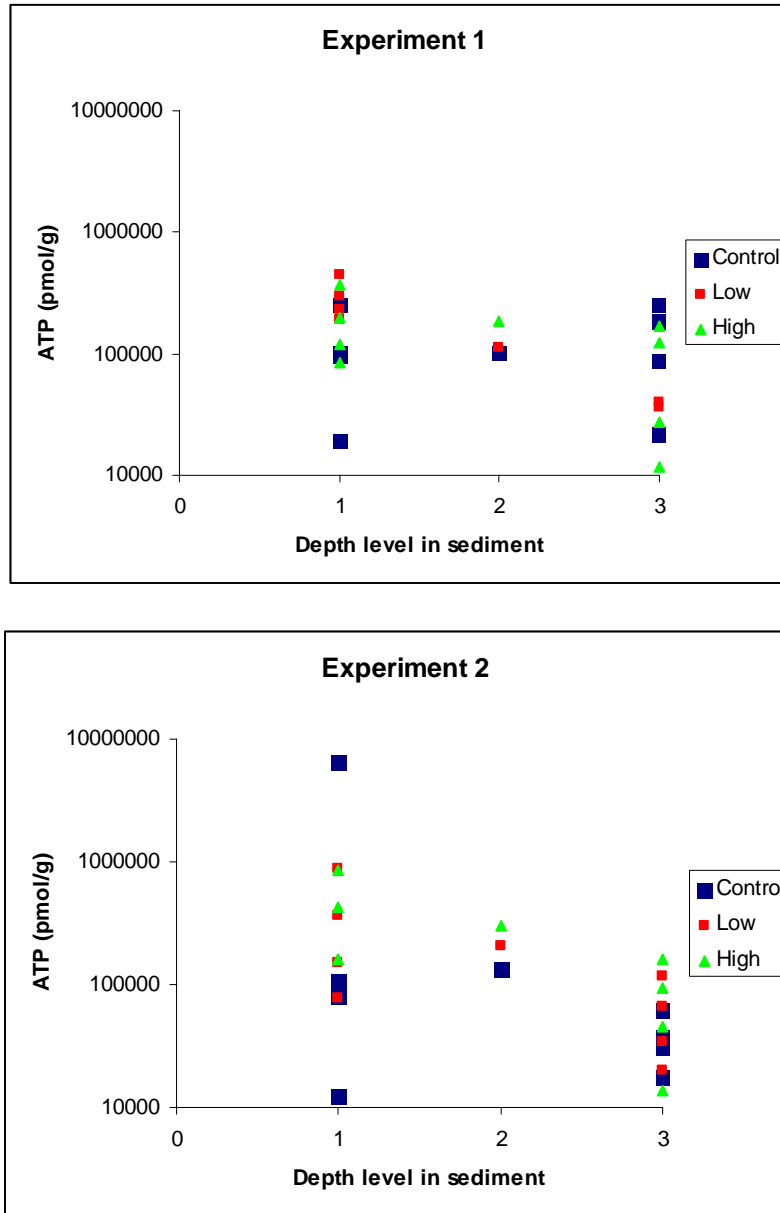

Figure 23. ATP Biomass (p mol/g) in sediment samples from the two experiments. The different treatments (Low=Low CO₂, High=High CO₂) and depth level in sediment (1=0-1.5 cm, 2=3-4 cm, 3=5.5-6.5 cm) are indicated in the figure.

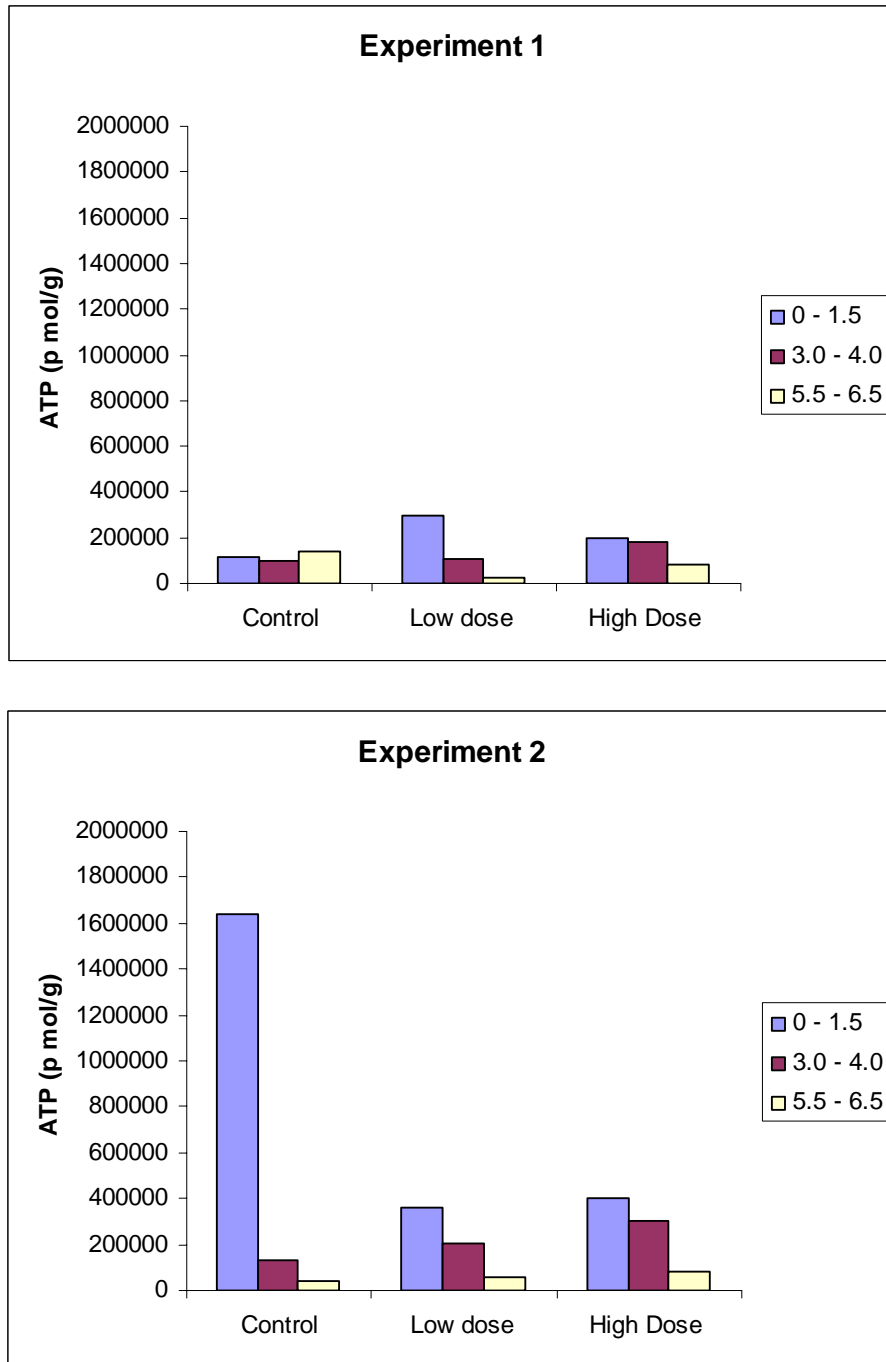

Figure 24. Mean ATP Biomass ($p \text{ mol/g}$) in sediment samples in the different treatments and sediment depth intervals (cm).

4.4.4 Results from DGGE-analyses by Aalesund University College

The sediment samples analyzed are listed in **Table 13**.

Viable counts (CFU)

A test sample was diluted with NSS and grown on VNSS-agar. The count was 9000 CFU/g (wet sediment). The number of bacteria was very low and shows that the samples (templates) must be concentrated before the PCR-reaction.

The effect of removing the clay particles

The samples were prepared as described in chapter 3.2.9. The effect of removing the clay particles (5 µm filters) is clearly shown on the gel below (see **Figure 25**). Two of the samples were briefly sonicated, but the best result was obtained by mixing the suspension on the whirl-mixer for 30 sec followed by filtration through a 5 µm filter. The results from the analyses are seen in **Figure 26** to **Figure 30** (comments on the results are found in the legend to each figure).

General comments

- It is possible to study the microbial diversity in sediment samples if the clay particles are removed and the bacterial fraction is “purified” and concentrated.
- The number of bacteria is very low measured by viable counts on VNSS-agar. (VNSS-agar is a “standard medium” for growing marine bacteria).
- The PCR-reaction also indicates that the template concentration is too low.
- The DGGE-gels, although the bands are weak, show a very high diversity in the microbial population, but the results are not clear enough to observe differences between samples from different benthic chambers, or to observe significant changes due to different CO₂-treatment.
- The DGGE-analyses may be improved if the templates were more concentrated. However, that is only possible to do with new and bigger samples. The minimum amount of sediment should not be less than 10 grams.

Table 13. *Sediments analysed at Aalesund University College.*

| SAMPLE NUMBER | CHAMBER | PARALLEL NUMBER | GEL | DEPTH CM | BAND INT AGAROSE PCR ¹⁾ |
|------------------------------|---------|-----------------|---------------|-----------|------------------------------------|
| FIRST SAMPLE COLLECTION (14) | | | | | |
| 01 | A1 | 1 | AG-01/DGGE-01 | 0.0 – 0.5 | 31 |
| 02 | A1 | 1 | | 0.5 – 1.0 | 32 |
| 03 | A1 | 1 | | 1.0 – 2.0 | 31 |
| 04 | A1 | 1 | | 2.0 – 3.0 | 26 |
| 05 | B1 | 1 | | 0.0 – 0.5 | 24 |
| 06 | B1 | 1 | | 0.5 – 1.0 | 32 |
| 07 | B1 | 1 | | 1.0 – 2.0 | 28 |
| 08 | B1 | 1 | | 2.0 – 3.0 | 16 |
| 09 | C1 | 1 | | 0.0 – 0.5 | 51 |
| 10 | C1 | 1 | | 0.5 – 1.0 | 53 |
| 11 | C1 | 1 | | 1.0 – 2.0 | 23 |
| 12 | C1 | 1 | | 2.0 – 3.0 | 20 |
| 13 | C1 | 1 | | 3.0 – 4.0 | 22 |
| 14 | C1 | 1 | | 4.0 – 5.0 | 27 |
| SECOND SAMPLE COLLECTION | | | | | |
| 15 | A1 | 1 | AG-02/DGGE-02 | 0.0 – 0.5 | 28 |
| 16 | A1 | 1 | | 0.5 – 1.0 | - |
| 17 | A1 | 1 | | 1.0 – 2.0 | 26 |
| 18 | A1 | 1 | | 2.0 – 3.0 | 27 |
| 19 | B1 | 1 | | 0.0 – 0.5 | 15 |
| 20 | B1 | 1 | | 0.5 – 1.0 | 26 |
| 21 | B1 | 1 | | 1.0 – 2.0 | 19 |
| 22 | B1 | 1 | | 2.0 – 3.0 | - |
| 23 | C1 | 1 | | 0.0 – 0.5 | 22 |
| 24 | C1 | 1 | | 0.5 – 1.0 | 18 |
| 25 | C1 | 1 | AG-03/DGGE-03 | 1.0 – 2.0 | - |
| 26 | C1 | 1 | | 2.0 – 3.0 | 18 |
| 27 | A2 | 1 | | 0.0 – 0.5 | 53 |
| 28 | A2 | 1 | | 0.5 – 1.0 | 35 |
| 29 | A2 | 1 | | 1.0 – 2.0 | 25 |
| 30 | A2 | 1 | | 2.0 – 3.0 | 46 |
| 31 | B2 | 1 | | 0.0 – 0.5 | 25 |
| 32 | B2 | 1 | | 0.5 – 1.0 | - |
| 33 | B2 | 1 | | 1.0 – 2.0 | 17 |
| 34 | B2 | 1 | | 3.0 – 3.0 | - |
| 35 | C2 | 1 | | 0.0 – 0.5 | 45 |
| 36 | C2 | 1 | | 0.5 – 1.0 | 28 |
| 37 | C2 | 1 | | 1.0 – 2.0 | 17 |
| 38 | C2 | 1 | | 2.0 – 3.0 | 13 |

¹⁾BAND INT = Intensity of the bands in the agarose gel measured with Kodak 1D image analysis system. The intensity should be higher than 50 (band peak value) to give satisfactory results in the DGGE-analysis. This is especially important if the bacterial diversity in the sample is high.

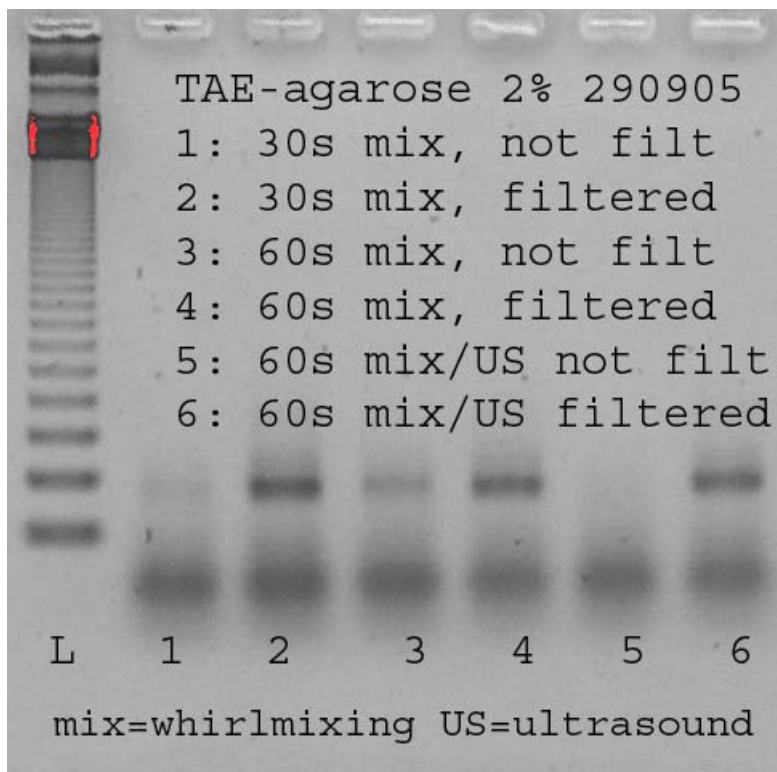

Figure 25. The effect of whirl-mixing, filtering and sonication of the sediment samples are clearly shown. It is not possible to use unfiltered samples as template for the PCR-reactions.

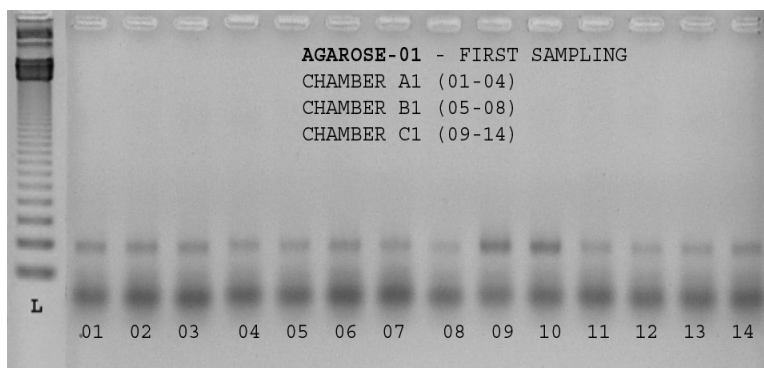

Figure 26. The PCR-products from the first sampling run on 2 % agarose gel. The bands are clearly visible, but should have had higher intensity, 09 (C1-0-0,5 cm) and 10 C1 (0,5-1,0 cm) are satisfactory.

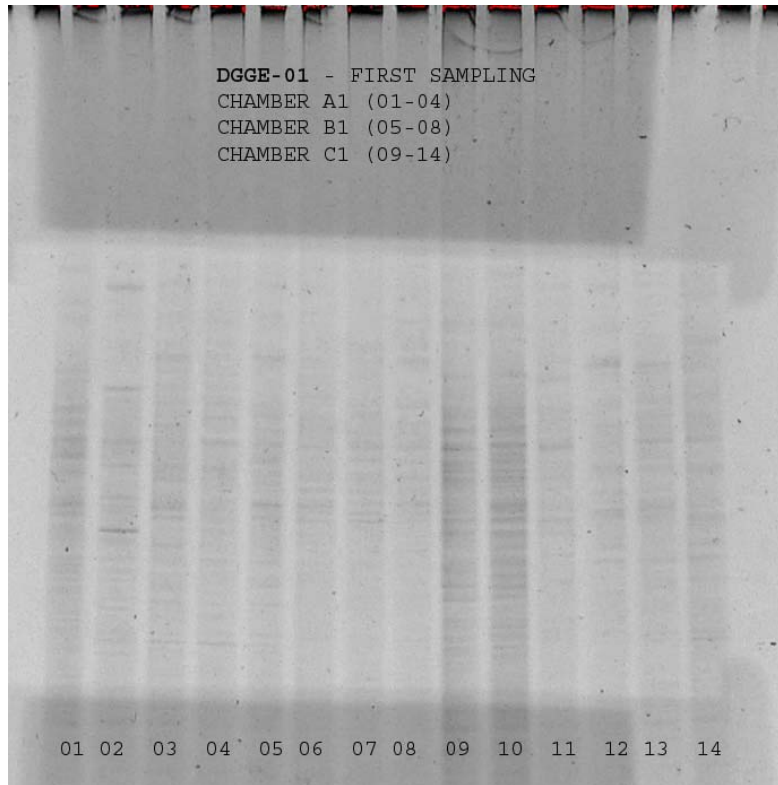

Figure 27. The same samples as shown in **Figure 26** analyzed by DGGE. The lanes have a huge number of bands, indicating a very high bacterial diversity in the marine sediments (one band represent one bacterial species).

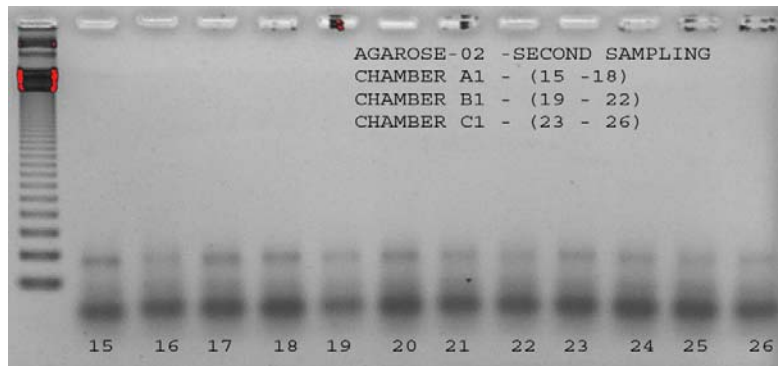

Figure 28. The PCR-products from the second sampling on 2 % agarose gel. The results are similar to those shown on **Figure 26**.

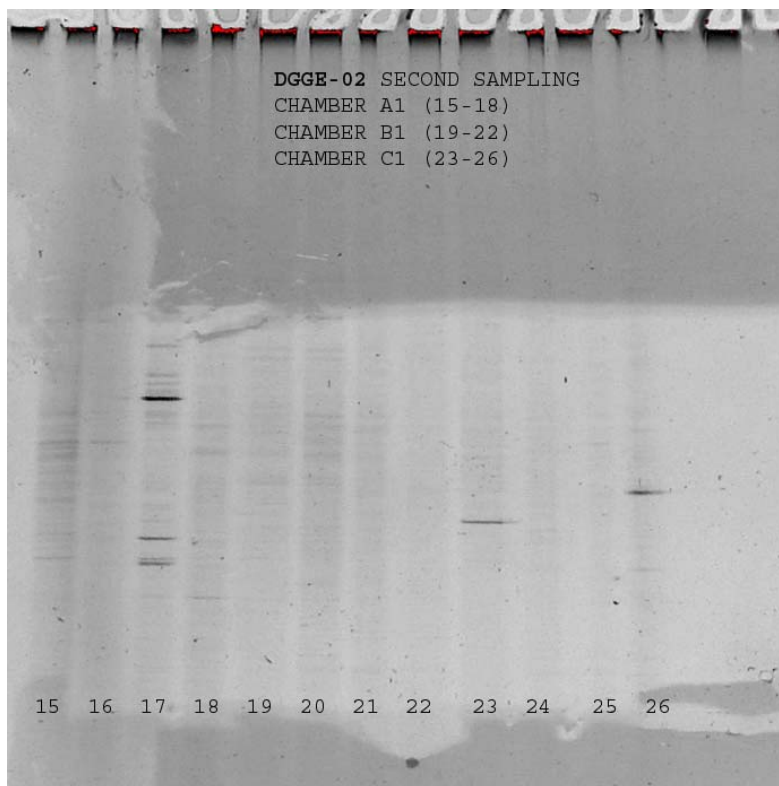

Figure 29. The same samples shown in **Figure 28** analyzed by DGGE. The results are mainly the same as shown in **Figure 27**. However, some dominant bands are seen in three lanes (17, 23 and 26).

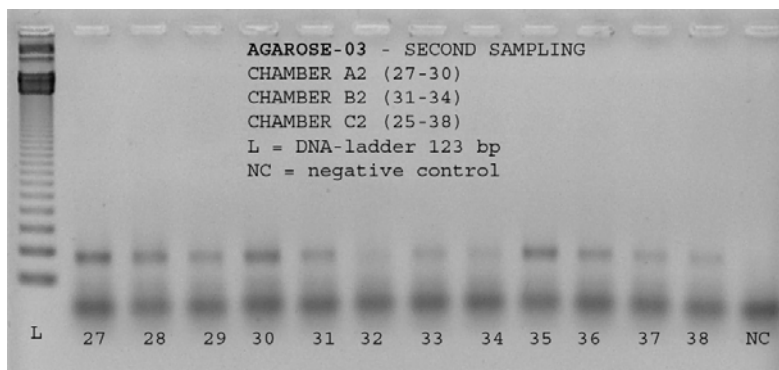

Figure 30. The PCR-products from A2, B2 and C2 chambers. The results seem similar to those seen in **Figure 26** and **Figure 28**. (DGGE analysis was not performed).

4.5 Responses in meiobenthos and nanobenthos

4.5.1 Nanobenthos

The vertical distribution of small size and large size nanobenthos in the sediment from the two experiments is shown in

Figure 31 and **Figure 32**. The number of small size nanobenthos in each layer ranged from 2×10^3 to 10^4 cells/cm² sediment in both experiments. The number was highest in the surface layer and decreased gradually with depth (

Figure 31). The number of small size nanobenthos cells in the chambers with increased CO₂ concentrations was significant higher compared with the control chamber in both experiments.

The number of large size nanobenthos was also highest in the surface layer and ranged from 10 to 10^2 cells/cm² in both experiments. The numbers decreased gradually with depth. In the control, large size nanobenthos only occurred in the surface sediment, 0-0.5 cm, (

Figure 31). The number of large size nanobenthos in the exposure chambers was significantly higher compared with the control chamber in both experiments.

Both size groups of nanobenthos thus responded with increased numbers to the CO₂ exposure. The response in the two experiments were also consistent.

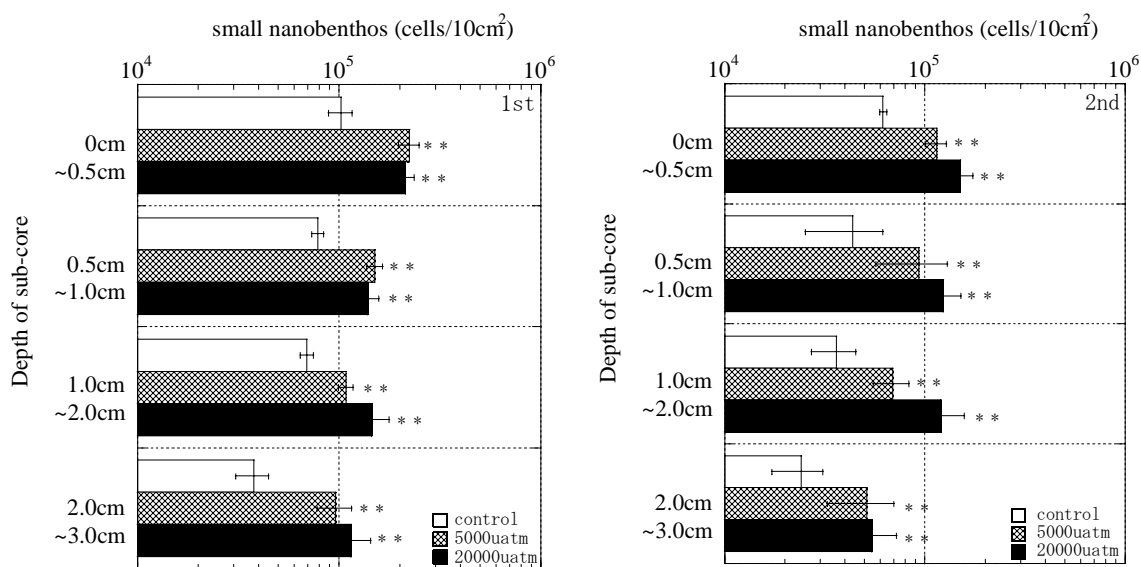

Figure 31. Vertical distribution of small size nanobenthos in the sediment Left: first experiment Right: second experiment** significant difference (Wilcoxon's rank test) $p < 0.05$. NB: medium CO₂=chamber B (see Table 1.).

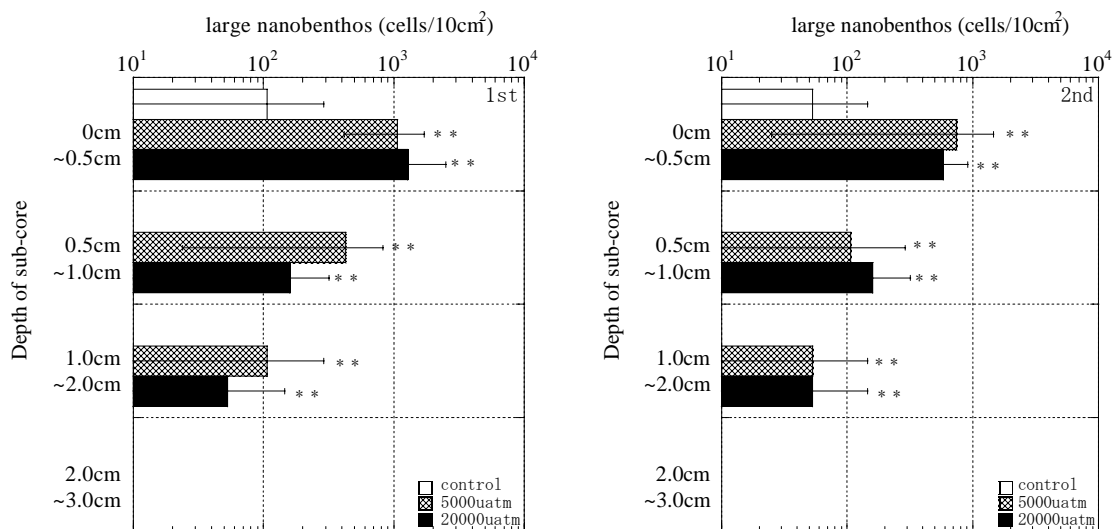

Figure 32. Vertical distribution of large size nanobenthos in the sediment. Left: first experiment Right: second experiment. ** significant difference (Wilcoxon's rank test) $p < 0.05$. NB: medium CO_2 = camber B (see Table 1.).

4.5.2 Meiobenthos

The mean number of animals per 6.58 cm^2 (sectional area of the polyethylene piston syringe) for each meiofaunal taxa/group observed in the top 3 cm layer of the sediment in the control chamber is shown in **Table 14**. Meiobenthos consisted mostly of Foraminifera, Ciliophora, Cnidaria, Nematoda, Kinorhyncha, Bivalvia, Polychaeta, Ostracoda, Harpacticoida and nauplius larvae. In particular, Foraminifera and Nematoda predominated over the other taxa, and accounted for 80% or more of the total meiobenthos in both experiments.

The vertical distribution of total meiobenthos, Foraminifera, Nematoda and Crustacea in the sediment of the experiments is shown in **Figure 33** to **Figure 36**.

Total meiobenthos decreased with depth, with numbers of up to 70 inds./cm^2 in the surface layer except for the $5,000 \mu\text{atm}$ chamber in the first experiment (**Figure 33**). The numbers in the 2 – 3 cm layer were around 20 inds./cm^2 . The abundance of total meiobenthos varied greatly among sub-cores obtained from the same chamber and no significant differences between chambers/treatments were therefore observed in any of the two experiments.

The number of Foraminifera was around 30 shells/cm^2 in the surface layer and around 10 shells/cm^2 in the bottom layer except for $5,000 \mu\text{atm}$ chamber in the first experiment. The number of Foraminifera tended to decline with depth except for the control chamber in the second experiment (**Figure 34**). For both experiments no significant differences among chambers were observed. It is, however, interesting to note that very high densities were observed in the surface layer in the $5,000 \mu\text{atm}$ treatment in the first experiment (B1). B1 also showed high NH_4 at the end of the experiment (**Figure 14**).

The number of Nematoda varied between 10 and 65 inds./cm^2 and did not decrease with depth as observed for Foraminifera. In the first experiment the number of Nematoda in the $5,000 \mu\text{atm}$ chamber

was significantly higher than in the two other treatments. In contrast the abundance in 0.5 – 1 cm layer of 5,000 μ atm in the second experiment was significantly lower compared with the control. Apart from this no significant differences related to CO₂ were observed.

The number of Crustacea was around 10 inds./cm² in the surface layer and around 10 inds./10 cm² in the 2 – 3 cm layer. Two of the observations were, however, in the in the 200-300 inds./10 cm² (surface layer of 5,000 μ atm chamber in the first experiment and the 1 – 2 cm layer of 5,000 μ atm chamber in the second experiment). Significant effects between treatments were observed (**Figure 36**). For example, the abundance of Crustacea in the 0 – 0.5 cm layer of 5,000 μ atm in the first experiment and the 1 – 2 cm layer of both exposure chambers in the second experiment were significantly higher compared with the control. On the other hand other 5,000 μ atm treatments showed lower abundance compared to the control (**Figure 36**) and consistent responses in Crustacea were difficult to identify.

Table 14. Mean number ($n = 3$) per 6.58 cm² (area of sub core sampling plastic syringes) of animals at each meiofaunal taxa/group within the top 3 cm layer in the control chamber. Numbers in parentheses indicate the standard deviation, * shows there was only a few animals in the chamber.

| | 1st experiment | | 2nd experiment | |
|-------------------------------|----------------|------|----------------|------|
| | number | % | number | % |
| FORAMINIFERA | 536 (270) | 40.4 | 893 (357) | 46.4 |
| CILIOPHORA | 11 (9) | 0.8 | 3 (5) | 0.1 |
| CNIDARIA | 5 (5) | 0.4 | 0 (0) | 0.0 |
| GASTROTRICHA | * | | * | |
| NEMATODA | 533 (102) | 40.2 | 832 (328) | 43.2 |
| NEMATODA (Desmoscolecidae) | 56 (37) | 4.2 | 75 (54) | 3.9 |
| KINORHYNCHA | 8 (8) | 0.6 | 13 (5) | 0.7 |
| CAUDOFOVEATA | * | | * | |
| BIVALVIA | 3 (5) | 0.2 | 3 (5) | 0.1 |
| POLYCHAETA | 13 (17) | 1.0 | 13 (17) | 0.7 |
| OSTRACODA | 21 (12) | 1.6 | 5 (9) | 0.3 |
| HARPACTICOIDA | 72 (37) | 5.4 | 56 (21) | 2.9 |
| Nauplius | 67 (48) | 5.0 | 32 (14) | 1.7 |
| Total meiofauna | 1325 (342) | | 1925 (653) | |

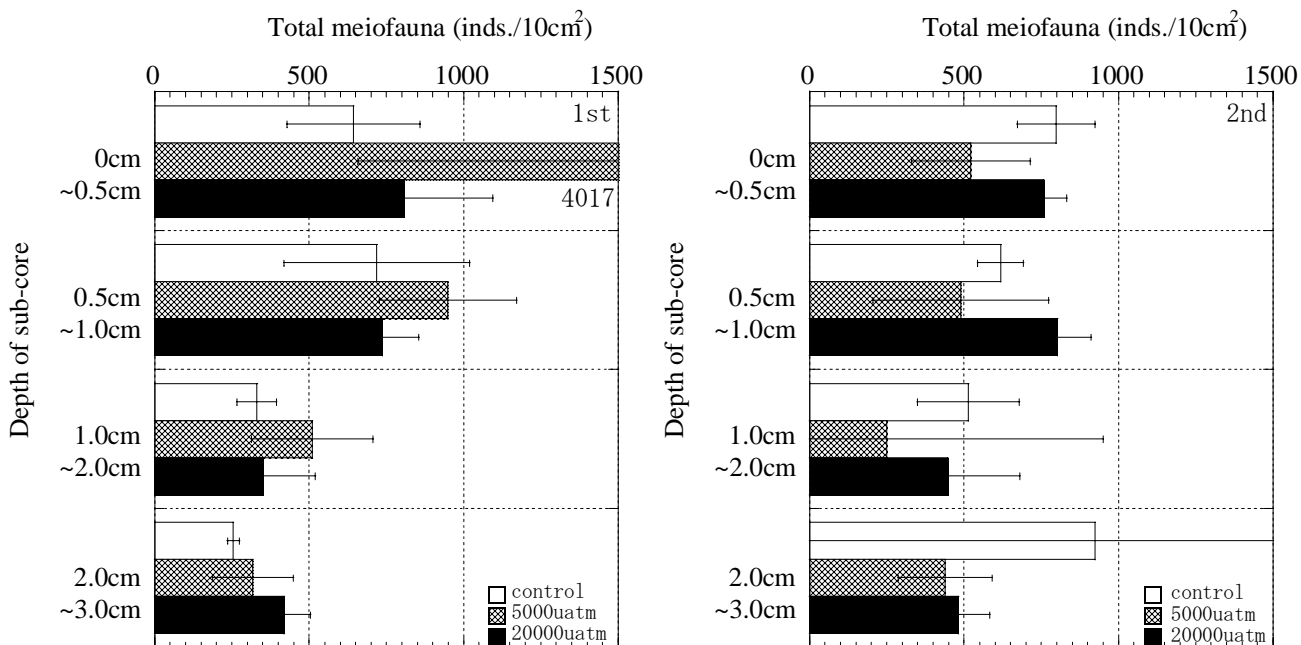

Figure 33. Vertical distribution of total meiobenthos in the sediment. Left: first experiment. Right: second experiment.

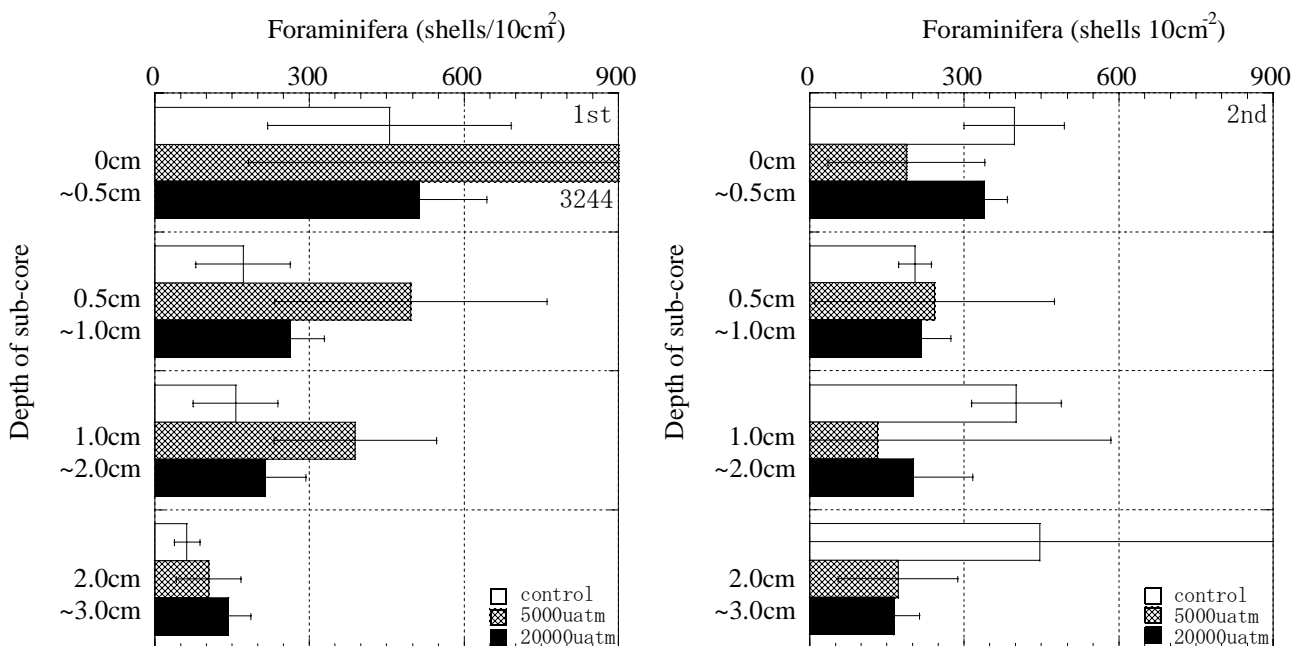

Figure 34. Vertical distribution of Foraminifera in the sediment. Left: first experiment. Right: second experiment.

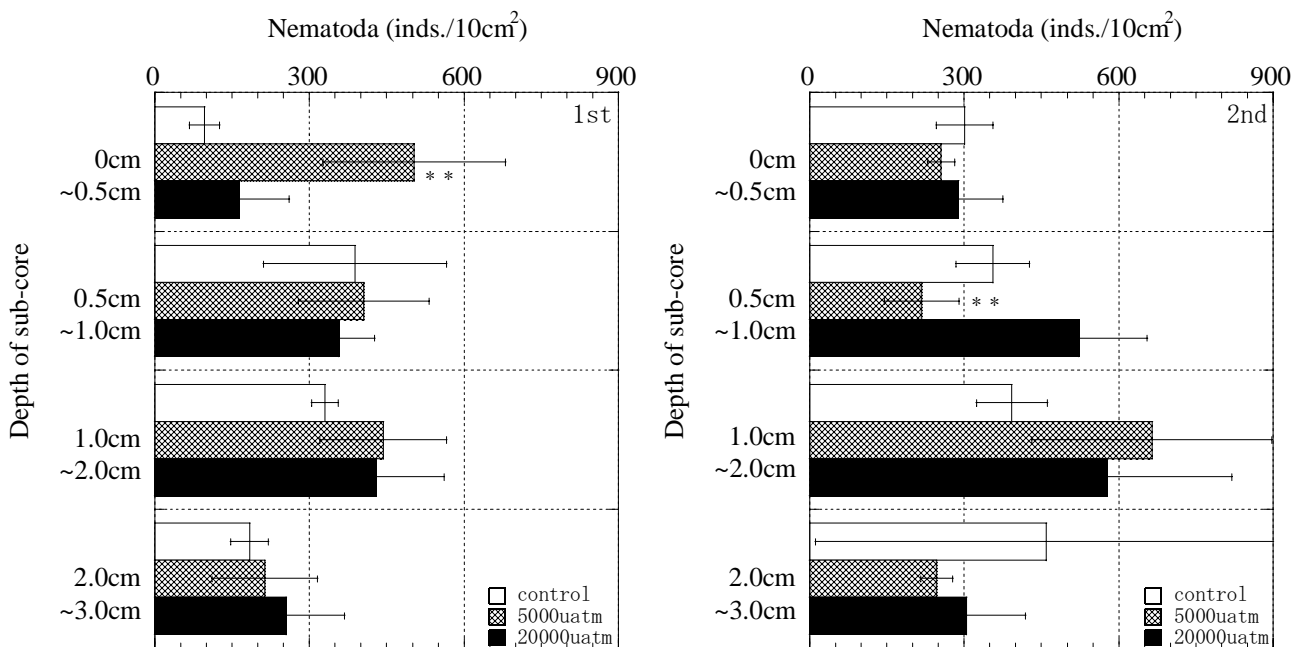

Figure 35. Vertical distribution of Nematoda in the sediment. Left: first experiment. Right: second experiment. ** significant difference (Wilcoxon's rank test) $p < 0.05$.

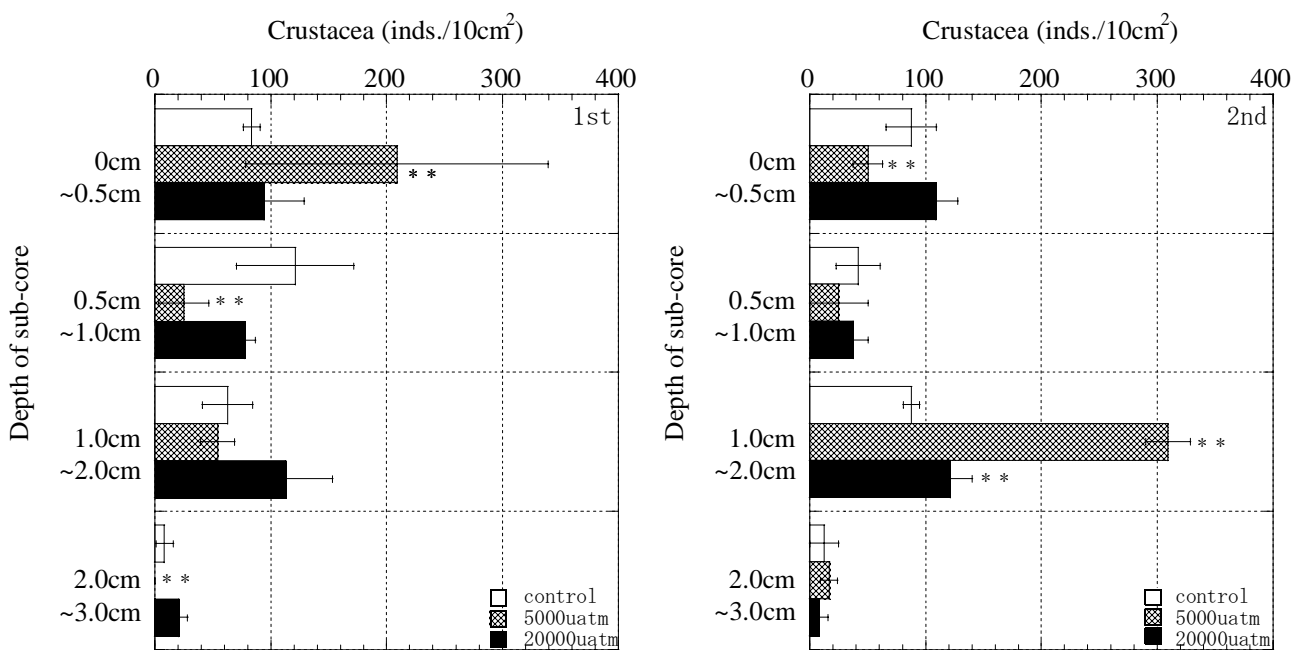

Figure 36. Vertical distribution of Crustacea in the sediment. Left: first experiment. Right: second experiment. ** significant difference (Wilcoxon's rank test) $p < 0.05$.

5. Discussion

5.1 Water quality in head space

The water above the sediment in all chambers experienced a nearly linear decline in oxygen over time, as expected from the anticipated metabolic rate and the fact that no oxygen was added underway. This decline was seen both in the data obtained from sensors in the chamber and water samples analysed by Winkler titration afterwards. At the end of each deployment the oxygen concentration in the headspace water was approximately 2 ml/l in all chambers, showing that no anoxia occurred in the water phase, although some hypoxia at the sediment /water interface at the end cannot be ruled out.

The oxygen consumption in the three chambers was in both experiments higher during the first half of the experiments than during the last period. Similar results were also observed for SiO₂. The reduced flux of SiO₂ out of the sediment is probably a consequence of reduced concentration gradient between pore water and headspace water. The situation is more complicated for oxygen due to the different respiratory processes involved in the sediment.

The oxygen and SiO₂ fluxes calculated for the first half of both experiments represent the in situ processes. It was generally difficult to identify clear consistent effects of the CO₂ on the fluxes of oxygen and SiO₂

The difference between the flux of NO₃ from the first period to the second period were generally higher in the chambers treated with CO₂ (A1, A2, B1 B2) compared with the control chamber (C1, C2) and are probably a consequence of the CO₂ exposure.

It was not possible to identify clear effects of the CO₂ treatment on the fluxes of NH₄-N. However, a clear increase in the flux of NH₄-N in chamber B1 from the first to the second half of the first experiment (and somewhat less clear in the second experiment) was observed (**Table 9**). It is interesting to note that the flux of NO₃ also changed clearly at the same time in this chamber.

The pH in the headspace water varied more and in a more predictable way in the 20.000 µatm treatment as compared to the 5.000 µatm treatment (**Figure 16**). This is caused by the lower pH in the water injected into the 20.000 µatm chamber and thus over steering other processes which might influence pH. In the control chamber the pH are gradually reduced from around pH=8 to pH~7.5. This means that also the control chamber have experienced a reduction in pH which actually may have influenced sensitive organisms.

Although considerable variation was observed in the pH in the different treatments, there was a clear difference in the overall pH regime between the treatments.

5.2 Microbial analyses, ATP and DNA

The determination of environmentally important microbial activities in the sediment samples showed some significant differences between the CO₂ enriched “high CO₂” and “low CO₂” chambers and the “control” with background CO₂ concentrations. Bacterial responses to the CO₂ exposure were, however, enumerated by several methods and by different institutions and not all results were consistent.

Methane production and sulphate reduction are important anaerobic microbial processes in organic matter degradation in marine environments. Both processes were stimulated by the low CO₂ addition

in both sets of experiments (**Figure 20** and **Figure 22**). In the second experiment sulphate reduction rates increased from low to high CO₂ concentrations (**Figure 22**).

It was difficult to identify clear consistent effect of the CO₂ treatment on bacterial biomass (determined by ATP analysis by BGS) as the first experiment indicated that bacterial biomass in the surface sediment increased compared to the control both in the low and the high dose treatment, whereas the opposite is the case in the second experiment when on all the data are considered, but still shows the same trend if the two possible outliers are excluded (see chapter 4.4.3).

The increased methane production and sulphate reduction rates are to a certain extent supported by measurements of the ATP content in the surface sediment samples (0-1.5 cm), which also indicated increasing levels of ATP in the surface sediment following the addition of CO₂ (most clearly in the first experiment, see chapter 4.4.3). Presumably in both groups the methanogenic and the sulphate-reducing micro organisms benefited from the dying of other bacteria due to less competition for substrates or by consuming the products of their degradation.

The results from the two experiments also seem to give the same general picture when it comes to microbial responses to CO₂ determined via quantitative PCR (qPCR) (**Figure 21**). Generally, cell numbers of *Bacteria* were higher than those of *Archaea*. Cell numbers of *Bacteria* generally were highest in the control chamber, and gradually decreased after the addition of low or high CO₂. *Archaea* in contrast, seemed to be stimulated by low CO₂ and only died off with high CO₂.

Differences were also indicated in bacterial counts after staining with DAPI, but only in the first experiment (**Figure 19** left), where the number of bacteria cells in the 20,000 µatm chamber was significantly lower (except for the 0 – 0.5 cm layer) compared with the control chamber and thus to certain degree resembles the results found by quantitative PCR (qPCR). Results from the different measurements related to bacterial counts/biomass show clear responses, but the results are not always consistent in the two experiments and across the different methods applied. This may be caused by differences in methods and that different sections of the sediment were analysed.

In conclusion, for this marine site these still preliminary microbiological results show a stimulative effect (increased numbers) of moderately elevated CO₂ concentrations on specific groups of the sediment microflora (*Archaea*) (**Figure 21**). Significant effects of high CO₂ concentrations were observed on both, microbial activities and cell numbers, indicating the stimulation or inhibition of distinct groups of micro organisms as a consequence of the long-term exposure of the sedimentary environment to elevated CO₂ concentrations. Furthermore, this combination of methods applied simultaneously by the different research groups on the same sediment provided a comprehensive and complimentary picture of the ecosystem and already indicates possible effects of high CO₂ concentrations on this previously undisturbed environment.

The denaturing gradient gel electrophoresis (DGGE) of sediment samples indicated a general high diversity in the microbial population, but due to the small sampling volumes the results were not clear enough to observe differences between samples from different benthic chambers, or to observe significant changes due to different CO₂-treatments. In any follow-up study, larger samples will be needed and the method by removing particles beforehand might be reinvestigated.

5.3 Meiofauna/nanobenthos/bacteria analyses RITE

Benthic organisms such as meiobenthos, nanobenthos and bacteria interact as a community. Examples of such interactions are predator-prey relationships and competition. Such interactions require that changes in the numbers of one group of organism in the experiment have to be compared with those of the other groups. The summarized results of the principal impacts of CO₂ using the RITE/Kanso data is shown in **Figure 37**. This figure shows the exposure/control abundance ratio for the main observed groups of benthos.

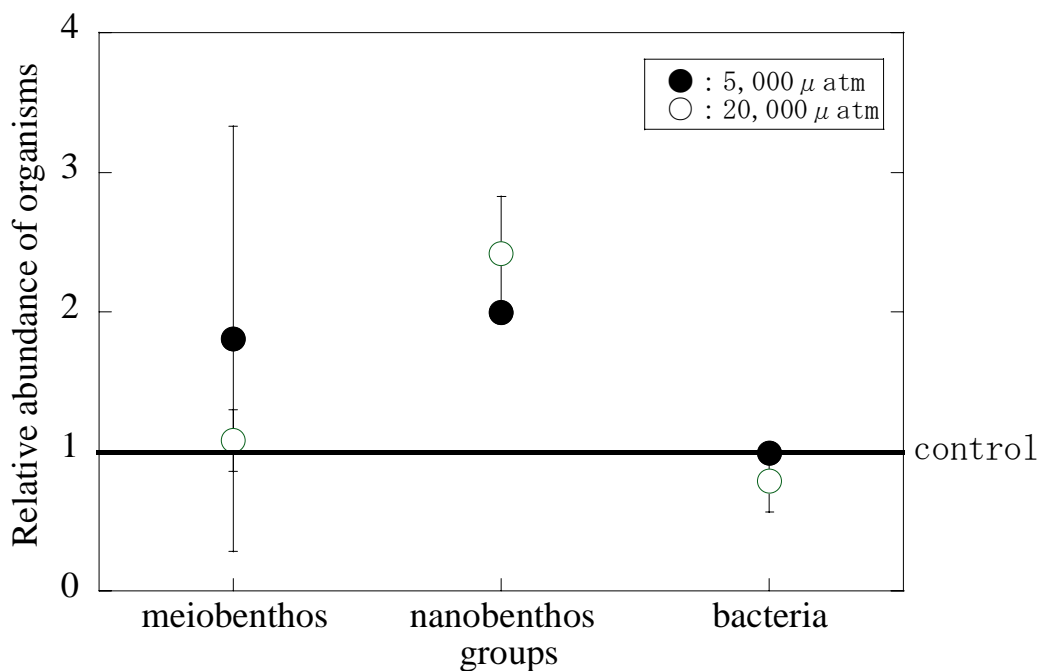

Figure 37. The total number of organisms observed in the sediment (0-3 cm) from both experiments. For each treatment the number of organisms is presented as relative to control.

Nanobenthos cells significantly increased in the high $p\text{CO}_2$ chamber and the largest deviation in abundance compared to the control was observed in the nanobenthos (**Figure 37**). Nanobenthos includes unicellular microorganisms such as flagellates, ciliates, and amoeba. These microbes are not only important food items for meiobenthos but are also a predator of bacteria. As nanobenthos is thought to be predated on by meiobenthos or to compete with meiobenthos for food, the increase of nanobenthos in the CO₂ exposed chambers suggests a decline of the activity of meiobenthos.

There were some significant differences in the meiobenthos abundance among the chambers (see **Figure 33** to **Figure 36**) but in most instances the changes in abundance were not statistically significant. An overall apparent increase of meiobenthos was indicated in the 5,000 μatm chamber but not for the 20,000 μatm chamber (**Figure 37**). However, meiobenthos abundances varied greatly even among sub-cores obtained from the same layer in the same chamber indicating a patchy distribution. The overall increase in meiobenthos abundance in the 5,000 μatm treatment was therefore not statistically significant and an effect of the added CO₂ can therefore not be claimed based on the present data.

Results from experiments conducted in the western North Pacific (Ishida et al. 2005) have, however, shown that meiobenthos abundance there decrease after around 2 weeks of CO₂ exposure ($p\text{CO}_2$ condition of 20,000 μatm). The experiments in Storfjorden were conducted over a period of approximately 9 days. Possibly a longer period of exposure is needed in order to show significant meiofauna mortality. In an experiment on biological impacts of direct injection of CO₂ on the seabed, organisms that died from the CO₂ exposure took some time to decompose (Carman et al., 2004). An alternative explanation is therefore that recently dead meiofauna were not adequately decomposed at the end of the Norwegian experiment and thus might have been counted as living animals. Such a situation would mask possible effects of the added CO₂ on meiofauna mortality.

Apart from in the surface sediment bacteria cells decreased in the 20,000 μatm chamber (compared to the control) in the first experiment and remained stable in the other sub-cores in both experiments (**Figure 19**). Results from *in situ* exposure experiments in the western North Pacific using the same device as this study (Ishida et al., 2005) showed that bacteria decreased after 3 days of exposure, but increased after 2 weeks of exposure in the 20,000 μatm $p\text{CO}_2$ condition. These results suggested that bacteria after some initial reduced abundance adapt to the high $p\text{CO}_2$ condition and can even proliferate presumably because of surplus of decomposing dead meiobenthos.

Bacteria are not a homogenous group of organisms and some micro organisms are probably more tolerant or more adapted to high $p\text{CO}_2$ than others. Some bacteria may also within days proliferate because they can take advantage of newly available decomposing organic matter. A complicating factor for understanding the bacterial responses from the enumeration of bacterial numbers is that both nanobenthos and meiobenthos affect bacterial numbers through predation. Meiofauna also prey on nanobenthos making the situation even more complicated. Observed responses on microbial numbers may therefore be caused both by direct effects of CO₂ on the bacteria and by secondary effects caused by increased or decreased predation pressure from nanobenthos and meiobenthos.

No overall bacterial response was observed in the 5,000 μatm $p\text{CO}_2$ treatment after 9 days (**Figure 37**). The number of nanobenthos did increase during the experiment and the predation pressure from nanobenthos on bacteria has therefore probably also increased. This seems not to have effected the number of bacteria in the 5,000 μatm $p\text{CO}_2$ treatment after 9 days, possibly because the increased predation pressure was balanced by a proliferation of CO₂ tolerant bacteria that can take advantage of decomposition organic matter (partly from meiofauna).

A small reduction in bacterial number was observed in the 20,000 μatm $p\text{CO}_2$ treatment (**Figure 37**). The lower bacterial number in the in the 20,000 μatm $p\text{CO}_2$ treatment compared to the 5,000 μatm $p\text{CO}_2$ treatment is probably caused by a higher initial bacterial mortality (as observed in Ishida et al., 2005) combined with an increased predation pressure from nanobenthos.

The relative changes of the *in situ* sediment community oxygen consumption (ISSCOC) as compared

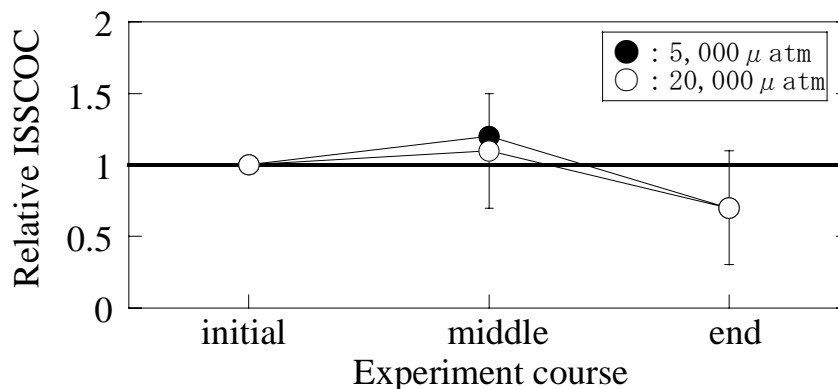

to control is shown in

Figure 38. The respiration activity increased slightly in the first phase, and then declined in the second phase in both exposure chambers. A reduction in oxygen consumption towards the end of the experiment were also observed from the flux measurements (**Table 9**). Quite high respiration activity is reported for meiobenthos in the deep-sea ocean (Shirayama, 1992, Witte et al., 2003). The increased respiration activity in the first phase may suggest disturbance of meiobenthos respiration resulting in hyperventilation (Randall et al., 1997). The subsequent decrease of respiration activity suggested that the meiobenthos activity weakens gradually with progress of time.

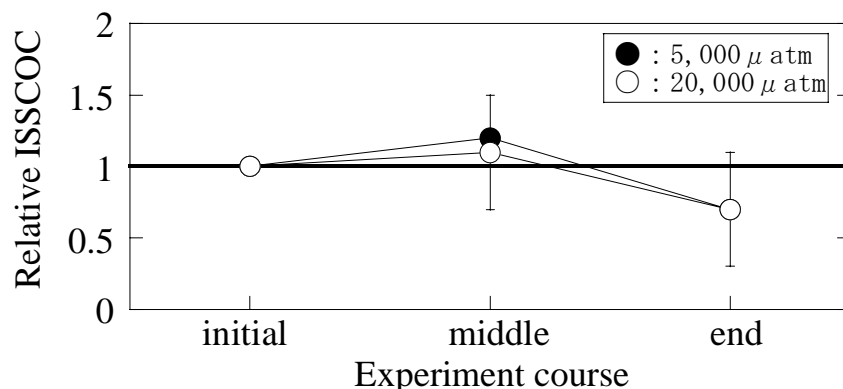

Figure 38. Relative changes of in situ sediment community oxygen consumption (ISSCOC) in each chamber as compared with the control.

5.4 Representatively of the conditions in the chambers

Several approaches have been suggested to mitigate the future atmospheric CO₂ concentration. The most important are ocean sequestration of carbon dioxide and underground geological storage of CO₂. Ocean sequestration may potentially affect marine life at the selected release sites. Such effects are probably related to the large changes in seawater chemistry (pH reduction, *p*CO₂ increase) near a site. Underground storage may also affect marine life in a similar way, if CO₂ leaks to overlying sediments and water.

The conditions in the chambers were meant to have relevance to both ocean sequestration and leakage from sub-seabed storage. In both scenarios moderate to quite large amounts of CO₂ may reach the sea floor.

In the *in situ* experiments we have exposed deep-sea sediment communities to elevated concentrations of carbon dioxide (average of 20,000 μ atm, 5,000 μ atm and control) for a limited period of time (9 days). The values of total carbon dioxide (T-CO₂), pH and *p*CO₂ during the experiments ranged between 2,280 – 7,940 μ mol L⁻¹, 7.98 – 6.29 and 226 – 29,982 μ atm in the 20,000 μ atm chamber, 2260 – 3790 μ mol L⁻¹, 7.98 – 6.96 and 228 – 4,669 μ atm in the 5,000 μ atm chamber and 2,270 – 2,600 μ mol L⁻¹, 7.98 – 7.61 and 220 – 670 μ atm in the control chamber, respectively. For these parameters, the conditions were thus quite different in the treatments, as intended. Due to limited field data and experience it is still somewhat unclear what exposure levels that actually may occur after ocean sequestration or leakage from geological storage of CO₂. Tentatively we expect the exposure levels in our experiments to be relevant for low to moderate exposure levels in a real situation. More severe exposure levels would however probably occur in the near field in case of a massive leakage of CO₂.

The oxygen saturation in the chambers was less than 20 % at the end of the experiments (**Figure 17**). In fact, the duration of the experiments were planned so that no anoxia should be expected. Although some differences in oxygen levels/consumption between chambers were observed, the overall picture was that all treatments experienced a fairly similar decline in oxygen. There is, however, a possibility that hypoxic conditions may have occurred at the sediment surface at the end of the experiments, but this has in case probably had little effect on the results since all chambers experienced a similar oxygen decline. It is, however, interesting to note that high densities of foraminiferans (and also other meiofauna groups) were observed in the surface layer in the 5000 μatm treatment in the first experiment (B1). B1 also showed quite high concentrations for NH_4 at the end of the experiment (**Figure 14**). This may be an indication that anoxic conditions would have developed if the experiments had been of a little longer duration. So in the case of new experiments at a similar site, it will be difficult to extend exposure periods without getting pronounced effects from the developing hypoxic conditions in the chambers (addition of oxygen would alleviate this situation).

5.5 Final remarks

5.5.1 Equipment and logistics

The experiments in 2005 in Norway demonstrated that it is possible to have an international scientific team work efficiently and successfully together at a suitable and easily accessed site like Storfjorden even with only modest experience from the area before, and at a moderate cost.

It was demonstrated that such advanced and heavy equipment as the Benthic Chamber can be moved and reassembled for use at such far-separated locations as Kumana trough near Japan and the Storfjorden in Norway without any significant problems.

The free float nature of the system allowed operation in Storfjorden from a relatively small vessel without the equipment which are usually found only on research vessels. The only requirement is that the vessel has enough capacity and deck space for transporting the equipment and a crane that can lift the BC-system from the ship and into the water.

Basic requirement at the onshore facility is a crane for lifting and moving the BC system within the facility. An indoor space for preparing the BC system for the experiment and performing the sampling in the chambers after retrieval is also preferable. Logistics, technical support and onshore facilities at the ODIM factory were adequate for this, providing ample space and support to the activities before and after deployments and the two field experiments in Storfjorden were completed without significant technical problems.

The Benthic Chamber system proved to be a reliable and cost effective tool for performing experiments on small sections of sediment *in situ* at medium depth. The Benthic Chamber system has also been successfully applied in the deep sea off Japan (e.g. at 2,000 metres depth in Kumana trough in 2006). For such large depths, there are few real alternatives to making pre-programmed, in-situ exposures, due to the difficulties of bringing sediments up and to shore without too much disturbance of the sediments and the organisms adapted to the deep sea conditions. For more shallow depths that can be reached by divers, other alternatives exist, although these will require more continuous monitoring and interception by personnel. For mid-depths like 400 m at Storfjorden, divers could not assist. Possibly a ROV or a scientific submarine could be used to perform a controlled exposure and subsequent monitoring and sampling, but this would require heavy support by an advanced research vessel and thus be quite expensive.

Our experience is that the sediment within the enclosed chambers remained quite undisturbed during the exposures. The experimental conditions during the experiments within the chambers were well

controlled both through recordings performed by electrodes and by the water samples collected automatically throughout the experimental period.

The size of the chambers renders the system suitable for testing effects on small organisms, especially bacteria and nanobenthos but also meiofauna and measurements of physical/chemical characteristics that require small sensors or samples of sediment can be performed. The limited chamber size does not, however, allow studies on macrofauna, and also poses some limitations for meiofauna analyses. The system has only three chambers. This limits the number of replicate treatments. In the Storfjorden experiments this was partly compensated for by performing two similar deployments, one right after the other.

5.5.2 Possible reasons for inconsistencies

The meiofauna responses as determined from counting were much less consistent in terms of response compared to the nanobenthos. The abundance of total meiobenthos varied greatly and no significant differences between chambers/treatments were therefore observed in any of the two experiments. Negative effects of high CO₂ on meiobenthos abundance that was found in similar previous experiments in the North Pacific (Ishida et al. 2005) can not be claimed to be documented based on the present data. The experiments in Norway were conducted over a relatively short time period (9 days). A longer period of controlled exposure would most probably have documented specific effects on meiofauna and provide figures and data for models.

A complicating factor for understanding the observed biological responses to the added CO₂ is that both nanobenthos and meiobenthos may affect bacterial numbers through predation. Meiofauna also prey on nanobenthos making the situation even more complicated. Observed responses on microbial numbers may therefore be caused both by direct effects of CO₂ on the bacteria and by secondary effects caused by increased or decreased predation pressure from nanobenthos and meiobenthos. One possible reason for some discrepancies is that recently dead meiobenthos may have been counted as still alive. Some of the other analyses also showed some discrepancy or no clear effect (bacterial DNA and microbial ATP), which may indicate methodological problems such as too short exposure time.

5.5.3 Some suggestions for follow-up

The results from Storfjorden for the different tests do show effects of increased CO₂ concentrations on microbes, nanobenthos and microbial processes, but to a much lesser extent on meiofauna. These data will be valuable as input to ecological models for CO₂ impact assessments and as basis for planning follow-up studies.

It is assumed that the benthos in the sediment has been impacted mainly through the overlying water according to scenarios for ocean storage of CO₂. In order to evaluate the impact to the ecosystem of leakages from sub-seabed storage it is probably more optimal to develop an experiment design that increases CO₂ also directly in the pore water. The benthic chamber system used in this study can be modified to accommodate such a design. Preliminary studies do however show that pore water pH (and *p*CO₂) will gradually change also when the CO₂ enriched water are added to the headspace.

During the CO₂-exposure in the benthic chambers, significant effects of increased CO₂ concentrations were observed on both microbial activities and cell numbers. These preliminary results indicate stimulation or inhibition of distinct groups of micro organisms as a consequence of the exposure of the sedimentary environment to elevated CO₂ concentrations. Consequently, future studies should focus on a more detailed analysis of presence and activities of key microbial groups and metabolic pathways.

In addition to the already mentioned methane producing and sulphate reducing micro organisms also nitrogen or CO₂ fixing (autotrophic), ammonium oxidising or other environmentally relevant micro organisms should be included.

From such studies it should be possible to identify candidates in the microbial flora/fauna, whose presence, absence or ratios of abundance could provide easily detectable and accurate indicators for the leakage of CO₂ from deep reservoirs into near-surface marine ecosystems. Our results indicate that the bacteria/archaea ratio (see **Figure 21**) could be such an indicator.

The experiments also rendered an array of physical, chemical and biological baseline data for the site that will become valuable for ecological assessments and future CO₂ experiments there or at similar sites.

The baseline data will be shared with other scientists in other disciplines, to become useful for other purposes as well, including model improvements and evaluations for offshore ocean – or sub-seabed CO₂ storage sites (e.g. Japan, North Sea, Barents sea).

Macrofauna are important prey organisms for bottom living fish. New experiments should therefore also focus on CO₂ exposure of larger animals (macrofauna). This may require a modification of the setup, possibly by some sort of collection of larger animals and placing inside chambers or in cages exposed to CO₂. Simultaneously, larger sediment samples containing various macrofauna organisms at in situ densities can be collected by a box corer and brought to a laboratory onshore for exposure tests there.

6. References

- Barry, J.P., K.R. Buck, C.F. Lovera, Z.L. Kuhn, P.J. Whaling, E.T. Peltzer, P. Walz and P.G. Brewer, 2004: Effects of direct ocean CO₂ injection on deep-sea meiofauna. *J. Oceanogr.* 60, 759-766.
- Blikra, L.H., E. Anda, J. Høst and O. Longva, 2006: The Åknes/Tafjord project: Probability and risk associated with landslides and tsunamis from Åknes and Hegguraksla. NGU Report 2006.039 (in Norwegian).
- Bøe, R., O. Longva, A. Lepland, L.H. Blikra, E. Sønstegaard, H. Haflidason, P. Bryn and R. Lien, 2004: Postglacial mass movements and their causes in fjords and lakes in western Norway. *Norw. Journ. Geology.* Vol. 84, pp 35-55.
- Caldeira, K. and M.E. Wickett, 2003: Anthropogenic carbon and ocean pH. *Nature* 425, 365-365.
- Carman, K.R., D. Thistle, J.W. Fleeger and J.P. Barry, 2004: Influence of introduced CO₂ on deep-sea metazoan meiofauna. *J. Oceanogr.*, 60, 767-772.
- Cord-Ruwisch, R., 1985: A quick method for the determination of dissolved and precipitated sulfides in cultures of sulfate-reducing bacteria. *J. Microbiol. Methods* 4, 33-36.
- Egeberg, P.K., 2000: Adenosine 5'-Triphosphate (ATP) as a Proxy for Bacterial Numbers in Deep-Sea Sediments and Correlation with Geochemical Parameters (Site 994). *Proceedings of the Ocean Drilling Programme, Scientific Results, Vol 164.* Paull, C.K., Matsumoto, R. Wallace, P.J. and Dillon, W.P. (Eds), 2000.
- Eller, G., S. Stubner and P. Frenzel, 2001: Group-specific 16S rRNA targeted probes for the detection of type I and type II methanotrophs by fluorescence in situ hybridisation. *FEMS Microbiol. Letters* 198, 91-97.
- Epstein, S.S. and J. Rossel, 1995: Enumeration of sandy sediment bacteria: search for optimal protocol. *Mar. Ecol. Prog. Ser.*, 117, 289-298.
- Golmen, L., 2002: The international project on CO₂ ocean sequestration. A summary of the experiment permitting process in Norway, 2002. Rep. No 4619, NIVA, Oslo, 43 p.
- Halliday, N.C., S.H. Coombs and C. Smith, 2001: A comparison of LHRP and OPC data from vertical distribution sampling of zooplankton in a Norwegian fjord. *Sarsia* 86, 87-99.
- Haugan, P. and H. Drange, 1996: Effects of CO₂ on the ocean environment. *Energ. Convers. Mgmt.* 37, 1019-1022.
- Higgins, R.P. and H. Thiel, 1988: *Introduction to the Study of Meiofauna.* Smithsonian Institute Press Washington, D. C., 488pp.
- Henckel, T., M. Friedrich, and R. Conrad, 1999: Molecular analyses of the methane-oxidizing microbial community in rice field soil by targeting the genes of the 16S rRNA, particulate methane monooxygenase, and methanol dehydrogenase. *Appl. Environ. Microbiol.* 65, 1980-1990.

- Ishida, H. and Y. Shirayama, 1999: The development of benthic chamber for in situ experiment. p. 102-103. In *Proceedings of the 2nd International Symposium on Ocean Sequestration of Carbon Dioxide*, ed. by H. Matsukawa, New Energy and Industrial Technology Development Organization, Tokyo.
- Ishida, H., Y. Watanabe, T. Fukuhara, S. Kaneko, K. Furusawa and Y. Shirayama, 2005: In situ enclosure experiment using benthic chamber system to assess the effect of high concentration of CO₂ on deep-sea benthic communities, *Journal of Oceanography*, **61**, 835-843.
- Klappenbach, J.L., P.R. Saxman, J.R. Cole and T.M. Schmidt, 2001: rrndb: the ribosomal RNA operon copy number database. *Nucleic Acids Res* 29:181-184.
- Krüger, M., P. Frenzel and R. Conrad 2001: Microbial processes influencing methane emission from rice fields. *Glob. Change Biol.* 7, 49-61.
- Kurihara, H., S. Shimode and Y. Shirayama, 2004: Sub-lethal effects of elevated concentration of CO₂ on planktonic copepods and sea urchins. *J. Oceanogr.* 60, 743-750.
- Lewis, E. and D.W.R. Wallace, 1998: *Program developed for CO₂ system calculations*, Publ. No. 4735, Env. Sciences Div., Brookhaven National Laboratory.
- Lüders, T., M. Manefield and M.W. Friedrich, 2004: Enhanced sensitivity of DNA- and rRNA-based stable isotope probing by fractionation and quantitative analysis of isopycnic centrifugation gradients. *Environ. Microbiol.* 6:73-78.
- Marlek, R., R. Bartlett and B. Evans, 2004: A technical appraisal of storage of Gordon CO₂ at Barrow Island, North West shelf. *APPEA J.* 44, 639-645.
- Pfannkuche, O. and P. Linke, 2003: GEOMAR landers as long-term deep-sea observatories. *Sea Technology*, **44**, 50-55.
- Randall, D., W. Burggren and K. French, 1997: *Eckert Animal Physiology*, 4th edition, W.H. Freeman and Company, pp. 562-570.
- Riebesell, U., 2004: Effects of CO₂ enrichment on marine phytoplankton. *J.Oceanogr.* 60, 719-729.
- Shirayama, Y., 1992: Respiration rates of bathyal meiobenthos collected using a deep-sea submersible SHINKAI 2000, *Deep-Sea Res.*, **39**, No.5, 781-788.
- Tengberg, A., F. D. Bovee, P. Hall, W. Berelson, D. Chadwich, G. Ciceri, P. Crassous, A. Devol, S. Emerson, J. Gage, R. Glud, F. Graziottini, J. Gundersen, D. Hammond, W. Helder, K. Hinga, O. Holby, R. Jahnke, A. Khripounoff, S. Lieberman, V. Nuppenau, O. Pfannkuche, C. Reimers, G. Rowe, A. Sahami, F. Sayles, M. Schurter, D. Smallman, B. Wehrli and P. D. Wilde, 1995: Benthic chamber and profiling landers in oceanography – A review of design, technical solutions and functioning. *Prog. Oceanog.*, **35**, 253-294.
- Witte, U. and O. Pfannkuche, 2000: High rates of benthic carbon remineralisation in the abyssal Arabian Sea. *Deep-Sea Res. II*, **47**, 2785-2804.
- Yamashita K. and N. Kawada, 1997: Size distribution analysis of test powders and test particles designated by JIS Z 8901. *J. Soc. Powder Technol.*, **34**, 528-535. (in Japanese)