

RE-food

Goa, India, Feb. 2018

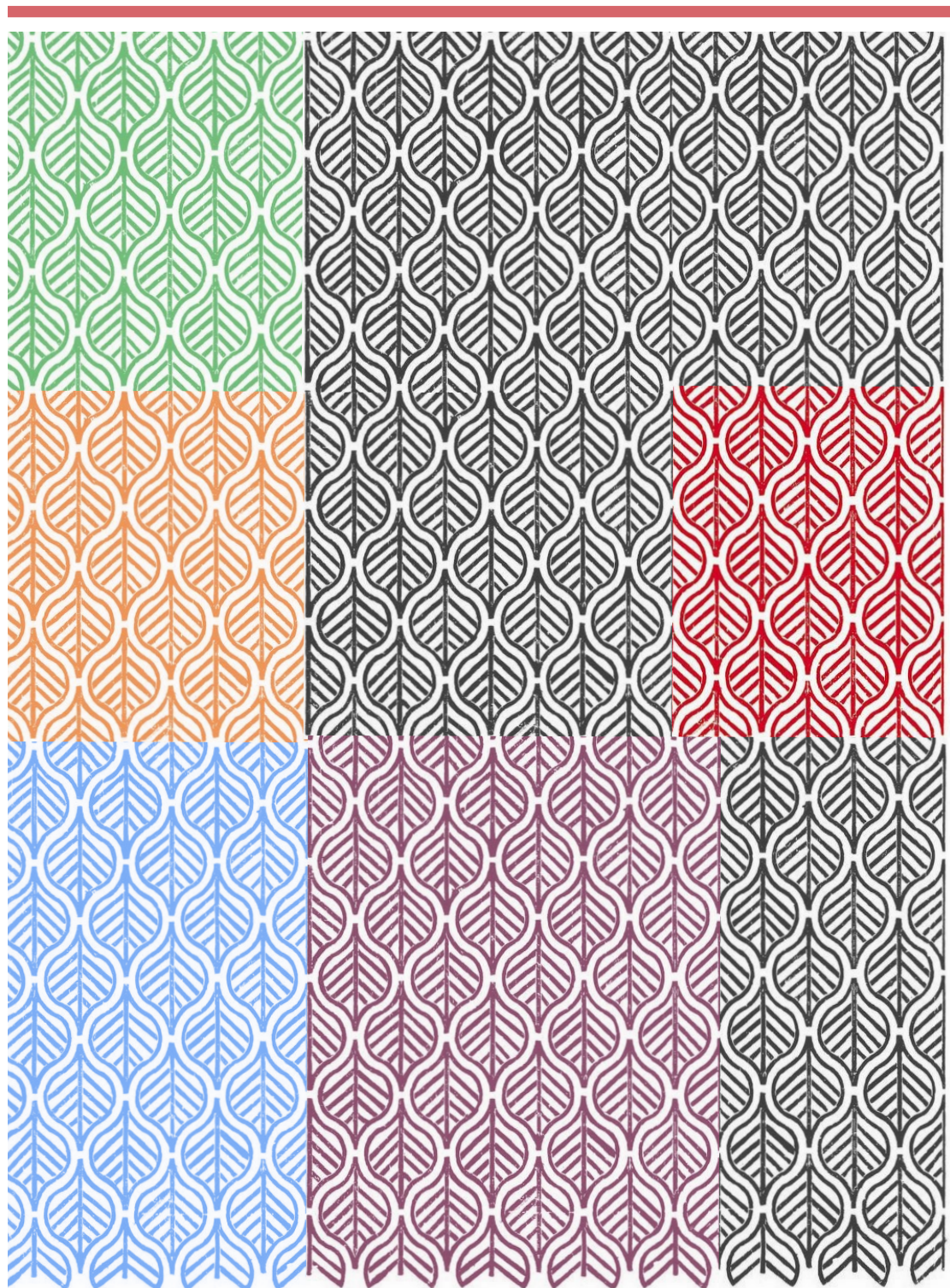

Abstracts and Summaries, 1st Symposium

Composed by:
Aleksander Eilertsen
Maitri Thakur
Kristina Widell
Guro Møen Tveit

Design by:
Aleksander Eilertsen

1st RE-food Symposium
Goa, India, Feb. 2018

**Sustainable technologies for food
processing and preservation**

ISBN: 978-82-14-06872-6

OC2018:00680
2018.06.20
V.20180620-1400



Sustainable technologies for food processing and preservation

RE-food is a three-year (2017-2019) interdisciplinary project focusing on developing a partnership between Norway and India to contribute towards strengthening of the global bio-economy by improving the food resource utilization in an energy efficient and climate friendly way. The project is funded by Research Council of Norway's INTPART program that supports international partnership projects for excellent education, research and innovation.

The project is coordinated by SINTEF Ocean (Norway) and includes Norwegian University of Science and Technology. The international partners include CSIR-Central Food Technological Research Institute, Indian Institute of Technology Kharagpur, Amity University and BITS Pilani from India. All partners are active contributors to excellent research, innovation and education activities, are involved in collaborative projects and provide high-caliber graduates and researchers.

Goals of RE-food

One-third of all food produced in the world is lost every year. To enable sustainable development of the food system, EU and Member States adopted the Sustainable Development Goals (SDG) in September 2015, which include a target to halve per capita food waste at the retail and consumer level by 2030, and reduce food losses along the food production and supply chains. While majority of food waste occurs at the consumption stage in Europe, in India most of the loss occurs at the post-harvest stage due to improper handling and cold chain management. The RE-food consortium is working on developing an integrated approach to deal with these challenges with focus on sustainable utilization of food resources to meet the growing global demand for food and feed ingredients. RE-food focusses on building a long-term cooperation between Norwegian and Indian partners as well as industry and governmental stakeholders in both countries. This partnership includes organization of joint symposiums; joint Master and PhD programs; reciprocal exchange of researchers between India and Norway and student internships in industry for Master students in India.

Goal of the Symposium

An annual symposium is organized to disseminate the research, innovation and education results achieved by RE-food as well as an opportunity to create new contacts to strengthen the cooperation on bio-economy. The first symposium in 2018 focused on Sustainable technologies for food processing and preservation including advances in rest raw material utilization, cold chain management, energy efficiency, and robotics in food handling.

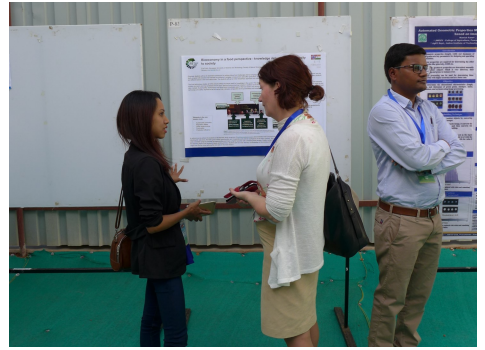

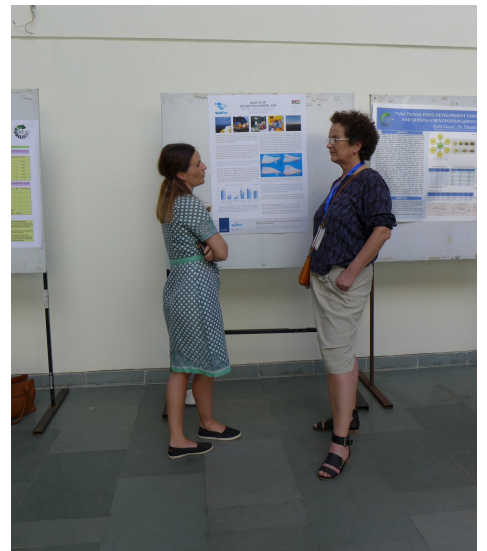
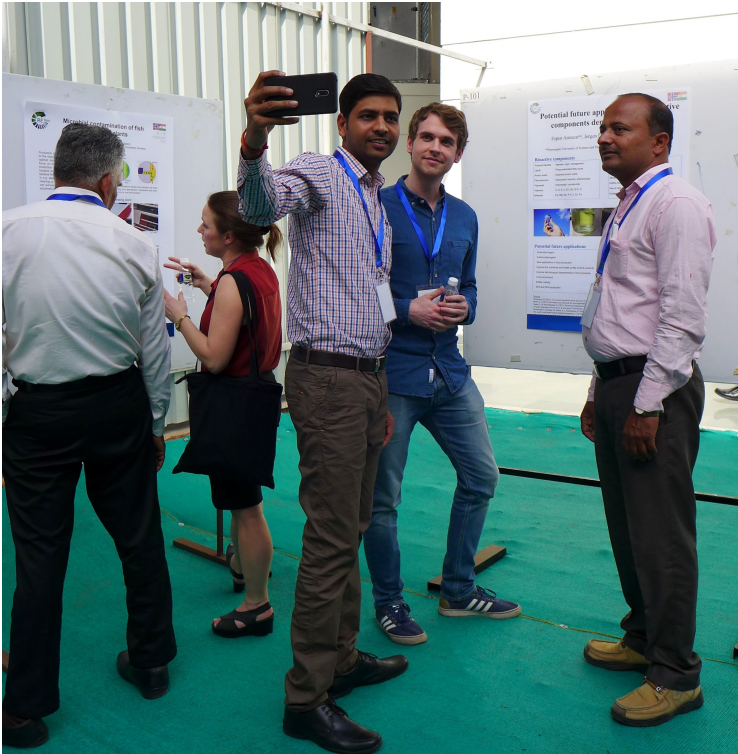

Summary of Symposium

RE-food is working towards solutions for
better utilization of food resources!

There is an urgent need to provide food and feed ingredients for the growing world population while tackling the problem of food loss at a global scale at the same time.

Solutions for reducing food loss and strengthening the bio-economy were in main focus areas for the first symposium arranged by the Indo-Norwegian RE-food project in Goa on 8-9 February 2018. The symposium was jointly arranged by SINTEF Ocean and BITS Pilani where almost sixty researchers and industry representatives from Norway and India met to discuss the emerging challenges of sustainable food production and preservation.

Climate friendly refrigeration for storage and transportation of food, energy efficient processing, utilization of rest raw materials and automation of handling and production were the main topics discussed. Researchers and students from both Norway and India presented their work in form of oral and poster presentations. Industry participants included Nishi Indo Foods, a surimi company and Suvichaar, a start-up promoting consumption of fresh fish.

“The challenges related to food security and food chains are the same in India and Norway. The waste is the same. It is just the scale that is different. I believe it is possible to find projects and solutions with value for both countries”

- Prof. Trygve Eikevik from NTNU in Norway.

Dr. Souvik Bhattacharyya from BITS Pilani India is quite confident that results coming out of this Indo-Norwegian collaboration can be immediately deployed by companies.

“And this is what this work is really about; finding solutions to some of the world global challenges, scientists and companies together so that we ensure that the solutions will be implemented”

- Dr. Marit Aursand, Special Advisor at SINTEF Ocean.





Figure 1: Group picture for the Symposium.

One third of all food that we produce is lost every year. How can we better utilize food resources in a sustainable manner? A new Indo-Norwegian food project is working towards a solution.

With our growing population comes an increased global demand for food and feed ingredients. While we need to speed up our food production to feed coming generations, we are living with a huge paradox: tons of edible food are thrown away every single day, although we know that people are starving in other parts of the world. Food security is in many ways our most pressing challenge.

Fighting food loss and for developing the bio-economy were in focus when the Indo-Norwegian RE-food project held its first annual symposium in Goa last week. Almost sixty researchers and industry representatives from

Norway and India met to discuss the emerging challenges of sustainable food production and preservation.

Better cooling and storage of food, automatization of food production and the use of rest-raw materials for commercial purposes, are all topics that RE-food works with. They also work with ways to recycle water and to save energy in food production to make the process more sustainable.

RE-food is an international partnership that focuses on bio-economy and sustainable utilization of food resources. The project is a cooperation between Norwegian partners SINTEF Ocean and NTNU, and Indian partners CSIR-CFTRI, IIT Kharagpur, Amity University and BITS Pilani. RE-food also collaborates with other industry and governmental stakeholders in both countries, and is supported by Innovation Norway in India.

- Royal Norwegian Embassy, New Delhi



BITS Pilani
K K Birla Goa Campus



Norwegian University of
Science and Technology

भारतीय प्रौद्योगिकी संस्थान खड़गपुर
Indian Institute of Technology
Kharagpur 



The Research Council
of Norway



Innovation
Norway



AMITY
UNIVERSITY



cftri



Sessions

p. 10—29 Utilization of bio-based rest raw materials

p. 30—45 Energy efficiency in food handling and processing

p. 46—61 Robotics and automations in food industry

p. 62—69 Industrial challenges

Abstract list

First session

Who	Title
Ravishankar	Losses in the Indian seafood sector: Causes and potential value addition solutions
R. Sarvanan	Combined Power and Cooling Systems for Cold Storage Applications
Ana Carvajal	Marine rest raw material handling and quality during storage and processing
Rasa Slizyte	Sustainable technologies for extraction of valuable components from salmon rest raw materials – DAFIA project
Guro Møen Tveit	Quality and safety of Atlantic cod (<i>Gadus morhua</i>) after thawing in water at different temperatures
Nutan Kaushik	Exploring the potential of rest raw material of oilseed industries as biopesticides
AA Zynudheen	Extraction and quality evaluation of calcium from discards of tuna and rohu
Inna Petrova	Production of fish protein hydrolysates: major costs and methods of their minimizing
Sunil Bhand	Biosensors for food Traceability

Utilization of bio-based rest raw materials

There is an urgent need to provide food for the growing world population while at the same time tackling the problem of food loss at a global scale. India is a major producer and exporter of food products, and food processing is recognized as a priority sector in their new manufacturing policy. In Norway the food processing industry generates a variety of rest raw materials from the seafood, meat and fruits and vegetables processing that go unutilized. Several possibilities for better utilization of bio-based rest raw materials was the theme for the first session during the 2018 RE-food Symposium. The session was filled with a total of nine presentations and was led by Dr. Souvik Bhattacharyya and Dr. Marit Aursand.

Losses in the Indian seafood sector: Causes and potential value addition solutions

C.N. Ravishankar^(a)

(a) Director, ICAR-Central Institute of Fisheries Technology, Cochin-29

Keywords: Fish waste, value addition, rest raw materials, economic utilization, marine minerals, industrial processing

Recent reports project a figure of US\$ 50 billion as the loss from seafood sector every year, due to poor management of available resources. Global fish waste generation is estimated to be in excess of 100 mMT, and in the Indian scenario it is >4 mMT.

The present paper discusses about the various value addition options to improve the economic utilization of fishery wastes. Recent developments in open sea farming especially cage and pen rearing highlights the bright future of fish meal industry in coming years, as most of these species demand high protein feeds for their optimum growth.

Another attractive option for the mass reduction of bulk waste is ensilaging and conversion to foliar spray, as foliar feeding is an effective method for correcting soil deficiencies.

The peptides formed by the hydrolysis of fish proteins are proven to have bioactive properties like antihypertensive, antithrombotic, immune modulatory and antioxidative properties. ICAR-CIFT has standardized a protocol for the extraction of collagen and its peptides from fish scale and bone, which have immense potential in cosmetics, food, biomedical applications etc. Another category of biomolecules with therapeutic value are chitins.

The Institute has standardized an industrial process for chitin, glucosamine hydrochloride, chitosan and carboxymethyl chitosan. Marine minerals form



another group of relatively unexplored class of biomolecules having functional and nutraceutical roles. The filleting wastes of tuna and other bigger fishes are very good sources for calcium and hydroxyapatite.

ICAR-CIFT has standardized a protocol to extract calcium and hydroxyapatite from fish bones and scales. Marine ecosystem is a rich reservoir of pigments such as astaxanthin and melanin. These pigments can be used both as natural colorants as well as antioxidants, in addition to a number of other therapeutic and prophylactic properties including anticancer, antihypertensive, Anti IDA etc.

The paper also discusses the major challenges and backwards viz. lack of consumer awareness and education, scattered nature of the sector, inappropriate cold chain management and lack of unified protocols for quality assurance etc., which must be overcome to achieve sustainable management of available resources as well as to reduce the amount of waste going to disposal route. ●

Combined Power and Cooling Systems for Cold Storage Applications

R. Saravanan^(a)

(a) Anna University, Chennai, India, rsarvanan@annauniv.edu

Keywords: *Combined Power and cooling, effective first law efficiency, cold storage.*

The use of low and medium temperature thermal sources such as solar energy or waste heat to produce simultaneous power and cold for cold storage applications is presented and discussed in this paper.

The system uses ammonia-water mixture as working fluid with absorption and desorption processes. From the effective first law analysis, configurations of combined absorption refrigeration and power cycles working with ammonia/ water activated with low temperature solar thermal energy is analyzed. From the operational view point for rural applications, modified single effect ammonia absorption systems with internal heat recovery to improve total system efficiency is proposed. **Figure 1** shows the pictorial view of the combined power and cooling system. The system is being designed for the cooling capacity of 10 TR with evaporator temperature of -10°C to take care of various products. The power output is about 2 kW and this ratio can be changed according to the operating conditions. ●





Figure 1: (a) Hot water simulator, (b) Pictorial view of combined power and cooling system APCS.

Marine rest raw material handling and quality during storage and processing

Ana Carvajal^(a), Revilija Mozuraityte^(b), Halvor Nygård^(c)

(a) SINTEF Ocean, Trondheim, Norway, ana.k.carvajal@sintef.no

(b) SINTEF Ocean, Trondheim, Norway, revilija.mozuraityte@sintef.no

(c) Nofima, Bergen, Norway, halvor.nygard@nofima.no

Keywords: Marine rest raw materials, quality, oxidation, processing, storage, antioxidants.

Acknowledgement:



The marine ingredients industry wants to utilize more of the rest raw materials into products for human consumption. To meet the quality requirements, there is a need for increased knowledge about how the quality of the raw material is affected by transport, storage and process conditions and how the quality can be preserved.

The quality of ingredients (eq. oil and protein fractions) intended for human consumption depend upon sorting, storage and handling of the rest raw material. Marine rest raw materials are especially vulnerable toward spoilage and degradation due to the presence of blood and endogenous enzymes.

Studies have been carried out on rest raw materials from mackerel and salmon where the effect of storage temperature and time on the quality of the produced ingredients have been evaluated. Increased storage time and temperature lead to increased amount of free fatty acid and oxidation status. Based on the analyzed oxidation parameters, rest raw materials from mackerel should not exceed 24 hours of storage before processing. Increased storage led to increased discoloration of the oil caused by a reaction between lipid oxidation products and traced of protein in the oil.

Reduction of storage time, lower and controlled storage and transportation temperature and addition of antioxidants or chemical preservatives are all strategies that can be used to preserve the quality during storage and processing.





Figure 1: Utilization of salmon rest raw materials into food grade oil and protein hydrolysates.

Acetic acid and sodium sulphite are preservatives that can be used to maintain the quality. Several tests were carried out in to study the effect of the chemical agents in preservation of the raw material. A combination of acetic acid (0.3 %) and sodium sulphite (0.1 %) had a positive effect on the preservation of salmon intestines. It resulted in restrained microbial spoilage and development of total volatile nitrogen (TVN). The oil had a lower oxidation status and reduced amount of free fatty acids. Sulphite also inhibited the discoloration of the oil, but the use of acetic acid without sulphite enhanced the discoloration.

Preservatives as acetic acid and sodium sulphite can be used to maintain the quality of the rest raw materials during storage. However, the storage temperature is a critical factor and need to be controlled throughout the whole value chain – from production of the raw material to further processing. •

Sustainable technologies for extraction of valuable components from salmon rest raw materials – DAFIA project

Rasa Slizyte^(a), Revilija Mozuraityte^(b) and Inga Marie Aasen^(c)

(a) SINTEF Ocean, Trondheim, Norway, Rasa.Slizyte@sintef.no

(b) SINTEF Ocean, Trondheim, Norway, Revilija.Mozuraityte@sintef.no

(c) SINTEF Materials and chemistry, Trondheim, Norway, Inga.M.Aasen@sintef.no

Keywords: Salmon, rest raw materials, oil, protein, gelatin, nucleic acids

Acknowledgement:



The main objective of the DAFIA project is to explore the conversion routes of municipal solid waste (MSW), and marine rest raw-materials (MRRM) from the fish processing industries, to obtain high added value products. More than 1.3 million tonnes of marine rest raw materials (MRRM) are generated in Europe each year. Some countries have traditionally been utilizing significant parts of the MRRM, mainly as silage, which is often processed into animal feed. Only a small fraction of the MRRM is used for human consumption or other value added applications. In other countries, due to the lack of specialized infrastructure, the MRRM are wasted or sent directly for animal feed without any attempt to recover the valuable components.

For instance, cut-offs of fish are wasted or sold for low value uses, such as the production of biogas, fuel or mink feed. Furthermore, thousands of tonnes of fish are discarded within European waters, due to low commercial value of the catches, lack of quota or because it has been required by law in the old common fisheries policy. New European directives introduce significant changes to these discarding practices. It will therefore be a challenge for the industry to develop methods to turn fish viscera and skin, currently considered as undesirable raw materials for hydrolysis and human consumption, into profitable products.

Traditional processing technologies (e.g. thermal extraction, hydrolysis, silage) for fish rest raw materials that contain significant amounts of oils, usually aims at high amounts of oil or maximized solubilization of proteins, with



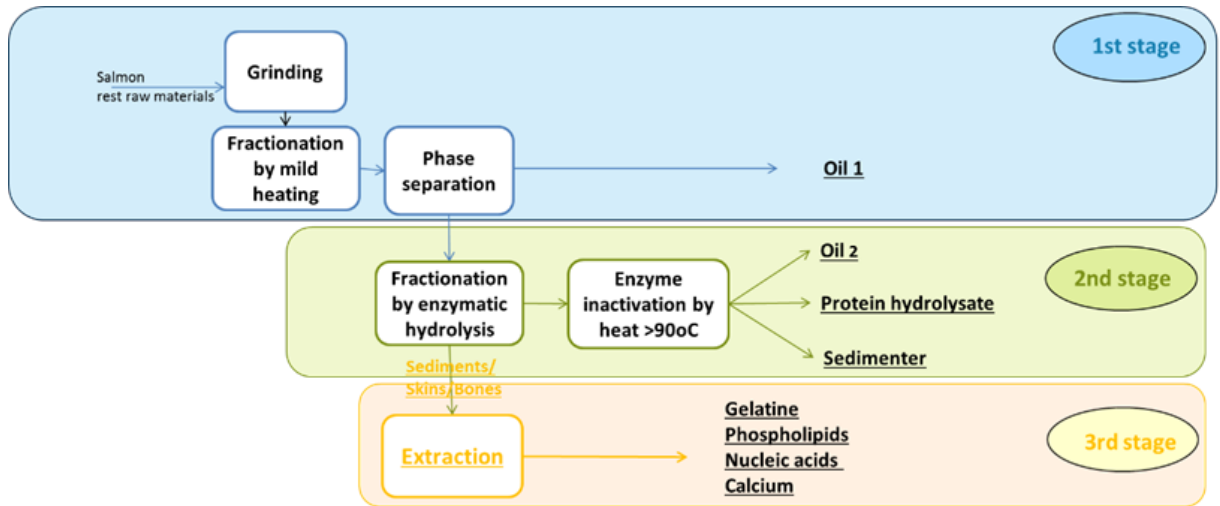

Figure 1: Three stage processes for utilizing salmon rest raw materials.

either the proteins or the oil considered as secondary products. Due to lower yields and insufficient quality, the proteins or the oil are considered as secondary products. Salmon rest raw materials like skins, backbones and viscera contained significant amounts of both lipids and proteins, which could be extracted and used as valuable ingredients in several applications. A new approach for traditional hydrolysis of fish rest raw materials containing significant amounts of oils will be presented. The basis of several stage processing is the mild thermal separation of oil prior to hydrolysis and further processing of the de-fatted rest raw material.

The oil obtained by thermal separation shows significantly higher quality compared to oil separated during hydrolysis with addi-

tion of commercial enzymes. The protein changes during the thermal separation step does not affect the hydrolysis of the proteins by the added proteases. The third stage of the processing covers further extraction of valuable components like gelatin, phospholipids, nucleic acids and calcium (Figure 1). Therefore, the three stage processing where oil is separated using mild heating during the first step look very promising both with regard to economical (up till 85% of oil from raw material is separated before hydrolysis) and quality aspects (oil contained low amount of free fatty acids and were not oxidized). ●

Quality and safety of Atlantic cod (*Gadus morhua*) after thawing in water at different temperatures

Guro Møen Tveit^(b,c), Irja Sunde Roiha^(d), Ásbjörn Jónsson^(a), Christoph Josef Backi^(e), Ulf Erikson^(c), Hanne Digre^(c), Bjørn Tore Lunestad^(d), Magnea G. Karlsdóttir^(a)

(a) Matis, Reykjavik, Iceland

(b) SINTEF Ocean, Trondheim, Norway, guro.tveit@sintef.no

(c) Norwegian University of Science and Technology (NTNU), Trondheim, Norway

(d) National Institute of Nutrition and Seafood Research (NIFES), Bergen, Norway

Keywords: Atlantic cod, thawing strategies, quality, fillets, contact thawing, water thawing, thawing temperatures

Acknowledgement: Thanks to The Norwegian Research Council (NRC) for founding of the QualiFish project (2014-2018).

The catch of marine whitefish is typically seasonal, whereas the land based processing industry has a need for all-year stable supply of raw materials. This challenge can be met by applying fish frozen at sea. When using frozen fish, the methods employed for thawing may influence the safety and quality of the final product. This study aimed to investigate the applicability of novel thawing strategies in order to provide an all-year supply of high-quality and safe cod products.

Two thawing trials were designed to determine the impact on fillet quality, safety, and shelf life by different thawing methods of pre-rigor frozen headed and gutted (H/G) Atlantic cod (*Gadus morhua*) during subsequent cold storage. The investigated thawing methods included contact thawing, in a converted plate freezer, and water thawing, with and without air circulation, as well as applying different thawing media temperatures.

In the first trial, comparative investigations of quality and safety factors after thawing in water, with (w/air) and without (wo/air) air circulation, and contact thawing were performed. Water thawing w/air provided faster thawing compared to water thawing wo/air and contact thawing. For all three methods, the quality of the thawed fish was acceptable and the shelf life of the fillets during chilled storage was between 10 and 14 days post-filleting.



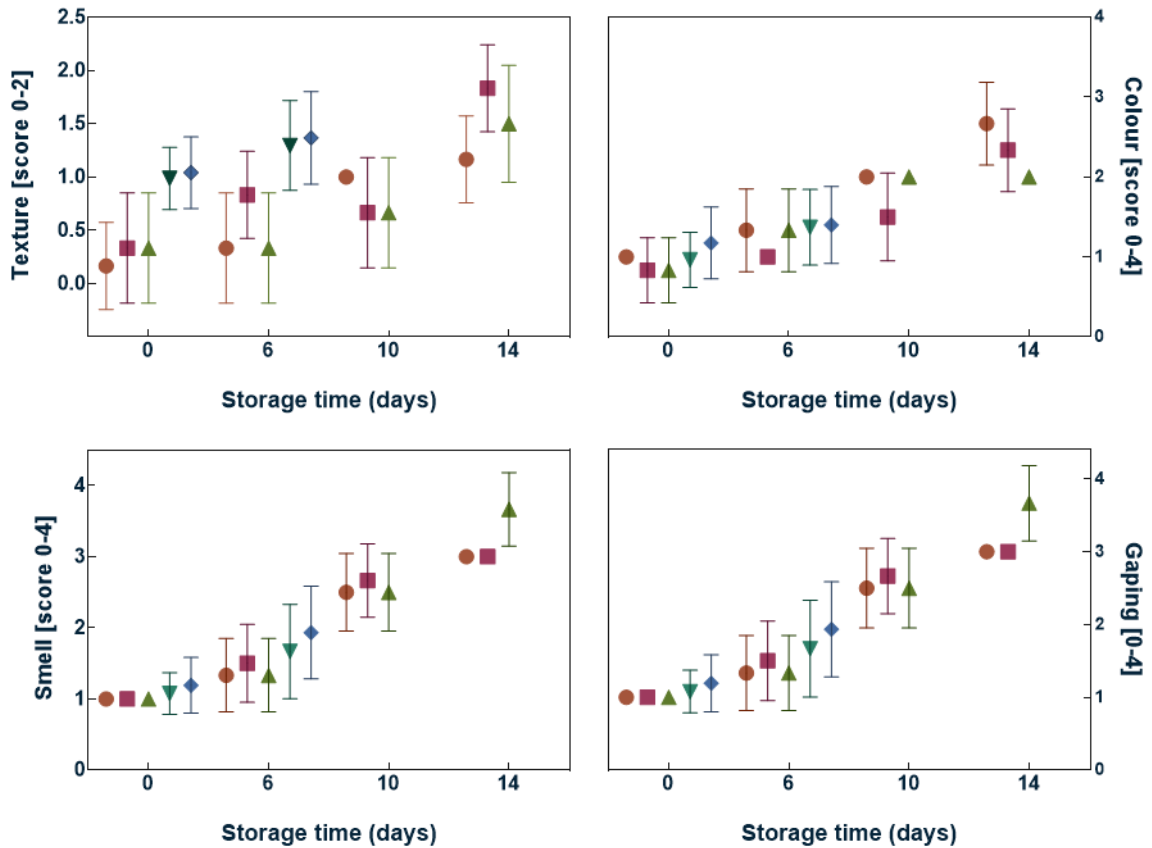

Figure 1: Texture, smell, color, and gaping scores of cod fillets from different thawed H/G cod blocks. Fillets were evaluated after 0, 6, 10, and 14 days chilled storage post-thawing. Values are given as means of at least six samples with standard error of the mean as y-error bars.

In the second trial, water thawing w/air was used, applying different thawing media temperatures, at constant 10°C (5-6 hrs.) or at 10°C (2 hrs.) and -0.5°C (26-27 hrs.). Water thawing at constant 10°C provided faster thawing compared to water thawing at 10 followed by -0.5°C. Both thawing strategies retained good quality fish. The hygienic conditions during the thawing processes were satisfactory and there were no indications of impaired food safety during any of the thawing strategies. No pathogens were detected in any of the fish samples, nor in the thawing media.

For all methods investigated, the quality of the thawed fish was good. Neither *Listeria monocytogenes* nor *E. coli* was detected in any of the samples analyzed. The results show that controlled freezing of cod, followed by appropriate thawing may provide the processing industry with an all-year delivery of raw materials, without compromising quality and safety of the final product. ●

Exploring the potential of rest raw material of oilseed industries as biopesticides

Nutan Kaushik^(a)

(a) Amity Food and Agriculture Foundation, Noida, India, nkaushik5@amity.edu

Keywords: Oilcakes, Biopesticide, Mustard, Jatropha, Karanja, Rapeseed

India is the 3rd largest rapeseed - mustard producer in the world after China and Canada with 12% world total production. India holds premiere position in rapeseed-mustard economy of the world with second and third rank in area and production respectively.

This crop accounts for nearly 1/3rd of the edible oil produced in India making it the countries key edible oilseed crop. India's oilseeds processing sector is made up of the three industrial groups viz Ghanis (crude small scale presses), solvent extractors and oil refiners engaged separately.

The Indian cultivars due to high content of erucic acid and glucosinolate have limited preference in Southern and Central Zone of India and in International market. While erucic acid comes in oil, glucosinolate comes in the seed cake left after extraction of oil.

On the other hand, Biodiesel has emerged as a major alternative to petrol-diesel. Considering the future scenario of non-edible oil seeds utilization for biodiesel production in the country from Jatropha and Pongamia there is need for efficient utilization of their cakes.



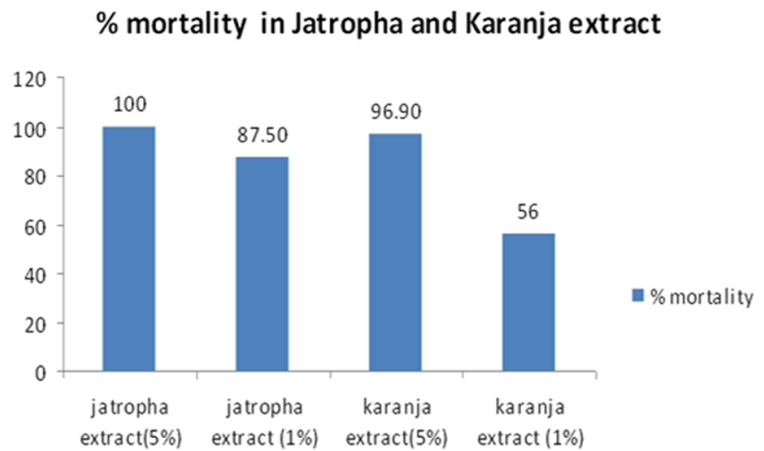

Figure 1: % mortality observed in Jatropha & Karanja extract at different concentrations against *H. Armigera*.

In present study an attempt was made to remove toxins from mustard, Jatropha and Karanja cakes by doing extraction in different solvents and assessing the efficacy of these extracts against Lepidopteran insects in order to find their utility as biopesticides.

Brassica seed methanol extract (100 mg/ml) showed good antifeed-ancy activity of 87.26% almost equivalent to pure sinigrin (10 mg/ml) against *S. Litura*. Details will be presented in the presentation. 5% Jatropha extract showed the high mortality rate against *Helicoverpa armigera* (Figure 1). ●

Extraction and quality evaluation of calcium from discards of tuna and rohu

A.A. Zynudheen^(a), George Ninan^(a), P.K. Binsi^(a), C.N. Ravishankar^(a)

(a) ICAR-Central Institute of Fisheries Technology, Kochi, India, zynu@rediffmail.com

Keywords: *Composition of Rohu & Tuna calcium Powder, quality, discards, rest raw materials, frames, feeding studies*

Tuna fillet is an important export item from India. Even though many species of tuna are used for filleting the most dominant species is yellow fin tuna. At present the tuna filleting waste like frames, heads and other parts are being handled unscientifically and leads to environmental pollution. In certain cases it is sold to local people who dry it and use as a feed component.

Rohu (*Labio rohita*) is an important freshwater species cultured widely throughout India. The present work is intended to extract calcium from the filleting frames of tuna and rohu and assess the quality. Tuna filleting discards were collected from filleting factory and frames were segregated and used for the present study.

Rohu was procured from local market and filleting frames were used for the extraction of calcium. A methodology was developed for the separation of bone and extraction of calcium. The work was carried out in the pilot plant of ICAR-CIFT, Kochi. The analysis of proximate composition of rohu calcium powder showed 12.67% moisture, 26.34% protein, 6.49% fat and 53.94% ash whereas tuna calcium powder had 11.55% moisture, 27.58 protein, 5.4 fat and 54.33% ash. Both samples have high ash and calcium content. The instrumental color and bulk density of the samples were tested. Rohu calcium powder exhibited better whiteness when compared to tuna sample.



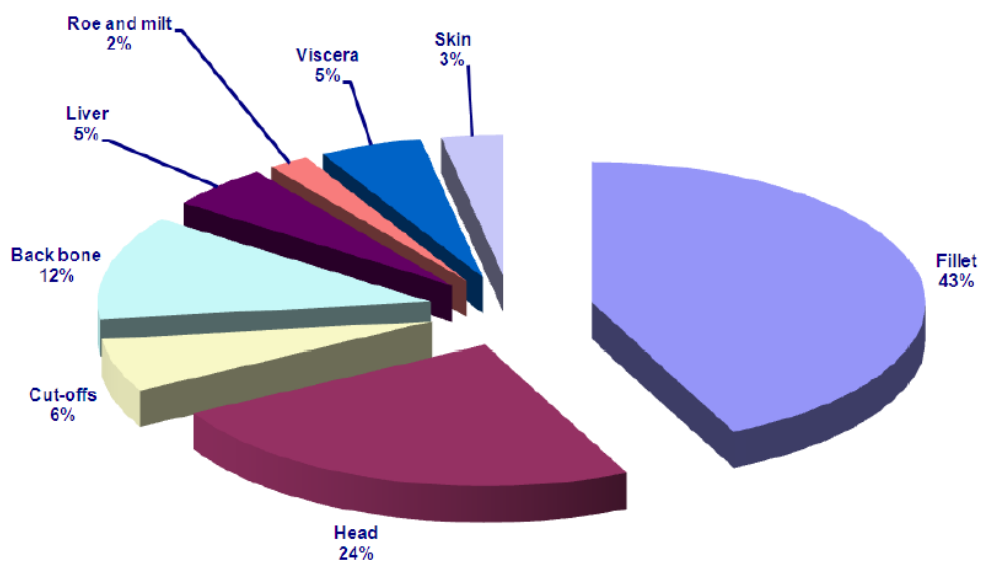

Figure 1: Percent division of parts within the category of loss during regular processing of fish.

Feeding studies were conducted with feed incorporated with the extracted calcium supplemented with vitamin D and peptide in albino rats. The weight gain pattern of the rat groups was almost similar and, no significant difference was observed among the groups. After 14 days the animals were sacrificed and tested for calcium content in blood and body. The calcium retention in the body was found to be high in animals fed with rohu calcium incorporated feed. The final product was encapsulated and test marketing studies conducted at Delhi have shown encouraging results. ●



Figure 2: Moving from general loss to profit and product usable as food supplements.

Production of fish protein hydrolysates: major costs and methods of their minimizing

Inna Petrova^(a), Ignat Tolstorebrov^(a), Trygve Magne Eikevik^(a)

(a) NTNU, Trondheim, Norway, inna.petrova@ntnu.no

Keywords: Fish protein hydrolysates, fish by-products, protein source

In the past years, the technologies, which aim to reduce food wastage through the utilization of remaining rest-products gain popularity among world community.

Fish and marine products is one of the most important source of animal protein on Earth used for human consumption. However, a huge part of the edible fish material is rested without further proper utilization. Thus, the rested fish matter is generally used for the production of cheap fish flour for animal feed, fish oil or even discarded unused. At the same time, the growing world population and increasing catching ability is required urgent methods of improved and increased utilization of edible protein part from the processed fish material. Fish material, which is nowadays delivered to be processed for cheap animal feed, can be used as a good nutritional source for human population.

At the moment, one of the most promising solution of fish rest-material utilization is the production of fish protein hydrolysates (FPH) for human consumption.

Fish protein hydrolysates (FPH) is a matter produced from fish or fish secondary material by the method of protein hydrolyzation (destruction of proteins in the fish tissues into small parts – peptides and amino acids). Thus, FPH is a mixture of distracted proteins. In addition to the previously mentioned benefits for the environment from the utilization of rests from the main fish material production, FPH are considered having a number of improved functional, bioactive, anti-oxidative and anti-hypertensive properties compared to the protein of origin.

FPH is generally produced in two forms: liquid and dried. Liquid FPH is a liquid mixture of hydrolyzed proteins, which mostly contains of water (containing up to 90 % of moisture). However, FPH in a liquid form is highly unstable for a



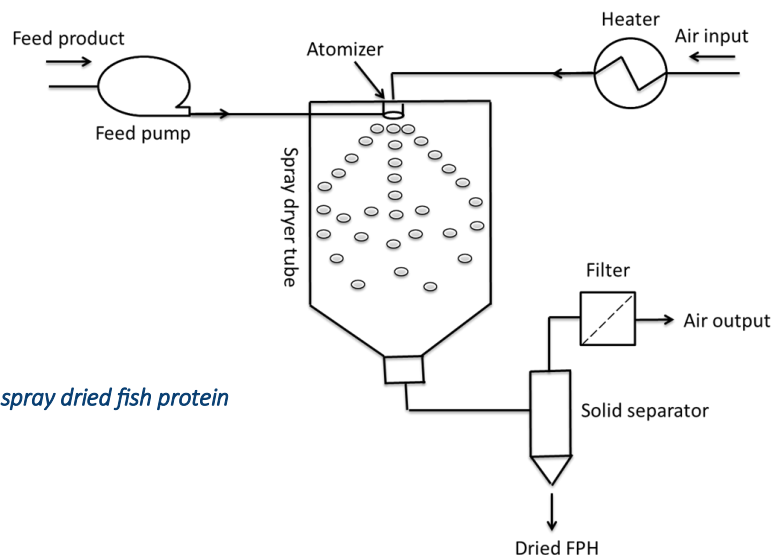

Figure 1: Production of spray dried fish protein hydrolysates.

long-term storage. In addition to a high ability to perish and go through undesirable oxidative changes, liquid FPH is difficult to be transported. Thus, the step of drying is highly needed to provide the remove of surplus of moisture from liquid FPH, stabilize the protein mixture and make their transportation and storage easier.

FPH technology is quite well known, but it has not been published any summary information on the equipment utilized for hydrolyzation or dehydration in frame of FPH production. Moreover, there is a gap in published information considering the energy used for FPH manufacture. Despite of the huge positive effect on economics and environment, FPH technology requires enormous amount of energy, which is delivered mainly for the drying step of the production. In frame of growing world energy consumption, it is urgent to evaluate such an energy load to adjust and minimize energy consumption, decrease economical costs and possibly eliminate a pollution factor.

This presentation has an aim to describe the main technological tools and equipment

used in FPH manufacture. The evaluated information will help to choose best methods of hydrolyzation treatment, understand main characteristics of mostly used dehydration techniques and equipment as well as propose the methods of possible energy reduction while maintaining high quality parameters of final FPH. The presentation will give a broad overview on FPH production step by step from the raw material used to the stage of FPH dehydration. In addition to the technical information on the technology, type, seasoning and availability of fish by-products will be discussed for the Norwegian fishery sector. Considering technological tools, hydrolysis stage will be evaluated and its efficiency and safety will be discussed. Based on the published knowledge, enzymatic hydrolysis will be described closer as the most promising solutions so far. Possible heat treatment methods used for dehydration before the main drying step will be discussed in order to evaluate their efficiency in the minimizing of energy costs of FPH production. Drying equipment used in FPH production will be evaluated in order to describe their energy consumption. Possible solutions for the effective energy utilization will be proposed during this presentation. •

Biosensors for food Traceability

Sunil Bhand^(a)

(a) BITS, Pilani K.K. Birla Goa Campus, Goa, India, sunilbhand@goa.bits-pilani.ac.in

Keywords: Biosensors, aflatoxin M1, nanostructures, food traceability, antibiotic residues, milk, water, fish

Acknowledgement: National Agricultural Innovation project ICAR, Acromed Invest AB Lund, Linköping University Sweden, University of Perpignan France, BITS Pilani.

There is immense need to identify the food contaminants as well as toxicants and their sources to have access to food traceability to avoid huge economic losses and also enable food safety and quality. Chemical contaminants such as mycotoxins (Aflatoxins) and the antibiotic residues need to be detected for regulatory compliance and traceability.

Biosensors have emerged as promising alternative for ultrasensitive and low level detection of such contaminants for field detection and regulatory compliance like Food Safety Standards Authority of India, FSSAI, European Union (EU) and US FDA.

In this work, specific examples are discussed for which bio-sensing platform have been developed by our group. First example is focused on a novel platform technology for detection of Aflatoxin M1 (a group 1 carcinogen) in milk. A magnetic nanoparticle integrated bio-probe for sensitive detection (down to few ng/L) using a field kit is presented (Fig. 1). An optical biochip platform for rapid and high throughput analysis of food toxins meeting EU standards as well as Indian standards is presented. The developed systems were cross validated with commercial kits as well as conventional analytical techniques.

Secondly a novel aptasensor for AFM1 detection and Kanamycin (antibiotic) detection is presented as alternative to antibodies based system. Finally, a novel nano-sensor based on functional materials for detection of endocrine



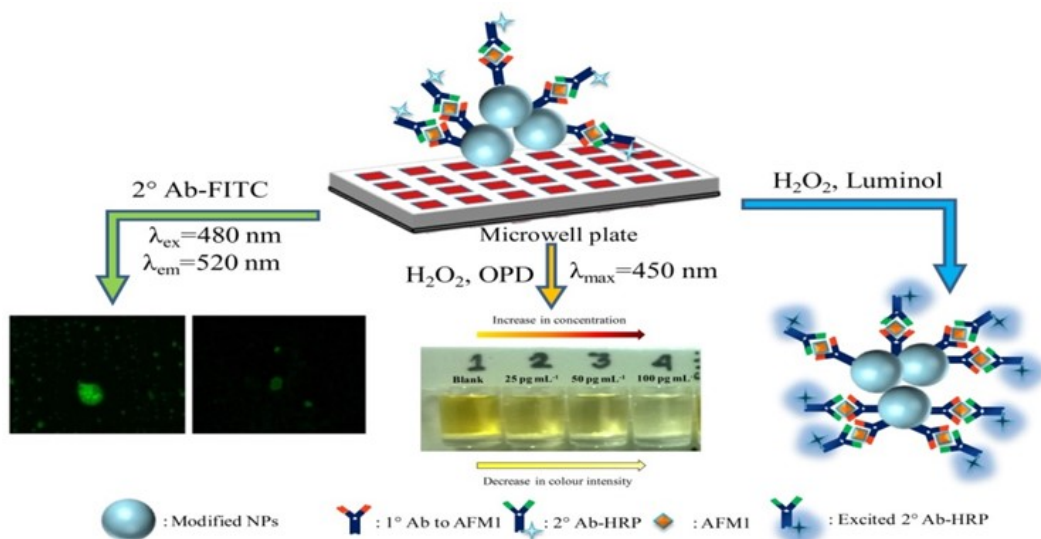

Figure 1: A schematic describing the optical detection system using nanoparticle sensing probe for toxin detection

disrupting system (17 β Estradiol) in water and fish tissues and heavy metals detection in water using porous materials is presented.

In conclusion—Novel biosensors developed for the detection of mycotoxins have potential for application in the area of food traceability. The developed biosensors meet regulatory standards and provide affordable solutions. They can be integrated for field based measurements. ●

Abstract list

Second session

Who

Title

Ignat Tolstorebrov

Low temperature drying and atmospheric freeze-drying of brown seaweeds

Kristina Widell

Refrigeration onboard Norwegian fishing vessels

Maddali Ramgopal

Solar energy based refrigeration systems for cold storages

Erlend Indergård

Optimal and energy efficient storage of root vegetables to prevent losses

Tom Ståle Nordtvedt

Energy efficient processing of seafood

Stefanie Blust

Integrated Supermarket Refrigeration for High Ambient Temperature Region (India)

Mihir Hazarika

Control strategies for CO₂ based refrigeration systems

Energy efficiency in food handling and processing

Food handling and processing include all parts of the value chain, from the products are produced or caught, to the consumer. For a large part of the food, preservation with either cooling/freezing or drying is necessary to preserve product quality and shelf life and to reduce food losses. To generate cooling or freezing effect (and in some value chains also drying), a refrigeration system is required. However, refrigeration systems require electricity, primarily to run the compressors. Reducing electricity consumption is a global goal and for the refrigeration systems and food processing, several measures can be done to increase their energy efficiency. Examples are to reduce the temperature difference between evaporator (cold side) and condenser (warm side), have a good control and regulation of the compressors, reduce unnecessary heat loads, reuse heat (and cold) internally, include heat pumps and to introduce energy management in the company.

Low temperature drying and atmospheric freeze-drying of brown seaweeds

Ignat Tolstorebrov^(a), Trygve Eikevik^(a), Inna Petrova^(a), Yulia Shokina^(b)

(a) NTNU, Trondheim, Norway, ignat.tolstorebrov@ntnu.no

(b) Murmansk State Technical University, Murmansk, Russian Federation

Keywords: Brown seaweeds, atmospheric freeze-drying, drying kinetics, quality

*Drying kinetics of *Saccharina latissima* (raw and blanched) at low and freeze-drying temperatures was studied. Physico-chemical, color, and thermal properties were determined for all the drying regimes.*

The atmospheric freeze-drying was explained based on thermal transitions in seaweeds with respect to temperature and moisture content. Drying temperature of 38.0 °C resulted in more yellow color, when compared with other samples. Sorption characteristics of dried raw seaweeds depended on salt content and showed high accumulation of moisture at relative humidity of air of 80.0 %.

The blanched seaweeds showed linear accumulation of moisture within increasing of relative humidity of drying air from 20.0 to 80.0 %, but high level of hysteresis was determined between sorption and desorption isotherms. The shrinkage development within dewatering of blanched and raw samples was also studied.

Thermal analysis of raw and blanched seaweed with different moisture content revealed several glass transition events in a wide temperature range and one melting endotherm in the temperature range between 141.9 and 167.9 °C. Some glass transitions were influenced by water soluble components. The dried seaweeds (both raw and blanched) are partly in glassy state, partly amorphous and crystalline, when dried at low drying temperatures. ●





Figure 1: Harvesting of Seaweed cultivated in Trøndelag, Norway.

Figure 2: Shows the difference in end-result when blanching before convective drying and not. Blanched seaweed dried clearly better than non-blanced.

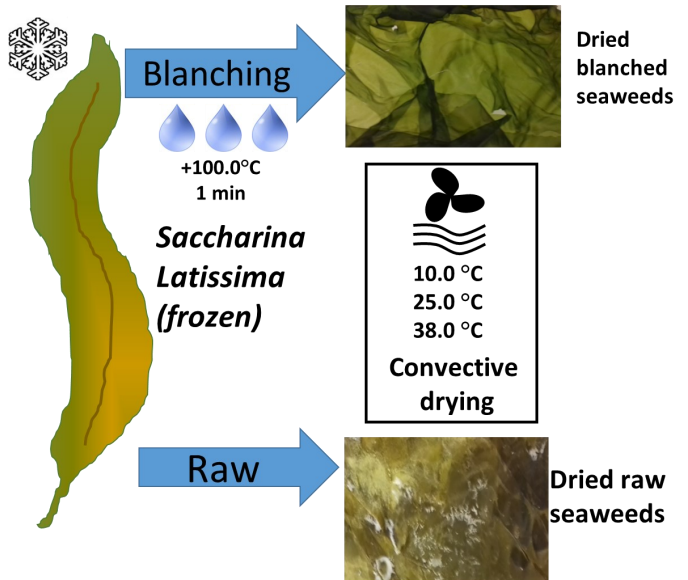
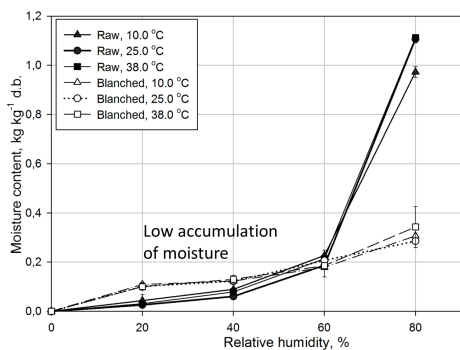

Refrigeration onboard Norwegian fishing vessels

Kristina N. Widell^(a), Tom Ståle Nordtvedt^(a)

(a) SINTEF Ocean, Trondheim, Norway, kristina.windell@sintef.no

Keywords: Pelagic fish, chilling, refrigerated sea water system, ammonia, carbon dioxide.

Fish is an important export product from Norway. Salmon is the largest product, with about 70 % of the total fish export value. Wild caught fish is divided into pelagic and demersal fish. Within the first group we find mainly Herring and Mackerel. Other pelagic fish, like blue whiting, are mainly used for production of feed (used in aquaculture). Demersal fish include Cod, Saithe and Haddock. These types of fish are often gutted and frozen onboard the fishing vessel.

Pelagic fish is caught in large quantities and transported fresh to processing on land. The temperature of the fish should be low and stable during transport, to avoid product damage. Ice was earlier used for this, but because of large amounts of fish onboard, tanks with refrigerated sea water (RSW) has been used since the 1960s. The water is chilled in a RSW system and circulated through all the fish tanks. A sketch of a RSW system is shown in Figure 1. The evaporator is a heat exchanger where heat from the circulated sea water is transported to the refrigerant. This water is cooled before the fish is caught and filled into the tanks.

Traditionally, common refrigerants in these systems were Freons (for example R22), but since they have ozone depleting potential and high global warming potential, they are being phased out. Instead, ammonia is more usual and some vessels have also installed refrigeration system with carbon dioxide.

Ammonia (NH₃, R717), is a natural refrigerant with good thermodynamic properties. It has no impact on either the ozone layer or the global warming. Ammonia is well used in the land based food processing industry in Norway. The toxicity can create problems if there is a leakage on board and it is therefore necessary that the system is situated in a separate room, that personnel is well trained and has appropriate safety equipment available.



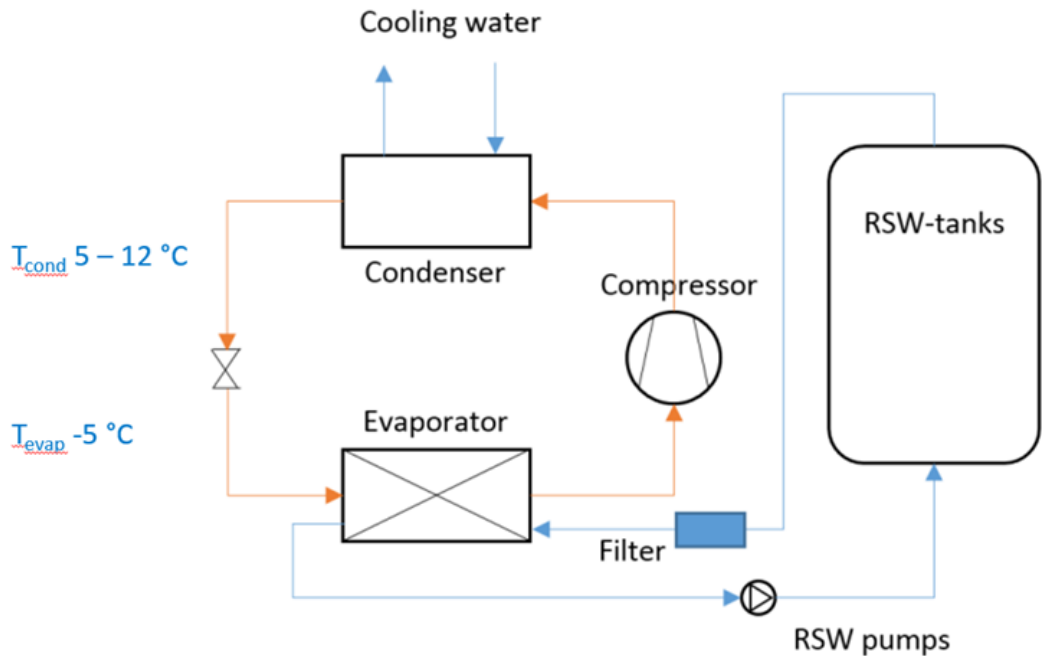

Figure 1: Sketch of RSW system. The system can contain several compressors, evaporators, condensers and RSW-tanks.

Carbon dioxide (CO₂, R744) in RSW-systems has not been common in Norway, nor in the rest of the world. Historically, there was an issue with high pressure, but the equipment nowadays tolerates this and components of different sizes exist or are being developed. Research activity at SINTEF and NTNU has contributed to the development of efficient and safe CO₂-systems. CO₂ systems are also more compact, which is especially important on ships, where space is limited. The refrigerant cost is low and will probably still be moderate in the future.

The ocean outside of Norway is cold, typically between 4 and 10 °C and fish caught there is more temperature sensitive than fish from warmer water. Therefore, the fish must be chilled during transport, to avoid bacterial growth and product quality reductions.

For mackerel and herring (pelagic fish) this is mainly done with refrigerated sea water (RSW) in large tanks onboard the vessels. In Norway, a successful change from ozone depleting refrigerants (with high global warming potential) to climate friendly natural refrigerants has been made during the last decade. Most vessels now use ammonia onboard, but some also use carbon dioxide. Several refrigeration vendors have research and development within this area. ●

Solar energy based refrigeration systems for cold storages

Maddali Ramgopal^(a), V Ravindra^(a)

(a) IIT Kharagpur, Kharagpur, India, ramg@mech.iitkgp.ernet.in

Keywords: Cold storage, solar energy, carbon dioxide, tri-generation, expansion engine

Statistics show that in India the annual product loss due to inadequate cold storage facilities amounts to more than 30 % of the total production. Considering the huge population and reducing farm lands, the country can ill afford these losses.

Availability of electricity is one of the major factors that is affecting the large scale development of cold storage facilities in the country. Being a tropical country with availability of abundant sunshine throughout the year, it is quite logical to explore refrigeration systems that can utilize solar energy for cold storage purposes.

A wide variety of refrigeration systems that can run on solar energy have been explored by researchers over the years. In addition to refrigeration, cold storages also require some amount of electricity for operating auxiliary equipment such as lights and fans. In addition, hot water may also be required for washing and other purposes. In the present study a carbon dioxide based tri-generation system has been conceived for providing required refrigeration to the cold storage, electrical power for operating the auxiliary equipment of the cold storage and hot water for cleaning and other purposes.

The system shown in **Figure 1** operates on a trans-critical cycle. Since trans-critical CO₂ cycles are characterized by large throttling losses, use of an expansion engine in place of the conventional throttle valve has been explored. A thermodynamic analysis of the system is carried out to find the operating regimes in which the system can provide, simultaneously refrigeration, heating and power. Results are obtained for a system that can produce 10



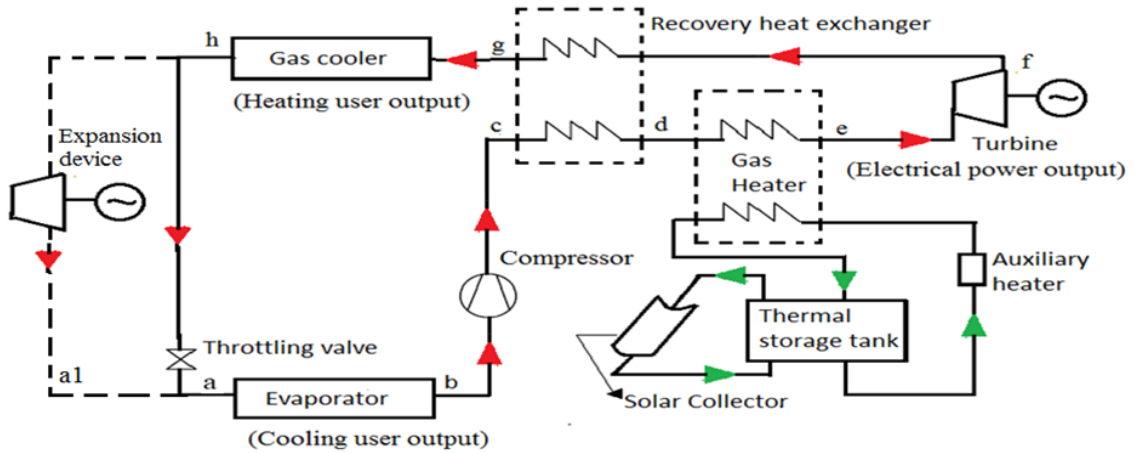

Figure 1: Schematic of a solar energy based, tri-generation system

Tons of Refrigeration at 2°C, suitable for storage of many types of fruits and vegetables. Effects of important operating parameters on the overall performance of the system are studied. ●

Optimal and energy efficient storage of root vegetables to prevent losses

Erlend Indergård^(a)

(a) SINTEF Ocean, Trondheim, Norway, erlend.indergard@sintef.no

Keywords: Industrial storage, refrigeration systems, root vegetables, carrot, swede, celeriac

Acknowledgement: Optirot is financed by Norwegian Industry and the Norwegian Research Council.

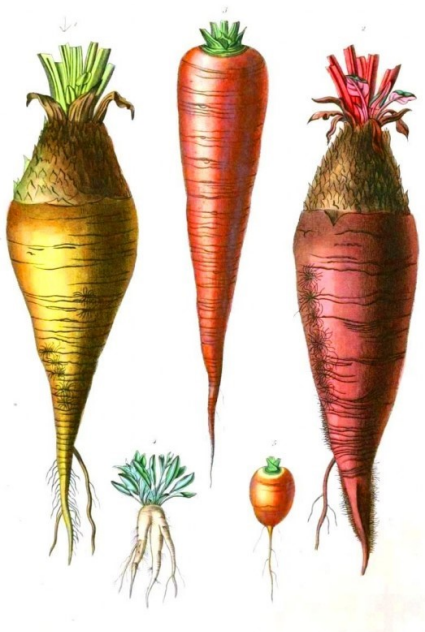

Figure 1: Root vegetables.

After harvesting, sorting and packing in wooden containers, the Norwegian root vegetables are stored normally at refrigerated temperatures for 3 to 8 months. During this period, up to 30 % of the products are lost. This represent €30.000.000 only for carrot, swede and celeriac.

In the project 'Optirot', financed by Norwegian Industry and the Norwegian Research Council, 26 industrial root vegetable storages are instrumented regarding air temperature, relative humidity, airstream and product temperature. The refrigeration systems are studied related to cooling capacity and energy efficiency.

Different solutions for distributing the refrigerated air through the storages shows significant changes in product temperature both in the core and the outer part of the wooden containers during the storage periods. This affects the respiration of the vegetables, storage time, and influence on the cooling capacity of the refrigeration systems.

The accumulated daily average product temperature is presented as the factor influencing the average degree of respiration, and is shown in **Figure 2**. ●



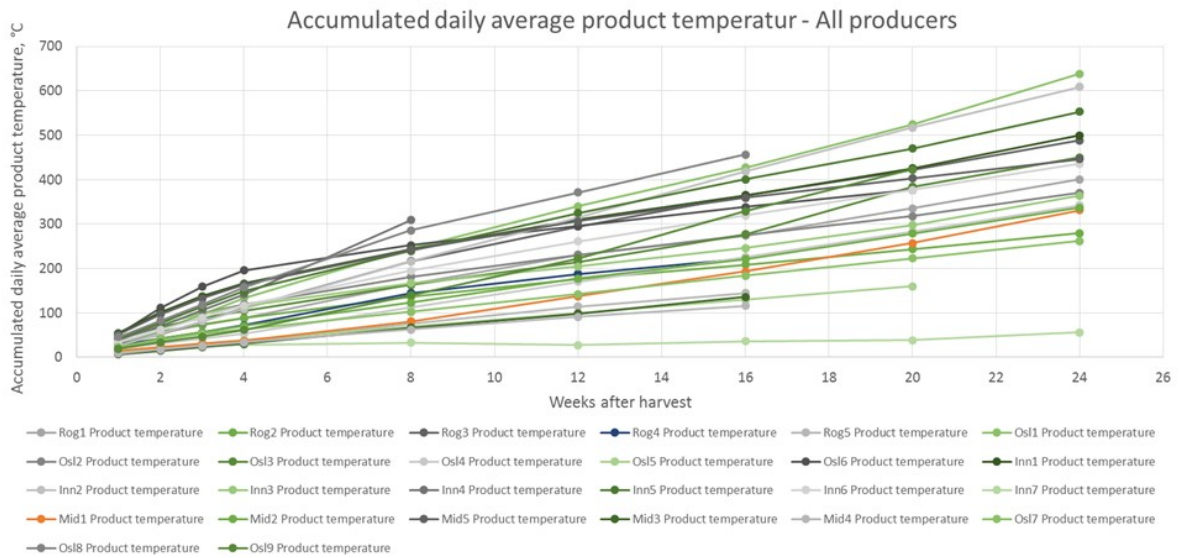

Figure 2: The accumulated daily average product temperature.

Figure 3: Space and air, is the at most key factor for good storage. Do not move all your crates in to a corner for convenience—this will stop the air circulation and return molded products and a much shorter storage life.



Energy efficient processing of seafood

Tom Ståle Nordtvedt^(a), Kristina N. Widell^(a)

(a) SINTEF Ocean, Trondheim, Norway, tom.s.nordtvedt@sintef.no

Keywords: Seafood industry, refrigeration systems, energy efficiency

The International Institute of Refrigeration (IIR) estimates that 25-30% of global food production is lost as waste due to lack of refrigeration. Additionally, refrigeration technologies are among the most energy-intensive technologies used in the food supply chain, accounting for about 35% of electricity consumption in the food industry.

The seafood industry is one of the most important industries in Norway. It can be divided into many sub categories, such as pelagic, clip-fish, white fish and farmed fish. An overview includes the energy usage in the industry that process and conserve fish after it is caught, and an overview of the energy usage for the hatchery produced fish. Solutions and examples for more energy efficient production is given.

The data available shows that there are large potentials for reduction in energy consumption in the sea food industry, and especially the pelagic and hatchery produced fish industry. For the white and farmed fish industry, there are indications of large reduction potentials. ●



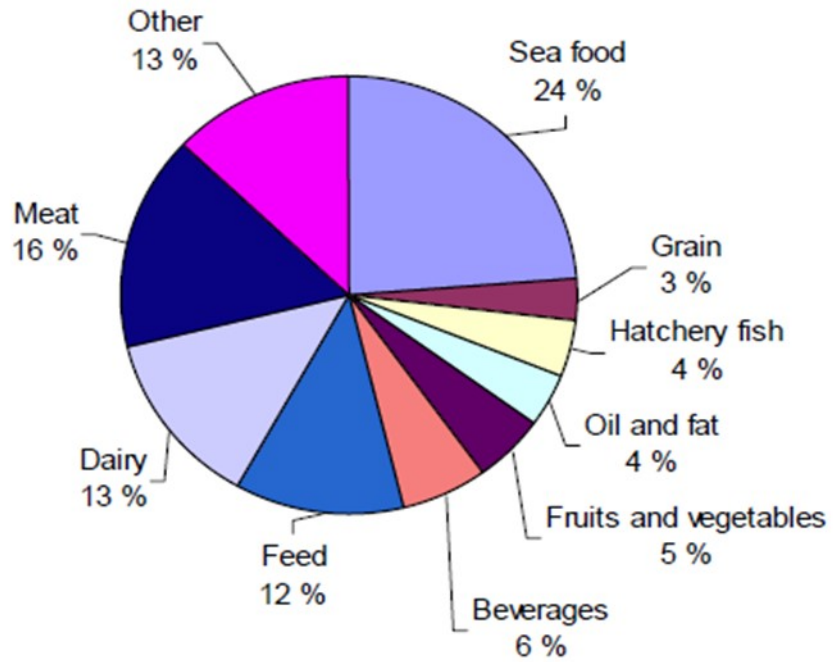

Figure 1: Distribution of energy consumption in Norwegian food production industry.

Integrated Supermarket Refrigeration for High Ambient Temperature Region (India)

Stefanie Blust^(a), Armin Hafner^(a), Krzysztof Banasiak^(b)

(a) NTNU, Trondheim, Norway, stefanieblust@web.de

(b) SINTEF Energy Research, Trondheim, 7034, Norway

Keywords: Commercial refrigeration, CO2 technology, ejector technology

Worldwide it is committed to eliminate the usage of ozone depleting HCFC and HFCs due to their high global warming potential (GWP). Therefore, the development of energy efficient and integrated refrigeration and A/C systems based on natural working fluids, adapted to the climatic conditions in India, is necessary.

A supermarket multifunctional test facility using CO2 is designed to improve the basic knowledge of CO2 refrigeration and its applications, especially for the supermarket sector. The operational mode can be changed simulating different applications as well as gas cooler outlet temperature to simulate various ambient conditions. For Southern India, a parallel compression configuration with ejectors for expansion work recovery is the most efficient mode. It can deliver and perform freezing, refrigeration and air conditioning loads, and has a heat reclaim option.

Higher ambient temperature conditions can be simulated by reducing the rotational speed of the gas cooler fans. For each ambient temperature the receiver pressure can be manually controlled maintaining the A/C evaporating temperature. By changing the glycol inlet temperature of the evaporators the particular evaporating temperatures can be adjusted. All those different configurations resulting in the possibility to understand the behavior of CO2 re-



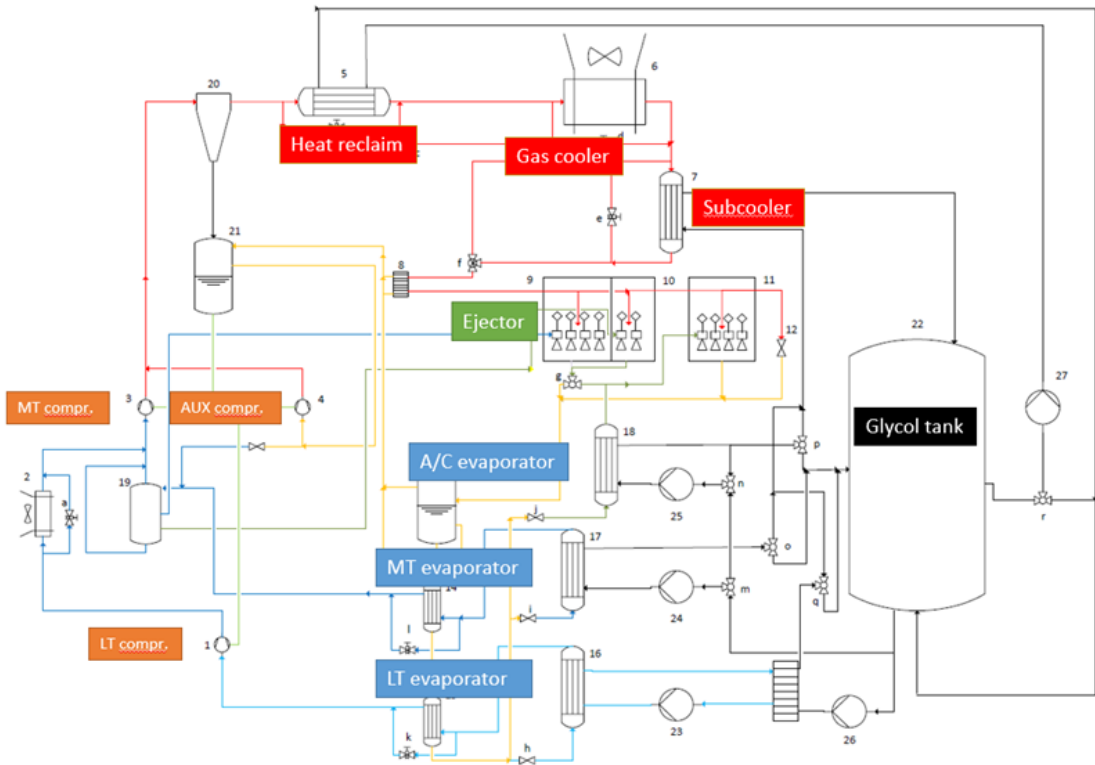

Figure 1: Supermarket multifunctional test facility mode 4 including caption.

frigeration for a wide range of applications as well as the respective influences between components. The most interesting is the possibility to demonstrate the feasibility of R744 trans-critical systems as a non-HFC based alternative to HCFC-22 in retail applications in countries with high ambient temperature.

Commissioning and calibration of the measuring device such as thermometers, pressure gauges and energy meters, setting all the appropriate set-points and preparing the required log-files have been the first step for performing test campaigns. Followed by the evaluation of the measurement results and comparison with nearby supermarket refrigeration and air conditioning installation. The CO2 refrigeration test facility is a preparation and demonstration site for a full-scale replacement of existing commercial refrigeration installations in India. ●

Control strategies for CO₂ based refrigeration systems

Mihir M. Hazarika^(b), Maddali Ramgopal^(b), Souvik Bhattacharyya^(a)

(a) BITS Pilani, Pilani, India

(b) IIT Kharagpur, Kharagpur, India, mmhazarika@iitkgp.ac.in

Keywords: CO₂, Trans-critical, High-side pressure, Refrigeration

Refrigeration systems are extensively used for food preservation everywhere across the world. However, the synthetic refrigerants used in refrigeration systems are harmful for the environment due to high global warming potential. In view of this, there is an increasing emphasis on the use of natural refrigerants in refrigeration systems. Among all the natural refrigerants, CO₂ is the most promising due to its superior thermophilically properties.

However, the critical temperature of CO₂ is very low (31.1°C). Hence, for hot climatic conditions, the heat rejection process has to be carried out under supercritical conditions for CO₂ based refrigeration systems, while the heat extraction is subcritical. The performance of such system strongly depends on the high side pressure at the gas cooler and for a particular gas cooler exit temperature, highest system COP is achievable only for a specific pressure in the gas cooler. Figure 1 shows the p-h plot for a trans-critical CO₂ based refrigeration system.

This plot clearly depicts that there exists an optimum gas cooler pressure for which maximum COP is possible for a trans-critical CO₂ based system. Extensive amounts of researches have been carried out on CO₂ based trans-critical system to propose suitable correlations as well as control strategies to maintain the optimum high side pressure. This study presents a comprehensive review of the control strategies proposed so far to maintain the optimum high side pressure in a trans-critical CO₂ based refrigeration system. ●



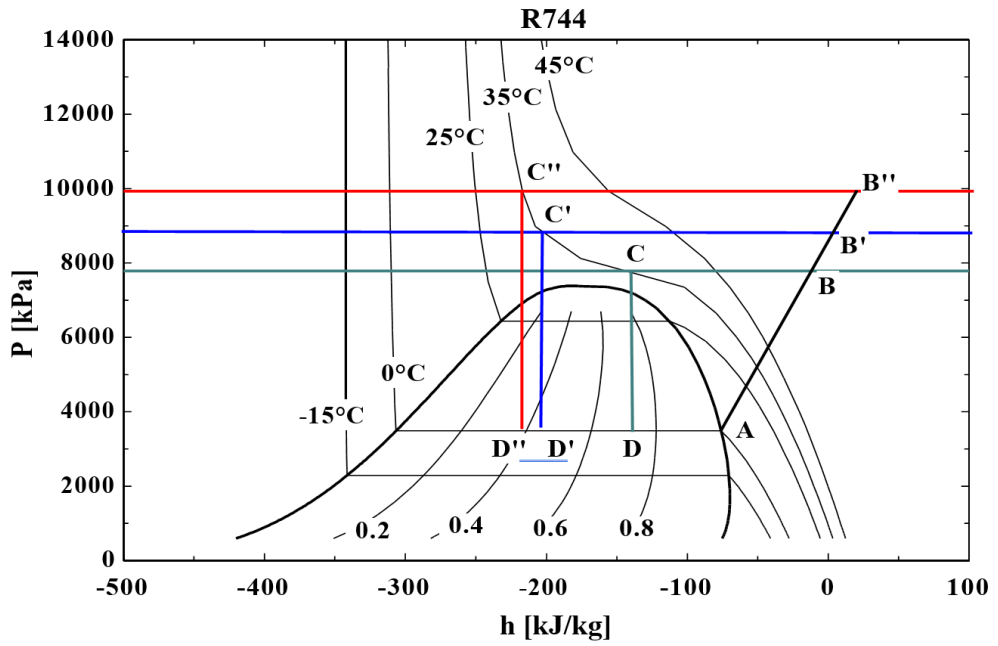

Figure 1: p-h plot for a trans-critical CO₂ based system

Abstract list

Third session

Who

Title

Maitri Thakur

ReValue project – Improved resource utilization in the Indo-European fish value chains

C.S. Kumar

Robotics at IIT Kharagpur with applications towards automated applications in food grading and quality assessment using image processing

Aleksander Eilertsen

Handling food with sensitivity and care, challenges for robotic grasping and manipulation.

Aleksander Eilertsen

Quality of food through vision systems, bringing the future to food inspections.

Jonatan Sjølund Dyrstad

Simplifying automation in the food industry using deep learning and virtual reality

Sandeep Singh

An information architecture for traceability and loss reduction in Public Distribution System (PDS) supply chain using EPCIS framework

Avik Mukherjee

Importance and evolution of food quality for sustainability and prosperity of Indian food industries in the era of globalized food chain

Robotics and automations in food industry

In the majority of today's food handling and processing human-interaction is employed, this due to the nature of foods fragile and pliable consistency—making them highly susceptible to damages and degradation as a result of being touched or handled, even “correctly”, but is not quite correct. Interaction with food is an extremely gentle operation in order not to reduce quality, however, even though we use humans for these, most delicate, tasks—we will need automation and robotics in our very near future. Automation or robotics, will reduce contamination and improve yield, and even increase quality if implemented right with new novel technologies. Discovering these new technologies and mechanical interactions demand research, and it is of paramount importance to allow the future of tomorrow a place in today's world.

ReValue project – Improved resource utilization in the Indo-European fish value chains

Maitri Thakur^{(a)*}, Kristina Widell^(a), Rasa Slizyte^(a), Nutan Kaushik^(b), Souvik Bhattacharyya^(c)

(a) SINTEF Ocean, Trondheim, Norway, maitri.thakur@sintef.no

(b) Amity University, Noida, India

(c) BITS Pilani, Pilani, India

Keywords: Resource utilization, fish value chains, cold chain management, bio-economy

ReValue is a three year INNO-INDIGO EraNet project with partners from Norway, Spain and India that that will contribute to achieving the SDG target on food losses reduction, by developing innovative technologies for Surimi industry, namely reducing losses by improved cold chain management and efficient conversion of rest raw materials (RRM) and wash water (WW) into value added protein and oil ingredients for food and feed applications.

Globally, fish losses account for 160.000.000 tonnes/year, out of which the Surimi industry is responsible for more than 3.5%. To use these RRM into value added ingredients for food and feed applications, proper management is required to preserve their quality. Because of the high content of proteins, lipids and other valuable compounds, these RRM are highly valuable from a nutritional, environmental and socio-economic point of view. The project running from 2018 to 2021 will:

1. Propose concepts for efficient supply chain logistics, cold chain management and climate friendly refrigeration technologies for optimal handling and storage of the fish resources and RRM to maintain their quality.
2. Increase the efficiency, profitability and environmental sustainability of the European and Indian marine processing industry by valorization of Surimi processing RRM and WW into high added value protein and lipid ingredients.



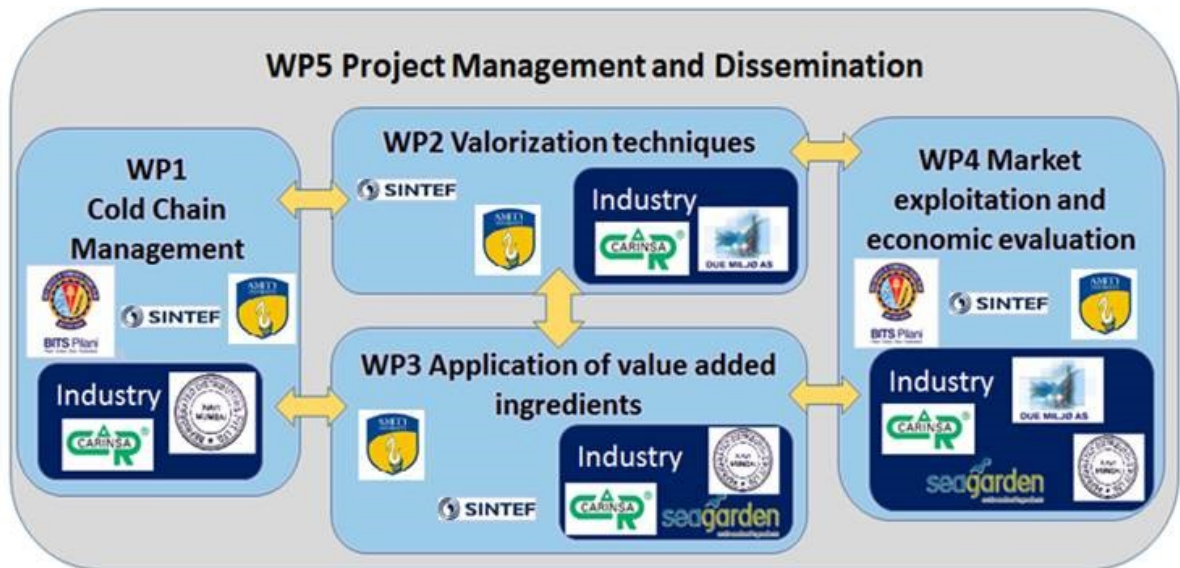

Figure 1: ReValue WP structure including Research and Industry partners

3. Evaluate the functionality of derived protein and oil ingredients as food and feed components
4. Build a basis for joint market exploitation for Europe and India for safe and nutritional ingredients for food and feed applications
5. Establish a sustainable partnership between ReValue partners and other relevant stakeholders from Europe and India working in the field of Bio-economy

A high market and economic impact will be achieved through strengthening the competitiveness of the Industrial Partners in the target market sectors. This presentation will provide an introduction to the project and share some preliminary results. ●

Robotics at IIT Kharagpur with applications towards automated applications in food grading and quality assessment using image processing

C.S.Kumar^(a)

(a) IIT Kharagpur, Kharagpur, India, kumar@mech.iitkgp.ernet.in

Keywords: Manipulation, compliant objects, food care, grasping, sensing, robotic handling, gripper design.

In today's agriculture, aquaculture and food processing industries, high quality produce demands proper grading and sorting system to check the food quality. Developments in robotic (computer) vision and Visual fruit detection using computer vision, image processing and artificial intelligence has been instrumental speeding up production processes and minimizing miss-grading and rejects.

We present some of the robotic technologies developed at IIT Kharagpur [1,2,3] that can be adapted for food / processing industries in a configurable and programmable manner. The design and features of robots developed at IIT Kharagpur in underwater, Figure 1 (a), as well as areal configurations will be discussed presented with some application experiments in related areas.

The concepts of the design, the features and application considerations can facilitate the adoption of the robotic application in agriculture, ocean and food industries at the raw material, fresh produce stage of the industry. Computer vision integration at this stage helps in extracting certain direct features like geometry, texture at the initial levels followed by subsequent integration / fusion of other information related to food condition quality as seen in Figure 1 (b) for a generic mapping application. The process flow involving 3D data capture with scanners, location determination linked to localization cum navigation as can be adopted in the robotic system will be presented as a framework [4]. Such frameworks can be coded into the application layer interfaces of robots like those available in IIT Kharagpur. These will



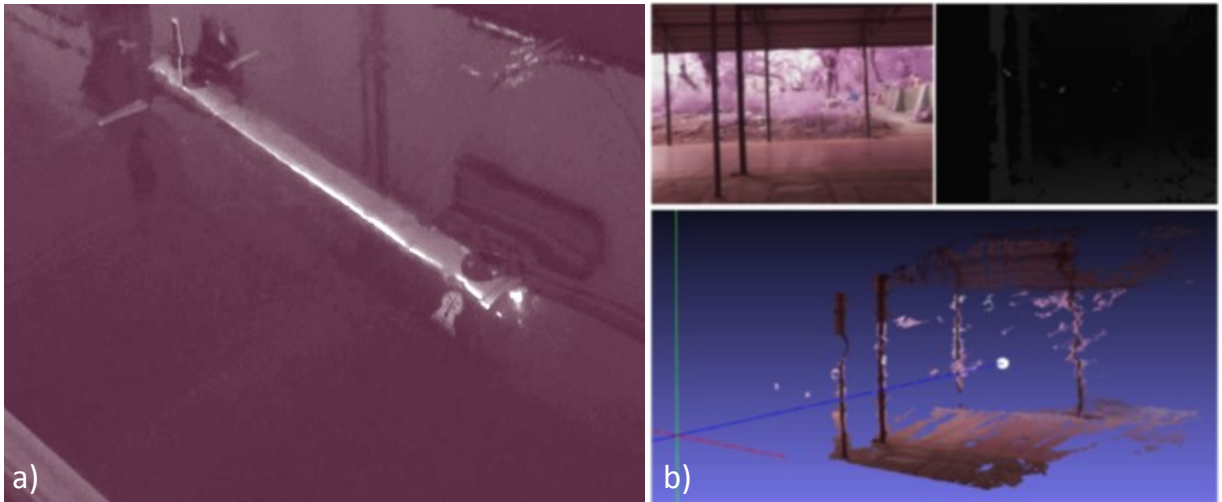

Figure 1: (a) Autonomous Underwater Robot vehicle developed at IIT Kharagpur for marine applications (b) Stereo vision for environment mapping in 3D for use on robotic platforms

hinge upon the image processing activities as well as robot localization schemes which will be couple to address such applications in initial food chain processing. Subsequently one can extend the same capture any potential defect related information that will be used to develop and build the quality control mechanisms in such applications.

This paper highlights the developments in robotics at IIT Kharagpur with the purpose of establishing the feasibility of using the same food applications. The technologies being suitable for a range of domains and a frame work presentation on the flexibility of configuring such robotic technologies in a collaborative mode for automation in a food chain processing ecosystem will be highlighted. Flexibility of adopting the technologies for different geographic, regional and environmental conditions

can be explored in a presentation-cum-discussion since these factors can be reconfigured for the quality control aspects of the application sector. In the workshop discussions on this aspect can enrich the knowledge base in such automated robotic by developing suitable application models for different geo-economic conditions in India / Norway where in food productivity and quality are highly valued to promote good food for health. ●

Handling food with sensitivity and care, challenges for robotic grasping and manipulation.

Aleksander Eilertsen^(a), Ekrem Misimi^(b)

(a) NMBU, Trondheim, Norway, aleksander.eilertsen@sintef.no
(b) SINTEF Ocean AS, Trondheim, Norway, ekrem.misimi@sintef.no

Keywords: Manipulation, compliant objects, food care, grasping, sensing, robotic handling, gripper design.

Acknowledgement: We would like to acknowledge the team at SINTEF, whom we have worked closely with on these tasks – John Reidar Mathiassen, Elling Ruud Øye, and Jonatan Sjølund Dyrstad.

One of the greatest challenges currently in robotically automated food manipulation is the actual interaction with these sensitive and compliant subjects¹. Lack of grippers with high dexterity and sensory compliancy has made it difficult to imitate the human hands' ability to perform complex operations, such as grasping and cutting, on, with or of food. Now, the dream of multifunctional and dexterous grippers is starting to become reality. Development of new sensors and better, faster, stronger, and smaller actuators – as well as computational power, has brought the idea of human-like action-performance on food, much closer.

In this paper, I will present some complex manipulation tasks on food interaction, and present some of our handling tools – and their designs. All, but one, have at the current state integrated some form of compliancy to enable good interaction with the food-raw-materials. I will present harvesting of chicken tender loins directly off the carcass; manipulations of whole salmon and cod on moving conveyor belt; and grasping of herring.

Chicken tender loins are humid and slippery. Harvesting is currently done with humans, not due to lack of purpose-designed machines – but rather that these machines produce more waste than what humans do. For our research, when we designed and developed a tool for harvesting said fillets, a key component was studying what differed between the machines and humans interaction. The machines cut into the meat in order to release it, whilst the human's innate understanding of its subject utilized the fillet anatomy to liber-



¹ Subject instead of object due to the nature of food-raw-materials being individual pieces with personal properties; sensitivity and care tailored to individual needs are essential to insure food quality is not degraded.



Figure 1: (a) Gribbot, (b) Fish movement, (c) Herring.

ate it without any damaging cuts. The same interaction pattern was replicated with the Gribbot. A beak-like construction with pressure compliance scraped along the chicken carcass separating the muscle by releasing the fascia. The integrity of the fillet was kept and the result yielded human-approximate performance.

Another case of human as operator is in fish sorting, an operation that needs the capability of handling slippery and compliant subjects in bulk. Our research group proposed a robotic system that could understand the dynamics of from where to approach the fish, as well as, tackle the compliancy and sensitivity needed. A frog-like four-fingered tool that needed only compliance along one axes sufficed in completing this task.

Lastly, grasping manipulation of herring in bulk – a complex task in need of sensory inputs. The gripper is currently in its completion phase. The design is tailored specifically for the shape and conformity of herring. Tactile sensors on the gripper are needed to both understand grasps and to navigate the bulk and crate from which

the fish are picked. This gripper was designed with adaptations in mind, the end-effector can be replaced – and in order to successfully pick the herring, from the crate, iterations were made.

These examples illustrates the complexity and difficulty in development of a universal gripper, when wanting to serve a large range of food application – and the solution for now is application based development of grippers. However, research show that manipulation capabilities with grippers can be improved by adding compliance and tactile sensors.

Understanding the task and its subject is of key importance if grippers, and or tools, shall operate with human-like abilities. My current research focuses on adding sensor intelligence to grippers that serve food-handling applications. By adding sensor intelligence, we hope to innate some ability of understanding grasping mechanisms directly into the gripper – allowing grasping for robot to become inherent. ●

Quality of food through vision systems, bringing the future to food inspections.

Aleksander Eilertsen^(a), Elling Ruud Øye^(b)

(a) NMBU, Trondheim, Norway, aleksander.eilertsen@sintef.no

(b) SINTEF Ocean AS, Trondheim, Norway, elling.ruud.oye@sintef.no

Keywords: Quality of food, fish quality, fruit quality, avocado, salmon, herring, cod, machine vision.

Acknowledgement: We would like to acknowledge the team at SINTEF, whom we have worked closely with on these tasks – Morten Bondø, Ekrem Misimi, and John Reidar Mathiassen.

Defining quality in food is a profession with tremendous importance for buying and selling, and deliverances of high-grade consumables. The task can be resource consuming and tiresome work for the operator whom needs to be "on" constantly. Using humans means that subjective perspectives will be reflected in classifications, detrition of supreme classification has a tendency to drop after longer periods of continues work. This leaves a space for machine classification, and we have worked for many years on projects focusing on moving from manual human operation to more autonomous grading.

The cruciality of correct quality grading affects the surplus for any food handling business. Grading defines which types of products can be produces, e.g. salmon as whole fish, fillet, lions, etc. The mundane task of grading of products by human operators can cause loss in efficiency and correct classification. Even if the quality grading task have strict rules it is often impossible to avoid subjective differences between inspectors which might lead to unwanted variation in the sorting of the product. Automation and digitalization of quality-sorting tasks might eliminate such variations while facilitating the possibility for documentation and traceability of each individual product.

Some of today's quality inspection are already to some degree automated. Features like weight or size can often be sorted by digitized scales or mechanical solutions letting products with only a specific size through. However, more intricate features, such as, small deformities of in salmon body, melanin or blood spots inside the abdomen of a gutted salmon, or the degree of meat inside a crab shell are often not easy to sort by, especially automatically. To get such operations autonomous, looking at and understanding what humans do when classifying is the key to port quality understanding to machines.

Technological advances in computational capacity, robotics and camera technologies are making it more feasible to automate these tasks. 3D cameras and



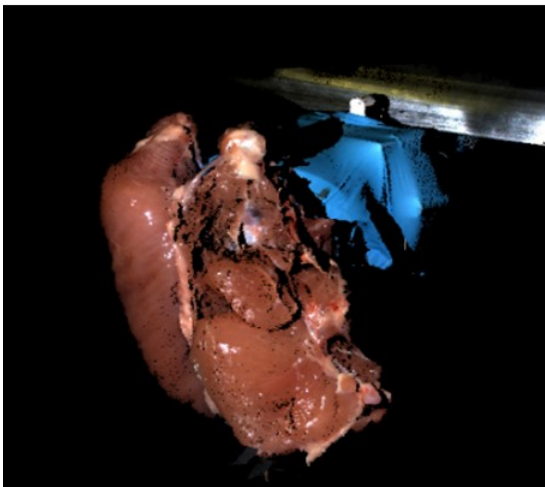
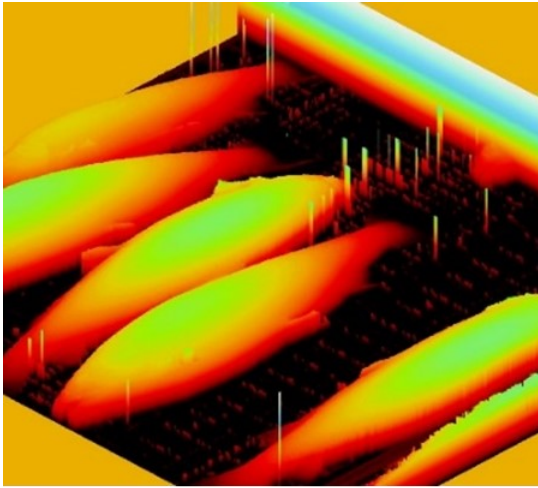

Figure 1. (a) Salmon weight estimation and quality of shape, (b) Sorting of rest-raw-materials, (c) Chicken fillet inspections for automatic harvesting, (d) Salmon scanning for deformities.

scanners, makes it possible to merge 3D data and color while GPUs can process huge amount of data at real time speeds. Further development of machine learning algorithms, like deep learning, makes the computer more capable to see correlation of the measurement data that the human quality inspectors do today. For autonomous quality inspections we need to move a high intelligence in to the realm of computers, looking at the intersection of what we as humans do when classifying and how to innate this to a machine vision system.

At SINTEF we are involved with several projects trying to automate specific tasks of quality inspection. These projects are the prefaces to what we need to do in order to give autonomous quality inspectors of the future an inherent inferred understanding of their task objectives. A selection of these projects will be presented: Quality grading of salmon based on deformities, detection of melanin and blood spots inside the abdomen of gutted salmon and sorting of rest-raw-materials after herring filleting, and more. ●

Simplifying automation in the food industry using deep learning and virtual reality

Jonatan S. Dyrstad^(a), John R. Mathiassen^(a)

(a) SINTEF, Trondheim, Norway, jonatan.dyrstad@sintef.no

Keywords: Automation, neural networks, virtual reality, grasping

Automated solutions in the food industry are often highly specialized and task specific. Automation is often done one sub-task at the time, and every time a new sub-task is going to be automated, a new development cycle is needed, even if the new sub-task is not that different from previously automated tasks.

In this work, we explore the possibilities for developing a more flexible robot, capable of being trained by human workers on site, as opposed to being programmed by engineers, to perform a wide variety of tasks. We focus on handling of food, and the potential applications of this work range from harvesting, to filleting and packaging.

As a step towards this goal, we have trained a robot to pick herring. We have shown that it is possible to teach an industrial robot how to pick herring out of a box, based solely on 30 demonstrations made by a human worker with little or no knowledge about robots and automation.

The demonstration of the task is done in virtual reality, where the worker puts on a virtual reality head set and controls the robotic gripper with a tracked hand controller as if it was his own hand. The demonstrations made by the worker are used to generate a data set which in turn is used to train a deep learning architecture.

This technology could enable automation in new parts of the food production process, which previously have been hard to automate. It can also make automation available for smaller producers, as more flexible robots don't rely on the same amount of throughput as traditional automated solutions to be cost effective. ●





Figure 1: Teaching a robot to pick herring in virtual reality.

An information architecture for traceability and loss reduction in Public Distribution System (PDS) supply chain using EPCIS framework

Sandeep Kumar Singh^(a), Mamata Jenamani^(a)

(a) IIT Kharagpur, India, sandeep.singh@iitkgp.ac.in

Keywords: Traceability System, GS1, EPCIS, RFID, Indian Public Distribution System (PDS).

The development of radio frequency identification (RFID) and its lowering costs contributes to the growth in the adoption of this technology in traceability systems. This technology is widely used in many fields such as manufacturing, logistics, agri-food, healthcare, animal tracking, road toll, and defense.

Agri-food sector is one of the most promising areas where the primary concern is to ensure food safety and quality while reducing losses. Hence, RFID turns out to be a viable option. In Indian PDS supply chain, about 40% food-grains are lost due to improper handling, transportation and lack of infrastructure as per CAG report 2013 (CAG, 2013). To minimize this loss, the need for a proper traceability system is realized and RFID is being actively considered as an alternative to replace the existing manual system.

The foundation of global application in traceability systems for food safety and quality is a unified coding system, such as GS1, EPC, and EAN.UCC. The implementation of traceability systems depends on data standardization and easy exchange of information among partners.

The traceability systems need to be encoded and given a single code to ensure the traceability and integrity for each participating object. First of all, based on the RFID application, an information architecture is proposed for Indian Public Distribution System (PDS) supply chain traceability. Secondly, a coding scheme is proposed based on EPCIS GS1 for Indian PDS supply chain, to ensure the global unification of the objects.



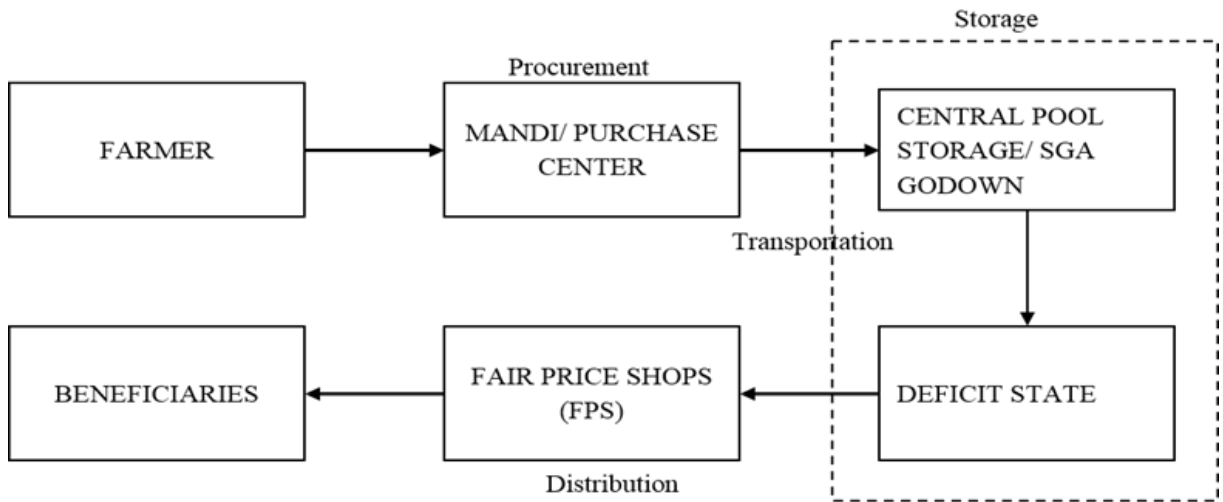

Figure 1: A PDS Supply Chain from Farmer to Beneficiary.

The procurement, storage, movement and distribution to final consumers are the major stages of the food grain supply chain as shown in Figure 1. In this system at Mandi/ Purchase center, RFID tag is attached to gunny bags for capturing real-time information throughout the supply chain. This real-time information can reduce the storage loss and transit loss of food grains. ●

Importance and evolution of food quality for sustainability and prosperity of Indian food industries in the era of globalized food chain

Avik Mukherjee^(a)

(a) Central Institute of Technology, Kokrajhar, Assam, India, ak.mukherjee@cit.ac.in

Keywords: Quality assurance, Quality control, Food safety, Food Safety Management System, HACCP

Importance of quality for any product or service is universal, and quite comprehensive. The basic concepts of quality used to depend on individual skills of personnel or service provider. As industrialized production of goods gradually took shape worldwide, quality measurement used to exclusively focus on testing and monitoring of finished products or sample(s) of finished products. As statistical tools started gaining popularity, product testing and monitoring became more effective and efficient in applying quality control on manufactured goods including food items. In the latter half of 20th century, food businesses became global, and application of quality control tools became increasingly challenging with international and intercontinental food chain operations.

In order to continue to thrive as commercial entities, food businesses gradually adopted a more proactive approach i.e. quality assurance through total quality management (TQM), instead of the reactive quality control through product inspection and testing. Development of HACCP system, and ISO series of standards are major examples of guidelines to implement this proactive approach in a food handling / manufacturing operation. Juran's concept of quality trilogy, Deming's concept of continuous improvement through application of Plan-Do-Check-Act (PDCA) cycle (following figure), and Taguchi's rule for manufacturing pioneered this evolution in this conceptual approach



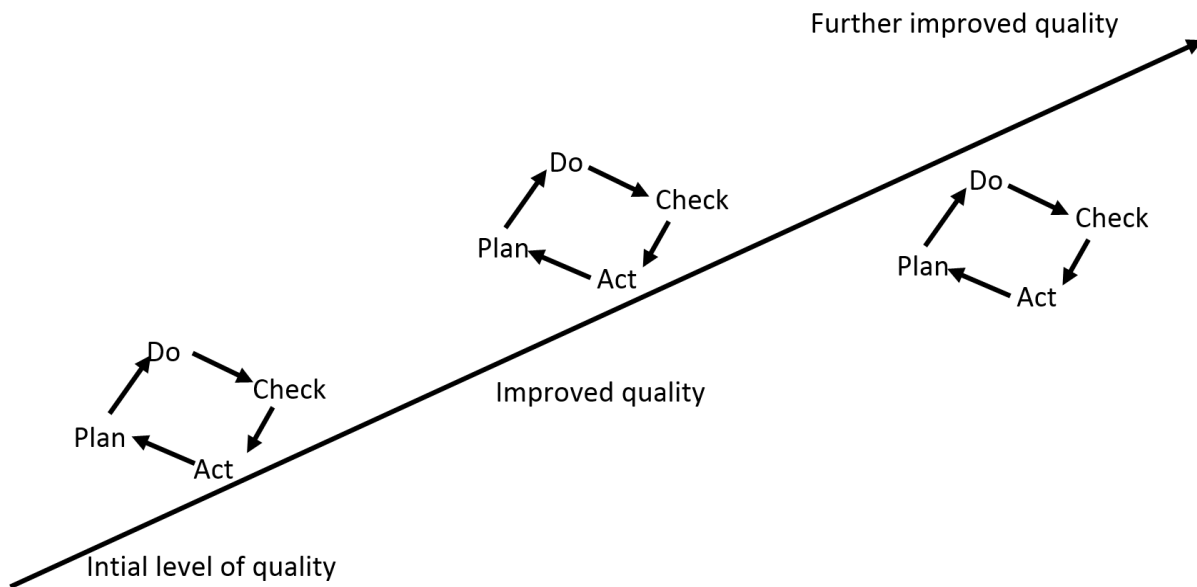

Figure 1: Schematic diagram of Deming's PDCA cycle for continuous quality improvement

towards quality of manufactured goods including food items.

Quality of food is perhaps more critical, compared to that of many other manufactured goods for obvious reasons. So, thorough evaluation of some of the quality assurance tools before their application in food manufacturing / handling operation is necessary.

In recent years, among many aspects of food quality, food safety issues have gained primary significance. Rapid, online detection techniques, including application of nano-biosensors have the potential to revolutionize application of quality assurance in order to ensure safe food to con-

sumers. This present work attempts to present a comprehensive review of this sea-change in the concepts and applications of tools, technologies and systems that guarantees safe food with consistent quality, as per consumers' demands. ●

Abstract list

Fourth session

Who

Title

Nambudini Damodaran

Energy efficient fresh fish processing and marketing-
a start up company experience in Kerala

Srikanth Mutnuri

Energy efficient fresh fish processing and marketing-
a start up company experience in Kerala

Dipak Chaudhari

Utilization of bio-based rest raw materials

Industrial challenges

Industrial success in sustainable future food requires that all bricks in the food value chain are well functioning together. A series of different actors, disciplines and skills are important elements in this aim, and the consumers acceptance of the products are essential. Bio-based materials are generally perishable and processing and handling affects the sensory, functional and nutritional properties. The industry needs to continuously innovate and produce smarter, faster and better but also introduce new products and processes. This symposium gave valuable presentations and groups discussions on how academia and industry could work together for innovation and recruitment for more sustainable food production.

Energy efficient fresh fish processing and marketing- a start up company experience in Kerala

Nambudiri Damodaran^(a)

(a) Kerala University of Fisheries and Ocean Studies, Kochi, India, ddnambudiri@gmail.com

Keywords: Traceability System, GS1, EPCIS, RFID, Indian Public Distribution System (PDS).

Daily consumption of fish and seafood in Kerala is 2000-2200 MT. Of these average 15% goes for export. Another 10% goes for fish oil / fish feed / manure production. Out of the 1600 MT fish, 50% fish (low cost) is consumed by the lower income group (30%) and the 50% by the middle and upper income group (70%). The middle /upper class customer's market for fresh fish in Kerala is 800 MT per day now. It is possible to create another 20-30 MT per day by encouraging the health conscious meat eaters to add fish products in their diet.

The fresh fish business is still done in the traditional way in Kerala. In the logistics and sales hardly 5-10 % technological input is employed. There is a vast opportunity to add technology in the sourcing of marine fish and farmed fish, in logistics and in distribution and in the customer sales. This paper deals with the study of a start up company in Kerala which is putting into practice the above concept in the fish processing sector.

Suvichaar Marine Products, a start up company established in the year 2016 in the fisheries sector sources fresh fish from a network of small fishermen and auctioneers across the coast of Kerala and Tamilnadu and also from the inland farmers. Suvichaar is the official agent of Karnataka Fisheries Development corporation. This enables the company to procure the best quality fish at a better price and which can be presented to the customer, in hygienic and fresh condition. Suvichaar sells chemical-free fresh fish through its own outlets, franchise outlets and online portal. Also the company makes sure to use edible ice for the preservation and display of fresh fish.

To optimize and co-ordinate raw material purchasing, the company is going digital by developing ERP and App. Apart from the central cold room, region-



Know the Market Size



Market Size in Kerala

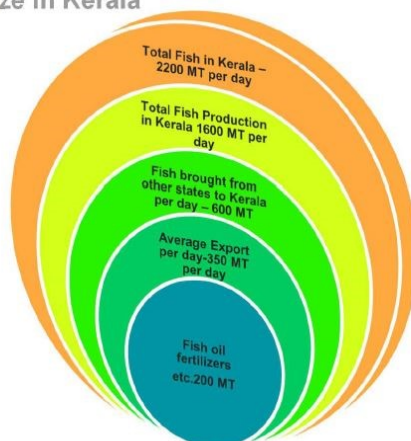

Proposed Market Volume

Fresh Fish market volume in Kerala - 1650MT/day
Fresh Fish market volume in Bangalore - 40-50MT/day
Fresh Fish market volume in Pune - 10MT/day
Fresh Fish market volume in Coimbatore - 5MT/day

Total Market Volume of Fresh Fish for proposed markets - 1700 MT/Day(2.25Bn USD Annually)
Accessible Market Volume for Suvichaar- 900MT/Day(1.2Bn USD annually)

Figure 1: A PDS Supply Chain from Farmer to Beneficiary.

alized cold rooms are being set up and use insulated/refrigerated vans for fish transport.

To get more penetration in deeper areas the company works in collaboration with traditional vendors. They are being supported by providing fish and storage facilities. In order to utilize the damaged fish and balance fish, production of value added fish is in planning. From the fish waste bio gas and manure is produced. In order to attract youth and children and to induct them to “fishy taste”, specially designed Fish cafes (both outlets and on wheels) with exclusively defined dishes /snacks are planned. The company is planning for Solar Powered Chilled rooms. Also the company is in the study of avoiding plastic carry bags for fresh fish packing by using PHA based 100% biodegradable carry bags to save the environment. Suvichaar is registered with Startups Valley in the Rural Development Project Sector.

In order to enable the company to sell chemical free fish, on-site test kit is being developed in association with CSIR. Also the company supports and monitor inland fish farming with the help of technology from National Centre for Aquatic Animal Health, Kochi.

This type of energy efficient online/offline/stand out outlets/ supermarket outlets type fresh fish supply business with strong network of sourcing from fishermen/farmers is unique in the country. The company’s initiatives have been recognized by receiving startup company approval. ●

Applied Research towards Sustainable Development Goals

Sirkanth Mutnuri^(a)

(a) BITS Pilani Goa, India, srikanth@goa.bits-pilani.ac.in

Keywords: Bioremediation, Wastewater treatment, Marine Biorefinery

Acknowledgement: Without collaborations, research will be incomplete. Our collaborators are IISc Bengaluru, IIT Kharagpur, NIT Surathkal, INRA Narbonne – France, Ecole de mines Nantes – France, Ghent University - Belgium, Caltech – USA, Technical University Hamburg Harburg - Germany, GIZ – Germany, International Water Management Institute Colombo - Srilanka, Cranfield University – UK. Presently collaborating with 6 countries.

The focus of this laboratory is on Sustainable Development Goals with major emphasis on Clean water Sanitation, Zero hunger, Affordable & Clean Energy, Climate Action and Responsible consumption and production.

Through our research projects we demonstrated single household vertical wetlands based domestic wastewater treatment, single household empowered septic tank for domestic wastewater treatment, 100 people equivalent empowered septic tank for domestic wastewater treatment. The advantage of these treatment systems are their cost effectiveness / affordability. For example, our 100 people equivalent treatment system operating costs is Rs 176 per day (total operating costs) whereas just the chlorination cost in a conventional treatment system is Rs 300 per day.

Our other projects focuses on anaerobic digestion of different wastes like we had put a horizontal plug flow reactor which could handle 1 ton of food waste per day. It is operational since 2010 and the output biogas is either burnt or supplied to cafeteria. We also are partners in demonstrating an anaerobic digester (currently under construction) for 10 tons of food waste and 20 tons of septage in Nashik. We also provided consultancy for building an anaerobic digester in Madgaon Municipal market which handles 700kgs of vegetable waste and 300kgs of fish waste.



100 people equivalent Empowered septic tank plant

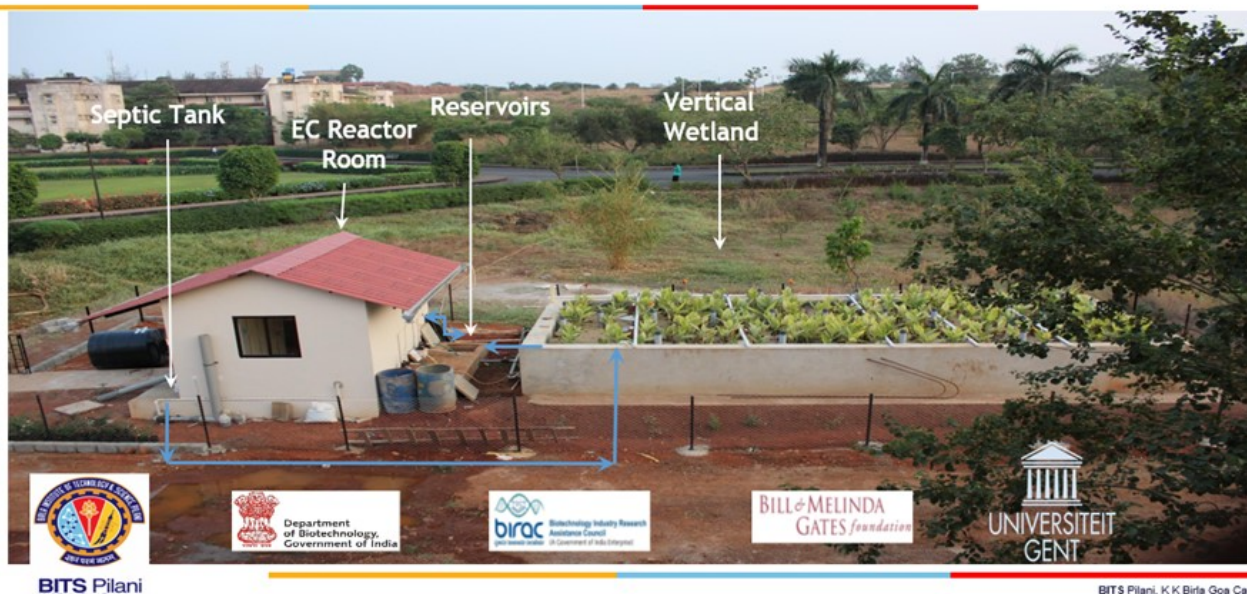

Figure 1: BITS Pilani Goa Campus Empowered septic tank plant.

Energy should not be the focus at the expense of soil fertility. Our project focuses on Terra preta sanitation (a type of compost), Phosphate rich organic manure and Struvite production for improving soil fertility. We are using the above mentioned composts / organic fertilizers to see improvement in crop productivity in selected villages in Pimpalner district of Maharashtra. Currently we are testing them on Bengal Gram, Onion and Wheat for the Rabi season. We will test it on other crops as well on summer crops and Kharif crops. We are also focussing on Marine Biorefinery

Our other works focuses on biodegradation of pollutants like paracetamol, crude oil / tar balls, enzyme production from different wastes, optimization of chemical oxygen demand procedure for sea water, Carbon dioxide sequestration using microalgae. ●

Utilization of bio-based rest raw materials, specifically for Surimi processing

Dipak Chaudhari^(a)

(a) Surimi, India, sandeep.singh@iitkgp.ac.in

Keywords: Traceability System, GS1, EPCIS, RFID, Indian Public Distribution System (PDS).

The surimi processing industry in India started recently in 1994 and developed full fledged only after 2000. The current surimi export from India has already reached about 90,000 MT annually.

By the normal standards, the requirement of head on/whole round fish for producing surimi is about 3 to 4 times. Which means we need about 3,00,000 MT of raw whole round fish. Usually, about 15 % of this is lost in wash water. Which means we loose about 45000 MT of fish protein as well as other soluble in the wash water per year.

Rest raw material for Surimi processing

1. Fish head and viscera
2. Fish scales
3. Fish skin and bones
4. Soluble and suspended solids in wash water

Currently the solid rest raw material is being used for making fish meal powder for use as feed ingredient.

The solids lost in wash water are untapped and needs huge effluent treatment capabilities. If these solids can be recovered prior to discharge as waste water, it will save huge complication of effluent treatment.



Wash water parameters

The wash water content varies with species as well as season. However, an average wash water parameters are as below :

Sr No	Parameter	Value Mg/L
1	pH	6.7~7.5
2	Total Dissolved solids	4000
3	Total suspended solids	5000
4	Chemical Oxygen Demand	8000
5	Biological Oxygen Demand	3000
6	Oil and Grease	1700

Possible technologies to extract useful elements

Various methods can be used to remove the solids/fats from the wash water for either use in animal nutrition, cosmetics or even specific human nutrition supplements.

1. The following processes can be adopted for this :
2. Ultra membrane filtrations /concentrators.
3. Spray drying.
4. Coagulations etc.
5. Condensing by using heat/steam.

Challenges

The various challenges envisaged for utilization of this recovered rest raw material are :

1. To achieve maximum extraction of solids from wash water
2. Cost effectiveness of the method of extraction.
3. Finding suitable use for the recovered solids.
4. If required need segregation of the solids in to different categories.

Group work

On day two the symposium participants were divided into five groups each of 6-8 people for group discussions related to the main themes of the symposium; utilisation of rest raw materials, cold chain management and energy efficiency and robotics in food handling. The main focus was on the two first topics and there were two groups working with each of these. The aim of the group work was for the groups to discuss and come up with challenges related to the topics both in Norway and India, and hopefully come up with possible joint research activities related to this.

The group leaders were in charge of summarizing the discussions and to give a short presentation of the findings for all participants at the end of the day. A lot of different ideas and suggestions for further collaborations were detected. One of the groups working with Cold Chain Management and Energy Efficiency lifted the limited capacity of cold and/or refrigerated storage of products to be a challenge in both countries. Similarly, one of the groups working with utilization of rest raw materials focused on the importance of keeping the initial quality of the rest raw material to ensure high quality end-products.

- Identify 3 main challenges relevant for each topic in the two countries.
- Identify 3-5 most important topics for Indo-Norwegian collaboration.
- How to involve more industry partners in joint projects from both cultures.

Regarding the last question, how to involve more industry partners in joint projects from both countries the groups suggested to focus on industrial challenges and conduct industry visits to learn more about the challenges the industry is facing.



Figure 1: Ongoing group discussions on day 2 of the RE-food Symposium at BITS Pilani Goa Campus. All symposium participants were divided into groups of 6-8 people for lively discussions related to one of the following topics: utilization of rest raw materials, robotics and food handling, cold chain management and energy efficiency.



Posters

Walk-about

Affiliation	Who	Title
NTNU	Espen Arntzen	Potential future applications for bioactive components derived from seaweed.
NMBU/SINTEF Ocean	Aleksander Eilertsen	Handling food with sensitivity and care, challenges for robotic grasping and manipulation.
NMBU/SINTEF Ocean	Aleksander Eilertsen	Quality of food through vision systems, bringing the future to food inspections.
NTNU	Eva Falch	Bio-economy in a food perspective - Knowledge delivery from university to society.
IIT Kharagpur	Mihir Hazarika	Control strategies for CO2 based refrigeration systems.
SINTEF Ocean	Erlend Indergård	Prolonged shelf life of fresh seaweed by storage in refrigerated seawater.
College of Food Processing Technology and Bio Energy	Amee J. Macwan, Manda Devi Ningthoujam	Cold Plasma: A Novel non Thermal technology for food Processing.
College of Food Processing Technology and Bio Energy	Avanee J. Macwan, Vidhi Vaja	Radiofrequency heating.
College of Food Processing Technology and Bio Energy	Manda Devi Ningthoujam	Cold plasma technology.

Affiliation**Who****Title**

JNKVV-College of
Agriculture

Manish Patel

Automated Geometric Properties Measurement System for Food Grains based on Image Processing.

NTNU

**Gunn Merethe
Bjørge Thomassen**

Microbial contamination of fish processing plants.

SINTEF Ocean

Guro Møen Tveit

Quality of gillnetted coastal cod (*Gadus morhua*).

Amity University

Ankit Paliwal

Water absorption kinetics of pearl millet during soaking and its effect on physical properties of millet flour.

MIT College of
Food Technology,
India

Fayaj Pathan

Studies on Preparation of Caffeine Free Coffee Mix From Rest Raw Material-Date Pits.

Project partners

Kristina Widell

ReFood poster.

Amity University

Sneha Nair

Polysaccharide based coatings incorporated with pomegranate peel extract preserves the phytochemical status of bell pepper (*Capsicum annuum L.*).

SINTEF, NTNU

**Armin, Kristina,
Trygve**

Refrigerants: Alternatives to HCFCs and high GWP HFCs in industrial food processing.

Amity University

Joyti Goyat

Functional food development using chia (*Salvia hispanica L.*) and quinoa (*Chenopodium quinoa*) ancient grains .

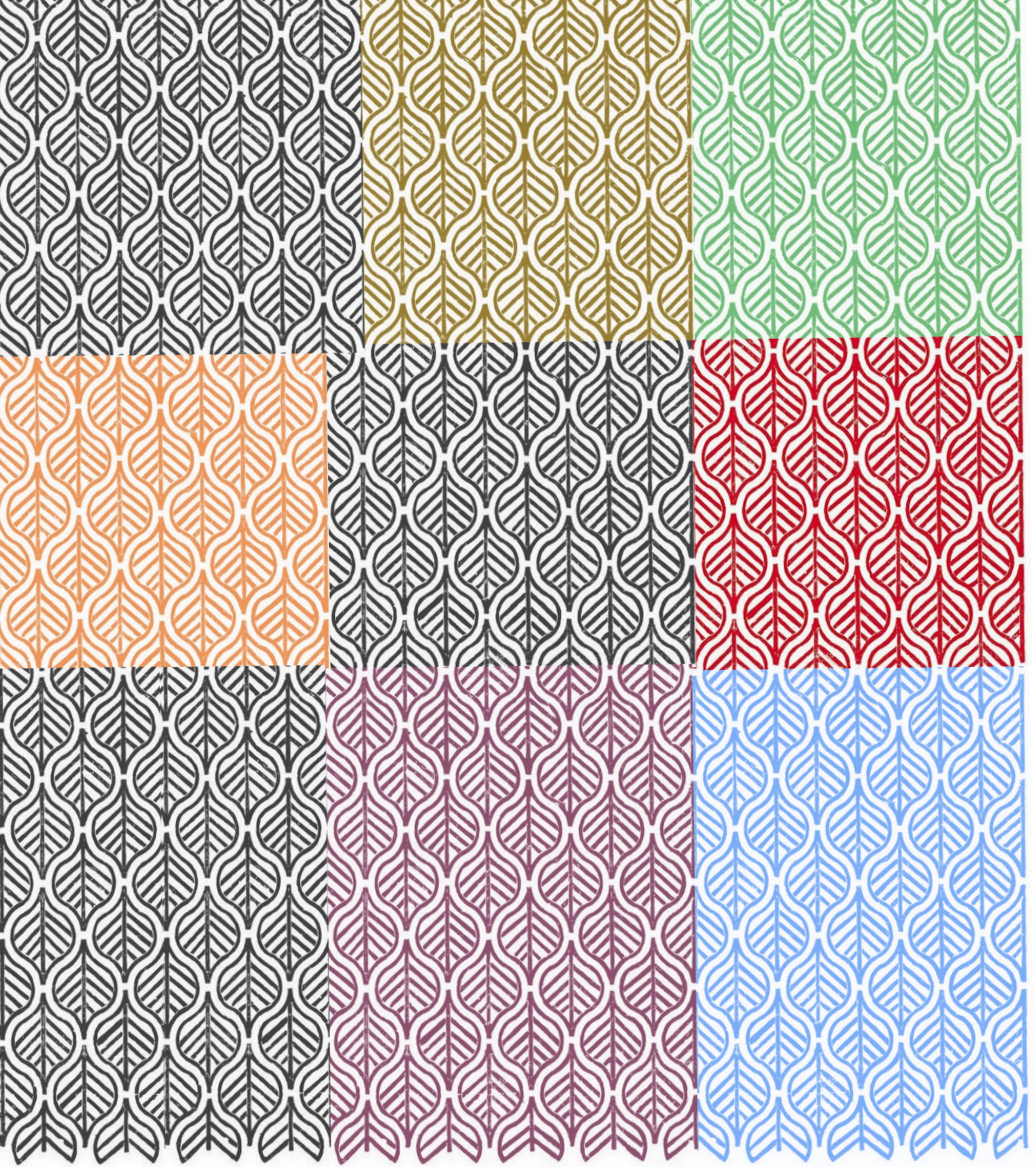

RE-food
Goa, India, Feb. 2018

Abstracts and Summaries, 1st Symposium