

*Lihn Bache-Andreassen*

**Harvested wood products in the context of  
climate change**

A comparison of different models and approaches  
for the Norwegian greenhouse gas inventory

---

*Reports* This series contains statistical analyses and method and model descriptions from the different research and statistics areas. Results of various single surveys are also published here, usually with supplementary comments and analyses.

© Statistics Norway, March 2009	<b>Symbols in tables</b>	<b>Symbol</b>
When using material from this publication, Statistics Norway shall be quoted as the source.	Category not applicable	.
	Data not available	..
	Data not yet available	...
	Not for publication	:
	Nil	-
ISBN 978-82-537-7563-0 Printed version	Less than 0.5 of unit employed	0
ISBN 978-82-537-7564-7 Electronic version	Less than 0.05 of unit employed	0.0
ISSN 0806-2056	Provisional or preliminary figure	*
Subject: 01.04.10	Break in the homogeneity of a vertical series	—
Print: Statistics Norway	Break in the homogeneity of a horizontal series	
	Decimal punctuation mark	.

## Summary

Emissions of greenhouse gases is accounted for and reported annually under the UNFCCC and the Kyoto protocol. In the current accounting system, emissions of CO<sub>2</sub> from harvested wood products (HWP) are attributed to the year of harvest and the country of harvest. All harvested wood is thus assumed to be oxidised to CO<sub>2</sub> in the year of harvesting, and no wood goes into long term storage. This is called the IPCC default approach. Much of the harvested wood will however be stored for a short or long period of time before it oxidises and this will cause a delayed emission of CO<sub>2</sub>. If more wood is stored than oxidised in a given year, harvested wood products will act as a sink and a removal of CO<sub>2</sub> is recorded. However, if the consumption of wood decreases to a level below what is oxidised, harvested wood products will act as a source and emissions of CO<sub>2</sub> is recorded. In Norway, as on many other countries, the stock of harvested wood products has been increasing for many years, and is likely to increase further. Including emissions/removals of CO<sub>2</sub> from harvested wood products in the post Kyoto 2012 regime is under consideration by the UNFCCC, and in that context it is imperative to evaluate estimation models and approaches for the reporting/accounting (IPCC 2006a).

In this report, different accounting approaches and methods for estimating the annual change of emissions/removals of CO<sub>2</sub> due to HWP are analysed. Results showing the emissions/removals of CO<sub>2</sub> in Norway reported by the different approaches are also presented. The analyses are constructed for Norwegian conditions and may not be applicable to other countries.

### Approaches and estimation methods/models

In this report a distinction is made between an approach and a method/model, and it is important to recognise the difference between them. The approaches describe how emissions are allocated to countries, depending on production, imports and exports of harvested wood products. Put into other words, is it the country where the wood is harvested or the country where the wood is used that should account for the harvested wood products? Estimation methods/models, on the other hand, are how the emissions and HWP stocks are estimated from national data and statistics.

If accounting of HWP is included in the accounting system under the UNFCCC in the next commitment period (after 2012), it will belong in the Agriculture, Forestry and Other Land Use (AFOLU) sector. The choice of approach will therefore have an impact on the emissions/removals accounted for in the AFOLU sector in the National Inventory Report (NIR). Since the approaches treats storage and trade of HWP in different ways, a common approach for accounting should be decided by the Conference of the Parties. If a common approach is not chosen, and all countries can use which approach they choose, this would lead to double counting or no counting of emissions from HWP. The consequence of this would be significant errors in the global emission estimates. Note that the stock change approach for HWP of domestic origin (SCAD) will not give the correct world total (see below). The approaches will give different incentives to national politics with respect to import and export of wood products if HWP are to be included in the accounting system. If emissions from HWP are to be reported only, and *not* accounted for, no incentives are given by the different approaches.

### Approaches and incentives

We have investigated five approaches; the stock change approach, the atmospheric flow approach, the production approach, the simple decay approach and the stock change approach for HWP of domestic origin. The first four are outlined in the 2006 IPCC Guidelines for National Greenhouse Gas Inventories (IPCC 2006a). The approaches differ in how the emissions from HWP are allocated to different countries depending on imports and exports, and will usually give different output with respect to both level and trend. For a country with large net export (or import)

of wood products, the different approaches will report extremely different emissions/removals of CO<sub>2</sub>. A thorough discussion of the policy relevance of the approaches is beyond the scope of this work, we have however included some incentives that they may give.

In the *stock change approach* (SCA), all HWP residing within the national boundaries are considered, regardless of country of origin. The SCA resembles the estimation methods used for other sources most closely, and it is consistent with how the Land Use, Land Use Change and Forestry (LULUCF) sector is treated in the Kyoto protocol and in the 1996 IPCC Guidelines (IPCC 1996; Kyoto protocol). It is also the simplest of the approaches with regard to data requirements. However, since a country can build up a stock of imported HWP, the SCA may give incentives to import wood from deforestation or other unsustainable sources like illegal loggings.

The *atmospheric flow approach* (AFA) estimates fluxes of carbon to and from the atmosphere for HWP residing within the national boundaries. All HWP residing within the national boundaries are considered, including imported wood. The AFA is inconsistent with the existing reporting/accounting system of LULUCF which is based on stock-changes. The numerical difference between the SCA and AFA is only net export, data requirements are thus almost as simple as for the SCA. In general, the atmospheric flow approach gives incentives to producing countries to increase their export, and not necessarily to increase the use of wood products. Emissions from imported wood-based biofuels would then be accounted for in the reporting country, which is different from the treatment of other imported biofuels. The AFA will give vast removals of CO<sub>2</sub> for a country with large net export of HWP.

In the *production approach* (PA) all domestically harvested wood is accounted for, including the amount that is exported. The exported HWP will thus remain in the inventory of the reporting country. The reporting country will therefore have a responsibility of exported wood residing in other countries, while imported wood are unaccounted for. As there is no easy way to know the fate of exported HWP, it is assumed in the estimation model that exported HWP is used in the same manner as if it were in domestic use. The complexity and uncertainty of this approach compared to the SCA is therefore high, and it is difficult to use national statistics to estimate the emissions/removals of CO<sub>2</sub>.

Although the *simple decay approach* (SDA) estimates fluxes of carbon to and from the atmosphere from domestically harvested woods rather than stock changes, it will give the same results as the production approach. The same arguments apply to the SDA as to the PA.

The *stock change approach for HWP of domestic origin* (SCAD) only includes domestically harvested wood that stays within the national boundaries. The possible problems with the SCA concerning imported, potentially unsustainable wood are thus avoided, as are the problems with having exported wood in the HWP inventory. The SCAD estimates are however more complex and uncertain than the SCA.

#### ***Estimation models and incentives***

Two models have been utilised for estimating the emissions/removals of CO<sub>2</sub> due to harvested wood products, the IPCC HWP model and the “revised” model. The IPCC HWP model is presented in the 2006 Guidelines (IPCC 2006a) as a default model (Tier 1). We have, wherever possible, estimated national values to be used instead of the default values provided by 2006 Guidelines, thus turning it into a Tier 2 model. The revised model is a combination of a country specific Tier 3 method developed at Statistics Norway (Gjesdal *et al.* 1996; Flugsrud *et al.* 2001) and the IPCC HWP model (IPCC 2006a).

The IPCC HWP model (Tier 1) is a flux method with a life-time analysis. Activity data on production, imports and exports of semi-finished wood products are required together with estimates on the lifetimes of the different products. Although the activity data are of good quality and easily accessible (FAO 2008), the flux method is sensitive to the life-time assumptions. The IPCC HWP model is easy to use, the risk of double counting is low and it will not require large resources to perform on a yearly basis. It is also applicable on all the approaches.

In the revised model (Tier 3), a total inventory of the solid wood carbon stock is, among others factors, based on information concerning the Norwegian building stock. Data from the Population and Housing Census is vital to this work, and the total inventory will give the most accurate results if it is performed in the same years as the census (normally every 10 years). The most important modifications of the direct inventories compared to the old method (Gjesdal *et al.* 1996; Flugsrud *et al.* 2001) are the inclusion of wood in uninhabited buildings like cabins, outbuildings and garages, the renovation sector and the civil engineering structures. The method has also been improved by assigning different wood contents to dwellings depending on type of building and year of construction. Changes in building tradition are thus incorporated in the model. The solid wood carbon stock in the IPCC HWP model is then fitted to the direct inventories, giving different half-lives for solid wood products for the different decades. The stock and stock changes in the non-inventory years are then estimated with the IPCC HWP model, both for solid wood products, paper products and waste.

The direct inventory in the revised model depends on high quality data regarding the Norwegian building stock. The most accurate information about residential buildings is found in the Population and Housing Census. It is therefore highly recommended that the direct inventories are updated every 10 years, following the cycle of the Population and Housing Census. For the years in between the direct inventories the resource use will be similar for the two models, while the direct inventories require significantly larger resources. As presented here, the revised method only applies to the stock change and atmospheric flow approach.

The two models will respond differently to incentives for increased use of wood in building constructions, panels, window frames etc. In the IPCC HWP model an increased use of wood in constructions may be recognised by a higher production or net import of solid wood products. However, if the products are imported as end-products such as prefabricated houses, they will not appear in the IPCC HWP model at all. In the revised model the estimated value for wood content in buildings and the share of wooden houses should be updated every time the direct inventory is performed, and will therefore reflect increased use of wood in constructions. Annual changes in the non-inventory years will be reflected by a higher production or net import of solid wood products, as in the IPCC HWP model.

An important factor to consider is whether to include HWP in landfills in the estimates or not. Including it may give incentives for storing HWP in landfills. This is in contradiction with the regulative from the Ministry of the Environment which comes into force July 1st 2009 (Ministry of the Environment 2008) concerning a prohibition on landfilling of biodegradable waste. If all wood and paper delivered to landfills are to be burned for bio energy, the annual change in carbon stock will decrease until it reaches zero (or close to zero). If waste is included this will be reflected in decreased removal of CO<sub>2</sub> in all approaches.

## Main results for emissions/removals of CO<sub>2</sub> in Norway

### *The IPCC HWP model*

Emissions/removals of CO<sub>2</sub> estimated with the IPCC HWP model and reported by the different approaches are shown in the figure below. Note that negative emissions are referred to as removals. It is evident that when HWP in landfills is not included, the PA and the SCAD turns the HWP pool to a source of emission in some years. This is especially evident for the SCAD where HWP is a source of CO<sub>2</sub> for all years between 1994 and 2004. Around 1993-1995 there is a pronounced change, especially in the AFA. This is due to a lower import during the recession of Norwegian economy around 1990 when there was a marked decrease in the number of dwellings being built. Note also the curve crossings in around 1993-1994 and 2004-2005 which are mainly caused by significant changes in the import/export balance. This is a clear example of the fact that the most suitable approach with regards to the amount of emission/removals of CO<sub>2</sub> reported will vary over time, even for a given country, depending on changes in imports and exports of wooden products.

On average during the commitment period, harvested wood products have acted as a sink of about 4 per cent (SCA), 3 per cent (PA, SDA), 11 per cent (AFA) and 0 per cent (SCAD) of the total sinks in the LULUCF sector in Norway when estimated with the IPCC HWP model (The Norwegian National Inventory Report 2008).

**Estimated emissions from HWP for the different approaches (waste is not included) estimated with the IPCC HWP model, 1990-2006. 1000 tonnes CO<sub>2</sub>**

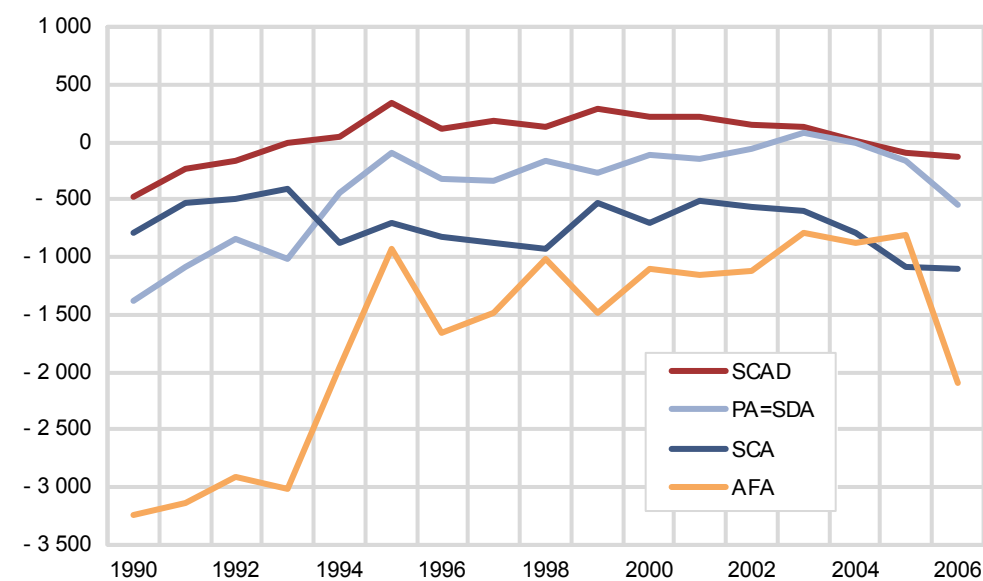

### *The revised model*

The direct inventories give the most accurate results if they follow the cycle of the Population and Housing Census. The two last censuses were in 1990 and 2001. In Norway in 2001, HWP in dwellings, landfills, non-residential buildings and furniture, fixtures and fittings were the most significant contributors to the total carbon stock. The distribution is shown in the sector diagram below. All products of the solid wood stock constitute in sum 78 per cent of the total carbon stock, HWP in landfills constitute 18 per cent and paper and paper products only 4 per cent. All categories have increased from 1990 to 2001, with a total of 21 per cent (4.2 million tonnes of carbon) for the entire carbon stock. This corresponds to an annual increase of 0.4 million tonnes of the carbon stock in Norway.

**The total carbon stock in Norway in 2001, estimated with the revised model**

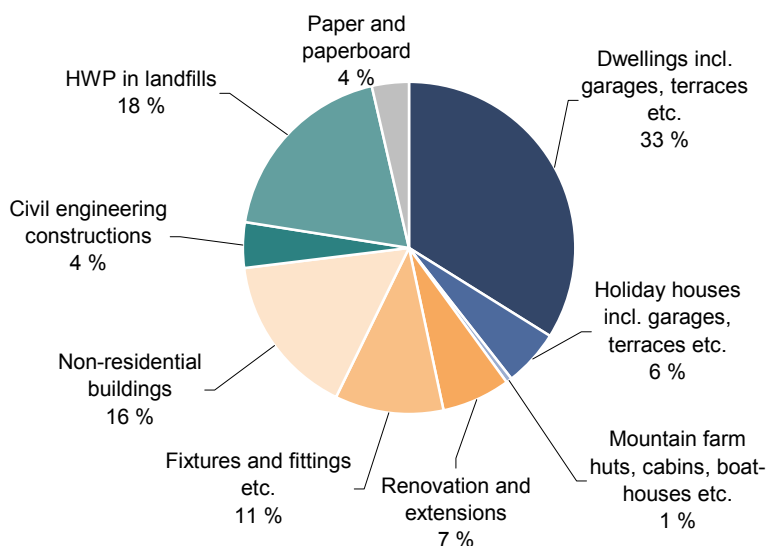

As mentioned earlier, the revised model is only applicable to the stock change and atmospheric flow approaches. Estimated emissions reported by the approaches are shown in the figure below, note that negative emissions are referred to as removals. Both approaches give removals of CO<sub>2</sub> for all years. For the SCA the removal due to HWP is in the order of 0.4-1 million tonnes, while for the AFA the removal varies between 3.2 and 0.7 million tonnes CO<sub>2</sub> for the entire reporting period. The mean removal from the SCA is 0.5 million tonnes CO<sub>2</sub>, and the mean removal reported by the AFA is 1.5 million tonnes CO<sub>2</sub>. The large variation for the AFA is due to a vast increase in import of semi-finished wood products from 1993-1995, resulting in less removals of CO<sub>2</sub> than in the years before 1993. On average during the commitment period, harvested wood products have acted as a sink of about 4 per cent (SCA) and 11 per cent (AFA) of the total sinks in the LULUCF sector in Norway when estimated with the revised model (The Norwegian National Inventory Report 2008).

**Estimated emissions from HWP for the SCA and AFA (waste is not included) estimated with the revised model, 1990-2006. 1000 tonnes CO<sub>2</sub>**

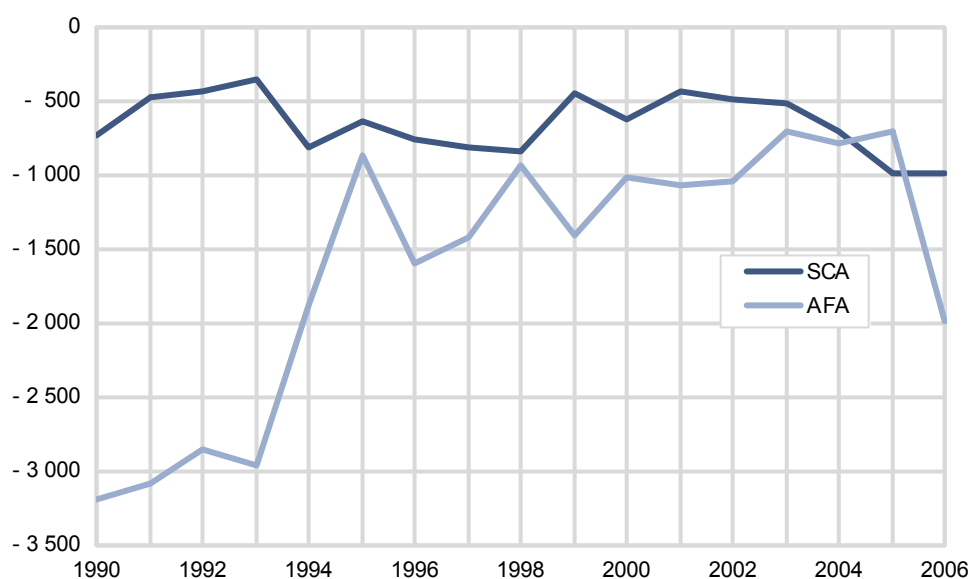

**Comparison of the two models**

Compared to the revised model, the SCA and the AFA yields a higher removal of CO<sub>2</sub> when estimated with the IPCC HWP model. The difference between the output from the two models increases from about 0.05 to 0.1 million tonnes CO<sub>2</sub> during the reporting period. This difference is trifling, although the revised model, especially as a mean of two inventory years, gives an overall higher accuracy than the IPCC HWP model. We believe that the reason for similar results is an accidental occurrence with the effect of the different half-lives in the revised model working in opposite directions, and this should not be used as an argument to favour the IPCC HWP model.

**Emissions of CO<sub>2</sub> for the proposed approaches estimated by the revised model and the IPCC HWP model in selected years (not including waste), 1990, 1995, 2001, 2006. 1000 tonnes CO<sub>2</sub>**

	The revised model		The IPCC HWP model			
	SCA	AFA	SCA	AFA	PA/SDA	SCAD
1990 .....	-730	-3 195	-783	-3 246	-1 374	-482
1995 .....	-640	-859	-706	-924	-97	337
2001 .....	-430	-1 061	-519	-1 149	-143	214
2006 .....	-989	-1 988	-1 096	-2 094	-554	-131

**Uncertainty and accuracy of the methods and approaches**

In general, the atmospheric flow approach requires an extra term in the calculation of emissions/removals of CO<sub>2</sub> compared to the stock change approach, i.e. net export, and will thus be associated with higher uncertainty. The production approach will always be associated with higher uncertainties than the other approaches, since estimates of the fate of exported HWP are highly uncertain. The stock change approach for HWP of domestic origin is probably associated with a lower uncertainty than the PA and a higher uncertainty than the SCA, especially if HWP in landfills are included (see below).

Including waste would lead to increased uncertainty, affecting the approaches to a varying degree. The PA, which includes domestically harvested wood only, will have the largest uncertainty. In theory, the part of exported domestically harvested wood that ends up in international landfills should be included. And only the part of domestically harvested wood in domestic landfills should be included, not imported HWP. Tier 1 estimates of carbon change in landfills in other countries could lead to substantial over- or under estimates, it is thus advised not to include it. The PA will thus only account for the portion of HWP in domestic landfills that originates from domestically harvested wood, and estimating this portion is burdened with a high uncertainty. The SCAD will be somewhat less uncertain than the PA since it is assumed to only account for domestically harvested woods in domestic landfills, it is however also burdened with a high degree of uncertainty compared to the SC and AF approaches. The uncertainty for the SCA and AFA will be lowest, since both methods account for all HWP in domestic landfills, and no waste in international landfills.

The highest uncertainty in the IPCC HWP model is connected to the lifetime assumptions and is about 50 per cent (IPCC 2006a). For the revised model we believe that it is the amount of wood used in buildings that is burdened with the highest uncertainty, which is about 25 per cent. When taken as a mean over the years where two direct inventories have been performed, the estimates of solid wood stocks from the revised model should not be any more uncertain than the results from the direct inventory years.



### **Structure of this report**

An overview of the abbreviations used throughout this report is given in Chapter 2, followed by a summary of the activity data, statistical data and parameters used in the calculations (Chapter 3). The two models used for estimating the carbon stocks in Norway are outlined in Chapter 4. A more thorough review is given in Appendix A and B. The different approaches are presented in Chapter 5, and the results and discussions for Norway in Chapter 6. Chapter 7 focuses on areas for methodological improvement.

### **Technical terms of reference**

In the 2006 Guidelines a chapter on harvested wood products is included in the Agriculture, Forestry and Other Land Use (AFOLU) sector (IPCC 2006a). The aim of our work was to examine the four different approaches that are presented for the reporting of emissions/removals of CO<sub>2</sub> from HWP. A fifth approach not presented in the Guidelines was also to be examined, the SCAD. CO<sub>2</sub> emissions/removals were to be estimated by both the IPCC HWP spreadsheet model provided by the 2006 Guidelines and an updated (if possible) version of the “combined method” developed at Statistics Norway (Gjesdal *et al.* 1996; Flugsrud *et al.* 2001). Both estimation models were to be evaluated in terms of accuracy, user-friendliness and resource requirements.

### **Acknowledgements**

The author would like to thank Ketil Flugsrud (Statistics Norway), Kim Pingoud (VTT Technical Research Centre of Finland), Knut Einar Fjulsrud (Norwegian Sawmill Industries Association) and Aasmund Bunkholt (Wood Focus Norway) for important contributions and interesting discussions during the work process. The contributions of Erik Engelién, Håkon Skullerud, Trond Sandmo and Nina Holmengen (Statistics Norway) are also greatly valued.

The project received financial support from the Norwegian Pollution Control Authority (SFT).

## Sammendrag

Utslipp av klimagasser regnskapsføres og rapporteres årlig under klimakonvensjonen (UNFCCC) og Kyoto-protokollen. I det nåværende systemet for regnskapsføring tilskrives CO<sub>2</sub>-utslipp fra treprodukter (harvested wood products, HWP) det landet og det året hvor treet ble hogget. Det antas dermed at alle treprodukter oksideres til CO<sub>2</sub> i høstningsåret, og at det ikke er noen langtidslagring. Dette kalles IPCC-standardtilnærmingen (approach). En stor andel av treproduktene vil imidlertid lagres for en kortere eller lengre periode før de oksideres, og dette vil føre til forsinket utslipp av CO<sub>2</sub>. Hvis det ett år lagres mer treprodukter enn hva som oksideres, vil treproduktene fungere som et sluk og utslippene av CO<sub>2</sub> vil senkes. Dersom forbruket av tre synker til et nivå under det som oksideres vil treproduktene derimot virke som en CO<sub>2</sub>-kilde, og utslippene vil øke. I Norge, som i mange andre land, har bruken av treprodukter økt i lengre tid, og denne økningen kommer sannsynligvis til å fortsette. Klimakonvensjonen vurderer å inkludere treprodukter i post-Kyoto-regimet, som skal tre i kraft etter 2012, og i den sammenhengen er det nødvendig å evaluere estimeringsmodeller og tilnærminger (approaches) for regnskapsføring og rapportering (IPCC 2006a).

I denne rapporten er forskjellige estimeringsmetoder og tilnærminger for å regnskapsføre utslipp/opptak av CO<sub>2</sub> grunnet HWP analysert. Resultater for Norge er presentert for begge estimeringsmodellene og alle de fem tilnæringsmetodene. Analysene tar utgangspunkt i norske forhold og er ikke nødvendigvis brukbare for andre land.

### Tilnærminger og beregningsmetoder/-modeller

I denne rapporten skiller det mellom tilnærminger og metoder/modeller og det er viktig å være klar over forskjellen mellom disse begrepene. Tilnærminger beskriver hvordan utslipp tilskrives enkeltland, avhengig av produksjon, import og eksport av treprodukter. Med andre ord, skal treprodukter regnskapsføres i landet hvor treet er hogget eller i landet der det faktisk brukes? Beregningsmetoder/-modeller, derimot, omhandler hvordan utslipp og HWP-lagre beregnes ut fra nasjonale data og statistikker.

Hvis treprodukter inkluderes i klimakonvensjonens regnskapssystem for perioden etter 2012, vil det bli i sektoren for AFOLU (Agriculture, Forestry and Other Land Use). Valg av tilnærming vil derfor ha betydning for utslipp/opptak som rapporteres i AFOLU-sektoren. Ettersom tilnærmingene behandler lagring av og handel med treprodukter på forskjellige måter, bør deltagerlandene bli enige om en felles praksis for regnskapsføring. Hvis dette ikke blir gjort, og landene fritt kan velge tilnærming, vil det medføre at utslipp fra treprodukter vil kunne bli dobbelt-regnet eller ikke regnet med i det hele tatt. Dette vil kunne forårsake betydelige feil i beregningen av globale utslipp. Det er viktig å merke seg at tilnærmingen SCAD ikke vil gi riktig global total (se nedenfor). Tilnærmingene vil gi forskjellige incentiver for nasjonal politikk med hensyn til import og eksport av treprodukter hvis treprodukter inkluderes i regnskapssystemet. Hvis utslipp fra treprodukter bare skal rapporteres, og *ikke* inngå i regnskapet, vil de forskjellige tilnærmingene ikke medføre noen incentiver.

### Tilnærminger og incentiver

Fem forskjellige tilnærminger er undersøkt: SCA (stock change approach), AFA (atmospheric flow approach), PA (production approach), SDA (simple decay approach) og SCAD (stock change approach for HWP of domestic origin). De fire første er beskrevet i IPCCs retningslinjer fra 2006 (IPCC 2006a). Tilnærmingene skiller seg fra hverandre med hensyn til hvordan utslipp fra treprodukter tilskrives land avhengig av import og eksport, og vil vanligvis gi forskjellig resultat både for nivå og trend. For et land med stor nettoeksport/-import av treprodukter vil de enkelte tilnærmingene gi svært forskjellige utslipp/opptak av CO<sub>2</sub>. En inngående

diskusjon om tilnærmingenes politiske relevans inngår ikke i denne rapporten, men noen incentiver de kan gi er omtalt.

SCA (stock change approach) behandler alle treprodukter innen landets grenser, uten å ta hensyn til opphavsland. SCA er tilnærmingen som ligner mest på beregningsmetodene brukt for andre utslippskilder, og den samsvarer med behandlingen av LULUCF-sektoren i IPCCs retningslinjer fra 1996 (IPCC 1996, Kyoto-protokollen). Dette er også den enkleste metoden med hensyn til nødvendige data. Ettersom et land kan bygge opp et lager av importerte treprodukter, kan metoden imidlertid gi incentiver til å importere trevirke som stammer fra avskoging eller andre ikke-bærekraftige kilder, som illegal hogst.

AFA (atmospheric flow approach) beregner karbonstrømmer til og fra atmosfæren for treprodukter innen landets grenser. Alle treprodukter inkluderes, også de som er importert. AFA samsvarer ikke med eksisterende regnskaps- og rapporteringssystemer for LULUCF, som er basert på lagerendringer. Nettoeksport utgjør hele forskjellen mellom SCA og AFA, og databehovene er dermed nesten like enkle for begge metodene. Generelt gir AFA produsentland incentiver til å øke eksporten, og ikke nødvendigvis til å øke bruken av treprodukter. Utslipp fra importert trebasert biobrensel vil med denne tilnærmingen bli regnskapsført i det rapporterende landet, noe som avviker fra behandlingen av annet importert biobrensel. AFA vil gi stort CO<sub>2</sub>-opptak for land med stor eksport av treprodukter.

PA (production approach) inkluderer alt trevirke og alle treprodukter produsert innenlands, også det som eksporteres. Eksporterte treprodukter vil altså inngå i det rapporterende landets regnskap. Dette landet vil altså være ansvarlig for eksporterte mengder, men ikke for det som importeres. Ettersom det er ukjent hva som skjer med eksporterte treprodukter, antas det i beregningsmodellen at de brukes på samme måte som produkter brukt innenlands. Sammenlignet med SCA er dermed denne tilnærmingen mye mer kompleks og usikker, og det er vanskelig å bruke nasjonal statistikk til å beregne utslipp/opptak av CO<sub>2</sub>.

SDA (simple decay approach) beregner karbonstrømmer til og fra atmosfæren fra trevirke produsert innenlands, også det som eksporteres. Selv om den ikke er basert på lagerendringer vil den gi samme resultat som PA.

SCAD (stock change approach for HWP of domestic origin) inkluderer bare trevirke produsert innenlands som også brukes innenlands. Problemene SCA kan ha i tilknytning til mulig import av ikke-bærekraftig trevirke unngås dermed, det samme gjelder problemet med å inkludere eksportert trevirke i regnskapet. SCAD-beregningene er imidlertid mer komplekse og usikre enn SCA-beregningene.

### ***Beregningsmodeller og incentiver***

To modeller er brukt i beregningene av utslipp/opptak av CO<sub>2</sub> fra treprodukter, IPCCs HWP-modell og den ”reviderte” modellen. IPCCs HWP-modell er presentert som en standardmodell (tier 1) i IPCCs retningslinjer fra 2006 (IPCC 2006a). Hvor det har vært mulig er standardverdiene i denne modellen erstattet av nasjonale verdier, noe som har gjort at vi har fått en tier 2-modell. Den reviderte metoden er en kombinasjon av en landsspesifikk tier 3-modell utviklet ved Statistisk sentralbyrå (Gjesdal *et al.* 1996, Flugsrud *et al.* 2001) og IPCCs HWP-modell.

IPCCs HWP-modell er en materialstrøm-metode (flux method) med en levetidsanalyse. Den krever data om produksjon, import og eksport av halvfabrikata av treprodukter, i tillegg til forskjellige produkters levetid. Selv om aktivitetsdataene er av god kvalitet og lett tilgjengelige (FAO 2008), er denne metoden følsom for levetidsantagelsene. IPCCs HWP-modell er enkel å bruke, faren for dobbelttelling er lav og det krever ikke store ressurser å bruke den årlig. Den er også anvendbar for alle tilnærmingene.

I den reviderte modellen baseres et totalregnskap (direct inventory) for karbonlageret i trevarer på blant annet informasjon om Norges bygningsmasse. Data fra Folke- og boligtellinger er viktig i dette arbeidet og totalregnskapet blir best hvis det utføres for årene med slike tellinger (normalt hvert tiende år). I denne sammenhengen benyttes trevarer (solid wood products) om alle treprodukter som ikke går til papirindustrien. Den viktigste modifiseringen fra den gamle metoden (Gjesdal *et al.* 1996, Flugsrud *et al.* 2001) er inkluderingen av trevirke i ubebodde bygninger som hytter, uthus og garasjer, i ROT-sektoren (rehabilitering, ombygging, tilbygg) og i konstruksjoner innen anlegg og samferdsel. Metoden er også forbedret ved å benytte varierende faktorer for treinnhold i boliger avhengig av bygningstype og byggeår. Dermed er endringer i bygningstradisjon inkorporert i modellen. Karbonlageret i trevarer i IPCCs HWP-modell tilpasses så karbonlagret fra totalregnskapet ved å justere halveringstiden for trevarer. Siden vi har estimert totalagreg for to år (1990 og 2001) resulterer dette i forskjellige halveringstider for trevarer før og etter 1990. Lager og lagerendringer for år hvor det ikke er utført totalregnskap beregnes ved hjelp av IPCCs HWP-modell, for både trevarer, papirprodukter og avfall.

Totalregnskapet i den reviderte modellen er avhengig av høy kvalitet på data om norsk bygningsmasse. Den mest nøyaktige informasjonen om boliger finnes i Folke- og boligtellingerne. Det anbefales derfor sterkt at totalregnskapet oppdateres hvert tiende år, i samme syklus som Folke- og boligtellingerne. For årene mellom totalregnskapene vil ressursbruken være den samme for de to modellene, mens totalregnskapene krever betydelig større ressurser. Som den er presentert her kan den reviderte metoden bare brukes på SCA og AFA.

De to modellene vil respondere forskjellig på incentiver for økt bruk av tre i bygningskonstruksjoner, paneler, vindusrammer etc. I IPCCs HWP-modell vil økt bruk av tre i konstruksjoner gjenspeiles i større produksjon eller nettoimport av treprodukter. Men hvis produktene importeres som sluttprodukter (f. eks. ferdighus) vil de overhodet ikke komme til syne i IPCCs HWP-modell. I den reviderte modellen vil beregnet treinnhold i bygninger og andelen trebygninger oppdateres hver gang et totalregnskap lages og vil derfor reflektere endringer i bruk av tre i konstruksjoner. Årlige endringer i år uten totalregnskap vil gjenspeiles i høyere produksjon eller nettoimport av treprodukter, som i IPCCs HWP-modell.

Det er viktig å vurdere hvorvidt treprodukter på avfallsdeponier skal inkluderes i beregningene. Hvis disse tas med kan det være et incentiv til å lagre treprodukter på deponier, noe som er i strid med Miljøverndepartementets forbud mot deponering av biologisk avfall på deponier fra 1. juli 2009. Hvis alt trevirke og papir som leveres til deponier brennes til energiformål, vil den årlige endringen i karbonlager minke inntil den når null (eller nesten null). Hvis avfall inkluderes vil dette reflekteres i lavere CO<sub>2</sub>-opptak i alle tilnærmingene.

## Hovedresultater for utslipp/opptak av CO<sub>2</sub> i Norge

### *IPCCs HWP-modell*

Figuren nedenfor viser utslipp/opptak av CO<sub>2</sub> beregnet med IPCCs HWP-modell rapportert av de forskjellige tilnærmingene. Merk at negative utslipp kalles opptak. Det er åpenbart at når treprodukter på avfallsdeponier ikke inkluderes vil PA og SCAD i noen år gjøre treproduktbeholdningen til en kilde for utslipp. Dette er særlig tydelig for SCAD, der treprodukter er en utslippskilde for CO<sub>2</sub> for alle år mellom 1994 og 2004. Rundt 1993-1995 er det en påtagelig endring, særlig for AFA. Dette henger sammen med lavere import under nedgangsperioden for norsk økonomi rundt 1990, da det var en markant nedgang i boligbyggingen. Merk også de kryssende kurvene rundt 1993-1994 og 2004-2005, som hovedsakelig henger sammen med endringer i import-/eksportbalansene. Dette er et klart eksempel på at hvilken tilnærming som er mest egnet med hensyn på mengden utslipp/opptak av CO<sub>2</sub> vil variere over tid, selv for samme land, avhengig av endringer i import og eksport av treprodukter.

I avtaleperioden har treprodukter gjennomsnittlig stått for henholdsvis 4 (SCA), 3 (PA, SDA), 11 (AFA) og 0 (SCAD) prosent av det totale opptaket i den norske LULUCF-sektoren når IPCCs HWP-modell benyttes (The Norwegian National Inventory Report 2008).

**Estimerte CO<sub>2</sub>-utslipp fra treprodukter for forskjellige tilnæringer (avfall ikke inkludert) beregnet med IPCCs HWP-modell, 1990-2006. 1000 tonn CO<sub>2</sub>**

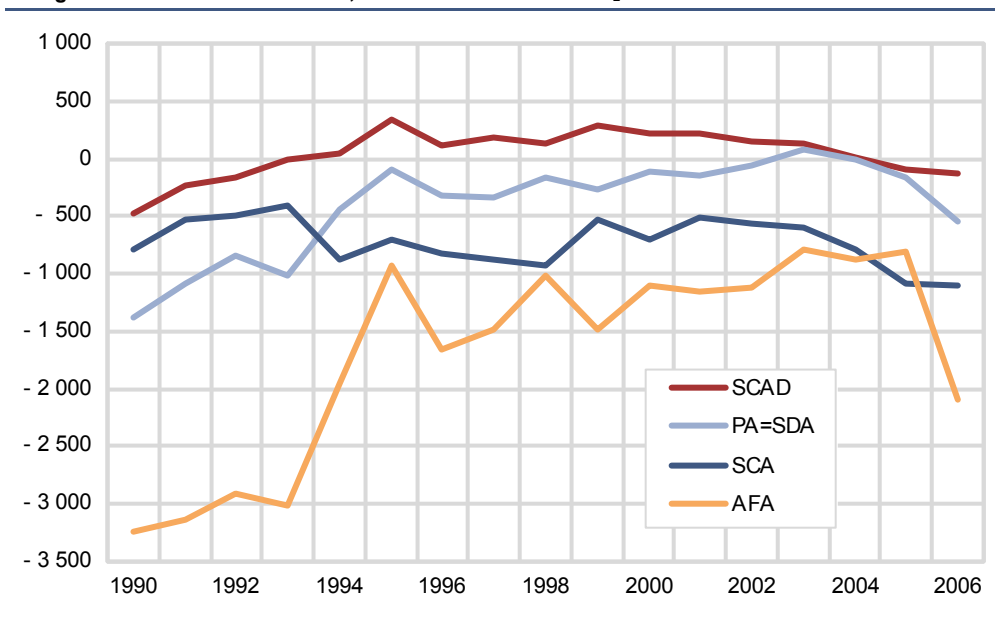

**Den reviderte modellen**

Totalregnskap gir det beste resultatet hvis de følger samme syklus som Folke- og boligtellningene. De to siste tellingene fant sted i 1990 og 2001. I 2001 var treprodukter i boliger, avfallsdeponier, yrkesbygg og møbler og inventar de viktigste bidragsyterne til det norske totallageret av karbon. Fordelingen er vist i sektordiagrammet nedenfor. Trevarer i bruk utgjør 78 prosent av det totale karbonlageret, treprodukter på deponier 18 prosent og papir og papirprodukter bare 4 prosent. Alle kategoriene har økt fra 1990 til 2001, med i alt 21 prosent (4,2 millioner tonn karbon) for det samlede karbonlageret. Dette svarer til en årlig økning på 0,4 millioner tonn av karbonlageret i Norge.

**Totalt karbonlager i Norge i 2001 beregnet med den reviderte modellen**

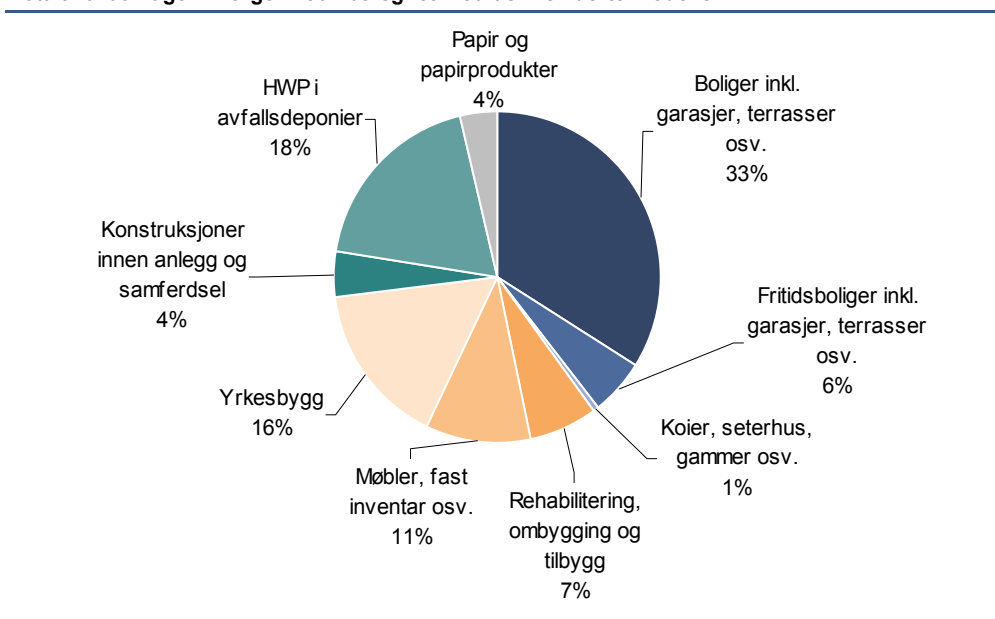

Som nevnt tidligere kan den reviderte modellen bare benyttes for SCA og AFA. Beregnede utslipp fra tilnærmingene er vist i figuren nedenfor, merk at negative utslipp kalles opptak. Begge tilnærminger gir opptak av CO<sub>2</sub> for alle år. For SCA er opptaket på grunn av treprodukter 0,4-1 millioner tonn, mens opptaket for AFA varierer mellom 0,7 og 3,2 millioner tonn CO<sub>2</sub> for hele rapporteringsperioden. Gjennomsnittlig opptak fra SCA er 0,5 millioner tonn CO<sub>2</sub>, og tilsvarende for AFA 1,5 millioner tonn CO<sub>2</sub>. Den store variasjonen for AFA skyldes sterk økning i importen av halvfabrikerte treprodukter fra 1993-1995, noe som har resultert i lavere opptak av CO<sub>2</sub> enn i årene før 1993. Gjennomsnittlig har treprodukter i avtaleperioden stått for henholdsvis ca. 4 (SCA) og 11 (AFA) prosent av det totale sluket i Norges LULUCF-sektor når den reviderte modellen er benyttet (The Norwegian National Inventory Report 2008).

**Estimerte CO<sub>2</sub>-utslipp fra treprodukter for SCA og AFA (avfall ikke inkludert) beregnet med den reviderte modellen, 1990-2006. 1000 tonn CO<sub>2</sub>**

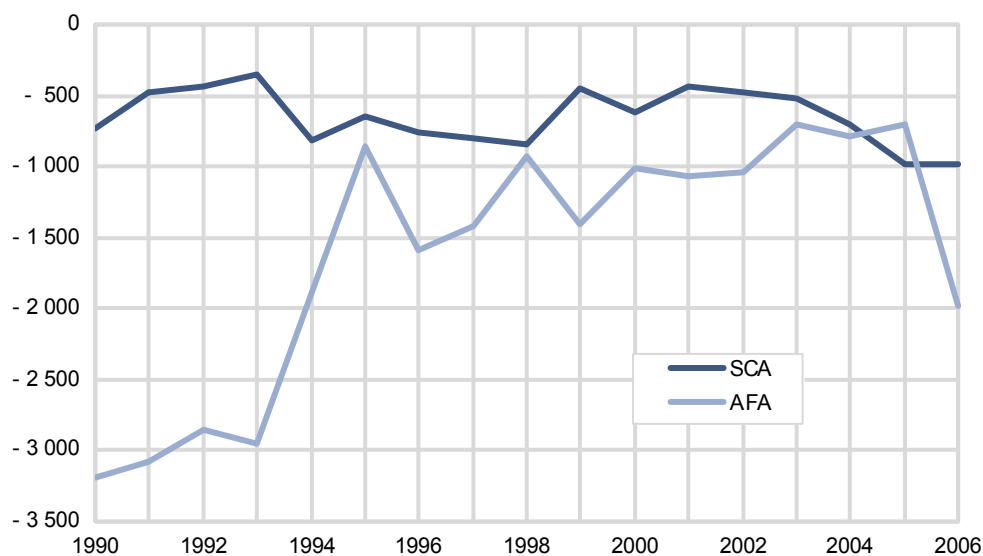

### Sammenligning mellom de to modellene

Sammenlignet med den reviderte modellen gir SCA og AFA høyere opptak av CO<sub>2</sub> når IPCCs HWP-modell benyttes. Forskjellen i resultat fra de to modellene øker fra ca. 0,05 til 0,1 millioner tonn CO<sub>2</sub> i løpet av rapporteringsperioden. Denne forskjellen er ubetydelig, selv om den reviderte modellen, særlig som et gjennomsnitt for to regnskapsår, gir høyere nøyaktighet enn IPCCs HWP-modell. Vi tror at sammenfallet mellom resultatene er tilfeldig, ettersom effekten av de forskjellige halveringstidene i den reviderte modellen virker i motsatte retninger, og dette bør ikke brukes som et argument for å favorisere IPCCs HWP-modell.

**Utslipp av CO<sub>2</sub> for de foreslåtte tilnærmingene beregnet med den reviderte modellen og IPCCs HWP-modell i utvalgte år (avfall ikke inkludert), 1990, 1995, 2001, 2006. 1000 tonn CO<sub>2</sub>**

	Den reviderte modellen		IPCCs HWP-modell			
	SCA	AFA	SCA	AFA	PA/SDA	SCAD
1990 .....	-730	-3 195	-783	-3 246	-1 374	-482
1995 .....	-640	-859	-706	-924	-97	337
2001 .....	-430	-1 061	-519	-1 149	-143	214
2006 .....	-989	-1 988	-1 096	-2 094	-554	-131

### Usikkerhet og nøyaktighet i metodene og tilnærmingene

Generelt trenger AFA et ekstra element for å beregne opptak av CO<sub>2</sub> sammenlignet med SCA, nemlig nettoeksport, og den vil dermed ha større usikkerhet. PA vil alltid ha større usikkerhet enn de andre tilnærmingene, ettersom beregninger for eksporterte treprodukter er svært usikre. SCAD har antagelig lavere usikkerhet enn

PA og høyere usikkerhet enn SCA, særlig hvis treprodukter på avfallsdeponier er inkludert (se nedenfor).

Usikkerheten øker hvis avfall inkluderes, noe som påvirker tilnærmingene i varierende grad. PA, hvor kun innenlands treprodukter er inkludert, vil ha størst usikkerhet. Teoretisk sett skal den delen av eksportert trevirke som ender på avfallsdeponier være inkludert. Og av trevirket som havner på norske avfallsdeponier skal bare det som er produsert innenlands inkluderes, ikke importerte treprodukter. Tier 1-beregninger av karbonendringer på avfallsdeponier i andre land kan føre til betydelige over- eller underestimer, det anbefales altså ikke å inkludere dette. PA vil altså bare inkludere treprodukter på innenlandske avfallsdeponier som stammer fra innenlands produksjon, og det er stor usikkerhet knyttet til slike beregninger. SCAD vil være noe mindre usikker enn PA, ettersom den kun skal inkludere innenlands trevirke i innenlandske deponier, den er imidlertid også svært usikker sammenlignet med SCA og AFA. Usikkerheten for SCA og AFA vil være lavest, ettersom begge metodene inkluderer alle treprodukter på innenlandske deponier og ikke noe på utenlandske deponier.

Den største usikkerheten i IPCCs HWP-modell henger sammen med antagelsene om levetid, og er ca. 50 prosent (IPCC 2006a). For den reviderte modellen tror vi at mengden trevirke brukt i bygninger har størst usikkerhet, ca. 25 prosent. Som et gjennomsnitt for de to årene med totalregnskap, skulle ikke beregningene av trelager fra den reviderte modellen være mer usikre enn resultatene for årene med totalregnskap.

### Rapportstruktur

En oversikt over forkortelser brukt i denne rapporten finnes i kapittel 2, fulgt av en oversikt over aktivitetsdata, statistiske data og parametere brukt i beregningene (kapittel 3). De to modellene som er benyttet for å beregne karbonlagre i Norge er gitt i kapittel 4, med en grundigere gjennomgang i Appendix A og B. De forskjellige tilnærmingene presenteres i kapittel 5, og resultater og diskusjoner for Norge i kapittel 6. Kapittel 7 fokuserer på områder for metodologisk forbedring.

### Tekniske termer

I IPCCs retningslinjer fra 2006 er et kapittel om treprodukter inkludert i AFOLU-sektoren (IPCC 2006a). Formålet med dette arbeidet har vært å undersøke de fire forskjellige tilnærmingene som er presentert for å rapportere utslipp/opptak av CO<sub>2</sub> fra treprodukter. En femte tilnærming som ikke er presentert i IPCCs retningslinjer er også undersøkt, SCAD. Utslipp og opptak av CO<sub>2</sub> skulle beregnes både ved hjelp av IPCCs HWP-regnearkmodell i IPCCs retningslinjer fra 2006 og en (om mulig) oppdatert versjon av den kombinerte metoden utviklet ved Statistisk sentralbyrå (Gjesdal *et al.* 1996; Flugsrud *et al.* 2001). Begge beregningsmetodene skulle evalueres med hensyn til nøyaktighet, brukervennlighet og ressursbehov.

### Bidragstere

Forfatteren vil takke Ketil Flugsrud (Statistisk sentralbyrå), Kim Pingoud (VTT Technical Research Centre of Finland), Knut Einar Fjulsrud (Treindustrien) og Aasmund Bunkholt (TreFokus) for viktige bidrag og interessante diskusjoner under arbeidet. Det settes også stor pris på bidragene fra Erik Engelién, Håkon Skullerud, Trond Sandmo og Nina Holmengen (Statistisk sentralbyrå).

Prosjektet har mottatt finansiell støtte fra Statens forurensningstilsyn (SFT).

## Innhold

<b>Summary</b> .....	<b>3</b>
<b>Sammendrag</b> .....	<b>10</b>
<b>1. Introduction</b> .....	<b>17</b>
<b>2. Abbreviations and definitions</b> .....	<b>18</b>
<b>3. Data sources</b> .....	<b>21</b>
3.1. The IPCC HWP model .....	21
3.2. The revised model.....	21
<b>4. Estimation methods and models</b> .....	<b>23</b>
4.1. The IPCC HWP model .....	23
4.2. The revised method - direct inventory and the IPCC HWP model.....	25
<b>5. Approaches for reporting and accounting</b> .....	<b>27</b>
5.1. The Stock-Change Approach (SCA) .....	27
5.2. The Atmospheric Flow Approach (AFA).....	28
5.3. The Production Approach (PA).....	29
5.4. The Simple Decay Approach (SDA) .....	30
5.5. The Stock Change Approach for HWP of Domestic Origin (SCAD) .....	30
<b>6. Results and discussions for Norway</b> .....	<b>32</b>
6.1. CO <sub>2</sub> emissions/removals estimated with the IPCC HWP model.....	32
6.2. CO <sub>2</sub> emissions/removals estimated with the revised model .....	38
6.3. Comparison of the models .....	41
6.4. Response of the models to some incentives for increased use of wood .....	42
6.5. Uncertainty in the methods and approaches .....	42
<b>7. Further work</b> .....	<b>45</b>
<b>References</b> .....	<b>46</b>
<b>Appendix</b>	
A. The IPCC HWP model .....	48
B. The revised model .....	53
C. Mathematical equations for estimating the carbon stock in the IPCC HWP models .....	64
D. FAO activity data included in the IPCC HWP model .....	68
<b>List of figures and tables</b> .....	<b>69</b>



## 1. Introduction

Forests play manifold roles in climate mitigation. They sequester carbon from the atmosphere when they grow by storing carbon in biomass and forest soil, and they deliver wood as raw material to the energy sector, wood and paper industry. A pool (stock) of harvested wood products (HWP) is created when wood is harvested for making products, like wooden houses, furniture or paper products. Owing to the fact that this wood is in use, the release of CO<sub>2</sub> to the atmosphere is delayed until the products are oxidised as waste or bio energy.

The HWP pool can be increased by using more wood as raw material for example when building houses. When wood is used as a substitute for more energy- and emission-intensive non-renewable materials (or fossil energy), the offset in greenhouse gas (GHG) emissions is called the “substitution effect”. The benefit of using wood as a raw material is further enhanced if it is used in a “cascaded” way, i.e. it is first used as products and then for bio energy.

In Norway, as in many other countries, the stock of HWP has been increasing for many years and it is likely to increase further. Changes in the HWP pool will therefore influence the amount of CO<sub>2</sub> emissions. It is probably the substitution effect that will contribute the most to an increase in the HWP pool, and thus give the key impact on climate mitigation. It is important to keep in mind that almost all wood that enters the HWP pool eventually will be oxidised to CO<sub>2</sub>, either when it is discarded for waste or used for bio energy. This implies that HWP stocks eventually will reach a steady state where the CO<sub>2</sub> emissions match the sequestration.

As of today, the HWP contribution is not included in the accounting system under the UNFCCC and the Kyoto protocol. The IPCC default approach is that emissions from HWP are attributed to the year of harvest and to the country of harvest. Estimation, reporting and accounting of the HWP contribution is under consideration by the UNFCCC and may be included in the post 2012 Kyoto regime.

In order to report and account for HWP, two matters must be addressed. The first is the methods used to estimate annual changes in the HWP stocks. They will be discussed in light of accuracy, user-friendliness, data availability and how much resources they require. The second is how the HWP contribution should be accounted for, and several approaches have been proposed. The approaches differ in how they allocate the emissions/removals of CO<sub>2</sub> from HWP between wood producing and consuming countries, and will thus report different annual emissions/removals for a given country in a given year.

The policy relevance of the approaches will be mentioned, but the reader is referred elsewhere for a more thorough review.

The background of this report is Chapter 12 of the 2006 IPCC Guidelines for National Greenhouse Gas Inventories, Harvested Wood Products (IPCC 2006a). Estimation models and approaches for accounting presented in the Guidelines are included in this report. In addition, one extra approach, the SCAD, is included and also a country-specific estimation model developed at Statistics Norway (Gjesdal *et al.* 1996; Flugsrud *et al.* 2001). It should be noted, however, that the Guidelines is very clear on the fact that any inclusion of a approach in the Guidelines does not imply any endorsement of that approach or any guidance on which approach to use by the IPCC. This also applies to the HWP model included in the Guidelines.

## 2. Abbreviations and definitions

<i>Approach</i>	Several different approaches are proposed that concerns how to account for the HWP contribution. The approaches differ in how they allocate the emissions/removals of CO <sub>2</sub> from HWP between wood producing and consuming countries, and will thus report different annual emissions/removals for a given country in a given year.
<i>AFA</i>	The Atmospheric Flow Approach reports fluxes of carbon to and from the atmosphere within the national boundaries. Only HWP that resides within the national boundaries is thus considered.
<i>AFOLU</i>	Agriculture, Forestry and Other Land Use is the sector in the 2006 IPCC Guidelines where HWP are treated. As of 2006 the sectors Agriculture and LULUCF are integrated in AFOLU.
<i>Direct inventory</i>	In the direct inventory the carbon stock of solid wood products such as dwellings, furniture, garages and non-residential buildings are estimated from building statistics and wood contents among other factors.
<i>FAO</i>	The Food and Agriculture Organization of the United Nations leads international efforts to defeat hunger. Serving both developed and developing countries, FAO acts as a neutral forum where all nations meet as equals to negotiate agreements and debate policy.
<i>First order decay</i>	The rate of loss of HWP from the HWP pool is estimated by a first order decay mechanism in the IPCC HWP model. First order decay is also known as first order exponential decay. The key features of first order exponential decay are that the rate of loss of mass at any given time is directly proportional to the mass present at that time, and that the half-life ( $t_{1/2}$ ) can be expressed by the mean lifetime $\cdot \ln 2$ .
<i>Flux method</i>	Stock changes may be estimated with a flux method, where the fluxes going in and out of storage are counted. If the fluxes going out of storage are of low quality or difficult to obtain, they can be estimated by a life-time analysis.
<i>GAB</i>	The Ground Property, Address and Building Register. We have only used the Building Register which is a part of GAB.
<i>GHG</i>	Greenhouse gas.
<i>HWP</i>	Harvested wood products include all wood material (including bark) that leaves harvest sites. Slash and other material left at harvest sites should be regarded as dead organic matter and not as HWP.
<i>HWP Contribution</i>	The contribution of harvested wood products to annual AFOLU CO <sub>2</sub> emissions/removals. Also referred to as emissions/removals from HWP.
<i>IPCC</i>	The Intergovernmental Panel on Climate Change was established in 1988 by the World Meteorological Organization and the UN Environment Programme. The IPCC surveys world-wide scientific and technical literature and publishes assessment reports that are widely recognized as the most credible existing sources of information on climate change. The IPCC also works on methodologies and responds to specific requests from the UNFCCC subsidiary bodies. The IPCC is independent of UNFCCC.
<i>1996 IPCC Guidelines</i>	The 1996 IPCC Guidelines for National Greenhouse Gas Inventories (IPCC 1996) comprised the Revised 1996 IPCC Guidelines for National Greenhouse Gas Inventories, together with the Good Practice Guidance and Uncertainty Management in National Greenhouse Gas Inventories and the Good Practice

	Guidance for Land Use, Land-Use Change and Forestry. The 1996 Guidelines give methodologies for estimating anthropogenic emissions by sources and removals by sinks of greenhouse gases in calculation of legally-binding targets during the first commitment period. The IPCC Guidelines divides GHG emissions/removals into sectors depending on their origin.
<i>2006 IPCC Guidelines</i>	The 2006 IPCC Guidelines (IPCC 2006a ) include new sources and gases as well as updates to the previously published methods whenever scientific and technical knowledge have improved since the previous guidelines were issued.
<i>IPCC HWP Model</i>	The IPCC HWP model spreadsheet is included in the 2006 Guidelines as a tool for estimating the HWP contribution (IPCC 2006a). The IPCC HWP model has been slightly modified by Kim Pingoud at VTT Technical Research Centre of Finland to 1) include the SCAD and 2) to make possible the use of different half-lives.
<i>Kyoto Protocol</i>	The Kyoto Protocol is an international agreement standing on its own, requiring separate ratification by governments, but linked to the UNFCCC. Among other things, it sets binding targets for the reduction of greenhouse-gas emissions by industrialized countries. The Kyoto protocol entered into force in 2005, and the first commitment period ends in 2012.
<i>Life-time analysis</i>	If the fluxes going out of storage in a flux model are of low quality or difficult to obtain, a life-time analysis can be used as an estimate of the decay. In this case, the products going into storage are assumed to have a certain life-time, and the decay of products may then be described by the appropriate decay function. First order decay is used as the decay function in the IPCC HWP method.
<i>LULUCF</i>	The Land Use, Land-Use Change and Forestry sector is one of the sectors in the 1996 IPCC Guidelines. In the 2006 IPCC Guidelines it is integrated with the Agriculture sector, thus forming the AFOLU sector. It is still common to use the 1996 division in the National GHG inventories.
<i>Method</i>	There are different methods on how to estimate stock changes, depending on data quality and availability. The flux method and stock method are used in this report.
<i>NIR</i>	The National Inventory Report is submitted annually, and contains information on emissions and removals of greenhouse gases and details of the activities the country has undertaken to implement the UNFCCC and Kyoto protocol.
<i>PA</i>	The Production Approach reports changes in the carbon stock in the HWP pool where the wood originates from domestic harvest. The HWP pool thus includes domestically harvested wood that is exported.
<i>SCA</i>	The Stock Change Approach reports changes in the carbon stock in the HWP pool in the country.
<i>SCAD</i>	The Stock Change Approach for HWP of Domestic Origin reports changes in the carbon stock in the HWP pool in the country where the wood originates from domestic harvest. In this approach only domestic wood that is residing in the country is thus considered.
<i>SDA</i>	The Simple Decay Approach reports net emissions of carbon to and from the atmosphere for domestically harvested wood, including domestic wood that is exported.
<i>Stock method</i>	In the stock method, stock changes are calculated as the difference in total stock at the beginning and end of the period.
<i>SWDS</i>	Solid waste disposal sites, also referred to as landfills.

- Tiers* A tier represents a level of methodological complexity. Tier 1 is the basic method, Tier 2 the intermediate and Tier 3 the most demanding method in terms of complexity and data requirements. Tier 2 and Tier 3 methods are generally considered to be more accurate than Tier 1 methods.
- $t_{1/2}$  The concept of half-lives originated in describing how long it takes atoms to undergo radioactive decay, it is however used in several other situations. In this report, the life-time of solid wood products and paper and paper products are described by their half-life – the mean time it takes a pool of HWP to lose half its mass. The mathematical relation between the half-life and life-time of a product is:  
 $t_{1/2} = \text{Average life-time} * \ln 2$ .
- UNFCCC* The United Nations Framework Convention on Climate Change is an international treaty that sets general goals and rules for confronting climate change.

### 3. Data sources

The overall estimation of the emissions/removals due to HWP with both models is indicated in figure 3.1. The statistical data sources and parameters needed in the calculations are elaborated below.

**Figure 3.1. The connection between activity data, parameters, models and approaches used in the estimation of emissions/removals due to HWP**

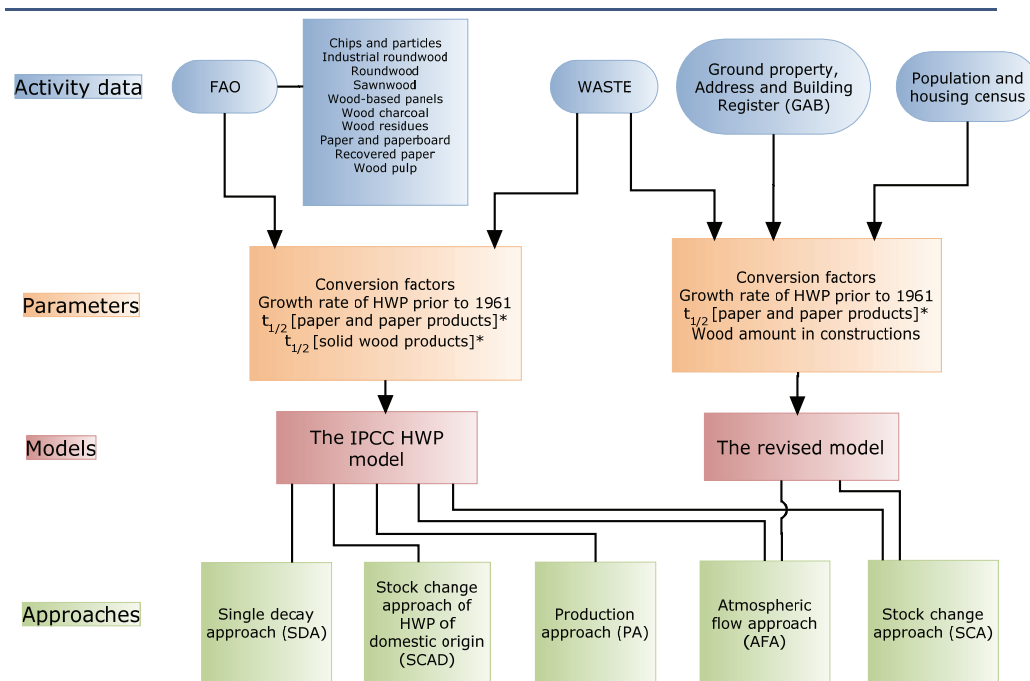

\*  $t_{1/2}$  refers to half-life

#### 3.1. The IPCC HWP model

The activity data needed as input in the IPCC HWP model are statistics on production, import and export of semi-finished wood products from the FAO statistical databases (FAO 2008). Appendix D shows the commodities that are included. Activity data on waste is found in the Waste sector spreadsheets (IPCC 2006b). In addition to the activity data, a set of parameters are needed. Default values for these parameters are provided by 2006 Guidelines (IPCC 2006a). Wherever it was possible, national values have been used instead of the default values, see table A4, Appendix A.

The national values of density, bark factor and growth rate of HWP consumption prior to 1961 have been estimated using the density and bark factor on Norwegian spruce, pine and deciduous trees (Kucera 1980, 1985; Lunnan *et al.* 1991) and commercial roundwood removals (Statistics Norway 2008a).

#### 3.2. The revised model

In the revised model, the solid wood stock is estimated by a direct inventory of the Norwegian building stock for the years 1990 and 2001. The statistical data sources are indicated in table 3.1, the wood factors are based on expert judgements by (Fjulsrud and Bunkholt, pers. comm. 2009). Fjulsrud and Bunkholt have also provided estimates of the total annual consumption of wood in the renovation and extension sector, and the total annual consumption and life-times of wood in civil engineering structures and for furniture, windows, doors, fixtures and fittings etc.

The annual stock changes are however estimated with the IPCC HWP model (after it is fitted to the direct inventories). The stocks and stock changes for paper and waste are estimated by the IPCC HWP model. The activity data for this part of the

calculations are the same as for the IPCC HWP model, except for the half-life of solid wood products. The half-lives are determined by the fitting of the IPCC HWP model to the direct inventories.

**Table 3.1. Statistical data sources for the components in the direct inventory**

---

<b>The Population and Housing Census (Statistics Norway 2008c)</b>
Number and average utility floor space of dwellings, divided by building type and construction year
<b>Building statistics (Statistics Norway 2009)</b>
Share of wooden dwellings
<b>The Ground Property, Address and Building Register (GAB) (Norwegian Mapping Authority 2009)</b>
Total basal area of garages, outhouses and annexes linked to dwellings
Total basal area of holiday houses, detached houses and farmhouses used as holiday houses
Total basal area of garages, outhouses and annexes linked to holiday houses
Total basal area of fishermen's shack, cabins, turf huts etc., boat-houses, wharfside sheds
Total basal area of non-residential buildings

---

## 4. Estimation methods and models

HPW includes all wood material (including bark) that leaves harvest sites. Slash and other material left at harvest sites should be regarded as dead organic matter and not as HWP. During one year, new products will be added to the HWP pool, while a part of the already existing HWP pool will be discarded from use. When products are added to the pool the emission of CO<sub>2</sub> from those products are offset, while used products that are discarded will add to the CO<sub>2</sub> emissions in that year. To emphasize, if more products enter the pool than what are discarded, the HWP contribution will be negative since less CO<sub>2</sub> is emitted than what is sequestered in wood products. HWP are thus acting as a sink, and this is referred to as removals of CO<sub>2</sub>. If more wood is discarded from use than stored in a given year, a net emission of CO<sub>2</sub> will occur and the HWP contribution will be positive. In this case HWP are acting as a source, and this is referred to as emissions of CO<sub>2</sub>. The annual stock changes in the HWP pool will thus determine the amount of CO<sub>2</sub> that is emitted to or sequestered from the atmosphere due to HWP, and is called the HWP contribution to AFOLU CO<sub>2</sub> emissions/removals. The basis for calculating the HWP contribution is therefore to estimate the stock changes in the existing HWP pools for any given year.

Two main estimation methods have been suggested for calculating the stock changes; the flux method and the stock method. The HWP pool consists of several sub pools and the data availability and corresponding quality for flux and stock data may differ for the different pools. A pure flux or a pure stock method is thus not necessarily the best overall choice of method when computing stock changes. A combination of the flux and stock method where the availability and quality of the activity data determine the best method to use in each case may give better results.

Two methods for estimating the HWP contribution with flux and stock data will be presented here. The first method is the IPCC HWP model provided as a spreadsheet in the 2006 IPCC Guidelines (IPCC 2006a), however with country-specific parameters whenever possible.

In the second method, which we have named the revised model, the solid wood stock is calculated by performing a direct stock inventory in selected years, while the paper stock and HWP in landfills are calculated with the IPCC HWP model. For the non-inventory years, stock changes of solid wood products are interpolated/extrapolated with the IPCC HWP model. The revised model is based on the combined method developed at Statistics Norway (Gjesdal *et al.* 1996; Flugsrud *et al.* 2001) and the model used for estimating the HWP contribution in the Finnish National GHG Inventory report (The Finnish National Inventory Report 2008).

It is important to note that not all models are applicable on all approaches, this will be discussed later.

### 4.1. The IPCC HWP model

A HWP spreadsheet is provided by the 2006 IPCC Guidelines (IPCC 2006a) to model the HWP contribution for any given country. The IPCC HWP model used is slightly modified by K. Pingoud at VTT Technical Research Centre of Finland to include the stock change approach for HWP of domestic origin. The HWP contribution is calculated for all the approaches for the entire reporting period, and this allows us to compare trends with other statistics to get a more comprehensive understanding of the driving forces. The IPCC HWP model is elaborated in Appendix A and the 2006 IPCC Guidelines (IPCC 2006a), only a brief description is given here.

In the IPCC HWP model the stock changes are calculated with a flux method. The inflow to the HWP pool is calculated from activity data on semi-finished products like sawnwood, wood pulp, wood-based panels and paper and paperboard (See Appendix D for the product groups included). Activity data on production, import and export dating back to 1961 are readily downloaded from the FAO database (FAO 2008). The growth rate of HWP consumption prior to 1961 is estimated.

The outflow from the HWP pools is estimated with a life-time analysis where it is assumed that the decay follows a first order decay mechanism, however other decay profiles may be applied if desired. The semi-finished products are aggregated in two main groups with very different half-lives; solid wood products and paper products. The model is very sensitive to the life-time estimations. The key feature of first order exponential decay is that the rate of loss of mass at any given time is directly proportional to the mass present at that time. The fact that the rate of loss only depends on the total stock in the previous year and the inflow in the given year causes the calculations to be rather easy to implement.

The advantage of counting the semi-finished products is that the activity data are easily available from the FAO database, they are of high quality, and the risk of double counting is low. The disadvantage is clearly that the fate of the products is less precisely known, and thus the half-lives are difficult to estimate. A loop hole is that products which are exported or imported as finished products will not be counted at all in this method, and this can have impact for a country which is a net importer or exporter of finished wood products.

If desired, it is also possible to include HWP in landfills. Data for these calculations are provided by the Waste Sector spreadsheets (IPCC 2006b). At the Tier 1 level, only the long-lived HWP stored in landfills are included. Note that there are no emissions from the long-lived HWP in landfills, and the carbon stock will increase for each year.

In addition to the FAO activity data, a set of lifetimes, conversion factors and growth rate of HWP prior to 1960 is needed in order to estimate the HWP contribution. Default values for all the factors are provided in the 2006 IPCC guidelines. All parameters have been evaluated in Appendix A and, whenever possible, national values have been estimated from available statistical data and employed instead of the default values. See table 4.4, Appendix A for the values used in the calculations.

The IPCC HWP model is applicable to all the approaches reviewed in this report.

### The HWP variables

The IPCC HWP model provides a set of variables that can be used to estimate the HWP contribution to AFOLU CO<sub>2</sub> emissions/removals for different approaches, see table 4.4. The HWP variables are mathematically defined in Appendix C.

The HWP variables give information about annual changes in carbon stock, trade flows and harvest. The changes in carbon stock depend on whether the carbon stocks are composed of wood from domestic harvest (DH), or if only wood that resides in the country is accounted for (DC):

$\Delta C_{\text{HWP IU DC}}$ : The annual carbon stock change for HWP in use within the national boundaries.

$\Delta C_{\text{HWP SWDS DC}}$ : The annual carbon stock change for HWP in domestic landfills

$\Delta C_{\text{HWP IU DH}}$ : The annual carbon stock change for domestically harvested HWP

$\Delta C_{\text{HWP SWDS DH}}$ : The annual carbon stock change for domestically harvested HWP in landfills

$P_{\text{IM}}$ : Annual imports of carbon in HWP

$P_{\text{EX}}$ : Annual exports of carbon in HWP

$H$ : Annual harvest of roundwood for products



**Table 4.4. HWP variables used to estimate the HWP contribution calculated by the IPCC HWP model.**

Variable definition	Variable names	
	HWP in "products in use"	HWP in landfills (SWDS)
1. Annual change in carbon stock in a) HWP in use, and b) HWP in solid waste disposal sites in the reporting country, this is wood carbon that came from domestic consumption of products, $\Delta C_{HWP\ DC} = \Delta C_{HWP\ IU\ DC} + \Delta C_{HWP\ SWDS\ DC}$	Variable 1A $\Delta C_{HWP\ IU\ DC}$	Variable 1B $\Delta C_{HWP\ SWDS\ DC}$
2. Annual change in carbon stock in a) HWP in use, and b) HWP in solid waste disposal sites where the wood in the products came from domestic harvest – trees harvested in the reporting country, this includes exported HWP to other countries, $\Delta C_{HWP\ DH} = \Delta C_{HWP\ IU\ DH} + \Delta C_{HWP\ SWDS\ DH}$	Variable 2A $\Delta C_{HWP\ IU\ DH}$	Variable 2B $\Delta C_{HWP\ SWDS\ DH}$
3. Carbon in annual imports of HWP to the reporting country including all wood-based material – roundwood, solid wood products, paper, pulp and recovered paper	$P_{IM}$	
4. Carbon in annual exports of HWP from the reporting country including all wood-based material – roundwood, solid wood products, paper, pulp and recovered paper	$P_{EX}$	
5. Carbon in annual harvest of roundwood for products – wood removed from harvest sites in the reporting country, including fuel wood	H	

Notation:  $\Delta$  refers to changes  
C refers to carbon stock  
IU refers to products In Use  
SWDS refers to products in landfills  
DC refers to products in Domestic Consumption  
DH refers to products from Domestic Harvest.

Carbon release to the atmosphere can also be estimated by the HWP variables, the mathematical equations are shown in Appendix C.

The HWP variables are provided by the IPCC HWP model for all years, and are used in the estimation of the HWP contribution reported by the different approaches (see Chapter 5).

### Tiers

The IPCC HWP model is a Tier 1 method when the default values provided by the 2006 IPCC Guidelines are employed. It can be converted to a Tier 2 method by using country-specific data to improve estimates of annual carbon change. Country-specific data can for instance be annual production, imports and exports, factors to convert activity data to carbon, half-lives or inclusion of the fraction of wood that decays in landfills. In this work, using the values in table A4, Appendix A, the IPCC HWP model can be considered a Tier 2 method.

## 4.2. The revised method - direct inventory and the IPCC HWP model

An alternative and country specific method for estimating emissions/removals of CO<sub>2</sub> from harvested wood products is to combine the flux method in the IPCC HWP model with a direct inventory of solid wood products (first order decay method and Method D, IPCC 2006, p.12.15-16). This method is elaborated in Appendix B, only a brief description is given here.

The three components of HWP are treated in the following way in this model:

**Paper and paper products:** The carbon stock of paper and paper products is estimated in the same manner as in the IPCC HWP model described in section 4.1, with mainly default parameters.

**HWP in landfills:** The carbon stock HWP in landfills is estimated in the same manner as in the IPCC HWP model described in section 4.1.

**Solid wood products:** The carbon stock of solid wood products has been estimated by performing direct inventories of wood stored in buildings (e.g. houses, cottages, garages, industrial buildings) for the years 1990 and 2001. Due to the lack of reliable statistics, the carbon stock in civil engineering constructions like bridges and piers, together with furniture, stairs and doors etc. was estimated by a flux method with a life-time analysis. The stock in the non-inventory years is then estimated in two steps. First the carbon stock of solid wood products in the IPCC HWP model<sup>1</sup> is fitted to the results from the direct inventories. This results in country specific and decade dependent values for the half-life of solid wood products. Second, the fitted HWP model is used to estimate the carbon stock and its annual change in the other years. The IPCC HWP model is thus used as an interpolation/extrapolation tool to the direct inventories, and this is a country-specific method.

A direct inventory can only be performed where the actual HWP pool is, which is as finished products. For solid wood products we have included wood stored in or in connection to buildings (e.g. houses, terraces, cottages, garages, furniture, industrial buildings) and in civil engineering constructions (e.g. bridges, piers). Typical parameters needed in the calculations are for example statistics on dwellings, holiday houses, garages and industrial buildings combined with the wood content per square meter of building, or estimations of how much wood is used yearly for renovation and extensions. The only time a total inventory of dwellings is performed in Norway is during a Population and Housing Census, thus these are the best years for performing direct inventories. The years of the two latest censuses, 1990 and 2001 were therefore chosen.

A country-specific method for estimating the stock inventory of carbon stored in buildings and furniture in Norway has earlier been developed at Statistics Norway (Gjesdal *et al.* 1996; Flugsrud *et al.* 2001). The same method has been used here, however with some improvements and modifications. The most important modification is the inclusion of uninhabited buildings like cabins, outbuildings and garages, civil engineering structures and wood used in the renovation sector for renovation and extensions. The method has also been improved by assigning different wood contents to dwellings depending on building type and construction year. Changes in building tradition are thus incorporated in the model. A comparison of the results with the revised model and the combined model is given in Appendix B.

As the revised model incorporates a direct stock inventory of buildings *in the country*, it is only applicable to the stock change and atmospheric flow approaches (see Chapter 5).

### Tiers

The stocks and stock changes of paper and paper products and HWP in landfills are calculated in the same manner as in the IPCC HWP model, and is thus a Tier 1 method. The stocks of solid wood products are calculated with a country-specific Tier 3 method.

---

<sup>1</sup> The IPCC HWP model used is slightly modified by Kim Pingoud at VTT Technical Research Centre of Finland to include the possibility of using different half-lives for solid wood products for different time periods.

## 5. Approaches for reporting and accounting

There are several suggestions on how to report the HWP contribution to AFOLU under the UNFCCC and how to account for it in the new commitment period after 2012. The purpose of all the approaches is to assign a net removal/emission of CO<sub>2</sub> from HWP to each country. All approaches assign the removals *when* they occur, the difference lies in *where* the removals are assigned, i.e. to which country. The question is if it is the producing or consuming country that should account for emissions/removals of CO<sub>2</sub> from the harvested wood products. Should it be allowed to build up a stock of HWP in another country than where the harvesting occurred, or only within the national barriers?

There are four different approaches described in the 2006 IPCC Guidelines (IPCC 2006a), all will be presented here. In addition an approach called the Stock change approach for HWP of domestic origin (SCAD) or Tuvalu approach is also presented. All approaches except the last will give the correct world total if the HWP contributions from all countries are summed up.

It is outside the scope of this report to go into depth concerning the policy relevance of the approaches, some incentives are however presented here. It should also be noted that the use of fuel wood will have very different incentives among the approaches, depending on imports and exports. This will however not be discussed further in this report.

In accordance with the 2006 IPCC Guidelines the HWP contribution is presented as CO<sub>2</sub> release from HWP. Note that the HWP contribution in all cases is expressed in terms of the HWP variables defined in section 4.1.

### 5.1. The Stock-Change Approach (SCA)

In the stock change approach (SCA), stock changes in HWP are accounted for in the consuming country, when and where they occur. The HWP stock thus includes all wood in the country, both products in use and products in landfills. The system boundary of the SCA is shown in figure 5.1 and is equal to the national boundary.

$$\begin{aligned} \text{Removal due to HWP} &= \text{Stock change consumed products} \\ &= \text{Wood consumption} - \text{decomposition/combustion of} \\ &\quad \text{wood consumed} \end{aligned}$$

Using the HWP variables (see table 4.4 and Appendix C), the HWP contribution to AFOLU net CO<sub>2</sub> emissions in the stock change approach is given by:

$$\begin{aligned} \text{HWP Contribution}_{SCA} &= -\frac{44}{12} \cdot (\Delta C_{HWP IU_{DC}} + \Delta C_{HWP SWDS_{DC}}) \\ &= -\frac{44}{12} \cdot (H + P_{IM} - P_{EX} - \uparrow C_{HWP DC}) \end{aligned}$$

The term 44/12 arises from the conversion of tonnes of carbon to tonnes of CO<sub>2</sub>.

The SCA resembles most closely the estimation methods used for other sources, and it is consistent with how LULUCF is treated in the Kyoto protocol and in the 1996 IPCC guidelines (IPCC 1996; Kyoto protocol). It is also the simplest of the approaches with regard to data requirements. However, since a country can build up a stock of imported HWP the SCA may give incentives to import wood from deforestation or other unsustainable sources like illegal loggings.

Figure 5.1. System boundary of the stock change approach

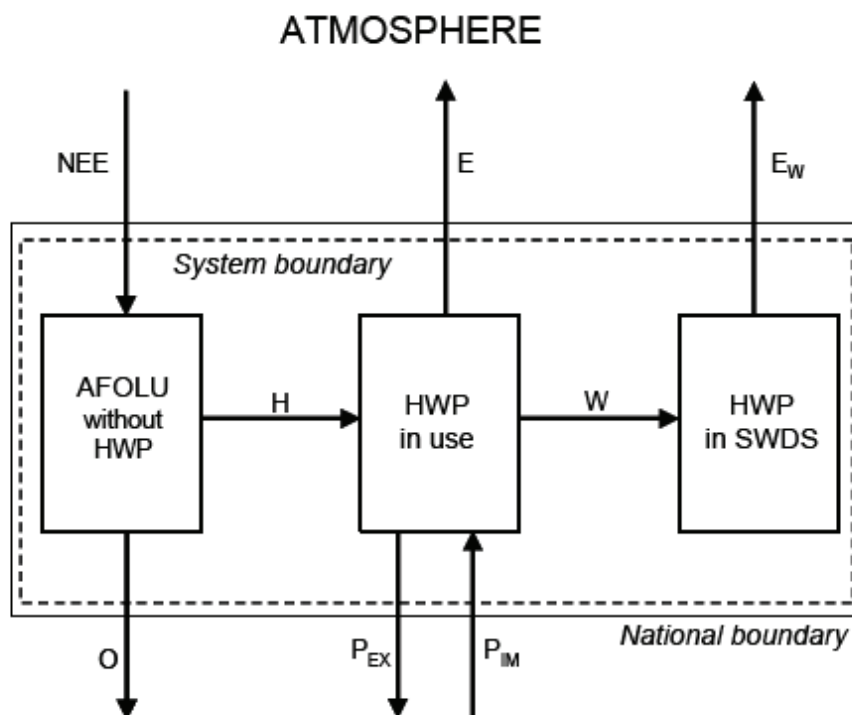

Source: 2006 IPCC Guidelines (IPCC 2006a).

NEE = net ecosystem exchange of carbon, E = carbon release to the atmosphere from HWP in use,  $E_w$  = carbon release to the atmosphere in landfills, H = carbon transfer in the form of harvested wood biomass transported from harvest sites, W = carbon transfer in the form of wood waste into landfills,  $P_{EX}$  = carbon transfer in the form of HWP exports,  $P_{IM}$  = carbon transfer in the form of HWP imports, O = possible other cross-border carbon transfers from rest of AFOLU (assumed zero here).

## 5.2. The Atmospheric Flow Approach (AFA)

In the atmospheric flow approach (AFA), the fluxes of carbon to and from the atmosphere are estimated, when and where they occur. Emissions from all HWP in domestic use are included. The system boundary of the AFA is shown in figure 5.2, and is the boundary between a country and the atmosphere.

$$\text{Removal due to HWP} = \text{Stock change consumed products} + \text{export} - \text{import}$$

Using the HWP variables, the HWP contribution to AFOLU net CO<sub>2</sub> emissions in the atmospheric flow approach is given by:

$$\begin{aligned} \text{HWP Contribution}_{AFA} &= -\frac{44}{12} \cdot (H - \uparrow C_{HWPDC}) \\ &= -\frac{44}{12} \cdot (\Delta C_{HWP IU DC} + \Delta C_{HWP SWDS DC} + P_{EX} - P_{IM}) \\ &= \text{HWP Contribution}_{SCA} - \frac{44}{12} \cdot (P_{EX} - P_{IM}) \end{aligned}$$

The last equation arises since the HWP contribution reported by the SCA is expressed by  $\Delta C_{HWP IU DC} + \Delta C_{HWP SWDS DC}$ . The only numerical difference between the AFA and the SCA is thus the term containing net export. The AFA will give vast removals of CO<sub>2</sub> for a country with a large net export of HWP, while for importing countries HWP will be a source of emissions.

The AFA is inconsistent with the existing reporting/accounting system of LULUCF which is based on stock-changes. And HWP would be treated differently than other

biomass like wood-based biofuels. The numerical difference between the SCA and AFA is only net export, data requirements are thus almost as simple as for the SCA. In general, the atmospheric flow approach gives incentives to producing countries to increase their export, and not necessarily to increase the stock of wood products. Note that in the specific case when the stock changes of carbon in the HWP pools are zero, the net carbon export must still be reported as the HWP contribution with this approach.

Figure 5.2. System boundary of the atmospheric flow approach

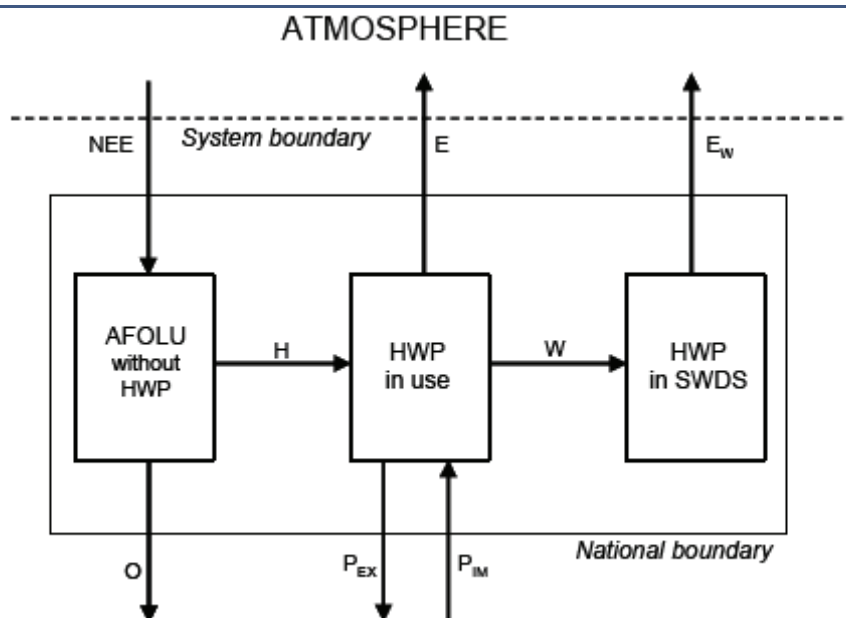

Source: 2006 IPCC Guidelines (IPCC 2006a).

NEE = net ecosystem exchange of carbon, E = carbon release to the atmosphere from HWP in use, E<sub>w</sub> = carbon release to the atmosphere in landfills, H = carbon transfer in the form of harvested wood biomass transported from harvest sites, W = carbon transfer in the form of wood waste into landfills, P<sub>EX</sub> = carbon transfer in the form of HWP exports, P<sub>IM</sub> = carbon transfer in the form of HWP imports, O = possible other cross-border carbon transfers from rest of AFOLU (assumed zero here).

### 5.3. The Production Approach (PA)

In the production approach (PA), stock changes in HWP are accounted for in the harvesting country, when, but not where they occur if products are traded. The HWP stock thus includes all wood from domestic harvest regardless of which country the wood is exported to. The system boundary of the PA shown in figure 5.3 will thus exceed the national boundary in order to include exported HWP. Imported HWP are however not included, and this approach does not provide a complete inventory of wood in national stocks.

$$\begin{aligned}
 \text{Removal due to HWP} &= \text{Stock change domestic-grown products} \\
 &= \text{Wood production} - \text{decomposition/combustion of wood grown in country}
 \end{aligned}$$

Using the HWP variables, the HWP contribution to AFOLU net CO<sub>2</sub> emissions in the production approach is given by:

$$\begin{aligned}
 \text{HWP Contribution}_{PA} &= -\frac{44}{12} \cdot (\Delta C_{HWP IU_{DH}} + \Delta C_{HWP SWDS_{DH}}) \\
 &= -\frac{44}{12} \cdot (H - \uparrow C_{HWP DH})
 \end{aligned}$$

Since exported HWP are included in the PA, the complexity and uncertainty of this approach compared to the SCA is high, and it is difficult to use national statistics as a basis for higher Tiers.

**Figure 5.3. System boundary of the Production Approach**

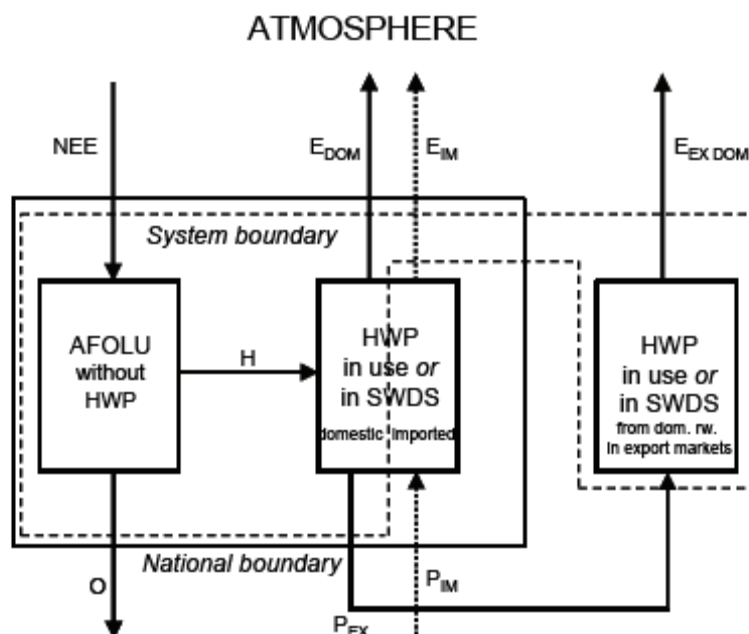

Source: 2006 IPCC Guidelines (IPCC 2006a).

NEE = net ecosystem exchange of carbon,  $E_{DOM}$  = carbon release to the atmosphere from the pools of domestically grown HWP in use and in landfills,  $E_{EX DOM}$  = carbon release to the atmosphere from the pools of domestically grown but exported HWP in use and in landfills,  $H$  = carbon transfer in the form of harvested wood biomass transported from harvest sites,  $P_{EX}$  = carbon transfer in the form of HWP exports,  $P_{IM}$  = carbon transfer in the form of HWP imports,  $O$  = possible other cross-border carbon transfers from rest of AFOLU (assumed zero here). Note that only those HWP in the export markets that are produced from domestic roundwood are within the system boundary, not those processed domestically from imported roundwood. The transfer  $P_{EX}$  can in principle include both.

#### 5.4. The Simple Decay Approach (SDA)

The simple decay approach (SDA) estimates net emissions/removals of carbon to and from the atmosphere when, but not where they occur if products are traded. Emissions from all HWP harvested domestically are included, also if the products are exported.

The HWP contribution to AFOLU net CO<sub>2</sub> emissions in the simple decay approach under 2006 IPCC Guidelines is given by:

$$HWP Contribution_{SDA} = -\frac{44}{12} \cdot (H - \uparrow C_{HWP DH})$$

Comparing this equation with the HWP Contribution from the PA, it is evident that the two equations are equal. The SDA will thus give the same HWP contribution as the production approach, and the SDA is therefore not discussed any further in this report.

#### 5.5. The Stock Change Approach for HWP of Domestic Origin (SCAD)

The stock change approach for HWP of domestic origin (SCAD), also known as the Tuvalu Approach, is the intersection of the SCA and PA. It only includes HWP from domestic harvest that stays within the national boundaries. This means that all exported and imported HWP are disregarded, only domestically harvested wood

that resides in the country is accounted for. This approach does not provide a complete inventory of wood in national stocks.

$$\begin{aligned} \textit{Removal due to HWP} &= \textit{Stock change domestic-grown products in domestic use} \\ &= \textit{Wood production} - \textit{decomposition/combustion of wood} \\ &\quad \textit{grown and in use in country} \end{aligned}$$

There are no HWP variables published that can be used to express the HWP contribution to AFOLU net CO<sub>2</sub> emissions in the stock change approach for HWP of domestic origin. However, if we use the same notation as above it can be expressed by:

$$\begin{aligned} \textit{HWP Contribution}_{SCAD} &= -\frac{44}{12} \cdot \left( \Delta C_{HWP IU_{DCDH}} + \Delta C_{HWP SWDS_{DCDH}} \right) \\ &= -\frac{44}{12} \cdot \left( H - P_{EX} - \uparrow C_{HWP_{DCDH}} \right) \end{aligned}$$

The possible problems with the SCA concerning imported, potentially unsustainable wood are avoided in the SCAD since only domestically harvested wood within country limits is accounted for. The problems with the PA where the country assumes responsibility of exported HWP from domestic harvest are also omitted in this approach. The SCAD estimates are however more complex and uncertain than the SCA, and this is the only approach that will not give a correct world total if the HWP contributions from all countries are summed up.

## 6. Results and discussions for Norway

### 6.1. CO<sub>2</sub> emissions/removals estimated with the IPCC HWP model

As mentioned earlier, the IPCC HWP worksheet (IPCC 2006a) is a tool for estimating the annual development of the carbon balance in HWP, using any of the alternative HWP approaches. The carbon stock in the model consists of three components, solid wood products, paper products and HWP stored in landfills.

The advantages with the IPCC HWP model is that it is easy to use, the activity data are easily accessed and of good quality, the risk of double counting is low and the model provides figures for all approaches for all years from 1990 to present. The results presented here are based on the procedure and figures in Appendix A, and can thus be considered to originate from a Tier 2 model. The product group “other industrial roundwood” is not included in the calculations in order to give a conservative estimate (as recommended in the IPCC HWP spreadsheet).

Using activity data from the FAO database together with the parameters shown in table A4, Appendix A, the IPCC HWP model gives the HWP contribution shown in figure 6.1, 6.2 and table 6.1. In order to discuss the effect of including HWP in landfills, results both with and without waste are presented.

**Figure 6.1. Estimated emissions from HWP including waste for the different approaches, estimated with the IPCC HWP model, 1990-2006. 1000 tonnes CO<sub>2</sub>**

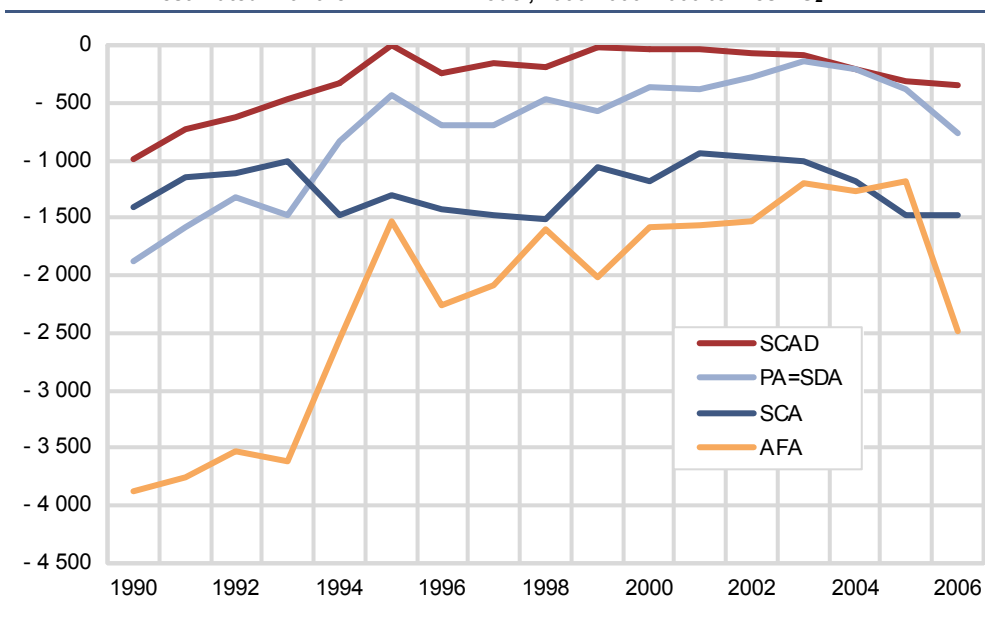



**Figure 6.2. Estimated emissions from HWP for the different approaches (waste is not included) estimated with the IPCC HWP model, 1990-2006. 1000 tonnes CO<sub>2</sub>**

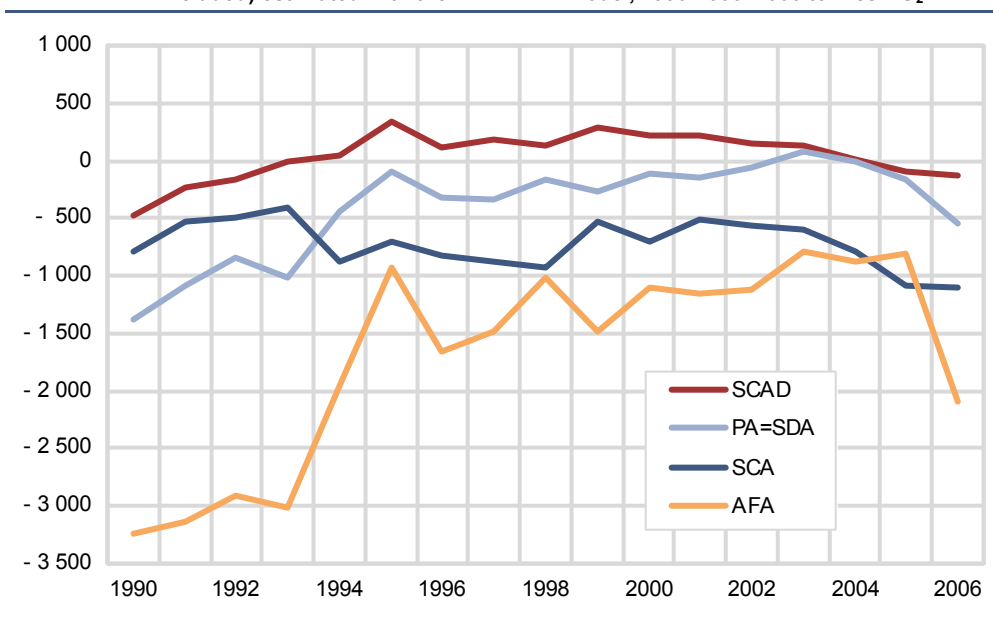

**Table 6.1. CO<sub>2</sub> emissions/removals to AFOLU for the different approaches (waste is not included) and net export, 1990-2006. 1000 tonnes CO<sub>2</sub>**

	SCA	PA/SDA	AFA	SCAD	Net export
1990	-783	-1 374	-3 246	-482	2 463
1991	-533	-1 089	-3 138	-241	2 605
1992	-493	-846	-2 912	-159	2 418
1993	-405	-1 009	-3 013	-12	2 608
1994	-872	-447	-1 945	42	1 074
1995	-706	-97	-924	337	218
1996	-829	-328	-1 660	109	831
1997	-880	-343	-1 492	180	612
1998	-923	-159	-1 013	133	91
1999	-526	-273	-1 487	279	961
2000	-705	-114	-1 102	220	397
2001	-519	-143	-1 149	214	630
2002	-572	-54	-1 128	153	556
2003	-605	81	-792	125	187
2004	-794	-4	-876	10	82
2005	-1 086	-167	-804	-96	-281
2006	-1 096	-554	-2 094	-131	997

In order to discuss changes in the different approaches, one should also keep the HWP variables in mind. The equations for calculating the HWP contribution for the different approaches from the HWP variables (Chapter 5) and the definition of the HWP variables (Chapter 4) are repeated here in order to make the interpretation easier.

- $\Delta C_{HWP\ IU\ DC}$ : The annual carbon stock change for HWP in use residing within the national boundaries
- $\Delta C_{HWP\ SWDS\ DC}$ : The annual carbon stock change for all HWP in domestic landfills
- $\Delta C_{HWP\ IU\ DH}$ : The annual carbon stock change for all domestically harvested HWP
- $\Delta C_{HWP\ SWDS\ DH}$ : The annual carbon stock change for domestically harvested HWP in landfills
- $P_{IM}$ : Annual imports of carbon in HWP
- $P_{EX}$ : Annual exports of carbon in HWP
- $H$ : Annual harvest of roundwood for products

$$HWP\ Contribution_{SCA} = -\frac{44}{12} \cdot (\Delta C_{HWP\ IU_{DC}} + \Delta C_{HWP\ SWDS_{DC}})$$

$$HWP\ Contribution_{AFA} = -\frac{44}{12} \cdot (\Delta C_{HWP\ IU_{DC}} + \Delta C_{HWP\ SWDS_{DC}} + P_{EX} - P_{IM})$$

$$HWP\ Contribution_{PA} = -\frac{44}{12} \cdot (\Delta C_{HWP\ IU_{DH}} + \Delta C_{HWP\ SWDS_{DH}})$$

$$HWP\ Contribution_{SCAD} = -\frac{44}{12} \cdot (\Delta C_{HWP\ IU_{DCDH}} + \Delta C_{HWP\ SWDS_{DH}})$$

Note that the proportion of waste in SCAD is set equal to the proportion of waste in PA (see Appendix C).

The HWP variables estimated with the IPCC HWP model are presented in figure 6.3 for the entire reporting period. Note that figure 6.3B is a segment of figure 6.3A, only showing values below 0.5 million tonnes C.

**Figure 6.3. Time development of the HWP variables (defined in table 4.4, Chapter 4), 1990-2006. Note that B is a segment of A, only showing values below 0.5 million tonnes C. 1000 tonnes CO<sub>2</sub>**

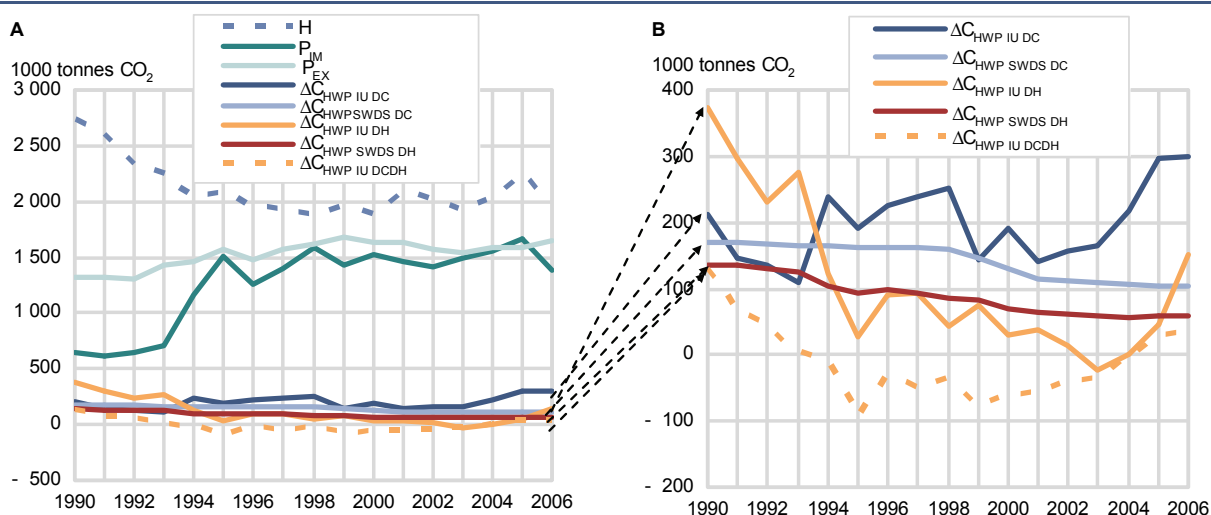

### An example

In order to get a better understanding of the HWP variables, the carbon flows and stock changes estimated by the IPCC HWP model for year 2000 are illustrated in figure 6.4 for the SCA and AFA (including waste). The emissions reported by the two approaches are calculated in the following way from the HWP variables shown in the figure:

$$\begin{aligned}
 HWP\ Contribution_{SCA} &= -\frac{44}{12} \cdot (\Delta C_{HWP\ IU_{DC}} + \Delta C_{HWP\ SWDS_{DC}}) \\
 &= -\frac{44}{12} \cdot (190\ 000 + 130\ 000)\ tonnes\ C \\
 &= -1173\ 000\ tonnes\ CO_2
 \end{aligned}$$

$$\begin{aligned}
 HWP\ Contribution_{AFA} &= -\frac{44}{12} \cdot (\Delta C_{HWP\ IU_{DC}} + \Delta C_{HWP\ SWDS_{DC}} + P_{EX} - P_{IM}) \\
 &= -\frac{44}{12} \cdot (190\ 000 + 130\ 000 + 1640\ 000 - 1530\ 000)\ tonnes\ C \\
 &= -1\ 576\ 000\ tonnes\ CO_2
 \end{aligned}$$

Figure 6.4. Illustration of estimated C flows and stock changes for the SC and AF approaches (waste is included), 2000. Million tonnes C

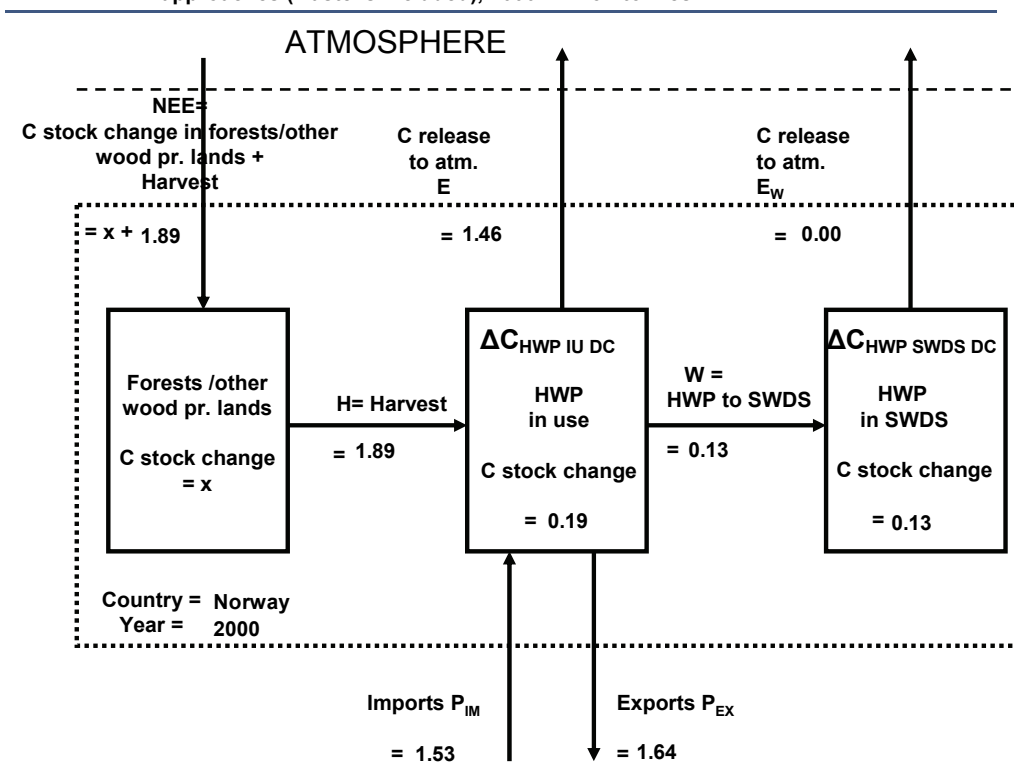

Source: IPCC HWP model spreadsheet (IPCC 2006a), slightly modified.

The HWP contributions for the different approaches estimated with the IPCC HWP model depends on many factors, thus it is difficult to interpret annual changes. The mathematical relationship between the activity data and the HWP contributions is complicated. This is also the case for the relationship between the different approaches. We have however tried to make some considerations.

As can be seen from figure 6.2 there is a pronounced change around 1993-1995. This is most evident in the atmospheric flow approach, but can be seen in all approaches. Figure 6.3 shows that the import and export variables ( $P_{IM}$  and  $P_{EX}$ ) are significantly larger than the stock change variables ( $\Delta C_{HWP}$ ). In the case of the AFA, which is the sum of the stock changes in wood in Norway and net export, it is clear that in periods with high net export, the net export term will dominate the equation. The emissions/removals reported by the AFA will then mainly be determined by the net export. The import/export balance of semi-finished HWP in Norway is shown in figure 6.5 and it is evident that the imports increased by almost a factor of two from 1993 to 1995, while the export only increased slightly. The increased import is mainly due to a large increase in imported roundwood, which in turn correlates with a marked increase in the number of houses being constructed after the recession in the Norwegian economy around 1990 (figure 6.6). Figure 6.8 displays the emissions/removals of  $CO_2$  reported by the approaches dating back to 1961, for easier comparison with the other statistics.

Note also the curve crossings in figure 6.2 around 1993-1994 and 2004-2005 which are mainly caused by significant changes in the import/export balance (see figure 6.5). This is a clear example of the fact that which approach is most suitable will vary over time, even for a single country, depending on changes in imports and exports of wooden products.

**Figure 6.5. Imports and exports at the level of semi-finished products used in the IPCC HWP model, 1961-2006. 1000 tonnes C**

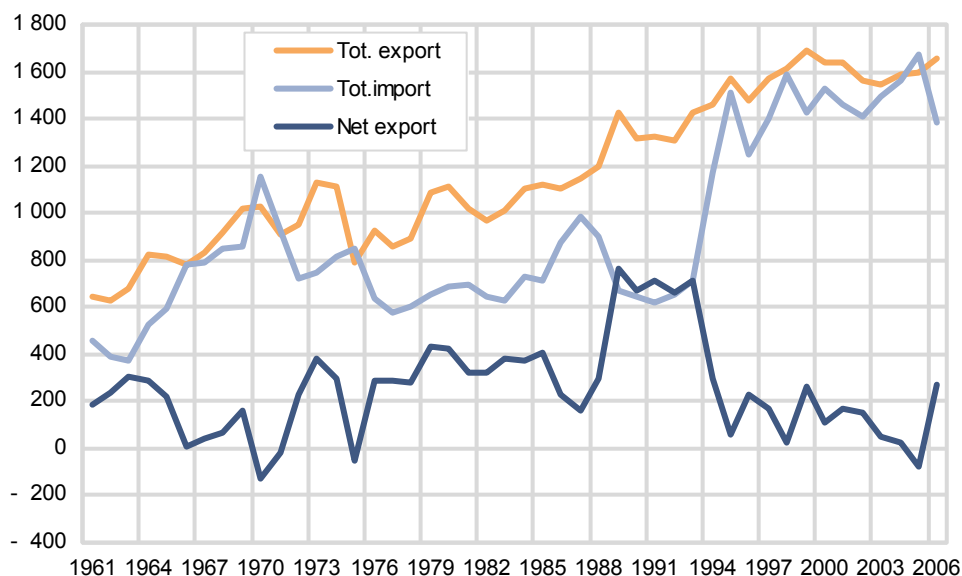

**Figure 6.6. Building work started, 1967-2007. Number of dwellings**

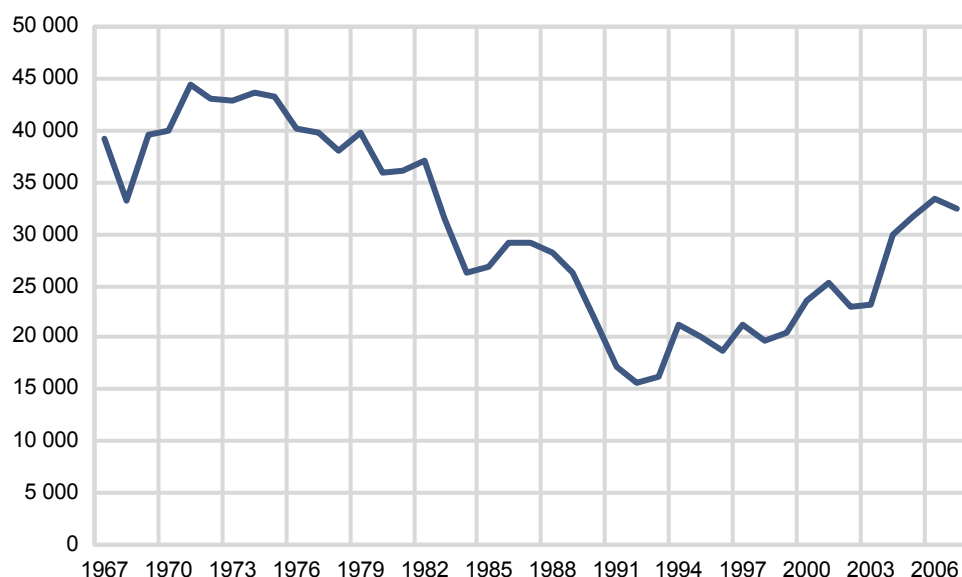

Source: Statistics Norway 2009

**Waste:** Including waste will always lead to increased removal of CO<sub>2</sub> since only long-lived HWP in landfills are included at the Tier 1 level. Comparing the HWP contributions in figure 6.1 and 6.2, it is clear that including waste shifts the different emission curves down by 200-600 1000 tonnes C during the reporting period. The difference between emissions with and without waste is shown in figure 6.7. It is evident that the annual change of sequestration of carbon in HWP in landfills is decreasing with time, thus making a smaller contribution to the emissions/removals of CO<sub>2</sub> due to HWP.

**Figure 6.7.** The effect of including waste on the emissions reported by the different approaches, 1990-2006. 1000 tonnes CO<sub>2</sub>

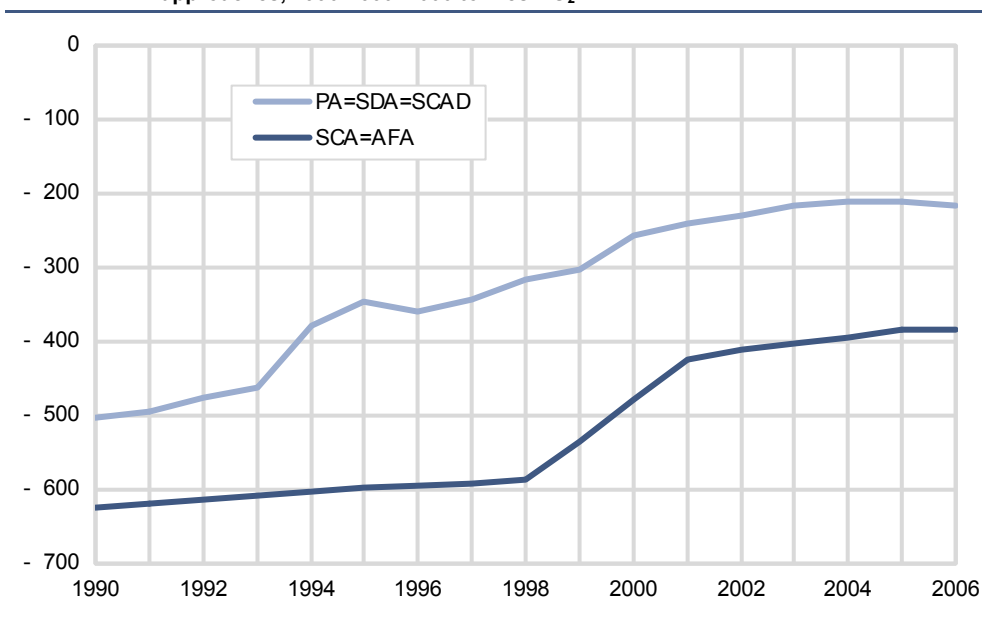

**Stock change approach:** With the SCA it is not allowed to build up a stock of HWP in other countries, it is however allowed to build up a stock of imported HWP. The emission curve in figure 6.2 thus shows the annual change in the stock of harvested wood products that is in use in Norway. The HWP contribution from the SCA has been negative during the reporting period, corresponding to a net binding of CO<sub>2</sub> in HWP.

**Atmospheric flow approach:** The AFA only takes the amount of emissions from the actual HWP stock into account, regardless of point of origin. The mathematical difference between the stock change approach and atmospheric flow approach is net export. This means that in years with considerable net export compared to the stock change (as in 1989-1994) it is the net export that mainly determines the HWP contribution from the AFA. Comparing the AF approach for the last 45 years (figure 6.8) with the net export in figure 6.5 it is evident that they are strongly correlated, which implies that the removal of CO<sub>2</sub> due to HWP estimated with the AFA mainly is determined by trade flows.

**Production approach:** When HWP in landfills are not included, the HWP contribution is close to zero in all years between 1995 and 2005. In 2003 there was a net emission of CO<sub>2</sub> from HWP. In the production approach, it is only allowed to build up stocks of domestically harvested wood. However, it is also allowed to build up stocks of domestic wood exported to other countries. The time development of the PA and SCA will resemble each other if net export is low compared to production. This is the case in the years after 1995.

**Stock Change Approach for HWP of Domestic origin:** SCAD is the intersection of the SCA and PA. In this case it is only allowed to build up a stock of HWP in domestic use of domestically harvested wood. This approach will never report higher removals from HWP than whichever of SCA or PA that reports the lowest removals. The time development of the HWP contribution from SCAD will resemble the PA the most in years where net export is low compared to production. From figure 6.2 it is evident that when waste is not included, HWP is turned into a source of CO<sub>2</sub> for the years between 1994 and 2004.

**Figure 6.8. Estimated emissions from HWP for the different approaches, 1961-2006. 1000 tonnes CO<sub>2</sub>**

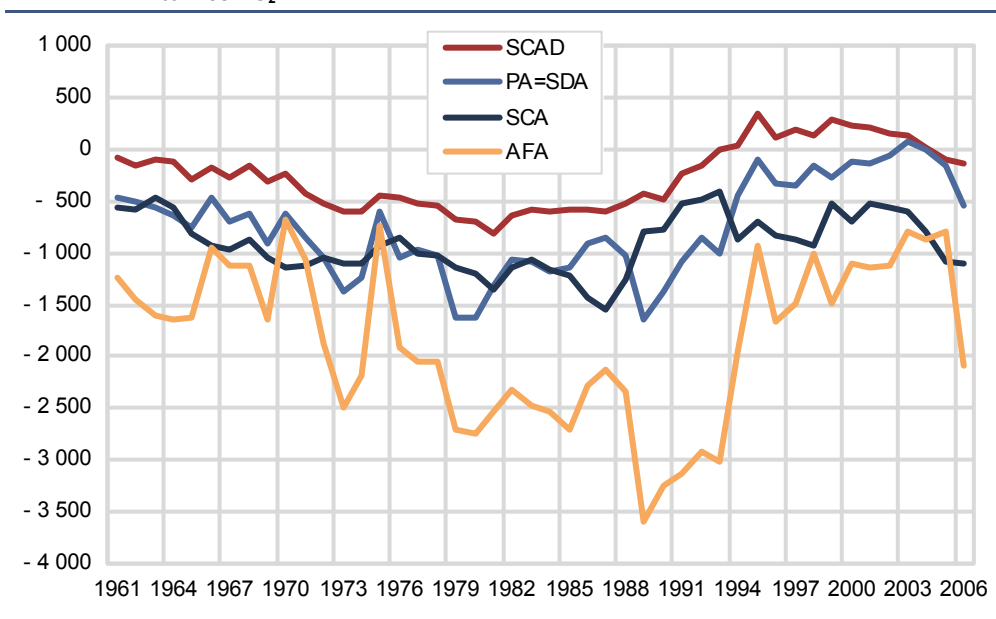

### 6.2. CO<sub>2</sub> emissions/removals estimated with the revised model

In Norway in 2001, HWP in dwellings, landfills, non-residential buildings and furniture, fixtures and fittings were the most significant contributors to the total carbon stock (figure 6.9 and table 6.2). If all products of the solid wood stock are summed up, it constitutes to 78 per cent of the total carbon stock, HWP in landfills with 18 per cent and paper and paper products with only 4 per cent. Almost all categories have increased from 1990 to 2001, with a total of 21 per cent (4.2 million tonnes of carbon) for the entire carbon stock. This corresponds to an annual increase of 0.4 million tonnes of the carbon stock in Norway.

**Figure 6.9. The total carbon stock in Norway in 2001, estimated with the revised model**

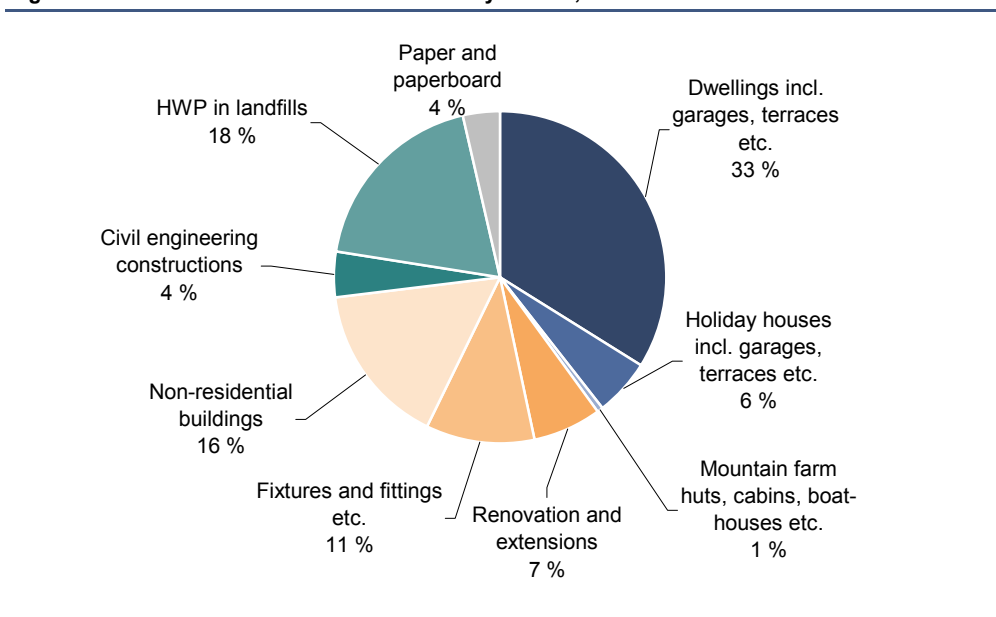

**Table 6.2. The total carbon stock in Norway for 1990 and 2001 estimated with the revised model. 1000 tonnes C**

	1990	2001
<b>Total carbon stock in Norway</b> .....	<b>19 674</b>	<b>23 425</b>
<b>Total carbon stock in solid wood products</b> .....	<b>14 569</b>	<b>16 605</b>
Dwellings .....	5 659	6 552
Terraces, windbreaks, fences etc. ....	261	301
Garages, outhouses and annexes linked to dwellings .....	343	400
Houses used as holiday houses .....	949	1 050
Garages, outhouses, annexes linked to holiday houses .....	69	77
Terraces, windbreaks, fences etc. linked to holiday houses ....	64	69
Mountain farm huts, cabins, boat-houses etc. ....	116	123
Non-residential buildings .....	2 897	3 388
Furniture, fixtures and fittings etc. ....	2 287	2 287
Civil engineering constructions .....	914	914
Renovation and extensions .....	1 010	1 445
<b>Total carbon stock in paper and paper products<sup>1</sup></b> .....	<b>753</b>	<b>961</b>
<b>Total carbon stock in long term stored waste<sup>2</sup></b> .....	<b>4 100</b>	<b>5 859</b>

<sup>1</sup> The stock of paper and paper products is estimated with the IPCC HWP model

<sup>2</sup> The stock of long term stored waste is estimated in the Waste sector spreadsheets (IPCC 2006b)

The two categories that remain unchanged from 1990 to 2001, furniture, fixtures and fittings etc. and civil engineering constructions, needs an additional explanation. The annual use of wood in both categories is used together with estimates of the life-times of the categories. A linear decay model was used, and the use of wood was assumed to be constant for all years. Since the annual use (i.e. inflow) is the same each year, it will give a constant carbon stock after a certain number of years depending on the half-life. The carbon stock of furniture, fixtures and fittings etc. and civil engineering constructions will thus be the same in 1990 and 2001.

Regarding the annual use of wood, in the 1930's it was normal to use more wood as a raw material in components like furniture, doors, windows, stairs, fixtures and fittings than it is today. This effect is countered by the increase in the number and average utility floor space of dwellings. As for the civil engineering constructions, although the number constructions of have increased during the century, the amount of wood used when building a construction have decreased. Based on this we do believe that it is plausible to use the same annual amount of wood in civil engineering constructions and furniture, fixtures and fittings etc. for the time periods of interest.

As mentioned in Chapter 4.2, the carbon stock in the non-inventory years is estimated by the IPCC HWP model. The IPCC HWP model is thus used as an interpolation/extrapolation tool to the direct inventories. The stock changes for paper and paper products in use and HWP in landfills are estimated by the IPCC HWP model for all years, including the years of the direct inventories. As recommended in the IPCC HWP spreadsheet, the product group "other industrial roundwood" is not included in the calculation order to give a conservative estimate.

The half-lives obtained when fitting the IPCC HWP model to the carbon stocks from the direct inventories are shown in table A4.

**Table 6.3. Values for the half-lives for solid wood products used when fitting the IPCC HWP model to the direct inventory results. Years**

	Before 1990	After 1990
Half-life of solid wood products .....	18.4	21.7

From table 6.3 it is evident that the half-life, and thus the lifetime, of solid wood products have increased after 1990. As mentioned before, the IPCC HWP model only takes primary wood products into consideration, import or export of more processed products like books, doors and pre-fabricated houses are unaccounted for. The change in lifetime of solid wood products is probably correlated to increased import of secondary wood products such as furniture and pre-fabricated

houses between 1990 and 2001 (Statistics Norway 2008b). The IPCC default value for the half-life of solid wood products is 30 years, which is significantly higher than the national values. A larger carbon stock will however make possible larger life-times. The reason for our low half-lives might just be that the direct inventories of solid wood products are incomplete, and a 20 per cent increase in the carbon stock for 1990 and 2001 will lead to higher half-lives (25 and 28 years respectively). One missing source in our calculations of the solid wood stock in Norway is buildings without permits. We have not tried to estimate the amount of buildings without permits, however in Finland it constitutes to more than 10 per cent to the carbon stock of the building stock (The Finnish National Inventory Report 2008). If the same proportion stands for Norway, the half-lives for solid wood products would increase to 21 and 25 years.

The effects of using national estimates for the two half-lives of solid wood products must be analysed separately. First, the half-life concerning the period before 1990 is adjusted down from the default value of 30 years. This is equivalent to adjusting the stock of solid wood products in 1990 down to fit the stock from the direct inventories. Since the decay rate is proportional to the size of the HWP pool, this will result in a decrease of the decay rate (and thereby the removals) of harvested wood products of about 25 per cent. Second, the half-life corresponding to the period after 1990 must be adjusted up in order to account for a higher stock in 2001. This will result in an increase in the decay of 37 per cent. Added together this will give an increase in emissions from HWP of about 3-4 per cent compared to the IPCC HWP model. This difference will be more thoroughly discussed later.

Figure 6.10 shows the estimated emissions from HWP for the stock change and atmospheric flow approach. Both approaches report removals of CO<sub>2</sub> due to HWP for all years. For the SCA the removal due to HWP is in the order of 0.4-1 million tonnes, while for the AFA the removal varies between 3.2 and 0.7 million tonnes CO<sub>2</sub> (See figure 6.10 and table 6.4). The large variation for the AFA is due to a vast increase in import of semi-finished wood products from 1993-1995, resulting in less removals of CO<sub>2</sub> than in the years before 1993. As discussed earlier this corresponds with the increased building activity after the recession in the Norwegian economy around 1990. On average during the commitment period, harvested wood products have acted as a sink of about 4 per cent (SCA) and 11 per cent (AFA) of the total sinks in the LULUCF sector (The Norwegian National Inventory Report 2008).

**Figure 6.10. Estimated emissions from HWP for the SCA and AFA (waste is not included) estimated with the revised model, 1990-2006. 1000 tonnes CO<sub>2</sub>**

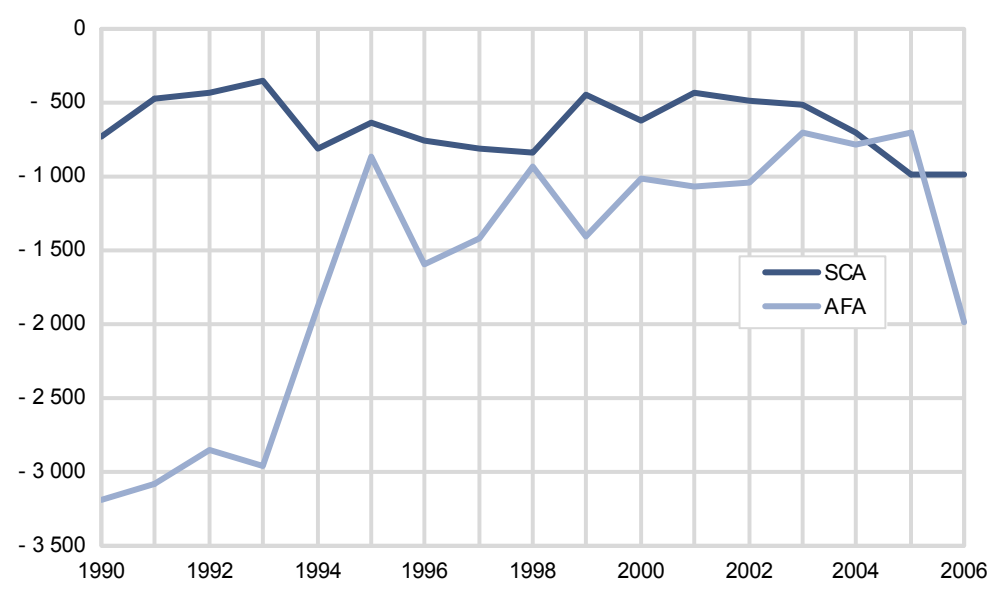



**Table 6.4. CO<sub>2</sub> emissions/removals estimated in the stock change approach, estimated with the revised method (not including waste), 1990-2006. 1000 tonnes CO<sub>2</sub>**

	SCA	AFA
1990 .....	-730	-3 195
1991 .....	-477	-3 083
1992 .....	-435	-2 854
1993 .....	-345	-2 955
1994 .....	-809	-1 884
1995 .....	-640	-859
1996 .....	-760	-1 593
1997 .....	-806	-1 419
1998 .....	-843	-935
1999 .....	-443	-1 405
2000 .....	-620	-1 017
2001 .....	-430	-1 061
2002 .....	-481	-1 038
2003 .....	-512	-700
2004 .....	-698	-781
2005 .....	-985	-705
2006 .....	-989	-1 988

Comparing with the SCA and AFA in figure 6.2, where the default value of 30 years is used, it is evident that the half-life is an important parameter that has a marked impact on the HWP contribution. A higher life-time will in this case result in a larger removal of CO<sub>2</sub> due to HWP.

Note that the results from the direct inventories of solid wood stock and the corresponding national values for half-lives can be used only with the stock change and atmospheric flow approaches. These approaches are the only ones who take all HWP in Norway into consideration, regardless of country of origin. With some additional assumptions and adjustments it might be possible to use the direct inventories together with other approaches, this is however not investigated further in this work.

### 6.3. Comparison of the models

In the IPCC HWP model the HWP contribution is estimated solely on the basis of production and trade flows of semi-finished wood products. In the revised model the stock of semi-finished solid wood products are connected to the end products by fitting it to a direct inventory of the carbon stock in Norway.

In the non-inventory years, the models are similar in usage. They are both easy to use, the activity data are easily available and they do not require large resources for the estimation of CO<sub>2</sub> emissions/removals. In the inventory year on the other hand, the revised model is quite comprehensive. New factors for the wood content of buildings etc. must be estimated each time, and the statistical data are not always on an easily accessible format. This work is however only performed every 10 years (the next Population and Housing Census is in 2011), and will lead to more accurate results than the IPCC HWP model.

Comparing the output from the two models it is important to be aware of the differences and similarities between them. First, paper and paperboard is treated equally in both models. Second, although wood is treated differently, the IPCC HWP model is fitted to the direct inventory results in the revised model. It is evident that the only practical difference between the two models in the non-inventory years is the half-life of solid wood products. Due to the lower half-lives, the revised method will always give less removal of CO<sub>2</sub> compared to the IPCC model.

Compared to the revised model, the SCA and the AFA give more removal of CO<sub>2</sub> when using the IPCC HWP model. The difference between the output from the two models increases from about 0.05 to 0.1 million tonnes CO<sub>2</sub> during the reporting period. This difference in output between the IPCC HWP model and the revised model is too small to be of any significance, although the revised model, especially

as a mean over two inventory years, gives an overall higher accuracy than the IPCC HWP model. We believe that the reason for similar results is an accidental occurrence with the effect of the different half-lives working in opposite directions, and it should not be taken as a reason to favour the IPCC HWP model.

#### **6.4. Response of the models to some incentives for increased use of wood**

Comparing how the two methods will respond to incentives for increased use of wood in building constructions, panels, window frames etc. is an important point. In the IPCC HWP model this may be recognised by a higher production or net import of solid wood products, however there is no guarantee that any increase here is due to a higher proportion of wood used when building houses. The imported wood might be used as fuel wood or for making furniture or other end products that are exported. An increase in the import of wooden products like doors, stairs and pre-fabricated houses will not be recognised either. In the revised model the estimated value for wood content in buildings and the share of wooden houses should be updated by specialists every time the direct inventory is performed. An increased (or decreased) use of wood in construction will then be reflected in the total carbon stock of solid wood products for that year. Changes in the non-inventory years will be reflected in the same manner in both estimation models.

The new regulations set by the Ministry of the Environment that comes into force July 1<sup>st</sup> 2009 states that all wood and paper delivered to landfills are to be burned for bio energy (Ministry of the Environment 2008). If only long-term stored HWP is included in the models (Tier 1) the annual change in carbon stock in landfills will approach zero. In the transition period, when continually less HWP is deposited, this will be reflected in a decreased removal of CO<sub>2</sub> due to HWP in all approaches. The HWP contribution will not be influenced by including waste when no more HWP is deposited in landfills. Note that if waste is treated on a Tier 2 level, where short-lived HWP also is included, HWP in landfills will contribute with emissions of CO<sub>2</sub> to the HWP contribution until all short-lived HWP is oxidised.

#### **6.5. Uncertainty in the methods and approaches**

Evaluating the uncertainty of the methods and approaches is difficult, we have however tried to make some considerations. The reader is also requested to read the uncertainty assessment of the IPCC HWP model, the default values and the activity data from FAO in the 2006 IPCC Guidelines (IPCC 2006a).

##### **The approaches in general**

One of the advantages with the SCA is that it is the simplest of the approaches with regard to data requirements, it is thus the approach with the least uncertainty. AFA requires an extra term in the calculation of the HWP contribution compared to the SCA, i.e. net export, and will thus be associated with higher uncertainty. The PA will always be associated with higher uncertainties than the other approaches, since estimates of the fate of exported HWP are highly uncertain. The SCAD is probably associated with a lower uncertainty than the PA and a higher uncertainty than the SCA, especially if HWP in landfills are included (see below).

##### **The direct inventories in the revised model**

The three main data sources in the direct inventories are the Ground Parcel, Address and Building Register (GAB) (Norwegian Mapping Authority 2009), the Population and Housing Censuses (Statistics Norway 2008c) and the amount of wood used in construction of buildings (Fjulsrud and Bunkholt, pers. comm. 2009). These data sources are elaborated below, and we believe that the largest uncertainty in the direct inventories is due to the wood factors for the different building constructions.

### ***The Ground Parcel, Address and Building Register (GAB)***

Data from the Ground Parcel, Address and Building Register (GAB) is used in several of the calculations. Measurement and processing errors in GAB may arise from the possibility that the municipalities make mistakes in registering data in the GAB register. The municipalities that do not put building cases online in the GAB register fill out a form that is sent to the county mapping office. In some cases the forms are filled in incorrectly. There are also some municipalities that for various reasons do not always follow the current registration rules for the GAB register. Buildings may be incorrectly classified, i.e. a building may be assigned a different type of building in the register than it should have. The statistics can also include buildings that are torn down, burnt down or otherwise non-existing, if not reported to the municipality. From the fifth of November 2007 the municipalities are transferred in groups from the Ground Parcel, Address and Building Register to the new property register, Matrikkelen. All municipalities will be transferred by the end of February 2009. In connection with the conversion the municipalities have conducted several quality tests. This may result in extra improvements in some municipalities in the future.

Only basal area is included in GAB. It is likely that the assumption of using basal area instead of total utility floor space is the largest source of uncertainty in our calculations. The assumption of using the basal area as the total utility floor space in non-residential buildings in 1990 will cause a significant systematic error in the absolute carbon stocks values. This error will however cancel out when stock changes are considered, as the same error is introduced in both inventories. The error introduced by using basal area as the total utility floor space for holiday houses, garages, annexes and outhouses is probably of lesser importance, as constructions of this type typically are one-storied buildings. Both assumptions will however lead to an underestimate of the total carbon stock.

### ***The amount of wood used in buildings***

The largest uncertainty is probably connected to the amount of wood used in buildings. In cooperation with Fjulsrud and Bunkholt (pers. comm. 2009), who have estimated the wood factors, the uncertainty is assessed to be around 20-25 per cent.

### ***The Housing and Population Census***

The Housing and Population Censuses are used as the data source for the age distribution of the dwelling stock. Sources of error and uncertainty of the results include collection and processing errors, register errors, non-response errors and model errors. A discussion of this is found in the Housing and Population censuses, and will not be elaborated here (Statistics Norway 2008c). There is however some additional errors arising from our use of the age distributions. The age-class of a building will for instance not change regardless of the number and extent of extensions, and the corresponding wood amount used in the calculations may thus not be correct. The type of a building may also change over time, for example from a storage building to a one-family house, and since different building types are connected to different wood amounts, the wood amount used in the calculations will be wrong.

### ***The IPCC HWP model***

There is a substantial variation in the annual consumption of wood products. This variation is to a certain degree masked by the decay of wood products which is estimated from a large HWP pool, varying much less annually. The annual estimation of the HWP contribution is thus more uncertain than a mean taken over for instance five or ten year intervals. This is even more pronounced with the revised model, where a mean change in solid wood stock taken over 10 years is no more uncertain than the stocks from the direct inventories. Apart from the modelling itself, uncertainties are also connected to the parameters used in the model. The highest uncertainty is connected to the estimated half-life of paper and

paper products and solid wood products, which is about 50 per cent. The effect of lowering the half-life of solid wood products has been elaborated earlier, and will not be repeated here. If waste is included it would lead to increased uncertainty, affecting the approaches to a different degree. For the other factors involved, the uncertainty is about 15 per cent, except for the densities where the uncertainty is about 25 per cent (IPCC 2006a)

### ***Paper and paper products***

Changes in the lifetime of paper and paper products will affect the approaches in very different ways since Norway is a big exporter of paper and paper products. The SCA and AFA are affected to the same degree, since they both account for the domestic stocks only. In periods with a significant annual change in net export of paper and paper products, the PA will be affected strongly since the annual stock changes thus will be increased. For the SCA, decreasing the half-life to 0.5 years will decrease the removal due to HWP with between -5 and +10 per cent.

### ***Waste***

At the Tier 1 level, only long-term stored HWP in landfills are included. Comparing the different approaches, the uncertainty will be lowest for the SCA and AFA since both methods account for HWP in landfills originating from both domestic and imported wood. The PA, which includes domestically harvested wood only, will have the largest uncertainty. Tier 1 estimates of carbon change in landfills in other countries could lead to substantial over- or under estimate so it is advised not to include this. The PA will thus only account for the portion of HWP in landfills that originates from domestically harvested wood. The SCAD will be somehow less uncertain than the PA since it is assumed to only account for domestically harvested wood in domestic landfills, it is however also burdened with a high degree of uncertainty. Excluding all HWP that oxidises clearly also introduces an error in the estimates.

## 7. Further work

The emissions/removals of CO<sub>2</sub> reported by the different approaches vary significantly, both annually and among the approaches. The annual variation for one approach may be large if there are significant changes in the production, import or export of harvested wood products. During the commitment period (1990-2006), the different approaches would have contributed with sequestration of up to 24 per cent (AFA in 1993, 1994) and emissions up to 3 per cent (SCAD in 1995) of the total sinks in the LULUCF sector (The Norwegian National Inventory Report 2008). On average during the commitment period, harvested wood products have acted as a sink of about 4 per cent (SCA), 3 per cent (PA, SDA), 11 per cent (AFA) and 0 per cent (SCAD) of the total sinks in the LULUCF sector. The numbers referred to is calculated with the IPCC HWP model without waste. When estimated with the revised model without waste, harvested wood products have acted as a sink of about 4 per cent (SCA) and 11 per cent (AFA). Emissions/removals from harvested wood products reported with PA/SDA and SCA will thus have a small but significant impact on the Norwegian greenhouse gas inventory. In 2006, the removals from HWP correspond to 1 per cent (PA/SDA) or 2 per cent (SCA) of the total Norwegian emissions of GHG. The emissions/removals reported by the AFA will obviously have a quite large impact in the total emissions, while the SCAD will have a small effect. This may however change in the future, depending on the relationship between production, import and export of wooden products. It is beyond the scope of this report to recommend one approach before the others, as this is a policy issue.

The revised model is more accurate and will reflect incentives for increased use of wood in a more transparent way than the IPCC HWP model. Changes in import/export of finished wood products such as pre-fabricated houses during the decades, will be reflected by the differing half-lives of solid wood products. The IPCC HWP model, on the other hand, is less resource demanding in the years where a direct inventory is performed. In the years between direct inventories, the resource use is about the same for the two models. In this report the emissions/removals of CO<sub>2</sub> estimated by the two models were quite similar. We do however believe that this is by chance only, and it should not be used as an argument to favour one model before another.

Both the IPCC HWP model and the revised model will be further improved if more parameters (half-lives and conversion factors) are estimated with country specific data instead of using the default values provided in the 2006 Guidelines. It should also be noted that the national values for the density of wood and the bark factor should be revised when the Norwegian Forest and Landscape Institute publishes the values that are used in the Forest Sector.

If the revised model is chosen as a basis for the reporting, a direct inventory should be performed in all coming years with a Population and Housing Census, the next being in 2011. A direct inventory for at least the year 1980 would further improve the results by introducing one more half-life for solid wood products.

Additional improvements of the direct inventory should also be aspired to. The direct inventories will be more comprehensive if more constructions with wood are included. In the HWP chapter of the Finnish National GHG Inventory report (The Finnish National Inventory Report 2008), it can be seen that in their case buildings without permits and garden tools (both groups excluded from the Norwegian inventory) constitutes a significant part of the total solid wood inventories (about 10-20 per cent). With the development of new and improved statistics and databases, (e.g. "matrikkelen") better estimates on the number, construction date and total utility floor space of buildings should be improved, thus giving better estimates on the carbon stock in the Norwegian building stock.

## References

- Bråthen B.E. (2008): *Personal communication*. Statistics Norway.
- FAO (2008): *Food and Agriculture Organization of the United Nations. Statistical Databases. FAOSTAT Forestry*. <http://faostat.fao.org>
- Fjulsrud K.E. & Bunkholt Aa. (2009): *Personal communication*. Norwegian Sawmill Industries Association and Wood Focus Norway.
- Flugsrud K., Hoem B., Kvingedal E. & Rypdal K. (2001): *Estimating the net emissions of CO<sub>2</sub> from harvested wood products; A comparison between different approaches*. SFT Report 1831:2001.
- Gjesdal S.F.T., Flugsrud K., Mykkelbost T.C. & Rypdal K. (1996): *A balance of use of wood products in Norway*. SFT Report 96:04.
- IPCC (1996): *1996 IPCC Guidelines for National Greenhouse Gas Inventories*. <http://www.ipcc-nggip.iges.or.jp/public/gl/invs1.html>.
- IPCC (2006a): *Chapter 12. Harvested Wood Products + HWP Worksheet MS Excel (V4\_12\_Ch12\_HWP\_Worksheet.xls)*. In: *2006 IPCC Guidelines for National Greenhouse Gas Inventories* (Pingoud K., Skog K.E., Martino D.L., Tonosaki M., Xiaoquan Z. & Ford-Robertson J.). <http://www.ipcc-nggip.iges.or.jp/public/2006gl>
- IPCC (2006b): *Volume 5, Waste*. In: *2006 IPCC Guidelines for National Greenhouse Gas Inventories*. <http://www.ipcc-nggip.iges.or.jp/public/2006gl/vol5.html>
- Kucera B. (1980): *Fysiske og anatomiske egenskaper hos lavlandsbjørk. Sluttrapport 343*. Norges Landbruksvitenskaplige Forskningsråd
- Kucera B. (1985): *Trevirkets egenskaper i tabellform. I Bjørk Osp Or*. Institutt for skogskjøtsel
- Kyoto protocol (1997). [http://unfccc.int/kyoto\\_protocol/items/2830.php](http://unfccc.int/kyoto_protocol/items/2830.php)
- Lunnan A., Navrud S., Rørstad P.K., Simensen K. & Solberg B. (1991): *Skog og skogproduksjon i Norge som virkemiddel mot CO<sub>2</sub>-oppbygning i atmosfæren*. Aktuelt fra Skogforsk,6
- Ministry of the Environment (2008). <http://www.regjeringen.no/en/dep/md/press-centre/Press-releases/2008/forbud-mot-deponering-av-nedbrytbart-avf.html?id=520348>
- Norwegian Association of General contractors (1990): *Notat om yrkesbyggmarkedet i Norge på mellomlang sikt (Note about the professional construction market in Norway at medium long sight)*.
- Norwegian Mapping Authority (2009): *The Ground Property, Address and Building Register*. <http://www.statkart.no/>
- Pingoud K., Savolainen I. & Seppälä H. (1996): *Greenhouse Impact in the Finnish Forest Sector Including Forest Products and Waste Management*. *Ambio*, 25, 318-326.
- Statistics Norway (2008a): *Commercial roundwood removals*. <http://www.ssb.no/english/subjects/10/04/20/>

Statistics Norway (2008b): *National external trade statistics*.  
<http://www.ssb.no/english/subjects/08/03/>

Statistics Norway (2008c): *Population and Housing Census*.  
<http://www.ssb.no/english/subjects/02/01/>

Statistics Norway (2009): *Building statistics*.  
<http://www.ssb.no/english/subjects/10/09/>

The Finnish National Inventory Report (2008).  
[http://unfccc.int/national\\_reports/annex\\_i\\_ghg\\_inventories/national\\_inventories\\_submissions/items/4303.php](http://unfccc.int/national_reports/annex_i_ghg_inventories/national_inventories_submissions/items/4303.php)

The Norwegian National Inventory Report (2008).  
[http://unfccc.int/national\\_reports/annex\\_i\\_ghg\\_inventories/national\\_inventories\\_submissions/items/4303.php](http://unfccc.int/national_reports/annex_i_ghg_inventories/national_inventories_submissions/items/4303.php)

## Appendix A

## The IPCC HWP model

In the 2006 IPCC Guidelines tiered methods are provided for estimates of the HWP variables (IPCC 2006a). As mentioned earlier, the HWP contribution reported by the approaches are estimated using the HWP variables. Default values are suggested for all parameters and activity data required on a Tier 1 level, and a HWP spreadsheet is provided to model the HWP variables and thus the HWP contribution for any given country. The HWP contribution is calculated back to 1960, and this allows us to compare trends with other statistics to get a more comprehensive understanding of the driving forces. In the IPCC HWP model the stock changes are calculated with a flux method with a lifetime analysis. The inflow each year is estimated from activity data on semi-finished products, while the outflow from the HWP pool follows a first order decay mechanism. Note that there is no real HWP stock on this level in the product chain. If desired, it is also possible to include HWP in landfills.

The advantage of counting the semi-finished products is that the activity data are easily available from the FAO database (FAO 2008), they are of high quality, and the risk of double counting is low. The disadvantage is clearly that the fate of the products is less precisely known, and thus the half-lives are difficult to estimate. A loop hole is that products which are exported or imported as finished products will not be counted at all in this method, and this can have impact for a country which is a net importer or exporter of finished wood products. Wood products that are imported as raw materials, and refined before they are exported will also be treated as if they still remain in the country. The advantage of focusing on the end products is that this is where the actual HWP pools are, however although statistics on production, import and export are available, the risk of double counting is high. In addition, knowledge of the composition and wood content of finished products is low, and half-lives for these product groups are also very difficult to estimate. Due to data quality and availability, the flux method is best suited to be based on semi-finished wood products.

The mathematical background for calculating the carbon stock and the HWP variables is given in Appendix C. This chapter will outline the data sources and parameters needed for the calculations.

The inflow to the HWP pool is calculated from activity data on semi-finished products like sawnwood, wood pulp, wood-based panels and paper and paperboard (See Appendix D for the product groups included). The 2006 IPCC Guidelines recommends that inputs to and outputs from HWP stocks since 1900 are used in order to make valid estimates of HWP in use for recent years. Activity data on production, import and export dating back to 1961 are readily downloaded from the FAO database (FAO 2008). The growth rate of HWP consumption prior to 1961 is estimated.

The outflow from the HWP pool is calculated by assuming that the oxidation of HWP follows a first order decay pattern, however other decay profiles may be applied if desired. The semi-finished products are aggregated in two main groups with very different half-lives; solid wood products and paper products. The key features of first order exponential decay is that the rate of loss of mass at any given time is directly proportional to the mass present at that time, and that the half-life ( $t_{1/2}$ ) can be expressed by the mean lifetime  $\cdot \ln 2$ . The fact that the rate of loss depends on the total stock in the previous year and the inflow in the given year, only causes the calculations to be rather easy to implement. This is in contradiction to a linear decay model where a complete history of the inflow is needed to calculate the outflow in a given year.



If HWP in landfills are to be included, the carbon stock is provided by the Waste Sector Tier 1 methods and spreadsheets (IPCC 2006b). HWP that are discarded from use and deposited at landfills will accumulate due to very long decay times in some cases, especially when stored under anaerobic conditions. It is assumed that HWP carbon equates to the “garden”, “wood” and “paper” waste categories. Note that the “garden” category is not currently in use in Norway. At the Tier 1 level, only the long-lived HWP stored in landfills are included. The amount is estimated directly by the Waste Sector spreadsheets. Note that there are no emissions from the long-lived HWP in landfills, and the carbon stock will increase for each year.

In addition to the FAO activity data, a set of parameters are needed in order to calculate the HWP contribution. Default values for all parameters are provided in the 2006 IPCC Guidelines (IPCC 2006a). If possible national values should however be employed instead of the default values.

### Default values

Table A1 shows the parameters needed as input in the IPCC HWP model as well as the default values provided by the 2006 IPCC Guidelines (IPCC 2006a). Together with the FAO activity data and, if required, the amount of HWP in landfills, this constitutes all information needed to estimate the HWP contribution for any given country. Used in this form the IPCC HWP model is a Tier 1 model.

**Table A1. Default values provided by IPCC for parameters used in the IPCC model**

	Roundwood, industrial roundwood, sawnwood, other industrial roundwood, pulpwood, chips, particles, wood fuel, wood residues <sup>1</sup>	Charcoal	Average for wood panels	Paper and paperboard, pulp, recovered fibre pulp, recovered paper
Density (oven-dry tonnes per m <sup>3</sup> of solid wood product or oven dry per air dry tonne of pulp or paper product)	0.45	0.9	0.628	0.9
Carbon fraction (tonnes carbon per oven dry tonne of wood material)	0.5	0.85	0.468	0.5
Half-life (yr)	30			2
Growth rate of HWP consumption prior to 1961 (yr <sup>-1</sup> )	0.0151			
Bark factor	1.13			

Source: Table 12.2, 12.3 and 12.4 in the 2006 Guidelines (IPCC 2006a)

<sup>1</sup> The density of roundwood etc. refers to temperate species only.

Default values are generally a reasonable alternative if there is no reason to believe that our country is any different than the other European countries. However, this is often not the case, and when possible default values should be evaluated to check their usability. The use of national values in stead of default values will convert the IPCC HWP Model to a Tier 2 model.

### National values

All the default values shown in table A1 have been examined into in order to determine if it is possible to estimate national values from existing statistics and other data sources.

### **Density**

As far as we know there are no national surveys concerning the density of charcoal, the different wood panels, paper, paperboard, pulp, recovered fibre pulp and/or recovered paper that can be used as a basis for estimating national values. In these cases the IPCC default values shown in table A1 are recommended.

The density of spruce, pine and deciduous trees have been measured for Norwegian trees (Kucera 1980, 1985), and these values can be used to estimate an average density for the aggregation "Roundwood, industrial roundwood, sawnwood, other industrial roundwood, pulpwood, chips, particles, wood fuel, wood residues" in table A1. The densities are shown in table A2.

**Table A2. National values for the density of wood, commercial roundwood removals and the corresponding estimated mean density for wood logged in Norway**

	Spruce	Pine	Deciduous trees
Density (oven-dry tonnes m <sup>-3</sup> )	0.380	0.440	0.503
Commercial roundwood removals (excluding fire wood) .....	76 %	22 %	2 %
Weighted mean density for solid wood (oven-dry tonnes m <sup>-3</sup> )	0.396		

Source: Kucera 1980, 1985 and Statistics Norway 2008a

The commercial roundwood removals excluding fire wood (Statistics Norway 2008a) was chosen as a guide to the distribution of the different types of wood in use in Norway. For deciduous trees the statistics date back to 1918, while coniferous trees were not divided into spruce and pine until 1996.

This gives a weighted mean density of 0.396 oven-dry tonnes per m<sup>3</sup> that can be used in the IPCC HWP model.

Using the FAO activity data for production, imports and exports of industrial roundwood it is evident that deciduous wood comprises a larger fraction of imported roundwood than of the harvest. Including this in the calculation will only lead to minor corrections, and not necessarily to a more accurate estimate for the density. Statistics on commercial roundwood removals only gives the amount of wood logged for sale. The portion of the different types of wood from roundwood removals that is not for sale does not necessarily need to be the same as the portion of the different types of wood from commercial roundwood removals. It is also likely that the portion of logging that was not for sale was higher in the beginning of the 20<sup>th</sup> century than it is now. Due to the lack of reliable data sources we have however not been able to take these factors into account.

Note that the densities stated in table A2 are not the same as those used in the forest sector accounted for under the Kyoto agreement. When these values are published by Norwegian Forest and Landscape Institute it is imperative to discuss which values that are most appropriate to use.

Using a lower value for the density than the default value provided by IPCC has a notable effect of lowering the CO<sub>2</sub> removals in the atmospheric flow approach for the years 1994-2005. The other approaches are affected to a much lower degree, and the change gives both an increase and a decrease in CO<sub>2</sub> emissions during the time period.

### **Carbon fractions**

As far as we know there are no national surveys concerning the carbon fractions of the different product types shown in table A1 that can be used as a basis for estimating national values. In this case it is recommended to use the IPCC default values.

## Half-lives

### Paper products

In Flugsrud *et al.* 2001 a lifetime of 1.2 years was used for paper and paper products. This value was derived from a publication by Pingoud *et al.* (1996) and was used with a linear decay model. However, in the reporting of HWP in the National GHG Inventory of Finland (The Finnish National Inventory Report 2008) where Kim Pingoud is involved, the IPCC default value of  $t_{1/2} = 2$  years is used. Thus, it does not seem appropriate to use the old lifetime as a basis for finding a new one corresponding to exponential decay. As far as we know there are no national surveys concerning the half-life of paper, paperboard, pulp, recovered fibre pulp and/or recovered paper that can be used as a basis for estimating a national value. In this case it is recommended to use the IPCC default value.

If the half-life of paper and paper products is increased to 3 years, the effect on the CO<sub>2</sub> emissions in the different approaches is a small decrease that varies with time. Decreasing the half-life to 1 year will however give a small increase in CO<sub>2</sub> emissions.

### Solid wood products

As far as we know there are no national surveys concerning the half-life of the solid wood product groups in table A1 that can be used as a basis for estimating a national value. A method for estimating a national half-life for solid wood products is utilised in the revised model (Appendix B) and will not be elaborated here.

### Growth rate of HWP consumption prior to 1961

An estimate of the growth of HWP consumption prior to 1961 in Norway may be found assuming that it is proportional to commercial removals of industrial roundwood (Statistics Norway 2008a). A growth rate of 0.9 % is found when fitting the available data between 1923 and 1960 to a first order exponential function.

The same arguments to the commercial removals of industrial roundwood statistics as mentioned in the segment concerning density applies here.

It is not unlikely that the growth of HWP consumption prior to 1961 has been lower in Norway than in the rest of Europe. Wood as a building material has been used in a much longer time in Norway compared to other European countries with less woodland.

Changing the growth of HWP consumption prior to 1961 from the default value of 0.0151 to 0.009 has a marginal effect on the HWP contribution.

### Bark factor

The bark factor of spruce, pine and deciduous trees are measured for Norwegian trees (Lunnan *et al.* 1991), and these values can be used to estimate an average bark factor. The bark factors are shown in table A3 (Statistics Norway 2008a).

**Table A3. National values for the bark factors of wood, the portion of logging for sale and the corresponding estimated mean for wood**

	Spruce	Pine	Deciduous trees
Bark factor .....	1.17	1.16	1.22
Portion of logging for sale (excluding fire wood) .....	76	22	2
Weighted mean bark factor .....	1.17		

Source: Lunnan *et al.* 1991 and Statistics Norway 2008a

The weighted mean bark factor is estimated in the same way as the density of solid wood. The same arguments to the commercial removals of industrial roundwood statistics as mentioned in the segment concerning density applies here.

It is uncertain if the bark factors used here are the same as the ones used in the forest sector accounted for under the Kyoto agreement. When these values are published by Norwegian Forest and Landscape Institute it is imperative to discuss which values that are most appropriate to use.

Changing the bark factor from the default value of 1.13 to 1.17 has a marginal effect on the net export and thus a marginal effect on the AFA. The other approaches are not affected on a detectable level.

### Summary of the national and default values used in the IPCC HWP model

Table A4 shows the values used as input in the IPCC HWP Model. National values are shown in bold figures.

**Table A4. Parameters used in the IPCC HWP model**

	Roundwood, industrial roundwood, sawnwood, other industrial roundwood, pulpwood, chips, particles, wood fuel, wood residues	Charcoal	Average for wood panels	Paper and paperboard, pulp, recovered fibre pulp, recovered paper
Density (oven-dry tonnes per m <sup>3</sup> of solid wood product or oven dry per air dry tonne of pulp or paper product)	0.396	0.9	0.628	0.9
Carbon fraction (tonnes carbon per oven dry tonne of wood material)	0.5	0.85	0.468	0.5
Half-life (yr)	30			2
Growth rate of HWP consumption prior to 1961 (yr <sup>-1</sup> )	0.009			
Bark factor	1.17			

Source: 2006 Guidelines (IPCC 2006a) for the default values  
National parameters derived in this work are shown in shaded cells.

### Tiers

The IPCC HWP model is a Tier 1 method when the default values provided by the 2006 IPCC Guidelines are employed. It can be converted to a Tier 2 method by using country-specific data to improve estimates of annual carbon change. Country-specific data can for instance be annual production, imports and exports, factors to convert activity data to carbon, half-lives or the fraction of wood that decays in landfills.

## The revised model

An alternative method for estimating emissions/removals from harvested wood products is to combine the flux method in the IPCC HWP model with a direct inventory of solid wood products (first-order decay method and Method D, IPCC 2006, p.12.15-16). The three components of HWP are treated in the following way in this model:

**Paper and paper products:** The carbon stock of paper and paper products is estimated in the same manner as in the IPCC HWP model described above, with default parameters. This part of the estimation is thus a Tier 1 method.

**HWP in landfills:** The carbon stock HWP in landfills is estimated in the same manner as in the IPCC HWP model described above. This part of the estimation is thus a Tier 1 method.

**Solid wood products:** The carbon stock of solid wood products has been estimated by performing direct inventories of wood stored in buildings (e.g. houses, cottages, garages, industrial buildings) for 1990 and 2001. Due to the lack of reliable statistics, the carbon stock in civil engineering constructions, furniture, stairs, fixtures and fittings was estimated by a flux method. The stock in the non-inventory years is then estimated in two steps. First the IPCC HWP model is fitted to the direct inventories, giving national values for the half-life of solid wood products. Second, the fitted HWP model is used to estimate the carbon stock and its annual change in the other years. The IPCC HWP model is thus used as an interpolation/extrapolation tool to the direct inventories, and this is a country-specific Tier 3 method.

The stock of paper and paper products and HWP in landfills is treated in exactly the same manner as in the IPCC HWP model described in Appendix A, and the calculations will not be elaborated here. A direct inventory can only be performed where the actual HWP pool is, which is as end products. For solid wood products we have included wood stored in or in connection with buildings (e.g. houses, terraces, cottages, garages, furniture, industrial buildings) and in civil engineering constructions. Typical parameters needed in the calculations are for example statistics on dwellings, holiday houses, garages and industrial buildings combined with the wood content per square meter of building, or estimations of how much wood is used yearly for renovation and extensions. This will be gone thoroughly into below. The only time a total inventory of dwellings is performed in Norway is during a Population and Housing Census, thus these are the best years for performing direct inventories. The years of the two latest censuses, 1990 and 2001 were thus chosen.

A country-specific method for estimating the stock inventory of carbon stored in buildings and furniture was developed by Gjesdal et al. in 1996 and later used and updated by Flugsrud et al. in 2001 for the years 1993 and 1998. The same methods are used here, however with some improvements and modifications. The most important modification is the inclusion of wood in uninhabited buildings like cabins, outbuildings and garages, the renovation sector and civil engineering structures. The method has also been improved by assigning different wood contents to dwellings depending on type of dwelling and year of construction. Changes in building tradition are thus incorporated in the model.

## Direct inventory, carbon stock in buildings in Norway

### *Carbon stock in residential buildings*

We have included dwellings together with garages, outhouses, annexes, terraces, windbreakers and fences etc. linked to dwellings in this pool.

### **Carbon stock in dwellings**

The Population and Housing Census gives an overview over habituated dwellings divided by types of buildings and year of construction. This gives us the possibility of taking changes in building tradition into account, and wood fractions for three different building type categories divided by year of construction are used.

The carbon stock in dwellings for a given year  $i$  is given by:

$$\text{Carbon stock}_i = \sum_{\text{Type of building}} \left[ \left( \sum_j^i \text{Total utility floor space}_j \cdot \text{Wood fraction}_j \right) \right] \\ \bullet d \bullet \text{Carbon fraction}$$

Where:

$i$ : The year when the direct inventory is performed

$j$ : Construction year of the dwelling

**Carbon stock $_i$** : The carbon stock in the year  $i$

**Total utility floor space $_j$** : Dwellings by utility floor space, built in year  $j$ , divided by building types. Data from the Population and Housing Census 1990 and 2001 (Bråthen, pers. comm. 2008). Uninhabited dwellings were estimated to contribute with 4.8 per cent of the inhabited dwellings (as in Flugsrud *et al.* 2001). For the aggregated categories detached houses and linked houses in table B4, the wood fraction is defined for wooden dwellings only. In these cases the total utility floor space must be multiplied with the share of wooden dwellings in year  $j$  (see below). Number of dwellings and average utility floor space divided by year of building and building type is shown in table B2 for 2001. Note that useful floor space is the unit in table B1 for 1990, not utility floor area. In order to account for the difference between useful floor space and utility floor space, conversion factors were estimated for the different dwelling types. The conversion factor for one dwelling type was estimated by the following equation:

$$\text{Conversion factor} = 1 \\ + \left( \frac{\text{Mean utility floor space in 2001} - \text{Mean useful floor space in 1990}}{\text{Mean useful floor space in 1990}} \right) \bullet (1 - x)$$

We chose to include dwellings built in 1981-1990 only. Dwellings built in this period of time will have the least share of extensions and demolition when comparing the results from the two censuses. The factor  $x$  is included to account for increased area due to extensions, and was chosen to be 0.5 for the categories “Detached house or farm house”, “Linked house, row house, terraced house or vertically divided two-dwelling building” and “Horizontally divided two-dwelling building or other house with less than 3 floors”. This corresponds to that 50 per cent of the increase in floor space between 1990 and 2001 is due to extensions, and 50 per cent is due to the difference between utility floor space and useful floor space. For the categories “Block of flats, or other building with 3 or more floors” and “Commercial building etc. or residential building for communities” we estimated that the amount of extensions were neglectable,  $x$  was thus set to zero. The conversion factors are included in table B1.

**Share of wooden dwellings:** Fraction of houses built with wood. The fraction of wooden houses is estimated with data from the Building statistics for the years 1951-2001 (Statistics Norway 2009) with the same method as in Flugsrud *et al.* 2001. Before 1950 the fraction of wooden houses was linearly extrapolated until it reached an estimated maximum value of 95 per cent for houses built before 1900. See table B3.

**Wood fraction:** Average amount of wood used in building dwellings in year *j*, divided by building types. This reflects changes in building tradition over the years, see table B4.

*d*: density of wood (oven-dry tonne pr m<sup>3</sup> of wood). The national value of 0.396 oven dry tonne wood / m<sup>3</sup> that was estimated earlier in this report was used ( table A4).

**Carbon fraction:** carbon fraction in oven dry wood. The IPCC default value of 0.5 tonnes carbon per oven dry tonne of wood was used.

**Table B1. Number of dwellings and average useful floor space by year of construction and building type, November 3<sup>rd</sup> 1990 and conversion factors**

Building type	Dwellings, total	Year of construction								Conversion factor between useful floor space and utility floor space
		< 1900	1901-1920	1921-1940	1941-1945	1946-1960	1961-1970	1971-1980	1981-1990	
Dwellings, total	1 751 363	127 367	100 839	167 268	20 989	358 209	308 485	374 190	294 016	
Detached house or farm house	1 018 145	88 930	63 438	93 567	13 972	188 858	170 288	214 636	184 456	1.12
Linked house, row house, terraced house or vertically divided two-dwelling building	250 285	3 390	3 824	7 396	1 144	42 077	49 160	76 978	66 317	1.05
Horizontally divided two-dwelling building or other house with less than 3 floors	129 684	8 951	12 323	22 577	2 128	50 196	12 024	10 111	11 373	1.05
Block of flats, or other building with 3 or more floors	328 673	23 248	18 894	40 854	3 179	71 383	73 516	69 402	28 197	1.02
Commercial building etc. or residential building for communities	24 577	2 849	2 359	2 874	566	5 696	3 497	3 063	3 674	1.10
Average useful floor space, m <sup>2</sup>	105	104	100	97	91	95	101	110	122	

Source: Bråthen, pers. comm. 2008

**Table B2. Number of dwellings and average utility floor space by year of construction and building type, November 3<sup>rd</sup> 2001**

Building type	Dwellings, total	Year of construction								
		< 1900	1901-1920	1921-1940	1941-1945	1946-1960	1961-1970	1971-1980	1981-1990	1991-2001
Dwellings, total	1 961 548	122 285	90 694	155 166	14 979	335 216	296 980	377 257	327 133	241 838
Detached house or farm house	1 119 844	69 372	53 312	82 786	10 354	180 337	170 435	222 672	207 211	123 365
Linked house, row house, terraced house or vertically divided two-dwelling building	248 694	3 370	3 090	5 788	593	33 636	42 244	64 413	54 096	41 464
Horizontally divided two-dwelling building or other house with less than 3 floors	166 374	12 809	14 855	23 405	2 021	50 476	11 576	11 173	15 876	24 183
Block of flats, or other building with 3 or more floors	360 770	31 233	15 075	38 570	1 414	61 405	66 708	72 300	36 219	37 846
Commercial building etc. or residential building for communities	65 866	5 501	4 362	4 617	597	9 362	6 017	6 699	13 731	14 980
Average utility floor space, m <sup>2</sup>	121	117	119	113	116	111	114	123	144	120

Source: Bråthen, pers. comm. 2008

**Table B3. Share of wooden dwellings, 1900-2000**

	<1900	1910	1930	1940	1951	1960	1970	1980	1990	2000
Detached wooden houses <sup>1</sup>	95	94	92	92	91	86	95	96	81	74
Linked wooden houses <sup>2</sup>	95	94	92	92	91	86	86	90	79	73

<sup>1</sup> Detached houses and farm houses.

<sup>2</sup> Linked houses, row houses, terraced houses, vertically divided two-dwelling buildings, horizontally divided two-dwelling building and other houses with less than 3 floors.

**Table B4. Average use of wood when building dwellings, by year of construction and building type, m<sup>3</sup> wood/m<sup>2</sup> dwelling**

	<1901	1901-1920	1921-1940	1941-1945	1946-1960	1961-1970	1971-1980	1981-1990	1991-2000	2001-2005	2010 TEK4 <sup>d</sup>
Detached wooden houses <sup>1</sup> .....	0.35	0.27	0.19	0.17	0.15	0.13	0.14	0.15	0.17	0.18	0.22
Linked wooden houses <sup>2</sup> .....	0.31	0.24	0.17	0.16	0.13	0.12	0.12	0.14	0.15	0.16	0.2
Block of flats <sup>3</sup> .....	0.08	0.055	0.035	0.02	0.015	0.015	0.018	0.02	0.025	0.027	0.03

<sup>1</sup> Detached houses and farm houses.

<sup>2</sup> Linked houses, row houses, terraced houses, vertically divided two-dwelling buildings, horizontally divided two-dwelling buildings and other houses with less than 3 floors.

<sup>3</sup> Block of flats, other buildings with 3 or more floors, commercial buildings etc. and residential buildings for communities.

<sup>4</sup> Calculated value that takes the new technical regulations (TEK) into consideration ([www.lovdata.no/cgi-wif/ldles?doc=sf/sf/sf-19970122-0033.html](http://www.lovdata.no/cgi-wif/ldles?doc=sf/sf/sf-19970122-0033.html))

Source: Fjulsrud and Bunkholt, pers. comm. 2009

Using the above data we obtain the following table showing the amount of wood and carbon stored in dwellings.

**Table B5. Carbon stock in dwellings**

	1990	2001
Wood stock in dwellings, m <sup>3</sup> .....	28 578 808	33 089 998
Carbon content in wood .....	0.5	0.5
Density of wood, tonne/m <sup>3</sup> .....	0.396	0.396
Total dwelling carbon stock (1000 tonnes) .....	5 659	6 552

The estimated carbon stock in Norwegian dwellings in 2001 divided by building type and construction year is shown in figure B1.

**Figure B1. Estimated carbon stock in dwellings, divided by building type and construction year, 2001. 1000 tonnes C**

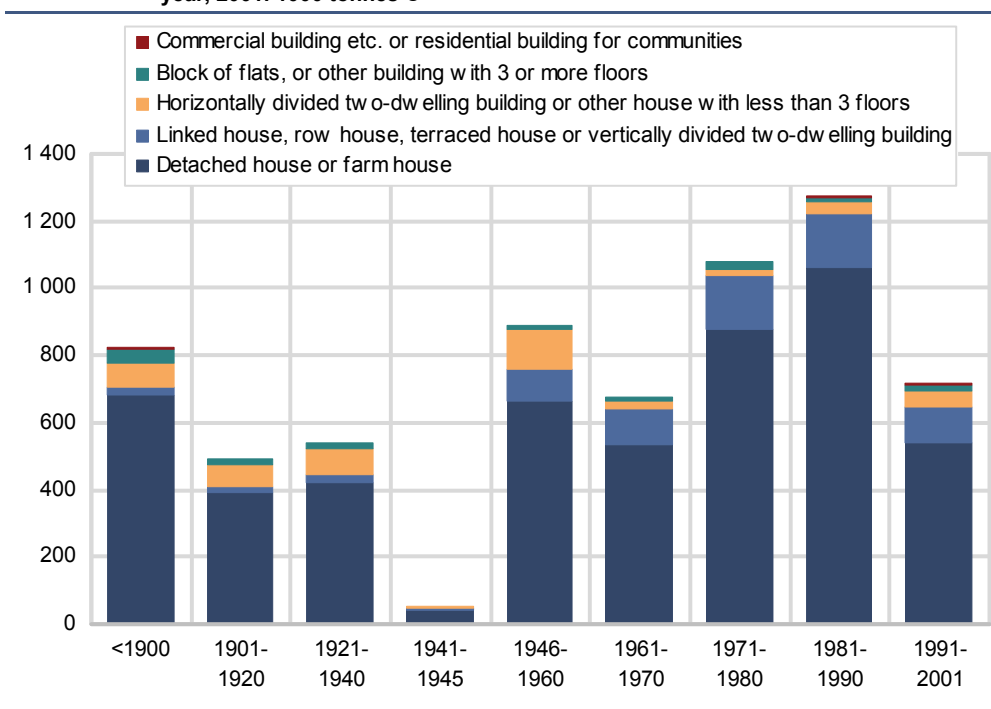

**Carbon stock in terraces, windbreaks, fences etc.**

The carbon stock in terraces, windbreaks, fences etc are estimated by the expression

$$Carbon\ stock_i = \sum_{Type\ of\ building} \left[ \left( \sum_j^i Dwellings_j \cdot Wood\ amount_j \right) \right] \cdot d \cdot Carbon\ fraction$$

**Dwellings<sub>j</sub>:** The total number of dwellings in year j, see table B1 and table B2.



**Wood amount<sub>i</sub>:** Wood amounts for terraces, windbreaks, fences etc based on normal design, size and materials divided by year of construction and building type, see table B6.

**Table B6. Average use of wood when building terraces, windbreaks, fences etc., by year of construction and building type, m<sup>3</sup> wood/dwelling**

	<1901	1901-1920	1921-1940	1941-1945	1946-1960	1961-1970	1971-1980	1981-1990	1991-2000	2001-2005
Detached wooden houses <sup>1</sup>	1.2	1.2	1.1	0.8	1.1	1.1	1.2	1.3	1.4	1.4
Linked wooden houses <sup>2</sup>	0.3	0.3	0.25	0.2	0.3	0.35	0.4	0.45	0.5	0.5
Block of flats <sup>3</sup>	0.03	0.03	0.03	0.02	0.03	0.04	0.04	0.05	0.05	0.05

<sup>1</sup> Detached houses and farm houses. <sup>2</sup> Linked houses, row houses, terraced houses, vertically divided two-dwelling buildings, horizontally divided two-dwelling buildings and other houses with less than 3 floors. <sup>3</sup> Block of flats, other buildings with 3 or more floors, commercial buildings etc. and residential buildings for communities.

Source: Fjulsrud and Bunkholt, pers. comm. 2009

Using the data we obtain the following table showing the amount of wood and carbon stored in terraces, windbreaks, fences etc.

**Table B7. Carbon stock in terraces, windbreaks, fences etc.**

	1990	2001
Wood stock in terraces, windbreaks, fences etc, m <sup>3</sup>	1 230 312	1 518 435
Carbon content in wood	0.5	0.5
Density of wood, tonne/m <sup>3</sup>	0.396	0.396
Total carbon stock in terraces, fences etc. (1000 tonnes) ...	261	301

### Carbon stock in garages, outhouses and annexes linked to dwellings

We have not been able to find reliable statistics showing the stock and utility floor space of garages, outhouses and annexes linked to dwellings divided by year of construction prior to 1990, so it is not possible to account for changes in building traditions.

The carbon stock in garages, outhouses and annexes linked to dwellings are estimated by the expression

$$\text{Carbon stock}_i = \text{Total utility floor space}_i \bullet \text{Wood fraction} \bullet d \bullet \text{Carbon fraction}$$

**Total utility floor space:** The total utility floor space for garages, outhouses and annexes linked to dwellings was obtained from the Ground Parcel, Address and Building Register (GAB) (Norwegian Mapping Authority 2009). GAB only contains information about basal area, however, and due to lack of other sources it was assumed that most garages, outhouses and annexes are one-storey buildings. Basal area was therefore used as total utility floor space, see table B8.

**Wood fraction:** The wood fraction used in garages, outhouses and annexes linked to dwellings was assumed to be 0.055 m<sup>3</sup>/m<sup>2</sup> (Fjulsrud and Bunkholt, pers. comm. 2009).

Using the above data we obtain the following table showing the amount of wood and carbon stored in garages, outhouses and annexes linked to dwellings.

**Table B8. Total utility floor space and carbon stock in garages, outhouses and annexes linked to dwellings**

	1990	2001
Total utility floor space of garages, outhouses and annexes linked to dwellings, m <sup>2</sup> .....	31 506 624	36 763 191
Wood fraction, m <sup>3</sup> /m <sup>2</sup> .....	0.055	0.055
Wood stock in garages, outhouses and annexes linked to dwellings, m <sup>3</sup> .....	1 732 864	2 021 976
Carbon content in wood .....	0.5	0.5
Density of wood, tonne/m <sup>3</sup> .....	0.396	0.396
Total carbon stock in garages, outhouses and annexes linked to dwellings (1000 tonnes) .....	343	400

**Carbon stock of holiday houses, huts, boat houses etc.**

We have not been able to find reliable statistics showing the stock and utility floor space of holiday houses, huts, boat houses etc. divided by year of construction prior to 1990, so it is not possible to account for changes in building traditions.

The carbon stock in holiday houses, garages linked to holiday houses, cabins, boat-houses etc. are estimated by the expression

$$\text{Carbon stock}_i = \text{Total utility floor space}_i \bullet \text{Wood fraction} \bullet d \bullet \text{Carbon fraction}$$

**Total utility floor space:** The total utility floor space for holiday houses, huts, boat houses etc was obtained from the GAB (Norwegian Mapping Authority 2009). GAB only contains information about basal area, however, and due to lack of other sources it was assumed that most holiday houses, huts and boat houses etc. are one-storey buildings. Basal area was therefore used as total utility floor space, see table B9. Note that there might be some double counting between detached houses and farmhouses used as holiday houses, and the uninhabited dwellings accounted for in the dwelling stock. We have not tried to correct for this.

**Wood fraction:** Average wood fractions are given by m<sup>3</sup> wood/m<sup>2</sup> utility floor space, see table B9.

**Table B9. The number and total basal area of buildings used as holiday houses, garages, outhouses and annexes linked to holiday houses and mountain farm hut, cabins etc. November 3<sup>rd</sup> 1990 and 2001, and the corresponding wood fractions**

	1990		2001		Wood fraction (m <sup>3</sup> /m <sup>2</sup> )
	Number	Basal area (m <sup>2</sup> )	Number	Basal area (m <sup>2</sup> )	
Holiday house (chalet, summerhouse etc.), detached house and farmhouse used as holiday house .....	348 313	25 652 528	386 358	28 361 381	0.19
Garage, outhouse, annex linked to holiday house .....	115 649	3 213 923	126 501	3 469 824	0.10
Mountain farm hut, fishermen's shack, cabin, turf hut etc., boat-house, wharfside shed .....	124 018	5 856 058	852 831	6 227 440	0.10

Source: GAB (Norwegian Mapping Authority 2009) and Fjulsrud and Bunkholt (pers. comm. 2009)

The carbon stock in terraces, windbreaks, fences etc. linked to holiday houses are estimated by the expression

$$\text{Carbon stock}_i = \text{Number of holiday houses}_i \bullet \text{Wood amount} \bullet d \bullet \text{Carbon fraction}$$

**Wood fraction:** The wood amount used in terraces, windbreaks, fences etc. linked to holiday houses was assumed to be 1 m<sup>3</sup> wood per holiday house (Fjulsrud and Bunkholt, pers. comm. 2009).

Using the above data we obtain the following table showing the amount of wood and carbon stored in holiday houses, huts, boat houses etc.

**Table B10. Carbon stock in houses used as holiday houses, mountain farm huts, cabins, boat-houses etc., and garages, outhouses, annexes, terraces etc. linked to holiday houses, 1990 and 2001**

	1990	2001
Wood stock in houses used as holiday houses, m <sup>3</sup> .....	4 794 580	5 300 877
Wood stock in garages, outhouses, annexes linked to holiday houses, m <sup>3</sup> ....	349 142	387 278
Wood stock in terraces, windbreaks, fences etc. linked to holiday houses, m <sup>3</sup> .....	321 392	346 982
Wood stock in mountain farm huts, cabins, boat-houses etc., m <sup>3</sup> .....	585 606	622 744
Carbon content in wood .....	0.5	0.5
Density of wood, tonne/m <sup>3</sup> .....	0.396	0.396
Total holiday houses etc. carbon stock (1000 tonnes) .....	1 198	1 318

**Carbon stock in non-residential buildings**

The carbon stock in non-residential buildings are estimated by the expression

$$\text{Carbon stock}_i = \text{Total utility floor area}_i \bullet \text{Wood fraction} \bullet d \bullet \text{Carbon fraction}$$

**Total utility floor space:** The total utility floor space for non-residential buildings was obtained from GAB (Norwegian Mapping Authority 2009). GAB only contains information about basal area, however, and due to lack of other sources basal area was set equal to total utility floor space for 1990. The total utility floor space of buildings completed for the years 1991-2001 is given in the building statistics (Statistics Norway 2009), and this value was added to the total utility floor space for 1990 to obtain the total utility floor space for 2001. Using basal area as utility floor space will introduce an error in the absolute values of the carbon stock, however, *changes* in the carbon stock will not be influenced by this since both years contain the same error.

**Wood fraction:** The wood fraction of non-residential buildings was assumed to be 0.1 m<sup>3</sup> wood/m<sup>2</sup> utility floor space (Fjulsrud and Bunkholt, pers. comm. 2009). This fraction might seem a bit high when compared to the wood fraction of blocks of flats. However, blocks of flats in Norway are built with a concrete frame and often with concrete walls. A large share of non-residential buildings is however built in wood, or with a considerable amount of wood, so a higher mean value for non-residential buildings is not unlikely.

Using the data, we obtain the following table showing the amount of carbon in non-residential buildings.

**Table B11. Carbon stock in non-residential buildings, 1990 and 2001**

	1990	2001
Total utility floor space in non-residential buildings, m <sup>2</sup> .....	146 328 955	171 105 497
Wood fraction, m <sup>3</sup> /m <sup>2</sup> .....	0.1	0.1
Wood stock in non-residential buildings, m <sup>3</sup> .....	14 632 896	17 110 550
Carbon content in wood .....	0.5	0.5
Density of wood, tonne/m <sup>3</sup> .....	0.396	0.396
Total non-residential building carbon stock, 1000 tonnes .....	2 897	3 388

**Carbon stock in doors, stairs, furnishing and furniture etc**

A total amount of about 350 000 m<sup>3</sup> wood is used each year for doors, stairs, windows, furniture, fixtures and fittings, however it proved difficult to find reliable estimates for the distribution of wood within this division (Fjulsrud and Bunkholt, pers. comm. 2009). The mean service life of these products is, however, quite long, and this stock should be included. Regarding the annual use of wood, in the 1930's it was normal to use more wood as a raw material in components like furniture, doors, windows, stairs, fixtures and fittings than it is today. When the increase in number and average utility floor space of dwellings is taken into account, we do believe that it is plausible to use the same annual amount of wood in furniture, fixtures and fittings etc. for the time period of interest. We chose to estimate the stock of wood in this division by using a flux method. The inflow in a given year (350 000 m<sup>3</sup> wood) is expected to remain unchanged in the pool for 5 years and

then decrease linearly from 5 to 55 years. This corresponds to a half-life of about 30 years (Fjulsrud and Bunkholt, pers. comm. 2009).

Using the data, we obtain the following table showing the amount of carbon in fixtures and fittings, doors, windows, furniture etc. Since the annual inflow is the same for all years, the carbon stock in this sector will be constant.

**Table B12. Carbon stock in furniture, fixtures and fittings, doors, windows, furniture etc., 1990 and 2001**

	1990	2001
Wood stock in furniture, fixtures and fittings etc., m <sup>3</sup> .....	11 550 000	11 550 000
Carbon content in wood .....	0.5	0.5
Density of wood, tonne/m <sup>3</sup> .....	0.396	0.396
Total carbon stock in furniture, fixtures and fittings etc. (1000 tonnes) ...	2 287	2 287

### ***Carbon stock in civil engineering constructions***

A total amount of about 130 000 m<sup>3</sup> wood is used in civil engineering constructions each year, however it proved difficult to find reliable estimates for the distribution of wood within this division (Fjulsrud and Bunkholt, pers. comm. 2009). Civil engineering constructions comprise, among others, bridge and pier constructions, platforms, safety fences and lamp posts. Although the number constructions of have increased during the century, the amount of wood used when building a construction have decreased. Based on this we do believe that it is plausible to use the same annual amount of wood in civil engineering constructions for the time period of interest. We chose to estimate the stock of wood in this division by using the same flux method as for furniture etc. The inflow in a given year (130 000 m<sup>3</sup> wood) is expected to remain unchanged in the pool for 10 years and then decrease linearly from 10 to 50 years. This corresponds to a half-life of about 30 years (Fjulsrud and Bunkholt, pers. comm. 2009).

Using the data, we obtain the following table showing the amount of carbon in civil engineering constructions. Since the annual inflow is the same for all years, the carbon stock in this sector will be constant.

**Table B13. Carbon stock in civil engineering constructions, 1990 and 2001**

	1990	2001
Wood stock in civil engineering constructions, m <sup>3</sup> .....	4 615 000	4 615 000
Carbon content in wood .....	0.5	0.5
Density of wood, tonne/m <sup>3</sup> .....	0.396	0.396
Total carbon stock in civil engineering constructions, 1000 tonnes ..	914	914

### ***Carbon stock originating from renovation and extensions***

The amount of wood used in renovation and extensions of holiday houses, residential and non-residential buildings each year is considerable. A part of the wood is used to replace materials renewed in connection with the renovation. However, due to the effect of extensions, increased standard and stricter technical regulations, about 35 – 40 per cent more wood is added than removed. Extensions of residential houses are already included in the carbon stock of dwellings, and to avoid double counting this was estimated to constitute of about 20 per cent. A net binding of 200 000 m<sup>3</sup> wood per year was therefore used (Fjulsrud and Bunkholt, pers. comm. 2009). In our calculations we assumed that no net binding occurred before 1960, followed by a linear increase from 0 to 200 000 m<sup>3</sup> between 1960 and 1970, and thereafter 200 000 m<sup>3</sup> per year.

Using the data, we obtain the following table showing the amount of carbon originating from renovation and extensions.

**Table B14. Carbon stock originating from renovation and extensions, 1990 and 2001**

	1990	2001
Wood stock originating from renovation and extensions, m <sup>3</sup> .....	5 100 000	7 300 000
Carbon content in wood .....	0.5	0.5
Density of wood, tonne/m <sup>3</sup> .....	0.396	0.396
Total carbon stock originating from renovation and extensions (1000 tonnes) .....	1 010	1 445

**Total carbon stock in Norway for the years 1990 and 2001**

Using the data for wood stock and carbon stock together with the paper stock (from the IPCC HWP model) and long term stored HWP in landfills (the waste model), we obtain the following table showing the total carbon stock in Norway for the years 1990 and 2001.

**Table B15. Solid wood stock and carbon stock in Norway, 1990 and 2001**

	1990		2001	
	Wood stock (m <sup>3</sup> )	Carbon stock (1000 tonne)	Wood stock (m <sup>3</sup> )	Carbon stock (1000 tonne)
<b>Total carbon stock in Norway</b>		<b>19 422</b>		<b>23 425</b>
<b>Total stock in solid wood products</b> .....	<b>74 855 600</b>	<b>14 569</b>	<b>86 067 539</b>	<b>16 605</b>
Stock in dwellings .....	28 578 808	5 659	33 089 998	6 552
Stock in terraces, windbreaks, fences etc .....	1 320 312	261	1 897 134	301
Stock in garages, outhouses and annexes linked to dwellings, m <sup>3</sup> ....	1 732 864	343	2 021 976	400
Stock in houses used as holiday houses .....	4 794 580	949	5 300 877	1 050
Stock in garages, outhouses, annexes linked to holiday houses .....	349 142	69	387 278	77
Stock in terraces, windbreaks, fences etc. linked to holiday houses ..	321 392	64	346 982	69
Stock in mountain farm huts, cabins, boat-houses etc. ....	585 606	116	622 744	123
Stock in non-residential buildings .....	14 632 896	2 897	17 110 550	3 388
Stock in fixtures and fittings etc. ....	11 550 000	2 287	11 550 000	2 287
Stock in civil engineering constructions .....	4 615 000	914	4 615 000	914
Stock originating from renovation and extensions .....	6 375 000	1 010	9 125 000	1 445
<b>Total stock in paper and paper products</b> <sup>1</sup>		<b>753</b>		<b>961</b>
<b>Total stock in long term stored waste</b> <sup>2</sup>		<b>4 100</b>		<b>5 859</b>

<sup>1</sup> The stock of paper and paper products is estimated with the IPCC HWP model

<sup>2</sup> The stock of long term stored waste is estimated by the Waste sector spreadsheets (IPCC 2006b)

**Fitting the IPCC HWP model to the solid wood stock inventories**

As discussed above, the carbon stock in the non-inventory years is estimated by the IPCC HWP model. The IPCC HWP model used is slightly modified by Kim Pingoud at VTT Technical Research Centre of Finland to include the possibility of using different half-lives for solid wood products for different time periods. First, the IPCC HWP model is fitted to the direct inventories, this is achieved by changing the half-lives of solid wood products until the carbon stock of solid wood products estimated by the IPCC HWP model are equal to the stocks estimated by the direct inventories. This results in country specific and decade dependent values for the half-life of solid wood products. Second, the fitted HWP model is used to estimate the carbon stock and its annual change in the other years. The IPCC HWP model is thus used as an interpolation/extrapolation tool to the direct inventories.

The stock changes for paper and paper products in use and HWP at landfills are estimated by the IPCC HWP model.

**Table B16. Values for the half-life for solid wood products used when fitting the IPCC HWP model to the direct inventory results. Years**

	1990 and before	1991 to present
Half-life of solid wood products .....	18.4	21.7

From the above parameters it is evident that the half-life, and thus the lifetime, of solid wood products have increased after 1990. As mentioned before, the IPCC HWP model only takes primary wood products into consideration, all import or export below that level in the product chain is not accounted for. The change in lifetime of solid wood products is probably correlated to increased import of

secondary wood products such as furniture and pre-fabricated houses between 1990 and 2001 (Statistics Norway 2008b).

Note that the results from the direct inventories and the corresponding national values for half-lives only can be used with the Stock change approach and the atmospheric flow approach since these approaches take all HWP in Norway into consideration, regardless of country of origin. With some additional assumptions and adjustments it might be possible to use the direct inventories together with other approaches, this is however not investigated further in this work.

### Comparison of the results from revised model (this report) and the “combined method” (Flugsrud *et al.* 2001)

The revised model is an evolution of the “combined method” developed at Statistics Norway (Flugsrud *et al.* 2001), it is thus interesting to compare the results from the two models. The differences between the two models are the treatment of paper and waste, and the direct inventory used in the revised model is also more comprehensive. The carbon stocks in Norway in 1990 estimated with both models are shown in the following table.

**Table B17. The carbon stock in Norway estimated with the combined method and the revised model, 1990. 1000 tonnes C**

	The combined method	The revised model	Per cent change
<b>Total carbon stock in Norway</b> .....	<b>15 248</b>	<b>19 422</b>	<b>27</b>
<b>Total carbon stock in solid wood products</b> .....	<b>8 475</b>	<b>14 569</b>	<b>72</b>
Dwellings .....	7 606	6 552	-14
Terraces, windbreaks, fences etc. linked to dwellings .....	--	301	
Garages, outhouses and annexes linked to dwellings .....	--	400	
Houses used as holiday houses .....	--	1 050	
Garages, outhouses, annexes linked to holiday houses ..	--	77	
Terraces, windbreaks, fences etc. linked to holiday houses .....	--	69	
Mountain farm huts, cabins, boat-houses etc. ....	--	123	
Non-residential buildings .....	130	3 388	2506
Furniture, fixtures and fittings etc. ....	739	2 287	209
Civil engineering constructions .....	--	914	
Renovation and extension .....	--	1 445	
<b>Total carbon stock in paper and paper products</b> .....	<b>381</b>	<b>753</b>	<b>98</b>
<b>Total carbon stock in waste</b> .....	<b>6 393</b>	<b>4 100</b>	<b>-36</b>

The most striking difference between the two models is in the carbon stock of non-residential buildings. It is not clear whether this estimate includes holiday houses etc. in the combined method, if so the real difference would be even bigger since holiday houses etc. are not part of the non-residential building stock in the revised model. The source of the vast difference in output between the two models is tripartite. In the combined model a wood fraction of  $0.035 \text{ m}^3/\text{m}^2$  is used, and only 20 per cent of the non-residential building stock is assumed to contain any wood at all. In cooperation with the experts Fjulsrud and Bunkholt (pers. comm., 2009) we believe that a wood factor of  $0.1 \text{ m}^3/\text{m}^2$  for *all* non-residential buildings is more correct to use. A wood fraction of  $0.1 \text{ m}^3/\text{m}^2$  is also plausible when compared to the wood fraction used for *all* blocks of flats in the revised model, which is  $0.03 \text{ m}^3/\text{m}^2$ . Blocks of flats in Norway are defined as buildings with a concrete frame, and they often have concrete walls. Within non-residential buildings in Norway, large segments are built in wood or with a considerable share of wood. In this context, the wood fraction coupled with the low share of wooden buildings used in the combined model seems unlikely low. Different data sources are also used for estimating the total utility floor space in the two models. Even though basal area from the building statistics (Statistics Norway 2009) is used as the total utility floor space in the revised model, this gives a higher estimate of the total utility floor space in non-residential buildings than what is used in the combined method (Norwegian Association of General contractors 1990). Together these three factors explain most of the difference in carbon stock in residential buildings between the two models.

The carbon stock in dwellings is quite similar in the two models, this is however quite coincidental. When the wood factor used for dwellings in the combined method is converted into  $\text{m}^3/\text{m}^2$  it seems to be about 50 per cent higher than in the revised model. The effect of using a higher wood factor is however partly outweighed by using the same share of wooden dwellings for all dwellings in 1990, regardless of construction year. The carbon stock in the revised model is more comprehensive as changes in building traditions are taken into consideration, and there was a higher wood fraction and share of wooden dwellings early in the 20<sup>th</sup> century compared to the 1990's.

There is also a large increase in the carbon stock in furniture in the combined method compared with the revised model. In the combined method a factor of 10 kg furniture/ $\text{m}^2$  utility floor space was used, and furniture in non-residential buildings was excluded. The revised model comprises more units such as doors, windows, stairs, fixtures and fitting, and the stock in both residential and non-residential buildings are included.

There are also several new stocks included in the revised model that was not treated in the combined method. This includes terraces, windbreaks, fences, garages, outhouses and annexes etc. linked to both dwellings and holiday houses, civil engineering constructions and the net binding of wood used during renovation and extension. It is unclear whether houses used as holiday houses, mountain farm huts, cabins and boat-houses etc. was included in the stock of non-residential buildings in the combined method.

The carbon stock in waste estimated by the two models is not comparable, as the combined method includes all carbon stored in landfills, not only the long-term stored carbon.

The main reasons for the difference in the carbon stock of paper and paperboard are the different decay models used to estimate the outflow (linear decay vs. first order exponential decay) and the difference in life-times used in the two models.

### **Tiers**

The stocks and stock changes of paper and paper products and HWP in landfills are calculated with a Tier 1 method. The stocks of solid wood products are calculated with a country specific Tier 3 method.

## Mathematical equations for estimating the carbon stock in the IPCC HWP models

Definitions of the HWP variables are given in table 4.4.

### Estimating annual change in carbon stock in “products in use”

The equations for estimating the carbon stock and its annual change in HWP pools are given by:

Starting with year  $i = 1900$  and continuing to present year, compute

$$C(i+1) = e^{-k} \cdot C(i) + \left[ \frac{1 - e^{-k}}{k} \right] \cdot \text{Inflow}(i)$$

$$\Delta C(i) = C(i+1) - C(i)$$

Where:

$i$  = year

$C(i)$  = the carbon stock of the HWP pool in the beginning of the year  $i$  [Gg C]

$C(1900) = 0.0$

$k$  = decay constant for first order decay [ $\text{yr}^{-1}$ ]

$\text{Inflow}(i)$  = the inflow to the HWP pool during year  $i$  [Gg C  $\text{yr}^{-1}$ ]

$\Delta C(i)$  = carbon stock change of the HWP pool during year  $i$  [Gg C  $\text{yr}^{-1}$ ] (e.g. variable 1 and 2 in table 4.4)

The inflow can be estimated for HWP pools in three different cases; wood in domestic consumption of products ( $\text{Inflow}_{DC}$ ), wood in products that comes from domestic harvest ( $\text{Inflow}_{DH}$ ), and wood in domestic consumption of products that comes from domestic harvest ( $\text{Inflow}_{DCDH}$ ). Inflows, and thereby activity data, going back to 1900 are needed in order to estimate the annual change in HWP stocks.

### ***Inflow to HWP in domestic consumption ( $\Delta C_{HWP\ IU\ DC}$ , variable 1A)***

The inflow to HWP products produced annually from domestic consumption is estimated by:

$$\text{Inflow}_{DC} = P + \text{SFP}_{IM} - \text{SFP}_{EX}$$

Where:

$\text{Inflow}_{DC}$  = carbon in annual consumption of solid wood or paper products that came from wood in domestic consumption [Gg C  $\text{yr}^{-1}$ ]

$P$  = carbon in annual production of solid wood or paper products [Gg C  $\text{yr}^{-1}$ ]

$\text{SFP}_{IM}$ ,  $\text{SFP}_{EX}$  = imports and exports of semi-finished wood and paper products. For solid wood this includes sawnwood, panels, and other industrial roundwood. For paper and paper products this includes paper and paperboard [Gg C  $\text{yr}^{-1}$ ]



***Inflow to HWP from domestic harvest ( $\Delta C_{HWP IU DH}$ , variable 2A)***

The inflow to HWP products produced annually from domestic harvest is estimated by:

$$Inflow_{DH} = P \cdot \left[ \frac{IRW_H}{IRW_H + IRW_{IM} - IRW_{EX} + WCH_{IM} - WCH_{EX} + WR_{IM} - WR_{EX}} \right]$$

Where:

$Inflow_{DH}$  = carbon in annual consumption of solid wood or paper products that came from wood harvested domestically [Gg C yr<sup>-1</sup>]

P = carbon in annual production of solid wood or paper products [Gg C yr<sup>-1</sup>]

$IRW_H$  = industrial roundwood harvest. This is the harvest of wood to make solid wood and paper products including IRW for export [Gg C yr<sup>-1</sup>]

$IRW_{IM}, IRW_{EX}$  = Industrial roundwood imports and exports [Gg C yr<sup>-1</sup>]

$WCH_{IM}, WCH_{EX}$  = wood chip imports and exports [Gg C yr<sup>-1</sup>]

$WR_{IM}, WR_{EX}$  = wood residues from wood products mills imports and exports [Gg C yr<sup>-1</sup>]

***Inflow to HWP in domestic consumption from domestic harvest ( $\Delta C_{HWP IU DCDH}$ )***

The inflow to HWP products produced annually from domestic consumption of domestic harvest is estimated by:

$$Inflow_{DCDH} = (P - SFP_{EX}) \cdot \left[ \frac{IRW_H - IRW_{EX}}{IRW_H + IRW_{IM} - IRW_{EX}} \right]$$

Where:

$Inflow_{DCDH}$  = carbon in annual consumption of solid wood or paper products that came from wood in domestic consumption that is harvested domestically [Gg C yr<sup>-1</sup>]

P = carbon in annual production of solid wood or paper products [Gg C yr<sup>-1</sup>]

$IRW_H$  = industrial roundwood harvest. This is the harvest of wood to make solid wood and paper products including IRW for export [Gg C yr<sup>-1</sup>]

$IRW_{IM}, IRW_{EX}$  = Industrial roundwood imports and exports [Gg C yr<sup>-1</sup>]

$SFP_{EX}$  = imports and exports of semi-finished wood and paper products. For solid wood this includes sawnwood, panels, and other industrial roundwood. For paper and paper products this includes paper and paperboard [Gg C yr<sup>-1</sup>]

Note that this inflow is not defined in 2006 Guidelines, and that there is no corresponding official HWP variable.

**Estimating annual change in carbon stock in landfills (SWDS)**

A part of HWP disposed in landfills will be deposited under anaerobic conditions and either decay slowly or never. In landfills there is thus a steady increasing pool of HWP that never decays.

***Change in HWP stock in domestic landfills ( $\Delta C_{HWP\ SWDS\ DC}$ , variable 1B)***

This amount is provided by the Waste Sector Tier 1 methods and spreadsheets, and is thus easily accessible. In this model it is assumed that HWP carbon equates to the “garden”, “wood” and “paper” waste categories. Note that the “garden” category is not used in the Norwegian waste model.

***Change in HWP stock in landfills where wood came from domestic harvest ( $\Delta C_{HWP\ SWDS\ DH}$ , variable 2B)***

In theory, exported wood that came from domestic harvest and have ended up in international landfills should be included. At least at a Tier 1 level this is judged to be too complicated to estimate, so it is not included. To estimate the portion of stored HWP in landfills that came from domestic harvest, the total HWP stock in landfills (variable 1B) is multiplied by the fraction of wood carbon consumed in the country in the current year that came from domestic harvest.

$$\begin{aligned}\Delta C_{HWP\ SWDS\ DH} &= \Delta C_{HWP\ SWDS\ DC} \cdot \left[ 1 - \frac{\text{imported wood material}}{\text{imported wood material} + \text{produced wood material}} \right] \\ &= \Delta C_{HWP\ SWDS\ DC} \cdot \left[ \frac{\text{produced wood material}}{\text{produced wood material} + \text{imported wood material}} \right]\end{aligned}$$

$$\text{imported wood material} = IRW_{IM} + WCH_{IM} + WR_{IM} + \text{Sawn}W_{IM} + WPan_{IM} + P \ \& \ PB_{IM} + WPulp \ \& \ recPapM$$

$$\text{produced wood material} = IRW_H$$

Where:

$\Delta C_{HWP\ SWDS\ DH}$  = Variable 2B = Annual change in carbon in HWP in domestic landfills where HWP came from domestic wood harvest [Gg C yr<sup>-1</sup>]

$\Delta C_{HWP\ SWDS\ DC}$  = Variable 1B = Annual change in carbon in HWP in domestic landfills [Gg C yr<sup>-1</sup>]

$IRW_H$  and  $IRW_{IM}$  = industrial roundwood harvest and industrial roundwood imports [Gg C yr<sup>-1</sup>]

$WCH_{IM}$  = wood chips imports [Gg C yr<sup>-1</sup>]

$WR_{IM}$  = wood residues from wood products mills imports [Gg C yr<sup>-1</sup>]

$\text{Sawn}W_{IM}$  = sawnwood imports [Gg C yr<sup>-1</sup>]

$WPan_{IM}$  = wood panel imports [Gg C yr<sup>-1</sup>]

$P \ \& \ PB_{IM}$  = paper and paperboard imports [Gg C yr<sup>-1</sup>]

$WPulp \ \& \ RecPap_{IM}$  = wood pulp and recovered paper imports [Gg C yr<sup>-1</sup>]

Note that this value will be quite uncertain.

***Change in HWP stock in domestic landfills where wood came from domestic harvest ( $\Delta C_{HWP\ SWDS\ DCDH}$ )***

There is currently not developed a method for estimating the part of HWP in domestic landfills that came from domestic harvest. Since waste in international landfills is excluded from  $\Delta C_{HWP\ SWDS\ DH}$  at the Tier 1 level we have however used the following relationship:

$$\Delta C_{HWP\ SWDS\ DCDH} = \Delta C_{HWP\ SWDS\ DH}$$

Note that this value will be quite uncertain, and that it is not defined in the 2006 Guidelines.

**Estimating annual imports and exports of HWP and annual HWP harvest**

Estimates of annual imports, exports and harvest are only needed for the most recent years (1990 and onwards). Annual imports and exports (variable 3 and 4) are calculated from all activity data shown in appendix D, except for industrial roundwood and other industrial roundwood. Total annual HWP harvest (variable 5) is defined as all wood and bark that leaves harvest sites, including fuel wood.

**Estimating carbon release to the atmosphere from the HWP variables**

Annual carbon release to the atmosphere may be estimated for two cases using the HWP variables:

For annual carbon release from wood stocks in domestic use:

$$\uparrow C_{HWP\ DC} = H + P_{IM} - P_{EX} - \Delta C_{HWP\ IU\ DC} - \Delta C_{HWP\ SWDS\ DC}$$

For annual carbon release from wood that originates from domestic harvest:

$$\uparrow C_{HWP\ DH} = H - \Delta C_{HWP\ IU\ DH} - \Delta C_{HWP\ SWDS\ DH}$$

Following the same notation it is also possible to express annual carbon release from wood stocks in domestic use that originates from domestic harvest:

$$\uparrow C_{HWP\ DCDH} = H - P_{EX} - \Delta C_{HWP\ IU\ DCDH} - \Delta C_{HWP\ SWDS\ DCDH}$$

Note that currently there is no method for estimating changes in carbon stock in landfills for wood in domestic use that originates from domestic harvest.

## Appendix D

**FAO activity data included in the IPCC HWP model**

Activity data for the commodities from the FAO statistical databases (FAO 2008) shown below are needed as input in the IPCC HWP model. The activity data is needed for all years going back to 1960.

	Production	Imports	Exports
Roundwood .....	X	X	X
Sawnwood .....	X	X	X
Wood-based panels .....	X	X	X
Industrial roundwood .....	X	X	X
Other industrial roundwood .....	X		
Wood charcoal		X	X
Wood residues		X	X
Chips and particles		X	X
Paper and paperboard .....	X	X	X
Recovered paper		X	X
Wood pulp		X	X

## List of figures and tables

### List of figures

#### 3. Data sources

- 3.1. The connection between activity data, parameters, models and approaches used in the estimation of emissions/removals due to HWP ..... 21

#### 5. Approaches for reporting and accounting

- 5.1. System boundary of the stock change approach ..... 28  
 5.2. System boundary of the atmospheric flow approach ..... 29  
 5.3. System boundary of the Production Approach ..... 30

#### 6. Results and discussions for Norway

- 6.1. Estimated emissions from HWP including waste for the different approaches, 1990-2006. 1000 tonnes CO<sub>2</sub> ..... 32  
 6.2. Estimated emissions from HWP for the different approaches (waste is not included) estimated with the IPCC HWP model, 1990-2006. 1000 tonnes CO<sub>2</sub> ..... 33  
 6.3. Time development of the HWP variables, 1990-2006. .... 34  
 6.4. Illustration of estimated C flows and stock changes for the SC and AF approaches (waste is included), 2000. Million tonnes C ..... 35  
 6.5. Imports and exports at the level of semi-finished products used in the IPCC HWP model, 1961-2006. 1000 tonnes C ..... 36  
 6.6. Building work started, 1967-2007. Number of dwellings ..... 36  
 6.7. The effect of including waste on the emissions reported by the different approaches, 1990-2006. 1000 tonnes CO<sub>2</sub> ..... 37  
 6.8. Estimated emissions from HWP for the different approaches, 1961-2006. 1000 tonnes CO<sub>2</sub> ..... 38  
 6.9. The total carbon stock in Norway in 2001, estimated with the revised model ..... 38  
 6.10. Estimated emissions from HWP for the SCA and AFA (waste is not included) estimated with the revised model, 1990-2006. 1000 tonnes CO<sub>2</sub> ..... 40

#### Appendix

- B1. Estimated carbon stock in dwellings, divided by building type and construction year, 2001. 1000 tonnes C ..... 56

## List of tables

<b>3.</b>	<b>Data sources</b>	
3.1.	Statistical data sources for the components in the direct inventory .....	22
<b>4.</b>	<b>Estimation methods and models</b>	
4.4.	HWP variables used to estimate the HWP contribution calculated by the IPCC HWP model. ....	25
<b>6.</b>	<b>Results and discussions for Norway</b>	
6.1.	CO <sub>2</sub> emissions/removals to AFOLU for the different approaches (waste is not included) and net export, 1990-2006. 1000 tonnes CO <sub>2</sub> .....	33
6.2.	The total carbon stock in Norway for 1990 and 2001 estimated with the revised model. 1000 tonnes C .....	39
6.3.	Values for the half-lives for solid wood products used when fitting the IPCC HWP model to the direct inventory results. Years .....	39
6.4.	CO <sub>2</sub> emissions/removals estimated in the stock change approach, estimated with the revised method (not including waste), 1990-2006. 1000 tonnes CO <sub>2</sub> .....	41
	<b>Appendix</b>	
A1.	Default values provided by IPCC for parameters used in the IPCC model.....	49
A2.	National values for the density of wood, commercial roundwood removals and the corresponding estimated mean density for wood logged in Norway.....	50
A3.	National values for the bark factors of wood, the portion of logging for sale and the corresponding estimated mean for wood .....	51
A4.	Parameters used in the IPCC HWP model.....	52
B1.	Number of dwellings and average useful floor space by year of construction and building type, November 3 <sup>rd</sup> 1990 and conversion factors.....	55
B2.	Number of dwellings and average utility floor space by year of construction and building type, November 3 <sup>rd</sup> 2001.....	55
B3.	Share of wooden dwellings, 1900-2000 .....	55
B4.	Average use of wood when building dwellings, by year of construction and building type, m <sup>3</sup> wood/m <sup>2</sup> dwelling .....	56
B5.	Carbon stock in dwellings.....	56
B6.	Average use of wood when building terraces, windbreaks, fences etc., by year of construction and building type, m <sup>3</sup> wood/dwelling .....	57
B7.	Carbon stock in terraces, windbreaks, fences etc. ....	57
B8.	Total utility floor space and carbon stock in garages, outhouses and annexes linked to dwellings .....	58
B9.	The number and total basal area of buildings used as holiday houses, garages, outhouses and annexes linked to holiday houses and mountain farm hut, cabins etc. November 3 <sup>rd</sup> 1990 and 2001, and the corresponding wood fractions.....	58
B10.	Carbon stock in houses used as holiday houses, mountain farm huts, cabins, boat-houses etc., and garages, outhouses, annexes, terraces etc. linked to holiday houses, 1990 and 2001 .....	59
B11.	Carbon stock in non-residential buildings, 1990 and 2001 .....	59
B12.	Carbon stock in furniture, fixtures and fittings, doors, windows, furniture etc., 1990 and 2001 .....	60
B13.	Carbon stock in civil engineering constructions, 1990 and 2001 .....	60
B14.	Carbon stock originating from renovation and extensions, 1990 and 2001 .....	61
B15.	Solid wood stock and carbon stock in Norway, 1990 and 2001 .....	61
B16.	Values for the half-life for solid wood products used when fitting the IPCC HWP model to the direct inventory results. Years .....	61
B17.	The carbon stock in Norway estimated with the combined method and the revised model, 1990. 1000 tonnes C.....	62