



Citation for published version:

Ashraf, MA, Tan, J, Davidson, MG, Bull, S, Hutchby, M, Mattia, D & Plucinski, P 2019, 'Continuous-flow liquid-phase dehydrogenation of 1,4-cyclohexanedione in a structured multichannel reactor', *Reaction Chemistry & Engineering*, vol. 4, no. 1, pp. 27-40. <https://doi.org/10.1039/C8RE00176F>

DOI:

[10.1039/C8RE00176F](https://doi.org/10.1039/C8RE00176F)

Publication date:

2019

Document Version

Peer reviewed version

[Link to publication](#)

Publisher Rights

CC BY

This is the authors' accepted manuscript of an article published in final form at:
<https://pubs.rsc.org/en/Content/ArticleLanding/2019/RE/C8RE00176F#!divAbstract>

University of Bath

General rights

Copyright and moral rights for the publications made accessible in the public portal are retained by the authors and/or other copyright owners and it is a condition of accessing publications that users recognise and abide by the legal requirements associated with these rights.

Take down policy

If you believe that this document breaches copyright please contact us providing details, and we will remove access to the work immediately and investigate your claim.

Reaction Chemistry & Engineering

Accepted Manuscript



This article can be cited before page numbers have been issued, to do this please use: M. A. Ashraf, J. Tan, M. G. Davidson, S. Bull, M. Hutchby, D. Mattia and P. Plucinski, *React. Chem. Eng.*, 2018, DOI: 10.1039/C8RE00176F.



This is an Accepted Manuscript, which has been through the Royal Society of Chemistry peer review process and has been accepted for publication.

Accepted Manuscripts are published online shortly after acceptance, before technical editing, formatting and proof reading. Using this free service, authors can make their results available to the community, in citable form, before we publish the edited article. We will replace this Accepted Manuscript with the edited and formatted Advance Article as soon as it is available.

You can find more information about Accepted Manuscripts in the [author guidelines](#).

Please note that technical editing may introduce minor changes to the text and/or graphics, which may alter content. The journal's standard [Terms & Conditions](#) and the ethical guidelines, outlined in our [author and reviewer resource centre](#), still apply. In no event shall the Royal Society of Chemistry be held responsible for any errors or omissions in this Accepted Manuscript or any consequences arising from the use of any information it contains.



Reaction Chemistry & Engineering

PAPER

Continuous-flow liquid-phase dehydrogenation of 1,4-cyclohexanedione in a structured multichannel reactor†

M. Arsalan Ashraf,*^a Julia Tan,^a Matthew G. Davidson,^b Steven Bull,^b Marc Hutchby,^b Davide Mattia^a and Pawel Plucinski*^a

Received 00th January 20xx,
Accepted 00th January 20xx

DOI: 10.1039/x0xx00000x

www.rsc.org/

A highly selective, scalable and continuous-flow process is developed for the liquid-phase dehydrogenation of 1,4-cyclohexanedione to hydroquinone in a millimetre-scale structured multichannel reactor. The square shaped channels (3 mm × 3 mm) were filled with 10 wt% Pd/C catalyst particles and utilized for the dehydrogenation reaction in single-pass and recycle modes. For the purpose to enhance process understanding and to maximize conversion and selectivity by process optimization, Design of Experiment (DoE) methodology was utilized by studying the effect of operating parameters on the catalytic performance in kinetic regime. The results demonstrated the strong influence of temperature and liquid feed flow on the conversion and selectivity, with liquid feed and N₂ flows influencing pressure drop significantly. A multi-objective optimization methodology was used to identify the optimum process window with the aid of sweet spot plots, with design space plots developed to establish acceptable boundaries for process parameters. In single-pass mode, complete conversion per pass per channel was not achievable whereas conversion increased from 59.8% in one-channel to 78.3% for two-channel-in-series while maintaining selectivity (> 99%) with intermediate hydrogen removal. However, for without intermediate H₂ removal step, selectivity was declined from > 99% in one-channel to 82.3% at the outlet of second-channel. In recycle mode, dehydrogenation reaction was resulted in almost complete conversion (> 99%) with very high selectivity (> 99%) and yield (> 98%). This combination of mm-scale multichannel reactor and DoE methodology opens the way to developing highly selective and scalable dehydrogenation processes in the fine chemical and pharmaceutical industries.

1. Introduction

Climate change, security of fossil fuels supply and other considerations are driving towards the development of a biomass-based economy. The existing industrial process routes are developed to synthesize chemicals from fossil feedstock. In turn, the oxygen-rich chemistry of bio-feedstocks requires novel synthetic routes to key chemicals that can be prepared using economic and environmentally viable processes.^{1, 2} In fine chemical and pharmaceutical industry, dehydrogenation is an interesting reaction in the formation of highly-valuable ketones, aldehydes and aromatic compounds from renewable feedstock. The endothermic dehydrogenation is usually performed at higher temperature and lower pressure. However, insufficient chemical stability of the most fine-chemicals requires the reaction to be performed at moderate condition in the liquid phase by the use of solvent. This dehydrogenation to aromatic compounds becomes more

complex in terms of achieving high selectivity when hydroxyl, carbonyl or acid anhydride group is attached to the ring.³

Hydroquinone is a key intermediate (benzene ring with two hydroxyl groups) in the production of many high-value fine-chemical and pharmaceutical ingredients, with hydroquinone currently produced from petroleum-based feedstocks such as benzene, phenol, and aniline.⁴ It has commercial applications such as an antioxidant in skincare products,⁵ as a polymerization inhibitor,⁶ and as a photo-developing agent.⁷ However, hydroquinone can potentially be synthesized by the dehydrogenation of 1,4-cyclohexanedione,⁸ which, in turn, can be derived from bio-renewable succinic esters⁹ that can be accessed from lignocellulosic feedstocks using fermentative processes.¹⁰

In fine-chemical processes, multiphase dehydrogenation of cyclohexanones is currently performed in conventional slurry reactors: For instance, the liquid phase dehydrogenation of 1,4-cyclohexanedione has been carried out in a batch slurry reactor at 215 °C over suspended Pd/C catalysts (10 – 200 μm) in a polyglycol solvent with a hydroquinone yield of 91.5%.⁸ In a similar study,¹¹ 4-hydroxyacetophenone was synthesized by dehydrogenation reaction in ~ 84% yield using a continuous stirred tank reactor (CSTR) over suspended Raney Ni catalyst at 280 °C. In another study,¹² a maximum yield of 92% was reported for dehydrogenation of a number of cyclic ketones to

^a Department of Chemical Engineering, University of Bath, Claverton Down, Bath BA27AY, United Kingdom. Email: M.A.Ashraf@bath.ac.uk, P.Plucinski@bath.ac.uk

^b Department of Chemistry, University of Bath, Claverton Down, Bath BA27AY, United Kingdom.

† Electronic Supplementary Information (ESI) available. See DOI: 10.1039/x0xx00000x



phenols in batch slurry reactor over suspended Pd/C catalyst in N,N-dimethylacetamide at 150 °C with a reaction time of 20 h. The main disadvantage of using slurry reactors is that the reactants face a range of residence times along and varying operating conditions that are dependent on their location in the reactor. This results in inefficient heat and mass transfer that can result in poor selectivity, with typical fine chemical processes producing 20 – 100 kg of unwanted by-products per kg of desired product.¹³

Continuous-flow technology is well established in bulk-chemical and petrochemical industry which can transform conventional batch-processes into more sustainable, highly selective and continuous-flow processes in fine-chemical and pharmaceutical industry.¹⁴ Millimeter-scale flow reactors have been used as an alternative to slurry reactors for dehydrogenation reactions due to their significant advantages of excellent heat and mass transfer, rapid mixing, and fine control of contact time.^{15, 16} This uniformity of reaction environment ensures that every reactant experiences the same operating condition and allows the reaction to operate in intrinsic kinetic regime, which enables the selectivity of the dehydrogenation reactions to be maximized,¹⁷ leading to waste by-product minimization.¹⁸ Additionally, this approach enables pilot scale work to be bypassed by scaling-up the number of reactors using well-established numbering-up processes¹⁹ that do not sacrifice selectivity or yield.^{20, 21} Heterogeneous catalysts can be wash-coated onto reactor channel walls, or used as packed bed inside the channels which avoids abrasion and separation of catalyst particles.²² Indeed, micro/mm-scale packed channel reactors have been shown to provide better reaction performance than non-packed bed channel reactors, particularly wall-coated channels that exhibit excellent mass transfer characteristics.²³

The yield of dehydrogenation reaction is limited by thermodynamics³ which results in lower conversion per pass through the flow reactor. In order to achieve the complete conversion without thermodynamic or kinetic limitations or to avoid side reaction, the dehydrogenation reaction can be performed with recycling of unconverted raw material or ideally by removing the products immediately during the course of reaction.²⁴ The determination of optimized conditions and operating window is necessary to achieve the complete conversion with the highest selectivity. This process can be aided by statistical design of experiments (DoE), which is a proven method for developing optimal processes by applying experimental design and analysis in a structured and organized manner.²⁵ The large number of process parameters that effect multiphase dehydrogenation reactions requires extensive testing to optimize performance. After screening out critical process parameters, experimental results are then analysed to develop predictive models that relate process parameters and response functions.^{26, 27} For chemical transformations, DoE helps identifying the optimal combination of process parameters for maximizing reactivity and selectivity.²⁸ Within the realm of DoE analysis, Response Surface Methodology (RSM) can be used to identify acceptable

process ranges to control response functions which, in turn, can lead to development of an adequate control strategy.²⁹

In this work, we present the first study on the continuous-flow liquid-phase dehydrogenation of 1,4-cyclohexanedione over 10 wt% Pd/C catalyst to produce high yield of hydroquinone in a mm-scale structured multichannel reactor. The reaction is performed in continuous flow (single-pass and recycle modes) at lower pressure using high-boiling-point solvent (tetraethylene glycol dimethyl ether) at optimized conditions identified by DoE methodology. To our knowledge, this is also the first study in multiphase dehydrogenation combining the experimental study and statistical modelling in both single-pass and recycle flow systems.

2. Experimental

2.1. Materials

Tetraethylene glycol dimethyl ether (99%), methanol (99.9%), and 1,4-cyclohexanedione (98%) were supplied by Acros Organics, UK. Biphenyl (99.5%), benzene-d₆ (99.6%) and 10 wt% Pd/C catalyst (reduced) were supplied by Sigma Aldrich, UK. Nitrogen gas was of high purity (> 99%) and was purchased from BOC, UK. All the chemicals, nitrogen, and 10 wt% Pd/C catalyst were used as received without any further purification.

2.2. Design of experiments

Design of experiment (DoE) is applied as a key tool to enhance process understanding and optimize the dehydrogenation reaction for the purpose to maximize conversion and selectivity. For this study, two sets of experimental design were generated using a D-optimal design for process parameters (temperature, liquid feed flow, nitrogen flow, and substrate concentration) and MODDE Pro 10.0.1 software (MKS Umetrics AB). The first experimental design for continuous dehydrogenation (single-pass mode) that employed a subset of 34 experiments is shown in Table S1 (see the ESI†), with Table S2 (see the ESI†) showing a second experimental design using 32 experiments for semi-continuous dehydrogenation (recycling mode). Designed experiments were performed to evaluate conversion, selectivity, and pressure drop as response functions. D-optimal experimental design coupled with regression analysis was used to develop a quadratic model from the experimental results that enabled the relationship between process parameters and response functions to be determined. Finally, all model predictions were then validated experimentally.

2.3. Catalytic performance evaluation

The liquid-phase dehydrogenation of 1,4-cyclohexanedione was carried out over 10 wt% Pd/C catalyst at favourable conditions of lower pressure (1.5 bar) and higher temperature (≤ 240 °C) in high boiling point ($T_{BP} = 275$ °C) solvent i.e., tetraethylene glycol dimethyl ether with excellent thermal and chemical stability. The experiments were conducted in a purpose-built experimental set-up (Fig.1), using a previously developed³⁰ mm-scale structured multichannel reactor at the



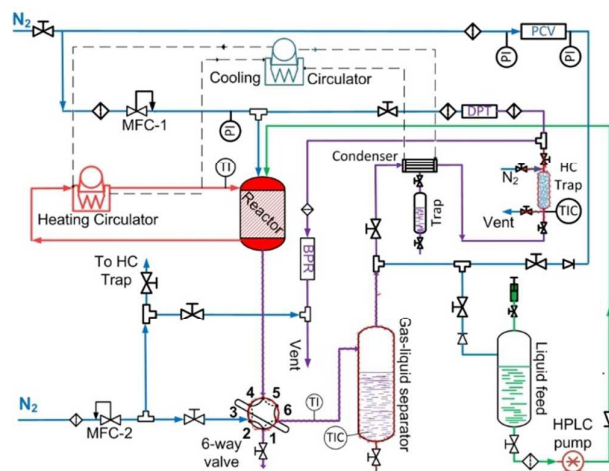

Fig. 1 Experimental schematic for measuring catalytic activity of three phase dehydrogenation reactions: MFC = mass flow controller, PCV = pressure control valve, BPR = back pressure regulator, HC = hydrocarbon, PI = pressure indicator, DPT = differential pressure transducer, TIC = temperature indicator and controller, and TI = temperature indicator.

University of Bath, as shown in Fig. S1 (see the ESI†). The reactor design allows the flexibility to operate multiple channels in single-pass, series and recycle modes. The reactor channel (3 mm × 3 mm, square shape, length = 10 cm) was selected due to the highest conversion of organic feedstock as compared to other channels (2 mm × 2 mm and 5 mm × 5 mm) in the previous study.³¹ The channel was packed with 210 mg of pre-reduced 10 wt% Pd/C catalyst (average particle size of activated carbon = 64.4 μm, Pd nanoparticles = ca. 5 nm³²⁻³⁴), with glass wool placed at each end of the chamber to hold the catalyst bed in place. The liquid and gas streams were preheated to reaction temperature in upfront static mixer (length = 6 cm). The reaction temperature was controlled using a heating system employing a recirculating fluid for heat transfer to the heat exchanging type structured multichannel reactor. A back-pressure regulator controlled the pressure at 1.5 bar to avoid air ingress into the reactor. A detailed description of the reactor and experimental setup is provided in the ESI†.

For the first experimental design, the reactor was operated in continuous flow mode with controlled temperature (T , 180 – 240 °C), nitrogen gas flow (F_G , 5 – 80 mL/min, 33.3 – 566.7 m³ m⁻² h⁻¹ at STP), liquid feed flow (F_L , 0.10 – 0.50 mL/min, 0.7 – 3.3 m³ m⁻² h⁻¹ at STP), and 1,4-cyclohexanedione concentration (C_0 , 1 – 10 wt% in tetraethylene glycol dimethyl ether).

The dehydrogenation reaction is limited by thermodynamics, requiring higher temperatures to achieve a reasonable conversion, however reaction selectivity is badly affected by high temperatures.³ Therefore, to achieve a higher yield, a second set of experiments was designed for semi-continuous operation, whereby the exit product liquid stream was recycled as a feedstock back into the reactor whilst gas was vented. The factors varied in the second set of

experiments were reactor inlet conversion (X_{in} , 0 – 100%), reactor temperature (T , 200 – 240 °C), nitrogen gas flow (F_G , 5 – 85 mL/min, 33.3 – 602.1 m³ m⁻² h⁻¹ at STP), and liquid feed flow (F_L , 0.10 – 0.50 mL/min, 0.7 – 3.3 m³ m⁻² h⁻¹ at STP). The feed stream contained 5 wt% 1,4-cyclohexanedione and hydroquinone (based on reactor inlet conversion) in tetraethylene glycol dimethyl ether.

Prior to catalytic testing, the reactor was purged with 45 mL/min nitrogen for 30 min at room temperature. The liquid feed was introduced at a flow rate of 0.50 mL/min for 10 min to wet the catalyst bed. Pre-wetting is commonly performed to achieve uniform distribution of the liquid substrate throughout the catalyst bed.³⁵ However, for miniaturized packed bed reactors, wet and dry start-up procedures can provide the same hydrodynamic state after stabilization due to strong capillary forces,³⁶ with pre-wetting carried out as a precautionary step in this study to ensure good reproducibility. After wetting, the liquid feed was stopped, and the reactor heated from room temperature to the desired reaction temperature with a continuous nitrogen flow. At the desired temperature, the reaction was initiated with liquid and gas flows using a co-current flow arrangement. For each experiment, the feed was allowed to flow for 60 min to ensure steady state condition. Subsequently, three liquid samples were collected at 10 minutes interval, which were then analysed by ¹H NMR spectroscopy using a 300 MHz Bruker spectrometer for product detection and quantification. Biphenyl was used as internal standard for quantification purposes. The sample used for ¹H NMR analysis was prepared by dissolving 0.2 mL of product in 0.5 mL benzene-d₆. Product ratios were validated using gas chromatography (GC system, 7890B, Agilent Technologies) coupled to mass spectrometric (MS, 5977A, Agilent Technologies) detection. The samples used for GC-MS analysis were prepared by dissolving product analytes in methanol prior to analysis.

3. Results and discussion

To develop a continuous-flow process for liquid-phase dehydrogenation, different parameters i.e., temperature, liquid feed flow, nitrogen gas flow, and substrate concentration were evaluated for catalytic performance in mm-scale structured multichannel reactor in single-pass and recycle modes.

The catalytic performance of multiphase dehydrogenation reaction can be assumed as a sequence of fundamental steps: (1) diffusion of 1,4-cyclohexanedione from the liquid feed stream to the surface of the Pd/C particles, (2) subsequent diffusion through the pore network of activated carbon, (3) followed by adsorption on the metallic Pd catalyst surface, (4) then surface reaction leading to the formation of products (i.e., hydroquinone, hydrogen etc.), (5) eventually the desorption of the products from the metallic Pd catalyst surface, (6) which diffuse away from the catalyst surface through the pore structure back to the bulk stream. Hydroquinone remains in the liquid phase whereas the produced hydrogen goes to the surrounding gas stream.



The plug flow behaviour in mm-scale structured packed bed reactor was confirmed by a number of appropriate criterions i.e., ratio of reactor to particle diameter, reactor length to particle diameter, and Peclet number. The presence of external and internal mass transfer diffusion limitation was evaluated at extreme operating conditions at higher conversion (79.1%) for the experiment N17 ($T = 240$ °C, $F_L = 0.1$ mL/min, $F_G = 5$ mL/min, and $C_o = 10$), see Table S1 in the ESI†.

The understanding of interaction at the interphase of liquid-solid is very important for uniform distribution of liquid stream surrounding the catalyst particles in heterogeneous multiphase reactors. Small catalyst particles (50 - 200 μm) in micro/mm-scale packed bed reactors alter the prevailing hydrodynamics of multiphase flow, which is not characteristic of trickle flow regimes, and helpful to overcome the non-idealities of trickle bed reactors: (1) incomplete wetting, (2) internal concentration gradient, (3) flow mal-distribution, and (4) temperature gradient on reactor scale.^{37, 38} The small particle size (64.4 μm) result in capillary forces dominating over viscous and gravitational forces, which results in almost complete wetting of the catalyst bed.³⁹ However further decrease in particle size (< 50 μm) will result in significant pressure drop over the catalyst bed. The dehydrogenation reaction is favoured at lower pressure. The smaller particles and longer channel length will increase the pressure drop significantly, with negative influence on yield and energy requirement. The Sie criterion⁴⁰ (eq. 1) was used to estimate the wetting characteristics of the catalyst packed bed.

$$\frac{(dP/dh)_{flow}}{(dP/dh)_{gravity}} = \frac{180\mu_L u_L}{h_L \varepsilon_b d_p^2 \rho_L g} \frac{(1-h_L \varepsilon_b)^2}{(h_L \varepsilon_b)^3} > 1 \quad (1)$$

where g is the gravitational constant (9.81 m/s^2), μ_L is the feed mixture viscosity (Pa.s), ρ_L is the feed mixture density (kg/m^3), ε_b is the catalyst bed voidage (0.40), d_p is the average diameter of catalyst particles (64.4 μm), and u_L is the superficial liquid feed velocity (m/s). Based on the observed values of liquid holdup in micro packed bed reactor between 0.65 – 0.85, a value of 0.75 was assumed for liquid holdup (h_L) in mm-scale packed bed reactor under investigation.³⁸ The criterion value of 15.9 > 1.0 confirmed that the catalyst bed was fully wetted, leading to a more stable hydrodynamic state and uniform 1,4-cyclohexanedione distribution around the catalyst particles in the mm-scale reactor when compared to a trickle bed reactor. A previous study using 165 μm catalyst particles for the oxidation of liquid organic feedstocks showed a non-significant influence of gravitational forces on the reactor performance,³¹ with all experiments in this study performed using a reactor aligned in a horizontal position.

The narrow residence time distribution is the characteristics of plug flow reactors, in addition to the uniformity of reaction environment that ensures same operating conditions for each reactant along the reactor. A previous study³¹ has shown that plug flow normally occurs for the flow ranges operating in our reactor system, with a reactor diameter (d_r) to particle diameter (d_p) ratio of 46.6 > 10 confirming the absence of wall effects on the plug flow

pattern.³⁸ The radial distribution of the substrate concentration in the reactor can be considered to be uniform for large $d_r/d_p > 25$ values.⁴⁰ The effects of axial gradients can be neglected based on the reactor length and particle diameter ratio (L_r/d_p) of 466 > 50, which was also confirmed by the particle Peclet number ($Pe_{p,ax}$),⁴¹ as calculated by eq. (2).

$$\frac{1}{Pe_{p,ax}} = \frac{\varepsilon_b}{\tau_b Re Sc} + \frac{0.45}{1+0.73(Re Sc)} < 0.10 \quad (2)$$

Where τ_b (1.58) is the tortuosity of the catalyst packed bed, Re is the Reynold number, and Sc is the Schmidt number. The details are provided in the ESI†. The Peclet number value of 0.003 < 0.10 confirms the absence of axial concentration gradients in catalyst bed of mm-scale flow reactor.

The mass transport limitations in heterogeneous catalytic reactors can alter the reaction rates, selectivity and even the reaction mechanism.^{42, 43} However, In order to evaluate the external mass transport limitation between the bulk fluid stream and the external catalyst surface, Mears criterion⁴⁴ is utilized as described by eq. (3).

$$\frac{-r_{obs} \rho_b r_p n}{k_{LS} C_B} < 0.15 \quad (3)$$

where $-r_{obs}$ is the observed rate of reaction, ρ_b is the catalyst bed bulk density (250 kg/m^3), r_p is the particle radius (32.4 $\times 10^{-6}$ m), n is the order of reaction (assumed as first order), k_{LS} is the overall liquid-solid mass transfer co-efficient (see the ESI†), and C_B is the concentration of 1,4-cyclohexanedione in tetraethylene glycol dimethyl ether. The Mears criterion value of 7.90 $\times 10^{-6}$ < 0.15 confirms the absence of a concentration gradient between the bulk liquid feed and the catalyst surface.

The absence of intraparticle (internal) mass transfer limitation was verified by using the Weisz-Prater criterion⁴⁵ which represents the ratio of reaction rate to the rate of diffusion in pores, as given by the Eq. (4).

$$C_{WP} = \frac{-r_{obs} \rho_b r_p^2}{D_{eff} C_{AS}} < 0.3 \quad (4)$$

Where C_{AS} is 1,4-cyclohexanedione concentration on catalyst surface which can be assumed equivalent to bulk concentration (C_B) in the absence of external mass transfer limitations, and D_{eff} is the effective diffusivity of 1,4-cyclohexanedione inside the liquid filled pores of catalyst particles (see the ESI†). Apart from lower bulk diffusivity in liquid reaction systems, the effective diffusivity is influenced by liquid phase non-idealities, high affinity of diffusing specie on the catalyst surface, molecule size comparable to the pore size, and adsorption phenomena.⁴⁶⁻⁵² The Weisz-Prater criterion value of 0.20 < 0.3 suggests the absence of pore diffusion limitation for reaction order of 2 and lower order.⁵³

These results suggest that the liquid-phase dehydrogenation reaction is performed in kinetic regime under the investigated conditions with no transport (extra-particle and intra-particle diffusion) limitations.

3.1. Continuous dehydrogenation of 1,4-cyclohexanedione



For continuous flow (single-pass mode) liquid-phase dehydrogenation of 1,4-cyclohexanedione, the results are shown in Table S1 (see the ESI†) for 34 experiments designed by using D-optimal methodology. All the experiments were performed over 10 wt% Pd/C catalyst packed in mm-scale structured multichannel reactor in randomized order to avoid experimental bias, with three central point experiments showing that results were reproducible, with deviations between each run within an experimental error of $\pm 2.9\%$.

Table 1 Regression coefficient of models for continuous dehydrogenation

Model term	Coefficient estimate	Standard error	P
(a) Conversion, X (Y_1)			
Constant	1.35	0.04	5.11×10^{-24}
X_1	0.36	0.02	5.65×10^{-15}
X_2	0.12	0.02	2.49×10^{-6}
X_3	-0.35	0.02	4.74×10^{-16}
X_4	5.94×10^{-3}	0.02	0.76
X_1^2	-0.18	0.03	6.73×10^{-6}
$X_1 \times X_2$	-0.11	0.02	2.31×10^{-6}
$X_1 \times X_3$	7.40×10^{-2}	0.02	5.30×10^{-4}
(b) Selectivity, S (Y_2)			
Constant	0.44	0.07	3.28×10^{-6}
X_1	-0.19	0.04	2.03×10^{-5}
X_2	0.03	0.04	0.50
X_3	0.13	0.04	2.04×10^{-3}
X_4	-6.97×10^{-2}	0.04	0.08
X_3^2	-0.32	0.07	6.31×10^{-5}
$X_1 \times X_3$	0.15	0.04	3.91×10^{-4}
(c) Pressure drop, ΔP (Y_3)			
Constant	0.73	0.05	2.71×10^{-14}
X_1	-0.01	0.02	0.58
X_2	0.19	0.02	7.63×10^{-9}
X_3	0.16	0.02	5.29×10^{-8}
X_4	-6.87×10^{-3}	0.02	0.76
X_2^2	-8.80×10^{-2}	0.04	0.02
X_3^2	-9.52×10^{-2}	0.04	0.03
$X_1 \times X_3$	4.59×10^{-2}	0.02	0.04

X_1 = temperature (T, °C), X_2 = nitrogen flow (F_G , mL/min), X_3 = liquid feed flow (F_L , mL/min), and X_4 = substrate concentration (C_0 , wt %).

The experimental results (Table S1, see the ESI†) were analysed and quadratic models were developed using eq. (5) for conversion (Y_1) of 1,4-cyclohexanedione, selectivity (Y_2) for hydroquinone, and pressure drop (Y_3) in terms of temperature (X_1), nitrogen flow (X_2), liquid feed flow (X_3), and substrate concentration (X_4), respectively.

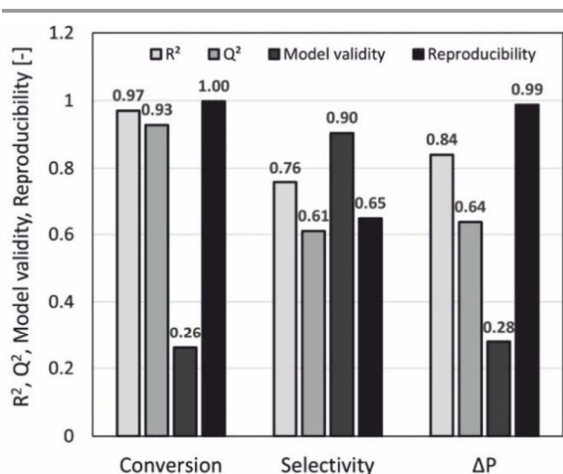

Fig. 2 Summary of fit for continuous dehydrogenation reaction of 1,4-cyclohexanedione.

$$Y_i = \beta_0 + \sum_{i=1}^k \beta_i X_i + \sum_{i=1}^k \beta_{ii} X_i^2 + \sum_{i < j} \beta_{ij} X_i X_j \quad (5)$$

where, Y_i is the response, β_0 is the intercept constant term, and β_i , β_{ii} and β_{ij} are the linear, square, and interaction regression coefficients, respectively. Experimental data was fitted to the models using a partial least square (PLS) method followed by model refinement with a statistical analysis. Each response function was analysed for data distribution using histograms. A logarithmic transformation was applied to

Table 2 Analysis of variance (ANOVA) of fitted model for continuous dehydrogenation

Source	DF	SS	MS (variance)	F	p	SD
(a) Conversion, X (Y_1)						
Total	34	58.14	1.71			
Constant	1	47.4	47.4			
Total corrected	33	10.74	0.33			0.57
Regression	7	10.42	1.49	120.6	0	1.2
Residual	26	0.32	1.24×10^{-2}			0.1
Lack of Fit (LoF)	24	0.32	1.33×10^{-2}	18.61	0.05	0.1
Pure error (pe)	2	1.43×10^{-3}	7.16×10^{-4}			0.03
RSD \times sqrt(F(crit)) = 0.17						
SD-pe \times sqrt(F(crit)) = 0.12						
(b) Selectivity, S (Y_2)						
Total	34	5.69	0.17			
Constant	1	0.6	0.6			
Total corrected	33	5.09	0.15			0.39
Regression	6	3.85	0.64	13.91	0	0.8
Residual	27	1.24	4.61×10^{-2}			0.21
Lack of Fit (LoF)	25	1.14	4.54×10^{-2}	0.84	0.68	0.21
Pure error (pe)	2	0.11	5.43×10^{-2}			0.23
RSD \times sqrt(F(crit)) = 0.34						
SD-pe \times sqrt(F(crit)) = 1.03						
(c) Pressure drop, ΔP (Y_3)						
Total	34	12.8	0.38			
Constant	1	10.27	10.27			
Total corrected	33	2.54	7.68×10^{-2}			0.28
Regression	7	2.13	0.3	19.5	0	0.55
Residual	26	0.41	1.56×10^{-2}			0.12
Lack of Fit (LoF)	24	0.4	1.68×10^{-2}	17.3	0.06	0.13
Pure error (pe)	2	1.94×10^{-3}	9.72×10^{-4}			0.03
RSD \times sqrt(F(crit)) = 0.19						
SD-pe \times sqrt(F(crit)) = 0.14						

DF = degree of freedom, SS = sum of square, MS = mean square, SD = standard deviation, RSD = residual standard deviation, sqrt(F(crit)) = square root of critical F.

determine conversion and pressure drops, whereas a negative logarithmic transformation was used to calculate selectivities for a normal distribution of data.

The regression coefficient of quadratic models along with standard error and P-values are given in Table 1. The model significance of each response function was evaluated through P-values, with a P-value of < 0.05 indicating that the coefficient influenced the response function significantly, whilst a P-value of 0.05 indicating a non-significant effect. Additionally, a positive coefficient value was considered to correspond to a synergistic effect, whilst a negative value indicated an antagonistic effect of the factor on the selected response.

The summary of fit ($R^2 > 0.5$, $Q^2 > 0.5$, model validity > 0.25 , and reproducibility > 0.5) was used as criteria to measure the



PAPER

Reaction Chemistry & Engineering

quality of model fit and its potential for prediction. As shown in Fig. 2, R^2 values of > 0.75 indicating a good fit with a sufficiently precise description of experimental data to the models. However, due to several factors influencing a chemical reaction, a lower $R^2 \sim 0.7$ was also considered acceptable,²⁷ whilst Q^2 values of > 0.50 confirmed the good predictive capability for all models. Model diversity was probed using validity values of > 0.25 , which confirmed the absence of statistically significant problems.⁵⁴ The high reproducibility values (> 0.5) proved that the variation of replicates was less than the overall variation of the response function. For conversion and pressure drop, the model validity values were lower due to very high reproducibility values close to 1.0.⁵⁵

The significance of the model and model terms was evaluated using P-value (< 0.05) and analysis of variance (ANOVA) at 95% confidence level. Finally, all model predictions were then validated experimentally. ANOVA data shown in Table 2 reveal that the models are statistically significant at 95% confidence level. The lack of fit (LoF) was calculated from the pure error and its residual. A high F-value implies that the lack of fit is non-significant relative to the pure error which suggests that the developed models are valid with good predictability. Statistical significance of the models were checked by comparing the values of the term “ $RSD \times \sqrt{F(\text{crit})}$ ” with “ regression-SD ” where lower first values for all responses confirm that models were significant at the 5% level. Lack of fit was non-significant for all models as confirmed by larger values for $SD\text{-pe} \times \sqrt{F(\text{crit})} = 1.0281$ than for $SD\text{-LoF}$. Fig. S2 (ESI[†]) reveals that the predicted values of the models were in good agreement with observed values, which confirmed the factors are successfully correlated with the responses in the developed models.

The understanding of the dehydrogenation process was developed by studying the influence of a series of operating parameters on process functions, i.e. conversion, selectivity, and pressure drop.

3.1.1. Dehydrogenation of 1,4-cyclohexanedione

The influence of temperature and nitrogen flow on the catalytic dehydrogenation of 10 wt% 1,4-cyclohexanedione is shown as response surface plots in Fig. 3 (A - D) for liquid flows of 0.10, 0.20, 0.40 and 0.50 mL/min ($0.7, 1.4, 2.7, 3.3 \text{ m}^3 \text{ m}^{-2} \text{ h}^{-1}$ at STP), respectively. With the variation in operating parameters, the conversion values ranged from 79.1 to 0.9%, with conversion rates decreasing with increased liquid flow from 0.1 to 0.5 mL/min, which is caused by the shorter residence time of 1,4-cyclohexanedione in the catalyst bed. Increasing temperature showed an overall positive influence on substrate conversion levels, due to the endothermic nature of reaction.⁵⁶ The highest conversion peak was found in the temperature region of 220 – 230 °C for all liquid feed flow rates, suggesting the presence of optimal operating conditions. Moreover, this finding is in agreement with the optimal temperature range (180 – 260 °C) observed previously in a batch slurry reactor,⁸ with the DoE helping to narrow down the optimal temperature range in this flow reactor. The lowest

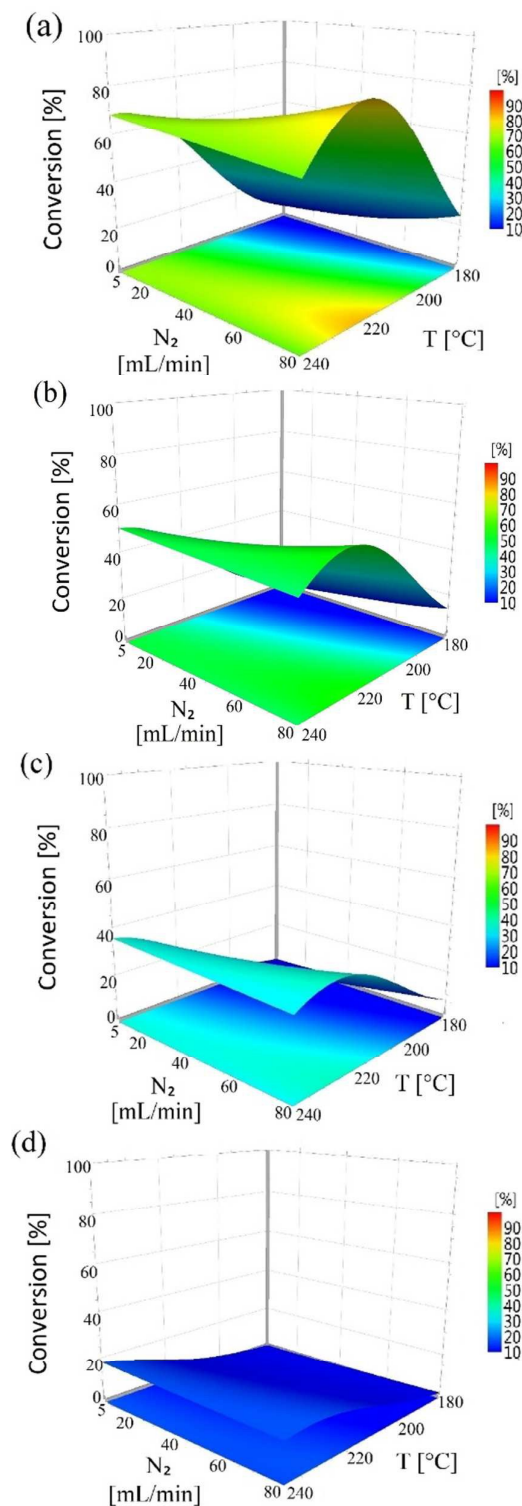
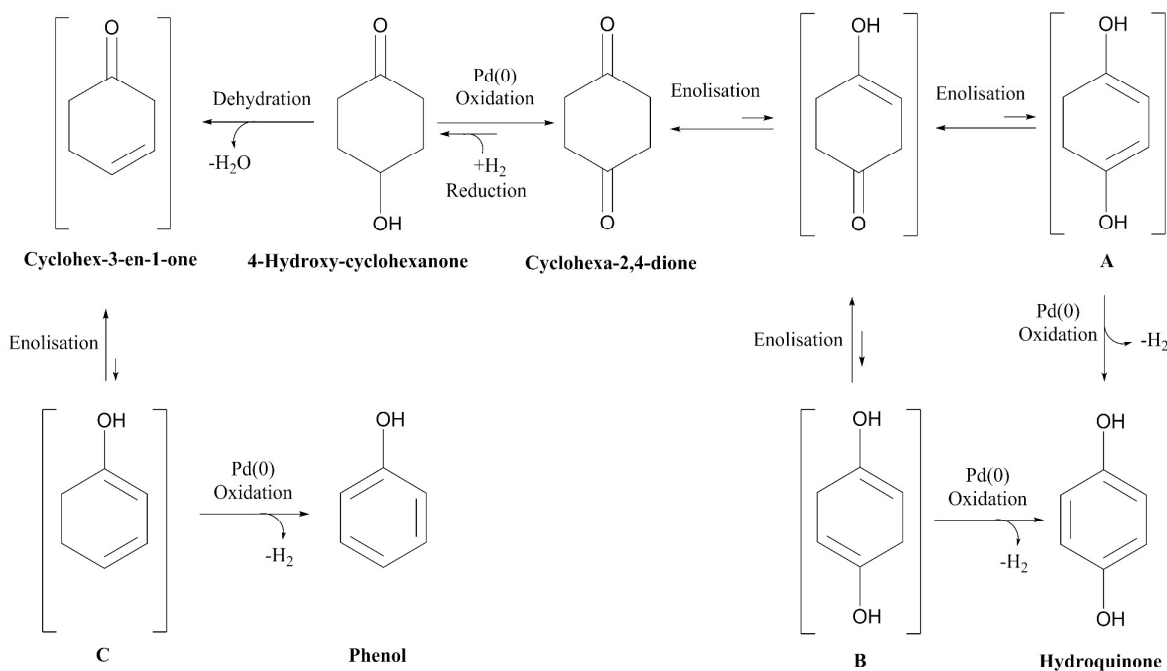

Fig. 3 Influence of temperature (180 – 240 °C) and nitrogen flow (5 – 80 mL/min, $33.3 - 566.7 \text{ m}^3 \text{ m}^{-2} \text{ h}^{-1}$ at STP) on conversion of substrate (10 wt%) for liquid feed flows of (a) 0.1 mL/min ($0.7 \text{ m}^3 \text{ m}^{-2} \text{ h}^{-1}$ at STP), (b) 0.2 mL/min ($1.4 \text{ m}^3 \text{ m}^{-2} \text{ h}^{-1}$ at STP), (c) 0.4 mL/min ($2.7 \text{ m}^3 \text{ m}^{-2} \text{ h}^{-1}$ at STP), and (d) 0.5 mL/min ($3.3 \text{ m}^3 \text{ m}^{-2} \text{ h}^{-1}$ at STP), in



conversion was obtained at the highest flow rate of 0.5 **3.1.2. Selectivity for formation of hydroquinone**



Scheme 1 Reaction schematic for dehydrogenation of 1,4-cyclohexanedione and formation of 4-hydroxy-cyclohexanone and phenol by-products.

mL/min and lowest temperature of 180 °C.

Nitrogen flow had a very minor but positive influence on conversion values, particularly at lower temperatures. This is likely to be due to removal of H₂ of the reactor serving to drive the equilibrium of the dehydrogenation reaction towards hydroquinone formation. This situation is different to conventional hydrogenation/oxidation reactions where one of the gaseous reactants (hydrogen or oxygen) needs to diffuse from the gas to the liquid phase, before it can reach the catalyst surface. This means that interactions between hydrogen (or oxygen) and the substrate on the catalyst surface is very important, with these type of catalytic hydrogenation/oxidation reactions strongly influenced by the hydrodynamics of the catalyst bed.⁵⁷ However, for the dehydrogenation reaction, 1,4-cyclohexanedione is already present in the liquid phase around the catalyst particle, which means its distribution over the catalyst active sites is more uniform as the catalyst bed is fully wetted due to the presence of strong capillary forces. Moreover, changing substrate concentration levels (1, 5, and 10 wt %) resulted in a non-significant effect on conversion rate as confirmed by a P-value of > 0.05 (Fig. S3, ESI[†]). The results clearly indicate that it is not possible to obtain complete conversion of 1,4-cyclohexanedione in a single pass. The maximum conversion per pass was found to be as 79.1% at operating conditions of $T = 240$ °C, $F_L = 0.1$ mL/min, $F_G = 45$ mL/min and $C_0 = 10$ wt% but the cost of lower selectivity of 91.9%. This result highlights the importance of finding operating window to obtain maximum conversion while maintaining selectivity > 99% at the same time.

The influence of operating conditions on the selectivity to hydroquinone was found to range from 91.9 to 99.8% under the investigated conditions. Scheme 1 shows the reactions occurring during the dehydrogenation process with hydroquinone, 4-hydroxycyclohexanone and phenol identified as products in all the 1,4-cyclohexanedione dehydrogenation experiments. The major reaction pathway for the conversion of 1,4-cyclohexanedione to hydroquinone is likely to proceed via an enolization pathway to afford bis-enols A and B that then undergo Pd(0) mediated dehydrogenation to afford hydroquinone. The hydrogen generated from dehydrogenation of bis-enols A and B may then be used for the Pd(0) mediated reduction of one of the keto groups of cyclohexa-1,4-dione to

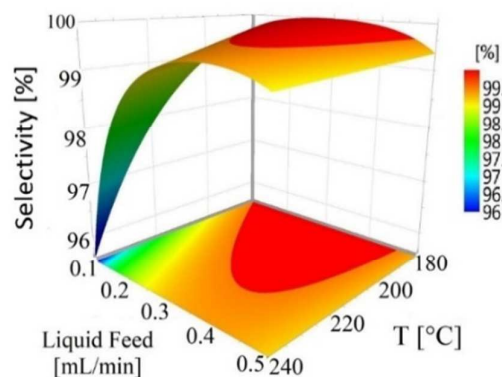

Fig. 4 Influence of temperature (180 – 240 °C) and liquid feed flow (0.1 – 0.5 mL/min, 0.7 – 3.3 m³ m⁻² h⁻¹ at STP) on the conversion and selectivity of 1,4-cyclohexanedione for a fixed nitrogen flow (40 mL/min, 266.4 m³ m⁻² h⁻¹ at STP) and substrate concentration (10 wt%), in single-pass mode.



PAPER

afford 4-hydroxycyclohexanone. Thermal dehydration of 4-hydroxycyclohexanone can then occur to afford cyclohex-3-en-1-one that can then enolise to afford bis-enol C which then undergoes Pd(0) mediated dehydrogenation to afford phenol. The influence of substrate concentration (1 – 10 wt%) and nitrogen flow (5 – 80 mL/min, 33.3 – 566.7 m³ m⁻² h⁻¹ at STP) on the selectivity of the dehydrogenation reaction was negligible (see response surface plots displayed in Figs S4 and S5, ESI†). Capillary forces dominate viscous and gravitational forces in packed beds containing catalyst particles < 200 μm,³⁹ resulting in a thicker liquid layer around the catalyst particles. Nitrogen flow occurs preferentially through the voids available around the catalyst particles, and as a consequence had no significant influence on selectivity.

Temperature (180 – 240 °C) and liquid feed flow (0.1 – 0.5 mL/min, 0.7 – 3.3 m³ m⁻² h⁻¹ at STP) showed a strong influence on selectivity as shown by the P-values (< 0.05) of regression coefficients. Fig. 4 shows that the selectivity for hydroquinone declined with increasing temperature at lower liquid feed flow rates, which is likely to be linked to the residence time of 1,4-cyclohexadione (and 4-hydroxycyclohexanone) in the catalyst bed. An increase in liquid feed flow from 0.1 mL/min (235 □, 5 wt% and 5 mL/min) to 0.2 mL/min (240 □, 5wt% and 5 mL/min) results in significant improvement in selectivity from 91.9% to 99.4% but at the price of drop in conversion values from 79.1% to 61.2%. The results clearly shows a wide operating window to obtain > 99% selectivity.

3.1.3. Pressure drop

The influence of operating parameters on the variation of pressure drop was also investigated. The pressure drop was found to be strongly dependent on the liquid feed rate (5 – 80 mL/min, 33.3 – 566.7 m³ m⁻² h⁻¹ at STP) and nitrogen flow (0.1 – 0.5 mL/min, 0.7 – 3.3 m³ m⁻² h⁻¹ at STP), as shown in response surface plot in Fig. 5. Temperature and substrate concentration appeared to be non-significant factors, as shown in contour plot in Fig. S6 (ESI†). Channel packing of fine catalyst particles in these type of fixed bed reactors are known to affect pressure drops,⁵⁸ so replicate experiments (N28, N29, and N30) were carried out using different catalyst packings

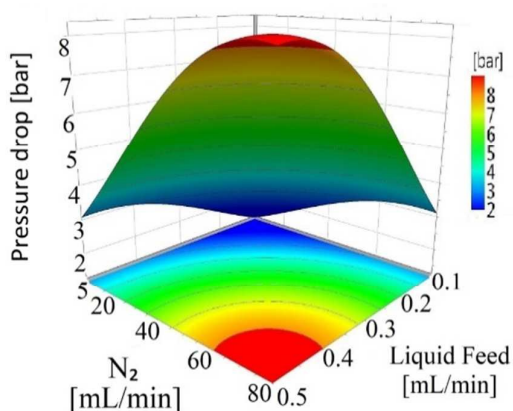

Fig. 5 Influence of nitrogen flow (5 – 80 mL/min, 33.3 – 566.7 m³ m⁻² h⁻¹ at STP) and liquid feed flow (0.1 – 0.5 mL/min, 0.7 – 3.3 m³ m⁻² h⁻¹ at STP) on the pressure drop for a substrate concentration of 1 wt% at 220 °C, in single-pass mode.

8 | *React. Chem. Eng., 2018, 00, 1-13*

Reaction Chemistry & Engineering

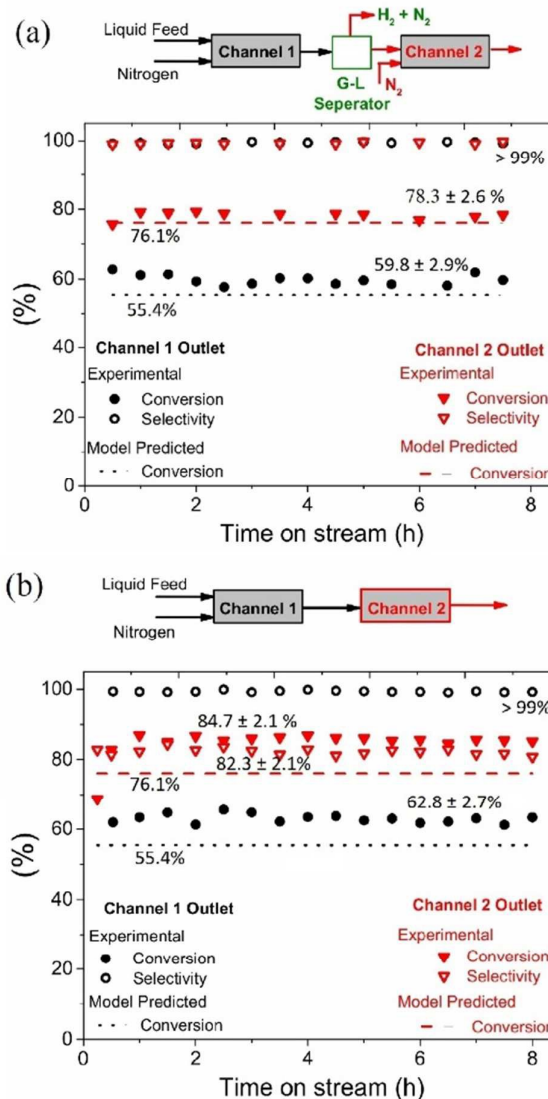

Fig. 6 Influence of intermediate gas (nitrogen and hydrogen) on activity and selectivity for the dehydrogenation of 1,4-cyclohexanedione in two-channels-in-series in continuous-mode (a) with intermediate hydrogen removal (b) without hydrogen removal

over three different days. These replicate experiments at centre point revealed reproducible pressure drop values (4.9 ± 0.4 bar) indicating that the pressure drop in these dehydrogenation reactions were not affected by the catalyst packing procedure.

3.2. Influence of channel arrangement and time on stream composition

The mm-scale structured reactor used in this study is much smaller in size and throughput when compared to conventional batch reactors, however, the throughput of the structured reactor can be increased by numbering-up mm-scale parallel channels.¹⁹ The time required to reach > 98% hydroquinone yield in semi-continuous mode was 9 h, with

This journal is © The Royal Society of Chemistry 20xx



reaction time being potentially reduced for a fixed reaction volume being achieved through numbering-up the number of mm-scale channels employed.

The reactor channels can be arranged in series to achieve higher yield, but this comes at a cost because of the need to use a large number of channels to drive conversion from 90% to > 99%, caused by increasingly lower conversions per pass (see Fig. 7). For a recycling mode, the channels could potentially be arranged in series to increase reactor conversion per pass, however, the hydrogen produced in one channel may influence the selectivity in the next channel. To study the influence of produced hydrogen on side reactions, experiments were performed by connecting two channels in series, with and without intermediate gas removal under operating conditions of $T = 230\text{ }^{\circ}\text{C}$, 210 mg catalyst, back pressure = 1.5 bar, nitrogen flow rate = 35 mL/min ($233.1\text{ m}^3\text{ m}^{-2}\text{ h}^{-1}$ at STP), liquid feed flow rate = 0.20 mL/min ($1.4\text{ m}^3\text{ m}^{-2}\text{ h}^{-1}$ at STP), and a substrate concentration = 5 wt%.

As shown in Fig. 6 (a), two channels were connected with intermediate gas removal in a gas-liquid (G-L) separator, with a fresh nitrogen feed (35 mL/min, $233.1\text{ m}^3\text{ m}^{-2}\text{ h}^{-1}$ at STP) then introduced in the second channel. At the outlet of first channel, conversion of 1,4-cyclohexanedione was found to be $59.8 \pm 2.9\%$, which increased to $78.3\% \pm 2.6\%$ in the second channel, with the selectivity for hydroquinone maintained at > 99% for both channels. However, when the product of the first channel was directly introduced into the second channel (no gas removal step, Fig. 6 (b)), then whilst the selectivity in first channel was maintained at > 99%, the selectivity in the second channel declined to $82.3 \pm 2.1\%$ due to the presence of hydrogen in the feed resulted in formation of 4-hydroxycyclohexanone. Therefore, the relatively high substrate conversion level ($84.7 \pm 2.1\%$) observed in the second channel is associated with the formation of 4-hydroxycyclohexanone and phenol side products arising from the unwanted hydrogenation pathway.

The catalyst maintained stability for conversion and selectivity in the dehydrogenation reaction over the 8 h reaction period (see Fig. 6). These conversion values suggest that the dehydrogenation reaction reaches steady state conditions in the first channel in less than 30 min, whereas it takes around 1 h to reach steady state conditions in the second channel.

3.3. Semi continuous dehydrogenation of 1,4-cyclohexanedione

The results of single-pass continuous confirmed that the complete conversion of 1,4-cyclohexanedione is not achievable under the investigated conditions which might be due to thermodynamic or kinetic limitations. In order to achieve complete conversion, the dehydrogenation reaction was performed in semi-continuous (recycle) mode in which liquid product stream is recycled back as feed. The produced hydrogen is separated in gas-liquid separator that is expected to overcome thermodynamic limitation when product stream is recycled back along with hydroquinone, unconverted 1,4-cyclohexanedione and/or any by-product formed. Moreover,

the rate of formation of the unwanted 4-hydroxycyclohexanone by-product is dependent on the concentration of hydrogen available to the catalyst bed. Therefore, the removal of hydrogen is also the key to minimize the reduction to 4-hydroxycyclohexanone. This could potentially be achieved by utilizing stoichiometric oxidants or hydrogen acceptors inside the catalyst bed, or by removing the produced hydrogen outside the catalyst bed using a sweep gas while recycling the liquid product stream to achieve higher yields.

In order to determine the optimum operating conditions for recycling mode closely resembling the conditions for single-pass, a second set of experiments was performed while discarding the produced hydrogen through gas-liquid separator. Table S2 (see the ESI[†]) shows the results of a second set of semi-continuous dehydrogenation experiments that were designed to study the influence of temperature (X_1), nitrogen flow (X_2), liquid flow (X_3), and reactor inlet conversion (X_5) on reactor outlet conversion (Y_4), selectivity (Y_5), and pressure drop (Y_6). The experimental results were analysed and transformations were applied to obtain normal distribution for better model estimation and statistical analysis. Negative logarithmic and logarithmic transformations were applied to analyse selectivities and pressure drops, whereas no transformation was required for recycled conversion. The quadratic models were developed according to equations (6 - 8).

$$Y_4 = 63.01 + 8.58 X_1 + 1.09 X_2 - 8.74 X_3 + 32.38 X_5 - 6.36 X_1 X_5 - 9.49 X_3 X_5 + 10.49 X_5^2 \quad (6)$$

$$Y_5 = 0.39 - 0.24 X_1 - 0.02 X_2 + 0.22 X_3 - 0.03 X_5 - 0.28 X_3^2 + 0.23 X_1 X_3 \quad (7)$$

$$Y_6 = 0.81 - 0.02 X_1 + 0.21 X_2 + 0.17 X_3 + 0.07 X_5 - 0.15 X_5^2 \quad (8)$$

All the response functions showed a good fit to experimental data (Fig. S7, see the ESI[†]), with all the models significant and adequate, as confirmed by ANOVA analysis (Table S3, see the ESI[†]). The P-values used to identify the significant model terms are given in Table S4 (see the ESI[†]). These results showed that nitrogen flow had a non-significant influence on the total conversion as shown in Fig. S8 (see the ESI[†]). Total conversion was enhanced with decreasing liquid

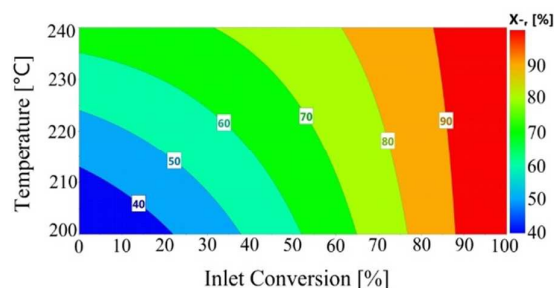

Fig. 7 Influence of reactor inlet conversion (0 – 100%) and temperature (200 – 240 °C) on reactor outlet conversion in recycle-mode with substrate concentration of 5 wt% and nitrogen flow of 45 mL/min ($299.7\text{ m}^3\text{ m}^{-2}\text{ h}^{-1}$ at STP).



feed flow rate, similar to conversion levels observed in the continuous experiments. The temperature showed an overall increasing trend on total conversion in the recycled experiments. The influence of varying reactor inlet conversion (0 – 100%) on recycled reactor outlet conversion is shown in Fig. 7. The reactor outlet conversion curves became steeper with increasing temperature, however increasing reactor inlet conversion values resulted in a decrease in reactor outlet conversion which was attributed to a lower concentration of 1,4-cyclohexanedione being available to the catalyst. This behaviour suggests a higher number of recycles or reactors-in-series was required to reach close to 100% conversion.

The influence of nitrogen flow, temperature, and liquid feed flow on selectivity is analogous to that observed in the continuous experiments (see Fig. S9 and Fig. S10, ESI†). The results proved that the presence of hydroquinone in the recycled feed had no effect on the selectivity, which is unsurprising as the hydroquinone product is expected to be stable and unreactive under the dehydrogenation conditions. Variation in pressure drop (Fig. S11, see the ESI†) in response to changes in operating factors were also analogous to those of the continuous experiments. However, an increase in pressure drop (~ 4 bar) was observed with increase in conversion from 0 to 100%, which was attributed to an increase in the density and viscosity of the mixture (Table S5, see the ESI†). Therefore, these results confirm that the selectivity values for hydroquinone formation of higher than 99% were present in the same region as seen under the continuous dehydrogenation conditions, suggesting that continuous experiment models could be utilized to identify the optimal conditions.

3.4. Optimization of liquid phase dehydrogenation

The conversion and selectivity of the dehydrogenation reaction of 1,4-cyclohexanedione was then optimized simultaneously using a multi-objective optimization process.⁵⁹ The first objective is to achieve high selectivity to hydroquinone > 99% which could be achieved in a wide process window, with the second objective to achieve high 1,4-cyclohexanedione conversion > 99%. However, substrate

conversion did not reach > 99% in a single pass through the reactor in a continuous operation mode. The results of semi-continuous experiments showed that a large number of reactors in series would be required to achieve > 99% conversion, which was not viable from an economical perspective due to high capital and operational costs. Therefore, as the presence of hydroquinone in the feed did not compromise selectivity in a semi-continuous operation mode, it is economically viable to recycle the liquid product while purging off the produced hydrogen to shift the equilibrium forward. Therefore, a conversion target for the second objective was selected as > 40% substrate conversion.

Optimal conditions for developed models were determined using MODDE to generate a Sweet Spot plot for this transformations.⁶⁰ Fig. 8 shows the Sweet Spot plot obtained through RSM plots using MODDE, highlighting the process window where the reactor can be operated to meet the specified targets. The bright green area in the plot indicates the sweet spot where both objectives (conversion > 40%, selectivity > 99%) are met and the blue area where only one target is fulfilled. A 4D contour plot for the sweet spot is shown in Fig. S12 (see the ESI†), indicating the sweet spots under the investigated conditions. A white area was identified at low liquid flow (0.10 mL/min, $0.7 \text{ m}^3 \text{ m}^{-2} \text{ h}^{-1}$ at STP) where no objective was met and no sweet spot was identified for 0.50 mL/min ($3.3 \text{ m}^3 \text{ m}^{-2} \text{ h}^{-1}$ at STP) liquid feed flow for a temperature range of 180 – 240 °C, nitrogen flow range of 5 – 85 mL/min ($33.3 - 602.1 \text{ m}^3 \text{ m}^{-2} \text{ h}^{-1}$ at STP) and substrate concentration range of 1 - 10 wt%.

Within the identified optimal operating window, the reactor also requires a set point where response remains insensitive to variation in a reasonable range of operating factors, described as a robust set-point. Based on the sweet spot plots, a criterion of 50% conversion and 99% selectivity was selected as target values for establishing an optimal robust set-point. Robustness analyses were carried out to find the robust set-point among the optimal set-points. A robust set-point was identified at a temperature of 231.4 °C, 69.3 mL/min ($464.5 \text{ m}^3 \text{ m}^{-2} \text{ h}^{-1}$ at STP) nitrogen flow, 0.21 mL/min ($1.4 \text{ m}^3 \text{ m}^{-2} \text{ h}^{-1}$ at STP) liquid feed flow and a concentration of

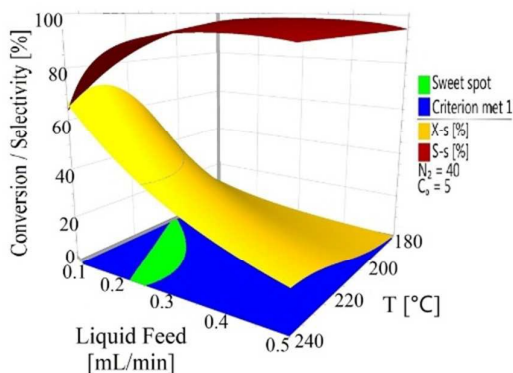

Fig. 8 Sweet spot plot based on objectives of > 40% conversion and > 99% selectivity in single-pass mode for varying temperature (180 – 240 °C) and liquid feed flow (0.1 – 0.5 mL/min, $0.7 - 3.3 \text{ m}^3 \text{ m}^{-2} \text{ h}^{-1}$ at STP) at fixed nitrogen flow (40 mL/min, $266.4 \text{ m}^3 \text{ m}^{-2} \text{ h}^{-1}$ at STP) and substrate concentration (5 wt%).

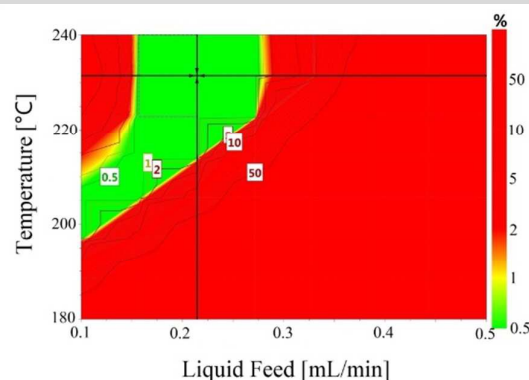

Fig. 9 Design space for the conversion of 1,4-cyclohexanedione in single-pass mode as a function of temperature (180 – 240 °C) and liquid feed flow (0.1 – 0.5 mL/min, $0.7 - 3.3 \text{ m}^3 \text{ m}^{-2} \text{ h}^{-1}$ at STP). The green area is the operating window to meet the desired specification, with the red area indicating risk of failure.



9.28 wt% 1,4-cyclohexanedione, which was predicted to afford 51.9% conversion and 99.3% selectivity with a pressure drop of 4.8 bar. This dehydrogenation model was validated by experimental testing using the robust set-point parameters, which gave conversion, selectivity and pressure drop values of 53.6%, 99.1% and 5.3 bar, which were 1.7%, 0.2% and 0.8 bar different from the predicted values, respectively.

The final step in the process development was to establish optimal control ranges of operating conditions within which the performance (conversion and selectivity) of the dehydrogenation reaction could be maximized. This was achieved by identifying the design space, which was defined as a region of operating conditions with the least probability of failure to achieve the desired process output in the form of conversion, selectivity and pressure drop, as part of a Quality by Design approach.⁶¹ Fig. 9 shows the design space generated by MODDE at the robust set-point with operating factors of temperature and liquid feed flow. Reactor conversion was assumed not to change while operating within the design space. The design space plots for 1,4-cyclohexanedione conversion as a function of nitrogen flow and substrate concentration are shown as Figs. S13 and S14 (see the ESI[†]), respectively, which enabled the development of strong process control procedures.

The aim of finding a robust set-point was to operate the reactor to achieve complete conversion (> 99%) while keeping the selectivity > 99% for a semi-continuous dehydrogenation process. Liquid phase semi-continuous dehydrogenation was carried out at robust set point with 231.4 °C temperature, 69.3 mL/min nitrogen (464.5 m³ m⁻² h⁻¹ at STP), 0.21 mL/min (1.4 m³ m⁻² h⁻¹ at STP) liquid feed with an initial concentration of 9.28 wt% 1,4-cyclohexanedione in tetraethylene glycol dimethyl ether as solvent. The simplified schematic of the set-up to carry out a semi-continuous dehydrogenation reaction in the same reactor is shown in Fig. 10. The reactor was packed with 210 mg of 10 wt% Pd/C catalyst, the catalyst pre-wetted with substrate, and the reactor temperature increased to 231.4 °C with a flow rate of 69.3 mL/min (464.5 m³ m⁻² h⁻¹ at STP) nitrogen. A liquid feed (9.28 wt% 1,4-cyclohexanedione) was then introduced at a rate 0.21 mL/min (1.4 m³ m⁻² h⁻¹ at STP) into the reactor from a feed vessel containing 20 mL initial feed volume. The feed vessel was equipped with a stirrer to enable homogenous mixing of a recycled product stream, with any gases being vented to atmosphere. The samples were

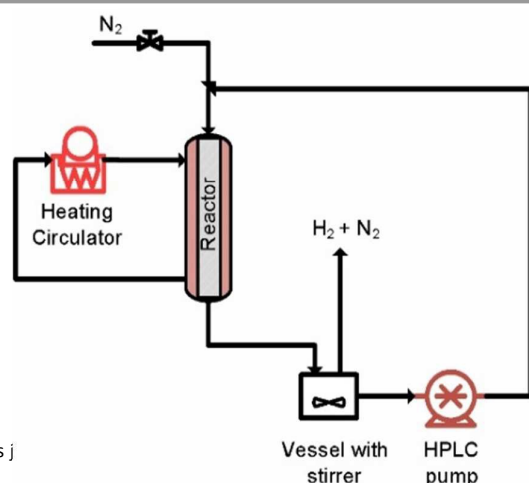

This j

Vessel with
stirrer HPLC
pump

Fig. 11 Catalytic activity and selectivity of semi-continuous dehydrogenation (recycle mode) at robust set-point, 231.4 °C, 69.3 mL/min (464.5 m³ m⁻² h⁻¹ at STP) nitrogen flow, 0.21 mL/min (1.4 m³ m⁻² h⁻¹ at STP) liquid feed flow and 9.28 wt% substrate concentration as a function of stream time (h).

collected from the feed vessel with time for analysis by ¹H NMR spectroscopy and GC-MS. Fig. 11 shows the conversion of 1,4-cyclohexanedione and selectivity for hydroquinone as a function of time-on-stream (h). The overall conversion is enhanced (1) by recycling of unconverted reactant and (2) by the removal of produced hydrogen in G-L separator which removed the thermodynamic limitation. The selectivity for formation of hydroquinone was very high (> 99%), which was maintained for ~11 h under the investigated conditions.

As discussed in the introduction, the liquid phase dehydrogenation of 1,4-cyclohexanedione in a batch slurry reactor previously resulted in a hydroquinone yield of 91.5%.⁸ In contrast, a hydroquinone yield of > 98% and no side products (> 99% selectivity) was observed in the mm-scale structured multichannel reactor used in this study, which was shown to function over a wide operating range.

4. Conclusions

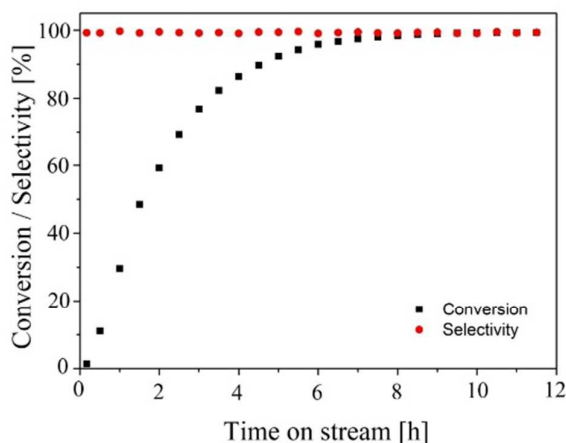
A highly selective and continuous-flow process is successfully developed for the liquid-phase dehydrogenation of 1,4-cyclohexanedione to hydroquinone over 10 wt% Pd/C catalyst in a scalable structured multichannel reactor. Design of Experiment (DoE) methodology was utilized for experimental design, to enhance process understanding along-with process optimization for the purpose to maximize yield. Experimental results were found to be in good agreement with the model's predicted values. Temperature and liquid feed flow strongly influenced conversion and selectivity, with liquid feed and N₂ flows influencing pressure drop significantly. Sweet spot plots were successfully used for multi-objective optimization, with optimum operating conditions found at a robust set-point of 231.4 °C, 69.3 mL/min (464.5 m³ m⁻² h⁻¹ at STP) nitrogen flow, 0.21 mL/min (1.4 m³ m⁻² h⁻¹ at STP) liquid feed flow, and 9.28 wt% 1,4-cyclohexanedione concentration. The continuous-flow process was successfully demonstrated for liquid-phase

React. Chem. Eng., 2018, 00, 3-13 | 11



dehydrogenation in single-pass and recycle modes. The results proved that complete conversion is not obtained in a single-pass per channel which might be due to thermodynamic or kinetic limitations. However, the conversion increased from 59.8% for one-channel to 78.3% for two-channel-in-series while maintaining high selectivity (> 99%) with intermediate hydrogen removal. For without intermediate H₂ removal step in gas-liquid separator, selectivity was dropped down to 82.3% in second channel. Finally, the experiments in recycle mode demonstrated the almost complete conversion (> 99%) of 1,4-cyclohexanedione was obtained for recycle mode dehydrogenation with very high selectivity (> 99%) and yield (> 98%).

Conflicts of interest

There are no conflicts to declare.

Acknowledgements

The authors acknowledge the EPSRC for funding the project "Terpene-based Manufacturing for Sustainable Chemical Feedstocks" EP/K014889/1. All the data of this study is available in the ESI†.

References

1. T. Letcher, J. Scott and D. A. Patterson, *Chemical Processes for a Sustainable Future*, Royal Society of Chemistry, Abingdon, U. K., 2014.
2. P. Imhof and J. C. van der Waal, *Catalytic Process Development for Renewable Materials*, Wiley VCH, Weinheim, Germany, 2013.
3. R. A. Sheldon and H. van Bekkum, *Fine Chemicals through Heterogeneous Catalysis*, Wiley, 2008.
4. P. M. Hudnall, in *Ullmann's Encyclopedia of Industrial Chemistry*, Wiley-VCH Verlag GmbH & Co. KGaA, 2000, DOI: 10.1002/14356007.a13_499.
5. F. Gokden and A. Lazzarotto, *Hydroquinone: Production, Uses, and Health Effects*, Nova Science Publishers, 2012.
6. N. N. Pozdeeva and E. T. Denisov, *Kinetics and Catalysis*, 2011, **52**, 506.
7. S. C. Gad and T. Pham, in *Encyclopedia of Toxicology (Third Edition)*, Academic Press, Oxford, 2014, DOI: <https://doi.org/10.1016/B978-0-12-386454-3.00855-1>, pp. 979-981.
8. US4024196 A, 1977.
9. A. T. Nielsen and W. R. Carpenter, *Organic Synthesis*, 1965, **45**, 25.
10. K.-K. Cheng, X.-B. Zhao, J. Zeng and J.-A. Zhang, *Biofuels, Bioproducts and Biorefining*, 2012, **6**, 302-318.
11. A. A. Lapkin, P. K. Heer, P. M. Jacob, M. Hutchby, W. Cunningham, S. D. Bull and M. G. Davidson, *Faraday Discussions*, 2017, **202**, 483-496.
12. J. W. Zhang, Q. Q. Jiang, D. J. Yang, X. M. Zhao, Y. L. Dong and R. H. Liu, *Chem Sci*, 2015, **6**, 4674-4680.
13. A. Cybulski, M. M. Sharma, R. A. Sheldon and J. A. Moulijn, *Fine Chemicals Manufacture: Technology and Engineering*, Elsevier Science, Amsterdam, The Netherlands, First edn., 2001.
14. J. Salaklang, V. Maes, M. Conradi, R. Dams and T. Junkers, *Reaction Chemistry & Engineering*, 2018, **3**, 41-47.
15. S. Schwolow, A. Neumüller, L. Abahmane, N. Kockmann and T. Röder, *Chemical Engineering and Processing: Process Intensification*, 2016, **108**, 109-116.
16. E. Novakova, N. Winterton, K. Jarosch and J. Brophy, *Catalysis Communications*, 2005, **6**, 586-590.
17. P. Kleinebudde, J. Khinast and J. Rantanen, *Continuous Manufacturing of Pharmaceuticals*, Wiley, 2017.
18. V. Hessel, *Chemical Engineering & Technology*, 2009, **32**, 1655-1681.
19. J. Wegner, S. Ceylan and A. Kirschning, *Chem Commun*, 2011, **47**, 4583-4592.
20. N. Kockmann, M. Gottsponer and D. M. Roberge, *Chemical Engineering Journal*, 2011, **167**, 718-726.
21. I. Rossetti and M. Compagnoni, *Chemical Engineering Journal*, 2016, **296**, 56-70.
22. A. Tanimu, S. Jaenicke and K. Alhooshani, *Chemical Engineering Journal*, 2017, **327**, 792-821.
23. Y. Su, Y. Zhao, F. Jiao, G. Chen and Q. Yuan, *AIChE Journal*, 2011, **57**, 1409-1418.
24. M. F. Nagiev, *The Theory of Recycle Processes in Chemical Engineering*, Pergamon, 1964.
25. Z. R. Lazic, *Design of Experiments in Chemical Engineering: A Practical Guide*, Wiley, 2006.
26. P. M. Murray, F. Bellany, L. Benhamou, D.-K. Bucar, A. B. Tabor and T. D. Sheppard, *Organic & Biomolecular Chemistry*, 2016, **14**, 2373-2384.
27. S. Soravia and A. Orth, in *Ullmann's Encyclopedia of Industrial Chemistry*, Wiley-VCH Verlag GmbH & Co. KGaA, 2000, DOI: 10.1002/14356007.e08_e01.pub2.
28. S. A. Weissman and N. G. Anderson, *Organic Process Research & Development*, 2015, **19**, 1605-1633.
29. R. H. Myers, D. C. Montgomery and C. M. Anderson-Cook, *Response Surface Methodology: Process and Product Optimization Using Designed Experiments*, Wiley, 2016.
30. D. V. Bavykin, A. A. Lapkin, S. T. Kolaczowski and P. K. Plucinski, *Appl Catal a-Gen*, 2005, **288**, 175-184.
31. P. K. Plucinski, D. V. Bavykin, S. T. Kolaczowski and A. A. Lapkin, *Catalysis Today*, 2005, **105**, 479-483.
32. X. Fan, V. Sans, S. K. Sharma, P. K. Plucinski, V. A. Zaikovskii, K. Wilson, S. R. Tennison, A. Kozynchenko and A. A. Lapkin, *Catal Sci Technol*, 2016, **6**, 2387-2395.
33. X. L. Fan, M. G. Manchon, K. Wilson, S. Tennison, A. Kozynchenko, A. A. Lapkin and P. K. Plucinski, *Journal of Catalysis*, 2009, **267**, 114-120.
34. T. Moreno, J. Garcia-Serna, P. Plucinski, M. J. Sanchez-Montero and M. J. Cocero, *Applied Catalysis A: General*, 2010, **386**, 28-33.
35. M. H. AlDahhan and M. P. Dudukovic, *Aiche Journal*, 1996, **42**, 2594-2606.
36. N. M. Márquez Luzardo, doctoral thesis, Technische Universiteit Delft, 2010.
37. A. Faridkhou, J.-N. Tourvieille and F. Larachi, *Chemical Engineering and Processing: Process Intensification*, 2016, **110**, 80-96.
38. J. A. Moulijn, M. Makkee and R. J. Berger, *Catalysis Today*, 2016, **259**, 354-359.
39. S. T. Sie, *Rev. Inst. Fr. Pét.*, 1991, **46**, 501-515.
40. S. T. Sie and R. Krishna, *Rev Chem Eng*, 1998, **14**, 203-252.



41. B. H. Alsolami, R. J. Berger, M. Makkee and J. A. Moulijn, *Industrial & Engineering Chemistry Research*, 2013, **52**, 9069-9085.
42. C. Sievers, Y. Noda, L. Qi, E. M. Albuquerque, R. M. Rioux and S. L. Scott, *ACS Catalysis*, 2016, **6**, 8286-8307.
43. L. Rodríguez-García, R. Walker, E. Spier, K. Hungerbühler and F. Meemken, *Reaction Chemistry & Engineering*, 2018, **3**, 55-67.
44. D. E. Mears, *Ind Eng Chem Proc Dd*, 1971, **10**, 541-547.
45. G. Ertl, H. Knözinger and J. Weitkamp, *Handbook of heterogeneous catalysis*, VCH, Weinheim, 1997.
46. P. A. Ramachandran and R. V. Chaudhari, *Three-phase catalytic reactors*, Gordon and Breach Science Publishers, New York, 1983.
47. A. Chantong and F. E. Massoth, *AIChE Journal*, 1983, **29**, 725-731.
48. C. N. Satterfield and J. R. Katzer, in *Molecular Sieve Zeolites-II*, American Chemical Society, 1971, vol. 102, ch. 55, pp. 193-208.
49. B. D. Prasher, G. A. Gabriel and Y. H. Ma, *AIChE Journal*, 1978, **24**, 1118-1122.
50. C. N. Satterfield, C. K. Colton and W. H. Pitcher, *AIChE Journal*, 1973, **19**, 628-635.
51. J. M. Smith, *Chemical Engineering Kinetics*, McGraw-Hill, 1981.
52. C. N. Satterfield, *Mass transfer in heterogeneous catalysis*, M.I.T. Press, 1970.
53. P. B. Weisz, *Journal*, 1957, **11**, 1.
54. J. Ermer and J. H. M. B. Miller, *Method Validation in Pharmaceutical Analysis: A Guide to Best Practice*, Wiley, 2006.
55. User Guide to MODDE - Umetrics, https://umetrics.com/sites/default/files/downloads/1/user_guide_to_modde_10.1.pdf, 2017).
56. J. M. Winterbottom and M. King, *Reactor Design for Chemical Engineers*, CRC Press, 2018.
57. N. Al-Rifai, F. Galvanin, M. Morad, E. H. Cao, S. Cattaneo, M. Sankar, V. Dua, G. Hutchings and A. Gavriilidis, *Chem Eng Sci*, 2016, **149**, 129-142.
58. A. Faridkhou, M. Hamidipour and F. Larachi, *Chemical Engineering Journal*, 2013, **223**, 425-435.
59. G. P. Rangaiah and P. A. Bonilla-Petriciolet, *Multi-Objective Optimization in Chemical Engineering: Developments and Applications*, Wiley, 2013.
60. E. Castillo, *Process Optimization: A Statistical Approach*, Springer US, 2007.
61. C. Hakemeyer, N. McKnight, R. St. John, S. Meier, M. Trexler-Schmidt, B. Kelley, F. Zettl, R. Puskeiler, A. Kleinjans, F. Lim and C. Wurth, *Biologicals*, 2016, **44**, 306-318.



Graphical Abstract

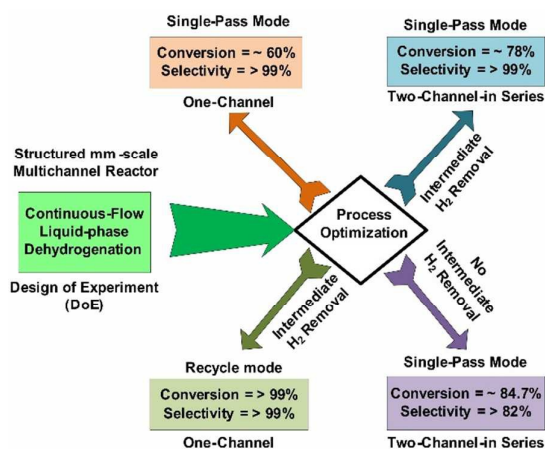

Novelty of Work (one sentence of text – 20 word maximum)

Highly-selective continuous-flow process is developed for liquid-phase dehydrogenation to produce high yield of hydroquinone in millimetre-scale structured multichannel reactor.

