

A key review of non-industrial greywater heat harnessing

Mazhar, AR, Liu, S & Shukla, A

Published PDF deposited in Coventry University's Repository

Original citation:

Mazhar, AR, Liu, S & Shukla, A 2018, 'A key review of non-industrial greywater heat harnessing' *Energies*, vol. 11, no. 2, 386

<https://dx.doi.org/10.3390/en11020386>

DOI 10.3390/en11020386

ESSN 1996-1073

Publisher: MDPI

This is an open access article distributed under the Creative Commons Attribution License which permits unrestricted use, distribution, and reproduction in any medium, provided the original work is properly cited

Copyright © and Moral Rights are retained by the author(s) and/ or other copyright owners. A copy can be downloaded for personal non-commercial research or study, without prior permission or charge. This item cannot be reproduced or quoted extensively from without first obtaining permission in writing from the copyright holder(s). The content must not be changed in any way or sold commercially in any format or medium without the formal permission of the copyright holders.

Review

A Key Review of Non-Industrial Greywater Heat Harnessing

Abdur Rehman Mazhar ¹, Shuli Liu ^{1,2,*} and Ashish Shukla ¹

¹ School of Energy, Construction and Environment, Coventry University, Coventry CV1 2HF, UK; mazhara4@uni.coventry.ac.uk (A.R.M.); ab4322@coventry.ac.uk (A.S.)

² School of Mechanical Engineering, Beijing Institute of Technology, Beijing 100081, China

* Correspondence: shuli.liu@coventry.ac.uk; Tel.: +44-(0)2477-657-822

Received: 12 December 2017; Accepted: 10 January 2018; Published: 7 February 2018

Abstract: The ever-growing concerns about making buildings more energy efficient and increasing the share of renewable energy used in them, has led to the development of ultra-low carbon buildings or passive houses. However, a huge potential still exists to lower the hot water energy demand, especially by harnessing heat from waste water exiting these buildings. Reusing this heat makes buildings more energy-efficient and this source is considered as a third-generation renewable energy technology, both factors conforming to energy policies throughout the world. Based on several theoretical and experimental studies, the potential to harness non-industrial waste water is quite high. As an estimate about 3.5 kWh of energy, per person per day could be harnessed and used directly, in many applications. A promising example of such an application, are low temperature fourth generation District Heating grids, with decentralized sources of heat. At the moment, heat exchangers and heat pumps are the only viable options to harness non-industrial waste heat. Both are used at different scales and levels of the waste-water treatment hierarchical pyramid. Apart from several unfavourable characteristics of these technologies, the associated exergetic efficiencies are low, in the range of 20–50%, even when cascaded combinations of both are used. To tackle these shortcomings, several promising trends and technologies are in the pipeline, to scavenge this small-scale source of heat to a large-scale benefit.

Keywords: passive houses; waste-heat harnessing; energy efficiency

1. Introduction

1.1. Background

The exponentially growing population of the Earth represents an extra burden, especially on the environment and energy resources. Concurrently the demand for buildings is estimated to increase by 67% for housing and 300% for service sector buildings [1], by 2050. Half of the global one third final energy consumption is accounted for by hot water for heating/cooling requirements in buildings [2]. To develop an overall sustainable energy system, the transformation towards a sustainable buildings sector would be vital, and it is part of the core agenda of energy summits and policies worldwide. At the United Nations Climate Change Conference COP 21 of 2015, in Paris, the goal of a comprehensive agreement on mitigating climate change with agreements on developing more efficient greener buildings with zero-carbon technologies, was reached by all nations of the world [3]. Consequently, a new Global Building Alliance was formulated to assist this transformation of the building sector in support of a low-carbon economy. It was concluded that globally about 50 EJ of energy could be saved annually by 2050, by improved policies aimed at buildings [2]. These savings would reduce 2 Gt of greenhouse gas emissions, by 2050 [1].

Hence it is clear that future buildings must have the three basic characteristics:

- Consume minimal amounts of energy
- Be energy efficient
- Source their energy from renewable sources

Ultra-low energy or Passive Houses are buildings having all these three attributes. They originated in the 1990s with the goal of providing comfortable indoor conditions with minimal energy consumption, by using passive technologies. They have proven to be versatile in a range of environmental conditions throughout the world, without compromising on the architectural quality [4]. Passive houses consume 80–90% lesser heating energy compared to conventional houses with a greater cost of only about 5–10% [4]. At the moment more than 25,000 passive houses have been built in Europe [5]. Ultimately, improvements are being made to this concept to transform buildings to near zero external energy consuming structures.

1.2. Scope

Since its birth, the passive house concept has been the focus of numerous studies with a lot of commercial interest, but mostly addressing the space heating demand, resulting in vast reductions within this domain, while the hot water demand has been largely overlooked. Usually passive houses are extremely air tight and insulated, with a focus on reducing the space heating/cooling demand [6]. Before the development of these types of buildings, the hot water demand was about 10–20% of the total energy consumed within a building. Due to improvements in other consumption domains with hot water demand being ignored, it now represents almost 50% of the total demand, as depicted in the Figure 1.

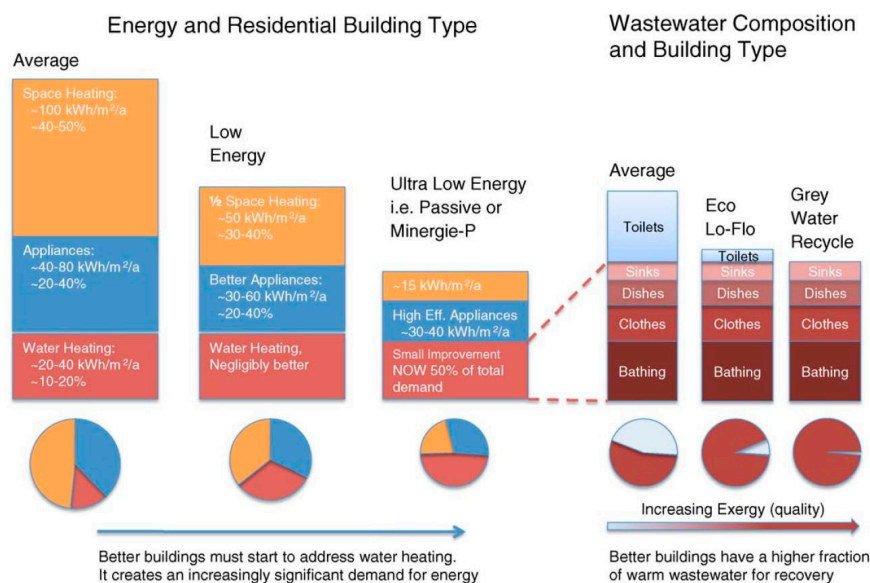

Figure 1. Distribution of energy consumption in buildings [6].

Currently, passive houses do not emphasize on heating water, smarter appliances and other energy utilities, making these sub-divisions highly inefficient [5], which defies the concept of low energy houses and reducing the carbon footprint. Although the heating demand of passive houses is less than 15 kWh/m², the hot water consumption is about 50 kWh/m². Due to human comfort requirements, it is extremely difficult to reduce the demand or the temperature of the hot water required. However, the wastewater from all sources excluding toilets enters the sewage system at a relatively high temperature and exergy content, as illustrated in Figure 1. Clearly this waste hot water or greywater (GW) is a major source of inefficiency, that must be addressed both in residential and commercial buildings.

At the moment, conventional second generation renewable sources like large scale wind and solar systems are not considered feasible, in dense urban areas, due to the high building densities, sensitive surroundings, limited potentials and their unpredictability [7]. This is a major reason why energy harnessing methods have received tremendous attention, by the researching community over the last decade. All physical processes have an upper limit to their efficiency as per the second law of thermodynamics, therefore there is theoretically an inexhaustible supply of man-made waste energy from conversion processes and fractions of it may be harvested. So, in a sense energy harnessing mechanisms are considered as a third generation renewable energy technology, since otherwise this unlimited supply of manmade waste energy would be discarded [8]. These sources are generally in the form of thermal, electromagnetic, light and mechanical vibrations [9], as depicted in Figure 2.

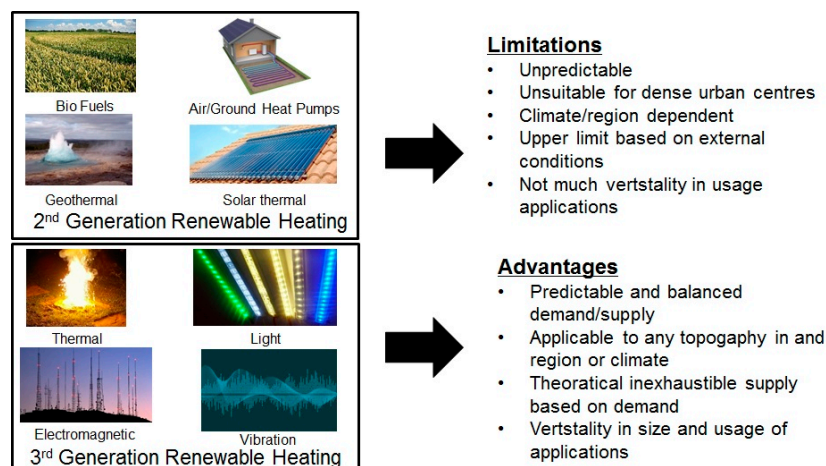

Figure 2. Waste water heat harnessing as a source of third generation thermal renewable energy.

1.3. Objectives

To harness this waste heat in GW, would not only minimize energy demand, it would make buildings more efficient, reduce the carbon footprint, increase the share of renewable energy consumed and revive the original concept of ultra-low energy houses. GW heat harnessing strengthens the initial three future building characteristics laid out in Section 1.1. At the same time, harnessing this heat with a passive technology would be preferred to conform to the overall goals of passive houses.

Limited research has been carried out within this domain. Whether it is the collection of GW data [10–14] or technologies to capture this waste heat [15–18], the possibilities researched upon have been very limited and lack a holistic picture. This is primarily due to the fact, that very low energies are involved in a harnessing technology, of a single unit, making it economical unviable. It is only until recently, with fluctuating fuel prices and environmental awareness, that researchers are exploring the possibility to tap this source. This paper presents a complete picture of all the elements involved in GW heat harnessing. In particular, the following objectives are researched upon, to give a holistic overview of the past and the future:

- The various output patterns of GW, and conventional methods used to source this data
- Commercially mature GW harnessing technologies used at different levels along sewage lines
- A critical analysis of the shortcomings of these technologies and their underlying hurdles, not making it to mainstream conventional buildings
- Upcoming ideas and technologies for harnessing along with the associated applications of potential usage

2. Characteristics of Greywater

Over the last decade, GW has come into the limelight of research not from the perspective of heat reclamation, but to reuse it for domestic applications requiring low-quality water [19]. Hence the availability of usage data of GW is scarce and mostly available from a different viewpoint [6]. The first step in the harnessing of heat is to determine the sources, measure the usage patterns and assess the potential of GW. Broadly speaking there are three types of water in the plumbing system of a conventional household as defined in Table 1 [15,20–22].

Table 1. Characterization of domestic sewage water.

Type	Source	Contents
Light or low-load GW.	Showers, WC basins, bathtubs.	Shampoo, soap, hair, bacteria, organic particles.
Heavy/dark-high load GW.	Dishwashers, kitchen basins, washing machines.	Surfactants, detergents, phosphates, heavy metals, suspended solids, organic particles, oil, grease, higher pH, bacteria.
Blackwater (BW).	Toilets, bidets.	Feces, urine, toilet paper.

Light GW is the best and most promising to be used in both, heat harnessing and re-usage applications. On the other hand, heavy GW requires grease traps and sludge removal before heat harnessing [20] as these impurities can clog heat exchangers, reducing considerably the efficiency. Blackwater is not suitable for harnessing due to its low temperature and waste contents [15].

In most conventional buildings, the separation of these three classes of water is non-existent [20]. Households have a plumbing system with a common stack, where the waste from each appliance is dejected to this line, irrespective of the water quality or the potential for re-use [21]. This is a great loss considering that the purpose of harnessing the heat and reusing the GW, is eliminated [20]. The stack is normally installed vertically, with a trap at the top, to avoid clogging and congestion by waste gases, as depicted in Figure 3.

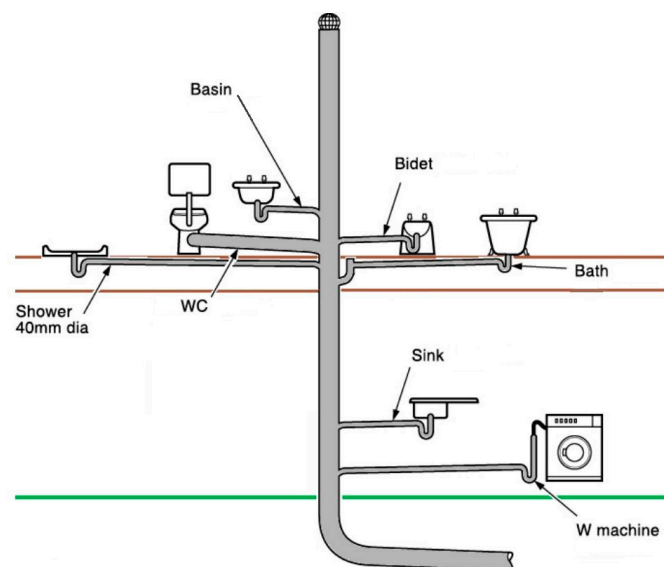

Figure 3. Plumbing system of a conventional household with a vertical stack pipe, P-traps with each appliance and sloped pipes towards the stack [21].

The figure also shows that there must be a P-trap connected to every GW-producing appliance and the piping must be sloped towards the stack. The P-trap has restrained dimensions and stringent legal requirements, limiting the installation flexibility of a data monitoring or a harnessing device [23]. At the same time, the slope of the pipe between the appliance and stack is minimal, which limits the flow pressure. This restricts the use of intrusive data monitoring devices and harnessing technologies causing substantial pressure losses. Finally, the sewage lines of most GW appliances are not easily accessible as they are beneath solid floors, as illustrated by the brown lines in Figure 3. The hardest waste pipes to access are those from baths and showers [22]. Hence to both, perform a quantitative study on GW or even harness the heat from it, the options are quite limited without major retrofitting of a conventional plumbing system [20]. However, passive houses and sustainable buildings have a more versatile layout, for such water and energy reclamation.

2.1. Collection of Production Data

Keeping in mind all these physical constraints, and the lack of economic feasibility in GW exploitation, one can understand the reasons for the scarce data. Consumption data, for commercial and residential buildings, is collected either in a field study or theoretically. The methodology and techniques for measurement of GW data are similar irrespective of the scale, i.e., the same for sewage or waste treatment plants:

- (a) **Experimental/Field study:** This is the more authentic way of collecting data, although considerable noise is present. One reason is, due to the unpredictable nature of the outflow of GW, that is highly dependent on the mood and characteristics of each user [10]. In a field study in the UK based on 25 houses, the water usage varied by a factor of seven, despite having homogenous specifications and building designs.

For the application of heat harnessing, the flow rates and temperatures of the GW, are the only quantities measured at the outlet pipe of each appliance [11]. The monitoring device is attached to the specific pipe of the appliance, and not the stack of Figure 3, as it would include black water [22]. There are three main components used for monitoring data:

- **The instruments:** Due to the restrictive layout of the pipes and the inability to obstruct the flow, because of biofilm deposits and pressure losses, flow is usually measured with a non-intrusive and non-invasive device. The most commonly used flow-meters, pertaining to these characteristics are ultra-sonic flow meters functioning on the Doppler effect [24]. Magnetic induction meters are also used, but are less common. Most clamp-on ultrasonic meters are in the £500–2000 range, depending on the specifications and accuracy required. The output of such devices are in the form of pulses whose frequency is proportional to the flow rate [10]. Usually the calibration of these meters, can be done manually with timed volume measurement techniques, depending on the accuracy required [11]. In terms of temperature measuring devices, a non-intrusive and non-invasive instrument is also used, for the same reasons. For sensors clamped on the pipe, it is important that errors due to the ambient temperature do not affect the measurement [12]. For some circumstances, sensors on probes can be used depending on the accuracy required and the access from the piping. The most common sensors include thermocouples and resistance based semiconductors, with prices starting at about £10 to about £500, depending on the materials and accuracy required [25]. These sensors operate on the Seebeck principle and the change in resistance with temperature, respectively. Since these devices have self-adhesives or clamps, the accuracy is quite limited when measuring the flow in a half-full pipe [26]. Infrared sensors and fibre optic sensors based on the principles of radiation and the Raman effect, respectively, are more accurate substitutes. Their prices range from £100–£2000, depending on the specification and accuracy.

- Power source: There are three mechanisms to power a data collecting instrument. The first type requires an external DC-Voltage in the range of 0–30 V. The second type can be plugged into normal AC sockets in a building. While the third type are self-powered by internal rechargeable batteries, the connected data logger or the data transmitting source.
 - Data transmitter: For acquiring long term data, a simple display LED on the instrument, does not suffice. There must be an external hard disk to record the time variation of data, over the period of observation, usually a few months [22]. This data is either transmitted wirelessly or through a communications cable i.e., Modbus, Ethernet, USB, etc. In some circumstances, it is transmitted directly to a hard disk via a connected data logger [11]. The frequency of transmission can be pre-defined depending on the precision required. Most household experiments use 5 to 10 min intervals, to record readings [10]. After acquiring the data, a cleaning process is required, to filter out errors for useful information [22].
- (b) Theoretical: This is a relatively unconventional way, but with advancements in artificial intelligence and computing algorithms, it is gaining popularity [27]. Normally the inflow of water from the main utility connection and/or the output from a boiler is measured. Based on statistical algorithms and artificial intelligence, the consumption and characteristics of the GW, at different points in the house are computed [15]. This method is called flow trace analysis [28]. Usually the model is validated based on field studies and has proved a reliable source usually having an accuracy of about 90% [27]. The versatility of these tools make it quite economical, considering that, they can be adjusted to different households and regions having different dynamics [27]. These theoretical models can also be economically used for forecasting, analysing the savings from harnessing devices and demand side management techniques [29]. In some circumstances, data with less precision is extrapolated to make it more precise over longer or more detailed time durations [10]. On the input of approximately 1 million users, the American Water Works Association, has developed one such comprehensive statistical prediction model [15]. Similarly, a water consumption calculator was launched in the UK for households, through a survey [13]. Based on statistical algorithms and input from over 100,000 users, on questions about usage patterns, a large dataset for domestic water usage was formulated. The ultimate objective of is similar to that of a smart meter, where households can assess their daily usage of water and associated heating energy, to eventually control wastage.

2.2. Production Patterns

About 16 million litres of water end up in the sewage lines of UK alone, from non-industrial buildings [13]. At the same time, water consumption is increasing at a rate of 0.5–1%, per year [11]. It is essential to understand, the patterns and temperatures of usage, before the potential to harness its heat, can be assessed.

2.2.1. Residential Buildings

Based on Table 1 there are five main appliances in households, producing GW, that are applicable for heat harnessing:

- Showers/baths
- WC basins
- Dishwashers
- Kitchen sinks
- Washing machines

Normally the highest production of GW in a household is before and after local working hours [30]. The typical usage profiles of these appliances, throughout a day as a percentage of the total use are presented in Figure 4.

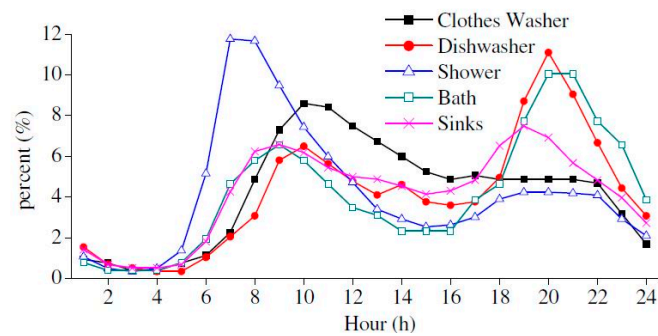

Figure 4. Water usage profile over a day [15].

This profile is almost consistent throughout the year, irrespective of the external weather conditions. At the same time the contents of the GW vary considerably depending on the occupancy, gender, age and features of the residents of a building.

Although the usage temperature of each appliance varies, a field study of 124 dwellings in the UK, illustrates the typical consumption temperatures shown in Figure 5, in a conventional household, with an average of 51.9 °C [14].

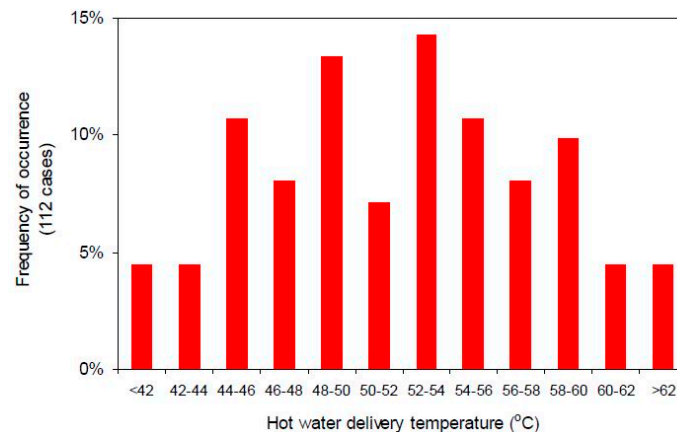

Figure 5. Temperature distribution of all usage in a conventional dwelling [14].

Depending on the region, environmental conditions and economic standard of a country, the GW output per person varies. A summary of the statistics, of different regions is provided in Figure 6 [30].

As evident, the average usage per person is about 140–150 L. An estimate from the Oak Ridge National Lab is that a person produces about 136 L per day [31]. In terms of individual appliances, showers consume most of the water, as depicted in Figure 7.

From the figure, about 64% of a household's water consumption corresponds to GW, with potential for harnessing heat. In another estimate, about 41–91% of the daily water consumed by an individual is GW, with a potential of heat harnessing [30].

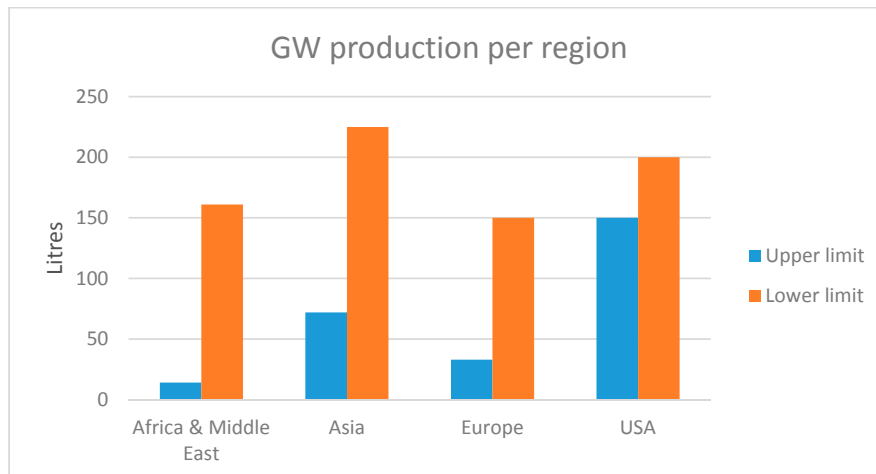

Figure 6. Greywater production per person per day.

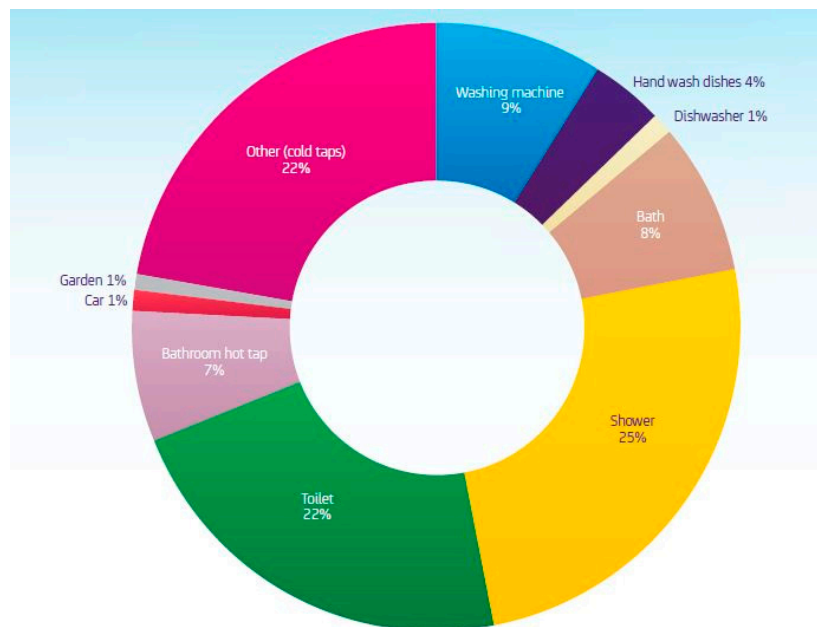

Figure 7. Distribution of water usage in a conventional household [13].

Showers/Baths & WC Basins

In the UK, about £2.3 billion is spent on heating water for showers [13]. A person showers 0.7 times a day for about 8.2 min. On an average, the flow rate of a shower head is 12 L/min. This computes to about 70 L of shower water generated per day [31]. Comparatively, when a bath is taken in a tub, about 80 L of water are used [13]. The average shower temperature is between 40–50 °C [25]. However these figures are subjective to a high rate of change, depending on the user and shower type, as depicted from a survey in Figure 8, of the UK [13].

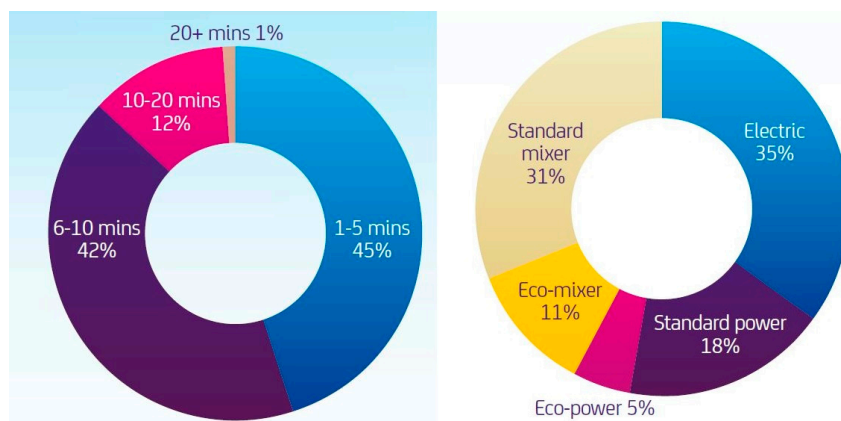

Figure 8. Distribution of showering times and shower types [13].

In this case, a standard shower mixer has a flow rate of 8 L/min, while an eco-mixer and an electric shower are low-flow, with a flow rate of 6 L/min. The standard power showers consume 13 L/min, and more energy compared to eco-power versions. Another recent strategy to cut consumption is using aerated showerheads that draw in air along with the water. Water used in the washroom basin is usually between 50–60 °C and about 50–60 L is consumed per week per person. As an estimate the flow rates, from taps of sinks and basins is about 2 L/min [22].

Dishwashers and Kitchen Sinks

In the UK, dishwashers and washing machines, consume £1.6 billion worth of electricity every year to heat water [13]. When washing dishes, there are two options, either via a dishwasher or a normal sink with hands. In general, the larger the size of a household, the more probable it is that they have a dishwasher. About 41% of households within a developed country, own a dishwasher [13]. Surprisingly, in terms of water usage and heating costs, eco-friendly dishwashers are a better option compared to simple sinks, for a large household. A conventional dishwasher, uses temperatures between 60–85 °C, at 10–25 L of water per wash [13,28]. For sinks, either a bowl-type mechanism to fill the sink can be used which is more economical, compared to constant running of hot water from the tap. 86% of users use the first type with two separate bowls for washing and rinsing. A wash using the bowl-type consumes about 8 L of water compared to about 30 L in a running tap, mechanism. The temperatures lie between 50–60 °C, when washing this way. On an average one person washes the dishes once a week in a dishwasher or 3–7 times a week, by hand. However, the larger the household, the more the frequency of washing, and the lesser the average per person.

Washing Machines

Washing clothes, can either be done in a machine or the old-fashioned way, with a tub of water using hands. However 97% of people use machines to wash their clothes [13]. A conventional washing machine consumes about 30–50 L of hot water per wash, irrespective of whether the machine is fully loaded or not. On an average, a household uses a washing machine 2–4.7 times a week, with only 25% usage at temperatures below 30 °C [13,28]. Or a single person uses a machine about once every 1–2 weeks. When it is done collectively in a large household the usage of water per person is not that high. The distribution of the average usage temperatures, as per different users are shown in Figure 9.

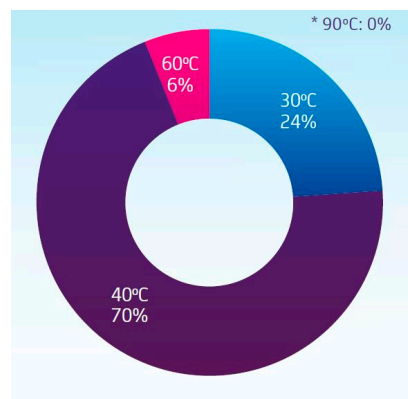

Figure 9. Washing machine temperature distribution as per users [13].

Based on the usage profiles of each appliance, the output GW is usually 5–10 °C lower than the consumed temperature, from the figures presented above [15]. In the case of showers and basins (kitchen and toilet) there is a simultaneous production of GW and demand of cold water (to be heated later on) [28]. However, in the case of washing machines and dishwashers, the demand and supply is not simultaneous, with gaps in water drawing between each cycle of operation, hence the use of a storage mechanism is necessary, in case GW is to be harnessed. In a conventional dishwasher, water is drawn and drained in three cycles per wash while in a washing machine it is done twice [28]. At the same time, the output flow rate from these appliances can be controlled by varied pipe diameters and configurations. Usually pipes at inlets are thinner compared to outlets, to maintain steady flow rates and pressure. The drain water flow rate can be controlled by different mechanisms including electronic actuating motor valves, operated by a PID controller [26].

2.2.2. Commercial Buildings

Compared to residential buildings the output flow patterns, from commercial buildings, are even more consistent and predictable, due to the prescribed usage timings along with legal requirements. At the same time, the potential to harness heat is much greater, due to the larger GW output flow rates. However, the versatility in building types and GW output characteristics, require custom solutions. In most commercial buildings, the usage peaks during the weekdays only [32].

The output profile of a shared bathroom in a hotel within a spa, in Shenzhen, China, shows the consistent nature of the GW output throughout the day (Figure 10).

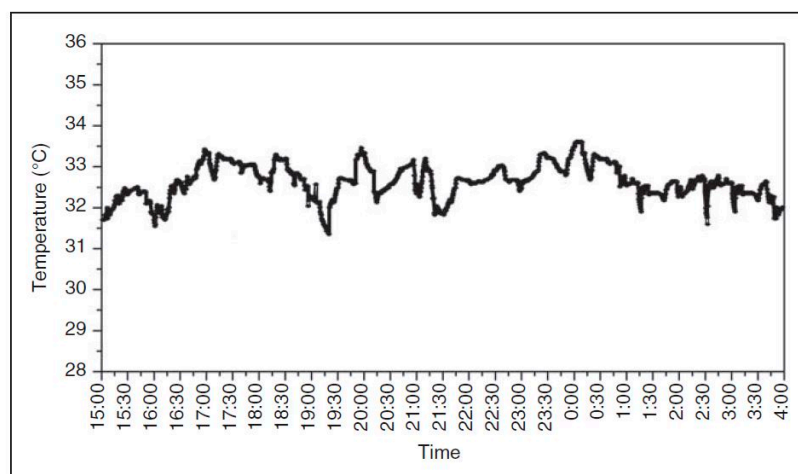

Figure 10. Greywater output from a commercial hotel and spa in China [32].

The mean temperature in this case is 32.5 °C, as the readings were recorded during peak summer, when relatively colder showers are preferred.

In another study, the potential to harness heat from common bathrooms and the dining facilities in army barracks, was analysed [31]. For the showering facilities, it was estimated that one cadet, had a daily usage of about 50 L. Considering 400–600 cadets in a barrack, the upper limit of the usage would be about 30,600 L per day, at about 30–50 °C. A general dining hall in the US military, provides meals to about 400–600 cadets per day. Each hall has at least two dishwashers, running for about 10.5 h a day, producing 635 L/h of GW at a temperature of about 60–80 °C. Considering these values, the favourable statistics in commercial showers in gyms, dining facilities in hotels, dorms in universities etc. can be projected.

3–16 L of GW per student is ejected from primary and intermediate non-boarding schools, based on a study in Kuwait [22]. Although the temperature is relatively low, since most is sourced from sinks and basins, the consistent nature and the relative purity of this light GW, make it favourable for harnessing.

Similarly, a room in a hotel produces slightly more GW than an average person in a household at 184 L while 327 L are produced per bed in a hospital [33]. The prospects are also huge in large residential apartments. As an example, a 41 flat building in Berlin with about a 100 tenants, produced 3000 L of low load GW on a daily basis [16]. It was estimated that a 330-room student dorm in Berlin, had the potential to harness 917 kWh of heat per day from the main sewage line of the building [34]. In terms of commercial buildings the highest potential exists in public swimming pools and water parks [26]. The temperature in a typical swimming pool is about 28–32 °C, which is comparatively lower. However, considering the massive volume of this light GW source and the purity, harnessing this heat is quite favourable. In a typical Olympic size swimming pool, an estimated 3,030,000 L of water are used.

2.3. Potential Usage

Although the constraints, for harnessing GW are considerable, the advantages outnumber them:

- The temperature profiles and the supply are almost consistent throughout the year, irrespective of the atmospheric conditions making, it predictable and reliable.
- The quantities and hence harnessing potential is quite significant especially in commercial buildings.
- Heat harnessing units are quite versatile in operation, and can be efficiently integrated into conventional plumbing systems.
- Most harnessing units have passive technologies, limiting maintenance and operational costs [35].
- These units extend the life of domestic water heaters, as their usage decreases [35].
- In countries having warm climates, there exists a possibility to remove heat from incoming water, to further cool it down, and add it to GW. Based on past experiences, it is more economical to use a co-generation facility for both heating and cooling [12].

According to the US Department of Energy, 350 TWh worth of energy is sent to the sewage system, every year in the USA [35]. With typical heat harnessing devices in the market, at least 40% of this could be recovered corresponding to 40 TWh of energy. This study concluded that only a mere 10–20% of the original thermal content of water is lost before it is converted into GW, and with typical harnessing devices, 30–50% of fuel usage for heating water, can be saved in a conventional household. GW produced in Germany and Switzerland, can heat about 3% of the buildings in these countries [36]. As an estimate about 1928 million m³ of waste water is produced in The Netherlands, with most of it being 20 °C, higher than the ambient temperature [36]. It was estimated that 6000 GWh per annum of thermal energy could be recovered in the sewage system of Switzerland [37].

Extracting 1 °C of heat from 1 m³ of GW, can save 4200 KJ or 1.17 kWh of energy. From Figure 6, the average GW produced per person is 140–150 L in a day, and estimating that between 10–20 °C

can be extracted from this amount, the upper limit of energy saved is 12,600 kJ or 3.5 kWh. On a national scale, for the 65 million population of the UK, this amount amplifies to about 228 GWh. As a comparison, a gas boiler would consume about 0.4 m³ on a daily basis to produce this 3.5 kWh. Annually this consumption is 145 m³ of natural gas and not burning it would save 320 kg of CO₂ per person per year [38]. This is considering an efficiency of about 80% to produce 3.5 kWh of heat, for a domestic gas boiler [39]. Of the total greenhouse gas emissions, 6% are due to heating water in the UK, which can be deducted by at least a half, with harnessing mechanisms [13]. Considering the average price of gas to be 2.8 pence per kWh in the UK, it would annually save about £45 in annual gas bills which is about 20% savings per person. The potential can be summarized in a Sankey diagram (Figure 11).

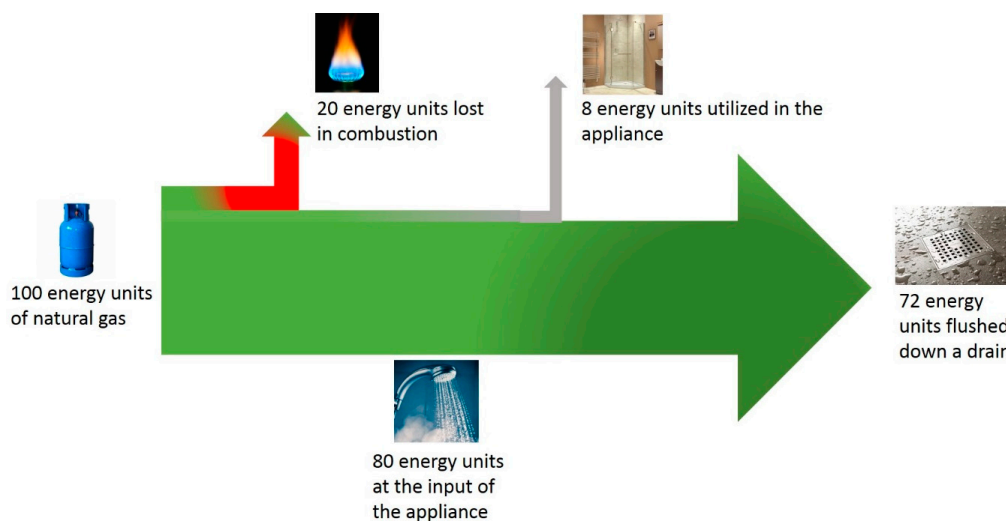

Figure 11. Potential after a sample usage cycle in an appliance.

Using an exergy analysis, the relative potential of the temperature and quantity of the water can be assessed [6]. Considering the fact that the average temperature of the incoming cold water is about 15 °C [14], the exergetic potential can be analysed. If we assume the dead state to be at 15 °C, the annual exergy of 150 L of water at 42 °C (usage average minus 10, as mentioned in Section 2.2.1), if all the potential was transferred as heat, would be 1946 kWh. However, if this potential was converted into mechanical work, the annual exergy would be a mere 95 kWh, since more than 90% would be energy due to the irreversibility's of the process. This shows that harnessing the heat via, heat exchange is the best utilization of this low-grade heat [38]. However, conventional devices are only able to capture 20–50% of this exergy, which calls for better harnessing options. On an average there needs to be a 38 °C increase in temperature, of the incoming mains water to heat it up, in a conventional household, which can be somewhat provided by the outgoing GW [14].

3. Mature Heat Harnessing Technologies

Heat harnessing from GW, is not a new concept. Over the last few decades, two commercially mature technologies to harness this low-grade waste heat have been developed. These are heat exchangers (HE) and heat pumps (HP) or a hybrid combination of the both [40]. The investment, operation and installation costs, of HEs are lesser and the technology is also simpler compared to HPs. However, the efficiencies of HEs are lower, and there is not much operational flexibility as compared to HPs. A major disadvantage of HPs is the maintenance of the mechanical equipment, especially the pumps involved. They are not passive technologies, defying the concept of ultra-low energy buildings. For smaller appliances, with space constraints, HPs are not feasible at all. Due to these limitations, hybrid combinations of the two technologies are common, as discussed in Section 3.4.

If we take a lower estimate of 60%, of heat recovered from a harnessing device, there is about 70% of fuel usage saved, as depicted in the Sankey diagram of Figure 12, which is a continuation of Figure 11.

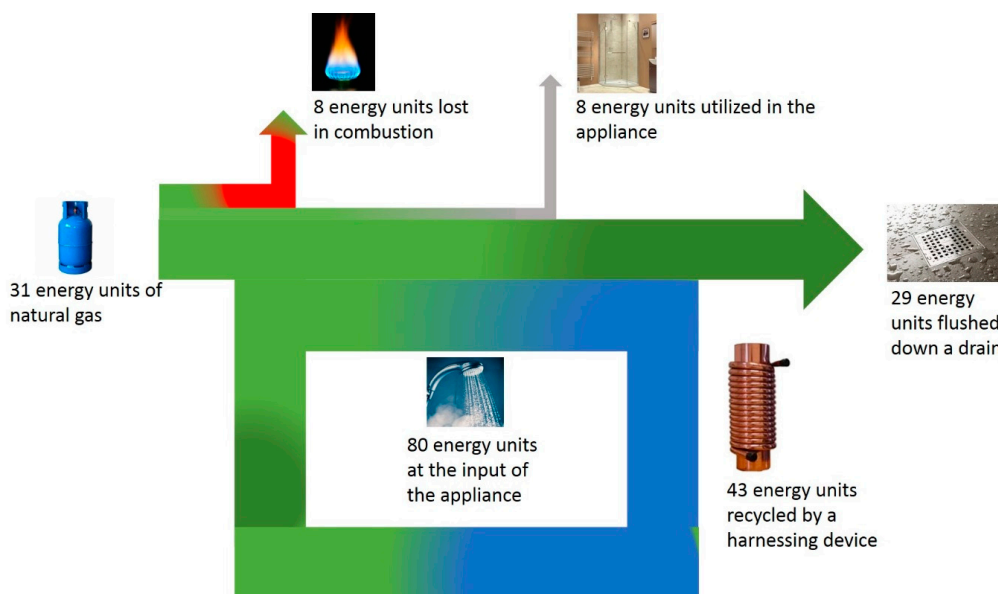

Figure 12. Sample usage cycle in an appliance after heat harnessing.

3.1. Levels of Heat Harnessing

There are three main levels at which heat can be harnessed as represented in Table 2 [16,34,40,41]:

Table 2. Different levels of waste water heat harnessing.

Level	Temperatures	Flow Rates	Technologies	Possible Recovery
At a building level, immediately after the GW exits the drain of an appliance	30–65 °C	2–20 L/min	HE and HPs	70–90% of the original energy content
At a larger district level, where the GW enters the sewage lines	15–30 °C	10,000 > L/min depending on the location and pipe diameter	Both in-line (plate HEs) and out-line (HEs & HPs) using additional pumps	A higher content of contaminants—40–50% of the original energy content
At a waste water treatment plant (WWTP), along with the purification process	10–20 °C	10,000 < L/min	HPs to transport the large quantities over distance	10–30% depending on before/ after purification

It is important to note that at the second and third level, the GW is no more, as defined in the last section. Instead, in sewage lines and WWTPs, harnessing is done on GW and BW containing a lot of sludge. At these points, there is a loss of temperature and due to the volume of water involved additional pumps are required [39]. In WWTP, after purification, the treated effluent can be used directly in a HP cycle without the need for an intermediate circuit. During harnessing at the last two levels, the potential to reduce the temperature of the water is only about 1–10 °C, compared to 10–30 °C at the building level, but since the flowrates and volume of water is high, considerable heat can be recovered [16]. Recovering heat directly at building levels is relatively simple and straightforward, with only the building owners amongst, the stakeholders. However, when it comes to the level of sewage and WWTPs, the number of stakeholders increases. At the same time, there are stringent

legal requirements both in terms of the minimum allowable temperature after the harnessing and the physical characteristics of the sludge [41]. This is because, it is impossible to treat sewage water below a certain temperature, usually 10 °C [12], as the nitrification process, is severely affected [37]. During the treatment process in the WWTP, the effluent also loses a further 5 °C [40]. Harnessing heat beyond this limit, would defy the concept of reducing the carbon footprint, as more additional energy would be required at the later stages in the treatment process. Another disadvantage of harnessing in sewage lines or WWTPs, is the distance in consumption and recovery. Normally WWTPs are located on the outskirts of a city and for harnessing purposes, sewage lines are accessible only at specific points, away from the general population. Ideally, in some circumstances the harnessed heat, can be used within the WWTP. As an example, it can be used for heating the digester tank or to dry the sludge [37].

Based on experience, the best compromise is recovery within a sewer, especially if it is to be done on a larger district scale [34]. For the second and third level, the energy recovered can be as high as 4000 MWh [42]. In terms of investment costs per unit of energy recovered, the easiest option is at the sewage level, however the potential to harness is lower, with most exergy already destroyed.

3.2. Heat Exchangers

HEs are a passive technology, without the need for any external energy source and having minimal maintenance requirements. They transfer heat and at the same time separate the fluids involved. Typically, 40–80% of the energy content of the GW can be recovered, and even more if cascaded combinations are used. However, these values are strongly dependent on the flow characteristics of both the fluids and the exchanger design [18]. To make the flow conditions turbulent, with forced convection, external pumps may be used to enhance the overall heat transfer coefficient [16]. However, this is mostly done in large scale sewage lines or treatment plants [34]. For the application of GW harnessing, it is important that the HEs are double walled to avoid any leakages to the incoming clean water and vented so that the drain line does not smell or get clogged.

Most technologies and research focus on shower water although most commercial HEs are equally useful to basins, dishwashers, sinks and washing machines. To demonstrate this, a commercial GWHE was tested on basins in an apartment building, showers in a student dorm, a dishwasher in a restaurant and a washing machines in a laundry facility [17]. Since the GW characteristics are different for all applications, the performance of the HE varied with the best outcome in the dishwashing facility, due to the relatively higher temperatures of +60 °C.

Broadly speaking, most commercial GWHEs can be distinguished on the following five characteristics.

3.2.1. Type

There are four main types, available in the market:

Shell and tube tank: This type, along with plate HEs, are the most common for liquid to liquid applications. However, both these types are more prone to fouling and suffer a considerably loss of efficiency with contaminants, as in the case of GW. Usually with GW the shell and tube type, consists of a large GW storage tank with spiral cold water tubes within [31]. Sometimes the tubes are within it, or on the circumference to avoid biofilm deposits. The main mechanism that enhances heat transfer compared to other types of HEs, is conduction caused by retention time of the GW rather than only the movement based convection heat transfer. As a rule of thumb the capacity of such a tank should be about 90 L (20 gallons) per person, and insulated from the outside [43]. This system is very versatile as this tank can be linked to more than one appliance at once. However, there are pressure losses in the cold-water coils and the efficiencies of these units are 40–50%.

Concentric pipes: This is the least expensive and simplest among all HEs. Also, known as tube-in-tube HEs, they can only be installed in vertical orientation. Usually an inner pipe followed by a gap immersed in a second pipe, make up this counter-flow HE. GW flows vertically through the inner pipe and clings to the circumference due to gravity and surface tension. The cold mains water flows between the inner and outer pipe, as depicted in Table 3. Usually a lining is part of the inner pipe, to prevent leakages and mixing of the fluids. The efficiency is less than 60% while there are almost no pressure losses. Compared to all other types of HEs, concentric pipe types are the least efficient due to their simplicity and lower surface areas of contacts. The biggest advantage of this configuration is that the problem of fouling is almost non-existent [44]. The start-up time for these devices is just 2–3 min before steady state operation is achieved [45].

Table 3. Overview of HEs.





Type	Manufacturers	Cost	Images
Falling Film/Gravity	<ul style="list-style-type: none"> Power Pipe Retherm Waterfilm Energy Inc. EcoInnovation Technologies Inc. Watercycles Energy Recovery Inc. 	£300–925	
Concentric pipes	<ul style="list-style-type: none"> Wavin Hei-tech B.V. BRIES Energietechnik 	£250–600	
Plate	<ul style="list-style-type: none"> Redi Ecodrain Hei-tech B.V. BRIES Energietechnik SUP Technology 	£300–2000	
Shell and tube tank	<ul style="list-style-type: none"> OSO Hotwater AS 	£1150	

Table 3. Cont.

Type	Manufacturers	Cost	Images
In-line sewage HE (plate type)	<ul style="list-style-type: none"> • Rabtherm • KASAG • Pressurepipe • Uhrig therm-liner • BB heatliner 	£750–1700 per kW	
Off-line HE	<ul style="list-style-type: none"> • DDI Cube • SHARC Energy Systems • Huber 	£5000<	

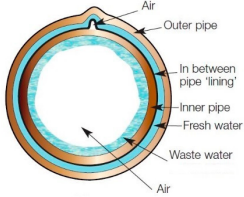
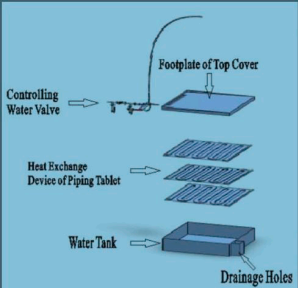
Falling-film: This is the most common type, with numerous commercial manufacturers [43]. There are at least ten patents, with minor variations in this technology, since the 1980s. Also known as gravity-film exchangers (GFX), since the GW falls due to gravity clinging to the circumference because of surface tension forming a film on this vertical pipe [46]. The GW passes through a central pipe, with the cold water passing in looped pipes along the circumference. The material ranges from aluminium, copper or even plastic [47]. To install such HEs with a desirable output, it is recommended that a vertical distance of at least 4 feet, should be available. However, an optimal balance between length and performance, must be reached. As a unit grows longer than the optimal, the benefits to the investment are not as much. It is the most energy efficient of all GWHEs, being in the range of 60–70%. Usually a turbulent flow with a boundary layer thickness of 1 mm is formed on the surface of the main pipe. The pressure loss, for the GW portion is negligible while that of the incoming cold water is noticeable, between 1–2 psi depending on the flow rate and length of the exchanger. This type, does not perform well with very high flows since in this case most of the GW falls in the central portion of the main pipe, without contacting the circumference [25]. In such circumstances, a series of cascaded arrangements are preferred [48]. In a study to enhance performance, the outer coils of the HE were covered with a jacket filled with water [26]. This reduced the contact resistance between the GW pipe and these coils, which normally have air within contact. The smaller the gaps between the main pipe and surrounding coils, the better the performance. For this reason, the squarer the coils are, the lesser the gap with a greater surface area and eventually the better the performance.

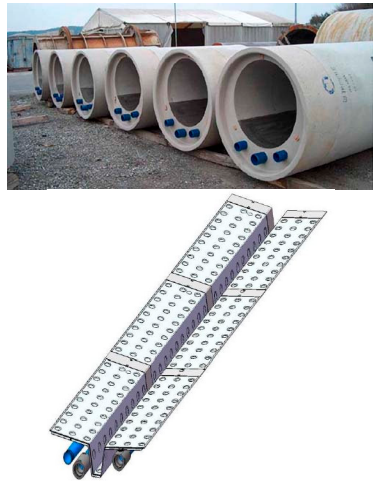
The GW pipes are from 2–6 inches while the cold-water coils are between 0.50 to 1 inch, in diameter. The lengths depend on the available area in the drain ranging from 2–10 ft. Considering these exchangers, there are three generations [26]: the first generation was counter-flow with single cold-water coils around the main pipe. This caused considerable pressure losses in this cold-water. In the second generation, there were multi-coils in a parallel arrangement causing lesser pressure losses. However, the flow was not counter flow causing lower efficiencies. In the latest third generation type, very thin multiple square coils are arranged in parallel along the inner pipe in a counter flow

arrangement. In this way, the pressure losses are reduced with the highest possible efficiency [35]. Since the cold-water coils are small, there can be noticeable lime deposits over time, due to the calcium carbonate in the mains flow.

Plate: This type is either used at building level applications or in-line harnessing in sewage pipes. In building level, this type is placed horizontally beneath the slab/tiles of the appliance, which makes it relatively more flexible to install. When used with showers, either the platform is integrated with a heat exchanger, called footplate HEs, or a multi-layer plate type exchanger is placed horizontally beneath the drain [43]. This consists of a series of plates, stamped together to make flow channels, with alternating flows through each plate, of GW and cold water. Each layer is linked to the adjoining one with a manifold at either end. The advantage of this type is the increased surface area of contact. Usually made from stainless steel to avoid corrosion and fouling. In footplate-type design, a chamber collected the GW, through which this GW was guided to plate HEs immersed inside [49]. In another design, a shower platform with an integrated lattice type plate exchanger is placed on the slab of a shower unit, recovering 50% of the heat content of the GW [50]. The efficiency of such devices is normally less than 50%. However, if space allows, cascading exchangers in series, can achieve heat recovery of up to 90%. The flow of the fluids is either counter flow or cross flow. Pressure losses in this design are minimal since there are no flow constrictions, similar to the concentric tube type. When this type is used at sewage level, there is a possibility to embed it within the main pipeline or place it on top of the lower side of the pipeline [36]. However, in both arrangements the efficiency is reduced considerably, as deposits and sediments tend to settle on the surface. Pumping and filtering this sewage water to an out-line HE can be a solution, but this increases the investment costs and is not practical without major infrastructure refurbishments [41].

3.2.2. Orientation

Vertical exchangers are much more efficient compared to the horizontal ones which are only 20% as efficient [47]. A common hurdle in installing HEs in a drainage system is the lack of space, which is why horizontal configurations are considered. An experimental analysis of the performance on the orientation of piped HEs showed several commercially available vertical exchangers with efficiencies in the range of 30–75%. When these units were installed in horizontal, the efficiency decreased drastically to a mere 5–20%. Consequently, for horizontal orientations, the system design would have to be oversized and the return on investment would increase from 3 to 15 years. The reason for such a lower efficiency is presented in Figure 13.

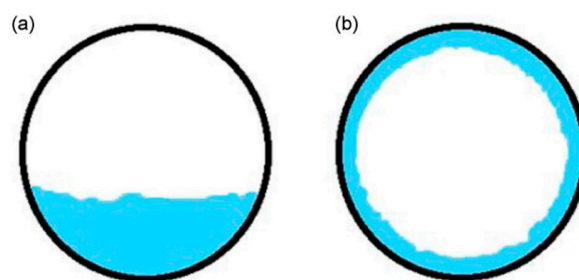

Figure 13. Fluid flow in (a) horizontal vs. (b) vertical heat exchangers [47].

As can be seen, in horizontal exchangers the fluid covers only half of the pipe circumference, while flowing, compared to a completely covered one in vertical flows. The surface area of contact is higher for the convective fluid in the case of vertical exchangers. To overcome this issue of orientation, a counter-flow concentric pipe arrangement in horizontal orientation can be a substitute, to increase the area of contact as shown in Figure 14.

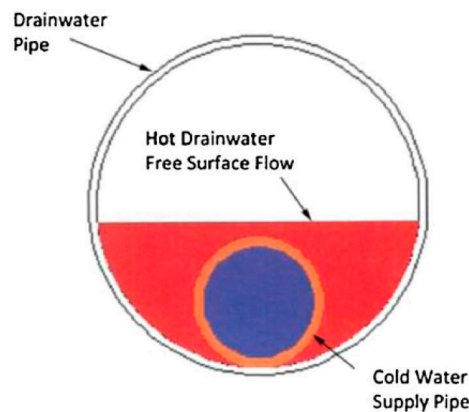

Figure 14. Proposed solution for horizontal HEs [47].

After testing this prototype, the efficiency was about 45%, which is still lower compared to vertical exchangers but higher than the horizontally installed ones. To further build on this theory the impact of tilting vertical falling film HEs to a maximum of 15° from the vertical was investigated [50]. As predicted the performance of the exchanger decreases when the angle of tilt increases. By tilting the angle by 2° there is a reduction of about 4% of the efficiency and as this angle increases the decrease in efficiency is quadratic instead of linear.

3.2.3. Location

In solo, HEs can be installed at building or at sewage levels (plate type). In hybrid combinations, it can either be a preheater or be on the last stage of heating. In sewage lines, it can be in-line or out-line with the assistance of additional pumps and filtration systems [41]. The precondition for an in-line installation, is that the sewer must have a diameter greater than 800 mm, a flowrate higher than 1800 L/min and the water must cover a surface of 0.8 m^2 on the bed of the line [37]. Either the HE is built into the sewage pipes or there is a plate exchanger on the bottom surface [51]. In the former case, this is implemented in new installations or with major infrastructure modifications. Usually out-line systems are present in hybrid with HPs to transport the heat over long distances. In out-line installations, the sewage water is pumped through an opening in the lower end of the pipe into a sieve filter, to block contaminants. It is then pumped to the intermediate circuit of a HE or directly to the evaporator of a HP. It is estimated that in Switzerland alone there are about 50 facilities using a combination of HEs, to harness sewage heat [12]. Three facilities in Zurich, all together have a capacity of about 5 MW, proving the sheer potential of this source. Similarly, a facility in Oslo is capable of heating an entire district within the city.

3.2.4. Anti-Fouling Mechanisms

Fouling is inevitable in HEs, especially in the long term with GW usage. However, it is more concerning in the evaporator of HPs, since in this case it also affects the performance of all the associated components. For this reason, it is mainly with regards to HPs, and is discussed in more detail in Section 3.3.

During the manufacturing of HEs, pipes can be dipped and baked in chemical coatings. Although this lowers the thermal conductivity, it can prevent corrosion and fouling. In solo HEs, the best passive mechanism for bio-film clean-up is regular cleaning and flushing of the pipes, with appropriate detergents. Usually auto-cleaning strainers or specific filters for larger biological impurities are recommended [36]. As the temperatures involved are not that high, the use of plastic HEs has also been investigated [36]. They reduce the investment costs and fouling to a certain level, however the durability is lower in the long term.

3.2.5. Operation Strategy

There are three options, for the connection of HEs at building level, as shown in Figure 15:

- preheated water can flow to both the storage and appliance—balanced condition
- preheated water flows only to the storage—unbalanced condition
- preheated water flows only to the appliance—balanced condition

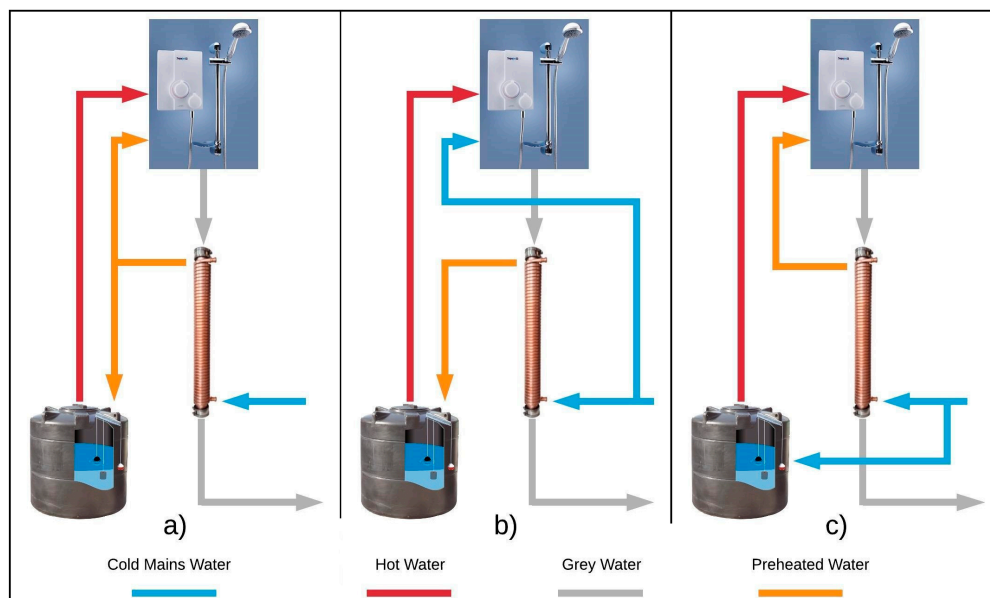

Figure 15. HE in (a) balanced flow with preheating (b) unbalanced flow (c) balanced flow without preheating [46].

Options (a) and (c) are both balanced, i.e., demand and supply flow rates are equal, but (a) has more flexibility. Both in terms of overall efficiency and financial incentives, option (a) is preferred [52]. Although balanced flow rate has the best possible results, but it is unlikely to occur in real conditions due to the transient nature of flows [18]. In balanced flow, the temperature gained by the mains water is equivalent to the temperature drop in the GW. In an unbalanced flow, the HE is used to preheat either the water in the storage tank or both appliance and tank. In this case the temperature drops are different, depending on the flow rates. Normally for balanced flow rates, the efficiency is greater than 50% while for unbalanced operation it is less [35].

In a study conducted on five different HEs with the GW having variable flowrates and temperatures, it was concluded that the flowrate was the most important criteria to determine the performance [25]. However, it was shown there is an optimum value for the flow rate in a drain pipe [10]. Every pipe has a Critical Flow Rate (CFR) below which the flow rate is proportional to efficiency. After this optimum value the efficiency decreases with increasing flow rate. The CFR for a drain exchanger depends on a number of factors related to its geometrical and metallurgical properties. As an estimate, the CFR is between 4–8 L/min for pipes having a diameter of 5–10 cm [53]. In a field study, it was concluded that it initially takes five minutes for a HE to warm up when operating within the CFR limit [25].

When considering flow rates in a HE, the associated pressure losses cannot be ignored, which are proportional to the square of the fluid velocity and length of the pipe. Based on the Darcy–Weisbach equation, they are inversely proportional to the diameter of the pipe [38]. In a simple falling film HEs, with a flow rate of 10 L/min, the pressure drop on the cold-water side can be in the range of 0.03–0.25 psi, per unit length [25].

A list of the different type of HEs, with details of commercial manufacturers and costs, is summarized in Table 3 [31,35,43].

In the most favourable conditions, the payback period for domestic HEs is around 2.5–5 years, depending on the usage criteria. However compared to the total cost of a building they cost less than 0.1%, hence the risk on investment is small [52].

3.3. Heat Pumps

Contrary to HEs, the purpose of HPs is to move heat opposite to the direction of natural flow i.e., from a low to a high temperature source. It does so with an external input of energy either in the form of electricity (vapor-compression cycle) or heat (absorption cycle). There are four main components of a HP: the evaporator, compressor, condenser and an expansion valve, installed in this order. The working fluid extracts heat from the evaporator, before being compressed and releasing the heat to the condenser, to be throttled back to the evaporator. The working fluid evaporates to gaseous phase, as it takes heat from the evaporator. Similarly, heat is lost when this pressurised gas condenses to a liquid phase in the condenser. The latent heat of these phase changes is high, making HPs capable of transferring large amounts of energy. It is important to note that the evaporator and condenser in a HP cycle are also HEs. Although HPs are a mature and developed technology, their association with GW is not that old. HPs can recover about 80–90% of the thermal energy from the GW [18].

The output of a HP can be used in many applications unlike HEs, where only water can be heated up, as HPs decouple demand and supply. A typical HP cycle for GW harnessing is presented in the Figure 16. Sometimes fan coils are used when the heated water from the condenser is used for space heating using air as the medium of heat extraction, e.g., floor heating.

Broadly speaking, most commercial HPs can also be distinguished by the following five characteristics.

3.3.1. Type

Depending on the cycle, there are two types:

Vapour-compression cycle: This is the more common version, with the input being only in the form of electrical energy. This energy is used to increase the pressure of the working fluid through a compressor. Usually centrifugal compressors are used for low evaporator pressures and refrigerants having large specific volumes while reciprocating compressors for the opposite. For flexible control of operation, a variable speed compressor, equipped with an electronic expansion valve is used, nowadays [6]. Usually an average compressor inputs 5–6 A of current at 220–240 V.

External heat/absorption cycle: In an absorption cycle, the pressure of the working fluid is increased by absorbing it into another medium and pumping it to a higher pressure. The electrical work input is lesser compared to the vapour-compression type, since a pump is used. To enable the working fluid to be absorbed into the absorption medium before being pumped, an external heat source is required. Hence both electrical and heat energy are required as inputs. In most cases, water is the absorbent and ammonia is the working fluid. COPs for absorption HPs are lower than for electrically powered ones [54].

Building regulations in most countries dictate that a COP of at least 2 must be achieved for vapour-compression HPs, supplying hot water to non-industrial buildings and 1 for absorption HPs [54].

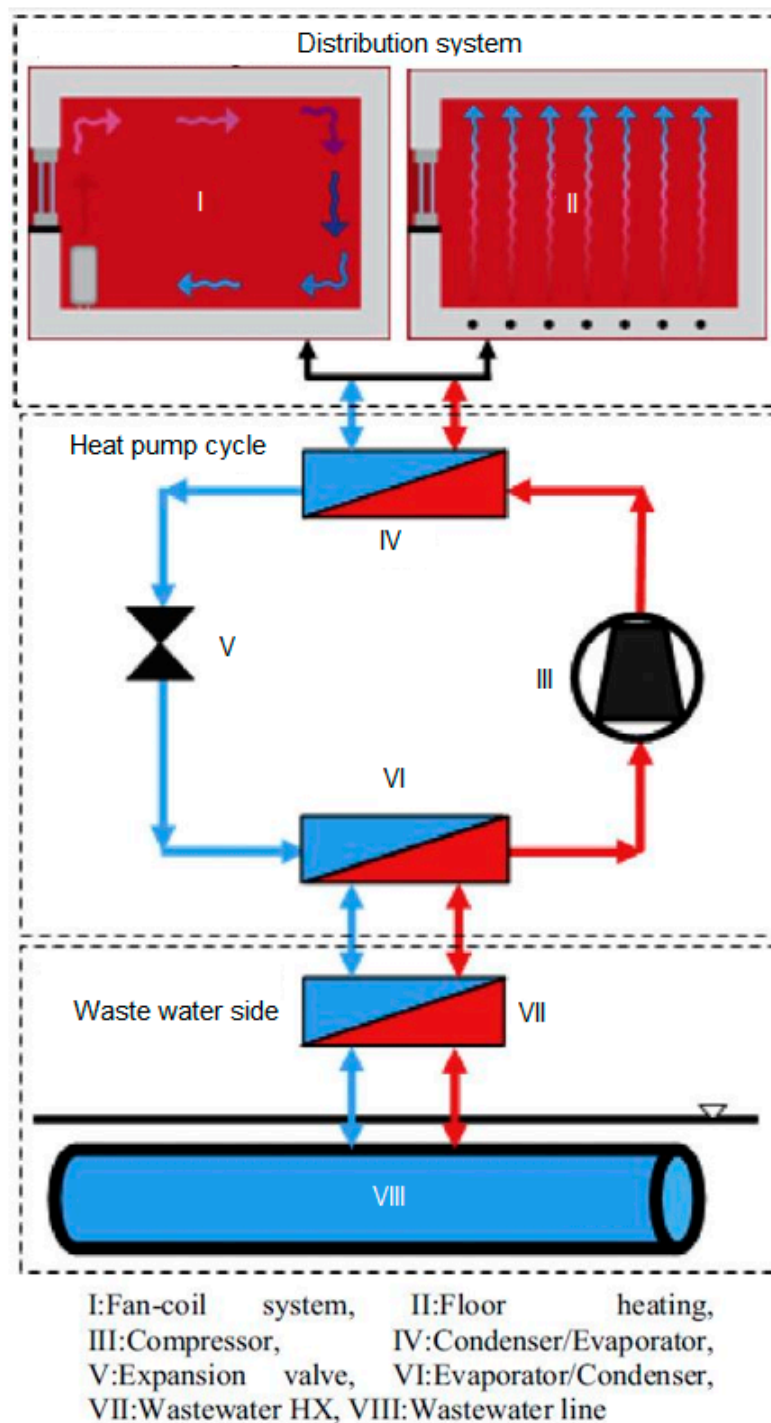

Figure 16. A typical HP to harness GW heat [36].

3.3.2. Type of Heat Exchangers for the Evaporator and Condenser

There are two main types, with regards to GWHPs; plate and shell-tube type [42]. Usually the evaporator is of the shell-tube type, while the condenser is of the plate type, since there are lesser impurities in the condenser end. Typically, a shell-tube type with the refrigerant in coils inserted into a GW storage/recovery tank is used [6]. Usually in large scale WWTPS, both evaporator and condenser are of the shell-tube type [36].

Fouling at the evaporator end is a major concern in GWHPs. The performance of a HP reduces by about 20% within 5 months of operation due to biofilm deposits, of a thickness of about 1 mm [32]. There are three major types of fouling; biological (biofilm deposits), corrosion and precipitation [32]. The mechanism for each type is dependent on various factors including the operating time, geometric structure, materials along with the hydrodynamic flow conditions. In a study, an electronic anti fouling mechanism was researched on [32]. However, this increases the energy input and deviates from the concept of passive technologies. Most large-scale evaporators have built-in de-fouling functions. In another study, rubber balls were circulated in the evaporator tubes, along with automatic brushes, after a fixed period of full load working [55]. A unique method, by using baffles consisting of rubber brushes having a manual screw on the outside of the exchanger, was experimentally analysed. Whenever deemed necessary they were rotated and positioned accordingly to clear up the biofilms. This passive method proved to be both economical and effective. Due to the scale of impurities at sewage level, it is estimated that the convective heat transfer coefficient of evaporators can be reduced by 40%, compared to HPs at building level [36].

As, explained with the operation of HEs in the last section, the supply from the condenser can either be direct making it dependent on demand, or independently requiring the output to be funnelled to a storage tank. In the first case, to provide a hot water output at a quick enough rate, the sizing of the HP increases substantially. However, in the second case the output hot water can be used for multiple purposes, not only for appliances.

3.3.3. Working Fluid

The working fluid/refrigerant, is selected based on the suitability of their phase change temperatures, heat transfer characteristics and other physical properties. The temperature at which the selected refrigerant evaporates should be lower than the target temperature in the evaporator, which in this case is about 10–60 °C, for all three levels of harnessing. Fluorinated hydrocarbons (HFCs) are now widely used, replacing chlorofluorocarbons (CFCs) [54]. The most applicable HFCs within this temperature range are R-134a, R-404a, R-407c and R-410a [54]. R-134a and R-410a, are the commonly used working fluids for non-industrial HPs [32]. In absorption HPs air, ammonia, carbon dioxide and water can be used, but with complicated systems and less desirable outputs [36].

3.3.4. Location of Installation

As mentioned, there are three possible levels, of integration of HPs to harness GW. The COP, considerably increases when the temperature lift is the least [6]. The temperature lift is the difference in temperature between the evaporator input and condenser output. When this lift is below 20 °C, the COP increases considerably, reaching up till 10. For this reason, the best desirable COP is achieved by harnessing at building level. At this level, the HP is linked in an off-line setup away from the drain line due to space constraints, unlike in-line HEs, with COPs in the range of 5–6 [18]. Usually the heating capacity of such small units are in the range of 0.8–10 KW [18]. As an example, a HP in a bathroom recovered 2400 kWh of heat with an electrical input to the compressor worth 410 kWh [6]. To recover more heat, cascaded combinations of more than one HP can be used. In another study, two cascaded serially linked HPs were used to recover heat from a commercial washing machine facility [56]. As per convention, the condensers are of the plate type and the incoming water is heated from 14 to 55 °C. The evaporators are of the shell-tube type, cooling the GW from 49 to 14 °C. The COP is always over 6, due to the operation strategy in which the mass flow rates of the output from the condenser (mains water) and input to the evaporator (GW) are balanced. The first HP has a higher temperature input using R134a, while the lower cascaded one has R407c. About 85% of the energy demand of this washing facility is met, using this serial combination.

When HPs, are used at the second level in sewage lines, the COP usually ranges from 1.77 to 10.63 [36]. Thermal ratings of most GWHPs used at this level, are in the range of 10–20,000 kW [36]. When designing a HP, in the sewage level, the predictability of the temperature flow along the pipe

line is important [12]. It is dependent on the flow condition, the geometric properties of the pipeline and the characteristics of the surrounding soil. For this reason, a mathematical model along with a location-flexible simulation was developed and validated based upon a field study in Switzerland. In a commercial application in Switzerland a shell & tube tank-HE was buried in a sewage pit external to a 100-bed hospital. This evaporator was part of a 30 kW HP operating at a COP of 3.8 [37].

Normally at WWTP, a hybrid combination of a HE-HP is used. However, in solo, more than a 100 HPs are operating in Scandinavia and Switzerland with ratings up to 70,000 kW. As an example, a large HP of this sort of 50 MW is operating in Lucerne, Switzerland. Similarly, a 9 kW HP with a COP between 2.5 to 3, was designed to transfer heat from the sludge in a sewage to be used at underground train stations in Glasgow [57]. Over 500 large scale HPs are operational worldwide, in sewage pipes and treatment plants [34] with thermal ratings from 10 kW to 50 MW [37].

3.3.5. Reversibility of Cycle

A considerable advantage of HPs is that it can additionally be operated in cooling mode (refrigeration cycle) by adding a reversible valve [31]. This is particularly advantageous in tropical countries or the Middle East where temperatures soar during the day, but are low in the night. The COP in cooling mode for HPs range from 2.23 to 5.35 [36].

Although the HP is considerably more efficient than HEs, nevertheless the operation is more complex, is not a passive technology and the performance is relatively more sensitive to the GW temperature and flow characteristics [32]. The major advantage is that since most HPs are linked to a thermal storage source, the applications in which the output heat can be used is manifold [52].

Some famous WWHP manufacturers are FrioTherm AG (Frauenfeld, Switzerland), TECSIR (Cancún, México), Nova Thermal Energy (Philadelphia, PA, USA), Viessmann (Allendorf, Germany), etc. The prices vary to a great deal and are dependent on the size, whether the components are sold separately or as a whole unit, the level of control of the HP and the performance. For building level applications, usually smaller units with dissociated components are available. For the next two levels, the units are sold as a whole, in a bulk casing.

3.4. Hybrid Systems

3.4.1. With Conventional and Renewable Technologies

In most circumstances the combination of a harnessing device with a conventional gas/electric boiler is, inevitable [33]. This is to enhance the reliability of operation and provide a backup especially for peak loads. Typically, most harnessing devices, act as pre-heaters while conventional heating mechanisms are used to heat the water to the required thermostat level. As an example, a HP in an experimental setup, with an output capacity of 24 kW was able to preheat the incoming cold water to 45 °C, in a student dorm in Germany [33]. A conventional gas boiler incremented it to the required 60 °C.

In other instances, the combination of a harnessing device with another renewable technology, is used. In a feasibility study using a GWHP with a backup Air Source Heat Pump (ASHP), was investigated, to fulfil the hot water and space heating demand [15]. This combination was used to maintain an indoor air temperature, within an apartment flat in New York. The COP of the unit was over 4, in all modes of operation, with total energy savings, of up to 34%.

The HP-HE-Solar thermal hybrid combination is the most famous, but has the highest capital investment. The most common type of solar thermal collectors are flat-plate types. Usually a dark plate absorber beneath a transparent cover is placed on the roof of buildings [58]. A fluid usually a mixture of water and an anti-freeze fluid, is circulated through these absorber plates to gain heat, which is then released to the primary heating circuit. The adjoining HP/HE work in the usual manner, with the only difference that the entire system has a relatively more complicated control system. Usually the HP/HE preheat the water before it flows to the solar thermal collectors and then to a gas/electric

boiler, if required [59]. This coupled system can reduce energy demands by 90%. The ecoMax by Eco Hybrid Solar (Stamford, CT, USA) is a commercially sold, domestic unit that integrates solar thermal energy with drain water heat recovery. As an example, a hybrid combination of a HE-HP with solar thermal collectors was used to heat the water of a public showering facility [59]. In this system, the solar collectors preheat the water followed by the HE and eventually the HP.

3.4.2. HE/HP Hybrids

This hybrid combination exists at all three levels of harnessing. Usually the HE is the preheater followed by a serially connected HP. At the building level, a small scale shower drain water hybrid system was installed and investigated [60]. In this analysis for a single-family house, the GW was used to preheat the cold water in a shell-tube HE, before finally acting as the heat input to the evaporator of a small HP. Initially the GW entered at a temperature of 32 °C, left the preheater at 27 °C and finally was discharged after the HP cycle at 15 °C. In this example, the temperature at which a shower was taken was 42 °C for an average time of 15 min, with a flow rate of 6 kg/min. These parameters were varied to carry out a sensitivity analyses. The capacity of this small scale, evaporator was 2.70 kW while the compressor input was about 0.60 kW, with a COP between 2.19 to 3.21. The output of this cascaded hybrid combination, for a three-person dwelling heated a 60 L tank of water. The results showed that about 60–70% of the fuel usage was saved. In a similar experiment [61], a regenerator and an evaporator was tested to recover shower heat. This study proved that such a domestic setup would have stable operation in any weather condition. According to the optimized results of this study, the condenser and evaporator temperatures of 11.68 °C and 51.5 °C respectively, gave a COP of 4.97.

As mentioned in the last section HE-HP hybrids at WWTP and sewage line levels, are more common than the solo use of these technologies. For operation at WWTPs, it is important to have appropriate control strategies to deal with the large-scale variations in the WW supply and heat demand. A notable offline pumped HE-HP system is present in Galashiels, Scotland. The system is placed off-line a 900-mm sewer line, with the first step being the diversion of the sewage water to this unit. Using a mechanical filtration system, the solids and liquids are separated. The liquid sewage is then, pumped to a series of cascaded HE and HP evaporators of 400 kW [62]. The harnessed energy is transferred to cold water, to be used on a college campus. The COP of these HPs are 4.8 providing 1.9 GWh of heat, on an annual basis.

4. Constraints and Shortcomings in Harnessing

Although a huge potential to harness GW exists, and most harnessing technologies are commercially available, the concept is yet to be mainstream. Three decisive factors, will influence the mass commercialization of GW harnessing systems [37]:

- (a) Prices compared to conventional fossil fuels
- (b) Harnessing size and possible linkage of supply with demand
- (c) Enhancing the heat density for better utilization

As mentioned the highest exergy content is at the building level. However, the following are the main concerns in harnessing GW at building level, especially with regards to HE and HP technologies (Table 4).

Table 4. Constraints of heat harnessing from GW.

S.No	Issues	Constraints Highlighted in the Study
1.	Biological impurities & fouling.	The GW has many biological impurities and detergents within it. When this water is in contact with a heat exchanging device, film deposits and fouling on the exchange surface are vulnerable. In the long term, this greatly effects the performance of the harnessing technology and requires higher efforts in maintenance. It is simply not worth it especially in small scale applications.
2.	Low pressure of incoming water streams.	The mains inflow cold water in the UK has typical pressures of about 1 bar with a minimum legal requirement of 0.7 bars. Transferring heat, to this, with flow restrictions in the exchanging surface, would lower the pressure, which is bearable to an extent. In the case of GW, the pressure is even lower with water flowing only due to the vertical pull of gravity, which makes the cushion for having pressure losses minimal. Unless additional pumps are used, which increases energy requirements and costs, going against the overall objective of passive heating mechanisms.
3.	High flow rates.	From the last two points, it is obvious that constrictions in the flow of GW, to extract the heat, are unacceptable. However, at the same time, the flowrate of this water is in the range of 6–15 L/min, depending on the application. This makes the extraction of heat difficult in a short amount of time without a fast heat transferring mechanism.
4.	Intermittent supply and demand patterns.	The flow of the GW is intermittent, with a high flow rate within a short interval of time. The usage pattern is also unpredictable depending on the user. This calls for a passive storage mechanism to decouple demand and supply with the need for a fast heat conducting mechanism.
5.	Space constraints.	Space is always a constraint especially in non-industrial setups. The installation space within appliances or even within the sewage system is limited. Heat can either be extracted at the exit of appliances or at the beginning of the main sewage pipe of a household. A compact, low cost, maintenance free extractor is required.
6.	Separation of GW and BW.	Usually in most buildings, there is a common stack without the separation of GW and BW. This limits the harnessing to be carried out before the GW enters the stack.

These constraints, point to the fact that there should be a better harnessing mechanism. It must have the ability to harness heat at reasonable rates and be a passive technology. Some characteristics of this proposed technology, at a building level, with regards to these constraints in conventional harnessing technologies, are as follows in Table 5.

Table 5. Conventional harnessing technologies vs. proposed technology.

Conventional Harnessing	Proposed Schema
Usually single-appliance based or single building based	Flexibility to be utilized with single appliances, single buildings or at a district level
Limited exergetic efficiencies	Higher heat extraction potential to enhance exergetic efficiency
Mechanical moving parts and high maintenance costs	Simple parts with higher reliability
Cost intensive	Mediocre costs reducing with research advancements in the future
Supply and demand coupled together since hot water must be produced when GW flows	Decoupled demand and supply, where the heat of the GW can be stored without the need to immediately transfer it
Limited demand side management and optimization techniques	Stored energy could be utilized by efficiently managing all resources since the constraint of time is removed
Heat recovery and heat storage done separately	Integrated heat recovery and storage in a single system
Usually only applicable to sensible heat storage on a small-scale level	Usage of high density latent heat storage, so heat could be transferred to any secondary source at any level making the versatility of usage applications larger
Only linked to a single building	Has the potential to be dynamically utilized on a large scale, with a smart controller Buildings could be utilized as a decentralized heat source on a district level conforming with the overall concept of smart energy grids
Must be custom designed based on application and topography	Applicable to a range of conditions only with minor changes

5. Potential Heat Harnessing Applications and Upcoming Technologies

Fluctuating fuel prices and environmental awareness is already promoting low carbon technologies as is required by the decisive factor (a) in the beginning of Section 4. As per factor (b), the possibility to harness waste heat at a district level at a considerable size is a way forward.

The decentralized use of this waste heat is a concept gaining popularity [33]. To be used at a district level, buildings must act as decentralized source and sink. At the same time, this heat must be extracted from main sewage lines of treatment plants, to supply the District Heating (DH) grid [42]. It is expected that in the future, heat would be transmitted by low temperature 4th generation DH grids [63]. These grids operate at comparatively lower temperatures of about 50 °C, with both centralized and decentralized sources. It is envisioned to be similar to a smart electricity grid with many promising pilot studies carried out in Scandinavia. Although household levels, might not be able to supply heat, commercial buildings and sewage harnessing can be a major source for this future grid. As an example, in Bern, 30 MW of heat can be harnessed, after GW has been cleansed in a treatment plant. 5 GWh of this recovered heat is used as a decentralized source of heat in a DH network [37]. Since the profiles of the buyers of this heat is different, additional heat stations to condition the heat are used. This system also provides chilled water in summer with the help of a reverse absorption heat pump cycle, as depicted in Figure 17.

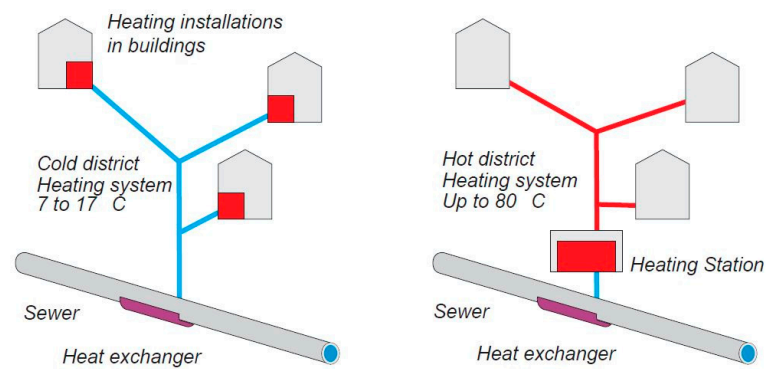

Figure 17. Harnessing system linked to a low temperature DH grid [37].

Non-industrial waste water heat is low grade with a low energy density. It is not sufficient to be utilized in a Rankine cycle or a work output cycle as illustrated by the exergy analysis in Section 2.3. According to the analysis, only thermal to thermal recovery is the best option to extract the energy. Nevertheless the concept of thermoelectric generators to directly convert thermal energy to electricity without any mechanical parts, is becoming quite famous [64]. These generators work on the Seebeck principle similar to PV cells.

Sensible heat storage (SHS) via HEs and HPs is a mature yet inefficient option nowadays. With recent developments in latent heat storage (LHS), Phase Change Materials (PCMs) are a promising technology having a much higher energy density. As per factor (c), of the decisive factors for mainstream integration of harnessing technologies, enhancing harnessing energy density is vital which is answered by LHS. The principle is the absorption or release of heat at a constant temperature, when a substance goes through a phase change. Normally a material absorbs heat to melt while releases heat to solidify. Although LHS materials are available in a range of phase types the most common are the solid-liquid types, due to the favourable conditions, including a relatively larger latent heat of fusion over a narrow temperature range, with a minimal change in volume [65]. The possibility of integrating heat harnessing and storage simultaneously, by using such medium is a novel approach. At the same time demand and supply could be decoupled opening the window to utilize this decentralized heat source in a wide range of applications.

LHS has been researched in numerous studies, especially in passive heating and cooling applications. However, there are a limited number of applications in the literature where PCMs were used to harness waste heat. Based on this literature, if PCMs can successfully be integrated into similar waste heat harnessing systems, they have a high potential to be successfully utilized with GW heat harnessing. The applications and characteristics of using PCMs to harness waste heat, in the literature are summarized in Table 6.

It is clear that although PCMs have been used in different waste heat recovery applications, they have been tested with GW, to a limited extent. Nevertheless, this shows that the potential exists.

Table 6. Latent thermal storage used in waste heat recovery applications.

Application	Reference	Overview	Results/Conclusions
Waste industrial heat at 500 K.	[66,67]	An experimental study was conducted to mimic the actual circumstances, on a large scale, where PCMs were used to recover and transfer latent heat from industrial waste at a temperature of over 500 K. Experiments were conducted for encapsulated PCMs and the packed bed configurations. The characteristics of six different PCMs were ranked according to different thermodynamic, chemical and economic considerations.	The metallic encapsulated design showed better transfer rates. While con-current flow compared with counter flow strategies provided better heat transfer rates.
Waste heat from a steel plant to a chemical plant.	[68]	In this theoretical study, the feasibility of using PCMs to transfer heat, at over 300 °C, from one industrial setup to another is analyzed. NaOH is used as the PCM, having a melting temperature of 320 °C. The feasibility analysis is done in terms of energy savings, exergy potential improvements, carbon emissions and economic aspects. Theoretically transferring 8.15 GJ of heat was analyzed, with different parameters and characteristics in comparison with conventional sensible storage heat mechanisms.	Compared to a sensible storage mechanism, about 2.76 times more energy is transferred. Comparatively this setup consumes only 8.6% of the energy, has 38% more exergy efficiency and 18% more carbon savings than a conventional system.
Recovering waste heat in dishwashers/washing machines.	[69,70]	In this experimental study, four different PCMs were used to preheat the cold water in a second cycle from the waste heat of the first cycle, in a washing machine and dishwashers. Thermal cycling was also investigated by testing the PCM in 1000 thermal cycles.	A temperature increase of 13.4 °C was achieved in the second cycle. The PCMs remained chemically stable with only a loss of 10% of the latent heat.
Simple PCM heat exchanger.	[71]	In this published patent, a coaxial heat exchanger with two cylindrical pipes is designed. The inner cylinder stores heat from a fluid to the PCM while the second cylinder contains the fluid, to which it must be transferred.	Although the heat exchanger can be used in a wide range of applications, the patent intends to use it for waste heat recovery applications.
Waste heat storage from cooking stoves.	[72]	This is a simulative study, in which a design is proposed for commercial stove tops to limit convective heat losses from the top. After storage of this otherwise wasted heat, the PCM can be discharged in other useful applications. The stove top is numerically analyzed to view the temperature and thermodynamic performance.	It is only feasible to use this stove top in commercial applications, since efficiencies are too low in domestic conditions.
Exhaust heat from an air-conditioning unit.	[73–76]	In this study, a PCM is used to capture the waste heat ejected from the condenser of an air conditioning unit and heat incoming cold water. Analysis is focused on using the finned tube heat exchanger to capture the waste heat, with different variations. An experimental test rig, with the different configurations investigates this phenomenon.	Results show that a Spiral Finned Double Tube exchanger in vertical position is best suited for this application. The PCM also has graphite embedded in it to enhance conductivity. COP of the air conditioner was enhanced as well.

Table 6. Cont.

Application	Reference	Overview	Results/Conclusions
Waste heat recovery from engine exhaust.	[77–79]	About 30% of the heat of combustion leaves a diesel engine via the exhaust. In this experimental study, a PCM heat exchanger integrated with a storage tank is used to extract this heat, with different loading conditions. A similar analysis is done for normal IC engines varying the parameters and conditions, in experimental and numerical studies.	About 10–15% of the heat of combustion is recovered, which is about 7% of the fuel energy, corresponding to about 86.45 kg/KJ of energy. Results show that the flow rate of the exhaust gas is a bottleneck yet to be addressed effectively.
Automobile coolant waste heat recovery.	[80]	In this experimental study, two important criteria; the heat transfer rate and time required to store energy from an engine coolant to a fin and tube heat exchanger filled with a PCM was analyzed. The recovered heat by this PCM, could be used to heat the engine during start-up. A PCM with a melting temperature of about 100 °C was selected.	The warm-up time of an engine was decreased by 34% using 4.2 kg of PCM by extracting heat from approximately 5.5 L of coolant.
Waste heat from a fuel cell.	[81]	A PCM was experimentally tested and analyzed for use in this application to harness waste heat from a fuel cell, normally between 60–100 °C. The addition of additives is also analyzed to enhance the thermal and chemical properties of the PCM. The effects of 1000 cycles on the long-term stability was also analyzed.	Magnesium nitrate Hexahydrate was analyzed for this specific application with several additives. Such additives, made the PCM extremely suitable to the application having all the desired properties.
Waste heat recovery from industrial air compressors.	[82]	The performance of a small-scale plate heat exchanging evaporator (2–5 kW) to recover waste heat from a compressor, using an organic PCM was experimentally tested. Using a numerical method, multiple conditions were simulated and analyzed for this specific application. The PCM is part of an organic Rankine cycle to eventually convert this heat to electrical energy.	Although it is feasible, proper control strategies varying with external conditions must be ensured, for smooth operation due to the unstable thermodynamics of the PCM.
Improving efficiency in household refrigerators.	[83]	A PCM slab is experimentally added on the outside surface of the evaporator of a common household refrigerator. The theory is that the PCM is capable of extracting the waste heat from the refrigerator and sharing the load with the evaporator. At times of low peak this energy is released back from the PCM, hence ensuring that the loads and performance of the refrigeration cycle are more or less consistent.	Such enhancement techniques by the addition of a PCM, enhances the heat transfer rate allowing a higher evaporating temperature. An increase in 5–15% of the COP is witnessed.

6. Conclusions

GW heat harnessing is gaining importance to ensure future buildings consume minimal energy and are efficient. Production data in terms of heat extraction is scarce and is normally sourced in field studies or using computer based algorithms. In residential buildings, showers consume most of the GW in terms of volume while dishwashers consume the most in terms of higher temperatures. The production patterns of commercial buildings are more consistent and are at a larger scale. Hence the potential exists in both building types with a greater outlook in commercial buildings.

Heat exchangers, heat pumps and hybrid combinations of both are the only commercially mature GW harnessing technologies. There are many variations in both types to be suited for a specific application. The energy efficiencies of these devices are normally over 50%, and their hybrid combinations with solar thermal energy, ensure more usage of renewable sources in the hot water energy mix of a building.

Although the potential, concept and motivation exist, GW recovery systems are yet to be a component of every non-industrial building. The economic competitiveness compared to the low oil and gas prices, the mismatching in demand and supply, the low efficiencies and most of all the technical constraints, has limited the expansion of this concept over the past few years.

However, with recent trends of fluctuating energy prices, new harnessing concepts with better efficiencies including LHS, a higher awareness on energy efficiency, the resolve to minimize carbon emissions, enhanced legal and commercial building practices, and with improved technicalities, it is clear that at all levels of sewage flow GW heat harnessing will become mainstream.

Author Contributions: For this review article Shuli Liu conceived the importance of waste heat recovery and formulated the overall structure of the research work. She also contributed substantially in discussion and critical analysis on the findings. Abdur Rehman Mazhar contributed on detailed literature review, formulation of various tables and graphs. Ashish Shukla contributed towards analyzing different heat harnessing technologies and on formulating the findings from the current study.

Conflicts of Interest: The authors declare no conflict of interest.

Abbreviations

GW	Grey water
BW	Black water
DC	Direct Current
AC	Alternating Current
min	Minutes
CO ₂	Carbon Dioxide
HE	Heat Exchanger
HP	Heat Pump
WWTP	Waste Water Treatment Plant
MW	Mega Watts
GFX	Gravity Film Exchangers
CFR	Critical Flow Rate
HFC	Fluorinated hydrocarbon
CFC	Chlorofluorocarbon
COP	Coefficient of Performance
WW	Waste Water
ASHP	Air Source Heat Pump
DH	District Heating
LHS	Latent Heat Storage
SHS	Sensible Heat Storage
PCM	Phase Change Material

References

1. International Energy Agency. *Technology Roadmap: Energy Efficient Buildings, Heating and Cooling Equipment*; International Energy Agency: Paris, France, 2011.
2. International Energy Agency. Tracking Clean Energy Progress 2016. In *Energy Technology Perspectives 2016*; International Energy Agency: Paris, France, 2016; pp. 1–82.
3. Christoff, P. The promissory note: COP 21 and the Paris Climate Agreement. *Environ. Politics* **2016**, *25*, 765–787. [[CrossRef](#)]

4. Schnieders, J.; Feist, W.; Rongen, L. Passive Houses for different climate zones. *Energy Build.* **2015**, *105*, 71–87. [[CrossRef](#)]
5. Stephan, A.; Crawford, R.H.; de Myttenaere, K. A comprehensive assessment of the life cycle energy demand of passive houses. *Appl. Energy* **2013**, *112*, 23–34. [[CrossRef](#)]
6. Meggers, F.; Leibundgut, H. The potential of wastewater heat and exergy: Decentralized high-temperature recovery with a heat pump. *Energy Build.* **2011**, *43*, 879–886. [[CrossRef](#)]
7. International Energy Agency. *Renewable Energy: RD & D Priorities*; International Energy Agency: Paris, France, 2006; p. 221.
8. Vatansever, D.; Siores, E.; Shah, T. Alternative Resources for Renewable Energy: Piezoelectric and Photovoltaic Smart Structures. *Glob. Warm. Impacts Future Perspect.* **2012**, 263–290. [[CrossRef](#)]
9. Yeatman, E.M. Energy harvesting—Small scale energy production from ambient sources. In Proceedings of the SPIE 7288, Active Passive Smart Structures and Integrated Systems, San Diego, CA, USA, 9–12 March 2009. [[CrossRef](#)]
10. Gill, Z.M.; Tierney, M.J.; Pegg, I.M.; Allan, N. Measured energy and water performance of an aspiring low energy/carbon affordable housing site in the UK. *Energy Build.* **2011**, *43*, 117–125. [[CrossRef](#)]
11. Wheatley, A.D.; Surendran, S. Greywater treatment and reuse results from a 50-person trial. *Urban Water J.* **2008**, *5*, 187–194. [[CrossRef](#)]
12. Dürrenmatt, D.J.; Wanner, O. A mathematical model to predict the effect of heat recovery on the wastewater temperature in sewers. *Water Res.* **2014**, *48*, 548–558. [[CrossRef](#)] [[PubMed](#)]
13. Energy Saving Trust. *At Home with Water*; Technical Report; Energy Saving Trust: London, UK, 2013.
14. Energy Savings Trust. *Measurement of Domestic Hot Water Consumption in Dwellings*; Technical Report; Energy Saving Trust: London, UK, 2008; pp. 1–62.
15. Ni, L.; Lau, S.K.; Li, H.; Zhang, T.; Stansbury, J.S.; Shi, J.; Neal, J. Feasibility study of a localized residential grey water energy-recovery system. *Appl. Therm. Eng.* **2012**, *39*, 53–62. [[CrossRef](#)]
16. Nolde, E. Water and energy recycling at a residential passive house. In Proceedings of the Poster Sustainable Building Conference, Graz, Austria, 25–28 September 2013; pp. 1353–1360.
17. Cautley, D. *Drain Water Heat Recovery—A Field Study of Commercial Applications*; ECW Report Number 272-1; Energy Center of Wisconsin: Madison, WI, USA, 2013.
18. Wallin, J.; Claesson, J. Analyzing the efficiency of a heat pump assisted drain water heat recovery system that uses a vertical inline heat exchanger. *Sustain. Energy Technol. Assess.* **2013**, *80*, 7–16. [[CrossRef](#)]
19. Al-Jayyousi, O.R. Greywater reuse: Towards sustainable water management. *Desalination* **2003**, *156*, 181–192. [[CrossRef](#)]
20. Allen, L.; Christian-smith, J.; Palaniappan, M. *Overview of Greywater Reuse: The Potential of Greywater Systems to Aid Sustainable Water Management*; Pacific Institute for Studies in Development, Environment & Security: Oakland, CA, USA, 2010.
21. Association of Plumbing & Heating Contractors Ltd. Sanitary Systems within the Home. Available online: <http://www.aphc.co.uk/UNDERSTANDING%20SANITARY%20SYSTEMS%20WITHN%20THE%20HOME.pdf> (accessed on 6 September 2017).
22. Alsulaili, A.D.; Hamoda, M.F. Quantification and characterization of greywater from schools. *Water Sci. Technol.* **2015**, *72*, 1973–1980. [[CrossRef](#)] [[PubMed](#)]
23. HM Government. *The Buildings Regulation: Drainage and Waste Disposal*; RIBA Enterprises Ltd.: Newcastle Upon Tyre, UK, 2015.
24. National Measurement System. An Introduction to Non-Invasive Ultrasonic. Available online: http://www.tuvnel.com/_x90lbm/An_Introduction_to_Non-Invasive_Ultrasonic_Flow_Metering.pdf (accessed on 6 September 2017).
25. Zaloum, C.; Lafrance, M. *Drain Water Heat Recovery Characterization and Modeling*; Sustainable Buildings and Communities, Natural Resource Canada: Ottawa, ON, Canada, 2007; pp. 1–42.
26. Wallin, J.; Claesson, J. Investigating the efficiency of a vertical inline drain water heat recovery heat exchanger in a system boosted with a heat pump. *Energy Build.* **2014**, *80*, 7–16. [[CrossRef](#)]
27. Corona-Nakamura, M.A.; Ruelas, R.; Ojeda-Magana, B.; Finch, D.W.C. Identification of domestic water consumption in a house based on fuzzy clustering algorithms. In Proceedings of the 2009 IEEE International Conference on Systems, Man and Cybernetics, San Antonio, TX, USA, 11–14 October 2009; pp. 3751–3756. [[CrossRef](#)]

28. Zaloum, C.; Gusdorf, J.; Parekh, A. *Performance Evaluation of Drain Water Heat Recovery Technology at the Canadian Centre for Housing Technology*; Sustainable Buildings and Communities, Natural Resource Canada: Ottawa, ON, Canada, 2007.
29. Eslami-Nejad, P.; Bernier, M. Impact of Grey Water heat recovery on the electrical demand of domestic hot water heaters. In Proceedings of the Eleventh International IBPSA Conference, Glasgow, UK, 27–30 July 2009; pp. 681–687.
30. Boyjoo, Y.; Pareek, V.K.; Ang, M. A review of greywater characteristics and treatment processes. *Water Sci. Technol.* **2013**, *67*, 1403–1424. [[CrossRef](#)] [[PubMed](#)]
31. Vavrin, J.L. *A Quantitative Study of the Viability of Greywater Heat Recovery (GWHR)*; Defense Technical Information Center: Belvoir Fort, VA, USA, 2011.
32. Shen, C.; Jiang, Y.; Yao, Y.; Deng, S.; Wang, X. A field study of a wastewater source heat pump for domestic hot water heating. *Build. Serv. Eng. Res. Technol.* **2013**, *34*, 433–448. [[CrossRef](#)]
33. Seybold, C.; Brunk, M.F. In-house waste water heat recovery. *REHVA J.* **2013**, *6*, 18–21.
34. Alnahhal, S.; Spremberg, E. Contribution to Exemplary In-House Wastewater Heat Recovery in Berlin, Germany. *Procedia CIRP* **2016**, *40*, 35–40. [[CrossRef](#)]
35. Dieckmann, J.; Cooperman, A.; Brodrick, J. Drain Water Heat Recovery. *ASHRAE J.* **2011**, *53*, 58–64.
36. Hepbasli, A.; Biyik, E.; Ekren, O.; Gunerhan, H.; Araz, M. A key review of wastewater source heat pump (WWSHP) systems. *Energy Convers. Manag.* **2014**, *88*, 700–722. [[CrossRef](#)]
37. Schmid, F. Sewage water: Interesting heat source for heat pumps and chillers. In Proceedings of the 9th International IEA Heat Pump Conference, Zürich, Switzerland, 20–22 May 2008.
38. Moran, M. *Engineering Thermodynamics*; CRC Press: Boca Raton, FL, USA, 1998.
39. Energy Saving Trust. *Domestic Heating by Oil: Boiler Systems—Guidance for Installers and Specifiers*; Technical Report; Energy Saving Trust: London, UK, 2008; p. 64.
40. Neugebauer, G.; Kretschmer, F.; Kollmann, R.; Narodoslowsky, M.; Ertl, T.; Stoeglehner, G. Mapping Thermal Energy Resource Potentials from Wastewater Treatment Plants. *Sustainability* **2015**, *7*, 12988–13010. [[CrossRef](#)]
41. Kordana, S. SWOT analysis of wastewater heat recovery systems application. In Proceedings of the 9th Conference on Interdisciplinary Problems in Environmental Protection and Engineering EKO-DOK, Boguszow-Gorce, Poland, 23–25 April 2017.
42. Cipolla, S.S.; Maglionico, M. Heat recovery from urban wastewater: Analysis of the variability of flow rate and temperature in the sewer of Bologna, Italy. *Energy Procedia* **2014**, *45*, 288–297. [[CrossRef](#)]
43. Kimmels, A. Shower Heat Recovery Systems. Meander Heat Recovery. Available online: http://www.meanderhr.com/report/meanderhr_com_shower_dwhr_overview.pdf (accessed on 15 September 2017).
44. Wavin. *Showersave Product & Installation Guide*; Wavin: Zwolle, The Netherlands, 2009.
45. Schuitema, R.; Sijphee, N.C.; Bakker, E.J. Energy performance of a drainwater heat recovery system Experimental results of drainwater heat recovery in 2005. In Proceedings of the European Conference and Cooperation Exchange on Sustainable Energy Systems 2005, Vienna, Austria, 5–8 October 2005.
46. Timea, G.; Rusu, T.; Dan, V. Technological Variations for Domestic Waste Water Heat Recovery. *ProEnvironment* **2010**, *3*, 313–317.
47. McNabola, A.; Shields, K. Efficient drain water heat recovery in horizontal domestic shower drains. *Energy Build.* **2013**, *59*, 44–49. [[CrossRef](#)]
48. Collins, M.; Van Decker, G.; Murray, J. Characteristic Effectiveness Curves for Falling Film Drain Water Heat Recovery Systems. *HVAC&R Res.* **2013**, *19*, 649–662. [[CrossRef](#)]
49. Manouchehri, R.; Banister, C.J.; Collins, M.R. Impact of small tilt angles on the performance of falling film drain water heat recovery systems. *Energy Build.* **2015**, *102*, 181–186. [[CrossRef](#)]
50. Lee, J.; Lee, D.; Yang, C.; Chen, C.; Ting, C. Developing the footplate for shower drain water heat recovery. *Am. J. Sci. Technol.* **2014**, *1*, 89–94.
51. Todoran, R. Modern Management Methods for Managing the Waste. *Managing* **2010**, *12*, 11–13.
52. Słyś, D.; Kordana, S. Financial Analysis of the Implementation of a Drain Water Heat Recovery Unit in Residential Housing. *Energy Build.* **2014**, *71*, 1–11. [[CrossRef](#)]
53. Beentjes, I.; Manouchehri, R.; Collins, M.R. An investigation of drain-side wetting on the performance of falling film drain water heat recovery systems. *Energy Build.* **2014**, *82*, 660–667. [[CrossRef](#)]
54. Goth, J. Heat Pumps. Available online: <https://www.energyinst.org/filegrab/?ref=3121&f=EI%2FEI+9.6> (accessed on 6 September 2017).

55. Chao, S.; Yiqiang, J.; Yang, Y.; Shiming, D. Experimental performance evaluation of a novel dry-expansion evaporator with defouling function in a wastewater source heat pump. *Appl. Energy* **2012**, *95*, 202–209. [CrossRef]
56. Nyers, J. COP and Economic Analysis of the Heat Recovery from Waste Water Using Heat Pumps. *Acta Polytech. Hung.* **2016**, *13*, 135–154.
57. Hytiris, N.; Ninikas, K.; Emmanuel, R.; Aaen, B.; Younger, P. Heat Energy Recovery from Waste Water in the Glasgow Subway System. *Procedia Eng.* **2016**, *165*, 394–403. [CrossRef]
58. Tanha, K.; Fung, A.S.; Leong, W.H. Investigating the performance of two types of Solar Domestic Water Heating (SDWH) systems with drain water heat recovery through computer simulation and experimental analysis. *ASHRAE Trans.* **2012**, *118*, 214–221.
59. Liu, L.; Fu, L.; Jiang, Y. Application of an exhaust heat recovery system for domestic hot water. *Energy* **2010**, *35*, 1476–1481. [CrossRef]
60. Dong, J.; Zhang, Z.; Yao, Y.; Jiang, Y.; Lei, B. Experimental performance evaluation of a novel heat pump water heater assisted with shower drain water. *Appl. Energy* **2015**, *154*, 842–850. [CrossRef]
61. Chen, W.; Liang, S.; Guo, Y.; Cheng, K.; Gui, X.; Tang, D. Investigation on the thermal performance and optimization of a heat pump water heater assisted by shower waste water. *Energy Build.* **2013**, *64*, 172–181. [CrossRef]
62. Dunsmore, I. Heat from Wastewater. Available online: http://www.waterprojectsonline.com/case_studies/2016/Scottish_SHARC_2016.pdf (accessed on 15 September 2017).
63. Lund, H.; Werner, S.; Wiltshire, R.; Svendsen, S.; Thorsen, J.E.; Hvelplund, F.; Mathiesen, B.V. 4th Generation District Heating (4GDH): Integrating smart thermal grids into future sustainable energy systems. *Energy* **2014**, *68*, 1–11. [CrossRef]
64. Baradey, Y.; Hawlader, M.N.A.; Ismail, A.F. Waste Heat Recovery in Heat Pump Systems: Solution to Reduce Global Warming. *Eng. J.* **2015**, *16*, 31–42.
65. Sharma, A.; Tyagi, V.V.; Chen, C.R.; Buddhi, D. Review on thermal energy storage with phase change materials and applications. *Renew. Sustain. Energy Rev.* **2009**, *13*, 318–345. [CrossRef]
66. Yagi, J.; Akiyama, T. Storage of thermal energy for effective use of waste heat from industries. *J. Mater. Process. Technol.* **1995**, *48*, 793–804. [CrossRef]
67. López-Sabirón, A.M.; Royo, P.; Ferreira, V.J.; Aranda-Usón, A.; Ferreira, G. Carbon footprint of a thermal energy storage system using phase change materials for industrial energy recovery to reduce the fossil fuel consumption. *Appl. Energy* **2014**, *135*, 616–624. [CrossRef]
68. Nomura, T.; Okinaka, N.; Akiyama, T. Waste heat transportation system, using phase change material (PCM) from steelworks to chemical plant. *Resour. Conserv. Recycl.* **2010**, *54*, 1000–1006. [CrossRef]
69. Beyhan, B.; Ahan, N.Ş.; Paksoy, H.Ö. *Phase Change Material Applications for Domestic Appliances*; Çukurova University Turkey: Adana, Turkey, 2008.
70. Paksoy, H.; Yilmaz, S.; Ozgul, G.; Yilmaz, M.Ö.; Mazma, H.E. *Thermal Energy Storage for More Efficient Domestic Appliances*; World Energy Council: London, UK, 2007.
71. Robert, L.; Longardner, W.J.L. Phase Change Heat Exchanger. U.S. Patent 5220954 A, 22 June 1993.
72. Devaraj, P.; Vishnu, S. *Waste Heat Storage Using PCM*; Thiagarajar College of Engineering: Madurai, India, 2012; pp. 35–38.
73. Alhamdo, M.H.; Theeb, M.A.; Golam, A.S. Finned double-tube PCM system as a waste heat storage. *IOP Conf. Ser. Mater. Sci. Eng.* **2015**, *95*, 12033. [CrossRef]
74. Al-Abidi, A.A.; Bin Mat, S.; Sopian, K.; Sulaiman, M.Y.; Lim, C.H.; Th, A. Review of thermal energy storage for air conditioning systems. *Renew. Sustain. Energy Rev.* **2012**, *16*, 5802–5819. [CrossRef]
75. Gu, Z.; Liu, H.; Li, Y. Thermal energy recovery of air conditioning system—Heat recovery system calculation and phase change materials development. *Appl. Therm. Eng.* **2004**, *24*, 2511–2526. [CrossRef]
76. Zhang, X.; Yu, S.; Yu, M.; Lin, Y. Experimental research on condensing heat recovery using phase change material. *Appl. Therm. Eng.* **2011**, *31*, 3736–3740. [CrossRef]
77. Prabu, S.S.; Asokan, M.A. A study of waste heat recovery from diesel engine exhaust using phase change material. *Int. J. Chem. Tech. Res.* **2015**, *8*, 711–717.
78. Kiran, C.S.; Reddy, R.M. Experimental Analysis of a Thermal Energy Storage System-Waste Heat Recovery. *Int. J. Innov. Res. Sci. Eng. Technol.* **2015**, *4*, 7768–7774. [CrossRef]

79. Altstedde, M.K.; Rinderknecht, F.; Friedrich, H. Integrating Phase-Change Materials into Automotive Thermoelectric Generators. *J. Electron. Mater.* **2014**, *43*, 2134–2141. [[CrossRef](#)]
80. Shon, J.; Kim, H.; Lee, K. Improved heat storage rate for an automobile coolant waste heat recovery system using phase-change material in a fin-tube heat exchanger. *Appl. Energy* **2014**, *113*, 680–689. [[CrossRef](#)]
81. Nagano, K.; Ogawa, K.; Mochida, T.; Hayashi, K.; Ogoshi, H. Thermal characteristics of magnesium nitrate hexahydrate and magnesium chloride hexahydrate mixture as a phase change material for effective utilization of urban waste heat. *Appl. Therm. Eng.* **2004**, *24*, 221–232. [[CrossRef](#)]
82. Cipollone, R.; Bianchi, G.; Battista, D.D. Experimental and numerical analyses on a plate heat exchanger with phase change for waste heat recovery at off-design conditions. *J Phys. Conf. Ser.* **2015**, 12038. [[CrossRef](#)]
83. Azzouz, K.; Leducq, D.; Gobin, D. Performance enhancement of a household refrigerator by addition of latent heat storage. *Int. J. Refrig.* **2008**, *31*, 892–901. [[CrossRef](#)]



© 2018 by the authors. Licensee MDPI, Basel, Switzerland. This article is an open access article distributed under the terms and conditions of the Creative Commons Attribution (CC BY) license (<http://creativecommons.org/licenses/by/4.0/>).